

# AGARD

ADVISORY GROUP FOR AEROSPACE RESEARCH & DEVELOPMENT  
7 RUE ANCELLE, 92200 NEUILLY-SUR-SEINE, FRANCE

---

AGARD ADVISORY REPORT 349

## Flight Vehicle Integration Panel Working Group 21 on Glass Cockpit Operational Effectiveness (l'Efficacité opérationnelle du poste de pilotage en verre)

*This Advisory Report has been prepared at the request of the Flight Vehicle  
Integration Panel of AGARD.*

19960715 020

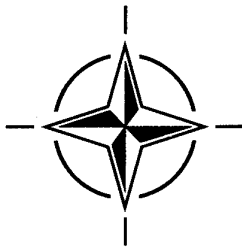

**NORTH ATLANTIC TREATY ORGANIZATION**

**DISTRIBUTION STATEMENT A**

Approved for public release;  
Distribution Unlimited

Published April 1996

*Distribution and Availability on Back Cover*

DTIC QUALITY INSPECTED A

# DISCLAIMER NOTICE

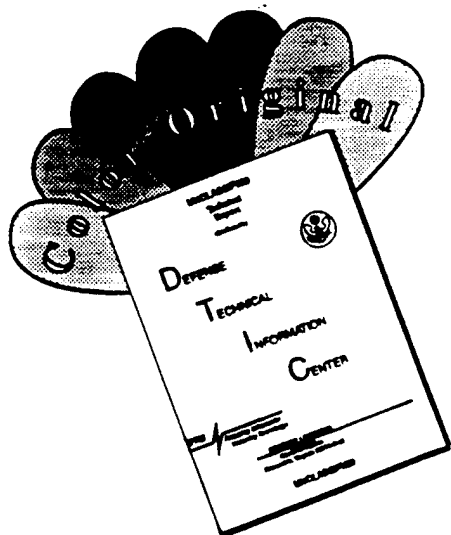

THIS DOCUMENT IS BEST QUALITY AVAILABLE. THE COPY FURNISHED TO DTIC CONTAINED A SIGNIFICANT NUMBER OF COLOR PAGES WHICH DO NOT REPRODUCE LEGIBLY ON BLACK AND WHITE MICROFICHE.

# AGARD

ADVISORY GROUP FOR AEROSPACE RESEARCH & DEVELOPMENT

7 RUE ANCELLE, 92200 NEUILLY-SUR-SEINE, FRANCE

---

**AGARD ADVISORY REPORT 349**

## **Flight Vehicle Integration Panel Working Group 21 on Glass Cockpit Operational Effectiveness**

(l'Efficacité opérationnelle du poste de pilotage en verre)

This Advisory Report has been prepared at the request of the Flight Vehicle Integration Panel of AGARD.

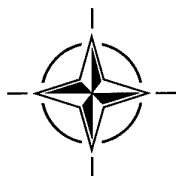

North Atlantic Treaty Organization  
*Organisation du Traité de l'Atlantique Nord*

---

DTIC QUALITY INSPECTED 1

# The Mission of AGARD

According to its Charter, the mission of AGARD is to bring together the leading personalities of the NATO nations in the fields of science and technology relating to aerospace for the following purposes:

- Recommending effective ways for the member nations to use their research and development capabilities for the common benefit of the NATO community;
- Providing scientific and technical advice and assistance to the Military Committee in the field of aerospace research and development (with particular regard to its military application);
- Continuously stimulating advances in the aerospace sciences relevant to strengthening the common defence posture;
- Improving the co-operation among member nations in aerospace research and development;
- Exchange of scientific and technical information;
- Providing assistance to member nations for the purpose of increasing their scientific and technical potential;
- Rendering scientific and technical assistance, as requested, to other NATO bodies and to member nations in connection with research and development problems in the aerospace field.

The highest authority within AGARD is the National Delegates Board consisting of officially appointed senior representatives from each member nation. The mission of AGARD is carried out through the Panels which are composed of experts appointed by the National Delegates, the Consultant and Exchange Programme and the Aerospace Applications Studies Programme. The results of AGARD work are reported to the member nations and the NATO Authorities through the AGARD series of publications of which this is one.

Participation in AGARD activities is by invitation only and is normally limited to citizens of the NATO nations.

The content of this publication has been reproduced  
directly from material supplied by AGARD or the authors.

Published April 1996

Copyright © AGARD 1996  
All Rights Reserved

ISBN 92-836-1034-2



*Printed by Canada Communication Group  
45 Sacré-Cœur Blvd., Hull (Québec), Canada K1A 0S7*

# Flight Vehicle Integration Panel Working Group 21 on Glass Cockpit Operational Effectiveness

(AGARD AR-349)

## Executive Summary

AGARD Flight Mechanics Working Group 21 was formed in April 1993 to address the topic of The Operational Effectiveness of Glass Cockpits. The working group represented the UK, US, Germany, The Netherlands, France, Italy and Canada, drawing its expertise from specialists in cockpit design, research and technology, human factors, flight operations and aircraft development. Initial discussions on this topic concluded that the objective for the working group could be best stated as:

*To summarize the status of current cockpits, highlight their benefits and weaknesses, and provide guidance for future cockpit design.*

The starting point to meet this objective was to gather data on a wide range of current cockpits spanning the last 25 years which covered the transition from traditional cockpits which were heavily dependant upon dedicated controls and displays to current cockpits using state-of-the-art glass technologies. In seeking to identify the strengths and weaknesses of these cockpit designs it became apparent that a general appraisal of the technologies employed in the cockpit would be a more constructive approach than a detailed critique of individual aircraft.

With a total of 19 cockpits representing fighter aircraft, helicopters and civil transports reviewed, and a position paper on each generated, the working group then focussed its attention on the single seat military fighter cockpit as being the greatest challenge for the cockpit designer. The missions for these aircraft were summarized to put the pilot's tasks in proper context. A detailed study of the technologies employed in the cockpit was then carried out to identify common practices, analyze their effectiveness and to highlight any unique capabilities.

It was observed that while the introduction of new cockpit technologies did realize increased mission effectiveness, greater mission demands also drove the aircrew to the limit of their performance. Hence the human factors issues of matching technological capability with that of the human in the context of the operational environment became an essential element of the group's deliberations.

With this in mind, the apparent mismatch between the technology and the operator led to an analysis of the process whereby cockpits were designed and developed. A starting point of the design process was identified as the mission requirements, which prompted a review of generic missions and their task decomposition. It was considered that stretching mission requirements and new cockpit technologies was likely to have a significant impact on training the human for this demanding role.

Given the above, an analysis of the strengths and weaknesses in current approaches enabled the group to anticipate future technology development, and to make recommendations for its adoption, by hypothesising on three generic cockpit solutions for the years 2000, 2010 and 2025.

# L'Efficacité opérationnelle du poste de pilotage en verre (AGARD AR-349)

## Synthèse

Le groupe de travail n° 21 du Panel AGARD FMP a été créé en 1993 pour examiner le sujet de l'efficacité opérationnelle des postes de pilotage en verre. Le groupe de travail était composé de représentants du Royaume-Uni, des Etats-Unis, de l'Allemagne, des Pays-Bas, de la France, de l'Italie et du Canada, spécialistes en conception de postes de pilotage, en recherche et développement, en facteurs humains, en opérations aériennes et en développement aéronautique. Suite aux discussions initiales qui ont eu lieu sur ce sujet, le groupe s'est donné pour objectif de:

**«Faire le point de l'état de l'art du poste de pilotage moderne, en soulignant les points forts et les points faibles, et donner des orientations pour le poste de pilotage du futur.»**

Le point de départ du groupe a été la collecte de données sur un large éventail de postes de pilotage couvrant les 25 dernières années. Cette période a marqué la transition entre les cockpits traditionnels, largement tributaires de commandes et de visualisations spécialisées et les postes de pilotage actuels, intégrant les dernières technologies du verre. Au cours de la recherche des points forts et des points faibles de ces différents types de poste de pilotage, il est apparu qu'une analyse générale des technologies mises en œuvre était plus positive que l'approche qui consiste à faire la critique détaillée de chaque appareil.

En tout, 19 postes de pilotage, représentant les avions de combat, les hélicoptères et les avions de transport, ont été examinés et un exposé de position a été présenté dans chaque cas. Le groupe de travail a ensuite consacré ses efforts à la question du poste de pilotage du chasseur monoplace, la considérant comme le défi le plus important pour le concepteur du poste de pilotage. Les missions assignées à ces aéronefs ont été détaillées afin de situer les tâches du pilote dans leur contexte opérationnel. Le groupe a réalisé une étude détaillée des technologies du cockpit afin d'identifier d'éventuelles pratiques communes, d'analyser leur efficacité et de mettre en lumière toute caractéristique particulière.

Il a été constaté que si la mise en œuvre des nouvelles technologies conduisait à une meilleure efficacité opérationnelle, les équipages travaillaient à la limite de leurs capacités en raison de l'accroissement des besoins opérationnels. Il s'ensuit que la prise en compte du facteur humain dans l'adéquation des moyens technologiques par rapport aux possibilités humaines en environnement opérationnel a constitué l'essentiel des délibérations du groupe.

Avec cette considération en vue, la constatation de la désadaptation apparente entre les technologies disponibles et les possibilités de l'opérateur a conduit à l'analyse du processus de conception et de développement du poste de pilotage. Les besoins opérationnels ont été pris comme point de départ du processus de conception et cette approche a débouché sur un examen des missions génériques, suivi de la décomposition de leurs tâches constitutives. A l'avis des membres du groupe de travail, l'extension simultanée des besoins opérationnels et des nouvelles technologies aura un impact non négligeable sur l'entraînement de l'opérateur humain à ce rôle difficile.

Cette analyse des points forts et des points faibles des approches adoptées à l'heure actuelle a permis au groupe de prévoir les développements technologiques futurs et de faire des recommandations concernant leur adoption sur la base de trois hypothèses de poste de pilotage générique pour les années 2000, 2010 et 2025.

***Figure 0.1 Cockpit Design – Past, Present and Future***

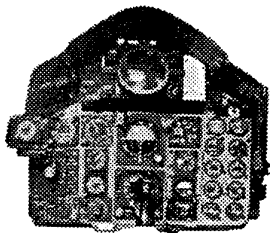

**• Past**

Gunsight, Radar scope, EW scope, Instruments and Armament panel

- *Benefits* Easy to learn, Easy to use, conventional
- *Weaknesses* Inflexible, single point failures, no growth potential, difficult to develop any situational awareness (SA)

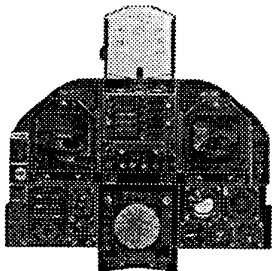

**• Present**

HUD, 3 or more Multi-Function Displays (5" or 6") and a Data Entry Panel (UFC)

- *Benefits* Flexibility, redundancy, and multi-mission capability
- *Weaknesses* Small displays, no HMD, poor global SA, workload intensive, effectively uses only 1/3 of panel for tactical display

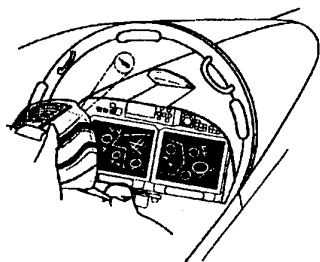

**• Cockpit 2000**

HMD, HUD, (2) 10" x 10" Multi-Function Displays, Automation, Decision Aids

- *Benefits* Increased flexibility, better global SA, reduced workload, off-boresight capability with HMD
- *Weaknesses* medium sized HMD and Displays, increasing mission requirements and off-board data requirements

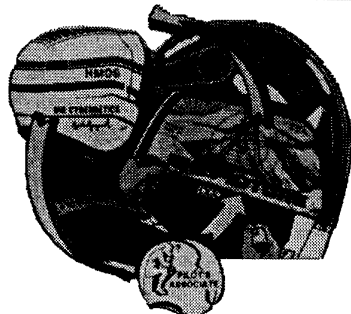

**• Cockpit 2010**

Larger, more capable, HMD, no HUD, 15" x 20" (300 in<sup>2</sup>) Display, Windowing, Adaptive Decision Aiding, Extensive Automation

- *Benefits* Enormous flexibility, Very good SA, further managed workload, multi-mission-multi-target capability
- *Weaknesses* Exposure to laser threat

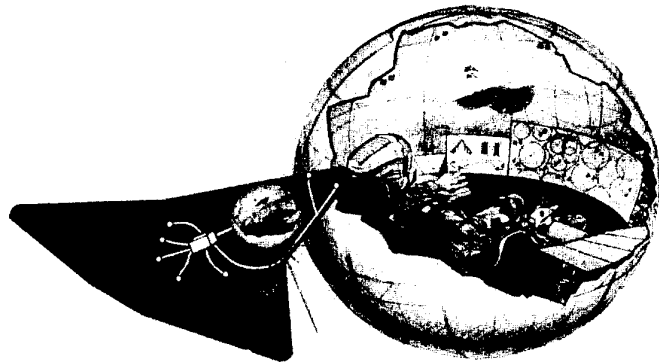

**• Cockpit 2025**

A 4' to 6' spheroid on which "the world" is projected, High Resolution HMD overlay and large Head-Down Displays, Adaptive Computer Intelligence and Internetted Data

- *Benefits* Very effective laser protection, very stealthy, immense situational awareness.
- *Weaknesses* No direct outside visibility

# Contents

	<b>Page</b>
<b>Executive Summary</b>	<b>iii</b>
<b>Synthèse</b>	<b>iv</b>
<b>Executive Summary Photo</b>	<b>v</b>
<b>Preface</b>	<b>viii</b>
<b>Préface</b>	<b>ix</b>
<b>Membership of AGARD FVP Working Group 21</b>	<b>x</b>
<b>1.0 Introduction</b>	<b>1</b>
1.1 Background	<b>1</b>
1.2 Purpose	<b>3</b>
1.3 Scope	<b>4</b>
1.4 References	<b>4</b>
1.5 Further Reading	<b>5</b>
<b>2.0 Mission Descriptions</b>	<b>7</b>
2.1 Introduction	<b>7</b>
2.2 Generic Mission Scenario	<b>7</b>
2.3 Fixed Wing Missions	<b>8</b>
2.4 Rotary Wing Missions	<b>12</b>
2.5 Conclusions	<b>15</b>
<b>3.0 Cockpit Descriptions</b>	<b>17</b>
3.1 Introduction	<b>17</b>
3.2 Design Constraints	<b>18</b>
3.3 Technology Trends in Glass Cockpits	<b>18</b>
3.4 Cockpit Technology Strengths and Weaknesses	<b>21</b>
3.5 Conclusions	<b>22</b>
<b>4.0 Technology Status and Trends</b>	<b>23</b>
4.1 Introduction	<b>23</b>
4.2 Current Cockpit Technology Overview	<b>23</b>
4.3 Output Devices	<b>24</b>
4.4 Input Devices	<b>28</b>
4.5 Cockpit Illumination Issues	<b>30</b>
4.6 Information Management Technology	<b>30</b>
4.7 Conclusion	<b>30</b>
4.8 References	<b>31</b>
<b>5.0 Ergonomics and Human Factors</b>	<b>33</b>
5.1 Introduction	<b>33</b>
5.2 The Subsystem “Human”	<b>33</b>
5.3 Situation Awareness	<b>35</b>
5.4 Automation	<b>38</b>
5.5 Head-Up Displays	<b>38</b>
5.6 Head- and Helmet-Mounted Displays	<b>38</b>



5.7	Multi Function Display and Switches	39
5.8	Anthropometry	40
5.9	Conclusions	41
5.10	References	41
<b>6.0</b>	<b>Training Considerations</b>	<b>45</b>
6.1	Introduction	45
6.2	Human Issues	45
6.3	Training Approaches	46
6.4	Training Time	47
6.5	Conclusions	48
<b>7.0</b>	<b>Cockpit Design Process</b>	<b>49</b>
7.1	Introduction	49
7.2	Design Practices & Problems	49
7.3	Cockpit Design Standards	50
7.4	Design Process Review	52
7.5	Summary	54
7.6	Further Reading	54
<b>8.0</b>	<b>Future Cockpits</b>	<b>55</b>
8.1	Introduction	55
8.2	Requirements for Future Cockpits	57
8.3	Candidate Solutions	59
8.4	Cockpit 2000	59
8.5	Cockpit 2010	61
8.6	Cockpit 2025	63
8.7	Technology Needs	65
8.8	Summary	66
<b>9.0</b>	<b>List of Abbreviations</b>	<b>67</b>
<b>Appendix A</b>	<b>— Aircraft Cockpit Descriptions</b>	<b>71-175</b>
	<b>Fixed Wing Combat Aircraft</b>	
	Tornado IDS	72
	F-15C Eagle	79
	F/A-18C/D Hornet	84
	F-15E Eagle	91
	AM-X	97
	F-16 Fighting Falcon	102
	Mirage 2000-5	108
	Rafale	113
	Harrier GR 7	118
	AV-8B Harrier II Plus	123
	F/A-18E/F Hornet	128
	EF 2000	131
	F-22	136
	<b>Rotary Wing Combat Aircraft</b>	
	EH101 Helicopter	139
	Tiger	143
	MV-22 Osprey Tiltrotor	149
	Longbow Apache Helicopter	154
	RAH-66 Comanche	161
	<b>Commercial Aircraft</b>	
	Civil Transport Aircraft, Specifically the Airbus A330	166

# Preface

In May 1990 the AGARD Flight Mechanics Panel held a symposium in Portugal addressing “Progress in Military Airlift”. During that meeting I had the opportunity to listen to a number of technical papers describing upgrades to military transport aircraft. After one particularly good technical paper on the addition of a glass cockpit to an existing, older, aircraft, a member of the audience asked the question “Did the upgrade of the avionics and cockpit described in your paper really improve the operational effectiveness of the aircraft?” This question started a number of discussions over the period of that symposium, all addressing “the glass cockpit” in some fashion or another. One result of these discussions was a proposal to the AGARD FMP to gather cockpit experts from NATO countries together to consider the topic in more detail.

AGARD FMP Working Group 21 was formed in 1993 to meet the following objective:

**Summarize the status of current cockpits, highlight their benefits and weaknesses, and provide guidance for future cockpit design.**

Five working meetings were held over the tenure of this working group. At each location our hosts provided hospitality, good working environments and technical tours which greatly enhanced the technical nature of each meeting. All of the working group members would like to express their sincere appreciation to our hosts:

British Aerospace Defence Ltd., Military Aircraft Division, Warton, UK, May 1993  
McDonnell Douglas Aerospace, St. Louis, USA, October 1993  
Sextant Avionique, Bordeaux, France, March 1994  
Eurocopter, Munich, Germany, September 1994  
Flight Research Laboratory, National Research Council, Ottawa, Canada, April 1995

As I am writing this preface, and the final report is approaching the “camera-ready” stage, I am able to state that this report was a clear team effort between all working group members and the content of these pages provides both a significant summary of the current “state of the art” and a basis to improve cockpits of future aircraft. AGARD must thank the working group members and the organizations that supported them for this activity.

I must also say that while I feel the report is one valuable outcome of the working group, an equally valuable outcome was the development of personal associations and friendships between working group members. I am privileged to have been a part of this activity and to have made such associations.

Stewart Baillie  
Member, AGARD Flight Vehicle Integration Panel (formerly the Flight Mechanics Panel)  
Chairman, AGARD FVP Working Group 21  
September 1995

# Préface

En mai 1990, le Panel AGARD de la Mécanique du Vol a organisé un symposium au Portugal sur le thème "Les avancées dans le transport aérien militaire". Lors de cette réunion, j'ai eu l'occasion d'assister à la présentation d'un certain nombre de communications traitant de la revalorisation des avions de transport militaires. Suite à la présentation d'un papier technique particulièrement intéressant, concernant l'adaptation d'un poste de pilotage en verre sur un aéronef d'une précédente génération, l'un des membres de l'assistance a posé la question suivante "La revalorisation de l'avionique et du poste de pilotage dont vous parlez dans votre communication a-t-elle réellement amélioré l'efficacité opérationnelle de l'avion?" Cette question a déclenché une série de questions du "poste de pilotage en verre". L'un des résultats de ces discussions a été la proposition faite au Panel FMP de réunir les spécialistes du cockpit des différents pays membres de l'OTAN pour considérer cette question plus en détail.

C'est ainsi que le Groupe de Travail No. 21 du Panel AGARD FMP a été créé en 1993 avec pour mandat de:

**Faire le point de l'état de l'art du poste de pilotage moderne, en soulignant les points forts et les points faibles, et donner des orientations pour le poste de pilotage du futur.**

Notre groupe de travail s'est réuni cinq fois en tout. Chez chacun de nos hôtes, l'accueil qui nous a été réservé, les conditions de travail particulièrement favorables et les visites techniques qui ont été organisées à notre intention n'ont pas peu contribué à la réussite de nos réunions sur le plan technique. L'ensemble des membres du groupe de travail tiennent à exprimer leurs vifs remerciements aux organismes suivants:

British Aerospace Ltd., Military Aircraft Division, Warton, UK, mai 1993; McDonnell Douglas Aerospace, St Louis, USA, octobre 1993; Sextant Avionique, Bordeaux, France, mars 1994; Eurocopter, Munich, Allemagne, septembre 1994; Flight Research Laboratory, National Research Council, Ottawa, Canada, avril 1995.

A l'heure où je rédige cette note, le rapport final sera bientôt prêt pour la photocomposition; je peux affirmer que sa réalisation est le résultat d'un véritable travail d'équipe de la part de l'ensemble des membres du groupe de travail; au fil des pages on y trouve non seulement une synthèse magistrale des technologies les plus récentes mises en œuvre dans ce domaine, mais aussi les éléments qui permettront d'améliorer les postes de pilotage des aéronefs de demain. A ce propos, l'AGARD se doit de remercier les membres du groupe, ainsi que les organismes qui leur ont apporté leur soutien.

J'ajouterais que, si ce rapport couronne brillamment le travail du groupe, il en est un autre résultat, tout aussi précieux à mes yeux, à savoir l'établissement de relations professionnelles et d'amitié entre ses membres. Pour ma part, j'ai été privilégié de pouvoir prendre part à ces travaux et de pouvoir nouer de telles relations.

# Membership of AGARD FVP Working Group 21

<b>Canada</b>	Stewart Baillie, Flight Research Laboratory, Institute for Aerospace Research, National Research Council, Canada Maj. Lee Obst, Aerospace Engineering Test Establishment (AETE), CFB Cold Lake
<b>France</b>	Col. Martin Theiry, Col. Denis Gariel, Centre d'Essais en Vol, Bretigny
<b>Germany</b>	Hans Hellmuth, Eurocopter France, Marignane Harro von Viebahn, TH Darmstadt Christoph Weber, ESG Elektronik-System und Logistik GmbH, Munchen
<b>Italy</b>	Maurizo Spinoni, Operativita del Sistema e Simulazione, Alenia, Torino Emilio Toso, Aermacchi Spa, Venegono Sup.
<b>The Netherlands</b>	Henk Kleingeld, National Aerospace Laboratory, Amsterdam Mike Piers, National Aerospace Laboratory, Amsterdam
<b>United Kingdom</b>	Tony Karavis, Man Machine Integration Division, DRA, Farnborough Terry Miller, Crew Station Integration Department, Westland Helicopters Ltd, Yeovil Peter Wilkinson, Systems Engineering Department, Military Aircraft Division, British Aerospace Defence Ltd., Warton Aerodrome
<b>United States</b>	Eugene Adam, McDonnell Aircraft Company, St. Louis Rebecca Morgan, Aircrew Systems Department, Naval Air Warfare Center, Patuxent River Robert Osgood, AI/CFHV, Wright Patterson AFB, Dayton

Special thanks must also go to:

Bruce Hamilton, Comanche Crewstation Design, Sikorsky Aircraft Corporation, Stratford CT.  
Mario Castellani, EFA Cockpit Group, Alenia,

whose efforts contributed substantially to working group technical discussions and the development of the final report.

## 1.0 INTRODUCTION

### 1.1 Background

The study of the historical development of aircraft shows that the evolution of cockpit design has followed the expansion of aircraft capabilities. At a time when flight times were expressed in seconds or minutes, the cockpit was merely the location of the pilot and flight controls; no instrumentation was present. As the performance of aircraft improved to allow cross-country flight, navigation instruments, engine instruments and rudimentary flight instruments appeared in the cockpit. When flight at night or in what are now referred to as "Instrument Meteorological Conditions" (IMC) became possible, cockpit designs included further instruments to allow the pilot and aircrew to perform this task. As the complexity of aircraft systems increased, the gauges, switches and status panels for the variety of systems expanded and became a part of the cockpit. As the density of air traffic became a factor in aircraft operations, radios, transponders and precision navigation systems were introduced into the cockpit. Technological advances in the capability to measure and calculate flight relevant information changed the instrument panel further with systems such as weather radar, flight directors, and moving maps. If the military roles of aircraft are considered, the systems of the aircraft to be monitored and managed expand to include weapons and those tactical systems which improve the ability for the pilot to perform his military role. Figures 1.1 and 1.2 demonstrates this expansion by depicting some milestone military cockpit designs through the years while Reference 1.1 provides a good historical overview of cockpit design.

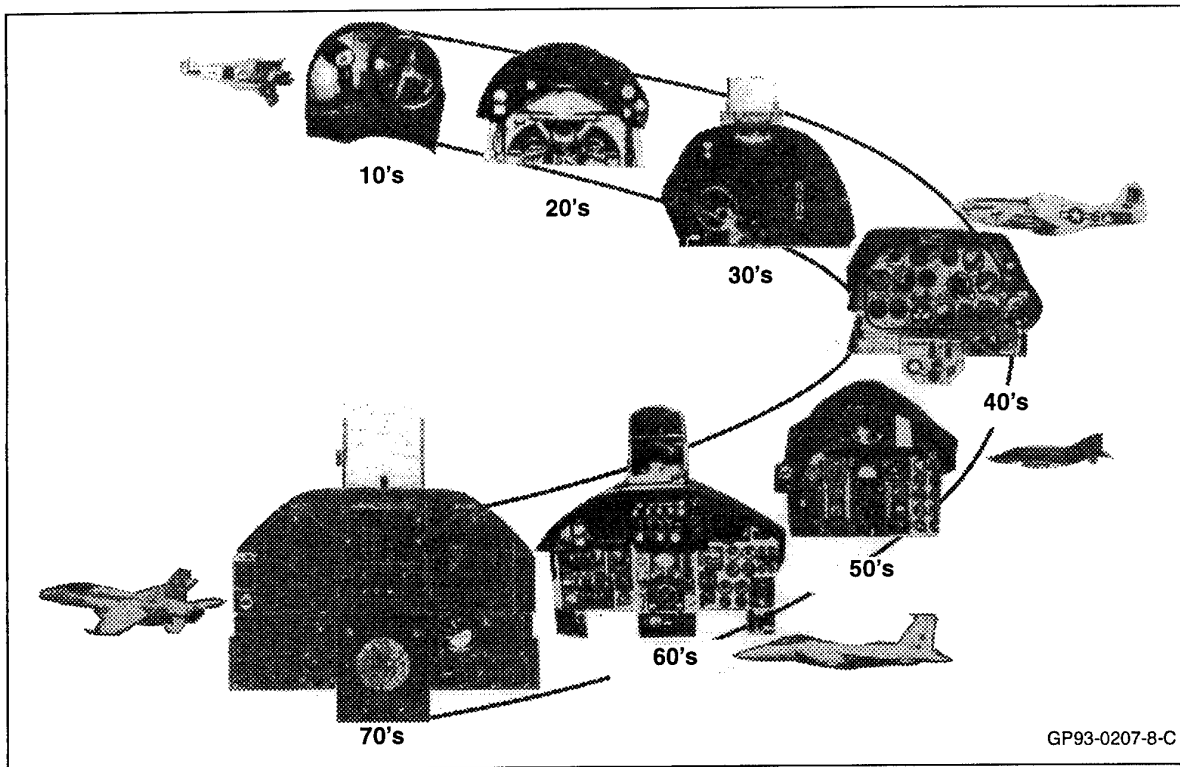

Figure 1-1 Early Military Cockpits

As alluded to in the previous discussion, cockpit instrumentation, in the form of mechanical, pneumatic or electrical dials and gauges, has expanded to fill all of the available area in the cockpit. Each of these additions has been made to address the various tasks that the pilot and aircrew must attend to during a flight, namely: **fly** the aircraft, **navigate** the aircraft, **monitor** the systems of the aircraft, **operate** the aircraft in conjunction with those around it, and **perform** mission related tasks. Figure 1.3 demonstrates this exponential growth by representing the number of controls per crew member resident in fighter aircraft cockpits versus the year of aircraft first flight. Clearly the aircraft and mission systems resident in the cockpit are becoming increasingly complex. With such a multitude of systems and information sources in the aircraft of today, the single-function or dedicated gauges and displays of previous generations of aircraft are being replaced with multi-function displays (MFD). These devices, generally cathode ray tube (CRT's) or flat panel

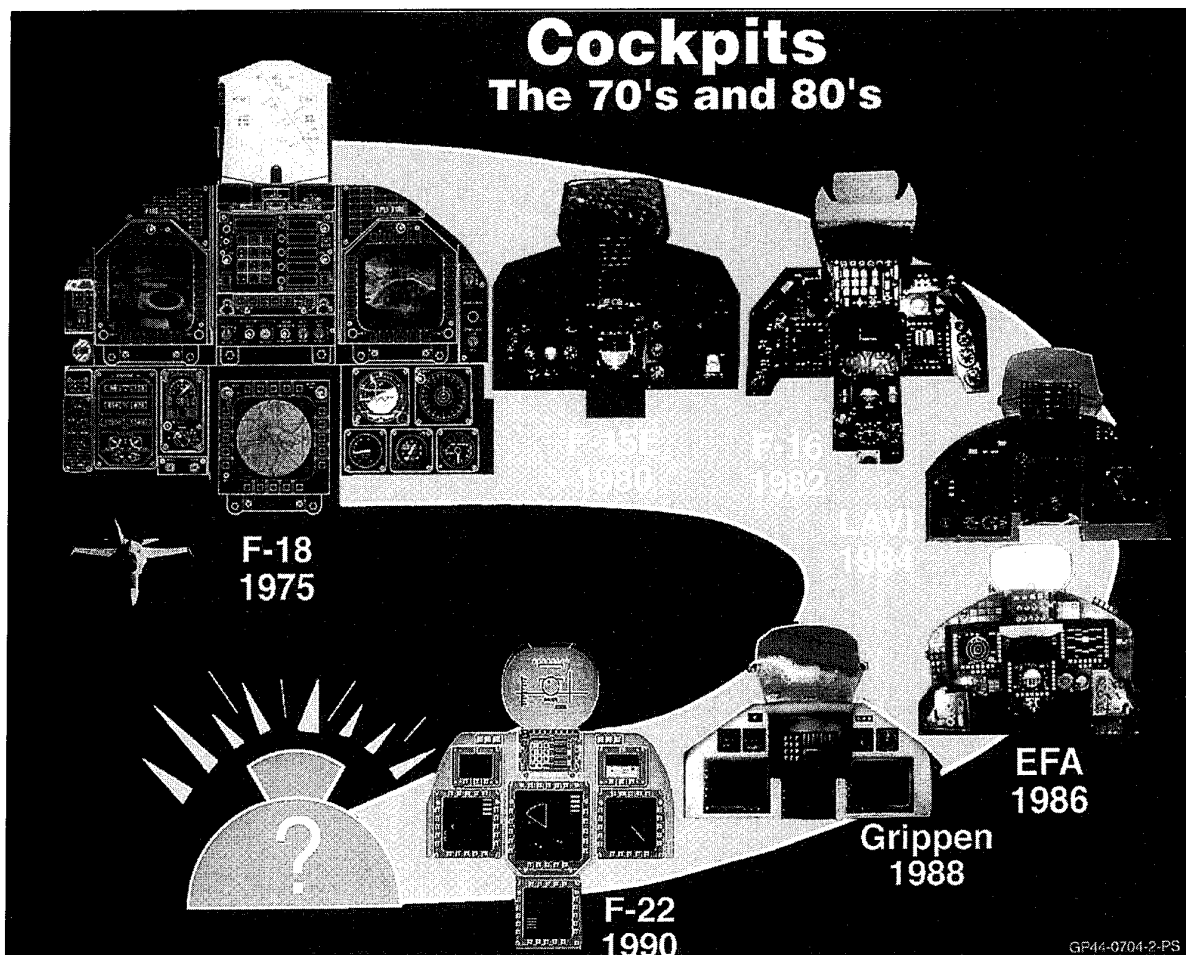

Figure 1-2 The Development of Glass Cockpits

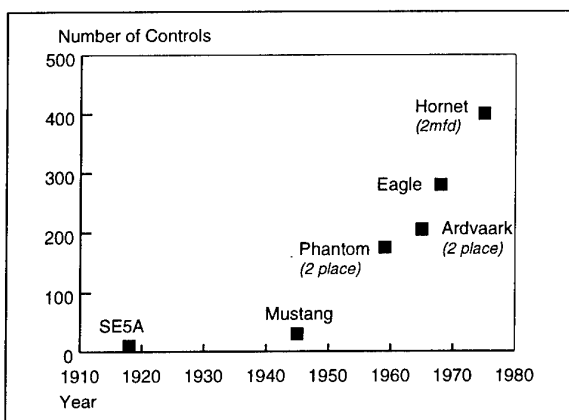

Figure 1-3 Growth in the Number of Cockpit Controls per Crew Member

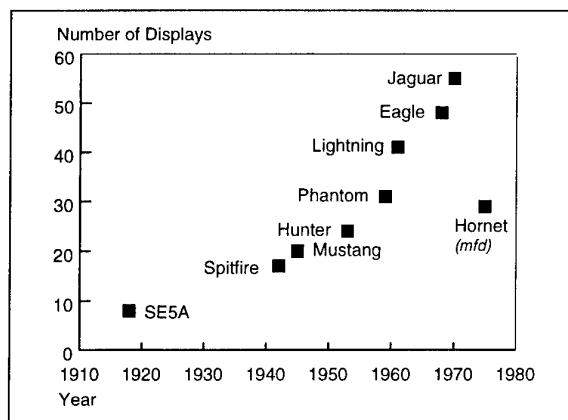

Figure 1-4 Growth in the Number of Cockpit Displays

technology displays, have done away with some of the instrument panel area concerns by allowing the same panel area to be used for a wide variety of purposes. This is made possible by the potential of MFDs for menu driven architectures. The term “glass cockpit” has been used to describe these cockpits since a significant portion, but by no means even 50%, of the available instrument panel area is taken up by these multi-function displays. As shown by Figure 1.4 the glass cockpit effectively halted the exponential growth in number of single purpose or “dedicated” cockpit displays resident in the fighter cockpit.

Interest in the development and optimization of the cockpit, once defined as physical location of where the "pilot-vehicle interface" takes place, is not new. As soon as more than one instrument was situated on an "instrument panel" in an aircraft, the first study of "what needs to go where" was probably conducted. With the advent of MFD's, the available instrument panel area in a cockpit is less of a restriction because the same area can be used for a number of different roles. Now that computer technology has provided the ability for flexible, programmable displays and so-called "intelligent interfaces", the study of cockpit designs has become an important field.

Over the past 10 or so years, AGARD has sponsored a variety of activities on the topic of aircraft cockpit design. An AGARD Avionics Panel meeting in 1982 entitled "Advanced Avionics and the Military Aircraft: Man/Machine Interface" (Reference 1.2) had, as part of its theme, the statement "To obtain the maximum benefit from advanced avionics requires that the most careful consideration be given to the interface between avionics systems and aircrews". A more recent AGARD activity, the Flight Mechanics Panel / Guidance and Control Panel Joint symposium of October 1992 on "Combat Automation for Airborne Weapon Systems: Man / Machine Interface Trends and Technologies" (Reference 1.3) stated in its theme "Presentation of accurate situational data at the right time in an appropriate format remains a significant challenge". As these theme statements indicate, the problem is not "what can we present the pilot to make him aware of a particular facet of his mission?" but rather "How can we integrate all of the information that we have to present into the easiest to interpret and most useful ensemble?" It appears that the answer to this question is the crux of the cockpit design problem of today.

In the process of evaluating cockpit designs however, it must be stressed that flight is not the sole objective of a combat aircraft, nor is mere transportation. In general the military combat airframe is a tool with which the aircrew performs an operationally relevant mission, such as the delivery of weapons to a target, the defence of air space from an adversary, or the surveillance of militarily relevant targets. The ability of the pilot (and his crew, if present) to perform the mission through the tactical use of all available system capabilities, with underlying considerations of the pilot workload, the pilot compensation for system deficiencies and the performance attainable in accomplishing the mission, is loosely defined as the operational effectiveness of the system. Clearly the cockpit design problem must always be considered in this context.

## 1.2 Purpose

With the concept of operational effectiveness, the general discussion of what makes up today's "glass cockpit" and a discussion on the human factors issues which are prevalent in today's cockpit in hand, the purpose and scope of this report can be identified. While it is clear that the use of electronic, multi-function displays has become a standard in the military cockpit of today, a close examination of the manner in which this technology has been implemented often reveals that the technology presents a mixed blessing. On one hand, glass cockpits provide immense versatility and flexibility to the cockpit designer and aircrew with resultant improvements in multi-mission performance and redundancy. On the other hand, glass cockpits require increased aircrew training and increased airframe cost. The pilot workload levels found in glass cockpits during typical missions are generally higher than those found in old technology cockpits, however this increase is accompanied by a vast improvement in mission capability. The glass cockpit is a busier place but it is being used to perform mission profiles that previous technology cockpits could not even attempt.

Despite its benefits over previous generations, it is clear that the multi-function (glass) cockpit is still far from optimum. Aside from the issue described above, the sheer volume of data now available to the aircrew in high threat environments can lead to poor situational awareness if the manner in which the data is presented to the aircrew is inappropriate. Additionally, the flexibility of multi-function displays can be easily misused, leading to less than optimum design choices in menu architecture and application, further degrading the overall aircraft operational effectiveness.

This report, produced by the AGARD Flight Mechanics Panel Working Group 21, presents a critical review of how "glass cockpit" technologies are being used in our current operational military aircraft and our near-future aircraft designs and provides discussion on the principles and philosophies which should underlie these applications. The objective of the working group was to create a document which:

- a) describes the current "state of the art" in cockpit design,
- b) highlights the benefits and weaknesses inherent in the use of these current glass cockpit systems,

- c) reviews the typical cockpit design process of today,
- d) describes the technologies and design approaches which may be able to influence future glass cockpit designs.,and,
- e) forecasts future cockpit design trends

### 1.3 Scope

While electronic multi-function displays can be found in a variety of military aircraft, the working group concentrated primarily on cockpits found in single and two crew combat aircraft (including rotorcraft) since these cases represent a use where the demands on the pilot and crew are severe. Since glass cockpits are also present in civil aircraft, a consideration of unique features of these applications was also made.

To meet the desired objectives this report is constructed around the following outline:

#### **Section 1 – Introduction**

– What is the background, purpose and scope of this report?

#### **Section 2 – Mission Descriptions**

– What is the pilot and crew required to do to complete a mission successfully?

#### **Section 3 – Current Glass Cockpits — Trends**

– What do the current glass cockpits consist of ?

– What are some of the technological highlights and trends of these cockpits ?

#### **Section 4 – Technology Status and Trends**

– What new technologies are becoming available ?

#### **Section 5 – Ergonomics and Human Factors**

– How can we tailor the cockpit to be the most suitable for the human operator ?

#### **Section 6 – Training Considerations**

– How can and how does the use of glass cockpits change the required aircrew training process?

#### **Section 7 – The Cockpit Design Process**

– What are the key problem issues with the current design process and what suggestions can be made to improve it?

#### **Section 8 – Future Cockpits**

– What are the cockpit concepts being considered to improve the operational effectiveness of future aircraft?

With consideration of the human factors issues in design as a major basis for this report, it is hoped that this document will provide an in depth discussion of the cockpit of today's aircraft and will serve as a foundation upon which to develop a more optimized pilot-vehicle-system interface of tomorrow.

### 1.4 References

- 1.1 Coombs, L.F.E., **The Aircraft Cockpit**, Patrick Stevens Limited, Wellingborough, Northamptonshire England, 1990
- 1.2 **Advanced Avionics and the Military Aircraft Man/Machine Interface**, AGARD Conference Proceedings 329 – Avionics Panel, April 1982
- 1.3 **Combat Automation for Airborne Weapon Systems: Man/Machine Interface Trends and Technologies**, AGARD Conference Proceedings 520, Flight Mechanics Panel / Guidance and Control Panel, October 1992



### **1.5 Further Reading**

**Modern Display Technologies and Applications**, AGARD Advisory Report 167, Avionics Panel Working Group 11, October 1982

**The Potential Impact of Developments in Electronic Technology on the Future Conduct of Air Warfare**, AGARD Advisory Report 232, Avionics Panel Workshop, October 1985

**Information Management and Decision Making in Advanced Airborne Weapon Systems**, AGARD Conference Proceedings 414, Aerospace Medical Panel, April 1986

**Improved Guidance and Control Automation at the Man/Machine Interface**, AGARD Advisory Report 228, Guidance and Control Panel Working Group 07, December 1986

**The Man-Machine Interface in Tactical Aircraft Design and Combat Automation**, AGARD Conference Proceedings 425 and Advisory Report 249, Flight Mechanics Panel / Guidance and Control Panel, October 1987

**Visual Effects in the High Performance Cockpit**, AGARD Lecture Series 156, Aerospace Medical Panel, May 1988.  
(includes a good selected bibliography )

**Integrated and Multi-Function Navigation**, AGARD Conference Proceedings 525, Guidance and Control Panel, May 1992

**Advanced Aircraft Interfaces: The Machine Side of the Man-Machine Interface**, AGARD CP 521, Avionics Panel, May 1992

## 2.0 MISSION DESCRIPTIONS

### 2.1 Introduction

The definition of system requirements in the beginning stages of system design is critical in the development of an aircraft cockpit. Aircraft which must perform multiple missions or roles as a single platform have a tremendously complex set of requirements due to both the complexity of each system installed in the aircraft and to the interactions between the various systems. The determination of the critical requirements for the design and testing of the cockpit interface to control and effectively use these systems is vital to the success of the entire weapon system. These requirements must be derived from the missions and mission tasks which the aircraft is intended to complete. Strict attention to meeting these requirements is essential to develop a cockpit in which the pilot can complete the mission successfully.

Mission tasks for military aircraft are comprised of many similar activities. These activities require that the cockpit design supports the sensors, weapons, system capabilities and tactics of the individual missions. The next generation of military aircraft is currently being designed with multi-mission capability as a prime focus, resulting in the need for more thorough requirement definition from both the technology and aircrew perspectives.

This section provides a high level description of common mission tasks for both fixed and rotary wing combat aircraft, so that the reader will understand more fully the driving force behind the technology described in the following sections of this report. The intent is also to make the reader aware of the activities occurring in the cockpit, so that they will better understand the need for the technologies included in an aircraft. A mission description for all aircraft, and indeed even all possible applications of a single aircraft, is beyond the scope of this section. Therefore the focus will be placed on missions for one and two place military combat aircraft.

### 2.2 Generic Mission Scenario

Development of a glass cockpit and the embodied man-vehicle interface is highly dependent upon a thorough understanding of the mission demands and the specific tasks which the crew must accomplish. Initial cockpit designs start on the basis of the physical layout of the cockpit and a concept of the controls and displays needed to accomplish these tasks. Controls and display concepts are, in turn, developed from an allocation of function between automation and the crew. The traditional ergonomic disciplines of task analysis and function allocation, coupled with newer cognitive science approaches to knowledge acquisition, help decompose high-level goals into the specific data used in the cockpit design process. The starting point for task analysis and knowledge acquisition is the generation of specific mission scenarios which document the missions, phases, segments, and tasks to be performed by the crew using the glass cockpit as an implementation tool. While aircraft vary widely in form (Civil vs.. Military, Fixed Wing vs. Rotary Wing) and even more widely in mission, the task of flying has many functions and segments which routinely occur on all forms and for all missions. The intent of generating a generic mission scenario is to provide a description of tasks common to all mission profiles. Essentially, these tasks occur regardless of the mission intentions. A generic mission scenario common to all types of aircraft includes the following task elements:

- |                      |   |
|----------------------|---|
| Mission Planning:    | Study mission requirements, gather relevant data (weather, navigation data, coordination data, etc.), develop execution concepts and flight plans, complete ground procedures.  |
| T/O & Departure:     | Takeoff, execute airfield departure, climb to cruise altitude.  |
| En route Procedures: | Operate aircraft in accordance with the specified flight rules and flight plan, and within normal aircraft operating envelope.  |
| Arrival & Landing:   | Contact approach control, enter controlled airspace, penetrate weather as required, adjust flight path as required, land, secure aircraft.  |
| Emergencies:         | React to and control critical and non-critical emergencies in flight or on the ground in a timely and effective manner to ensure the safety and integrity of the aircraft and crew.   |
| Navigation:          | Manage aircraft systems and navigation aids so as to arrive at the desired destination in an efficient manner. Navigation may be internal systems (INS, Doppler), external aids (Radio NAV AIDS, LORAN, OMEGA, GPS) or visual (watch, map, ground). |

- Communications:** The pilot must be able to communicate with external agencies (both tactical & non-tactical), other aircraft, and/or crew. Communications may be voice (secure/non-secure radio) or electronic (data link, IFF).
- Post Flight:** Secure the aircraft and systems, collect and process mission data, debrief crew/parent agencies as required, report maintenance actions as required.

### 2.3 Fixed Wing Missions

Fixed wing air combat missions can be broadly divided in two distinct categories; Air-to-Air (A/A) and Air-to-Ground (A/G). A/G missions are essentially offensive and may encompass some A/A mission tasks (reactions to air threats, self defence capabilities). A/A missions may be defensive (protection of friendly forces or assets) or offensive in nature (sweep/escort). Most fixed wing combat aircraft are capable of conducting both mission categories either by virtue of specific mission variants of a single airframe or by the use of optimized weapons and sensors in a multi-role variant. A few aircraft (F-18, EF 2000, Rafale) are, or will be, able to conduct both missions in a true multi-mission fashion. For the purposes of this report, each of these missions will be described separately.

**2.3.1 Air-to-Ground (A/G)** – Air-to-Ground attack by its very definition is an offensive mission designed to disrupt, limit and/or destroy the enemy's war making potential before it can be brought to bear against friendly forces or territory. A/G missions can typically be broken down into five broad categories or specific missions: offensive counter air (OCA), air interdiction (deep strike, DS), battlefield air interdiction (BAI), close air support (CAS), and suppression of enemy air defences (SEAD). All of these missions may also encompass air-to-air task elements depending on the aircraft's self protection capabilities. Other specialised aircraft (EW, AWACS, sweep/escort) may also be called upon to provide overall support to the mission. Common tasks associated with these offensive missions include the following:

- Mission Planning:** Intelligence: tasking, target, threats, support elements, friendly forces, timing, escape and evade.  
 Target Description: photos, reconnaissance area.  
 Weapon Selection Support: AWACS, WILDWEASEL, jammers, tanker.  
 Environment: VFR/IFR, day/night, chemical/nuclear hazard.  
 Attack Planning: weather concerns, target type, terrain, threat, alternate targets.  
 Route Planning: fuel available, safe passage routes, terrain.  
 Coordination with support elements: detailed threat description, last minute intelligence.
- Departure and Rendezvous:** Takeoff, execute airfield departure, climb to cruise altitude, rendezvous with flight / attack package, support aircraft and/or tanker aircraft as required.
- En route:** Review threats and target data, cruise to pre-strike tanker for air refuelling, contact command and control agency for final coordination and target updates, maintain route and altitude as required, proceed to ingress entry point.
- Ingress:** Monitor altitude and route as required, adhere to emission control (EMCON) procedures, flight integrity and mutual support, employ passive/active sensors to detect and analyze threats, avoid/react to/or engage threats as required, manage active/passive EW suite and countermeasures, monitor navigation to ensure timely and accurate flight to target area, avoid terrain and obstacles.
- Acquire target (A/G):** Set up active and/or passive sensors to acquire the target, monitor air and ground based threats, positively identify the target(s) and avoid fratricide, set up and manage self protection suite as required.
- Attack (A/G):** Identify and designate target for attack, select desired weapon and attack axis, release and guide the weapon (if required), employ ECM suite, maintain situational awareness on other formation members (as required), damage assessment.
- Egress:** As per ingress and return to friendly territory.

- Return to Base: Climb to cruise altitude, follow safe routing, air refuelling if required, pass on post flight mission/damage assessment report.
- Land: Penetration and approach depending upon weather, traffic and base EMCON procedures, follow safe arrival procedures.
- Post Flight Debrief: Retrieve and review mission data tapes, intelligence debriefing and report.

**2.3.2 Offensive Counter Air (OCA)** – The following description is an example of an Offensive Counter Air (OCA) mission scenario to illustrate how and when the above mission tasks are required. The objective of the offensive counter air mission is to acquire and sustain air supremacy. This is accomplished to provide support to all friendly air operations and to prevent enemy forces from effectively interfering with the friendly surface and air operations. OCA missions are designed to seek out and destroy, disrupt, or limit enemy air power at the source of its power base. OCA targets are typically identified, prioritized, and targeted by the air commander's staff with overall campaign objectives in mind. Examples of air-to-surface targets include airfields (with aircraft), runways, shelters, revetments, maintenance and support facilities, petroleum, oil and lubricant storage tanks, weapon storage facilities, command, control, communications, and intelligence facilities and surface to air missile (SAM) systems. Air-to-air targets include hostile aircraft in enemy territory.

The air task order (ATO), includes information on target timing, weapons, defences, description, location, objectives and force package size. Key systems required to execute the mission effectively include: (1) Mission planning & real time intelligence, (2) 24 hour operations with all weather capability, (3) command, control, and communications both pre and post target, (4) accurate navigation capabilities, (5) autonomous target acquisition, (6) precision guided munitions with stand-off capability, (7) threat warning and some automated defensive countermeasure systems, and finally (8) self defence weapon capability. Figure 2-1 shows the mission profile and many of the required mission activities of an OCA mission.

**2.3.3 Air-to-Air (A/A)** – Air-to-Air missions may be offensive or defensive in nature. The objective of Offensive A/A missions is to establish air supremacy over enemy territory through the destruction of enemy air to air fighters and airborne C<sup>3</sup> aircraft (AWACS, Command & Control). Offensive A/A missions are primarily made up of one of the following mission types:

- (1) Sweep / escort: Provide air superiority fighter support to friendly aircraft operating in hostile territory. Targets are primarily enemy fighter aircraft. Sweep/escort missions are often employed as part of a larger integrated strike package; and
- (2) Attack of High Value Airborne Assets: Disrupts the enemy's C<sup>3</sup> system by attacking airborne radar surveillance and C<sup>2</sup> aircraft.

The objective of Defensive A/A missions is to protect all friendly assets from air attack through the defence of installations and the planned destruction of enemy fighters and support aircraft. Defensive A/A missions are essentially comprised of Defensive Counter Air (Area Theatre Defence/Point Theatre Defence/Airborne High Value Platform Defence/Subsonic Cruise Missile Defence/ High Altitude, High Speed Overflight Protection), Combat Air Patrols (CAP), Air Policing and Surveillance, and Quick Reaction Alert (QRA) / scramble mission elements. DCA missions are performed to detect, identify, intercept, and destroy all enemy aircraft which are engaged in attacking friendly forces on one's side of the FEBA. Air defensive aircraft can be employed to protect friendly assets such as air bases, communication lines and vital economic and war making potential industrial complexes. DCA has two primary missions to support:

- (1) Point Air Defence: Aircraft defend and protect single targets such as airfields, storage facilities, command and control facilities, and key communication points.
- (2) Area Air Defence: Aircraft defend and protect groups of high priority targets within specified geographic areas.

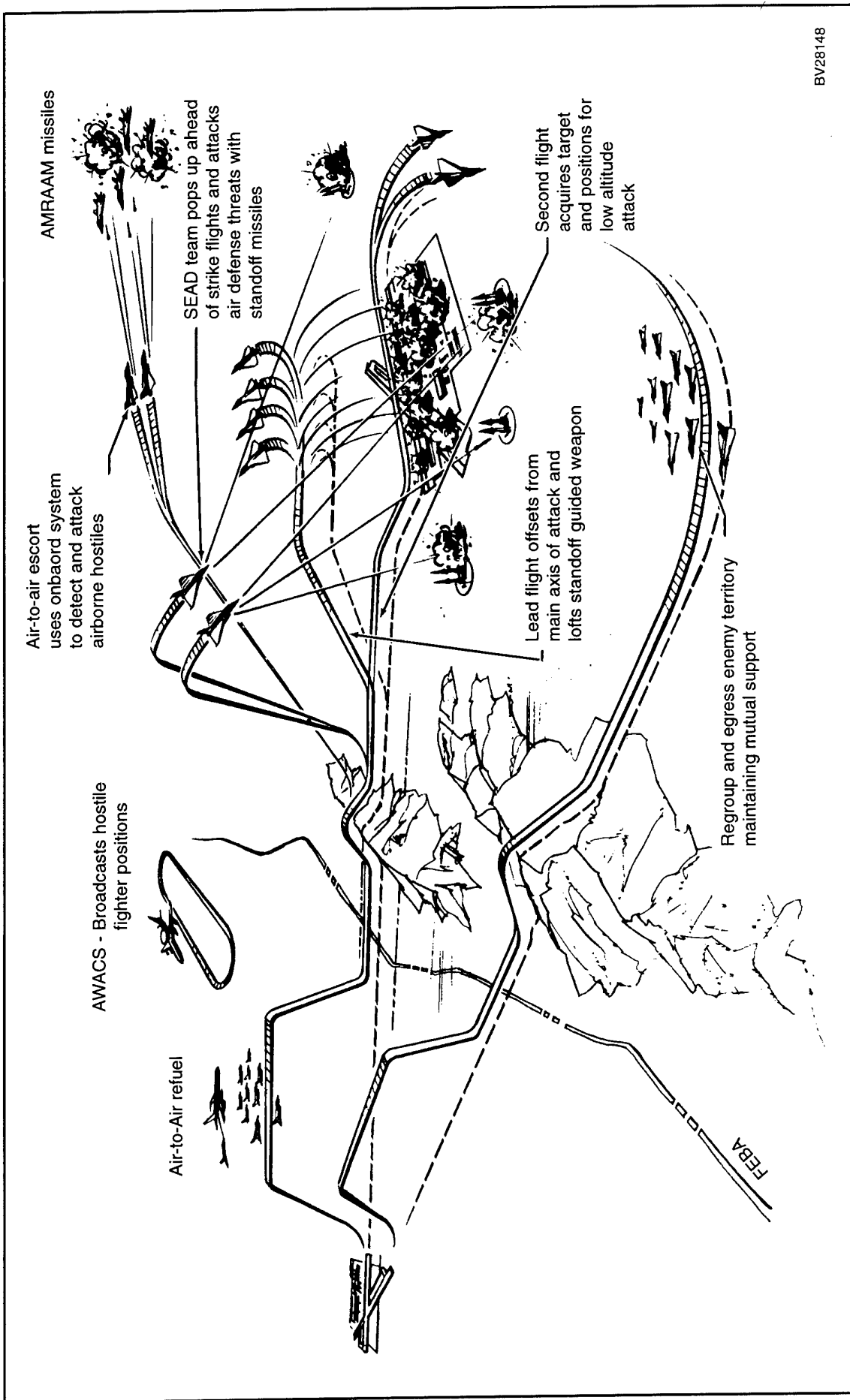
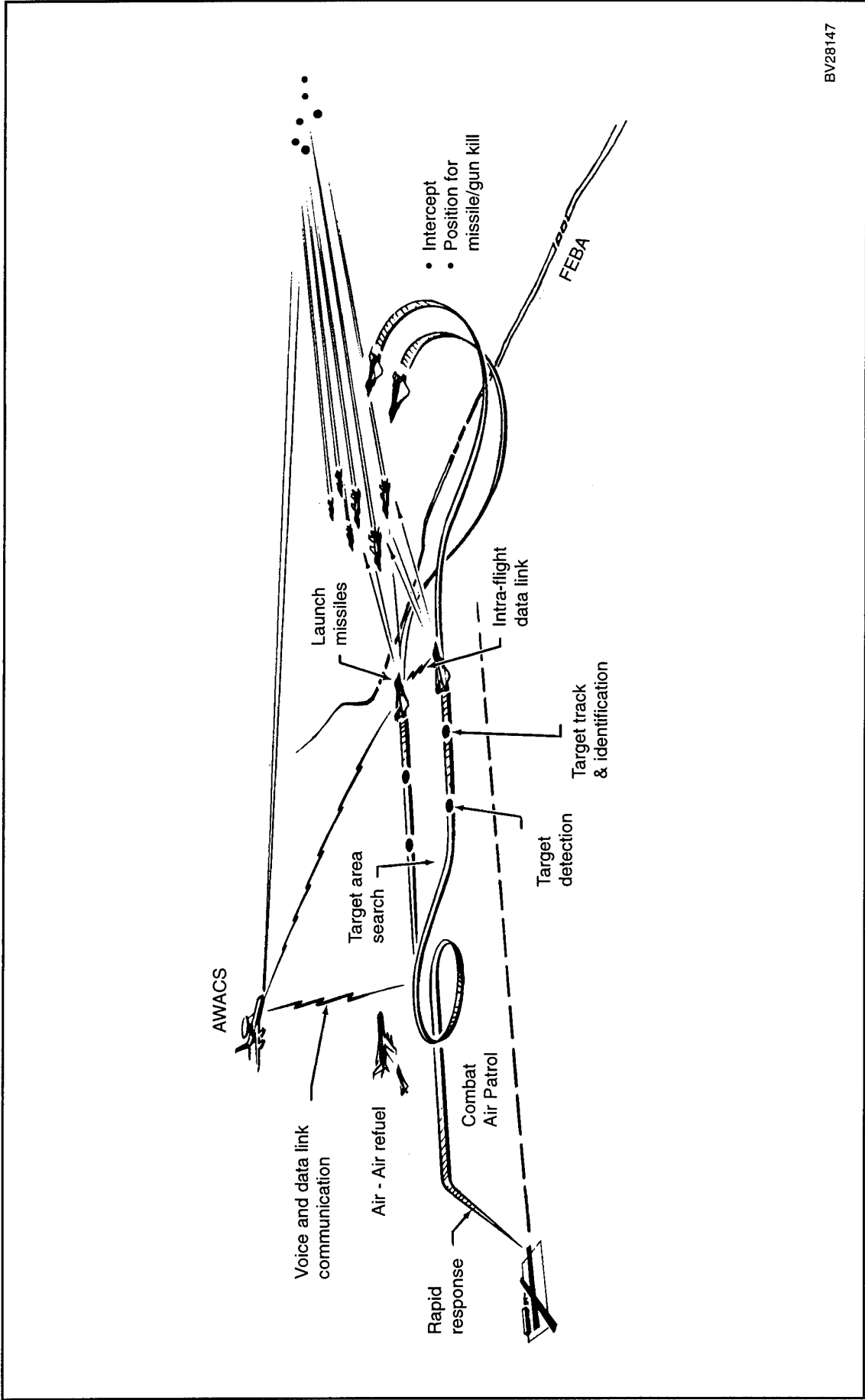

Figure 2-1 Offensive Counter Air Scenario



BV28147

Figure 2-2 Defense Counter Air Scenario

Common tasks associated with both offensive and defensive A/A missions include the following:

Mission Planning:	Study threats, incorporate plan of attack and load data.
Departure:	Takeoff (scramble or normal), execute airfield departure, climb to cruise altitude.
En route:	Follow established routing or vectors from GCI or AWACS to rendezvous with package (offensive missions) to area of responsibility (area defence), or CAP point; may include cruise to prestrike tanker for air refuelling, max endurance loiter in CAP area. Review Rules of Engagement (ROE), threat capability and tactics, monitor total situation.
Target Area Search:	Set up active and passive sensors for coordinated search and targeting of threats. Monitor air and ground threats, maintain situational awareness using own ship systems and/or datalink from other aircraft, target identification (using target position, track, IFF, other sensors or visually), share target information within the flight (datalink, comm, visual signals).
Air Engagement:	Designate and prioritise target(s) for attack, plan attack in accordance with the ROE. Beyond Visual Range missile launch, position for re-attack, second target, or disengage, follow up with visual attack as required.
Egress:	Monitor threats, return to friendly territory, contact AWACS for instructions.
Return to Base:	Climb to cruise altitude and perform post-attack refuelling or return to base as required.
Land:	Penetration and approach depending upon weather and traffic conditions.

Typically all DCA missions are reactive and “scramble “ from alert posture to intercept incoming enemy aircraft. Some preplanned missions such as CAP can be assigned to provide air assets for continuous airborne defence. Key capabilities of DCA missions include (1) 24 hour all weather capability, (2) target assignment and cueing from command, control and communications agencies, (3) autonomous target detection and identification, (4) situational awareness of the air battle, (5) Visual range and beyond visual range capabilities, and (6) threat warning and automated defensive countermeasures system capabilities. Figure 2-2 shows the mission profile and many of the required mission activities of a DCA mission.

## 2.4 Rotary Wing Missions

Helicopters are versatile machines capable of conducting a wide variety of missions in most environmental conditions. Military flight operations routinely occur any time of the day or night and in all but the worst weather conditions, depending upon helicopter capability. Mission flight altitude is dictated by the perceived level of threat. Low and slow flight profiles, using terrain and vegetation concealment, to the point of flying between, rather than over, the trees, may be used to reduce the risk of enemy detection and attack, if warranted. The military missions of helicopters can be globally grouped into missions over land, such as combat support and manoeuvre, or missions over the sea, such as anti-submarine, anti-surface vessel, fleet or convoy protection, reconnaissance of enemy shipping, combat search and rescue, and transport of personnel and/or equipment/weapons. To demonstrate the tasks and conditions embodied in military helicopter missions, the Manoeuvre, Combat Support and Anti-Submarine missions will be considered in more detail.

**2.4.1 Manoeuvre** – The manoeuvre mission is a combat mission over land characterized by the requirement for high agility. This mission involves the use of firepower and movement to engage and destroy enemy assets. Typical manoeuvre missions are attack, reconnaissance and security, air assault, air combat, special operations, and command and control. Attack missions include anti-armour, air combat, aerial security, joint air attack with fixed wing, supporting fires, antipersonnel, and suppression of enemy air defence. Reconnaissance and security missions include raids, feints, counterattacks, and covering operations. Air assault missions include bypassing obstacles, reinforcing or extracting forces, establishing airheads in enemy rear areas, blocking enemy movement, and exploiting targets of opportunity. Air combat includes defensive and offensive air-to-air combat. Command and control missions support command elements with rapid movement, information, and immediate control of situations. Manoeuvre missions are typically preplanned

and coordinated with ground and other air units, but may come with short notice and require immediate execution. Helicopters utilized by the military for Manoeuvre missions are attack helicopters or utility helicopters sometimes modified with add-on equipment. Attack helicopters are usually purpose-built and have night vision systems (for pilotage), target acquisition systems (infrared, radar, TV, direct view optics, laser rangefinder/designator), aircraft survivability sensors (laser, radar and chemical warning as well as active and passive countermeasures), weapons (missiles, rockets and gun systems), and sophisticated communications equipment (secure, multi-waveform, digital modem, etc.) but may be modified utility aircraft. Reconnaissance aircraft often use day/night target detection systems to extend search capabilities and digital radios for rapid and covert transmission of data, but reconnaissance may be conducted without specialized equipment. A typical military attack mission scenario is represented in the following figure. Common tasks associated with manoeuvre missions include:

Mission Planning:	Intelligence preparation of battlefield to meet the Commander's objectives and concepts, staff estimates (Mission, Enemy, Terrain, Troops, Time), prepare mission data (communications plan, route planning, timing), coordinate with supporting elements (logistics, fire support, ground elements, airspace coordination), conduct aircraft preparation (maintenance, preflight, weapons).
Startup:	Normal startup and initialization tests on ground or scramble startup with lift off as fast as possible, conduct initialization checks partly in-flight, perform the in ground effect hover power check, initialization of position measurement equipment.
Departure:	Takeoff, execute departure, climb to cruise altitude
Transition:	Transition to contour (low-level) flight mode, enter flight corridor, make coordination calls, proceed to release point, transition flight to supported brigade, information exchange with ground forces at the rendezvous point (if applicable), receive final orders for squadron.
Ingress:	Transition to nap of the earth (NOE) flight mode, avoid terrain and obstacles, avoid detection. NOE flight to supported battalion, each aircraft crew seeks its optimal first firing position, squadron leader contacts supported battalion.
Reconnaissance:	Identify and occupy observation positions, search for targets using passive sensors, report targets and locations, identify targets and activity, monitor and respond to self-protection equipment, change position and repeat.
Attack:	Identify firing positions and occupy, identify target responsibility and coordinate attack, select weapons, recognize targets and engage/fire, change firing position and repeat.
and/or Rescue:	Search for men to be rescued, approach and take on board, observe surrounding area.
and/or Air to air combat:	Acquire airborne threat, aim and fire missiles or gun, verify result, report to squadron leader.
Egress:	NOE flight to rendezvous point, status check, status report to squadron leader, regroup with flight and enter exit corridor, exit engagement area as in Ingress.
Return:	Climb to contour flight altitude, make coordination calls, follow safe routing to base, transition flight, status report to base (Regiments command post).
Land:	Penetration and approach depending upon weather, traffic and base EMCON procedures, follow safe arrival procedures, fuel-up and re-arm for reengagement, visual inspection, minor maintenance (as required), load mission planning or systems shut down.
Post Flight Debrief:	Retrieve and review mission data tapes, intelligence debriefing and report, conduct tactical mission analysis, technical post flight test, LRU change if necessary.



Transport helicopters together with combat support and protection helicopters transfer troops and weapons to or from fighting zones. In principle, they have to fight against airborne threats in all phases, and against ground forces near the FLOT. Squadrons, which combine the capabilities for fighting against armoured targets (i.e. tanks) and ground forces, perform missions against targets behind enemy lines. They can fight “stand-alone”, without the assistance of their own ground forces or they can perform missions in close contact with ground forces, in principle staying over friendly terrain using their long-distance fighting capabilities against tanks and similar threats. Within one mission a second engagement period can be performed by changing the engagement area. The mission optionally can be performed by using a forward supply point. In all scenarios and in principle in all airborne mission phases, combat against airborne threats is possible. The missions can be performed day and night and also in adverse weather conditions. A typical mission starts from the rear support base about 80 km behind the engagement zone. The distance to the supported brigade command post (~60 km) is performed in transition flight, which means obstacles are overflown, flight in principle is straight and level. Typical speed is about 220 km/h (day) and 150 km/h (night), with flight heights between 30 m (day) and 50 m (night). This is also valid for return flight. The 20 km from the rendezvous point at the brigade to the firing positions is flown in nap-of-the-earth (NOE) flight conditions. That means obstacles are partly underflown. Flight directions and heights

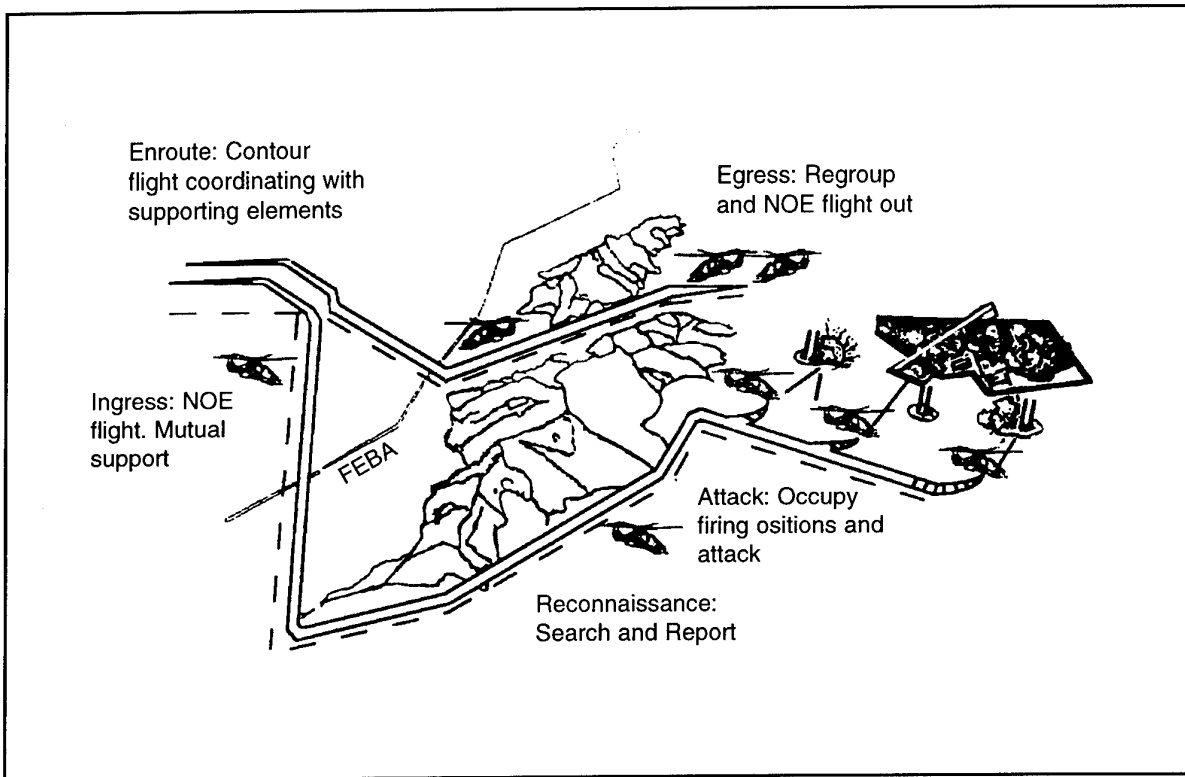

Figure 2-3 Rotary Wing Attack Mission Scenario

vary according to the terrain. Speeds differ from about hover to 80 km/h (night) and 150 km/h (day) with flight heights between 3 m (day) and 5 m (night) up to 10 m (day) and 20 m (night). This is also valid for the egress mission phase.

**2.4.2 Combat Support** – Combat support missions are generally classified as command, control, communications, and intelligence enhancement, air movement of combat power, aerial mine warfare, search and rescue, air movement, fire support, or intelligence and electronic warfare. Command, control, communications, and intelligence enhancement missions include such tasks as movement of command representatives in and around the battlefield, movement of liaison personnel, aerial courier/message services, reconnaissance for lines of communication and aerial radio relay/retransmissions. Air movement of combat power includes the repositioning of troops and equipment, movement of artillery and fire support assets, support to combat engineers, and positioning of air defence systems. Aerial mine warfare missions require the dispersal of land mines from the air to create barriers to movement at short notice. Search and rescue missions involve location and retrieval of lost/injured personnel. Air movement missions involve movement of large quantities of bulk logistic material such as fuel, ammunition, food, etc. Fire support missions involve direct support to artillery units by providing target locations, fire requests/adjustments and damage assessments. Intelligence

and electronic warfare missions typically involve evaluation of specific targets and locations, use of specialized electronic data collection equipment, and employment of active countermeasures.

**2.4.3 Anti-Submarine** – An anti-submarine mission is a typical naval helicopter mission. The adversary in this mission is becoming more difficult to acquire due to his increased speed and stealth. A typical anti-submarine mission involves:

Mission Planning:	Intelligence: tasking, target, threats, timing. Weapon selection. Support: AWACS, jammers. Environment: VFR/IFR, day/night, chemical/nuclear hazard. Attack Planning: target type, threat, alternate targets. Route Planning: fuel available. Coordination with support elements: detailed threat description, last minute intelligence, integrated planning, briefings.
Departure:	Takeoff, ship departure, climb to cruise altitude.
En route:	Review threats & target data, contact command and control agency for final coordination and target updates, route and altitude as required, proceed to ingress entry point.
Ingress:	Altitude and route as required, follow (EMCON) procedures, employ passive/active sensors to detect and analyze threats, avoid or react to threat(s) as required, manage active/passive EW suite and countermeasures, monitor navigation to ensure timely and accurate flight to target area.
Acquire target:	Set up active and/or passive sensors to acquire the target, monitor air threats, positively identify the target(s) and avoid fratricide, set up and manage self protection suite as required
Attack:	Identify and designate target for attack, select desired weapon and attack axis, release the weapon, employ ECM suite, damage assessment, re-attack if necessary
Return to Ship:	Climb to cruise altitude, acquire mother ship, pass on mission/Intel assessment report
Land:	Penetration and approach depending upon weather, and ship EMCON procedures, land, secure aircraft on deck/hanger
Post Flight Debrief:	Retrieve and review mission data tapes, Intel debriefing and report

## 2.5 Conclusions

The intent of this mission description section is not only to give the reader a high level overview of the types of missions the pilot (and crew?) can perform, but also to provide a better understanding of the tasks the pilot must perform in order to complete those missions. In addition, this section makes it apparent just how many activities the pilot must attend to in the process. Clearly, a lot must be accomplished. While the section does not describe in detail all the switch actions and button pushing that is required to accomplish each task, it does reflect that the pilot is immersed in a complex and busy environment.

The next section of this document describes a variety of cockpit designs which are currently being used to accomplish the missions described here. An underlying concept that should be kept in mind is that the development of a cockpit requires the design team to carefully implement a systems engineering method for deriving the true mission requirements. It should also be noted that there are always tradeoffs to be addressed in the cockpit design process. The design process is accomplished, in part, by using analytical techniques to determine mission, system, and task requirements, and by analysing prospective designs to ensure that the pilot has the information, skills, and system capability to perform the design mission or missions. This section has provided the basis for determining the kinds of tasks necessary to successfully complete those missions.

### 3.0 COCKPIT DESCRIPTIONS

#### 3.1 Introduction

The primary purpose of a modern combat aircraft is to engage and destroy hostile targets while ensuring ownship survivability to fight again another time. Over the past two decades western fighter aircraft have proven themselves effective, reliable tools in achieving this goal with up to 96 : 0 kill ratios reported for some aircraft types (F-15 for example). An integral part of this success can be attributed to the advances made in providing the pilots with better information and cockpits.

The cockpit is the tool that the pilot uses to interface with the aircraft to perform the mission tasks described in the previous section (Mission Descriptions). Greater emphasis on multi-role capable aircraft equipped with more sophisticated weapons and sensors has forced cockpit designers to provide increasingly complex controls and video /

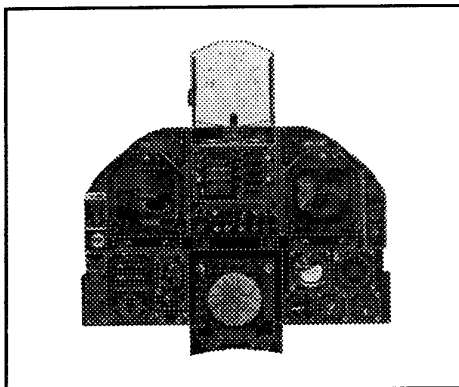

Figure 3.1 Generic Glass Cockpit

graphic displays to the pilot. Single purpose CRT's and electro-mechanical displays are no longer capable of supporting these systems, which has led to a moderate growth in the use of "glass cockpit" technologies over the past 25 years. Greater emphasis on mission effectiveness, weapons accuracy, and reduced pilot workload in the cockpit has made further demands on the technologies currently embodied in the cockpit. As a result of these demands designers of recent cockpits have replaced conventional head-down electromechanical instruments with more flexible (and capable) multi-function displays, HUD's, and more recently HMD's, as shown in Figure 3.1. Applications of these glass technologies can now be found in almost all military and many civilian aircraft. For the purpose of this report, AGARD WG 21 members have adopted the following definition of "glass cockpit technology":

*those portions of the cockpit capable of providing pilot interaction with, and dynamic display of a variety of versatile, flexible video or graphic symbology and imagery in support of aircraft flight data, systems, sensors, and/or weapons.*

To understand how various glass cockpit technologies have been employed in current production aircraft, the working group performed an informal study of 19 aircraft, including military rotary and fixed wing combat aircraft and civil transports. A detailed description of each of these cockpits, including full page colour photographs, is presented at Appendix A. Each cockpit described is either currently resident on "in-service" aircraft, in preliminary design, or in a production and evaluation aircraft. Each description highlights:

- aircraft characteristics
- missions & mission equipment
- cockpit layout
- underlying cockpit design concepts
- HOTAS/HOCAS (Hands on Throttle/Collective and Stick)
- descriptions of major cockpit systems – HUD, data entry systems, displays
- backup modes of the cockpit
- planned improvements

The aircraft cockpits represented in the Appendix are:

- |                     |                            |                                     |
|---------------------|----------------------------|-------------------------------------|
| 3.1 Tornado         | 3.8 Rafale                 | 3.15 Tiger                          |
| 3.2 F-15 C Eagle    | 3.9 Harrier GR-7           | 3.16 MV-22 Osprey                   |
| 3.3 F-18 C/D Hornet | 3.10 AV-8B Harrier II Plus | 3.17 Longbow Apache                 |
| 3.4 F-15 E Eagle    | 3.11 F-18 E/F Hornet       | 3.18 RAH-66 Comanche                |
| 3.5 AMX             | 3.12 Eurofighter 2000      | 3.19 Commercial Airline<br>Cockpits |
| 3.6 F-16 C/D        | 3.13 F-22                  |                                     |
| 3.7 Mirage 2000-5   | 3.14 EH 101                |                                     |

This section will highlight trends in the use of various glass cockpit technologies as evidenced in the analysis of the aircraft cockpits described in Appendix A. While the list of aircraft analyzed is by no means exhaustive, the analysis of this limited set of aircraft cockpits clearly indicates certain trends and common usage of some glass cockpit technologies. Following a discussion of these trends, a summary of the relative strengths and weaknesses of the various technologies will be presented. A more thorough discussion of available glass cockpit technologies, the relative merits and drawbacks of each, and the trends in industry is given in the next section.

### 3.2 Design Constraints

Although many of the technologies required for greater use of glass in the cockpit were available for the earlier aircraft (ie F-15, F-16, Tornado) they were not implemented for various reasons. Some of the factors which have influenced the amount of glass technology manufacturers have used in a new aircraft cockpits include ;

**Technological Risk** risk / cost management principles required that the incorporation of newer video, graphic and display technologies could be achieved at acceptable levels of cost, performance, and reliability prior to installation into a new cockpit.

**Multi-Role Aircraft** the trend towards aircraft which are capable of multi-missions / roles, and the supporting array of weapons and sensors required for that capability, cannot be accommodated using mechanical instruments and single purpose CRT's.

**Cockpit Size** stealth, performance and affordability concerns have driven designers to smaller aircraft while increased use of "systems" require more control and display area. This conflict results in cockpit space being at a premium, thus efficient, multi-purpose use of the main instrument panel area is paramount.

**Flexibility / Growth** rapid development of better sensors and weapons systems demand flexibility in modern cockpits through software changes instead of hardware. Additionally the high cost of modern combat aircraft requires longer in-service life supported by major upgrade programs. The inherent flexibility of the glass cockpit make supporting both of these objectives easier, quicker and more cost effective as compared to more conventional cockpits.

### 3.3 Technology Trends in Glass Cockpits

The cockpit descriptions presented in Appendix A have been grouped according to aircraft type; namely fixed combat aircraft, rotary wing military aircraft, and civilian transport. Within these groups, the aircraft are presented in order of the approximate design period that they were conceived and/or built. This ordering presents, among other things, a chronology of the application of glass cockpit technologies over the past 25 years. However, use of a particular technology was also a function of mission requirements, cost, risk factors and even political considerations.

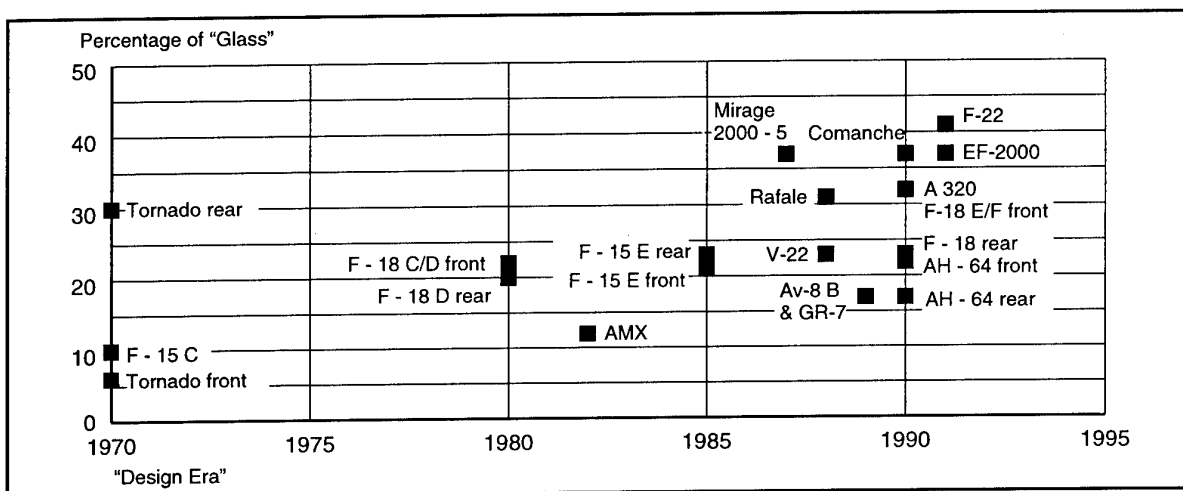

Figure 3-2 Trend in Cockpit "Flexible" Display Area

The most obvious change in cockpits designed over the past two and a half decades has been the steady growth in the amount of available instrumentation space dedicated to glass displays. Using the descriptions of aircraft cockpits contained in Appendix A, a study of the use of glass technology in each cockpit was performed by comparing the area of interactive flexible displays (excluding the HUD) with the total area available on the main instrument panel (not including side panels). The result of this effort, plotted against the year the aircraft was designed, (Figure 3-2) indicate a slow but steady growth in the area dedicated to glass displays from roughly 15 % to approaching 40 % of the main instrument panel.

From the cockpit descriptions presented in Appendix A, a "summary at a glance" page was developed to highlight the variety of technologies present in each cockpit and is included as Table 3-1. This summary provides the structured information upon which the trends in cockpit technology can be assessed and an evaluation of the strengths and weaknesses of generalized, present day, glass cockpits can be performed. These evaluations, presented in section 3.4, are based on the presentations by various working group members and company representatives on each cockpit, discussions of operational requirements and problems, and simulator demonstrations of a selected number of these cockpits to the working group over its tenure.

Technology trends evident from an examination of Table 3-1 highlight a move towards more flexible software driven multi-function displays; the use of HUD's and more recently HMD's; a consistent reliance on the interaction/control through the use of conveniently located data entry panels; the general acceptance and wide spread use of the HOTAS concept; and limited applications of Direct Voice Input (DVI). Side panels in these cockpits have generally become less cluttered over the years and there is a clear trend towards presenting more mission critical information "upfront" and "eyes out". A brief summary of some of the more apparent trends in cockpit technology is given below:

**HUD's** have replaced conventional weapons sights and are present in all of the fixed wing combat aircraft identified in Appendix A. The trend in HUD's has been primarily toward enlarging the instantaneous and total FOV (from 16 - 18 deg to 30 deg) and providing both stroke and raster capabilities in order to support Electro-Optical sensors and weapon systems. Limited applications of HUD's are also evident on recently designed combat rotary wing aircraft (eg. Tiger) and have been introduced in some civil airline carriers.

**MFD's** have replaced the majority of conventional round dials and now occupy up to 40 % of the available instrument panel space. Size of the individual displays, however, has not significantly increased over the past 20 years. The trend to move to colour displays (both hybrid and full colour) is readily apparent and some CRT and electromechanical instruments are being replaced by Active Matrix Liquid Crystal Displays (AMLCD) in more recent aircraft (Rafale, Tiger, F-18 E/F).

**HMD's** were first used in combat rotary wing aircraft and are still more prevalent there than in fixed wing aircraft. HMD's are present in only 6 of the 18 aircraft surveyed. However, the working group anticipates that their use will increase dramatically over the next 5 - 10 years as this technology matures and older cockpits are retrofitted with HMD's. Applications have been primarily for the display of electro-optical (E) sensor data, and weapons sights, and some flight symbology. The trend to change from monocular systems first used on the Apache helicopter to biocular and binocular systems is apparent. In the future, we expect that HMD's may even replace the HUD as the primary weapons, sensor and flight data display.

**HOTAS** As more flexible MFD's have been added to the cockpit, the ability to control aircraft, sensor and weapon functions through software driven keys has also increased with a commensurate increase in the number of functions controlled via HOTAS. Although an increase in the number of switches on the stick and throttle(s) is not apparent as the physical size, shape and location of these switches have reached a practical limit, increased flexibility and control is being provided by using multi-function switches, master moding, and a cursive type controller (ie. mouse) to operate soft keys on the MFD's. Unfortunately, this greater degree of flexibility has also added complexity and may force alternative technologies such as DVI to be used in future cockpits.

**Data Input/Output** Almost all of the aircraft described in Appendix A have some sort of conveniently located, flexible digital data entry panel which has almost become the accepted standard for military aircraft. Several aircraft also include a rapid data insertion capability for mission planning. However, this capability is not common

Table 3-1 Aircraft Cockpit Technology / Function Matrix

	F-15C	F-15E	F-15E	TORNADO	TORNADO	AMX	F-18A-D	F-18E/F	F-18E	AV-8B Plus	HARRIER GR7	MIRAGE 2000-5	RAFALE	EF2000	TIGER	TIGER	AH-64 LONGBOW	AH-64 LONGBOW	EH-101	RAH-66 Comanche	A330
Multifunction Head Down Displays	2	2	2	SM	SM	C	2	1	1	2	2	3	2	3	2	2	2	2	8	3	3
Monochrome Technology (note 1)	C	C	C				C	L	L	SM	SM	LSM	L	SM	L	L	C	L	L	L	L
Colour Technology (Note 1)	1	1	3			1	3	3	3		SM	SM	L	SM	L	L	C	L	SML	L	SM
Reversionary Displays	SM	SM	SM			SM	SM	L	L												
No. of Modes																					
Flight Data																					
Navigation																					
Map																					
Warnings (note 2)																					
Warnings/Cautions																					
EW																					
Eng/Fuel																					
Weapons/Mode Selection																					
Radar																					
HUD Symbology																					
Head Level Display																					
IFOV																					
TFOV																					
Monochrome																					
Colour																					
Cursive																					
Raster																					
HUD Symbology																					
Head Up Display																					
IFOV	18						18	22	22	20	20	18x18	30x22	20	20	20	20	20	20	20	52x30
TFOV	20						20	28	28	22	24	24	30	20	20	20	20	20	20	20	52x30
Cursive																					
Raster																					
Primary Flight Data																					
Sensors (Note 2)																					
No. of Modes																					
Monocular FOV																					
Binocular FOV																					
Cursive																					
Raster																					
Helmet Tracker																					
Sensors (Note 2)																					
Night Vision (Note 3)																					
EW																					
Radar																					
Engines																					
Fuel																					
Compass																					
Other																					
Data Input Facility																					
Up Front Controller																					
DVI																					
Control & Display Units																					
Data Cartridge																					
Data Link																					
Touch Screen																					
HOTAS/HOCAS	11	9	6				10	10	8	9	17	14	21	14	14	12	6	6	19	14	3
Stick Functions	6	6	6				8	8	8	8	17	9	11	11	12	12	13	13	21	8	8
Hand Controller																					

Note: 1. SM = shadow mask; L = LCD; P = pseudo colour; C = CRT  
 2. I = image intensifiers; F = Forward looking IR; S = Steerable IR; R = Radar; T = TV tracker; LT = Laser spot tracker; N = NVGs  
 3. I = Image Intensifiers; F = Forward looking IR; S = Steerable IR; R = Radar; T = TV tracker; LT = Laser spot tracker; N = NVGs

to all aircraft designed in a similar time period and appears to be more a function of the customer's choice and economics rather than technology availability. While Direct Voice Output, DVO, particularly for warnings, are widely accepted in all types of aircraft, Direct Voice Input, DVI, have only seen very limited use in designs to date and only in non flight critical applications.

**Multi-sensor Integration (MSI)** Limited application of sensor integration (or sensor fusion) onto a single display has been achieved in some cockpit designs (F-18, EF-2000, AH-64). Problems still exist in achieving common reference systems between a variety of sensors and the display of that information based on different formats, range scales, and sources.

### 3.4 Cockpit Technology Strengths and Weaknesses

The technological trends cited in the last section define the evolution of the cockpit over the past 25 years. Each of the technologies currently present in the cockpit provide some increase in effectiveness or tactical advantage but most have weaknesses in application as well. The table below summarizes discussions held by Working Group 21 on the relative merits and pitfalls of today's cockpit technology.

#### Technology

Potential Benefits	Potential Weaknesses or Current Issues
<b>Multi-Function Displays (MFDs)</b>	
Flexibility – the same instrument panel area can serve multiple purposes	Too much flexibility can lead to poor procedures and confusion (where is this information supposed to be? / How do I get to it?)
High brightness and resolution	Currently supported by a menu architecture which can become cumbersome and confusing and also uses up display area for labels or requires more expensive software labelled switches
The MFD cockpit can be easily reconfigured to retain important information in the event of a display failure	Considering the vast volume of information that can be displayed, the restricted size of a cockpit display is currently a weakness
The MFD can allow the integration of a variety of sensors into one picture.	How should the combination of the information from sensors with differing perspectives and information content be performed? Is the required computing power available?
MFD symbols can be generated in colour	Colour currently reduces resolution and brightness compared to monochrome.
Pictorial information can be presented	Currently there are few guidelines to suggest what <u>should</u> and what <u>should not</u> be presented
<b>Head-Up Display (HUD)</b>	
Provides primary flight and sighting information in a "head out format"	Uses the best instrument panel real estate for the HUD display/optics package
Very accurate boresight reference	Limited field of view and off-boresight capability
	Increases visual obscuration (another piece of glass between the pilot and the world) , clutter of symbology
<b>Up-Front Controller (UFC)</b>	
Makes use of HUD package real estate	Keyboard entry of data is often non-optimum
Promotes "head out"	Over reliance by cockpit systems
Reduces cockpit switch count	
<b>Hands-On-Throttle and Stick (HOTAS) or -Collective and Stick (HOCAS)</b>	
Allows system control with hands on controls	Complex, not enough switches for all uses
<b>Direct Voice Input (DVI)</b>	
Reduces reliance on switches	Error rates
Transfers workload to another "channel"	Shutdown of vocalization in periods of stress
Reduces "head- in" cockpit time	Untried in the battlefield environment

## Technology

### Potential Benefits

Simplifies laborious data entry tasks  
(ie. position information)

### Potential Weaknesses or Current Issues

Currently speaker dependent only (must be trained for each crew member)

### Data Cartridge Input

Reduces in cockpit mission planning

Requires on-ground support hardware

Reduces data input tasks

### Moving Map

Improved navigational awareness

Limitations on brightness, colour, detail, data base

### Helmet Mounted Display (HMD)

Improved "head out" capability

Ill defined symbology

Large off-boresight capability

Poorer sighting accuracy

Reduced HUD requirement

Increased helmet weight

## 3.5 Conclusions

Over the past 25 years there has been a marked increase in the use of glass technologies in the design of modern combat and civilian aircraft cockpits. An analysis of 19 current in service, or preproduction cockpits clearly demonstrates the increased use of software controlled MFD's, HUD's and HMD's, and automated data entry and control functions. All of the emerging or mature technologies promise to improve overall mission effectiveness through the reduction of pilot workload, increased mission flexibility, and the ability to support more sophisticated weapons and sensors. However, each of these technologies comes at a price and carries its own set of limitations and problem areas.



## 4. TECHNOLOGY STATUS AND TRENDS

### 4.1 Introduction

As presented in Section 3, the man-machine interface of existing glass cockpits consists of a blend of different display and control technologies ranging from conventional electro-mechanical dials to flat-panel colour displays and helmet mounted displays. This is mainly because new technologies have been introduced to the cockpit in an evolutionary and continuous manner rather than by the revolutionary introduction of radically different display and control concepts.

Of course the perception that cockpit design has developed in a pure evolutionary manner is not entirely correct since specific cockpit designs have indeed been revolutionary. A notable example is the McDonnell Aircraft F/A-18 which first introduced the glass cockpit concept in an operational military aircraft. Nevertheless, in new aircraft designs and subsequent updates, new technologies have normally been introduced cautiously, leading to the coexistence of various versions of an aircraft, all designed to respond to the same operational requirements, but characterized by the inclusion of a wide spectrum of display and control technologies.

In this Section an overview of available state-of-the-art display and control technologies will be presented, as will an evaluation of the maturity of each technology as far as application to current operational aircraft is concerned. In addition, the more likely future developments in displays, controls and other Man-Machine-Interface (MMI) technologies will be identified, leading up to a more thorough analysis of future cockpit design trends in Section 8, Future Cockpits.

### 4.2 Current Cockpit Technology Overview

When examples of current Glass Cockpits were reviewed in Section 3, a number of MMI elements were in evidence. These elements can be divided in two groups:

**Output devices:** constituting the vehicle-to-pilot channel of the MMI, formed essentially by:

- Head Down Displays (HDDs);
- Dedicated Displays;
- Head Up Displays (HUDs);
- Helmet Mounted Displays (HMDs);
- Direct Voice Output (DVO).

**Input devices:** constituting the pilot-to-vehicle interface:

- Hands On Throttle And Stick (HOTAS) controls;
- Keyboards;
- Data Transfer Devices (DTD);
- Direct Voice Input (DVI);
- Touch-screens;

It is clear that such a division is rather crude, since some of the output devices listed above are also used to input data. For example HMDs are used as input devices in target designation by the pilot looking at the target and pushing a HOTAS button, or uttering a voice command. Despite this minor shortcoming, the above classification of MMI elements will be retained in this section for sake of simplicity. The technology of DVI/DVO will be treated in the input devices category even though it is clearly an integral input/output system.

In the following paragraphs, the state-of-the-art in display and control technology will be described for each of the above listed elements. In addition, an overview of illumination issues of modern Glass Cockpits will also be presented.

As already highlighted, in some current Glass Cockpits state-of-the-art technology has been integrated with more conventional equipment which are used for back-up purposes in the event of major electronic faults. These more traditional equipments and technologies will also be considered and discussed.

### 4.3 Output Devices

**4.3.1 Head Down Displays (HDDs)** – Early HDDs were based on cathode ray tube (CRT) oscilloscopes that presented radar video to the pilot. These displays were monochrome and only able to present the raw data produced by the radar source. As modern airborne computers have become smaller, lighter and more capable, it has become possible to generate complex moving graphical symbology in real-time, and consequently, to transform the raw sensor data into a synthetic pictorial representation for the pilot. HDDs built around modern CRT technology and sophisticated symbol generators have become standard equipment in almost all recent civil and military cockpits. They not only replace the conventional dials and gauges, but they are capable of presenting different combinations of information on demand during the mission, which provides the potential to improve the pilot's situational awareness while making more efficient use of cockpit space. This selectable streaming of information to a single display has given rise to the name Multi-Function Display or MFD.

Since MFDs have the intrinsic capability to present processed rather than raw information, psychologists and human factors experts have found the MFD to be a tool to reduce pilot workload and increase pilot situational awareness while avoiding the saturation of the pilot with a plethora of data. While the root of development in this area is an information processing rather than hardware issue, the concept is a fundamental concern which is driving the development of the display technology. As an example, the availability of colour CRT displays have increased the capability of MFDs and are proving to be essential for certain applications such as map displays.

HDDs consist of two basic components, the display itself and the symbol generator. In some applications these are in a single unit, in others a single symbol generator (backed up by a similar unit for reliability reasons) is capable of driving several MFDs as well as the HUD and the HMD. With this integrated architecture, most HDDs are capable of displaying any video image derived from sources such as TV/IR cameras and map generators as well as the basic flight symbology which normally appears on the HUD.

Today there are basically two HDD technologies in use, CRTs and Active Matrix Liquid Crystal Displays (AMLCDs). Other technologies such as plasma displays and Light Emitting Diodes (LEDs) are less common, although LED displays are found increasingly in applications such as multi-function warning displays and programmable keys. In CRTs, the most commonly used type is shadow mask technology, but beam index and penetration tubes have had limited application.

CRTs and AMLCD HDDs are currently available in either monochrome or colour. Monochrome HDDs have a higher resolution and brightness and are used where such characteristics are essential while the use of colour is becoming more prevalent to give further information content to display formats. NVG-compatibility, which is a typical requirement for current designs, is achieved by using appropriate phosphors, colour selections and display filters.

Images on CRT HDDs can be generated either in a raster mode or in a cursive writing (stroke) mode. Cursive writing provides better definition and symbol brightness, but the amount of stroke symbology that can be written at reasonable update rate is limited, so large, filled areas are impractical. When displaying filled areas becomes important (e.g. when presenting geographic maps) the raster mode is essential, unfortunately this mode has brightness limitations must be considered. A compromise solution in some applications is the use of a mix of raster scanning for imagery with cursive, or stroke, symbology written in the fly-back period. A further complication is that the structure (ie. pixel size/spacing) of a display surface, such as raster or LCD matrix, may create display artifacts through aliasing if the image source structure differs from the display structure.

An interesting development of HDDs is the Head Level Display, which is located immediately below the HUD, as typified by the Rafale aircraft (see Section 3 and Appendix). This type of display, using a CRT or LCD and

associated optics, presents an image which is collimated at infinity, thus reducing the need for the pilot to refocus his gaze when transitioning from a "look-out" to a "look-in" situation. In addition, the location of the Head Level Display allows novel applications, such as the presentation of weapon aiming symbology in an area below the normal HUD Field of View (FOV).

In the foreseeable future, larger display panels with higher brightness and resolution will become available and affordable. These improvements will maximize the effective display area of the cockpit allowing a more flexible, intuitive and integrated presentation of information such as plan and perspective views, split screen and movable inserts.

Another display technology that is currently in the research phase is the stereoscopic, or 3-Dimensional, display. This technology enables the presentation of a 3-D image to the pilot. Up to now, these displays have required the user to wear devices such as shuttered or polarizing spectacles. Current research efforts have eliminated this requirement. The addition of a third dimension will offer the capability to more effectively present the outside world to the pilot and can also be used to declutter and separate certain types of information. The advantages of this technology must be assessed in concert with a consideration of the image computation capability that it requires, and issues such as reliability and cost.

**4.3.2 Dedicated Displays** – Despite the widespread introduction of MFDs into the cockpit, dedicated instruments such as those for basic flight parameters and engine conditions, are still resident in most modern glass cockpits. These basic displays are now, however, more often in the form of dedicated, flat panel displays (eg EF-2000) rather than the traditional pneumatic and electro-mechanical devices.

There are two basic reasons for retaining dedicated displays. Safety reasons often dictate the retention of a number of dedicated standby instruments which are fundamentally disassociated with the primary bus and electrical architectures of the aircraft. Also, it is sometimes preferable to present specific information in specific locations in the cockpit, to facilitate rapid access. It is clear, however, that as soon as large size, high integrity, reconfigurable HDDs with no single point of failure become available, the rationale for dedicated displays will have less substance.

Typical dedicated displays seen in current glass cockpits are: Back-up primary flight, engine and fuel information, warning panels, attitude getters, threat warning displays, armament panels, communication and identification read-outs. While more and more information is being presented on single, more integrated, forms of display, the requirement for essential "Get-U-Home" information will still have to be addressed in future cockpits.

**4.3.3 Head Up Displays (HUDs)** – HUDs are found on practically all contemporary combat aircraft and some military helicopters, and their use is widening on transport aircraft. The HUD concept was derived from opto-mechanical gun sights that were used on older generations of combat aircraft. The later versions of these optical sights were indeed similar to modern HUDs, since they presented collimated weapon aiming symbology on a semi-reflective glass surface in front of the pilot's eyes. However, these gun sights were mechanically-driven and the symbols were in a fixed format.

The modern HUD was made possible by the development of bright Cathode Ray Tubes (CRTs) and robust combining optics. As computer capabilities have improved, the generation of complex dynamic symbology has become possible. Weapon aiming symbology is now supplemented by basic flight symbology (e.g. attitude, speed, height, vertical speed, G) and navigation data. The advent of imaging sensors, such as FLIR and Low Light Level TV, have introduced the requirement for raster capable HUDs so that the images from these sources can also be displayed "eyes out". Modern HUDs have the dual capability of presenting raster imagery with cursive symbology written during the raster flyback period. It should be noted that HUDs are still the only equipment capable of ensuring the symbology positioning precision required for weapon aiming purposes (typically about 1 mrad).

Modern HUDs are almost universally based on a monochrome CRT and some form of optical relay system. The final combiner element of the HUD optics allows the pilot to see the reflected collimated image of the CRT superimposed upon the natural forward view. Combiners were initially conventional reflectors, using partial silvering to proportion the reflective/transmissive properties. The use of dichroic coatings which reflect only a selected, but still fairly broad, frequency band of light, were later used to improve the contrast of the HUD image, albeit with some discoloration of the outside world when seen through the combiner. These dichroic coatings are

tailored to match the wavelength of light produced by the CRT phosphor. More recently, the use of holographic combiners has not only improved the reflective properties by exactly matching the reflective wavelength to the phosphor characteristic wavelength, but has also reduced the level of outside world discoloration to almost zero.

The size of the displayed image measured in degrees subtended from the pilot's eye position is defined as the field of view (FOV). The image size when viewed from the design eye box, is called the Instantaneous FOV (IFOV), and the total image that can be seen with head movement in all directions is called Total FOV (TFOV). Latest holographic HUDs have a TFOV in the order of 20 vertical by 30 horizontal degrees and IFOV about 17 x 25 degrees, compared with a typical TFOV of 20 x 20 degrees and IFOV of 16 x 16 degrees capability for reflective optics, dual-combiners HUDs.

The desire for a HUD with a wider field of view requires the use of larger optical elements and therefore exacerbates the installation penalties of HUD units in the cockpit. Techniques such as dual combiners, whilst improving the HUD FOV, create more visual obstructions for the pilot. Holographic technology continues to be improved, resulting in combiner optical properties which enable wider instantaneous and total field of views with less overall obstruction. Further increases in HUD FOV are now becoming constrained by cockpit geometry considerations, as well as technological limitations. Since the intent of increasing the HUD FOV is to increase the engagement and sensing "field of view" for the aircraft weapons and systems, current technological developments suggest that the later appears to be more easily achievable by the use of Helmet Mounted Displays (HMDs).

In concert with an HMD, the HUD may still be an installation in future cockpits. Further evolution of the HUD may rely on the miniaturization of existing technologies and the introduction of colour in the displayed image, although the stringent brightness requirements of the HUD image will continue to be a source of concern. Further developments of Liquid Crystal Displays (LCDs) could provide a solution in this area.

**4.3.4 Helmet Mounted Displays (HMD)** – As alluded to in previous paragraphs, the maximum available HUD FOV is only a fraction of the external field of regard important to a modern combat aircraft and its pilot. During typical operations the pilot will often lose reference to essential data (such as attitude, basic flight and weapon aiming parameters presented on the HUD) whenever he looks outside the HUD field of view. This is a very frequent occurrence during combat manoeuvring, for example. In addition, the off-boresight capability of modern air-to-air and air-to-surface weapons cannot be fully exploited on an aircraft equipped with a HUD only, since the HUD implementation requires the pilot to manoeuvre the aircraft in order to overlay the HUD weapon aiming symbology on the target for designation. Moreover, on many aircraft operating at low altitude at night the HUD is used to present a raster video derived from an IR or image intensifier sensor. This is an adequate installation when displaying imagery from fixed forward-looking sensors, but this display/image combination can cause spatial disorientation if the image is produced by a non-fixed or slewable sensor unless due consideration is given to the method of presenting the imagery and symbology.

All of these HUD deficiencies drive the requirement to present the symbology normally presented on the HUD together with the raster video derived from a slewable IR sensor and/or from a night vision enhancement device, directly to the pilot's eye.

Helmet mounted devices were first used operationally on helicopters, where monocular Helmet Mounted Sights (HMSs) were used to control turret guns, slewable sensors and to designate ground targets for air-launched rockets and missiles, and on fixed-wing aircraft in conjunction with a radar and infra-red air to air missiles. These applications consisted essentially of a helmet position tracker and a mini-gunsight with a combiner in front of the (single) eye. Symbology was typically a simple collimated aiming marker reticle, generated by a miniature lamp or a Light Emitting Diodes (LEDs) pattern.

When miniature CRTs became available, they were integrated as a helmet display source, thereby enabling more complex, dynamic symbology to be provided and ultimately used to display the output of imaging electro-optical sensors. This Helmet Mounted Display (HMD) is in many respects optically similar to the HUD, in as much as it has a display source, an optical relay and a combining element. Since this is the only item of avionic equipment the pilot wears, however, there are a multitude of design aspects which must be considered. Size, weight, centre of gravity (CG), inertia, field of view, exit pupil, eye relief, inter-pupillary distance and comfort are some of the inter-related variables that the HMD designer must consider. In addition, the helmet must provide protection, life support and communication facilities. The umbilical cable for the HMD must not restrict the pilot's head

mobility and must be capable of rapid disconnection in the event of emergency egress or ejection. In a high g aircraft, where the forces of acceleration, ejection and wind blast must be survived by the helmet and the pilot, the design of the helmet is critical not only to mission success but also pilot survival. These issues are addressed further in Section 5.6.

HMDs were initially monocular in the interests of minimising weight, and were used for applications such as weapon aiming and daytime flying. Binocular HMDs have been produced and are considered to be more appropriate for enduring tasks and night operations where binocular rivalry problems become more manifest. Binocular systems have the potential to portray stereoscopic imagery, although the accuracy requirements to achieve this are severe. Binocular systems which display identical imagery to both eyes are, strictly speaking, termed biocular systems.

One of the earliest HMDs was the Night Vision Goggle (NVG), which, whilst providing an important and unique operational capability to both helicopters and fixed-wing aircraft, had the significant disadvantage of adding about 800 g mass high and forward of the CG of the pilot's head. The integration of image intensifier tube(s) to an HMD is one way of overcoming this issue and provides what is generally referred to as the Integrated Helmet.

Most HMDs to date may be considered as "add-on" devices. In the future, for optimal performance (in all respects), the helmet shell/optics/life support functions must all be considered systematically from the outset of design to provide a truly integrated concept.

An essential element of any HMD system is the helmet tracking system. This must measure the angle of the helmet relative to the aircraft, and in some cases the position of the head in aircraft x, y, and z axes. The volume in which the system is effective (the head motion box) must not restrict the pilot's normal head motion. Electro-magnetic, IR, optical and acoustic technologies have all been developed with varying degrees of success. Accuracies approaching 2-3 mrad are achievable in some instances which almost approaches HUD accuracies. Only when these accuracies can be reliably achieved and adequate, high integrity, HMDs are available, will designers have the option of relying on HMDs for targeting and thus be able to delete the HUD from the cockpit.

The ability to track the pilot's eye direction offers potential advantages such as more natural aiming, designation of controls within the cockpit and, due to the eye's natural stability, this capability could be used to damp out the effects of turbulence on HMD aiming. Although there are several systems which function reasonably well in laboratory conditions, systems which operate satisfactorily in a cockpit have yet to be developed. In general, the operating principle of an eye tracker is the detection of the corneal reflection of a collimated IR beam, relating that to the centre of the eye and finally computing the direction of gaze. This angle must then be added to the output of the helmet positioning system to determine the orientation of the eye sightline relative to the aircraft axes system. It is reasonable to expect that acceptable eye tracking performance will be achievable for the next generation of cockpits.

Most state-of-the-art HMDs are still monocular, but some binocular examples have been produced. The typical HMD FOV is about 30 deg circular with a resolution of about 2000 x 800 pixels. Monochromatic, cursive imagery is used to ensure sufficient brightness in high ambient light conditions. Larger FOVs and exit pupils tend to increase the weight of HMDs disproportionately. The FOV in binocular HMDs can also be increased by reducing the stereo overlap region of the two optical fields although this can introduce undesirable effects such as an uneven brightness level across the total field. Recent developments in high performance sub-miniature ( $1/2$  in) CRTs and holographic optical configurations have enabled the realization of wider FOVs at less weight and volume.

In the near future the trend will probably be to fit military aircraft cockpits with HMDs and an associated "low-profile" HUDs to ensure on-axis weapon delivery for gun and bombs and as a standby device. HMD CRTs will probably be replaced by miniature, high resolution LCDs, with colour being a realistic option. Achieving adequate brightness for all viewing conditions remains a concern.

When considering that the "windowless" cockpit is a realistic option for future cockpit designs (see also Section 8, Future Cockpits), the HMD will probably be a vital element for future aircraft, capable of presenting symbology, sensor video as well as synthetic external world imagery with an unrestricted field of regard, limited only by human physiological movement constraints.

## 4.4 Input Devices

Crew control of the different aircraft systems has been achieved by means of a variety of control devices, actuated by fingers, hands and feet. In older cockpits, the main instrument panel, quarter panels and side consoles were crowded with switches, push buttons and rotaries, each dedicated to a single control function. In the modern glass cockpit, only a limited number of dedicated controls, such as those for system power supplies, emergency actuations, weapon release, etc., are retained to achieve high integrity levels or rapid access for these functions. The remainder of control functions are met by the introduction of multi-function controls, reducing the use of essential cockpit space and adopting the same concept of providing a function only when it is really needed as already considered for HDDs. Typical examples of multi-function controls are the multi-function keys around the HDDs. These are normally associated with variable captions presented on the HDD surface adjacent to the key. More recently, these multi-function keys have been developed with integral, internal, multi-legend LEDs (EF-2000) thus freeing more of the HDD surface for the display of information.

Similarly, push buttons or rotary controls may be located adjacent to LCD or LED matrix displays to indicate the selected parameter (e.g. communication frequency/channel selectors). In a similar way, push buttons with integral multi-legend LED matrices and associated read-out areas are being used to make better use of prime cockpit space. A prime example of this are the typical Up Front Controllers seen in many of today's aircraft cockpits.

The more common input devices are discussed in the following paragraphs.

**4.4.1 HOTAS controls** – Adoption of the Hands On Throttle And Stick (HOTAS) and Hands on Collective and Stick (HOCAS) philosophy is almost universally pursued in modern cockpits since it allows more immediate and effective operation during the most critical phases of the mission. In combat the pilot cannot afford to look into the cockpit for the correct switch and take his hands off the throttle or stick to operate it. This realization led to the concept of placing critical, fast reaction controls where the pilot places his hands during critical phases of the mission.

In order to achieve the HOTAS goal, it is necessary to shape the stick and throttle tops ergonomically and to locate controls in such a way to enable an instinctive activation. State-of-the-art stick and throttle tops are appropriately contoured to enable effective grip without undemanded action on the controls. It is desirable to retain access to the HOTAS controls without undue hand twist. Multi-functioning of HOTAS controls has been used widely, but it should be used judiciously due to the necessity for instinctive operation in high stress, high workload situations.

It should be noted that in some cockpits the appropriate use of a two-axis controller on the throttle or stick reduces the need for multi-function keys around the HDDs. In fact the pilot can use finger operated, force-sensing joysticks to move a cursor on the HDDs and/or HUD in order to select the appropriate functions. Reliability concerns, however, normally require a back-up control capability thus requiring multi-function keys around the HDDs to be retained.

**4.4.2 Keyboards** – On many occasions the crew is required to input strings of alpha-numerical data into the weapon system. Typical examples are navigation route sequencing, route point coordinates, IFF codes, etc. A full, computer-like keyboard is often impractical for space and operability constraints. For this reason data entry keyboards on combat aircraft and helicopters are always miniaturized and tailored to fit in the (small) available space. Normally these keyboards consist of an array of relatively small push buttons on which is engraved the character/function. Associated with these keys is a read-out display (scratch-pad), using LCD or LED matrices with full alpha-numeric capability.

The requirement for precise data input in all vibration conditions wearing gloves limits the minimum size and separation of data input keys. To overcome this problem, data entry facilities with multi-legend keys have been introduced, allowing a better use of the limited cockpit space. These keys usually incorporate LED or LCD technology.

The use of keyboards is being supplemented by use of Direct Voice Input (DVI) systems, as detailed in a following paragraph. However, entering long strings of alphanumeric characters can be faster and more reliable on a keyboard than with current state-of-the-art DVI systems. Even when DVI recognition rates approach 100%, data input keyboards are likely to be retained in the cockpit for back-up purposes.

**4.4.3 Data Transfer Devices (DTD)** – As discussed in Section 2, mission planning is an integral part of the tasks performed to accomplish a mission with a military aircraft. Usually this planning is accomplished prior to takeoff, and typically at a planning station which is not in the aircraft. This process generates a large amount of data that requires loading into the aircraft systems. Typical data includes route points, targets, weapon packages, weapon release parameters, IFF codes and changing times, COMM frequencies and channels, etc. In order to avoid the lengthy, boring and error-prone procedure of manually entering this data in the cockpit, almost all modern aircraft use some form of Data Transfer Device (DTD). This device normally consists of some form of solid state data storage medium which is loaded with the required mission data using the ground based facility. The DTD is then inserted in a receptacle in the cockpit to download the data into the aircraft systems. It is also possible to use the DTD to load other data such as default display settings and DVI templates that are unique for each individual pilot to “customize” the cockpit.

Normally these data cassettes are also used to record some mission parameters in flight for analysis on the ground during the de-briefing (for example the time and coordinates of weapon release). State-of-the-art technology in solid state memories can store vast amounts of data. Optical storage (laser discs) is another technology that has been used, in particular for loading digital maps onto the aircraft.

**4.4.4 Direct Voice Input / Direct Voice Output (DVI/DVO)** – The aural communication channel has until recently been used only for radio communications and audio warnings. The increase of information available to the pilot in modern cockpits has required cockpit designers to consider changing the mode of data transfer from the visual to the aural channel for some types of information. At the same time the technology of voice recognition has matured to the extent that it is being relied upon as an integral part of the MMI in certain current aircraft cockpits (EF-2000 and Rafale).

Apart from the use of audio for communication between the crew and the external world or between crew members, major applications of voice communication in modern cockpits are:

- voice messages: messages played into the cockpit audio system to alert the pilot to aircraft or weapon system status. These messages were originally analog recordings but now can also be computer generated using voice synthesizers or digitized speech. The advantage of these messages lies in the increased information content of the message, when compared to an audio tone, thus reducing reliance on pilot memory.
- combined sound and synthetic voice messages: the best compromise using an appropriate sound for attention getting purposes and speech for providing information.
- voice input: use of voice for commands to an aircraft system. This can be advantageous in some operational situations allowing the pilot to remain ‘HOTAS’. Voice input can also be used to shortcut multiple key presses with a single command. The main requirements for a voice input system are a high recognition rate in all operational environments and a short, associated reaction time. Perceptions of shortcoming in this area are the reason that voice input systems, which are available, have not been widely adopted on operational aircraft. As mentioned previously, both the EF-2000 and the Rafale use voice input to control some aircraft systems.
- voice dialogue: the ultimate development of aural input/output, in that it allows pilot input as well as system voice response to act as an effective information exchange and control system. As yet no systems with this capability have been operationally tested.

Trends in DVI/DVO systems suggest a wide use in future operational aircraft. An interesting complimentary development is the concept of 3D sound generation, i.e. the capability of generating sounds for the pilot as if coming from any direction in the space around him. This technology will enable the pilot to spatially separate different audio cues to increase detectability and intelligibility, as well as providing an indication of direction for some essential information (e.g. the approach direction of a SAM). Current laboratory effort in this area appears promising.

**4.4.5 Touch Screens** – A recent development of input devices is the touch screen. It normally consists of a frame of IR sensors which is applied around the HDD surface. These sensors detect the presence of a finger on the

HDD surface. Alternate approaches use resistive, capacitive, or surface acoustic wave technology to locate the finger on the display surface. All of these technologies have their respective advantages and disadvantages which are too complicated to detail in this report. A major shortcoming of all of these systems, however, is the lack of adequate tactile feedback and the difficulty of the pilot locating his finger accurately in a dynamic environment. For these reasons touch screens have not yet been adopted widely, although a touch screen has been incorporated into the Rafale.

#### **4.5 Cockpit Illumination Issues**

The advent of multiple emissive displays in the cockpit justifies some consideration of their effect on aircrew operation in the cockpit over the whole range of ambient lighting conditions from bright sunlight through to night time.

Current cockpit design practice has adopted a mix of different display technologies (e.g. CRT, LED, LCD). In order to maintain a effective operational environment, it is necessary to achieve an homogeneous brightness level throughout the cockpit in spite of these display technologies and outside light levels. Some modern lighting systems utilize sensors strategically placed in the cockpit to provide input to a computer based controller which evenly balances display illumination under all conditions. The pilot normally selects an AUTO mode in which single display brightness levels are varied according to well defined laws. Manual override modes are retained to cater for personal preferences or reversionary situations.

Another important issue is compatibility of cockpit displays and lighting with Night Vision Goggles (NVGs). NVG compatibility must be considered from the outset as retrofit solutions are expensive and not always fully effective.

#### **4.6 Information Management Technology.**

The term Information Management Technology is used to describe a broad range of system automation capabilities with the potential to exercise data collection, processing and presentation more rapidly and accurately than a human operator. The objective of such technology is not to replace the human operator, but rather to facilitate the tactical decision making of the human operator by providing salient information with a high degree of certainty while minimizing human-system interaction.

At the simplest level, Information Management Technology can be used to “fuse” data within the system architecture and/or at the display surface to support detection, classification and identification tasks thus enhancing aircrew situational awareness. Multi Sensor Correlation, Decision Support Systems, Expert Systems, Inter/Intra Sensor Managers, and Tactical Decision Aids are examples where data is managed at the subsystem level rather than by the human operator. Image enhancement techniques can be used to provide implicit cues visually.

The maturity of information management technologies ranges from data correlation algorithms and databases, which are relatively well understood today, to “intelligent” architectures, adaptive neural networks and “fuzzy logic” based predictors which are more “leading-edge” in nature. In general, growth in this technology area is being driven by specific applications. The performance of contributing sensors, software architectures and computing resources, in conjunction with the projected aircrew information requirements, define the envelope within which this capability is being developed. Automatic Target Recognition and Non-Cooperative Target Identification techniques are also being developed.

Information Management Technology is an emerging consideration for glass cockpits, and the impact this will have on requirements for onboard processing capability will be significant. Information Management Technologies will not only reduce or possibly alleviate the current problem of limited display area but also will provide an engineering solution to enhance the behavioral limits of human cognition as glass cockpits evolve to meet changing military and civilian operational requirements.

#### **4.7 Conclusions**

This Section has reviewed the display and control technology options that are available to the designer to meet the cockpit mission requirements. Current applications of this technology have been identified and future trends in



technology development have been indicated. In so doing, some of the human factors issues in matching technology to human capability within the operational environment have been identified and will be examined in the next section. Mention has also been made of some of the information and mission management techniques that are required to increase situational awareness and decrease operator workload.

In the context of this report, it has not been possible to describe in any depth the more detailed aspects of these technologies. The reader is recommended to consult the reference list for a more detailed treatise of the subject matter.

#### 4.8 References

- 1) AGARD-AR-169 "Modern Display Technologies and Applications", 1982
- 2) AGARD-LS-126 "Modern Display Technologies for Airborne Applications", 1983
- 3) AGARD-LS-155 "Knowledge Based Concepts and Artificial Intelligence: Applications to Guidance and Control", 1987
- 4) AGARD-LS-156 "Visual Effects in the High Performance Aircraft Cockpit", 1988
- 5) AGARD-CP-371 "Human Factors Considerations in High Performance Aircraft", 1984
- 6) AGARD-CP-425 "The Man-Machine Interface in Tactical Aircraft Design and Combat Automation", 1987
- 7) AGARD-CP-517 "Helmet Mounted Displays and Night Vision Goggles", 1991
- 8) AGARD-CP-520 "Combat Automation for Airborne Weapon Systems: Man/Machine Interface Trends and Technologies, 1993
- 9) AGARD-CP-521 "Advanced Aircraft Interfaces: The Machine Side of the Man-Machine Interface", 1992
- 10) AGARD 76th AMP Symposium on "Virtual Interfaces: Research and Applications"
- 11) IEEE/AESS Symposium "The Cockpit of the 21st Century: Will High Tech Pay Off?", 1990
- 12) "Head-Up Displays versus Helmet Mounted Displays – The issues" – E.C. Adam
- 13) "Tactical Cockpits – Flat Panel Imperatives" – E.C. Adam
- 14) "Aircraft/Mission Requirements Approach for Helmet Mounted Display Decisions" – R.K. Osgood

## 5.0 ERGONOMICS AND HUMAN FACTORS

### 5.1 Introduction

Consideration of human engineering principles and practices is critical to the successful design and deployment of glass cockpit systems. While human engineering has long been a part of cockpit design, this discipline was rarely considered as critical to the mission success of the system as such disciplines as airframe structural engineering or propulsion. The advent of glass cockpits, however, has focused awareness on the need for the system to accommodate if not compensate for human performance limitations. This chapter discusses some of the most critical human factors for glass cockpit design and development and identifies some technologies discussed in the previous chapter with the potential to enhance human performance.

Over the years the pilot's task has evolved from flying the aircraft "right side up" to managing a complex weapon system. The ability to manually fly an aircraft which has been an important criterion to select crew personnel for a long time, has become less important in comparison to the abilities to monitor and control a highly automated system, to perceive and comprehend an immense stream of data, and to achieve and maintain situation awareness. Advanced aircraft, sensor and weapon technology have led to faster dynamics in the rate of change of information and hence to reduced time for situation assessment, processing and decision-making.

As the complexity and the level of automation of the aircraft and its sensors and weapons grows, it becomes increasingly important to have a close look at the man-machine interface because the limitations of the human in the cockpit have been reached or even exceeded. Cockpit design has often been driven by performance and limits of technology instead of pursuing a human centered design. This led for instance to cockpit layouts which show related information on different screens in separated locations using various kinds of symbols, scales, and display devices. Sometimes only a few indications of concern for harmonizing system design with human capabilities are found.

Advances in sensor technologies, (e.g. increased radar search volumes, night vision support or improved threat detection systems) and the introduction of data links and onboard data bases caused a data explosion in the cockpit with which the human operator has to cope. Moreover, raw data instead of information is often presented to the pilot. He is expected to perceive and to select the relevant pieces, to comprehend their meaning and to put them together in his mind as an integral whole in order to get the information which he needs. This chain of acquiring information is extremely susceptible to failure especially in phases of high workload.

Also, the aircraft themselves provide new capabilities which have a direct impact on the MMI. New materials and an improved structure design enable the airframe to sustain high G loads and high G onset rates. Computer controlled unstable configurations enlarge the flight envelope and provide additional manoeuvrability. Thrust vectoring also introduced new problems concerning spatial orientation due to the great difference between the aircraft body axis, the flight vector and the line of sight.

These developments and trends may lead to an increasing gap between the system capabilities and the human capabilities. This gap may cause either permanent, excessive demands on the pilot, which also have an impact on flight safety, or the pilot will not make full use of all system features. Both consequences will prevent the system from reaching the projected performance and because of that the effectiveness in terms of mission performance and the cost benefit ratio will be degraded. Therefore, the balance of the operator and the system capabilities should be a design guideline from the very beginning of the system planning stage.

### 5.2 The Subsystem "Human"

In this section the pilot is regarded as a subsystem within the aircraft which has a performance envelope like the other on board subsystems or the airframe itself. The pilot's envelope can be described by the human's capabilities and limits. The description of the capabilities and limits in turn involves some difficulties because many of the human mechanisms particularly human cognition and decision making are not fully understood and are the subject of ongoing research. The measurement of relevant parameters is often complicated or even impossible. Besides, the performance envelope of an individual is not constant. Many environmental and personal influences shape behavior and performance over time. For the cockpit designer, it is important to become sensitive to the dependencies and to have a sound knowledge of the sensory, cognitive and motor capabilities and limitations of the subsystem "pilot". For any subsystem, leaving the operational envelope means a degradation of performance.

**5.2.1 Human Capabilities** – Comprehensive descriptions of the human senses and their capabilities can be found in the literature e.g. in Reference 9. Nevertheless, a few important examples and their impact on cockpit design are given in the next paragraphs.

**Visual** – One of the most important visual cues for self-locomotion and for guiding a vehicle is the visual flow field. The flow field which is mainly perceived via the peripheral vision is processed without demanding attention. The perception of this flow strongly influences the perception of motion and spatial orientation. The loss of these real world cues due to adverse weather, insufficient brightness, a missing ground reference or a closed cockpit is followed by a loss of orientation and a visual-vestibular mismatch. Also the amount of the vehicle maneuverability the pilot is willing to use may decrease. A similar effect is observed when head mounted devices (e.g.NVG) reduce the visual cue environment and negatively affect the handling qualities of an aircraft (Reference 13).

The well-known instruments which take the place of the environmental references have the disadvantage that they require attention capacity and have to be scanned frequently. Displays providing a wide field of view of motion cues or additional peripheral displays which stimulate the orientation vision can improve the motion perception and spatial orientation without consuming capacity of attention. Extracting information from instruments, which is equivalent in concept to pattern recognition, means that the pilot has to align the eyes with the foveal region of the retina. The retina foveal region is generally taken to be one to two degrees. Except for the above mentioned visual cues all items of information that are presented visually have to be consciously focussed and processed in order to receive the information.

Humans can identify about nine distinct colours and they can distinguish about 24 when hue, saturation, and luminosity are varied. An advantage of the use of colour is that the cognition of colour occurs fast and relatively automatically. The cockpit designer has also to take into account that colour perception in the peripheral vision is degraded compared to the foveal vision. Colour can be used to group symbols into categories, to reduce visual clutter, to add additional information to a symbol or an alphanumeric, as an attention getter, to separate elements which can not be separated in space. The advantage of colour in aviation displays is not undisputed. There is evidence that colour leads to performance improvements in complex displays or pictorial formats, especially for search tasks, whereas no advantage was observed in well formatted or simple displays. A reduced response time and error rate was also observed when using shape and redundant colour coding instead of shape coding only. The application of colour as a coding mechanism should avoid the danger of over-use. The use of a large colour palette for coding can degrade search performance by creating a “colour-busy” background and will create difficulties in distinguishing between colours.

**Aural** – The audio channel is used for verbal communication, warnings, system messages, answers to pilot queries, threat identification and so forth. It can be a synthetic voice or some kind of sound. Auditory signals alert the pilot faster than visual displays, are independent of eye fixation and head position, and do not use panel space. Another advantage of auditory signals and messages is that auditory perception is less affected by high G loads.

Voice warnings are more flexible than simple sounds, because they not only alert the pilot to any existing problem but can concurrently provide more information. This is especially important during high workload, when the meaning of a signal may be forgotten. Confusion followed by a false action may also occur when similar tones are used for different alerts. No more than seven ( $\pm$  two) tones should be used to ensure absolute discrimination. Because audio messages do not provide a permanent record a visual backup may be considered as a reminder.

Unfortunately the human’s input channel via the ear is not very reliable. That means that a sound or voice may be perceived but does not reach the level of cognition, which in particular may happen during phases of high workload. The human has the ability to subconsciously process sound and, depending on what is expected or what is stored in the memory, a certain sound pattern can be “automatically” transferred to the level of cognition. A good example is the recognition of one’s own name in a nearby conversation to which one is not listening. However, a disadvantage of voice communication between humans is that under stress, humans tend to stop talking.

The use of the human’s ability to hear spatially is relatively new. Because every pilot uses headphones during flight, different sounds can be generated for both ears and thus provide a spatial sound or voice. This adds a new degree of freedom to the audio input channel. To maintain the virtual location of the sound source during head movements it is necessary to detect the pilot’s head position in all three axes and to calculate the appropriate sound pattern for each ear. When implementing a spatial auditory system it should be noted that the spatial location of a sound may require additional attention capacity of the pilot and that the human tends to turn the head to the direction which a sudden sound

comes from. Suffice to say that the hardware must be capable of detecting for instance the direction of an approaching threat as an input for a spatial audio system.

**Tactile** – Another channel which can be used to convey information is the tactile sense. An active stick can be used to alert the pilot when limits of the flight envelope are approached. Because the human's hand is very sensitive in terms of distinguishing forces, steps or variations of the forces of a computer controlled stick can give the pilot additional information about the behaviour of the aircraft.

**5.2.2 Degradation of human performance** – Agile aircraft like the F-16 or the EF2000 allow an acceleration in the aircraft's z-axis up to +9G. Without any protection a human can sustain up to +4G in the z-axis with clear vision. In order to sustain high levels of G-load and high rates of G onset the pilots are protected by various means. Full coverage anti-G trousers, pressure breathing and/or a slight tilting of the seat were introduced into agile aircraft with the aim of avoiding a degradation of the pilot's capabilities during high G manoeuvres and high G-onset rates which are the primary cause for "G-induced Loss of Consciousness" (G-LOC). Based on today's equipment it seems that a load of about +9G is the limit provided that the aircraft's and the pilot's z-axis coincide. If the next generation aircraft are designed for more manoeuvrability, thus requiring more G tolerance by the pilot, a completely different cockpit design may be required. The pilot must be in highly reclined position or use a liquid filled suit to prevent a deterioration of his well-being, at least during the manoeuvres. Concerning the location of instruments and controls which are not attached to the seat or the helmet a radically new approach will be demanded.

Noise, temperature and vibration are cockpit related causes of fatigue (Reference 10). Despite the fact that the measurement of fatigue is uncertain or at best difficult, fatigue leads to increased error rates and a degradation of performance. Vibration as well as turbulence hamper motor interactions when fine movements are required, e.g. data entry via a keyboard or touch-screen. Noise from different sources not only reduces the intelligibility of communications but also increase the level of stress. Active noise reduction takes remedial action.

Apart from all the environmental conditions and impacts which degrade the well-being of the pilot the individual condition or shape can positively or negatively influence the performance envelope. The individual mood and motivation, personal problems, illness, motion sickness, tiredness, medication, alcohol or drugs can dramatically effect the performance of the human subsystem. The selection and training of crew personnel remains one of the most important tasks to assure the effectiveness of an airborne weapon system.

**5.2.3 Human Cognition** – Personal and environmental influences dramatically impact the ability of a human operator to acquire, assimilate and act on the data and information available from aircraft systems. The limits of memory and attention capacity can be offset in the glass cockpit by design of an information interface that takes advantage of the human ability to recognize patterns. Physical and mental patterns in the arrangement of cockpit equipment (controls and displays) and information elements within display formats, as well as the logic for accessing and configuring display formats, minimize the frequency and complexity of human-system interaction. Optimal use of patterns make it possible to obtain information "at a glance" using a scan pattern. Rapid transfer of information aids the operator in developing and maintaining situational awareness, the basis for successful decision-making.

### 5.3 Situation Awareness

From a System Analysis point of view the pilot and the aircraft including all subsystems can be regarded as a unit. This unit is expected to fulfil its mission effectively. In this context, "effective" means that the specific mission tasks are completed safely with an optimal use of resources (e.g. time, fuel, weapons) with an acceptable level of performance. This ambitious demand requires that the pilot is aware of his situation at all time during the mission.

Thus a prerequisite for operational effectiveness is a sufficient level of situation awareness. Even though it is not difficult to determine whether an isolated subsystem improves the awareness of a certain state, e.g. a navigation display facilitates the assessment of the own position, the measurement of the pilot's overall SA remains intricate (Reference 1). In addition, the measurement of SA is not yet an exact science.

Subsystems which the pilot uses during the mission may have been optimised for their specific task, but the proof that the subsystem also works in conjunction with the other subsystems must not be omitted. Small changes of a single item, e.g. the relocation of a button, can have a considerable impact on the performance of the unit, which might not be obvious. That is why the positive or negative contribution of every subsystem to SA should be carefully examined in an integrated system environment.

**5.3.1 Definitions of Situational Awareness (SA)** – SA has been defined by M. Endsley and C. Bolstad (Reference 1) as “the perception of the elements in the environment within a volume of time and space, the comprehension of their meaning, and the projection of their status in the near future” and by E. Adam (Reference 4) as “knowing what’s going on so that you can figure out what to do”. It can be divided into three distinct levels; long term, global SA; short term, tactical SA and “ownship” SA. Short term SA comprises the combat situation (A/A, A/G) within visual range including all threats, within range of the aircraft, essential flight parameters and visual navigation. Long term SA comprises the combat situation on the ground and in the air beyond visual range up to 200 NM including the location of threats, navigation aids, long-term flight path, terrain and map information. Ownship SA includes the status of the aircraft, its configuration and resources (e.g. fuel, weapons), and the status of each subsystem. Figure 5-1 illustrates the first two types of these SAs.

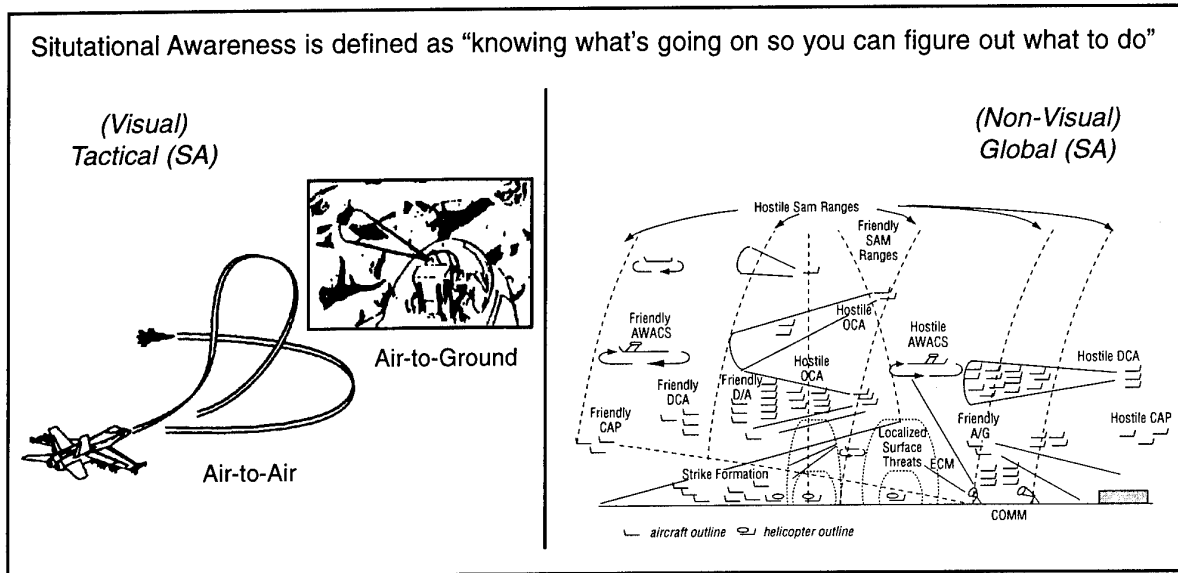

Figure 5-1 Global and Tactical Situational Awareness

**5.3.2 Approaches to achieve SA** – Head down operations and the acquisition of information from within the cockpit during hostile contact engagements is becoming undesirable for tactical SA. It is therefore highly desirable that all essential sensor, weapon, and flight information is made available ‘head up’ either on a HUD or HMD. With the latter facility, weapons and sensors can be slaved to the pilot’s line of sight, possibly even when looking through the bottom of the cockpit depending on the mission. This may also require a dynamic modification of display illumination when the pilot wants to look “through” the instrument panel. Information which is displayed on the helmet visor can be removed from the instrument panel which in turn provides additional space for other information. All necessary inputs should be done by using the buttons and switches on the throttles and the stick (HOTAS) or voice input. Other input channels which could be utilised are eye movement or other physiological mechanisms.

The most suitable devices for supporting long term SA are head down displays. Because the amount of available information exceeded the available space on the instrument panel, multi-function displays (MFD), including programmable switches, were introduced to the cockpit. Regarding the MMI, MFDs have led to new problems:

- The content of information at a certain location changes.
- The function of a switch changes.
- The pilot has to select/to configure a page/a display, which also means a loss of displayed/immediate information
- The displayed information/page can change automatically due to procedural software.
- Related information can be presented at different locations using different scales or coordinate systems and symbols.
- Display clutter.

Moreover the size of the MFDs is still too small to convey a comprehensive picture of the overall situation, and the pilot would be unable to read it anyway. To overcome these problems cockpit developers made several suggestions.

The instrument panel could be completely used as a touch sensitive display area. The available information should be filtered, processed into an integral whole and displayed on the screen while making full advantage of the large area. If the required size of flat panel displays is still not available a tessellation of the instrument panel with display modules will be the most likely solution. The displays must provide a sufficient contrast ratio, a high resolution, and full colour capability including NVG compatibility. A full colour raster mode also requires the correction of aliasing artefacts and colour correction of small or thin symbols in the foreground of different coloured areas.

One of the major problems concerning the MMI and SA is that the amount of available, onboard data is enormous. The humans perceptive and cognitive capabilities are insufficient to integrate all this data unless it is well organized and intuitive. Various approaches were suggested to support the pilot in acquiring the relevant information.

Data can be filtered, but filtering data also means a selection and potential loss of information. Thus the design of the filter has to be done extremely carefully as the choice of data is transferred from the pilot to the system designer, except for those filters the pilot can select or deselect while airborne (e.g. declutter). This approach, whilst denying the pilot full authority, has the potential advantage of reducing cockpit workload. With pilot involvement at the design stage there is no reason why this approach should not be acceptable to aircrew. However, the design team should be aware of the fact that they will never be able to foresee all situations and circumstances the aircraft and its pilot will encounter during an in-service time of two to three decades.

Another method to select and therefore to reduce the data which is presented to the pilot is the incorporation of a decision aiding system. The disadvantage of such a system is that it uses a knowledge base and can therefore only cope with those situations which are stored in the base. The same problem is inherent to artificial intelligence systems, even though they may be able to gain experience and to draw simple conclusions. Before such systems will find their way into the cockpit they will have to prove that they react appropriately under all circumstances, including the most unlikely of situations. Unfortunately, these situations are at moments in which the pilot needs the most help. Nevertheless, aiding systems, by whatever name, can considerably support the operator by presenting additional or preprocessed information at the right time and at the right place.

A possible method to shorten the time a pilot requires to assess a situation is to show predictive data (Reference 22). As the definition given above says the projection of the current status to the near future is an important part of achieving SA. The prediction of a status requires that the pilot repeatedly perceives the current status and that he compares it to a behavioural model stored in his long term memory in order to extrapolate the status to the near future. This is a task which a computer can perform quite well, relieving the pilot to perform other tasks. The indicator for the altitude trend is a simple example for such kind of indications (Figure 5-2). Also, a little bar for the speed trend proved to be very useful for takeoff monitoring or the early detection of a windshear.

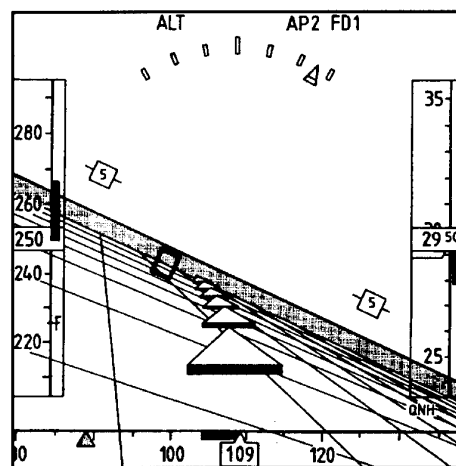

Figure 5-2 Indicators for predicted parameters (Reference 22)

Another rather convenient approach to enhance the SA is to convert data to information or even commands before it is presented to the pilot. This kind of preprocessing has a considerable potential to reduce the workload because it reduces the necessary amount of mental effort to extract the desired information from the data. For instance, instead of displaying a parameter as a number or as a pointer on a dial covering the entire range the desired information "parameter is within permissible range" is given. This information removes the need for the pilot to perceive the parameter and the configuration, which he needs for the assessment of the permissible range, comparing it to the value stored in his or her long term memory and finally deciding whether an action is required or not. This kind of data processing into appropriate information could also be called "fuzzy" information presentation because it doesn't provide an exact value but it provides the information which is actually needed at a sufficient level. Also a couple of parameters can be integrated into a single, multidimensional symbol, which shows a qualitative instead of a quantitative indication. This is sometimes called an 'object display'. This kind of information presentation also necessitates predictive indications. Another example may be the display of threats and their range in a map view, which is raw data. The pilot has to extract

the desired information whether he is endangered or not. If the system would provide the information “you are not in range of all known threats” together with an associated prediction “within the next 20 seconds in all directions” then there is no need for the pilot to look at his tactical display at a specific moment. Nevertheless, the pilot should have access to raw data and exact information whenever he needs it. He should also be able to choose the level of information/data which is most suitable for the prevailing circumstances. This approach is tantamount to a flexible allocation of tasks, which means that the preprocessing and integration of data can be alternatively done by the pilot or by the system.

#### 5.4 Automation

Automation simply means that a task is accomplished by a machine instead of a human. The automation of control tasks assigns the monitoring function to the pilot. If the pilot is at the controls the monitoring task can be assigned to the machine.

One possibility to cope with a high level of automation is flexible task allocation. That means that the pilot and not the designer allocates a task to the machine or to himself or herself. Such kind of worksharing necessitates that the tasks are clearly defined and that the pilot is aware of the status of the task allocation at any time. The tasks can range from monitoring a subsystem to complex decision making depending on the performance of the machine. Pursuing this design philosophy the pilot who remains responsible for all tasks can guide and control the aircraft including all systems at a level which is appropriate for the situation and his current workload.

Ongoing research on multi-modal interfaces and virtual displays reveals some encouraging results. Multi modal interfaces utilizing voice input, pointing devices, eye movement and gesture recognition are also promising means to improve the flexibility in the cockpit.

#### 5.5 Head-Up Displays

The HUD is mainly used to display essential flight information (attitude, speed, heading, etc) and weapon delivery symbology. One focus of recent research activities has been the symbology for pitch and roll information, which is of critical importance when flying in or recovering from unusual attitudes. The recommendations derived from these research activities are that the design of a HUD symbology should follow the above mentioned Gestalt principles of closure, similarity and proximity of related information.

As the pilot has to look through the HUD combiner and the canopy to the outside world, it is very important that the combiner and the canopy do not distort his view and that the symbology is positioned accurately relative to his view of the world. This is especially important for the new HUDs providing raster capabilities. Raster symbology or images should be used very carefully to prevent confusion or deterioration of the perception of the outside world.

On the other hand the recognition of the symbology may be disturbed by the outside background. The perceptual process of coloured HUD symbology can become increasingly difficult against the background of changing colour hues and saturations compared to that of monochrome symbols. Therefore the use of colour in a HUD should be done very carefully. Because HUD formats often differ from “head-down” presentations, difficulties may be experienced when switching between both formats.

#### 5.6 Head- and Helmet-Mounted Displays

Storey, Osgood, and Schueren (1994) reported in a thorough review of the literature that ground, simulation, and flight test reports lauded the benefits of an HMD when added to current air vehicle systems. Detailed benefits as reported by the pilots and researchers included:

- Improved visual acquisition of target areas and aircraft
- Improved off-boresight attack capabilities
- Improved situational awareness (head-up manoeuvring and rapid finding of area of interest)

The following list summarizes some of the major Human Factors concerns for HMD integration into combat aircraft:

Fit: Comfort was seen as the primary detractor from HMD acceptance and utility by every test.

**Reliability:** This was seen as the second most serious detractor from acceptance by the operations community. The user is mainly concerned with system failure in flight. The ergonomist would be wise to have alternative sources of information available to the pilot to ensure safe return to base.

**Weight:** Total head supported weight greater than 5.3 lbs degrades pilot performance after one hour in helicopter vibration environments (Reference 14). Helmets weighing 5.0 lbs have been flight and centrifuge tested comfortably to 7.0 G (Reference 15). Current aircraft mounted air to ground weapons have a maximum limit of 7.0 G. The CG of the HMD must be very close to normal head CG or pilots report significant problems.

**Optics:** Monocular systems are acceptable for day symbology displays but cause binocular rivalry for night video displays and are therefore undesirable at night (References 15 and 16). Binocular rivalry negatively affects pilot performance over time. 50% to 70% see-through transmissivity is required at night. Optics must be stowable for safety of flight and visual acuity reasons. Optical coatings must not significantly change outside world colour. More specifically, white, red, green and blue colours must be discernible. Pilots desired maximum control over optics adjustment in-flight specifically inter-pupillary distance (IPD), eye relief (distance from the surface of the eye to the optical surface), and vertical positioning. 28 – 34 mm eye relief was found to be acceptable depending on overall system design (Reference 15). Anecdotal experience with current helmet mounted devices (ie. night vision goggles) suggests that expert fitting of helmets and optics may alleviate the pilot preference for adjustable optics, provide better optical quality and produce lighter helmets as well.

**Field of View (FOV):** 30° FOV is the absolute minimum for video sensor display with 40° FOV being desired. Very little performance increase using simulators was seen with FOVs greater than 40° (References 17 and 18). However, a caveat with respect to the size of the FOV is that it is very task dependent, and should be evaluated in comprehensive flight tests. Symbology should be kept within the central 25° to 27° to minimize eye movements. Day optimized HMDs do not require a FOV above 25°–30° but FOVs less than 20 degrees were subjectively deemed too small for use in a dynamic manoeuvring environment (Reference 19). Visual obscuration should be no worse than current helmets, especially with respect to peripheral field and look-up angles.

**Symbology:** Accuracy of four mr is required in the normal weapon employment envelope (approximately 30° cone around the aircraft nose) while accuracies of seven mr is acceptable outside of this cone. 10 mr errors were considered excessive (Reference 20). Symbol size of 10.7 mr was considered optimal even though it is 50% larger than normal HUD symbology (Reference 15). Distortions in the canopy must be compensated for day use. Symbol latency of 55 msec caused significant problems during the day but not at night (Reference 15). The goal is a 60 Hz or 16.67 msec update rate.

**Aircraft Integration:** Aircraft interface requirements are dependent on aircraft type and expected missions. One basic requirement is the use of the 1553 bus which allows most aircraft avionics information to be accessible to the HMD. The power supply unit, display generator and processor would preferably be in a single line-replaceable-unit, within the constraints of space, weight, cooling requirements and logistics.

Based on flight and simulation studies, HMD systems increase situational awareness, reduce workload, and improve exchange ratios during air-to-air engagements by as much as 2:1 (Reference 21). This effectively acts as a force multiplier allowing smaller numbers of friendly aircraft to handle more enemy aircraft. It is expected that the benefits of an HMD would include a positive contribution to the single seat, multi-role cockpit.

## 5.7 Multi Function Display and Switches

In order to cope with the enormous amount of data onboard, MFDs were introduced. The advantage of a MFD is that information can be removed from the instrument panel which is not relevant for a specific phase of the mission or, to put it in other words, the MFD can be configured according to the present needs. But MFDs often impose additional workload on the pilot. He has to have a mental model of the information system so that he is aware of what information is available and how to access it. If the menu structure is deep or broad the operator may 'get lost' in the system especially when he is unable to retrieve his mental model from the long term memory due to a stressful situation. An approach to overcome these problems was made by using pictorial formats on a touch sensitive screen. Another approach is that the organization of the menus and display pages is based on the concept of function instead of subsystems. Selecting a function at a high level should cause the disappearance of irrelevant segments of the menu and thus reducing the choice. Required controls and information to accomplish a specific task should be grouped together



in close proximity and easily accessible. The label of multifunction switches or controls should not only indicate the function of the switch but also the current status. The operator should also be provided with feedback on the result of selecting a switch.

## 5.8 Anthropometry

The main measures of a cockpit are defined by various standards and regulations. Table 5.1 gives examples of standards for military and civil aircraft. Even though the FAR and SAE standards are applicable only for civil aircraft they may comprise useful information.

Federal Aviation Regulation (FAR)	Society of Automotive Engineers (SAE)	Military Standards (MIL)
FAR 25.772	ARP 268	MIL 203F
FAR 25.777	AS 290	MIL 1333B
FAR 25.781	AS 580B	MIL 81711A
FAR 25.1381		MIL 33576

Table 5.1: Applicable standards for cockpit measures

Deviating from the standards one can observe two contradictory trends. On the one hand humans become taller from generation to generation and on the other hand more women will become pilots. For instance in Germany the average height of young man has increased by 76 mm in the years from 1947 to 1984. That means that the bandwidth of human heights which have to fit into the cockpit grows in both directions. Table 5.2 shows the average heights of men and women in different groups.

	percentile	age	height [mm]
small woman	05.	18–59	1554
tall woman	95.	18–59	1756
small man	05.	18–59	1656
tall man	95.	18–59	1886
tall man	95.	20–24	1921

Table 5.2: Average height of german men and women in 1985 (Reference 7)

Table 5.2 clearly shows that the “new generation” young man (20–24 years) is nearly 40 mm taller than the average man and that women are about 100 mm smaller than men. This means that the bandwidth of heights will be enlarged by 140 mm in comparison to the 5 to 95 percentile man (18–59 years).

The population extremes have a large impact on current and future cockpit design. Cockpit seat adjustment mechanisms have to be adapted for improved accommodation. Whereas extreme large subjects impact cockpit size and weight the extreme small subjects impact reach and vision envelopes. For comparison, the population extremes for a couple of selected nationalities is given in Figure 5.3. The comparison of males and females of similar height and sitting height given in Table 5.3 does not show significant differences.

	Male	Female
Functional Reach (in.)	25.9 – 30.5	26.5 – 29.9
Sitting Eye height (in.)	39.4 – 43.3	41.0 – 45.7
Leg Length (in.)	27.9 – 31.3	28.3 – 30.5
Body Weight (lb)	109 – 183	105 – 173

Table 5.3: Comparison of Males and Females of Similar Height (64 in.) and Sitting Height (34 in.)

On the other hand the strength of small subjects is significantly different between the sexes, thus reducing the maximum control force and G-tolerance. Also the different body mass distributions have an impact on ejection safety. Figure 5–4 shows the body segment weights for both male and female. Thus, careful consideration of female physiology for ejection systems will be required. Traditional considerations of aircrew anthropometry have concentrated mainly on one parameter at a time e.g. sitting eye height or functional reach. Recognition of the fact that a single human body can comprise of a range of different percentile sizes of limbs or body segments has led to the investigation and development of multi-variate design techniques.

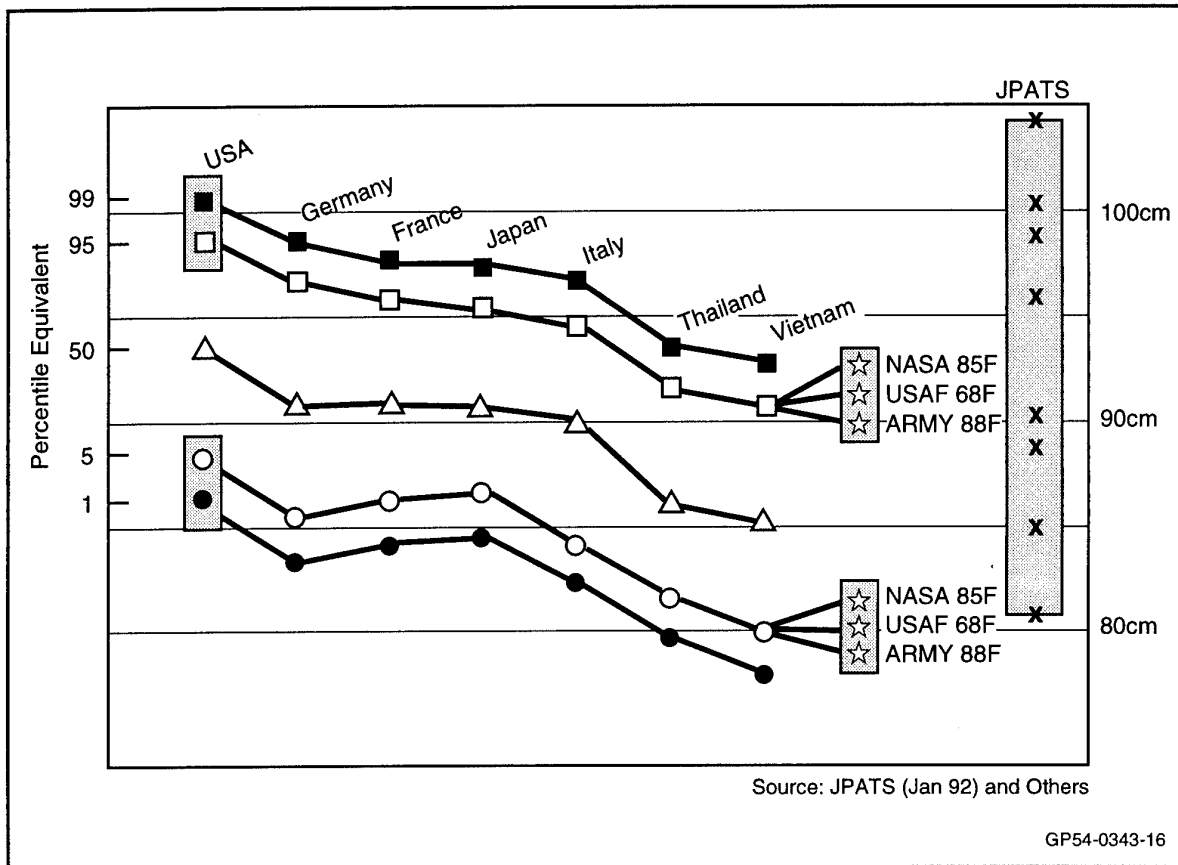

Figure 5-3 Comparative Population Extremes for Selected Nationalities (Sitting Height) and JPATS

## 5.9 Conclusions

Since consideration of Human Factors principles are critical to the successful design and deployment of glass cockpit systems the intent of this section was to highlight some important MMI issues that the cockpit designer has to take into account.

The selection of promising technologies described in the previous chapter does not guarantee a successful cockpit design. Much attention has to be paid to the integration of each subsystem. Human performance and limitations have to be kept in mind while designing the pilot's dialogue with the aircraft and its systems.

## 5.10 References

- 1 **Combat Automation for Airborne Weapon Systems: Man/Machine Interface Trends and Technologies**, AGARD CP 520, April 1993
- 2 Earl L. Wiener, David C. Nagel, **Human Factors in Aviation**, Academic Press, 1988
- 4 Eugene C. Adam, **Tactical Cockpits – Flat Panel Imperitives**, Information Display Technology Seminar Lecture Notes, 1987, Society for Information Display, Playa del Rey, CA, USA
- 5 Eugene C. Adam, **Head-Up Displays Versus Helmet Mounted Displays**, SPIE Proceedings Volume 2465
- 6 H. Greil, **Der Körperbau im Erwachsenenalter**, Dissertation, Humboldt Universitaet, Berlin
- 7 Woodson E. Wesley, **Human Factors Design Handbook**
- 8 Earl L. Wiener, Barbara G. Kanki, Robert L. Helmreich, **Cockpit Resource Management**

- 9 Boff K.R., Lincoln J.E., **Engineering Data Compendium: Human Perception and Performance** (Volumes 1–3), Wright Patterson Air Force Base
- 10 Hamilton, Bruce E., **Expanding the Pilot's Envelope**
- 11 **Workshop on Human Factors / Future Combat Aircraft**, 4 PWR SM TG, 4–6 Oct. 1994, Ottobrunn, Germany
- 12 **The Human–Machine Interface in Airborne Systems**, IEEE/AESS Symposium, Dayton, Ohio, Dec. 1980
- 13 Stewart W. Baillie, Roger H. Hoh, **The Effect of Reduced Useable Cue Environments on Helicopter Handling Qualities**, CASI Flight Test Symposium, Ottawa, March 1994
- 14 US. Army Human Engineering Laboratory, **Aircraft crewman helmet weight study, progress report no. 1, PNVs–related problems: pilots reflections on visually coupled systems**, 1976–1987.
- 15 J.C. Curtis, **Night system development and integration**, General Dynamics research report, ERR–FW–3056, 1989.
- 16 S. Hale and D. Piccione, **Pilot assessment of the AH–64 helmet–mounted display**, International Symposium on Aviation Psychology, 1989.
- 17 Robert. K. Osgood, M.J. Wells, **The effect of field–of–view size on performance of a simulated air–to–ground night attack**, AGARD CP 517: Helmet–Mounted Displays and Night Vision Goggles, 1991
- 18 General Dynamics, **HMD FOV vs. pilot performance study**, General Dynamics research report, 1986
- 19 General Dynamics & Lockheed, **YF–22A part task simulation no. 2, 3, and 4 & full mission simulation no 3 and 4**, General Dynamics & Lockheed CDRLs for YF–22 program, 1987–1989.
- 20 D. Borje, **Helmet–mounted display system evaluation**, SA–35R–89, 1989.
- 21 C. Arbak, P. King, R. Jauer and E. Adam, **Helmet–mounted display/sight tactical utility study**, AAMRL– TR–88–022, 1988.
- 22 Ch. Below, H.v.Viebahn, M.Hammer, **4D Flight Guidance Displays**, SPIE Technical Conference “Synthetic Vision for Vehicle Guidance and Control”, Aerosense 1995, Orlando

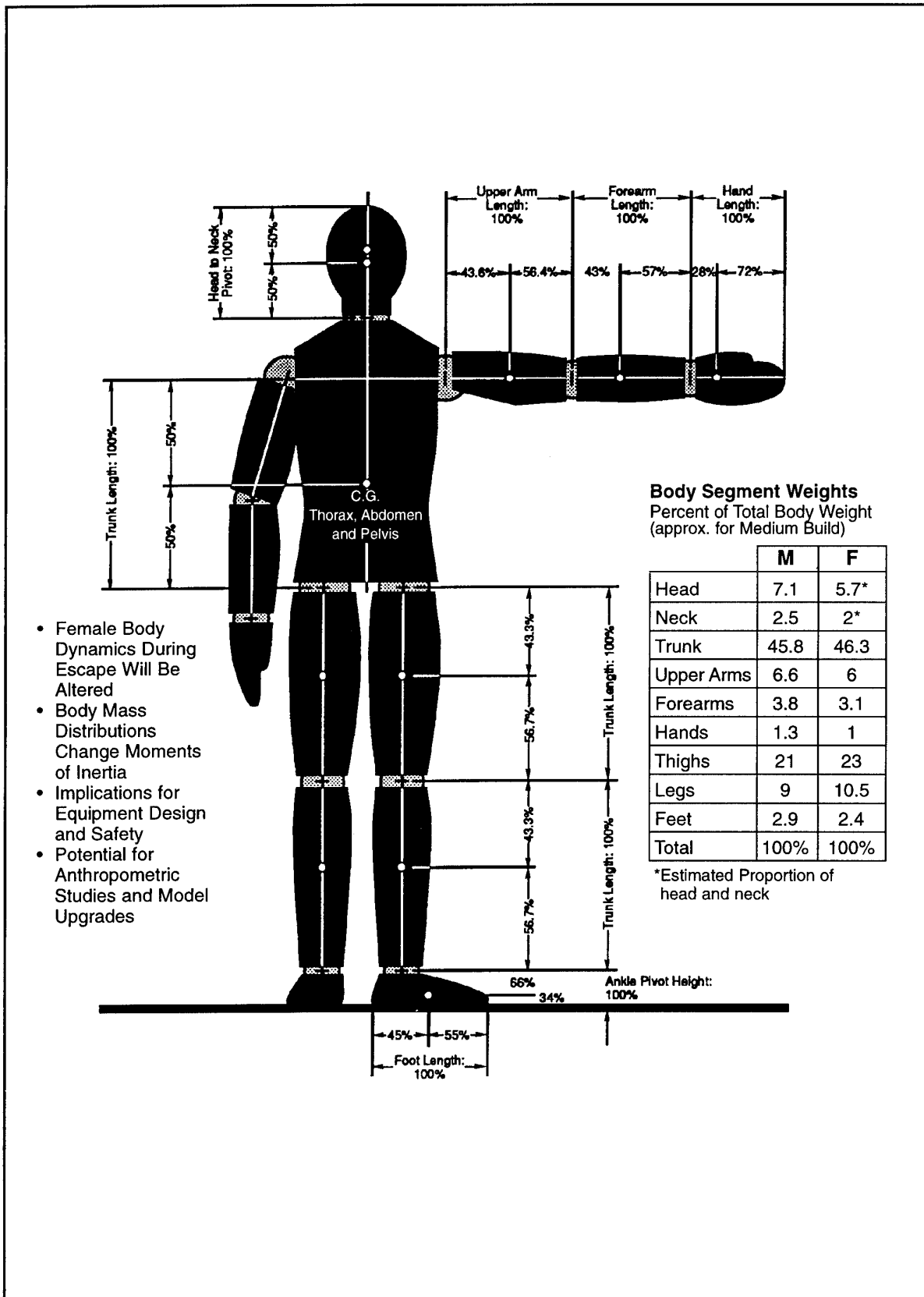

Figure 5-4 Ejection Safety

## 6.0 TRAINING CONSIDERATIONS

### 6.1 Introduction

The objective of any pilot training is to ensure the pilot knows the full capability of the vehicle and is well practised in the art of using it to achieve a successful mission. Training will always be required whatever the vehicle and whether fitted with glass displays or not. From the previous section we have seen the pilot's limitations and when these are combined with cockpits which have evolved from simple dials, single role, single mission vehicles to 'glass cockpit', multi-role, multi-mission day and night capable aircraft a lot of training is required. The evolutionary nature of aircraft design, systems performance and weapons capabilities and changing operational scenarios are having major effect on cockpit design. Aircrew training must evolve in parallel to ensure that the aircrew capabilities are in step with those of the vehicle.

This section investigates the particular needs, changes of training syllabus and problems involved in training pilots when glass cockpit aircraft are introduced by discussing human issues, past and present training methods and time for training future glass cockpit crews. This section limits its view to a fixed wing combat aircraft and also limits the training discussion from a flight qualified ('wings') pilot through to a fully qualified operational pilot.

### 6.2 Human Issues

In this section, training problems as related to the human have been divided into four categories and the effect of glass cockpits is discussed for each topic.

**6.2.1 Aircrew selection criteria** – Humans learn new skills or techniques by modifying and adding to previously experienced situations or acquired skills. In the case of learning to be an effective military pilot, the route from basic flight training to fully qualified combat pilot is highly structured and goal orientated. At present, pilots are selected by their education, performance in physical aptitude tests, anthropometric size, psychological tests and leadership qualities. The introduction of glass cockpits only brings a new technology to the pilot interface. The training regime will always be required regardless of the display hardware or concepts used in the cockpit.

The concept of operating menus or soft keys is common place therefore the interaction with the aircraft and its systems via a multi-function screen will not be a novelty to present day trainees. A person used to seeing information presented in this format on a screen will not have any cognitive difficulties in understanding and accepting them in a moving vehicle. Therefore no additional difficulties in pilot training due to glass cockpit technology is anticipated. No change is expected in aircrew selection criteria nor the progress of a person through their training, due to the change to glass cockpits. Indeed the cockpit should be designed so that a super human is not required to operate it. It is suggested by this group that the selection of military pilots will be the same as it is now since the same qualities will always be required.

**6.2.2 Situational Awareness** – A pilot can plan and react to a given scenario when he understands the constraints and features of that scenario, the so called 'situational awareness'. He achieves this by the integration of several pieces of data into a total picture of the airborne environment. In a conventional cockpit, the pilot is taught and learns to take the miscellaneous data from instruments and external sources and create a picture in his mind and then decide what he needs to do. With a glass cockpit, the cockpit designer is attempting to accomplish the first stage using technology not previously available. This first stage is the creation of a picture, not in the pilot's mind, but on a flat piece of glass. By careful design, this can be made to be easily assimilated to a 'global' view. This change of emphasis in the cockpit has the potential for a significant change in training both on time and direction of training, particularly in the time to become an effective fighter pilot. It is postulated that since the flexibility of a glass cockpit allows for the fusion of disparate data into an integrated 'picture', the trainee will take less time to learn to become 'aware'. However, the additional complexity of the systems and operating architecture may slightly increase the training time.

**6.2.3 Crew Coordination/ Cockpit Resource Management** – Most resource management problems boil down to a lack of team work between crew members or any other person in the scenario. The reasons are psychological in nature and can be recognised in any field of human operation. Some of these are lack of basic awareness, not communicating effectively, ego, authoritarian styles, etc. This leads to poor team work and inappropriate task sharing resulting in increased workload and ineffective decision making. The introduction of glass cockpits will not make these problems easier to solve nor simplify the training because the psychological effects of individuals in coordinating with others will

still be there. Moreover, in two place aircraft, glass cockpits could increase the severity of the cockpit management problem since each crew member may have configured his displays differently. Considering the instructor/pupil situation, the instructor needs to recognize and correct the pupil's mistakes in a timely manner. If a two seat glass cockpit aircraft is being used, a pupil has a wider choice of functions available and thus the opportunity for incorrect selection is higher. Also the speed that pupils can select menu pages makes it difficult for an observer to follow. Therefore it is imperative that the instructor has visibility of the student's situation and actions in order to prevent serious errors and or undesirable trends. The instructors station will have to be more complex with extra functions and display surfaces such that the instructor can remain on top of the situation and in command.

**6.2.4 Pilot Conversion from Round Dial to Glass Cockpits** – Basic pilot skills (navigation and airmanship) learnt in aircraft employing conventional cockpits allow the pilot to more easily transition to more sophisticated aircraft in part because the pilot is not trained to be dependant on, and 'over-awed' by, the technology. This could result in more quantity and quality of training required for other pilots not so trained. The introduction of glass cockpits with all their flexibility combined with the demands of multi-role aircraft has increased training time, and hence cost. However, once learnt, the operation of glass cockpits is both more efficient and versatile. The increase in training has more to do with the increase in sensors, weapons and aircraft capabilities than a glass cockpit *per se*.

### 6.3 Training Approaches

It is accepted today that, due to high cost of flying training, the trend is to rely on greater amounts of simulated situations to be included in the training curriculum. Figure 6-1 gives an indication of the relative cost and effectiveness of all teaching methods. An integrated training regime which includes simple classroom aids, part task trainers, weapons and avionics trainers, full mission simulators and the aircraft, must be looked upon as the minimum suite required for training fighter pilots. Each element must be properly balanced and dovetailed with the others. It is the overall 'suite' that must be cost effective. This section looks at the various methods of teaching and examines the changes that should be included due to the introduction of glass cockpits.

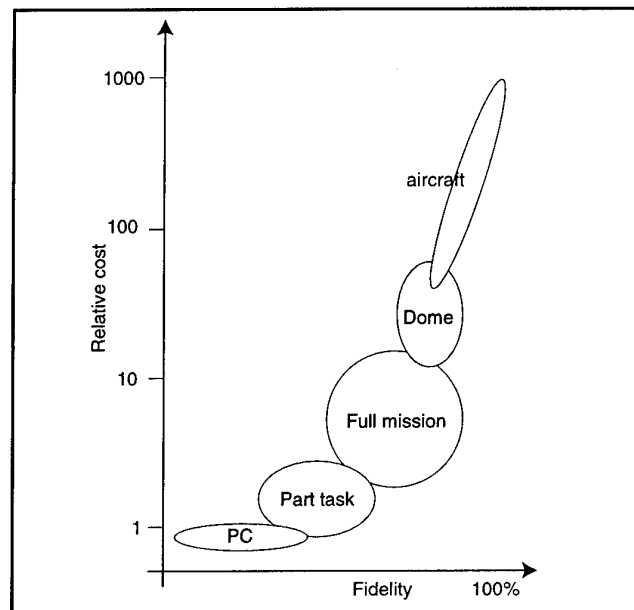

Figure 6-1 The Cost of Training Fidelity

**6.3.1 Lectures** – Lectures classically tend to be rigidly structured serial events in which single systems are taught. Generally they have a low instructor to pupil ratio. Heavy reliance is placed on the experienced lecturer at his blackboard dispensing data with the aid of diagrams, large static boards and articulated models to supplement the lecture. The learning process requires the student to work through diagrams and, in order to understand the working of a system, the student is required to exercise considerable imagination. The use of articulated models or pictures from glass displays does help somewhat but these are cumbersome and time consuming to use. It is, therefore, considered that teaching glass cockpits is not efficient in a traditional lecture arrangement. However, class discussions are essential for tactical techniques, interactive discussions and extension of experience from experts. When used correctly these discussions augment the learning process significantly.

**6.3.2 Computer Aided Training (CAT)** – Classrooms fitted with TV projectors can, separately or in combination, portray computer generated pictures of formats, panels, etc. This substitute for the blackboard is the suggested minimum for teaching the fundamentals of a glass cockpit. Using appropriate displays and controls linked to a computer model of the system, the student is provided with an operationally representative model of the system and can rehearse tasks as they would be conducted in the aircraft. Individual students can use this type of CAT advantageously by allowing the learning process to be self-paced. Personal computers used as training aids have been used for single systems as well as complex cockpits. Their use to teach the operation of glass cockpits is most appropriate with an effective instructor/pupil ratio of 1.

**6.3.4 Procedures Trainers** – The sections above described training methods which did not physically represent the system being taught. Having learnt individual systems, these need to be combined to appear as they would in the aircraft cockpit. This can be done by the use of an orientation or procedures trainer. Although not a flight simulator, the procedures trainer can be capable of comprehensive fault simulation and reduces the time required on a full mission simulator. Switchology, system operation and emergency procedures are the province of Procedure Trainers. The increasing use of glass technology in the cockpit will likely increase the need for hands-on Procedure Trainers in the future.

**6.3.5 Full mission simulators** – The advantages of flight simulators are well known but, for the sake of completeness, they are listed here; low cost of operation relative to the aircraft; use independent of weather or time of day; effective use of available time; greater utilisation than the aircraft and control of conditions and malfunctions with no hazard to crew. The use of full mission simulators will increase dramatically due to the requirement to train in multi-role, various weapon scenarios that are to be expected of modern combat aircraft. This dramatic increase of use is because of the useful simulator features such as stop/freeze options, controllable weather, controllable threat and all day/night use. Training scenarios may be generated by computers and there may be more than one aircraft (simulator) involved through the use of networking several simulators in an architecture now becoming known as Distributed, Interactive Simulation (DIS). Coordination of non-airborne assets in these scenarios is also a possibility.

Full mission simulators need to represent the aircraft and its mission scenario as closely as it is possible. High fidelity flight characteristics, outside scene, weapons and sensors (especially EO type sensors) are extremely important. The use of representative aircraft glass cockpit hardware is implicit and requires the use of the actual cockpit hardware such as HMD, HUD, mission processors etc.

**6.3.6 Flying training** – There is no substitute for actual flying operations in the high stress environment with multiple friendly and “bogey” aircraft. Here is where learnt procedures must be adhered to, paying particular attention to ‘eyes out of the cockpit’ and the pilot’s time management for safe operations. For example, the attack mission in poor weather and/or at night is still being practised in flight because simulators do not have sufficient fidelity to represent real world operations. This adds significant cost to the overall training and risk, when performed in actual conditions. Limited training opportunities exist because of dependency on weather and/or hours of darkness.

All procurement of aircraft in the future would, ideally, be just single seat, combat ready aircraft, to reduce program costs. The current trend, however, is still to procure specific two seat training variants. The prime reason for this is because simulators cannot replicate the operational aircraft sufficiently.

Training approaches can be summarised as follows:

		lectures	computer based	simulation	flight time
Old conventional cockpits		Relatively long time	none	Very little	Long time
Present day ‘glass’ cockpits	Simple missions	Short time	Relatively short	Moderate time	Relatively long
	Night/ in weather	Relatively long time	Relatively short	High, more required	Relatively long
Future cockpits		Expect to decrease	Expect to increase	Very high	Slightly reduced

Table 6-1 Summary of Training Approaches

## 6.4 Training time

Total training time is the measure that this report will use to indicate trends in training. This time includes classroom time, simulator time, flying time and time on a squadron assignment. Figure 6-2 indicates that throughout the last 30 years basic flying training has taken a steady decrease in time due to improvements in aircraft ‘carefree handling’, better aerodynamic response and more autopilot functions. This time will level out because there will always be some time

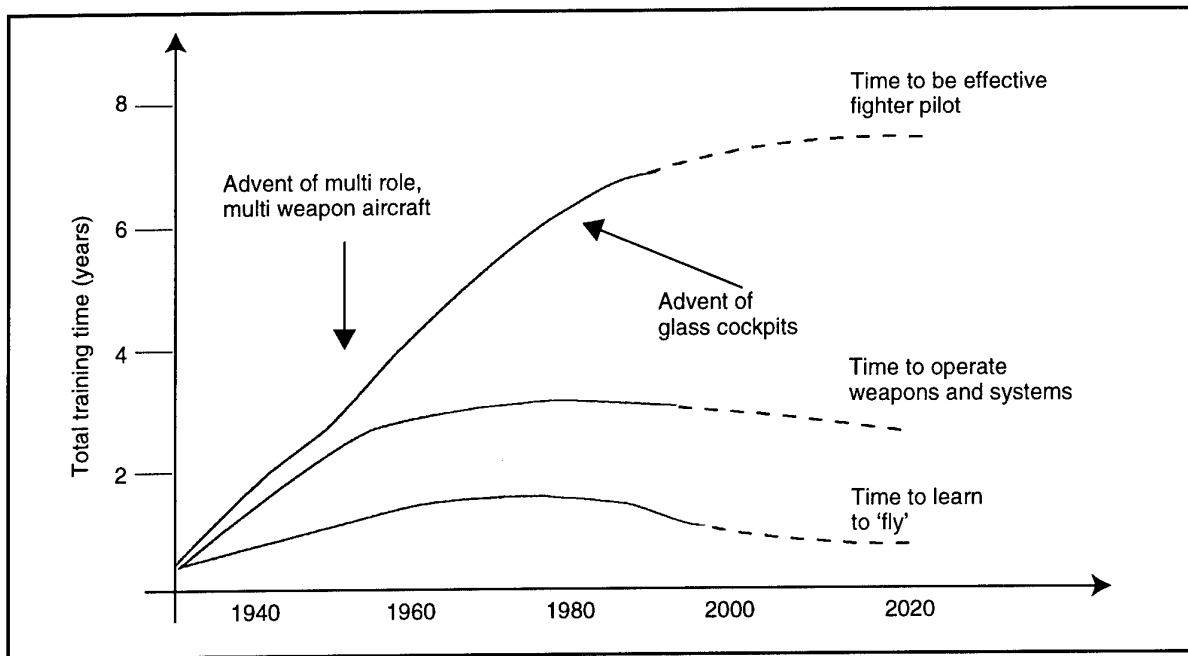

Figure 6-2 Trend of Training Time

required to convert an ab initio student into a pilot. Conversely, the time taken to learn the aircraft systems and weapons has increased rapidly due to the multi role aircraft, complex systems and the proliferation of data squeezed into the cockpit. It can be said that this time to learn the systems is in proportion to the quality of the design of a given cockpit (Refer to Section 7). It is predicted that as better integration, more sophisticated on-board data fusion and decision aids are added to the aircraft, there will be a reduction in the time required to learn to manipulate more complex systems. Finally the time taken to learn to be an effective fighter pilot, i.e. to learn tactics, make good operational decisions, use the best weapon in a particular scenario is increasing. It is predicted that there will be an increase in this time as more smart weapons are added to the aircraft and regular practice for all weapons and modes are required. It will be seen that by adding these three components, the overall conclusion is that total training time will continue to increase.

One change in training philosophy which might reduce this huge time may be to have groups of pilots trained as specialists in one particular role or weapon system. In this way the flexible multi-role aircraft would be the same for the host nation but the pilots would not be experts in all of the missions or roles.

## 6.5 Conclusions

The evolutionary nature of displays in the cockpits means that pilots who have been trained on previous aircraft have to transition to the new technology displays. Concepts previously learnt have to be re-trained. This retraining can be longer and thus expensive. When glass cockpits were first introduced the designer attempted to lessen the impact by making the displays emulate the old mechanical instruments because the technology was not sufficiently advanced to be able to integrate the information into simple, large pictures. In the future display concepts now considered novel will be common place and will be easily assimilated because all aircraft, even ab initio trainers, will have glass displays. Thus at present, the training time required for glass cockpit aircraft is longer but in the future this time requirement should reduce. In either event both display approaches will have the potential, with careful design, to produce better man-machine interfaces and thereby reduce training time and cost.

One advantage claimed for the glass cockpit concept is that decisions can be made faster since the data can be presented in a more intuitive form. Training of new pilots should be shorter, particularly if the student is well versed in interacting with a screen. Therefore it should be possible to shorten the time taken to get the pilot thinking in a mission oriented role. However, increased mission complexity and weapons system versatility have resulted in an overall increase in total training time required. The use of simulators to train modern combat aircrew will likely continue to increase in significance, however will not replace the need for actual flying training. The next section describes the Design and Development process. One of the aims for future cockpit design must be to simplify operations so that the effort required in training can be kept to acceptable levels.



## 7.0 THE COCKPIT DESIGN PROCESS

### 7.1 Introduction

In recent years, military procurement agencies have recognised a vast gulf between promised system performance (or that demonstrated in the laboratory) and that realised in the field. A prime cause of this has been identified as a mismatch between equipment and the humans that have to use or service it. Thus initiatives such as MANPRINT (MANpower & PeRsonnel INTeGration) have been launched to change an equipment-oriented view of systems development towards a broader view that considers hardware, software and "liveware" together as a system. Such initiatives are active within the US and UK. NATO working groups are addressing similar issues and other nations are showing stronger interest in these concepts.

MANPRINT aims to improve weapon system performance at reduced cost by better integration of all aspects of the Human Factors (HF) discipline in the design process. In particular, it formalises the process of Human Engineering by mandating a framework within which HF activities have to be programmed, carried out and reported. Looking specifically at the aircraft cockpit, there are concerns that the introduction of the glass cockpit in itself has been a mixed blessing as identified in section 1. These concerns have prompted critical reviews of the glass cockpit to understand the reasons why its full potential has not always been realised. One such initiative is this present AGARD Working Group.

In particular, section 5 has identified a mismatch between the capabilities of many glass cockpits and the human operators. In addressing this issue, the question that has to be asked is "what process caused or allowed this mismatch to occur"? It is thus apparent that the design of the total man-machine interface and the underlying systems as a coherent entity is one of, if not the most important task facing the prime systems contractor. The point must be made strongly that the cockpit is the product of the process and will suffer or benefit from the approach taken. When seen in this light, the process of cockpit design is almost as important as the product (the cockpit Man Machine Interface [MMI]). Hence a study of the glass cockpit, warts and all, would not be complete without consideration of a typical cockpit design process and its influence on the cockpit.

This section of the report will start by examining typical design practices, the problems inherent therein and the consequent effect on the cockpit. Current issues in the link between process and product will be highlighted. Next, the many cockpit design standards and guidelines will be examined in terms of their influence on the design process. A bibliography of the most relevant reference material is given. Finally, a review of cockpit design process good practice is presented along with recommendations. Two papers are referenced that give further insight into the design process employed on two current programmes, one fixed-wing and one rotorcraft.

### 7.2 Design Practices & Problems

Whilst there are initiatives seeking to improve the process by which man-in-the-loop systems are procured, designed, developed and fielded, there have been many problems associated with the way cockpits have been brought into being. The cockpit has often been viewed in a very narrow sense as a hardware interface between two system elements. Engineers working in the cockpit design area have often seen the task as one of shoe-horning the available technology into a small volume. The interaction between the pilot and vehicle has often been neglected and cockpit solutions have not been derived with regard to task requirements.

Traditional design approaches have not been sufficiently user-centred; the pilot is usually expected to adapt to the cockpit given him. Many aircraft systems cannot be considered to be as integrated as much as interfaced. The pilot is required to scan several displays and integrate the data in order to maintain awareness of the situation which takes time and resource that cannot be devoted to any other activity. The detailed MMI of the cockpit is often not matched to the task that the pilot has in hand or the role required of him. For instance, system status pages are often designed more for engineering authenticity than rapid interpretation of a problem situation to determine what needs to be done to rectify the problem. Controls may be of the wrong form for rapid location, identification and operation at night, under stress and pulling G.

A current trend is that aircraft are required to be multi-role either within one aircraft configuration (F-18, EF2000), or as different variants of one type (F-15, Tornado). If the roles are quite different e.g. Air to Air and Air to Surface, then it is impossible to optimize the aircraft for both roles and some form of compromise is required. This is true not just of the aircraft but also the cockpit. This compromise has greatest effect on overall cockpit configuration and a "dedicated" approach to cockpit equipment; the glass cockpit with multi-function displays and controls is inherently more flexible.

Aircraft development is a protracted process and changing conflict scenarios lead to changing aircraft and hence cockpit requirements during the development process. Operational aircraft often suffer from bolted-on equipment in a non-optimum position to meet a new requirement. Indeed, no early requirement is ever complete in terms of all the eventual uses to which the aircraft will be put. Traditionally, cockpits do not have slack built-in as space is always at a premium. However, the flexibility of the glass cockpit helps in this respect as role and requirement changes may be handled by software change without the need for extra hardware.

Evaluations of cockpit developments are usually undertaken in mock-up facilities using test pilots as subject matter experts. Assessments often rely on pilot opinion from which conclusions are drawn; performance ratings are predominantly subjective rather than objective due to a lack of metrics and performance measures that link crew and cockpit contribution to mission effectiveness. Differences in opinion between pilots, and between pilots and designers can become entrenched and difficult to resolve.

Due to the important role of aircrew evaluation of developing cockpit concepts, the cockpit design process is often much more iterative than for other disciplines. This iteration poses a major design problem with myriad requirements for change not being identified until the evaluation phase. The later in the programme that a change is agreed, the greater the cost of implementing it. From the cockpit viewpoint, estimating costs, programming design activities and remaining within budget is made more difficult due to this iterative nature.

It is not uncommon for customer aircrew representatives to change on a frequent basis. This can lead to changing cockpit requirements and evaluation recommendations. Changes in the world conflict scenarios and hence operational requirements within the development time frame of the aircraft are also likely. Changing requirements, for whatever reason, equates to increased development times and cost. Overall, the handling of change in a fixed-price contract with tight budgets is a major issue to be resolved in consideration of the design process.

The integration of cockpit design with the wider system design process is a key area which is often problematic. Lack of ownership of a common requirement leads to dissonant assumptions about what is required. Lack of communication between cockpit and equipment/systems engineers leads to myriad implementation difficulties based on isolated or mistaken assumptions.

There is often difficulty in tracing cockpit and system solutions back to operational requirements. Top-down functional decompositions often start in mid-air or with a requirement generated by the contractor. Initiatives such as MANPRINT will place great emphasis on traceability of solutions back to requirements.

One of the major concerns of cockpit design is the effective integration of all cockpit elements. This is made more difficult where the incorporation of Government Furnished Equipment is required. Interface, interaction and configuration control are important concerns.

Having identified the major problems and issues which have to be addressed in the cockpit design process, let's examine the available standards and guidelines which aim to ameliorate the situation.

### **7.3 Cockpit Design Standards**

It has been said (somewhat tongue-in-cheek) that the best thing about standards is that there are so many of them! Dependent on the customer, there are numerous standards that are referenced covering the application of good HF advice, principles and guidelines, the best known and most often quoted being MIL-STD-1472. There are also several standards that apply specifically to the design process: MIL-H-46855, STANAG 3994 AI & DEF STAN 00-25 Part 12 (Systems), to name but three. These latter standards aim to provide designers with a description of, and guidance on how to apply, human factors methods and techniques during the various stages of the design life-cycle. Specific activities are required to be undertaken which are to be scheduled by means of a Human Engineering Programme Plan (HEPP).

Contractors have experienced difficulty when the advice offered in several standards that are mandated in the development contract are in conflict with one another or cannot be met with the available technology. Waivers to strict compliance with the standards or specifications then have to be agreed between contractor and customer. This practice may be less common in relation to some procurement agencies than others.

One of the commonest criticisms levelled against standards is that they could have a potentially inhibiting effect on the creativity of designers. It is accepted that there are occasions when standards will restrict choice, but this is for reasons of consistency or good practice. In summary, it should be borne in mind that the majority of HF standards present guidelines and good advice that aim to improve systems usability by:

- offering the possibility of consistency;
- providing a disciplined framework for HF recommendations that make them accessible to non-specialists;
- representing consensus about good practice.

This sub-section concludes with a list of some of the most useful and often-referenced standards, guidelines and books related to Human Engineering in the cockpit. This list is by no means exhaustive but is intended to cover the more important issues; each standard will also contain further references that will provide additional information.

MIL-C-81774 - Control Panel, Aircraft, General Requirements for.

MIL-H-46855 - Human Engineering Requirements for Military Systems, Equipment and Facilities.

MIL-L-18276 - Lighting, Aircraft Interior, Installation of.

MIL-L-85762 - Lighting, Aircraft Interior, Aviator's Night Vision Imaging System (ANVIS) Compatible.

MIL-M-8650 - Mockups, Aircraft, General Specification for.

MIL-STD-250 - Aircrew Station Controls & Displays for Rotary Wing Aircraft.

MIL-STD-411 - Aircrew Station Signals.

MIL-STD-850 - Aircrew Station Vision Requirements for Military Aircraft.

MIL-STD-1295 - Human Factors Engineering Design Criteria for Helicopter Cockpit Electro-Optical Display Symbology.

MIL-STD-1333 - Aircrew Station Geometry for Military Aircraft.

MIL-STD-1472 - Human Engineering Design Criteria for Military Systems, Equipment and Facilities.

MIL-STD-1787 - Military Standard Aircraft Display Symbology.

AMC-P 602-1 - MANPRINT Handbook for RFP Development.

AMC-P 602-2 - MANPRINT Handbook for Non- Developmental Item Acquisition.

AR 602-1 - Human Factors Engineering Program

AR 602-2 - Manpower & Personnel Integration (MANPRINT) in Materiel Acquisition Process.

DOD-HDBK-743 - Anthropometry of Military Personnel.

STANAG 3224 AI - Aircrew Station Lighting.

STANAG 3370 AI - Aircrew Station Warning, Cautionary & Advisory Signals.

STANAG 3622 AI - External Vision from Aircrew Stations.

STANAG 3705 AI - Human Engineering Design Criteria for Controls & Displays in Aircrew Stations.

STANAG 3800 AI - Night Vision Goggles Lighting Compatibility Design Criteria.

STANAG 3994 AI - The Application of Human Engineering to Advanced Aircrew Stations.

DEF STAN 00-25 - Human Factors for Designers of Equipment.

DEF STAN 00-970 - Design of Airworthiness Requirements for Service Aircraft.

Boff K.R., & Lincoln J.E. Engineering Data Compendium: Human Perception and Performance (Vols 1-3). Wright-Patterson Air Force Base.

Booher H.R. MANPRINT, An Approach to Systems Integration. US Dept. of the Army.

Meister D., & Farr D. The Utilisation of Human Factors Information by Designers. Office of Naval Research.

Van Cott H.P., & Kinkade R.G. Human Engineering Guide to Equipment Design. Joint Army - Navy - Air Force Steering Committee (USA).

#### **7.4 Design Process Review**

In summary, it can be seen from the above that operational problems in the cockpit can stem from the process adopted in its design and development. Hence the effectiveness of a cockpit and the pilot within it bear a direct relationship to the efficacy of the process that derived it. This is even more true for complex and integrated glass cockpits than for more conventional predecessors.

As it is argued that product should not be separated from process, there is a case for as much R&D effort to be applied to design process issues as to product issues. Cost and timescale benefits that can be realised in an improved cockpit design process will have a consequent effect on the wider design process. Improvements in cockpit and crew effectiveness can also be realised through process improvements; this will have a direct and positive effect on vehicle performance. A cockpit that is easier to operate and maintain is more marketable and cheaper to support with consequent benefits for the contractor and customer.

Following the guidelines of design standards (such as the ones referenced above) can lead to improvements in the design process. It is also important to recognize and harness appropriately the contribution that aircrew, engineers and Human Factors specialists can make to the process. A comprehensive but rational design process that addresses all the problem issues raised above will have significant benefits on the cost versus performance trade-off for the contractor and reap a better return on investment for the customer.

As has been identified, contracts and design improvement initiatives are requiring the generation of a Human Engineering Programme Plan (HEPP) by which to plan, manage and control cockpit design activities. It should be noted that this HEPP may well need to be integrated in a higher level design programme such as a Manufacturer's MANPRINT Management Plan. Several of the referenced standards prescribe activities to be undertaken in the design process and describe what has to be done. Each stage of a typical design process will be addressed in turn.

**7.4.1 Up-front Analysis** – An initial starting point for the analysis process might be a critical review or study of a predecessor or comparable system. Formal methods have been derived, such as Early Comparability Analysis, to examine previous applicable systems so that lessons can be learned in terms of major design issues or major task drivers. At this stage some of the initial tradeoffs between the MANPRINT domains of Manpower, Personnel and Training can be performed.

**7.4.2 Requirements Capture** – One of the key top level documents is the System Requirement which may well be generated by the customer or defined by the contractor in terms of a Customer Needs Profile. As we are concerned with matching the capabilities of the cockpit with the personnel who will operate it, a detailed profile of the user (Target Audience Description) should be provided by the customer or generated by the contractor. Early analysis of the System Requirement should concentrate on its implications for human-system integration, particularly in terms of the performance required.

**7.4.3 Mission Analysis** – An extensive understanding of the system requirement should be demonstrated by generation of a series of mission profiles on a time line basis which the vehicle has to carry out. Analysis of these profiles and the operational scenario in which they are set defines the activities that the aircraft must complete in the context of the surrounding environment. Task decomposition of this form identifies the system functions that the aircraft requires, independent of whether they are performed by the crew, the machine or in co-operation.

**7.4.4 Function Analysis** – Identification of required functions within the mission context against a timeline aids derivation of the system behavioral characteristics. Expert knowledge of the task domain and projected technology capabilities and constraints enables an initial allocation of function to man or machine to be carried out. Dependent on the exact approach taken, it might be truer to say that it is vehicle tasks rather than system functions that are allocated to the proposed system elements. As these Mission and Function Analyses are key steps between the top level requirement and subsequent cockpit definition, it is important that the approach and findings are agreed with both system designers in areas allied to the cockpit and the customer (or his operational representatives).

**7.4.5 Conceptual Cockpit Design** – At this stage a conceptual design of the cockpit can be proposed starting with the overall configuration and cockpit geometry. This cockpit configuration is required early on to analyze and agree its impact on aircraft lines and airframe issues. A concept of operation for the cockpit in terms of general operating philosophies should be generated.

**7.4.6 Task Analysis** – Using the mission time lines generated previously, the tasks allocated to the crew can be analyzed in increasing levels of detail. All required tasks should be analyzed at a high level though tasks deemed to be critical due to task difficulty, workload or safety criteria should be analyzed in even more detail. The workload demanded of the crew must be assessed for potential overload in which case some of the prior assumptions/allocations will require revisiting.

**7.4.7 Health & Safety** – At an early stage of cockpit development, it must be assessed in terms of the hazard it might represent to the health of the aircrew. Coupled with this, any safety implications of the developing cockpit and concept of operation should be identified and analyzed. Again, this might require an element of re-work. However, the earlier that design problems are discovered and rectified the cheaper the solution.

**7.4.8 Detailed MMI Design** – The detailed Task Analysis identified above can now be used to derive the requirement for control functions and information presentation in the cockpit, the “what” rather than the “how”. This requirement can be met by matching technology capability to task requirement, consistent with the operating philosophies and safety criteria identified previously. There is much detailed information in the Human Factors standards referenced above that supports this design effort.

**7.4.9 Design Evaluation** – Experience within the major aircraft manufacturers points to the necessity for cockpit layouts and concepts to be evaluated in mock-ups, rigs and simulators. These facilities should be viewed as design tools in their own right and therefore utilised from the earliest stages of the design process. As the design progresses and concepts firm up, the mock-ups and simulations used for evaluation are required to be more sophisticated and of higher fidelity. The following facilities and the use to which they may be put are recommended as typical to satisfy the evaluation requirements of a major development programme.

A static cockpit should be commissioned that is an accurate 3-dimensional full-scale mock-up which may be integral with a representation of the aircraft front fuselage. It can be fitted with representative seat, rudder pedals, stick and throttle tops. Initially, control areas may be represented by white on black pictures of the layout; these should soon be replaced by the actual form of control.

With the seat adjusted to put the aircrew at the correct sitting position and the full harness fitted, assessment of the cockpit internal features can be made. The acceptability of the reach and vision envelopes to all general display and control areas in the cockpit is assessed to agree the overall cockpit configuration. A more detailed evaluation may also be performed covering the necessity for and location of every single feature in the cockpit. The same mock-up can be used to assess external vision from the cockpit and aircrew ingress to and egress from the cockpit (in both normal and emergency conditions). It is important for these types of trial that subjects are chosen to span the full anthropometric aircrew size range that is required. Appropriate aircrew clothing and personal equipment (life-support, G-protection etc.) should be worn for each evaluation.

In a similar way to that in which a static cockpit is commissioned and used, an active cockpit should be brought on line at a slightly later stage in the cockpit design process. The internal dimensions of the cockpit and the equipment with which it is furnished should be as representative as possible in form, fit and function, given that much of it may be either off-the-shelf equipment or manufactured in-house. The cockpit is linked to an assessment control station and the computer facilities that house the simulation software. The basic facility should include an aircraft model, which when interfaced with the outside world visual system and the inceptors in the cockpit, enables the pilot to fly the simulation and receive realistic cues. Provision of aircraft system models and interactive displays and controls allows pilot assessment of the cockpit via mission-capable simulation.

This form of active cockpit is now seen very much as a design tool in its own right. It is commissioned and used as early on in the project as possible providing much useful information on parameters and moding to be incorporated in the developing design. It also gives increased confidence on the acceptability of proposed concepts and thus provides a risk-reduction function, so important to the system developer in a fixed-price contract. This vehicle is the prime means by which acceptable user-in-the-loop performance is demonstrated; this may be a contractual obligation in the era of MANPRINT.

**7.4.10 Cockpit Qualification** – Cockpit qualification covers the dual issues of the aircraft/cockpit being safe to fly (certification) and fit for purpose. A formal plan for demonstrating qualification will be required that has to be agreed with the customer. The whole process before first flight is concerned with gathering evidence from the design route (mainly design documentation and assessment reports) to convince the acceptance authorities that the cockpit meets the required criteria. The early focus of attention will be on the airworthiness of the vehicle, i.e. is it safe to fly, later attention will focus more on meeting performance acceptance criteria. It may be necessary to build specific ground-based facilities and perform assessments on them in support of this activity. Qualification continues into the vital airborne phase of the evaluation process which is discussed next.

**7.4.11 Flight Test** – Whilst a significant level of risk-reduction of the cockpit design process can be achieved via evaluation on the ground, final validation can only be obtained in the air. Specific aspects of the cockpit design can only be fully evaluated and validated in the operational environment and so the cockpit design team should be involved in derivation of the required flight test programme and analysis of the results. This evaluation may well feed back into the design process not just as validation/qualification evidence but also as required re-work. A phased approach is usually taken that progressively explores and validates the flight envelope and system performance.

**7.4.12 Post-design Evaluation** – Service tests by a customer operational evaluation unit may reveal further in-service modification requirements. A formal procedure will be required to handle this leading to contractor/customer service release or the need for further system modification. On-going service experience of use (exercises, engagements etc.) should be recorded and monitored to build a database of information for effectiveness analysis and prospective product improvement e.g. mid-life update etc.

## 7.5 Summary

This section has made the case that the cockpit is very much a product of the design process and will benefit or suffer from the approach taken. Typical problems inherent in current design practices have been highlighted and reference made to the cockpit design standards that are available for guidance. The section concluded with a review of the key stages in what might be considered cockpit design best practice.

## 7.6 Further Reading

For a more detailed description of a specific cockpit design approach, Reference 1 discusses the method adopted for the EF2000 Aircraft project and Reference 2 discusses the approach taken for the Comanche Helicopter.

- 1 Wilkinson P.R., **The Integration of Advanced Cockpit and System Design**, AGARD CP521 - Avionics Panel, May 1992.
- 2 Hamilton B., **Comanche Crew Station Design**, AIAA-92-1049, February 1992.

## 8.0 FUTURE COCKPITS

### 8.1 Introduction

From the foregoing chapters it can be seen that a great deal of progress has been made in the development and application of new cockpit technology in the last 30 years.

Figure 8-1 outlines the progress of that era. The analog cockpit of the 60's two-place F-4 Phantom was followed by the HUD/CRT/Analog equipped cockpit of the one-place F-15 Eagle which gave way to the HUD/ Multi Function Display (glass) cockpit of the dual-mission, one-place F/A-18 Hornet. Most recent fighters use similar cockpit schemes:

- 1) A Head-Up Display,
- 2) Two, three, or more Multi-Function Displays,
- 3) A Data Entry Panel, and
- 4) Hands-on-Throttle-and-Stick (HOTAS).

In addition, newer aircraft and helicopter designs employ both HMDs and Direct Voice Input.

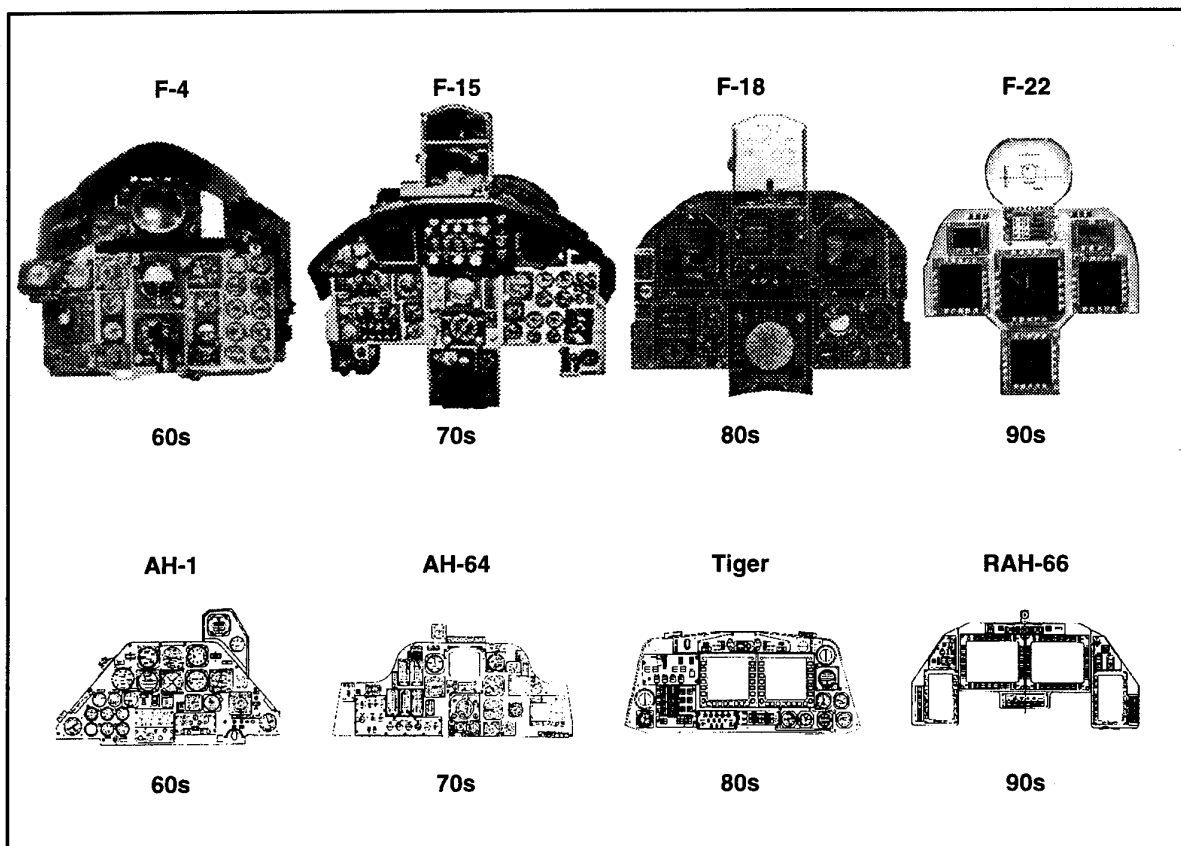

Figure 8-1 Cockpits have Progressed From "Steam Gauges" to Multi-Purpose Displays

**8.1.1 Background** – Over the last 30 years gunsights were replaced by HUD's which grew from 10° to 30° in Field-Of-View and now also provide raster displays of sensor imagery at night. Low brightness cathode ray tube displays were replaced with high brightness CRT's or liquid crystal flat panels with soft keys for direct interface with display formats. Comm, Nav, Ident controls and numeric keyboards were moved from the console and integrated into Up-Front Controls and moving map displays became common in the 80's. In addition, to improve operability during manoeuvres, a number of functions were added to the stick and throttle (or collective) in a concept which has generally become known as HOTAS.

and moving map displays became common in the 80's. In addition, to improve operability during manoeuvres, a number of functions were added to the stick and throttle (or collective) in a concept which has generally become known as HOTAS.

This chapter will summarize the benefits and weaknesses of current cockpit designs and present three notional designs for tactical cockpits spanning the next 30 years.

**8.1.2 Benefits and Weaknesses** – The modern “glass cockpit” has been a mixed blessing as outlined previously. For the cockpit designer and crew it has provided immense versatility, flexibility and growth with resultant mission performance improvements. The increased flexibility of the “glass cockpit” has allowed the performance of both air-to-air and air-to-ground missions by a single airframe. This multi-mission, multi-sensor platform obviously has increased cost, training and average crew workload over that of round dial cockpits. But these factors are offset by fewer aircraft types yielding lower life-cycle costs. And although the so called “glass cockpit” category is very broad the worst of them can perform missions that the best round dial cockpits cannot perform.

As shown in Table 8–1 each “glass cockpit” characteristic has benefits and weaknesses that should be addressed in future cockpit designs.

Item	Benefit	Weakness	Potential Solution
Multi Function Displays	Flexibility	Small Size	Large Flat Panels
Head-Up Displays	Head Out	Fixed, Narrow FOV	Helmet Display
Helmet-Mounted Displays	Off-Axis Data	Weight, CG, bulk	Technology
Up-Front Control	Head Forward	Prime Cockpit Space	Touch, Flat Panel
Control & Display Unit	Saves Console Space	Bottleneck	Voice Control, MFD
Hands On Throttle(Coll.) & Stick	Hands on Control	Complexity, Limited	Voice Control
Map Displays	Easy Navigation	Brightness, Currency	Digital
Automation	Workload Reduction	Limited Application	Decision Aides

**Table 8–1 Benefits and Weaknesses of Today's Cockpits**

Three general comments apply to recent cockpit developments:

- 1) Cockpit technology application generally lags availability by 15 years or more. For example, MFD's for glass cockpits were available for the F-4 Phantom in the early 60's but were not put into production until the mid 70's, and Helmet Mounted Display technology was available in the early 70's but except for the Apache helicopter application in the 80's, they did not reach production in fighters until the mid 90's, over 25 years after the technology was available.
- 2) The developing threat density, multi-sensor and multi-mission requirements could swamp the crew of even our “glass cockpits” with uncorrelated information on what are essentially single-sensor displays.
- 3) The displays are too small for good Situation Awareness and occupy on average only one-third of the instrument panel area.

**8.1.3 The Problem** – There are two major problems with using today's cockpit in tomorrow's sensor/mission environment:

- 1) Today's pilot spends a great deal of time managing (fiddling) and mentally integrating information from numerous displays which reduces time for tactics (flying) and,



- 2) Useful combat information is available on only one-third (see Chapter 3) of the instrument panel, the rest is unproductive space that generally does not contribute to the “kill”, and therefore is a waste of prime real estate.

Fiddling and Flying – The first problem requires the pilot to fiddle around with a host of multi-mode sensors and try to integrate mentally the data from the three primary displays while flying the aircraft. Radar, EW and data link (JTIDS) are presently displayed on three separate displays, on three different range scales with two or three different “ownship” locations. Not exactly a formula for good Situational Awareness (SA). Although some aircraft have recently incorporated various forms of multi-sensor integration it is generally displayed on a 6” or 7” display. While this helps SA in low-to-medium intensity conflicts, the density of information and the lack of a truly “integrated format” still lead to marginal SA levels in high-intensity environments. A solution to this problem is increased sensor automation and the incorporation of decision aiding and multi-sensor integration. This pre-processed information could be presented on a much larger display surface as an overlay on a tactical situation display, such as a moving map.

Unproductive Space – The second problem, that of inefficient use of the instrument panel space is simple mathematics. The average instrument panel is roughly 18” high by 24” wide or about 400 square inches. Using three 5” or 6” displays yield a total display area of 75 to 108 inch<sup>2</sup>. Therefore, on average, 70 to 80% of the instrument panel is unproductive and inflexible, devoid of combat data and unable to contribute to SA, the “fight”, or bombs-on-target during the critical one-minute of target contact. It is important to remember that the pilot is in the aircraft only to make good tactical decisions and execute them. Everything else is secondary. However, the effectiveness of tactical decision-making by the pilot is directly proportional to the Situation Awareness (SA) state of the pilot. Larger displays capable of displaying “fused” data as well as “windowing” pertinent information to the tasks at hand will definitely improve the pilot SA level.

However, a cockpit revolution is in the making. Many cockpit related technologies are in advanced states of development that will help the pilot cope with the data explosion coming from on-board/off-board sensor and processing advances. Technologies such as helmet systems, large flat panel displays, speech recognition, colour graphics, decision aiding and multi-sensor integration algorithms are available that promise big performance payoffs for future generation cockpits.

## 8.2 Requirements for Future Cockpits

Never has the cockpit designer had such a rich selection of emerging technologies from which to choose. But in times of reduced budgets, this treasure trove of technologies is under severe pressure to pay its way on-board in combat kills, safety, or survivability. Therefore, each technology and mission requirement needs to be evaluated on the basis of which problem it solves and the cost effectiveness of that solution over the alternatives.

**8.2.1 Situational Awareness (SA)** – The working group believes that future cockpits must improve SA in all flight phases and aircraft roles to improve the crew performance. SA as defined in Chapter 5 is simply “knowing what is going on so you can figure out what to do”; where are the friendlies, bogies, SAM’s and unknowns with respect to my flight?; what are their intentions, my intentions, own-ship status and my options?. It’s obvious that present cockpits, by separating primary sensor data, on different displays and range scales with different “ownship” positions do not give the pilot the SA required to achieve the desired exchange ratios against equivalent quality targets. Total SA may be considered as internal (ownship) SA and external SA. The internal SA means knowing the status of the systems, modes etc.. As shown previously in Figure 5-1, external SA is a two-fold problem: Tactical (visual range) and Global (beyond visual range).

Tactical SA (The Little Picture) – Tactical SA covers close-in, visual air-to-air and air-to-surface combat and visual navigation. M on N aerial combat is one of the arenas where the pilot and machine are taxed to their physical and mental limits. For equivalent aircraft, each pilot’s SA, acted upon by the eye, brain, hands and feet is the primary determinant of “who shoots” and “who chutes”.

Tactical SA Solution – The tactical SA problem is perhaps best solved by a helmet mounted system that:

- 1) Tracks the pilot’s head position and slaves sensors and weapons to the helmet line-of-sight, and
- 2) Displays combat and flight information on the helmet visor.

Both McDonnell F-15 and UK simulator evaluations have shown a 2:1 exchange ratio improvement with an HMDs over the HUD using present weapons and sensors. In the Air-to-Air role, they provide faster visual lock-ons, rapid-fire radar

and IR missile launches, target handoff to wingman, and better attitude awareness at all times. In the Air-to-Ground role, they allow off-boresight target designations, offset NAV waypoint updates, and target handoff to wingman. It also allows greater standoff range and higher altitudes at bomb release.

Global SA (The Big Picture) – Global SA generally covers the non-visual spherical world at ranges from 0 to 200 miles. Most often a Plan View display is best, with “ownship” position decentered because of higher interest and lethality in the forward hemisphere. Separate sensors on small displays or multi-sensor integration on small displays are no match for the complexity of this environment composed of dozens of pieces of information.

Global SA Solution – The beyond-visual-range Situational Awareness solution requires the “fusion” of RADAR/EW/JTIDS navigation and map on a large display. Additional information such as “decision aiding” or “expert systems” data and flight path data would greatly enhance SA. This would allow the pilot to look at a single image source with sensor and system inserts as required to “*get the Big Picture*”. Simulators have shown a 50% increase in exchange ratio when display size increases from 5” to 10” square with no other system changes, simply as a result of better SA.

**8.2.2 Other Requirements** – There are a host of other mission (chapter 2) or environmental requirements which must be considered in any future cockpit design. The following outlines a few of them and their potential cockpit consequences.

Threats (Laser, CBR) – Laser (tuneable, multi-frequency/colour) may drive us to a closed (windowless) cockpit with “the world” recreated from on/off-board databases and hardened sensors. NBC (Nuclear, Biological, Chemical) will require aircraft to have a completely self contained environment system.

Affordability – Single seat, multi-mission, with careful attention to all “ilities” of the design.

Multi-Mission Aircraft – Flexible cockpit with integrated controls and displays, decision aiding and vastly improved sensor capabilities.

Single Crew Design – Multi-source, fused SA displays with extensive stealth, automation and intuitive integrated controls and displays.

In Weather Attack – SA created from on/off-board databases, sensors and all-weather precision guided weapons.

Mission Planning/Replanning – Data link, on-board databases, intuitive interfaces.

Precision Strike – High resolution sensors, integrated displays and controls, Precision Guided Weapons.

Stand-Off Weapons – Precision guided weapons, data links, easy setup, launch and leave, integrated displays and controls.

Multiple Target Attack on a Single Pass – Multiply launchable weapons, supporting sensors, and attack route planning and decision aiding.

Flexibility – Reconfigurable displays and controls and intuitive, integrated formats.

Female Pilots – Wider range of adjustments (seat, rudder-pedals, helmet) and lower operating forces (brakes, stick loads).

Low Altitude Navigation – Active systems such as Low Probability of Intercept (LPI), steerable sensors, helmet displays, data bases and 3D autopilot.

Mission Reliability – Redundant displays and processors, in-flight reconfigurability

Stealth – Signature information incorporated into navigation and combat operations

Life Support/Agility – Atlantis Warrior (fluid filled suit) or other technologies for higher ‘g’ forces and NBC protection.

Off-Board Assets – Data link, fused information, and intuitive, integrated displays and controls.

Helicopter Specific – Unique requirements for armour plating, obstacle protection, carefree handling, crash seats.

Each of these requirements impacts future cockpit designs in one form or another putting extreme pressure on the affordability requirement.

### 8.3 Candidate Solutions

It is obvious that the breadth of requirements listed above could have a geometric set of possible solutions. To make the number of candidate solutions tolerable, we will limit them to three broad technology spans covering the next 30 years. For want of better terms we will call them Cockpit 2000, Cockpit 2010 and Cockpit 2025 indicating the year that the technology will most likely be available for design start or roughly 7 to 10 years before IOC.

**8.3.1 The Mission** – To take the “limiting case” we will choose the following strike/fighter mission which can also be applied to future helicopter missions.

**Single place, networked, air-to-air and air-to-surface combat with multi-target attack on a single pass, day or night or foul weather.**

A stealth aircraft design is assumed. A single-crew station is also assumed because of affordability driven issues which are likely to result in a 5 to 10% savings in acquisition and life cycle cost over a two crew air-vehicle design. This of course requires a more comprehensive cockpit design.

**8.3.2 Sensor Fusion** – The first problem to deal with in future cockpits is to improve a pilot’s Global SA. To do this requires sensor fusion. The three primary sensors: Radar, EW and Data Link (JTIDS or other off-board data) have widely varying functional characteristics which complicate this issue:

- 1) Radar generally searches the forward hemisphere of the aircraft with the 40 to 80 mile range being most commonly used.
- 2) EW presents a 360° plan view display for surface-to-air and air-to-air threats with a 25 to 50 mile range most commonly used.
- 3) Data link (JTIDS) will normally present a 360° plan view of various types of information depending on whether the source is inter-net or intra-net which can include national assets such as space platforms. The range scale selected by the crew will vary from 25 to 150 miles depending on the situation. A new class of information will be available to future fighters and helicopters that will include “video pictures” of target scenes transmitted near real-time to aircraft already in-flight to the target area. Tactical fusion of EO and IR sensors will also be a requirement to take advantage of the best features of each sensor.

**8.3.3 Display Size** – As shown in Figure 8-2 the display size required to impart various aircraft pieces of information to the crew is dependent on the information content of the source. Three to six inch displays are adequate for status and sensor displays but a comprehensive “picture” of radar targets, EW threats, JTIDS data, topographic map and the flight profile all overlaid on one another forces the requirement for a larger display area to provide the Global SA the crew requires to fly and fight. It is estimated that a display of ten inches square (100 inch<sup>2</sup>) or larger is required to provide even a medium threat “Global SA picture” adequately in future aircraft cockpits.

### 8.4 Cockpit 2000

The working group has assumed that the next generation strike/fighter will start development in the year 2000. It will be tasked to do the mission outlined above but against medium sized tactical targets in medium intensity environments against current generation threats using weapons now in production.

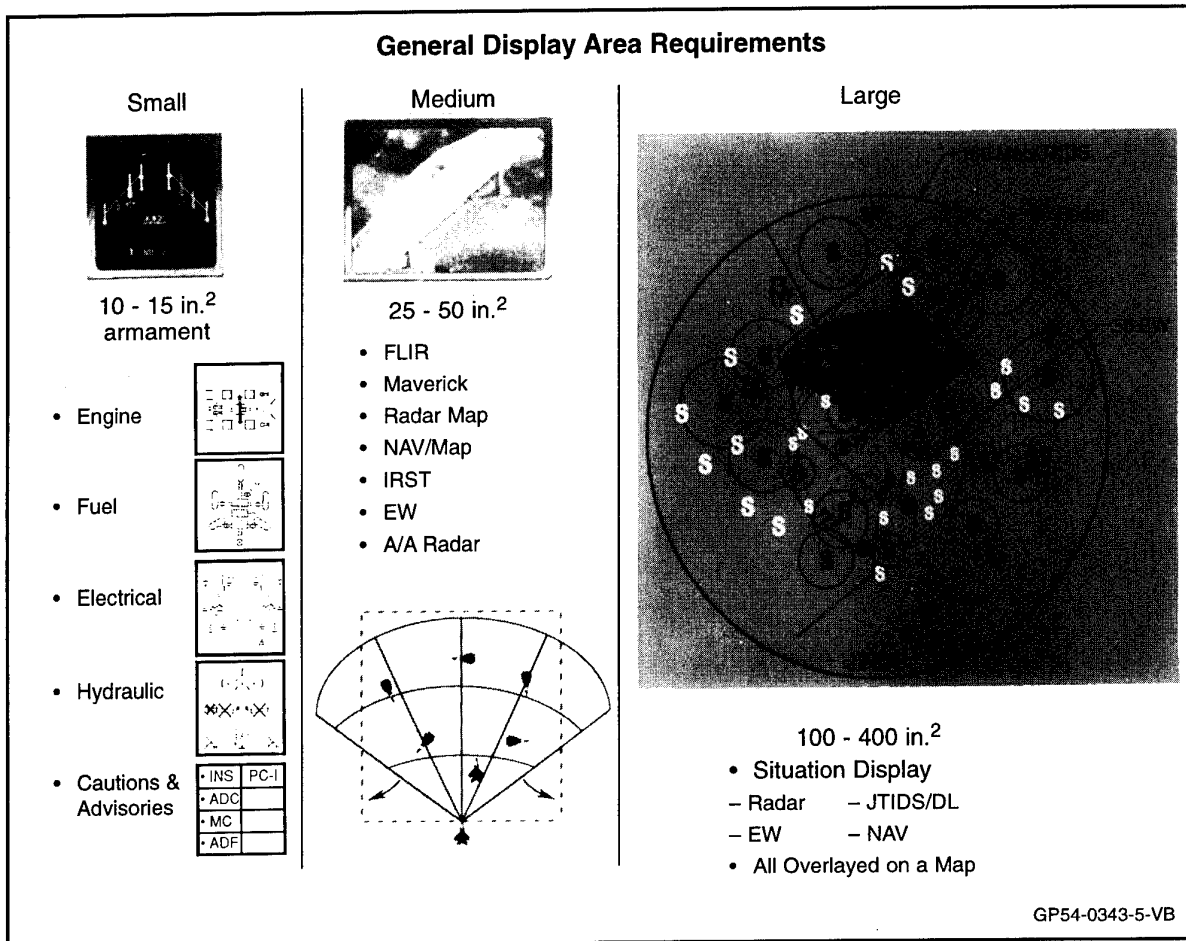

Figure 8-2 General Display Area Requirements

**8.4.1 Cockpit 2000 Technology** – Budget constraints will suggest a single place cockpit which will require a number of technology applications not present in many of today's aircraft. These technologies are:

- 1) **Helmet Mounted Display** – A lightweight stroke and raster day HMD of 15° to 30° monocular Field-Of-View for visual aerial and Air-to-Ground combat and a 30° to 50° Field-Of-View biocular system for the night mission. The day HMD technology is mature and therefore medium to low risk. The night HMD is medium to high risk for fighters because of helmet bulk, forward CG and other safety-of-flight issues. The importance of an adequate HMD cannot be overstated. It is the "linchpin" to unlocking the cockpit for solving the pilot's Global SA problem. The logic flows as follows:
  - a) Until primary sensor data is correlated and fused and then overlaid on a large map display of at least 10"x10" we cannot materially improve the pilot's Global SA.
  - b) Until the present HUD's physical size and location is altered there is no room for a 10"x10" or larger display on the instrument panel.
  - c) Until adequate HMD's are produced which convince pilots that most HUD functions can be performed as well or better on an HMD we cannot alter the present HUD size or its location which effectively splits the main instrument panel into areas too small for large displays (see Figure 8-1).
- 2) **Display Size** – Rapidly advancing flat panel technology will make display sizes of 10"x10" and larger common by the year 2000. They will most likely use AMLCD technology and will offer the required life, brightness and resolution required for combat aircraft environments.
- 3) **Automation** – A number of new or improved automation features will be required to provide SA and manage workload, such as: Decision Aids, Mission Planning, target classifiers/identifiers, Sensor Fusion and a System Manager.

- 4) Weapons – Simple set-up, precision guided launch-and-leave weapons will reduce workload while increasing survivability.

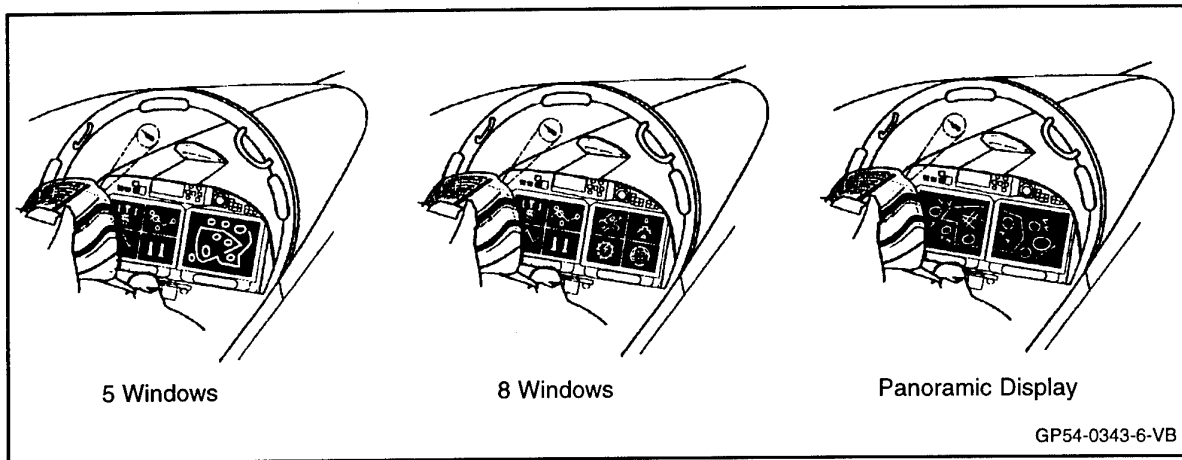

Figure 8-3 Three Views of Cockpit 2000

**8.4.2 Cockpit 2000 Approach** – As shown in Figure 8-3 a generic cockpit instrument panel of 24” wide by 18” high will support the installation of two nominal 10”x10” displays. There will still be sufficient room for a low-profile HUD (if necessary) supplemented by a medium field-of-view HMD.

The advantages of this cockpit over present day designs are:

- 1) There is approximately 3 to 4 times the display area (200 inch<sup>2</sup> vs. 50 to 75).
- 2) This display area has the flexibility of providing a large panoramic Global Situation Display across both displays or on either of the large displays leaving room for 4 or more split-screen displays.
- 3) The low-profile HUD and the 20° – 30° FOV HMD for fighters, 40° – 60° for helicopters complement each other and provide redundancy.
- 4) The flat-panel Up-Front control can provide a bright, full-colour attitude display when the pilot is not performing input functions which greatly reduces the chance of pilot disorientation.
- 5) Voice control and touch-sensitive surfaces improve “system interfaces”.
- 6) A stick or throttle mounted macro-switch can be programmed by the pilot to provide rapid format set-up to suit desired operational approaches. Each “click” would format the whole cockpit to any combination from eight split-screen inserts to a panoramic format.

Cockpit 2000 offers a significant improvement in performance over current cockpits especially for the single-crew, multi-mission pilot. We believe that all of the technologies necessary to build this cockpit are on acceptable growth curves to initiate design in the year 2000.

## 8.5 Cockpit 2010

Joint Service operability and single-seat multi-mission employment will be high priority goals for Cockpit 2010. Cockpit 2010 builds on the Cockpit 2000 concept by using larger displays to provide better SA by providing the pilot with more simultaneous supporting data in a less cluttered form. Advanced technology HMD's will provide larger FOV's and perhaps colour to provide more effective heads-out capability.

Future pilots will be forced to deal with the ever-expanding flood of tactical information into the fighter cockpit, which will drive the need for a new generation of cockpit technology. Affordability issues, driven by continued force reductions and limited defense budgets in the post-2000 era, will ensure continued emphasis on lethality and survivability in a one-seat aircraft. To succeed in this environment, pilots must have access to, and be able to exploit tactically, all significant information including data received from off-board sources. We believe the best way to accomplish this is a combination of a large, fused display that presents the mission “big picture” in an uncluttered, organized, and intuitive fashion, and a helmet mounted display tailored for the close-in, visual arena.

Improved sensors, weapons and decision-aiding technology will provide relief from excessive workload and task saturation that could result from the requirement to fly both air-to-air and air-to-ground missions, destroy multiple targets on a single pass, and quickly replan missions in-flight if required.

**8.5.1 Cockpit 2010 Technology** – By 2010, head-down display technology using flat panel techniques is expected to support sizes up to 15”x 20” (300 in<sup>2</sup>) while attaining the brightness and contrast levels needed for the potentially high ambient light conditions of combat operations. A U.S. Air Force simulation program called Panoramic Cockpit Controls and Displays (PCCADS) has shown marked increases in performance for a 300 in<sup>2</sup> display over a 100 in<sup>2</sup> display. A 15”x 20” (300 in<sup>2</sup>) display will also fit in most cockpit instrument panels with room for additional supplemental displays or a low-profile HUD. Active matrix liquid crystal display (AMLCD) technology currently shows the most promise for delivering these sizes in direct-view or projection while plasma, electroluminescent, and other display types require varying levels of technical breakthroughs to become viable options.

Helmet display and head tracker technology is rapidly maturing and should be ready by 2010 to replace most of or all of the HUD functions. Weapon and sensor cuing using a highly accurate, monocular display with a 20° to 40° field-of-view will provide a tremendous advantage in close dynamic manoeuvring engagements with high off-boresight missiles while 30° to 50° binocular HMD’s will greatly enhance night or in-weather operations.

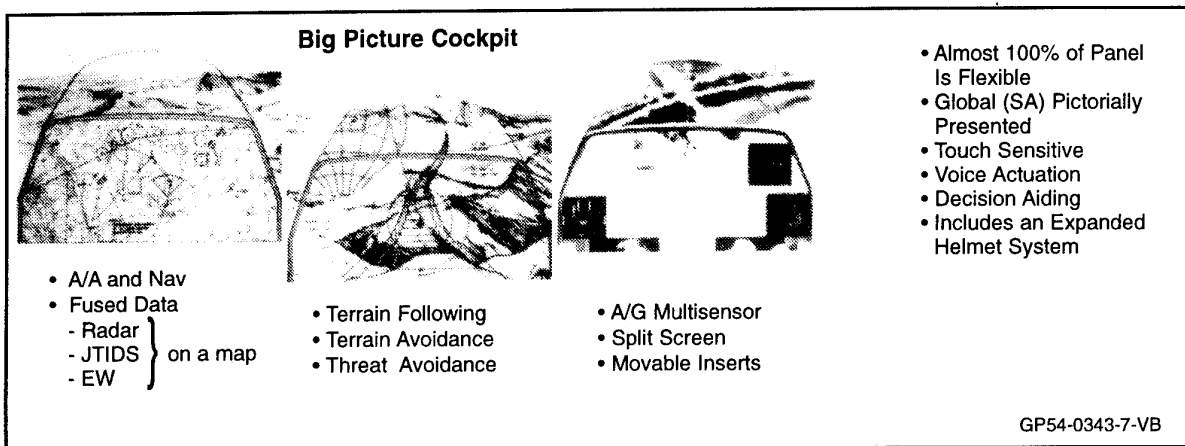

Figure 8-4 The Cockpit 2010 “Big Picture” Provides Total Reconfiguration Flexibility

**8.5.2 Cockpit 2010 Approach** – While the two large displays of Cockpit 2000 offer improved performance, increasing availability of off-board data will require ever increasing panel space if the pilot is to have access to simultaneous “source data”. A large 15”x 20” (300 in<sup>2</sup>) main situation display combined with a helmet mounted display for visual tactical engagements, and a small HUD (if needed) for gunnery and landing tasks, will alleviate much of this problem and provide many benefits allowing future fighter pilots to kill more targets efficiently with less losses. As shown in Figure 8-4, the Cockpit 2010 layout offers a great deal of flexibility and versatility for all mission phases:

- 1) Formats tailored for air-to-air, navigation, or air-to-ground will be easily selectable and intuitive.
- 2) In air-to-air or air-to-ground a global, bird’s eye, or “big picture” view of the mission scenario will provide the background for fusing information from multiple on-and off-board sources. Navigation routes, threat locations and lethal zones, map details, and signature cues will be combined to give the pilot an integrated view of his mission.
- 3) Windows containing specific system, sensor, and weapon imagery will be available at the pilot’s request or when required. High resolution sensors and advanced smart weapons will be integrated in an intuitive format for ease of use.
- 4) Decision aiding software will increase flexibility by allowing in-flight mission replanning, signature management, and multiple air-to-ground precision strikes on a single pass.
- 5) Off-board information, received well before reaching the target area will help the pilot achieve SA and simplify decision making in the target area.

## 8.6 Cockpit 2025

Rapidly improving and easily accessible laser weapon technology will endanger the viability of manned aircraft. Mobile, high-powered, "frequency-agile" lasers will be available to any country willing to invest modest sums. The laser is a potential weapon that strikes the weakest link in the weapon system, the human eye. It uses modest amounts of power, the "light-bullet" can be shaped in diameter and thickness for maximum effectiveness, the bullet travels at the speed of light and if the laser weapon is airborne it can shoot in any direction. The most concerning factor is that the laser can be of any frequency or frequencies which will negate any hope of a viable spectral filter-set in the pilot's visor.

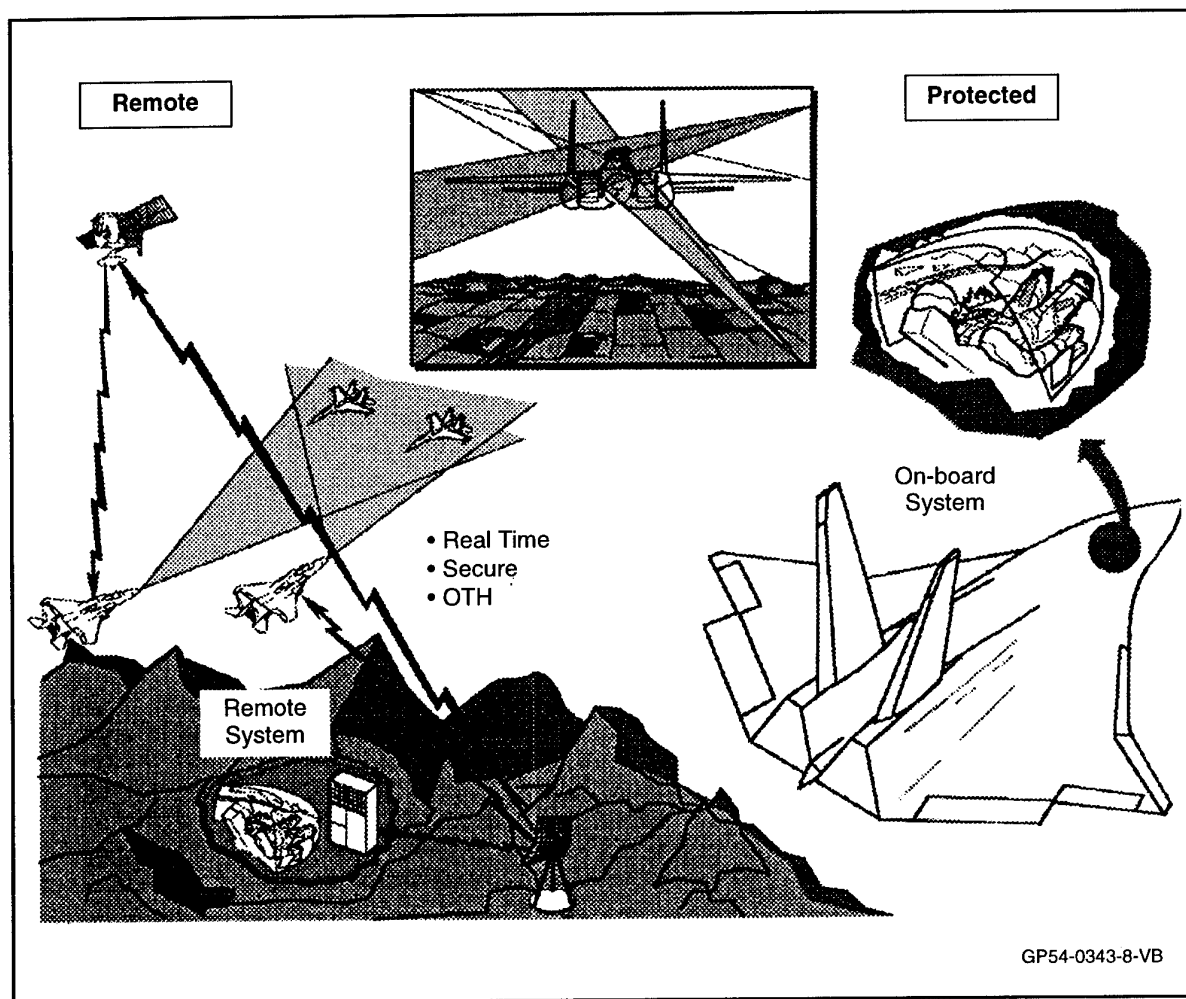

Figure 8-5 Laser Protection Alternatives

As shown in Figure 8-5 there are two broad alternatives available to the designer. Remote or Protected. If the pilot is flying the aircraft remotely (RPV) we will have to design a "ground-borne" cockpit that functionally resembles an "airborne" cockpit.

Because the ground-borne cockpit no longer has size, weight, power or ambient restrictions, nor 'g' forces on the pilot, many problems disappear. It also may be more efficient for these "ground-borne cockpits" to use a crew of two or more to divide the workload. However, the problem with this approach is the ground-air-ground link between the pilot (or crew) and the aircraft. It must be near real-time, secure and capable of broad-band video rates. Although the technology exists to do this, it is a tenuous link and some complications can arise when large concentrations of forces are required at any one time in a local area. The alternative thought of protecting the pilot in-flight is potentially more difficult technically and psychologically.

**8.6.1 Cockpit 2025 Technology** – All of the three candidate laser-protected-cockpit-approaches described herein use similar technologies but to varying degrees. Each approach requires advanced helmet systems, large flat panel displays, high resolution, high throughput graphics processors, decision aides, MSI and expert systems. The present trend of technology portends that the necessary technologies will be available in the 2025 time frame. The highest risk perhaps is still the HMD because it is head mounted and there is an ever increasing demand for resolution, colour, and field-of-view which generally adds weight, bulk and CG shifts which effect performance, safety and pilot comfort.

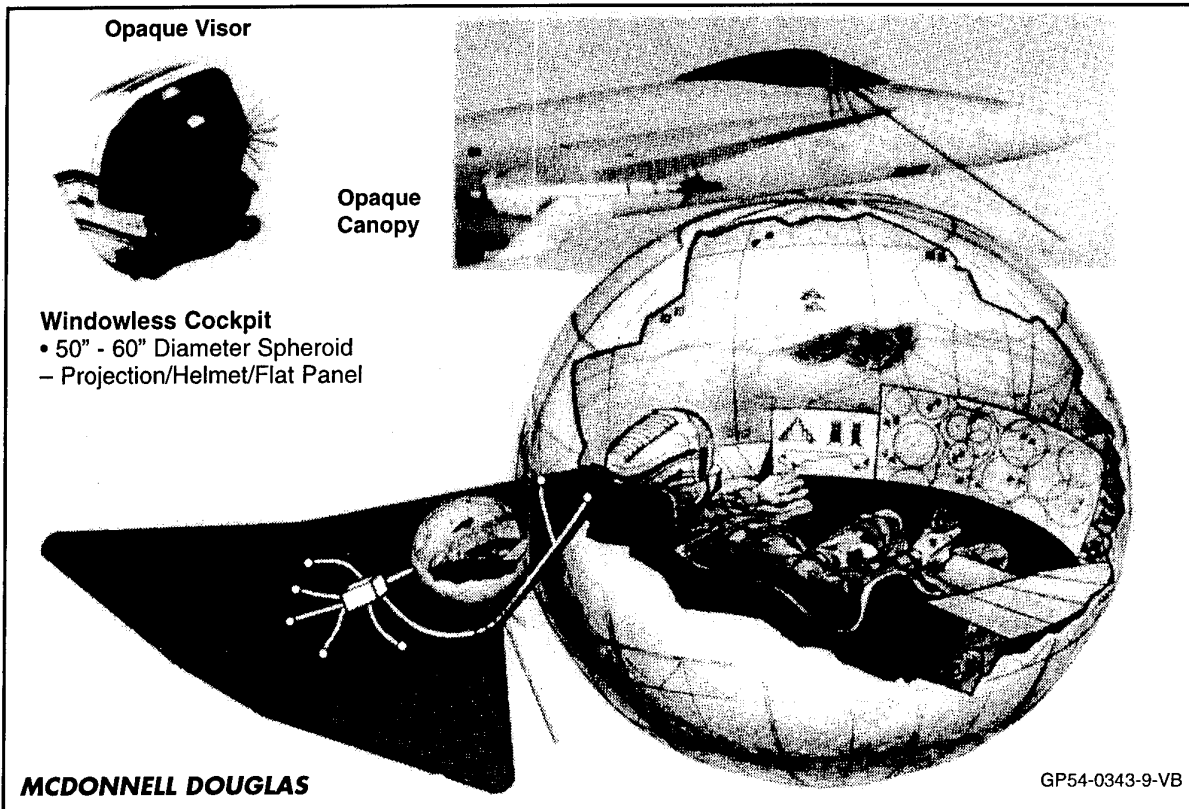

Figure 8-6 Opaque and Windowless Cockpits

**8.6.2 Cockpit 2025 Laser Protection Cockpits** – If the “piloted aircraft” is to be viable in an advanced laser weapon environment there are three general solution candidates. As shown in Figure 8–6 they are:

- 1) An opaque helmet visor,
- 2) an opaque canopy or
- 3) a no-canopy or “windowless cockpit” design.

**8.6.2.1 Cockpit 2025 – Opaque Helmet Visor Approach** – Current helmet visors provide laser protection by including band-blocking filters or PZLT techniques for turning the visor opaque when struck by a nuclear flash. The problem with this approach is that a “frequency-agile” laser can “shoot” a number of frequencies including non-visual wavelengths, therefore the use of static or even dynamic filters that cover the laser wavelength spectrum quickly leads to a totally opaque (no see-through) visor. This is the cheapest solution but leaves the pilot with only information that can be provided by an HMD projected on the opaque visor. No panel displays will be available to him. Enormous improvements in display and optics technology would be required to replicate the “world” as the pilot wants to see it. This “virtual” world would have to include navigation, systems and sensor data, HUD and/or Helmet displays and some form of outside world references.

**8.6.2.2 Cockpit 2025 – Opaque Canopy Approach** – The opaque canopy approach using either paint, fixed or removable structure or an electrically actuated canopy and windshield coating that can be manually selected by the pilot before entering the combat zone would protect the pilot from all but the most powerful lasers. The pilot would then be flying in an environment similar to any of today’s modern, all-weather fighters during an in-weather (IMC) attack where there are no outside “visual references”.



Improved sensors, displays, data bases and helmet technology would in fact give the Cockpit 2025 opaque canopy pilot many advantages over today's cockpit. The helmet display could provide line-of-sight perspective views of the outside world "through" the opaque canopy from databases, wide-band staring arrays and slewable sensors. The instrument panel would of course be completely visible and large displays showing "fused" data supplemented with decision aides and expert systems would add greatly to a pilots global and tactical SA. This approach takes the middle ground technically and cost wise, and provides a viable solution to the laser threat problem. It also provides a "clear canopy" for training and safety if an "electronic" mechanism or structure is used to render the canopy opaque.

**8.6.2.3 Cockpit 2025 – Windowless Cockpit** – The "windowless cockpit" is the most challenging solution from all aspects: psychologically, technically and operationally because it permanently obscures the outside world. The main elements of this notional concept is an imbedded 50" to 60" diameter dome on which would be projected a medium-resolution "virtual world" from on-board data bases. This "virtual world" would be enhanced with real-time on/off board sensor data. An advanced, wide-field-of-view HMD would be provided which would overlay high resolution data wherever the pilot was looking and very large head-down displays would provide Global SA. Perhaps it would help to picture this concept as a high fidelity domed simulator reduced in size to fit into a combat aircraft.

Although the windowless cockpit seems like an extreme approach it does have the following advantages:

- 1) Aircraft stealth and aero performance would be enormously enhanced by the absence of a canopy bump.
- 2) Every flight in Windowless Cockpit 2025 could be flown VFR if the pilot desires by not pressing "the world as it is" button. This virtual world would provide outstanding enhanced cognitive (visual flow field) clues in all flight regions and the excellent stealth characteristics possible for this type of air vehicle design would greatly reduce the need for manoeuvring, adding to reduced chances of disorientation.
- 3) Much of the spherical data presently displayed in cockpits on flat displays would also be available to be displayed as perspective views and at "real world" angles.

## 8.7 Technology Needs

Chapter 4 provides a detailed treatment of technology trends for current and future "glass" cockpits. Suffice to say that budget constraints, design-to-cost and other risk-adverse pressures will require that only mature technologies will get on-board each cockpit generation. The following matrix, Table 8-2, outlines the primary technologies and performance requirements are postulated as necessary to meet the three candidate cockpit requirements.

	Cockpit 2000	Cockpit 2010	Cockpit 2025
<b>Helmet Mounted Display</b>			
– Fixed Wing Aircraft	20° – 30° Mono	30° – 50° Binocular	50° – 90° Binocular
– Helicopters	40° – 60° Binocular	50° – 70° Binocular	70° – 100° Binocular
<b>Head-Up Display</b>	10° – 20°	10° – 30° if required	Not Required
<b>Head-Down Display</b>	10 in. to 12 in.	15 in. to 20 in.	15 in. to 30 in.
<b>Touch Technology</b>	1/4 in. Accuracy	1/8 in. Accuracy	1/8 in. Accuracy
<b>Voice Command</b>	Connected, Trained	Connected, Untrained	Connected, Untrained
<b>Decision Aids</b>	Expert Systems	Adaptive Systems	Adaptive AI

**Table 8-2 Technology Requirements for Candidate Cockpits**

## 8.8 Summary

In spite of the progress in cockpit technology over the last 25 years, the members of this AGARD working group believe that there will be continued demand for improved performance and survivability in future cockpit designs. The future multi-mission, all-weather, single-seat design must fight and win in an NBC, advanced weapon and developing laser threat environment. The achievement of this capability is further complicated by the requirement for affordability, even in the face of lower quantities of aircraft which tends to drive prices upwards. The affordability driver may however be a blessing in disguise by forcing design teams to *simplify systems to not what is capable but to what is necessary*. Some current aircraft for instance have over 30 radar modes. They can be designed, but can they be learned, used and maintained?

On the basis of discussion between working group members over the course of the working group tenure, it is postulated that the three candidate crew stations described herein provide a solution to meet the ever expanding requirements for the next 30 years. Furthermore, all of the necessary technologies are on maturity curves that coincide with the targeted technology dates of 2000, 2010 and 2025.

## 9.0 LIST OF ABBREVIATIONS

2D	2 Dimensional	DTM	Data Transfer Module
3D	3 Dimensional	DTU	Data Transfer Unit
A/P	Autopilot	DU	Display Unit
A/A	Air-to-Air.	DVI	Direct Voice Input
A/C	Aircraft	DVO	Direct Voice Output
A/G	Air-to-Ground.	E/WD	Engine/Warning Display
AAR	Air-to-Air Refueling	E/O	Electro-Optical.
ADI	Attitude Display Indicator	ECAM	Electronic Centralized Aircraft Monitor
AFATDS	Advanced Field Artillery Tactical Data System	ECM	Electronic Counter Measures
AFB	Air Force Base	EFIS	Electronic Flight Instrument System
AFCS	Automatic Flight Control System	EHSD	Electronic Horizontal Situation Display
AMLCD	Active Matrix Liquid Crystal Display	EIS	Electronic Instrument System
AMRAAM	Advanced Medium Range Air-to-Air Missile	EHSD	Electronic Horizontal Situation Display
ASTOVL	Advanced Short Take Off/Vertical Landing	EL	Electro Luminescent
ATC	Air Traffic Control	EM	Electro Magnetic
ATF	Advanced Tactical Fighter	EMCON	Emissions Control
ATHS	Airborne Target Handoff System	EMD	Engineering and Manufacturing Development
AUW	All Up Weight	EMS	Engine Monitoring System
AVTR	Airborne Video Tape Recorder	ENG	Engine(s)
BAI	Battlefield Air Interdiction	EOB	Electronic Order of Battle
BDA	Battle Damage Assessment	ESAS	Enhanced Situational Awareness System
BIT	Built In Test	ESM	Electronic Surveillance Measures
BRT	Bright	ESRRD	E-Scope/Radar Repeater Display
C/F	Chaff/Flare	EVS	Enhanced Vision System
C <sup>2</sup>	Command and Control	EW	Electronic Warfare
C <sup>3</sup>	Command Control and Communication	EWWS	Electronic Warfare Warning Set
CAP	Combat Air Patrol	FADEC	Full Authority Digital Engine Control
CAS	Close Air Support; Calibrated Air Speed	FAR	Federal Aviation Regulation
CASEVAC	Casualty Evacuation	FEBA	Forward Edge of Battle Area
CCIP	Continuously Computed Impact Point	FLIR	Forward Looking Infra Red
CDU	Control Display Unit	FLOT	Forward Line of Own Troops
CG	Center of Gravity	FOV	Field Of View
CMD	Countermeasures Dispenser	FSDU	Function Selection and Display Unit
COMM	Communication	FWC	Flight Warning Computer
CPY	Copy	FWD	Forward
CRPMD	Combined Radar and Projected Map Display	G	Gravity
CRT	Cathode Ray Tube	GAG	Gunner Armament Grip
DASS	Defensive Aids Sub System	GCI	Ground Controlled Intercept
DC	Digital Computer	GEO	Geographic Coordinates
DGPS	Differential GPS	GPS	Global Positioning System
DMC	Display Management Computer	HAVE QUICK	A secure mode of radio operation
DMG	Digital Map Generator	HDD	Head Down Display
DMT	Dual Mode Tracker		

HIDSS	Helmet Integrated Display and Sight System	MLS	Microwave Landing System
HLD	Head Level Display	MMI	Man Machine Interface
HMD	Helmet Mounted Display or Head Mounted Display	MMS	Mast Mounted Sight / Missile Management System
HMS/D	Helmet Mounted Sight/Display	MPCD	Multi Purpose Color Display
HMSS	Helmet Mounted Sighting System	MSI	Multi Sensor Integration
HOCAS	Hands On Collective And Stick	NAV	Navigation
HOTAS	Hands On Throttle And Stick	NAVAIDS	Navigation Aids
HSI	Horizontal Situation Display	NBC	Nuclear, Biological, Chemical
HUD	Head Up Display	NCTR	Non Cooperative Target Recognition
HYDR	Hydraulics	ND	Navigation Display
ICP	Integrated Control Panel	NDE	Navigational Data Entry
ICS	Internal Countermeasures Set	NHC	Navigator Hand Controller
IDM	Improved Digital Modem	NM	Nautical Miles
IFDL	Intra Flight Data Link	NOE	Nap Of the Earth
IFF	Identify Friend or Foe	NVG	Night Vision Goggle
IFOV	Instantaneous Field Of View	OCA	Offensive Counter Air
IFR	Instrument Flight Rules	ODU	Optional Display Unit
IGE	In Ground Effect	OMEGA	Omega Navigation Systems
IHADSS	Integrated Helmet And Display Sight System	OSTM	On Board System Test and Monitoring
IHS	Integrated Helmet System	OTH	Over The Horizon
ILS	Instrument Landing System	PCCADS	Panoramic Cockpit Controls And Displays
IMC	Instrument Meteorological Conditions	PFD	Primary Flight Display
IN	Inertial Navigation	PFR	Primary Flight Reference
INS	Inertial Navigation System	PGM	Precision Guided Munitions
INTERCOM	Intercommunications	PHC	Pilot Hand Controller
IR	Infra Red	PMFD	Primary Multi Function Display
IRST	Infra Red Search and Track	PP	Present Position
JAR	Joint Airworthiness Requirements	PSMK	Pilot Sensor Moding Key
JDAM	Joint Direct Attack Munition	PTT	Push To Talk
JSOW	Joint Stand Off Weapon	PVI	Pilot Vehicle Interface
JTIDS	Joint Tactical Information Data System.	PLZT	Lead Lanthanum Zirconium Titanate
LCD	Liquid Crystal Display	QRA	Quick Reaction Alert
LED	Light Emitting Diode	RDE	Rapid Data Entry (pre-loaded cartridge)
LHLD	Left Hand Lateral Display	RECCE	Reconnaissance
LINS	Laser Inertial Navigation System	RFI	Remote Frequency Indicator / Request For Information
LPI	Low Probability of Intercept	RHLD	Right Hand Lateral Display
LRSOFF	Long Range Special Operations Forces	ROE	Rules of Engagement
LRU	Line Replacable Unit	RPMD	Repeater Projected Map Display
LST	Laser Spot Tracker	RWR	RADAR Warning Receiver
MANPRINT	Man Power and Personnel Integration	SA	Situational Awareness.
MAR	Minimum Avionics Requirement	SAAHS	Stability and Attitude Hold System
MAW	Missile Advance Warning	SAE	Society of Automotive Engineering
MC	Mission Computer		
MDL	Mission Data Loader		
MFD	Multi-function Display		
MHDD	Multi-function Head Down Display		

SAHR	Standard Attitude Heading Reference	TSSAM	Tri Service Standoff Attack Missile
SAM	Surface to Air Missile	TTI/TTA	Time to Initiate/ Time to Attack
SAR	Search And Rescue; Synthetic Aperture Radar	TV/TAB	Television Tabulator Display
SEAD	Suppression of Enemy Air Defense	TV	Television
SEAM	Sidewinder Expanded Acquisition Mode	UFC	Up Front Controller
SMFD	Secondary Multi Function Display	UFD	Up Front Display
SOCOM	Special Operations Command	UHF	Ultra High Frequency (radio)
STRS	Stores	UTM	Universal Transverse Mercator
T/O	Take Off	VERTREP	Vertical Replenishment
TAC	Tactical	VFR	Visual Flight Rules
TACAN	Tactical Area Navigation System	VIS	Visionics
TADS	Target Acquisition and Designation System	VSLED	Vibration, Structural Life, and Engine Diagnostic
TAMPS	Tactical Aircraft Mission Planning Station	VSTOL	Vertical Short Take Off and Landing
TASMO	Tactical Support of Maritime Operations	VVI	Vertical Velocity Indicator
TF	Terrain Following	WFOV	Wide Field Of View
TFOV	Total Field Of View	WVR	Within Visual Range

## **Appendix A – Aircraft Cockpit Descriptions**

A study of technologies previously employed in current operational aircraft cockpits, and those technologies being implemented in recently designed cockpits was conducted for the purposes of this report. Nineteen in-service, or near in service combat and civil aircraft were selected for study based on the intent not to examine every western combat aircraft, but rather to gather data from across a broad spectrum of aircraft representing changing design philosophies and available cockpit technologies used over the past 25 years. Aircraft examined included fixed and rotary wing combat aircraft, and the A330 Airbus as a representative modern civil aircarrier employing glass cockpit technology. Aircraft are presented in the order of their approximate design period to highlight the advances made in the employment of glass technology over the past two and a half decades. The Aircraft cockpit descriptions contained in this Appendix are given in the table below.

<b>Number</b>	<b>Aircraft</b>	<b>Design Era</b>	<b>Page Number</b>
<b>Fixed Wing Combat Aircraft</b>			
1	Tornado	1970	73
2	F-15C Eagle	1970	80
3	F-18 C/D Hornet	1975	85
4	F-15 E Eagle	1982	92
5	AMX	1982	98
6	F-16 C/D Falcon	1983	103
7	Mirage 2000-5	1987	109
8	Rafale	1988	114
9	Harrier – GR-7	1989	119
10	AV-8B Harrier II Plus	1989	124
11	F-18E/F Hornet	1990	129
12	EF-2000	1991	132
13	F-22	1991	137
<b>Rotary Wing Combat Aircraft</b>			
14	EH 101	1984	140
15	Tiger	1985	144
16	MV-22 Osprey	1988	150
17	AH-64 Longbow Apache	1990	155
18	RAH-66 Commanche	1990	162
<b>Commercial Aircraft</b>			
19	Civil Transport Aircraft, Specifically the A330 Airbus	1990	167

**Panavia 200  
Tornado IDS**

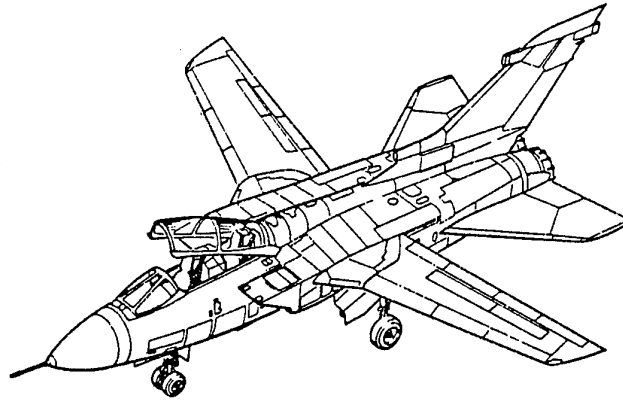
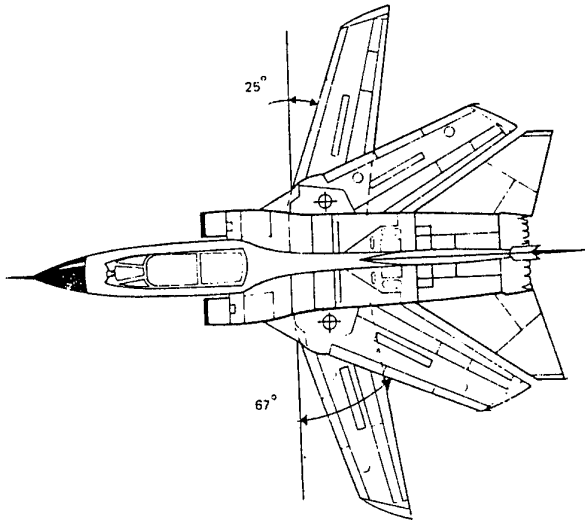
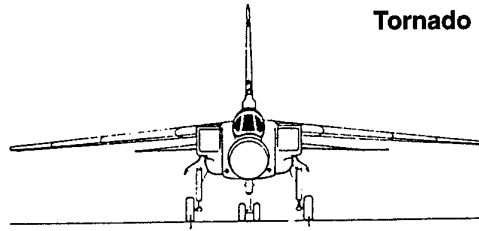
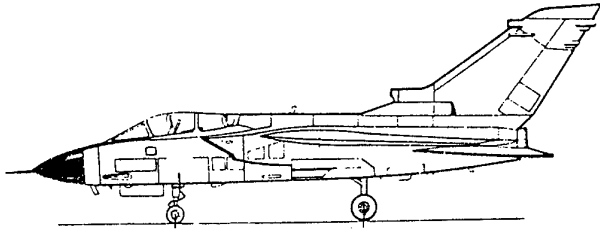

#### AIRCRAFT CHARACTERISTICS

The Tornado IDS is a two seat, all weather, variable geometry wing, supersonic fighter-bomber capable of high speed low level penetration in automatic terrain following modality.

- |   |                                      |
|---|--------------------------------------|
| - Two Seater                                | - Overall Length: 17.23 m            |
| - Supersonic                                | - Overall Height: 5.95 m             |
| - Fly-By-Wire Controls                      | - Operational Empty Weight: 14000 kg |
| - Variable Geometry Wing                    | - Max. T/O Weight: 28000 kg          |
| - Propulsion: two RB 199 (6800 kg reheated) | - Max. Payload: 9000 kg              |
| - Wingspan: 13.91/8.56 m                    | - Max. Speed: > M 2 / 800 Kts        |

#### MISSIONS AND MISSION EQUIPMENT

Primary Roles: - Battlefield Air Interdiction (BAI)  
 - Offensive Counter Air (OCA)  
 - Tactical Support of Maritime Operations (TASMO)

Secondary Roles: - Armed Reconnaissance  
 - Air Defence

Mission Equipments: - Ground Mapping Radar  
 - Terrain Following Radar  
 - Integrated Electronic Warfare System  
 - Duplicated Avionic Bus  
 - Repeater Projected Map Display (RPMD, front cockpit)  
 - Combined Radar and Projected Map Display (CRPMD, rear cockpit)  
 - Head Up Display  
 - two Television Tabulator Displays (TV/TABs, rear cockpit)

Armament: - 2 x 27mm Mauser guns  
 - 2 x AIM 9-L A/A Missiles  
 - Free-Fall and Retarded Bombs  
 - Laser Guided Bombs  
 - Submunition Dispensers  
 - Cluster and Denial Bombs  
 - Air-To-Surface Missiles

## Panavia 200 Tornado IDS

### HOTAS

HOTAS controls are provided to both the crew members in order to allow management of main aircraft systems, attack functions and on-board sensors; these controls are located on Throttle, Stick, Pilot Hand Controller (PHC) and Navigator Hand Controller (NHC).

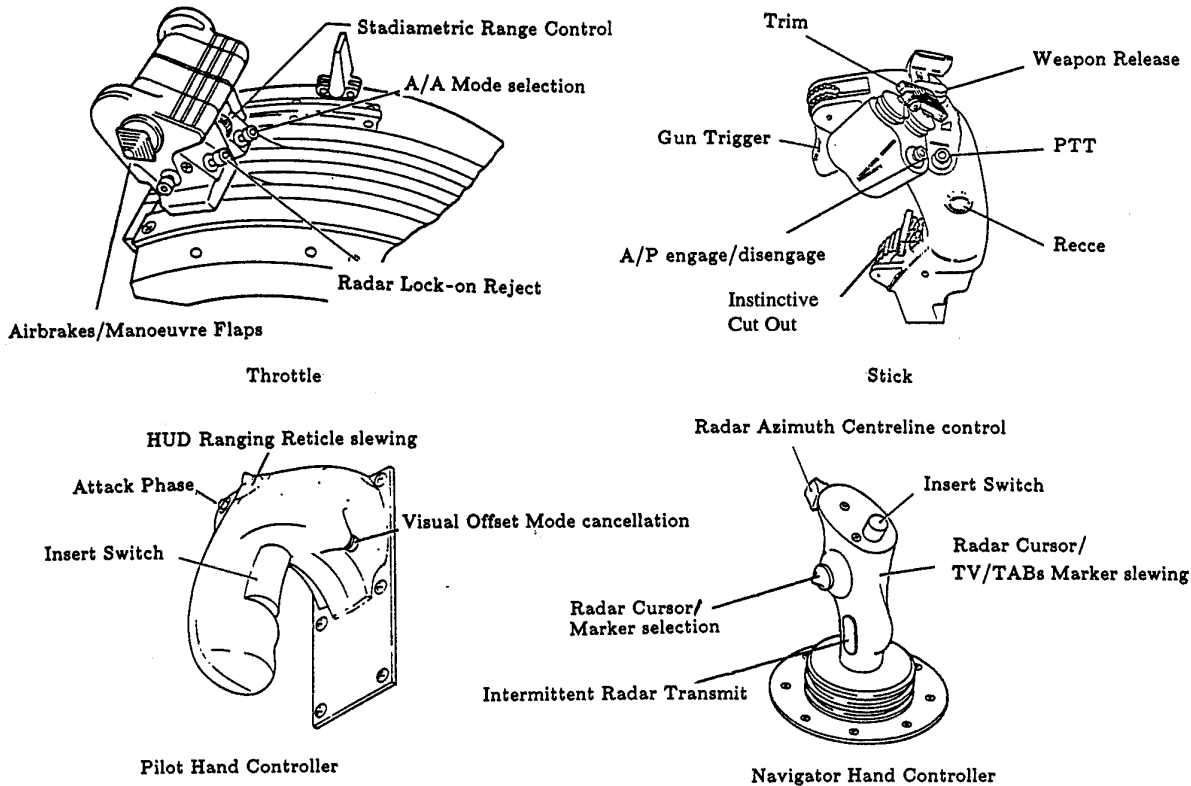

### HUD

The HUD is a monochrome collimated display visualizing navigation/attack information to the pilot by means of appropriate symbology organized in display formats activated upon selection of the relevant navigation and attack phases.

- 25° Total Field Of View
- Basic flight
- Normal/Radio navigation
- Flight Director
- Navigation/Attack designation
- A/A gun and missile attack
- A/S weapon aiming/release

### DATA ENTRY

Mission Data can be inserted into mission computer by means of:

- Rapid Data Entry (RDE, pre-loaded cartridge)
- TV/TABs (manual insertion)

Mission data includes:

- Routepoints 3D coordinates
- Planned Target and Offsets Points 3D coordinates
- Mission Timings
- Intelligence Points 2D coordinates
- Auxiliary navigation station coordinates

Self-defence, IFF and Comm. data are inserted by means of the relevant dedicated control panels.

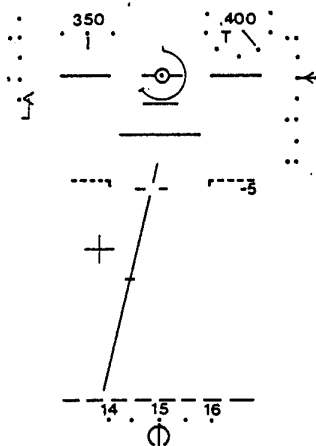



## Panavia 200 Tornado IDS

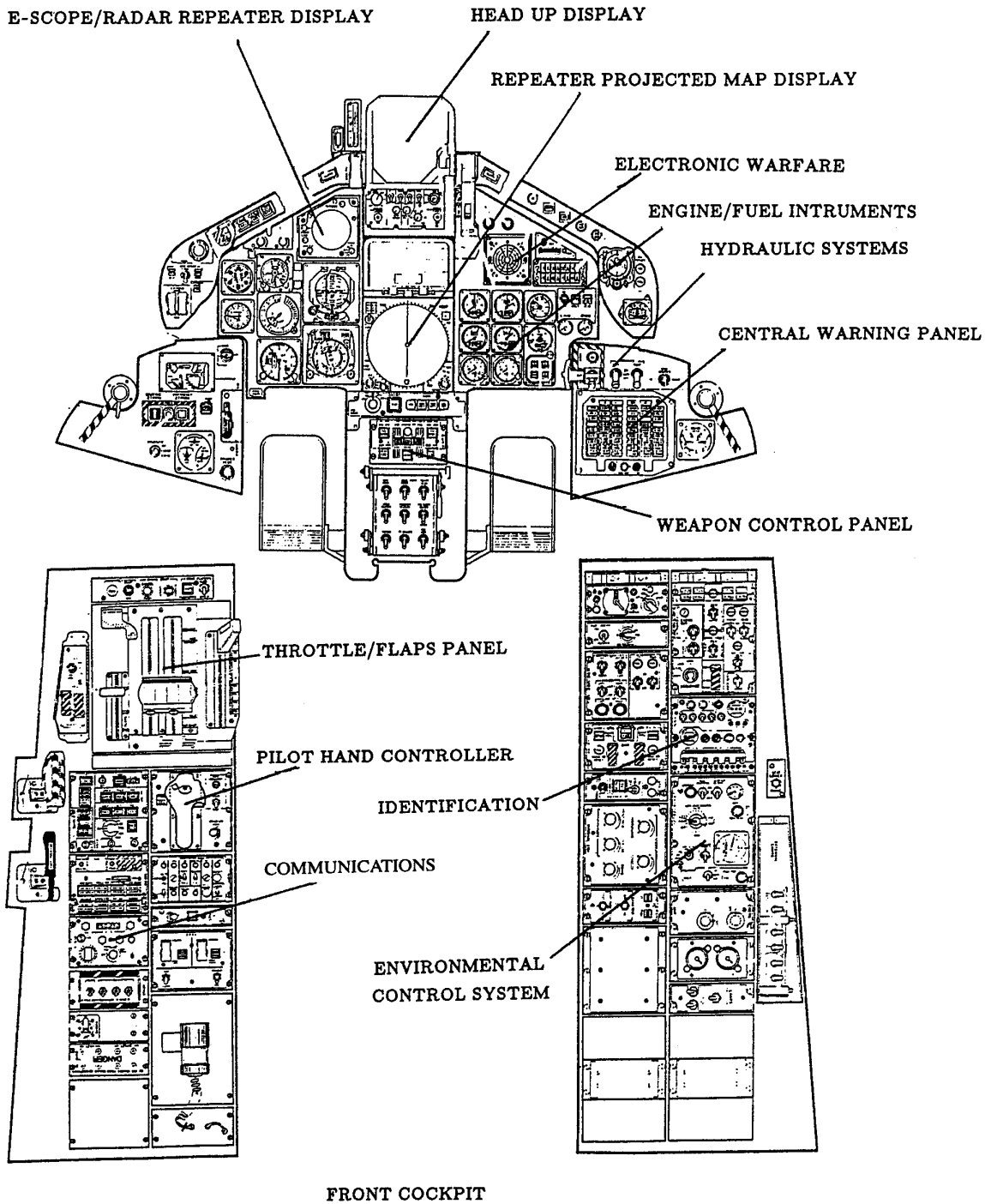

### UNDERLYING DESIGN CONCEPTS

Tornado IDS cockpit is designed in order to allow efficient sharing of mission tasks between the two crew members (Pilot and Navigator/Weapon System Officer).

Mission data and information from onboard processing are available to the crew and managed by means of the Integrated Displays and Controls System, composed by the HOTAS controls and onboard displays.

- HOTAS Controls for main Nav / Attack functions
- Head-Up Nav / Attack and basic flight information
- Flight Plan, Armament and Attack information on TV/TABs
- Up-Front data entry facility via TV/TABs
- Reversionary flight instrumentation

Panavia 200  
Tornado IDS

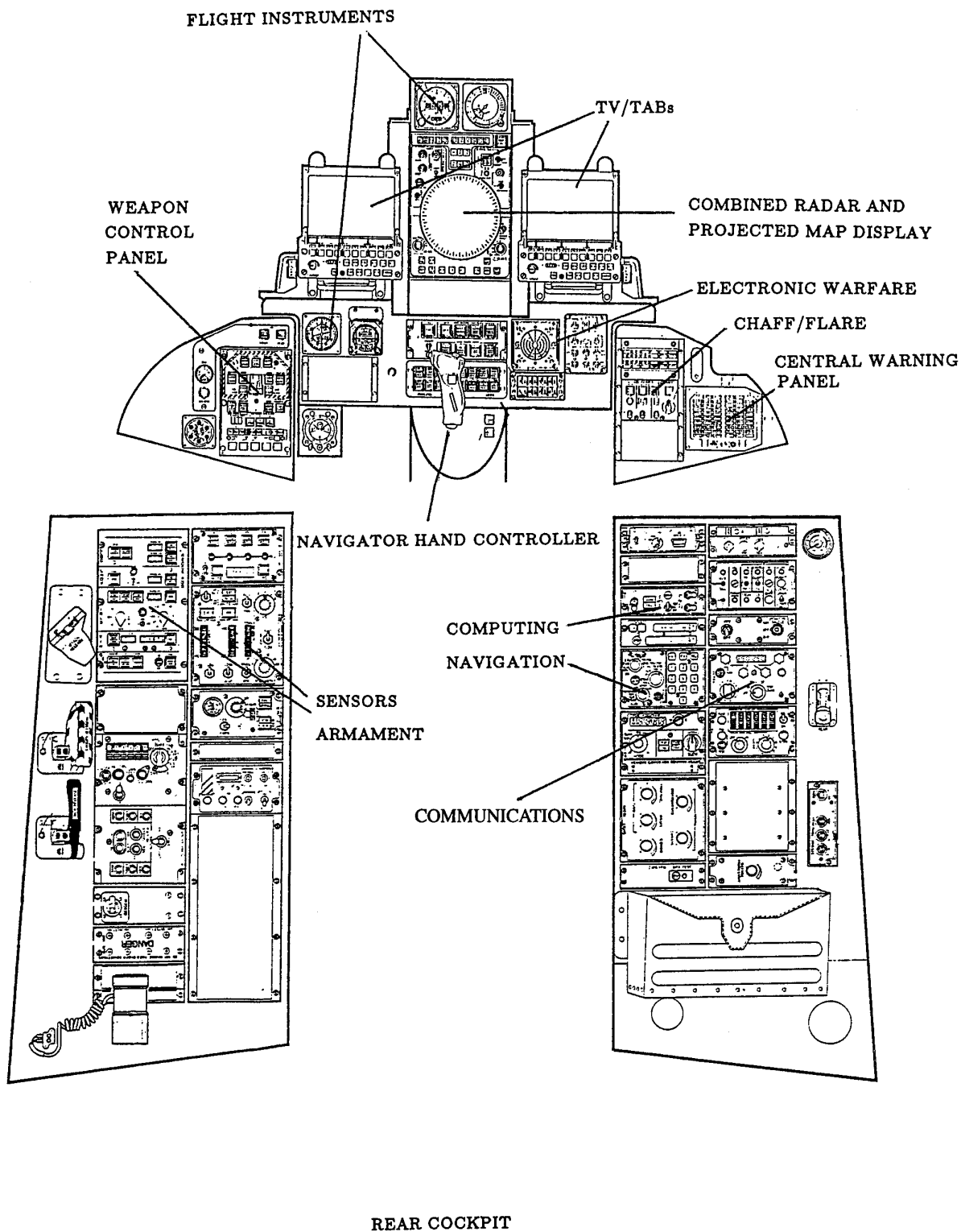

## Panavia 200 Tornado IDS

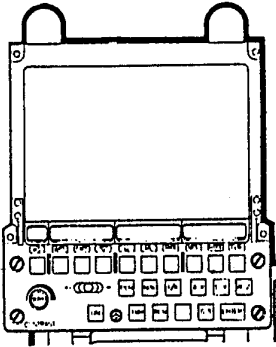

### TELEVISION/TABULATORS (TV/TABs, rear cockpit)

The TV/TABs are monochromatic raster display dedicated to present navigation, tactical and system status information to the Navigator and also to insert data in the a/c mission computer; the information is arranged in appropriate formats managed by means of multifunction and dedicated keys.

- 6"x5" Useful Area
- Planned Route
- Preplanned Targets and Offsets
- Stations Location
- Navigation/Attack Steering Information
- Mission Timings
- Navigation Fixing
- Mission Database Information
- Systems Status

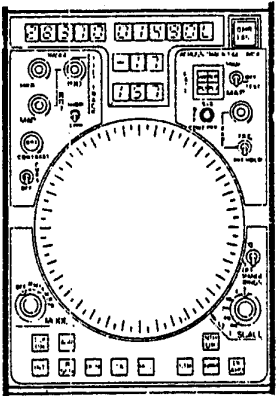

### COMBINED RADAR and PROJECTED MAP DISPLAY (CRPMD, rear cockpit)

The CRPMD is an electro-optical display visualizing the radar returns image in addition to the remote map reader image. Appropriate electronic symbology and controls allow management of radar sensor for A/G attack or navigation purposes.

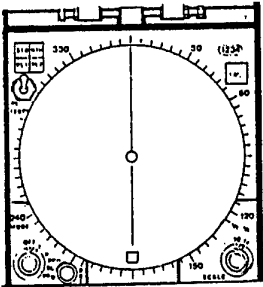

### REPEATER PROJECTED MAP DISPLAY (RPMD, front cockpit)

The RPMD is an optical display visualizing to the pilot the map image from the remote map reader; it can visualize the same image as the CRPMD or a differently positioned map image as required.

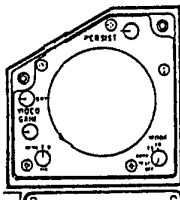

### E-SCOPE/RADAR REPEATER DISPLAY (ESRRD, front cockpit)

The ESRRD is an electronic display (CRT) visualizing Ground Mapping Radar returns as repeater of the CRPMD or Terrain Following Radar returns and symbology for TF navigation.

### BACKUP INSTRUMENTATION

Backup flight instruments are available to the pilot; flight instruments are available also to the navigator for information on current flight parameters.

Pilot: - Magnetic Compass

Navigator - Baro Altimeter  
 - Mach/Anemometer  
 - Attitude Indicator  
 - Bearing Distance & Heading indicator

### PLANNED IMPROVEMENTS

In order to extend mission flexibility and operational effectiveness of Tornado IDS, improvements to avionic and weapon system are under evaluation:

- Raster/Stroke HUD
- NVG Compatible lighting
- Navigation FLIR
- TRN / GPS
- Datalink
- Digital Remote Map Reader
- A/S Missiles

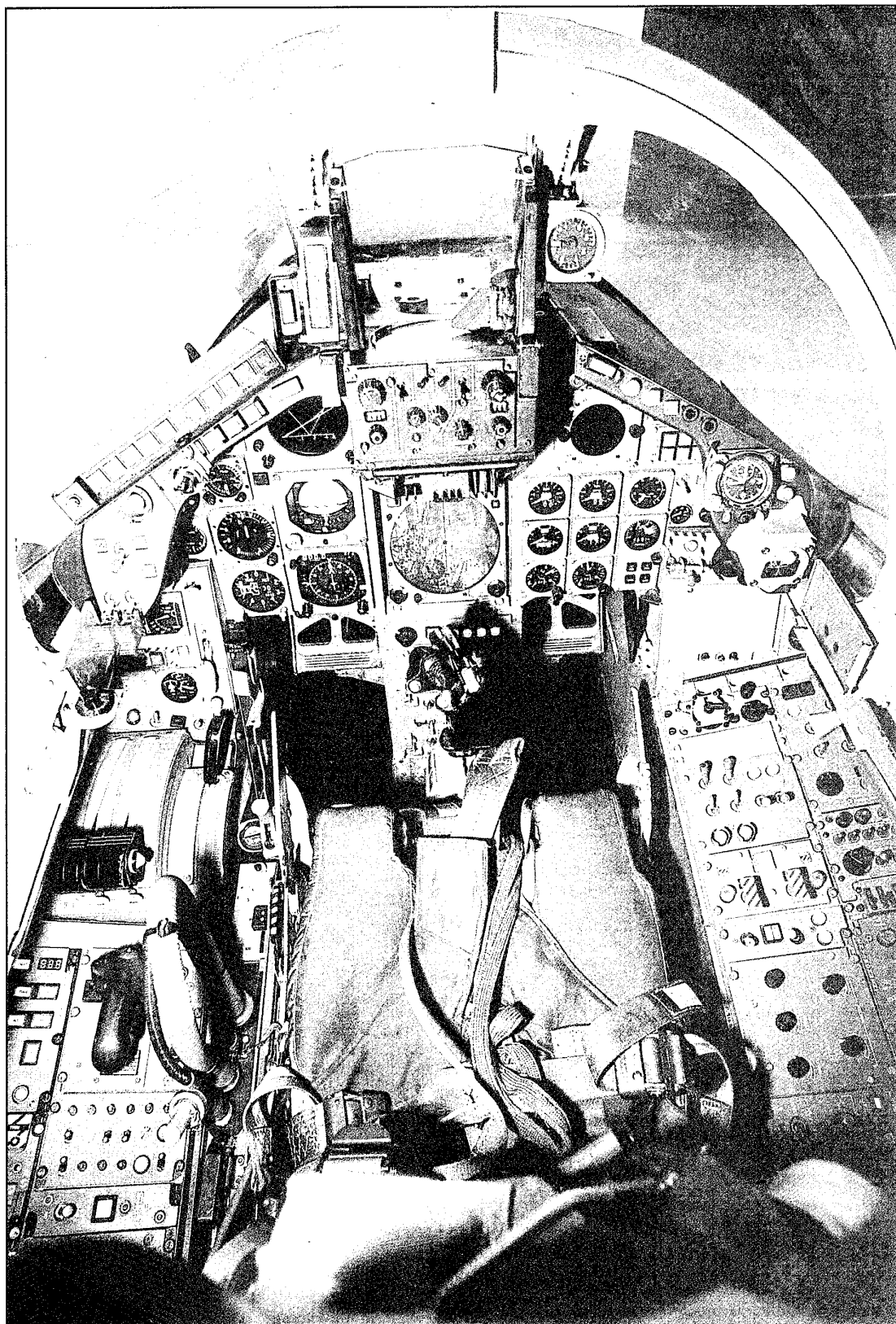

Panavia MRCA Tornado IDS

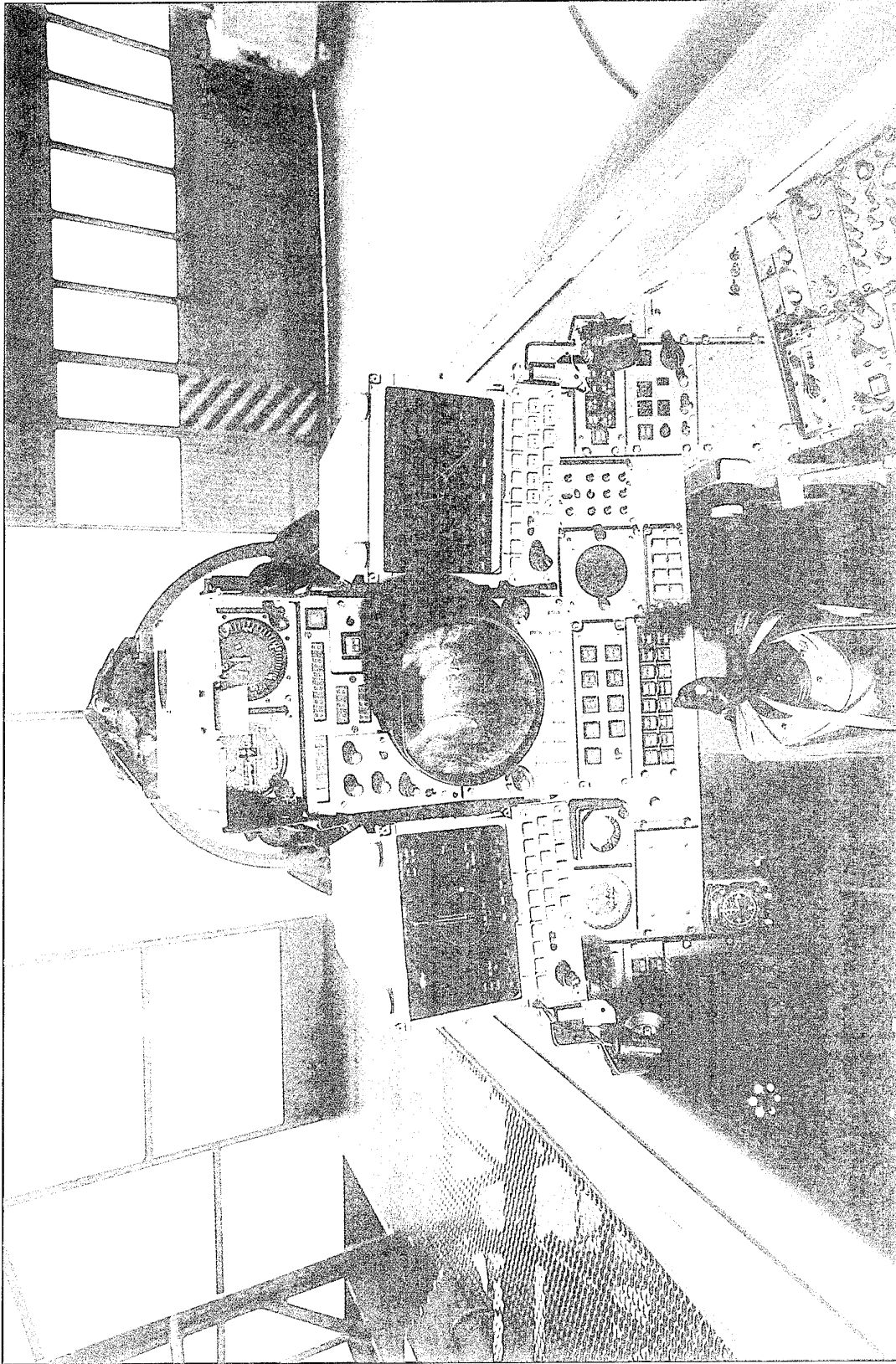

Panavia MRCA Tornado IDS Rear Cockpit

## F-15C Eagle

### Aircraft Characteristics

The F-15C is a High-Performance, Supersonic, All-Weather, Day and Night, Air Superiority Fighter Built by McDonnell Douglas Aerospace.

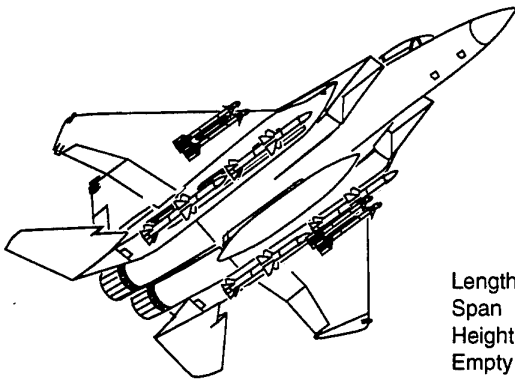

Length	63 ft, 9 in.
Span	42 ft, 10 in.
Height	18 ft, 8 in.
Empty Weight	29,500 lb
Max Gross Weight	68,000 lb
Payload	38,500 lb
Max Speed	2.5 M
Unrefuel Range	800 - 2,000 NM

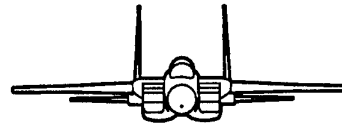
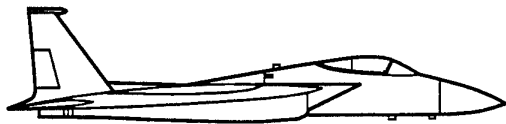
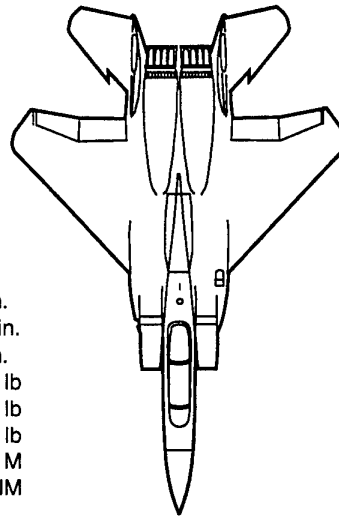

### Missions and Mission Equipment

#### Missions:

- Air Superiority (Offensive and Defensive)
- Air-to-Ground Capability

#### Mission Equipment:

- KY-58 Secure Speech System
- Have Quick II
- In Flight Refueling (Boom)
- Data Transfer Module Set
- PW F100 Engines

### Sensors

- Radar - APG-63 or -70 (A/A and A/G With Doppler Beam Sharpening)
- Tactical Electronic Warfare System (TEWS)

### Weapons, Air-to-Air

- AIM-120
- AIM-7
- AIM-9
- 20mm Gattling Gun

### Weapons, Air-to-Ground:

- Iron Bombs
- Cluster Bombs
- GBU-10 (Laser Guided Bomb)

# F-15C Eagle

## Cockpit Layout

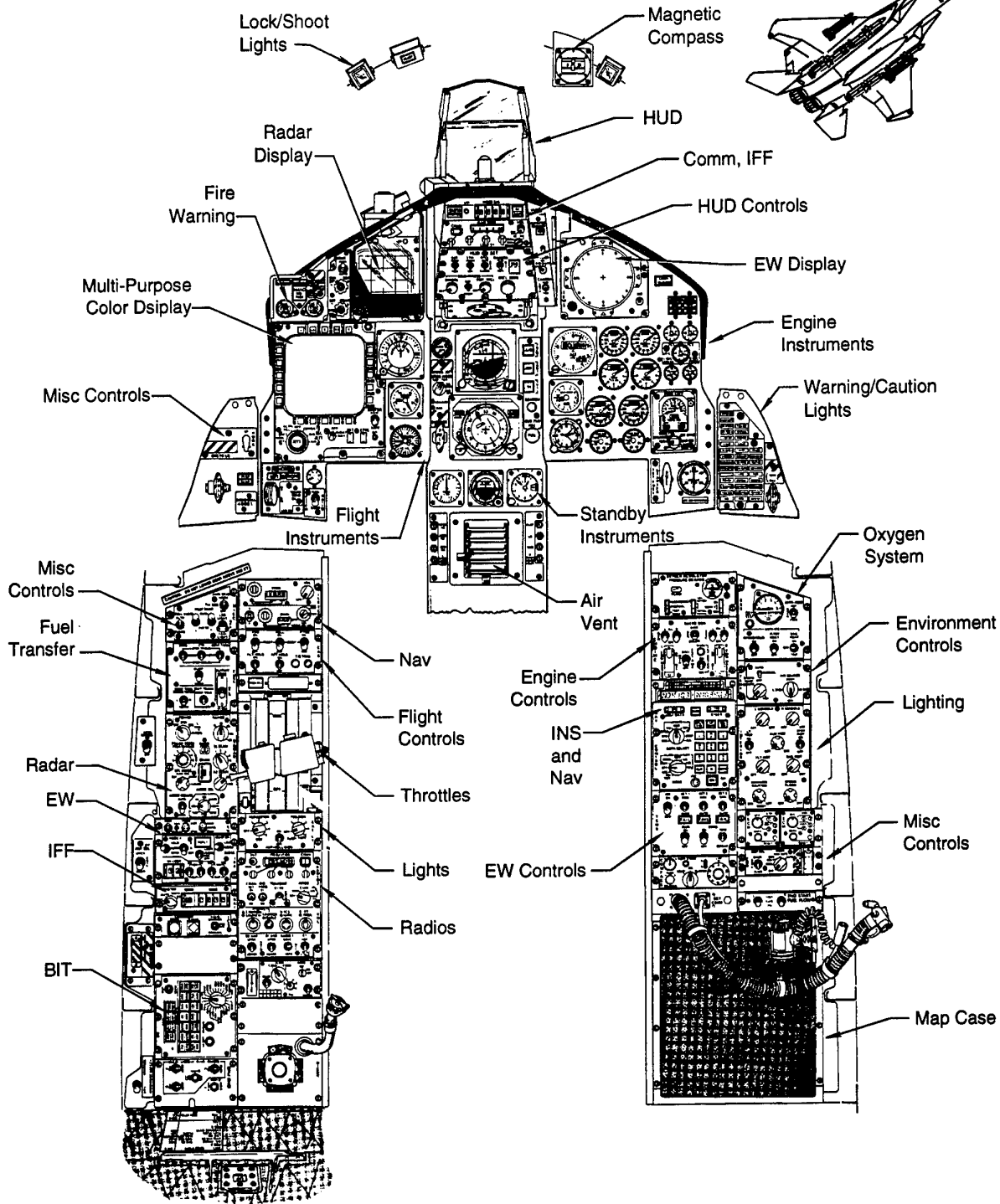

## Underlying Design Concepts

- HOTAS Prominent
- Functionally Grouped Instruments

F-15C Eagle

HOTAS

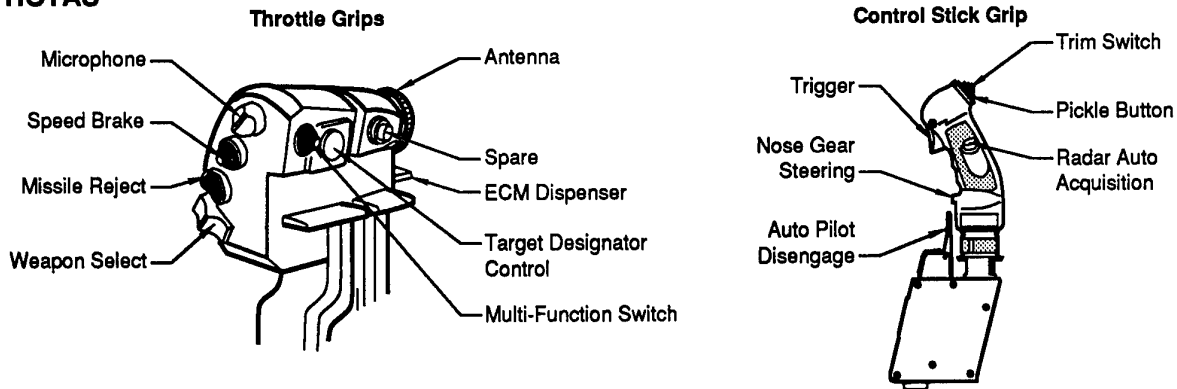

The HOTAS Controls Enable Immediate Control of the Current Attack Mode so That in a Visual Situation, the Pilot Need Not Look in the Cockpit. All HOTAS Commands to Attack Mode Avionics are Interfaced Through the Central Computer, and Weapons Commands are Interfaced Through the Programmable Armament Control Set.

HUD



The HUD System is an Electro-Optical Sight System That Develops Symbolic Flight and Attack Steering Information and Projects the Symbols into the Pilot's Field-of-View (FOV). The HUD Display Modes are Governed by the Master Mode Buttons. In A/A Master Mode, the MRM, SRM, or GUN Attack Display is Selected by the Throttle Weapon Switch.

- Display: Total FOV = 20°
- Inst FOV = 18°
- Stroke Only
- Mono Green
- Red Standby Depressible Reticle

Data Entry

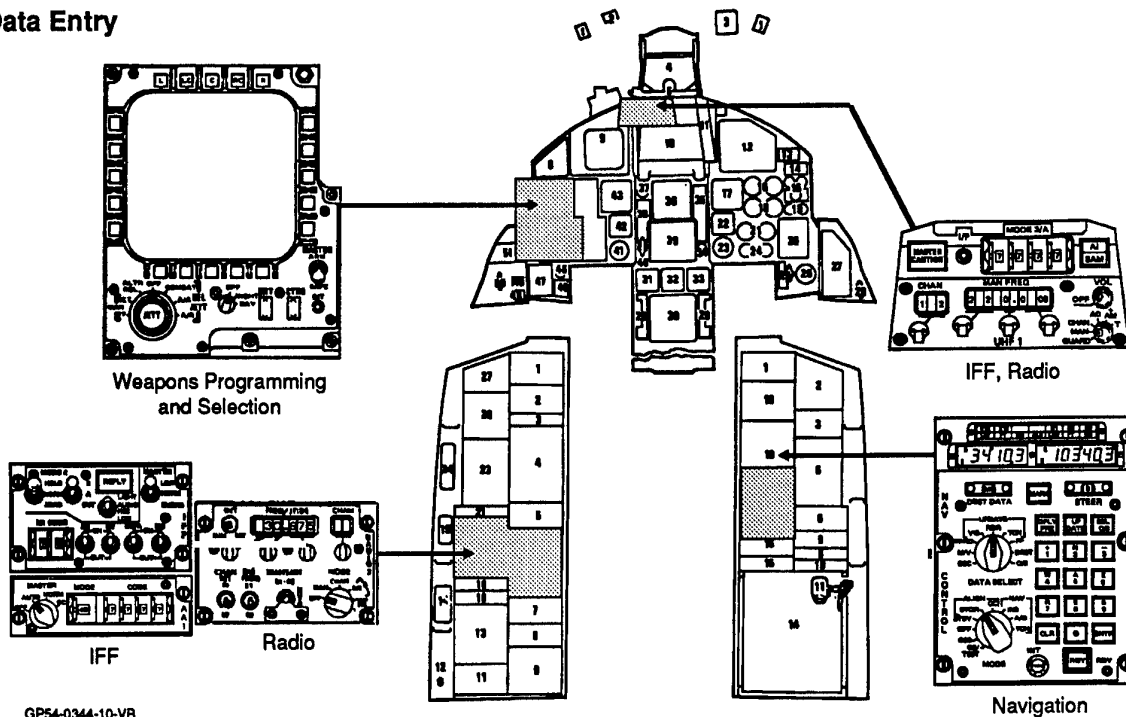



**Displays**

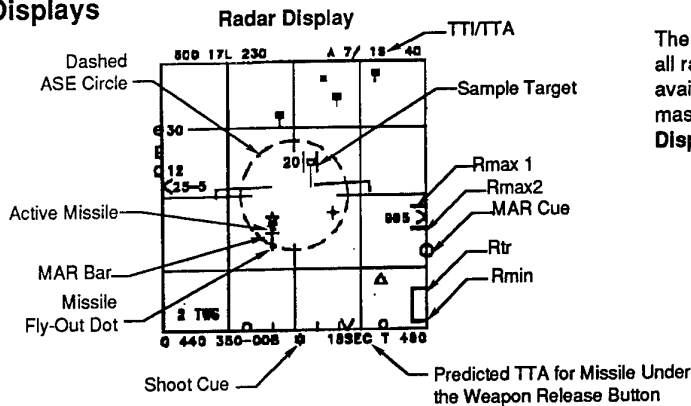

The Radar Scope provides tactical situation displays for all radar modes and video sensors. The type of display available on the indicator is a function of the operating master mode of the aircraft and the munition selected.

**Display:** 4 inch by 4 inch CRT  
 Hybrid stroke/raster  
 525 lines  
 Mono green  
 A/A and A/G maps  
 EO/FLIR

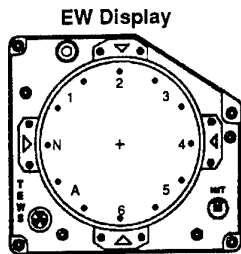

The Tactical Electronic Warfare System consists of four major sections:

- RWR - Radar Warning Receiver
- ICS - Internal Countermeasures Set
- EWWS - Electronic Warfare Warning Set
- CMD - Countermeasures Dispenser

**Display:** 4 inch circular CRT  
 Stroke only  
 Mono green

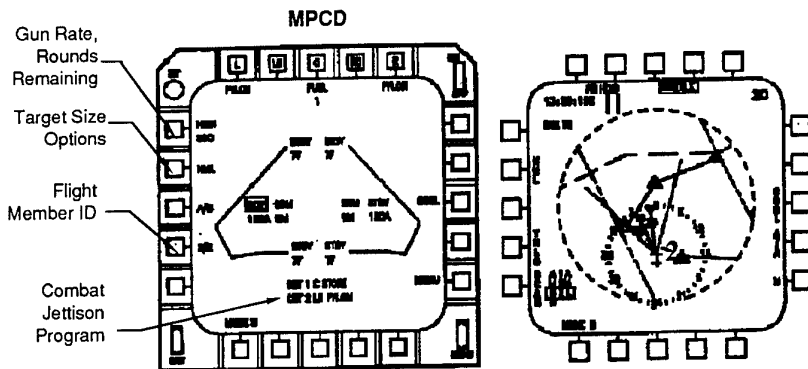

Multi-Purpose Color Display (MPCD) formats include Armament, Situation Display, Data Transfer and BIT.

**Display:** 5 inch by 5 inch CRT  
 Hybrid Stroke/Raster  
 525 lines  
 Full Color Capable

**Backup Instruments**

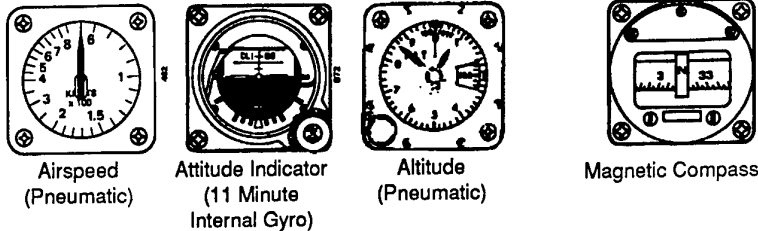

**Planned Improvements**

- Liquid Crystal Displays
- WFOV HUD
- Helmet Mounted Display
- Night Vision Goggles
- GPS
- Digital Map System
- High Resolution SAR
- Data Link
- IRST
- Fused Sensor Data
- Computer Processors
- Avionics Architecture

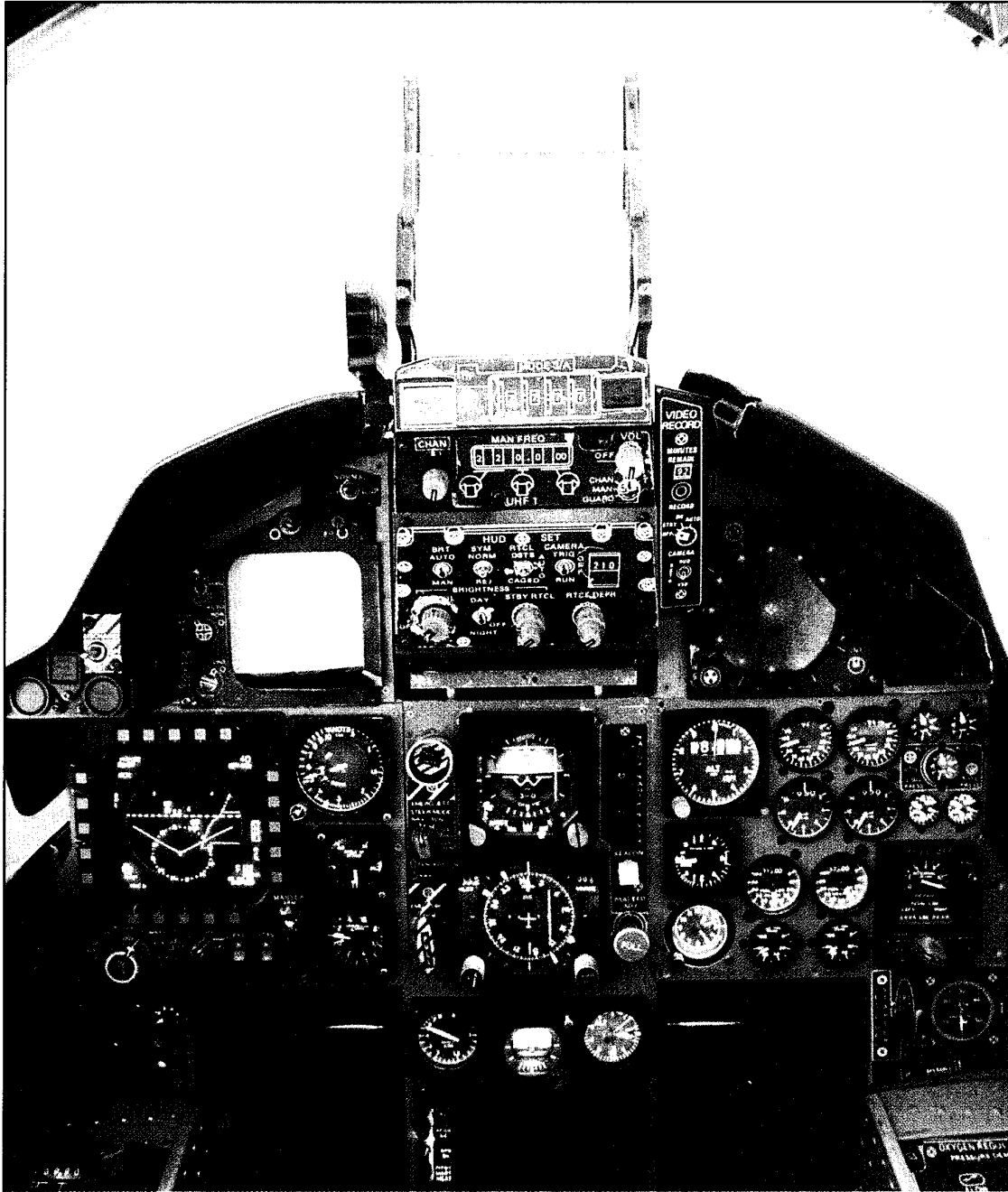

F-15C Eagle

**F/A-18C/D Hornet**

The F/A-18C/D Is a High Performance, Supersonic, All-Weather, Day or Night, Multi-Mission Strike Fighter Built by McDonnell Douglas Aerospace

**Aircraft Characteristics**

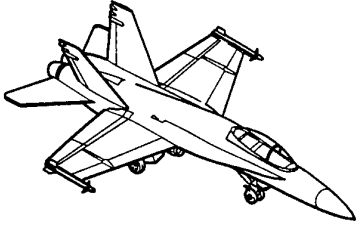

Length	56 ft, 0 in
Span	40 ft, 5 in
Height	15 ft, 4 in
Empty Weight	24,440 lb
Max Gross Weight	51,900 lb
Payload	27,460 lb
Max Speed	2.0 M
Unrefueled Range	500-1900 NM

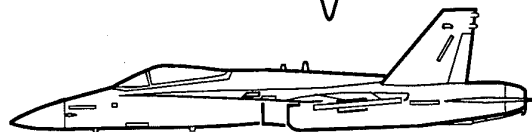
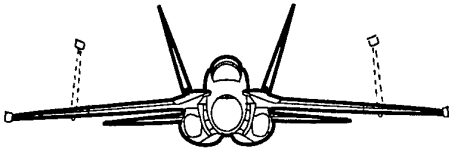
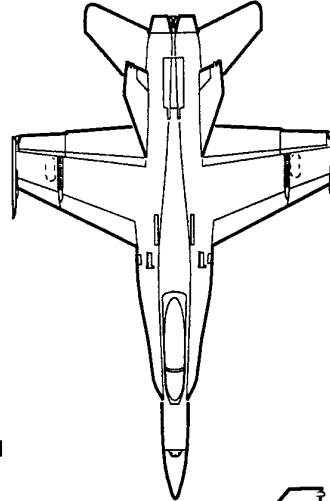

**Missions and Mission Equipment**



Missions:

- Air-to-Ground Interdiction
- Air-to-Air (Offensive and Defensive)

Mission Equipment:

- GE F404 Engines
- In-Flight Refueling (Probe and Drogue)
- KY-58 Secure Speech

**Weapons:**

 Air-to-Air	 Air-to-Ground	
	Conventional	Guided
<ul style="list-style-type: none"> <li>• AIM-120</li> <li>• AIM-7</li> <li>• AIM-9</li> <li>• 20 mm Ammo</li> </ul>	<ul style="list-style-type: none"> <li>• MK-82 SE</li> <li>• MK-82 LD</li> <li>• MK-83 LD</li> <li>• MK-84 LD</li> <li>• Rockeye II</li> <li>• LAU-10</li> <li>• LAU-61</li> <li>• LAU-68</li> <li>• CBU-59 APAM</li> <li>• MK-76</li> <li>• MK-106</li> <li>• 20 mm Ammo</li> <li>• Mines</li> </ul>	<ul style="list-style-type: none"> <li>• Walleye I</li> <li>• Walleye I ER/DL</li> <li>• MK-82 LGB</li> <li>• MK-83 LGB</li> <li>• MK-84 LGB</li> <li>• AGM-65E/F/G</li> <li>• AGM-84</li> </ul>

**Sensors:**

- APG-65 or -73 radar (A/A and A/G with Doppler Beam Sharpening)
- Electronic Warfare
- FLIR
- HARM
- Data Link

## F/A-18C/D Hornet

### Cockpit Layout Front Crew Station

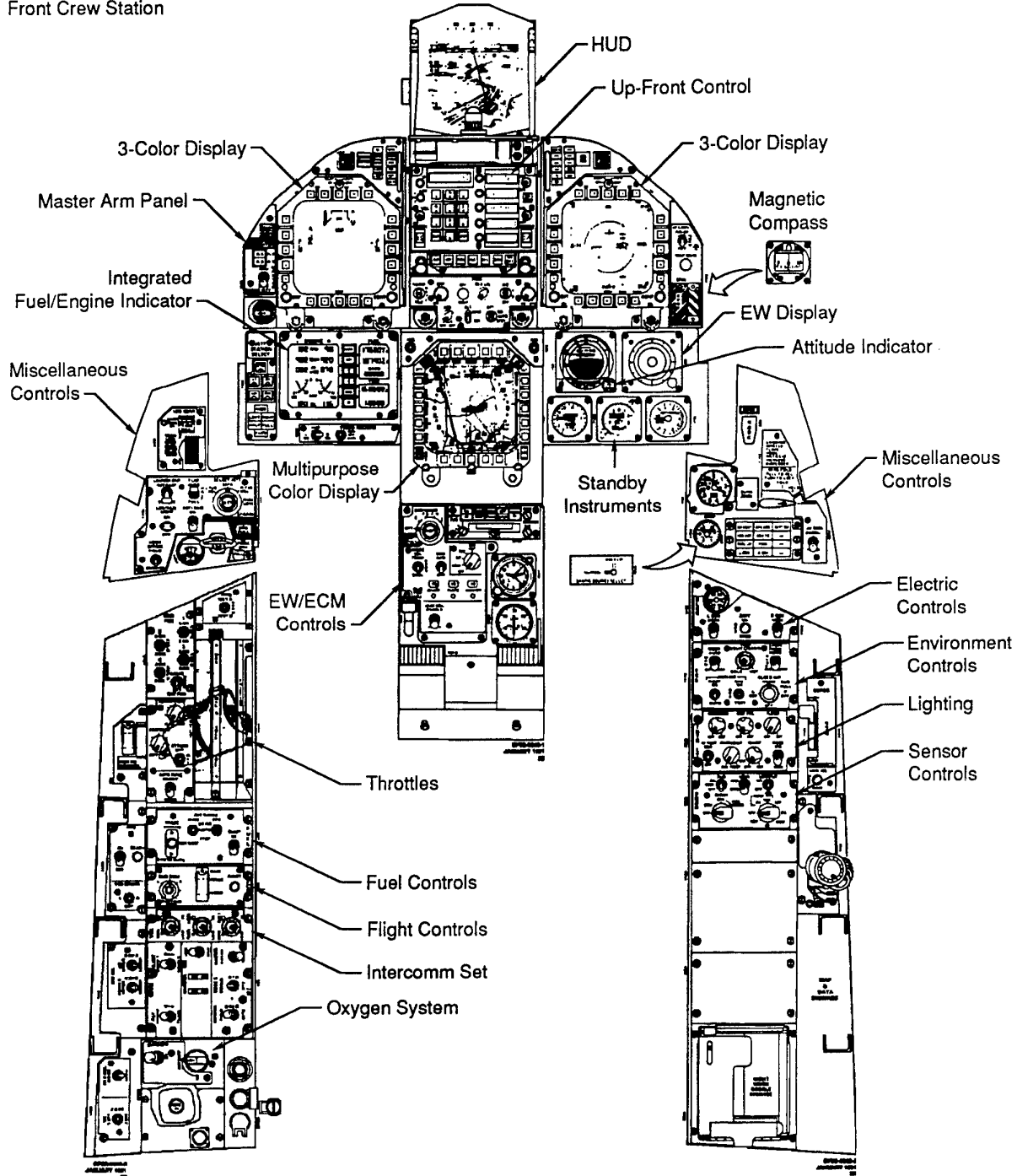

### Underlying Design Concepts

- Multi-Purpose Displays for Flexible, Rapidly Accessible Mission Information
- HOTAS for Immediately Accessible Controls

**Aft Crew Station**

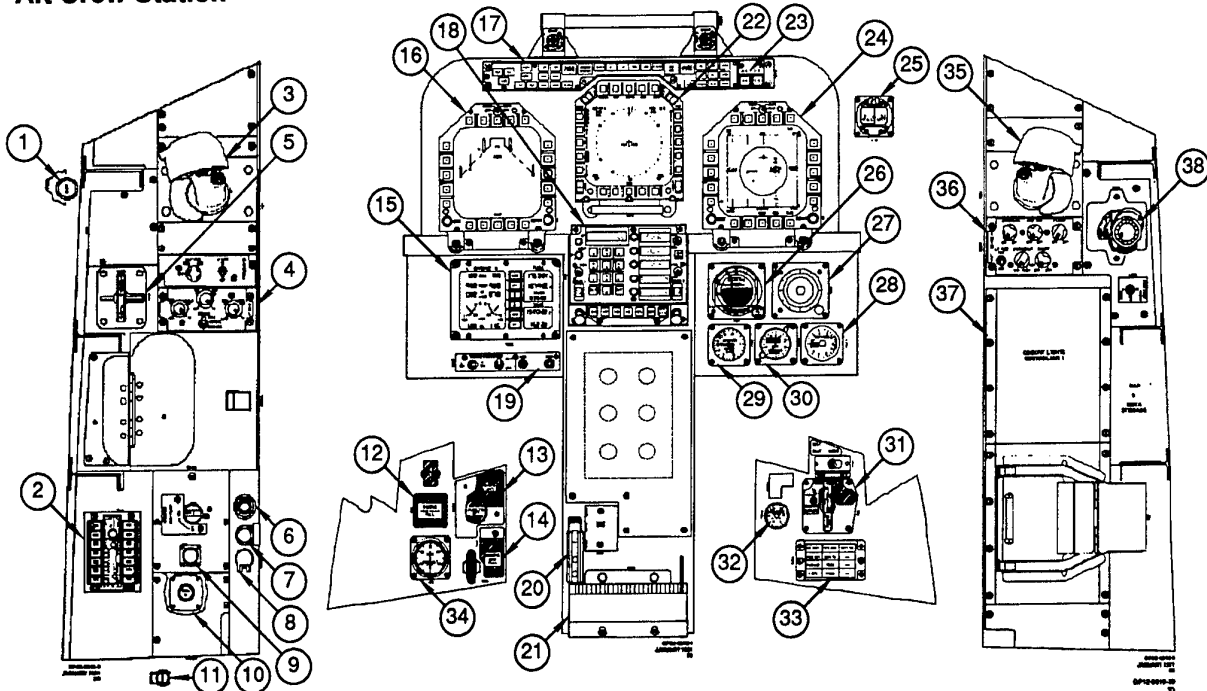

- 1. ECM Dispenser Switch
- 2. ECM Control Panel
- 3. Left Hand Controller
- 4. Volume Control Panel
- 5. Emergency Canopy Jettison
- 6. Anti-G Coupling
- 7. Vent Suit Coupling
- 8. Oxygen Coupling
- 9. Oxygen Quantity Indicator and Test Control
- 10. Anti-G Valve
- 11. Communications Connector
- 12. Emergency Landing Gear Control
- 13. Emergency Jettison Control
- 14. Park/Emergency Brake

- 15. Integrated Fuel/Engine Indicator
- 16. Left Digital Display Indicator
- 17. Warning Lights
- 18. Up-Front Control
- 19. Heading/Course Video Record Control
- 20. Rudder Pedal Adjust
- 21. Air Conditioning Outlet
- 22. Multipurpose Color Display
- 23. Master Mode Select
- 24. Right Digital Display Indicator
- 25. Standby Compass
- 26. Attitude Reference Indicator
- 27. Electronic Warfare Display
- 28. Vertical Speed Indicator

- 29. Standby Airspeed Indicator
- 30. Standby Altimeter
- 31. Escape Sequence Indicator
- 32. Hydraulic Pressure Indicator
- 33. Caution Lights
- 34. Cabin Pressure Altimeter
- 35. Right Hand Controller
- 36. Interior Light Control Panel
- 37. Cockpit Lights Controller
- 38. Utility Light

**Aft Crew Station Hand Controls**

This two-seat version of the F/A-18 provides enhanced crew situation awareness and allows the pilot to concentrate on flying.

This especially helps the crew during night, adverse weather or dense threat environments.

The back seater can independently do practically everything the pilot can except fly the aircraft.

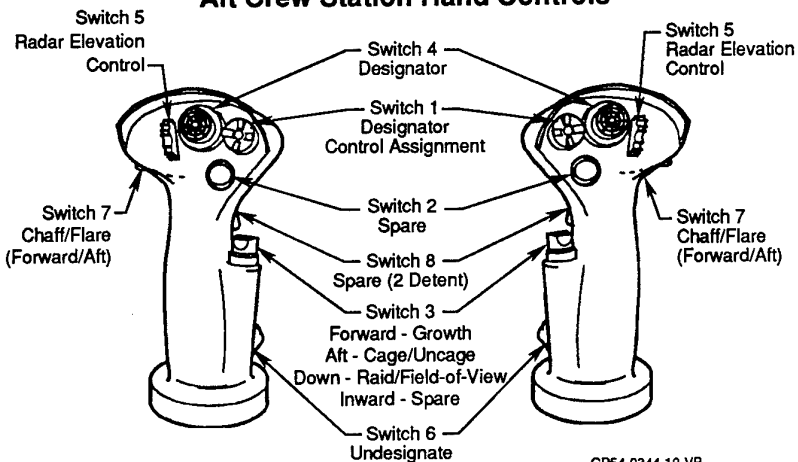

F/A-18C/D Hornet

HOTAS

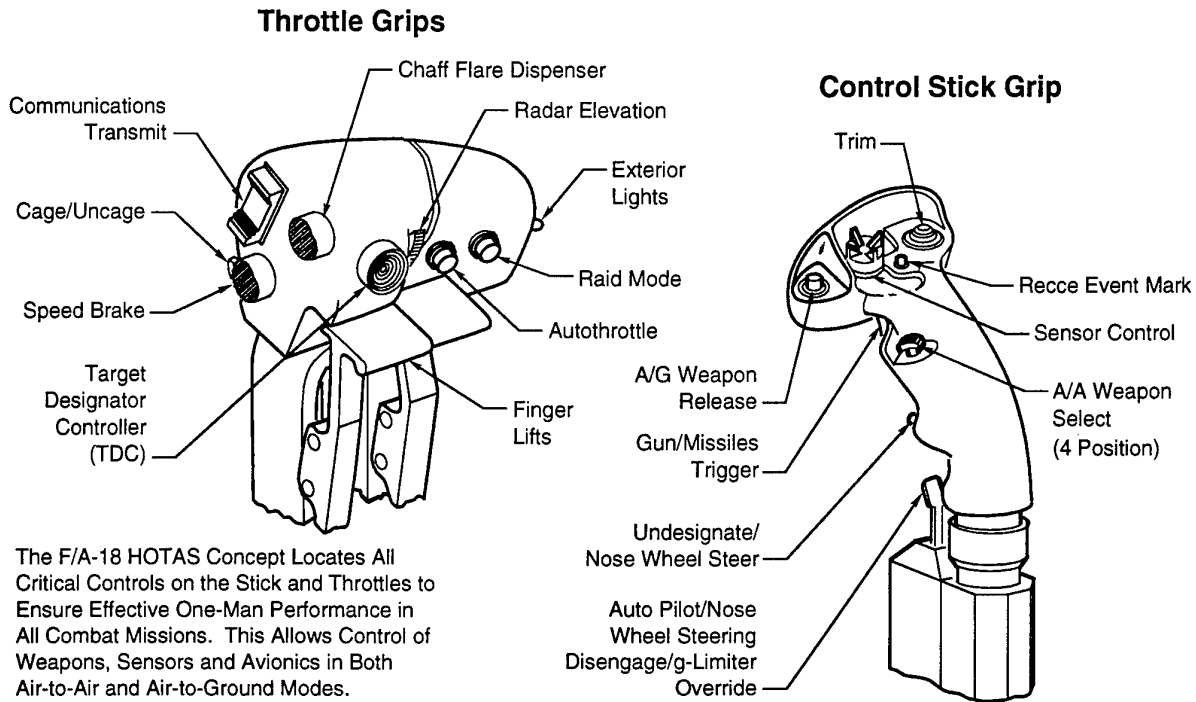

Head-Up Display (HUD)

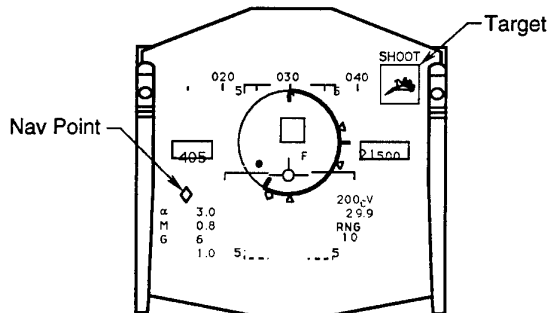

- The HUD is the Primary Flight Instrument and Weapon Delivery Display. It is an Electro-Optical Device With Formats That Vary Depending Upon Mode and Weapon Selections.
- Display: FOV = 20°  
Stroke and Raster  
Mono Green

Data Entry

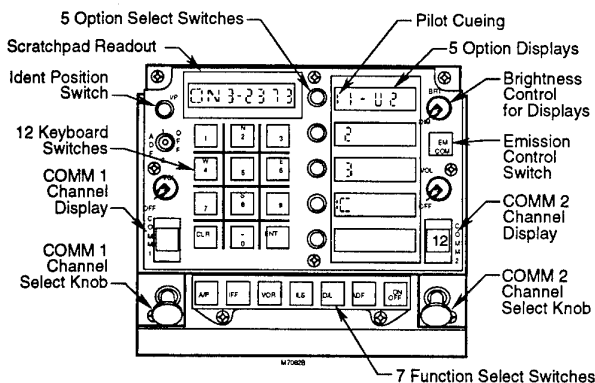

Up-Front Control

- The Up-Front Control Provides Single-Hand/Either-Hand Control of Communication, Navigation and Identification Equipment, and Weapon Data Entry. Its location Eliminates the Need for Vertigo-Inducing Head Movements.
- Display: 6 Rows of Alphanumerics Only  
Monochrome
- Data Can Also be Entered Through the Display Formats.

**Displays**

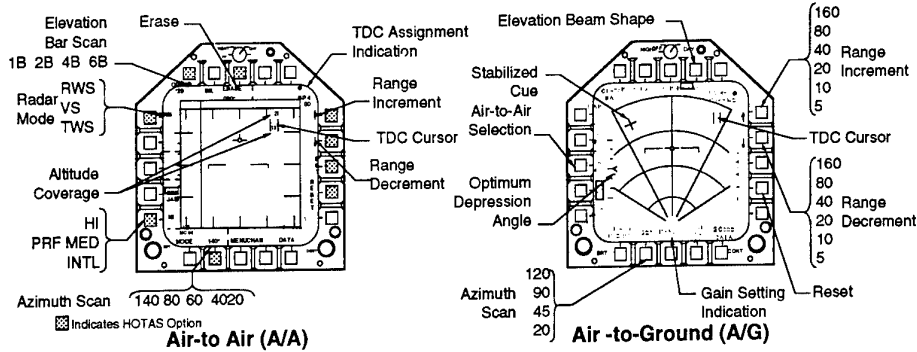

The APG-65 or -73 radar provides A/A and A/G information. All radar controls are accessed through the format, bezel pushbuttons or HOTAS. A/A modes include search, track while scan and automatic acquisition. A/G modes include real beam map, synthetic aperture radar and sea search. Radar information can be displayed on any of the three cockpit displays:

- |   |   |
|---|---|
| <p>2 Digital Display Indicators (DDIs)</p> <ul style="list-style-type: none"> <li>• 5 by 5 Inch CRT</li> <li>• Stroke and Raster</li> <li>• 3 Color KROMA (red, yellow, green)</li> </ul> | <p>1 Multipurpose Color Display (MPCD)</p> <ul style="list-style-type: none"> <li>• 5 by 5 Inch CRT</li> <li>• Stroke and Raster</li> <li>• Full Color</li> </ul> |
|---|---|

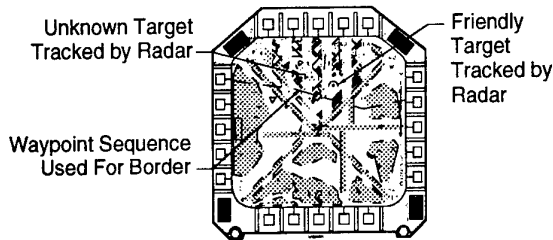

**Moving Digital Map**

The Moving Digital Map can show various scaled full color maps and is the basis of the tactical situation display. The integration of radar and map information provides excellent situation awareness.

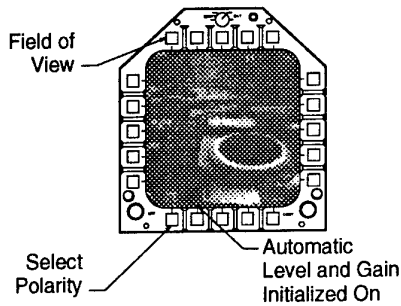

**Forward Looking Infra-Red (FLIR)**

The FLIR system provide day and night attack and surveillance capability.

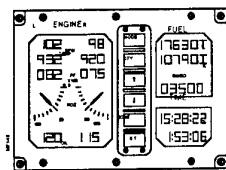

**Integrated Fuel/Engine Instrument**

- Fuel and engine information have been combined into this efficient, compact display. More complete fuel system information is available through a DDI Page.
- Display: Liquid crystal display Monochrome

**Back-Up Instruments**

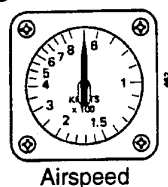

**Planned Improvements - The F/A-18E/F**

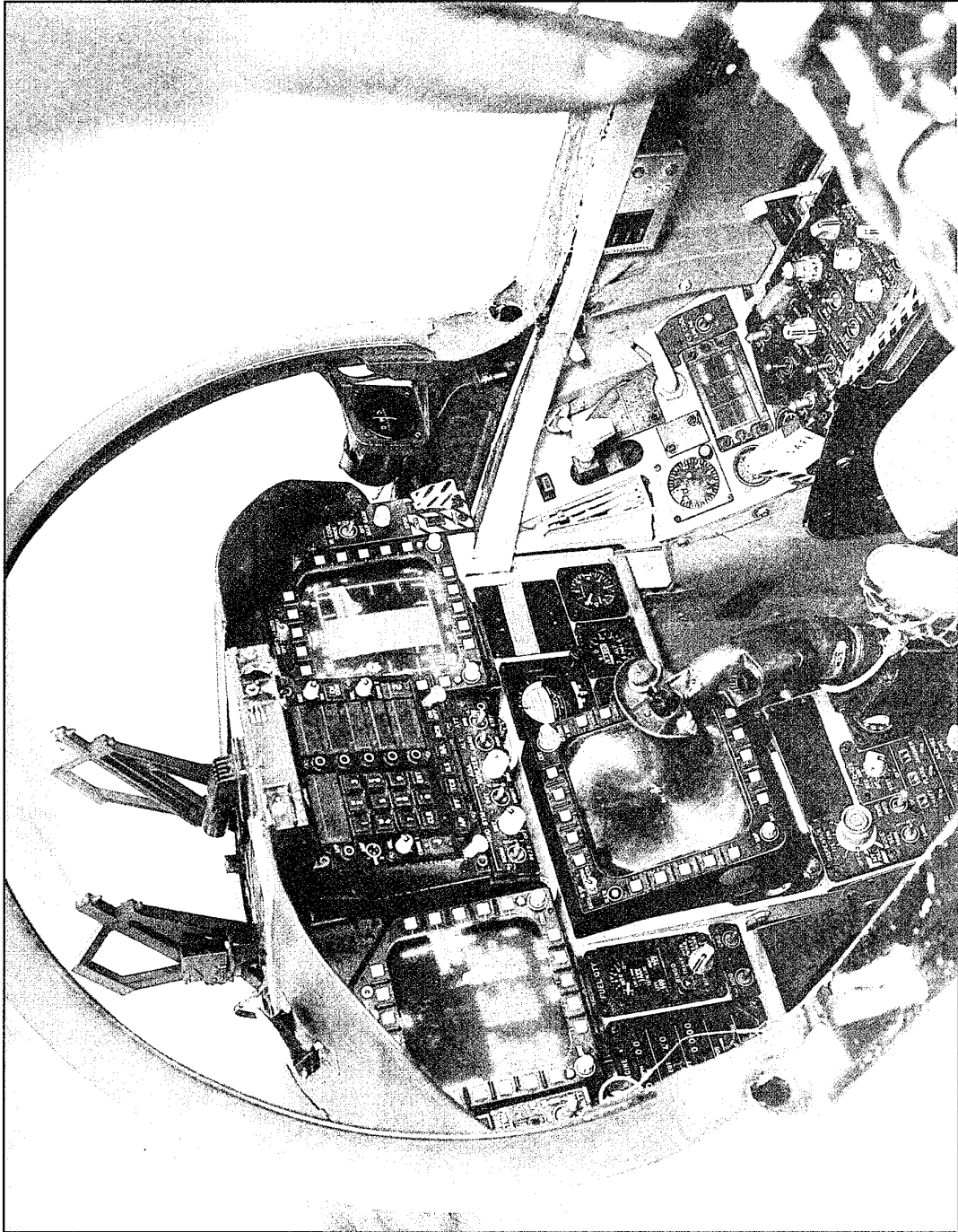

F-18 A/B



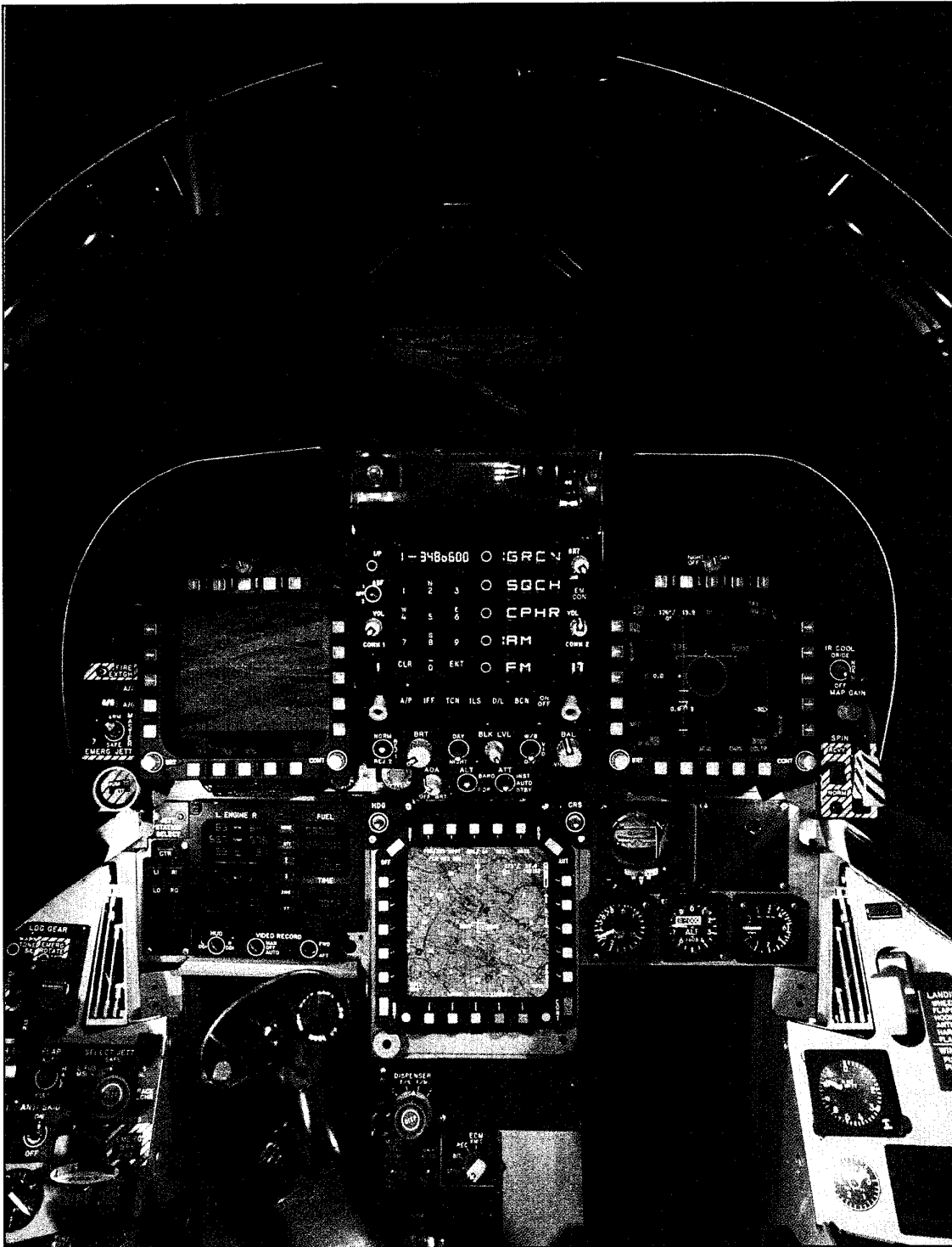

F-18 C/D

## F-15E Eagle



### Aircraft Characteristics

The F-15E is a High-Performance, Supersonic, All-Weather, Dual Role Fighter Built by McDonnell Douglas Aerospace. All Aircraft Are Manufactured in the Two-Engine, Two-Seat Configuration for Maximum Survivability and Mission Effectiveness. The F-15E Thrust-to-Weight Ratio and Excellent Maneuverability Provide a Combat Edge in its Air-to-Ground and Air-to-Air Roles.

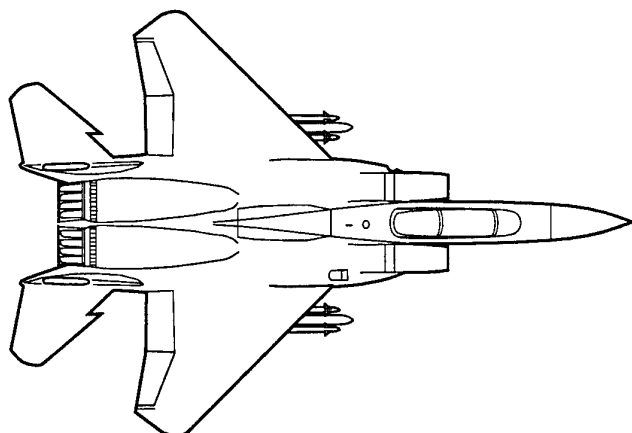

• Length	63 ft, 9 in.
• Span	42 ft, 10 in.
• Height	18 ft, 8 in.
• Empty Weight	33,500 lb
• Max. Gross Weight	81,000 lb
• Payload	47,500 lb
• Max. Speed	2.5 M
• Unrefuel Range (Nominal Mission Profile)	900 - 1,700 NM

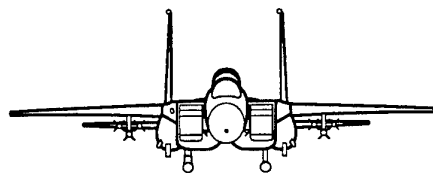
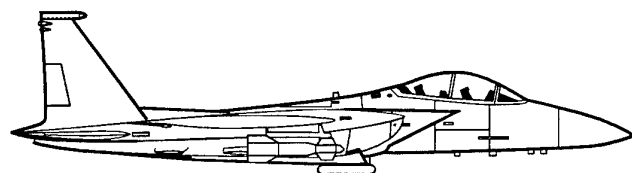

### Missions

- Interdiction
- Air Superiority

### Mission Equipment

- APG-70
  - Air-to-Air Search and Track
  - Air-to-Ground Synthetic Aperture
- Tactical Electronic Warfare System
- Have Quick Radio
- KY-58 Secure Speech
- In-Flight Refueling (Boom)

### Weapon Capabilities

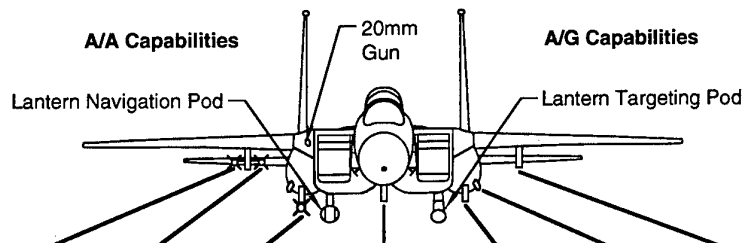

Inboard Pylon (Sta 2/8)		Left/Right CFT Inboard Row	Centerline Pylon (Sta 5)	Left/Right CFT		Inboard Pylon (Sta 2/8)
Right LAU (2B/8B)	Left LAU (2A/8A)			Inboard Row	Outboard Row	
AIM-9 AIM-120 AIS Pod	AIM-9 AIM-120 AIS Pod	AIM-7 AIM-120	Bombs Nuclear Datalink	Bombs CBU's Dispensers GBU's Nuclear	Bombs CBU's Dispensers GBU's	Bombs Dispensers GBU's AGM's Nuclear

GP54-0344-3-VB



**F-15E Eagle**

**Front Cockpit Layout**

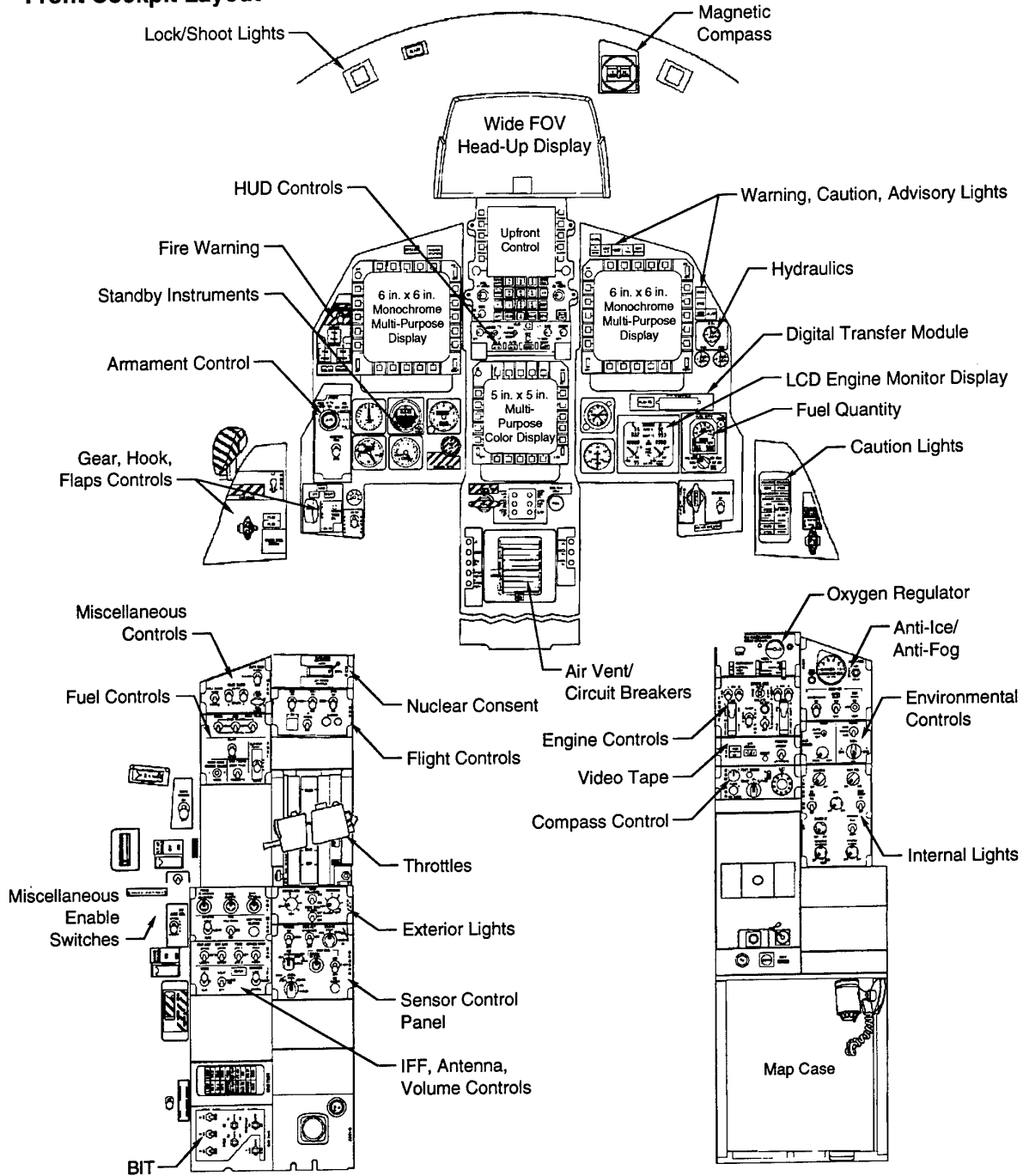

**Underlying Design Concepts**

- Flexibility With Programmable Multi-Purpose Displays
- Ease of Use With Hands-On Throttle-and-Stick (HOTAS) Controls
- Head-Up Operations With Up-Front Control and Wide Field-of-View HUD

- Functionally Grouped Instruments and Controls
- Instrument Qualified HUD Allows Replacement of Main ADI Ball With Electronic ADI

F-15E Eagle



Aft Cockpit Layout

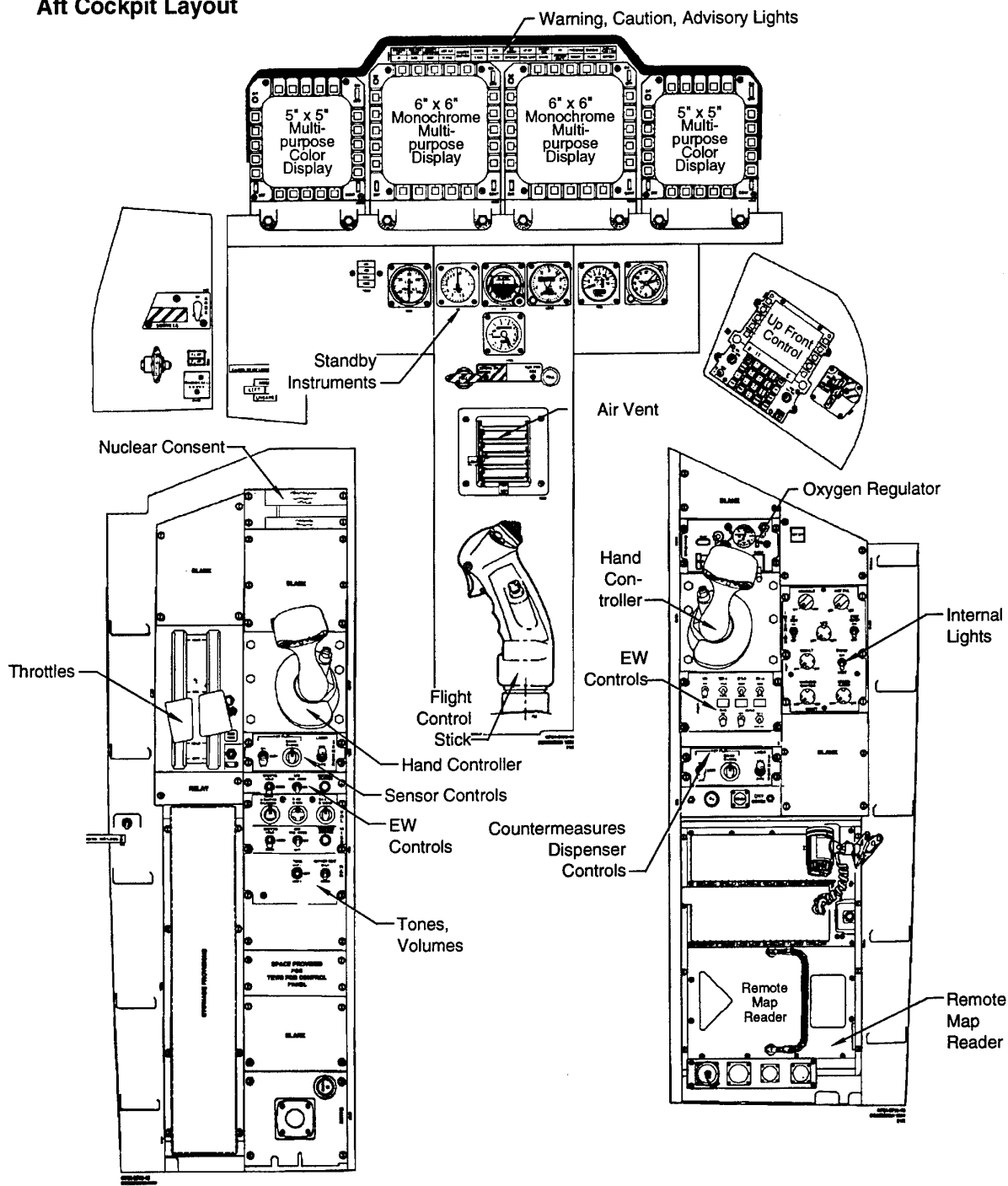

**Underlying Design Concepts**

- Missionized Cockpit for More Efficient Weapon System Operation
- Ease of Use Enhanced With Added Twin Hand Controllers
- Improved Crew Mutual Support With Separate Control of Repeatable Display Formats
- Separation of Crew Responsibilities With Dedicated Control Panels



F-15E Eagle

**HOTAS**

**Front Cockpit Controls**

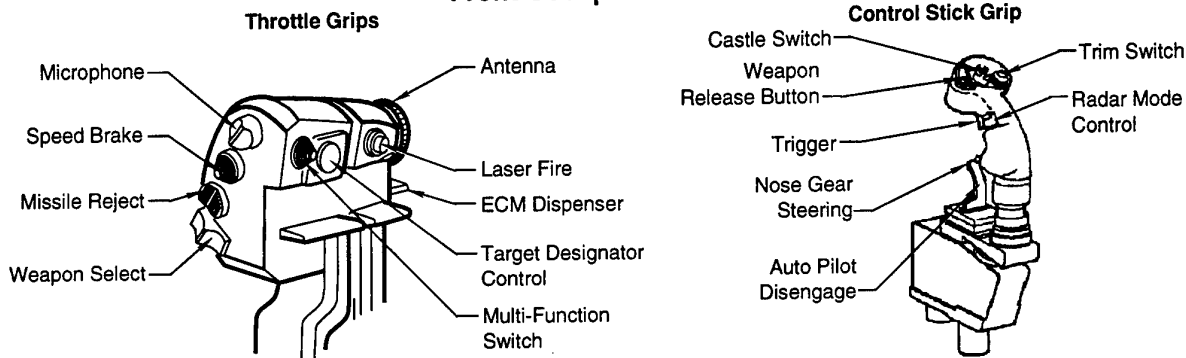

**Rear Cockpit Hand Controllers**

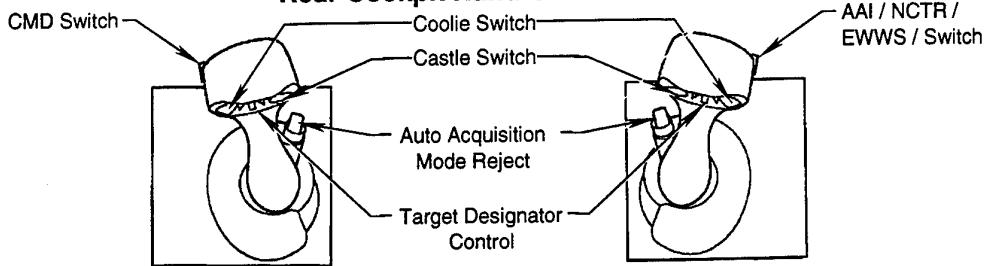

The HOTAS Controls Enable Immediate Control of the Current Attack Mode so That in a Visual Situation, the crew need Not Look in the Cockpit. All HOTAS Commands to Attack Mode Avionics are Interfaced Through the Central Computer, and Weapons Commands are Interfaced Through the Programmable Armament Control Set.

**HUD**

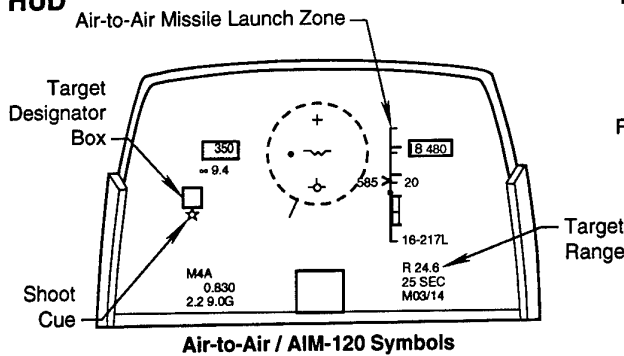

The Holographic HUD Displays Projected Raster Video Imagery and Stroke Symbols in a Wide Field-of-View to the Pilot. The HUD Display Modes are Governed by the Master Modes and Include Navigation, FLIR Video, Flight Control and Weapon Delivery Formats. The HUD is the Primary Flight Instrument in the F-15E.

Display: FOV = 28° Azimuth/21° Elevation  
Stroke and Raster Monochrome Green

**Data Entry**

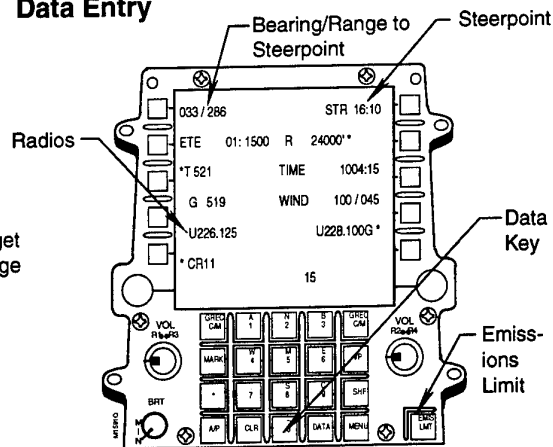

**Up Front Control**

The UFC is an Information and System Interface Which Also Provides Control of Most Avionics Subsystems. Two Menus, Two Data Displays, and Several Submenus can be Accessed from Either Cockpit. An Integrated Keypad and Option Push Buttons Provide Control Over Displayed Systems, Including Data Entry.

Display: 6 Rows of 20 LCD Characters  
Alphanumerics Only  
Monochrome

**F-15E Eagle**



**Displays**

**Tactical Situation Display**

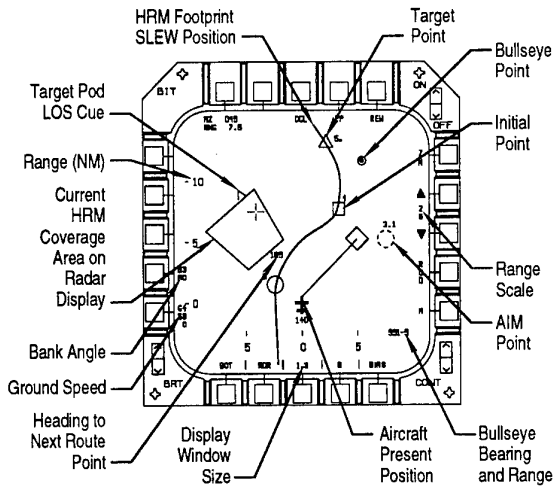

**Tactical Electronic Warfare System**

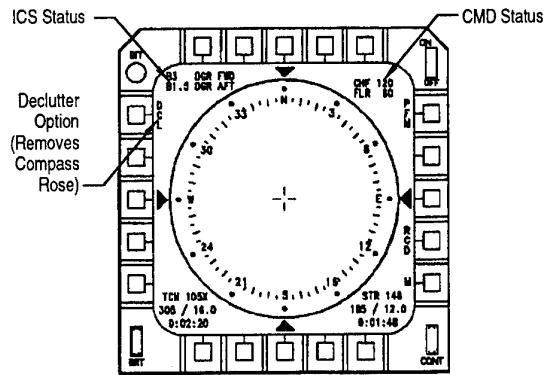

Multi-Purpose Displays Provide the Necessary Formats for Building Aircrew Situation Awareness in All Phases of Flight. The Tactical Situation Display is Used for Navigation and Sensor Pointing. The TEWS Format Consolidates the Radar Warning Receiver, Internal Countermeasures Set, Electronic Warfare Warning Set, and Countermeasures Dispenser. The Electronic ADI Along With the EHSI Provide Data for Instrument Flying. Other Formats Include Weapons, Built-In Test, Data Transfer, and Interfaces to Sensors.

**Displays:**

Multi-Purpose Display  
6 inch by 6 inch CRT  
Stroke and Raster  
Monochrome

Multi-Purpose Color Display  
5 inch by 5 inch CRT  
Stroke and Raster  
Full Color

**Back-Up Instruments**

**Engine Monitor Display**

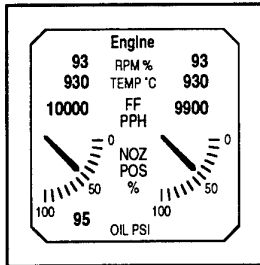

3 in. by 3.5 in. Liquid Crystal Monochrome Displays

Airspeed

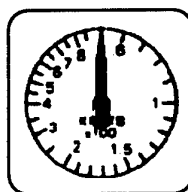

Altitude

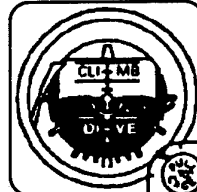

Altitude

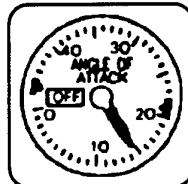
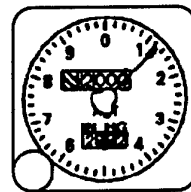

Angle-of-Attack

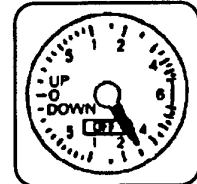

Vertical Velocity

**Planned Product Improvements**

- Helmet Mounted Displays
- Global Positioning System
- Digital Map Set
- Radar Upgrades (High Resolution Synthetic Aperture)
- Data Link
- Multi-Target A/G Attack
- Ground Collision Warning
- JDAM/JSOW Integration
- Avionics Architecture

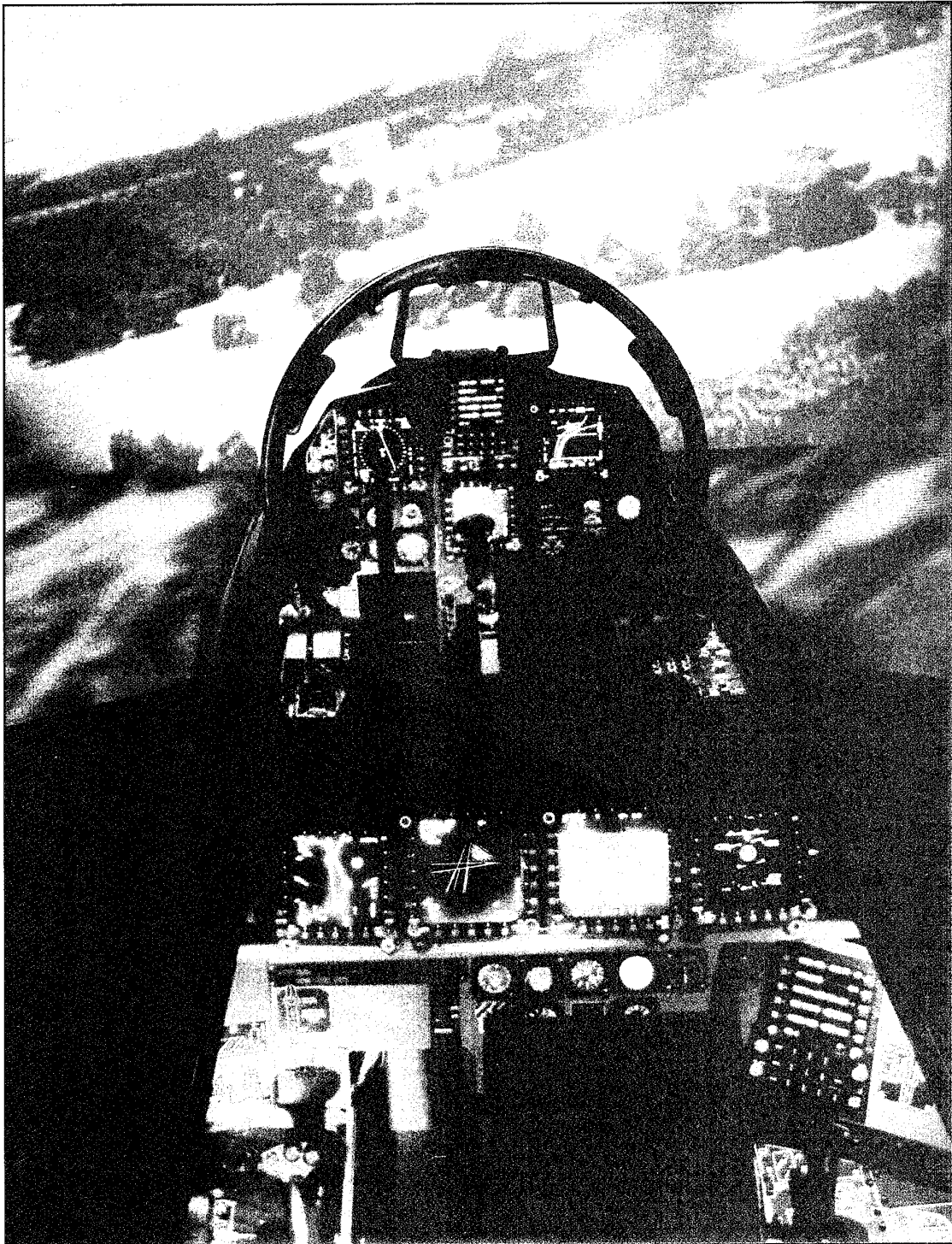

F-15 E

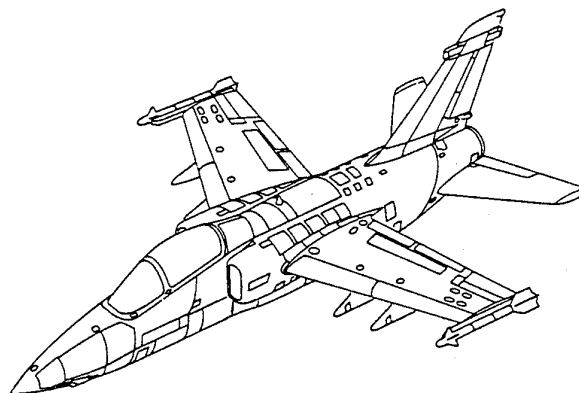
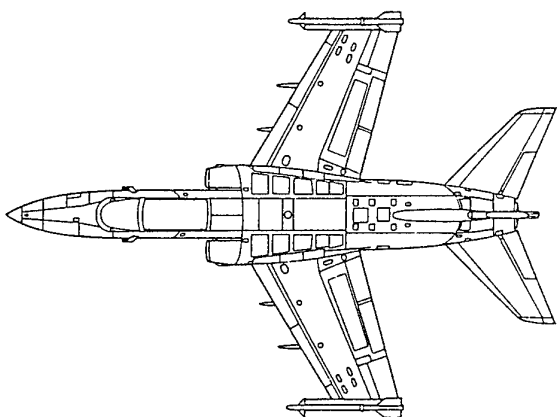
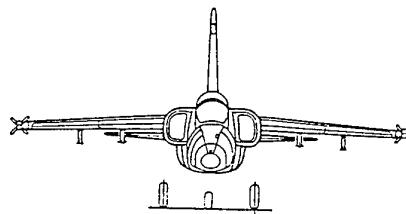
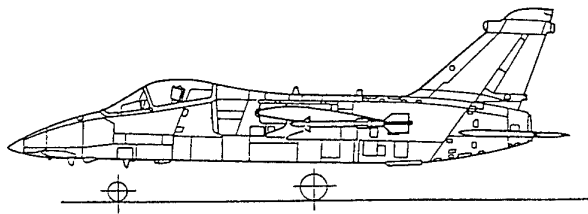
**Alenia-Aermacchi-Embraer AM-X****AIRCRAFT CHARACTERISTICS**

The AM-X is a single seater, subsonic, single engine light tactical attack aircraft.

- Single Seater (Twin Seater Trainer)	- Operational Empty Weight: 6700 kg
- High Subsonic	- Max. T/O Weight: 13000 kg
- Fly-By-Wire Controls	- Max. Payload: 3800 kg
- Propulsion: one RB 168-807 Turbofan (5000 kg Dry)	- Max. Speed: > M 0.8 / 480 Kts
- Overall Length: 13.55 m	- Operating Range: > 250 NM (internal fuel, lo-lo-lo mission)
- Overall Height: 4.55 m	
- Wingspan: 9.97 m (including A/A missiles)	

**MISSIONS AND MISSION EQUIPMENT**

**Primary Roles:** - Battlefield Air Interdiction (BAI)  
 - Close Air Support (CAS)  
 - Armed Reconnaissance  
**Secondary Roles:** - Offensive Counter Air (OCA)  
 - Air Defence (against low level flying intruders)

**Mission Equipments:**

- Radar Ranging FIAR Pointer
- Integrated EW System (RWR, C/F, AECM)
- Duplicated Avionic Bus and Mission Computer
- Head Up Display
- Multifunction Colour Head Down Display
- INS plus SAHR
- TACAN
- Internally Mounted Recce System plus ORPHEUS Recce Pod

**Armament:**

- 2 x AIM 9-L A/A Missiles (Wingtip Installation)
- 1 x 20mm M60A1 or 2 x 30mm DEFA internal gun installation
- Free-Fall and Retarded Bombs (MK 82, 83, 84)
- Anti-Runway Bombs
- Laser Guided Bombs
- Cluster and Denial Bombs
- Rockets



## Alenia-Aermacchi-Embraer AM-X

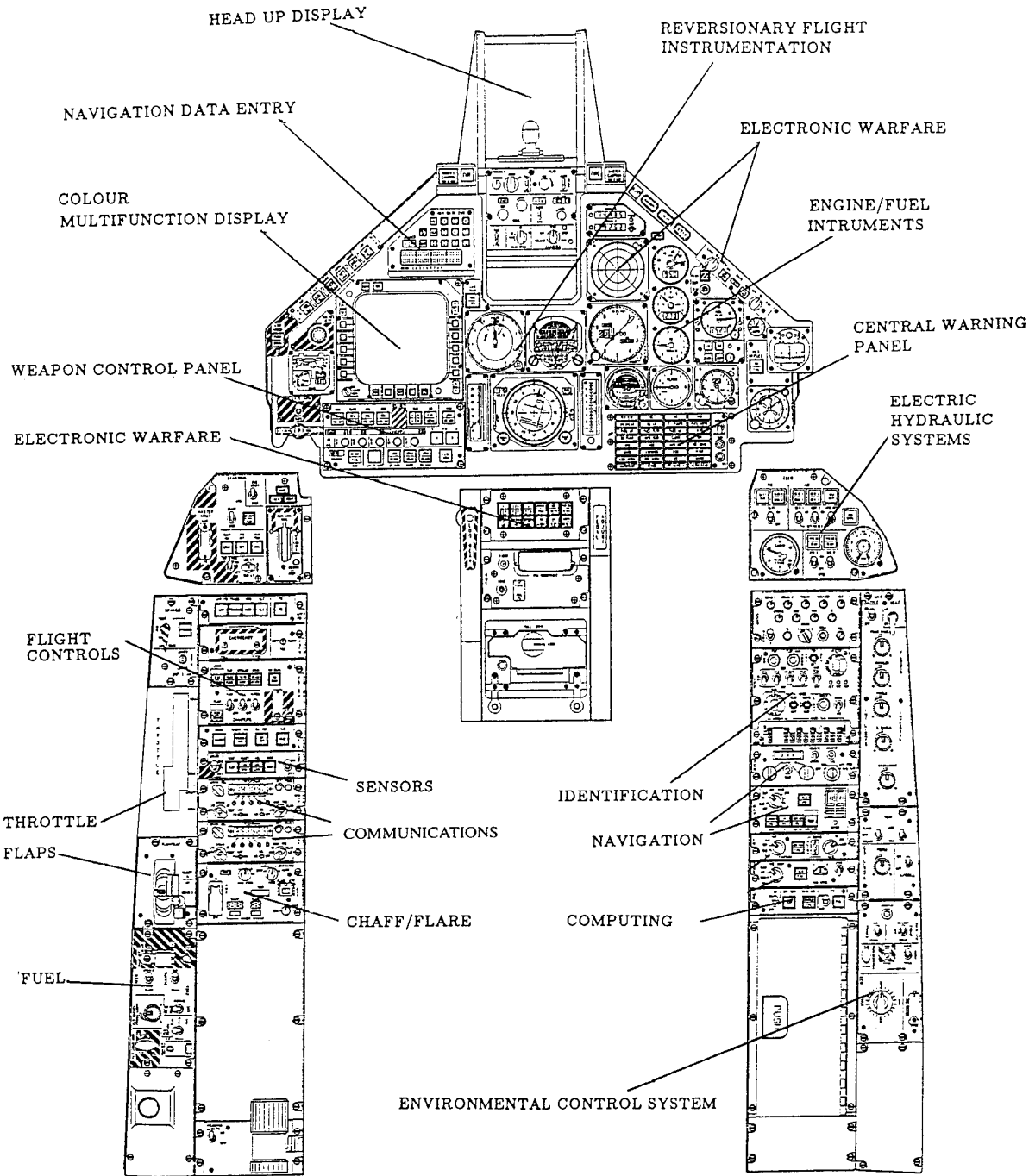

## UNDERLYING DESIGN CONCEPTS

AM-X cockpit is designed in order to provide great external visibility (16° over the nose) and easy access to information and functions control in each phase of flight.

Pilot workload is reduced by means of appropriate design concepts such as:

- HOTAS Controls of main Navigation/Attack functions
- Head-Up Navigation/Attack and basic flight information
- Tactical situation, mission/systems status information on MFD
- RWR head-up presentation
- Head-up Navigation Data Entry facility
- Reversionary flight instrumentation

## Alenia-Aermacchi-Embraer AM-X

### HOTAS

HOTAS controls allows the pilot to manage the most important navigation/attack functions and aircraft systems; this is obtained by means of dedicated and multifunction switches located on throttle and stick:

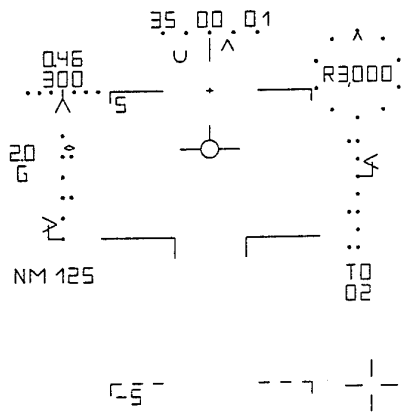
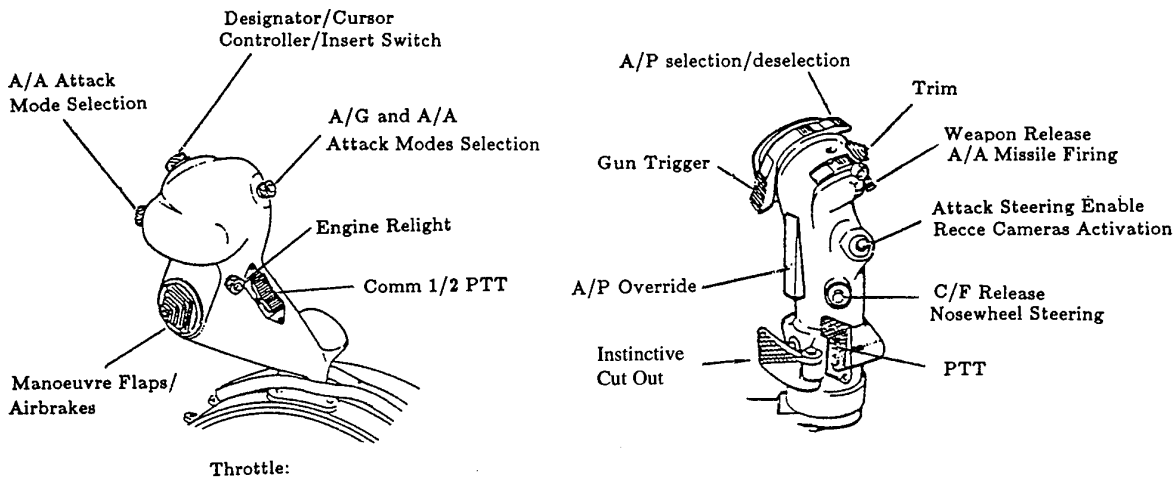

### HUD

The HUD is a collimated display utilized as primary source of navigation/attack information for the pilot; information is presented by means of appropriate display formats automatically activated upon selection of the relevant navigation and attack phases.

- 22° Total Field of View
- Basic flight data
- Normal/Radio navigation data
- Autopilot monitoring and Flight Director
- Navigation/Attack designation symbology
- A/A gun and missile attack symbology
- A/G weapon aiming/release symbology

### DATA ENTRY

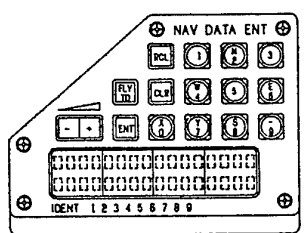

Data related to mission database information, including target data for preplanned attack can be inserted in the system by means of:

- Rapid Entry with Data Transfer Module (DTM, pre-loaded cartridge)
- Navigation Data Entry (NDE, manual insertion)

Mission data includes:

- Routepoints 3D coordinates
- Planned Target 3D coordinates
- Mission Timings
- Threat areas coordinates/lethality radius
- Auxiliary navigation points coordinates
- Radio Stations coordinates/frequencies/channels

Self-defence, IFF and Comm. data are inserted by means of the relevant dedicated control panels.

## Alenia-Aermacchi-Embraer AM-X

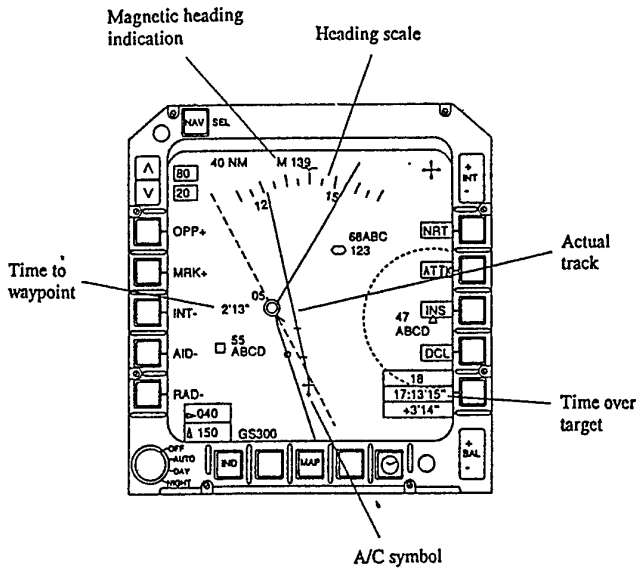

### MULTIFUNCTION HEAD DOWN DISPLAY

The multifunction head-down display is a full colour raster/stroke CRT dedicated to present to the pilot, in a graphic form, navigation, tactical and system status information arranged in appropriate formats.

Multifunction and dedicated keys are provided for activating the relevant functions in each format.

- 5"x5" Useful Area
- 525 Active Lines
- Planned Route
- Preplanned Target
- Stations Location
- Steering Information
- Threat Locations/Warnings
- Mission Timings
- Mission Database Information
- Systems Status

### BACKUP INSTRUMENTATION

Backup flight data are provided to the pilot by means of conventional instruments:

- Baro Altimeter
- Mach/Anemometer
- Attitude Indicator
- Climb/Dive Indicator
- Angle Of Attack Indicator
- Magnetic Compass

### PLANNED IMPROVEMENTS

In order to extend mission flexibility and operational effectiveness improvements to avionic and weapon system are under evaluation:

- Raster/Stroke HUD
- Navigation FLIR
- Targeting POD
- NVG Compatible lighting
- Improved EW and Self Defence System
- LINS / GPS
- Datalink
- Digital Remote Map Reader
- Multimode Radar
- A/S Missiles

An EW dedicated twin seater platform is also under development.

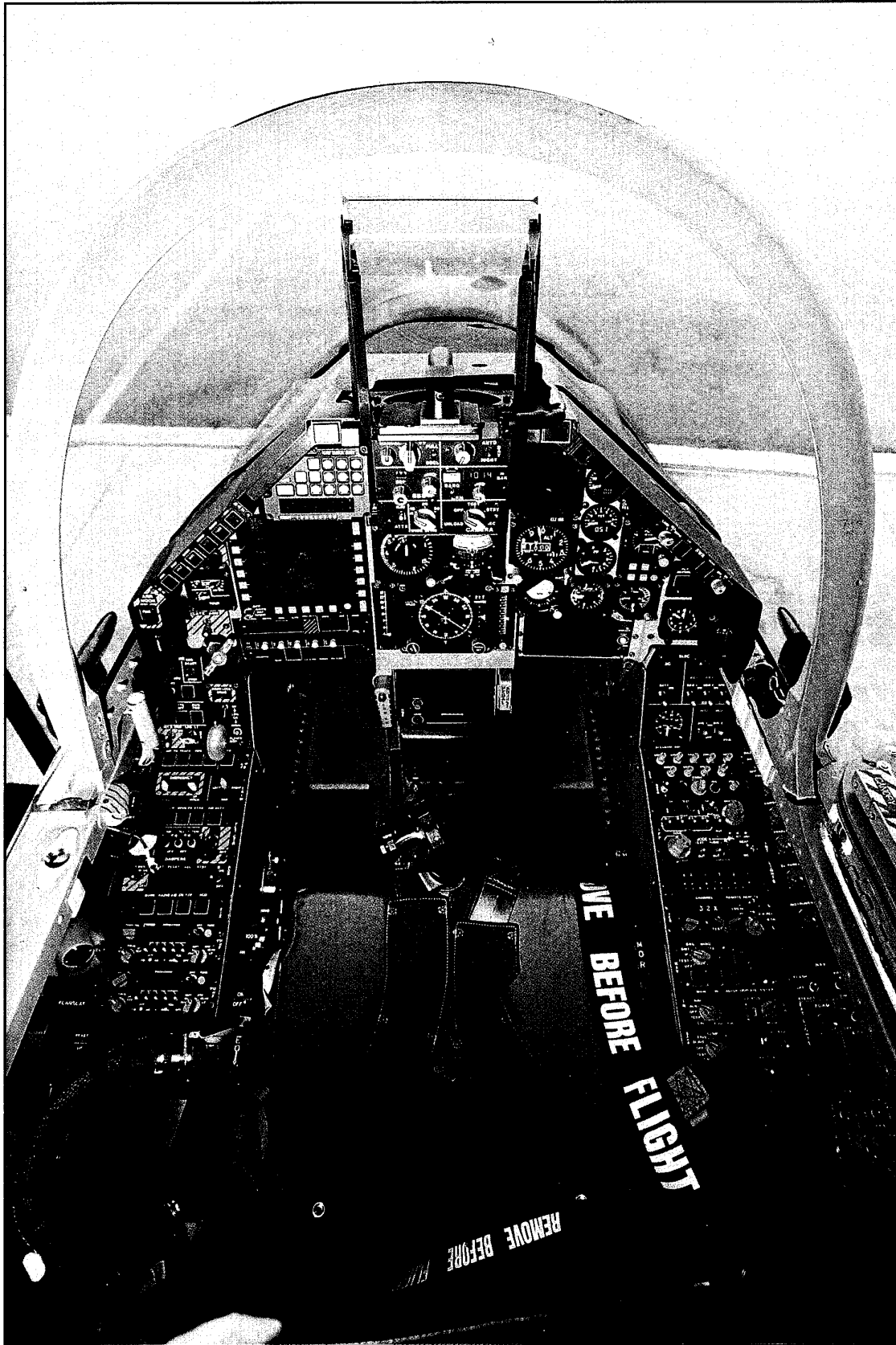

Alenia-Aermacchi-Embraer AM-X

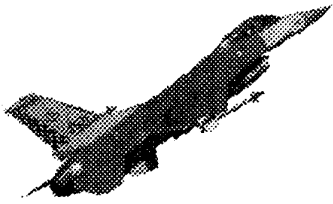

## F-16C Fighting Falcon

### Aircraft Characteristics

The F-16C is a High-Performance, Supersonic, Multirole Tactical Fighter Built by Lockheed Martin. Primarily, Aircraft Are Manufactured in the Single-Engine, Single-Seat Configuration, With the F-16D Two-Seat Version Performing the Role of Trainer. Aerodynamically the F-16 is Designed to Maximize Maneuverability, With Features Like Forebody Strakes, Automatic Leading Edge Flaps, and Fully Movable Horizontal Tails. The Hydraulic Flight Control Surfaces Are Controlled Through a Redundant Fly-by-Wire System.

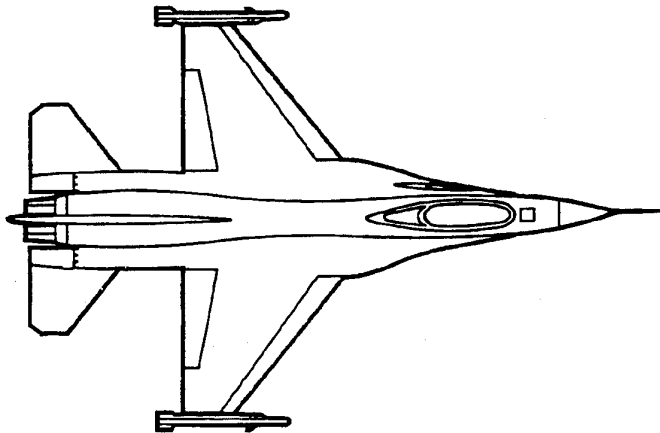

• Length	49 ft, 3 in.
• Span	32 ft, 10 in.
• Height	16 ft, 7 in.
• Empty Weight	19,200 lb
• Max. Gross Weight	37,500 lb
• Payload	8,800 lb
• Max. Speed	2.05 M
• Unrefuel Range (Nominal Mission Profile)	500 - 700 NM

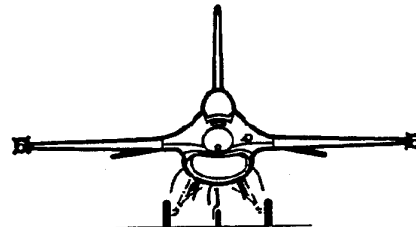
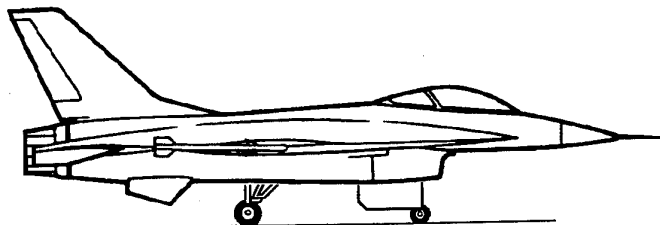

### Weapon Capabilities

#### Missions

- Interdiction, Close Air Support, SEAD
- Air Defense

#### Mission Equipment

- Fire Control Radar
  - Air-to-Air Search and Track
  - Air-to-Ground Mapping
- Threat Warning System
- Have Quick Radio
- In-Flight Refueling (Boom)

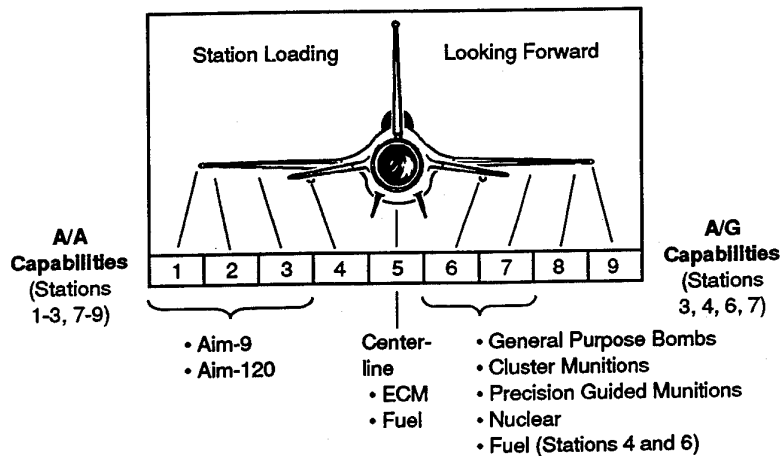

## F-16C Fighting Falcon

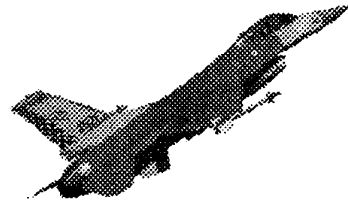

### Cockpit Layout

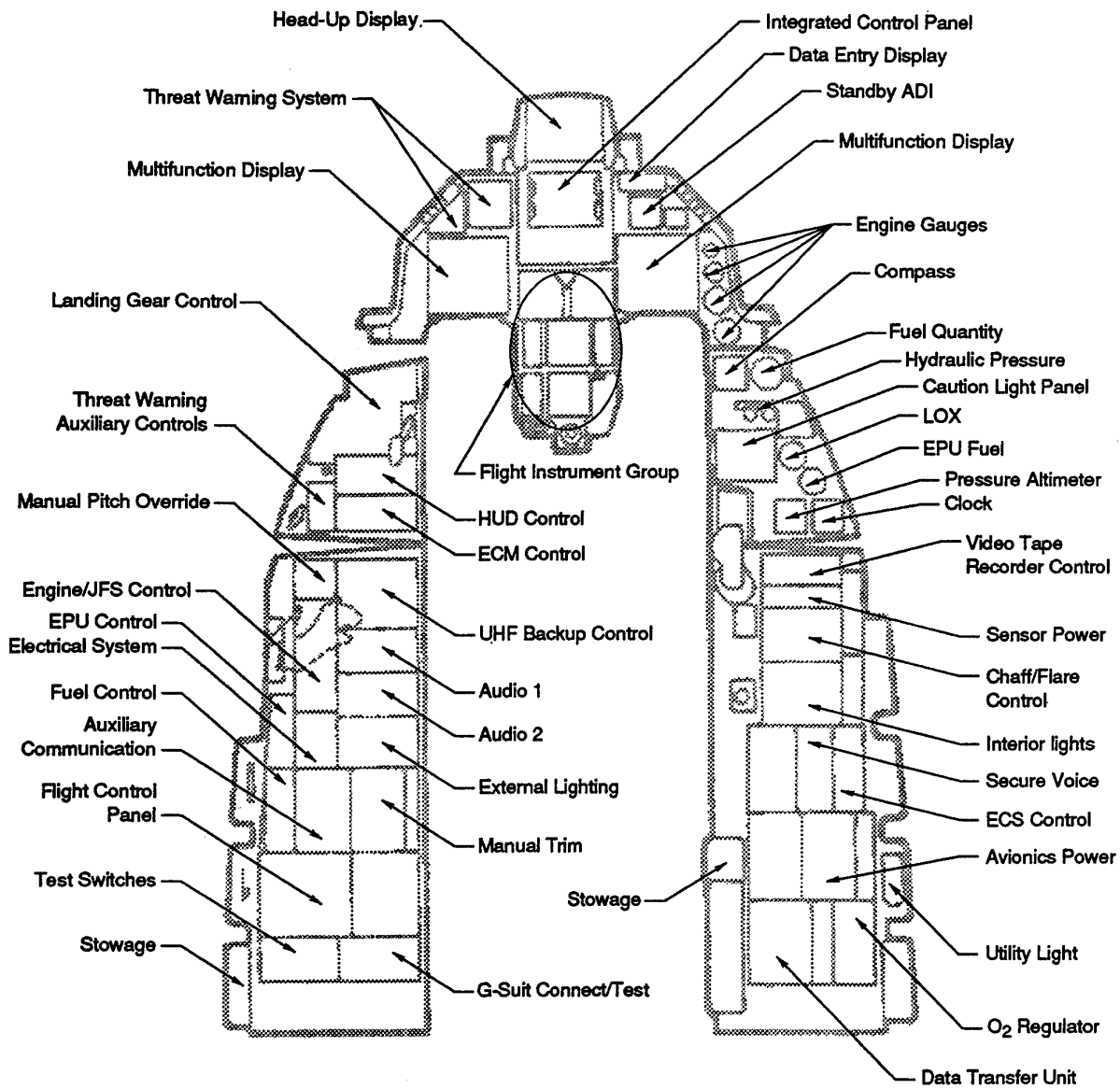

### Underlying Design Concepts

- Flexibility With Programmable Multifunction Displays
- Ease of Use With Hands-On Throttle-and-Stick (HOTAS) Controls
- Head-Up Operations With Up-Front Control and Wide Field-of-View HUD

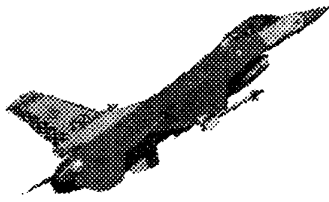

**F-16C Fighting Falcon**

**Hands-On Controls**

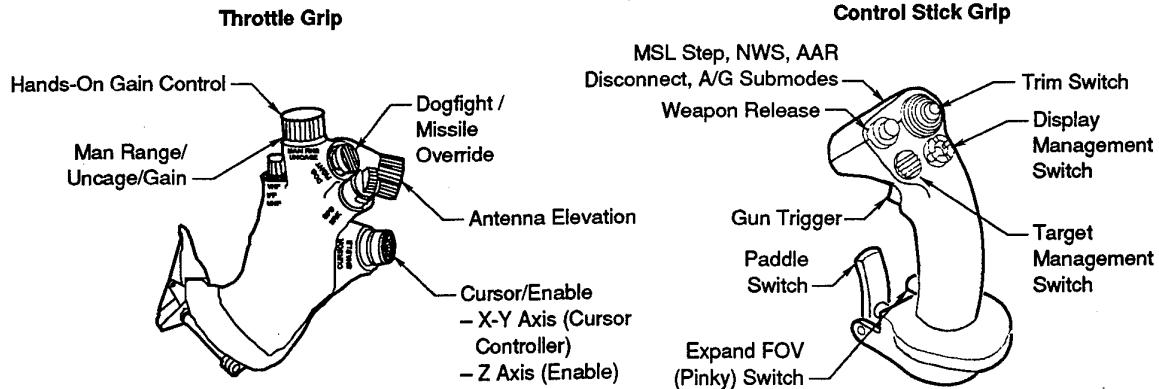

Hands-On Control Enables Immediate Access to Attack Modes so That in a Visual Situation, the Pilot Need Not Look in the Cockpit.

**HUD**

**Data Entry**

**Air-to-Ground Symbology**

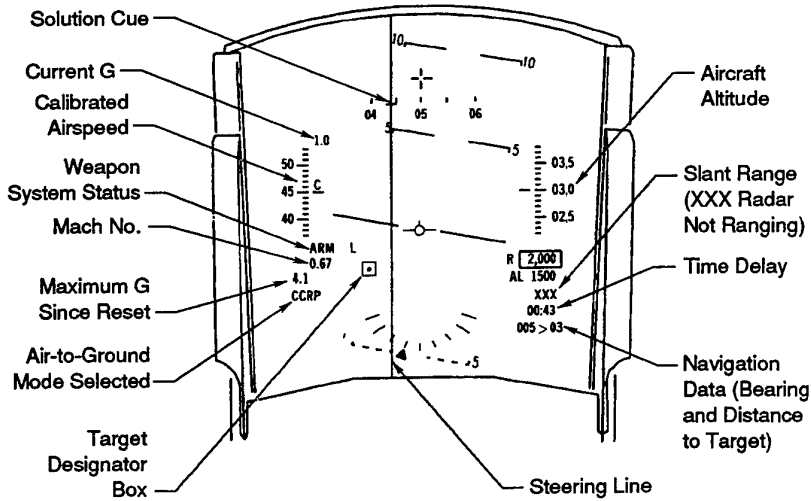

The HUD Provides Flight Symbols Relating to Attack, Navigation, Weapon, Aiming, and Landing Modes.

- Display:
- FOV = 25° Azimuth / 23° Elevation
  - Stroke and Raster Monochrome Green

**Integrated Control Panel (ICP)**

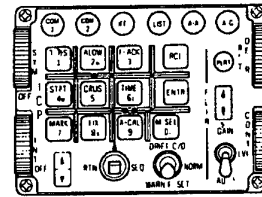

**Data Entry Display (DED)**

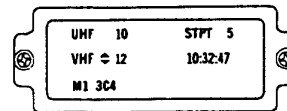

Up-Front Controls Provide a Head-Up Weapons and CNI Interface. Data Accessed Through the ICP is Presented for Display on the DED.

- DED:
- LED Dot Matrix Display
  - Alphanumerics Only
  - Monochrome

# F-16C Fighting Falcon

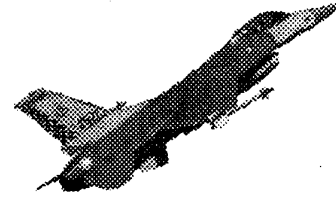

## Displays

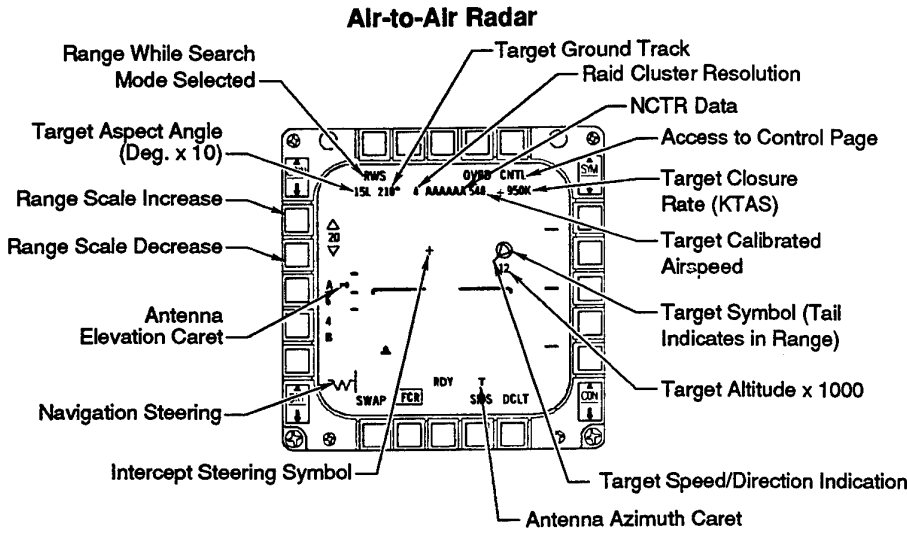

- Two Multifunction Displays Provide the Necessary Formats for Building Pilot Situation Awareness in All Phases of Flight. Radar, EO Weapon, Stores, and Other Video Displays Are Provided.

- Multifunction Displays:
  - 4 in. by 4 in. CRT
  - Raster Only
  - Monochrome

## Ground Map Radar

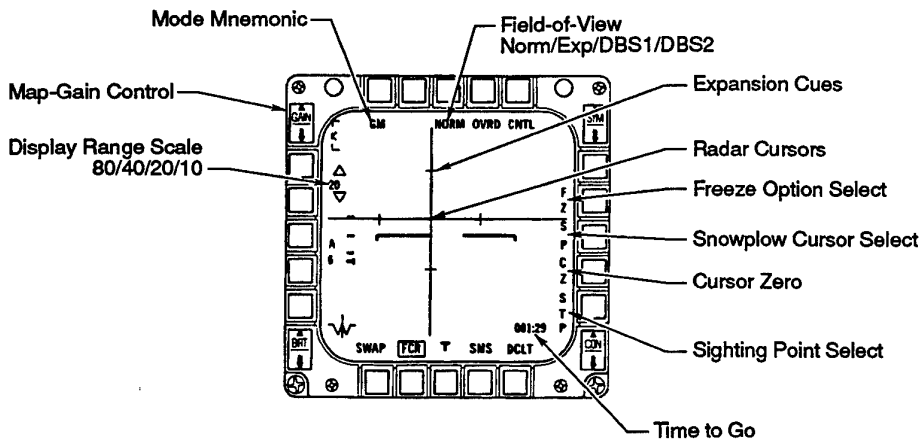

## Flight Instruments

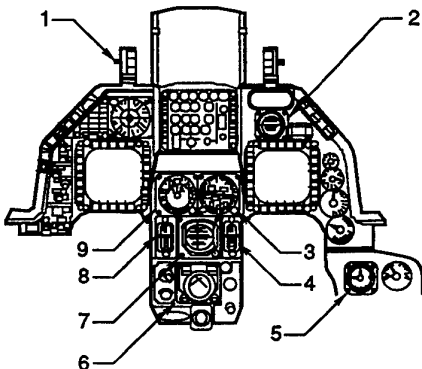

1. AOA Indexer
2. Standby Attitude Indicator
3. Altimeter
4. Vertical Velocity Indicator
5. Magnetic Compass
6. Horizontal Situation Indicator
7. Attitude Director Indicator
8. AOA Indicator
9. Airspeed/Mach Indicator



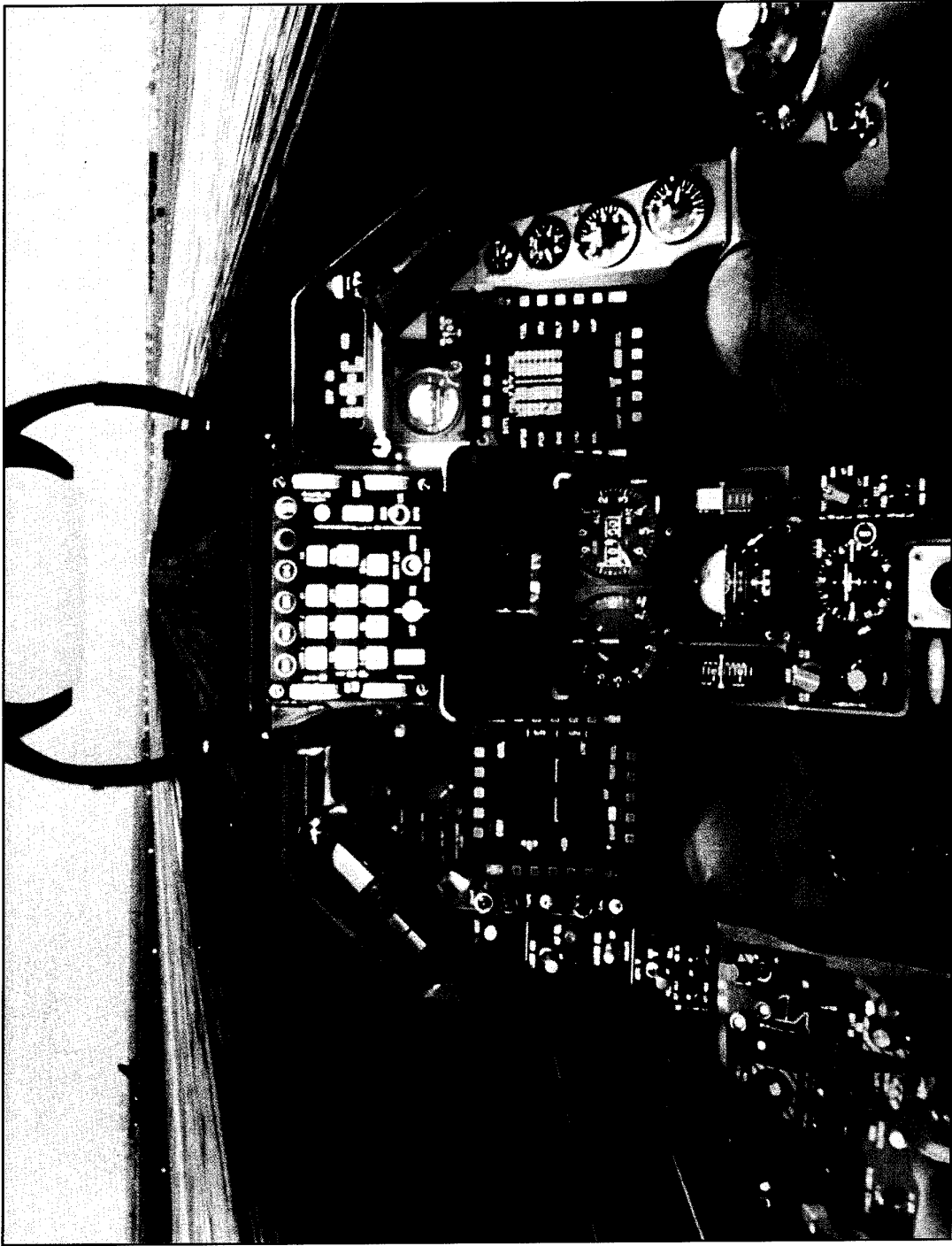

F16 C

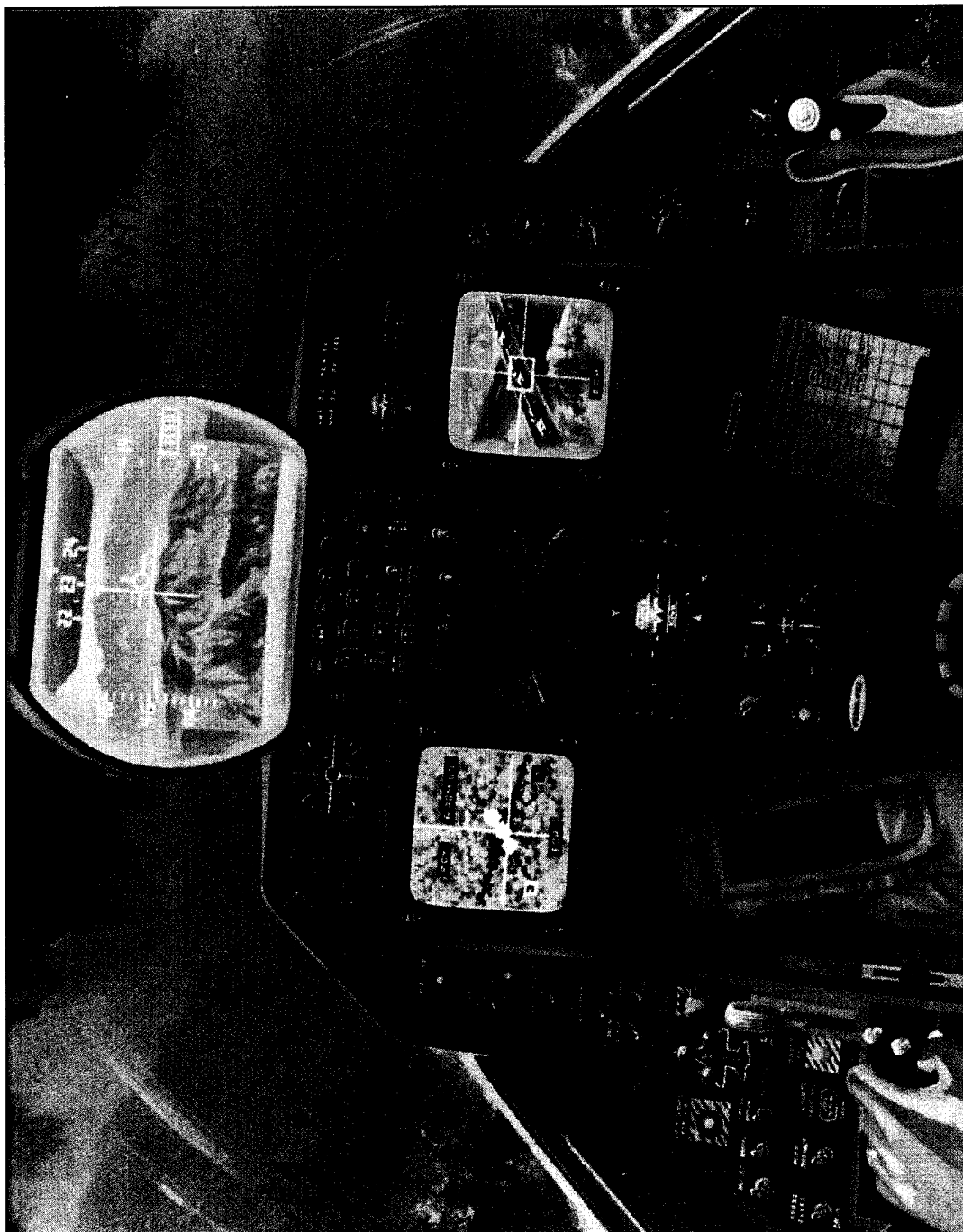

F-16 C

**Mirage 2000-5**AIRCRAFT CHARACTERISTICS

- Single engine multirole aircraft available in single seater or two seater version.
- Powered by a SNECMA M53P2 of 9.5T thrust (with AB).
- Aerodynamic configuration: instable delta.
- Flight control system: fly by wire allowing extreme agility and care free handling.
- Multirole capability with air to air multitarget fire control as well as air to ground functions.

- Main armaments (9 store stations):
  - 4 MICA (EM missile)
  - 2 MAGIC (IR missile)
  - 2 internal 30 mm guns
  - Modular bombs and all conventional weapons
  - 2 Laser guided missiles or bombs
  - APACHE (air to ground stand off missile)

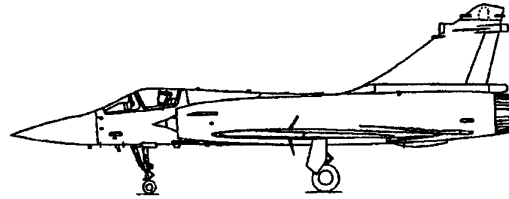
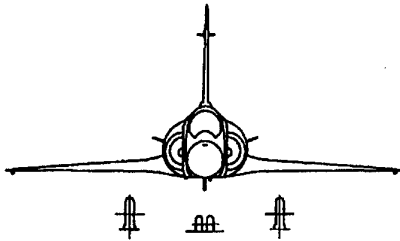

Empty weight:7.7T  
 Maximum take off weight:16.5T  
 Max speed:800 kt  
 Max Mach:2.2

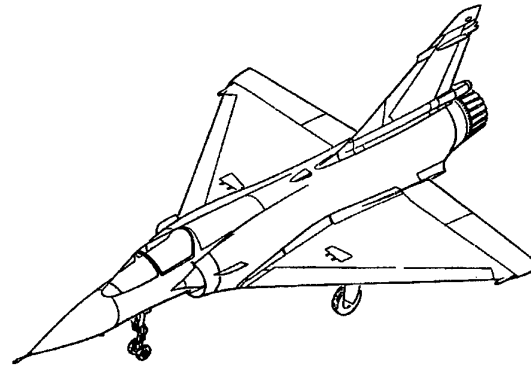
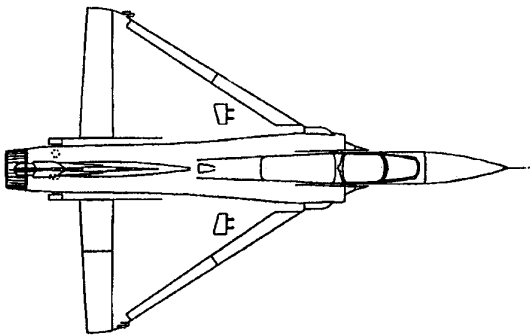
MISSIONS AND MISSION EQUIPMENT

The aircraft is fitted with the following sensors:

- RDY radar:
  - multitarget
  - multiwave form
- Integrated Counter Measure System:
  - EM warning and jamming
  - EM and IR decoying

Two main computers gather sensors information as well as loaded data.

Necessary information for the type of mission selected by the pilot are presented on the following displays:

- HUD (18°-18°)monocolour.
- Head Level Display (HLD ): (18°-9°), monocolour and collimated to infinity.
- HDD (5"-5") full colour.
- 2 Lateral Displays (3.5"-4.5") full colour.

## Mirage 2000-5

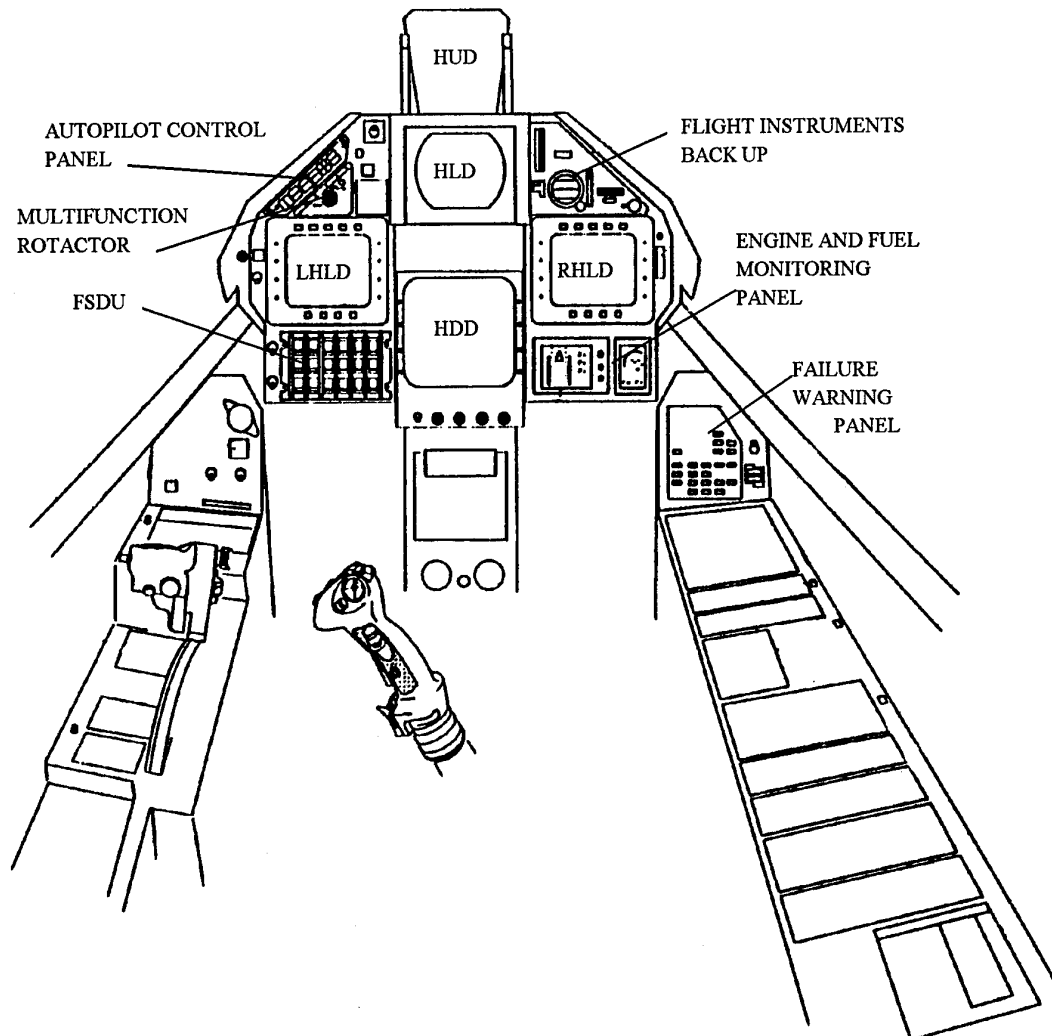

### UNDERLYING DESIGN CONCEPT

The organisation of the controls and the information provided in the different displays aim at minimizing pilot's work load and allowing a quick and easy access to the controls. In this respect, the following rules are used:

#### -Central displays

in normal operating mode, information is distributed on the 3 central displays (HUD, HLD, HDD) and optimized for each different mission phases:

- HUD is dedicated to short term information.
- HLD is dedicated to medium term information.
- HDD is dedicated to long term information.

#### -LHD and FSDU

Both Left Hand Lateral Display (LHL) and Function Selection and Display Unit (FSDU) enable exchanges between pilot and Weapons Delivery and Navigation System (WDNS)

Main functions are selected on the FSDU.

Function options are selected on the LHL.

Sensor options are selected on the FSDU.

#### -RHL

Right Hand Lateral Display (RHL) is dedicated to environment data or sensors image.

#### -Display Dedication Switch

Located on the stick handgrip, this switch enables the pilot, by selecting a priority display, to dedicate the multiplexed WDNS and sensor controls to the selected display.

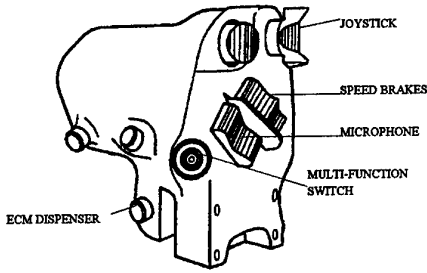

HOTAS

The HOTAS controls are of different categories:  
 -non multiplexed aircraft controls  
 -non multiplexed WNDS controls  
 -multiplexed WNDS controls  
 -multiplexed sensor controls

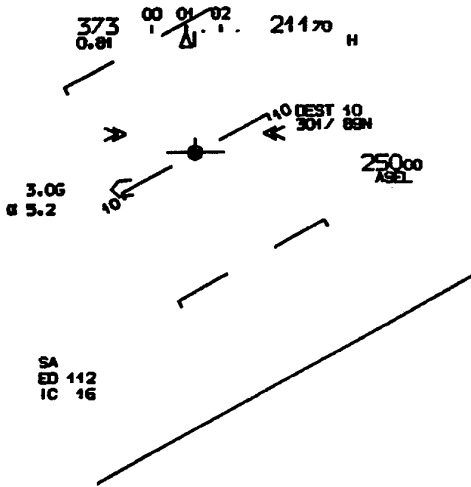
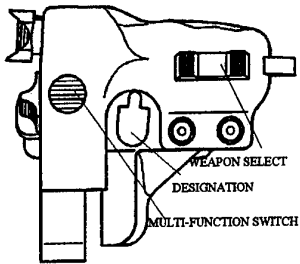
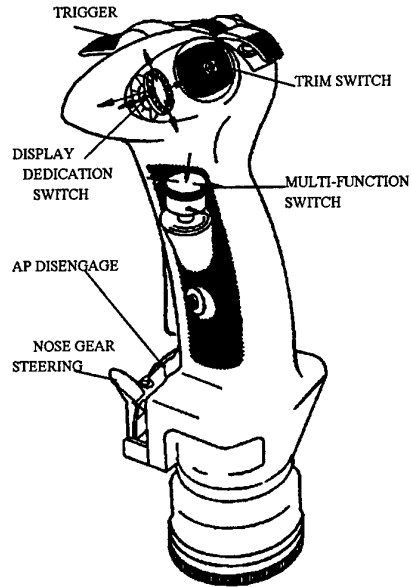

HEAD UP DISPLAY

The HUD is a 18°-18° monochrome display allowing cursive and raster image. It is dedicated to short term information:

- Basic flight information
- Steering data
- Firing controls data
- Designation data
- FLIR image if aircraft is fitted with

Associated with the HUD, the HLD is a 17°-9° monochrome and collimated to infinity display.

The following information ( medium term) are displayed:

- Air to Air map and interception guidance information associated to Air to Air fire controls.
- Air to Ground map and designation cue for updating an marking

HEAD UP DISPLAY

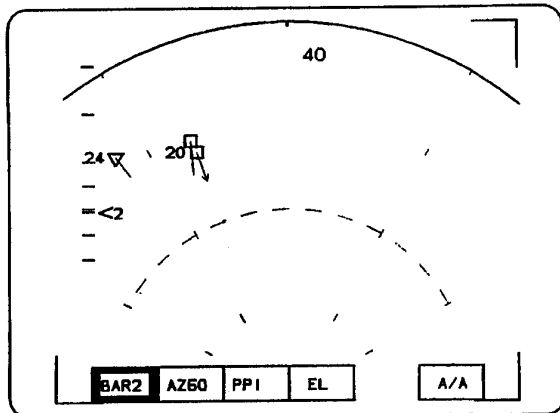

HEAD LEVEL DISPLAY

DATA ENTRY

Data entry is achieved by the following means:

- A mass memory cassette loaded during mission preparation.
- Controls situated on the LD front panel
- A multifunction rotator allowing the modification of digital parameters.
- Different control and display units (identification, navigation.)

## Mirage 2000-5

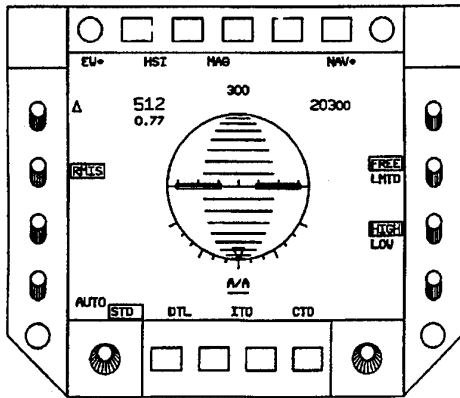

LATERAL DISPLAY (spherical indicator)

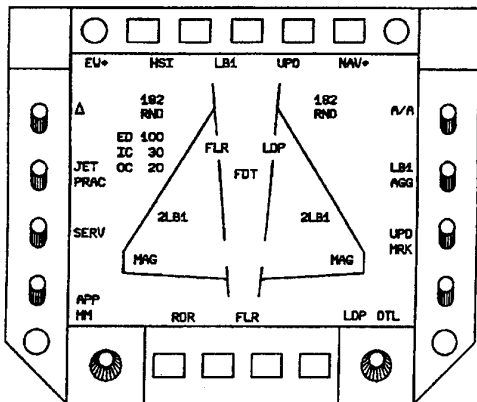

LATERAL DISPLAY (armament data)

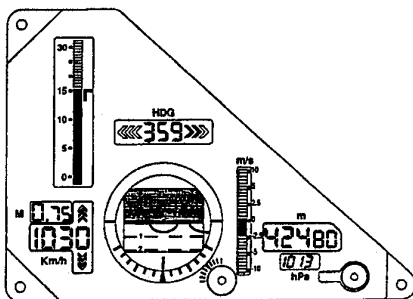

### HEAD DOWN DISPLAY

HDD is a high brightness full colour 5"-5" LCD. It is dedicated to the survey of aircraft environment ( long term information).

For that purpose, two types of use are available:

-Tactical situation function which processes information coming from various sources:

- a data base filled via mass memory (mission preparation information)
- Radar
- Self protection system
- main computers.

Data display mode: upon pilot's request, consultation of detailed information for some objects displayed

### LATERAL DISPLAYS

The 2 lateral displays are full colour shadow mask CRT Those 3.5"-4.5" displays are multimode and able to draw cursive as well as raster symbology.

A lot of controls are available on the LD front panel providing the pilot with a great deal of selections for symbology and data insertion such as:

- Horizontal situation
- Spherical indicator
- data insertion and armament selection and preparation.

### BACK UP INSTRUMENTATION

Flight back up is achieved by the Combined Flight Monitoring Equipment which displays:

- Attitude
- Mach number
- Calibrated airspeed
- Pressure altitude
- Vertical speed
- Angle of attack
- Gyromagnetic heading



Mirage 2000-5

## Rafale

### AIRCRAFT CHARACTERISTICS :

- Twin engine multirole aircraft available in 3 versions:
  - single seater for the Air Force
  - single seater for the Navy ( carrier capability)
  - two seater for the Air Force
- Powered by 2 M88 engines 7.5 T thrust each
- Aerodynamic configuration: instable delta-canards
- Flight control system: digital fly by wire allowing extreme agility and care free handling.
- Full multirole capability due to the superposition of air to air and air to surface functions

- Main armements (14 store stations) :
  - MICA ( air to air EM or IR missile)
  - APACHE ( air to ground stand off missile)
  - ASSW missile
  - Laser guided weapons
  - Modular bombs and all conventional weapons
  - 30 mm internal gun

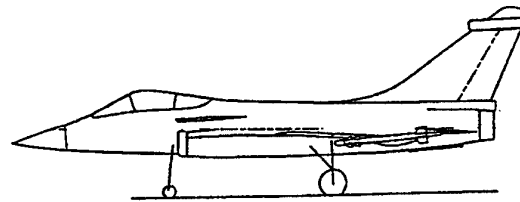
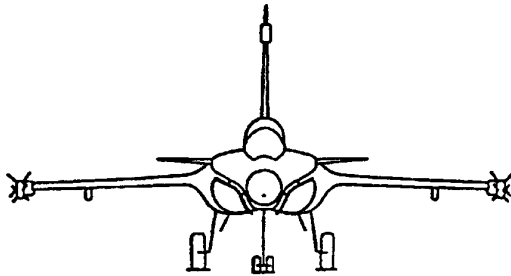

Empty weight: ≈10T  
 Max take off weight: ≈20T (22T for NAVY)  
 Max speed: 750kt  
 Max Mach: 1.6

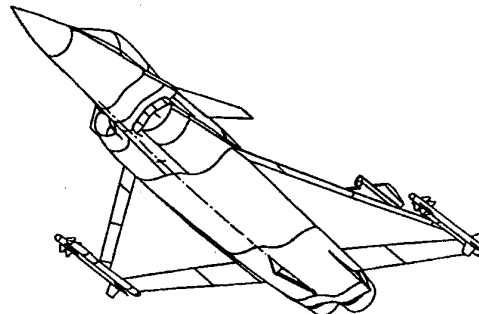
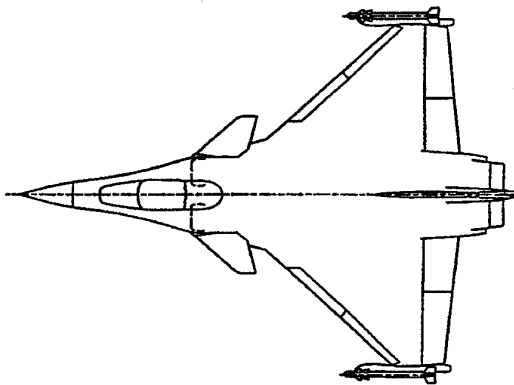

### MISSIONS AND MISSIONS EQUIPMENT

The aircraft is fully multirole and fitted with the following sensors:

- RBE2 radar
  - multi target
  - 2 plan phase array antenna
  - interleaved modes (terrain following, ground mapping, Air to Air...etc)
- Optronic (visible, laser and IR search and track sensor)
- Counter measure system (SPECTRA)
  - EM warning jamming and decoying
  - IR warning and decoying
  - Laser warning and decoying
  - Missile launch warning

Two main mission computers gather sensors information as well as loaded data and data-link information  
 Necessary information for the type of mission selected by the pilot are presented on the following displays

- HUD (30°-22°) monocolour holographic
- Helmet mounted sight system
- Head Level Display (20°-20°), coloured and collimated to infinity
- 2 Lateral Displays (5"-5" touch screen)



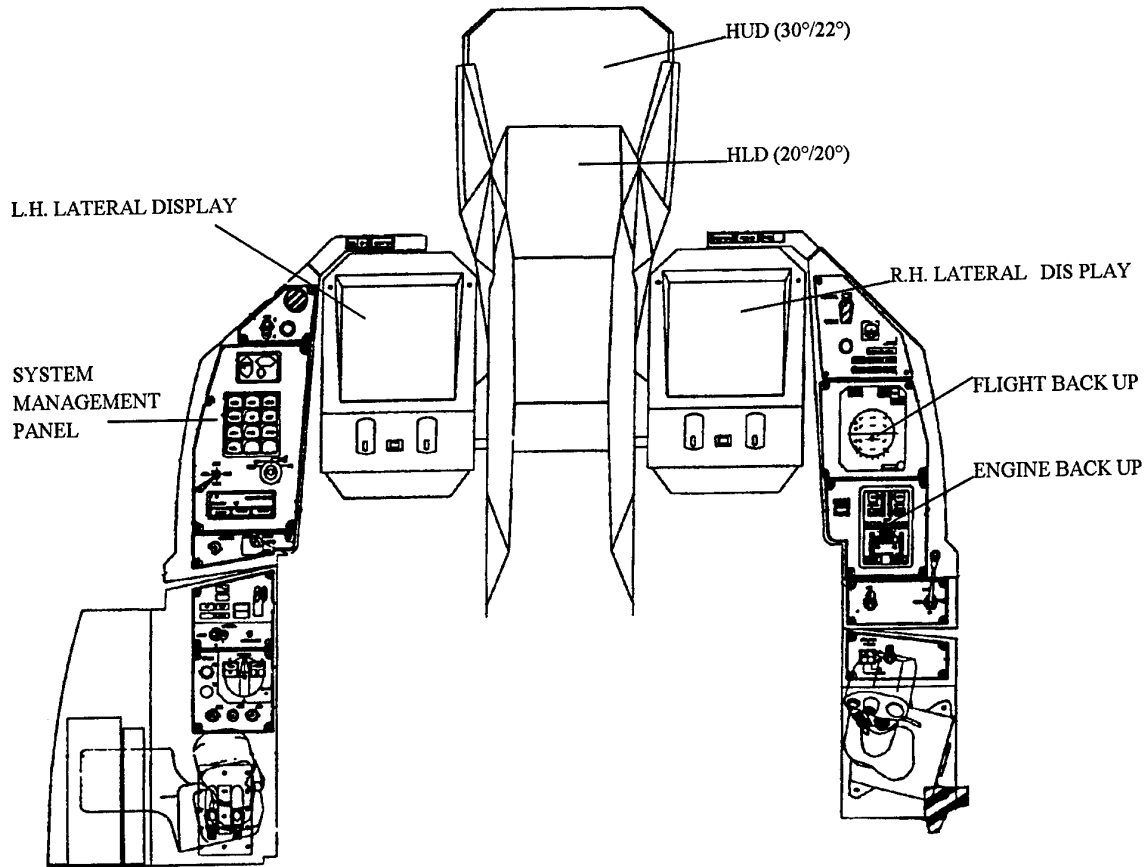

COCKPIT LAYOUT

### UNDERLYING DESIGN CONCEPT

The man machine interface has been designed to:

- minimize pilot's work load
- optimise presentation of information
- reduce action and reaction time
- preserve operational capability after first failure

The application of those principles leads to the following concept:

- HUD presents short term information
- Head Level Display (HLD) presents medium and long term information (tactical information)
- Left Hand Lateral Display (LHLD). is a system management display
- Right Hand Lateral Display (RHLD). is a multipurpose display

Every display can be reconfigured on LD or HLD in case of failure.

The juxtaposition of HLD and HUD allows the presentation of short, medium and long term information in a limited part of pilot's field of view without eyes accommodation changes.

Moreover, the collimation to infinity of HLD allows to present information on an apparently larger surface than the physical size of the display.

Helmet mounted sight system allows target or navigation designation in a very large part of pilot's field of view.

Reduction of action and reaction time results of numerous HOTAS commands as well as the use of touch screens for both lateral displays and system management panel

## Rafale

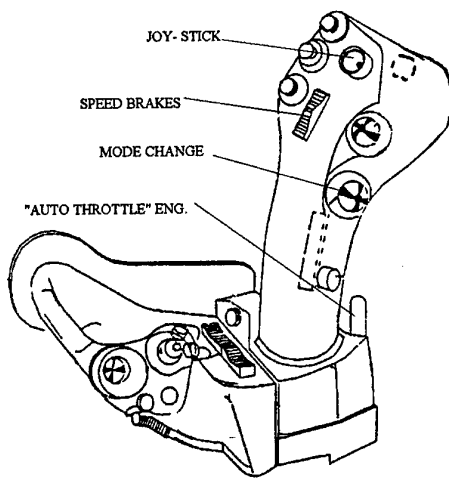

### HOTAS

Hotas functionality is designed for real time selections, except for throttle extension which is for short term selections. The cockpit is fitted with a single throttle for both engines enabling easy use of switches. The operation of Hotas controls always provides tactile and visual feedback.

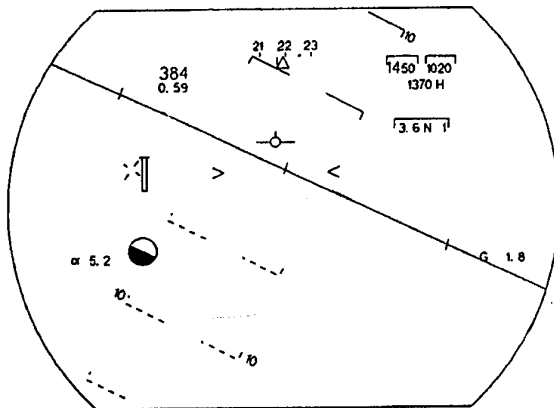
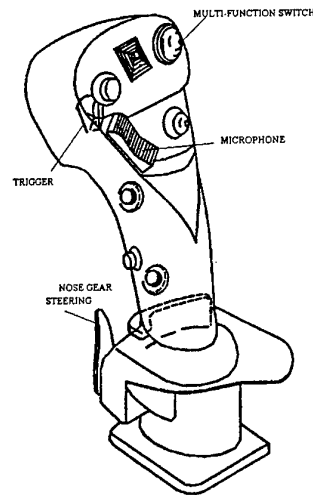

HUD

HUD is a 30°-22° monocolour display allowing raster and stroke image.

It presents the following information (according to the mission phase):

- Basic flight information
- Steering information
- Firing help data
- Designation data
- Synthesized external scenery
- FLIR image
- Alarms

Situated just below, the HLD is a 20°-20° multichrome display collimated to infinity presenting tactical information elaborated from sensors data fusion, data link and preparation system data.

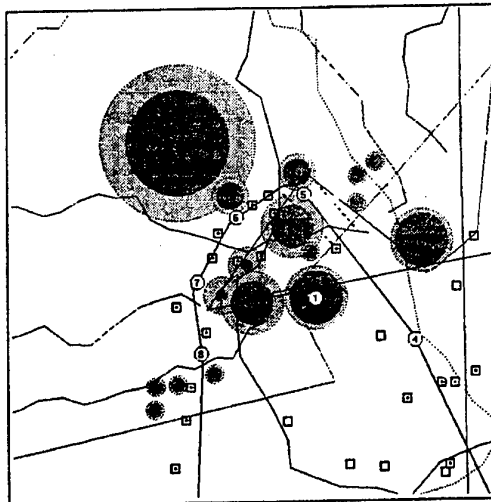

HLD

### ACCESS TO THE SYSTEM

Access to armament system modes is achieved by Hotas control on the side stick. Touch screen allows mode selection.

Quick mode change is achieved by Hotas control on throttle grip.

In every system mode, access to permanent functions (communication, identification, localisation, navigation...etc) is achieved via a touch surface on the System Management Panel.

Aircraft system access is achieved by two four positions quick access lever.

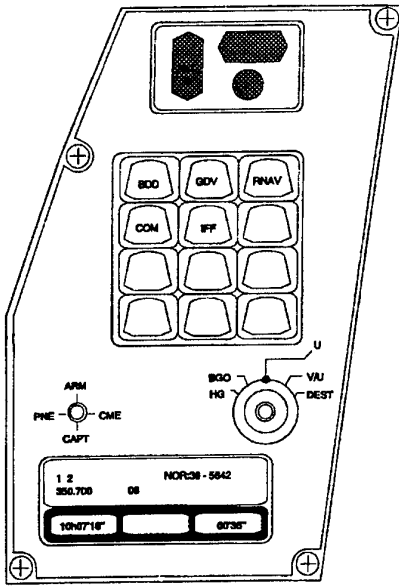

SYSTEM MANAGEMENT PANEL

DATA ENTRY

Data entry is achieved by the following means:

- Storage cassettes loaded on ground by the mission preparation computer
- Touch screen: selecting a parameter on a touch screen allows its modification. A free rotating and depress knob is used to set and insert the data value.
- A slewable cursor can be used, as back-up, to select parameters on the lateral displays.
- A slewable cursor is used to modify a flight plan on HLD
- A preselected data knob allows a quick change of some permanent function parameters on the System Management Panel

LATERAL DISPLAYS

Lateral Displays are 5"-5" full colour touch screen LCD. Information between the two displays is shared as follows:

LHLD:

- System management.
- Sensors image
- Failures and associated C-L
- Alarms

RHLD:

- Sensors image
- Aircraft systems
- Environment (HSI, EW, ...)
- Alarms

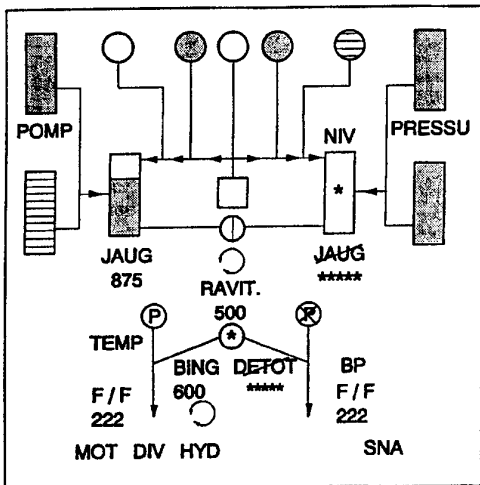

LATERAL DISPLAY (fuel system)

BACK-UP INSTRUMENTATION

Back-up instrumentation is designed as follows

- Flight instruments LCD which provides all necessary parameters (airspeed, altitude, attitude, heading...)
- Engine and fuel monitoring LCD.

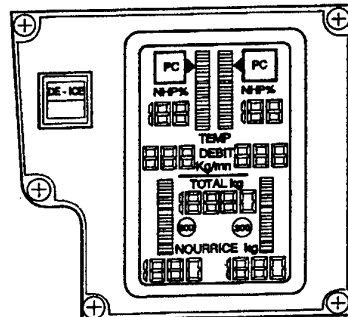
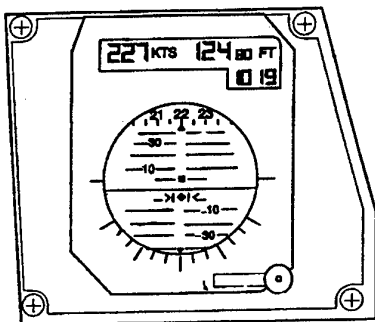

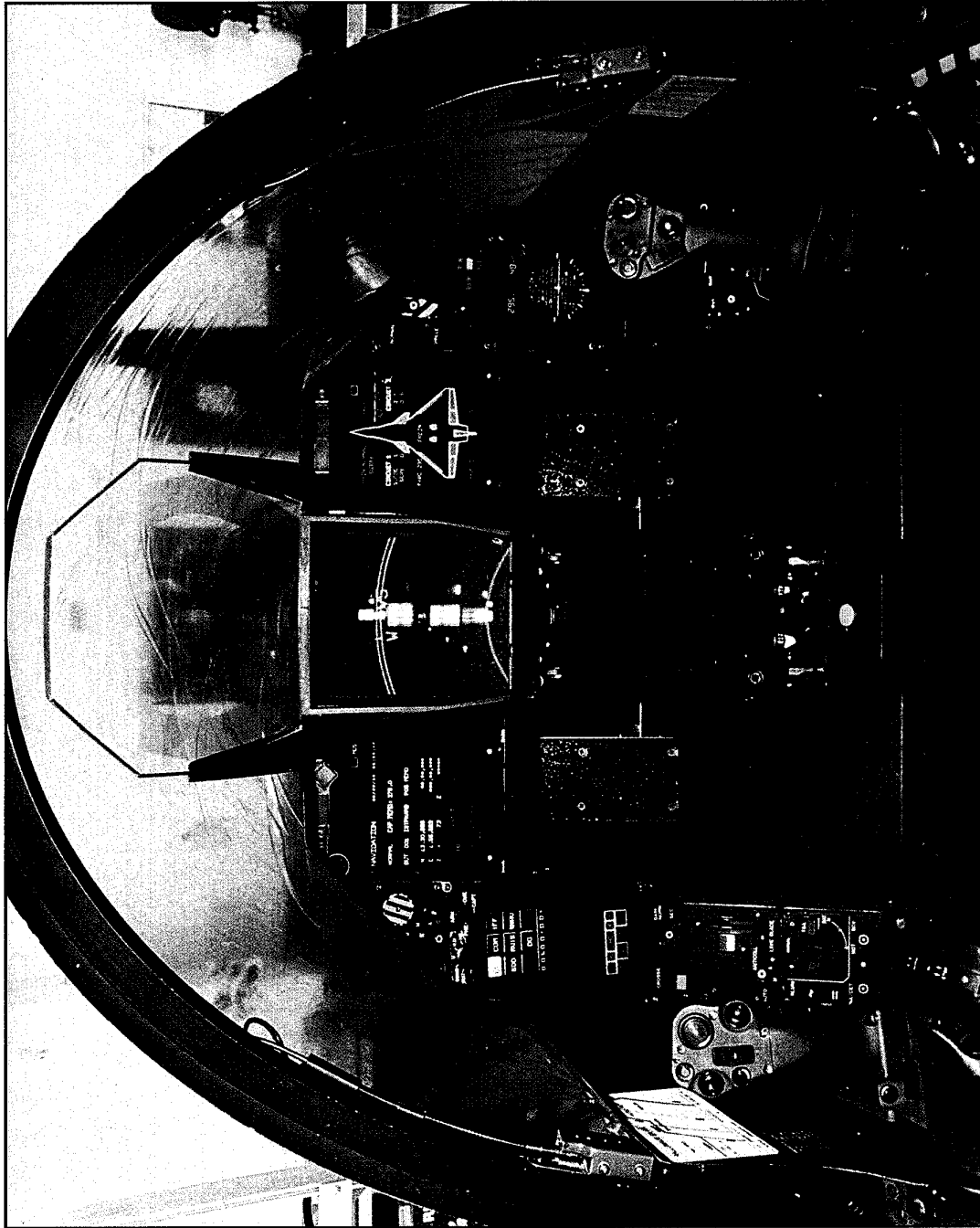

Rafale

## Harrier GR 7

### I. Aircraft Characteristics

The Harrier is a single engined vectored thrust vertical and short take off and landing (VSTOL) fighter built by British Aerospace, with a day and night battlefield air interdiction/close support capability. The main elements of the aircraft sensor fit are the dual mode tracker (DMT), which uses a TV and laser spot tracker (LST), a forward looking infrared camera and Gen III night vision goggles. In conjunction with the FLIR, the thermal cuing aid allows multiple targets to be followed concurrently.

The avionics system is controlled via a dual redundant 1553B data bus operating a central mission computer, and comprises an inertial navigation system, a digital map, angle rate bombing system, stores management system, ECM including RWR, multimode jammer, a missile approach warner, and self defense management system as well as the sensors. The avionic systems are well integrated, the pilot operating the entire suite via three display units, the up front controller and HOTAS controls. A comprehensive range of weapons can be carried on underwing and fuselage pylons, including air to air missiles, free-fall, cluster and retarded bombs as well as provision for guns and external fuel tanks.

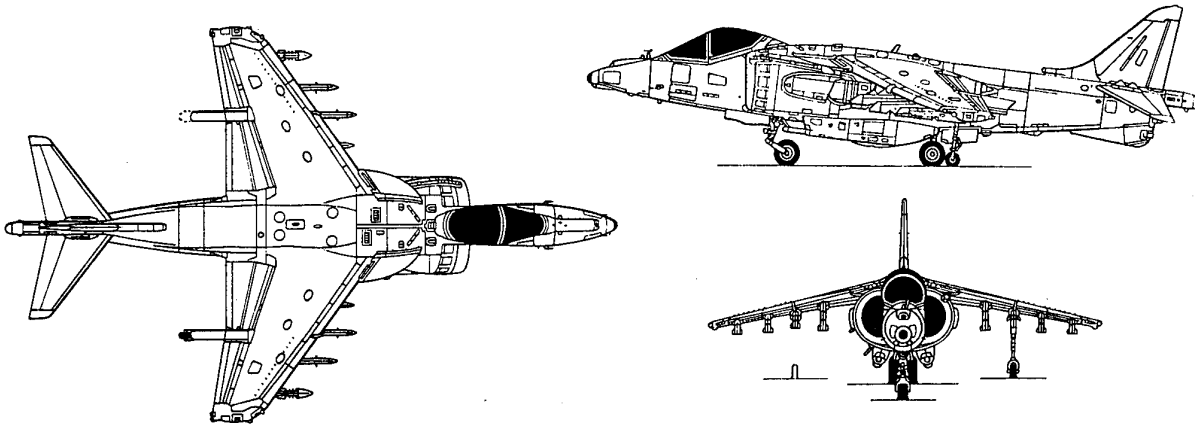

*(Jane's/Mike Keep)*

Length	47 ft 1.5 in	Operating Weight	19180 lb (VTO)
Span	30 ft	Max operating weight	31000 lb (STO)
Height	11 ft 7 in	Max useful load	6750 lb
Max speed	0.87 Mach (sl)	Ferry range	2000 miles
	0.98 at altitude	Operational radius	700 miles
Engine	Rolls Royce Pegasus II vectored thrust turbofan		

### II Missions and Mission Equipment

The Harrier GR7 is a day and night battlefield air interdiction/close support fighter which can operate from forward unprepared sites. It has the following mission equipment.

Weapons carried on six underwing stores stations include:

- Two underfuselage 25mm cannon
- Freefall or retarded bombs
- Cluster bombs
- Up to six Aim 9L Sidewinders
- Paveway Laser Guided Bombs
- Matra 155 rocket pods

#### Mission Equipment

The essential mission-oriented equipments are listed below. Other equipments, such as radios, IFF, Air Data Systems, etc are not listed.

- Inertial Navigation System
- Recce pod
- Dual Mode Target Seeker/Tracker (TV and Laser Spot Tracker)
- Dual Combiner HUD
- Flare/Chaff dispenser
- Stores Management System
- Night Vision Goggles
- Moving Map Display
- FLIR
- Angle Rate Bombing Set
- Display Computer
- ECM (MAW and RWR)

## Harrier GR 7

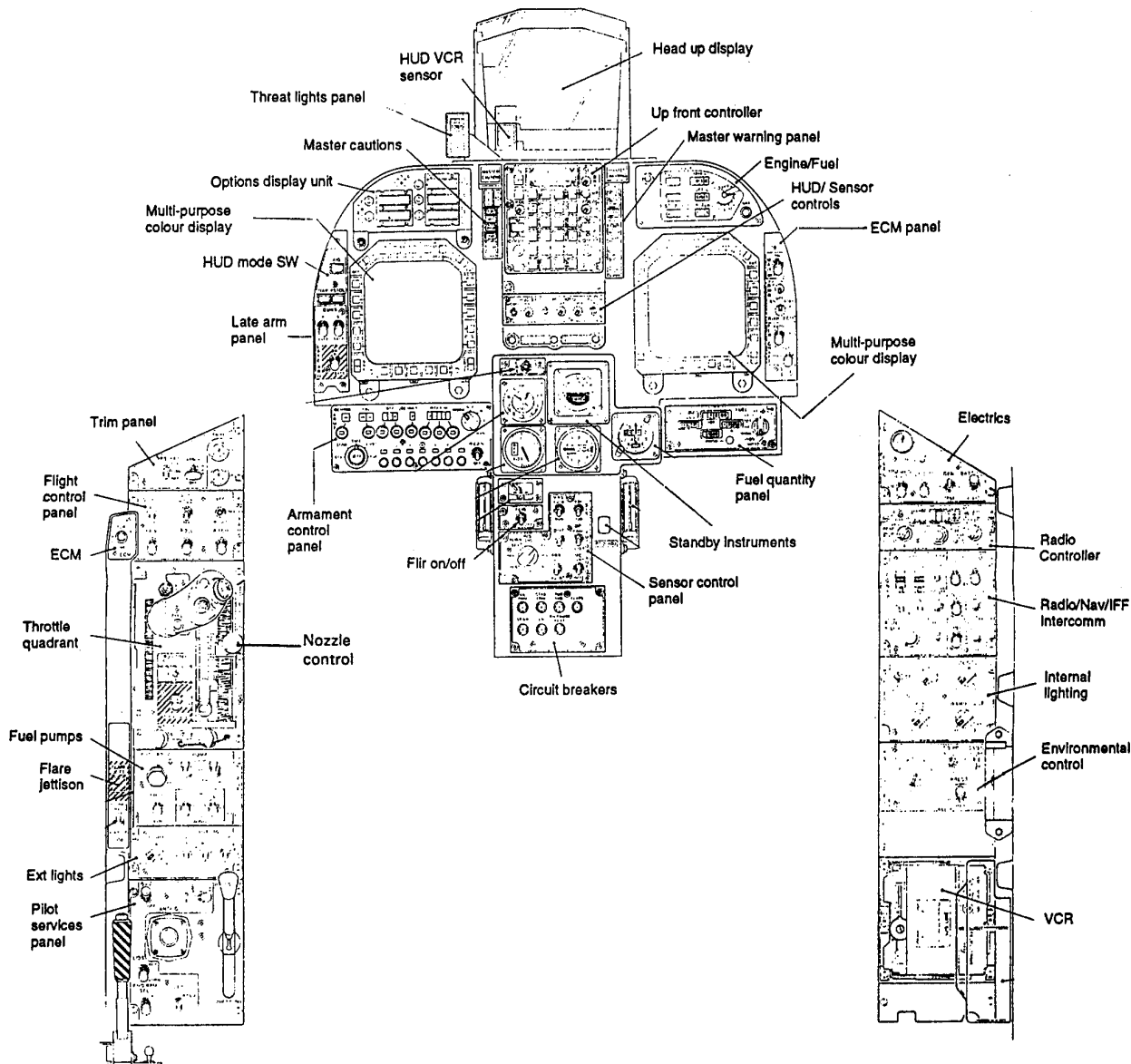

The cockpit is optimised for the night low level role of the aircraft. "Head in" time is minimised by efficient use of the prime panel area. Mission critical displays, and systems controls all reside on the main instrument panel. Subsidiary equipment is located in the two side consoles in a conventional layout. The main elements of the avionics suite are all controlled via the 20 'soft keys' around each of the two multipurpose colour displays, the up front controller and options display unit. A data cartridge facilitates the insertion of mission data into the mission computer. Time critical selections are made via the HOTAS controls.

As a VSTOL aircraft with low level operations as a primary role, the cockpit has been designed to provide the pilot with a good unobstructed all-round field of view. The aircraft is controlled in jet-borne flight and during transition from wing-borne to jet-borne flight by vectoring the thrust of the engine. An additional control is provided in the cockpit to control the angle of the nozzles. Whilst jet-borne, flight control is maintained by nose, tail and wing tip mounted thrusters powered by engine bleed air. The control column, in conjunction with a stability augmentation system, proportions the thrust appropriately.

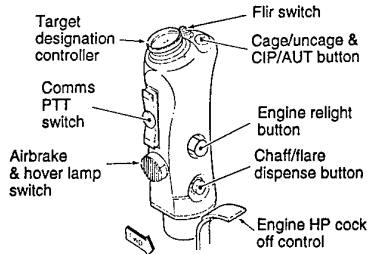

Throttle lever

- **Target Designation Controller**  
Slews target diamond; designates on release
- **Press to transmit (Comms 1 and 2)**
- **Airbrake and hover lamp switch**
- **HPcock**
- **Chaff/Flare emergency dispense**
- **Engine relight switch**
- **FLIR Switch**  
4 position: fwd - unused  
aft - cue limit  
left - HUD FLIR reject display  
right - FLIR black/white hot
- **Cage/uncage (A/A mode) CCIP/AUT (A/G mode)**

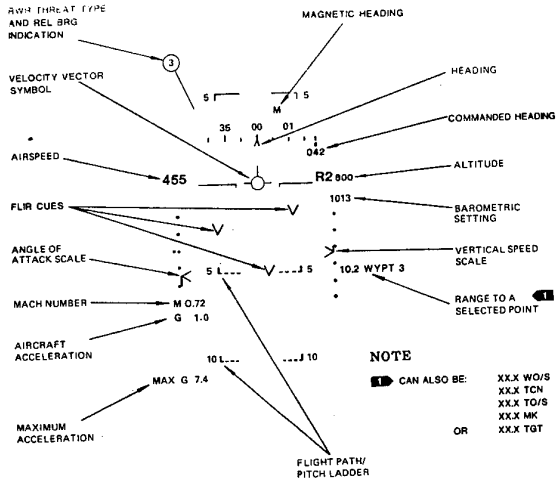

Typical NAV Mode Head UP Display

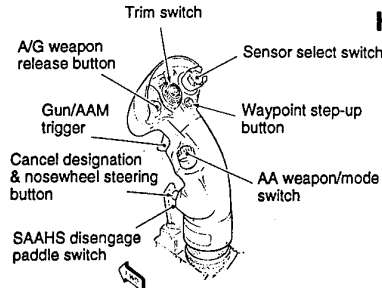
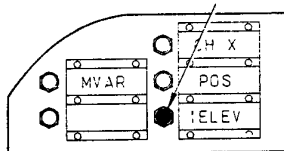
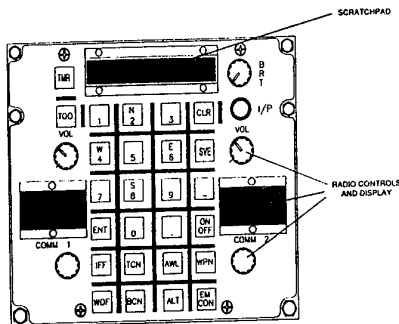

Control column

**Harrier GR 7**

- **A/G weapon release**
- **Trigger Camera (if fitted)/gun/Sidewinder**
- **Nosewheel steering (u/c down)**  
cancel designations (u/c up)
- **SAAHS disengage**
- **A/A weapon/mode switch**  
any selection selects A/A mode  
aft - SEAM  
down - A/A gun mode  
fwd - Sidewinder
- **Waypoint step up button**
- **Sensor Select switch**  
fwd - HUD mode  
aft - selects DMT LST  
then toggles DMT TV or LST  
left - selects track-up or decentered up map  
right - PP/Look ahead for map  
down - waypoint step down
- **Aileron trim**

- **Dual combiner raster/cursive**
- **20° x 16° field of view**
- **Three main modes - VSTOL, Nav and Air to Ground**
- **Display of FLIR and DMT imagery**
- **Reversionary symbol sets (if Mission Computer fails Display Processor takes over).**

- **Up Front Controller**
- **Main input device to Mission Computer**
- **Command and data inputs to IN, comms, IFF**
- **Displays comms frequencies**
- **Scratch pad display**

- **Options Display Unit**
- **Presents options available for modes selected by UFC**
- **Selection of option enables inputs via UFC (which are then displayed on UFC).**

### Harrier GR 7

The MPCDs operate in graphic or raster modes and are used in conjunction with the upfront controller as the means of inputting data to the mission computer and for the selection of stores, stores moding, fusing, map modes, etc. The functions of each display can be interchanged according to pilot's preferences. There are eight basic displays, MENU, EHDS (Electronic Horizontal Situation Display), FLIR, STRS (Stores), DMT (Dual Mode Tracker), ECM (Electronic Warfare), HUD, ENG, EMS (Engine Monitoring System), and BIT. Typical MPCD formats are illustrated below. The EHS display may be superimposed over the map display.

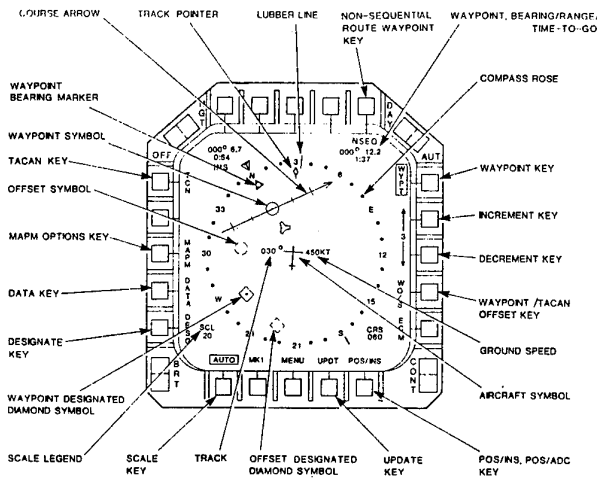

**EHDS Symbology and Keys**

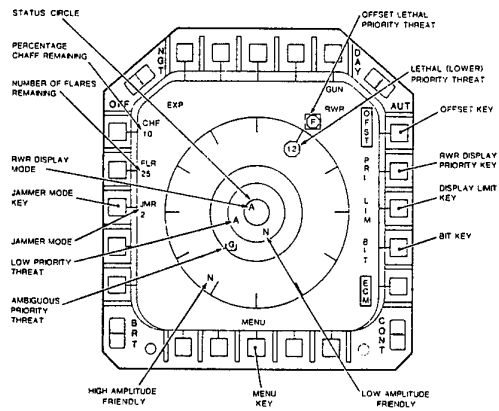

**Electronic Warfare Display**

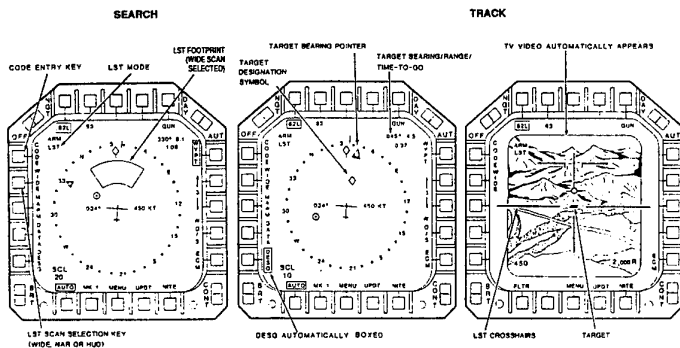

**DMT LST Mode**

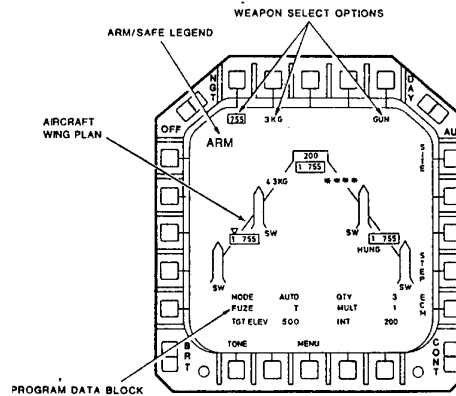

**Typical Stores Display**

### Back-up Instruments

The two MPCDs are identical and functionally totally interchangeable. Furthermore, the HUD display can be selected to be shown on either of them. In the event of failure of one display surface the MC automatically reconfigures the MPCD displays to provide the pilot with essential data. In addition to the MPCD/UFC method of managing the stores, a dedicated Stores Panel is provided as an alternative. Mechanical standby instruments are:- altimeter, airspeed indicator, vertical speed indicator, angle of attack, compass and attitude.

### Planned Improvements

A Harrier II Plus for USMC and other Air Forces is a radar equipped version of the AV 8B. A Harrier III version is being studied jointly by McDonnell Douglas and British Aerospace. Although not finalised, the design of the Advanced Short Take-off/Vertical Landing (ASTOVL) is likely to have a larger folding composite wing, longer fuselage, a developed engine, and EF2000-like avionics including an advanced radar. Initially aimed at replacing current Sea Harriers it could also supercede the present ASMC AV-8Bs.



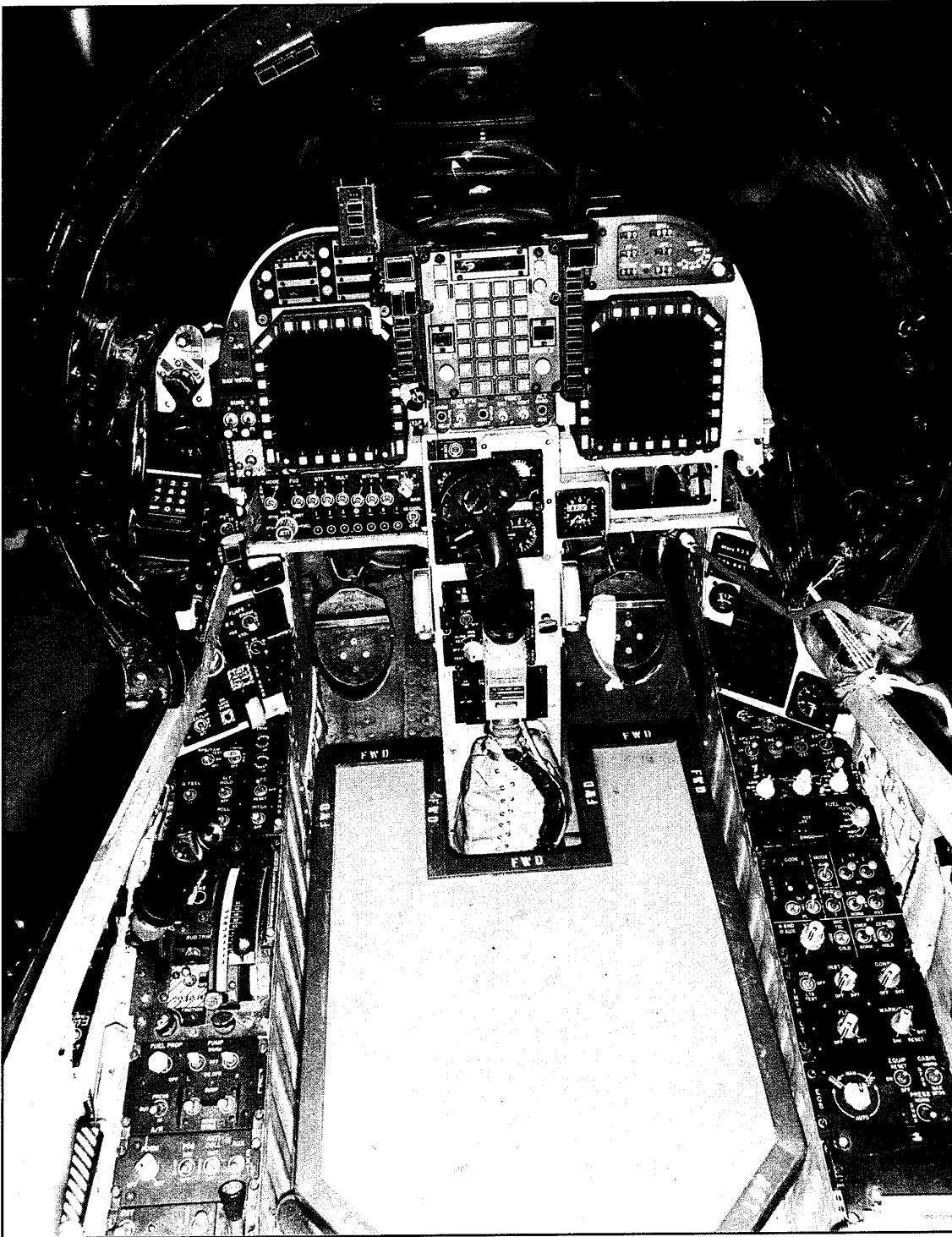

Harrier GR 7

## AV-8B Harrier II Plus

### Aircraft Characteristics

The AV-8B Harrier II Plus is a McDonnell Douglas Built, Adverse Weather, Multi-Mission Vertical/Short Take-Off and Landing (VSTOL). Aircraft Capable of Ship-Based and Land-Based Operations During Day or Night.

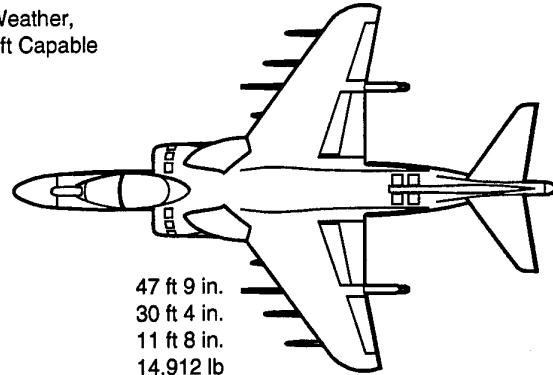
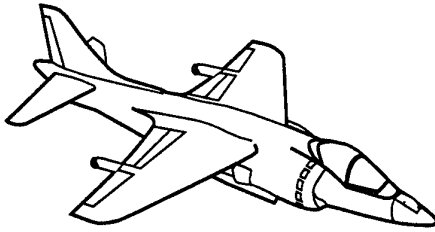

Length	47 ft 9 in.
Span	30 ft 4 in.
Height	11 ft 8 in.
Empty Weight	14,912 lb
Max Gross Weight	32,000 lb
External Payload	11,795 lb
Max Speed	1.0 Mach
Unrefueled Range	1,000 - 1,500 NM

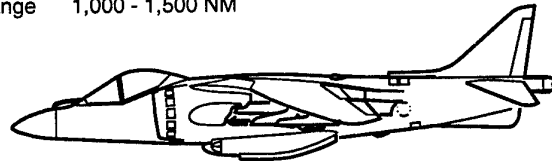
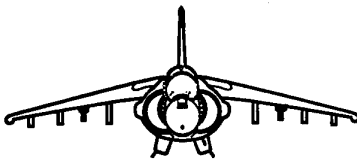

### Mission and Mission Equipment

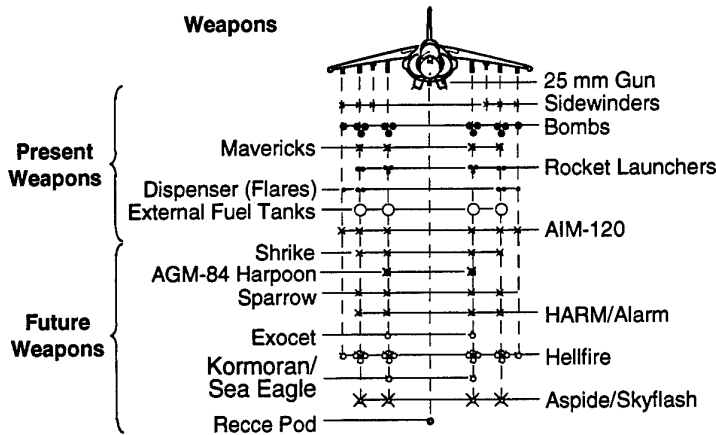

#### Missions

- Close Air Support
- Air-to-Air (Offensive and Defensive)

#### Mission Equipment

- Rolls Royce Pegasus 408
- Data Storage Unit
- Auto Target Handoff Systems (ATHS)
- In Flight Refueling (Probe and Drogue)
- Have Quick/SINCGARS Radios
- KY-58 Secure Speech System

#### Sensors

- APG 65 Radar (A/A, A/G and Mapping Modes)
- Electronic Warfare
- FLIR With Provisions for a Laser Spot Tracker (LST)
- GPS

**Cockpit Layout**

Cockpit Incorporates Night Vision Goggle (NVG) Compatible Lighting

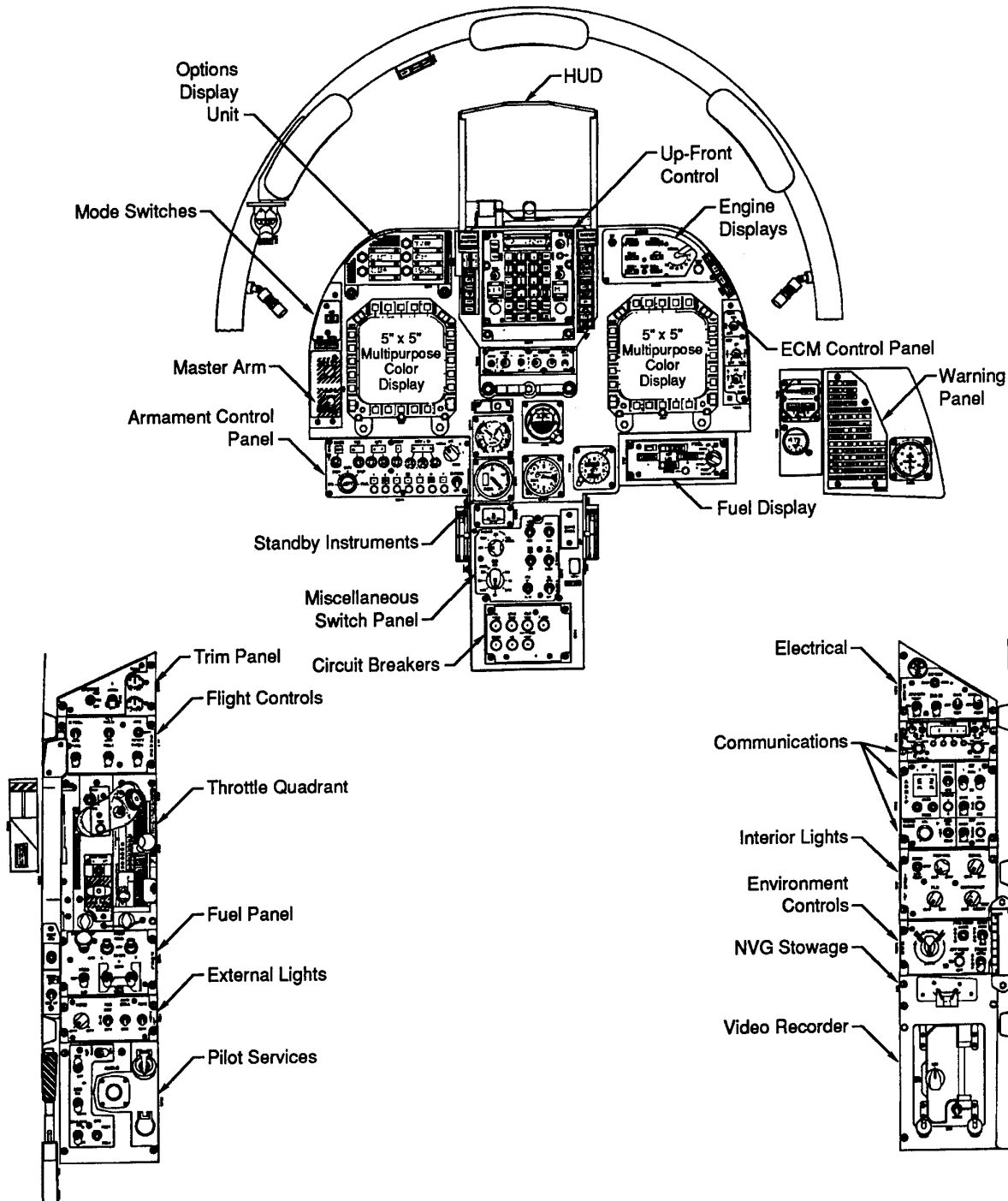

**Underlying Design Concepts**

- Multipurpose Displays for Flexible, Accessible Information
- HOTAS With Immediate Access Controls
- Functionally Grouped Instrument Panels

## AV-8B Harrier II Plus

### HOTAS

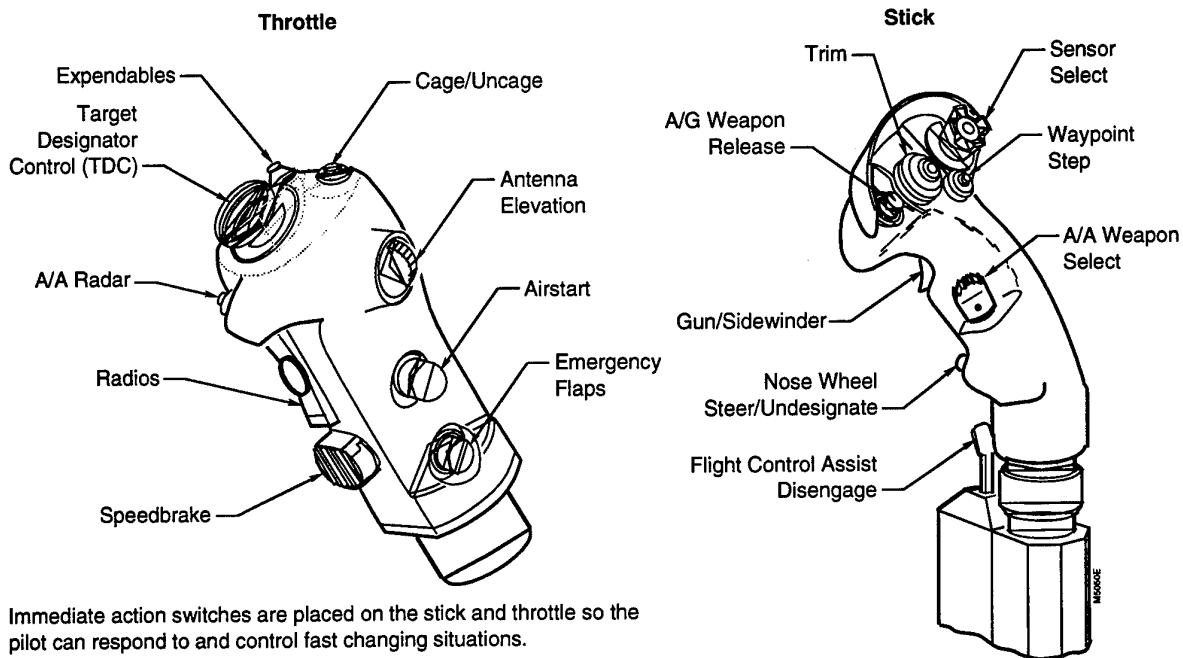

### HUD

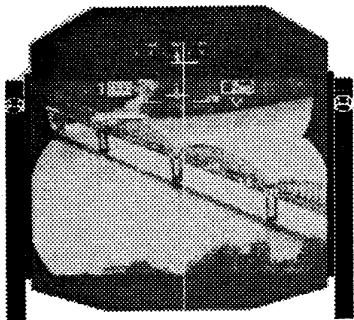

The HUD provides flight information and weapon delivery display. It is an electro-optical device with varying formats, depending upon mode and weapon selections. Nav FLIR imagery is displayed in the HUD for night navigation.

- FOV: Total = 22°  
Instantaneous = 16° x 20°
- Stroke and Raster
- Mono Green

### Data Entry

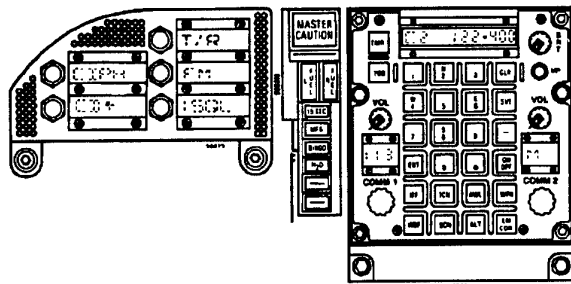

#### Up-Front Control (UFC) and Option Display Unit (ODU)

Together the UFC and ODU provide data entry and selection for the aircraft. There are 5 selectable option lines and one scratch pad. All Lines Display Monochrome alphanumeric.

- Data Can Also Be Entered Through the Display Formats

**Displays**

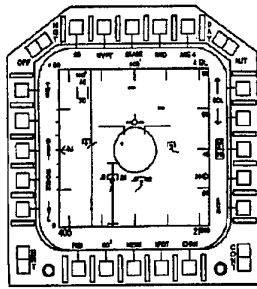

**Air-to-Air (A/A)**

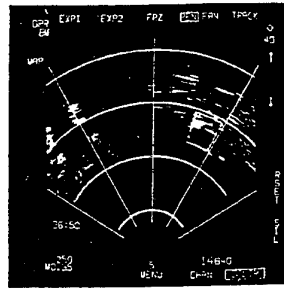

**Air-to-Ground (A/G)**

The APG-65 radar provides A/A and A/G information. All radar controls are accessed through the radar format, and bezel pushbuttons or HOTAS. A/A modes include search, track while scan and automatic acquisition. A/G modes include real beam map, synthetic aperture radar and sea search. Radar information can be displayed on either of the cockpit displays:

- 2 Multipurpose Color Displays (MPCD)
- 5 by 5 Inch CRT
- Stroke and Raster
- Full Color
- 525 and 875 Lines Video

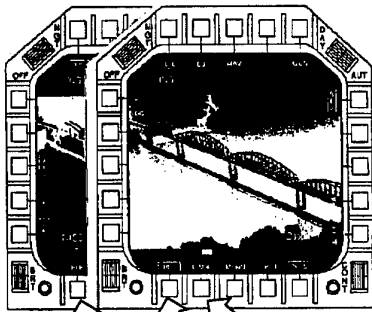

- White Hot
- Black Hot
- LIM/0
- LIM/4
- LIM/8
- Polarity

**Navigation Forward Looking Infrared (FLIR)**

The Nav FLIR System Enables Day or Night Operations, Coupled With Night Vision Goggles for Off-Axis Situational Awareness.



**Color Moving Map**

The Color Moving Map is the Basis of a Tactical Situation Display Which Greatly Increases Pilot Situation Awareness. Navigation and Targeting Data Overlays Allow HOTAS Control

**Backup Instruments**

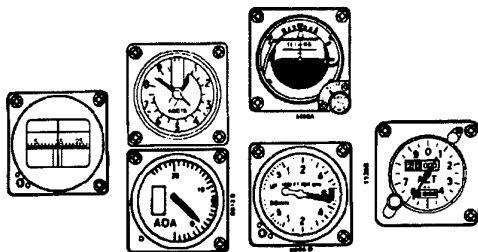

- Attitude
- Airspeed
- Vertical Velocity
- Angle-of-Attack
- Altitude
- Magnetic Compass

**Planned Improvements**

- Voice Recognition System
- Helmet Mounted Display
- Data Link
- Laser Spot Tracker (LST)

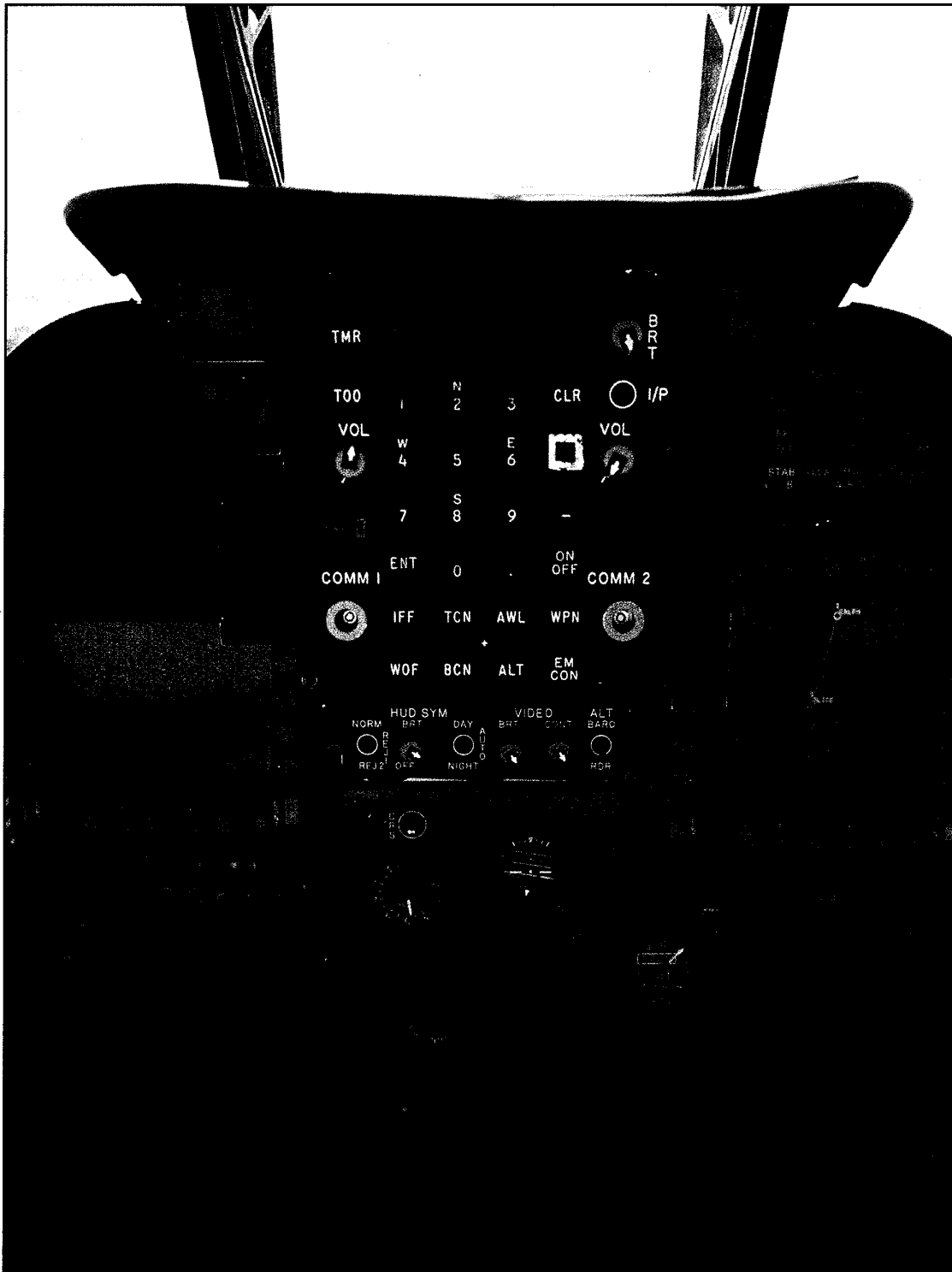

AV-8B Harrier II Plus

## F/A-18E/F Hornet

The F/A-18E/F, Like the Combat-Proven F/A-18C/D it Improves Upon, is Fully Capable in Both Air-to-Air and Air-to-Ground Missions, Including Air Superiority, Day/Night Strike With Precision-Guided Weapons, Fighter Escort, Close Air Support, Suppression of Enemy Air Defenses, Reconnaissance, and Forward Air Control.

The Cockpit of the Single-Seat F/A-18E Retains the Strengths of the Previous Model's "Glass Cockpit", While Adding a New Flat Panel Up Front Control Based on Liquid Crystal Display Technology.

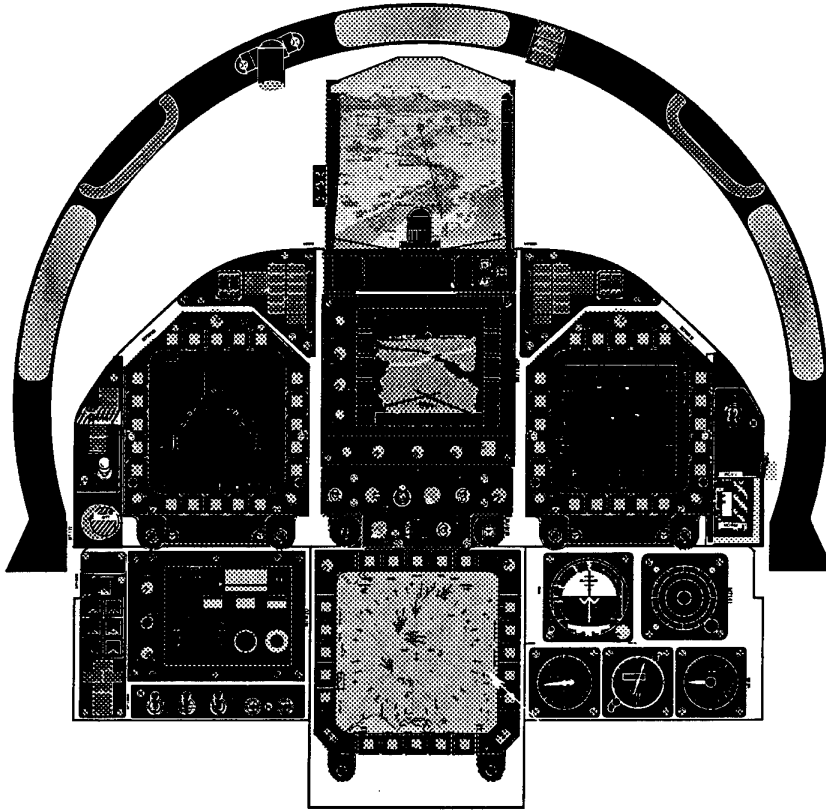

The Upgraded Hornet Offers Greater Range, a Larger Payload Capacity, More Powerful Engines, Enhanced Survivability, and Built-In Potential to Incorporate Future Systems and Technologies to Meet Emerging Threats.

The F/A-18E/F Development Program is on Cost and Schedule for a December 1995 First Flight.

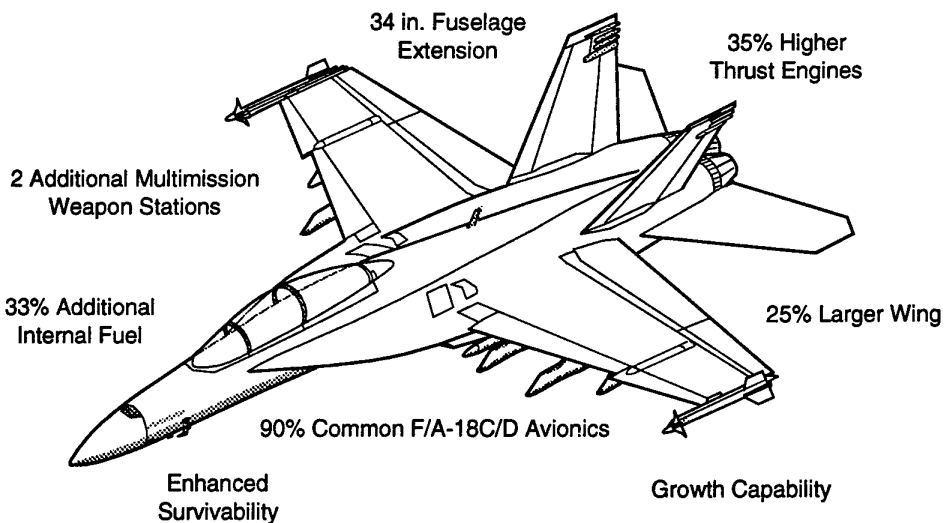

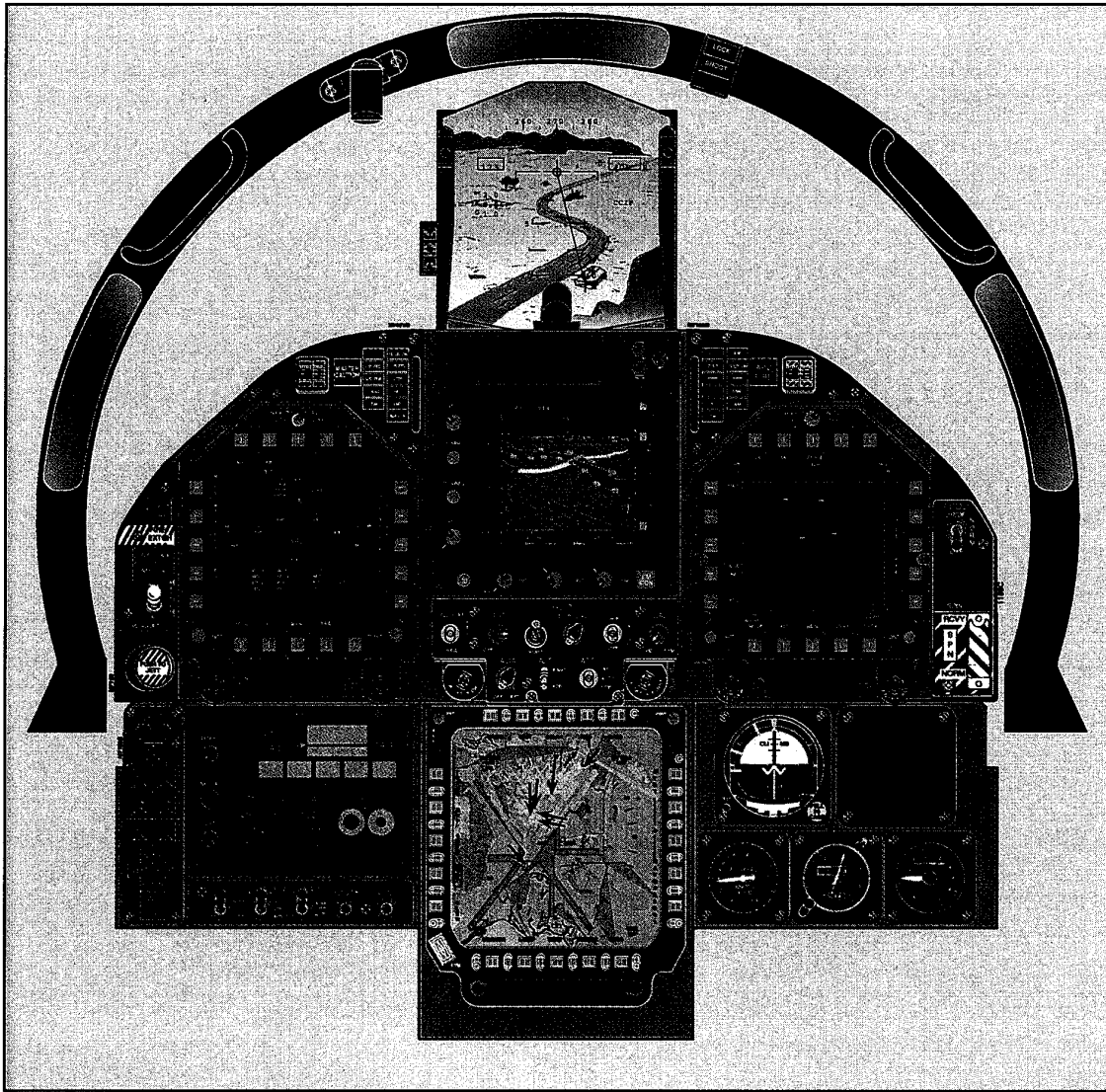

**F/A-18E/F Forward Crew Station**



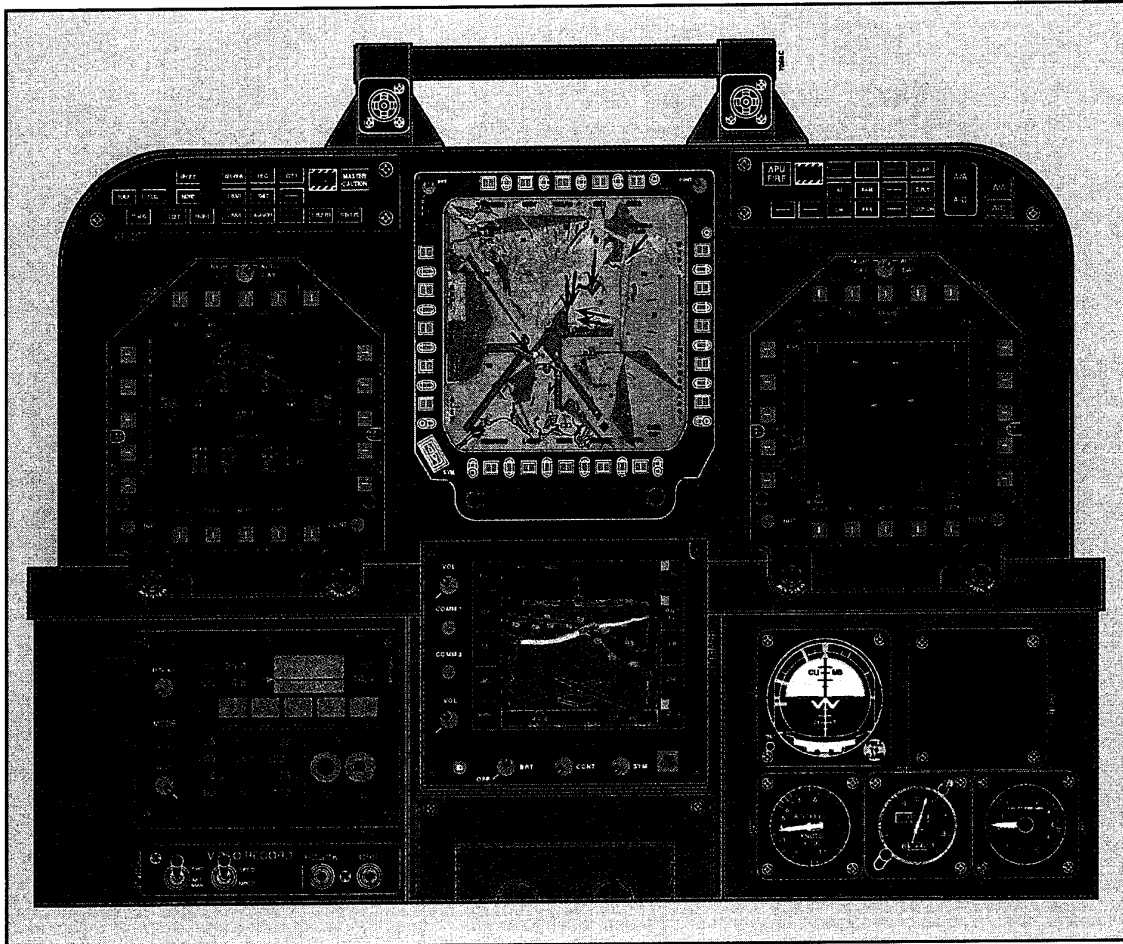

**F/A-18E/F Aft Crew Station**

**EF2000****I AIRCRAFT CHARACTERISTICS**

EF2000 is a single-seat, high performance dual-role combat aircraft designed by Alenia, British Aerospace, CASA and DASA. It has an unstable delta-canard configuration which is optimised for the Air-to-Air role with a complementary Air-to-Surface capability. The aircraft is powered by twin EJ200 reheated turbofan engines. Its aerodynamic configuration and Fly-By-Wire Flight Control System make for an extremely agile aircraft with carefree handling. Performance is in the Mach 2+ class with a take-off run of less than 300m and a flareless landing within 500m.

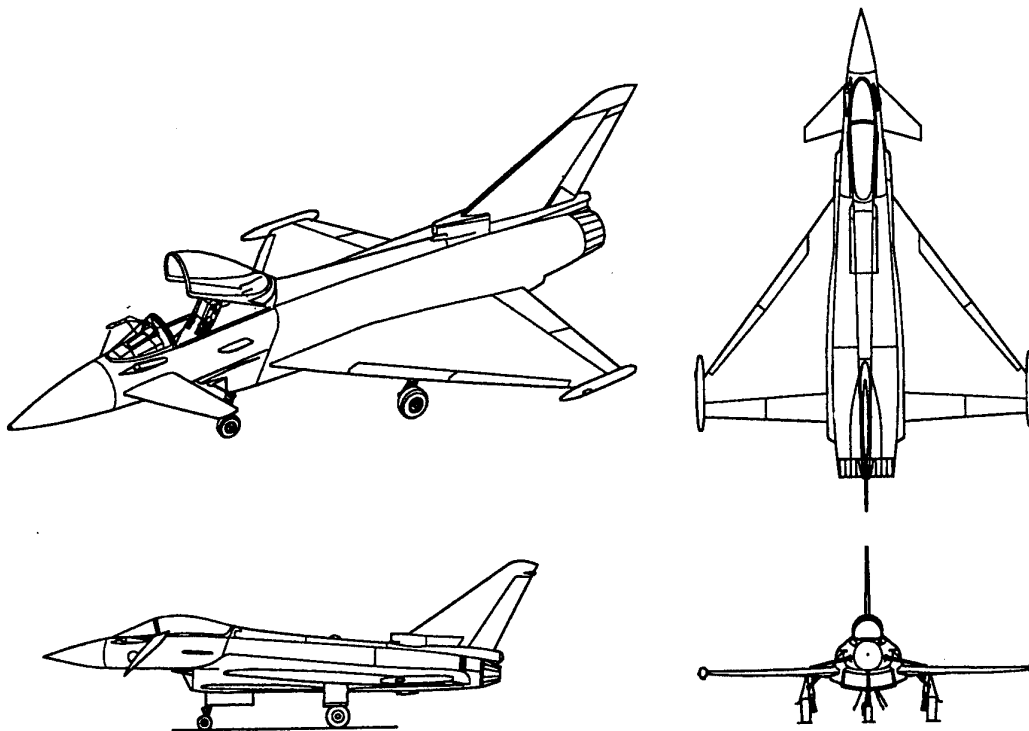

Length 15.96m  
 Span 10.95m  
 Wing Area 50m<sup>2</sup>  
 Thrust 120/180kN

Max speed Mach 2+  
 Weight Empty 9,750 Kg  
 Max Op Weight 21,000 Kg  
 Max Load 6,500 Kg

**II MISSIONS & MISSION EQUIPMENT**

EF2000 is a dual-role aircraft: Air Defence covers Air Superiority, Air Intercept, CAP, Air Escort and Fighter Sweep; in the Air to Surface role EF2000 covers Battlefield Interdiction / Close Air Support, Armed Reconnaissance and Column Cover. The prime sensor is the ECR90 multi-mode radar with a multi-target capability that is complemented by an Infra-Red Search and Track sensor. Weapons carried include:

- \* 1 x 27mm cannon
- \* 4 x AMRAAM
- \* 6 x ASRAAM or AIM9L
- \* Aspide
- \* Freefall or Retarded Bombs
- \* Cluster Bombs
- \* Laser Guided Bombs
- \* Anti-radiation Missiles

The Avionic System comprises of highly integrated Attack & Identification, Armament Control, Defensive Aids, Navigation, Communication, Flight Control, Utilities Control, Integrated Monitoring & Recording and Displays & Controls Sub-systems which communicate via EFABUS (fibre optic, 20Mbit) and MIL STD 1553B data buses.

### III COCKPIT DESCRIPTION

EF2000

#### Design Concept

The prime mission information is presented to the pilot in as head-up an area as possible using the HUD, Helmet Mounted Sighting System (HMSS) and three Multi-function Head Down Displays (MHDD). Information presentation is task related, moded by phase of flight and with no more than three access levels. Control allocation is done on a priority basis with frequently required or combat accessible controls being provided via HOTAS, with DVI in a complementary role.

A supporting philosophy is that the pilot should not be required to monitor the state of any sub-system or equipment. This is realised by extensive health monitoring at the sub-system level (in particular routine housekeeping functions) with the pilot only being informed of exceptions to normal operation via an intelligent warning system. When practical, detection, diagnosis and correction of a fault takes place without pilot intervention.

#### Main Display Suite

The prime display surfaces are a wide-angle holographic HUD and three large full colour raster-cursive shadowmask CRT Multi-function Head Down Displays. These MHDDs have soft keys on three sides for system and format interaction. The function of each key is identified by a two-line LED legend embedded in the key head thus avoiding extra clutter on the main display surface.

#### Helmet Mounted Sighting System

The HMSS has a wide FOV with a dual sight and raster display capability. The HMSS is an integral part of a Helmet-mounted Equipment Assembly which also provides Night Vision Enhancement and ocular protection. The HMSS allows for pilot / system cuing (sensors and weapons) as well as a display of weapons and sensor modes, target and shoot cues, flight and sensor information.

#### Lighting Control & NVG Compatibility

An integrated lighting control concept provides automatic brightness level and balance control across the whole cockpit under all lighting conditions. Manual override authority and reversionary control is provided. All cockpit display technologies (location, emission, control) are designed for NVG compatibility.

#### Hands On Throttle And Stick (HOTAS)

HOTAS functionality provides for sensor control (throttle), weapons and defensive aids control (stick), and flight management. The operation of a HOTAS control provides immediate visual, aural or tactile feedback to the pilot. The most frequently used throttle-mounted functions is an X-Y slew and insert cruciform switch which controls the position of a cursor across all HUD and MHDD displays enabling extensive display/system manipulations.

#### Manual Data Entry Facility

This facility combines the data entry and moding tasks from a variety of aircraft subsystems into one focal area in the cockpit on the left-hand glareshield. Its main functions are:

- o Subsystem selection keys dedicated to
  - Navigation (waypoints, routes, TACAN, MLS),
  - V/UHF Radio 1 & 2 (modes & freqs.),
  - Data Link,
  - NIS / IFF (modes and codes),
  - Defensive Aids Subsystem,
- o Moding keys for task selection;
- o Data Entry Keyboard with variable legend keys and read-out area.

## EF2000

Some of the waypoint and route manipulation routines can also be performed in conjunction with the HOTAS X-Y controller operating on the map display or the waypoint list / route manipulation format.

### Direct Voice Input (DVI)

DVI is used as a system control and data entry medium that allows the pilot to maintain a head-up/head-out and HOTAS operational position. The application of DVI has been limited in scope to maximise the recognition rate and hence utility of the system. The following functions are implemented via DVI, none of which are safety critical:

- o Tactical information read-out;
- o Target selection and sensor moding;
- o Data link interaction;
- o Radio channel selection and frequency change;
- o Navigation waypoint selection and route manipulation;
- o Display format selection and moding.

### Mission Data Loading

All mission-specific data recording and loading will be performed by means of a portable storage medium so that manual input of mission data by the pilot during Ground Procedures is avoided. Typical data to be loaded by this means includes:

- o Armaments package & configuration data;
- o Digital map data;
- o DVI voice templates;
- o Navigation waypoint & route data;
- o Tactical attack & defensive data;
- o Pilot Sensor Moding Key (PSMK).

This last item, the PSMK, is a very useful facility whereby the pilot can specify default values to certain attributes of the Displays and Controls sub-system in accordance with individual preference.

### Side Consoles

The side consoles only house control functions that are used either infrequently (such as in reversionary situations) or primarily on the ground. These controls are grouped according to function/purpose rather than the equipment controlled.

### Prime Display Reversions

Following HUD failure, flight information from the same source is available on the MHDDS. To allow reconfiguration following MHDD failure, the packages normally associated with a particular display surface can be swapped to appear on another MHDD. No format reconfiguration or combination is allowed. Total loss of the display suite results in a Get You Home situation.

### Get You Home Instruments

The Get You Home Instruments provide the pilot with an independent set of flight data which will enable him to return the aircraft to base in the event of total loss of the main display suite. Dedicated Attitude and Heading reversionary instruments driven from the FCS are mounted on the right hand glareshield top. The same glareshield side area provides reversionary displays of Airspeed, Altitude and Vertical Speed behind a "flip-back" panel which normally displays tactical Nav/Comms/Ident readouts. A number of high priority warnings will be hard wired through to the Dedicated Warning Panel for reversionary use.

### Warning System

The aim of the warning system is to

- o **Alert** the pilot to a warning situation;
- o **Inform** the pilot what the situation is;
- o **Advise** the pilot of any consequences and action that should be taken.

An intelligent system is provided that will prioritise warnings according to phase of flight and defined warning categories. The main presentation and control of warnings information will utilise visual attention getters, attention getting sounds (attensons), the Voice Warning System, the Dedicated Warning Panel (on the right hand quarter panel) and the MHDD presentation of information relating to aircrew procedures and warning consequences. A hard-wired Get You Home warning system is also provided.

### IV LEVEL OF INFORMATION INTEGRATION

The prime flight reference display is the HUD which serves a dedicated purpose but with the amount of information displayed being dependent on phase of flight moding and pilot-selectable de-clutter levels. Immediately below the HUD on its front face is a flat panel display dedicated to the management and control of data link tactical information/messages.

Whilst being multi-purpose, the three head-down displays are initially configured to serve particular purposes. The central MHDD is the hub of the head-down display suite presenting the Pilot's Awareness format which is primarily a digital map display with integrated navigation and tactical information overlays.

The left-hand MHDD displays an attack-oriented format in all airborne phases of flight; on the ground it displays a ground procedures / autocue format. The right-hand MHDD is then given over to being truly multi-purpose in that its prime airborne format (elevation view) can be replaced by any of the other selectable formats i.e. Disorientation Recovery, FLIR, Defensive Aids Sub-System, Stores, Engines, Hydraulics, Fuel, Waypoints List, Radio Frequencies List, Warnings Procedures and Consequences.

Track and target data from the main sensors (Radar, FLIR, Data Link & DASS) is subject to a data fusion process in order that best available information is presented to the pilot on any of the display formats. Symbology coding and grouping is used where appropriate to indicate affiliation of tracks/targets, sources of data, threat status etc. Tactical support is provided via threat priority calculations which are displayed along with C<sup>2</sup> information/cues.

Attack sensor moding and control is mainly performed by means of HOTAS controls in conjunction with the Attack and Elevation format displays. Data Link moding and control is accomplished via head-up left glareshield and panel just below the HUD areas, with pointing and assignment functionality available via the X-Y marker on the Pilot's Awareness format. Where appropriate, Icons are used in conjunction with the HOTAS X-Y function for more intuitive interaction.

DVI is implemented as a complement to HOTAS to allow the pilot to remain head-out or head-up for longer periods of the mission. Moding or data entry by DVI has the same impact on subsystem functions and cockpit displays as if a manual selection has been made. No mixed moding of DVI and manual functions is possible. Simple DVI functions will be provided with audio feedback only whilst complex functions will also have HUD Read Out Line feedback.



EF 2000

## I AIRCRAFT CHARACTERISTICS

The F-22 is a single seat, dual engine fighter aircraft. The aircraft design balances stealth, performance, and advanced avionics to achieve First-Look, First-Kill capability. The F-22 is powered by Pratt & Whitney F119-PW-100 thrust vectoring engine, capable of producing approximately 35,000 pounds of thrust in afterburner. The F-22 can achieve and sustain supersonic cruise without the use of afterburner.

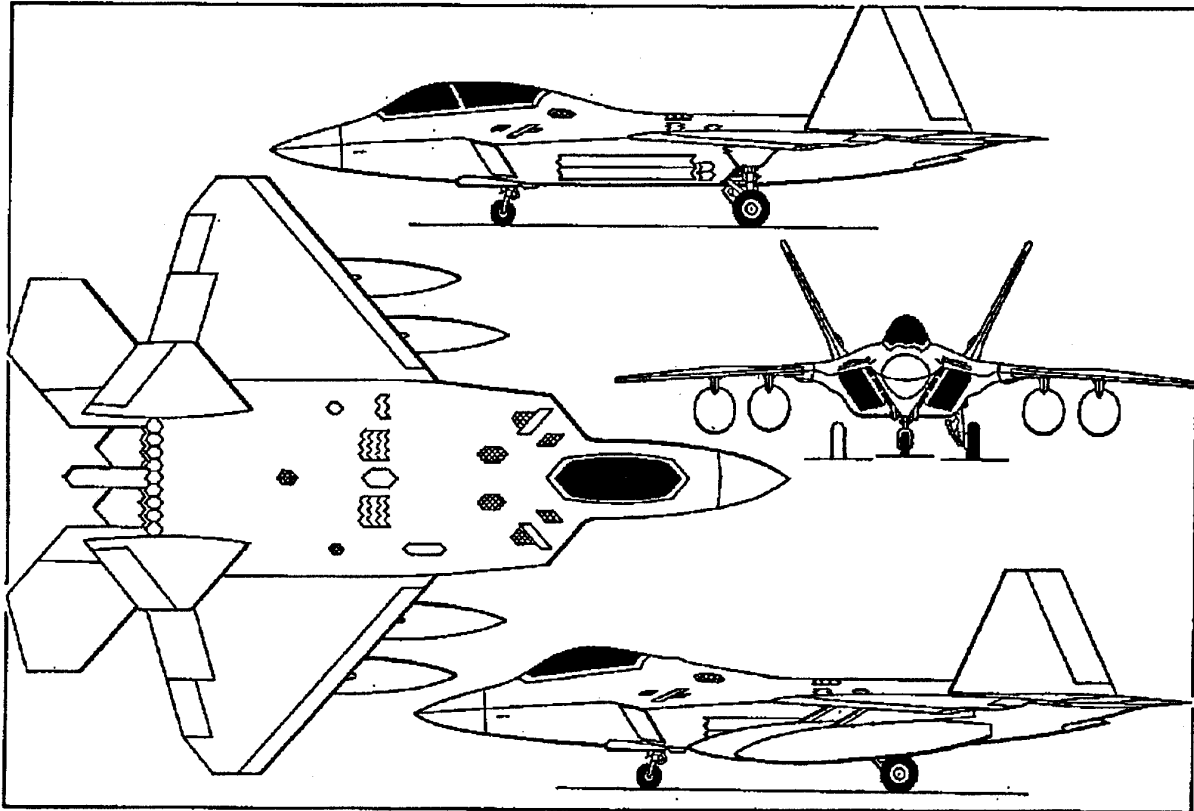

*"Reproduced from Jane's All the World's aircraft (1994)"  
© Janes Information Group Ltd.*

## II MISSIONS & MISSION EQUIPMENT

### **Display Suite**

The Primary Flight Reference is a 30°H x 25°V TFOV HUD. The cockpit head down displays consist of two 3" x 4" Up Front Displays (UFDs), three 6" x 6" Secondary Multifunction Displays (SMFDs), and one 8" x 8" Primary Multifunction Display (PMFD). The UFDs are bi-level, color LCDs. The MFDs are full color LCDs. The MFDs provide display functionality through bezel buttons that surround each display.

### **Interior Lighting**

The panel lighting is Electro Luminescent (EL) and provides balanced brightness throughout the cockpit. The pilot can adjust the lighting of consoles, flood lights, and bezels. The displays can be adjusted individually but automatic brightness control is built-in.

**F-22****Hands On Throttle And Stick (HOTAS)**

The HOTAS design provides the pilot control over all critical aircraft functions that are required during combat and/or under G. HOTAS functionality includes sensor control, communications, flight management, display management, expendables, and weapons release.

**Manual Data Entry**

Manual data entry is accomplished via the Integrated Control Panel (ICP) which is mounted on the HUD control panel. The following functionality is provided via the ICP:

- Naviation
- IFF Data
- HUD Functions
- Auto pilot
- Steer point
- Mark
- Communication
- AVTR
- IFDL
- Altimeter Setting
- Time
- Cruise

**Mission Data Loading**

All mission data is loaded into the aircraft via the Data Transfer Unit (DTU). This capability eliminates the need for the pilot to laboriously input this data manually in the aircraft prior to taking off. The pilot makes changes in mission planning using the Mission Support System. Much of the mission planning data can also be changed in the cockpit if necessary.

**Side Consoles**

The side consoles provide controls for the following functions:

- Lighting
- Fuel
- Engines
- Life Support Equipment
- Emergency Controls
- ECS
- Audio
- Flight Controls
- AVTR

Most of the functions are used only before take-off or in case of emergency.

**III BACKUP MODES & EQUIPMENT**

**Prime Display Backups** - The display formats on the heads-down displays can be swapped between displays. In case of the main processor failure, primary flight information formats are embedded in the displays themselves so that it is always available. Basic flight information is available both heads-up and heads-down. In addition, basic attitude information is constantly displayed on the right UFD.

**Warning System** - All warning, caution, and advisory information is presented on the left UFD. Warning messages are also presented on the HUD and through the pilot headset. Warnings consist of both subsystem health and tactical advisories.

**IV LEVEL OF INFORMATION INTEGRATION**

The F-22 utilizes the HUD as the Primary Flight Reference (PFR) for navigation. The same information can be presented heads down on the PMFD. The PMFD acts as the situation display where the pilot gets the "big picture" information for both A/A and navigation modes. The right SMFD provides a moving map in the navigation mode. The center SMFD provides subsystem information such as engines, fuel, and stores management.



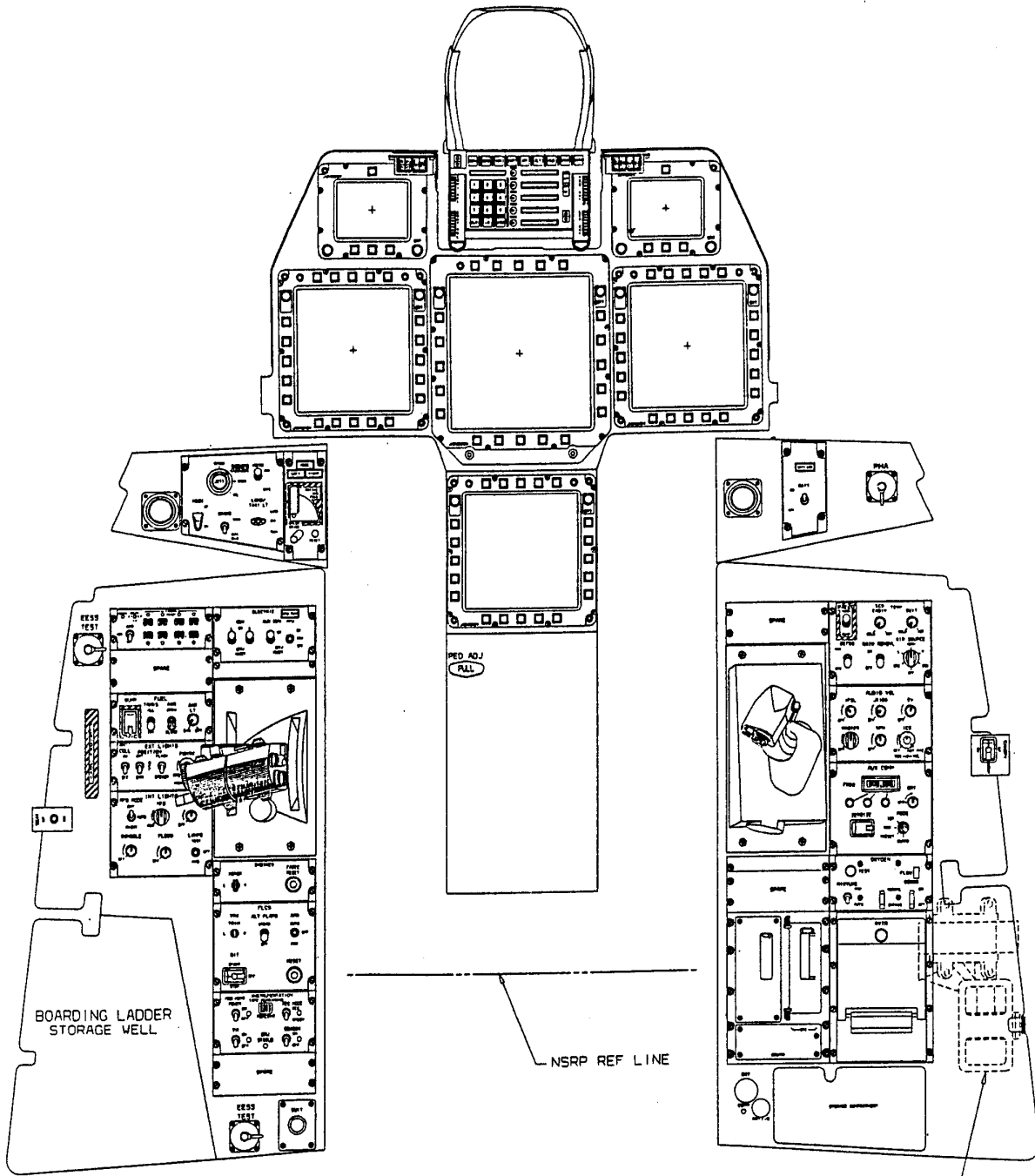

F-22 COCKPIT GENERAL ARRANGEMENT

## EH101 Helicopter

The EH101 is a multi variant, heavy lift, day and night, adverse weather helicopter built by European Helicopter Industries (EHI). The helicopter has:

- \* Three engines for greater capability in single engine failure,
- \* Active vibration control system for reduced structural fatigue, enhanced comfort and reduced crew fatigue.
- \* All systems duplex and triplicated for greater safety and survivability.
- \* The flight control system provides comprehensive autopilot modes in 3 dimensions.
- \* All the above allow single pilot anti submarine operations in night IMC.
- \* Options: choice of engines, automatic bladefold, automatic tailfold, rear loading ramp.
- \* Composite rotor blades with twist, profile changes and paddle tips for high performance in a small diameter.

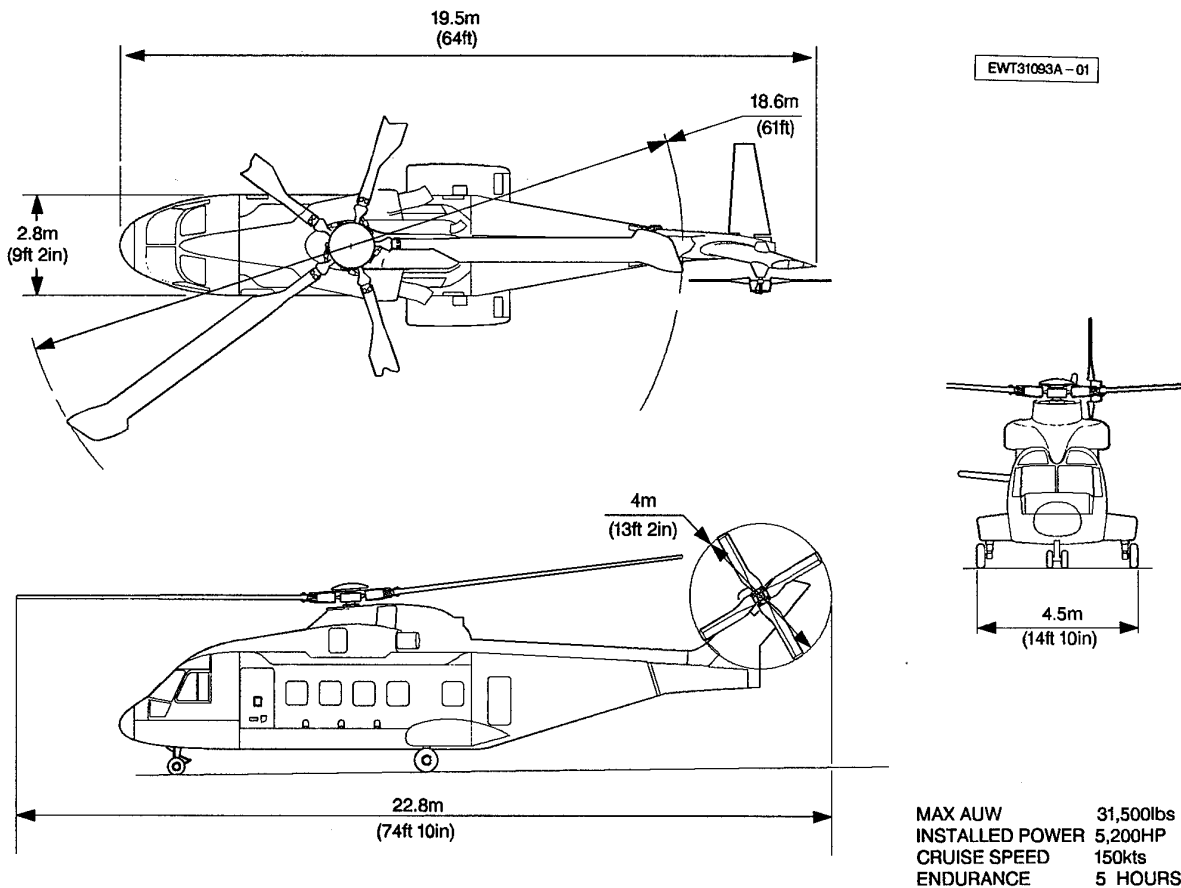

### Missions and Mission equipment

\*The Naval variant roles are: autonomous anti-submarine hunter-killer, SAR, casevac, Vertrep. Fitted with 360 degree radar, dunking sonar, sonobuoys, ESM, digital map. Weapons include depth charges and 4 torpedoes.

\*The Army variant roles are: Battlefield transport, insurgence, SAR, casevac, Vertrep. 35 troops or a vehicle carried internally, rear loading ramp. Fitted with FLIR, MAWS, digital map, IR suppression, chaff and flares.

\*The Civil variant carries up to 30 passengers in airline style comfort.

**EH101 Helicopter**

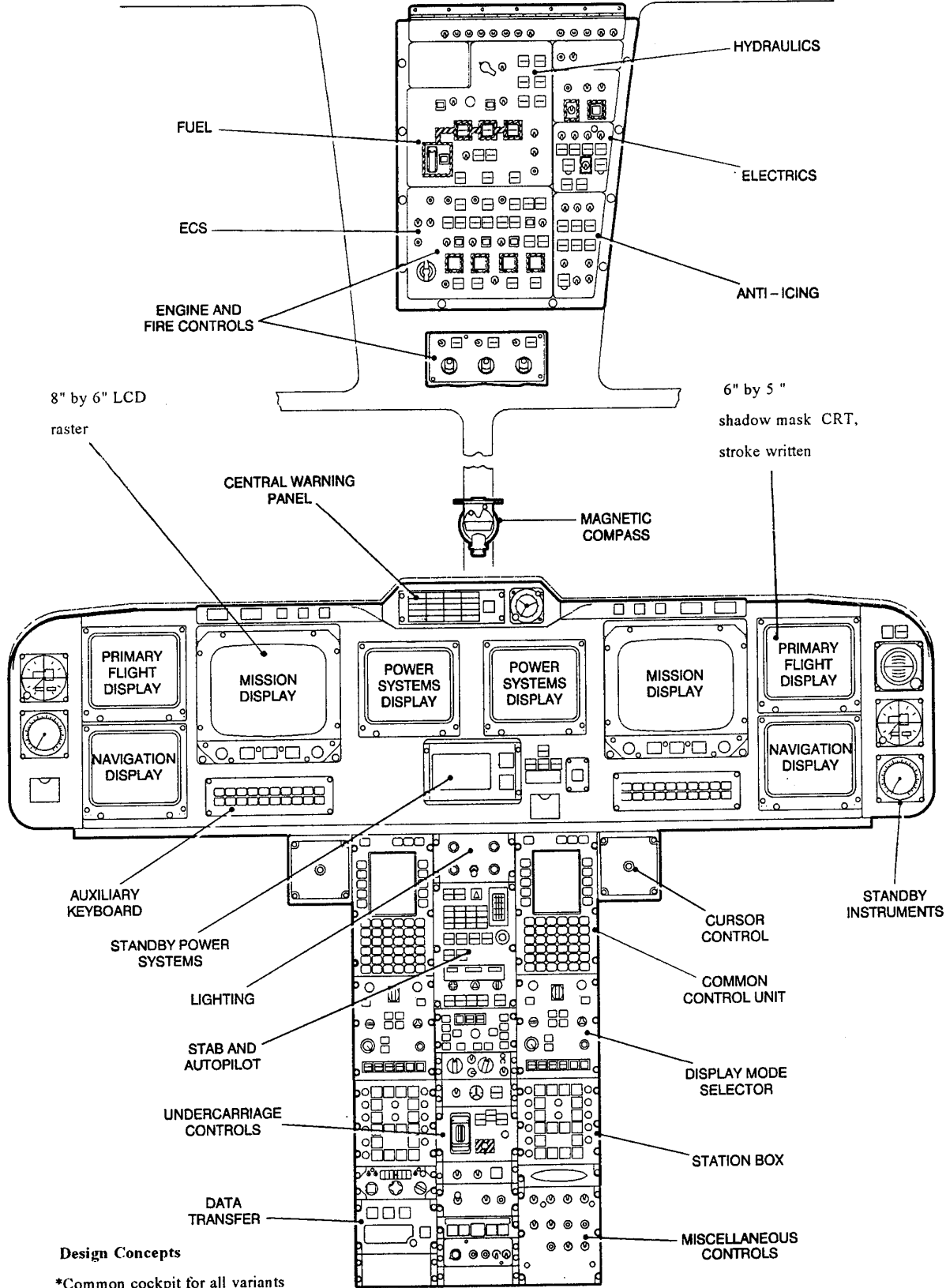

**Design Concepts**

- \*Common cockpit for all variants
- \*Single or dual pilot operation
- \*Display by exception
- \*All colours are non-saturated
- \*Colour change has a shape change
- \*Control and status on pushbuttons

### EH101 Helicopter

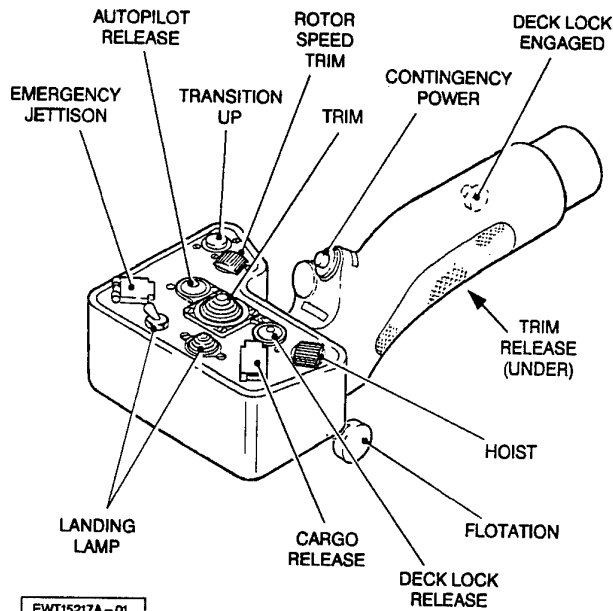

EWT15217A-01

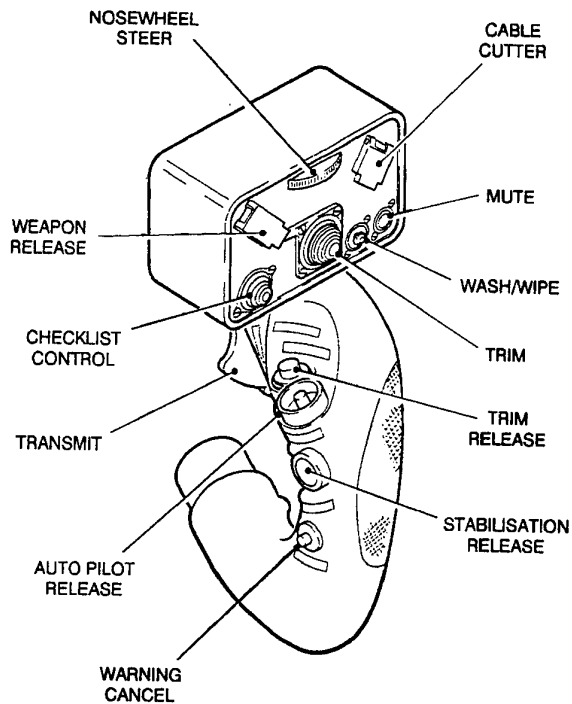

#### Data Entry

Data is entered in the mission system via multifunction controllers, a stiff stick controller and dedicated buttons on the interseat console, this allows the mission displays to be used fully for mission information. Gives all crew members access to Navigation, Communications, Digital Map, Radar, Sonics, IFF, Electronic surveillance, Weapons and Databases .

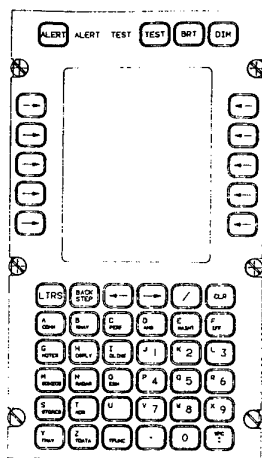

- \* Wide menu 'trees' and less than 3 levels 'deep'
- \* Top level menu selection by dedicated keys
- \* Certain short cuts possible in lower levels

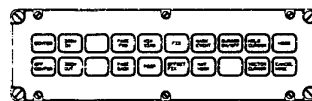

#### Warnings, Cautions and Advisories

- Warnings are individual red indicator lamps and red attention getters in front of both pilots. Certain high priority warnings have voice messages.
- Cautions are a yellow highlighted list of captions on the Secondary Power Systems. Attention getters are in front of each pilot.
- Advisories are a green list of captions on the Secondary Power Systems.

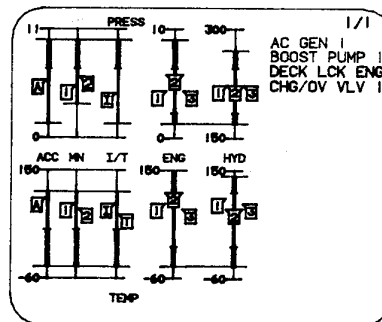

#### Mission Upload and Download

Information is transferred to the Avionic system using the portable storage media this includes Navigation, Comms, Sonics and ESM databases. Post flight information retrieved also includes comprehensive Health and Usage Monitoring and Built In Test data.

**EH101 Helicopter**

Display formats special to EH101;

a) Power 'cruise' display. Expands the normal operating region and normalises the limits of power plants, torque and rotor speed according to operating conditions.

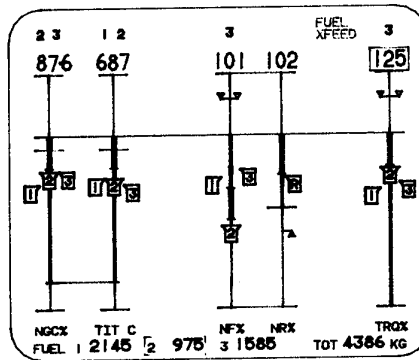
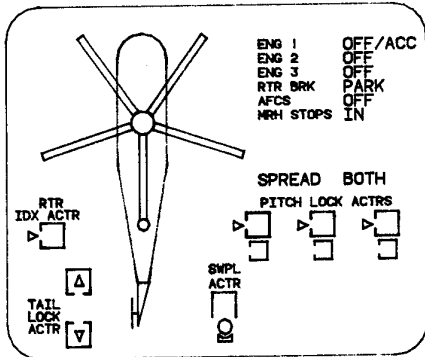

b) The Naval variant 'bladefold' display. Quick diagnosis of sequence and fault status.

c) The Naval variant 'cable' display. Shows pertinent data in plan form for use in the dunking sonar situation.

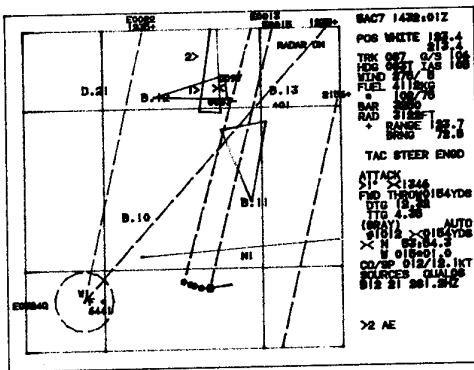
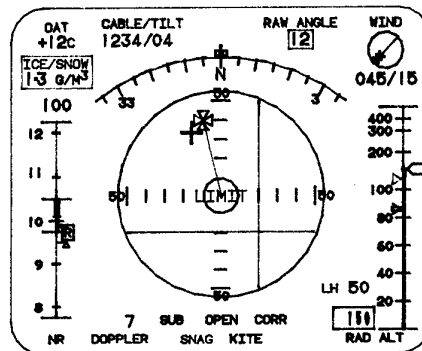

d) Combined Radar, ESM, Map, Tactical and sub-surface data.

**Back Up modes**

For Display Unit failures - format exchange switches and 'two in one' composite formats can be selected.

For Symbol Generator failures - reconfiguration switching can be selected.

For failure of a dual sensor - alternate source can be selected.

Standby instruments included on the instrument panel: standby artificial horizon, standby altimeter, standby airspeed indicator, standby compass and standby power systems panel.

**Planned Improvements**

- \* Six 8 by 8 displays each capable of all formats /sensors
- \* NVG Helmet display

\* Full NVG compatibility

## Tiger

The **TIGER** is a highly agile, multi-role, day and night, adverse weather, combat helicopter built by EUROCOPTER.

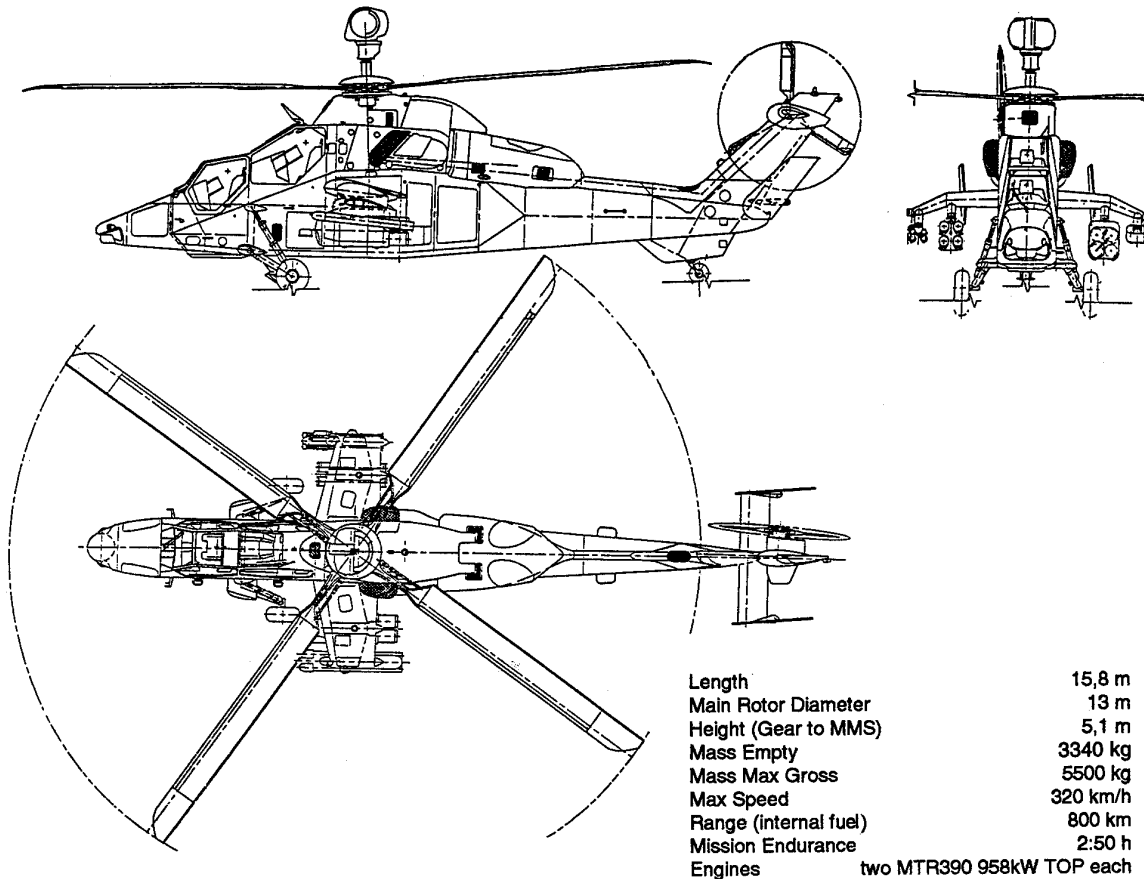

### MISSION & MISSION EQUIPMENT

The TIGER is a multi-role attack helicopter which can be configured for Antitank, Escort, Close Combat Support, Anti-Air and Reconnaissance. Currently there are two versions: one with a Mast-Mounted Sight and nose-mounted pilotage FLIR, and one with a turreted gun and Roof-Mounted Sight. Compatibility with existing weapons and sighting systems was a design requirement.

#### Sensors: (configuration depending)

- Mast Mounted Sight with IR and TV camera, HOT tracker and Laser-Range Finder
- or Roof Mounted Sight with IR and TV camera, Laser-Range-Finder and a direct optical sight
- nose mounted FLIR for piloting
- Laser/Radar warning receiver

#### Weapons: (configuration depending)

- Anti-Tank Missiles HOT and/or TRIGAT
- Anti-Air Missiles STINGER or MISTRAL
- 30mm Turret-Gun
- Gun-Pod
- various unguided Rockets.

### COCKPIT LAYOUT

The TIGER is configured with a tandem, two crew-member cockpit. External visibility has been optimised beyond the MIL requirements for NOE flight and for best all around view, not only for the forward pilot station, but also for the rear Gunner/Commander station. Both crewstations have pedals, collective and centre-cyclic flight controls allowing full flight control from either station. The Avionic System is based on a federated network of intelligent subsystems, designed around two dual redundant MIL-1553B data busses, one for basic avionics and one for the Mission Equipment.

As a principle the C&Ds for the Armament System, the Visionics System as well as for the basic Helicopter Systems, and Automatic Flight Control System are separated from the Basic Avionics C&Ds. For these only secondary control and display functions are performed in addition via the basic avionics system. A set of standby instruments in the forward station supports starting the helicopter and, in the case of major failures, "safe return" flight. All mission sensors can be used by either crew member. The crew-member piloting the helicopter may immediately select the sensor needed to support his flight path selection and/or obstacle avoidance task. All displays can be selected by the pilot to use either English or metric units. The cockpit is fully compatible with third generation night vision goggles.

Tiger

COCKPIT LAYOUT

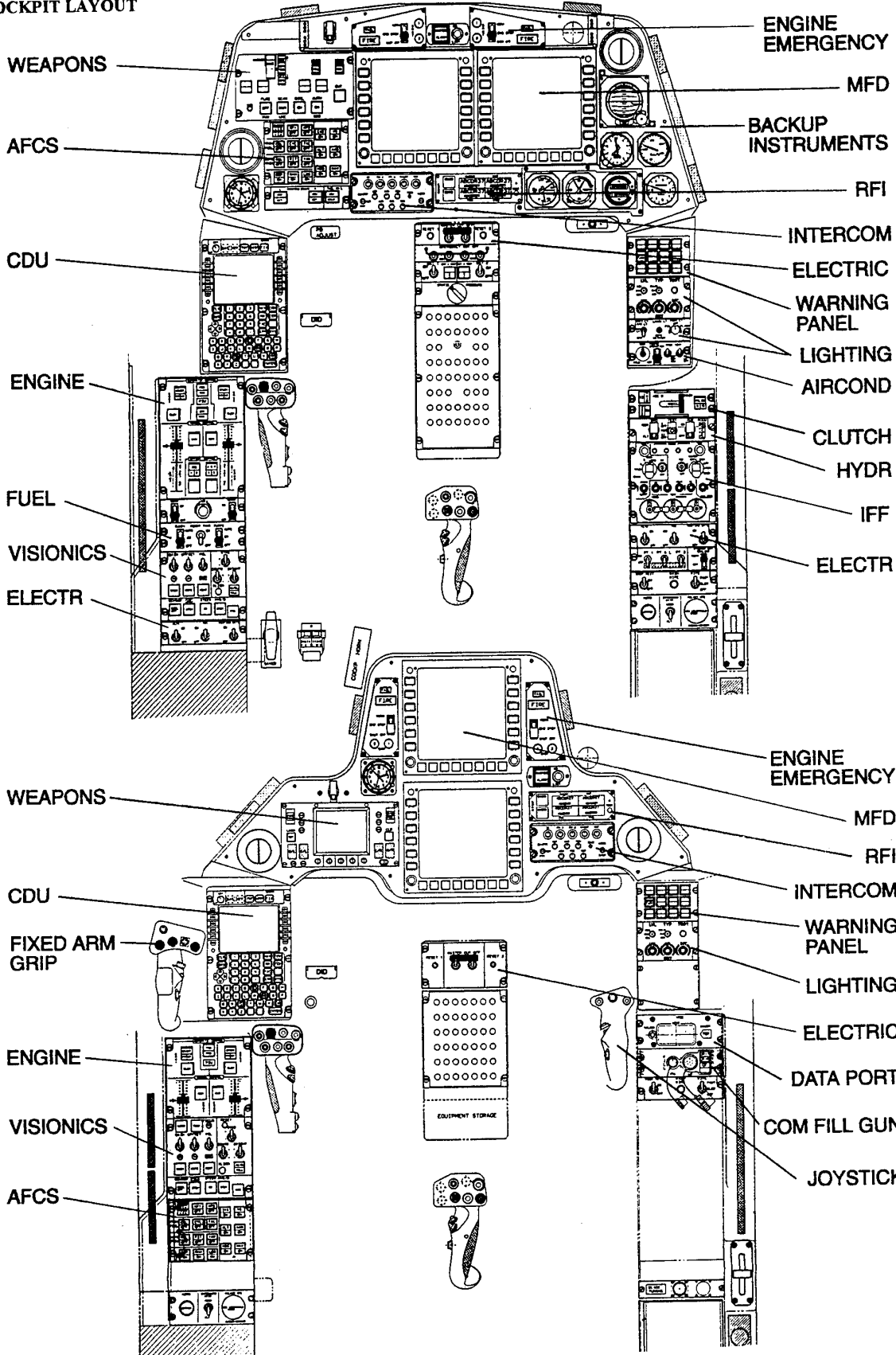

WEAPONS

AFCS

CDU

ENGINE

FUEL

VISIONICS

ELECTR

WEAPONS

CDU

FIXED ARM GRIP

ENGINE

VISIONICS

AFCS

ENGINE EMERGENCY

MFD

BACKUP INSTRUMENTS

RFI

INTERCOM

ELECTRIC

WARNING PANEL

LIGHTING

AIRCOND

CLUTCH

HYDR

IFF

ELECTR

ENGINE EMERGENCY

MFD

RFI

INTERCOM

WARNING PANEL

LIGHTING

ELECTRIC

DATA PORT

COM FILL GUN

JOYSTICK

EQUIPMENT STORAGE

# Tiger

## HOCAS

The Hands on Collective and Stick (HOCAS) located on the flight controls controls enable immediate control of engines, AFCS, Sight System, Weapon System, and radio communication without the need to look into the cockpit. In addition to these controls, there are weapon system and map controls on the Gunner Armament Grips (GAG) in the rear cockpit. The right GAG can also be used for interactive work with the digital map. Between 7 and 14 switches are located on the grips.

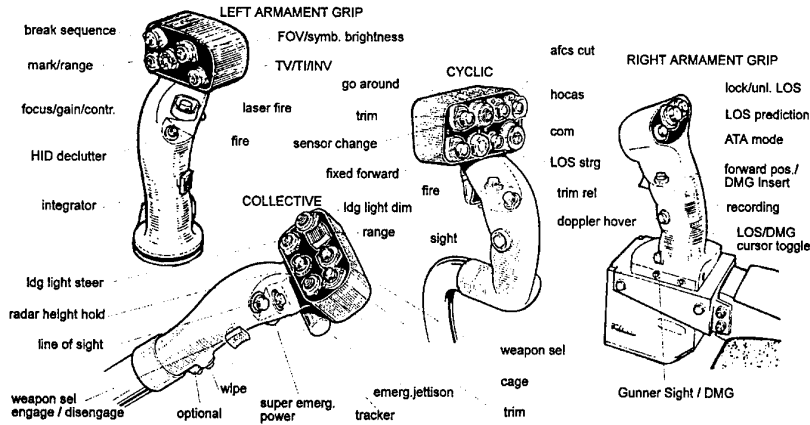

## HEAD UP DISPLAYS - HUD/HMD/HID (configuration depending, one for each crew member)

**HMD:** There are three types of helmet mounted displays available. A Helmet Mounted Sight (HMS), a Helmet Mounted Sight and Display (HMS/D) and an Integrated Helmet System (IHS). All HMDs use an electromagnetic sensor to monitor head position and movement. All primary flight information required to fly the helicopter to the next way point and some targeting information is provided head up. Reduced or full symbology can be selected, depending on the amount of artificial/symbologic information which is needed to fill the gap created by reduced visual cues of external vision information. Sensor images can also be presented on the helmet.

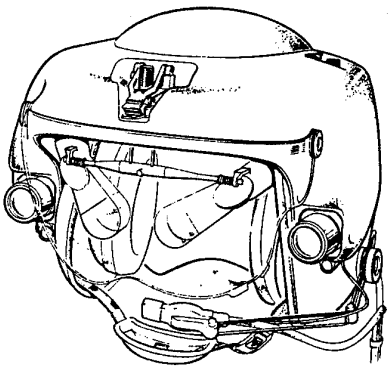

(IHS)

**HMS:** The HMS is a monocular helmet sight only.

**HMS/D:** The HMS/D is a monocular helmet sight and display. The HMD can combine symbology with sensor images.

**IHS :** The IHS system is a binocular helmet sight system with two Image Intensifier Tubes integrated optically with CRT images.

The HMD can combine symbology with sensors or IIT pictures.  
 Display (IHS): FOV 40° circular  
 CRT raster/stroke  
 mono green/525 lines

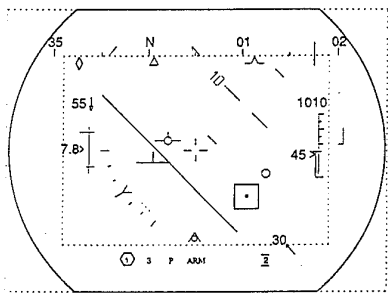

(HMS/D and IHS Format)

**HUD:** The roof mounted Head Up Display in the front cockpit provides piloting and axial firing symbology for the ground support versions.

Display: FOV 20° circular  
 CRT stroke  
 mono green

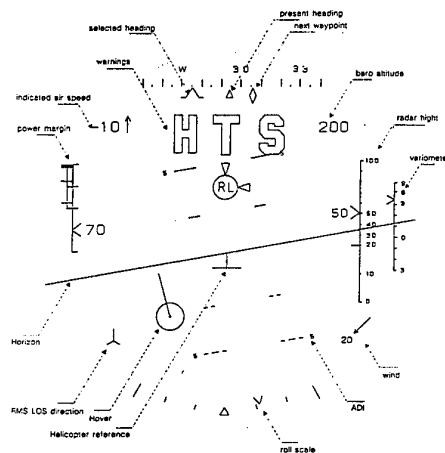

(HUD Format)



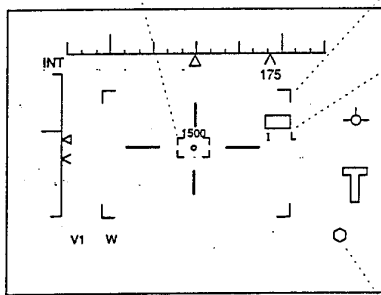

(HID Format)

**HID:** The roof-mounted sight with its Head In Display in the rear cockpit provides symbology and sensor pictures for target acquisition and firing of the anti tank missiles. When using the HID, the gunner has all main visionics and weapon functions available on the HOCAS GAG.

Display: FOV 20° circular  
 CRT stroke  
 mono green

**DATA ENTRY** The data entry is performed mainly via a Control and Display unit. Prepared mission data can be entered into the system by using Data Cartridges.

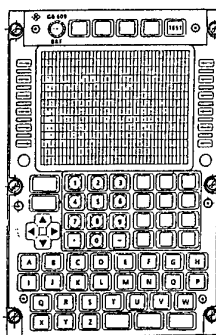

**CDU:** The Control and Display Unit is the centralised dialogue device for

- Radio Com/Nav
- Autonomous Nav
- Mission/Route Management
- OSTM (Onboard System Test and Maintenance)

The CDU has a full alphanumeric keyboard, line select keys and direct access keys. All data entries are performed using a scratchpad philosophy.

Display: 14 lines / 40 characters  
 LED  
 mono yellow

**DISPLAYS**

**MFD:** Two Multi Function Displays are provided in each cockpit. They have identical capabilities (full redundancy).

The main display modes are

- PFD Primary Flight
- NAV Navigation
- A/C Aircraft = a/c systems (example: Fuel System)
- TAC Tactical = maps
- VIS Visionics = sensor pictures
- CPY copy function (other station repeater)
- ECM Electronic Counter Measures = Radar/Laser Warning
- ARM Armament

Display: 6" x 6" colour LCD  
 512 x 512 pixels (quadr.)

The menu hierarchy of the display modes has a maximum three levels. The top level of each mode is accessible with only one key press. The Primary Flight mode display changes automatically between forward flight and hover symbology. There are four Navigation displays available depending on the area of interest of the crew. Three display formats with map underlays can be selected with route and way points, tactical information, ECM threats, and navigational aids. A conventional HSI presentation supports standard Instrument Flight Rule (IFR) flight.

All basic Aircraft Systems can be monitored using pictorial presentation for quick interpretation of status. "Do Lists" below the pictogram suggest immediate actions to be performed. Check lists are also available. The status of the Avionics Systems is provided in functional block diagram form. For tactical works two types of maps are available for tactical planning, the synthetic map and a digital map. Both types of maps have tactical overlays which can be edited by the crew. All sensor images can be displayed on either MFD. To ease crew coordination, a "copy" function allows display of whatever is currently displayed on the other crewmembers MFD. ECM information and library analysis results are provided on another format. The complete stores/weapons situation is provided on a single display.

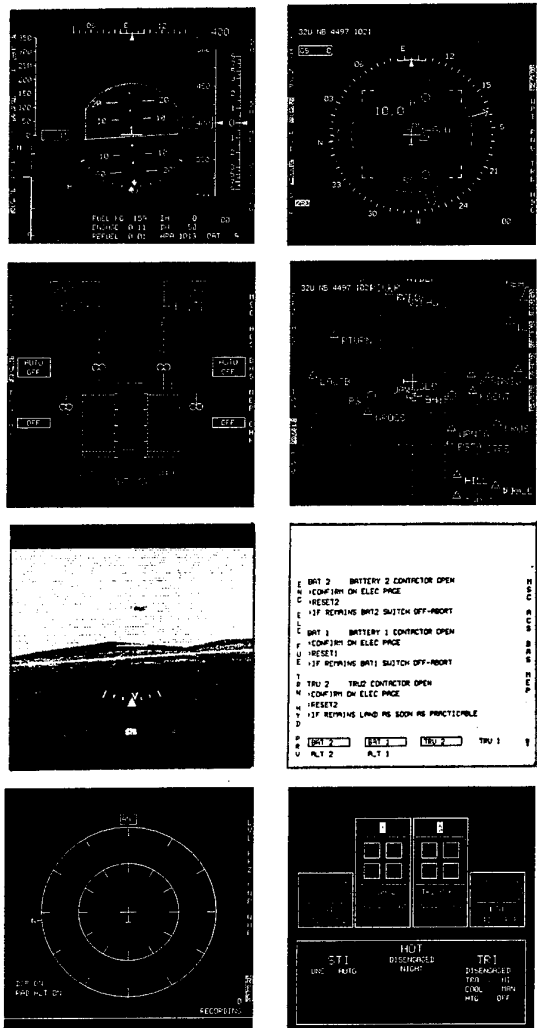

## Tiger

### DIGITAL MAP

The Digital Map provides topographical and tactical information needed for the mission. Three map scales (paper map based, 1:50 000 to 1:500 000) with three zoom factors are available. When used as a navigational aid, the movement and rotation of the map is correlated by the present position and the heading of the helicopter. Map movement can also be controlled by the right gunner armament grip for tactical work. Cursor or helicopter position can be displayed in either GEO or UTM coordinates, and settings such as map orientation or decluttering of symbology can be changed by the crew. Tactical information is provided by overlays which can be configured by the pilot/gunner according to mission needs. Furthermore, these overlays are grouped according to thematic classes for easier access. Basic manipulations like copying, deleting or editing of overlays can be done by means of cursor functions within the framework of a graphical user interface. A built-in graphics editor tailored to the tactical work allows fast on-line update of the tactical information. This also includes modification of the routes and waypoints.

### DATA LINK

Overlay information can be received or transmitted via radio data link. If the address of the receiver is provided by the CDU, data link transfer can be initiated directly from the management page of the digital map. By this means, direct exchange of digital tactical information among squadron members is possible. The data link also allows for automatic position request by squadron leader. As result he gets the position of all the members of his squadron in a graphical presentation.

### VIDEO MEMORY

The digital map generator includes a video memory capability and so provides the possibility to store and replay individual or series of sensor images together with additional image information during the mission. Video memory images can be correlated to a corresponding map representation using two MFDs simultaneously. This enables the aircrew to detect and identify targets and transfer their coordinates to the fire control computer without exposing the helicopter to enemy fire.

### BACKUP INSTRUMENTS

In the front cockpit there is a set of mechanical/electrical backup instruments which includes ADI, Altimeter, Airspeed Indicator, Variometer, NR/NTL, T45/TRQ, NG, and Clock. A Remote Frequency Indicator in each cockpit allows HOCAS selection of radio channels and direct instantaneous access to emergency frequencies.

### WARNING CONCEPT

A subset of the following devices are used, depending upon priority and redundancy level, to indicate warnings:

- Master Warning Light for all red alarms
- Engine Fire Alarm Lights
- Dedicated Warning Panel for all red alarms and selected amber warnings needed during engine startup
- All alarms, warning/cautions and advisories in 8 letter abbreviations on the two top lines of all MFDs
- Attention getting symbols on HMD and HUD
- Warning tones in the headsets
- do-lists on the MFD of up to five lines of actions to be performed

### PLANNED IMPROVEMENTS

- GPS
- missile approach warning
- automatic air surveillance and warning system using mast mounted pulse doppler radar

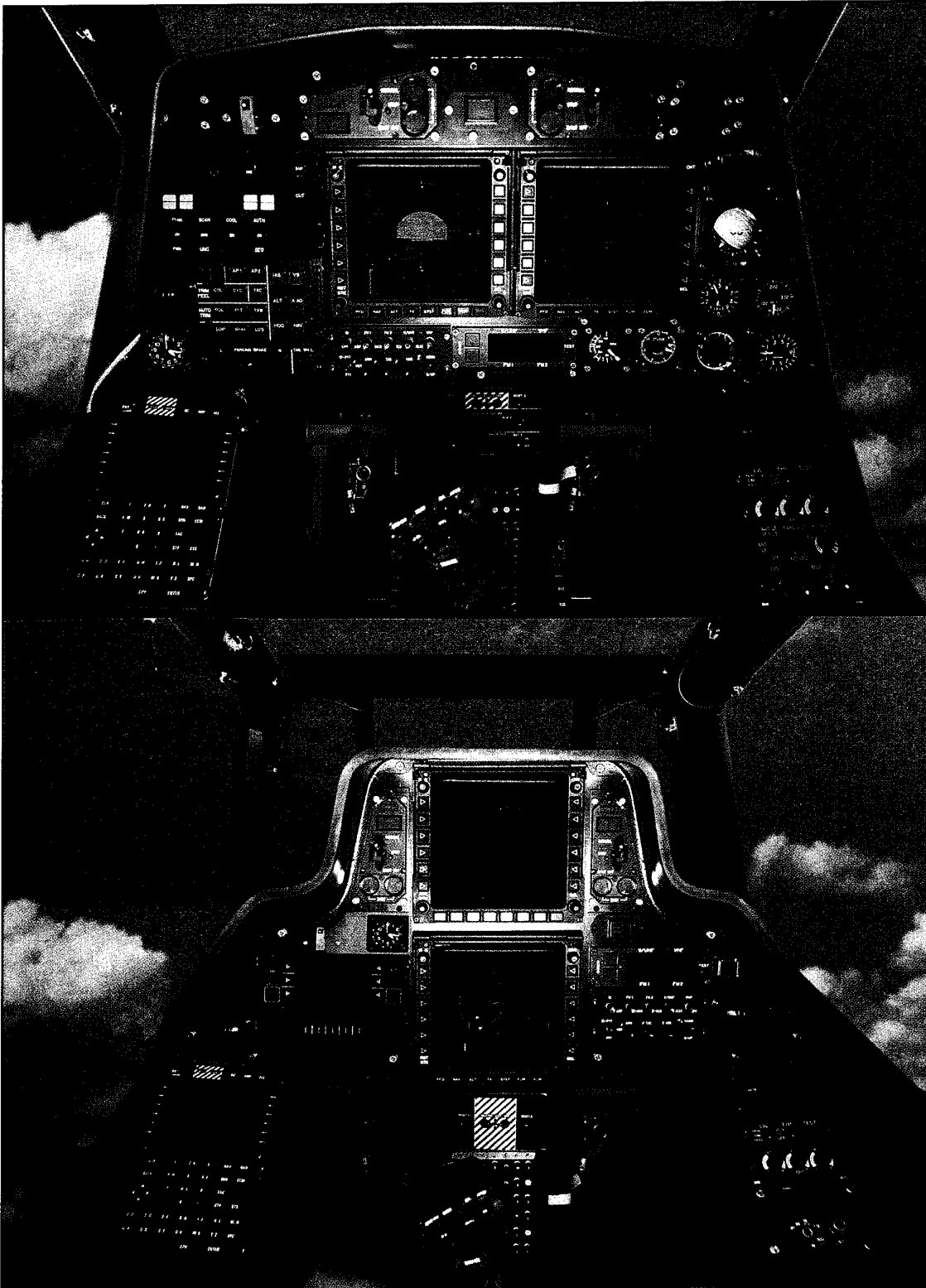

Tiger Cockpit

## MV-22 Osprey Tiltrotor

The MV-22 Osprey Tiltrotor (manufactured by a joint team of Boeing Defense & Space Group - Helicopters Division and Bell Helicopter Textron) will replace the CH-46 helicopter in the United States Marine Corps Troop Assault, Troop Transport, and External Cargo missions. Taking advantage of its unique ability to takeoff and land vertically, coupled with high speed forward flight, enables the MV-22 to take twice as many troops and/or cargo twice as far, twice as fast. In addition to the basic MV-22, the CV-22 with additional mission equipment will directly support the United States Special Operations Command (US SOCOM) Long Range Special Operations Forces (LRSOF) missions.

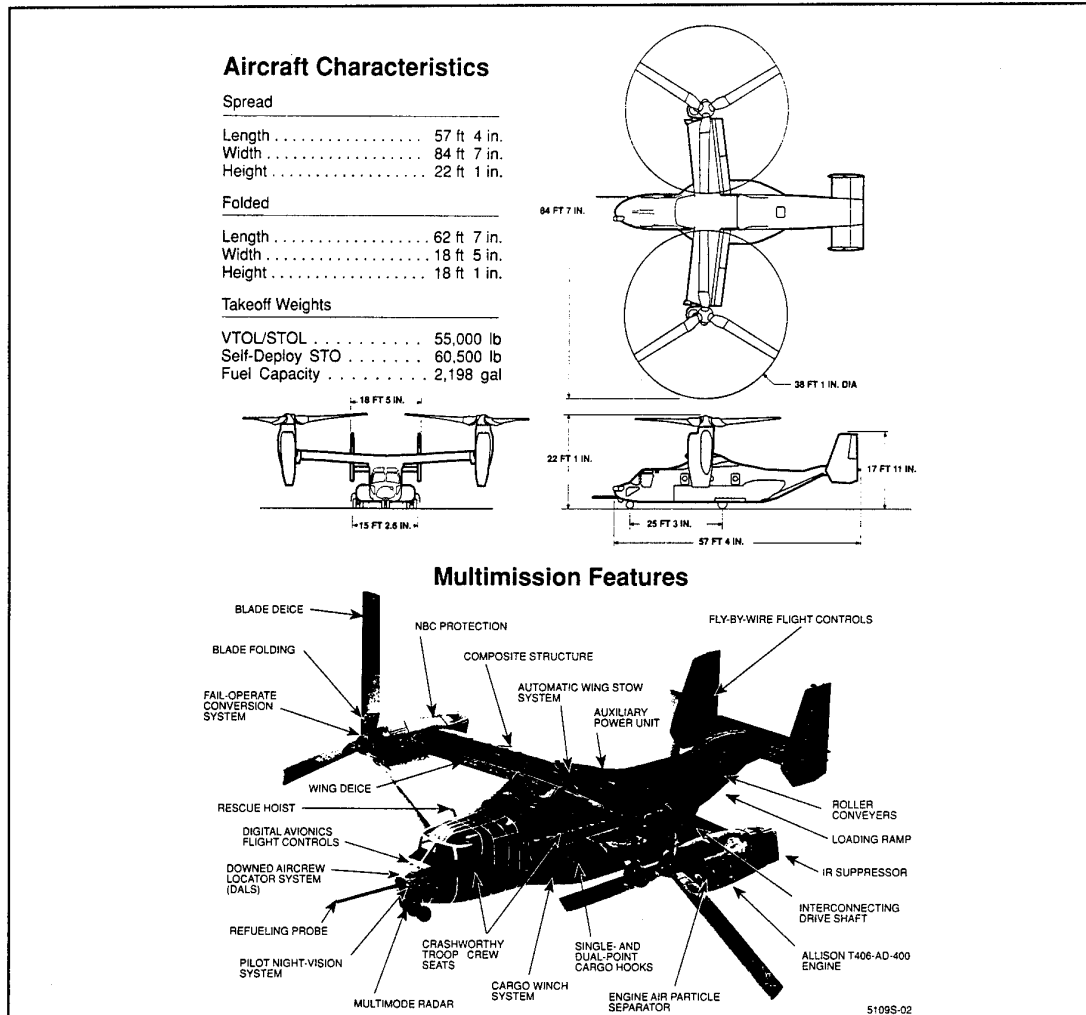

### MISSIONS:

- US Marine Corps (MV-22)
  - Amphibious Assault Transport of Troops, Equipment, and Supplies from Assault Ships and Land Bases
  - External Cargo Missions
- US Navy (HV-22)
  - Strike Rescue, Delivery and Retrieval of Special Warfare Teams
  - Logistics Transportation in Support of the Fleet
- US Air Force (US SOCOM) (CV-22)
  - Long Range Special Operations Missions, Insertion and Extraction of Special Forces Teams and Equipment
- US Army (MV-22)
  - Aeromedical Evacuation
  - Special Operations
  - Long Range Combat Logistic Support
  - Combat Air Assault
  - Low Intensity Conflict Support

**MISSION EQUIPMENT:**

- Integrated Mission Avionics Suite
- Dual Redundant MIL-STD-1553B Data Bus Architecture
- 64-bit RISC-based Advanced Mission Computer
- Five Unique Interface Units to Process Analog Signals from Throughout Aircraft
- Fully NVG Compatible Aircraft (including Cockpit/Cabin, Interior/Exterior Lighting)

**COCKPIT ARRANGEMENT:**

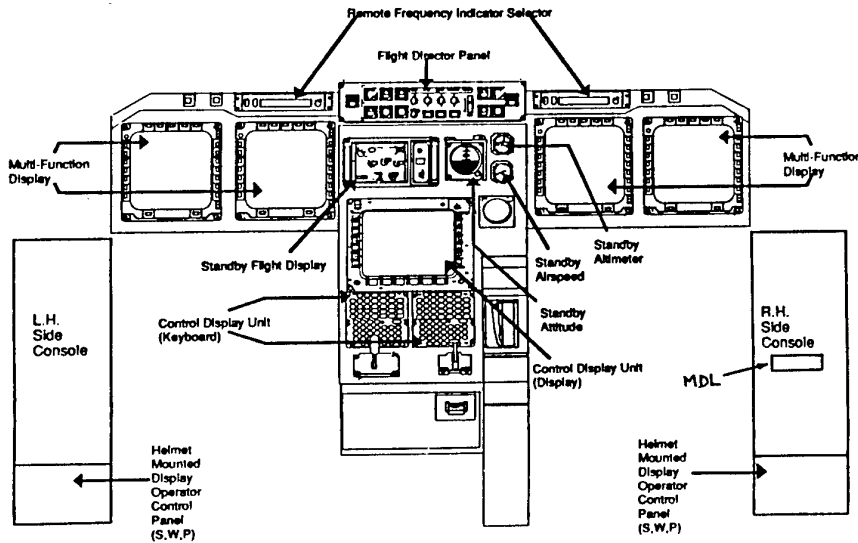

**AVIONICS ARCHITECTURE:**

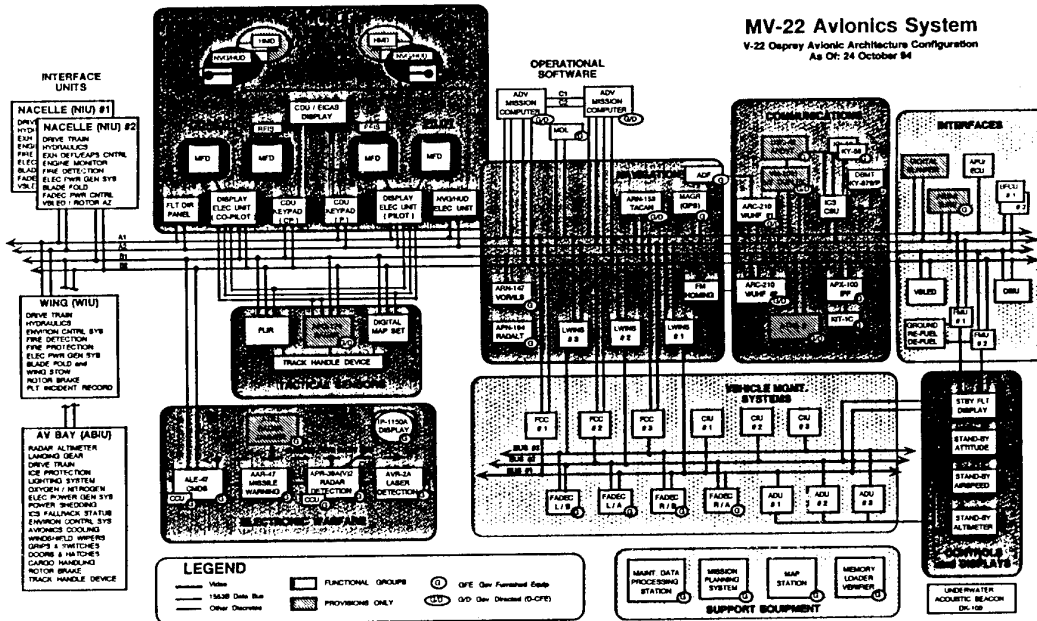

## MV-22 Osprey Tiltrotor

### V-22 Thrust/Power Lever Grip

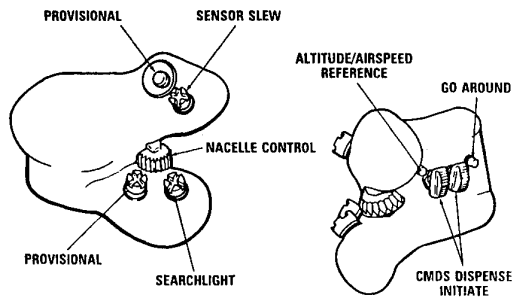

### V-22 Cyclic Stick Grip

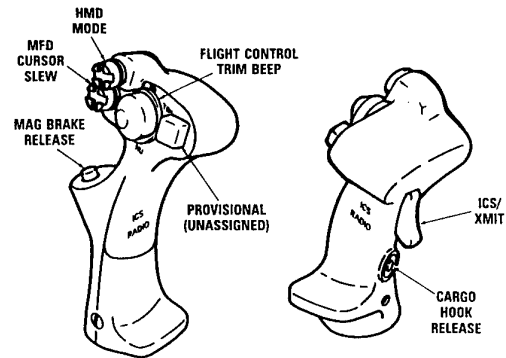

#### **DATA ENTRY:**

- Primary Data Entry Through CDU/EICAS Keyboards; Data can be entered independent of mode of use and then recalled to allow transfer into a data field (i.e., "hot scratchpad")
- Additional Inputs Through HOTAS and Selected Functions on Flight Director Panel and Miscellaneous Side Console Controls
- Preplanned Mission Data Loaded via Mission Data Loader (MDL) Cartridge

#### **WARNINGS / CAUTIONS / ADVISORIES:**

- Notification by Exception Philosophy; Allow system to track performance and provide indication when normal situation is degraded
- "Cascading Logic" Implementation
- Dedicated Crew Alerting System area on CDU/EICAS Display (Backup available on MFDs in case of CDU/EICAS failure)

#### **MISSION UPLOAD / DOWNLOAD:**

- Mission Data Loader (MDL) is used to enter the majority of the data used by the V-22
- Generated by the Tactical Aircraft Mission Planning Station (TAMPS) and contains pre-planned Flight Routes, Communications Plan (frequencies, call signs, security information, call nets, etc...), and mission management data including tactical data and navigation data overlays
- MDL also stores data related to mission performance, fault and maintenance data, as well as Vibration, Structural Life, and Engine Diagnostic (VSLED) data used for trend analysis

**UNIQUE DISPLAY FORMATS:**

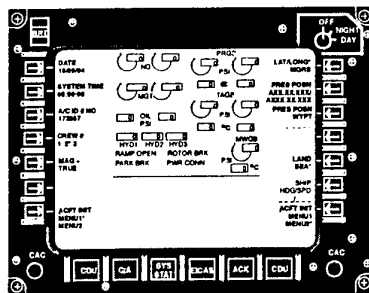
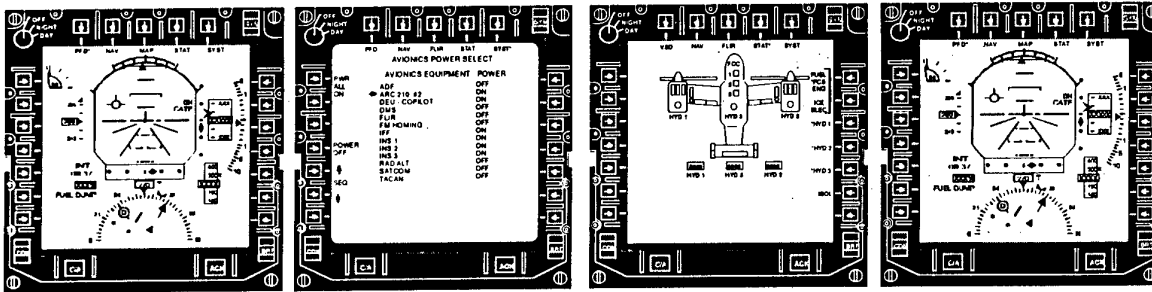

11/5/94

CKPT PREFLT 9

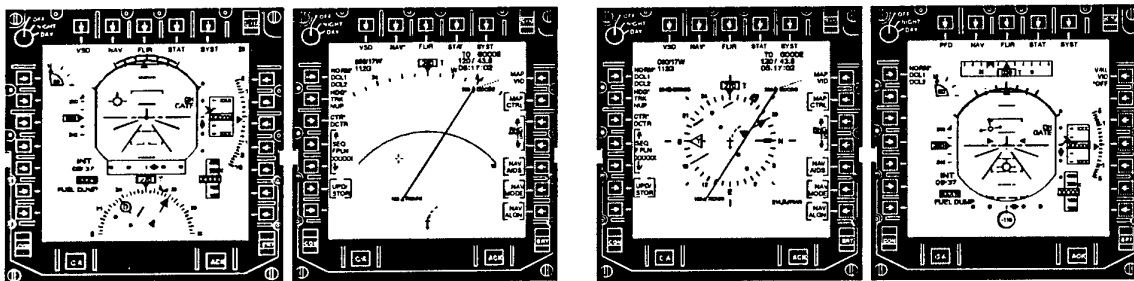

11/7/94

RP1-5

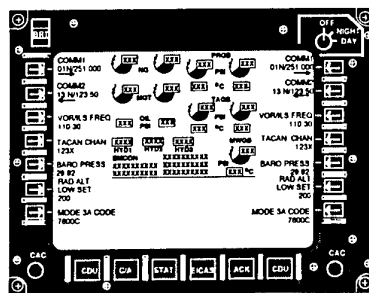

**PLANNED IMPROVMENTS:**

- Flat Panel Color MFDs
- Fully Integrated Helmet Mounted Sight/Display System
- Integrated Weapon Control for Nose Turreted Gun

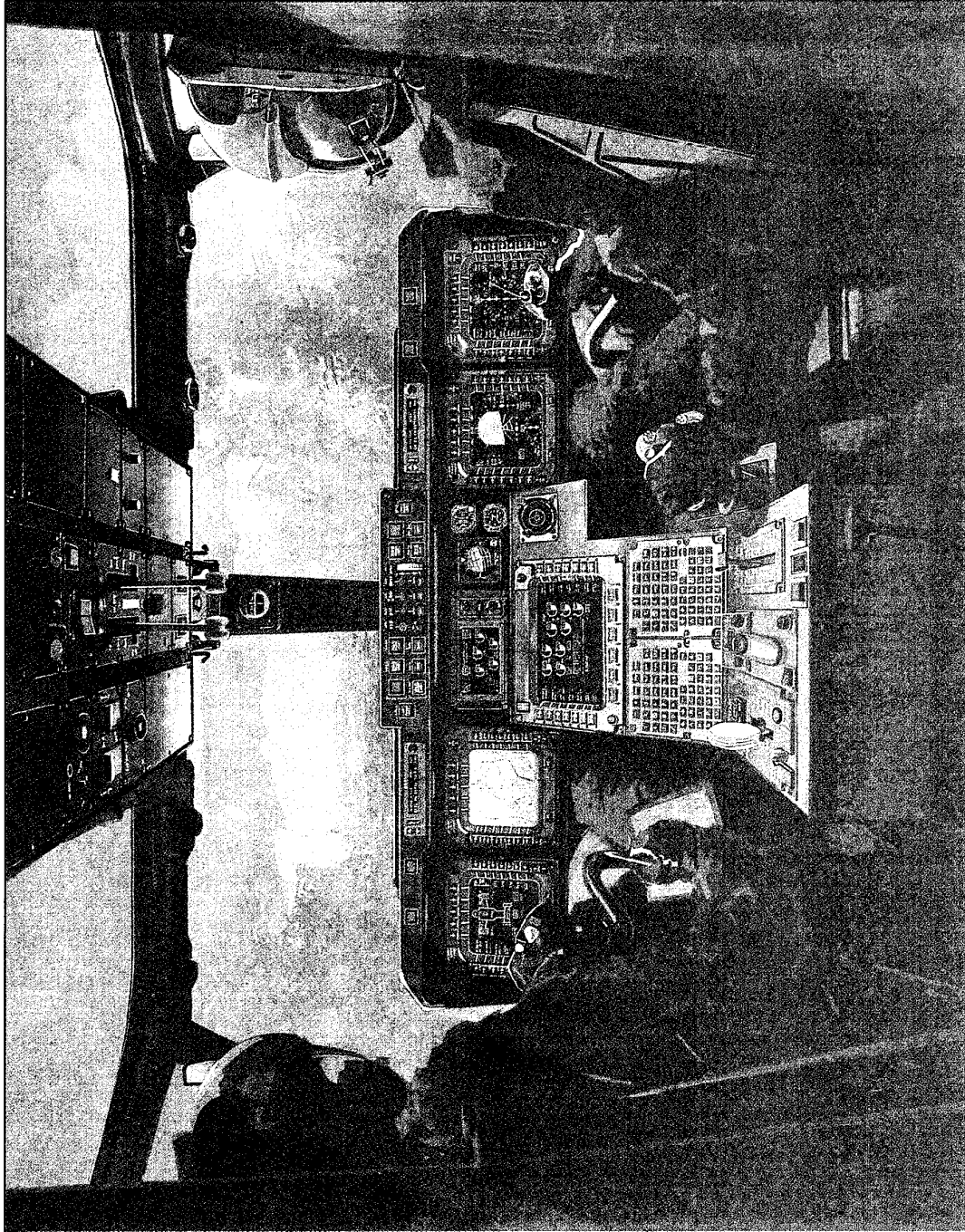

MV-22 Osprey Tiltrotor



## Longbow Apache Helicopter

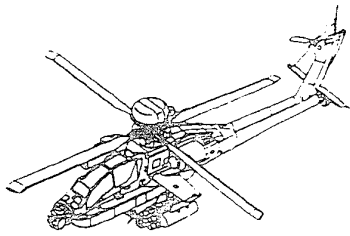

### Aircraft Characteristics

The AH-64D Longbow Apache is an Advanced, Multi-Mission, All-Weather, Day and Night, Heavy Attack Helicopter Manufactured by McDonnell Douglas Helicopter Systems. It is a Land Force, Combat Maneuver System That Operates in the Same Environments as Other Combat Systems – Close to the Earth. It is Most Effective When Employed at Night or During Periods of Reduced Visibility.

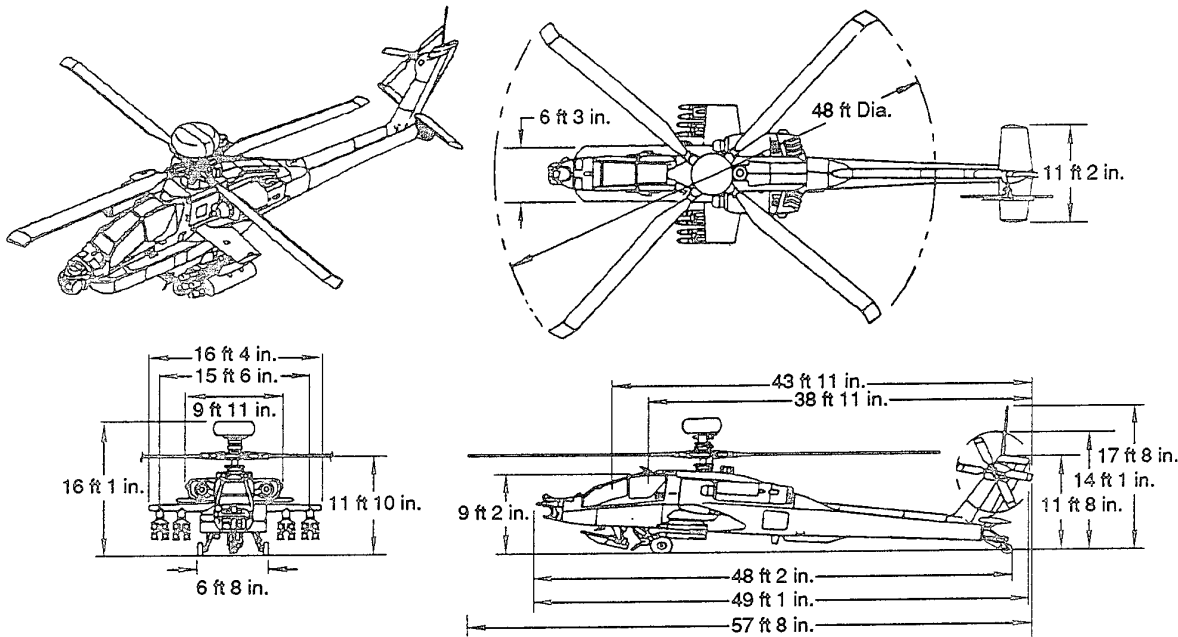

Leading Particulars (See Level, Standard Day, Mission Gross Weight):			
• Length, Including Main Rotar.....	57 ft 8 in.	• Empty Weight.....	11,800 lb
• Width.....	16 ft 4 in.	• Primary Mission Gross Weight.....	16,491 lb
• Height.....	16 ft 1 in.	• Max. Gross Weight.....	22,283 lb
• Rotor Diameter.....	48.00 ft	• Max. Range, Internal Fuel.....	220 NM
• Vertical ROC.....	1,555 fpm	• Max. Endurance, Internal Fuel.....	3.20 Hr.
• Max. Level Flight Speed.....	141 kt	• Air Portability	
• Design Limit Speed.....	197 kt	Transportable In:.....	C-17, C-130, C-141 or C-5A
• Engines (2) T700-GE-701C Each.....	1,890 shp		

### Missions

#### Primary

- Anti-Armor
- Armed Reconnaissance
- Security
- Deep Attack

#### Alternate

- Air Defense Suppression
- Close Support
- Coastal Defense
- Special Operations
- Peace Keeping/Crisis Response

#### Weapon Capability:

- HELLFIRE Missiles (RF/SAL).....16
- 70mm Multi-Purpose Submunitions.....76
- 30mm Ammunition Rounds.....1,200
- Air-to-Air Missiles (Wingtip-Mounted).....4

### Mission Equipment

- Fire Control Radar
- Target Acquisition Designation System
- Automated Mission Planning Station
- Pilot Night Vision Sensor
- Night Vision Compatible Crew Stations
- Radar Warning Receiver
- Chaff

## Longbow Apache Helicopter

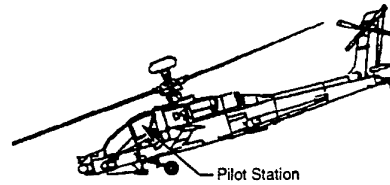

### Pilot Station Layout

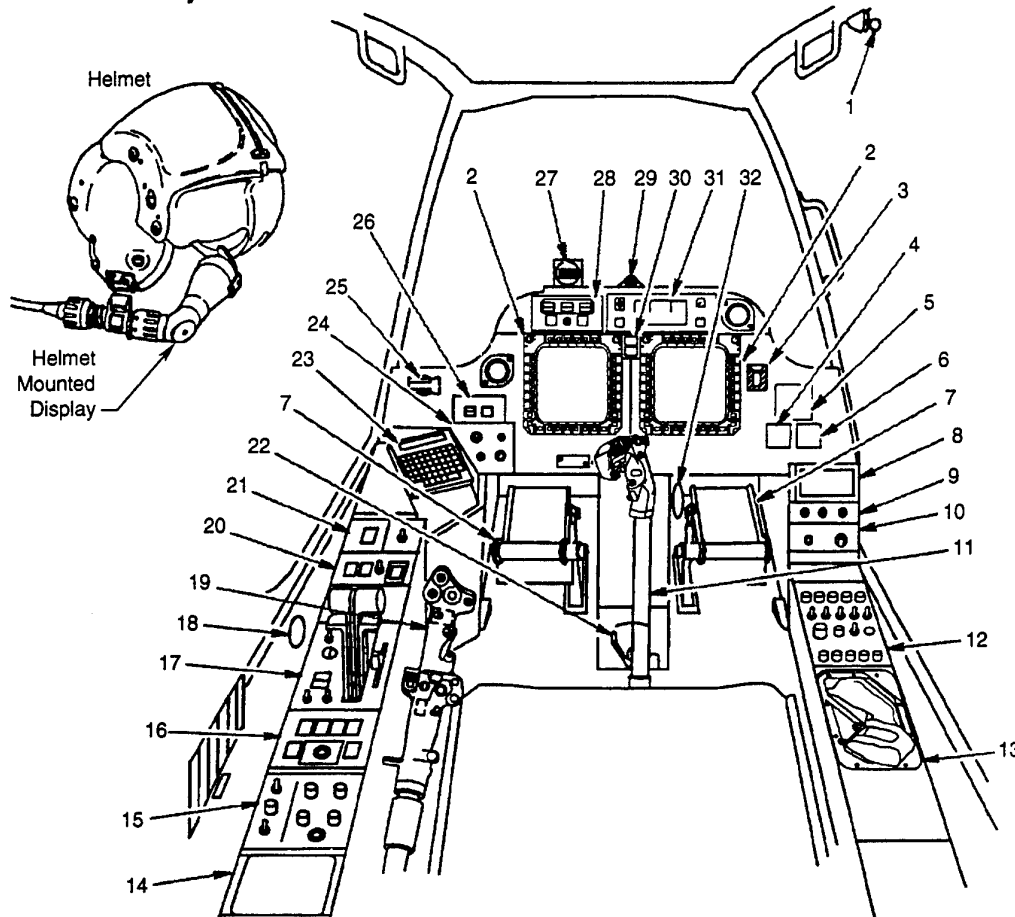

1. Canopy Door Release	10. Windshield Wiper Panel	18. Outside Air Temperature	27. Standby Compass
2. Multifunction Display	11. Cyclic Stick	19. Collective Stick	28. Fire Detection/Extinguish Panel
3. Master Zeroize	12. Communications Panel	20. Emergency Panel	29. Boresight Reticle Unit
4. Standby Airspeed Indicator	13. IHADSS Storage	21. Tail Wheel Lock/NVS Mode Panel	30. Master Warning/ Master Caution Pushbutton
5. Standby Attitude Indicator	14. Lighting Distribution Unit	22. Pedal Adjust Lever	31. Up-Front Display
6. Standby Altimeter	15. Exterior/Interior Lighting Panel	23. Keyboard Unit	32. Parking Brake Handle
7. Directional Control Pedals	16. Selective Stores Jettison Panel	24. Video Control Panel	
8. Data Transfer Cartridge	17. Power Lever Quadrant	25. Canopy Jettison Handle	
9. Check Overspeed Test/ Generator Reset Panel		26. Armament Panel	

### Underlying Design Concepts

- Flexibility With Programmable Multifunction Displays
- Ease of Use With Hands-On Throttle-and-Stick (HOTAS) Controls
- Head-Up Operations With Up-Front Display and Helmet Mounted Display
- Optimized Integration of Instruments and Controls

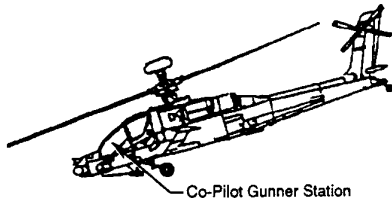

Co-Pilot Gunner Station

**Co-Pilot Gunner Station Layout**

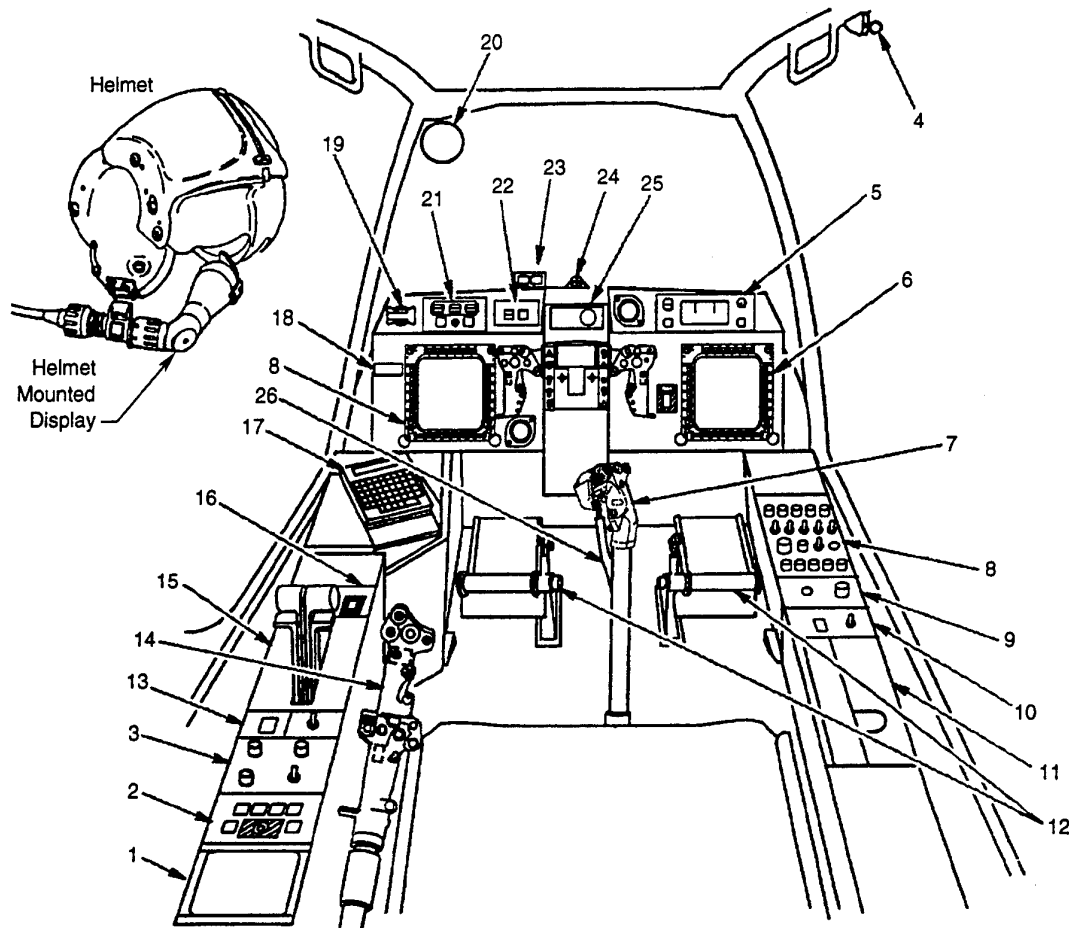

1. Lighting Distribution Unit	8. Communications Panel	15. Power Lever Quadrant	22. Armament Panel
2. Storage Jettison Panel	9. Windshield Wiper Panel	16. Emergency Panel	23. Master Warning / Master Caution Pushbuttons
3. Interior Lighting Control Panel	10. Processor Select Panel	17. Keyboard Unit	24. Boresight Reticule Unit
4. Canopy Door Release	11. IHADSS Storage	18. Radio Call Placard	25. Optical Relay Tube
5. Up-Front Display	12. Directional Control Pedals	19. Canopy Jettison Handle	26. Pedal Adjust Lever
6. Multifunction Display	13. Tail Wheel Lock / NVS Mode Panel	20. Rear View Mirror	
7. Cyclic Stick	14. Collective Stick	21. Fire Detection / Extinguishing Panel	

**Underlying Design Concepts**

- Missionized Cockpit for More Efficient Co-Pilot - Gunner Operations
- Hands-On Targeting and Weapons Delivery
- Full Flight Control Capabilities
- Improved Crew Mutual Support Through Multifunction Displays

## Longbow Apache Helicopter

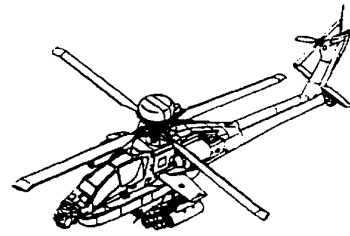

### HOTAS

All Fire Control Radar Switches Located on the Pilot's and CPG's Collective Grip Are Also Located on the CPG's Targeting Grips. The Locations of Shared Switches Are Standardized Among Grips to Simplify Learning. This Control and Display Redundancy Permits Either Crew Member to Acquire and Engage Targets With Equal Efficiency. The AH-64D Cyclic, Collective, and Targeting Grips Were Designed Without Multiple-Function Grip Switches. Each Switch Position Performs one Function Only.

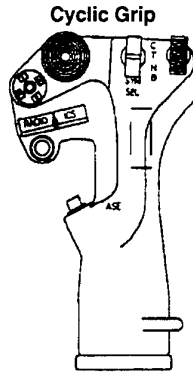
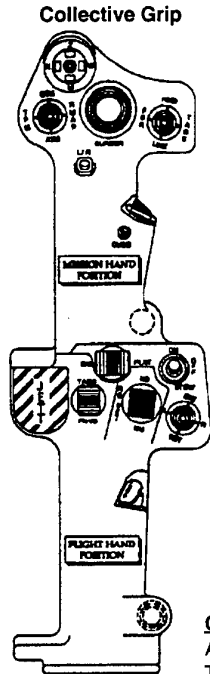

#### Cyclic Grip Switch

Force Trim/Hold, Weapons Action Select, Symbology Select, Weapons Trigger, Automatic Stabilization Equipment Disengage, Radio Transmit, Radio/ICS Select

#### Collective Grip Switch

FCR Scan Size, Cursor, Sight Select, Enter, FCR Scan, Cued Search, Missile Advance, Search Light Power, Search Light Position, Stabilator Control, Guarded CHOP, Tailwheel Unlock, TADS/PNVS Select, Emergency Jettison Stores, Boresight/Polarity, Cursor Display Select, FCR Mode

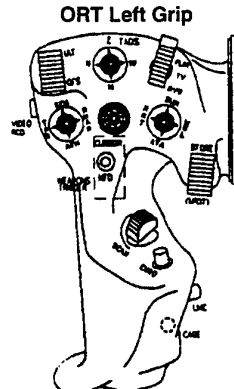

#### ORT Left Grip

#### ORT Left Grip Switches

Image Auto Track, TADS Field-of-View, TADS Sensor Select, Weapons Action, Store/Update, Cursor MFD Select, FCR Scan, Cued Search, Linear Motion Compensation, Weapons Trigger, Cursor Controller, FCR Mode, Video Record

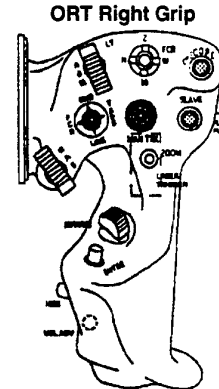

#### ORT Right Grip

#### ORT Right Grip Switches

Laser Tracker, FCR Scan Size, C-Scope, FLIR Polarity, Sensor Slave, Sensor Manual Tracker, Display Zoom, Laser Trigger, Missile Advance, Head Down Display, Cursor Enter, IAT Polarity, Sight Select

### Integrated Helmet and Display Sighting System (IHADSS)

- Monocular, Mono Green, Projected Raster
- 50° Diameter Field-of-View
- Symbology or Composite 875 Line Video in 4:3 Aspect Ratio

HMD Weapon and Flight Formats Provide Basic Flight Instruments and Weapons Aiming, While Still Allowing Night Vision Imagery for Pilotage and Target Acquisition

#### Transition Mode Flight Format

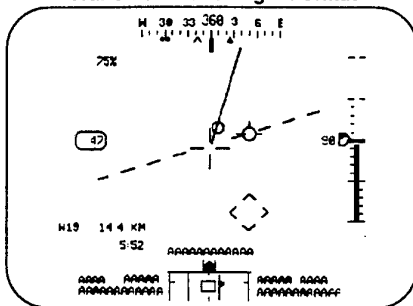

### Data Entry – Up-Front Display

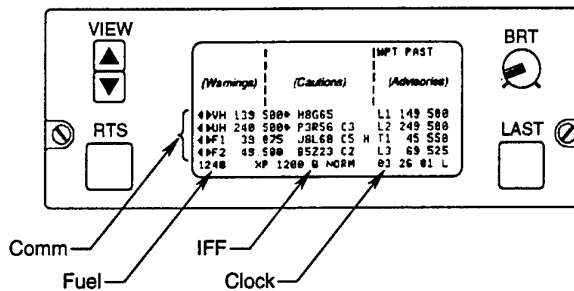

- 10 Line x 35 Column, Mono Green LED
- 2 Comm Pushbuttons, Scrolling Rocker Switch

The Up-Front Display Provides Continuous Notifications of Warning/Caution/Advisory Conditions, Voice and Digital Comm Status, IFF Status, Fuel Remaining, and Current Time

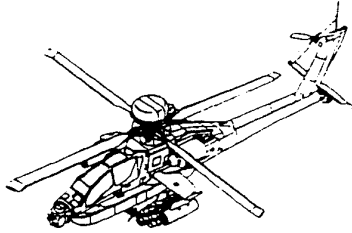

## Longbow Apache Helicopter

### Displays

- 6" x 6" Raster CRT, 1:1 Aspect Ratio
- Mono Green, 875 or 525 Line Composite Video
- 23 Variable, 7 Fixed Legend Pushbuttons

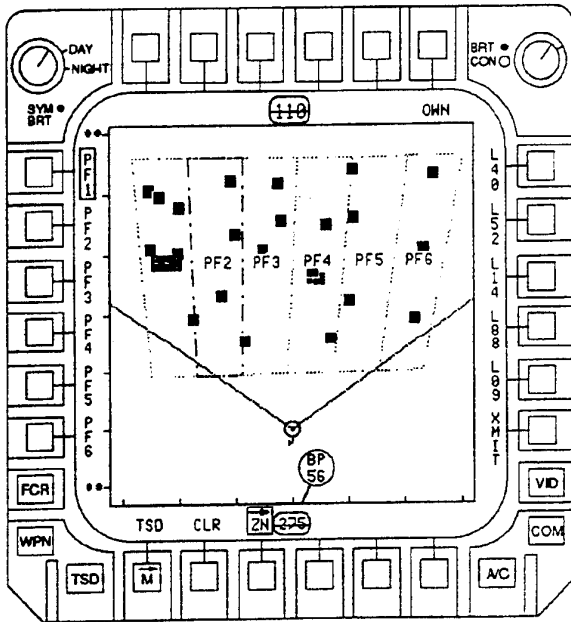

#### Tactical Situation Display (TSD) Page

- Moving "Stick Map" Display
- Navigation Routes and Control Measures
- Hazards, Targets and Threats
- Engagement Areas With Priority Fire and No Fire Zones
- Enables Battle Management and Attack Team Coordination
- Minimizes Fratricide Potential
- Redundant Acquisition Source Selection
- Battle Damage Assessment and Digital Target Reports
- Hot-Link to Aircraft Survivability Equipment Pages (Appropriate Page Configurations)

#### Weapon Page

- Weapons (Gun, Missile, Rocket) Status and Configuration
- Weapon Inventory and Status Displayed in Icons
- Arm/Safe Status Indication
- Sight and Acquisition Source Selections
- Laser Configuration Parameters
- IHADSS Boresight and Grayscale Functions
- Hot-Link to Coordinate Data and Aircraft Survivability Pages

#### Planned Product Improvements:

- Color Liquid Crystal Displays
- Digital Map System
- Improved Computer Processors
- Generation 2 FLIR
- Stinger or Starstreak Air-to-Air Missile
- Rotorcraft Pilot's Associate Technology
- Insertion

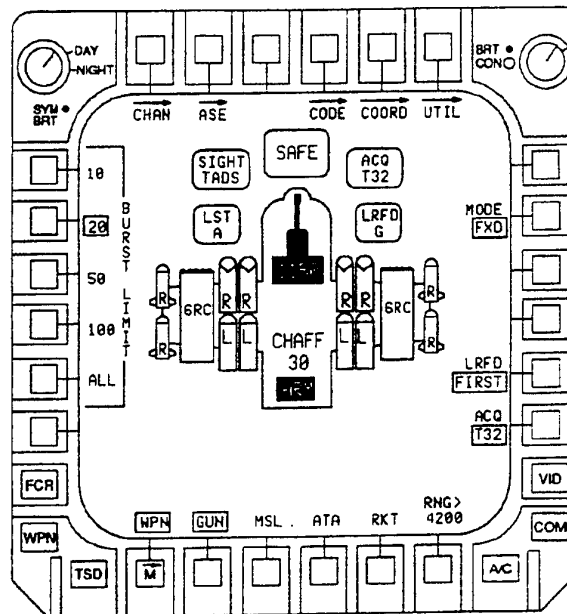

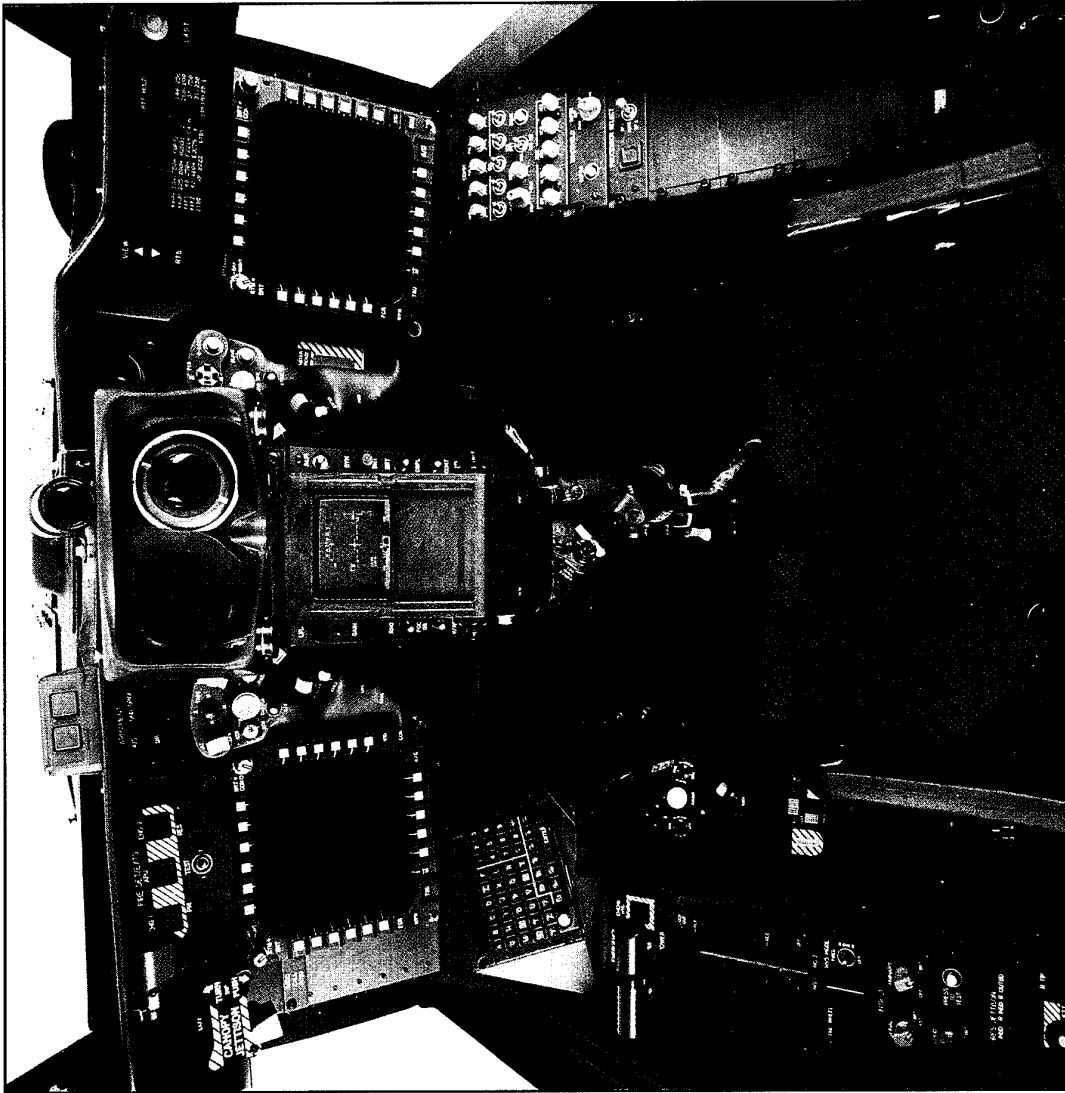

AH-64D Longbow Apache Front Cockpit (Co-Pilot/Gunner)

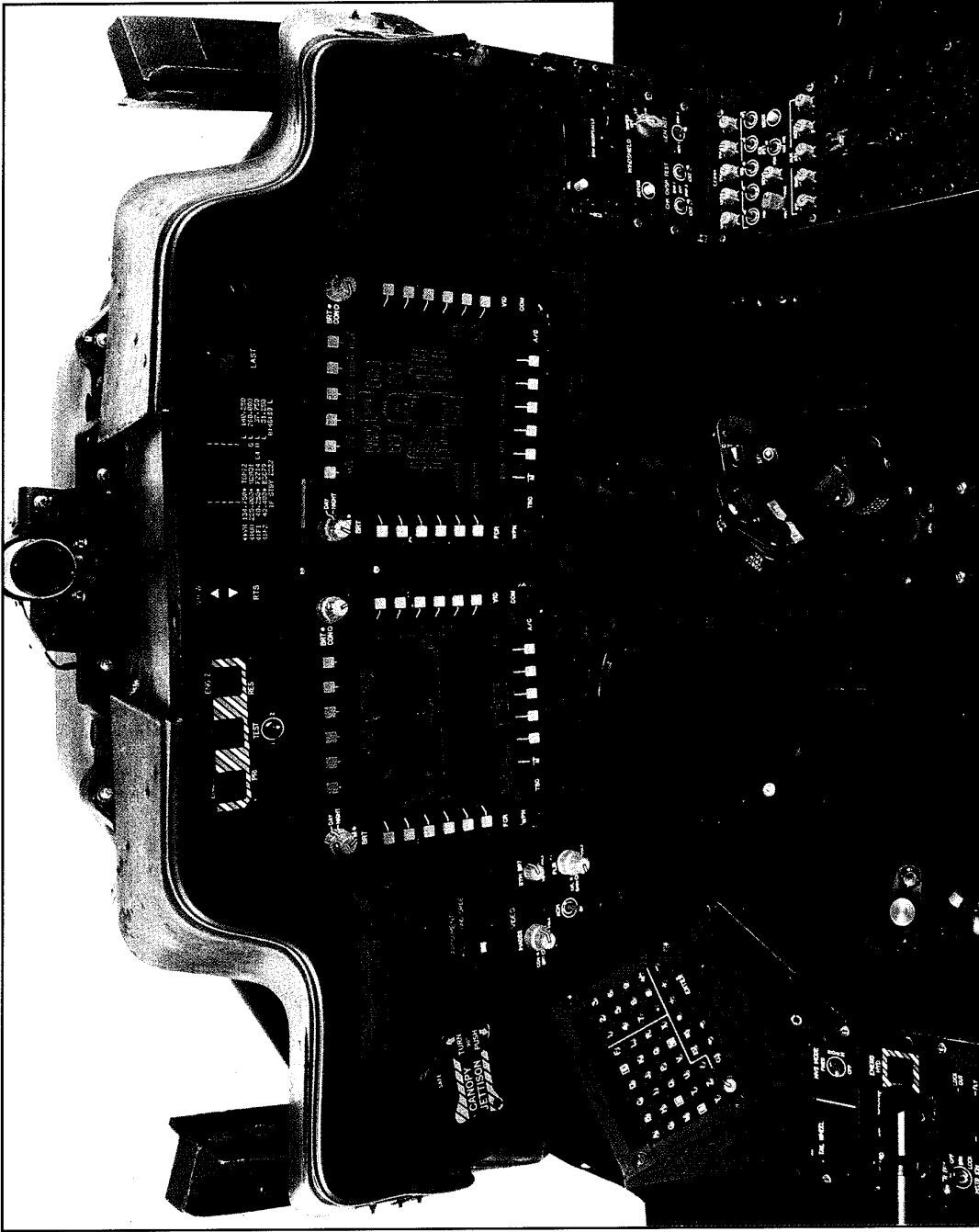

AH-64D Longbow Apache Front Cockpit (Co-Pilot/Gunner)

## Boeing Sikorsky RAH-66 Comanche

### AIRCRAFT CHARACTERISTICS

The RAH-66 Comanche will replace the US Army's fleet of AH-1 Cobra attack helicopters and the OH-58 Kiowa scout helicopters. The Comanche will provide the core of the aeroscout function for the Army and provide attack capabilities for light Divisions and Cavalry units by replacing these aircraft.

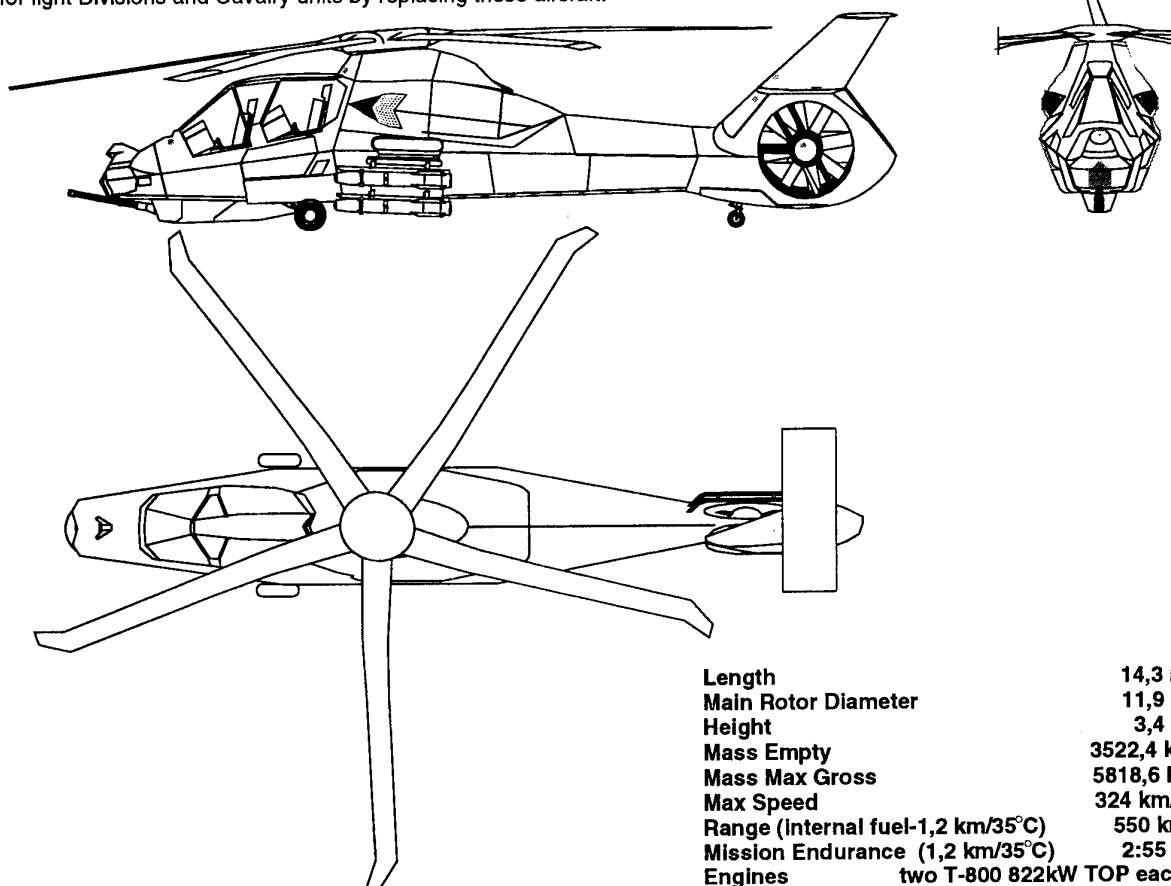

Length	14,3 m
Main Rotor Diameter	11,9 m
Height	3,4 m
Mass Empty	3522,4 kg
Mass Max Gross	5818,6 kg
Max Speed	324 km/h
Range (Internal fuel-1,2 km/35°C)	550 km
Mission Endurance (1,2 km/35°C)	2:55 h
Engines	two T-800 822kW TOP each

### MISSIONS AND MISSION EQUIPMENT

The Comanche's primary missions are armed reconnaissance and attack, both of which have implied self-defense air-to-air combat requirements. Comanche is also able to perform as a fire support platform for artillery. The following mission equipment will be available on Comanche:

- Sensors:
  - Nose-Mounted Sight with Infrared and TV Camera; Aided Target Detection/Classification
  - Laser rangefinder/designator
  - Millimeter Wave Radar (Longbow)
  - Nose-Mounted, Second generation Infrared Pilotage Sensor
  - Laser, Chemical, and Radar Warning Receivers
- Weapons:
  - HELLFIRE (Laser, Longbow)
  - Hydra 70 (2.75" Folding Fin Aerial Rocket)
  - STINGER/TACAMS
  - 20 mm Turreted Gun

### COCKPIT LAYOUT

The Comanche is a tandem-seat aircraft with the pilot in the front and copilot /gunner in the rear. The two cockpits are physically and functionally identical. The aircraft is fully flyable from either cockpit using a three-axis side-arm controller as cyclic and a displacement collective. Seats are energy attenuating and armored with separate wing armor and an optional armor kit for the floor. The cockpits are night vision goggle compatible.

**Control and Display Concept:** The aircraft, mission avionics, sensors, and weapons are all controlled via an integrated network of computers working in parallel within an open bus architecture. This allows most control functions to migrate to the displays where information and resources can be combined independent of hardware implementation. As a result, the control and display operations are designed around the concept of identifying specific, discrete mission segments and then supplying the required information and controls for task completion. Tasks are accomplished independently, interactively, or simultaneously. Responsibility for mission tasks can be dynamically allocated to either crewmember.



### Boeing Sikorsky RAH-66 Comanche

#### COCKPIT LAYOUT

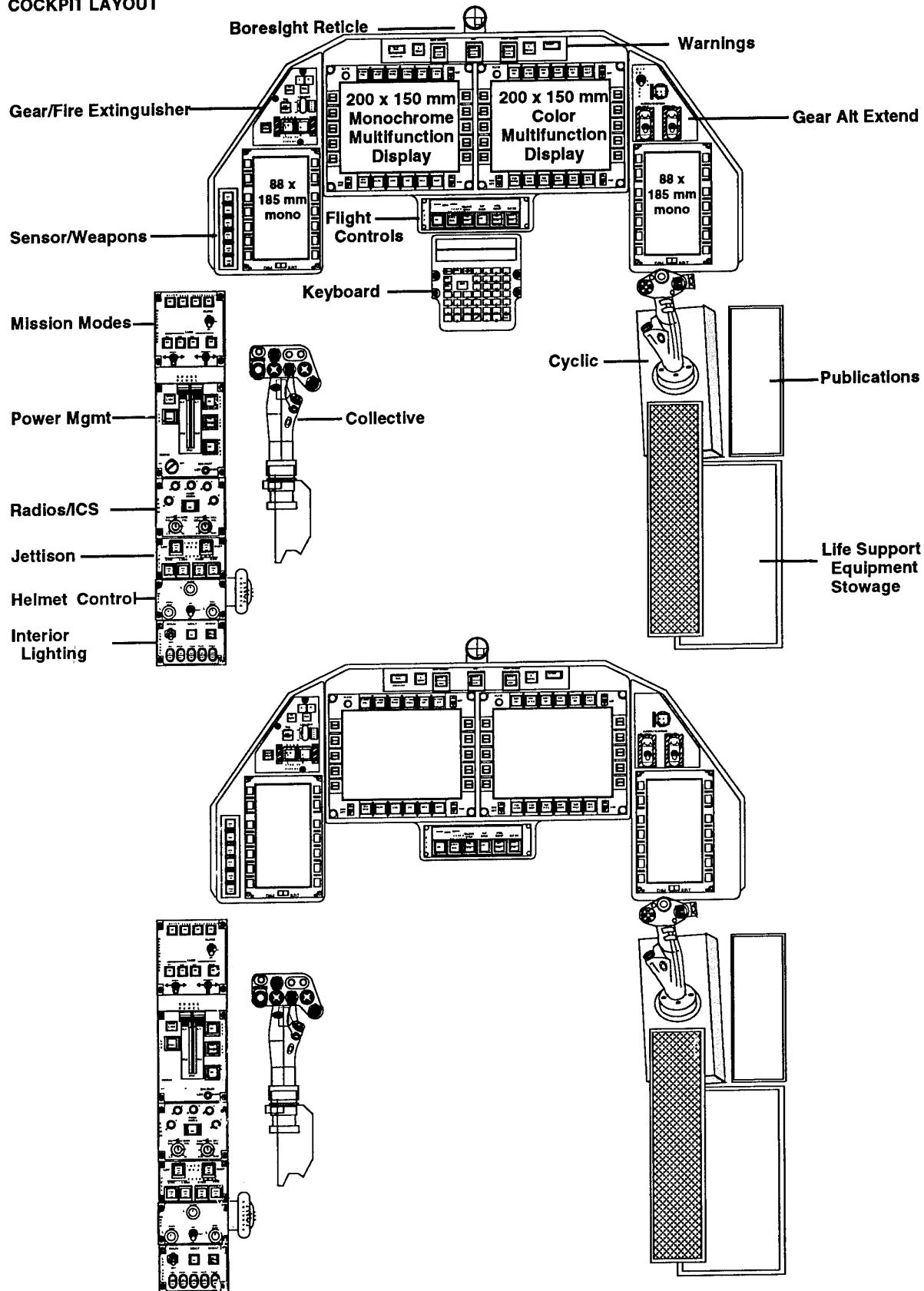

## Boeing Sikorsky RAH-66 Comanche

**HOTAS:** The Hands On Grips controls enable immediate access to sensors, weapons, radios, target data, and access to subsystem management.

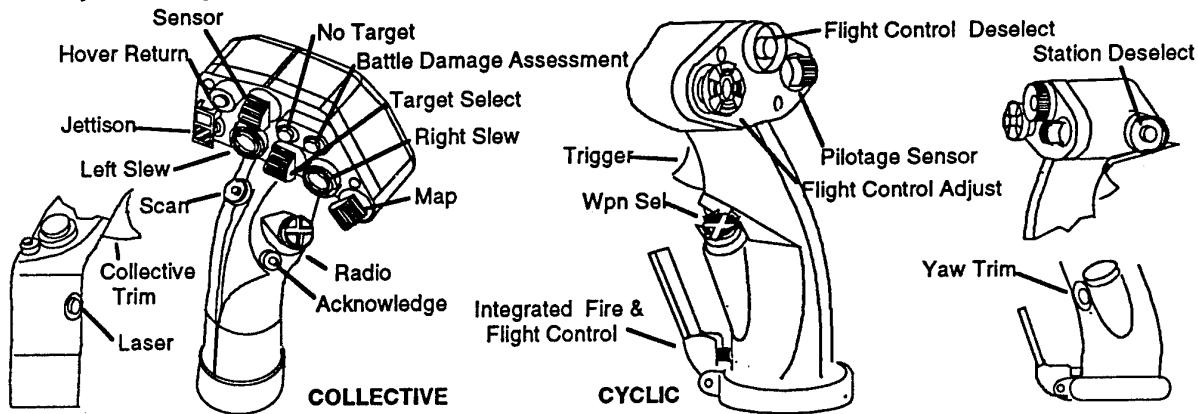

### HEAD-UP DISPLAY

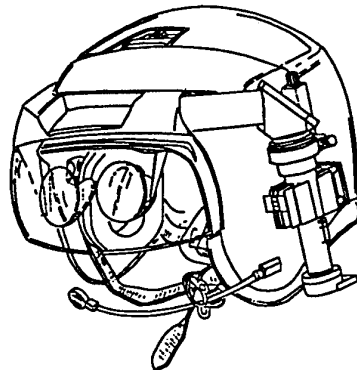
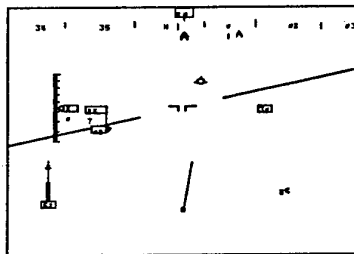

**HIDSS:** The Helmet Integrated Display and Sight System (HIDSS) is a biocular helmet-mounted display for flight information and night vision sensors and a sight system for use with weapons. Each crewmember has a helmet providing acoustic and impact protection which mounts two CRTs and a magnetic helmet tracker on a removable frame. The HIDSS can combine symbology with sensor images. It displays pilotage symbology, weapon's symbology, helicopter and ASE warnings:  
**Display:** FOV 52° x 30° CRT  
 Raster/stroke  
 525 lines (960 pixels/line)

### DATA ENTRY

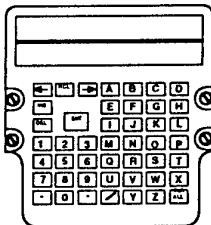

**Keyboard:** A keyboard is provided to allow the crew to enter data directly into the avionics. The keyboard is an intelligent, 2 line, 46 character device. It has insert and overstrike modes, free text or up to four data fields with protected prompts. Data can be entered independent of mode of use and then recalled to allow transfer into a data field (e.g. a frequency can be entered into the keyboard as a scratchpad and then recalled for use in the radio frequency tuning routines).

**DTU:** A high speed, high capacity Data Transfer Unit is used to allow transfer of required mission data (flight plans, communications plans, map data, and flight software) from ground planning stations to the aircraft.

### DISPLAYS

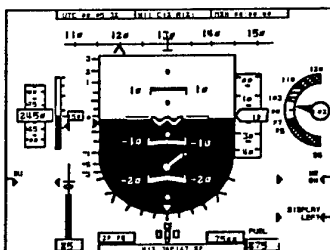

**PRIMARY FLIGHT DISPLAY**

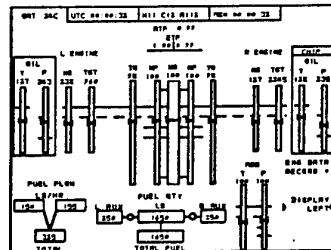

**ENGINE INSTRUMENTS**

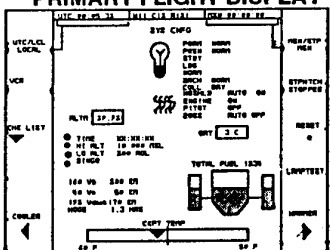

**AIRCRAFT CONFIGURATION**

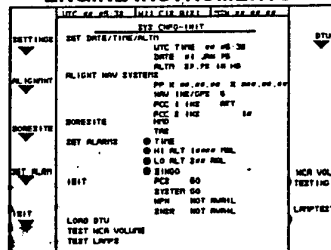

**AIRCRAFT INITIALIZATION**

**Left MFD:** The left MFD of each cockpit is used for display and control of sensors, communications mgmt, Warnings, Cautions, and Advisories, instruments, health status, navigation, ASE, Weapons mgmt, and subsystem control.

**Display:** 200 mm x 150 mm LCD  
 Monochrome  
 640 x 480 or 960 x 480 pixels

**Right MFD:** The right MFD of each cockpit is used for the tactical situation display. This display includes map data, navigation overlays, threat overlays, battle plans, and recommended actions. It is fully interchangeable with the left display.

**Display:** 200 mm x 150 mm LCD  
 Color  
 640 x 480 or 960 x 480 pixels

## Boeing Sikorsky RAH-66 Comanche

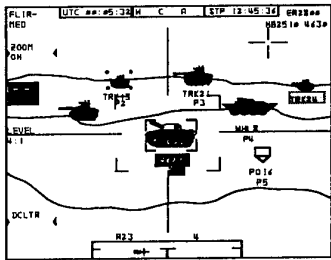

**SENSOR DISPLAY**

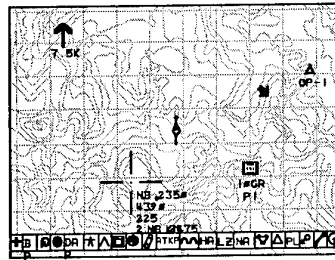

**TACTICAL SITUATION DISPLAY**

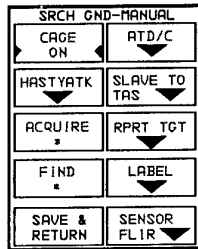

**SENSOR CONTROL**

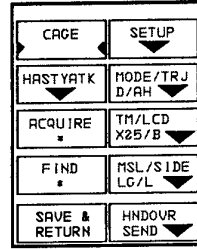

**WEAPONS CONTROL**

**Right Wing MFD:** The right wing MFD is used for aircraft status (status of laser, doors, etc.), radio display, and ordnance status. It is also the backup flight display.

**Display:** 88 mm x 185 mm LCD  
Monochrome  
280 x 580 pixels

**Left Wing MFD:** The left wing MFD of each cockpit is used for the tactical status (status and function of sensors, weapons) and controlling active tasks.

**Display:** 88 mm x 185 mm LCD  
Monochrome  
280 x 580 pixels

The Comanche crew interface was designed to meet the challenges of added capabilities/technologies and total dependence upon a glass cockpit interface while increasing crew situation awareness and effectiveness with reduced workload. This is accomplished by designing to a mental model in which the aircraft systems were viewed as tools to accomplish identified tasks rather than as generic capabilities which the crew would have to integrate into best available solutions. Workload problems, such as menu navigation, maintenance of situation awareness, and crew coordination, were identified and supported by embedded design features. Whenever possible, all required data is brought to the crew rather than forcing them to search for data. Data is preprocessed into answers rather than facts

### DIGITAL MAP

The Comanche has two map generation modules which allows each station to have independent map displays. Each map module is capable of displaying a digital map, a digitized map, custom maps, and video pictures. The aircraft carries the data necessary for the map to cover 90000 km<sup>2</sup> in up to 4 scales. The digital database also supports generation of lines of sight, height above threshold, and perspective views. A wide variety of navigation, tactical, and situation awareness overlays are available.

### DATA LINK

The Comanche is interoperable with most US Army battlefield digital systems. It uses Improved Digital Modem (IDM), Airborne Target Handover System (ATHS), and Advanced Field Artillery Tactical Data System (AFATDS) protocols. Comanche can transmit sensor images and receive digitized photos.

### VIDEO MEMORY

The Comanche uses bulk data memory to store sensor images processed during aided target detection and classification. The crew can review sensor sweeps from masked positions to optimize recognition and identification, generate reports, and build situation awareness without exposing the aircraft.

### BACKUP MODES

The Comanche has multiple levels of redundancy and is capable of automatic reconfiguration. Flight critical components operate off permanent magnet generators and independent of mission computers. Backup displays appear automatically on the right wing MFD upon mission computer failure. This display provides aircraft flight information, engine parameters, and basic Warning, Caution, and Advisory displays.

### WARNING CONCEPT

The Comanche is designed on a display by exception basis. The crew is not required to monitor systems for performance or faults. Every device on-board the aircraft has built-in testing and undergoes periodic health statusing. The results of this testing are processed to eliminate false and spurious alerts. Indications caused by faulty sensors or processing are noted and reported as advisories. Context is introduced to prevent alerting the crew to changes which are caused by normal crew actions. All fault events are filtered to identify information which the crew requires and all events are stored for postflight analysis. Information which needs to be provided to the crew is sorted into "like" systems with "like" outcomes. These grouped "like" events are then provided to the crew interface management software as Warnings, Cautions, and Advisories. The individual events are presented to the crew as a "segment" within a "banner" presented on the right MFD. Each "segment" is worded to convey system, fault type, and immediacy of required action. "Segments" are accompanied by either a tone or voice message if severity warrants. If conditions permit, the crew may opt to access a Warnings, Cautions, and Advisories routine which allows a disciplined overview of the current fault situation, detailed information about specific events (access the specific fault which had been grouped with "like" faults), specific Go/NoGo lists, and emergency checklists. In the context of Comanche, Warnings, Cautions, and Advisories include tactical alerts, such as notification of search radars, and advisories from the avionics system.

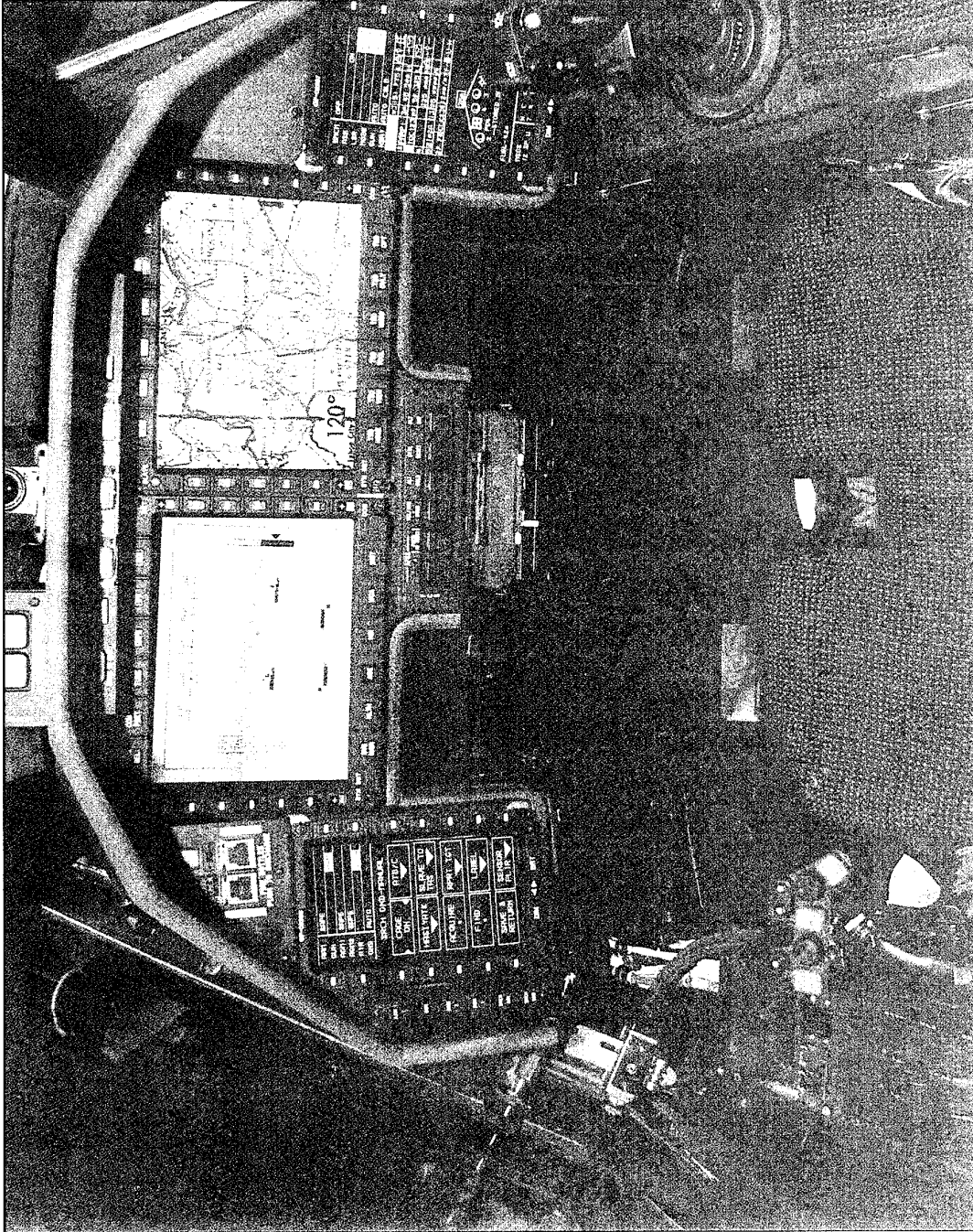

RAH-66 Comanche Front and Rear Cockpit

## Civil Transport Aircraft, Specifically the Airbus A330

### I. AIRCRAFT CHARACTERISTICS

At the present time it is almost unthinkable that newly designed transport aircraft enter service without a glass cockpit (e.g. A330; B777; MD-11; F100). The same applies to a number of upgraded versions of aircraft which have been in operation for many years (e.g. B747-400; B737/300; F50).

This concept started, for the larger transport aircraft, with the arrival of the Airbus A310, the Boeing 757/767 and the McDonnell Douglas MD-80 in the early eighties.

All major aircraft manufacturers have continued this development in expanding their range of aircraft, enhancing automation and display concepts and implementing new designs in flight control.

One of these aircraft, the Airbus A330, because of its innovative features in many respects, will be highlighted and serve as a model for the description to follow.

The A330 is a medium to long range twin-engined transport aircraft, capable of seating up to 440 passengers. The aircraft, which entered service in 1993, combines the advanced technology developed for the A320 and A340 series with experiences from the A300 and A310 aircraft.

Main design- and operational- features are:

- \*Efficient use of cockpit space.
- \*Display flexibility.
- \*Two crew operation with CRT displays.
- \*Fly by wire flight control system.
- \*Sidestick controllers.
- \*High level of automation in flight control.
- \*Full authority digital engine control (FADEC).
- \*Centralized maintenance system.

Basic certification is according to JAR 25 and JAR AWO rev. 2 to include Category II and Category III approach with autoland.

	A330-300		A330-300
Max. Take-off weight	212 000 kg	Max. fuel capacity	93 500 lit.
Max. Landing weight	174 000 kg	Max. operating altitude	41 000 ft.
Max. Zero fuel weight	164 000 kg	Vmo/Mmo	330 kt CAS/86

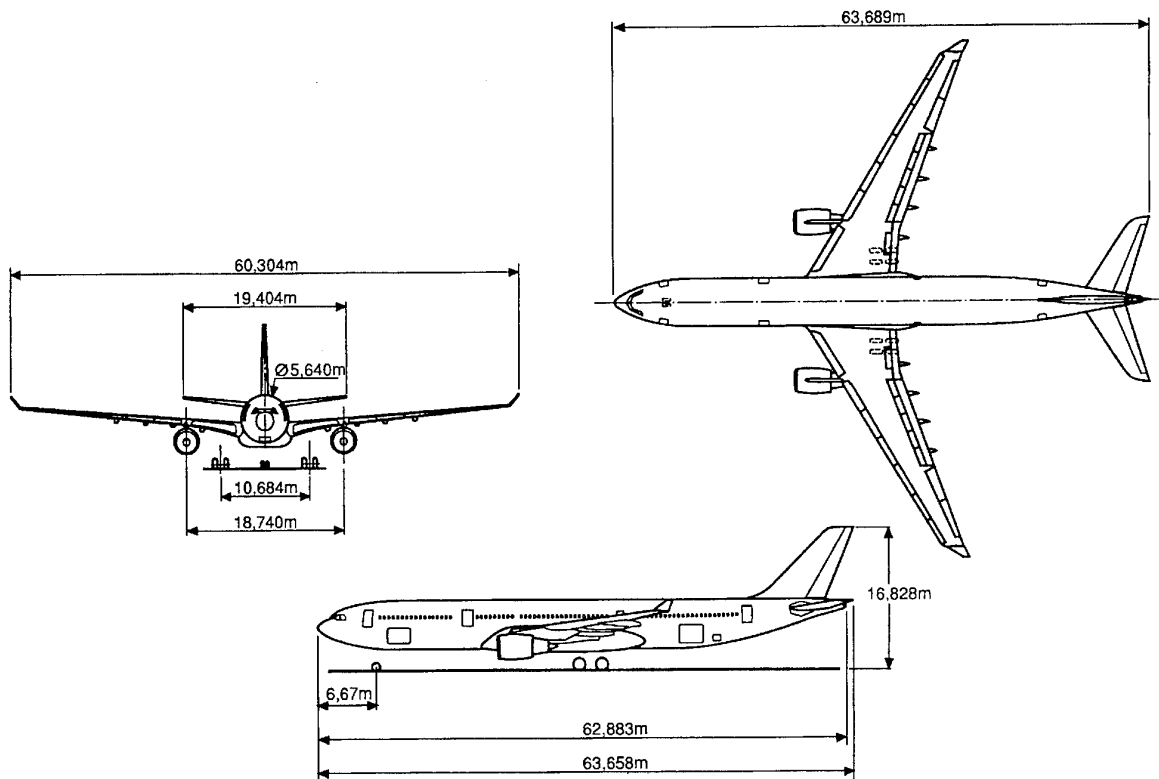

# Airbus A330

## II. COCKPIT FUNCTIONALITY (MISSIONS AND MISSION EQUIPMENT)

### LAYOUT OF INSTRUMENT PANEL

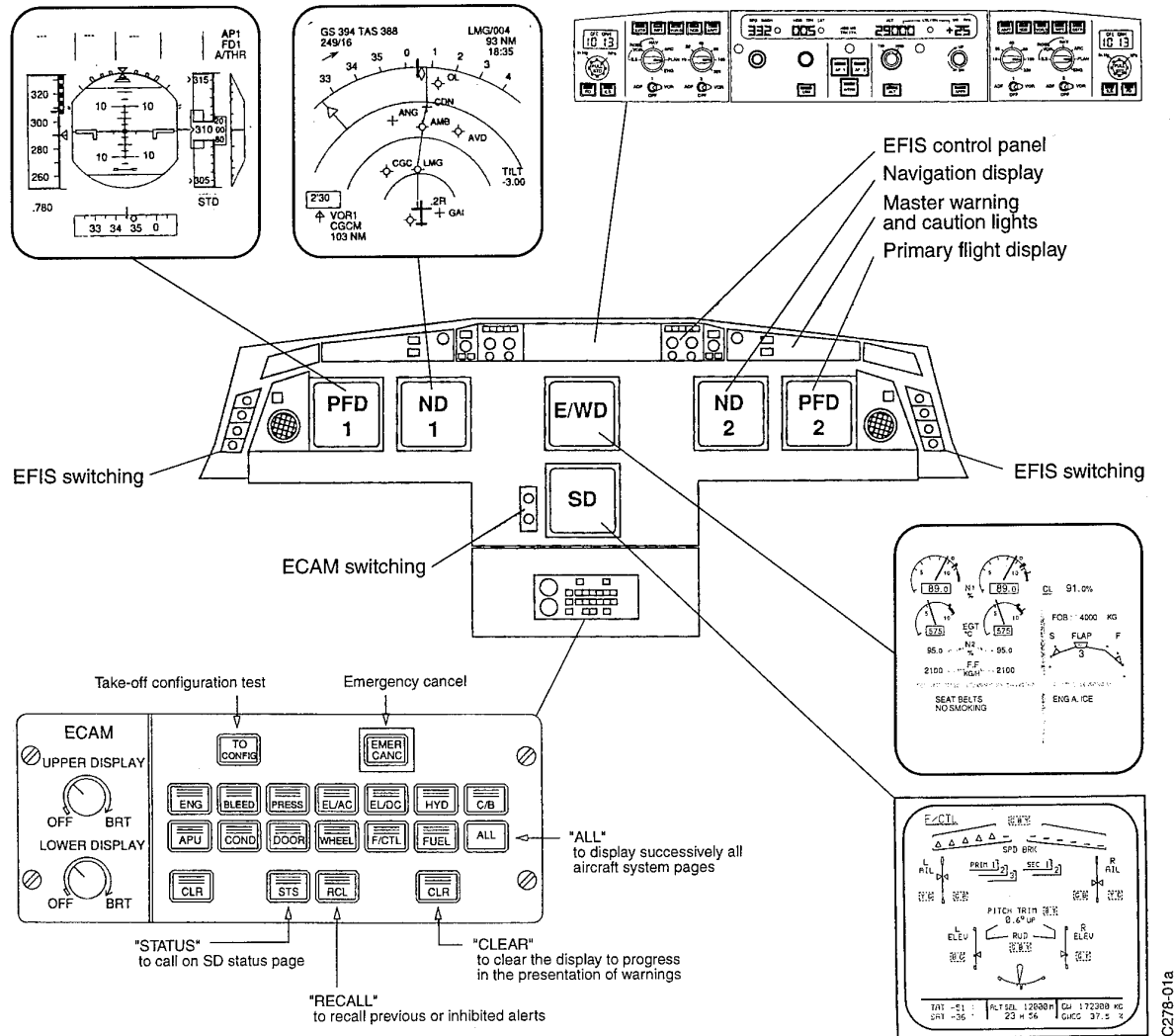

### UNDERLYING DESIGN CONCEPTS

#### General

- \*Cockpit commonality for the Airbus A319 up to, for the present, the A340.
- \*Simplification by reduction of components (dials, lights and switches).
- \*Intelligent use of color.

#### Primary Flight- and Navigation Display (Electronic Flight Instrumentation System-EFIS)

##### Primary Flight Display-PFD:

- \*Short term flight information.
- \*Retaining basic T, regarding relative position of flight information.
- \*Flight mode annunciation and flight progress alerting.

##### Navigation Display-ND:

- \*Medium term flight information.
- \*Adaptability of display mode.
- \*Specific information (e.g. weather and traffic related).

C278-01a

Engine and system display concept (Electronic Centralized Aircraft Monitor-ECAM)

- \*Provision of engine and system (status) display.
- \*Alert messages and failure indication.
- \*Step-by-step display of the relevant procedures.
- \*Remaining status and advisories.

Flight Warning System

- \*Automatic monitoring of system performance.
- \*Advance warnings are to be provided if trends indicate system degradation to the point of imminent failure.
- \*Analyses of failed (sub)system(s) or system components.
- \*Suppression of relatively non-critical alerts in high workload phases of flight.
- \*Prioritising of multiple failures.
- \*Proposed corrective action for the crew in abnormal system operation.
- \*Analyses for display of system status and remaining performance.
- \*Reduction of the number of different warnings.

Central Maintenance System

Main objective is to enhance the operational efficiency of the aircraft.

Reporting mode (active in flight):

- \*Recording of events necessitating maintenance on the ground.
- \*Optional print-out in flight.
- \*Provisions for ACARS data exchange with the ground.

Interactive mode (active on ground):

- \*For assistance of maintenance crews.

Service mode:

- \*Provides system status and servicing requirements.

## DESCRIPTION OF PRIMARY ELEMENTS

The Electronic Instrument System (EIS) satisfies the ARINC 429 databus standard with ARINC 600 packaging. It consists of the following primary elements:

Display Unit (DU): Display function.

- \*Six identical full color DU's.
- \*Size 7.25 inch x 7.25 inch.
- \*Each DU has a resident symbol generator.

For flight operation: EFIS.

- \*EFIS-PFD for attitude, airspeed/Mach, altitude, vertical speed, heading, radio altitude, navigation/approach deviations, flight progress status and traffic resolutions (optional TCAS).
- \*EFIS-ND provides navigation information in three possible modes of display: ROSE, ARC and PLAN; integration of weather information is possible in ARC mode; Traffic information (optional TCAS).

For system operation: ECAM.

- \*ECAM-Engine/Warning Display (E/WD) displays engine primary indications, warning/caution or memo messages, fuel quantity and slats/flaps position.
- \*ECAM-System Display (SD) displays aircraft system synoptic diagram- or status- messages.

EICAS, the counterpart of ECAM for the, in general, US-built transport aircraft provides identical functions, except for the step-by-step procedure.

Display Management Computer (DMC): Acquisition and processing function.

- \*Three identical DMC's.
- \*Each DMC has two independent channels: EFIS and ECAM.
- \*Each DMC can drive all six DU's with four independent formats: PFD; ND; E/WD; SD.

Flight Warning Computer (FWC): Alert messages, memo's, aural alerts, auto callouts, flight phase monitoring.

- \*Two identical FWC's.
- \*Each FWC is connected to all DMC's.

Description of alert messages:

Four levels are distinguished in alert messages. The highest, level 3, indicates an emergency condition, requiring immediate crew action; red is the colour of the indications; continuous repetitive chimes or special signals like the fire warning bell. Successive lower level warnings indicate diminishing seriousness of the event, use of different colors and aural alerts until level 0, which is information only.

# Airbus A330

## SOUNDS DEFINITION

WARNING SIGNAL	CONDITION	DURATION	SILENCING *
CONTINUOUS REPETITIVE CHIME	RED WARNINGS	PERMANENT	Depress MASTER WARN pb
SINGLE CHIME	AMBER CAUTION	1/2 sec.	
CAVALRY CHARGE	A / P DISCONNECTION BY TAKE OVER pb	1.5 sec	Second push on TAKE OVER pb
	A / P DISCONNECTION DUE TO FAILURE	PERMANENT	Depress MASTER WARN pb or TAKE OVER pb
CLICK	LANDING CAPABILITY CHANGE	1/2 sec (3 pulses)	
CRICKET + "STALL" message (synthetic voice)	STALL	PERMANENT	NIL
INTERMITTENT BUZZER	SELCAL CALL	PERMANENT	Depress RESET key on ACP
CONTINUOUS BUZZER	CABIN CALL	PERMANENT	Depress RESET key on ACP
C CHORD	ALTITUDE ALERT refer to 1.22	1.5 sec	new ALTITUDE selection or depress MASTER WARN pb
		PERMANENT	
AUTO CALL OUT (synthetic voice)	HEIGHT ANNOUNCEMENT BELOW 400 FT Refer to 1.34	PERMANENT	NIL
GROUND PROXIMITY WARNING (synthetic voice)	refer to 1.34	PERMANENT	NIL
"WINDSHEAR" (synthetic voice)	WINDSHEAR	REPEATED 3 TIMES	NIL
"PRIORITY LEFT" "PRIORITY RIGHT" (synthetic voice)	A / P TAKE OVER pb	1 sec	NIL
"RETARD" (synthetic voice)	THRUST LEVER NOT IN IDLE POSITION FOR LANDING	PERMANENT	THRUST LEVER

## Architecture - Flight Warning System (FWS)

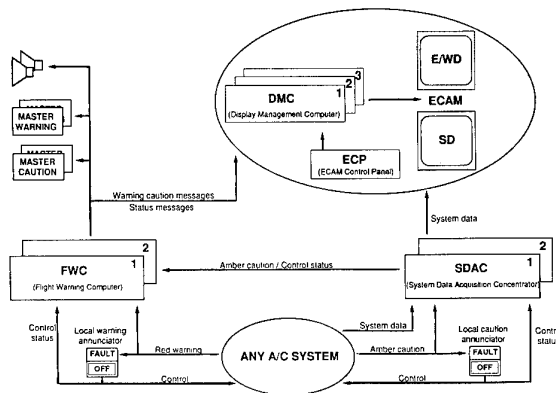

## III SYSTEM ARCHITECTURE AND BACK-UP MODES

The EIS is the primary display system. Main characteristics are:

\*A fully redundant EIS architecture

The three partitioned DMC's (EFIS/ECAM) drive the six DU's, resulting in full reconfiguration capability and full independence between EFIS and ECAM switching.

Result is improved dispatchability; no operational degradation if one DMC fails.

\*Fully redundant flight instrumentation displays for both crew members (PFD and ND in left- and right-instrument panel).

A back-up system, consisting of electro-mechanical instruments for the primary flight parameters enables basic instrument flight in case of massive failure of the primary display system.

## Architecture

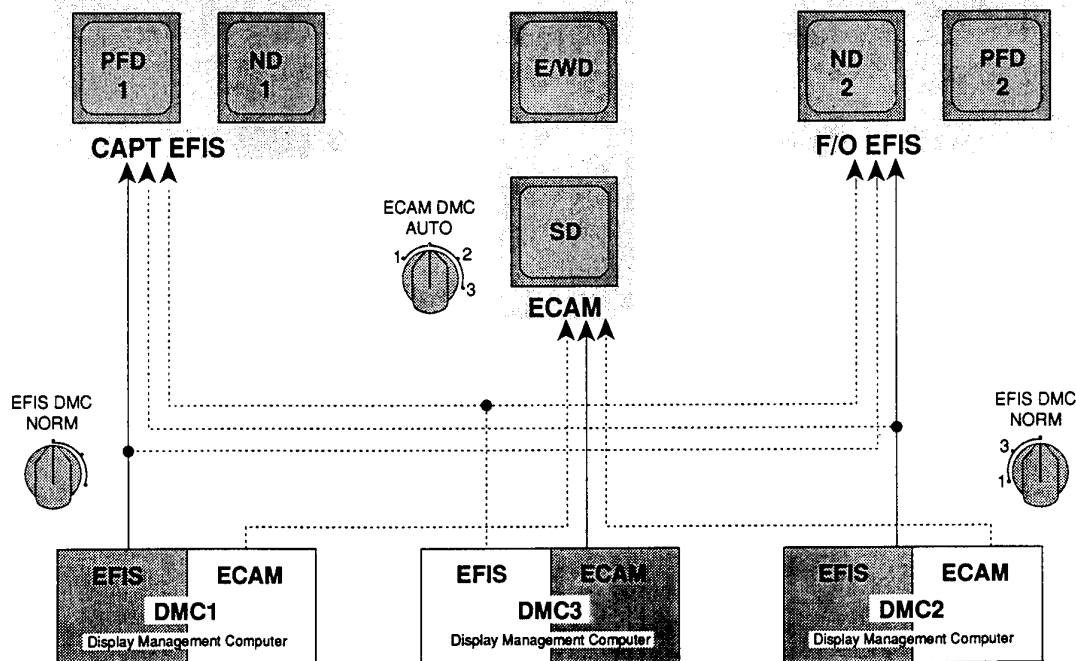



#### IV IMPROVEMENTS

Mentioned improvements are not specific for the A330 aircraft, but are more of a general nature.

Display hardware:

The next generation will most probably use flat panel LCD's in stead of CRT's. Benefits are a reduction in depth from approximately 45 cm. to less than 10 cm. and a reduction in weight and heat dissipation. Reliability will be improved.

Datalink:

This provision will enable high rate digital data exchange between aircraft and ground. Thus ATC clearances can be displayed. Another area of particular value is uplinking actual and forecast weather information.

Enhanced Vision Systems (EVS):

The envisaged replacement of precision approach systems, like ILS and MLS, by autonomous satellite based systems (i.e. DGPS) has created an integrity and thus safety problem. EVS can be seen as supplemental to DGPS, providing some guidance overlap near the Category I limits and primary guidance beyond that until Category IIIB operational limits.

Enhanced Situational Awareness System (ESAS):

This is the ultimate system which comprises, but is not restricted to EVS. It monitors the environment like other aircraft, terrain, atmospheric hazards, traffic on the ground and warns or takes action whenever boundaries of certain risk are approached.

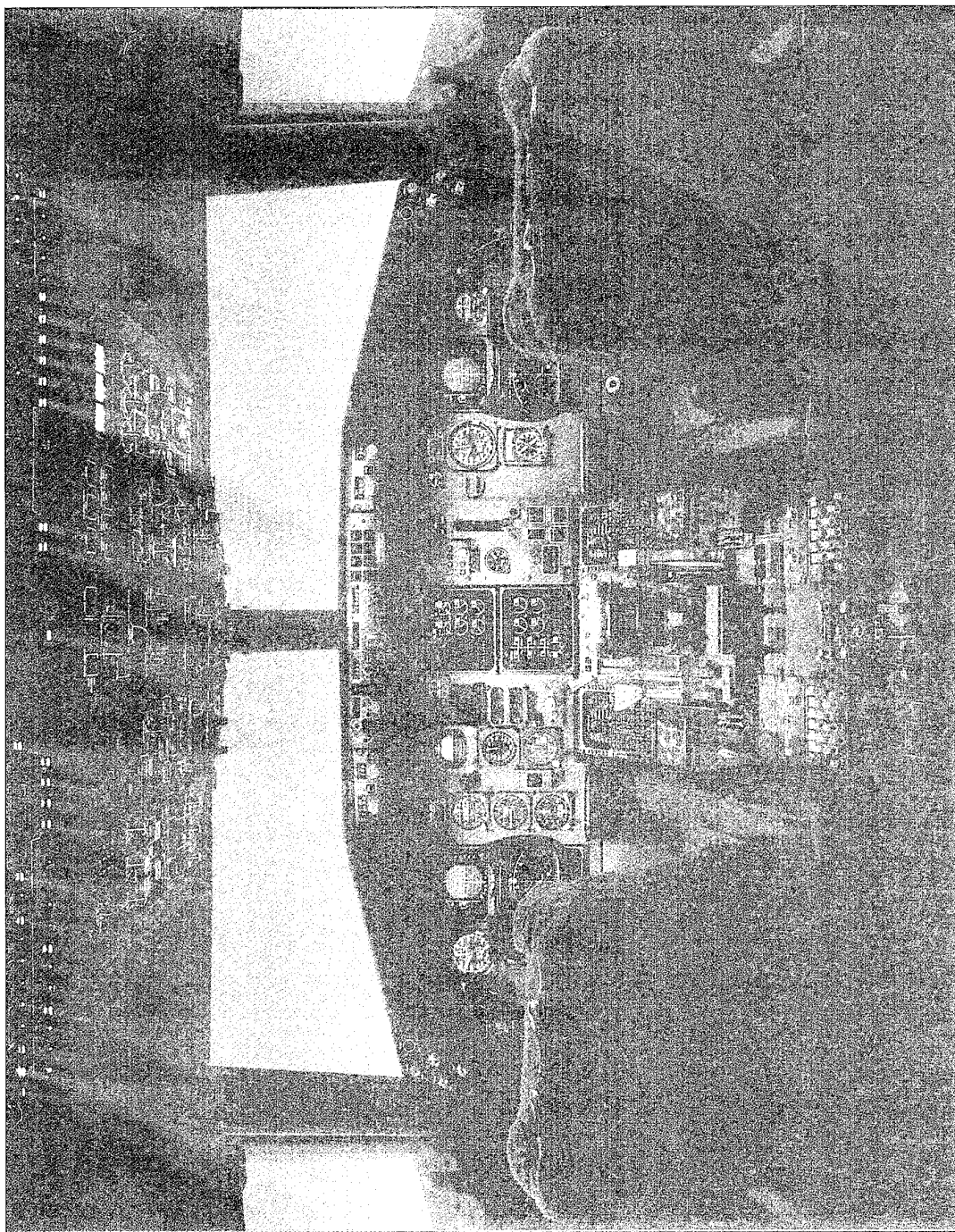

Boeing 767

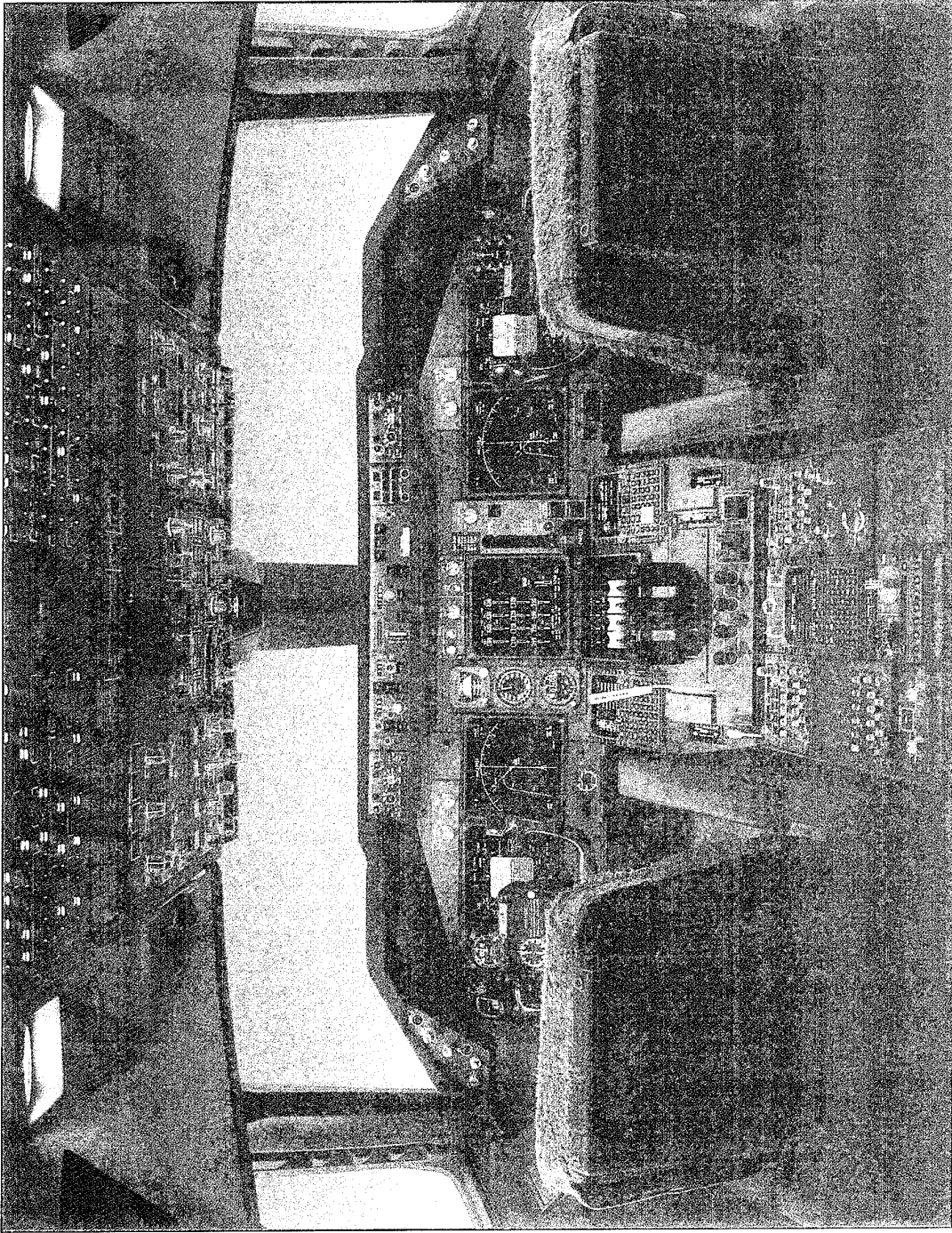

Boeing 747-400

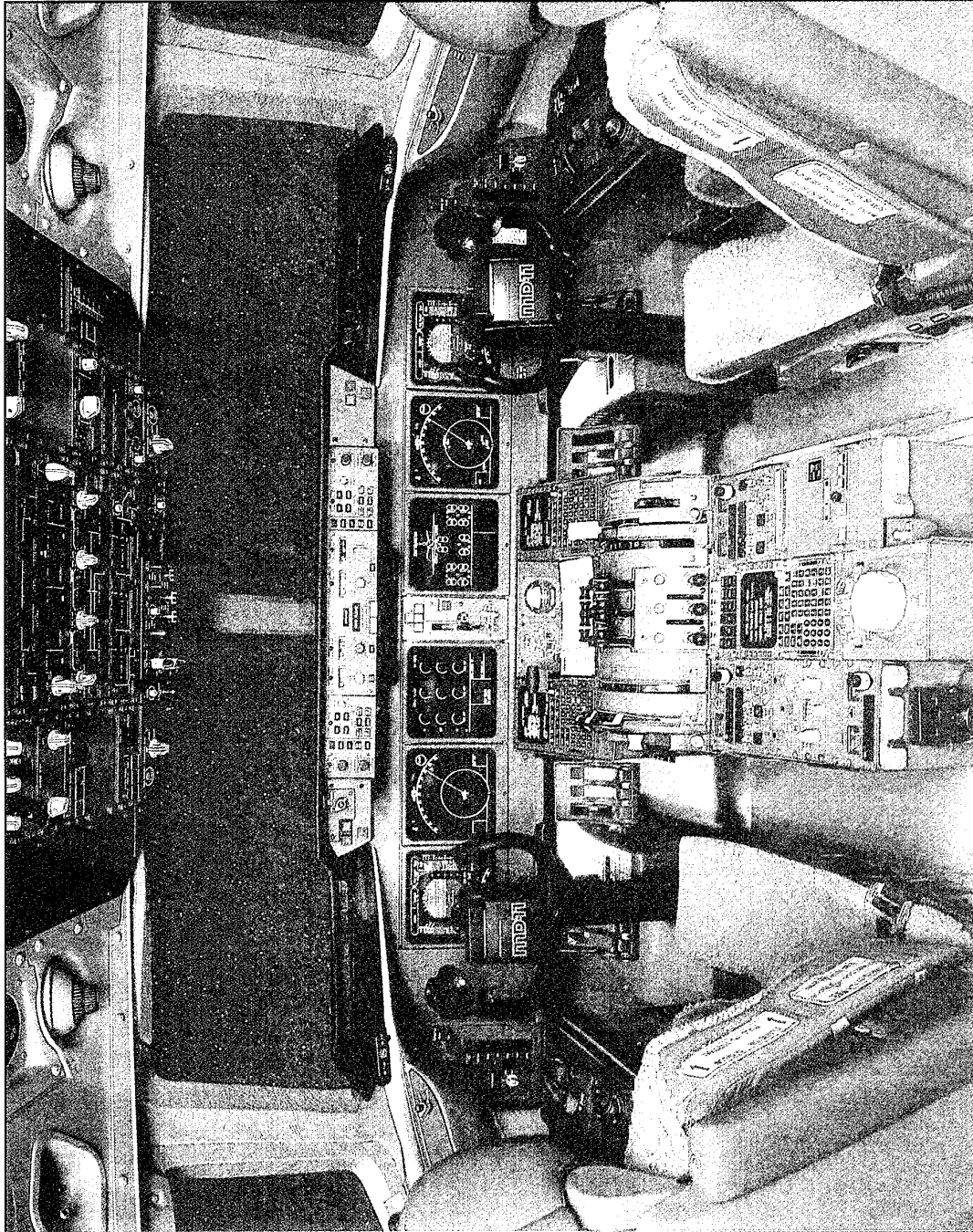

MD-11

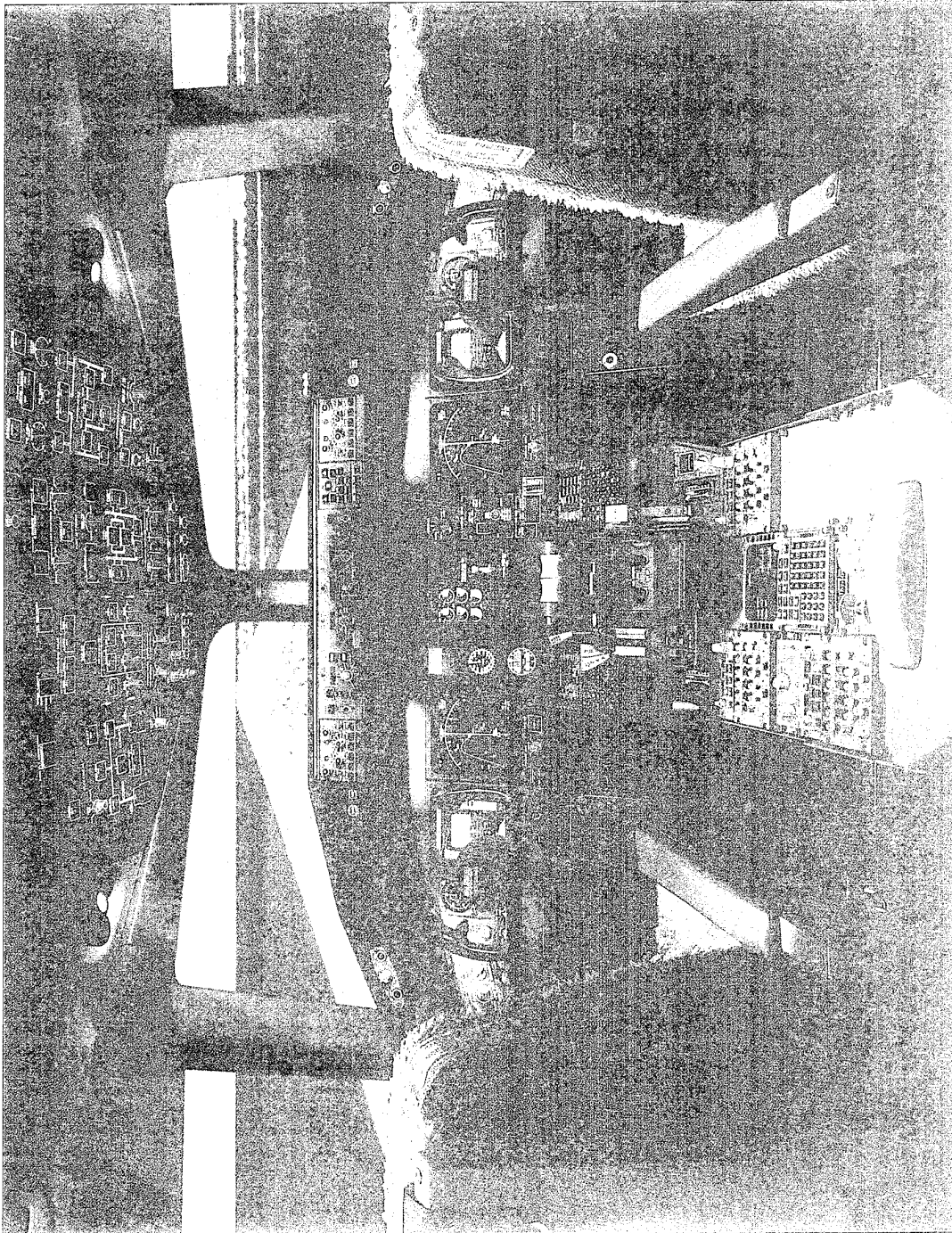

Boeing 777

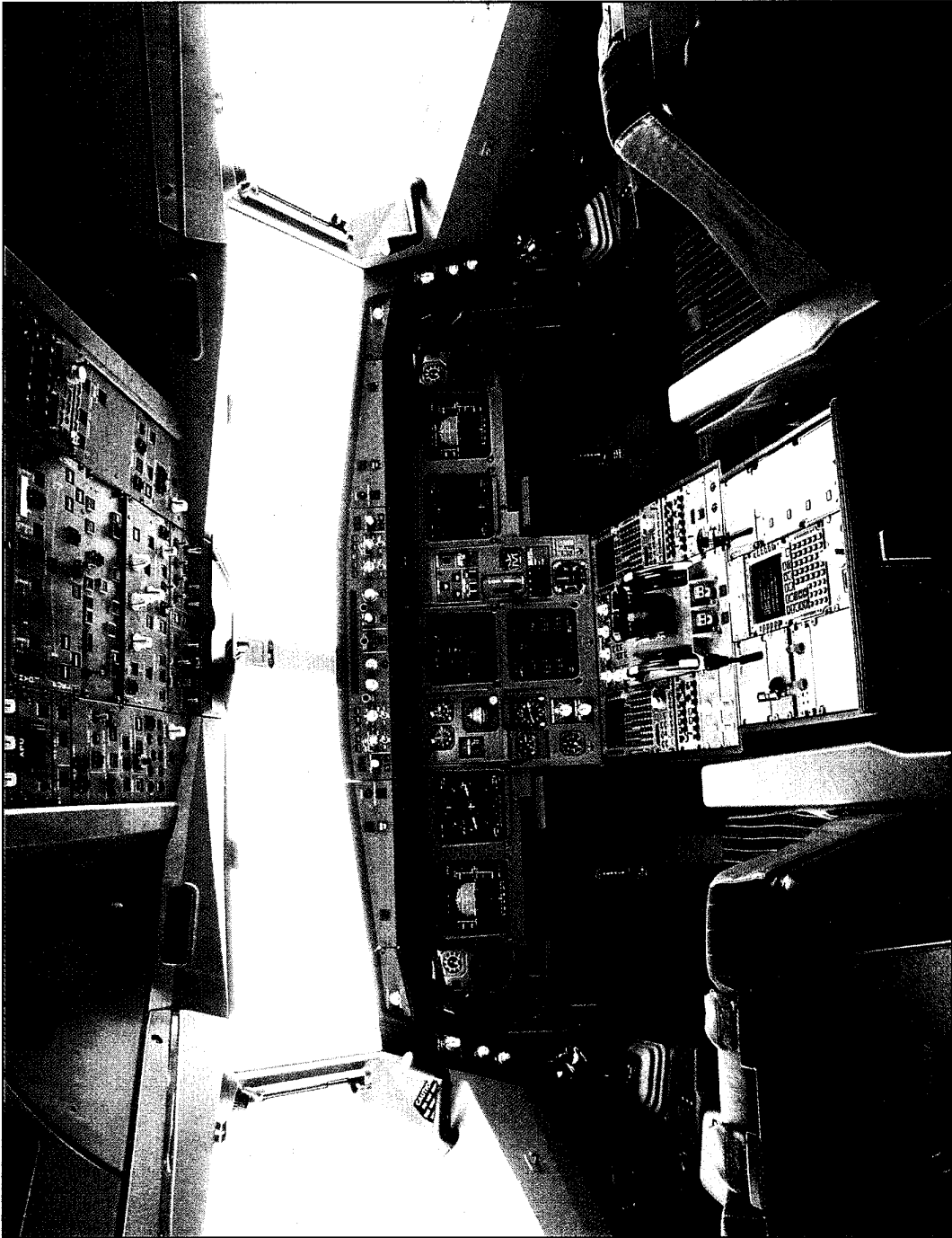

Airbus A335

## REPORT DOCUMENTATION PAGE

<b>1. Recipient's Reference</b>	<b>2. Originator's Reference</b> AGARD-AR-349	<b>3. Further Reference</b> ISBN 92-836-1034-2	<b>4. Security Classification of Document</b> UNCLASSIFIED/ UNLIMITED		
<b>5. Originator</b> Advisory Group for Aerospace Research and Development North Atlantic Treaty Organization 7 rue Ancelle, 92200 Neuilly-sur-Seine, France					
<b>6. Title</b> Flight Vehicle Integration Panel Working Group 21 on Glass Cockpit Operational Effectiveness					
<b>7. Presented at/sponsored by</b>					
<b>8. Author(s)/Editor(s)</b> Multiple			<b>9. Date</b> April 1996		
<b>10. Author's/Editor's Address</b> Multiple			<b>11. Pages</b> 188		
<b>12. Distribution Statement</b> There are no restrictions on the distribution of this document. Information about the availability of this and other AGARD unclassified publications is given on the back cover.					
<b>13. Keywords/Descriptors</b>					
<table style="width: 100%; border: none;"> <tr> <td style="width: 50%; vertical-align: top;">                     Fighter aircraft                      Helicopters                      Cockpits                      Design                      Human factors engineering                      Man machine systems                      Pilots (personnel)                      Flight crews                 </td> <td style="width: 50%; vertical-align: top;">                     Technology                      Flight instruments                      Operational effectiveness                      Helmet mounted displays                      Situational awareness                      Head up displays                      Display devices                 </td> </tr> </table>				Fighter aircraft Helicopters Cockpits Design Human factors engineering Man machine systems Pilots (personnel) Flight crews	Technology Flight instruments Operational effectiveness Helmet mounted displays Situational awareness Head up displays Display devices
Fighter aircraft Helicopters Cockpits Design Human factors engineering Man machine systems Pilots (personnel) Flight crews	Technology Flight instruments Operational effectiveness Helmet mounted displays Situational awareness Head up displays Display devices				
<b>14. Abstract</b>					
<p>The members of AGARD FMP Working Group 21, representing aircraft manufacturers, research institutions and operational organizations, met over a two year period, 1993-1995 to address the following objective:</p> <p><b>Summarize the status of current cockpits, highlight their benefits and weaknesses, and provide guidance for future cockpit design.</b></p> <p>This report, the result of those meetings, is structured around the series of questions listed below:</p> <ol style="list-style-type: none"> <li>1) What are the pilot and crew required to do to complete a mission successfully?</li> <li>2a) What do the current glass cockpits consist of?</li> <li>2b) What are some of the technological highlights and trends of these cockpits?</li> <li>3) What new technologies are becoming available?</li> <li>4) How can we tailor the cockpit to be the most suitable for the human operator?</li> <li>5) How can and how does the use of glass cockpits change the required aircrew training process?</li> <li>6) What are the key problem issues with the current design process and what suggestions can be made to improve it?</li> <li>7) What are the cockpit concepts being considered to improve the operational effectiveness of future aircraft?</li> </ol> <p>With consideration of the human factors issues in design as a major basis for this report, this document provides an in depth discussion of the cockpit of today's aircraft and can serve as a foundation upon which to develop a more optimized pilot-vehicle-system interface of tomorrow.</p>					

AGARD

NATO  OTAN

7 RUE ANCELLE • 92200 NEUILLY-SUR-SEINE

FRANCE

Télécopie (1)47.38.57.99 • Télex 610 176

DIFFUSION DES PUBLICATIONS

AGARD NON CLASSIFIEES

Aucun stock de publications n'a existé à AGARD. A partir de 1993, AGARD détiendra un stock limité des publications associées aux cycles de conférences et cours spéciaux ainsi que les AGARDographies et les rapports des groupes de travail, organisés et publiés à partir de 1993 inclus. Les demandes de renseignements doivent être adressées à AGARD par lettre ou par fax à l'adresse indiquée ci-dessus. *Veuillez ne pas téléphoner.* La diffusion initiale de toutes les publications de l'AGARD est effectuée auprès des pays membres de l'OTAN par l'intermédiaire des centres de distribution nationaux indiqués ci-dessous. Des exemplaires supplémentaires peuvent parfois être obtenus auprès de ces centres (à l'exception des Etats-Unis). Si vous souhaitez recevoir toutes les publications de l'AGARD, ou simplement celles qui concernent certains Panels, vous pouvez demander à être inclu sur la liste d'envoi de l'un de ces centres. Les publications de l'AGARD sont en vente auprès des agences indiquées ci-dessous, sous forme de photocopie ou de microfiche.

CENTRES DE DIFFUSION NATIONAUX

**ALLEMAGNE**

Fachinformationszentrum Karlsruhe  
D-76344 Eggenstein-Leopoldshafen 2

**BELGIQUE**

Coordonnateur AGARD-VSL  
Etat-major de la Force aérienne  
Quartier Reine Elisabeth  
Rue d'Evere, 1140 Bruxelles

**CANADA**

Directeur, Services d'information scientifique  
Ministère de la Défense nationale  
Ottawa, Ontario K1A 0K2

**DANEMARK**

Danish Defence Research Establishment  
Ryvangs Allé 1  
P.O. Box 2715  
DK-2100 Copenhagen Ø

**ESPAGNE**

INTA (AGARD Publications)  
Carretera de Torrejón a Ajalvir, Pk.4  
28850 Torrejón de Ardoz - Madrid

**ETATS-UNIS**

NASA Headquarters  
Code JOB-1  
Washington, D.C. 20546

**FRANCE**

O.N.E.R.A. (Direction)  
29, Avenue de la Division Leclerc  
92322 Châtillon Cedex

**GRECE**

Hellenic Air Force  
Air War College  
Scientific and Technical Library  
Dekelia Air Force Base  
Dekelia, Athens TGA 1010

**ISLANDE**

Director of Aviation  
c/o Flugrad  
Reykjavik

**ITALIE**

Aeronautica Militare  
Ufficio del Delegato Nazionale all'AGARD  
Aeroporto Pratica di Mare  
00040 Pomezia (Roma)

**LUXEMBOURG**

Voir Belgique

**NORVEGE**

Norwegian Defence Research Establishment  
Attn: Biblioteket  
P.O. Box 25  
N-2007 Kjeller

**PAYS-BAS**

Netherlands Delegation to AGARD  
National Aerospace Laboratory NLR  
P.O. Box 90502  
1006 BM Amsterdam

**PORTUGAL**

Estado Maior da Força Aérea  
SDFA - Centro de Documentação  
Alfragide  
2700 Amadora

**ROYAUME-UNI**

Defence Research Information Centre  
Kentigern House  
65 Brown Street  
Glasgow G2 8EX

**TURQUIE**

Millî Savunma Başkanlığı (MSB)  
ARGE Dairesi Başkanlığı (MSB)  
06650 Bakanlıklar-Ankara

**Le centre de distribution national des Etats-Unis ne détient PAS de stocks des publications de l'AGARD.**

D'éventuelles demandes de photocopies doivent être formulées directement auprès du NASA Center for AeroSpace Information (CASI) à l'adresse ci-dessous. Toute notification de changement d'adresse doit être fait également auprès de CASI.

AGENCES DE VENTE

NASA Center for  
AeroSpace Information (CASI)  
800 Elkridge Landing Road  
Linthicum Heights, MD 21090-2934  
Etats-Unis

ESA/Information Retrieval Service  
European Space Agency  
10, rue Mario Nikis  
75015 Paris  
France

The British Library  
Document Supply Division  
Boston Spa, Wetherby  
West Yorkshire LS23 7BQ  
Royaume-Uni

Les demandes de microfiches ou de photocopies de documents AGARD (y compris les demandes faites auprès du CASI) doivent comporter la dénomination AGARD, ainsi que le numéro de série d'AGARD (par exemple AGARD-AG-315). Des informations analogues, telles que le titre et la date de publication sont souhaitables. Veuillez noter qu'il y a lieu de spécifier AGARD-R-*nnn* et AGARD-AR-*nnn* lors de la commande des rapports AGARD et des rapports consultatifs AGARD respectivement. Des références bibliographiques complètes ainsi que des résumés des publications AGARD figurent dans les journaux suivants:

Scientific and Technical Aerospace Reports (STAR)  
publié par la NASA Scientific and Technical  
Information Division  
NASA Headquarters (JTT)  
Washington D.C. 20546  
Etats-Unis

Government Reports Announcements and Index (GRA&I)  
publié par le National Technical Information Service  
Springfield  
Virginia 22161  
Etats-Unis  
(accessible également en mode interactif dans la base de  
données bibliographiques en ligne du NTIS, et sur CD-ROM)



Imprimé par le Groupe Communication Canada  
45, boul. Sacré-Cœur, Hull (Québec), Canada K1A 0S7



AGARD holds limited quantities of the publications that accompanied Lecture Series and Special Courses held in 1993 or later, and of AGARDographs and Working Group reports published from 1993 onward. For details, write or send a telefax to the address given above. *Please do not telephone.*

AGARD does not hold stocks of publications that accompanied earlier Lecture Series or Courses or of any other publications. Initial distribution of all AGARD publications is made to NATO nations through the National Distribution Centres listed below. Further copies are sometimes available from these centres (except in the United States). If you have a need to receive all AGARD publications, or just those relating to one or more specific AGARD Panels, they may be willing to include you (or your organisation) on their distribution list. AGARD publications may be purchased from the Sales Agencies listed below, in photocopy or microfiche form.

NATIONAL DISTRIBUTION CENTRES

## BELGIUM

Coordonnateur AGARD — VSL  
Etat-major de la Force aérienne  
Quartier Reine Elisabeth  
Rue d'Evere, 1140 Bruxelles

## CANADA

Director Scientific Information Services  
Dept of National Defence  
Ottawa, Ontario K1A 0K2

## DENMARK

Danish Defence Research Establishment  
Ryvangs Allé 1  
P.O. Box 2715  
DK-2100 Copenhagen Ø

## FRANCE

O.N.E.R.A. (Direction)  
29 Avenue de la Division Leclerc  
92322 Châtillon Cedex

## GERMANY

Fachinformationszentrum Karlsruhe  
D-76344 Eggenstein-Leopoldshafen 2

## GREECE

Hellenic Air Force  
Air War College  
Scientific and Technical Library  
Dekelia Air Force Base  
Dekelia, Athens TGA 1010

## ICELAND

Director of Aviation  
c/o Flugrad  
Reykjavik

## ITALY

Aeronautica Militare  
Ufficio del Delegato Nazionale all'AGARD  
Aeroporto Pratica di Mare  
00040 Pomezia (Roma)

## LUXEMBOURG

See Belgium

## NETHERLANDS

Netherlands Delegation to AGARD  
National Aerospace Laboratory, NLR  
P.O. Box 90502  
1006 BM Amsterdam

## NORWAY

Norwegian Defence Research Establishment  
Attn: Biblioteket  
P.O. Box 25  
N-2007 Kjeller

## PORTUGAL

Estado Maior da Força Aérea  
SDFA - Centro de Documentação  
Alfragide  
2700 Amadora

## SPAIN

INTA (AGARD Publications)  
Carretera de Torrejón a Ajalvir, Pk.4  
28850 Torrejón de Ardoz - Madrid

## TURKEY

Millî Savunma Başkanlığı (MSB)  
ARGE Dairesi Başkanlığı (MSB)  
06650 Bakanlıklar-Ankara

## UNITED KINGDOM

Defence Research Information Centre  
Kentigern House  
65 Brown Street  
Glasgow G2 8EX

## UNITED STATES

NASA Headquarters  
Code JOB-1  
Washington, D.C. 20546

**The United States National Distribution Centre does NOT hold stocks of AGARD publications.**

Applications for copies should be made direct to the NASA Center for AeroSpace Information (CASI) at the address below. Change of address requests should also go to CASI.

SALES AGENCIES

NASA Center for  
AeroSpace Information (CASI)  
800 Elkridge Landing Road  
Linthicum Heights, MD 21090-2934  
United States

ESA/Information Retrieval Service  
European Space Agency  
10, rue Mario Nikis  
75015 Paris  
France

The British Library  
Document Supply Centre  
Boston Spa, Wetherby  
West Yorkshire LS23 7BQ  
United Kingdom

Requests for microfiches or photocopies of AGARD documents (including requests to CASI) should include the word 'AGARD' and the AGARD serial number (for example AGARD-AG-315). Collateral information such as title and publication date is desirable. Note that AGARD Reports and Advisory Reports should be specified as AGARD-R-nnn and AGARD-AR-nnn, respectively. Full bibliographical references and abstracts of AGARD publications are given in the following journals:

Scientific and Technical Aerospace Reports (STAR)  
published by NASA Scientific and Technical  
Information Division  
NASA Headquarters (JTT)  
Washington D.C. 20546  
United States

Government Reports Announcements and Index (GRA&I)  
published by the National Technical Information Service  
Springfield  
Virginia 22161  
United States  
(also available online in the NTIS Bibliographic  
Database or on CD-ROM)



Printed by Canada Communication Group  
45 Sacré-Cœur Blvd., Hull (Québec), Canada K1A 0S7