

NASA CR-168217

NASA CONTRACTOR REPORT

CHARACTERIZATION OF PMR POLYIMIDE RESIN AND PREPREG

Paul H. Lindenmeyer, C. H. Sheppard

BOEING AEROSPACE COMPANY
SEATTLE, WASHINGTON

CONTRACT NAS3-22523

DEPARTMENT OF DEFENSE
PLASTICS TECHNICAL EVALUATION CENTER
ARRADCOM, DOVER, N. J. 07801

NASA
National Aeronautics and
Space Administration
Lewis Research Center
Cleveland, Ohio 44135

DTIC QUALITY INSPECTED 1

DISTRIBUTION STATEMENT A

Approved for public release;
Distribution Unlimited

19960312 060

PLASTED 4/6/79

DISCLAIMER NOTICE

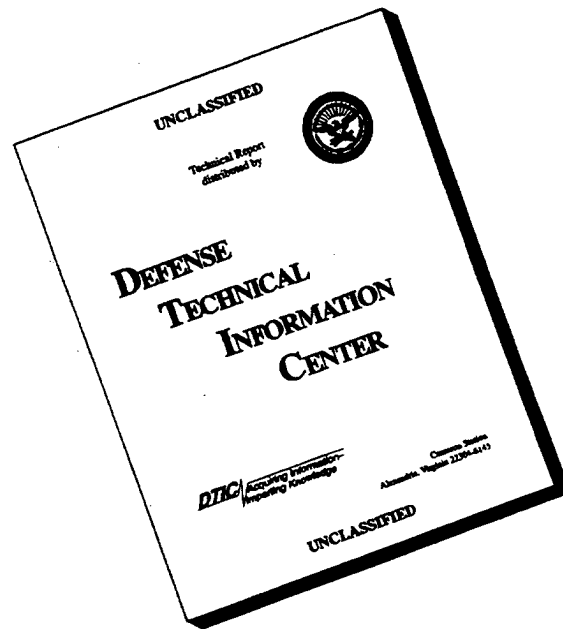

THIS DOCUMENT IS BEST QUALITY AVAILABLE. THE COPY FURNISHED TO DTIC CONTAINED A SIGNIFICANT NUMBER OF PAGES WHICH DO NOT REPRODUCE LEGIBLY.

NASA CONTRACTOR REPORT

CHARACTERIZATION OF PMR POLYIMIDE RESIN AND PREPREG

Paul H. Lindenmeyer, C. H. Sheppard

BOEING AEROSPACE COMPANY
SEATTLE, WASHINGTON

CONTRACT NAS3-22523

NASA
National Aeronautics and
Space Administration
Lewis Research Center
Cleveland, Ohio 44135

FORWARD

This work was conducted under the technical direction of Dr. Richard W. Lauver, Polymer Matrix Composite Section, Materials Division, NASA-Lewis Research Center, Cleveland, Ohio. The Materials and Processes Department of the Boeing Aerospace Company was responsible for the work performed under this contract. Mr. C. H. Sheppard was the program manager and Dr. M. E. Taylor served as the technical leader for the first six months. The authors acknowledge the technical assistance provided during the program by the following Boeing Aerospace Company personnel:

B. H. Hunter

J. Vry

Verla Monroe

Oscar Davis

CONTENTS

	<u>Page</u>
Summary	1
Introduction	2
Model Compounds, Precursors and Monomers	3
Selection of Baseline System	3
Quantification of HPLC Data	5
Definition and Characterization of Cure Cycle	6
Baseline Prepreg and Laminate Properties	9
Aging Studies of Baseline Resin Solutions	9
Influence of Various Possible Contaminants	10
Characterization of Commercial Monomers and Resins	11
Conclusions and Recommendations	11
Appendix A Chemical Characterization Procedures	45
Appendix B Composite Laminating Procedures	65
Appendix C Composite Mechanical and Physical Properties	67
Appendix D Prepreg Physical Properties	71

LIST OF FIGURES

<u>NUMBER</u>		<u>PAGE</u>
1	Chemistry of PMR-Polyimide Resin System	13
2	Fourier Transform Infrared Spectra of Nadic Anhydride	14
3	Fourier Transform Infrared Spectra of Nadic Ester	15
4	Fourier Transform Infrared Spectra of MDA	16
5	Fourier Transform Infrared Spectra of BTDA	17
6	Fourier Transform Infrared Spectra of BTDE	18
7	Fourier Transform Infrared Spectra of Monoimide of NA	19
8	Fourier Transform Infrared Spectra of Bisimide of NA	20
9	Recommended Cure Cycle	21
10	DuPont DMA Characterization of Cure Cycle	22
11	Dielectric Dissipation Loss Factor	23
12	Comparison of DSC, Moisture Evolution and Gas Chromatography/Mass Spectroscopy	24
13	Comparison of DSC, Moisture Evolution and Gas Chromatography/Mass Spectroscopy After 2 Hrs Aging at 150°F	25
14	Cure Analysis by Infrared	26

LIST OF TABLES

<u>NUMBER</u>		<u>PAGE</u>
I	Melting Points of Monomers, Precursors and Model Compounds	27
II	Elution Time Ratios for Monomers, Precursors and Model Compounds	28
III	Typical HPLC Data from Boeing-U.S. Polymeric Data Base for PMR-15 Resin Solutions	29
IV	Typical HPLC Data from Boeing-U.S. Polymeric Data Base for PMR-15 Prepregs	30
V	Tentative Limits for HPLC Data Taken from Overall Averages of Boeing-U.S. Polymeric Data Base	31
VI	Quantization of HPLC Data for PMR-15	32
VII	Quantization of Baseline Resin in Mole Percent	33
VIII	Comparison of Mechanical Properties of Unidirectional Laminates from Baseline Resin Solution with the Averages from the Boeing-U.S. Polymeric Data Base	34
IX	Aging Studies on PMR-15 Resin Solutions	35
X	Calculated Weight Percent and (Mole Percent) for Contaminated Resin Solution	36
XI	Measured Concentration for Contaminated Resin Solution	37
XII	Prepreg and Composite Properties for First Level Contamination	38
XIII	Laminate Mechanical Properties for First Level Contamination	39
XIV	Prepreg and Composite Properties for Second Level Contamination	40
XV	Laminate Mechanical Properties for Second Level Contamination	41
XVI	Measured Weight Percent Concentrations for Commercial Resins	42
XVII	Prepreg and Composite Properties for Commercial Resins	43
XVIII	Laminate Mechanical Properties for Commercial Resins	44

SUMMARY

This document is the final program report describing work performed by the Boeing Aerospace Company (BAC) for the National Aeronautics and Space Administration (NASA) Lewis Research Center under contract NAS3-22523. The objective of the work was to develop a data base and procedures for the chemical characterization of PMR-15 resin solutions and graphite prepreg. In addition it provided a basic understanding of PMR-15 resin chemistry; this was translated into processing procedures for the production of high quality graphite composites. The program was divided as follows into four (4) technical tasks and one reporting task: 1) definition of baseline system, 2) chemical characterization of commercial grade monomers and solutions, 3) sensitivity of processing to specific chemical variables, 4) characterization of commercial prepreps, and 5) reporting.

During this program, the PMR monomers and selected model compounds representative of postulated PMR-15 solution chemistry were acquired and characterized. Based on these data a baseline PMR-15 resin was formulated and its processing characteristics and composite properties were evaluated. Commercially available PMR-15 resins were then obtained and characterized. Composite panels were fabricated and evaluated. Additionally, the effects of four chemical variations were evaluated using the above techniques. The variations were: 1) the substitution of 10% or 20% of theoretical amounts of nadic ester by the equivalent amount of nadic anhydride, 2) the substitution of 10% or 20% of the BTDE by BTDA, 3) the substitution of 10% and 20% of the nadic ester and MDA with equivalent amount of the mononadimide and 4) the advancement of PMR-15 baseline resin at 150°F for 30 and 60 minutes.

nadie ester
This investigation has shown that PMR-15 resin solutions may be characterized by HPLC methods, and that final composite properties depend primarily upon the amount of unreacted NE present in the prepreg prior to cure. At relatively low temperatures the NE and MDA appear to undergo a reaction that adversely effects the physical properties (especially the high temperature aging characteristics) of the resulting composites. Unfortunately, the most likely reaction products of such a combination, the mono and bisimide, could not be confirmed as existing in the aged resins. Furthermore, deliberate addition of these materials did not produce the same adverse effects upon properties that aging produced.

In addition to the aging problem, this investigation has shown that one (or more) as yet unidentified reactions caused by mild heating can occur during the commercial preparation of PMR-15 resins. The isocratic HPLC method has been shown to be the most sensitive method known at present for detecting the existence of such reactions and determining the minimum amount of unreacted NE (10% by weight) necessary to produce parts with acceptable high temperature performance.

INTRODUCTION

The purpose of this study was to characterize the monomers, resin and processing variables of PMR-15 polyimide so that the most critical variables (impurities, composition, process temperatures/times, degree of advancement, etc.) could be defined in terms of their effect on prepreg processibility and composite properties. The polymer employed in this study was the high temperature resistant, addition-type polyimide resin system (designated PMR, for polymerization of monomer reactants) developed at NASA-Lewis Research Center. The resin uses three monomers (Figure 1): the monomethylester of 5-norbornene-2, 3-dicarboxylic acid (NE), the dimethyl ester of 3,3',4,4'-benzophenone tetracarboxylic acid (BTDE), and 4,4'-methylenedianiline (MDA). In the system as originally developed, both of the esters were prepared by esterification of the corresponding anhydrides by refluxing at a 50 percent concentration in methyl alcohol. The resin solution was then obtained by mixing the monomer solutions in the mole ratio required to obtain a nominal molecular weight of 1,500 (NE:MDA:BTDE as 2: 3.084: 2.084) at a concentration of 50% by weight in methanol. This solution was then used to impregnate graphite fibers or cloth, and most of the solvent driven off. Although it is generally assumed that essentially no reaction occurs during the preparation of prepreg in this manner, this is clearly only an approximation and prepreg is routinely kept frozen prior to use in order to minimize premature reaction.

As this resin system was further developed for commercialization it became desirable to reduce the amount of solvent involved in the preparation of prepreg cloth and tapes. This resulted in the development of the so-called "hot melt" process in which the esterifications are carried out in a highly concentrated (90%) solution in methanol, and the prepregging carried out with similarly highly concentrated solutions. The high viscosity of such solutions requires powerful stirring and handling equipment not easily duplicated in the laboratory. The "hot melt" process also increases the possibility of local high temperature or high concentrations which can further complicate the

chemistry of the curing reactions. Thus the commercially attractive "hot melt" process requires even more careful quality control in order to assure that resins and prepregs prepared by this process can be cured into composite laminates having the high temperature properties and the high temperature aging characteristics potential to the PMR-15 resin system. This study was designed to identify the critical variables and to develop characterization techniques which could be used to control the quality of the resulting composite laminates, and, to the extent possible, increase our understanding of the basic chemical reactions involved.

MODEL COMPOUNDS, PRECURSORS AND MONOMERS

In order to identify and characterize the impurities that might reasonably be expected to exist in the PMR-15 resin system, preparations were made or obtained of the following precursors and model compounds:

1. 5-norbornene-2, 3-dicarboxylic acid anhydride (NA)
2. 3,3', 4,4'-benzophenone tetracarboxylic dianhydride (BTDA)
3. The monoimide formed from NA and MDA
4. The bisimide formed from 2NA and MDA
5. The tri- and tetra-methyl esters of BTDA

In addition the three monomers, NE, MDA and BTDE were obtained from a number of sources in order to select the highest purity possible for the baseline system. All these materials were characterized by (1) melting points via differential scanning calorimetry (DSC), (2) Fourier transform infrared spectroscopy (FTIR), and (3) high performance liquid chromatography (HPLC). The melting points of the purest specimens obtained are listed in Table I, the infrared spectra in Figures 2 through 8, and the qualitative HPLC results are summarized in Table II. In most cases these latter data are given as the observed ratio of the elution time of the characteristic peak to the tetrahydrofuran (THF) marker peak characteristic of the isocratic HPLC method used (Appendix A.1). The exception to this occurs in the determination of ratios of the three isomers of BTDE; the ratios in Table II are relative to the first isomer to emerge from the column. The quantification of these data will be discussed in a subsequent section.

SELECTION OF BASELINE SYSTEM

Our objective in this selection was to obtain the purest available monomers and to develop methods to quantitatively characterize the resulting baseline resin system. After investigation of monomers supplied by several commercial resin manufacturers, as well as several specimens prepared by esterifying the two anhydrides in our laboratory, it was decided that NE and BTDE obtained from U.S. Polymeric offered the best available choice for the baseline system. The NE showed essentially a single HPLC peak and the BTDE exhibited an average of only 3.56% of the total area in the HPLC spectrum which could be attributed to the triester. This selection of U.S. Polymeric-prepared monomers allowed the use of a substantial data base of HPLC results obtained over several years of a cooperative quality control program between Boeing and U.S. Polymeric. The HPLC data in Table III are typical examples from this data base. Unfortunately these data are all expressed in terms of the percent area under the curve with no attempt to account for the difference in absorptivity coefficients. Thus even if one assumes that the absorptivity of all the BTDE isomers as well as the triester have similar absorptivity, this data base tells us only that the relative amounts occur in the ratios of 1: 2.47: 1.80: 0.19 where the first three represent the diester isomer and the last the triester. Please note the distinction between the elution time ratios of Table II which serve to qualitatively identify the peaks in the HPLC spectrum and these relative ratios of the areas under the curves.

These monomers were prepared by the commercially desirable "hot melt" method with a minimum amount of methanol (approximately 10%) and thus are characteristic of present commercial practice.

In the preparation of our baseline resin solution these two monomers were again diluted and combined with MDA to obtain a resin solution that was 50% solids by weight. Although the ratio of monomers was always held at the nominal (NE:MDA:BTDE as 2: 3.084: 2.084) the uncertainty as to the amount of methanol in the BTDE created some uncertainty in the quantitative stoichiometry. The amount of methanol in the BTDE was estimated by heating at 316K (110°F) to constant weight or 16 hours.

The Boeing-U.S. Polymeric data base contains HPLC data on resin solution and prepreg. Typical results are given in Tables III and IV and the overall average values are summarized in Table V. Here again the elution time ratios serve only to

qualitatively identify the various peaks and the only quantitative aspects of these data are the relative peak area ratios.

QUANTIFICATION OF HPLC DATA

In order to make use of this data base and to obtain the quantification in terms of weight percent or mole percent it becomes necessary to carry out a number of calibrations as well as to make certain assumptions that may have questionable validity.

First, since the isocratic HPLC method upon which the existing HPLC data is based does not detect a peak for the MDA, it was necessary to develop a method that could detect MDA in a reasonable time. This method uses a reverse phase column and a gradient mobile phase. This gradient method detects all three major monomer components of the resin solution; however, it does not resolve the BTDE isomers (Appendix A.2).

Now if one assumes that the absorptivity of all components are the same in both HPLC methods, we can obtain three independent ratios of the amounts of the four principle components: NE, BTDE, MDA and the triester. We thus require only a single independent calibration of one of these components in order to quantitatively determine the weight percent of each of the three monomers and the principle impurity, the triester. In view of the uncertainty of the amount of methanol in BTDE we carried out calibration runs for all three major components, NE, BTDE and MDA. Although the existing isocratic HPLC data base consisted essentially of only the BTDE:NE:Triester ratios, this method of calibration permits the conversion of the existing data base to weight percent along with the baseline system. Thus we have included in Table VI the average weight percent of BTDE and triester as well as the proposed lower limit of NE from Table V. However, since data for MDA was not included in the data base, only the baseline system provides measured weight percent for all major components. Note that even for the baseline system where all four identified and quantified components are known there still exists an unidentified quantity of material obtained by subtraction of the known quantities from 100 percent. This presumably represents some reaction product.

In view of the uncertainties involved and the assumptions necessary to arrive at this weight percent, it must really be considered as no more quantitative than the

percentage area of the HPLC measurements from which it is derived. The only advantage in expressing the results in weight percent rather than percent of total area under the HPLC curve is that weight percent can be compared with the theoretical values. Thus the proposed lower limit of 2.8% area for the NE peak works out to be about 10 weight percent of the resin. Comparing this to the 21.69 weight percent of NE theoretically initially present, we can see that composites made with resins in which more than about half of the NE has already reacted would not have sufficient out life in a manufacturing environment. However, if composites were fabricated under ideal laboratory conditions the composite properties would be well within accepted tolerances.

In order to further reduce the data from weight percent to mole percent it becomes necessary to make an additional assumption concerning the molecular weight of this unknown reaction product. Table VII contains this mole percent for the baseline system assuming that the reaction product is (1) the monoimide of NE and MDA, (2) the bisimide of 2NE and MDA, and (3) a reaction product of two MDA molecules with a single NE molecule. This latter product is not precluded by steric considerations but it is considered most unlikely to occur except in the case of locally very high concentrations of MDA with respect to NE. Although the formation of the mono or bisimide are considered to be the most probable reaction products, no direct evidence for their formation is found in the HPLC data. There was also no evidence for the formation of the third possibility, but since the MDA molecule is not observed in this HPLC method and presumably is held up in the column, it is not unreasonable to assume that this reaction product might also be held up in the column.

DEFINITION AND CHARACTERIZATION OF CURE CYCLE

The cure cycle selected for this work was adopted from the cycle developed on contract NAS1-15009 "Quality Control of PMR-15" and detailed in Document No. D180-20545-5A in NASA CR-159182 (see Appendix B.1). The allowable limits for this cure cycle illustrated in Figure 9 had been selected to allow the operation of certain commercial autoclaves. For most of the work described in this report the temperature was increased to 522K (480°F) at 1.7K (3°F) per minute and held at this temperature for 30 minutes. At this point 650 mm of Hg (24 inches) vacuum and 1379 Pa (200 psi) positive pressure was applied and the temperature increased to 602K (625°F) at (1.7K (3°F) per minute and held for two hours. The temperature was then lowered at 1.1K (2°F) per minute to 322K (120°F) and the pressure released. Laminates cured in this

manner were then subjected to a six hour post cure in an air circulating oven at 602K (625°F). Heat up rate for the post cure did not exceed 3K (6°F) and a cool down rate of 1.1K (2°F) per minute.

A number of methods were investigated to characterize the chemical and physical changes which occur during this cure cycle. The physical changes were found to be best characterized by dynamic mechanical analysis (DMA) using the DuPont compound pendulum method (see Appendix A.2). Typical results are shown in Figure 10. The first three damping peaks occur at 373K (212°F), 423K (302°F) and 503K (446°F), and correspond very nicely with (1) the melting of the monomers, (2) the imidization reaction, and (3) the glass transition or softening and flow of the polyimide. The frequency curve, which is a measure of modulus, clearly shows that the first damping peak corresponds to a decrease in modulus (melting) while the second corresponds to the increase in modulus due to the imidization reaction. The third peak shows a frequency and damping relationship typical of the glass transition in a thermoplastic polymer. During the 30 minute holding period at 522K (480°F) both the damping and the frequency increase slightly which would be consistent with the completion of the ring closing imidization reaction and the continued flow of the thermoplastic polyimide. With the resumption of heating at the end of the 30 minute hold period, both the damping and the frequency decrease to a minimum at about 563K (554°F) and then increase as the crosslinking reaction begins to influence the flow properties of thermoplastic polyimide. The 30 minute hold period at 522K (480°F) is a reasonable point to apply pressure to effect the best possible consolidation of a composite material since it is just above the glass transition of the essentially complete polyimide and below the activation temperature for the crosslinking reaction.

Other methods of physically characterizing the cure cycle including dielectric dissipation loss factor (see Figure 11 and Appendix A.3), differential scanning calorimetry (DSC) (Appendix A.4), and direct measurement of the flow by trimming away and measuring the "flash" from laminates were evaluated during the program. In general these methods produced results in agreement with those of the above described DMA. However, these results were not considered to be as reproducible or significant as those produced by DMA, since measurement of resin flash did not yield continuous results, and the sensitivity of the other two methods depends upon the scanning rate.

Chemical characterization of the cure cycle was studied (Appendix A.5) using Fourier transform infrared spectroscopy (FTIR), moisture evolution (Appendix A.6 and Figure 12) and gas chromatography-mass spectroscopy (GC/MS) (Appendix A.7). Some uncertainty in interpretation was encountered with all of these methods in that it was not possible to exactly duplicate the cure conditions. However, sufficient detail was obtained to allow the development of excellent cure cycles. It was observed that the maximum in moisture evolution occurred at 423K (302°F); this coincides with the observed damping peak previously identified with the formation of amide esters. The corresponding maximum in methanol evolution was observed somewhat later at about 463K (375°F). Thus it is reasonable to conclude that most of the imidization reaction occurs in the region from 393K (248°F) to 503K (446°F). Boeing therefore concluded that the first reaction step involved the formation of the amide-ester with the liberation of water, as indicated in Figure 1. The formation of amide-acids, which would liberate moisture, is possible, but not supported by experimental data. While both reactions probably occur, the formation of amide-acids is not considered to be particularly significant.

In heated FTIR studies, the PMR resin was scanned through the proposed cure cycle with the following results. An FTIR absorption band was observed at 1860 cm^{-1} . This band first appears at 435K (325°F), increases to a maximum by the temperature of the 30 minute hold at 522K (480°F) and then disappears during this period (see Figure 13). This band and a companion band at 1775 cm^{-1} are known to be characteristic of an anhydride; the formation of anhydrides has been previously suggested in the literature. One possibility is that any diacid present in the original resin or formed by the hydrolysis of a BTDE isomer would first form an anhydride by the elimination of water before it could undergo the imidization reaction. It may be that this mechanism is the slowest part of the imidization reaction that requires the holding time at 522K (480°F) for its completion. Since we lack any quantitative estimate of the amount of reaction that occurs by this mechanism it is not possible to estimate its importance in the overall cure of PMR-15.

Another key observation made during the cure cycle studies was that, in the volatile evolution test (Appendix A.6), the evolution of cyclopentadiene begins well in advance of the thermally activated crosslinking reaction. Significant amounts of cyclopentadiene are evolved by 463K (374°F) while the increase in damping and modulus due to crosslinking, as measured by the DMA, did not begin until 563K (554°F). The observation of significant amounts of cyclopentadiene evolution at temperatures below

473K (392°F) does not agree with previous assumption concerning the decomposition of the nadic ring, but can be explained by the presence of two isomeric forms of the nadic material. This observation becomes even more significant since it was observed that increased aging tended to increase the cyclopentadiene, converting the shoulder at 463K (374°F) into a small maximum.

BASELINE PREPREG AND LAMINATE PROPERTIES

Celion 3000 graphite tow was impregnated with the 50% by weight solution of the baseline system. The resulting prepreg was laid up in a unidirectional laminate and cured as described in the previous section. The physical and mechanical properties of these laminates are given in Table VIII along with the average values from the data base of several hundred specimens. The solution-coated prepregs made on this program yielded laminates with mechanical properties only very slightly lower than the average values from the data base. Note that monomers used in our baseline solutions were esterified as a 90% solution but the prepregs were made by coating from a 50% solution. The laminates in the data base were made with both the monomers and the prepregs prepared from the more concentrated (i.e., 90%) solution. (See Appendix B, C and D for Composite Fabrication, Prepreg Properties and Composite Properties.)

AGING STUDIES ON BASELINE RESIN SOLUTIONS

Solutions of the baseline resin in two concentrations 50% and 67% were aged at three different temperatures, 295K (72°F), 316K (110°F) and 339K (150°F), for a variety of times up to 165 hours. The resulting solutions were analyzed using the HPLC methods (Appendix A). The results of this analysis, tabulated in Table IX, show that the concentration of BTDE and the triester did not change by more than the experimental error during any of the aging time and temperatures measured. On the other hand both the NE and the MDA concentrations decreased with aging, indicating the probability of some kind of a reaction product between these two monomers. Although a very weak "reaction peak" that increased with aging was observed in the HPLC gradient method, this peak could not be identified with either the mono or the bisimide of NE and MDA, the most logical reaction products to be expected. The weight percent of "reaction product" given in Table IX was obtained by difference since the observed peak could not be positively identified and calibrated.

Although the model compound work had established the elution time ratios for these two materials (see Table II) no systematic increase at these locations was observed. However, both of these compounds are known to have limited solubility in methanol. The possibility exists that these compounds were formed, but precipitated from the solution and were not observed or included in the HPLC sample due to the high viscosity of the resin solution. Subsequent observations, during substitution of the monoimide for part of the formulation, supported this possibility.

A number of additional measurements (e.g., FTIR (Appendix A.6), dielectric loss (Appendix A.4), DMA (Appendix A.9), etc.) were made on these aged solutions as the resin was carried through the cure cycle. Unfortunately none of these measurements showed any systematic change with aging. This was especially disappointing in the case of the torsional braid data which did show some differences in apparent viscosity. This method is not quantitative however, so no significance could be attributed to these differences.

INFLUENCE OF VARIOUS POSSIBLE CONTAMINANTS

In order to assess the influence of various extraneous materials likely to occur in PMR-15 resins, three of the most likely such materials, BTDA, NA, and the monoimide of NA and MDA, were selected for investigation. These materials were substituted for equivalent amounts of the monomers at the 10% and 20% levels. The calculated weight percent and mole percent compositions of these six formulations are given in Table X along with the composition of the baseline resin, for comparison. Resin solutions having these nominal concentrations were made up and analyzed by the HPLC methods described in Appendix A. The results are given in Table XI. Celion 3000 graphite tow was impregnated with these 10% substituted solutions, and the prepregs were used to lay up and cure unidirectional panels. A baseline solution that had been aged for 1/2 hour at 150°F was included. The prepreg and composite properties are summarized in Table XII and the mechanical properties of the resulting laminates are in Table XII (see Appendix B, C and D for procedures). Note that at this level of contamination laminates with mechanical properties not significantly different from the baseline or the data base averages were produced.

Upon proceeding to the second level of contamination it was observed that the mixture in which BTDA was substituted for 20% of the BTDE could not be processed due to the insolubility of BTDA in alcohol. Consequently data on this formulation was not

obtained. The prepreg and composite properties of this level are given in Table XIV and the mechanical properties of the laminates in Table XV. Note that the flexural strength and interlaminar shear were reduced by this level whereas the flexural modulus was essentially unchanged. Since it was not reasonable to expect a level of contamination in excess of 20%, no third level was attempted.

CHARACTERIZATION OF COMMERCIAL MONOMERS AND RESINS

Commercially prepared monomers and polymer solutions were obtained from four manufacturers, Ferro, Fiberite, Hexcel and U.S. Polymeric. The Fiberite specimens were eliminated from further testing after it was discovered that this manufacturer apparently used a different chemistry based upon ethanol rather than methanol as the solvent. The HPLC results for these commercial resin prepregs are summarized in Table XVI, the prepreg and composite properties in Table XVII and the mechanical properties of the composites in Table XVIII. Analytical techniques, composite fabrication and composite evaluation are given in the Appendices.

CONCLUSIONS AND RECOMMENDATIONS

The primary objective of this program was to develop a data base and procedures for the chemical characterization of PMR 15 resin solutions and graphite prepreg. In addition, the program was to provide a basic understanding of the PMR-15 resin chemistry for translation into quality control techniques for the manufacture of quality prepreg and high performance graphite reinforced structure. The objectives of the program were met. The procedures developed have been subsequently utilized to develop material and process specifications at Boeing. More detailed conclusions, and recommendations for further studies are presented below.

Conclusions

- o Chemical characterization techniques using HPLC, infrared, and thermal analysis techniques were developed with sufficient reproducibility to be viable for use as a quality control tool.
- o Sufficient chemical and/or physical property data was obtained on the PMR-15 resin to enable the development of a processing cycle for both graphite broadgoods and graphite composite structure.

- o The PMR-15 resin was shown to be very tolerant with respect to some composite properties when contaminated with the more obvious potential model compounds.
- o The PMR-15 resin was shown to be sensitive to its thermal history during resin, prepreg, and composite manufacture.
- o Excellent analytical methods (i.e., DSC, infrared, volatile evolution, etc.) were developed for the study of the chemistry and physical transformations (i.e., DMA) of PMR resins.

Recommendations

- o Sufficient data and/or techniques are available for the development of a Mil Specification on PMR resins and broadgoods. This work should be pursued.
- o The relationships between the processing conditions and the isothermal stability of PMR resins should be determined.
- o The degradation kinetics and chemistry of PMR resins should be evaluated to determine graphite reinforced structure's life at high temperatures.

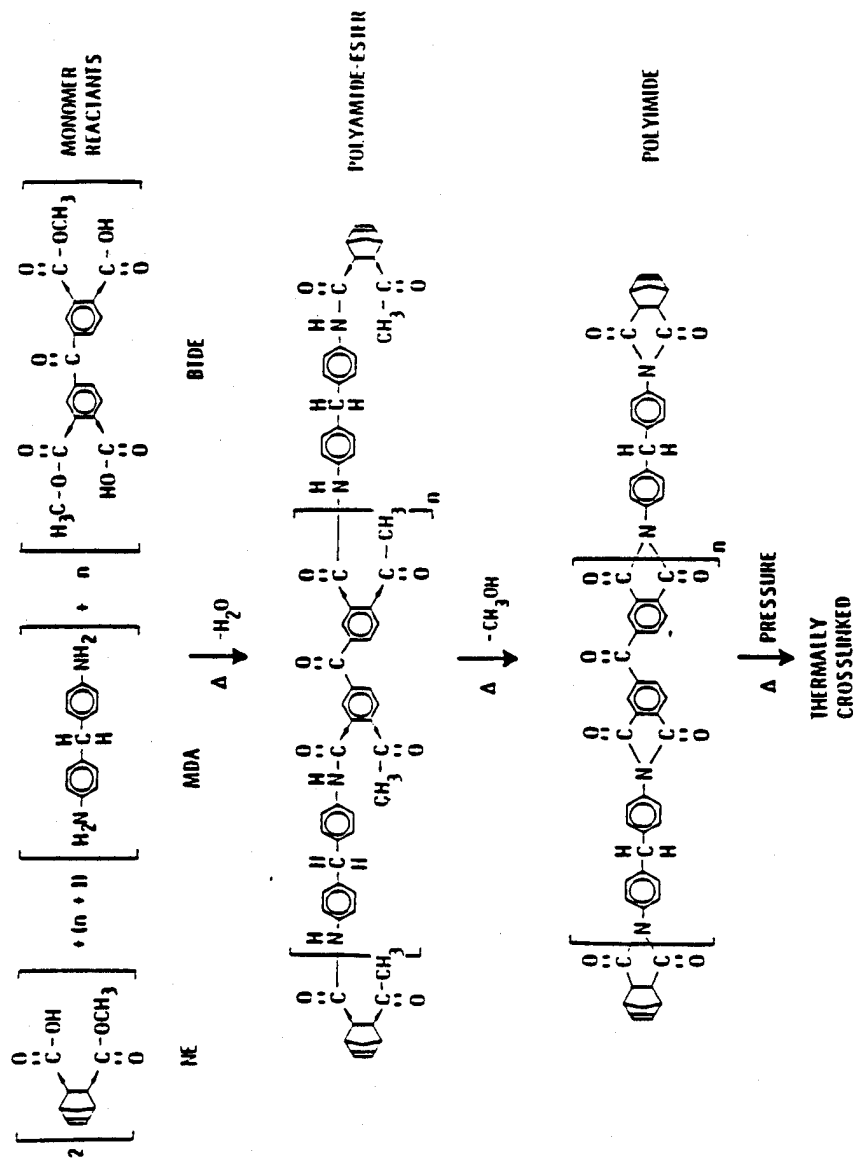

Figure 1. Proposed reaction sequence for PMR-polyimide resin

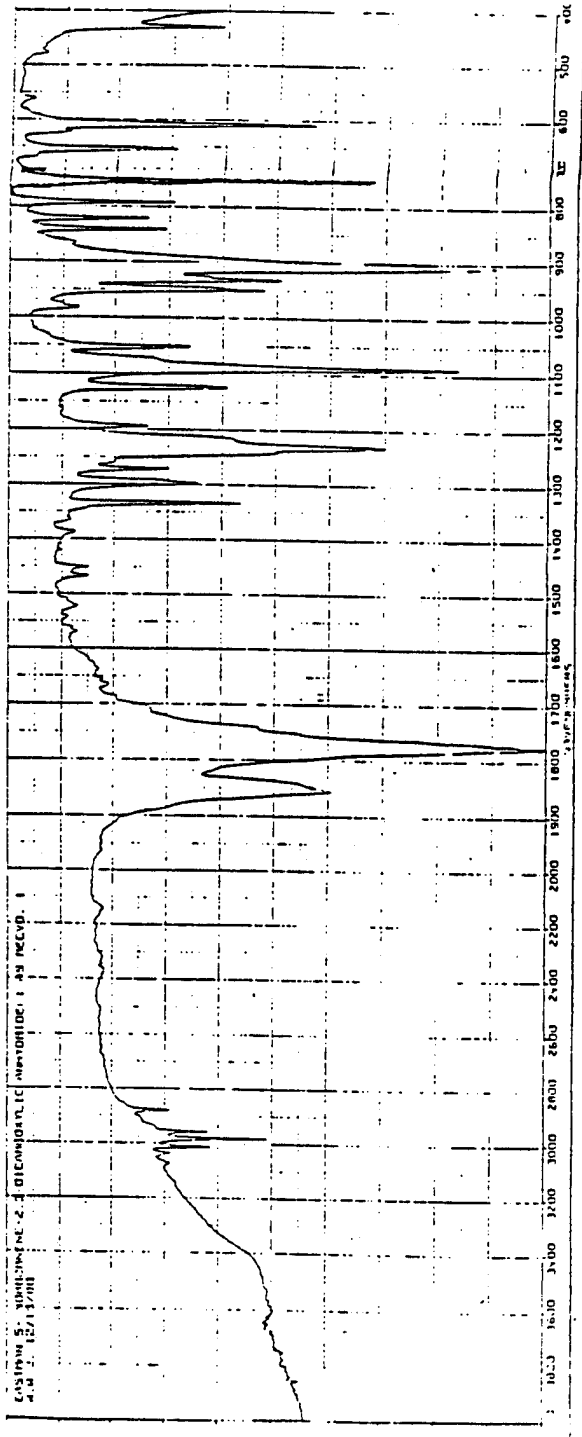

Figure 2. FTIR Spectrum of 5-norbornene - 2, 3 - dicarboxylic acid anhydride (NA) - Eastman

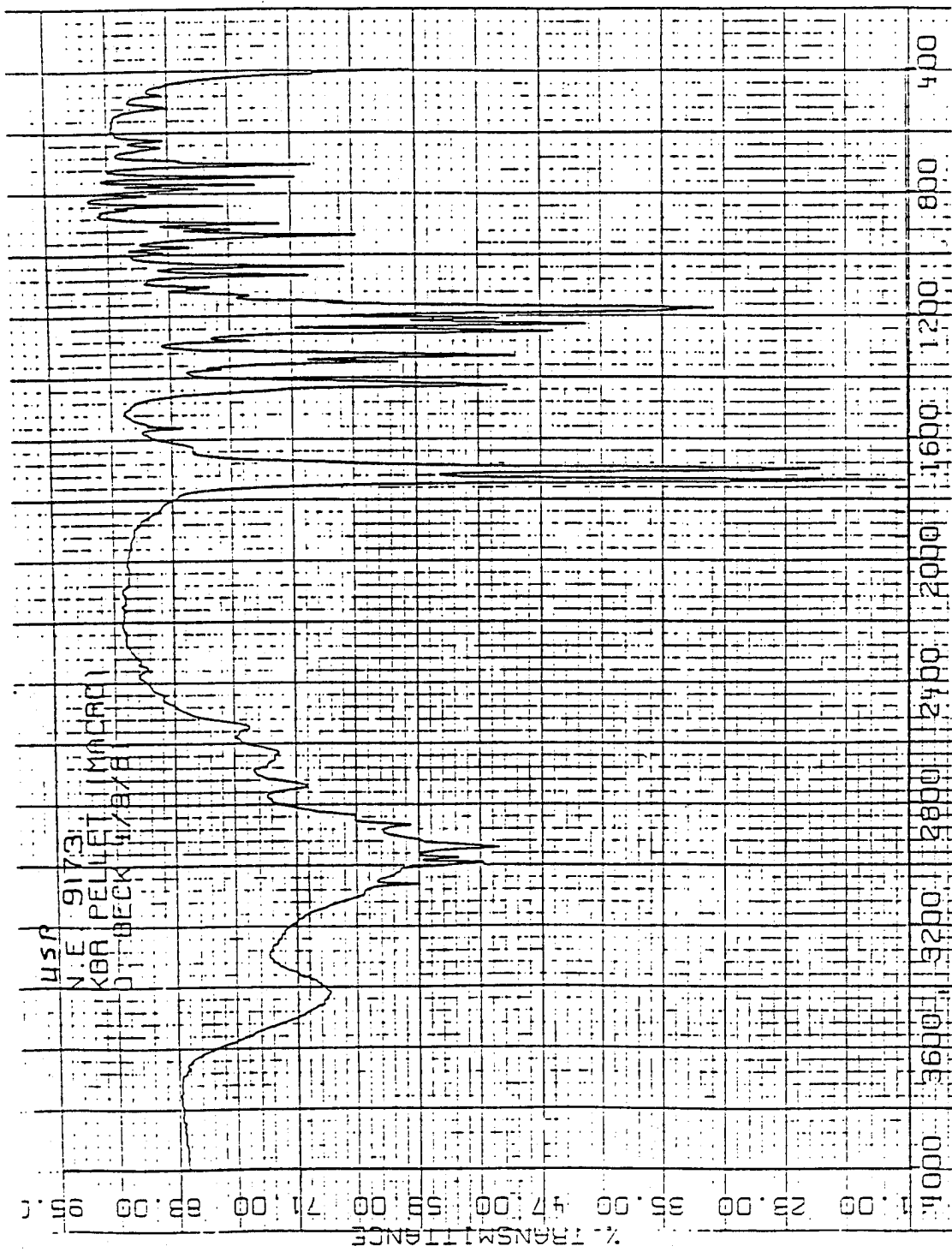

Figure 3. FTIR Spectrum of Monomethylester of 5 - norbornene - 2, 3 - dicarboxylic acid (NE) - U.S. Polymeric

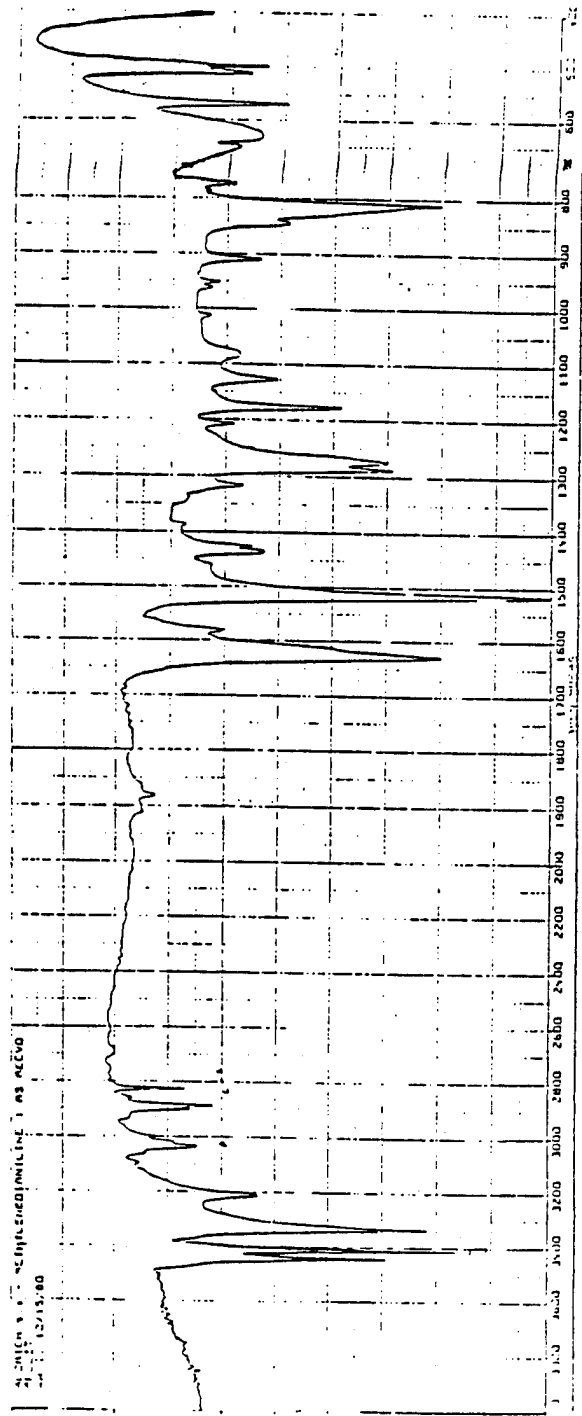

Figure 4. FTIR Spectrum of 4.4' - Methyleneedianiline (MDA) aldrich

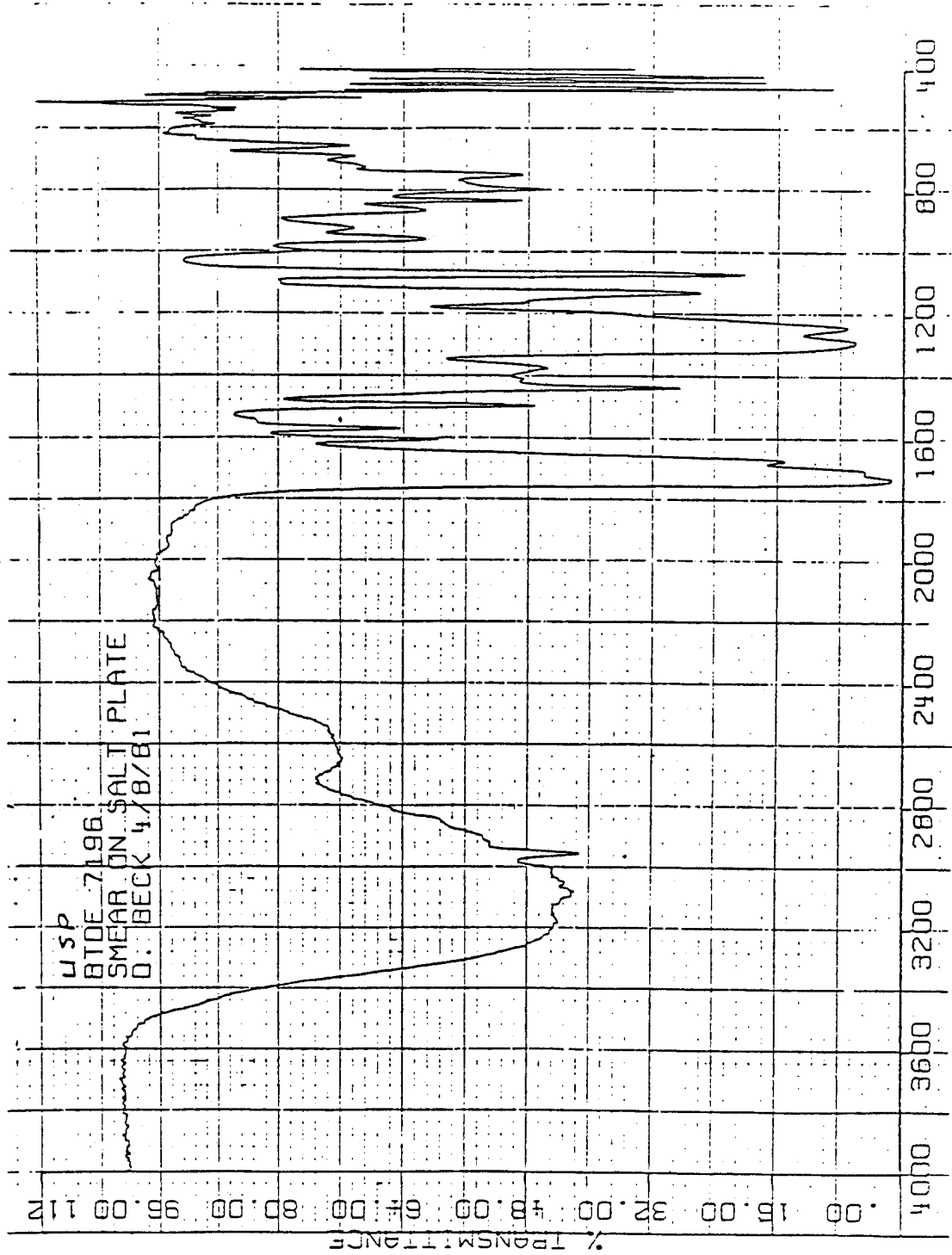

Figure 6. FTIR Spectrum Dimethylester of 3, 3', 4, 4' benzophenonetetracarboxylic acid (BTDE)

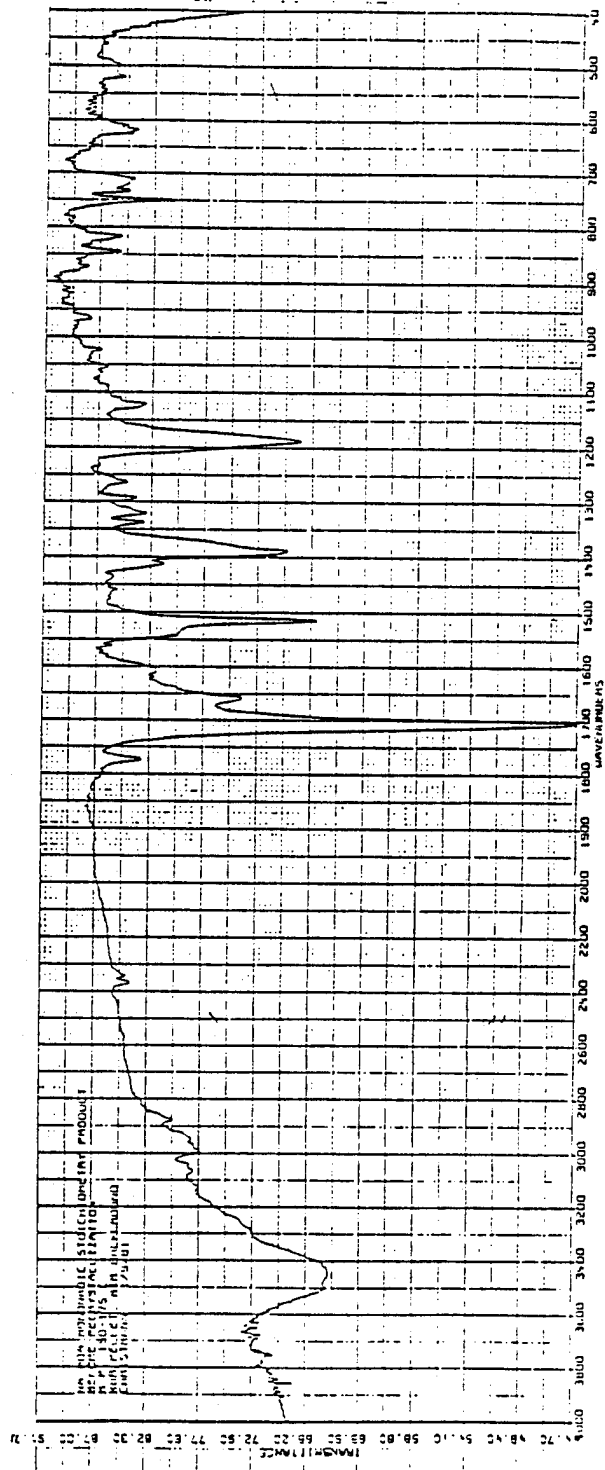

Figure 7. FTIR Spectrum of the monoimide of NA and MDA

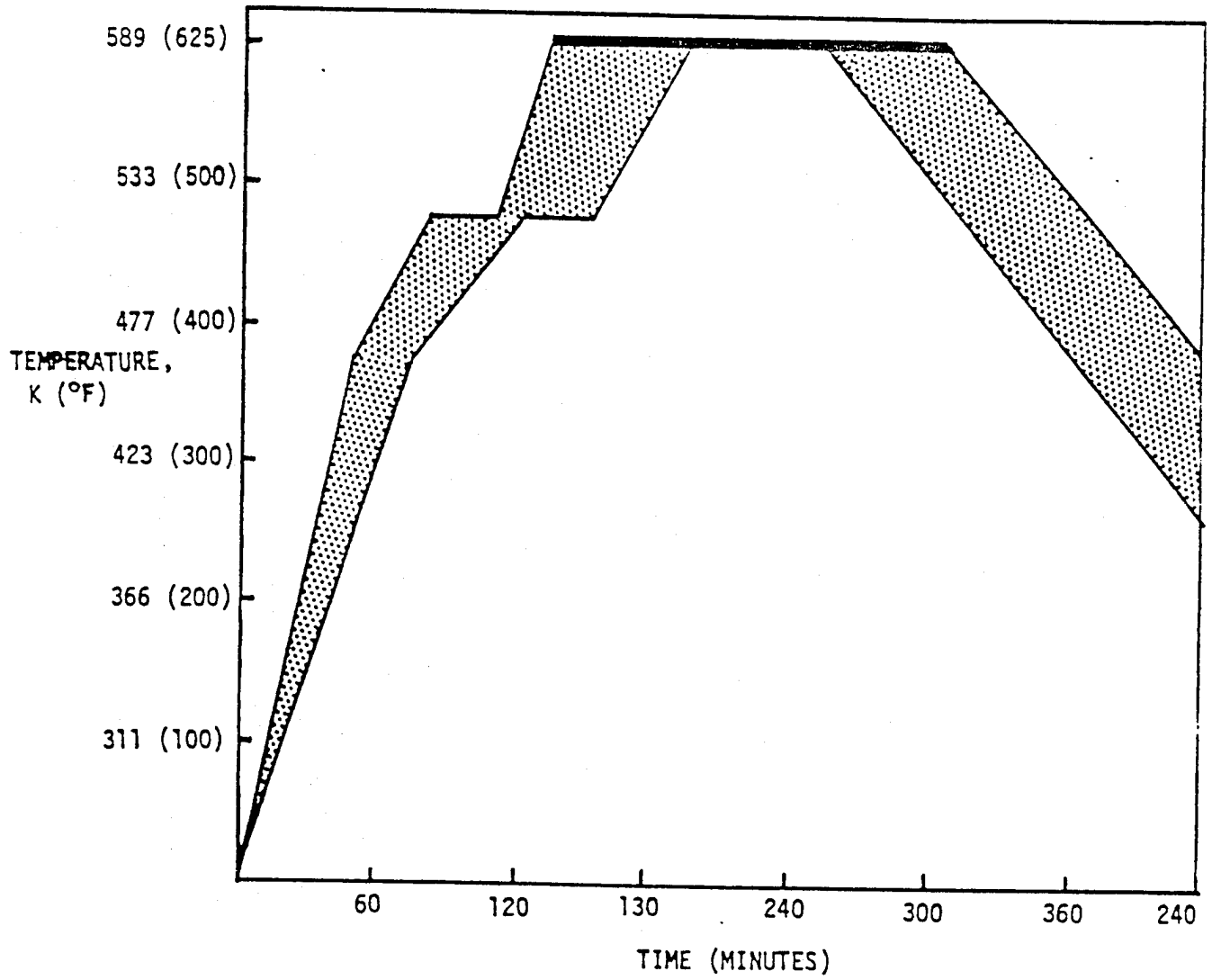

Figure 9. Recommended Cure Cycle

Sample: PMR-15
Size: 10.7 X 6.35 X .33
Rate: 1.7
DMA
Date: 28-Oct-82

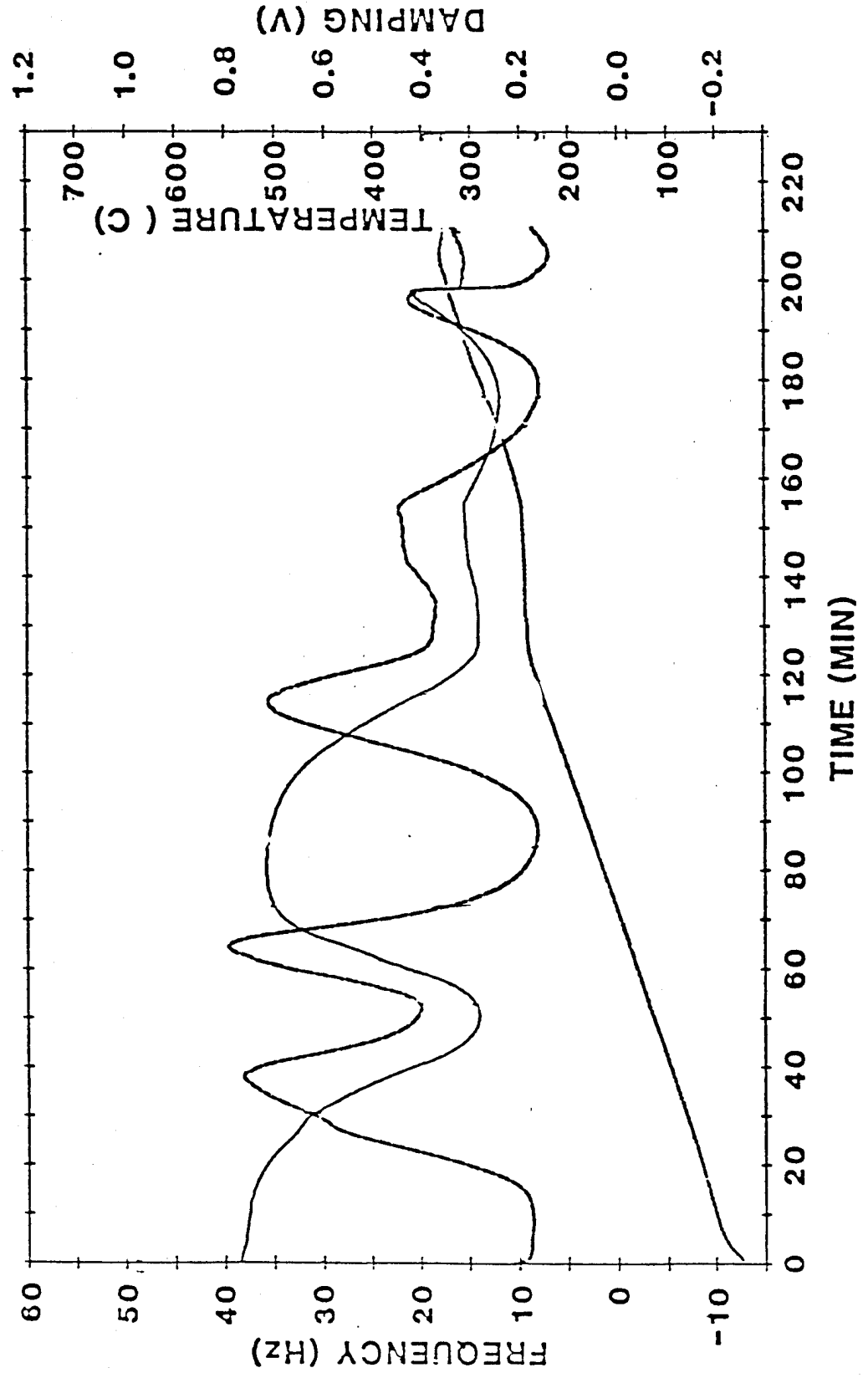

Figure 10

PMR-15 DIELECTRIC AT 1 KHz

5 DEG. C/MIN HEAT RATE

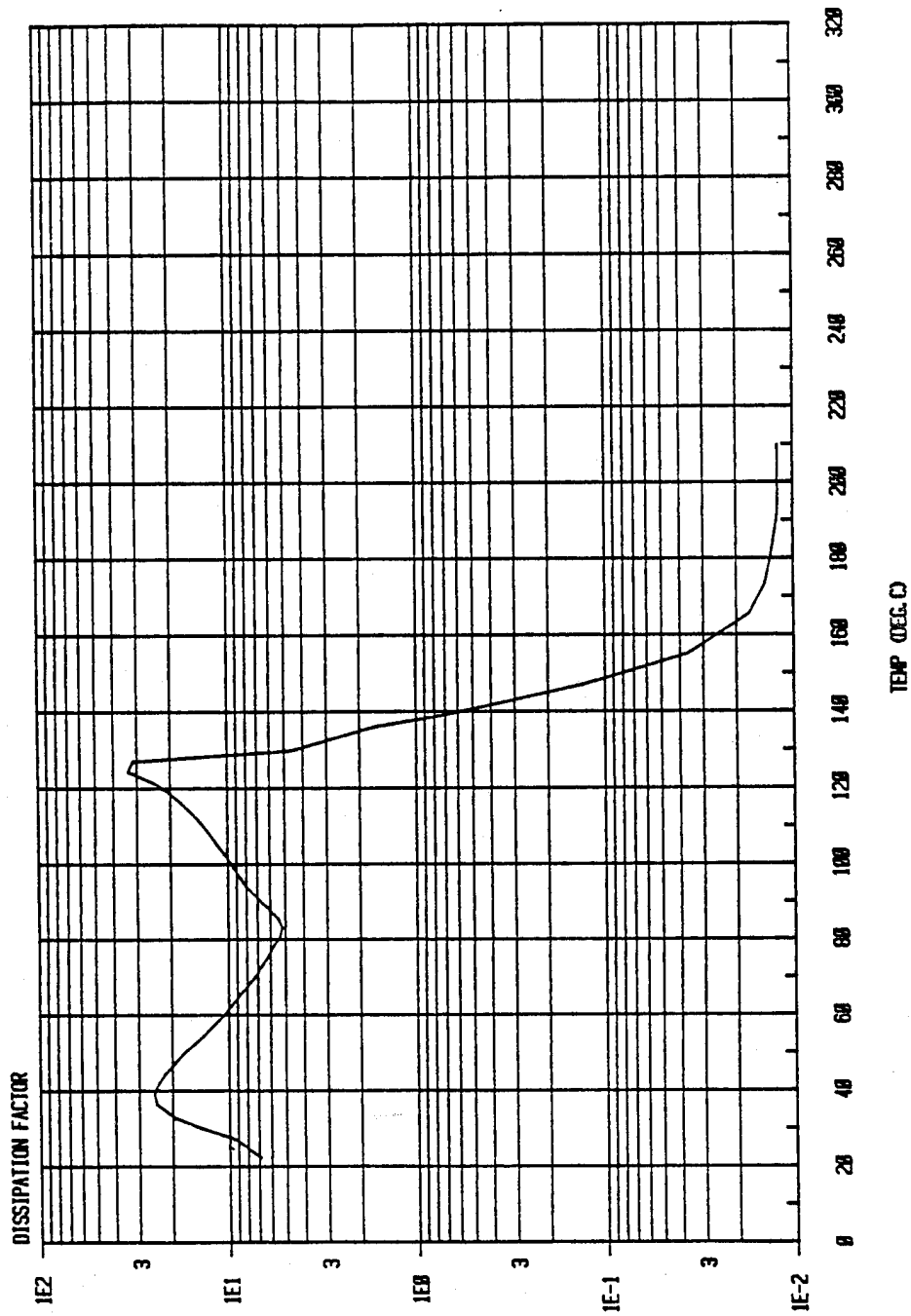

Figure 11

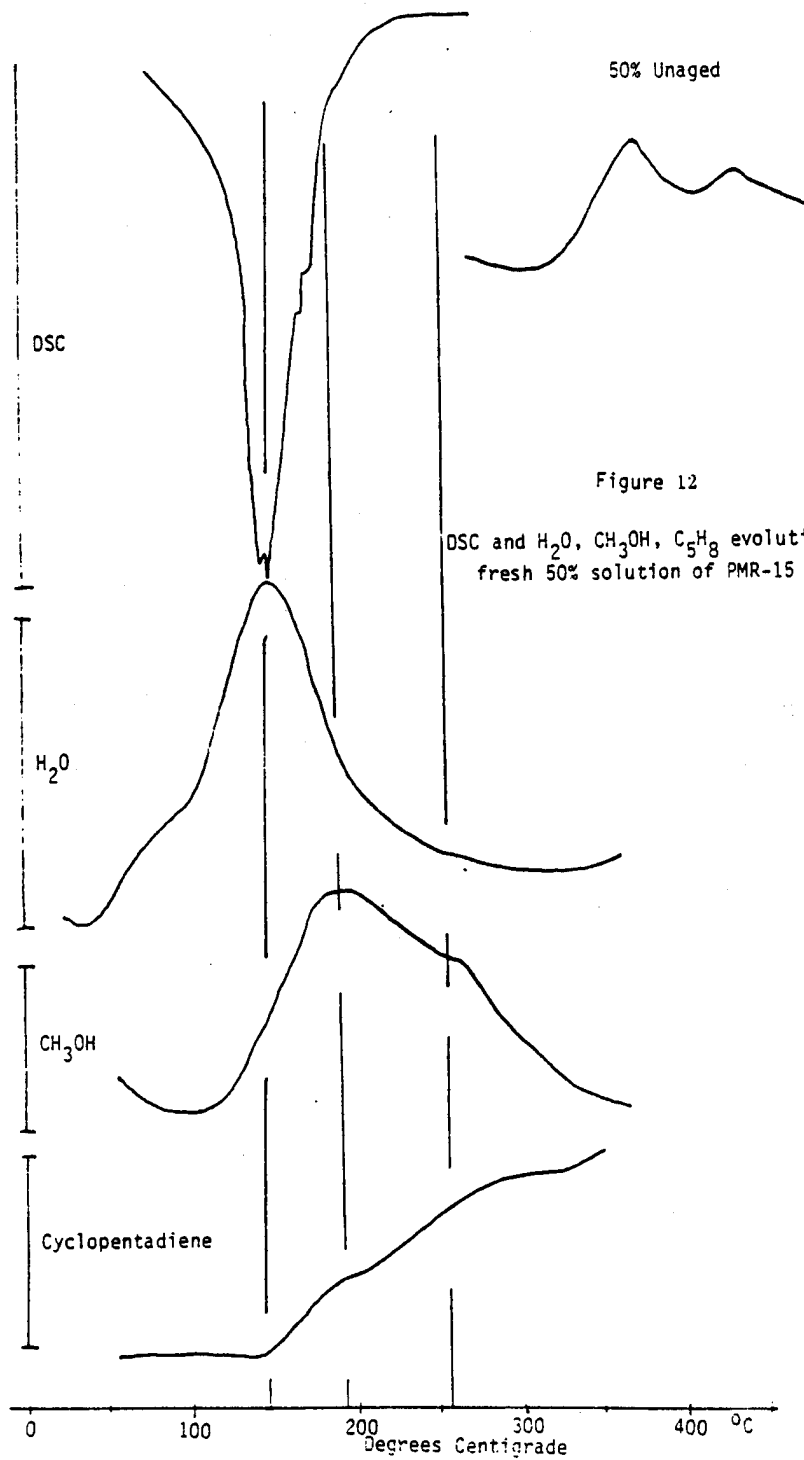

Figure 12

DSC and H₂O, CH₃OH, C₅H₈ evolution of a fresh 50% solution of PMR-15 resin

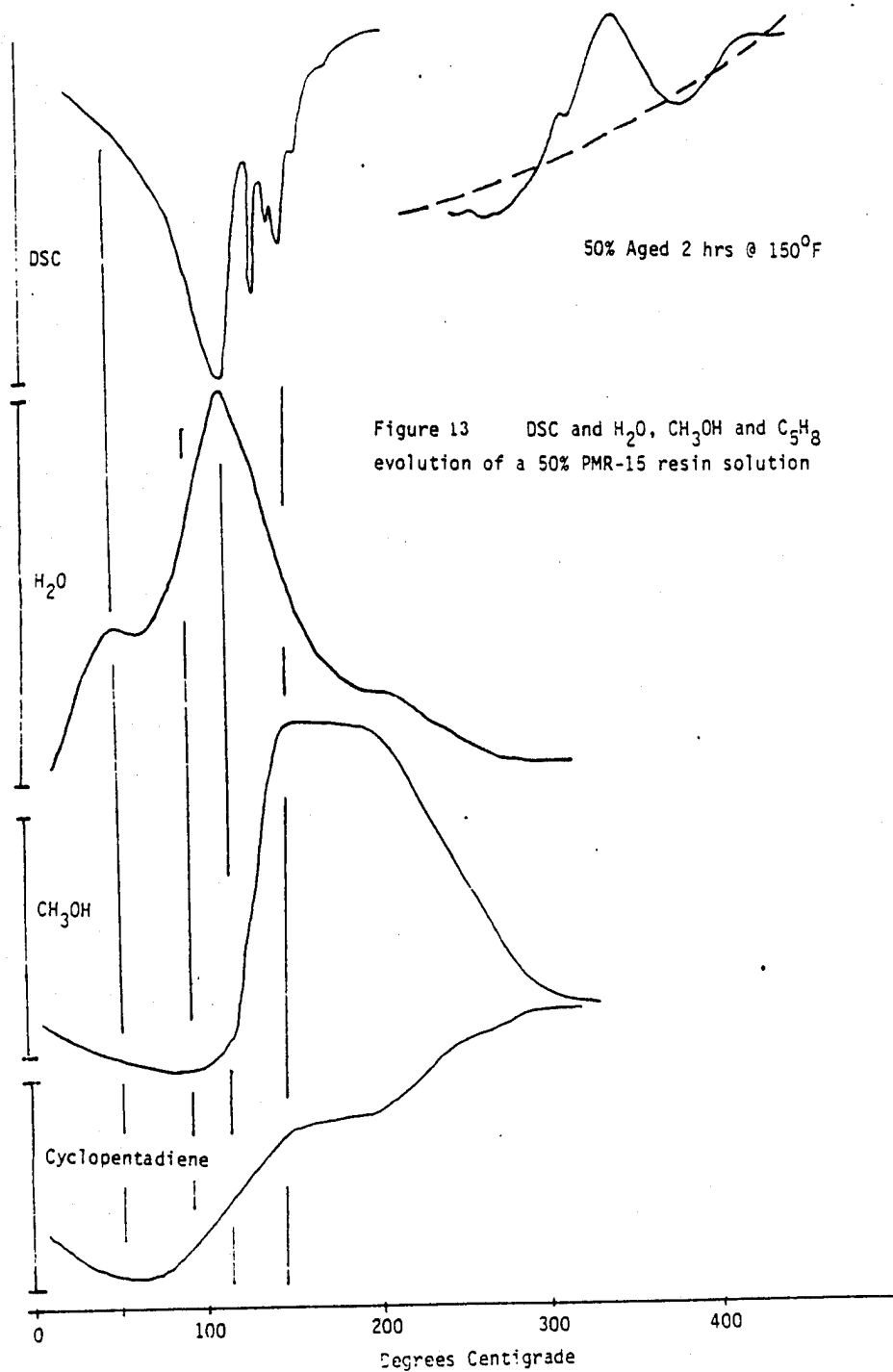
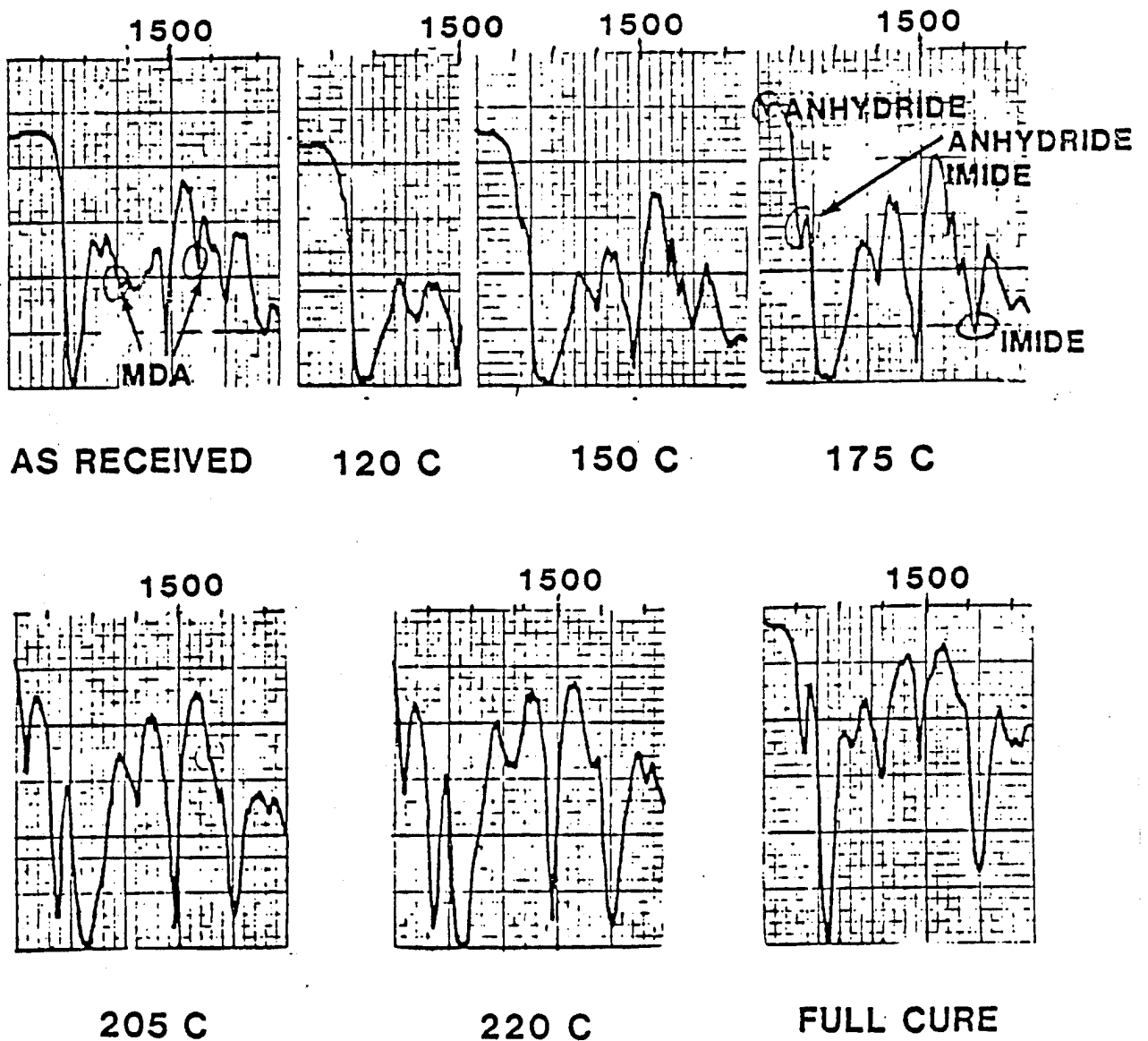

Figure 13 DSC and H₂O, CH₃OH and C₅H₈ evolution of a 50% PMR-15 resin solution



CURE ANALYSIS BY INFRA RED

Figure 14

TABLE I MELTING POINT MAXIMA OF MONOMERS AND MODEL COMPOUNDS

MATERIAL	MP, K(°F)	IMPURITY M.P. K(°F)
Eastman - NA	369 (205)	
Eastman - BTDA	497 (435)	477 (399)
Eastman - BTDA (Rxd)	500 (441)	
Aldrich - MDA	365 (198)	
NASA Lewis - MDANI	464 (376)	
Boeing - MDANI	451 (352)	
NASA Lewis - MDA _{di} NI	537 (511)	527 (489)
Boeing - MDA _{di} NI	534 (502)	
NASA Lewis - BTTE	389 (244)	

TABLE II
ELUTION TIME RATIO FOR MONOMERS AND MODEL COMPOUNDS

Material	HPLC Elution Time Ratio to THF Marker
BTDA	0.48 - 0.52
BTDE	0.52 - 0.75 (1.00, 1.13, 1.30)*
Monoimide of NE and MDA	1.05 - 1.07
Triester of BTDA	1.09 - 1.11 (1.70)*
Nadic Ester	1.12 - 1.14
Nadic Anhydride	1.35 - 1.36
Tetra Ester of BTDA	1.78 - 1.80
Bisimide of NE and MDA	2.16 - 2.17
Methylene Diamine (MDA)	—

* BTDE isomers and triester relative to 1st BTDE peak
MDA is not observed in the isocratic HPLC method

TABLE III

TYPICAL HPLC DATA FROM BOEING-U.S. POLYMERIC DATA BASE FOR PMR-15 RESIN SOLUTIONS

Sample No.	NE		1st BTDE		2nd BTDE		3rd BTDE		BT Tri E	
	Ratio	% Area	Ratio	% Area	Ratio*	% Area	Ratio*	% Area	Ratio*	% Area
WR 5889	1.10	3.61	0.582	17.27	1.11	42.67	1.25	27.27	1.68	8.75
WR 5417	1.08	3.66	0.567	17.18	1.11	42.17	1.29	27.91	1.69	8.62
WR 5608	1.15	3.60	0.670	16.49	1.13	42.15	1.32	33.11	1.23	2.57
WR 5866	1.13	3.84	0.649	16.08	1.13	43.61	1.35	32.56	1.78	3.90
WR 5909	1.12	3.58	0.694	15.86	1.10	41.15	1.29	36.94	1.65	2.47
WR 6040	1.12	4.19	0.514	18.71	1.11	46.41	1.29	30.67	1.68	3.86
Average	1.12	3.75	0.612	16.93	1.12	43.02	1.30	31.41	1.62	5.26
This Project	1.11	4.87	0.635	16.81	1.14	41.23	1.35	31.94	1.71	5.23

* Ratio Relative to 1st BTDE Isomer Peak

TABLE IV

TYPICAL HPLC DATA FROM BOEING-U.S. POLYMERIC DATA BASE FOR PMR-15 PREPREGS

Sample No.	NE			1st BTDE			2nd BTDE			3rd BTDE			BT Tri E		
	Ratio	% Area	Ratio	% Area	Ratio*	% Area	Ratio*	% Area	Ratio*	% Area	Ratio*	% Area	Ratio*	% Area	
2W4582	1.13	3.60	0.565	16.44	1.11	40.45	1.27	26.57	1.69	12.93					
2W4604	1.14	3.65	0.594	19.43	1.12	44.74	1.29	31.51	-	-					
2W4632	1.12	3.94	0.603	15.83	1.13	45.45	1.36	29.33	1.80	4.77					
2W4643	1.15	3.02	0.591	15.25	1.13	42.26	1.33	31.55	1.79	5.43					
2W4651	1.11	3.03	0.573	16.21	1.15	40.55	1.42	37.13	1.96	2.91					
3W2020	1.13	4.31	0.60	18.32	1.12	44.37	1.30	30.98	1.70	1.64					
Average	1.13	3.59	0.587	17.0	1.13	42.97	1.31	31.29	1.78	3.69					

* Ratio Relative to 1st BTDE Isomer Peak

TABLE VI
 QUANTIZATION OF HPLC DATA FOR PMR-15

	Concentration in Weight Percent				Difference
	NE	BTDE	MDA	BT TRI E	
PMR-15 Theoretical	21.69	44.51	33.80	—	—
Baseline Solution This Project	16.20	40.45	28.20	8.3	6.85
Boeing-U.S. Polymeric Data Base	10.00*	40.45	—	6.54	—
Average					
SSD Deviation	—	0.63	—	2.09	—

* This represents the lower limit rather than the average from the data base.

TABLE VII

Quantization of Baseline Resin in Mole Percent

Assumed Composition of Difference	Concentration in Mole Percent				Difference
	NE	BTDE	MDA	BT TRI E	
Monoimide of NA and MDA	22.37	28.35	38.50	5.39	5.39
Bisimide of NA and MDA	22.73	28.81	39.13	5.48	3.84
NA + 2 MDA	22.82	28.92	39.27	5.50	3.48
Theoretical PMR-15	27.90	29.07	42.03	--	--

TABLE VIII

Comparison of Mechanical Properties of Laminate made from
Baseline Resin Solutions (this project) with Averages from Data Base

Ultimate Flexural Stress	Baseline MPa (ksi)	Data Base Average MPa (ksi)	
		\bar{X}	σ
at			
295K (72°F)	1446 (210)	1569 (228)	151 (22)
585K (600°F)	296 (130)	293 (134)	96 (14)
Flexural Modulus	GPa (Msi)		
at			
295K (72°F)	113.7 (16.7)	123.9 (18.2)	9.5 (1.4)
289K (600°F)	117.1 (17.0)	121.2 (17.2)	8.9 (1.3)
Ultimate Interlaminar Shear	MPa (ksi)		
295K (72°F)	93.0 (13.5)	96.4 (14.0)	5.5 (0.8)
589K (600°F)	48.9 (7.1)	55.8 (8.1)	7.6 (1.1)

\bar{X} overall average

σ standard deviation

TABLE IX

Aging Studies on PMR-15 Resin Solutions

Run #	Solution Concentration	Time (hours)	Temperature	Concentration in Weight Percent					Reaction Product
				NE	BTDE	MDA	BT Tri E		
41	50%	0	316K (110°F)	17.53	41.67	27.32	5.23		8.25
48	50%	0.5	316K (110°F)	14.15	39.63	24.12	3.85		8.25
49	50%	2.0	316K (110°F)	8.35	42.29	23.72	4.00		21.64
50	50%	4.0	316K (110°F)	7.42	41.06	22.32	3.44		25.76
51	50%	24.0	316K (110°F)	4.18	40.04	15.84	2.54		37.40
52	50%	0.25	339K (150°F)	7.20	40.45	20.02	3.39		28.94
53	50%	1.00	339K (150°F)	5.15	41.27	19.39	3.28		30.91
54	50%	2.0	339K (150°F)	3.28	43.31	18.85	2.48		32.08
55	50%	165.0	295K (72°F)	8.71	41.07	17.29	3.97		28.96
56	67%	0	316K (110°F)	10.58	42.50	23.65	3.45		19.82
57	67%	0.5	316K (110°F)	8.39	43.11	23.49	3.81		21.20
58	67%	2.0	316K (110°F)	6.30	41.88	23.05	3.35		25.42
59	67%	4.0	316K (110°F)	5.69	41.07	22.21	2.70		28.33
60	67%	24.0	316K (110°F)	5.58	42.13	17.32	3.72		31.35
61	67%	0.25	339K (150°F)	8.10	43.01	21.17	3.19		24.53
62	67%	1.00	339K (150°F)	4.68	42.08	19.72	3.60		27.92
63	67%	2.00	339K (150°F)	3.10	41.57	17.73	3.43		34.23

TABLE X

Calculated Weight Percent and (Mole Percent)
for Contaminated Resin Solutions

	NE	BTDE	MDA	
PME-15 BASELINE	21.69 (27.90)	44.51 (29.07)	33.80 (43.02)	
				N-IMIDE
10% N-IMIDE	19.63 (25.83)	44.75 (29.91)	31.79 (41.39)	3.83 (2.87)
20% N-IMIDE	17.55 (23.64)	45.00 (30.79)	29.74 (39.65)	7.70 (5.91)
				NA
10% NA	19.59 (25.11)	44.66 (29.07)	33.92 (43.02)	1.98 (2.79)
20% NA	17.48 (22.32)	44.82 (29.07)	34.06 (43.02)	3.65 (5.58)
				BTDA
10% BTDA	21.85 (27.90)	40.35 (26.17)	34.05 (43.02)	3.73 (2.91)
20% BTDA	22.02 (27.90)	36.14 (23.25)	34.31 (43.02)	7.53 (5.82)

TABLE XI

Measured Concentration

Run #	Description	NE	BTDE	MDA	BT Tr E	Difference
7T	Baseline	16.20 (21.69)	40.45 (44.51)	28.20 (33.80)	8.3 (-)	6.85 (-)
8T	10% NA (substituted)	13.50 (19.56)	38.72 (44.66)	27.80 (33.92)	8.85 (-)	11.13 (1.98)
10T	20% NA (substituted)	12.40 (17.48)	41.70 (44.82)	23.53 (34.06)	6.90 (-)	15.41 (3.65)
9T	10% BTDA (substituted)	17.50 (21.85)	39.00 (40.35)	24.70 (34.05)	4.50 -	14.30 (3.73)
-	20% BTDA (substituted)	- (22.02)	- (36.14)	- (34.31)	- -	- (7.53)
11T	10% N-MDA (substituted)	14.3 (19.63)	41.6 (44.75)	25.16 (31.79)	5.82 -	13.12 (3.83)
12T	20% N-MDA (substituted)	13.2 (17.55)	42.05 (45.00)	22.20 (29.74)	5.75 -	16.80 (7.70)
52	Aged 1/4 hour	7.20 -	40.45 -	20.02 -	3.39 -	28.94 -
54	Aged 1 hour	5.15 -	41.27 -	19.39 -	3.28 -	30.91 -

() Theoretical expected weight percent

BTDE/NE and BTDE/BT Tri E measured by isocratic - absorption HPLC

BTDE/MDA and BTDE/NE measured by gradient - reverse phase HPLC

TABLE XII

Prepreg Properties

	PMR-15 +10% NA	PMR-15 +10% BTDA	PMR-15 +10% N-IMIDE	PMR-15 1/2 hr at 150°F
Volatiles (%)	10.2	9.2	8.1	8.2
Gel Time (sec.)	40	40	35	35
Resin Content %	38.3	38.4	39.0	37.5

Composite Properties

Resin Content %	28.6	28.2	29.3	27.0
Specific Gravity (gm/cc)	1.62	1.63	1.60	1.61
Void Volume (%)	<1	<1	<1	<1
Fiber Volume (%)	65.7	67.2	64.2	67.3

TABLE XIII

Laminate Mechanical Properties for First Level Contamination

	PMR-15 +10% NA	PMR-15 +10% BTDA	PMR-15 +10 N-IMIDE	PMR-15 1/2 hr at 150°F	PMR-15 Baseline		
Flexural Strength (KSI)						\bar{X}	σ
RT	261.7 (239.0)	266.2 (237.7)	219.2 (204.9)	234.1 (208.7)	228	22	
600°F	170.7 (155.9)	120.1 (107.2)	130.9 (122.3)	126.5 (112.8)	134	14	
Flexural Modulus (MSI)							
RT	17.1 (15.6)	16.2 (14.5)	16.3 (15.2)	15.8 (14.1)	18.2	1.4	
600°F	17.4 (16.0)	19.7 (17.6)	20.7 (19.3)	20.3 (18.1)	17.6	1.3	
Interlaminar Shear							
RT	13.7	13.7	15.1	13.0	14.0	0.8	
600°F	7.6	6.3	6.9	6.9	8.1	1.1	

() normalized to 60% fiber volume

TABLE XIV

Prepreg Properties

	PMR-15 + 20% NA	PMR-15 + 20% N-IMIDE	PMR-15 1 hr. at 150°F
Volatiles (%)	8.7	9.5	9.2
Gel Time (sec.)	40	35	45
Resin Content (%)	36.7	37.7	36.7

Composite Properties

Resin Content (%)	35.4	29.7	30.6
Specific Gravity (gm/cc)	1.57	1.61	1.61
Void Volume (%)	<1	<1	<1
Fiber Volume (%)	58.1	64.7	63.6

TABLE XV

Laminate Mechanical Properties for Second Level of Contamination

	PMR-15 +20% NA	PMR-15 +20% N-IMIDE	PMR-15 1 hr. 150°F	PMR-15 BASELINE		
				\bar{X}	σ	
Flexural Strength (ksi)	RT	173.4(179.1)	175.7(162.9)	174.5(164.6)	228	22
	600°F	117.5(121.3)	113.1(108.5)	123.8(116.8)	134	14
Flexural Modulus (msi)	RT	17.0(17.6)	18.4(17.1)	18.7(17.6)	18.2	1.4
	600°F	17.6(18.2)	18.2(16.9)	19.5(18.4)	17.6	1.3
Interlaminar Shear	RT	13.5	12.8	14.2	14.0	0.8
	600°F	6.1	6.1	6.4	8.1	1.1

() Normalized to 60 percent fiber volume.

TABLE XVI

Measured Weight Percent Concentration
for Commercial Resins

	NE	BTDE	MDA	BT Tri E	Difference
PMR-15 Theoretical	21.69	44.51	33.8	-	-
Baseline	16.20	40.45	28.20	8.3	6.85
Hexcel	11.00	43.54	19.15	7.5	18.81
U.S. Polymeric	13.03	45.30	22.68	2.44	13.55

TABLE XVII

Prepreg and Composite Properties for Commercial Resins

Prepreg Properties		
	Hexcel	U.S. Polymeric
Volatiles (%)	7.6	9.5
Gel Time (sec.)	40.0	45
Resin Content (%)	35.9	38.2
Composite Properties		
	Hexcel	U.S. Polymeric
Resin Content (%)	47.2	48.1
Specific Gravity	1.57	1.57
Void Volume (%)	0	0
Fiber Volume	56.2	57.1

TABLE XVIII

Laminate Mechanical Properties for Commercial Resins

	Hexcel	U.S. Polymeric
Flexural Strength (KSI)		
RT	196.9 (210.2)	192.6 (202.4)
600°F	97.6 (104.2)	97.8 (102.8)
Flexural Modulus (MSI)		
RT	14.8 (15.8)	16.58 (17.42)
600°F	13.3 (14.2)	15.55 (16.33)
Interlaminar Shear (KSI)		
RT	14.7 (15.6)	13.24 (13.91)
600°F	6.1 (6.5)	5.83 (6.13)

() normalized to 60% fiber volume.

APPENDIX A

CHEMICAL CHARACTERIZATION PROCEDURES

A.1 High Pressure Liquid Chromatography (Isocratic Method)

Test shall be performed with a duPont Model 850 or equivalent.

a. Sample Preparation

(1) Neat resin

From a sample of each material make a 0.1 g/5 ml solution using tetrahydrofuran (THF) as the solvent. Filter the solution through a 0.2 micron filter.

(2) Prepreg

Obtain a 0.3 gram sample of prepreg. (This should provide approximately 0.1 gram of resin. The quantity may have to be adjusted depending on resin content.) Discard any backing or carrier. Make a solution using 5 ml of THF solvent. Mechanically shake the solution for ten minutes minimum. Filter the solution through a 0.2 micron filter.

b. Instrument Parameters

Column: Two calibrated Type 1 duPont SE 60 size exclusion columns, nonsilanized.

Mobile Phase: 2:1 water: THF plus 0.01% acetic acid. Note: Water must be ultra-pure and THF must be uninhibited and distilled in glass.

Elution Rate: 1.0 ml/minute

Sample Size: 3 microliter

Chart Speed: 2.0 - 3.0 cm/minute

UV Detector Wavelength: 210 nm 2 A.U.F.S.
(absorption units full scale)

UV Detector Attenuation: X8 Note: Depending on the instrument the attenuation may have to be adjusted to give full page width chromatograms.

c. Analysis

- (1) The required area of integration shall be $100,000 \pm 20,000$ total area counts of the chromatogram.
- (2) The minimum area of integration shall be 0.625% of the total chromatogram area.

d. Column Calibration

This method describes a procedure for calibration of the Type 1 duPont SE 60 size exclusion, nonsilanized columns used for the high performance liquid chromatography described above.

(1) Sample preparation

Make up three solutions using benzanilide, 1/, 4-bromoacetanilide, 2/ and acenaphthene 3/ by combining 0.020 grams of each material in 5 ml of THF.

Blend 2.8 parts of the benzanilide solution with 4.0 parts of the 4-bromoacetanilide solution with 0.75 parts acenaphthene solution. This solution will then be used in the calibration procedure.

Notes

- 1/ Benzanilide, $C_6H_5CONHC_6H_5$, melting point $162-164^\circ C$, from Tridon Chemical, Inc., 255 Oser Avenue, Hauppauge, NY 11787.
- 2/ 4-bromacetanilide, $CH_3CONHC_6H_4Br$, melting point $165-166^\circ C$, from Tridon Chemical, Inc., 255 Oser Avenue, Hauppauge, NY 11787.
- 3/ Acenaphthene, $C_{10}H_6(CH_2)_2$, melting point $90-95^\circ C$, from Aldrich Chemical Co., P.O. Box 355, Milwaukee, Wisconsin 53201.

(2) Instrument parameters

Mobile phase:	See B.1.2.1.b (previous page)
Elution rate:	1.0 ml/minute
Sample size:	1 microliter
Chart speed:	2-3 cm/minute
UV Detector Wavelength:	254 nm 2 A.U.F.S.
UV Detector Attenuation:	X64

(3) Analysis

This evaluation is made by determination of:

N = theoretical plate number

α = column selectivity

K' = capacity factor

R_s = resolution

The determination is made from the chromatogram.

Calculate N as follows for 4-bromoacetanilide:

$$N = 16 \left(\frac{V_0}{tw} \right)^2$$

where V₀ = elution volume in seconds

tw = baseline of extrapolated triangle in seconds

Calculate K' for both benzanilide and acenaphthene as follows:

$$K' = \frac{t_r - t_0}{t_0}$$

where t_r = elution volume in seconds for each compound, respectively

t₀ = elution volume in seconds for 4-bromoacetanilide.

NOTE: t₀ is not calculated from the tetrahydrofuran elution volume but because of difficulty at times in detecting this marker; use 4-bromoacetanilide as the marker.

Calculate α as follows:

$$\alpha = \frac{K'_2}{K'_1}$$

where K₁' = K' for benzanilide

K₂' = K' for acenaphthene

Calculate R_s as follows:

$$R_s = \frac{1}{4} \frac{(\alpha - 1)}{\alpha} \sqrt{N} \frac{K_2'}{K_2' + 1}$$

(4) Requirements

For each column set $N = 7000$ (minimum) $R_s = 4$ (minimum).

(5) Column handling instructions

Store the column in methanol when not in use.

Flush the column with mobile phase to a stable baseline before injecting samples or standards.

If the column deteriorates below specification requirements it may be cleaned by pumping two to five column volumes of the following solvents through the column in the following order.

methanol
tetrahydrofuran
cyclohexane
methylene chloride
methanol

NOTE: The above solvents must be high purity solvents.

A.2 High Pressure Liquid Chromatography (Gradient Method)

Test shall be performed with a duPont Model 850 or equivalent.

a. Sample preparation

From a sample of the resin make a 0.1 g/5 ml solution using methanol as the solvent. Filter the solution through a 0.2 micron filter. Inject 3 microliters using the instrumental parameters given below.

b. Instrument parameters

Column	Varian R. P. MCH10		
Mobile Phase	Methanol: Water		
Program	M.P.	Flow	Time
	40:60	1.5	0.0
	80:20	2.0	15.0
	100:00	2.0	18.0
Detector	UV at 210 and 254 nm		

c. Typical chromatogram

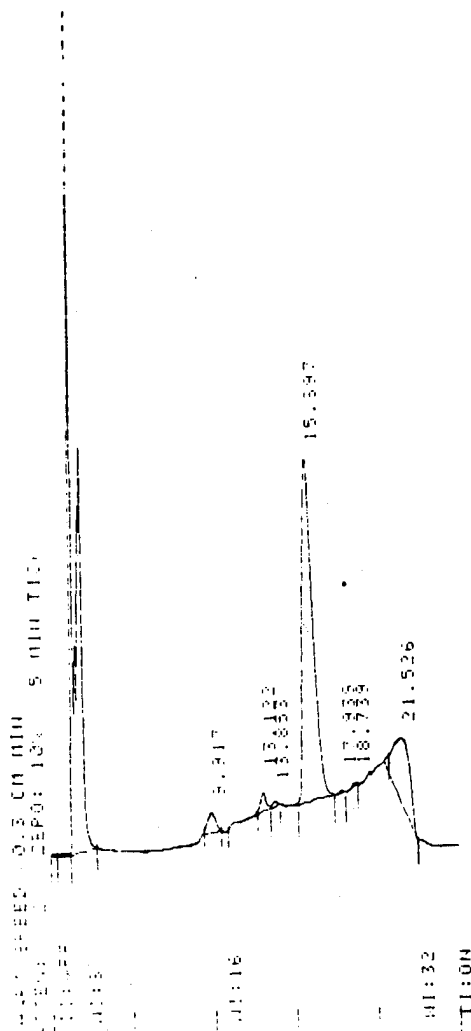

A.3 Dynamic Mechanical Analysis (DMA) (duPont Method)

The equipment used shall be a duPont 981 Dynamic Mechanical Analyzer or its equivalent.

Test Method for Prepreg

a. The sample is run under the following conditions:

Sample Size Length	Approximately 25 mm. The length must be sufficient to fit in the instrument jaws without buckling.
Sample Size Width	7.50 to 8.00 mm
Sample Size Thickness	The thickness of two ply which should be approximately 0.3 to 0.5 mm.
Working Length	Actual measurement of sample between clamps, with the gap between sample arms in position 2
Sample Mode	Horizontal Position
Number of Plies	2
Heat Rate	5°C/min
Temperature Range	0°C to 350°C
Oscillation Amplitude	0.20 mm
Environment	Nitrogen

Insert the sample in the sample clamps making sure that the sample is centered within the clamps and perpendicular to the arms. The test accuracy is dependent upon placing the same length of sample in each arm clamp. Also the sample dimensions must be measured accurately to the nearest 0.01 mm. The sample thermocouple must be centered between the arms and located as close to the sample as possible without interfering with the vibrating arms. Enclose the test chamber and start the nitrogen flow at 51/minute. Record the damping and frequency versus temperature. A typical DMA curve is shown in Figure 10.

A.4 Dielectrometer Analysis of Resins

This method describes the procedure for monitoring the gelling and advancement of resinous materials.

The instrument shall be capable of measuring the dissipation factor of materials as a function of temperature. Typical equipment is as follows:

duPont 900 Thermal Analysis Console with Dielectrometer Cell

General Radio Automatic Capacitance Bridge, type 1673

The following variables must be controlled.

- | | |
|--|------------------------------------|
| a. Temperature range | ambient to 400°C |
| b. Heating rate | 5°C/min. |
| c. Capacitance bridge frequency | 1000 Hz |
| d. Sample size | Sufficient to fill the teflon ring |
| e. Inner and outer diameter of teflon template | 1.5" |

The sample is placed between the plates of the capacitance bridge. This done by placing a teflon template around the sample, and sandwiching it between aluminum foil, and inserting the total package between the electrodes of the dielectrometer.

Place the sample sandwich in the dielectrometer cell between the boron nitride insulators and assemble cell. Allow the system to equilibrate with the automatic capacitance bridge turned on. Begin the run by turning the thermal analyzer to "Heat" position. Record time, temperature, conductance, and capacitance reading.

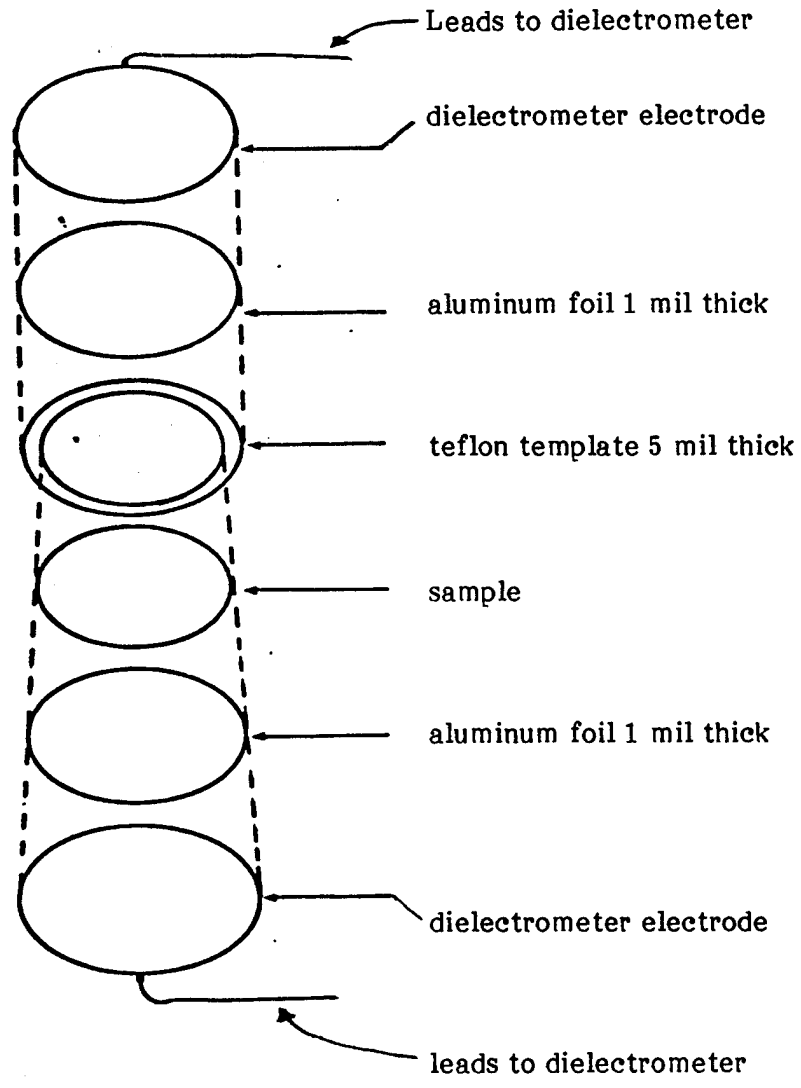

Calculations

The dissipation factor is calculated by the following formula:

$$\text{Tan } \alpha = \frac{G}{2\pi fc}$$

where

- Tan α = dissipation factor
- G = conductance (mhos)
- C = capacitance (farads)
- f = frequency (hertz)

The above formula can be reduced to $\text{Tan } \alpha = \frac{G}{6.28C}$ when $f = 1000 \text{ Hz}$

where

$\text{Tan } \alpha$ = dissipation factor

G = conductance in micromhos

C = capacitance in nanofarads

Plot the dissipation factor versus temperature.

A.5 Differential Scanning Calorimetry

Use a duPont 990 instrument, or equivalent, using the following control variables.

Sample size:	7.0 mg
Temperature:	ambient to 150°F
Rate of heating:	5.0°C/minute maximum
X-axis:	10.0°C/minute
Y-axis:	1 mcal/sec/inch
Reference:	empty pan
Atmosphere:	air, no flow

A.6 Infrared Analysis of PMR-15

A Fourier transform spectrophotometer or equivalent using the following IR scan parameters:

- a. resolution - 8.0 cm^{-1}
- b. number of scans in sample beam - 16
- c. number of scans in reference beam - 16
- d. wave numbers per in. - 200
- e. spectral range $500\text{-}4 \text{ cm}^{-1}$ (standard plot) 204

Place a portion of the resin/solvent solution on a NaCl salt block. (If using prepreg extract resin from tape using acetone.) The sample shall be of sufficient thickness to produce a spectrum whose strongest bond indicates $15^{+5}_{-10} \%T$.
Allow solvent to evaporate and scan the sample.

A.7 Procedure for Determining Volatiles Using GC/MS

1. Experiment layout

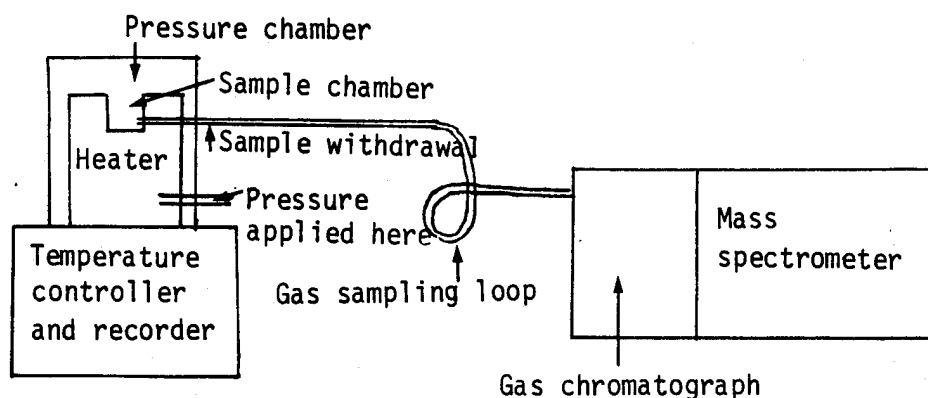

2. Procedure description

A duPont Differential Scanning Calorimeter Pressure Cell was modified slightly to hold a large amount of the resin. The cell was then interfaced directly to a gas sampling loop of a Varian Gas Chromatograph which was interfaced with a duPont Mass Spectrometer. The use of a thermal analyzer cell gave temperature program capability as well as environmental and pressure control to the sample. Interfacing with the gas sampling loop gave the option of sampling under constant flow conditions or maintaining a closed cell with periodic sampling. The gas chromatograph enabled the separation of any compounds evolving and the mass spectrometer was used to qualitatively identify the compounds. In the case of determining water content the Mass Spectrometer was replaced and the thermal analyzer system was interfaced directly to a duPont Moisture Monitor for moisture evolution analysis.

A.8 Gas Chromatography/Mass Spectroscopy

Use a Hewlett Packard FM Scientific 5750 gas chromatograph or equivalent.

a. Sample preparation

Extract a sample of prepreg with reagent grade methanol at room temperature. Make sure all the resin is extracted from the fibers. Filter the solution to remove the fibers. Use resin solution as made.

b. Instrument parameters

Column:

Alltech Catalog no. C-5000

Alltech Reference No. 97783L

Length: 6 feet

O.D.: 0.125 inch

I.D.: 0.085 inch

Loading: 10%

Stationary phase: UCW-98

Support: Chrom W-Hp

Mesh: 80/100

Upper limit: 300 + C

Sample size: 1 microliter

Oven temperature: Room Temperature to 392°F

Program rate: 27F/minute

Detector: Flame Ionization

Detector port temperature: 482°F

Injector port temperature: 437°F

Carrier gas: Helium (ultra-pure)

Range: 10-11

Attenuation: 256

Chart speed: 0.25 inch/minute

c. Procedure

Before injecting the sample, stabilize the baseline. When the baseline is stabilized, inject the sample and mark the injection event as time zero. Hold for one minute at room temperature before programming to upper limits. Allow time for all of the sample to clear the column and the baseline to stabilize again. Once the analysis is complete, program the column to its upper temperature limits to flush the column.

A.9 Dynamic Mechanical Analysis (Rheometrics Method)

Prepreg PMR-15 resin solution on 181 Style A1100 finished glass fabric.

Mounting Rectangular Sample Torsion Fixture - To mount a Rectangular Torsion fixture, proceed as follows:

- a. Install 3" Oven, (EC-3020).
- b. Verify that air gauge on pressure regulator (at rear of Test Station) indicates 35 PSI (60 PSI for TX-10,000 XYZT transducer and RMS-605 models with motor air bearing), MAIN POWER switch is ON, MOTOR switch is OFF, Transducer SELECT switch is set to type of Transducer in use, and equipment has been warmed for 30 minutes minimum.
- c. Clean the locating surfaces on the upper and lower fixtures to ensure that no foreign particles are present.
- d. Set THERMOCOUPLE select switch to EXTERNAL.
- e. Align the locating hole on the upper (long) S-2-A Rectangular Torsion Fixture with the locating pin on the upper spindle. Install the fixture and secure hand tight. The fixture should snap cleanly into place. If it does not, loosen the knurled ring halfway (to prevent the fixture from falling), pull down until the fixture comes loose, and repeat.
- f. Align the locating hole on the lower (short) fixture with the locating pin on the lower spindle. Install lower fixture on the spindle. While holding the knurled

ring so that it catches the threads on the fixture, spin the ring clockwise until tight. If the fixture does not snap cleanly into place, loosen the ring completely, pull up on the fixture while rocking it carefully, and repeat.

CAUTION

Do not over-tighten knurled ring or damage to Transducer may result.

- g. At Signal Conditioner set OFFSET ON/OFF switch to ON. Rotate OFFSET RADIANS control until the jaws of both fixtures are parallel. Adjust the COARSE and FINE OFFSET ADJUST until TORQUE and NORMAL meters indicate zero.

Mounting Rod Fixture - The Rod Fixtures consist of two cylindrical rod holders with three sets of collets for 1/8, 3/16, and 1/4 inch diameter. Mounting is accomplished in the same manner as with the Rectangular Sample Torsion Fixture with the exception that the OFFSET RADIANS dial is not used.

When running a test with the rod fixtures, the TEST switch is set to PARALLEL PLATE, and the sample height is entered as the gap.

Sample Insertion - The sample should be approximately 2.5 inches (63.5 mm) long or slightly less, and .5 inches wide (12.7 mm).

NOTE

Standard inserts measure .030" (.762 mm), .060" (1.52 mm), .125" (3.17 mm) thick samples. Samples should be tailored to these sizes. Small decreases in thickness can be compensated for by the addition of precision shim stock.

- a. Slip the appropriate size aluminum insert onto each end of the sample.
- b. Raise the upper spindle as far as possible with the Spindle Adjust.

- c. Measure the width and thickness of the sample and record for program entry. Place one end of sample (with insert) into the lower fixture.
- d. Slide both rectangular collars over the free end of the sample bar. Orient them so that the setscrews are facing forward. Slide one collar over the jaws of the lower fixture and tighten the setscrew firmly. The top of the insert should be flush with the top of the jaws of the lower fixture.
- e. Lower the upper fixture with the Fine Spindle Position Adjust so that the upper end of the sample (with insert) slides into the jaws of the upper fixture. The insert should be flush with the jaws of the fixture. Slide the rectangular collar up as far as it will go and tighten the setscrew firmly. If the sample is to be cooled, retighten both setscrews after cooling.
- f. Check that the external thermocouple in the environmental chamber is close to the sample but not touching.
- g. Adjust the slide stop so the tools do not touch the oven when the oven door is closed. Tighten the Slide Lock.

Making Measurements (Temperature Sweep)

NOTE

The numbers and entires used in the following sample procedures are for PMMA at 1 Hz. Individual tests are designed by the user.

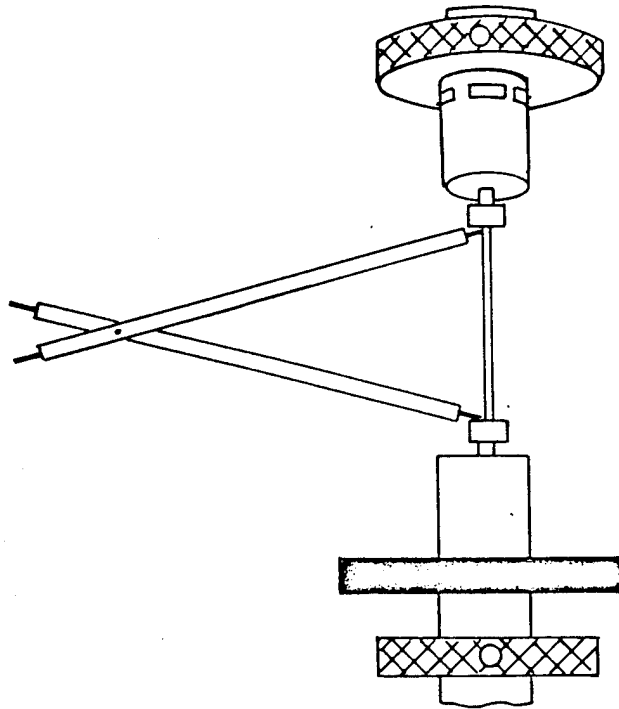

Figure A.9-1 Sample Height Measurement

- a. Raise the upper fixture with the Fine Spindle Adjust until the NORMAL meter deflects to the left. This indicates tension on the sample to ensure that the sample has not buckled. If temperature sweep mode is to be used, and the spring loaded upper fixture is installed, set the tension to one-half of full scale deflection. When set, lock the upper spindle.
- b. Measure the height from insert to insert with dividers as shown in Figure A.9-1, then use calipers to measure length of divider spacing.
- c. Set TEMP °C to desired starting point and press OVEN ON switch. Follow the nitrogen set-up procedure described in Section 4.2.2 if low temperature measurements are desired. Monitor the NORMAL meter; allow the sample to equilibrate until NORMAL meter reading does not change for five minutes.
- d. Set the Signal Conditioner DYNAMIC/STEADY selector to DYNAMIC and adjust the OFFSET RADIANS control until TORQUE meter reads zero. Set the Computer switches as follows:

1. Set MODE switch to TEMP SWEEP.
2. Set TEST switch to TORSION RECT.
3. Set RATE to 6.3 (Rads/Sec).
4. Set STRAIN to 0.1 percent.

NOTE

$$\text{Strain} = \frac{\theta \times \text{sample thickness}}{\text{sample length}},$$

where angle θ equals motor rotation in radians. Angle θ can never exceed 0.5 radians or an input overload will occur.

5. Press TEST GEOMETRY and enter, via Data Terminal, sample dimensions in millimeters.
6. Press SWEEP PARAMETERS and enter via Data Terminal: final temperature, degrees per step, and thermal soak time.
7. Press PRINTER and enter, via Data Terminal, data to be printed.
8. Press PLOTTER, and enter via Data Terminal the data to be plotted, the materials range, and the temperature range covered. (If modulus range is not known, it will be necessary to run several single points without plotting at various temperatures. If modulus range is known, proceed to step (i).

NOTE

PMMA runs between 10^6 and 10^{11} Dynes/cm² @ -150°C to +300°C. Figure A.9-2 shows a sample plot of PMMA at 1 Hz.

- e. Make sure that the NORMAL meter is to the left of the zero setting (i.e. is indicating tension on the sample). If not, raise the Fine Spindle Positioner. Also make sure that the TORQUE panel meter is set to zero using the OFFSET RADIANS control. If the sample is soft, it may not support a large tension but the important thing is that there is not a deflection to the right, indicating compressive force on sample.

Figure A.9-2
 DYNAMIC MECHANICAL PROPERTIES OF PMMA AT 1 HZ

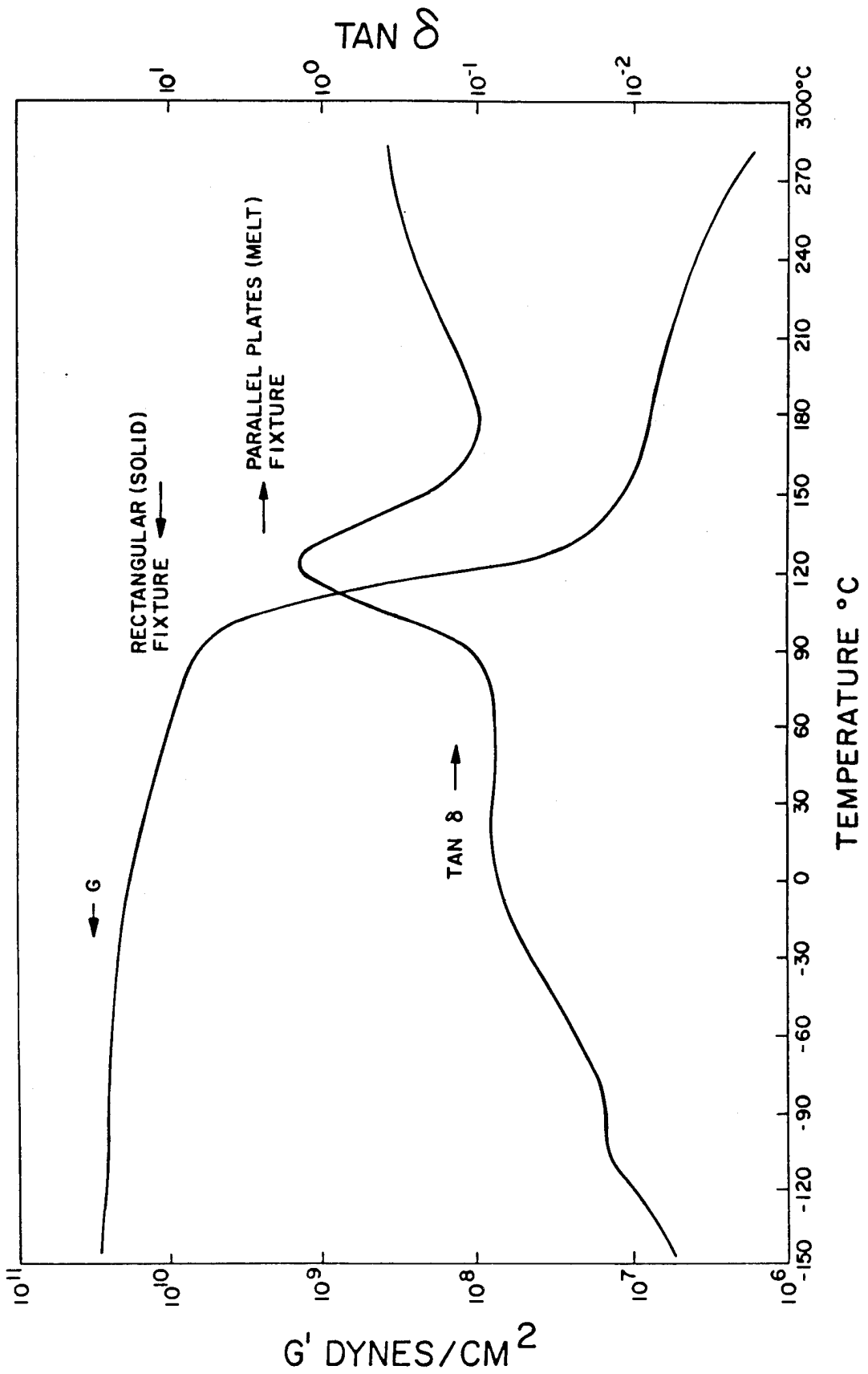

- f. Set MODE selector to SINGLE and press START. Set PRINTER ENABLE and PLOTTER ENABLE switches OFF (light out). Turn chart recorder to 6 in/min. Check that the sine wave response of the red (torque) pen is smooth and symmetrical.
- g. Tap the oven while observing the TORQUE trace and ensure that no deflection (indicating rubbing of the fixture against the oven) occurs.
- h. Set the chart to 6 in/hr. and observe the envelope formed by the Torque trace. When the sides of the envelope are parallel to the baseline, the sample is at thermal equilibrium. If the envelope has parallel sides skewed from the baseline, this indicates thermal drift in the Transducer. This may be unavoidable at the highest sensitivities.
- i. When the sample is at starting temperature and at thermal equilibrium set MODE selector switch to TEMP SWEEP and press PRINTER ENABLE and PLOTTER ENABLE switches On (light lit). Press RESET then START. The test will proceed as programmed. When the test is complete, oscillation will stop.

Sample and Fixture Removal

- a. Procure a pair of work gloves for sample and fixture removal. Environmental chamber will retain heat for some time.
- b. Open environmental chamber and slide to the right. Loosen the setscrews on the rectangular clamps.
- c. Loosen the Spindle Lock and raise spindle to the uppermost position. Re-lock spindle.
- d. Slide out the rectangular sample and remove the aluminum inserts.
- e. Loosen the knurled ring on upper fixture halfway. (It may be necessary to use the tools provided).

- f. Pull down on the knurled ring so that the upper fixture snaps free of the spindle. Loosen the ring completely and remove the fixture.
- g. Loosen the knurled ring on the lower fixture completely.
- h. Pull up on the lower fixture while gently rocking back and forth until the fixture is removed.

APPENDIX B

COMPOSITE LAMINATING PROCEDURES

B.1 Composite Fabrication

- a. Cut the prepreg plies and stack them on a nonporous Teflon release fabric that has been previously placed on a metal caul plate.
- b. Place on the top of the layup a layer of porous Teflon (Taconic #7015 or equivalent), followed by three plies of Style 120 glass fabric, three plies of Style 181 glass fabric, a pressure plate, and two additional plies of Style 181 glass fabric as a vent layer on top of the layup. Place metal bars (equivalent to laminate thickness) on all sides of stacked prepreg to prevent fiber washing.
- c. Seal the above assembly in a vacuum bag shown below in such a manner that no leaks occur and the vacuum source is in contact with the bleeder. Apply a vacuum of 5 inches Hg.

Vacuum Bag
Side View

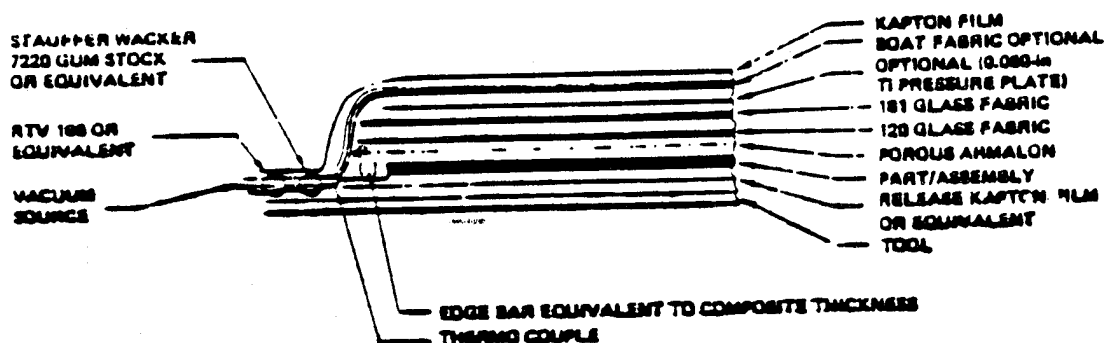

- d. Cure in an autoclave in accordance with the temperature, pressure, and vacuum profile shown below.

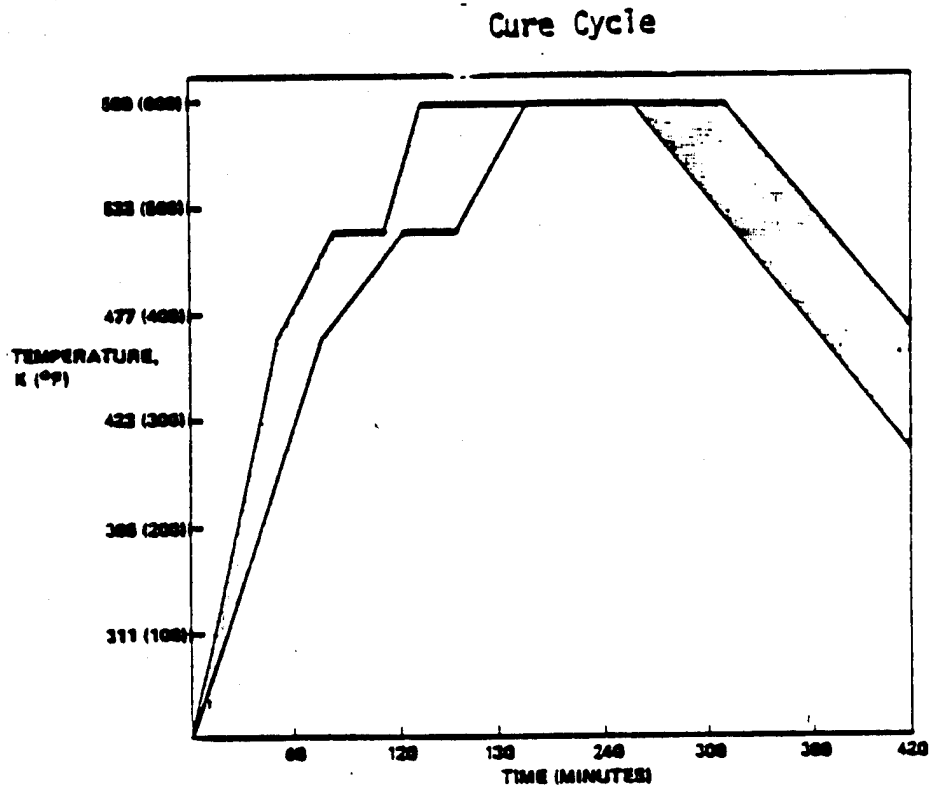

- e. Remove vacuum bagging and bleeder materials from cured part, and post-cure in an air-circulating oven for six hours at 625°F. Restraint of the laminate is required during post-cure.

APPENDIX C

COMPOSITE MECHANICAL AND PHYSICAL PROPERTIES

C.1 Composite Mechanical Properties

C.1.1 Flexural Properties

Determine ultimate flexural strength and modulus of elasticity (see Figure in C.1.2) for specimen) in accordance with ASTM D790 as modified below. The flexural test specimen consists of a straight-sided rectangular cross section having the specified thickness. Span thickness ratio is maintained constant at 32 to 1. Nominal specimen length is 102 mm (4 inches) but varies with thickness. The specimen width remains constant at 12.7 mm (0.5 in). The flexural specimens are loaded at quarter span points. Ultimate flexural strength is calculated with the following equation:

$$F_b = \frac{3PS}{4bt^2}$$

- F_b = Stress in the outer fiber at failure
- P = Maximum load carried by specimen Newtons (lbs)
- S = Major span meters (inches)
- b = Width of specimen meters (inches)
- t = Thickness of specimen meters (inches)

The modulus of elasticity is calculated as follows:

$$E_b = \frac{11}{64} \frac{S^3}{bt^3} m$$

- E_b = Modulus of elasticity in flexure
- S = Span (meters) inches
- b = Width of specimen (meters) (inches)
- t = Thickness of specimen meters (inches)
- m = Slope of the initial straight-line portion of the loading deflection curve.
N/m (lb/in.)

C.1.2 Interlaminar Shear Properties

Determine ultimate interlaminar strength in accordance with ASTM D2344 as modified below. The interlaminar shear test specimens shown below are short, rectangular cross-section bars.

The testing is accomplished on a flexure testing fixture using three-point loading with the span being equal to four times the specimen thickness. Interlaminar shear stress at failure is computed from the following equation:

$$T_i = \frac{3P}{4A}$$

T_i = Interlaminar shear stress kPa (ksi)

P = Total load at failure, Newton (lbs)

A = Cross-sectional area m^2 (in^2)

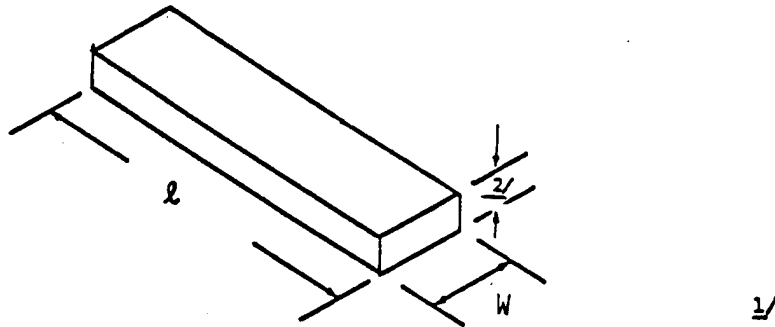

- 1/ Parallel to within + 0.005 inch with a .125 edge flatness requirement in accordance with MIL-STD-10.
- 2/ Minimum thickness 0.070 inch + 0.010, -0
- 3/ = 1.00 inch for short beam shear specimen
= 4.00 inch for flexure specimen
- 4/ W = 0.250 inch for short beam shear specimen
 W = 0.500 inch for flexure specimen

Schematic of Flexure and Short Beam Shear Specimen

C.2 Composite Physical Properties

C.2.1 Density

Determine the density of the composite in accordance with ASTM D792.

C.2.2 Resin Content

Determine the resin content of the composite as follows.

- a. Transfer specimens, accurately weighed to the nearest milligram, to an 80-ml glass beaker.
- b. Carefully measure 50 ml of concentrated sulfuric acid and pour into the beaker containing the sample. Cover the beaker with a watch glass, place on a hot plate in a fume hood, and heat at $400^{\circ} \pm 10^{\circ}\text{F}$ until white fumes are visible above the acid solution.
- c. Maintain this condition for a minimum of 20 minutes or until the solution turns black. At this point, carefully add dropwise a 30 percent solution of hydrogen peroxide until the solution turns clear. Continue heating beaker for a minimum of one hour. During this period, add dropwise the hydrogen peroxide solution to clear the acid whenever the acid turns black. Cool the acid solution to room temperature, add 2 ml of hydrogen peroxide, and heat until white fumes appear. Continue heating for 10 minutes, then cool to room temperature. If acid turns black, repeat the procedure until acid remains clear. (Note: This process shall be accomplished in a fume hood with air exchange.)
- d. Filter the acid solution using a fritted glass crucible (coarse) and wash a minimum of three times separately with either distilled or deionized water and then with acetone. Dry the glass crucibles at 150°F in an air-circulating oven a minimum of 30 minutes, cool to room temperature in a desiccator, and weigh. Remove the graphite yarn and obtain the crucible weight.
- e. Calculate: Percent Resin Content = $\frac{W_1 - W_2}{W_1} \times 100$

where W_1 = weight of sample

W_2 = weight of graphite yarn after acid digestion of the resin matrix

- f. Requirements are listed in Appendix E.2.

C.3.3 Fiber Volume and Void Volume

- a. Fiber volume and void volume are determined from the results of the density determination and the resin content determination using the following:

Calculate fiber volume (V_f) from the formula

$$V_r = \frac{W_f \cdot c}{f \cdot W_c} \times 100$$

Calculate resin volume (V_r) from the formula

$$V_f = \frac{W_r \cdot c}{r \cdot W_c} \times 100$$

Calculate void content (V_v) from the formula $100 - (V_f + V_r)$

where W_c = weight of original sample

W_f = weight of fiber

W_r = $W_c - W_f$ = weight of resin

f = density of graphite (from supplier)

r = density of resin (from supplier)

c = density of composite in accordance with ASTM D792.

APPENDIX D

PREPREG PHYSICAL PROPERTIES

D.1 Resin Content/Graphite Areal Weight

- a. Cut three samples, each 3 grams minimum, equally spaced across the width of the prepreg at least 1 inch from the edge of the prepreg. Weigh to the nearest milligram (W_1). Measure area (A) of each sample to the nearest 0.1 square inch.
- b. Extract the three samples in separate soxhlet extractors containing 40 to 50 ml acetone.

Option: Resin may be extracted in methylethylketone.

- c. After extraction, dry the fibers at elevated temperature to constant weight. Allow to cool at room temperature in a desiccator.
- d. Obtain the weight of the fibers to the nearest milligram (W_2).

e. Calculate:

$$\text{Percent Resin Content} = \frac{W_1 - W_2}{W_1} \times 100$$

f. Calculate:

$$\text{Graphite Areal Weight} = \frac{W_2}{A} \frac{\text{gm}}{\text{m}^2}$$

D.2 Prepreg Volatile Content

- a. Obtain three specimens (2.0 to 4.0 g) in a pattern that will be representative of the entire sample. The specimens must be taken at least 1 inch from the edge.

- b. Remove the carrier from each specimen, place in a tared aluminum dish, and weigh to the nearest milligram. Place the aluminum dish with specimen in an air-circulating oven regulated to $600 \pm 10^{\circ}\text{F}$.
- c. Close the oven door and start a clock. After 30 minutes, remove the aluminum dishes and place in a desiccator to cool. Weigh the specimens to the nearest milligram.

$$\text{Percent Volatiles} = \frac{A - B}{A} \times 100$$

where A = weight of specimen before test

B = weight of specimen after test

D.3 Gel Time

- a. Preset the temperature on a Fisher-Johns melting point apparatus to 477K (400°F).
- b. Insert a 6.35m x 6.35mm, (0.25 x 0.25 in) sample of prepreg between two cover glasses and place on the heated platform of the Fisher-Johns apparatus.
- c. Start a stopwatch or timer and begin to probe on the top of the coverglass with a wooden pick.
- d. Record the time when the resin gels. The gel point is reached when no resin movement is observed through the coverglass when moderate pressure is applied.
- e. Report the gel time as the average of three or more determinations.

1 Report No NASA CR-168217	2 Government Accession No.	3 Recipient's Catalog No.
4 Title and Subtitle Characterization of PMR-Polyimide Resin and Prepreg	5 Report Date March, 1984	6 Performing Organization Code 2-3621
	7 Author(s) C.H. Sheppard, P.H. Lindenmeyer, A.B. Hunter	8 Performing Organization Report No D180-26031-2
9 Performing Organization Name and Address Boeing Aerospace Company Engineering Technology P.O. Box 3999 Seattle, Washington, 98124	10 Work Unit No.	11 Contract or Grant No. NAS3-22523
	12 Sponsoring Agency Name and Address	13 Type of Report and Period Covered Contractor
		14 Sponsoring Agency Code
15 Supplementary Notes Technical Representative: Dr. Richard Lauvier NASA/LRC Cleveland, Ohio		
16 Abstract Procedures for the chemical characterization of PMR-15 resin solutions and graphite-reinforced prepregs were developed, and a chemical data base was established. In addition, a basic understanding of PMR-15 resin chemistry was gained; this was translated into effective processing procedures for the production of high quality graphite composites. During the program the PMR monomers and selected model compounds representative of postulated PMR-15 solution chemistry were acquired and characterized. Based on these data, a baseline PMR-15 resin was formulated and evaluated for processing characteristics and composite properties. Commercially available PMR-15 resins were then obtained and chemically characterized. Composite panels were fabricated and evaluated. <i>See See Page 1</i>		
17 Key Words (Suggested by Author(s)) <i>Quality Control</i> Polyimide, PMR resin, nadic esters, chemical characterization, model compounds, high pressure liquid chromatograph (HPLC), dynamic mechanical analysis (DMA), volatile evolution.	18 Distribution Statement Unclassified, Unlimited	
19 Security Classif. (of this report) Unclassified	20 Security Classif. (of this page) Unclassified	22 Price*