

TRADOC Pamphlet 350-13

U.S. Army Training and Doctrine Command

DISTRIBUTION STATEMENT A

Approved for public release;
Distribution Unlimited

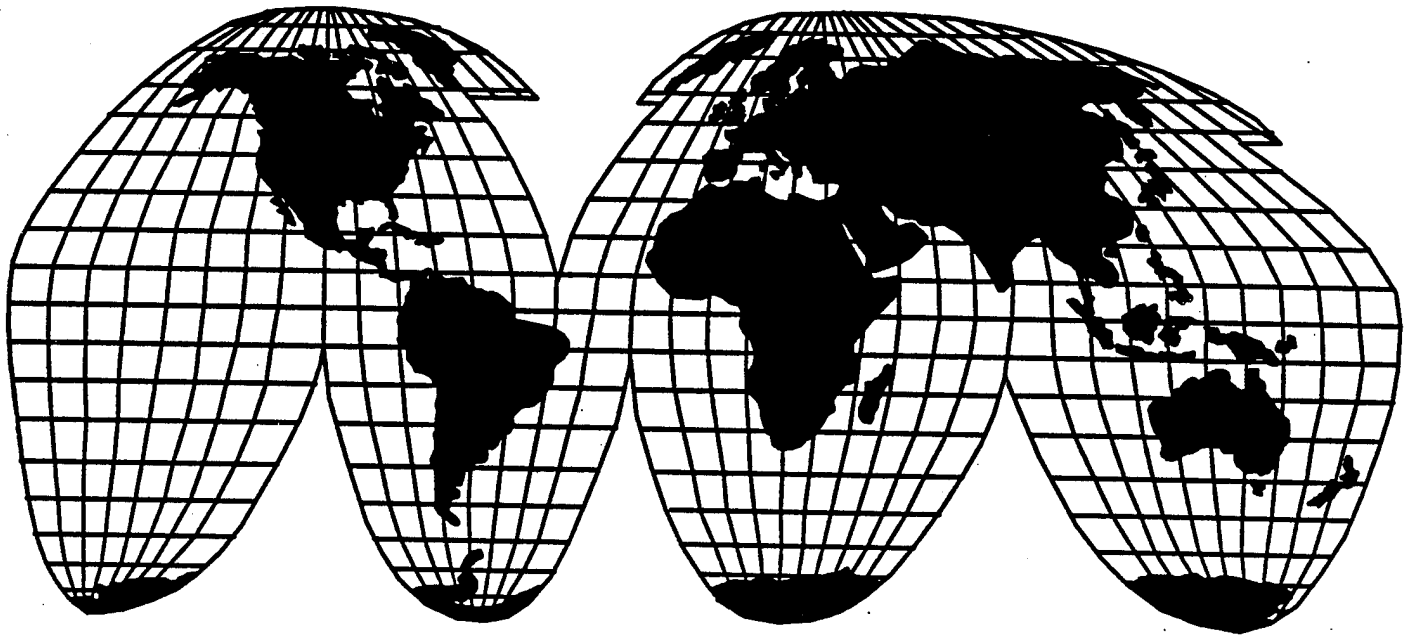
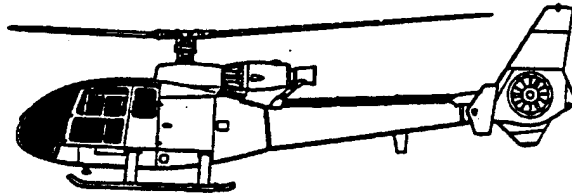

LIGHT OPPOSING FORCE (OPFOR) ORGANIZATION GUIDE

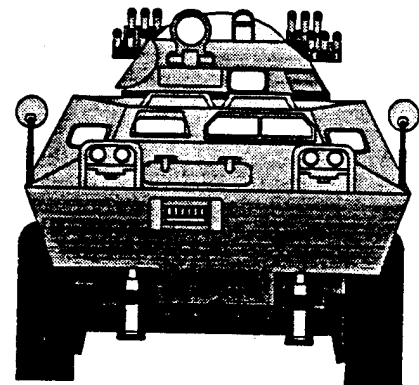

TRADOC
Deputy Chief of Staff for Intelligence

19960229 045

DISCLAIMER NOTICE



THIS DOCUMENT IS BEST QUALITY AVAILABLE. THE COPY FURNISHED TO DTIC CONTAINED A SIGNIFICANT NUMBER OF PAGES WHICH DO NOT REPRODUCE LEGIBLY.

DEPARTMENT OF THE ARMY
HEADQUARTERS
U.S. ARMY TRAINING AND DOCTRINE COMMAND
Deputy Chief of Staff for Intelligence (DCSINT)
Fort Monroe, Virginia 23651-5000

15 September 1994

Training

**Light Opposing Force (OPFOR)
Organization Guide**

Preface

This organization guide is the second in a series of six Training and Doctrine Command Pamphlets that documents the capabilities-based OPFOR model. The capabilities-based OPFOR model will become the basis for the forces and doctrine used by the OPFOR units at the Combat Training Centers (CTC) and in the TRADOC Common Teaching Scenario.

The proponent for this pamphlet is the TRADOC Deputy Chief of Staff for Intelligence. This pamphlet serves as the coordinating draft for the guide's final publication as a Department of the Army Information Pamphlet. Users are encouraged to send comments and suggested improvements on DA Form 2028 (Recommended Changes to Publications and Blank Forms) directly to the TRADOC ODCSINT, Threat Support Division, ATTN: ATZL-CST, Fort Leavenworth, Kansas 66027-5310. Suggested improvements may also be submitted using DA Form 1045 (Army Ideas for Excellence Program (AIEP) Proposal).

Unless otherwise stated, whenever the masculine gender is used, both men and women are included.

DISTRIBUTION RESTRICTION: Approved for public release; distribution is unlimited.

Introduction

Concept

This Organization Guide is one of a series of six Training and Doctrine Command Pamphlets that document the capabilities-based Opposing Force (OPFOR) model. This model was developed to provide a flexible training threat that can be tailored to represent a wide range of potential threat capabilities and organizations. The model features a heavy and a light OPFOR package, each containing three documents: an organization guide, an operations handbook and a tactics handbook.

The capabilities-based OPFOR model represents a break from past practice in two principal respects. First, while the heavy and light packages are based on the doctrine and organization of foreign armies, they are not simply unclassified handbooks on the forces of a particular nation. The OPFOR packages are composites that were deliberately constructed to provide a wide range of capabilities. Second, the packages are not associated with a fixed order of battle but, rather, provide the building blocks from which a large number of potential orders of battle can be derived.

The capabilities-based OPFOR model will become the basis for the forces and doctrine used by the OPFOR units at the Combat Training Centers (CTC) and in the TRADOC Common Teaching Scenarios. The heavy and light packages were designed to accommodate the existing CTC OPFORs at the time of publication with relatively minor changes but have the flexibility to adapt to the changing training requirements of the force-projection Army.

Light OPFOR Package

The Light OPFOR is based on the military forces of a number of third-world countries. Although influenced by the forces of the Former Soviet Union (FSU), it is clearly unique. A certain degree of extrapolation is required since doctrine for most of these countries is so poorly documented. Since this is OPFOR doctrine, and therefore not tied dogmatically to a single source country, the doctrine can be more fully articulated than in the past. Organizationally, the Light OPFOR takes a "building block" approach, which provides a great deal of flexibility.

Light OPFOR Organization Guide

The Light OPFOR Organization Guide is the first of the Light OPFOR series of handbooks. Unlike previous OPFOR publications which provided a fixed structure, this guide provides the customer with an organizational menu from which to draw the forces needed to fulfill his training requirements. For principal customers, such as the CTCs and the TRADOC Centers and Schools, this is a collaborative process. For the concept to work successfully, both the Threat Support Division (TSD) and the individual customer must work together to tailor the most appropriate force structure and order of battle for

the training required. TSD is solely responsible for production of the guide; however, order of battle development is a joint responsibility between TSD and the user. This joint effort is expected between TSD and TRADOC trainers and instructors; however, CAC Threats stands ready to provide assistance to all customers in building their training products.

Equipment

Former Soviet systems provide the equipment baseline for the guide. This was done for two primary reasons. First, many potential threat countries are equipped predominantly with FSU systems, which are widely proliferated throughout the world. Second, the equipment listed within the organizations is intended to be *representative* of a unit's or organization's capability. Listing these familiar, well-documented systems paints an immediate, concrete picture, whereas listing generic descriptors such as *Medium Tank* or *Antitank Guided Missile* would not. Moreover, generic descriptors would not lead to the development of consistent equipment sets.

To achieve specific training objectives or merely to provide variety within the organizations, "gray" systems can be substituted for those within the equipment lists. Appendix A contains several substitution matrices for major systems, as well as general guidelines for the substitution process. The matrices are guides; they are not intended to be all-inclusive, listing every conceivable system. In constructing an order of battle, therefore, trainers may substitute systems not listed in the matrices. However, they should follow the same general philosophy and guidelines detailed in Appendix A. System substitution is another aspect covered during the joint order of battle development process.

Structure

The Light OPFOR Organization Guide depicts the forces of a country divided geographically into an unspecified number of military regions, each with a number of subordinate military districts. Most combat forces are stationed within the military districts, which can vary widely in their strengths and capabilities.

District strength could range from a single separate light infantry brigade to a mechanized infantry division. Well-equipped districts equate roughly to divisions, whereas a well-equipped region would equate roughly to an army. The guide allows for standing armies and divisions, but districts with separate brigades would be much more common and in keeping with the spirit of the Light OPFOR concept. If a trainer finds himself building multiple standing divisions and armies, it may be that the Heavy OPFOR Organization Guide better suits his training needs.

Subordinate to the Ministry of Defense, all arms of the armed forces are controlled by the General Staff/National Headquarters, which also controls the highly-centralized pool of national assets. These assets include a wide variety of combat support and combat

service support units which may be allocated to subordinate regions and districts, or held at the national level. Like the military regions and districts, most of these assets are not limited to a specific number. Their inclusion in this guide merely provides the option for, but does not mandate, their inclusion in any developed order of battle. From the single brigade within a district to the potentially vast pool of assets at the national level, the size of the force needed to facilitate training is the determining factor in sizing the OPFOR.

For example, if a training scenario called for an OPFOR force roughly equivalent to a division, Region A could have three subordinate districts, all of which border an international boundary with a traditional enemy. The northernmost and southernmost districts, predominantly mountainous, could contain one or two separate light infantry brigades, with a relatively small amount of organic combat support and combat service support at the district level. The central district, however, is predominantly rolling terrain and contains the best mechanized avenue of approach into the interior of the country. This district, therefore, could have two separate mechanized infantry brigades and one tank brigade; additional combat support and combat service support could either be organic at the district level, or allocated to the region by the General Staff/National Headquarters as hostilities increase.

Presentation of Information

The organization charts in this guide focus on maneuver units. They range from the lowest level (infantry and tank squad) up to the highest level (General Staff/National Headquarters). At each level, the guide breaks down subordinate combat support and combat service support units and subunits whenever feasible, for greater detail. To avoid extensive duplication, subunits common to several unit types are depicted once and cross-referenced thereafter. Subunits defined in greater detail have a page reference underneath their box in the organization chart; subunits with no page reference are not further defined. As a rule, equipment listings only account for individual weapons up to and including the maneuver battalion. Unless organic to the battalion, individual weapon totals for combat support and combat service support units are not listed.

The guide begins with the structure of military districts and divisions. Then the guide addresses the variety of maneuver brigades: light infantry, motorized infantry, mechanized infantry, and tank. Infantry brigades are subdivided into separate and divisional brigades. Separate brigades are those subordinate only to the district headquarters; they may operate independently, or in concert with other brigades within the district. A divisional brigade is organic to a standing division and always operates as part of the division. The guide then addresses the army and region structure, followed by the national structure and possible organizations within the pool of assets controlled by the General Staff/National Headquarters. The final set of charts addresses the Air Force, Navy, and Special Operations Command.

CONTENTS

Preface	i	
Introduction	ii	
MILITARY DISTRICTS AND DIVISIONS		
Military District	1	
Mechanized Infantry Division	2	
Motorized Infantry Division	3	
Light Infantry Division	4	
LIGHT INFANTRY BRIGADES (SEPARATE AND DIVISIONAL)		
Light Infantry Brigade (Sep)	89	
Light Infantry Brigade (Div)	92	
MOTORIZED INFANTRY BRIGADES (SEPARATE AND DIVISIONAL)		
Motorized Infantry Brigade (Sep)	110	
Motorized Infantry Brigade (Div)	113	
MECHANIZED INFANTRY BRIGADES (SEPARATE AND DIVISIONAL)		
Mechanized Infantry Brigade (Sep)	125	
Mechanized Infantry Brigade (Div)	128	
TANK BRIGADE		
Tank Brigade	144	
NATIONAL STRUCTURE		150
MINISTRY OF THE INTERIOR		151
MILITARY REGION		152
ARMY		154
GENERAL STAFF/NATIONAL HEADQUARTERS (NATIONAL ASSET POOL)		155
Airborne Infantry Brigade		156
Artillery Organizations		172

Directorate of Military Intelligence	178
Engineer Organizations	180
Signal Organizations	183
Chemical/Smoke Organizations	184
Rear Services	188
Navy	189
Air Force and Air Defense Command	190
Special Operations Command	212
APPENDIX A: Substitution Matrices	A-1
APPENDIX B: Cargo Trucks, Trailers and Radio Substitution	B-1
GLOSSARY	GLOSSARY-1
INDEX	INDEX-1

Military District (Heavy Example)

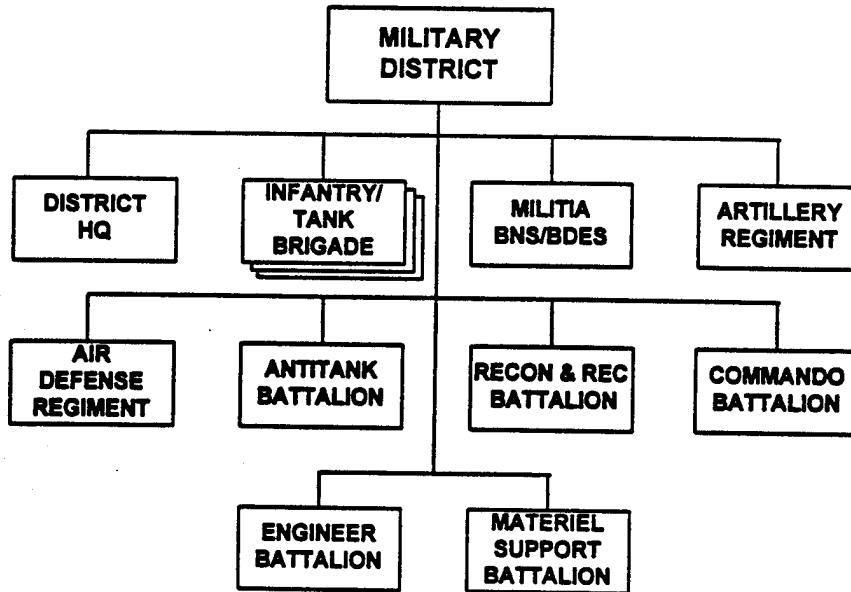

Military District (Light Example)

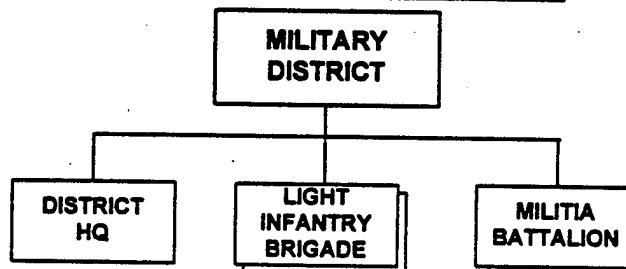

NOTES:

1. Forces subordinate to the district can vary widely, as shown in the two examples above. Unless the district contains a standing division, maneuver forces will be composed of separate brigades. A basically rural, mountainous district with no major population centers, for example, may have only a single separate light infantry brigade, with little or no additional combat support and combat service support. A district astraddle a major avenue of approach and which contains several major population/industrial centers, however, may contain the degree of forces in the first example, which is the "high end" of what a district may contain.
2. Districts may have separate brigades controlled by the district commander, which is the norm, or they may have standing divisions. Standing divisions could be found in districts along an international border, districts which contain historically-threatened avenues of approach, or around critical cities/facilities. Any district participating (as a whole) in large-scale offensive operations would form a division headquarters, or its equivalent.
3. The predominant type of brigade(s) in the district will determine whether supporting assets will be towed or self-propelled.

Mechanized Infantry Division

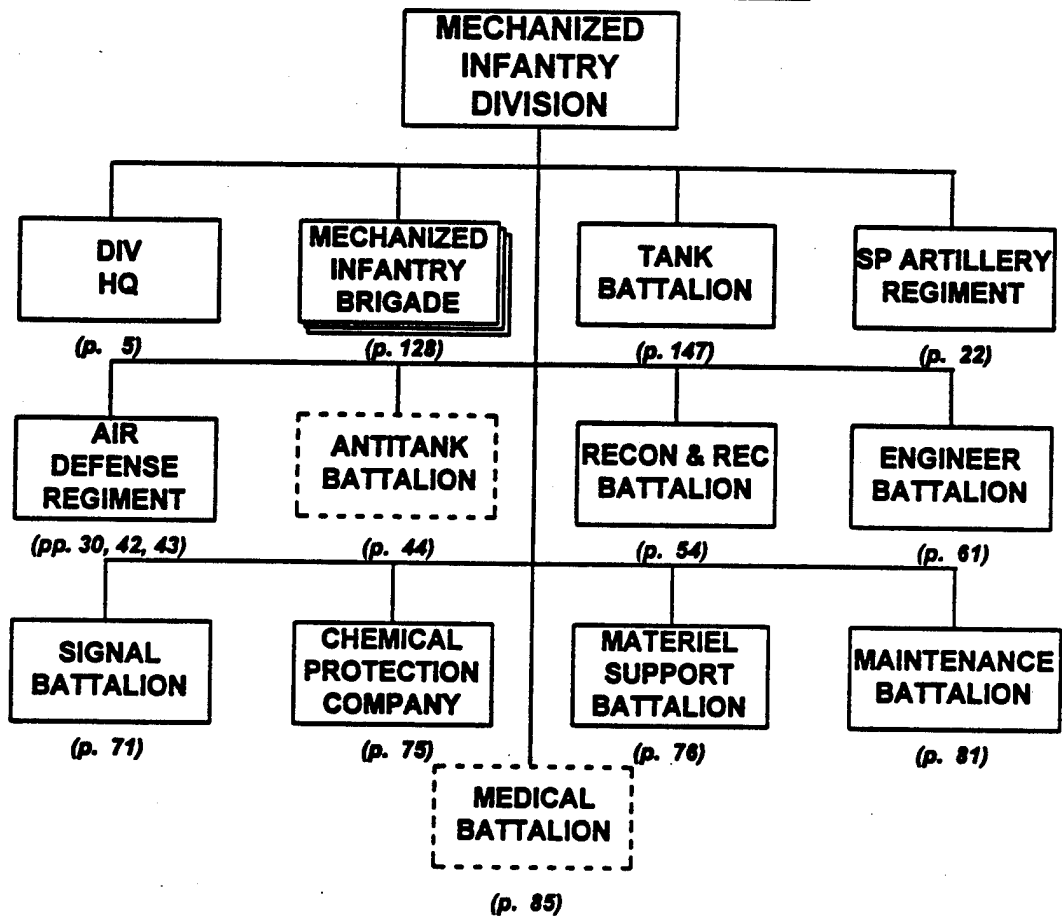

Motorized Infantry Division

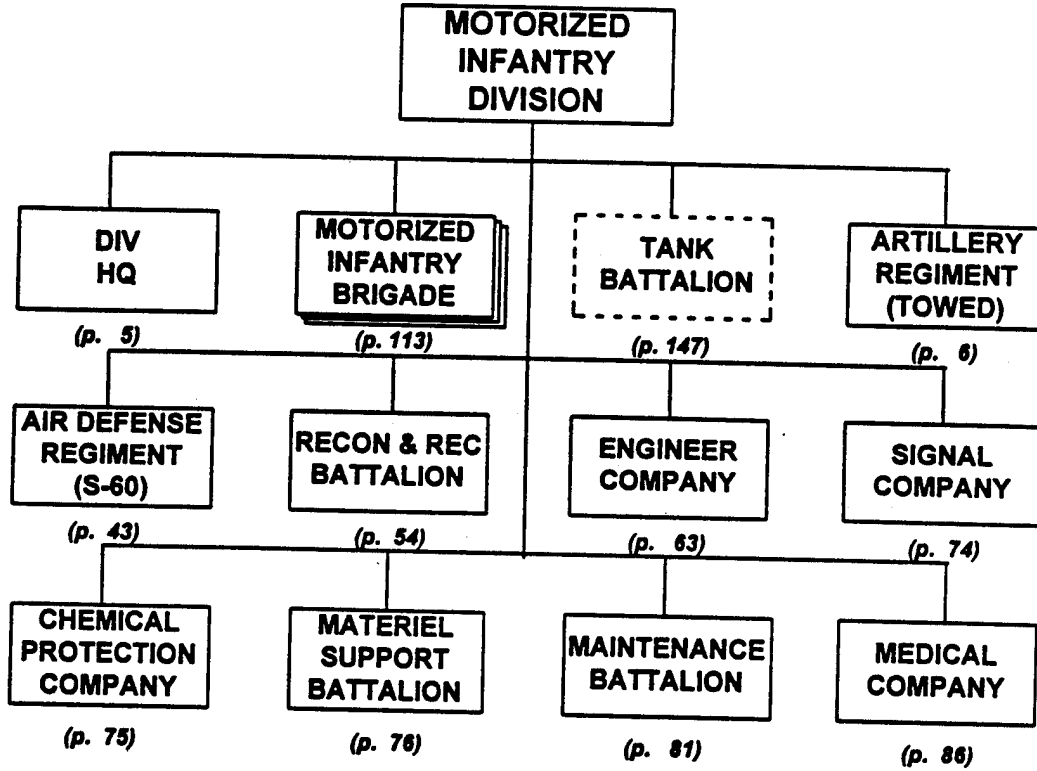

Light Infantry Division

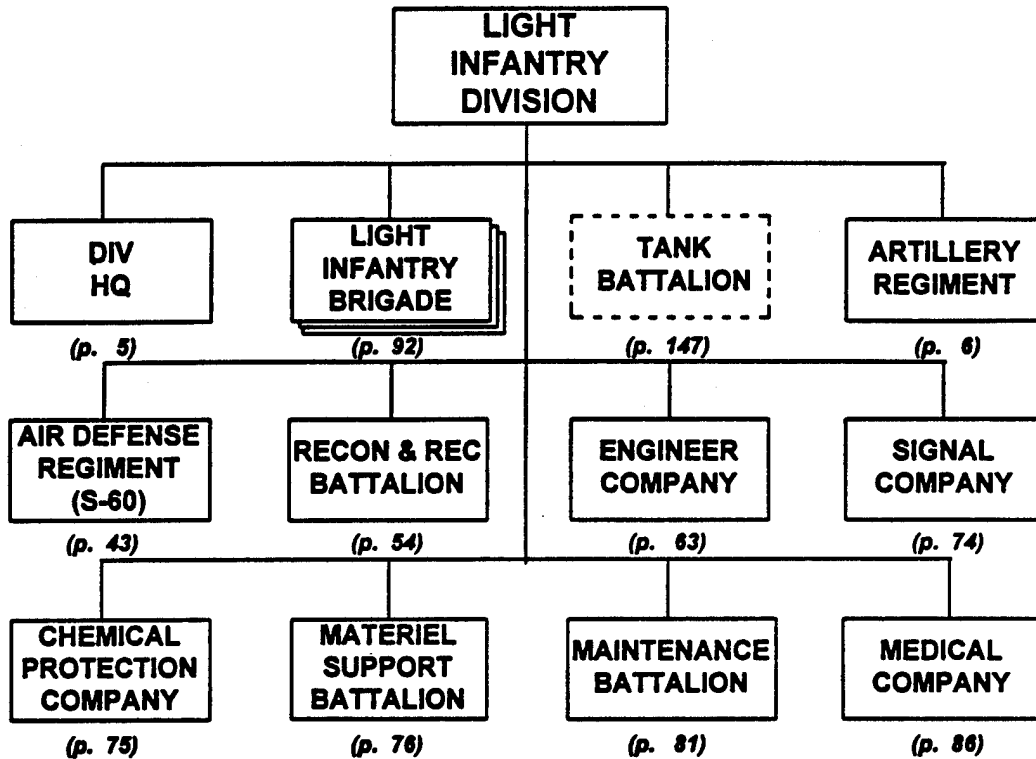

NOTES:

1. Infantry units within the divisions depicted above are light, motorized, or mechanized infantry brigades (divisional). These brigades differ structurally from their separate counterparts found within districts.
2. Normally, each division has three infantry brigades of the same type. Light and motorized infantry divisions may have a Tank Battalion; however, this is the exception to the rule.
3. Light and motorized infantry divisions are more common than mechanized infantry divisions.
4. When a division mobilizes, additional combat support and combat service support assets come from the pool of assets at the national level. Engineer and signal assets are notable examples.

**Division Headquarters, Light Inf Div, Mtzd Inf Div,
and Mech Inf Div or MD**

**DIVISION
HEADQUARTERS**

PRINCIPAL ITEMS OF EQUIPMENT

Equipment	Total	Equipment	Total
SAM, SA-16/18	6	Ambulance	1
ATGL, RPG-7V	3	Sedan	2
5.45-mm LMG, RPK-74	3	Trailer, Cargo, 1-Axle	4
APC, BTR-60/70/80	3	Trailer, Generator	3
Truck, Utility	12	Trailer, POL (900-Liter)	1
Truck, Light	9	Trailer, Water (900-Liter)	1
Truck, Medium	4	Trailer, Kitchen	3
Van, Command	12	Radio, VHF, Vehicle Mount, Medium-Power	3
Van, Maintenance	1		
Van, Signal	2		
Truck, POL (4,000 or 5,200-Liter)	1		

NOTE:

1. Standing divisions will always have a headquarters as shown above.
2. District headquarters will not necessarily be equipped as shown, but could be during wartime if their mission requires an additional tactical headquarters.

**Artillery Regiment, Light Inf Div and Mtzd Inf Div, or MD
or Army or National**

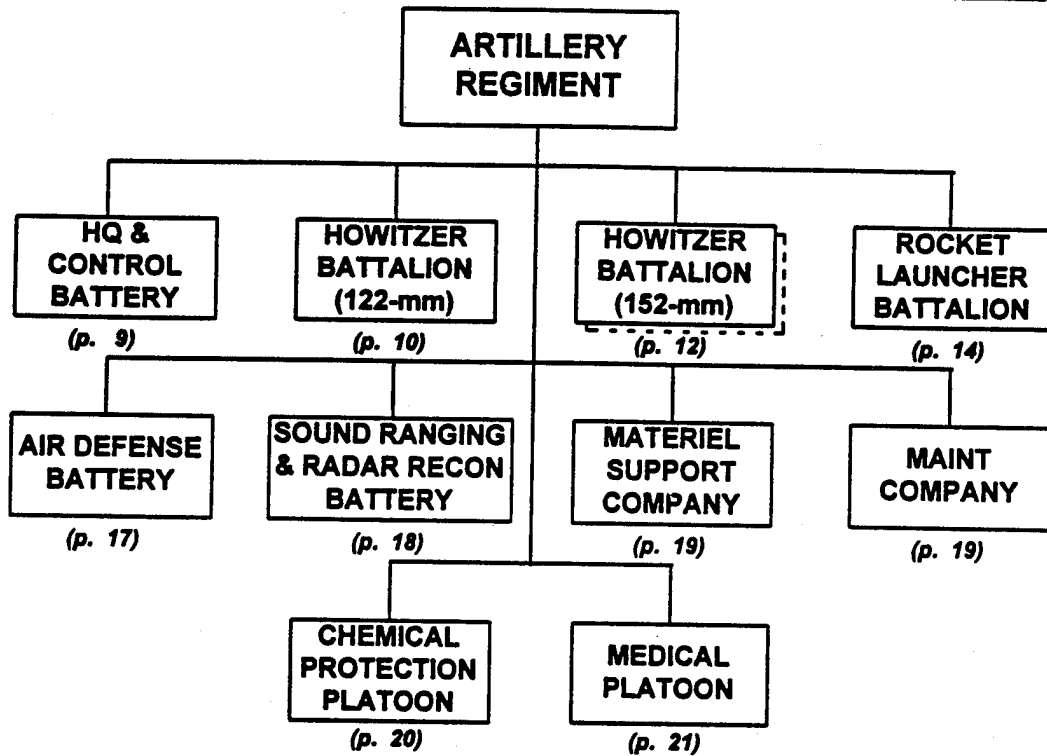

NOTES:

1. Most regiments have one of each type howitzer and rocket launcher battalion. Regiments with two 152-mm howitzer battalions are more common in districts with more than four maneuver brigades.
2. Divisions always have regiments with only one of each type battalion.

ARTILLERY REGIMENT, Divisional, MD, Army, National

<i>Principal Items of Equipment</i>	<i>HQ & Control Btry</i>	<i>Howitzer Bn (122-mm)</i>	<i>Howitzer Bn (152-mm)</i>	<i>Rocket Launcher Bn</i>	<i>Air Defense Btry</i>	<i>Sound Ranging & Radar Recon Btry</i>	<i>Material Support Co</i>	<i>Maintenance Co</i>	<i>Chem Protection Plt</i>	<i>Medical Plt</i>	<i>TOTAL</i>
ARMORED VEHICLES											
ACV, BTR (R-145BM)	2			1		2					5
Chemical Recon Vehicle, BRDM-2RKh	1								3		4
Mobile Recon Post, PRP-3/4		1	1			1					3
APC, Radar, MT-LB (SNAR-10)						2					2
ACRV, 1V18		3	3	3							9
ACRV, 1V19		1	1	1							3
WEAPONS											
122-mm Howitzer, D-30		18									18
152-mm Gun Howitzer, D-20			18								18
122-mm Rocket Launcher, BM-21				18							18
23-mm AA Gun, ZU-23					6						6
ATGL, RPG-7V	4	18	18					4			44
SAM, SA-7/14	3										3
TRUCKS											
ACRV, 1V110 (Battery FDC)		3	3	3							9
ACRV, 1V111 (Battalion FDC)		1	1	1							3
Truck, Utility	6	1	1	5		6	1	1			21
Truck, Light	2	12	12	6	6	7				1	46
Truck, Medium	1	34	34	44	2		40	3		2	160
Truck, Decon, ARS-12U/14									3		3
Truck, Decon, DDA-53/66									1	1	2
Truck, Crane								1			1
Truck, POL (4,000/5,200-L)		2	2	2			12				18
Truck, Recovery								1			1
Truck, Water (2,000-L)									2		2
Van										1	1
Van, Command				1							1
Van, Maintenance		1	1	3		4		14			23
Van, Radar						1					1
Van, Signal	3	2	2	2							9
Van, Survey						1					1
Ambulance		1	1	1						4	7

ARTILLERY REGIMENT, Divisional, MD, Army, National (Cont)

<i>Principal Items of Equipment</i>	<i>HQ & Control Btry</i>	<i>Howitzer Bn (122-mm)</i>	<i>Howitzer Bn (152-mm)</i>	<i>Rocket Launcher Bn</i>	<i>Air Defense Btry</i>	<i>Sound Ranging & Radar Recon Btry</i>	<i>Material Support Co</i>	<i>Maintenance Co</i>	<i>Chem Protection Plt</i>	<i>Medical Plt</i>	<i>TOTAL</i>
TRAILERS											
Trailer, Cargo, 1-Axle	1			36		1		3			41
Trailer, Cargo, 2-Axle		11	11				30				52
Trailer, Generator	2			2		2		2			8
Trailer, Kitchen	1	4	4			1				1	11
Trailer, POL (900/1,200-L)		2	2	2							6
Trailer, Water (900/2,000-L)		1	1	1		1	1		2	1	8
Trailer, Welding								1			1
RADARS											
Radar, CM/CB, ARK-1						1					1
RADIOS											
VHF, Manpack, Low-Power	6	20	20	18		13	1	1			79
VHF, Portable, Low-Power	1	2	2		3						8
VHF, Vehicle Mount, Medium-Power	4					4			3		11
HF, Manpack, Low-Power	1								1	1	3
HF, Vehicle Mount, Medium-Power	5										5
HF/VHF, Vehicle, Medium-Power	3	4	4	2							13
HF/VHF, Vehicle, High-Power	1										1
Radio Relay, VHF/UHF	1										1
Warning Receiver	1	1	1	1	3	1					8
MISCELLANEOUS											
Rangefinder, Laser, SAGE GLOSS	1	4	4			2					11
Sound Ranging Set						1					1

Headquarters and Control Battery, Arty Regt, Light Inf Div and
Mtzd Inf Div, or MD or Army or National and SP Arty Regt,
Mech Inf Div or MD or Army or National

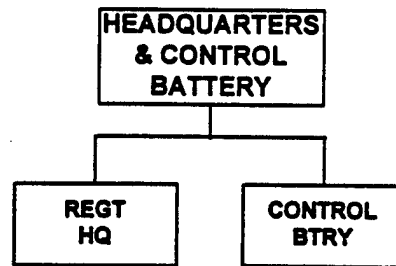

PRINCIPAL ITEMS OF EQUIPMENT

Equipment	Total	Equipment	Total
SAM, SA-7/14	3	Radios:	
ATGL, RPG-7V	4	VHF, Manpack, Low-Power	6
ACV, BTR (R-145BM)	2	VHF, Portable, Low-Power or	
Truck, Utility	6	Very-Low-Power	1
Truck, Light	2	VHF, Vehicle Mount, Medium-Power ..	4
Truck, Medium	1	HF/VHF, Vehicle Mount,	
Chemical Recon Vehicle,		Medium-Power	3
BRDM-2RKh/RKhM	1	HF/VHF, Vehicle Mount,	
Van, Signal	3	High-Power	1
Trailer, Cargo, 1-Axle	1	HF, Manpack, Low-Power	1
Trailer, Generator	2	HF, Vehicle Mount, Medium-Power	5
Trailer, Kitchen	1	Radio Relay, VHF/UHF	1
Rangefinder, Laser, SAGE GLOSS	1	Warning Receiver	1

122-mm Howitzer Battalion, Light Inf Bde (Sep) and Mtzd Inf Bde (Sep), or Arty Regt, Light Inf Div and Mtzd Inf Div, or MD or Army or National

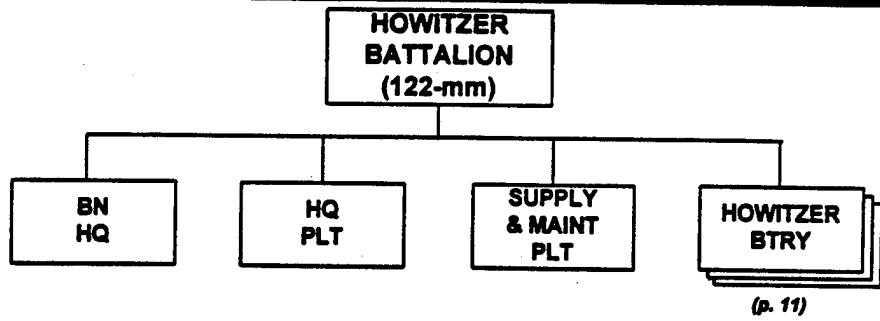

PRINCIPAL ITEMS OF EQUIPMENT

Equipment	Total	Equipment	Total
122-mm Howitzer, D-30.....	18	Ambulance.....	1
ATGL, RPG-7V.....	18	Trailer, Cargo, 2-Axle.....	11
5.45-mm LMG, RPK-74.....	18	Trailer, POL (1,200-Liter).....	2
ACRV, 1V110 (Battery FDC).....	3	Trailer, Water (900-Liter).....	1
ACRV, 1V18 (Battery COP).....	3	Trailer, Kitchen.....	4
ACRV, 1V19 (Battalion COP).....	1	Rangefinder, Laser, SAGE GLOSS.....	4
ACRV, 1V111 (Battalion FDC).....	1	Radios:	
Mobile Recon Post, PRP-3/4*.....	1	VHF, Manpack, Low-Power.....	20
Truck, Utility.....	1	VHF, Portable, Low-Power	
Truck, Light.....	12	or Very-Low-Power.....	2
Truck, Medium.....	34	HF/VHF, Vehicle Mount,	
Truck, POL (4,000 or 5,200-Liter).....	2	Medium-Power.....	4
Van, Signal.....	2	Warning Receiver.....	1
Van, Maintenance.....	1		

FOOTNOTE: * This system includes the SMALL FRED battlefield surveillance radar.

122-mm Howitzer Battery, 122-mm Howitzer Bn, Light Inf Bde (Sep) and Mtzd Inf Bde (Sep), or Arty Regt, Light Inf Div and Mtzd Inf Div, or MD or Army or National

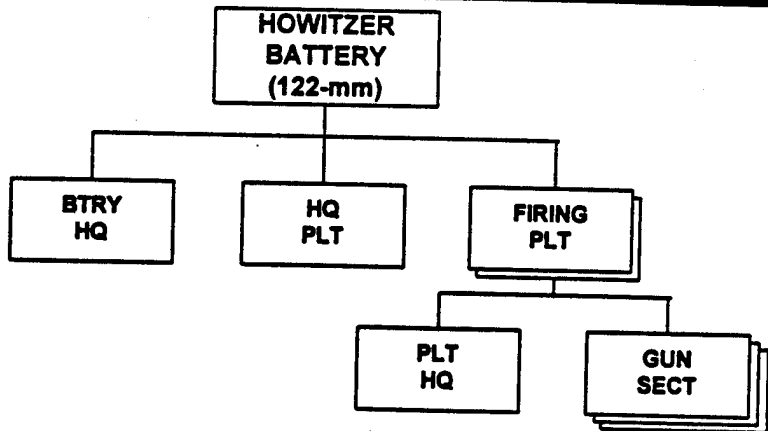

PRINCIPAL ITEMS OF EQUIPMENT

Equipment	Total	Equipment	Total
122-mm Howitzer, D-30.....	6	ACRV, 1V18 (Battery COP)*	1
ATGL, RPG-7V.....	6	Trailer, Cargo,.....	1
5.45-mm LMG, RPK-74.....	6	Rangefinder, Laser, SAGE GLOSS.....	1
Truck, Light	1	Radios:	
Truck, Medium	8	VHF, Manpack, Low-Power.....	6
ACRV, 1V110 (Battery FDC)*	1	VHF, Vehicle Mount, Medium-Power ..	1

FOOTNOTE: * The ACRV, 1V110 (Battery FDC) and 1V18 (Battery COP) have been replaced by the 1V21 series ACRV in some units.

152-mm Howitzer Battalion, Arty Regt, Light Inf Div and
Mtzd Inf Div, or MD or Army or National

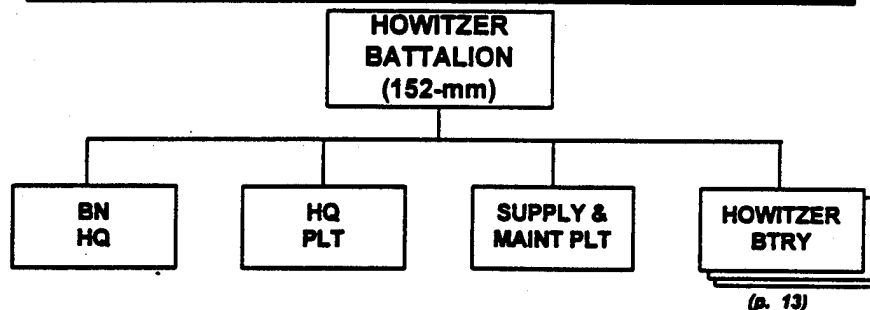

PRINCIPAL ITEMS OF EQUIPMENT

Equipment	Total	Equipment	Total
152-mm Gun-Howitzer, D-20.....	18	Ambulance	1
ACRV, 1V110 (Battery FDC)	3	Trailer, Cargo, 2-Axle	11
ACRV, 1V18 (Battery COP)	3	Trailer, POL (1,200-Liter)	2
ACRV, 1V19 (Battalion COP)	1	Trailer, Water (900-Liter)	1
ACRV, 1V111 (Battalion FDC)	1	Trailer, Kitchen	4
Mobile Recon Post, PRP-3/4*	1	Rangefinder, Laser, SAGE GLOSS.....	4
ATGL, RPG-7V	18	Radios:	
5.45-mm LMG, RPK-74	18	VHF, Manpack, Low-Power	20
Truck, Utility.....	1	VHF, Portable, Low-Power	
Truck, Light	12	or Very-Low-Power	2
Truck, Medium	34	HF/VHF, Vehicle Mount,	
Truck, POL (4,000 or 5,200-Liter)	2	Medium-Power	4
Van, Signal.....	2	Warning Receiver	1
Van, Maintenance	1		

FOOTNOTE: * This system includes the SMALL FRED battlefield surveillance radar.

**152-mm Howitzer Battery, 152-mm Howitzer Bn, Arty Regt,
Light Inf Div and Mtzd Inf Div, or MD or Army or National**

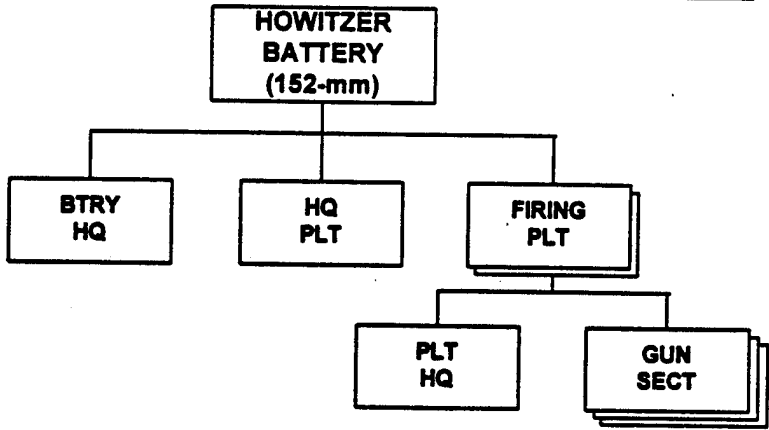

PRINCIPAL ITEMS OF EQUIPMENT

Equipment	Total	Equipment	Total
152-mm Gun-Howitzer, D-20.....	6	Trailer, Kitchen.....	1
ATGL, RPG-7V.....	6	Rangefinder, Laser, SAGE GLOSS.....	1
5.45-mm LMG, RPK-74.....	6	Radios:	
ACRV, 1V110 (Battery FDC).....	1	VHF, Manpack, Low-Power.....	5
ACRV, 1V18 (Battery COP).....	1	HF/VHF, Vehicle Mount,	
Truck, Light.....	4	Medium-Power.....	1
Truck, Medium.....	34		
Trailer, Cargo, 2-Axle.....	3		

FOOTNOTE: * This system includes the SMALL FRED battlefield surveillance radar.

Rocket Launcher Battalion, Arty Regt, Light Inf Div and Mtzd Inf Div, or MD or Army or National, and SP Arty Regt, Mech Inf Div, or MD or Army or National

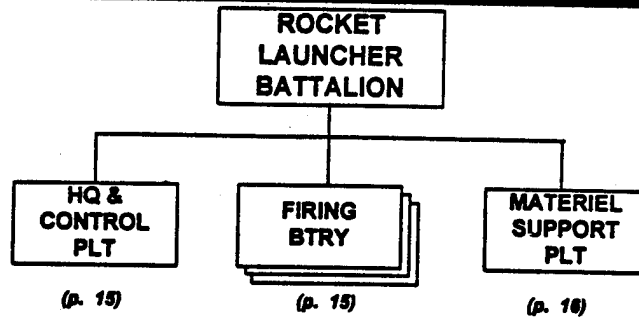

PRINCIPAL ITEMS OF EQUIPMENT

Equipment	Total	Equipment	Total
122-mm Rocket Launcher, BM-21 (Grad)	18	Van, Command	1
ACV, BTR (R-145BM)	1	Van, Signal	2
ACRV, 1V110 (Battery FDC)	3	Ambulance	1
ACRV, 1V18 (Battery COP)	3	Trailer, Cargo, 1-Axle	36
ACRV, 1V19 (Battalion COP)	1	Trailer, Generator	2
ACRV, 1V111 (Battalion FDC)	1	Trailer, Water (900-Liter)	1
Truck, Light	6	Trailer, POL (1,200-Liter)	2
Truck, Utility	5	Radios:	
Truck, Medium	44	VHF, Manpack, Low-Power	18
Van, Maintenance	3	HF/VHF, Vehicle Mount, Medium-Power	2
Truck, POL (4,000 or 5,200-Liter)	2	Warning Receiver	1

Headquarters and Control Platoon, Rocket Launcher Bn, Arty Regt, Light Inf Div and Mtzd Inf Div, or MD or Army or National, and Rocket Launcher Bn, SP Arty Regt, Mech Inf Div, or MD or Army or National

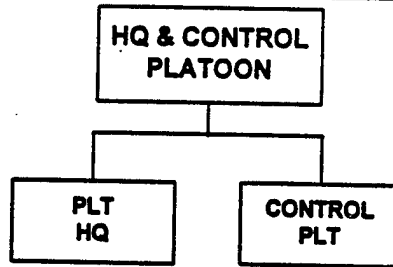

PRINCIPAL ITEMS OF EQUIPMENT

<u>Equipment</u>	<u>Total</u>	<u>Equipment</u>	<u>Total</u>
ACV, BTR (R-145BM)	1	Ambulance	1
ACRV, 1V19 (Battalion COP)	1	Trailer, Generator.....	1
ACRV, 1V111 (Battalion FDC)	1	Radios:	
Truck, Utility.....	1	VHF, Manpack, Low-Power	5
Truck, Medium	1	HF/VHF, Vehicle Mount,	
Van, Command	1	Medium-Power	2
Van, Signal.....	2	Warning Receiver	1

Firing Battery, Rocket Launcher Bn, Arty Regt, Light Inf Div and Mtzd Inf Div, or MD or Army or National, and Rocket Launcher Bn, SP Arty Regt, Mech Inf Div, or MD or Army or National

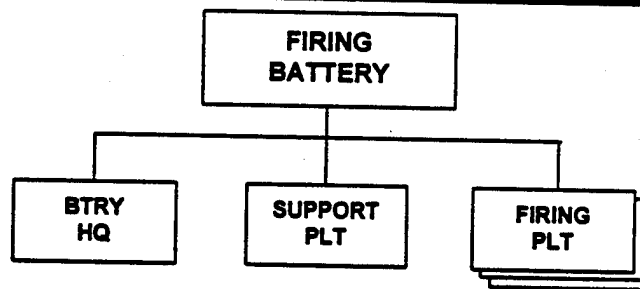

PRINCIPAL ITEMS OF EQUIPMENT

<u>Equipment</u>	<u>Total</u>	<u>Equipment</u>	<u>Total</u>
122-mm Rocket Launcher, BM-21	6	Truck, Light	2
ACRV, 1V110 (Battery FDC)	1	Truck, Medium	6
ACRV, 1V18 (Battery COP)	1	Trailer, Cargo.....	6
Truck, Utility.....	1	Radio, VHF, Manpack, Low-Power	4

Materiel Support Platoon, Rocket Launcher Bn, Arty Regt, Light Inf Div and Mtzd Inf Div, or MD or Army or National, and Rocket Launcher Bn, SP Arty Regt, Mech Inf Div, or MD or Army or National

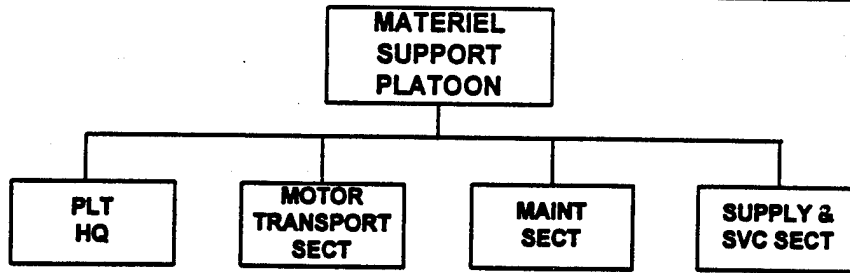

PRINCIPAL ITEMS OF EQUIPMENT

Equipment	Total	Equipment	Total
Truck, Utility.....	1	Trailer, Generator.....	1
Truck, Medium	25	Trailer, POL (900-Liter)	2
Truck, Maintenance	3	Trailer, Kitchen	3
Truck, POL (4,000 or 5,200-Liter)	2	Radio, VHF, Manpack, Low-Power	1
Trailer, Cargo	18		

**Air Defense Battery, Arty Regt, Light Inf Div and Mtzd Inf Div,
or MD or Army or National**

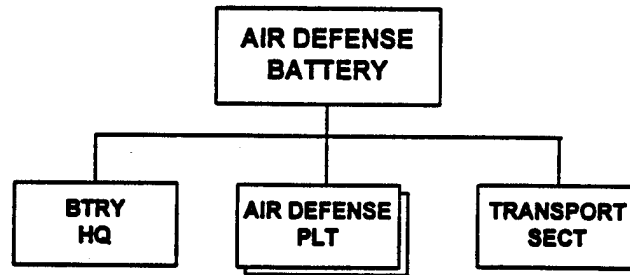

PRINCIPAL ITEMS OF EQUIPMENT

Equipment	Total	Equipment	Total
23-mm AA Gun, ZU-23.....	6	Radios:	
Truck, Light	6	VHF, Portable, Low-Power	3
Truck, Medium	2	Warning Receiver	3

**Sound Ranging and Radar Reconnaissance Battery, Arty Regt, Light Inf Div
and Mtzd Inf Div, or MD or Army or National, and SP Arty Regt, Mech Inf
Div, or MD or Army or National**

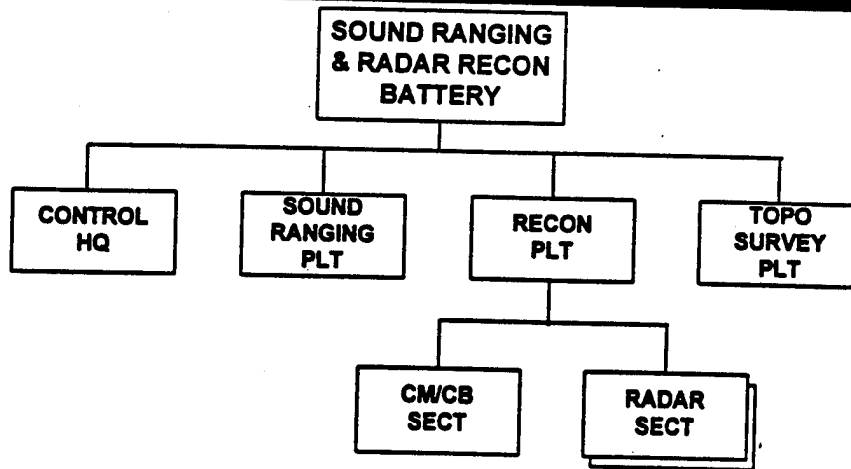

PRINCIPAL ITEMS OF EQUIPMENT

Equipment	Total	Equipment	Total
ACV, BTR (R-145BM)	2	Trailer, Kitchen	1
APC, Radar, MT-LB (SNAR 10)*	2	Trailer, Water (900-Liter)	1
Mobile Recon Post, PRP-3/4**	1	Rangefinder, Laser, SAGE GLOSS	2
Truck, Light	7	Sound Ranging Set	1
Truck, Utility	6	Radar, Countermortar/Counterbattery, ARK-1	1
Van, Maintenance	4	Radios:	
Van, Survey	1	VHF, Manpack, Low-Power	13
Van, Radar	1	VHF, Vehicle Mount, Medium-Power ..	4
Trailer, Cargo, 1-Axle	1	Warning Receiver	1
Trailer, Generator	2		

FOOTNOTES:

* This system includes the BIG FRED battlefield surveillance radar.

** This system includes the SMALL FRED or TALL MIKE battlefield surveillance radar.

Materiel Support Company, Arty Regt, Light Inf Div and Mtzd Inf Div, or MD or Army or National, and SP Arty Regt, Mech Inf Div, or MD or Army or National

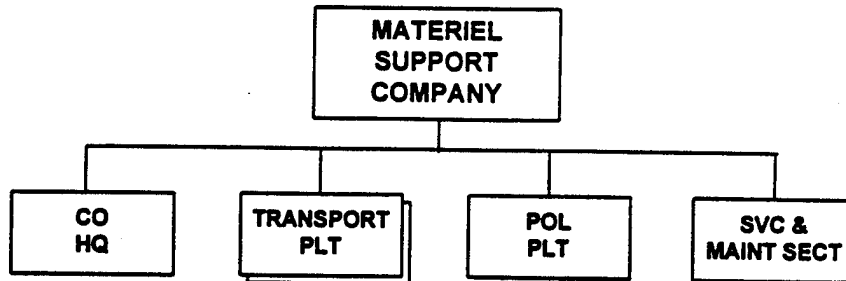

PRINCIPAL ITEMS OF EQUIPMENT

<u>Equipment</u>	<u>Total</u>	<u>Equipment</u>	<u>Total</u>
Truck, Utility.....	1	Trailer, Cargo, 2-Axle.....	30
Truck, Medium	40	Trailer, Water (900-Liter)	1
Truck, POL (5,200-Liter).....	12	Radio, VHF, Manpack, Low-Power	1

Maintenance Company, Arty Regt, Light Inf Div and Mtzd Inf Div, or MD or Army or National, and SP Arty Regt, Mech Inf Div, or MD or Army or National

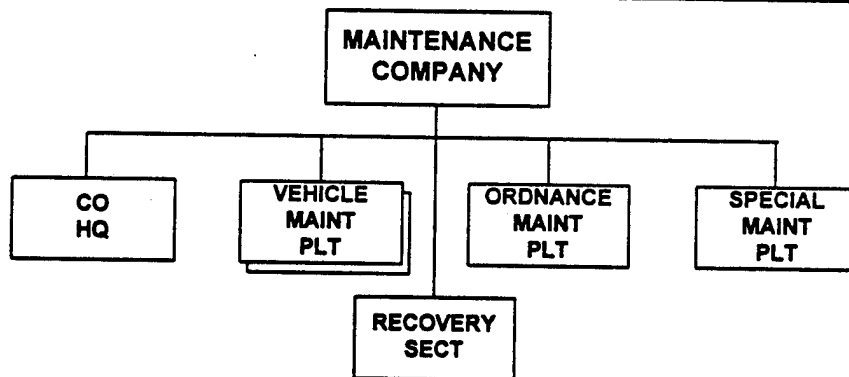

PRINCIPAL ITEMS OF EQUIPMENT

<u>Equipment</u>	<u>Total</u>	<u>Equipment</u>	<u>Total</u>
ATGL, RPG-7V.....	4	Truck, Recovery	1
5.45-mm LMG, RPK-74.....	2	Trailer, Cargo, 1-Axle.....	3
Truck, Crane	1	Trailer, Generator.....	2
Truck, Utility.....	1	Trailer, Welding.....	1
Truck, Medium	3	Radio, VHF, Manpack, Low-Power	1
Van, Maintenance	14		

Chemical Protection Platoon, Arty Regt, Light Inf Div and Mtzd Inf Div, or MD or Army or National, and SP Arty Regt, Mech Inf Div, or MD or Army or National, or Mtzd Inf Bde (Sep and Div) and Mech Inf Bde (Sep and Div) and Tank Bde

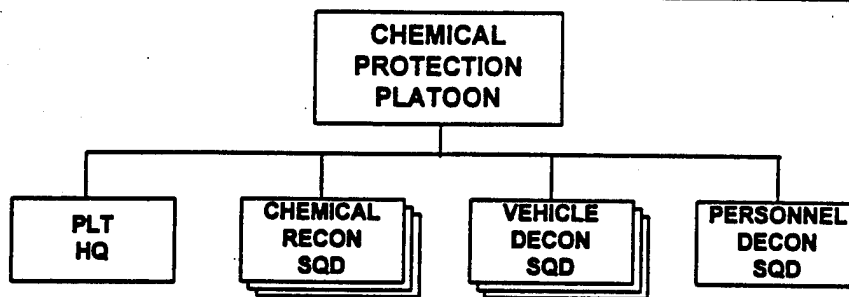

PRINCIPAL ITEMS OF EQUIPMENT

Equipment	Total
Chemical Recon Vehicle, BRDM-2RKh or RKhM.....	3
Truck, Decon, ARS-12U/14	3
Truck, Decon, DDA-53/66.....	1
Truck, Water (2,000-Liter).....	2

Equipment	Total
Trailer, Water (1,200-Liter)	2
Radios:	
VHF, Vehicle Mount, Medium-Power ..	3
HF, Manpack, Low-Power.....	1

Medical Platoon, Arty Regt, Light Inf Div and Mtzd Inf Div, or MD or Army or National, and SP Arty Regt, Mech Inf Div, or MD or Army or National, or Light Inf Bde (Sep and Div), Mtzd Inf Bde (Sep and Div), Mech Inf Bde (Sep and Div), and Tank Bde

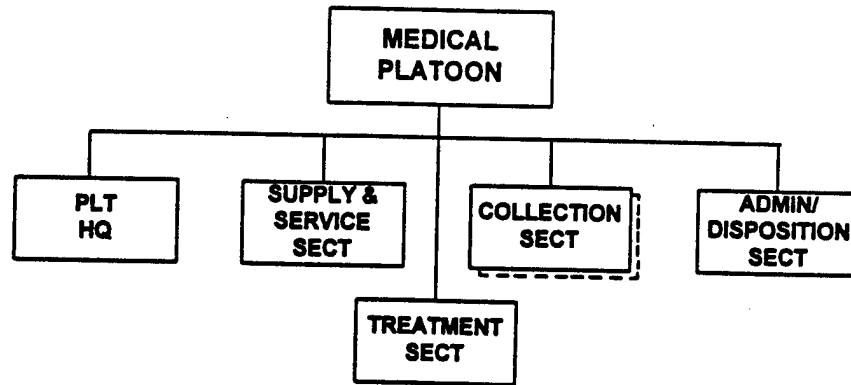

PRINCIPAL ITEMS OF EQUIPMENT

<u>Equipment</u>	<u>Total</u>	<u>Equipment</u>	<u>Total</u>
Van, Hospital	1	Ambulance	4
Truck, Medium	2	Trailer, Kitchen	1
Truck, Light	1	Trailer, Water (900-Liter)	1
Truck, Decon, DDA-53/66.....	1	Radio, VHF, Manpack, Low-Power	1

NOTES:

1. Other general purpose trucks may serve as ambulances.
2. Some medical platoons, particularly those in mechanized and tank units, have two collection sections.

SP Artillery Regiment, Mech Inf Div or MD or Army or National

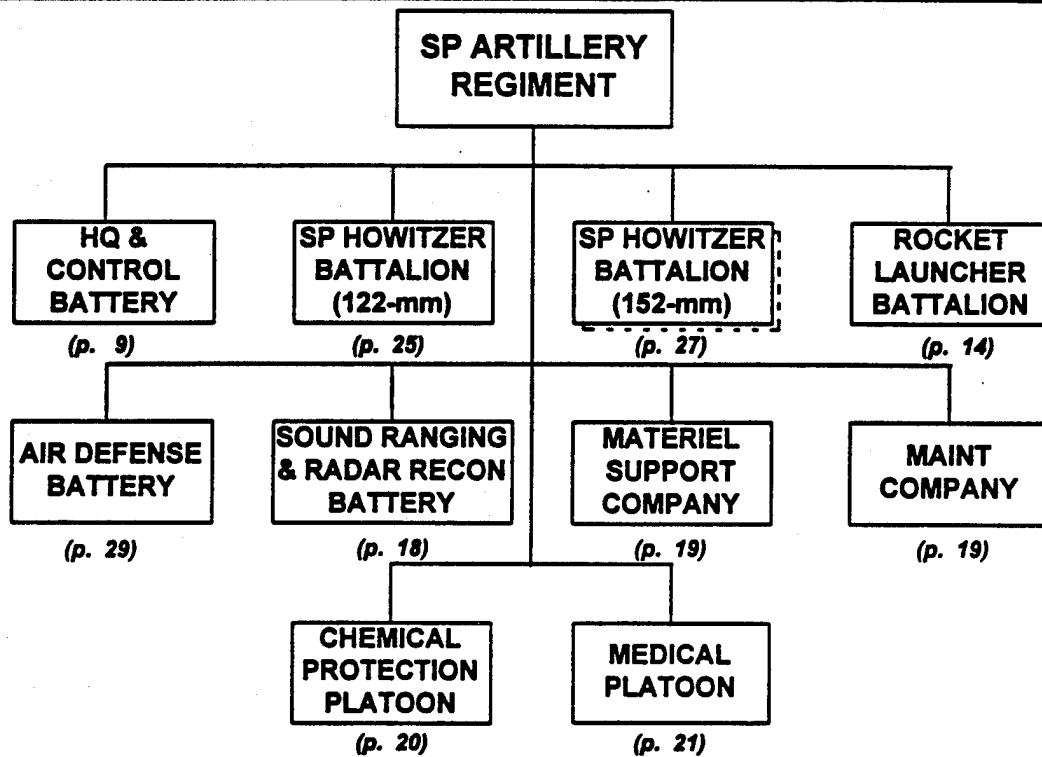

SP ARTILLERY REGIMENT, Divisional, MD, Army, National

<i>Principal Items of Equipment</i>											
	<i>HQ & Control Btry</i>	<i>SP Howitzer Bn (122-mm)</i>	<i>SP Howitzer Bn (152-mm)</i>	<i>Rocket Launcher Bn</i>	<i>Air Defense Btry</i>	<i>Sound Ranging & Radar Recon Btry</i>	<i>Material Support Co</i>	<i>Maintenance Co</i>	<i>Chem Protection Plt</i>	<i>Medical Plt</i>	<i>TOTAL</i>
ARMORED VEHICLES											
ACV, BTR (R-145BM)	2			1		2					5
Chemical Recon BRDM-2RKh/RKhM	1								3		4
Mobile Recon Post, PRP-3/4		1	1			1					3
APC, Radar, MT-LB (SNAR-10)						2					2
ACRV, 1V13/1V13M/1V22		3	3								6
ACRV, 1V14/1V14M/1V23		3	3								6
ACRV, 1V15/1V15M/1V24		1	1								2
ACRV, 1V16/1V16M/1V25		1	1								2
ACRV, 1V18				3							3
ACRV, 1V19				1							1
WEAPONS											
122-mm SP Howitzer, 2S1		18									18
152-mm SP Howitzer, 2S3			18								18
122-mm Rocket Launcher, BM-21				18							18
23-mm AA Gun, ZU-23					6						6
ATGL, RPG-7V	4	6	6					4			20
SAM, SA-7/14	3										3
TRUCKS											
ACRV, 1V110 (Battery FDC)				3							3
ACRV, 1V111 (Battalion FDC)				1							1
Truck, Utility	6			5		6	1	1			19
Truck, Light	2	4		6	1	7				1	22
Truck, Medium	1	14	20	44	2		40	3		2	126
Truck, Decon, ARS-12U/14									3		3
Truck, Decon, DDA-53/66									1	1	2
Truck, Crane								1			1
Truck, POL (4,000-5,200-L)		2	4	2			12				20
Truck, Recovery								1			1
Truck, Water (2,000-L)									2		2
Van										1	1
Van, Command				1							1
Van, Maintenance		2	2	3		4		14			25
Van, Radar						1					1
Van, Signal	3	3	4	2							12
Van, Survey						1					1
Ambulance		1	1	1						4	7

SP ARTILLERY REGIMENT, Divisional, MD, Army, National (Cont)

<i>Principal Items of Equipment</i>	<i>HQ & Control Btry</i>	<i>SP Howitzer Bn (122-mm)</i>	<i>SP Howitzer Bn (152-mm)</i>	<i>Rocket Launcher Bn</i>	<i>Air Defense Btry</i>	<i>Sound Ranging & Radar Recon Btry</i>	<i>Material Support Co</i>	<i>Maintenance Co</i>	<i>Chem Protection Plt</i>	<i>Medical Plt</i>	<i>TOTAL</i>
TRAILERS											
Trailer, Cargo, 1-Axle	1			36		1		3			41
Trailer, Cargo, 2-Axle		16	17				30				63
Trailer, Generator	2	2		2		2		2			10
Trailer, Kitchen	1	3	3			1				1	9
Trailer, POL (900/1,200-L)		2	4	2							8
Trailer, Water (900/2,000-L)		1	1	1		1	1		2	1	8
Trailer, Welding								1			1
RADARS											
Radar, CM/CB, ARK-1						1					1
RADIOS											
VHF, Manpack, Low -Power	6	10	10	18		13	1	1			59
VHF, Portable, Low- Power	1				3						4
VHF, Vehicle Mount, Medium-Power	4	28	28			4			3		67
HF, Manpack, Low-Power	1								1	1	3
HF, Vehicle Mount, Medium-Power	5										5
HF/VHF, Vehicle, Medium-Power	3			2							5
HF/VHF, Vehicle, High-Power	1										1
Radio Relay, VHF/UHF	1										1
Warning Receiver	1	2	2	1	3	1					10
MISCELLANEOUS											
Rangefinder, Laser, SAGE GLOSS	1	4	4			2					11
Sound Ranging Set						1					1

**122-mm SP Howitzer Battalion, Mech Inf Bde (Sep and Div) and Tank
Bde, or SP Arty Regt, Mech Inf Div or MD or Army or National**

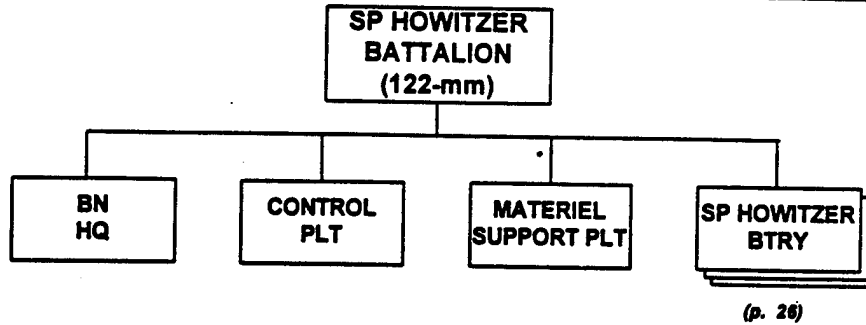

PRINCIPAL ITEMS OF EQUIPMENT

Equipment	Total	Equipment	Total
122-mm SP Howitzer, 2S1	18	Van, Signal.....	3
ATGL, RPG-7V	6	Trailer, Cargo, 2-Axle.....	16
5.45-mm LMG, RPK-74.....	18	Trailer, Generator.....	2
ACRV, 1V13/1V13M/1V22 (Btry FDC)	3	Trailer, POL (1,200-Liter)	2
ACRV, 1V14/1V14M/1V23 (Btry COP)	3	Trailer, Water (1,200-Liter)	1
ACRV, 1V15/1V15M/1V24 (Bn COP).....	1	Trailer, Kitchen.....	3
ACRV, 1V16/1V16M/1V25 (Bn FDC).....	1	Rangefinder, Laser, SAGE GLOSS.....	4
Mobile Recon Post, PRP-3/4*	1	Radios:	
Truck, Light	4	VHF, Manpack, Low-Power.....	10
Truck, Medium	14	VHF, Vehicle Mount,	
Truck, POL (4,000 or 5,200-Liter)	2	Medium-Power	28
Van, Maintenance	2	Warning Receiver	2
Ambulance	1		

FOOTNOTE: * This system includes the SMALL FRED or TALL MIKE battlefield surveillance radar.

122-mm SP Howitzer Battery, 122-mm SP Howitzer Bn, Mech Inf Bde (Sep and Div) and Tank Bde, or Mech Inf Div or MD or Army or National

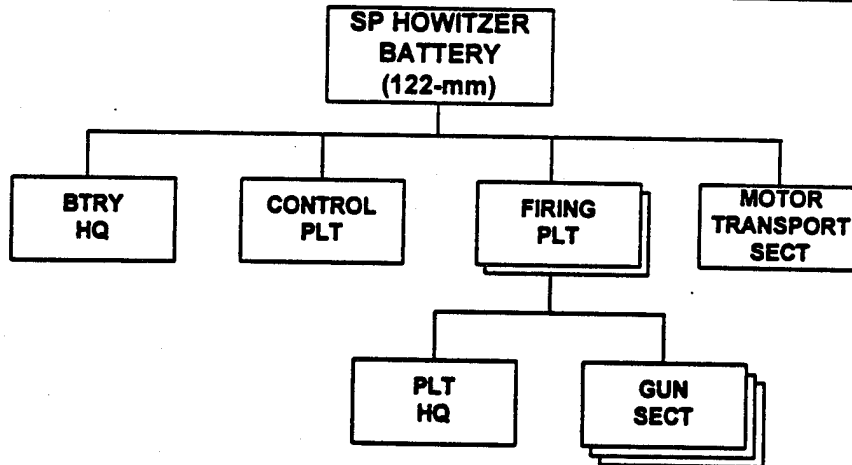

PRINCIPAL ITEMS OF EQUIPMENT

Equipment	Total
122-mm SP Howitzer, 2S1	6
ATGL, RPG-7V	2
5.45-mm LMG, RPK-74	6
ACRV, 1V13/1V13M/1V22 (Btry FDC)	1
ACRV, 1V14/1V14M/1V23 (Btry COP)	1
Van, Signal.....	1

Equipment	Total
Truck, Medium	3
Trailer, Cargo, 2-Axle.....	3
Rangefinder, Laser, SAGE GLOSS.....	1
Radios:	
VHF, Manpack, Low-Power.....	2
VHF, Vehicle Mount, Medium-Power ..	8

**152-mm SP Howitzer Battalion, SP Arty Regt, Mech Inf Div or
MD or Army or National**

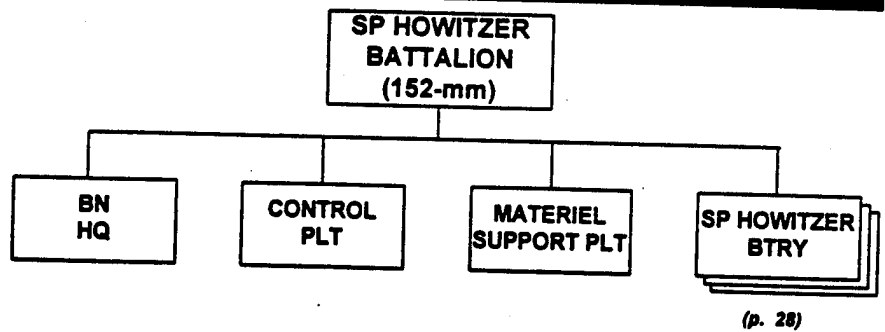

PRINCIPAL ITEMS OF EQUIPMENT

Equipment	Total	Equipment	Total
152-mm SP Howitzer, 2S3	18	Ambulance	1
ATGL, RPG-7V	6	Trailer, Cargo, 2-Axle	17
5.45-mm LGM, RPK-74	18	Trailer, Water (1,200-Liter)	1
Mobile Recon Post, PRP-3/4*	1	Trailer, Kitchen	3
ACRV, 1V13/1V13M/1V22 (Btry FDC)	3	Trailer, POL (1,200-Liter)	4
ACRV, 1V14/1V14M/1V23 (Btry COP)	3	Rangefinder, Laser, SAGE GLOSS	4
ACRV, 1V15/1V15M/1V24 (Bn COP)	1	Radios:	
ACRV, 1V16/1V16M/1V25 (Bn FDC)	1	VHF, Manpack, Low-Power	10
Truck, Medium	20	VHF, Vehicle Mount,	
Van, Maintenance	2	Medium-Power	28
Truck, POL (4,000 or 5,200-Liter)	4	Warning Receiver	2
Van, Signal	4		

FOOTNOTE: * This system includes the SMALL FRED or TALL MIKE battlefield surveillance radar.

**152-mm SP Howitzer Battery, 152-mm SP Howitzer Bn, Arty
Regt, Mech Inf Div or MD or Army or National**

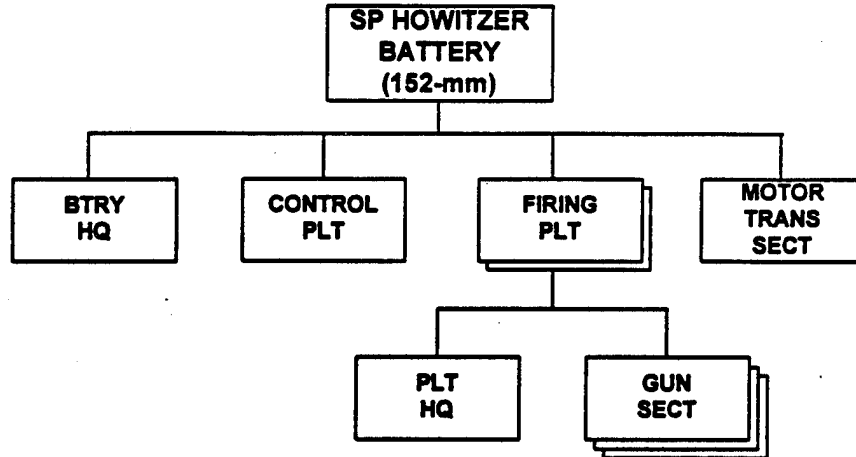

PRINCIPAL ITEMS OF EQUIPMENT

Equipment	Total
152-mm SP Howitzer, 2S3	6
ATGL, RPG-7V	2
5.45-mm LGM, RPK-74	6
ACRV, 1V13/1V13M/1V22 (Btry FDC)	1
ACRV, 1V14/1V14M/1V23 (Btry COP)	1
Van, Signal	1

Equipment	Total
Truck, Medium	3
Trailer, Cargo, 2-Axle	3
Rangefinder, Laser, SAGE GLOSS	1
Radios:	
VHF, Manpack, Low-Power	2
VHF, Vehicle Mount, Medium-Power ..	8

Air Defense Battery, SP Arty Regt, Mech Inf Div or MD or Army or National

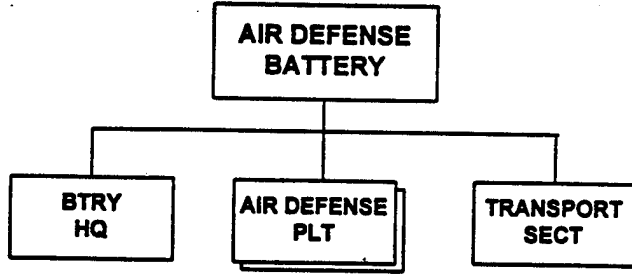

PRINCIPAL ITEMS OF EQUIPMENT

Equipment	Total	Equipment	Total
23-mm SPAA Gun, ZSU-23-4*	6	Radios:	
ACV, BTR-60 (PU-12).....	1	VHF, Portable, Low-Power	1
Truck, Light	1	VHF, Vehicle Mount,	
Truck, Medium	3	Medium-Power	7
Trailer, Generator.....	2	Warning Receiver	3

FOOTNOTE: *This system includes the GUN DISH fire control radar.

**Air Defense Regiment, Mech Inf Div or MD or Army
or National (Air Defense Command)**

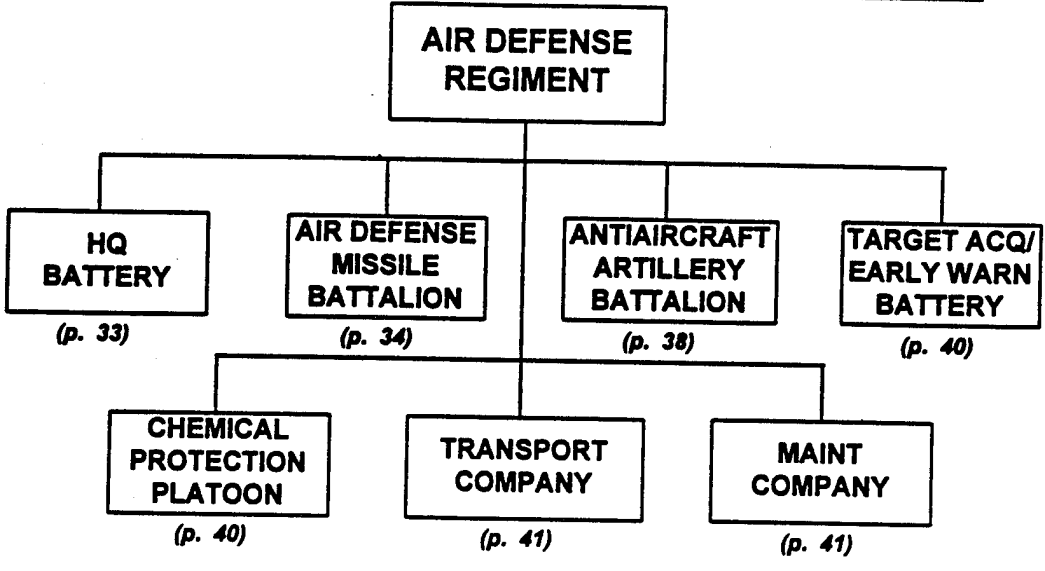

AIR DEFENSE REGIMENT, Divisional, MD, Army, National								
<i>Principal Items of Equipment</i>	<i>HQ Battery</i>	<i>Air Defense Missile Bn</i>	<i>Antiaircraft Artillery Bn</i>	<i>Target Acq/ EW Btry</i>	<i>Chem Protection Plt</i>	<i>Transport Co</i>	<i>Maintenance Co</i>	<i>TOTAL</i>
ARMORED VEHICLES								
APC, BTR-60 (PU-12)		1						1
ACV, BTR (R-145BM)	1		2					3
Chem Recon Vehicle, BRDM-2RKh					3			3
WEAPONS								
57-mm AA Gun, S-60			18					18
SAM, SA-8/GECKO		8						8
SAM, SA-7/14	3	21	12					36
TRUCKS								
Truck, Utility	1	7	8	3		1	1	21
Truck, Light	3	19	4	1		1	1	29
Truck, Medium	2	38	60			36	3	139
Truck, Decon, DDP/DDA		1			4			5
Truck, Chem Recon, UAZ-69RKh			1					1
Truck, Crane		2	1					3
Truck, POL (4,000/5,200-L)	2	15	4			8		29
Truck, Water (900/1,200-L)			1			3		4
Van	2	18	2					22
Van, Computer				1				1
Van, Maintenance		2	3	1		2	8	16
Van, Radio/Radar Recon			6					6
Van, Signal	4	4	2					10
Ambulance	2	2	1					5

AIR DEFENSE REGIMENT, Divisional, MD, Army, National (Cont)

<i>Principal Items of Equipment</i>	<i>HQ Battery</i>	<i>Air Defense Missile Bn</i>	<i>Antiaircraft Artillery Bn</i>	<i>Target Acq./ EW Btry</i>	<i>Chem. Protection Plt</i>	<i>Transport Co</i>	<i>Maintenance Co</i>	<i>TOTAL</i>
TRAILERS								
Trailer, Cargo, 1-Axle		11						11
Trailer, Cargo, 2-Axle	1		5	1		30	3	40
Trailer, Generator	2	6	6				7	21
Trailer, Kitchen	1	9	7	1			1	19
Trailer, POL (900/1,200-L)	2	7	2			8		19
Trailer, Van	4	12		1				17
Trailer, Water (900/1,200-L)	2	3	7	1			1	14
RADARS								
Aer. Surv./Tgt Acq, LONG TRACK				2				2
Aer.Surv/Tgt Acq, FLAT FACE			2					2
Radar, Fire Control, FLAP WHEEL			3					3
Radar, HF, THIN SKIN				1				1
RADIOS								
VHF, Manpack, Low-Power	1	9	24	2		1	1	38
VHF, Portable, Low-Power		3						3
VHF, Portable, Very-Low-Power			15					15
VHF, Vehicle Mount, Medium-Power	1	31	2	3	3			40
HF, Manpack, Low-Power			1	2	1			4
HF, Vehicle Mount, Medium-Power			2					2
HF/VHF, Vehicle, Medium-Power	4	4	2					10
HF/VHF, Vehicle, High-Power	2	2						4
Radio Relay, VHF/UHF	1	1						2
Warning Receiver	2	7	5					14
MISCELLANEOUS								
SA-8 Transloader (TELAR)		15						15

**Headquarters Battery, Air Defense Regt, Mech Inf Div or MD
or Army or National (Air Defense Command)**

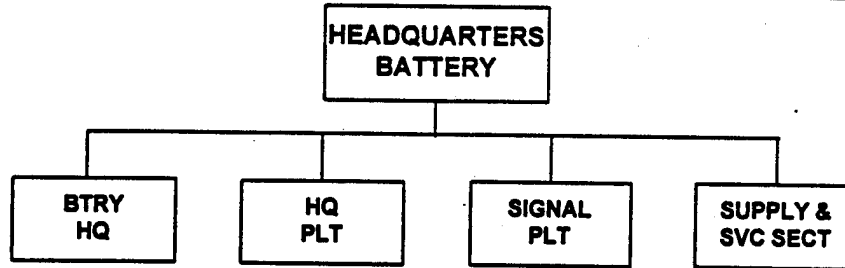

PRINCIPAL ITEMS OF EQUIPMENT

Equipment	Total
SAM, SA-7/14	3
ACV, BTR-60 (PU-12).....	1
Truck, Utility.....	1
Truck, Light	3
Truck, Medium	2
Van, Medium	2
Van, Signal.....	4
Trailer, Van.....	4
Trailer, Generator.....	2
Trailer, Kitchen.....	1

Equipment	Total
Ambulance	2
Radios:	
VHF, Manpack, Low-Power	1
VHF, Vehicle Mount, Medium-Power ..	1
HF/VHF, Vehicle Mount, Medium-Power	4
HF/VHF, Vehicle Mount, High-Power..	2
Radio Relay, VHF/UHF.....	1
Warning Receiver	2

**Air Defense Missile Battalion (SA-8), Air Defense Regt, Mech Inf Div
or MD or Army or National (Air Defense Command)**

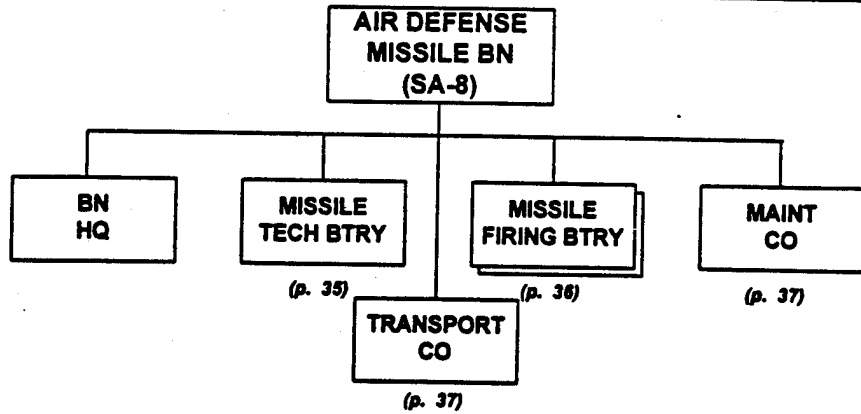

PRINCIPAL ITEMS OF EQUIPMENT

<u>Equipment</u>	<u>Total</u>	<u>Equipment</u>	<u>Total</u>
SAM, SA-8/GECKO TELAR*	8	Truck, Decon.....	1
SAM, SA-7/14	21	Trailer, Cargo, 1-Axle.....	11
ASV, BRDM-2	5	Trailer, Van	12
ACV, BTR-60(PU-12).....	1	Trailer, Generator.....	6
Truck, Utility.....	7	Trailer, Water (1,200-Liter)	2
Truck, Light	19	Trailer, Kitchen	9
Truck, Medium	38	Radios:	
Van, Medium	18	VHF, Manpack, Low-Power.....	9
Van, Signal.....	4	VHF, Portable, Low-Power	3
Van, Maintenance	2	VHF, Vehicle Mount,	
Truck, POL (5,200-Liter).....	15	Medium-Power	31
Truck, Crane	2	HF/VHF, Vehicle Mount,	
SA-8 Missile Transloader (TELAR		Medium-Power	4
Chassis).....	15	HF/VHF, Vehicle Mount, High-Power..	2
Ambulance	2	Radio Relay, VHF/UHF.....	1
Trailer, POL (1,200-Liter)	7	Warning Receiver	7

FOOTNOTE: * The TELAR includes the LAND ROLL fire control/target acquisition radar.

Missile Technical Battery, Air Defense Missile Bn (SA-8), Air Defense Regt, Mech Inf Div or MD or Army or National (Air Defense Command)

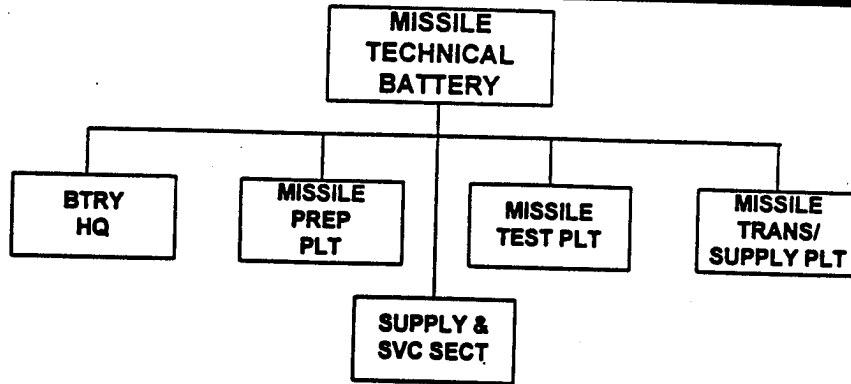

PRINCIPAL ITEMS OF EQUIPMENT

Equipment	Total	Equipment	Total
SAM, SA-7/14	3	Trailer, Generator.....	1
Truck, Utility.....	1	Trailer, Van.....	1
Truck, Light	6	Trailer, Kitchen.....	2
Truck, Medium	5	Radios:	
Truck, Crane	2	VHF, Portable, Low-Power	3
Trailer, Cargo, 1-Axle.....	1	VHF, Manpack, Low-Power.....	1

**Missile Firing Battery, Air Defense Missile Bn (SA-8), Air Defense Regt,
Mech Inf Div or MD or Army or National (Air Defense Command)**

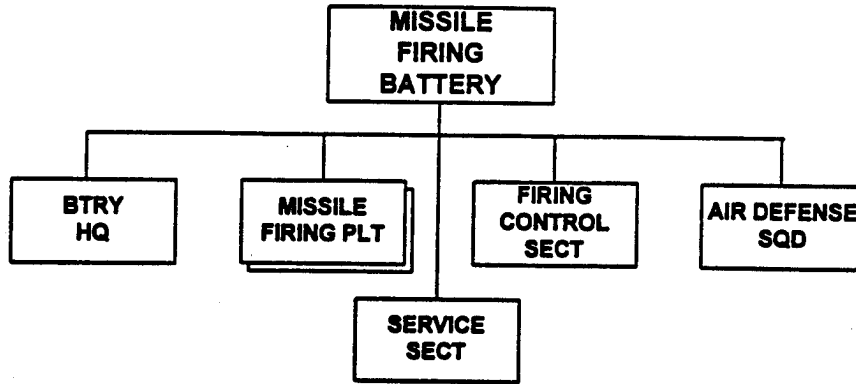

PRINCIPAL ITEMS OF EQUIPMENT

Equipment	Total	Equipment	Total
SAM, SA-8/GECKO TELAR*	4	Trailer, Cargo, 2-Axle	1
SAM, SA-7/14	3	Trailer, Van	1
ACV, BTR (R-145BM)	1	Trailer, Kitchen	1
Truck, Utility	1	Radios:	
Van, Medium	2	VHF, Manpack, Low-Power	1
SA-8 Missile Transloader, (TELAR Chassis)	2	VHF, Vehicle Mount, Medium-Power ..	6
		Warning Receiver	1

FOOTNOTE: * The TELAR includes the LAND ROLL fire control/acquisition radar.

**Maintenance Company, Air Defense Missile Bn (SA-8), Air Defense Regt,
Mech Inf Div or MD or Army or National (Air Defense Command)**

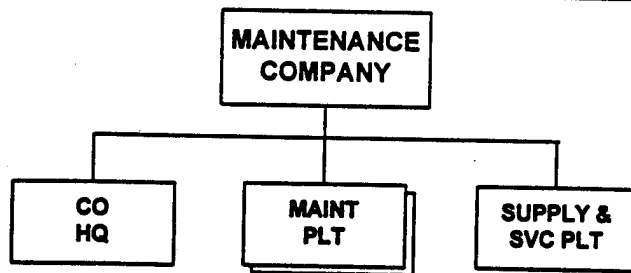

PRINCIPAL ITEMS OF EQUIPMENT

<u>Equipment</u>	<u>Total</u>	<u>Equipment</u>	<u>Total</u>
Truck, Utility.....	1	Trailer, Cargo, 2-Axle.....	3
Truck, Light.....	1	Trailer, Generator.....	7
Truck, Medium.....	3	Trailer, Water (900-Liter).....	1
Van, Maintenance.....	8	Trailer, Kitchen.....	1
Radar Calibration Vehicle (TELAR Chassis).....	2	Radio, VHF, Manpack, Low-Power.....	1

**Transport Company, Air Defense Missile Bn (SA-8), Air Defense Regt,
Mech Inf Div or MD or Army or National (Air Defense Command)**

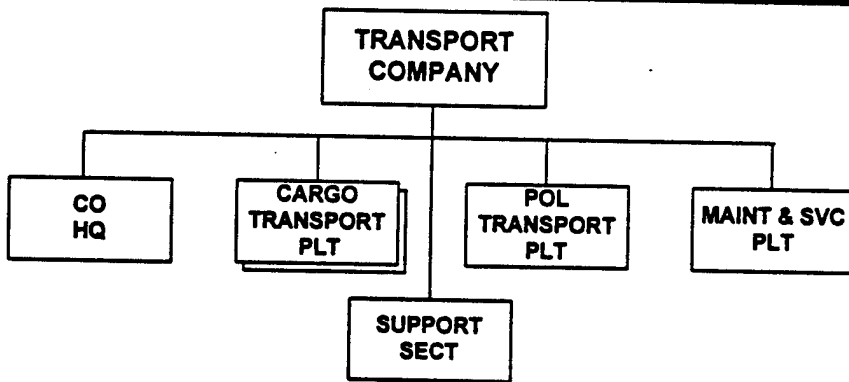

PRINCIPAL ITEMS OF EQUIPMENT

<u>Equipment</u>	<u>Total</u>	<u>Equipment</u>	<u>Total</u>
Truck, Utility.....	1	Trailer, POL (1,200-Liter).....	7
Truck, Light.....	1	Trailer, Generator.....	3
Truck, POL (900-Liter).....	15	Trailer, Water (900-Liter).....	3
Van, Medium.....	37	Trailer, Kitchen.....	1
Van, Maintenance.....	3	Trailer, Van.....	2
Trailer, Cargo, 2-Axle.....	5	Radio, VHF, Manpack, Low-Power.....	1

**Antiaircraft Artillery Battalion (S-60), Air Defense Regt, Mech
Inf Div or MD or Army or National (Air Defense Command)**

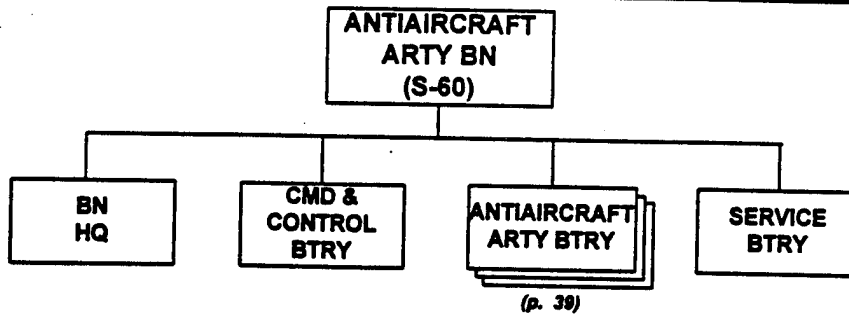

PRINCIPAL ITEMS OF EQUIPMENT

Equipment	Total
57-mm AA Gun, S-60.....	18
SAM, SA-7/14	12
ACV, BTR (R-145BM)	2
Truck, Utility.....	8
Truck, Light	4
Truck, Medium	60
Van, Signal.....	2
Van, Maintenance	3
Van, Radar	6
Truck, POL (5,200-Liter).....	4
Truck, Crane	1
Truck, Water (1,200-Liter).....	1
Ambulance	1
Truck, Chemical Recon, UAZ-69RKh	1
Trailer, POL (1,200-Liter)	2

Equipment	Total
Trailer, Cargo, 2-Axle.....	5
Trailer, Generator.....	6
Trailer, Kitchen.....	7
Trailer, Water (900-Liter)	7
Radars:	
Fire Control, FLAP WHEEL	3
Aerial Surveillance/Target Acquisition, FLAT FACE.....	2
Radios:	
VHF, Portable, Very-Low-Power	15
VHF, Manpack, Low-Power.....	24
VHF, Vehicle Mount, Medium-Power ..	2
HF/VHF, Vehicle Mount, High-Power..	2
HF, Manpack, Low-Power.....	1
HF, Vehicle Mount, Medium-Power	2
Warning Receiver	5

**Antiaircraft Artillery Battery, Antiaircraft Arty Bn (S-60), Air Defense Regt,
Mech Inf Div or MD or Army or National (Air Defense Command)**

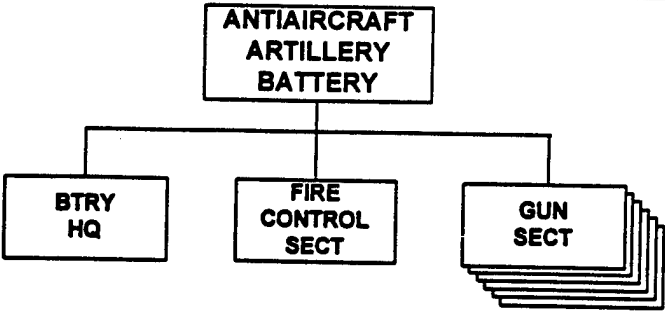

PRINCIPAL ITEMS OF EQUIPMENT

Equipment	Total	Equipment	Total
57-mm AA Gun, S-60.....	6	Trailer, Water (900-Liter).....	1
SAM, SA-7/14.....	3	Trailer, Kitchen.....	1
Truck, Light.....	1	Radar, Fire Control, FLAP WHEEL.....	1
Truck, Medium.....	15	Radios:	
Truck, POL (4,000-Liter).....	1	VHF, Portable, Very-Low-Power.....	3
Van, Radar.....	2	VHF, Manpack, Low-Power.....	6
Trailer, Generator.....	1	Warning Receiver.....	1
Trailer, POL (1,200-Liter).....	1		

Target Acquisition/Early Warning Battery, Air Defense Regt, Mech Inf Div or MD or Army or National (Air Defense Command)

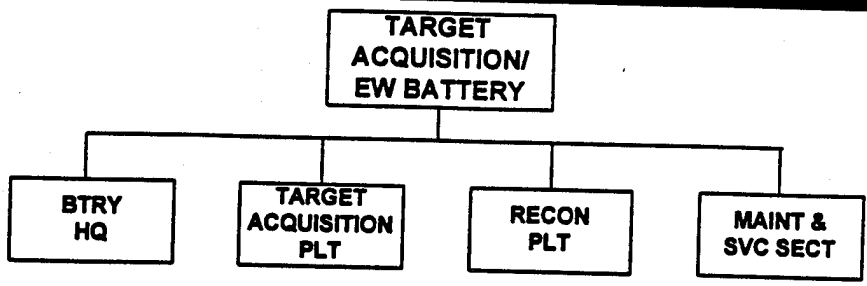

PRINCIPAL ITEMS OF EQUIPMENT

<u>Equipment</u>	<u>Total</u>	<u>Equipment</u>	<u>Total</u>
Truck, Utility.....	3	Radars:	
Truck, Light	1	Aerial Surveillance/Target	
Van, Maintenance	1	Acquisition, LONG TRACK	2
Van, Computer.....	1	Height Finding, THIN SKIN	1
Trailer, Cargo, 2-Axle.....	1	Radios:	
Trailer, Van.....	1	VHF, Manpack, Low-Power.....	2
Trailer, Kitchen.....	1	VHF, Vehicle Mount, Medium-Power ..	3
Trailer, Water (900-Liter)	1	HF, Manpack, Low-Power.....	2

Chemical Protection Platoon, Air Defense Regt, Mech Inf Div or MD or Army or National (Air Defense Command)

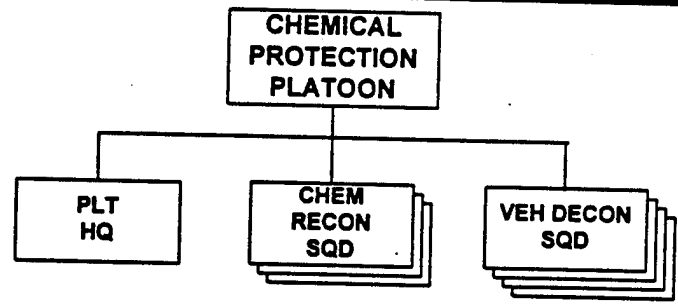

PRINCIPAL ITEMS OF EQUIPMENT

<u>Equipment</u>	<u>Total</u>	<u>Equipment</u>	<u>Total</u>
Chemical Recon Vehicle, BRDM-2RKh		Radios:	
or RKhM	3	VHF, Vehicle Mount, Medium-Power ..	3
Truck, Decon.....	4	HF, Manpack, Low-Power.....	1

**Transport Company, Air Defense Regt, Mech Inf Div
or MD or Army or National (Air Defense Command)**

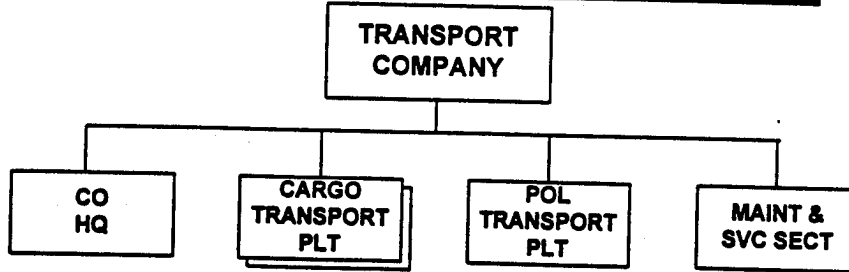

PRINCIPAL ITEMS OF EQUIPMENT

Equipment	Total	Equipment	Total
Truck, Utility.....	1	Truck, POL (4,000-Liter).....	8
Truck, Light	1	Trailer, POL (1,200-Liter)	8
Truck, Medium	36	Trailer, Cargo, 2-Axle.....	30
Van, Maintenance	2	Radio, VHF, Manpack, Low-Power	1
Truck, Water (2,000-Liter).....	3		

**Maintenance Company, Air Defense Regt, Mech Inf Div
or MD or Army or National (Air Defense Command)**

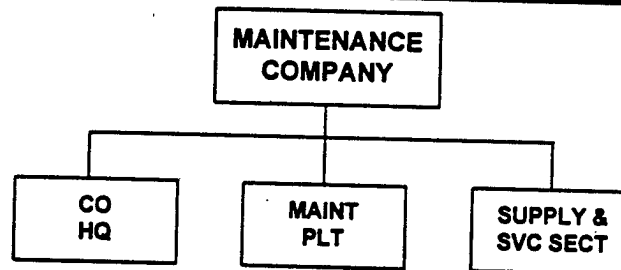

PRINCIPAL ITEMS OF EQUIPMENT

Equipment	Total	Equipment	Total
Truck, Utility.....	1	Trailer, Generator.....	7
Truck, Light	1	Trailer, Water (900-Liter)	1
Truck, Medium	3	Trailer, Kitchen	1
Van, Maintenance	8	Radio, VHF, Manpack, Low-Power	1
Trailer, Cargo, 2-Axle.....	3		

**Air Defense Regiment (ZSU-57-2), Mech Inf Div or Army
or National (Air Defense Command)**

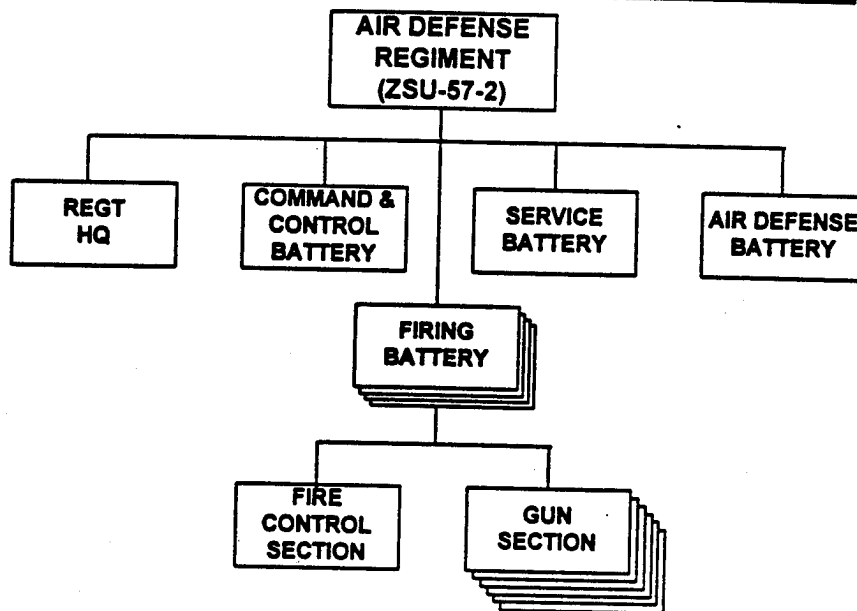

PRINCIPAL ITEMS OF EQUIPMENT

Equipment	Total	Equipment	Total
57-mm SPAA Gun, ZSU-57-2.....	24	Truck, Chemical Recon, UAZ-69RKh	1
23-mm SPAA Gun, ZSU-23-4*	6	Trailer, POL (1,200-Liter)	2
SAM, SA-7/14	15	Trailer, Cargo, 1-Axle.....	5
ACV, BTR (R-145BM)	2	Trailer, Generator.....	8
Truck, Utility.....	10	Trailer, Kitchen	7
Truck, Medium	57	Radios:	
Truck, Light	3	VHF, Portable, Very-Low-Power	15
Van, Signal.....	2	VHF, Manpack, Low-Power	24
Van, Radar	8	VHF, Vehicle Mount, Medium-Power ..	2
Truck, POL (4,000 or 5,200-Liter)	3	HF/VHF, Vehicle Mount, High-Power..	2
Truck, Crane	1	HF, Manpack, Low-Power.....	1
Truck, Water (900-Liter).....	1	HF, Vehicle Mount, Medium-Power	2
Ambulance	1	Warning Receiver	5

FOOTNOTE: * This system includes the GUN DISH fire control radar.

**Air Defense Regiment (S-60), Light Inf Div and Mtzd Inf Div, or Army
or National (Air Defense Command)**

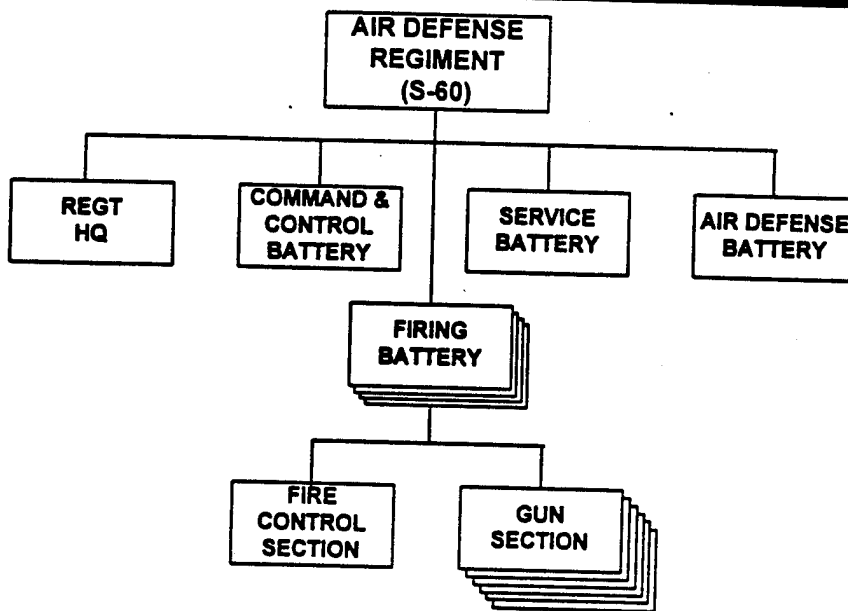

PRINCIPAL ITEMS OF EQUIPMENT

Equipment	Total	Equipment	Total
57-mm AA Gun, S-60.....	24	Trailer, Cargo, 1-Axle.....	5
23-mm AA Gun, ZU-23.....	6	Trailer, Generator.....	8
ACV, BTR (R-145BM).....	2	Trailer, Kitchen.....	7
SAM, SA-7/14.....	15	Radars:	
Truck, Utility.....	10	Fire Control, FLAP WHEEL.....	4
Truck, Light.....	3	Aerial Surveillance/Target	
Truck, Medium.....	77	Acquisition, FLAT FACE.....	2
Van, Signal.....	2	Radios:	
Van, Radar.....	8	VHF, Portable, Very-Low-Power.....	15
Truck, Chemical Recon, UAZ-69RKh.....	1	VHF, Manpack, Low-Power.....	24
Truck, Crane.....	1	VHF, Vehicle Mount, Medium-Power..	2
Truck, POL (4,000 or 5,200-Liter).....	4	HF/VHF, Vehicle Mount, High-Power..	2
Truck, Water (2,000-Liter).....	1	HF, Manpack, Low-Power.....	1
Ambulance.....	1	HF, Vehicle Mount, Medium-Power.....	2
Trailer, POL (1,200-Liter).....	2	Warning Receiver.....	5

NOTE: Some air defense regiments are equipped with the 100-mm KS-19 AAA gun. Regiments so equipped may be organized as above, or in three battalions, each with three firing batteries. In this organization, regimental total KS-19 would be 54 systems.

**Antitank Battalion, Light Inf Bde (Sep), Mtzd Inf Bde (Sep), and
Mech Inf Bde (Sep), or MD or Army or National**

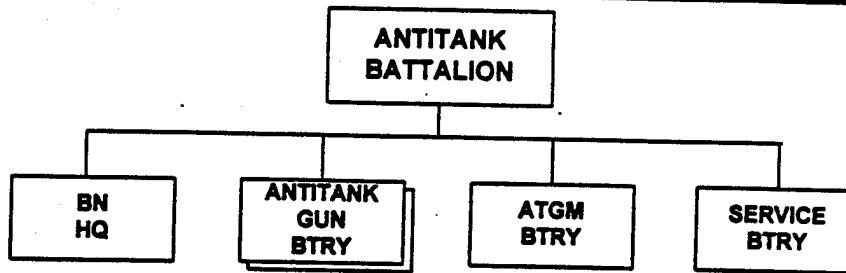

PRINCIPAL ITEMS OF EQUIPMENT

Equipment	Total	Equipment	Total
ATGM Vehicle, BRDM-2, w/AT-3/SAGGER or BRDM-2, w/AT-5/SPANDREL	9	Trailer, Water (900-Liter)	1
100-mm Antitank Gun, T-12/MT-12	12	Trailer, Kitchen	2
ATGL, RPG-7V	9	Trailer, POL (1,200-Liter)	1
ACV, BTR (R-145BM)	5	Rangefinder	3
Truck, Light	18	Radar, Battlefield Surveillance, Man-Portable, PSNR-1	3
Truck, Utility	3	Radios:	
Truck, Light	4	VHF, Manpack, Low-Power	24
Truck, Medium	12	VHF, Vehicle Mount, Medium- Power	14
Van, Signal	2	HF/VHF, Vehicle Mount, Medium- Power	3
Van, Maintenance	2	HF, Vehicle Mount, Medium-Power	1
Truck, POL (4,000 or 5,200-Liter)	2	Radio Relay, VHF/UHF	1
Ambulance	1	Warning Receiver	1
Trailer, Cargo, 2-Axle	10		
Trailer, Generator	1		

NOTES:

1. Some armies have three antitank gun batteries, instead of two antitank gun batteries and one ATGM battery.
2. Separate brigades and well-equipped districts will have either the battalion as depicted above, or a battalion composed entirely of ATGM batteries, in which case it will be called an ATGM battalion. During force modernization, the tendency is for districts/brigades with offensive contingency missions to have an ATGM battalion, whereas districts/brigades with primarily defensive contingency missions have the standard antitank battalion.

Commando Battalion, MD or National (Special Operations Command)

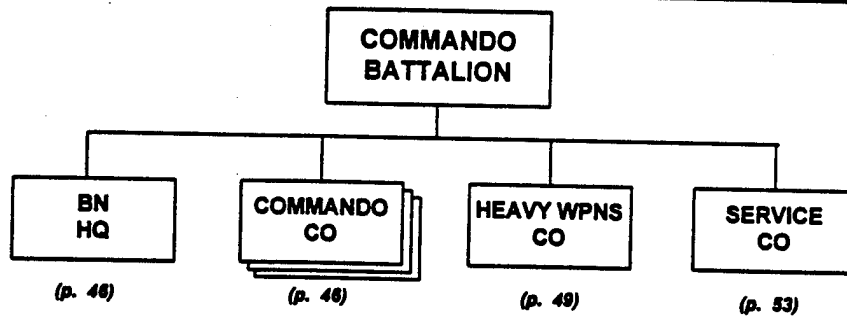

PRINCIPAL ITEMS OF EQUIPMENT

Equipment	Total	Equipment	Total
9-mm Pistol, PM.....	131	Truck, Light	32
5.45-mm Assault Rifle, AK-74.....	385	Trailer, POL (900-Liter)	5
7.62-mm GP MG, PKM.....	54	Trailer, Cargo, 1-Axle.....	5
7.62-mm Sniper Rifle, SVD.....	27	Trailer, Water (900-Liter)	2
12.7-mm Heavy MG, NSV	4	Van, Maintenance	1
40-mm Under-Barrel Grenade Launcher, BG-15.....	83	Night Vision Goggles, PNV-57	84
30-mm Automatic Grenade Launcher, AGS-17	6	Night Vision Sight, NSP-3 (Small Arms)..	89
60-mm Mortar, Light	9	Night Vision Sight, PPN-3 (MG)	58
73-mm Recoilless Antitank Gun, SPG-9	2	Radios:	
ATRL, RPG-18/22.....	132	VHF, Portable, Low-Power	75
ATGL, RPG-7V.....	54	VHF, Manpack, Low-Power	2
ATGM Manpack, AT-7/SAXHORN	3	VHF, Vehicle Mount, Medium-Power ..	1
SAM, SA-16/18	10	HF, Vehicle Mount, Medium-Power	1
Truck, Utility.....	1	Burst Transmission Radio.....	5
		Warning Receiver	1

NOTES:

1. Currently, Commando battalions are only found in the Special Operations Command and in the heavier, more well-equipped districts. These battalions are specially trained in suppressing counterrevolutionary activity, and their role in conventional operations is to provide special reconnaissance and direct action teams to act behind enemy lines. Evidence suggests that regions may be forming and training commando battalions.
2. Night observation goggle totals do not include those used by vehicle drivers.

**Battalion Headquarters, Commando Bn, MD
or National (Special Operations Command)**

**BATTALION
HEADQUARTERS**

PRINCIPAL ITEMS OF EQUIPMENT

<u>Equipment</u>	<u>Total</u>	<u>Equipment</u>	<u>Total</u>
9-mm Pistol, PM.....	4	Night Vision Sight, NSP-3 (Small Arms)....	3
5.45-mm Assault Rifle, AK-74.....	8	Radios:	
40-mm Under-Barrel Grenade Launcher, BG-15.....	2	VHF, Portable, Low-Power	1
ATRL, RPG-18/22.....	4	VHF, Manpack, Low-Power.....	2
SAM, SA-16/18	2	VHF, Vehicle Mount, Medium-Power	1
Truck, Utility.....	1	HF, Vehicle Mount, Medium-Power	1
Truck, Light	3	Burst Transmission Radio.....	1
Night Vision Goggles, PNV-57	2	Warning Receiver	1

**Commando Company, Commando Bn, MD or
National (Special Operations Command)**

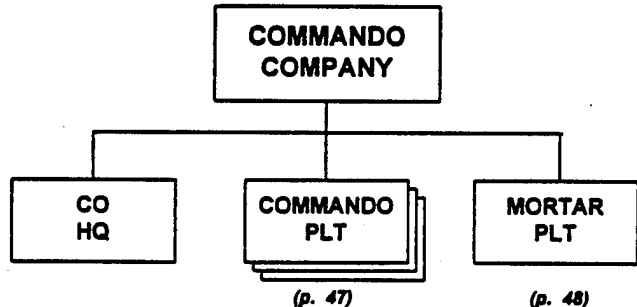

PRINCIPAL ITEMS OF EQUIPMENT

<u>Equipment</u>	<u>Total</u>	<u>Equipment</u>	<u>Total</u>
9-mm Pistol, PM.....	37	60-mm Mortar, Light	3
5.45-mm Assault Rifle, AK-74.....	93	Night Vision Goggles, PNV-57	18
7.62-mm GP MG, PKM.....	18	Night Vision Sight, NSP-3 (Small Arms)..	24
7.62-mm Sniper Rifle, SVD.....	9	Night Vision Sight, PPN-3 (MG)	18
40-mm Under-Barrel Grenade Launcher, BG-15.....	20	Radios:	
ATRL, RPG-18/22.....	40	VHF, Portable, Low-Power	18
ATGL, RPG-7V	18	Burst Transmission Radio.....	1

**Commando Platoon, Commando Co, Commando Bn, MD
or National (Special Operations Command)**

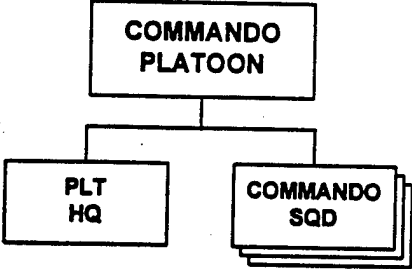

PRINCIPAL ITEMS OF EQUIPMENT

Equipment	Total	Equipment	Total
9-mm Pistol, PM.....	12	ATRL, RPG-18/22.....	12
5.45-mm Assault Rifle, AK-74.....	26	ATGL, RPG-7V.....	6
7.62-mm GP MG, PKM.....	6	Night Vision Goggles, PNV-57.....	4
7.62-mm Sniper Rifle, SVD.....	3	Night Vision Sight, NSP-3 (Small Arms)....	6
40-mm Under-Barrel Grenade Launcher, BG-15.....	6	Night Vision Sight, PPN-3 (MG).....	6
		Radio, VHF, Portable, Low-Power.....	4

**Commando Squad, Commando Plt, Commando Co, Commando Bn,
MD or National (Special Operations Command)**



- | | |
|-----------------------|--------------|
| Squad Leader | AK-74 |
| Senior Rifleman (x 2) | BG-15, AK-74 |
| Genadler (x 2) | RPG, PM |
| Machine Gunner (x 2) | PKM, PM |
| Rifleman (x 5) | AK-74 |
| Rifleman | SVD |

PRINCIPAL ITEMS OF EQUIPMENT

Equipment	Total	Equipment	Total
9-mm Pistol, PM.....	4	ATRL, RPG-18/22.....	4
5.45-mm Assault Rifle, AK-74.....	8	ATGL, RPG-7V.....	2
7.62-mm GP MG, PKM.....	2	Night Vision Goggles, PNV-57.....	1
7.62-mm Sniper Rifle, SVD.....	1	Night Vision Sight, NSP-3 (Small Arms)....	2
40-mm Under-Barrel Grenade Launcher, BG-15.....	2	Night Vision Sight, PPN-3 (MG).....	2
		Radio, VHF, Portable, Low-Power.....	1

**Mortar Platoon, Commando Co, Commando Bn, MD
or National (Special Operations Command)**

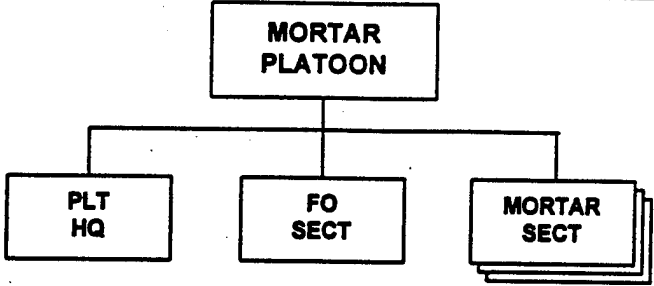

PRINCIPAL ITEMS OF EQUIPMENT

<u>Equipment</u>	<u>Total</u>
60-mm Mortar, Light	3
5.45-mm Assault Rifle, AK-74	15
40-mm Under-Barrel Grenade Launcher, BG-15.....	2

<u>Equipment</u>	<u>Total</u>
ATRL, RPG-18/22.....	4
Night Vision Goggles, PNV-57	4
Night Vision Sight, NSP-3 (Small Arms)....	4
Radio, VHF, Portable, Low-Power.....	5

**Heavy Weapons Company, Commando Bn, MD
or National (Special Operations Command)**

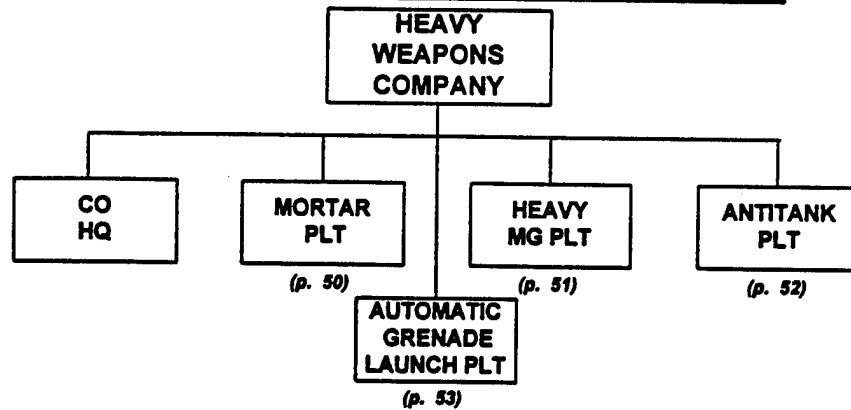

PRINCIPAL ITEMS OF EQUIPMENT

Equipment	Total
82-mm Mortar, M1937/2B9.....	4
ATGM Manpack, AT-7/SAXHORN.....	3
73-mm Recoilless Antitank Gun, SPG-9.....	2
30-mm Automatic Grenade Launcher, AGS-17.....	6
9-mm Pistol, PM.....	16
5.45-mm Assault Rifle, AK-74.....	71
12.7-mm Heavy Machine Gun, NSV.....	4

Equipment	Total
40-mm Under-Barrel Grenade Launcher, BG-15.....	18
SAM, SA-16/18.....	8
ATGL, RPG-7V.....	3
ATRL, RPG-18/22.....	8
Truck, Light.....	15
Night Vision Goggles, PNV-57.....	24
Night Vision Sight, NSP-3 (Small Arms)..	10
Night Vision Sight, PPN-3 (MG).....	4
Radio, VHF, Portable, Low-Power.....	15

**Mortar Platoon, Heavy Wpns Co, Commando Bn, MD
and National (Special Operations Command)**

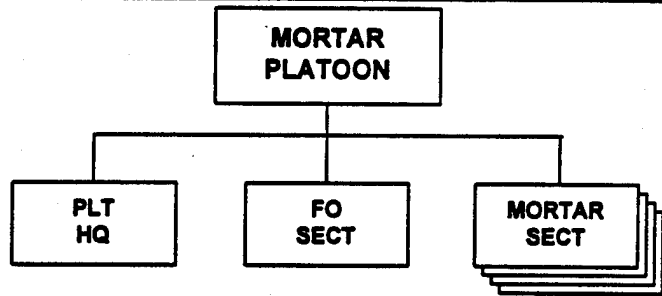

PRINCIPAL ITEMS OF EQUIPMENT

Equipment	Total	Equipment	Total
82-mm Mortar, M1937/2B9.....	4	ATRL, RPG-18/22.....	2
5.45-mm Assault Rifle, AK-74.....	28	Night Vision Goggles, PNV-57.....	6
40-mm Under-Barrel Grenade Launcher, BG-15.....	6	Night Vision Sight, NSP-3 (Small Arms)....	4
SAM, SA-16/18.....	2	Truck, Light.....	5
		Radio, VHF, Portable, Low-Power.....	5

**Heavy Machinegun Platoon, Heavy Wpns Co, Commando Bn,
MD or National (Special Operations Command)**

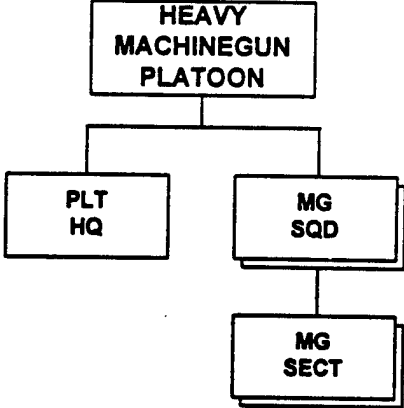

PRINCIPAL ITEMS OF EQUIPMENT

Equipment	Total
12.7-mm Heavy MG, NSV	4
SAM, SA-16/18	2
ATRL, RPG-18/22	2
ATGL, RPG-7V	3
9-mm Pistol, PM	4
5.45-mm Assault Rifle, AK-74	15

Equipment	Total
40-mm Under-Barrel Grenade Launcher, BG-15	5
Truck, Light	3
Night Vision Goggles, PNV-57	6
Night Vision Sight, NSP-3 (Small Arms)....	4
Night Vision Sight, PPN-3 (MG)	4
Radio, VHF, Portable, Low-Power	3

**Antitank Platoon, Heavy Wpns Co, Commando Bn, MD
or National (Special Operations Command)**

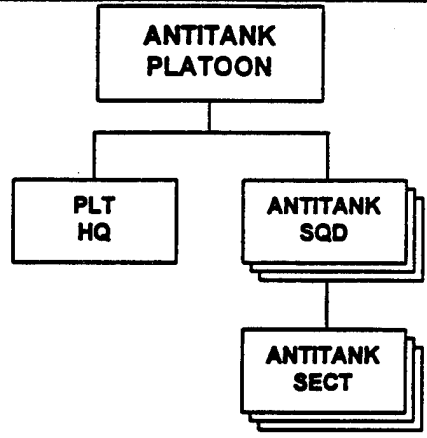

PRINCIPAL ITEMS OF EQUIPMENT

Equipment	Total
ATGM Manpack, AT-7/SAXHORN.....	3
73-mm Recoilless Antitank Gun, SPG-9.....	2
9-mm Pistol, PM.....	5
5.45-mm Assault Rifle, AK-74.....	12
40-mm Under-Barrel Grenade Launcher, BG-15.....	7

Equipment	Total
SAM, SA-16/18	2
ATRL, RPG-18/22.....	2
Truck, Light	4
Night Vision Goggles, PNV-57	6
Radio, VHF, Portable, Low-Power.....	5

Automatic Grenade Launcher Platoon, Heavy Wpns Co, Commando Bn, MD or National (Special Operations Command)

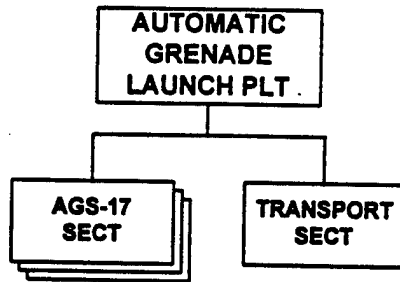

PRINCIPAL ITEMS OF EQUIPMENT

<u>Equipment</u>	<u>Total</u>	<u>Equipment</u>	<u>Total</u>
30-mm Automatic Grenade Launcher, AGS-17	6	ATRL, RPG-18/22	2
9-mm Pistol, PM	6	Truck, Light	3
5.45-mm Assault Rifle, AK-74	14	Night Vision Goggles, PNV-57	3
SAM, SA-16/18	2	Radio, VHF, Portable, Low-Power	4

Service Company, Commando Bn, MD or National (Special Operations Command)

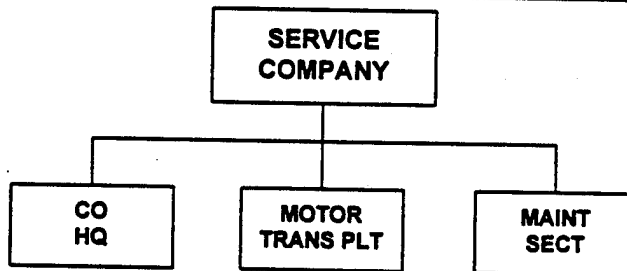

PRINCIPAL ITEMS OF EQUIPMENT

<u>Equipment</u>	<u>Total</u>	<u>Equipment</u>	<u>Total</u>
9-mm Pistol, PM	1	Trailer, POL (900-Liter)	5
5.45-mm Assault Rifle, AK-74	17	Trailer, Cargo, 1-Axle	5
40-mm Under-Barrel Grenade Launcher, BG-15	3	Trailer, Water (900-Liter)	2
ATRL, RPG-18/22	3	Van, Maintenance	1
Truck, Light	14	Radio, VHF, Portable, Low-Power	2

**Reconnaissance and Radioelectronic Combat Battalion, Light
Inf Div, Mtzd Inf Div, and Mech Inf Div, or MD or Army or
National (Directorate of Military Intelligence)**

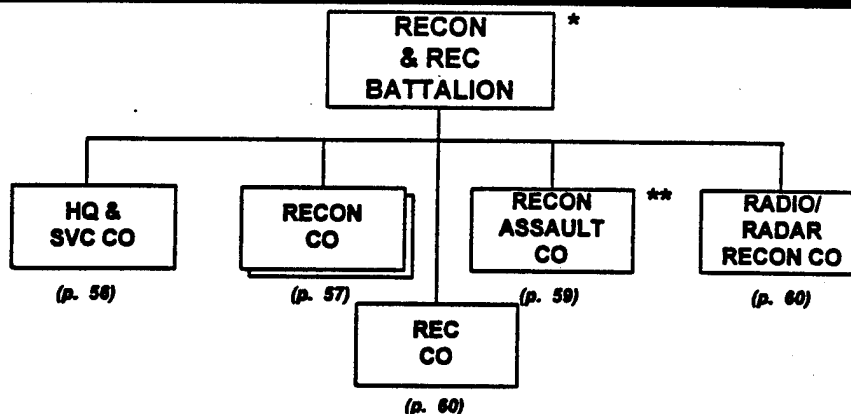

PRINCIPAL ITEMS OF EQUIPMENT

<u>Equipment</u>	<u>Total</u>	<u>Equipment</u>	<u>Total</u>
ACV, BRDM-2U	1	Radar Intercept/Direction Finder	3
ACV, BTR (R-145BM)	2	Radio Intercept/Direction Finder, VHF/HF	10
ACV, BRM-1K***	7	Communications Jammer, VHF	6
ASC, BRDM-2 or APC, BTR-60/70/80	22	Communications Jammer, HF	3
ATGL, RPG-7V	29	Proximity Fuze Jammer, SPR-1	9
5.45-mm LMG, RPK-74	29	Radios:	
Truck, Utility	5	VHF, Manpack, Low-Power	12
Truck, Light	2	VHF, Vehicle Mount, Medium-Power	52
Truck, Medium	9	HF/VHF, Vehicle Mount, Medium-Power	6
Van, Command	6	HF/VHF, Vehicle Mount, High-Power	2
Van, Radio/Radar Recon	13	HF, Manpack, Low-Power	6
Van, Maintenance	2	HF, Vehicle Mount, Medium-Power	2
Truck, Van	6	Radio Relay, VHF/UHF	1
Truck, POL (5,200-Liter)	2	Radio Telegraph	6
Ambulance	1	Warning Receiver	6
Trailer, Generator	2		
Trailer, Water (900-Liter)	1		
Trailer, Kitchen	4		
Trailer, POL (1,200-Liter)	2		

NOTES:

1. Lighter forces, such as the light infantry division and motorized infantry division, have a reconnaissance and radioelectronic combat battalion as shown above. The mechanized Infantry division and army have a variant which differs only in the composition of the reconnaissance company, which is shown on page 58.

2. Military districts could have either this reconnaissance and radioelectronic combat battalion, or the above variant with BMPs in the reconnaissance company.

FOOTNOTES:

*Although all battalions were once called reconnaissance and radioelectronic combat, the recent tendency has been for them to be called reconnaissance and electronic warfare. Both names exist, even though equipment and function remain the same. In new units and units which have changed terminology, the REC company is called the electronic warfare company.

**The Recon assault company is also called the long-range reconnaissance company or the airborne reconnaissance company.

***This system includes the TALL MIKE battlefield surveillance radar.

**Headquarters and Services Company, Recon & REC Bn, Light
Inf Div, Mtd Inf Div, and Mech Inf Div, or MD or Army or
National (Directorate of Military Intelligence)**

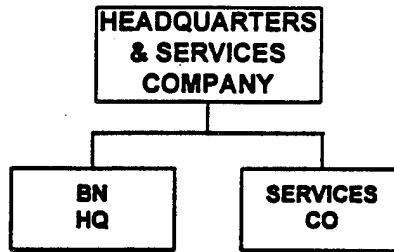

PRINCIPAL ITEMS OF EQUIPMENT

<u>Equipment</u>	<u>Total</u>	<u>Equipment</u>	<u>Total</u>
ACV, BRM-1K*	1	Radio Intercept/Direction Finder,	
ACV, BTR (R-145BM)	2	VHF/HF	1
Truck, Utility.....	4	Radios:	
Truck, Light	5	VHF, Manpack, Low-Power.....	2
Truck, Medium	4	VHF, Vehicle Mount, Medium-Power ..	3
Van, Command	2	HF/VHF, Vehicle Mount,	
Van, Maintenance	1	Medium-Power	2
Truck, POL (4,000-Liter).....	2	HF/VHF, Vehicle Mount, High-Power..	1
Ambulance	1	HF, Manpack, Low-Power.....	2
Trailer, POL (1,200-Liter)	2	HF, Vehicle Mount, Medium-Power	1
Trailer, Generator.....	2	Radio Relay, VHF/UHF.....	1
Trailer, Water (900-Liter)	1	Radio Telegraph.....	6
Trailer, Kitchen.....	4	Warning Receiver	2

FOOTNOTE: * This system includes the TALL MIKE battlefield surveillance radar.

**Reconnaissance Company, Recon & REC Bn, Light
Inf Div or Mtzd Inf Div, or MD or National
(Directorate of Military Intelligence)**

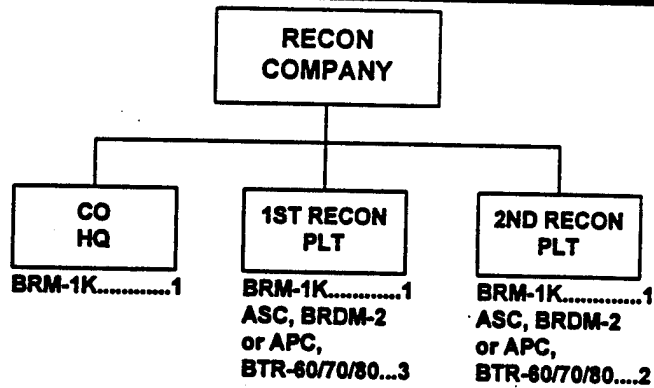

PRINCIPAL ITEMS OF EQUIPMENT

<u>Equipment</u>	<u>Total</u>	<u>Equipment</u>	<u>Total</u>
ACV, BRM-1K*	3	Truck, Light	1
ASC, BRDM-2 or APC, BTR-60/70/80	5	Radios:	
ATGL, RPG-7V	8	VHF, Vehicle Mount, Medium-Power ..	8
5.45-mm LMG, RPK-74	8	Warning Receiver	1

FOOTNOTE: * This system includes the TALL MIKE battlefield surveillance radar.

**Reconnaissance Company, Recon & REC Bn, Mech Inf Div or
MD or Army or National (Directorate of Military Intelligence)**

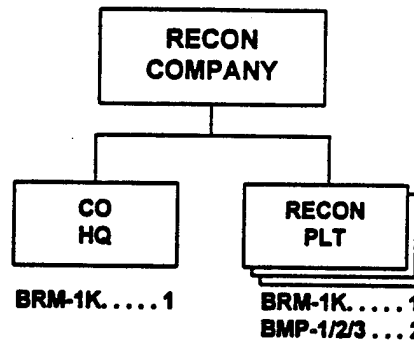

PRINCIPAL ITEMS OF EQUIPMENT

<u>Equipment</u>	<u>Total</u>	<u>Equipment</u>	<u>Total</u>
ATGL, RPG-7V	8	Radios:	
5.45-mm LMG, RPK-74	8	VHF, Vehicle Mount,	
ACV, BRM-1K*	4	Medium-Power	10
AICV, BMP-1/2	6	Warning Receiver	1
Truck, Light	1		

NOTE: The mix of BRM-1K and BMP vehicles can vary.

FOOTNOTE: * This vehicle includes the TALL MIKE battlefield surveillance radar.

**Reconnaissance Assault Company, Recon & REC Bn, Light
Inf Div, Mtzd Inf Div, and Mech Inf Div, or MD or Army or
National (Directorate of Military Intelligence)**

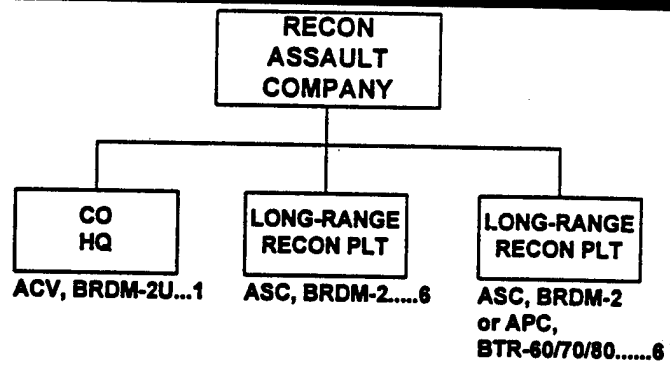

PRINCIPAL ITEMS OF EQUIPMENT

Equipment	Total	Equipment	Total
ACV, BRDM-2U	1	Radios:	
ASV, BRDM-2 or APC, BTR-60/70/80	12	VHF, Manpack, Low-Power	3
ATGL, RPG-7V	13	VHF, Vehicle Mount,	
5.45-mm LMG, RPK-74	13	Medium-Power	13
		HF, Vehicle Mount, Medium-Power	1
		Warning Receiver	1

NOTE: Personnel in the reconnaissance assault company (also called the long-range reconnaissance company) have parachute training. Small teams of five to six men can enter the enemy rear area by parachute, helicopter, vehicle, or on foot. They can also land by transport helicopter with their combat vehicles.

**Radio/Radar Reconnaissance Company, Recon & REC Bn,
Light Inf Div, Mtzd Inf Div, and Mech Inf Div, or MD or
Army or National (Directorate of Military Intelligence)**

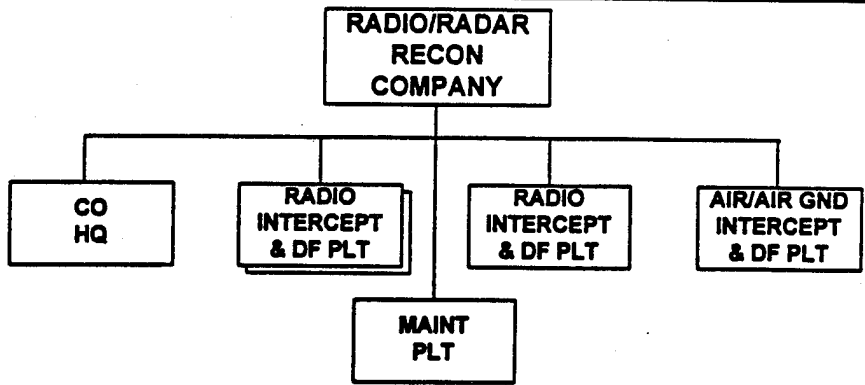

PRINCIPAL ITEMS OF EQUIPMENT

<u>Equipment</u>	<u>Total</u>	<u>Equipment</u>	<u>Total</u>
Truck, Light	1	Radios:	
Van, Command	2	VHF, Manpack, Low-Power	7
Van, Radio/Radar Recon	13	HF/VHF, Vehicle Mount,	
Van, Maintenance	1	Medium-Power	4
Van	6	HF/VHF, Vehicle Mount, High-Power ..	1
Radio Intercept/Direction Finder,		HF, Manpack, Low-Power	4
HF/VHF	7	Warning Receiver	1
Radar Intercept/Direction Finder	3		

**Radioelectronic Combat Company, Recon & REC Bn,
Light Inf Div and Mtzd Inf Div, or MD or Army or
National (Directorate of Military Intelligence)**

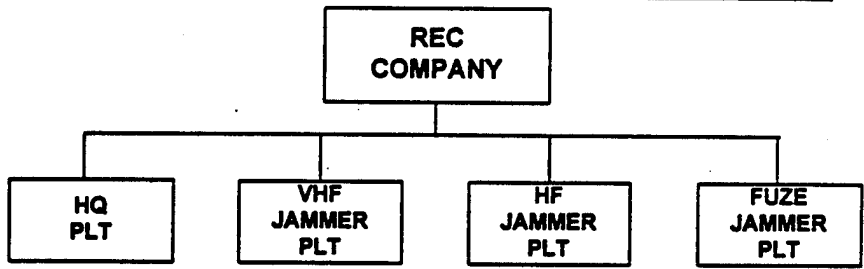

PRINCIPAL ITEMS OF EQUIPMENT

<u>Equipment</u>	<u>Total</u>	<u>Equipment</u>	<u>Total</u>
Van, Command	2	Communications Jammer, HF	3
Radio Intercept/Direction Finder,		Proximity Fuze Jammer, SPR-1	9
VHF/HF	2	Radio, HF, Vehicle Mount,	
Communications Jammer, VHF	6	Medium-Power	20

Engineer Battalion, Mech Inf Div or MD or Army or National (Engineer Brigade)

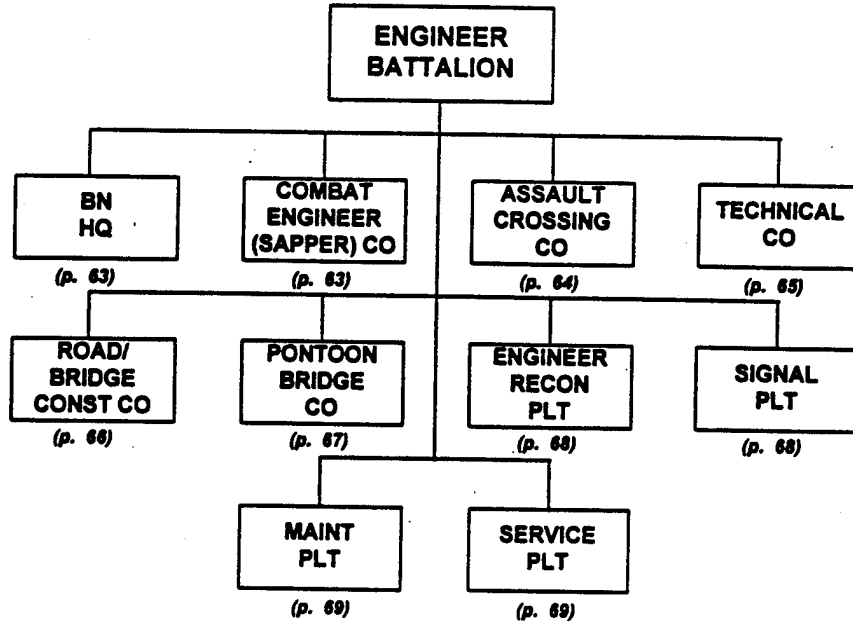

ENGINEER BATTALION, Divisional, MD, Army, National											
Principal Items of Equipment	Battalion HQ	Combat Engr Co	Assault Crossing Co	Technical Co	Road/Bridge Construction Co	Pontoon Bridge Co	Engr Recon Plt	Signal Plt	Maintenance Plt	Service Plt	TOTAL
ARMORED VEHICLES											
APC, BTR-60/70/80							3				3
ACV, BTR (R-145BM)		1									1
ACV, BRDM-2U			1								1
WEAPONS											
ATGL, RPG-7V		2					6				8
ENGINEER EQUIPMENT											
Bridge, Truck-Launched					8						8
Tracked Amphibian, K-61/PTS			12								12
Trailer, Amphibious, PKP			3								3
Tracked Ferry, GSP/PMM-2			6								6
Bridge, PMP Center						16					16
Bridge, PMP Ramp						2					2
Bridge, PMP Service						1					1
Assault Boat			10								10
Power Boat						6					6
Piledriver Set, KMS				1							1
Mine-layer, GMZ		3									3
Mine-clearer, MTK/MTK-2		2									2
Mine Detector, DIM		2					1				3
Engineer Recon Vehicle, IRM							2				2
Armored Engineer Tractor, IMR		2									2
Ditching Machine, BTM/MDK				4							4
Dozer				6	2						8
Tractor				2							2
Truck, Sawmill					1						1
Trailer, Saw					1						1
Grader					2						2
Concrete Mixer					1						1
Truck, Water Purification				1							1
TRUCKS											
Truck, Utility	2			1	1	1	2	1		1	9
Truck, Medium	1	5	2	13	2		1	1	1	1	27
Truck, Dump				1	2						3
Truck, Crane			1								1
Truck, Crane Shovel				2	1						3
Van										1	1
Van, Maintenance									4		4
Van, Signal	1							1			2
TRAILERS											
Trailer, Cargo, 1-Axle	1	2			1						4
Trailer, Cargo, 2-Axle			1	1					1		3
Trailer, Compressor			1								1
Trailer, Generator				1	1			1	1	1	5
RADIOS											
VHF, Vehicle Mount, Medium-Power	1	8	3	3	3	4	3				25
HF, Manpack, Low-Power	1	1	1	1	1	1	3				9
HF/VHF, Vehicle, Medium-Power	1							1			2
HF/VHF, Vehicle, High-Power	1							1			2
Warning Receiver								1			1

**Battalion Headquarters, Engineer Bn, Mech Inf Div or MD or Army
or National (Engineer Brigade)**

**BATTALION
HEADQUARTERS**

PRINCIPAL ITEMS OF EQUIPMENT

<u>Equipment</u>	<u>Total</u>	<u>Equipment</u>	<u>Total</u>
Truck, Utility.....	2	Radios:	
Truck, Medium	1	HF/VHF, Vehicle Mount, Medium-	
Van, Signal.....	1	Power	1
Trailer, Cargo, 1-Axle.....	1	HF/VHF, Vehicle Mount, High-Power..	1
		HF, Manpack, Low-Power.....	1

**Combat Engineer (Sapper) Company, Engineer Bn, Mech Inf
Div or MD or Army or National (Engineer Brigade)**

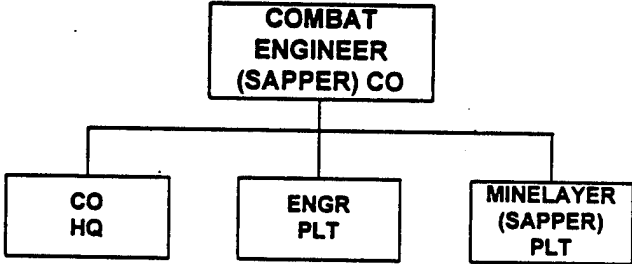

PRINCIPAL ITEMS OF EQUIPMENT

<u>Equipment</u>	<u>Total</u>	<u>Equipment</u>	<u>Total</u>
ACV, BTR (R-145BM)	1	Trailer, Cargo, 1-Axle.....	2
ATGL, RPG-7V	2	Radios:	
Armored Engineer Tractor, IMR	2	VHF, Vehicle Mount, Medium-Power ..	8
Mineclearer, MTK/MTK-2	2	HF, Manpack, Low-Power.....	1
Mine Detector, DIM.....	2		
Minelayer, GMZ	3		
Truck, Medium	5		

**Assault Crossing Company, Engineer Bn, Mech Inf Div or MD
or Army or National (Engineer Brigade)**

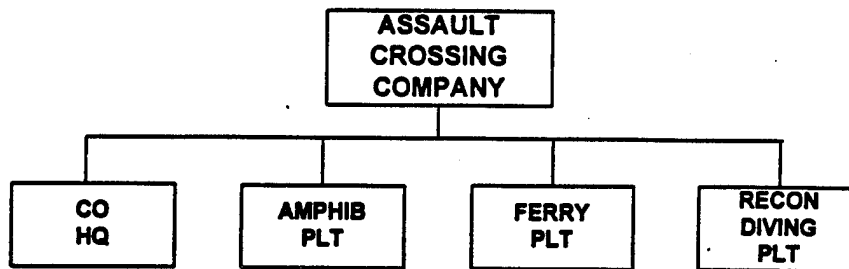

PRINCIPAL ITEMS OF EQUIPMENT

<u>Equipment</u>	<u>Total</u>	<u>Equipment</u>	<u>Total</u>
ACV, BRDM-2U	1	Trailer, Cargo, 2-Axle	1
Truck, Medium	2	Trailer, Compressor	1
Truck, Crane	1	Radios:	
Tracked Amphibian, K-61/PTS	12	VHF, Vehicle Mount, Medium-Power ..	3
Tracked Ferry, GSP/PMM-2	6	HF, Manpack, Low-Power	1
Assault Boat	10		
Trailer, Amphibious, PKP	3		

NOTE: Two GSP heavy amphibious ferry vehicles make up one ferry.

Technical Company, Engineer Bn, Mech Inf Div or MD or Army or National (Engineer Brigade)

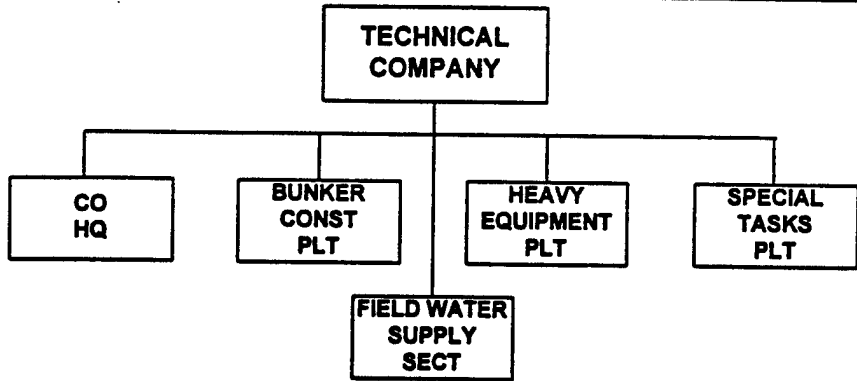

PRINCIPAL ITEMS OF EQUIPMENT

Equipment	Total
Truck, Utility.....	1
Truck, Medium	13
Truck, Crane Shovel	2
Truck, Dump	1
Truck, Water Purification	1
Ditching Machine, BTM/MDK	4
Dozer.....	6
Piledriver Set, KMS.....	1

Equipment	Total
Tractor	2
Trailer, Cargo, 2-Axle.....	1
Trailer, Generator.....	1
Radios:	
VHF, Vehicle Mount, Medium-Power ..	3
HF, Manpack, Low-Power.....	1

**Road / Bridge Construction Company, Engineer Bn, Mech Inf Div or MD
or Army or National (Engineer Brigade)**

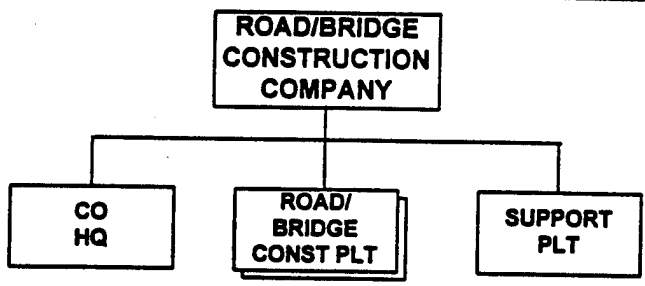

PRINCIPAL ITEMS OF EQUIPMENT

Equipment	Total
Truck, Utility.....	1
Truck, Medium	2
Truck, Crane Shovel	1
Truck, Dump	2
Truck, Sawmill.....	1
Bridge, Truck-Launched	8
Dozer.....	2
Grader	2
Concrete Mixer	1

Equipment	Total
Trailer, Cargo, 1-Axle.....	1
Trailer, Generator.....	1
Trailer, Saw.....	1
Radios:	
VHF, Vehicle Mount, Medium-Power ..	3
HF, Manpack, Low-Power.....	1

**Pontoon Bridge Company, Engineer Bn, Mech Inf Div or MD or Army
or National (Engineer Brigade)**

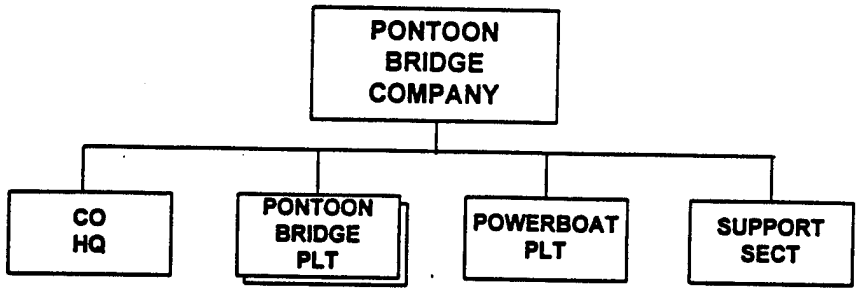

PRINCIPAL ITEMS OF EQUIPMENT

Equipment	Total	Equipment	Total
Truck, Utility.....	1	Radios:	
Bridge, PMP Center.....	16	VHF, Vehicle Mount, Medium-Power ..	4
Bridge, PMP Ramp.....	2	HF, Manpack, Low-Power.....	1
Bridge, PMP Service.....	1		
Powerboat	6		

NOTE: A full bridge set consists of 32 center and 4 ramp sections. The half-set held by the engineer battalion can make up a bridge (119 meters of 60-ton bridge, 191 meters of 20-ton bridge) or several rafts.

**Engineer Recon Platoon, Engineer Bn, Mech
Inf Div or MD or Army or National (Engineer Brigade)**

**ENGINEER
RECON
PLATOON**

PRINCIPAL ITEMS OF EQUIPMENT

Equipment	Total	Equipment	Total
ATGL, RPG-7V.....	6	Engineer Recon Vehicle, IRM.....	2
APC, BTR-60/70/80	3	Radios:	
Truck, Utility.....	2	VHF, Vehicle Mount, Medium-Power ..	3
Truck, Medium	1	HF, Manpack, Low-Power.....	3
Mine Detector, DIM.....	1		

**Signal Platoon, Engineer Bn, Mech Inf Div or
MD or Army or National (Engineer Brigade)**

**SIGNAL
PLATOON**

PRINCIPAL ITEMS OF EQUIPMENT

Equipment	Total	Equipment	Total
Van, Signal.....	1	Radios:	
Trailer, Generator.....	1	HF/VHF, Vehicle Mount,	
Truck, Utility.....	1	Medium-Power	1
Truck, Medium	1	HF/VHF, Vehicle Mount, High-Power..	1
		Warning Receiver	1

**Maintenance Platoon, Engineer Bn, Mech Inf Div
or MD or Army or National (Engineer Brigade)**

**MAINTENANCE
PLATOON**

PRINCIPAL ITEMS OF EQUIPMENT

Equipment	Total	Equipment	Total
Truck, Medium	1	Trailer, Generator.....	1
Van, Maintenance	4		
Trailer, Cargo, 2-Axle.....	1		

**Service Platoon, Engineer Bn, Mech Inf Div or
MD or Army or National (Engineer Brigade)**

**SERVICE
PLATOON**

PRINCIPAL ITEMS OF EQUIPMENT

Equipment	Total	Equipment	Total
Trailer, Generator.....	1	Truck, Medium	1
Truck, Utility.....	1	Van.....	1

Engineer Company, Light Inf Bde (Sep and Div), Mtzd Inf Bde (Sep and Div), Mech Inf Bde (Sep and Div), and Tank Bde, or Light Inf Div and Mtzd Inf Div

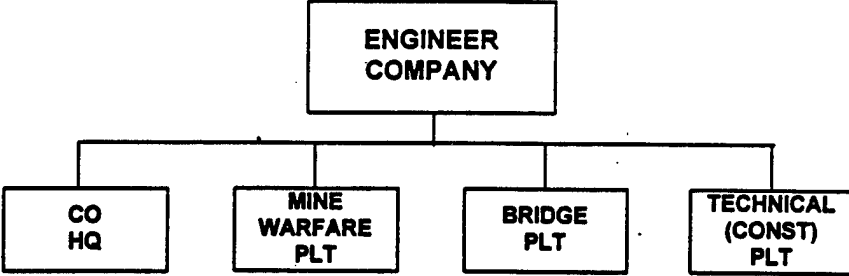

PRINCIPAL ITEMS OF EQUIPMENT

Equipment	Total	Equipment	Total
APC, BTR-60/70/80	3	Bridge, Truck-Launched	*5
ATGL, RPG-7V	4	Ditching Machine, PZM/TMK	4
Truck, Utility.....	1	Dozer.....	1
Truck, Medium	8	Minelayer, PMR.....	3
Truck, Dump	2	Mineclearing Plow**	9
Truck, Crane	1	Mine Roller-Plow**	3
Truck, Crane Shovel	2	Radios:	
Truck, Water Purification	1	VHF, Vehicle Mount, Medium-Power ..	4
Van, Maintenance	1	HF or VHF, Manpack, Low-Power	4
Trailer, Cargo, 2-Axle.....	2		

NOTES:

1. The light infantry division or motorized infantry division has only one engineer company; however, both would probably receive additional support from national-level engineer organizations during wartime.
2. Engineer companies in the light infantry brigades and motorized infantry brigades will not have the following equipment: Ditching Machine, Dozer, Mineclearing Plow, and Mine Roller Plow.

FOOTNOTES:

- * Tank brigades have tank-launched bridges instead of the truck-launched version.
- ** Plows are present in the engineer company organic to light infantry divisions and motorized infantry divisions only if the division has a tank battalion.

Signal Battalion, Mech Inf Div or Army or National (Signal Brigade)

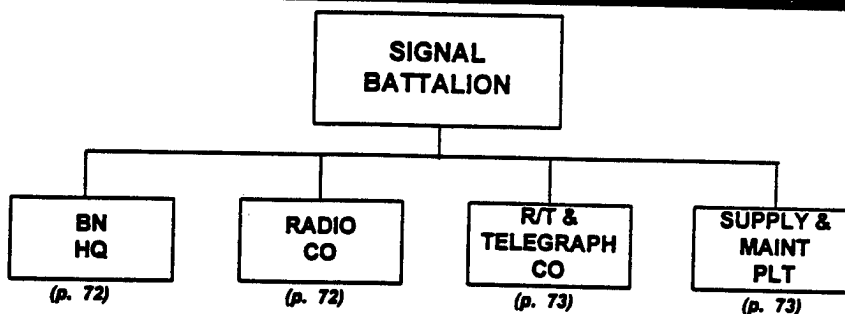

PRINCIPAL ITEMS OF EQUIPMENT

Equipment	Total
ACV, BTR (R-145BM)	8
Truck, Utility.....	12
Truck, Light	7
Truck, Medium	9
Van, Maintenance	4
Van, Signal.....	33
Truck, POL (4,000 or 5,200-Liter)	1
Ambulance	1
Bus	1
Motorcycle	13
Trailer, Cargo, 2-Axle.....	10
Trailer, Generator.....	10
Trailer, Kitchen.....	2

Equipment	Total
Trailer, POL (1,200-Liter)	1
Trailer, Water (900-Liter)	1
Radios:	
VHF, Manpack, Low-Power.....	20
VHF, Vehicle Mount, Medium-Power ..	6
HF/VHF, Vehicle Mount, Medium-Power	7
HF/VHF, Vehicle Mount, High-Power..	8
HF, Manpack, Low-Power.....	5
HF, Vehicle Mount, Medium-Power	8
Radio Relay, VHF/UHF.....	6
Communication Center	2
Warning Receiver	3

Battalion Headquarters, Signal Bn, Mech Inf Div or Army or National (Signal Brigade)

BATTALION HEADQUARTERS

PRINCIPAL ITEMS OF EQUIPMENT

Equipment	Total	Equipment	Total
Truck, Utility.....	4	Radio, HF, Manpack, Low-Power	1

Radio Company, Signal Bn, Mech Inf Div or Army or National (Signal Brigade)

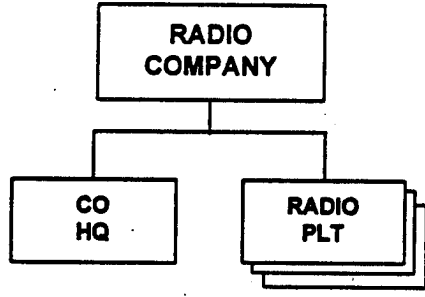

PRINCIPAL ITEMS OF EQUIPMENT

Equipment	Total	Equipment	Total
ACV, BTR (R-145BM)	8	Radios:	
Truck, Utility.....	4	VHF, Manpack, Low-Power.....	7
Truck, Medium	1	VHF, Vehicle Mount, Medium-Power ..	6
Van, Signal.....	12	HF/VHF, Vehicle Mount,	
Trailer, Cargo, 2-Axle.....	1	Medium-Power	6
Trailer, Generator.....	3	HF/VHF, Vehicle Mount, High-Power..	8
		HF, Manpack, Low-Power.....	1
		HF, Vehicle Mount, Medium-Power	8
		Warning Receiver	1

**Radio Telephone and Telegraph Company, Signal Bn, Mech Inf Div
or Army or National (Signal Brigade)**

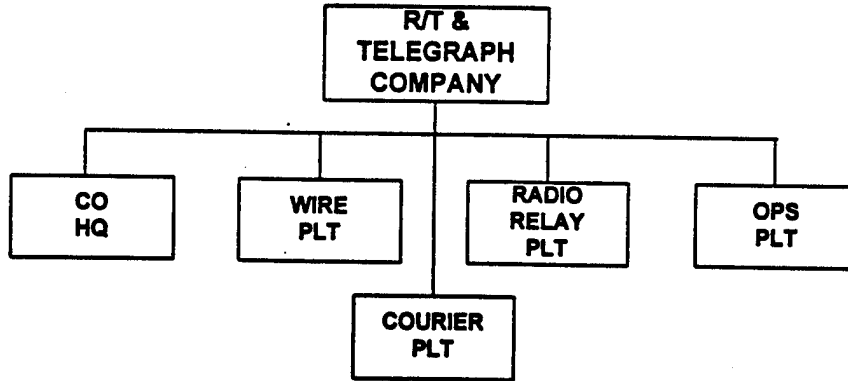

PRINCIPAL ITEMS OF EQUIPMENT

Equipment	Total	Equipment	Total
Truck, Utility.....	3	Radios:	
Truck, Medium	2	VHF, Manpack, Low-Power.....	13
Van, Light	4	HF/VHF, Vehicle Mount, Medium-	
Van, Signal.....	21	Power	1
Motorcycle	13	HF, Manpack, Low-Power.....	2
Trailer, Cargo, 2-Axle.....	4	Radio Relay, VHF/UHF.....	6
Trailer, Generator.....	5	Communications Center.....	2
		Warning Receiver	2

**Supply and Maintenance Platoon, Signal Bn, Mech Inf Div or
Army or National (Signal Brigade)**



PRINCIPAL ITEMS OF EQUIPMENT

Equipment	Total	Equipment	Total
Truck, Utility.....	1	Trailer, Cargo, 2-Axle.....	5
Truck, Medium	6	Trailer, Generator.....	2
Truck, POL (4,000 or 5,200-Liter)	1	Trailer, POL (1,200-Liter)	1
Van, Light	3	Trailer, Water (900-Liter)	1
Van, Maintenance	4	Trailer, Kitchen	2
Ambulance	1	Radio, HF, Manpack, Low-Power	2
Bus	1		

Signal Company, Light Inf Div and Mtzd Inf Div

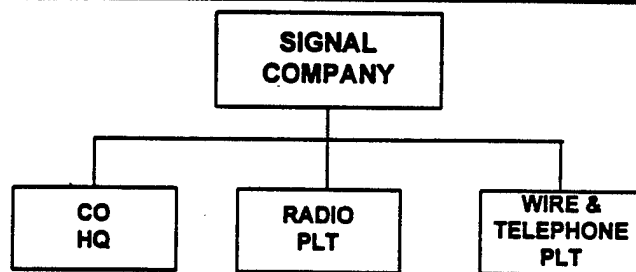

PRINCIPAL ITEMS OF EQUIPMENT

Equipment	Total	Equipment	Total
ACV, BTR (R-145BM)	3	Radios:	
Truck, Utility.....	5	VHF, Manpack, Low-Power	7
Truck, Light	3	VHF, Vehicle Mount, Medium-Power ..	2
Van, Signal.....	7	HF/VHF, Vehicle Mount,	
Motorcycle	3	Medium-Power	2
Trailer, Generator.....	4	HF/VHF, Vehicle Mount,	
		High-Power	2
		HF, Manpack, Low-Power.....	2
		HF, Vehicle Mount, Medium-Power	2
		HF, Van Mount, High-Power.....	1
		Radio Relay, VHF/UHF.....	2
		Warning Receiver	3

NOTES:

1. During wartime, the light infantry division and the motorized infantry division will probably receive signal support from the national-level.
2. The radios listed support the division headquarters, but some may be attached to subordinate headquarters.
3. Motorcycles provide the division commander with messenger/courier service.

**Chemical Protection Company, Light Inf Div, Mtzd Inf Div, and
Mech Inf Div, or Army**

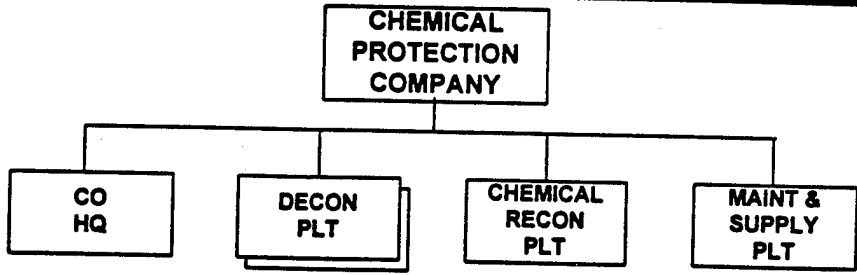

PRINCIPAL ITEMS OF EQUIPMENT

Equipment	Total	Equipment	Total
Chemical Recon Vehicle, BRDM-2RKh/RKhM.....	4	Truck, Water (2,000-Liter).....	2
Truck, Decon, ARS-12U/14	12	Trailer, Water (1,200-Liter)	2
Truck, Decon, TMS-65	2	Trailer, Water (900-Liter)	2
Truck, Utility.....	2	Radios:	
Truck, Light	3	VHF, Vehicle Mount,	
Truck, Medium	6	Medium-Power	4
Truck, POL (4,000 or 5,200-Liter)	2	HF, Manpack, Low-Power.....	2

**Materiel Support Battalion, Light Inf Div, Mtzd Inf Div, and Mech
Inf Div, or MD or Army or National (Rear Services)**

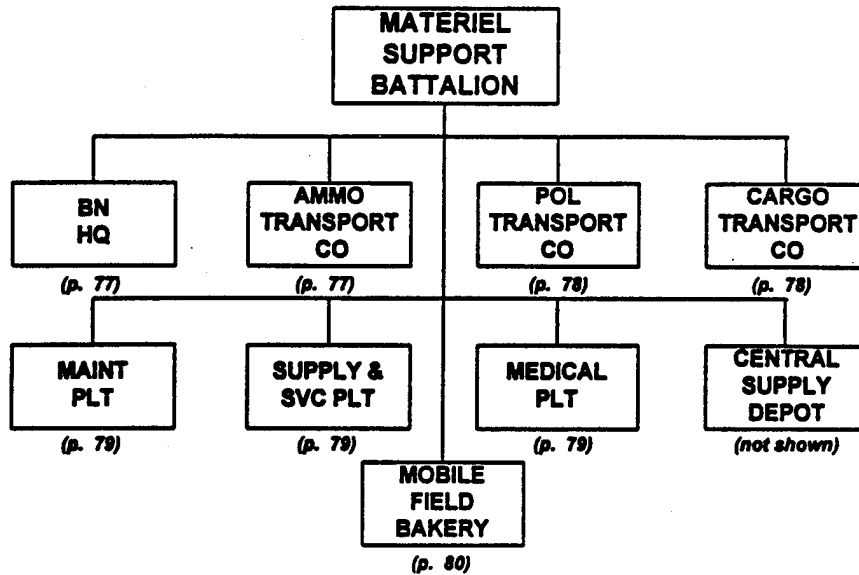

PRINCIPAL ITEMS OF EQUIPMENT

Equipment	Total
SAM, SA-7/14	2
ATGL, RPG-7	19
Truck, Utility	7
Truck, Light	31
Truck, Medium	90
Truck, Crane	6
Truck, Kitchen	2
Truck, POL (4,000 or 5,200-Liter)	100
Truck, Water (900-Liter)	6
Van	3
Van, Light	33
Van, Signal	1
Van, Maintenance	9

Equipment	Total
Van, Mobile Field Bakery	4
Ambulance	1
Trailer, Cargo, 2-Axle	64
Trailer, Cargo, 1-Axle	2
Trailer, POL (1,200-Liter)	90
Trailer, Generator	6
Trailer, Water (900-Liter)	7
Radios:	
VHF, Manpack, Low-Power	5
HF/VHF, Vehicle Mount, Medium-Power	1
HF, Manpack, Low-Power	1
Warning Receiver	2

**Battalion Headquarters, Materiel Support Bn, Light Inf Div, Mtzd Inf Div,
and Mech Inf Div, or MD or Army or National (Rear Services)**

**BATTALION
HEADQUARTERS**

PRINCIPAL ITEMS OF EQUIPMENT

Equipment	Total	Equipment	Total
Truck, Utility.....	2	Radios:	
Van.....	2	HF, Manpack, Low-Power.....	1
Trailer, Cargo, 2-Axle.....	2	HF/VHF, Vehicle Mount, Medium- Power	1
		Warning Receiver	1

**Ammunition Transport Company, Materiel Support Bn, Light Inf Div, Mtzd Inf
Div, and Mech Inf Div, or MD or Army or National (Rear Services)**

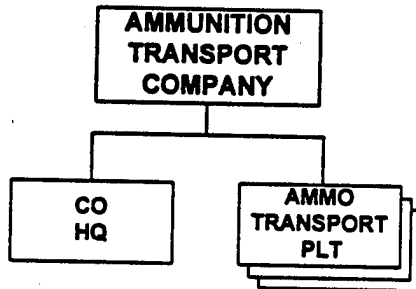

PRINCIPAL ITEMS OF EQUIPMENT

Equipment	Total	Equipment	Total
ATGL, RPG-7V	3	Truck, Crane	1
Truck, Utility.....	1	Trailer, Cargo, 2-Axle.....	60
Truck, Medium	60	Radio, VHF, Manpack, Low-Power	1

POL Transport Company, Materiel Support Bn, Light Inf Div, Mtzd Inf Div, and Mech Inf Div, or MD or Army or National (Rear Services)

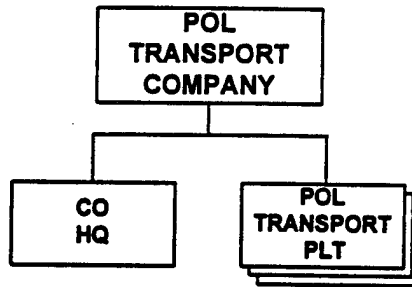

PRINCIPAL ITEMS OF EQUIPMENT

Equipment	Total	Equipment	Total
ATGL, RPG-7V	4	Truck, POL (4,000 or 5,200-Liter)	50
Truck, Utility	1	Trailer, POL (1,200-Liter)	50
Truck, Crane	1	Radio, VHF, Manpack, Low-Power	1

Cargo Transport Company, Materiel Support Bn, Light Inf Div, Mtzd Inf Div, and Mech Inf Div, or MD or Army or National (Rear Services)

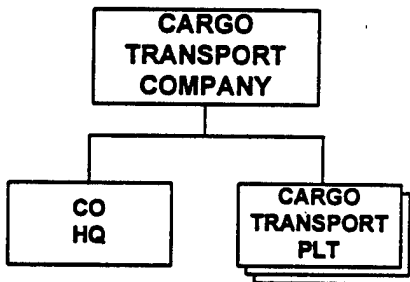

PRINCIPAL ITEMS OF EQUIPMENT

Equipment	Total	Equipment	Total
ATGL, RPG-7V	3	Truck, Medium	30
Truck, Utility	1	Truck, Crane	1
Truck, Light	30	Radio, VHF, Manpack, Low-Power	1

Maintenance Platoon, Materiel Support Bn, Light Inf Div, Mtd Inf Div, and Mech Inf Div or MD or Army or National (Rear Services)

**MAINTENANCE
PLATOON**

PRINCIPAL ITEMS OF EQUIPMENT

<u>Equipment</u>	<u>Total</u>	<u>Equipment</u>	<u>Total</u>
ATGL, RPG-7V	1	Trailer, Generator	6
Van, Maintenance	9	Truck, Crane	1

Supply and Service Platoon, Materiel Support Bn, Light Inf Div, Mtd Inf Div, and Mech Inf Div or MD or Army or National (Rear Services)

**SUPPLY &
SERVICE
PLATOON**

PRINCIPAL ITEMS OF EQUIPMENT

<u>Equipment</u>	<u>Total</u>	<u>Equipment</u>	<u>Total</u>
ATGL, RPG-7V	1	Van, Maintenance	1
Truck, Light	3	Trailer, Cargo, 1-Axle	2
Truck, Kitchen	2	Trailer, Cargo, 2-Axle	2
Truck, Water (2,000-Liter)	6	Trailer, Water (900-Liter)	3
Van, Light	1		

Medical Platoon, Materiel Support Bn, Light Inf Div, Mtd Inf Div, and Mech Inf Div or MD or Army or National (Rear Services)

**MEDICAL
PLATOON**

PRINCIPAL ITEMS OF EQUIPMENT

<u>Equipment</u>	<u>Total</u>
Ambulance	1

**Mobile Field Bakery, Materiel Support Bn, Light Inf Div, Mtd Inf Div,
and Mech Inf Div, or MD or Army or National (Rear Services)**

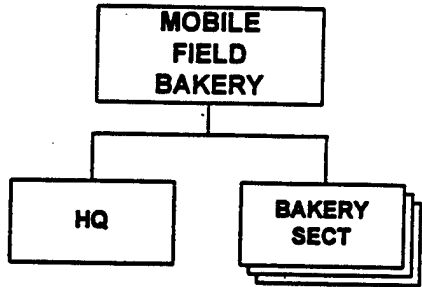

PRINCIPAL ITEMS OF EQUIPMENT

Equipment	Total
Truck, Medium	8
Van, Mobile Field Bakery.....	4

Equipment	Total
Trailer, Water (900-Liter)	4

**Maintenance Battalion, Light Inf Div, Mtzd Inf Div, and Mech Inf Div,
or Army or National (Rear Services)**

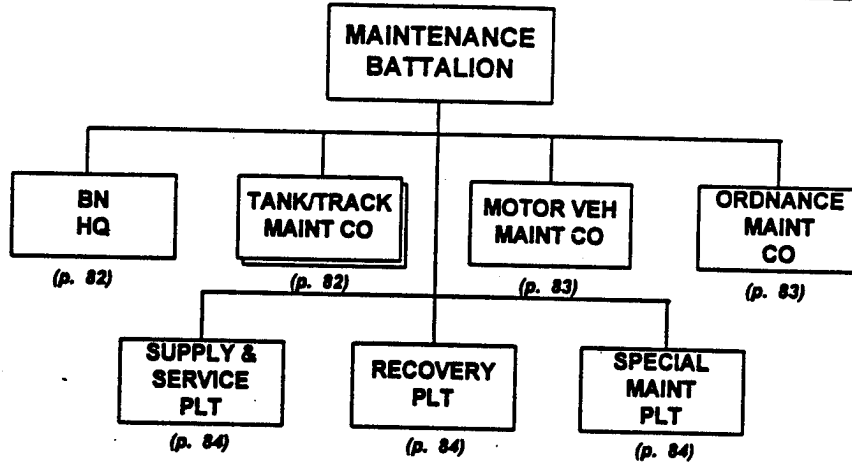

PRINCIPAL ITEMS OF EQUIPMENT

<u>Equipment</u>	<u>Total</u>	<u>Equipment</u>	<u>Total</u>
ATGL, RPG-7V	12	Armored Recovery Vehicle	2
Truck, Utility	5	Trailer, Cargo, 2-Axle	14
Truck, Light	4	Trailer, Generator	7
Truck, Medium	22	Trailer, POL (1,200-Liter)	4
Truck, Heavy	1	Tractor-Trailer, Lowboy	2
Van, Light	3	Trailer, Water (900-Liter)	1
Van, Signal	1	Trailer, Kitchen	3
Van, Maintenance	42	Radios:	
Truck, POL (4,000 or 5,200-Liter)	4	VHF, Manpack, Low-Power	5
Truck, Crane	3	VHF, Vehicle Mount, Medium-Power ..	4
Truck, Recovery	6	HF/VHF, Vehicle Mount, Medium-Power	1
Truck, Water (2,000-Liter)	1	HF, Vehicle Mount, Medium-Power	1
Ambulance	1	Warning Receiver	1
Tracked Amphibian, K-61/PTS	1		
Tractor, Artillery, AT-S	1		
Motorcycle	3		

NOTES:

1. Mechanized infantry divisions and armies will have three tank/track maintenance companies and one motor vehicle maintenance company, as depicted above. Maintenance Battalions at the national level (Rear Services) are a mixture of the two variants.
2. Light infantry divisions and motorized infantry divisions normally have two motor vehicle maintenance companies and one tank/track maintenance company. Light infantry divisions may only have one of each type.

**Battalion Headquarters, Maintenance Bn, Light Inf Div, Mtd Inf Div, and
Mech Inf Div, or Army or National (Rear Services)**

**BATTALION
HEADQUARTERS**

PRINCIPAL ITEMS OF EQUIPMENT

Equipment	Total	Equipment	Total
Truck, Utility.....	2	Radios:	
Van, Light	1	VHF, Manpack, Low-Power.....	1
Motorcycle	3	HF/VHF, Vehicle Mount, Medium- Power	1
		Warning Receiver	1

**Tank/Track Maintenance Company, Maintenance Bn, Light Inf Div, Mtd Inf Div,
and Mech Inf Div, or Army or National (Rear Services)**

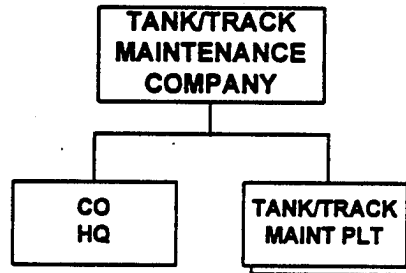

PRINCIPAL ITEMS OF EQUIPMENT

Equipment	Total	Equipment	Total
ATGL, RPG-7V.....	4	Truck, Crane	1
Truck, Utility.....	1	Trailer, Cargo, 2-Axle.....	4
Truck, Medium	6	Trailer, Generator.....	2
Van, Light	1	Radio, VHF, Manpack, Low-Power	1
Van, Maintenance	14		

Motor Vehicle Maintenance Company, Maintenance Bn, Light Inf Div, Mtd Inf Div, and Mech Inf Div, or Army or National (Rear Services)

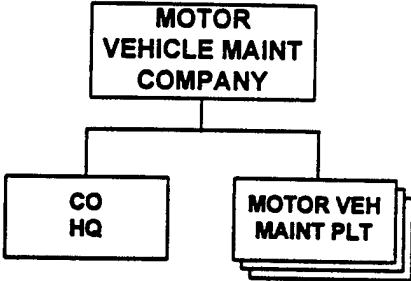

PRINCIPAL ITEMS OF EQUIPMENT

<u>Equipment</u>	<u>Total</u>	<u>Equipment</u>	<u>Total</u>
ATGL, RPG-7V	4	Truck, Crane	1
Truck, Utility.....	1	Trailer, Cargo, 2-Axle.....	4
Truck, Medium	6	Trailer, Generator.....	2
Van, Light	1	Radio, VHF, Manpack, Low-Power	1
Van, Maintenance	14		

Ordnance Maintenance Company, Maintenance Bn, Light Inf Div, Mtd Inf Div, and Mech Inf Div, or Army or National (Rear Services)

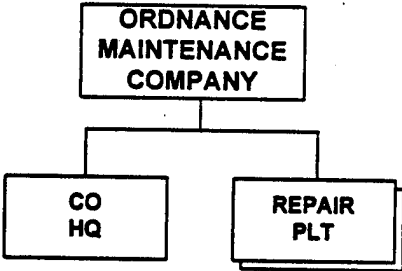

PRINCIPAL ITEMS OF EQUIPMENT

<u>Equipment</u>	<u>Total</u>	<u>Equipment</u>	<u>Total</u>
ATGL, RPG-7V	3	Van, Maintenance	8
Truck, Utility.....	1	Trailer, Cargo, 2-Axle.....	2
Truck, Crane	1	Trailer, Generator.....	2
Van, Light	1	Radio, VHF, Manpack, Low-Power	1

**Supply and Service Platoon, Maintenance Bn, Light Inf Div, Mtzd Inf Div,
and Mech Inf Div, or Army or National (Rear Services)**

**SUPPLY &
SERVICE
PLATOON**

PRINCIPAL ITEMS OF EQUIPMENT

<u>Equipment</u>	<u>Total</u>	<u>Equipment</u>	<u>Total</u>
ATGL, RPG-7V	1	Ambulance	1
Truck, Light	4	Trailer, Cargo, 2-Axle	4
Truck, Medium	10	Trailer, POL (1,200-Liter)	4
Truck, Heavy	1	Trailer, Water (900-Liter)	1
Truck, POL (4,000 or 5,200-Liter)	4	Trailer, Kitchen	3
Truck, Water (2,000-Liter)	1	Radio, VHF, Manpack, Low-Power	1

**Recovery Platoon, Maintenance Bn, Light Inf Div, Mtzd Inf Div, and
Mech Inf Div, or Army or National (Rear Services)**

**RECOVERY
PLATOON**

PRINCIPAL ITEMS OF EQUIPMENT

<u>Equipment</u>	<u>Total</u>	<u>Equipment</u>	<u>Total</u>
Truck, Recovery	2	Tractor-Trailer, Lowboy	2
Tracked Amphibian, K-61/PTS	1	Radios:	
Tractor, Artillery, AT-S	1	VHF, Vehicle Mount, Medium-Power ..	4
Armored Recovery Vehicle	2	HF, Vehicle Mount, Medium-Power	1

**Special Maintenance Platoon, Maintenance Bn, Light Inf Div, Mtzd Div,
and Mech Inf Div, or Army or National (Rear Services)**

**SPECIAL
MAINTENANCE
PLATOON**

PRINCIPAL ITEMS OF EQUIPMENT

<u>Equipment</u>	<u>Total</u>	<u>Equipment</u>	<u>Total</u>
Van, Maintenance	6	Trailer, Generator	1

Medical Battalion, Mech Inf Div or Army

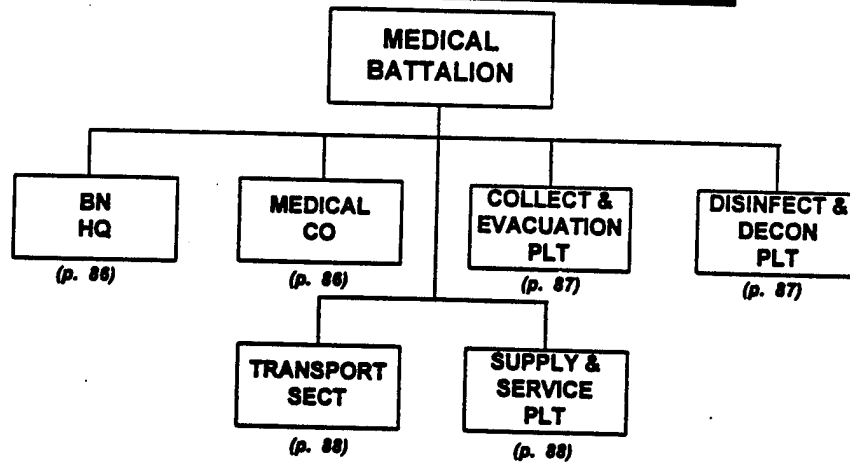

PRINCIPAL ITEMS OF EQUIPMENT

Equipment	Total	Equipment	Total
Ambulance	20	Trailer, Cargo, 2-Axle	10
Truck, Utility	4	Trailer, Generator	2
Truck, Light	1	Trailer, POL (1,200-Liter)	2
Truck, Medium	21	Trailer, Decon, DDP	3
Truck, Decon, DDA-53/66	1	Trailer, Kitchen	4
Truck, Decon, ARS-12U/14	3	Trailer, Water (900-Liter)	1
Truck, POL (4,000 or 5,200-Liter)	2	Radios:	
Truck, Water (2,000-Liter)	3	VHF, Manpack, Low-Power	3
Van, Light		HF/VHF, Vehicle Mount,	
Van, Maintenance	2	Medium-Power	1
Van, Generator	1	HF, Manpack, Low-Power	1
Van, Hospital	9	Warning Receiver	1

NOTES:

1. Medical Battalions are planned at the national level (Rear Services), but are not part of the current structure. When formed, they will probably be allocated to regions and/or districts in wartime.
2. Currently, only **standing** mechanized infantry divisions and armies have medical battalions.

Battalion Headquarters, Medical Bn, Mech Inf Div or Army

BATTALION HEADQUARTERS

PRINCIPAL ITEMS OF EQUIPMENT

Equipment	Total	Equipment	Total
Truck, Utility.....	1	Radios:	
Van, Light	1	HF/VHF, Vehicle Mount, Medium-Power	1
		HF, Manpack, Low-Power.....	1
		Warning Receiver	1

**Medical Company, Light Inf Div and Mtzd Inf Div, or Medical Bn,
Mech Inf Div or Army**

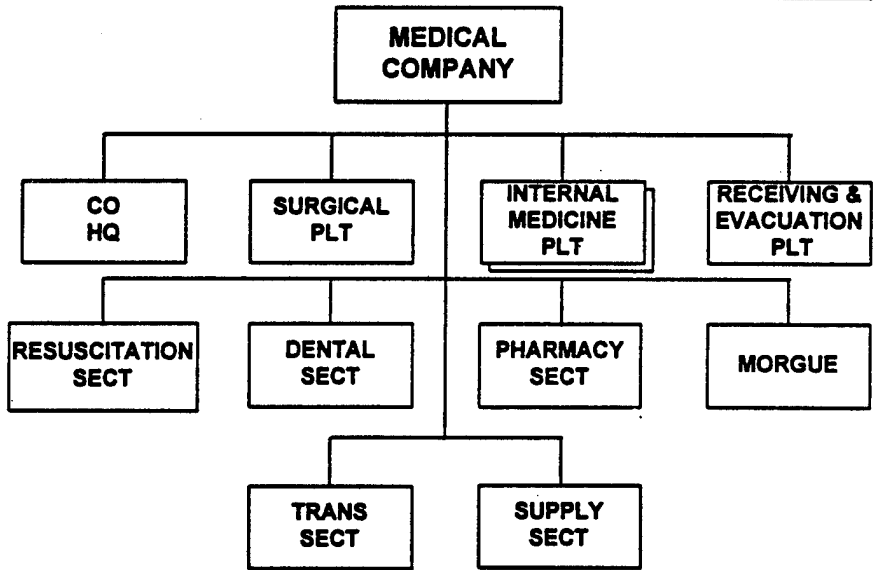

PRINCIPAL ITEMS OF EQUIPMENT

Equipment	Total	Equipment	Total
Truck, Utility.....	1	Van, Hospital	9
Van, Light	1	Radio, HF, Manpack, Low-Power	1
Van, Generator.....	1		

Collection and Evacuation Platoon, Medical Bn, Mech Inf Div or Army

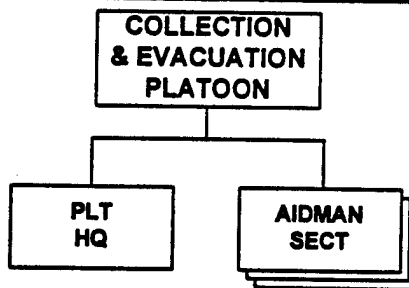

PRINCIPAL ITEMS OF EQUIPMENT

Equipment	Total	Equipment	Total
Ambulance	4	Truck, Medium	7
Truck, Light	1	Trailer, Cargo, 2-Axle	7
Truck, Utility	1	Radio, HF, Manpack, Low-Power	1

Disinfection and Decontamination Platoon, Medical Bn, Mech Inf Div or Army



PRINCIPAL ITEMS OF EQUIPMENT

Equipment	Total	Equipment	Total
Truck, Decon, DDA-53/66	1	Trailer, Cargo, 2-Axle	1
Truck, Decon, ARS-12U/14	3	Trailer, Decon, DDP	3
Truck, Utility	1	Trailer, Water (900-Liter)	1

Transport Section, Medical Bn, Mech Inf Div or Army

**TRANSPORT
SECTION**

PRINCIPAL ITEMS OF EQUIPMENT

Equipment	Total	Equipment	Total
Ambulance	20	Van, Maintenance	2
Truck, Utility	1	Trailer, Generator	2
Truck, Medium	8	Trailer, POL (900-Liter)	2
Truck, POL (4,000 or 5,200-Liter)	2	Radio, HF, Manpack, Low-Power	1

Supply and Service Platoon, Medical Bn, Mech Inf Div or Army

**SUPPLY &
SERVICE
PLATOON**

PRINCIPAL ITEMS OF EQUIPMENT

Equipment	Total	Equipment	Total
Truck, Medium	6	Trailer, Cargo, 2-Axle	2
Truck, Water (2,000-Liter)	3	Trailer, Kitchen	4

Light Infantry Brigade (Separate)

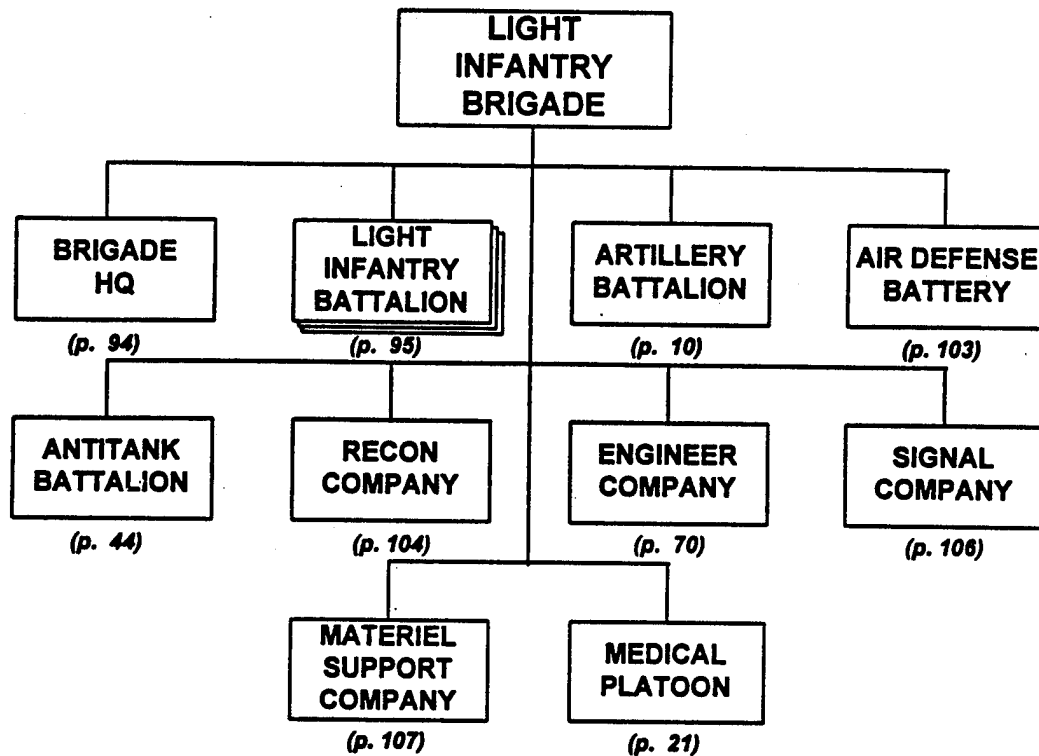

NOTES:

1. Equipment totals for the brigade headquarters and subordinate battalion headquarters reflect only the totals for the command element. Headquarters strengths vary from unit to unit at both the brigade and battalion levels, ranging from 50 personnel to over 100. These figures include staff elements, and various headquarters support functions, such as maintenance and supply. Most of these personnel, including officers, carry the AK-74 assault rifle.
2. Individual weapons for personnel are counted only at the maneuver battalion and below.
3. Night vision goggle totals, for both maneuver elements and supporting assets, do not include those worn by vehicle drivers. These figures vary widely from unit to unit, although separate brigades tend to field more goggles in combat support and combat service support units.

LIGHT INFANTRY BRIGADE (SEPARATE)

<i>Principal Items of Equipment</i>	<i>Brigade HQ</i>	<i>Light Inf Bn (3x)</i>	<i>Artillery Bn (122-mm)</i>	<i>Air Defense Btry</i>	<i>Antitank Bn</i>	<i>Reconnaissance Co</i>	<i>Engineer Co</i>	<i>Signal Co</i>	<i>Material Support Co</i>	<i>Medical Plt</i>	<i>TOTAL</i>
ARMORED VEHICLES											
ACV, BTR (R-145BM)	3				5						8
APC, BTR-60/70/80							3				3
ASC, BRDM-2						8					8
ACV, BRDM-2U						1					1
Mobile Recon Post, PRP-3/4			1								1
Prime Mover, MT-LBT					14						14
ACRV, 1V18			3								3
ACRV, 1V19			1								1
WEAPONS											
60-mm Mortar, Light		18									18
122-mm Howitzer, D-30			18								18
73-mm Recoilless Gun, SPG-9		6									6
100/125-mm AT Gun, MT-12/2A45M					12						12
ATGM Manpack, AT-4/SPIGOT		12									12
ATGM Vehicle, BRDM-2 w/AT-3/5					9						9
23-mm AA Gun, ZU-23				8							8
SAM, SA-7/14	3	27									30
ENGINEER EQUIPMENT											
Truck, Water Purification							1				1
Bridge, Truck-Launched							5				5
Minelayer, PMR-3							3				3
TRUCKS											
ACRV, 1V110 (Battery FDC)			3								3
ACRV, 1V111 (Battalion FDC)			1								1
Truck, Utility	3	6	1	1	3		1	5	2		22
Truck, Light	6	21	12	8	18			1	4	1	71
Truck, Medium			34		12		8		45	2	101
Truck, Dump							2				2
Truck, Crane							1				1
Truck, Crane Shovel							2				2
Truck, Decon, DDA-53/66										1	1
Truck, Kitchen	1										1
Truck, POL (4,000-5,200-L)			2		2				15		19
Truck, Water (2,000-L)	1	3							4		8
Van, Command	3										3
Van, Hospital										1	1
Van, Kitchen							1				1
Van, Maintenance			1		2		1		2		6
Van, Signal			2		2			5			9
Ambulance			1		1					4	6

LIGHT INFANTRY BRIGADE (SEPARATE) (Cont)

<i>Principal Items of Equipment</i>	<i>Brigade HQ</i>	<i>Light Inf Bn (3x)</i>	<i>Artillery Bn (122-mm)</i>	<i>Air Defense Btry</i>	<i>Antitank Bn</i>	<i>Reconnaissance Co</i>	<i>Engineer Co</i>	<i>Signal Co</i>	<i>Material Support Co</i>	<i>Medical Plt</i>	<i>TOTAL</i>
TRAILERS											
Trailer, Cargo, 2-Axle			11		10		2		30		53
Trailer, Generator					1			4	1		6
Trailer, Kitchen			4		2				2		8
Trailer, POL (900-1,200-L)			2		1				15		18
Trailer, Water (900-1,200-L)			1		1				1		3
RADARS											
Radar, BS, Manportable, PSNR-1					3	2					5
RADIOS											
VHF, Manpack, Low-Power	14	174	20	3	24			7		1	243
VHF, Portable, Low-Power	2	6	2			10					18
VHF, Portable, Very-Low-Power		12									12
VHF, Vehicle Mount, Medium-Power		12			14	8	4				38
HF, Manpack, Low-Power						1	4	2	3		10
HF, Vehicle Mount, Medium-Power	4	3			1	1		2			11
HF/VHF, Vehicle Mount, Med-Power			4		3			2			9
HF/VHF, Vehicle Mount, High-Power								2			2
HF, Van Mount, High-Power								1			1
Radio Relay, VHF/UHF					1			2			3
Warning Receiver	1		1		1	1		3			7
MISCELLANEOUS											
Rangefinder		3			3						6
Rangefinder, Laser, SAGE GLOSS			4								4
Periscopic Aiming Circle, PAB2A		3									3
Collimator (Aiming Stakes)		18									18
Motorcycle						10					10

Light Infantry Brigade (Divisional)

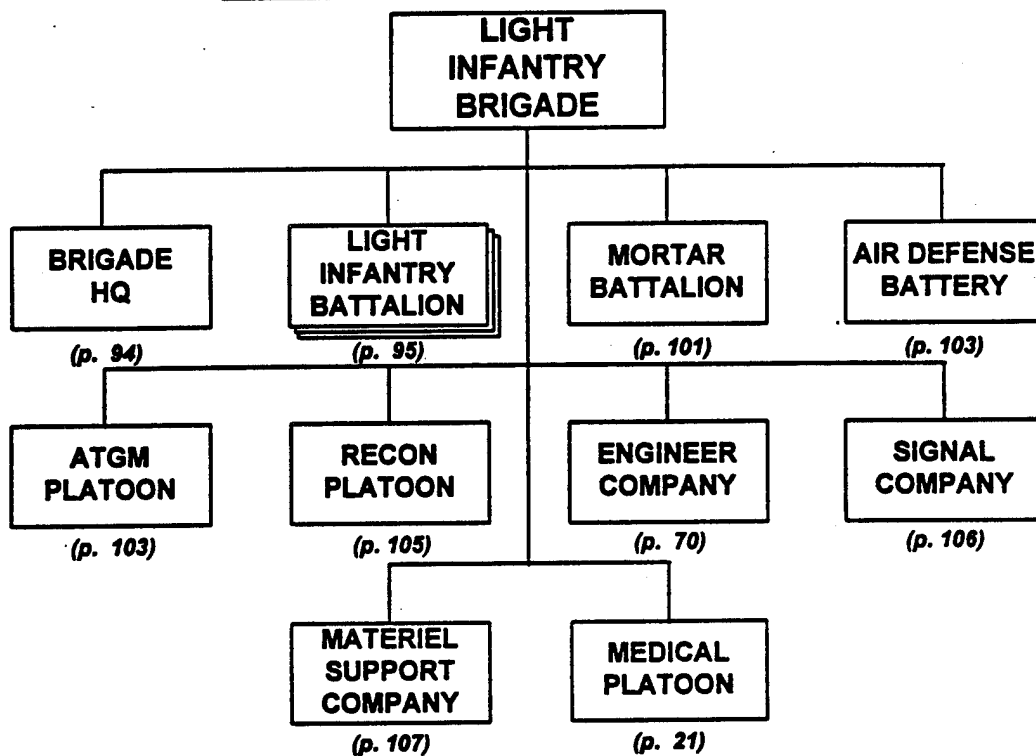

NOTES:

1. Equipment totals for the brigade headquarters and subordinate battalion headquarters reflect only the totals for the command element. Headquarters strengths vary from unit to unit at both the brigade and battalion levels, ranging from 50 personnel to over 100. These figures include staff elements, and various headquarters support functions, such as maintenance and supply. Most of these personnel, including officers, carry the AK-74 assault rifle.
2. Individual weapons for personnel are counted only at the maneuver battalion and below.
3. Night vision goggle totals, for both maneuver elements and supporting assets, do not include those worn by vehicle drivers. These figures vary widely from unit to unit, although separate brigades tend to field more goggles in combat support and combat service support units.

LIGHT INFANTRY BRIGADE (DIVISIONAL)											
Principal Items of Equipment	Brigade HQ	Light Inf Bn (3x1)	Mortar Bn	Air Defense Btry	ATGM Pn	Recon Pn	Engineer Co	Signal Co	Material Support Co	Medical Pn	TOTAL
ARMORED VEHICLES											
ACV, BTR (R-145BM)	3										3
ASC, BRDM-2						4					4
APC, BTR-60/70/80							3				3
WEAPONS											
60-mm Mortar, Light		18									18
120-mm Mortar, M1943/2S12 or 82-mm Mortar, M1937/2B9			18								18
73-mm Recoilless Gun, SPG-9		6									6
ATGM Manpack, AT-4/SPIGOT		12			6						18
23-mm AA Gun, ZU-23				8							8
SAM, SA-7/14	3	27									30
ENGINEER EQUIPMENT											
Bridge, Truck-Launched							3				3
Mineslayer, PMR-3							3				3
TRUCKS											
Truck, Utility	3	6	3	1			1	5	2		21
Truck, Light	6	21	20	8	3			1	4	1	64
Truck, Medium							8		45	2	55
Truck, Dump							2				2
Truck, Crane							1				1
Truck, Crane Shovel							2				2
Truck, Decon, DDA-53/66										1	1
Truck, Kitchen	1										1
Truck, POL (4,000/5,200-L)			1						15		16
Truck, Water (2,000-L)	1	3							4		8
Truck, Water Purification							1				1
Van, Command	3										3
Van, Hospital										1	1
Van, Maintenance			1				1		2		4
Van, Signal			2					5			7
Ambulance			1							4	5
TRAILERS											
Trailer, Cargo, 1-Axle									30		30
Trailer, Cargo, 2-Axle			10				2				12
Trailer, Generator								4	1		5
Trailer, Kitchen			2						2		4
Trailer, POL (900/1,200-L)									15		15
Trailer, Water (900/1,200-L)			2						1		3
RADARS											
Radar, BS, Man-Portable, PSNR-1			2			1					3
RADIOS											
VHF, Manpack, Low-Power	14	174	18	3	3			7		1	220
VHF, Portable, Low-Power	2		2								4
VHF, Portable, Very-Low-Power		6									6
VHF, Vehicle Mount, Medium-Power		12				4		4			20
HF, Manpack, Low-Power							4	2	3		9
HF, Vehicle Mount, Medium-Power	4	3						2			9
HF/VHF, Vehicle Mount, Medium-Power			3					2			6
HF/VHF, Vehicle Mount, High-Power								2			2
HF, Van Mount, High-Power								1			1
Radio Relay, VHF/UHF								2			2
Warning Receiver	1		1					3			5
MISCELLANEOUS											
Rangefinder		3	3								6
Periscopic Aiming Circle, PAB2A		3	6								9
Collimator (Aiming Stakes)		18	18								36

Brigade Headquarters, Light Inf Bde (Sep and Div) and Mtzd Inf Bde (Sep and Div)

BRIGADE HEADQUARTERS

PRINCIPAL ITEMS OF EQUIPMENT

<u>Equipment</u>	<u>Total</u>
ACV, BTR (R-145BM)	3
SAM, SA-7/14	3
Truck, Utility.....	3
Truck, Light	6
Van, Command	3
Truck, Water (2,000-Liter).....	1
Truck, Kitchen	1

<u>Equipment</u>	<u>Total</u>
Radios:	
VHF, Manpack, Low-Power	14
VHF, Portable, Low-Power	2
HF, Vehicle Mounted, Medium-Power	4
Warning Receiver	1

Light Infantry Battalion, Light Inf Bde (Sep and Div)

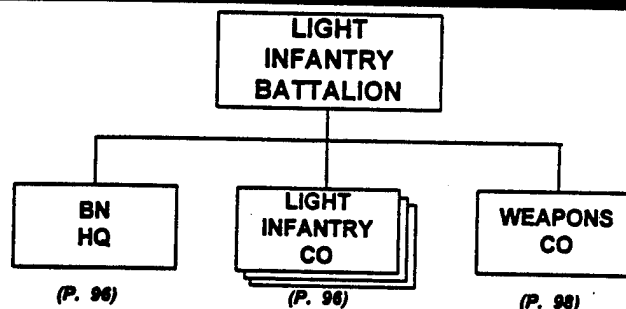

PRINCIPAL ITEMS OF EQUIPMENT

Equipment	Total	Equipment	Total
9-mm Pistol, PM.....	119	Periscopic Aiming Circle, PAB2A.....	1
5.45-mm Assault Rifle, AK-74.....	301	Collimator (Aiming Stakes).....	6
5.45-mm LMG, RPK-74.....	54	Night Vision Goggles, Type-85.....	36
7.62-mm GP MG, PKM.....	27	Night Vision Goggles, PNV-57.....	14
7.62-mm Sniper Rifle, SVD.....	9	Night Vision Sight, NSP-3	
40-mm Under-Barrel Grenade		(Small Arms).....	36
Launcher, BG-15.....	63	Night Vision Sight, PPN-3 (MG).....	27
ATGL, RPG-7V.....	60	Radios:	
60-mm Mortar, Light.....	6	VHF, Manpack, Low-Power.....	58
SAM, SA-7/14.....	9	VHF, Portable, Low-Power.....	2
ATGM Manpack, AT-4/SPIGOT.....	4	VHF, Portable, Very-Low-Power.....	4
73-mm Recoilless Gun, SPG-9.....	2	VHF, Vehicle Mount, Medium-	
Truck, Utility.....	2	Power.....	4
Truck, Light.....	7	HF, Portable, Very-Low-Power.....	4
Truck, Water (2,000-Liter).....	1	HF, Vehicle Mount,	
Rangefinder.....	1	Medium-Power.....	1

**Battalion Headquarters, Light Infantry Bn, Light Inf Bde (Sep and Div)
and Mtzd Inf Bn, Mtzd Inf Bde (Sep and Div)**

**BATTALION
HEADQUARTERS**

PRINCIPAL ITEMS OF EQUIPMENT

Equipment	Total	Equipment	Total
9-mm Pistol, PM.....	4	Radios:	
5.45-mm Assault Rifle, AK-74.....	8	VHF, Manpack, Low-Power.....	2
Truck, Utility.....	1	VHF, Portable, Low-Power.....	2
Truck, Light.....	1	VHF, Vehicle Mount, Medium-Power..	1
Truck, Water (2,000-Liter).....	1	HF, Vehicle Mount, Medium-Power.....	1

Light Infantry Company, Light Inf Bn, Light Inf Bde (Sep and Div)

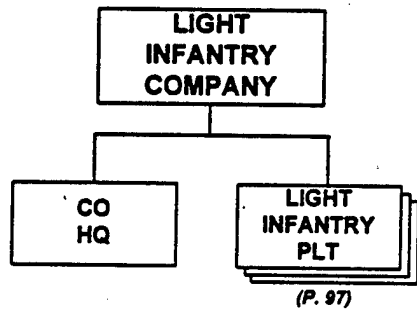

PRINCIPAL ITEMS OF EQUIPMENT

Equipment	Total	Equipment	Total
9-mm Pistol, PM.....	32	Night Vision Goggles, Type-85.....	12
5.45-mm Assault Rifle, AK-74.....	76	Night Vision Goggles, PNV-57.....	4
5.45-mm LMG, RPK-74.....	18	Night Vision Sight, NSP-3 (Small Arms)..	12
7.62-mm Sniper Rifle, SVD.....	3	Night Vision Sight, PPN-3 (MG).....	9
7.62-mm GP MG, PKM.....	9	ATGL, RPG-7V.....	15
40-mm Under-Barrel Grenade Launcher, BG-15.....	21	Radio, VHF, Manpack, Low-Power.....	16

**Light Infantry Platoon, Light Inf Co, Light Inf Bn, Light Inf Bde
(Sep and Div)**

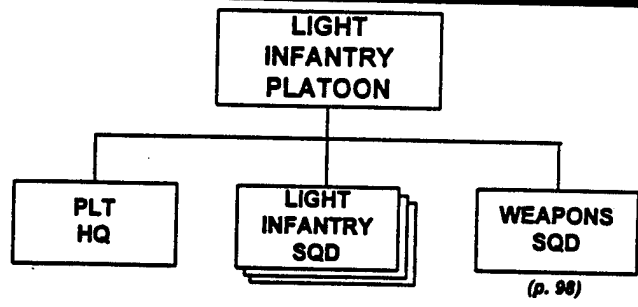

PRINCIPAL ITEMS OF EQUIPMENT

Equipment	Total	Equipment	Total
9-mm Pistol, PM.....	10	ATGL, RPG-7V.....	5
5.45-mm Assault Rifle, AK-74.....	24	Night Vision Goggles, Type-85.....	4
5.45-mm LMG, RPK-74.....	6	Night Vision Goggles, PNV-57.....	1
7.62-mm Sniper Rifle, SVD.....	1	Night Vision Sight, NSP-3	
7.62-mm GP MG, PKM.....	3	(Small Arms).....	4
40-mm Under-Barrel Grenade Launcher, BG-15.....	7	Night Vision Sight, PPN-3 (MG).....	3
		Radio, VHF, Manpack, Low-Power.....	5

**Light Infantry Squad, Light Inf Plt, Light Inf Co, Light Inf Bn,
Light Inf Bde (Sep and Div)**



- Squad Leader.....AK-74
- Machine Gunner (x 2).....RPK-74
- Rifleman (x 5).....AK-74
- Grenadier.....RPG-7V/PM

PRINCIPAL ITEMS OF EQUIPMENT

Equipment	Total	Equipment	Total
9-mm Pistol, PM.....	1	ATGL, RPG-7V.....	1
5.45-mm Assault Rifle, AK-74.....	6	Night Vision Goggles, Type-85.....	1
7.62-mm Sniper Rifle, SVD.....	*1	Night Vision Sight, NSP-3	
7.62-mm LMG, RPK-74.....	2	(Small Arms).....	1
40-mm Under Barrel Grenade Launcher, BG-15.....	2	Radio, VHF, Manpack, Low-Power.....	1

FOOTNOTE: * One squad per platoon has an SVD sniper rifle.

**Weapons Squad, Light Inf Plt, Light Inf Co, Light Inf Bn,
Light Inf Bde (Sep and Div)**

**WEAPONS
SQUAD**

Squad Leader.....AK-74
 Machine Gunner (x 3).....PKM/PM
 Asst Machine Gunner (x 3).....AK-74
 Grenadier (x 2).....RPG-7V/PM

PRINCIPAL ITEMS OF EQUIPMENT

Equipment	Total	Equipment	Total
9-mm Pistol, PM.....	5	Night Vision Goggles, Type-85.....	1
5.45-mm Assault Rifle, AK-74.....	4	Night Vision Sight, NSP-3 (Small Arms).....	1
7.62-mm GP MG, PKM.....	3	Night Vision Sight, PPN-3 (MG).....	3
40-mm Under-Barrel Grenade Launcher, BG-15.....	1	Radio, VHF, Manpack, Low-Power.....	1
ATGL, RPG-7V.....	2		

Weapons Company, Light Inf Bn, Light Inf Bde (Sep and Div)

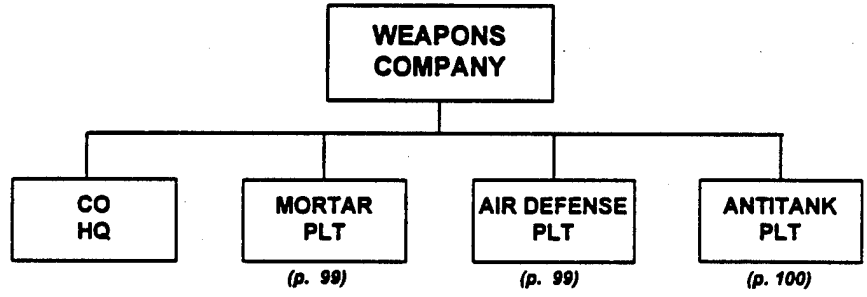

PRINCIPAL ITEMS OF EQUIPMENT

Equipment	Total	Equipment	Total
60-mm Mortar, Light.....	6	Rangefinder.....	1
SAM, SA-7/14.....	9	Periscopic Aiming Circle, PAB2A.....	1
ATGM, AT-4/SPIGOT.....	4	Collimator (Aiming Stakes).....	6
73-mm Recoilless Gun, SPG-9.....	2	Radios:	
9-mm Pistol, PM.....	19	VHF, Vehicle Mount, Medium-Power.....	3
5.45-mm Assault Rifle, AK-74.....	65	VHF, Manpack, Low-Power.....	8
ATGL, RPG-7V.....	15	VHF, Portable, Very-Low-Power.....	4
Truck, Utility.....	1		
Truck, Light.....	6		

Mortar Platoon, Wpns Co, Light Inf Bn, Light Inf Bde (Sep and Div)

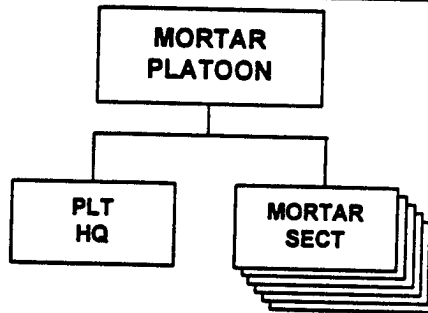

PRINCIPAL ITEMS OF EQUIPMENT

<u>Equipment</u>	<u>Total</u>	<u>Equipment</u>	<u>Total</u>
60-mm Mortar, Light	6	Periscopic Aiming Circle, PAB2A	1
9-mm Pistol, PM	7	Collimator (Aiming Stakes)	6
5.45-mm Assault Rifle, AK-74	24	Truck, Light	1
ATGL, RPG-7V	6	Radio, VHF, Manpack, Low-Power	2
Rangefinder	1		

Air Defense Platoon, Wpns Co, Light Inf Bn, Light Inf Bde (Sep and Div)

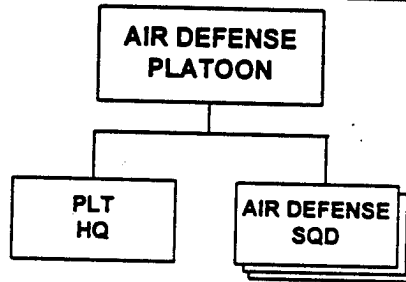

PRINCIPAL ITEMS OF EQUIPMENT

<u>Equipment</u>	<u>Total</u>	<u>Equipment</u>	<u>Total</u>
SAM, SA-7/14	9	Radios:	
9-mm Pistol, PM	2	VHF, Vehicle Mount,	
5.45-mm Assault Rifle, AK-74	12	Medium-Power	3
ATGL, RPG-7V	3	VHF, Portable, Very-Low-Power	4
Truck, Light	3		

Antitank Platoon, Wpns Co, Light Inf Bn, Light Inf Bde (Sep and Div)

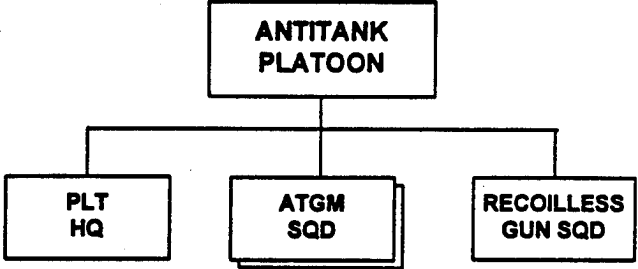

PRINCIPAL ITEMS OF EQUIPMENT

Equipment	Total	Equipment	Total
ATGM, Manpack, AT-4/SPIGOT	4	ATGL, RPG-7V	6
73-mm Recoilless Gun, SPG-9	2	Truck, Light	2
9-mm Pistol, PM	7	Radio, VHF, Manpack, Low-Power	6
5.45-mm Assault Rifle, AK-74	26		

Mortar Battalion, Light Inf Bde (Div)

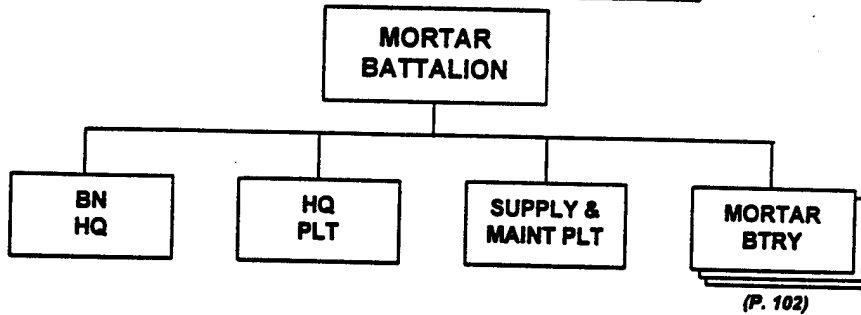

PRINCIPAL ITEMS OF EQUIPMENT

Equipment	Total	Equipment	Total
120-mm Mortar, M1943/2S12 or 82-mm Mortar, M1937/2B9.....	18	Rangefinder.....	3
5.45-mm LMG, RPK-74.....	18	Periscopic Aiming Circle, PAB2A.....	6
ATGL, RPG-7V.....	18	Collimator (Aiming Stakes).....	18
Truck, Utility.....	3	Radar, Battlefield Surveillance, Man- Portable, PSNR-1.....	2
Truck, Light.....	20	Radios:	
Truck, POL (4,000 or 5,200-Liter).....	1	VHF, Manpack, Low-Power.....	18
Van, Signal.....	2	VHF, Portable, Low-Power or Very-Low-Power.....	2
Van, Maintenance.....	1	HF/VHF, Vehicle Mount, Medium-Power.....	3
Ambulance.....	1	Warning Receiver.....	1
Trailer, Cargo, 2-Axle.....	10		
Trailer, Water (900-Liter).....	2		
Trailer, Kitchen.....	2		

Mortar Battery, Mortar Bn, Light Inf Bde (Div)

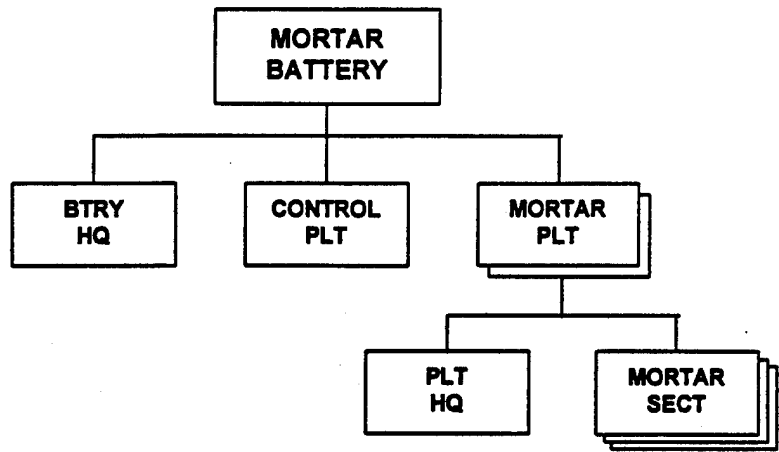

PRINCIPAL ITEMS OF EQUIPMENT

Equipment	Total
82-mm Mortar, M1937/2B9.....	6
5.45-mm LMG, RPK-74.....	6
ATGL, RPG-7V.....	6
Truck, Utility.....	1
Truck, Light.....	6
Trailer, Cargo, 1-Axle.....	2
Rangefinder.....	1

Equipment	Total
Periscopic Aiming Circle, PAB2A.....	2
Collimator (Aiming Stakes).....	6
Radios:	
VHF, Manpack, Low-Power.....	5
HF/VHF, Vehicle Mount, Medium-Power.....	1

Air Defense Battery, Light Inf Bde (Sep and Div) and Mtzd Inf Bde (Sep and Div)

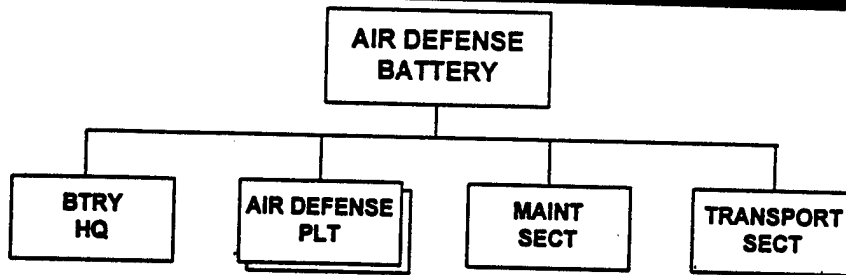

PRINCIPAL ITEMS OF EQUIPMENT

Equipment	Total	Equipment	Total
23-mm AA Gun, ZU-23.....	8	Truck, Light	8
Truck, Utility.....	1	Radio, VHF, Manpack, Low-Power	3

ATGM Platoon, Light Inf Bde (Div) and Mtzd Inf Bde (Div)

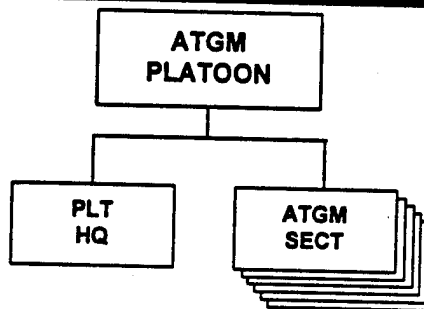

PRINCIPAL ITEMS OF EQUIPMENT

Equipment	Total	Equipment	Total
ATGM, Manpack, AT-4/SPIGOT	6	Truck, Light	3
ATGL, RPG-7V	6	Radio, VHF, Manpack, Low-Power	3

Reconnaissance Company, Light Inf Bde (Sep), Mtd Inf Bde (Sep), Mech Inf Bde (Sep), and Tank Bde

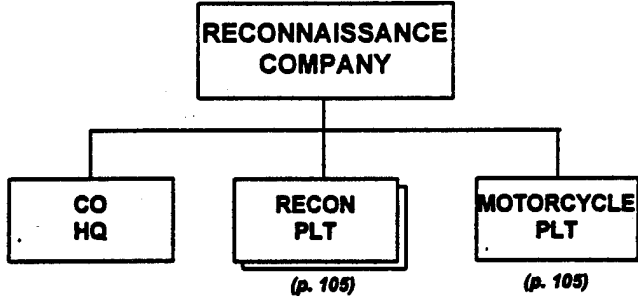

PRINCIPAL ITEMS OF EQUIPMENT

Equipment	Total
ACV, BRDM-2U	1
ASC, BRDM-2	8
9-mm Pistol, PM	11
5.45-mm Assault Rifle, AK-74	60
5.45-mm LMG, RPK-74	17
40-mm Under-Barrel Grenade Launcher, BG-15	8
ATGL, RPG-7V	8
Motorcycle	10
Night Vision Goggles, PNV-57	19
Night Vision Sight, NSP-3 (Small Arms) ..	16

Equipment	Total
Radar, Battlefield Surveillance, Man- Portable, PSNR-1	2
Radios:	
VHF, Portable, Low-Power	10
VHF, Vehicle Mount, Medium-Power	8
HF, Manpack, Low-Power	1
HF, Vehicle Mount, Medium-Power	1
Warning Receiver	1

Reconnaissance Platoon, Light Inf Bde (Div), Mtzd Inf Bde (Div), and Mech Inf Bde (Div), or Recon Co, Light Inf Bde (Sep), Mtzd Inf Bde (Sep), Mech Inf Bde (Sep), and Tank Bde

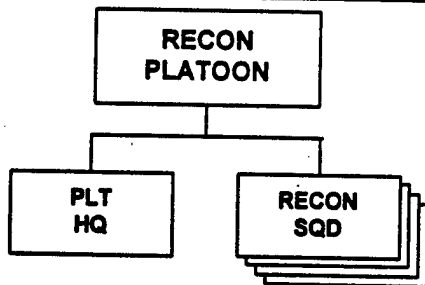

PRINCIPAL ITEMS OF EQUIPMENT

<u>Equipment</u>	<u>Total</u>	<u>Equipment</u>	<u>Total</u>
ASC, BRDM-2.....	4	Night Vision Goggles, PNV-57	4
9-mm Pistol, PM.....	5	Night Vision Sight, NSP-3 (Small Arms).....	8
5.45-mm Assault Rifle, AK-74.....	29	Radar, Battlefield Surveillance, Man- Portable, PSNR-1	1
5.45-mm LMG, RPK-74.....	4	Radio, VHF, Vehicle Mount, Medium-Power	4
40-mm Under-Barrel Grenade Launcher, BG-15.....	4		
ATGL, RPG-7V.....	4		

Motorcycle Platoon, Recon Co, Light Inf Bde (Sep), Mtzd Inf Bde (Sep), Mech Inf Bde (Sep), and Tank Bde

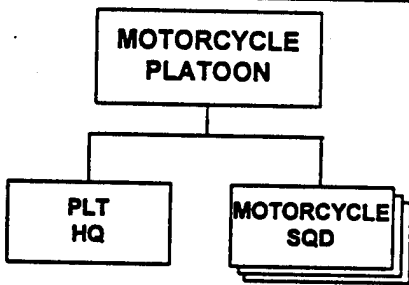

PRINCIPAL ITEMS OF EQUIPMENT

<u>Equipment</u>	<u>Total</u>	<u>Equipment</u>	<u>Total</u>
Motorcycle.....	10	Night Vision Goggles, PNV-57	10
9-mm Pistol, PM.....	1	Radio, VHF, Portable, Low-Power.....	10
5.45-mm LMG, RPK-74.....	9		

Signal Company, Light Inf Bde (Sep and Div), Mtzd Inf Bde (Sep and Div), Mech Inf Bde (Sep and Div), and Tank Bde

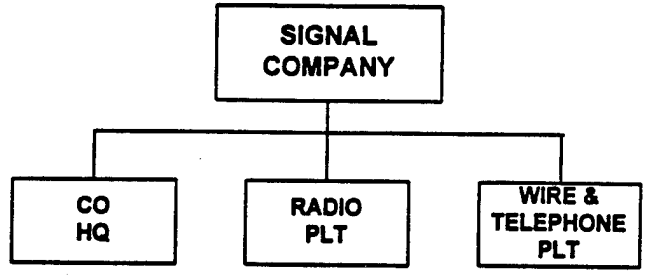

PRINCIPAL ITEMS OF EQUIPMENT

Equipment	Total	Equipment	Total
Truck, Utility.....	5	HF/VHF, Vehicle Mount, High-Power..	2
Truck, Light	1	HF, Manpack, Low-Power.....	2
Van, Signal.....	5	HF, Van Mount, High-Power.....	1
Trailer, Generator.....	4	HF, Vehicle Mount,	
Radios:		Medium-Power	2
VHF, Manpack, Low-Power.....	7	Radio Relay, VHF/UHF.....	2
HF/VHF, Vehicle Mount,		Warning Receiver	3
Medium-Power	2		

NOTE: Radios listed support the brigade headquarters.

Materiel Support Company, Light Inf Bde (Sep and Div), Mtzd Inf Bde (Sep and Div), Mech Inf Bde (Sep and Div), and Tank Bde

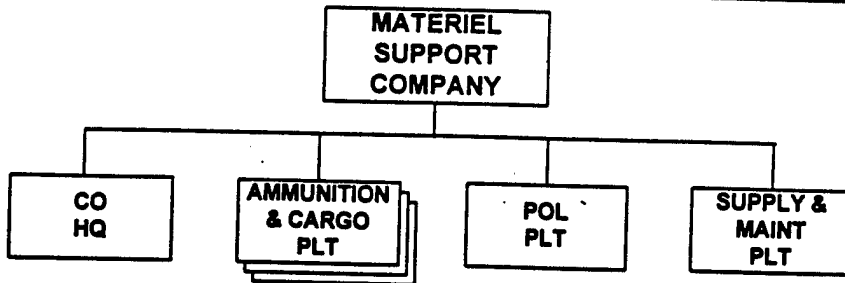

PRINCIPAL ITEMS OF EQUIPMENT

Equipment	Total	Equipment	Total
Truck, Utility.....	2	Trailer, Cargo, 2-Axle.....	30
Truck, Light	4	Trailer, POL (1,200-Liter)	15
Truck, Medium	45	Trailer, Kitchen	2
Van, Maintenance	2	Trailer, Water (900-Liter)	1
Truck, Water (2,000-Liter).....	4	Trailer, Generator.....	1
Truck, POL (4,000 or 5,200-Liter)	15	Radio, HF, Manpack, Low-Power	3

NOTE: Some brigades of all types still have separate elements to provide supply and transportation functions; however, the tendency has been to consolidate these functions into one unit for ease of control. The organization depicted above is the standard structure, although different brigade types may have more of one specific type of support vehicle and fewer of another.

Light Infantry Brigade (Militia)

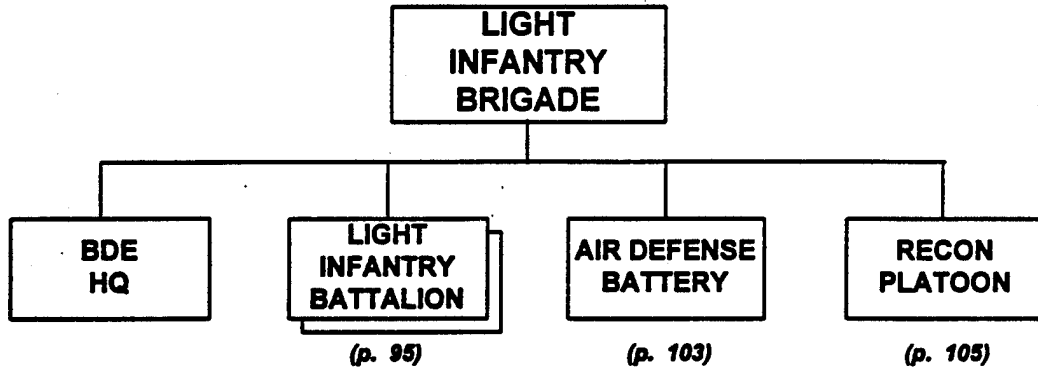

NOTES:

1. Districts, depending on their population/population centers, may or may not be able to constitute a brigade-sized militia force; many districts will have, at most, a battalion. These forces may or may not act as an integrated force. Regardless of militia size, every village, farm cooperative, or factory has a militia formation, manned in wartime by the workers and peasants, over-age reservists, medically-retired soldiers, women, and young men not yet old enough for military service. The militia conducts point defense of its own villages and towns, air ambushes, and performs reconnaissance and small raids in support of the overall national resistance to invaders. They could receive additional combat support and combat service support assets from the district, but this would be extremely rare.
2. Although included in the above referenced light infantry battalion totals, militia forces will not have night vision sights or goggles.

LIGHT INFANTRY BDE (MILITIA)					
<i>Principal Items of Equipment</i>	<i>Brigade HQ</i>	<i>Light Inf Bn (2x)</i>	<i>Air Defense Btry</i>	<i>Recon Plt</i>	<i>TOTAL</i>
ARMORED VEHICLES					
APC, BTR-60	3				3
ASC, BRDM-2				4	4
WEAPONS					
60-mm Mortar, Light		12			12
73-mm Recoilless Gun, SPG-9		4			4
ATGM Manpack, AT-4/SPIGOT		8			8
23-mm AA Gun, ZU-23			8		8
SAM, SA-7/14	3	18			21
TRUCKS					
Truck, Utility	3	4	1		8
Truck, Light	6	14	8		28
Truck, Kitchen	1				1
Truck, Water (2,000-L)	1	2			3
Van, Command	3				3
RADARS					
Radar, BS, Manportable, PSNR-1				1	1
RADIOS					
VHF, Manpack, Low-Power	14	116	3		133
VHF, Portable, Low-Power	2	4			6
VHF, Portable, Very-Low-Power		8			8
VHF, Vehicle Mount, Medium-Power		8		4	12
HF, Vehicle Mount, Medium-Power	4	2			6
Warning Receiver	1				1
MISCELLANEOUS					
Rangefinder		2			2
Periscopic Aiming Circle, PAB2A		2			2
Collimator (Aiming Stakes)		12			12

Motorized Infantry Brigade (Separate)

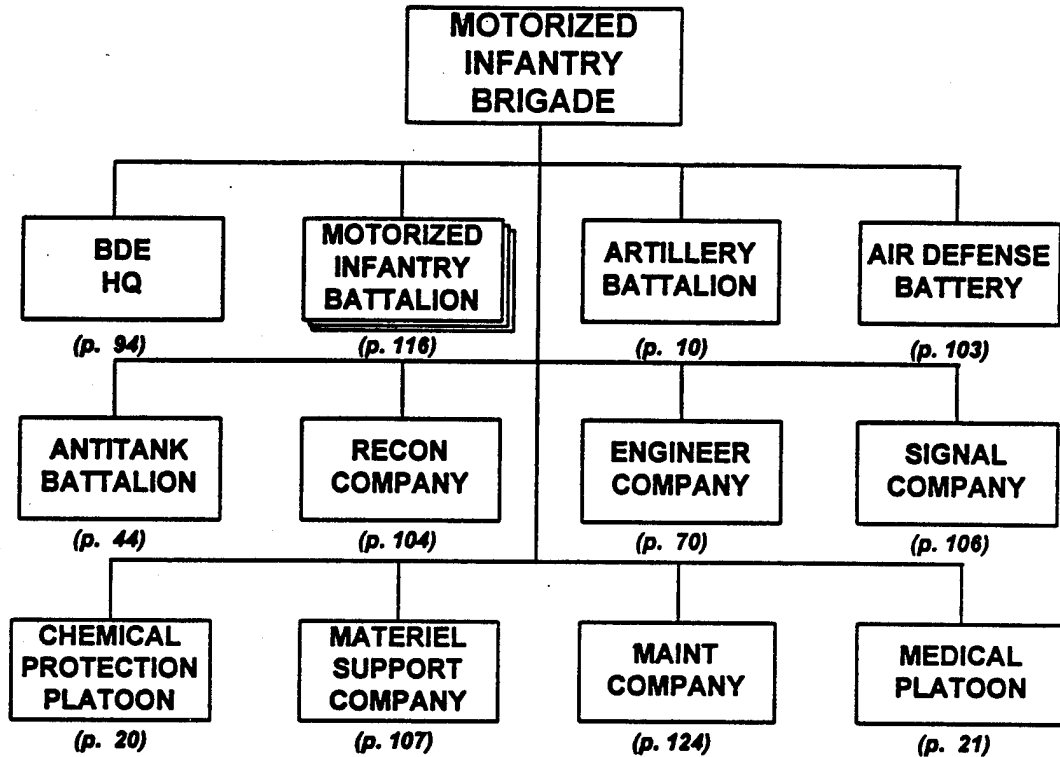

NOTES:

1. Equipment totals for the brigade headquarters and subordinate battalion headquarters reflect only the totals for the command element. Headquarters strengths vary from unit to unit at both the brigade and battalion levels, ranging from 50 personnel to over 100. These figures include staff elements, and various headquarters support functions, such as maintenance and supply. Most of these personnel, including officers, carry the AK-74 assault rifle.
2. Individual weapons for personnel are counted only at the maneuver battalion and below.
3. Night vision goggle totals, for both maneuver elements and supporting assets, do not include those worn by vehicle drivers. These figures vary widely from unit to unit, although separate brigades tend to field more goggles in combat support and combat service support units.

MOTORIZED INFANTRY BRIGADE (SEPARATE)

Principal Items of Equipment											TOTAL	
	Brigade HQ	Motorized Inf Bn (3x)	Artillery Bn (122-mm)	Air Defense Btry	Antitank Bn	Reconnaissance Co	Engineer Co	Signal Co	Chem Protection Plt	Material Support Co		Maintenance Co
ARMORED VEHICLES												
ACV, BTR (R-145BM)	3				5							8
ASC, BRDM-2						8						8
ACV, BRDM-2U						1						1
APC, BTR-60/70/80							3					3
Chemical Recon Vehicle, BRDM-2RK/RK/M									3			3
Mobile Recon Post, PRP-3/4			1									1
Prime Mover, MT-LBT					14							14
ACRV, 1V18			3									3
ACRV, 1V19			1									1
WEAPONS												
82-mm Mortar, M1937/2B9		12										12
122-mm Howitzer, D-30			18									18
73-mm Recoilless Gun, SPG-9		6										6
100/125-mm AT Gun, MT-12/2A45M					12							12
ATGM Manpack, AT-4/SPIGOT		12										12
ATGM Vehicle, w/AT-3/5					9							9
23-mm AA Gun, ZU-23				8								8
SAM, SA-7/14	3	27										30
ENGINEER EQUIPMENT												
Truck, Water Purification							1					1
Bridge, Truck-Launched							5					5
Minelayer, PMR-3							3					3
TRUCKS												
ACRV, 1V110 (Battery FDC)			3									3
ACRV, 1V111 (Battalion FDC)			1									1
Truck, Utility	3	51	1	1	3		1	5		2	1	68
Truck, Light	6	33	12	8	4			1		4		69
Truck, Medium		135	34		12		8			45	2	238
Truck, Decon, ARS-12U/14									3			3
Truck, Decon, DDA-53/66									1			1
Truck, Dump							2					2
Truck, Crane							1				1	2
Truck, Crane Shovel							2					2
Truck, Kitchen	1											1
Truck, POL (4,000/5,200-L)			2		2					15		19
Truck, Recovery											2	2
Truck, Water (2,000-L)	1	3							2	4		10
Van, Command	3											3
Van, Hospital											1	1
Van, Maintenance			1		2		1		2	9		14
Van, Signal			2		2			5				9
Ambulance			1		1						4	6

MOTORIZED INFANTRY BRIGADE (SEPARATE) (Cont)

<i>Principal Items of Equipment</i>	<i>Brigade HQ</i>	<i>Motorized Inf Bn (3x)</i>	<i>Artillery Bn (122-mm)</i>	<i>Air Defense Btry</i>	<i>Antitank Bn</i>	<i>Reconnaissance Co</i>	<i>Engineer Co</i>	<i>Signal Co</i>	<i>Chem Protection Plt</i>	<i>Material Support Co</i>	<i>Maintenance Co</i>	<i>Medical Plt</i>	<i>TOTAL</i>
TRAILERS													
Trailer, Cargo, 2-Axle			11		10		2			30			53
Trailer, Generator					1			4		1	6		12
Trailer, Kitchen			4		2					2			8
Trailer, POL (900/1,200-L)			2		1					15			18
Trailer, Water (900/1,200-L)			1		1				2	1			5
RADARS													
Radar, BS, Manportable, PSNR-1					3	2							5
RADIOS													
VHF, Manpack, Low-Power	14	177	20	3	10			7			1	1	233
VHF, Portable, Low-Power	2	6	2			10							20
VHF, Vehicle Mount, Medium-Power		72			28	8	4		3		5		120
HF, Manpack, Low-Power						1	4	2	1	3			11
HF, Vehicle Mount, Medium-Power	4	3			1	1		2					11
VHF, Portable, Very-Low-Power		12											12
HF/VHF, Vehicle Mount, Medium-Power			4		3			2					9
HF/VHF, Vehicle Mount, High-Power								2					2
HF, Van Mount, High-Power								1					1
Radio Relay, VHF/UHF					1			2					3
Warning Receiver	1		1		1	1		3					7
MISCELLANEOUS													
Rangefinder		3			3								6
Rangefinder, Laser, SAGE GLOSS			4										4
Periscope Aiming Circle, PAB2A		3											3
Collimator (Aiming Stakes)		12											12
Motorcycle						10							10

Motorized Infantry Brigade (Divisional)

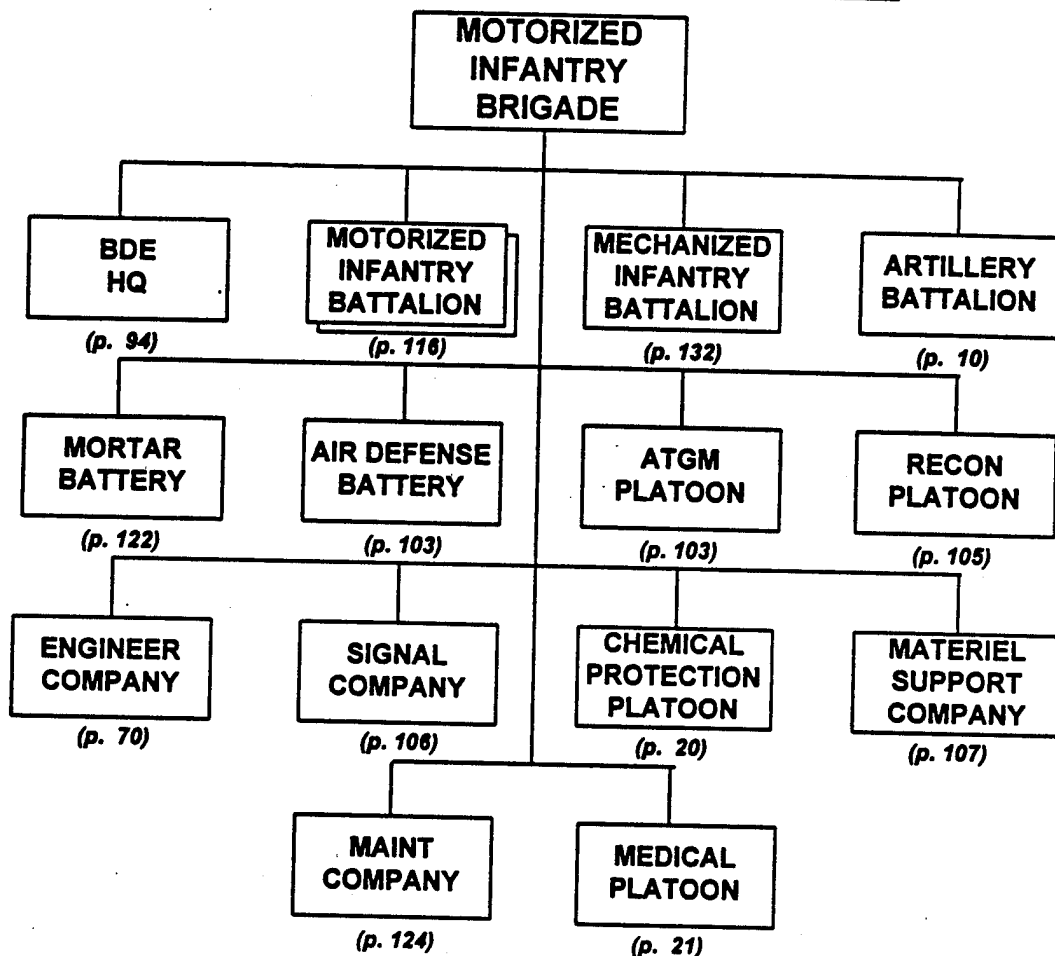

NOTES:

1. Equipment totals for the brigade headquarters and subordinate battalion headquarters reflect only the totals for the command element. Headquarters strengths vary from unit to unit at both the brigade and battalion levels, ranging from 50 personnel to over 100. These figures include staff elements, and various headquarters support functions, such as maintenance and supply. Most of these personnel, including officers, carry the AK-74 assault rifle.
2. Individual weapons for personnel are counted only at the maneuver battalion and below.
3. Night vision goggle totals, for both maneuver elements and supporting assets, do not include those worn by vehicle drivers. These figures vary widely from unit to unit, although separate brigades tend to field more goggles in combat support and combat service support units.

MOTORIZED INFANTRY BRIGADE (DIVISIONAL)															
Principal Items of Equipment	Brigade HQ	Motorized Inf Bn (2x)	Mech Inf Bn	Artillery Bn (122-mm)	Mortar Btry	Ak Defense Btry	ATGM Ptl	Reconnaissance Ptl	Engineer Co	Signal Co	Chem Protection Ptl	Material Support Co	Maintenance Co	Medical Ptl	TOTAL
ARMORED VEHICLES															
ACV, BMP-1K/2K, or ACV, BTR			1												1
AICV, BMP-1/2 or APC, BTR-60/70/80			36						3						39
ACV, BTR (R-145BM)	3		1												4
ASC, BRDM-2								4							4
Chemical Recon Vehicle, BRDM-2RKh/RKhM											3				3
Mobile Recon Post, PRP-3/4				1											1
ACRV, 1V18				3											3
ACRV, 1V19				1											1
Armored Recovery Vehicle			1												1
WEAPONS															
120-mm Mortar, M1943/2S12 or 82-mm Mortar M1937/2B9		8	6		8										22
122-mm Howitzer, D-30				18											18
73-mm Recoilless Gun, SPG-9		4													4
ATGM Manpack, AT-4/SPIGOT		8	6				6								20
23-mm AA Gun, ZU-23						8									8
SAM, SA-7/14	3	18	9												30
ENGINEER EQUIPMENT															
Truck, Water Purification									1						1
Bridge, Truck-Launched									5						5
Minelayer, PMR-3									3						3
TRUCKS															
ACRV, 1V110 (Battery FDC)				3											3
ACRV, 1V111 (Battalion FDC)				1											1
Truck, Utility	3	34	3	1	2	1			1	5		2	1		53
Truck, Light	6	22	5	12		8	3			1		4		1	62
Truck, Medium		90	15	34	9				8			45	2	2	205
Truck, Decon, ARS-12U/14											3				3
Truck, Decon, DDA-53/66											1				1
Truck, Dump									2						2
Truck, Crane			1						1				1		3
Truck, Crane Shovel									2						2
Truck, Kitchen	1														1
Truck, Recovery			1										2		3
Truck, POL (4,000/5,200-L)			2	2								15			19
Truck, Water (2,000-L)	1	2	1								2	4			10
Van, Command	3														3
Van, Hospital														1	1
Van, Maintenance				1					1			2	9		13
Van, Signal				2						5					7
Ambulance				1										4	5

MOTORIZED INFANTRY BRIGADE (DIVISIONAL) (Cont)

<i>Principal Items of Equipment</i>	<i>Brigade HQ</i>	<i>Motorized Inf Bn (2x)</i>	<i>Mechanized Inf Bn</i>	<i>Artillery Bn (122-mm)</i>	<i>Mortar Btry</i>	<i>Air Defense Btry</i>	<i>ATGM Plt</i>	<i>Reconnaissance Plt</i>	<i>Engineer Co</i>	<i>Signal Co</i>	<i>Chem Protection Plt</i>	<i>Material Support Co</i>	<i>Maintenance Co</i>	<i>Medical Plt</i>	<i>TOTAL</i>
TRAILERS															
Trailer, Cargo, 1-Axle			2												2
Trailer, Cargo, 2-Axle				11					2			30			43
Trailer, Generator			1							4		1	6		12
Trailer, Kitchen			2	4								2			8
Trailer, POL (900/1,200-L)			1	2								15			18
Trailer, Water (900/1,200-L)			1	1							2	1			5
RADARS															
Radar, BS, Manportable, PSNR-I								1							1
RADIOS															
VHF, Manpack, Low-Power	14	118	51	20	8	3	3			7			1	1	226
VHF, Portable, Low-Power	2	4	6	2											14
VHF, Vehicle Mount, Medium-Power		48	40						4		3		5		100
HF, Manpack, Low-Power									4	2	1	3			10
HF, Vehicle Mount, Medium-Power	4	2	2		3			4		2					20
VHF, Portable, Very-Low-Power		8	4												12
HF/VHF, Vehicle Mount, Medium-Power				4						2					6
HF/VHF, Vehicle Mount, High-Power										2					2
HF, Van Mount, High-Power										1					1
Radio Relay, VHF/UHF										2					2
Warning Receiver	1			1						3					5
MISCELLANEOUS															
Rangefinder		2													2
Rangefinder, Laser, SAGE GLOSS				4											4
Rangefinder, Stereoscopic, DS-1			1												1
Periscopic Aiming Circle, PAB2A		2	1		2										5
Collimator (Aiming Stakes)		8	6		8										22

Motorized Infantry Battalion, Mtzd Inf Bde (Sep and Div)

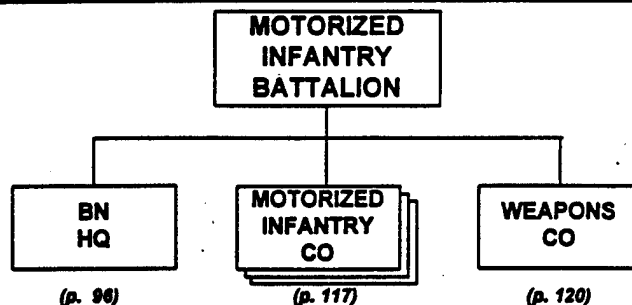

PRINCIPAL ITEMS OF EQUIPMENT

Equipment	Total
9-mm Pistol, PM.....	119
5.45-mm Assault Rifle, AK-74.....	281
5.45-mm LMG, RPK-74.....	54
7.62-mm Sniper Rifle, SVD.....	9
7.62-mm GP MG, PKM.....	27
40-mm Under-Barrel Grenade Launcher, BG-15.....	63
ATGL, RPG-7V.....	58
82-mm Mortar, M1937/2B9.....	4
SAM, SA-7/14.....	9
ATGM Manpack, AT-4/SPIGOT.....	4
73-mm Recoilless Gun, SPG-9.....	2
Truck, Utility.....	17
Truck, Light.....	11
Truck, Medium.....	45
Truck, Water (2,000-Liter).....	1

Equipment	Total
Rangefinder, Stereoscopic, DS-1.....	1
Periscopic Aiming Circle, PAB2A.....	1
Collimator (Aiming Stakes).....	4
Night Vision Goggles, Type-85.....	36
Night Vision Goggles, PNV-57.....	14
Night Vision Sight, NSP-3 (Small Arms).....	36
Night Vision Sight, PPN-3 (MG).....	27
Radios:	
VHF, Manpack, Low-Power.....	59
VHF, Portable, Low-Power.....	2
VHF, Portable, Very-Low-Power.....	4
VHF, Vehicle Mount, Medium-Power.....	24
HF, Vehicle Mount, Medium-Power.....	1

Motorized Infantry Company, Mtzd Inf Bn, Mtzd Inf Bde (Sep and Div)

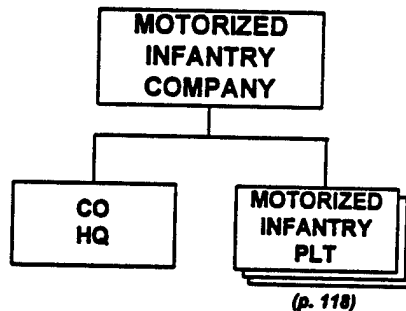

PRINCIPAL ITEMS OF EQUIPMENT

Equipment	Total
9-mm Pistol, PM.....	32
5.45-mm Assault Rifle, AK-74.....	76
5.45-mm LMG, RPK-74.....	18
7.62-mm Sniper Rifle, SVD.....	3
7.62-mm GP MG, PKM.....	9
40-mm Under-Barrel Grenade Launcher, BG-15.....	21
ATGL, RPG-7V.....	15
Truck, Utility.....	4

Equipment	Total
Truck, Medium.....	12
Night Vision Goggles, Type-85.....	12
Night Vision Goggles, PNV-57.....	4
Night Vision Sight, NSP-3 (Small Arms).....	12
Night Vision Sight, PPN-3 (MG).....	9
Radios:	
VHF, Manpack, Low-Power.....	16
VHF, Vehicle Mount, Medium-Power..	4

**Motorized Infantry Platoon, Mtzd Inf Co, Mtzd Inf Bn,
Mtzd Inf Bde (Sep and Div)**

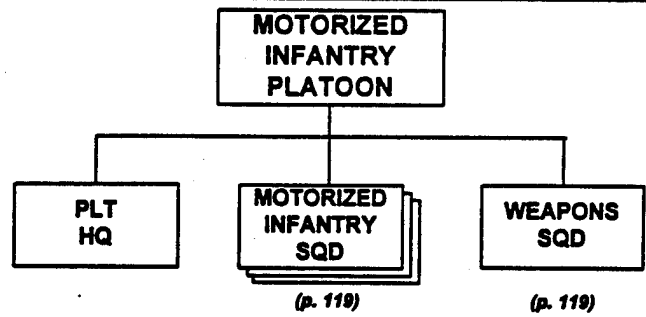

PRINCIPAL ITEMS OF EQUIPMENT

Equipment	Total
9-mm Pistol, PM.....	10
5.45-mm Assault Rifle, AK-74.....	24
5.45-mm LMG, RPK-74.....	6
7.62-mm Sniper Rifle, SVD.....	1
7.62-mm GP MG, PKM.....	3
40-mm Under-Barrel Grenade Launcher, BG-15.....	7
ATGL, RPG-7V.....	5
Truck, Utility.....	1

Equipment	Total
Truck, Medium	4
Night Vision Goggles, Type-85.....	4
Night Vision Goggles, PNV-57.....	1
Night Vision Sight, NSP-3 (Small Arms).....	4
Night Vision Sight, PPN-3 (MG)	3
Radios:	
VHF, Manpack, Low-Power.....	5
VHF, Vehicle Mount, Medium-Power ..	1

**Motorized Infantry Squad, Mtzd Inf Plt, Mtzd Inf Co, Mtzd Inf Bn,
Mtzd Inf Bde (Sep and Div)**

**MOTORIZED
INFANTRY
SQUAD**

Squad Leader.....AK-74
 Machine Gunner (x 2).....RPK-74
 Rifleman (x 5).....AK-74
 Grenadier.....RPG-7V/PM

PRINCIPAL ITEMS OF EQUIPMENT

Equipment	Total	Equipment	Total
9-mm Pistol, PM.....	1	ATGL, RPG-7V.....	1
5.45-mm Assault Rifle, AK-74.....	6	Truck, Medium.....	1
5.45-mm LMG, RPK-74.....	2	Night Vision Goggles, Type-85.....	1
7.62-mm Sniper Rifle, SVD.....	1*	Night Vision Sight, NSP-3	
40-mm Under-Barrel Grenade		(Small Arms).....	1
Launcher, BG-15.....	2	Radio, VHF, Manpack, Low-Power.....	1

FOOTNOTE: * One squad per platoon has an SVD sniper rifle.

**Weapons Squad, Mtzd Inf Plt, Mtzd Inf Co, Mtzd Inf Bn, Mtzd Inf Bde
(Sep and Div)**

**WEAPONS
SQUAD**

Squad Leader.....AK-74
 Machine Gunner (x 3).....PKM/PM
 Asst Machine Gunner (x 3)....AK-74
 Grenadier (x 2).....RPG-7V/PM

PRINCIPAL ITEMS OF EQUIPMENT

Equipment	Total	Equipment	Total
9-mm Pistol, PM.....	5	Truck, Medium.....	1
5.45-mm Assault Rifle, AK-74.....	4	Night Vision Goggles, Type-85.....	1
7.62-mm GP MG, PKM.....	3	Night Vision Sight, NSP-3	
40-mm Under-Barrel Grenade		(Small Arms).....	1
Launcher, BG-15.....	1	Night Vision Sight, PPN-3 (MG).....	3
ATGL, RPG-7V.....	2	Radio, VHF, Manpack, Low-Power.....	1

Weapons Company, Mtzd Inf Bn, Mtzd Inf Bde (Sep and Div)

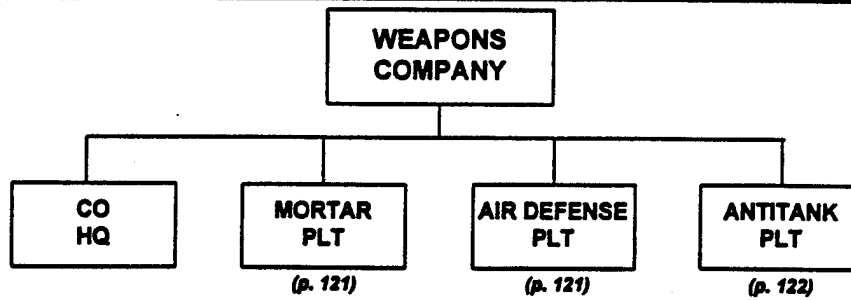

PRINCIPAL ITEMS OF EQUIPMENT

Equipment	Total
82-mm Mortar, M1937/2B9.....	4
SAM, SA-7/14	9
ATGM, AT-4/SPIGOT.....	4
73-mm Recoilless Gun, SPG-9.....	2
9-mm Pistol, PM.....	16
5.45-mm Assault Rifle, AK-74.....	56
ATGL, RPG-7V	13
Truck, Utility.....	3
Truck, Medium	8

Equipment	Total
Rangefinder, Stereoscopic, DS-1 or DM-09/DAK-1.....	1
Periscopic Aiming Circle, PAB2A	1
Collimator (Aiming Stakes).....	4
Radios:	
VHF, Manpack, Low-Power.....	8
VHF, Portable, Very-Low-Power	4
VHF, Vehicle Mount, Medium- Power	10

Mortar Platoon, Wpns Co, Mtzd Inf Bn, Mtzd Inf Bde (Sep and Div)

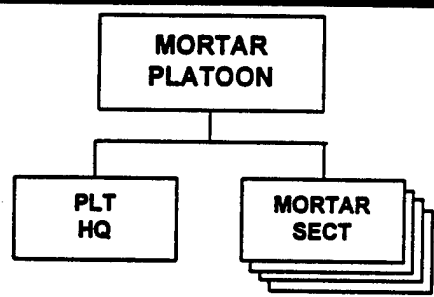

PRINCIPAL ITEMS OF EQUIPMENT

Equipment	Total	Equipment	Total
82-mm Mortar, M1937/2B9.....	4	Periscopic Aiming Circle, PAB2A	1
9-mm Pistol, PM.....	5	Collimator (Aiming Stakes).....	4
5.45-mm Assault Rifle, AK-74.....	21	Radios:	
ATGL, RPG-7V	4	VHF, Manpack, Low-Power.....	2
Truck, Utility.....	1	VHF, Vehicle Mount, Medium-	
Truck, Light	8	Power	2
Rangefinder, Stereoscopic, DS-1 or			
DM-09/DAK-1.....	1		

Air Defense Platoon, Weapons Co, Mtzd Inf Bn, Mtzd Inf Bde (Sep and Div)

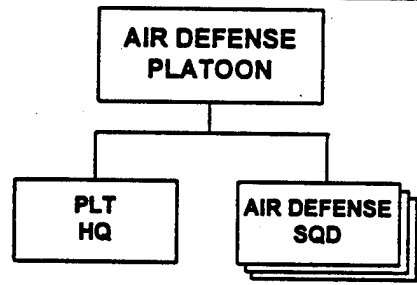

PRINCIPAL ITEMS OF EQUIPMENT

Equipment	Total	Equipment	Total
SAM, SA-7/14	9	Truck, Light	3
9-mm Pistol, PM.....	4	Radios:	
5.45-mm Assault Rifle, AK-74.....	9	VHF, Portable, Very-Low-Power.....	4
ATGL, RPG-7V	3	VHF, Vehicle Mount,	
Truck, Utility.....	1	Medium-Power	4

Antitank Platoon, Wpns Co, Mtzd Inf Bn, Mtzd Inf Bde (Sep and Div)

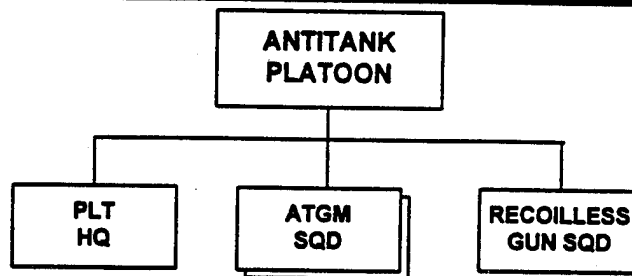

PRINCIPAL ITEMS OF EQUIPMENT

Equipment	Total	Equipment	Total
ATGM, AT-4/SPIGOT	4	Truck, Light	3
72-mm Recoilless Gun, SPG 9	2	Radios:	
9-mm Pistol, PM	7	VHF, Manpack, Low-Power	6
5.45-mm Assault Rifle, AK-74	26	VHF, Vehicle Mount,	
ATGL, RPG-7V	6	Medium-Power	4
Truck, Utility	1		

Mortar Battery, Mtzd Inf Bde (Div)

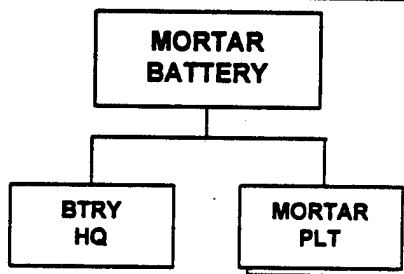

(p. 123)

PRINCIPAL ITEMS OF EQUIPMENT

Equipment	Total	Equipment	Total
120-mm Mortar, M1943/2S12	8	Collimator (Aiming Stakes)	8
ATGL, RPG-7V	8	Radios:	
Truck, Utility	2	VHF, Manpack, Low-Power	8
Truck, Medium	9	HF, Vehicle Mount,	
Periscopic Aiming Circle, PAB2A	2	Medium-Power	3

NOTE: Weapon and equipment figures assume a well-equipped headquarters element, which would include the battery headquarters, forward observer/reconnaissance section, radio telephone section, and transport section.

Mortar Platoon, Mortar Btry, Mtzd Inf Bde (Div)

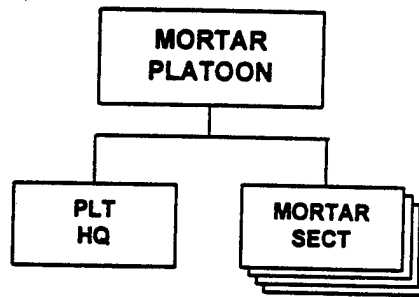

PRINCIPAL ITEMS OF EQUIPMENT

Equipment	Total	Equipment	Total
120-mm Mortar, M1943/2S12	4	Radios:	
ATGL, RPG-7V	4	VHF, Manpack, Low-Power	4
Truck, Light	4	HF, Vehicle Mount, Medium-	
Periscopic Aiming Circle, PAB2A	1	Power	1
Collimator (Aiming Stakes)	4		

**Maintenance Company, Mtzd Inf Bde (Sep and Div), Mech Inf Bde
(Sep and Div), and Tank Bde**

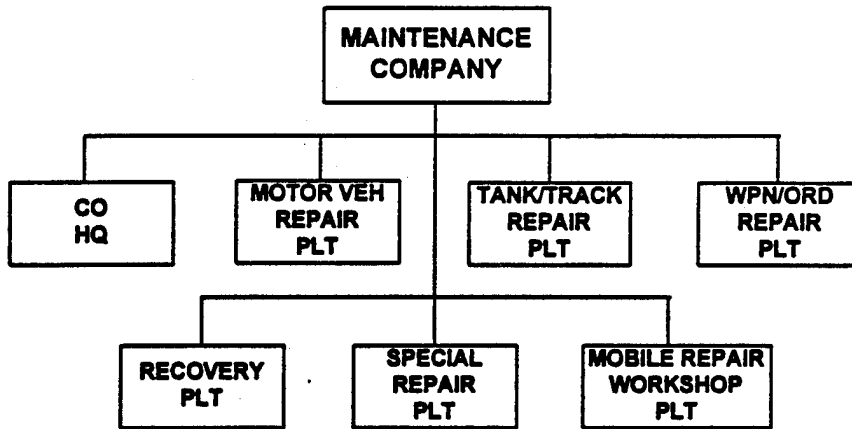

PRINCIPAL ITEMS OF EQUIPMENT

<u>Equipment</u>	<u>Total</u>	<u>Equipment</u>	<u>Total</u>
Van, Maintenance	9	Trailer, Generator	6
ATGL, RPG-7V	3	Radios:	
Truck, Crane	1	VHF, Manpack, Low-Power	1
Truck, Medium	2	VHF, Vehicle Mount,	
Truck, Recovery	2	Medium-Power	5
Truck, Utility	1		

NOTE: The special repair platoon consists of an arc and gas welding section, battery repair and recharging section, and electrical repair section.

Mechanized Infantry Brigade (Separate)

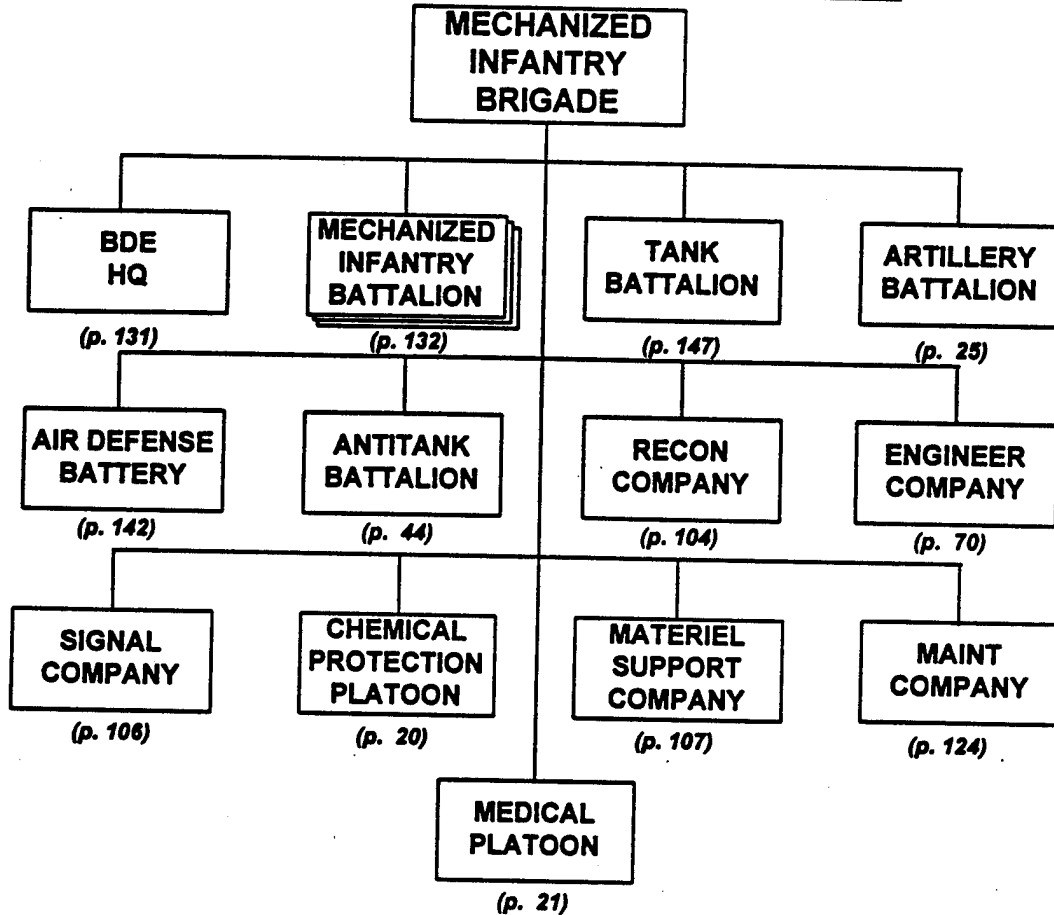

NOTES:

1. Equipment totals for the brigade headquarters and subordinate battalion headquarters reflect only the totals for the command element. Headquarters strengths vary from unit to unit at both the brigade and battalion levels, ranging from 50 personnel to over 100. These figures include staff elements, and various headquarters support functions, such as maintenance and supply. Most of these personnel, including officers, carry the AK-74 assault rifle.
2. Individual weapons for personnel are counted only at the maneuver battalion and below.
3. Night vision goggle totals, for both maneuver elements and supporting assets, do not include those worn by vehicle drivers. These figures vary widely from unit to unit, although separate brigades tend to field more goggles in combat support and combat service support units.

MECHANIZED INFANTRY BRIGADE (SEPARATE)														
Principal Items of Equipment	Brigade HQ	Mechanized Inf Bn (3x)	Tank Bn	Artillery Bn (122-mm)	Air Defense Btry	Antitank Bn	Reconnaissance Co	Engineer Co	Signal Co	Chem Protection Plt	Material Support Co	Maintenance Co	Medical Plt	TOTAL
ARMORED VEHICLES														
Medium Tank, T-55K/62K			1											1
Medium Tank, T-55/62			21											21
ACV, BMP-1K/2K, or ACV, BTR		3	1											4
AICV, BMP-1/2, or APC, BTR-60/70/80		108						3						111
ACV, BTR (R-145BM)/BMP-1KSh	3	3	1			5								12
ASC, BRDM-2							8							8
ACV, BRDM-2U							1							1
Chemical Recon Vehicle, BRDM-2RKh/RKhM										3				3
Mobile Recon Post, PRP-3/4				1										1
Prime Mover, MT-LBT						14								14
ACRV, 1V13/1V13M/1V22				3										3
ACRV, 1V14/1V14M/1V23				3										3
ACRV, 1V15/1V15M/1V24				1										1
ACRV, 1V16/1V16M/1V25				1										1
ACV, BTR-60 (PU-12)					1									1
Armored Recovery Vehicle		3												3
WEAPONS														
120-mm Mortar, M1943/2S12, or 82-mm Mortar, M1937/2B9		18												18
122-mm SP Howitzer, 2S1				18										18
100/125-mm AT Gun, MT-12/2A45M						12								12
ATGM Manpack, AT-4/SPIGOT		18												18
ATGM Vehicle, w/AT-3/5						9								9
23-mm AA Gun, ZU-23					8									8
SAM, SA-7/14	3	27												30
ENGINEER EQUIPMENT														
Truck, Water Purification								1						1
Bridge, Truck-Launched								5						5
Ditching Machine, PZM/TMK								4						4
Dozer								1						1
Mineslayer, PMR-3								3						3
Mineclearing Plow								9						9
Mine Roller-Plow								3						3
TRUCKS														
Truck, Utility	3	9				3		1	5		2	1		24
Truck, Light	6	15		4	1	4		1		4		1		36
Truck, Medium		45	7	14	6	12		8		45	2	2		141
Truck, Crane		3						1			1			5
Truck, Crane Shovel								2						2
Truck Decon, ARS-12U/14										3				3
Truck, Decon, DDA-53/66										1				1
Truck, Dump								2						2
Truck, Kitchen	1													1
Truck, POL (4000/5200-L)		6	3	2		2					15			28
Truck, Recovery		3										2		5
Truck, Water (2,000-L)	1	3								2	4			10
Van, Command	3													3
Van, Hospital													1	1
Van, Kitchen			1											1
Van, Maintenance			1	2		2		1			2	9		17
Van, Signal				3		2			5					10
Ambulance			1	1		1							4	7

MECHANIZED INFANTRY BRIGADE (SEPARATE) (Cont)

<i>Principal Items of Equipment</i>	<i>Brigade HQ</i>												<i>TOTAL</i>
	<i>Mechanized Inf Bn (3x)</i>	<i>Tank Bn</i>	<i>Artillery Bn (122-mm)</i>	<i>Air Defense Btry</i>	<i>Antitank Bn</i>	<i>Reconnaissance Co</i>	<i>Engineer Co</i>	<i>Signal Co</i>	<i>Chem Protection Plt</i>	<i>Material Support Co</i>	<i>Maintenance Co</i>	<i>Medical Plt</i>	
TRAILERS													
Trailer, Cargo, 1-Axle		6	1										7
Trailer, Cargo, 2-Axle			6	16		10		2		30			64
Trailer, Generator		3	1	2	2	1			4	1	6		20
Trailer, Kitchen		6		3		2				2			13
Trailer, POL (900/1,200-L)		3	1	2		1				15			22
Trailer, Water (900/1,200-L)		3	3	1		1			2	1			11
RADARS													
Radar, BS, Manportable, PSNR-1						3	2						5
RADIOS													
VHF, Manpack, Low-Power	14	153	1	10		10			7		1	1	197
VHF, Portable, Low-Power	2	30			1		10						43
VHF, Portable, Very-Low-Power									3				3
VHF, Vehicle Mount, Medium-Power		120	24	28	9	28	8	4		1		5	227
HF, Manpack, Low-Power			2				1	4	2		3		12
HF, Vehicle Mount, Medium-Power	4	6	5			1	1		2				19
HF/VHF, Vehicle Mount, Medium-Power						3			2				5
HF/VHF, Vehicle Mount, High-Power									2				2
HF, Van Mount, High-Power									1				1
Radio Relay, VHF/UHF						1			2				3
Warning Receiver	1		1	2	3	1	1		3				12
MISCELLANEOUS													
Rangefinder						3							3
Rangefinder, Laser, SAGE GLOSS				4									4
Rangefinder, Stereoscopic		3											3
Periscopic Aiming Circle		3											3
Collimator (Aiming Stakes)		18											18
Motorcycle							10						10

Mechanized Infantry Brigade (Divisional)

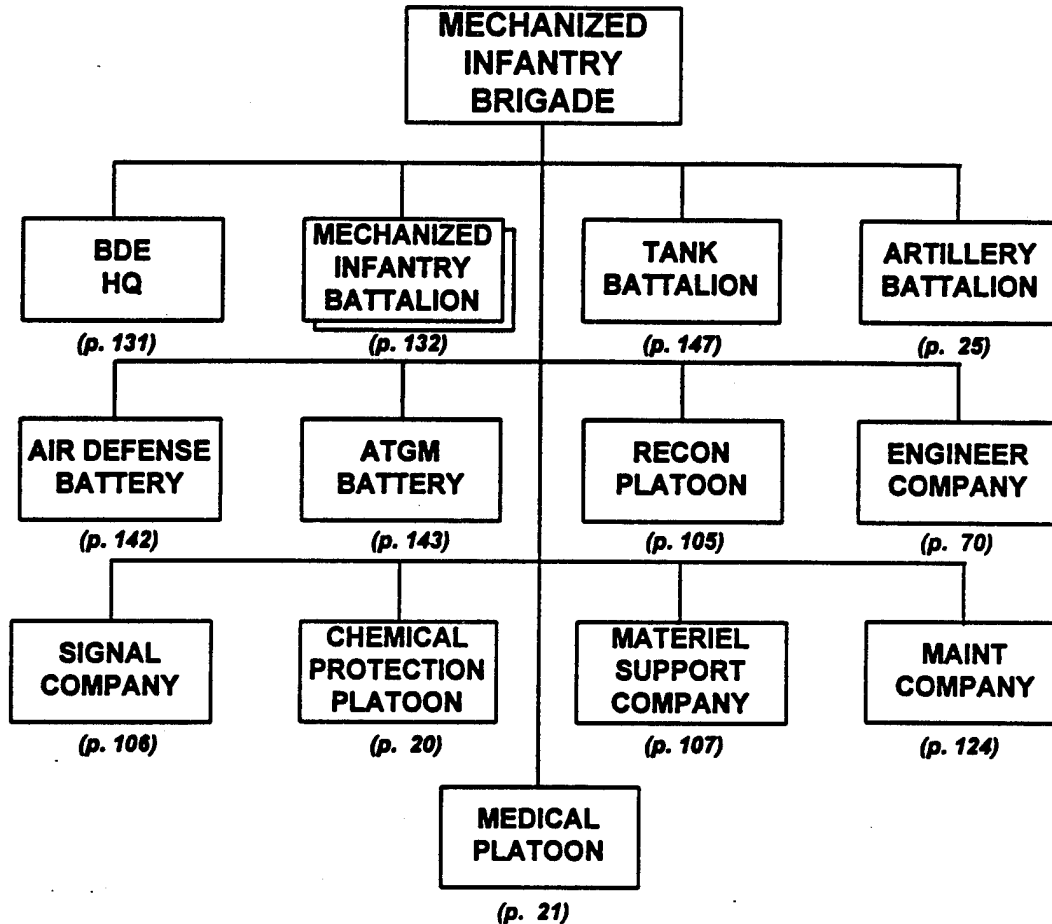

NOTES:

1. Equipment totals for the brigade headquarters and subordinate battalion headquarters reflect only the totals for the command element. Headquarters strengths vary from unit to unit at both the brigade and battalion levels, ranging from 50 personnel to over 100. These figures include staff elements, and various headquarters support functions, such as maintenance and supply. Most of these personnel, including officers, carry the AK-74 assault rifle.
2. Individual weapons for personnel are counted only at the maneuver battalion and below.
3. Night vision goggle totals, for both maneuver elements and supporting assets, do not include those worn by vehicle drivers. These figures vary widely from unit to unit, although separate brigades tend to field more goggles in combat support and combat service support units.

MECHANIZED INFANTRY BRIGADE (DIVISIONAL)														
Principal Items of Equipment														
	Brigade HQ	Mechanized Inf Bn (2x)	Tank Bn	Artillery Bn (122-mm)	Air Defense Bty	Antitank Bn	Reconnaissance Plt	Engineer Co	Signal Co	Chem Protection Plt	Material Support Co	Maintenance Co	Medical Plt	TOTAL
ARMORED VEHICLES														
Medium Tank, T-55K/62K			1											1
Medium Tank, T-55K/2			21											21
ACV, BMP-1K/2K, or ACV, BTR		2	1											3
AICV, BMP-1/2, or APC, BTR-60/70/80		72	1					3						76
ACV, BTR (R-145BM)/BMP-1KSh	3	2	1			3								11
ASC, BRDM-2							4							4
Chemical Recon Vehicle, BRDM-2RKR/KHM										3				3
Mobile Recon Post, PRP-3/4				1										1
Prime Mover, MT-LBT						14								14
ACRV, 1V13/1V13M/1V22				3										3
ACRV, 1V14/1V14M/1V23				3										3
ACRV, 1V15/1V15M/1V24				1										1
ACRV, 1V16/1V16M/1V25				1										1
ACV, BTR-60 (PU-12)					1									1
Armored Recovery Vehicle		2												2
WEAPONS														
120-mm Mortar, M1943/2S12, or 82-mm Mortar, M1937/2B9		12												12
122-mm SP Howitzer, 2S1				18										18
100/123-mm AT Gun, MT-12/2A45M						12								12
ATGM Manpack, AT-4/SPIGOT		12												12
ATGM Vehicle, w/AT-5/6						9								9
23-mm SPAA Gun, ZSU-23-4					8									8
SAM, SA-7/14	3	18												21
ENGINEER EQUIPMENT														
Truck, Water Purification							1							1
Bridge, Truck-Launched							5							5
Ditching Machine							4							4
Dozer							1							1
Minelayer, PMR							3							3
Mineclearing Plow							9							9
Mine-Roller Plow							3							3
TRUCKS														
Truck, Utility	3	6				3	1	5		2	1			21
Truck, Light	6	10		4	1	4		1		4		1		31
Truck, Medium		30	7	14	6	12	8			45	2	2		126
Truck, Decon, ARS-12U/14									3					3
Truck, Decon, DDA-53/66									1			1		2
Truck, Dump							2							2
Truck, Crane		2					1				1			4
Truck, Crane Shovel							2							2
Truck, Kitchen	1													1
Truck, POL (4,000/5,200-L)		4	3	2		2				15				26
Truck, Recovery		2												2
Truck, Water (2,000-L)	1	2							2	4				9
Van, Command	3													3
Van, Hospital													1	1
Van, Kitchen			1											1
Van, Maintenance			1	2		2	1			2	9			17
Van, Signal				3		2		5						10
Ambulance			1	1		1						4		7

MECHANIZED INFANTRY BRIGADE (DIVISIONAL) (Cont)

<i>Principal Items of Equipment</i>	<i>Brigade HQ</i>	<i>Mechanized Inf Bn (2x)</i>	<i>Tank Bn</i>	<i>Artillery Bn (122-mm)</i>	<i>Air Defense Btry</i>	<i>Antitank Bn</i>	<i>Reconnaissance Plt</i>	<i>Engineer Co</i>	<i>Signal Co</i>	<i>Chem Protection Plt</i>	<i>Material Support Co</i>	<i>Maintenance Co</i>	<i>Medical Plt</i>	<i>TOTAL</i>
TRAILERS														
Trailer, Cargo, 1-Axle		4	1											5
Trailer, Cargo, 2-Axle			6	16		10		2			30			64
Trailer, Generator		2	1	2	2	1			4		1	6		19
Trailer, Kitchen		4		3		2					2			11
Trailer, POL (900/1,200-L)		2	1	2		1					15			21
Trailer, Water (900/2,000-L)		2	3	1		1				2	1			10
RADARS														
Radar, BS, Manportable, PSNR-1						3	1							4
RADIOS														
VHF, Manpack, Low-Power	14	102	1	10		10			7			1	1	146
VHF, Portable, Low-Power	2	12			1									15
VHF, Vehicle Mount, Medium-Power		80	24	28	9	28	4	4		3		5		185
HF, Manpack, Low-Power			2				1	4	2	1	3			13
VHF, Portable, Very-Low-Power		8												8
HF, Vehicle Mount, Medium-Power	4	4	5			1			2					16
HF/VHF, Vehicle Mount, Medium-Power		4				3			2					9
HF/VHF, Vehicle Mount, High-Power									2					2
HF, Van Mount, High-Power									1					1
Radio Relay, VHF/UHF						1			2					3
Warning Receiver	1		1	2	3	1			3					11
MISCELLANEOUS														
Rangefinder						3								3
Rangefinder, Laser, SAGE GLOSS				4										4
Rangefinder, Stereoscopic, DS-1		2												2
Periscopic Aiming Circle, PAB2A		2												2
Collimator (Aiming Stakes)		12												12

**Brigade Headquarters, Mech Inf Bde (Sep and Div)
and Tank Bde**

**BRIGADE
HEADQUARTERS**

PRINCIPAL ITEMS OF EQUIPMENT

Equipment	Total	Equipment	Total
ACV, BTR (R-145BM)/BMP-1KSh	3	Radios:	
SAM, SA-7/14	3	VHF, Manpack, Low-Power	14
Truck, Utility	3	VHF, Portable, Low-Power	2
Truck, Light	6	HF, Vehicle Mount, Medium	
Van, Command	3	Power	4
Truck, Water (2,000-Liter)	1	Warning Receiver	1
Truck, Kitchen	1		

Mechanized Infantry Battalion, Mech Inf Bde (Sep and Div)

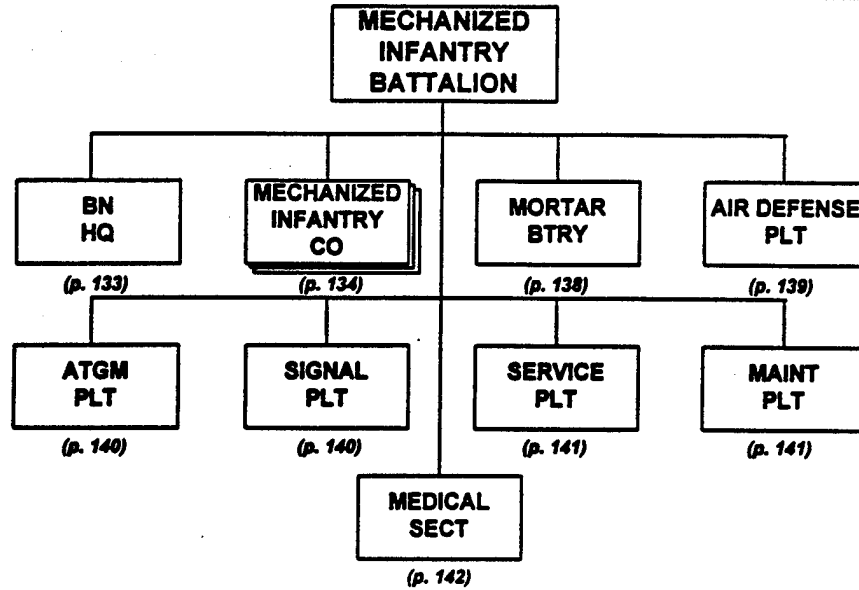

PRINCIPAL ITEMS OF EQUIPMENT

Equipment	Total	Equipment	Total
ACV, BMP-1K/2K or ACV, BTR (R-145BM).....	1	Truck, Crane	1
AICV, BMP-1/2 or BTR-60/70/80	36	Truck, POL (4,000 or 5,200-Liter)	2
ACV, BTR (R-145BM)	1	Trailer, POL (900-Liter)	1
9-mm Pistol, PM.....	120	Trailer, Water (900-Liter)	1
5.45-mm Assault Rifle, AK-74.....	327	Trailer, Cargo, 1-Axle.....	2
5.45-mm LMG, RPK-74	27	Trailer, Kitchen.....	2
7.62-mm Sniper Rifle, SVD.....	9	Trailer, Generator.....	1
40-mm Under-Barrel Grenade Launcher, BG-15.....	54	Rangefinder, Stereoscopic, DS-1	1
ATGL, RPG-7V	36	Periscopic Aiming Circle, PAB2A	1
120-mm Mortar, M1943/2S12 or 82-mm Mortar, M1937/2B9.....	6	Collimator (Aiming Stakes).....	6
SAM, SA-7/14	9	Night Vision Goggles, PNV-57	56
ATGM Manpack, AT-4/SPIGOT	6	Night Vision Sight, NSP-3 (Small Arms).....	53
Armored Recovery Vehicle	1	Radios:	
Truck, Utility.....	3	VHF, Manpack, Low-Power.....	51
Truck, Light	5	VHF, Portable, Low-Power	6
Truck, Medium	15	VHF, Portable, Very-Low-Power	4
Truck, Recovery.....	1	VHF, Vehicle Mount, Medium-Power	40
Truck, Water (2,000-Liter).....	1	HF, Vehicle Mount, Medium-Power	2

Battalion Headquarters, Mech Inf Bn, Mech Inf Bde (Sep and Div)

**BATTALION
HEADQUARTERS**

PRINCIPAL ITEMS OF EQUIPMENT

Equipment	Total	Equipment	Total
ACV, BMP-1K/2K or ACV, BTR (R-145BM).....	1	Radios:	
9-mm Pistol, PM.....	4	VHF, Manpack, Low-Power.....	2
5.45-mm Assault Rifle, AK-74.....	8	VHF, Portable, Low-Power.....	2
Truck, Utility.....	1	VHF, Vehicle Mount, Medium-Power.....	1
Truck, Light.....	1	HF, Vehicle Mount, Medium-Power.....	1
Truck, Water (2,000-Liter).....	1		

Mechanized Infantry Company, Mech Inf Bn, Mech Inf Bde (Sep and Div)

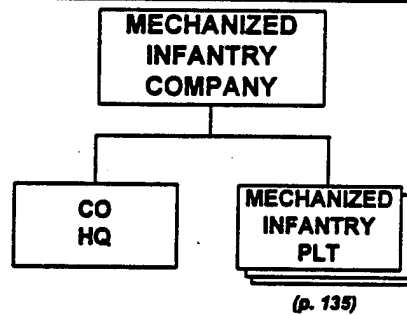

PRINCIPAL ITEMS OF EQUIPMENT

Equipment	Total	Equipment	Total
AICV, BMP-1/2 or APC, BTR-60/70/80	10	40-mm Under-Barrel Grenade Launcher, BG-15.....	18
9-mm Pistol, PM.....	32	Night Vision Goggles, PNV-57	13
5.45-mm Assault Rifle, AK-74.....	61	Night Vision Sight, NSP-3 (Small Arms)....	9
5.45-mm LMG, RPK-74.....	9	Radios:	
7.62-mm Sniper Rifle, SVD.....	3	VHF, Manpack, Low-Power	12
ATGL, RPG-7V	10	VHF, Vehicle Mount, Medium-Power	9

NOTE: Although not standard, some divisional BTR and BMP-equipped companies still have a machine gun platoon. The organization is listed on page 51.

**Mechanized Infantry Platoon, Mech Inf Co, Mech Inf Bn,
Mech Inf Bde (Sep and Div)**

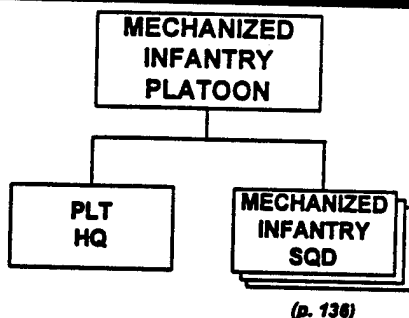

PRINCIPAL ITEMS OF EQUIPMENT

Equipment	Total
AICV, BMP-1/2 or APC, BTR-60/70/80	3
9-mm Pistol, PM	10
5.45-mm Assault Rifle, AK-74	19
5.45-mm LMG, RPK-74	3
7.62-mm Sniper Rifle, SVD	1
40-mm Under-Barrel Grenade Launcher, BG-15	6

Equipment	Total
ATGL, RPG-7V	3
Night Vision Goggles, PNV-57	4
Night Vision Sight, NSP-3 (Small Arms)	3
Radios:	
VHF, Vehicle Mount, Medium-Power	3
VHF, Manpack, Low-Power	4

**Mechanized Infantry Squad, Mech Inf Plt, Mech Inf Co, Mech Inf Bn,
Mech Inf Bde (Sep and Div)**

**MECHANIZED
INFANTRY
SQUAD**

Squad Leader/Vehicle Commander.....AK-74
 Asst Squad Leader/Vehicle Gunner.....PM/AK-74
 Vehicle Driver/Mechanic.....PM
 Machine Gunner.....RPK-74
 Grenadier.....RPG-7V/PM
 Rifleman (x 4).....AK-74

PRINCIPAL ITEMS OF EQUIPMENT

<u>Equipment</u>	<u>Total</u>	<u>Equipment</u>	<u>Total</u>
AICV, BMP-1/2 or APC, BTR-60/70/80	1	ATGL, RPG-7V	1
9-mm Pistol, PM	3	Night Vision Goggles, PNV-57	1
5.45-mm Assault Rifle, AK-74	6	Night Vision Sight, NSP-3 (Small Arms)....	1
5.45-mm LMG, RPK-74	*1	Radios:	
7.62-mm Sniper Rifle, SVD	**1	VHF, Vehicle Mount,	
40-mm Under-Barrel Grenade Launcher, BG-15	2	Medium-Power	1
		VHF, Manpack, Low-Power	1

FOOTNOTES:

- *Some units have equipped the senior rifleman with a RPK-74 instead of the AK-74, which would bring the equipment totals to five and two, respectively.
- **One squad per platoon has an SVD sniper rifle.

**Machine Gun Platoon, Mech Inf Co, Mech Inf Bn,
Mech Inf Bde (Div)**

**MACHINE GUN
PLATOON**

PRINCIPAL ITEMS OF EQUIPMENT

<u>Equipment</u>	<u>Total</u>	<u>Equipment</u>	<u>Total</u>
AICV, BMP-1/2 or APC, BTR-60/70/80	2	Night Vision Sight, NSP-3 (Small Arms).....	1
9-mm Pistol, PM	9	Night Vision Sight, PPN-3 (MG)	6
5.45-mm Assault Rifle, AK-74.....	6	Radios:	
7.62-mm GP MG, PKM.....	6	VHF, Manpack, Low-Power.....	1
40-mm Under-Barrel Grenade Launcher, BG-15.....	2	VHF, Vehicle Mount, Medium-Power	2

Mortar Battery, Mech Inf Bn, Mech Inf Bde (Sep and Div)

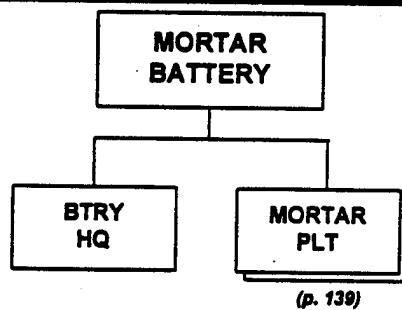

PRINCIPAL ITEMS OF EQUIPMENT

Equipment	Total	Equipment	Total
120-mm Mortar, M1943/2S12 or		Periscopic Aiming Circle, PAB2A	1
82-mm Mortar, M1937/2B9.....	6	Collimator (Aiming Stakes).....	6
9-mm Pistol, PM.....	10	Night Vision Goggles, PNV-57	3
5.45-mm Assault Rifle, AK-74.....	47	Night Vision Sight, NSP-3 (Small Arms)....	6
ATGL, RPG-7V.....	6	Radios:	
Truck, Utility.....	1	VHF, Manpack, Low-Power.....	6
Truck, Medium	7	VHF, Vehicle Mount,	
Rangefinder, Stereoscopic, DS-1	1	Medium-Power	3

NOTE: Weapon figures assume a well-equipped headquarters element, which would include the battery headquarters, forward observer/reconnaissance section, radio telephone section, and transport section.

Mortar Platoon, Mortar Btry, Mech Inf Bn, Mech Inf Bde (Sep and Div)

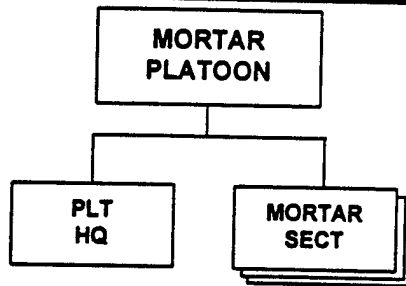

PRINCIPAL ITEMS OF EQUIPMENT

Equipment	Total	Equipment	Total
120-mm Mortar, M1943/2S12 or 82-mm Mortar, M1937/2B9.....	3	Collimators (Aiming Stakes)	3
9-mm Pistol, PM	4	Night Vision Goggles, PNV-57	1
5.45-mm Assault Rifle, AK-74.....	18	Night Vision Sight, NSP-3 (Small Arms)....	3
ATGL, RPG-7V	3	Radios:	
Truck, Medium	3	VHF, Manpack, Low-Power	3
Periscopic Aiming Circle, PAB2A	1	VHF, Vehicle Mount, Medium-Power	1

Air Defense Platoon, Mech Inf Bn, Mech Inf Bde (Sep and Div)

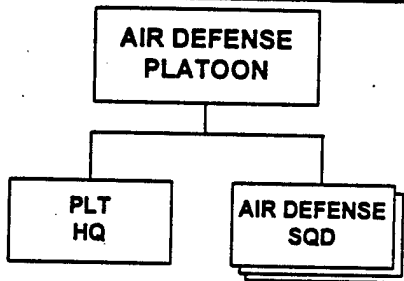

PRINCIPAL ITEMS OF EQUIPMENT

Equipment	Total	Equipment	Total
SAM, SA-7/14	9	Night Vision Sight, NSP-3 (Small Arms)....	3
AICV, BMP-1/2 or ACV, BTR-60/70/80	3	Radios:	
9-mm Pistol, PM	4	VHF, Portable, Very-Low-Power	4
5.45-mm Assault Rifle, AK-74.....	9	VHF, Vehicle Mount, Medium-Power	3
Night Vision Goggles, PNV-57	4		

ATGM Platoon, Mech Inf Bn, Mech Inf Bde (Sep and Div)

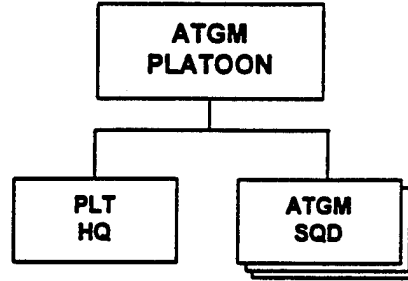

PRINCIPAL ITEMS OF EQUIPMENT

Equipment	Total	Equipment	Total
ATGM Manpack Launcher, AT-4/SPIGOT	6	Night Vision Goggles, PNV-57	4
AICV, BMP-1/2, or APC, BTR-60/70/80	3	Night Vision Sight, NSP-3 (Small Arms)....	3
9-mm Pistol, PM	3	Radios:	
5.45-mm Assault Rifle, AK-74	24	VHF, Portable, Low-Power	3
		VHF, Vehicle Mount, Medium-Power	3

Signal Platoon, Mech Inf Bn, Mech Inf Bde (Sep and Div)

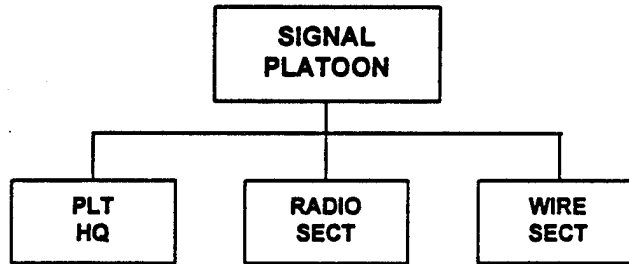

PRINCIPAL ITEMS OF EQUIPMENT

Equipment	Total	Equipment	Total
9-mm Pistol, PM	1	Radios:	
5.45-mm Assault Rifle, AK-74	13	VHF, Manpack, Low-Power	3
ACV, BTR (R-145BM)	1	VHF, Vehicle Mount, Medium-Power	3
Truck, Utility	1	HF, Vehicle Mount, Medium-Power	1
Truck, Medium	2		
Van, Signal	1		
Night Vision Goggles, PNV-57	4		
Night Vision Sight, NSP-3 (Small Arms)....	2		

Service Platoon, Mech Inf Bn, Mech Inf Bde (Sep and Div)

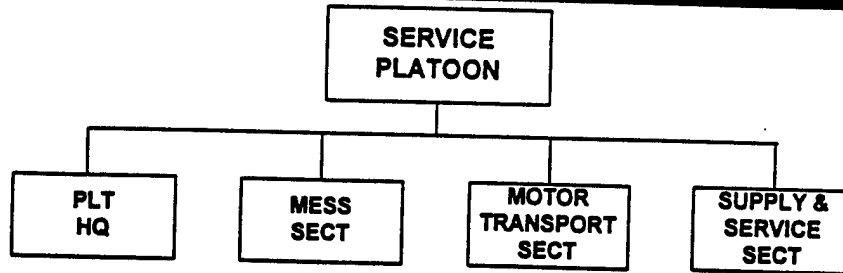

PRINCIPAL ITEMS OF EQUIPMENT

Equipment	Total	Equipment	Total
9-mm Pistol, PM.....	1	Trailer Cargo, 1-Axle.....	1
5.45-mm Assault Rifle, AK-74.....	19	Trailer, Water (900-Liter).....	1
Truck, Light.....	4	Trailer, Kitchen.....	2
Truck, Medium.....	4	Night Vision Sight, NSP-3 (Small Arms)....	2
Truck, POL (4,000 or 5,200-Liter).....	2	Radio, VHF, Manpack, Low-Power.....	3
Trailer, POL (900-Liter).....	1		

Maintenance Platoon, Mech Inf Bn, Mech Inf Bde (Sep and Div)

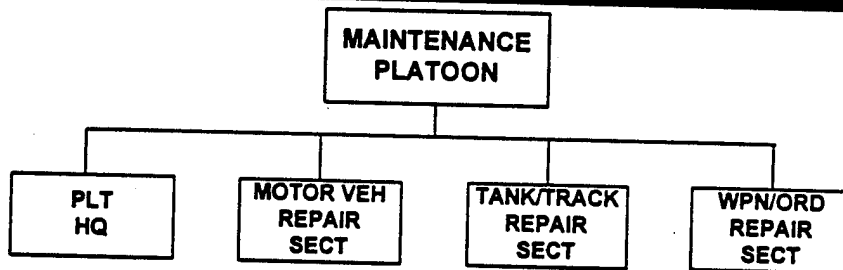

PRINCIPAL ITEMS OF EQUIPMENT

Equipment	Total	Equipment	Total
9-mm Pistol, PM.....	1	Truck, Recovery.....	1
5.45-mm Assault Rifle, AK-74.....	21	Armored Recovery Vehicle.....	1
Van, Maintenance.....	4	Trailer, Generator.....	1
Truck, Crane.....	1	Night Vision Sight, NSP-3 (Small Arms)....	4
Truck, Medium.....	2	Radio, VHF, Manpack, Low-Power.....	1

Medical Section, Mech Inf Bn, Mech Inf Bde (Sep and Div)

MEDICAL SECTION

PRINCIPAL ITEMS OF EQUIPMENT

Equipment	Total	Equipment	Total
Ambulance	1	Night Vision Goggles, PNV-57	1
5.45-mm Assault Rifle, AK-74	3	Night Vision Sight, NSP-3 (Small Arms)....	1
Trailer, Cargo, 1-Axle.....	1	Radio, VHF, Portable, Low-Power.....	1

Air Defense Battery, Mech Inf Bde (Sep and Div)

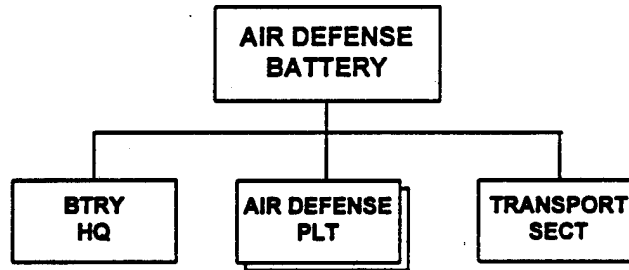

PRINCIPAL ITEMS OF EQUIPMENT

Equipment	Total	Equipment	Total
23-mm SPAA Gun, ZSU-23-4*	8	Radios:	
ACV, BTR-60 (PU-12).....	1	VHF, Portable, Low-Power	1
Truck, Light	1	VHF, Vehicle Mount,	
Truck, Medium	4	Medium-Power	9
Trailer, Generator.....	2	Warning Receiver	3

NOTE: Some units have one SA-9/GASKIN platoon (4) and one ZSU-23-4 platoon.

FOOTNOTE: * This system includes the GUN DISH fire control radar.

ATGM Battery, Mech Inf Bde (Div)

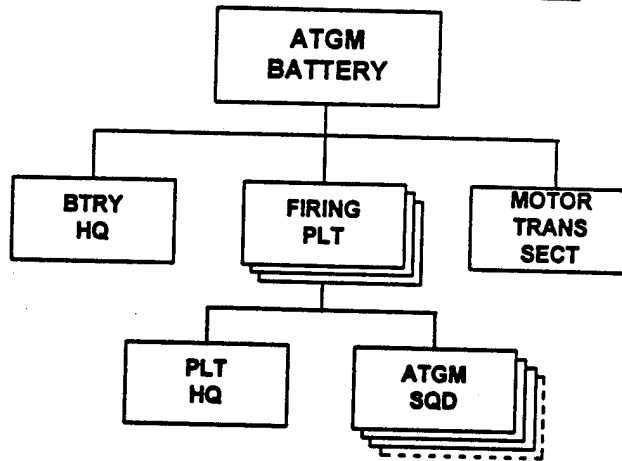

PRINCIPAL ITEMS OF EQUIPMENT

Equipment	Total	Equipment	Total
ATGM Vehicle, BRDM-2 w/AT-3/ SAGGER or AT-5/SPANDREL.....	9-12	Radar, Battlefield Surveillance, Man-Portable, PSNR-1	1
ATGL, RPG-7V	9-12	Radios:	
ACV, BRDM-2U	4	VHF, Manpack, Low-Power.....	4
Truck, Medium	3	VHF, Vehicle Mount, Medium-Power	13-16
Rangefinder.....	1		

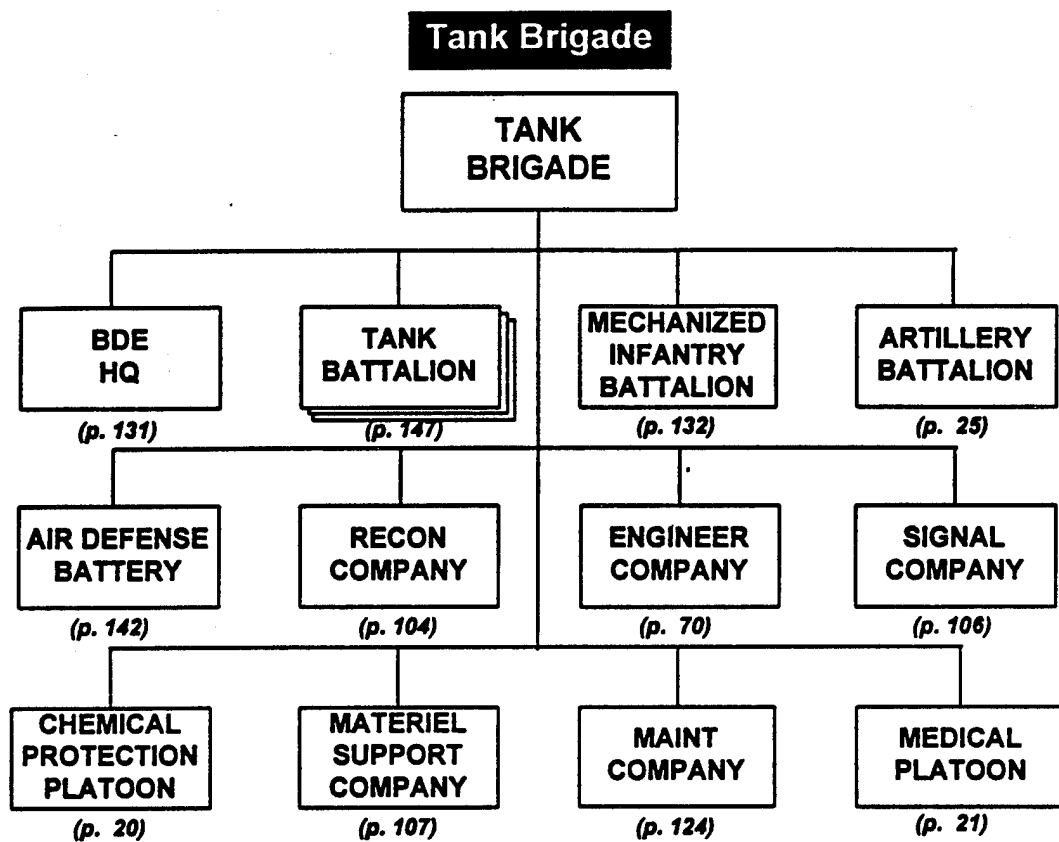

NOTES:

1. Equipment totals for the brigade headquarters and subordinate battalion headquarters reflect only the totals for the command element. Headquarters strengths vary from unit to unit at both the brigade and battalion levels, ranging from 50 personnel to over 100. These figures include staff elements, and various headquarters support functions, such as maintenance and supply. Most of these personnel, including officers, carry the AK-74 assault rifle.
2. Individual weapons for personnel are counted only at the maneuver battalion and below.
3. Night vision goggle totals, for both maneuver elements and supporting assets, do not include those worn by vehicle drivers. These figures vary widely from unit to unit, although separate brigades tend to field more goggles in combat support and combat service support units.

TANK BRIGADE													
Principal Items of Equipment	Brigade HQ	Tank Bn (3x)	Mechanized Inf Bn	Artillery Bn (122-mm)	Air Defense Btry	Reconnaissance Co	Engineer Co	Signal Co	Chem Protection Plt	Material Support Co	Maintenance Co	Medical Plt	TOTAL
ARMORED VEHICLES													
Medium Tank, T-55K/62K		3											3
Medium Tank, T-55/62		63											63
ACV, BMP-1K/2K, or ACV, BTR		3	1										4
AICV, BMP-1/2 or APC, BTR-60/70/80			36										36
ACV, BTR (R-145BM)/BMP-1Ksh	3	3	1										7
ASC, BRDM-2						8							8
ACV, BRDM-2U						1							1
ACV, BTR-60 (PU)					1								1
Chemical Recon Vehicle, BRDM-2RKb/RKbM									3				3
Mobile Recon Post, PRP-3/4				1									1
ACRV, 1V13/1V13M/1V22				3									3
ACRV, 1V14/1V14M/1V23				3									3
ACRV, 1V15/1V15M/1V24				1									1
ACRV, 1V16/1V16M/1V25				1									1
Armored Recovery Vehicle			1										1
WEAPONS													
120-mm Mortar, M1943/2S12 or 82-mm Mortar, M1937/2B9			6										6
122-mm SP Howitzer, 2S1				18									18
ATGM Manpack, AT-4/SPIGOT			6										6
23-mm SPAA Gun, ZSU-23-4					8								8
SAM, SA-7/14	3		9										12
ENGINEER EQUIPMENT													
Truck, Water Purification							1						1
Bridge, Truck-Launched							5						5
Ditching Machine, BTM/MDK							4						4
Dozer							1						1
Minelayer, PMR							3						3
Mineclearing Plow							9						9
Mine-Roller Plow							3						3
TRUCKS													
Truck, Utility	3		3				1	5		2	1		15
Truck, Light	6		5	4	1			1		4		1	22
Truck, Medium		21	15	14	6		8			45	2	2	113
Truck, Decon, ARS-12U/14									3				3
Truck, Decon, DDA-33/66									1			1	2
Truck, Dump							2						2
Truck, Crane			1				1				1		3
Truck, Crane Shovel							2						2
Truck, Kitchen	1		9										10
Truck, POL (4,000/5,200-L)		9	2	2						15			28
Truck, Recovery			1								2		3
Truck, Water (2,000-L)	1		1						2	4			8
Van, Command	3												3
Van, Hospital												1	1
Van, Kitchen		3											3
Van, Maintenance		3		2			1			2	9		17
Van, Signal				3				5					8
Ambulance		3		1								4	8

TANK BRIGADE (Continued)

<i>Principal Items of Equipment</i>	<i>Brigade HQ.</i>	<i>Tank Bn. (3x)</i>	<i>Mechanized Infantry Bn.</i>	<i>Artillery Bn. (122-mm)</i>	<i>Air Defense Btry.</i>	<i>Reconnaissance Co.</i>	<i>Engineer Co.</i>	<i>Signal Co.</i>	<i>Chem Protection Plt.</i>	<i>Material Support Co.</i>	<i>Maintenance Co.</i>	<i>Medical point</i>	<i>TOTAL</i>
TRAILERS													
Trailer, Cargo, 1-Axle		3	2										5
Trailer, Cargo, 2-Axle		18		16			2			30			66
Trailer, Generator		3	1	2	2			2		1	6		17
Trailer, Kitchen			2	3						2			7
Trailer, POL (900/1,200-L)		3	1	2						15			21
Trailer, Water (900/1,200-L)		9	1	1					4	1			16
RADARS													
Radar, BS, Manportable, PSNR-1						2							2
RADIOS													
VHF, Manpack, Low-Power	14	3	51	10			4	7			1	1	91
VHF, Portable, Low-Power	2		4		1	10			3				20
VHF, Vehicle Mount, Medium-Power		72	40	28	9	2	4		1		5		161
HF, Manpack, Low-Power		6				1		2		3			12
HF, Vehicle Mount, Medium-Power	4	15	2			1		2					24
HF/VHF, Vehicle Mount, Medium-Power								2					2
HF/VHF, Vehicle Mount, High-Power								2					2
HF, Van Mount, High-Power								1					1
Radio Relay, VHF/UHF								2					2
Warning Receiver	1	3		2	3	1		3					13
MISCELLANEOUS													
Rangefinder, Laser, SAGE GLOSS				4									4
Rangefinder, Stereoscopic, DS-1			1										1
Periscopic Aiming Circle, PAB2A			1										1
Collimator (Aiming Stakes)			6										6
Motorcycle						10							10

Tank Battalion, Mech Inf Bde (Sep and Div) and Tank Bde

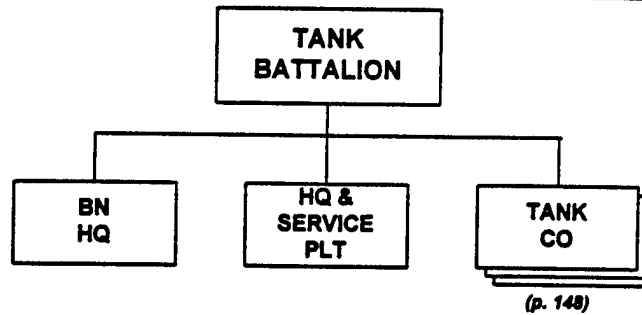

PRINCIPAL ITEMS OF EQUIPMENT

Equipment	Total	Equipment	Total
Medium Tank, T-55K/62K (Command Vehicle).....	1	Trailer, Cargo, 2-Axle.....	6
Medium Tank, T-55/62.....	21	Trailer, Cargo, 1-Axle.....	1
ACV, BMP-1K/2K.....	1	Trailer, Generator.....	1
ACV, BTR (R-145BM).....	1	Trailer, POL (1,200-Liter).....	1
9-mm Pistol, PM.....	52	Trailer, Water (900-Liter).....	3
5.45-mm Assault Rifle, AKS-74.....	20	Radios:	
ATGL, RPG-7V.....	2	VHF, Manpack, Low-Power.....	1
Truck, Medium.....	7	VHF, Vehicle Mount, Medium-Power.....	24
Truck, POL (4,000 or 5,200-Liter).....	3	HF, Manpack, Low-Power.....	2
Van, Maintenance.....	1	HF, Vehicle Mount, Medium-Power.....	5
Van, Kitchen.....	1	Warning Receiver.....	1
Ambulance.....	1		

**Tank Company, Tank Bn, Mech Inf Bde (Sep and Div)
and Tank Bde**

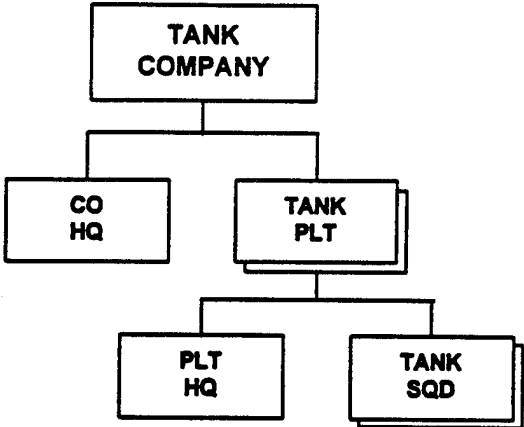

PRINCIPAL ITEMS OF EQUIPMENT

Equipment	Total	Equipment	Total
Medium Tank, T-55/62.....	7	Radios:	
9-mm Pistol, PM.....	16	VHF, Vehicle Mount,	
5.45-mm Assault Rifle, AKS-74.....	4	Medium-Power	7
		HF, Vehicle Mount,	
		Medium-Power	1

Tank Battalion (31-Tank Variant), Tank Bde

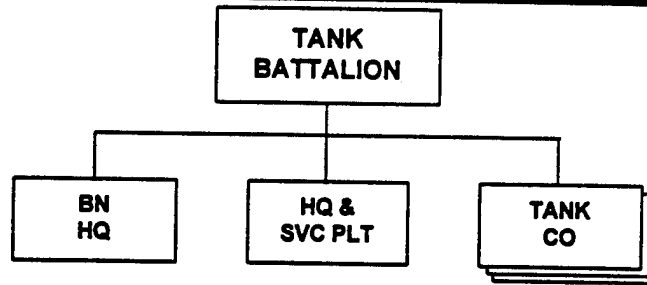

PRINCIPAL ITEMS OF EQUIPMENT

Equipment	Total	Equipment	Total
Medium Tank, T-55K/62K (Command Vehicle).....	1	Trailer, Cargo, 2-Axle.....	6
Medium Tank, T-55/62.....	30	Trailer, Cargo, 1-Axle.....	1
ATGL, RPG-7V.....	2	Trailer, Generator.....	1
ACV, BMP-1K/2K.....	1	Trailer, Water (900-Liter).....	1
ACV, BTR (R-145BM).....	1	Radios:	
Truck, Medium.....	7	VHF, Manpack, Low-Power.....	1
Truck, POL (4,000 or 5,200-Liter).....	3	VHF, Vehicle Mount, Medium-Power.....	33
Van, Maintenance.....	1	HF, Manpack, Low-Power.....	2
Van, Kitchen.....	1	HF, Vehicle Mount, Medium-Power.....	5
Ambulance.....	1	Warning Receiver.....	1

NOTE: Most tank brigades are composed of the standard 22-tank battalion. However, in the Capital Defense Force, the tendency is toward 31-tank battalions with more modern equipment. These may be singular battalions, or within the brigade structure.

National Structure

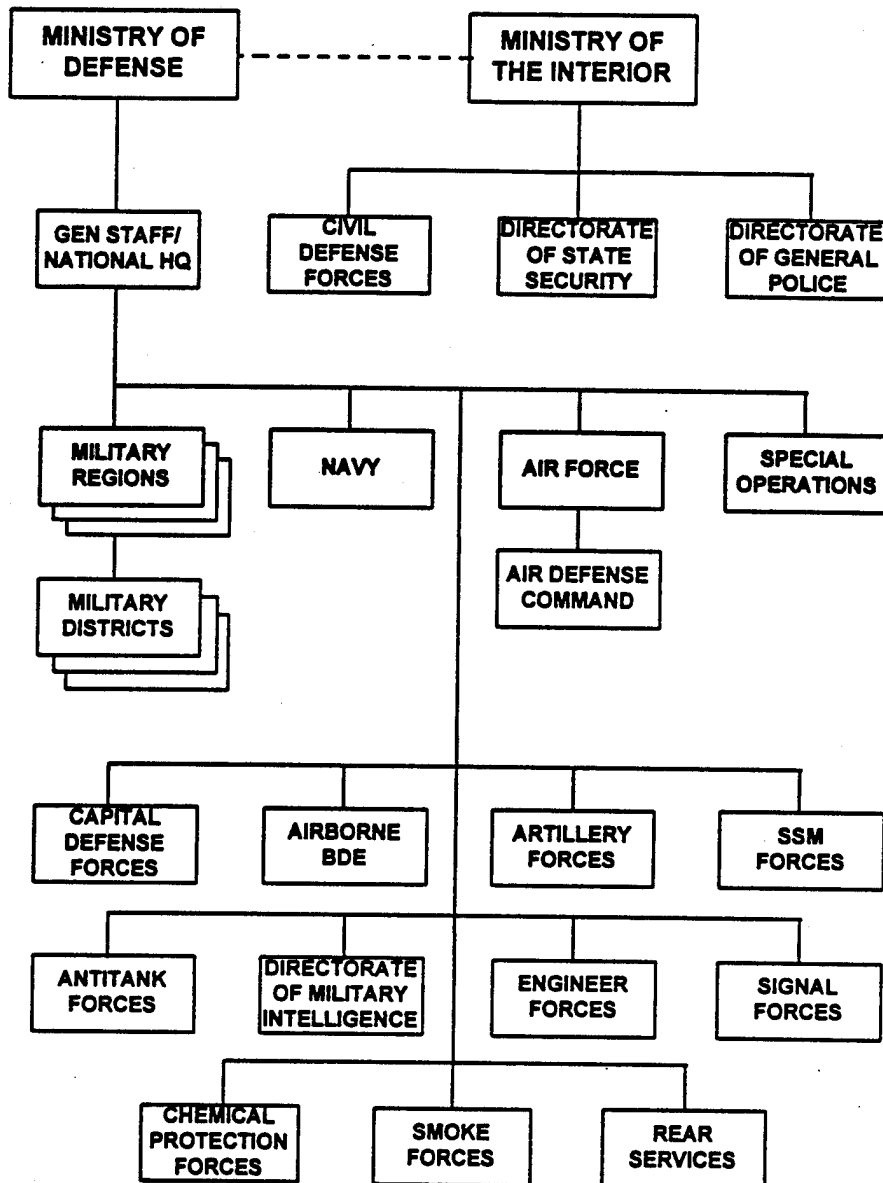

NOTES:

1. The General Staff/National Headquarters, subordinate to the Ministry of Defense, controls the armed forces. The ground component of the armed forces is the largest.
2. Most maneuver units are contained in military districts, which are subordinate to regions. These units, along with the pool of national assets depicted at the bottom of the chart, comprise the bulk of the ground component of the armed forces.
2. Since the number of regions, subordinate districts, and number of maneuver units is variable, the size of the Air Force, Air Defense Command, Navy, and the number and type of combat support and combat service support units at the national level varies, as well.

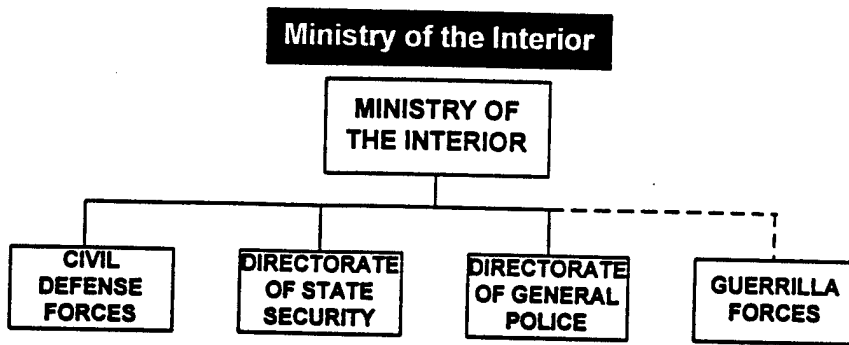

NOTES:

1. The number of civil defense brigades is not fixed. As a rule, they are separate light or motorized infantry brigades; they may be augmented by engineer assets, which they would receive from the General Staff/National Headquarters. Normal missions include emergency engineering, rescue, and similar disaster relief functions.
2. Structures for the Directorates of State Security and General Police are not depicted.
3. Guerrilla forces are controlled by the Ministry of the Interior, from whom they receive political guidance; their structure, which mirrors that of militia forces within the districts, is depicted on page 108.

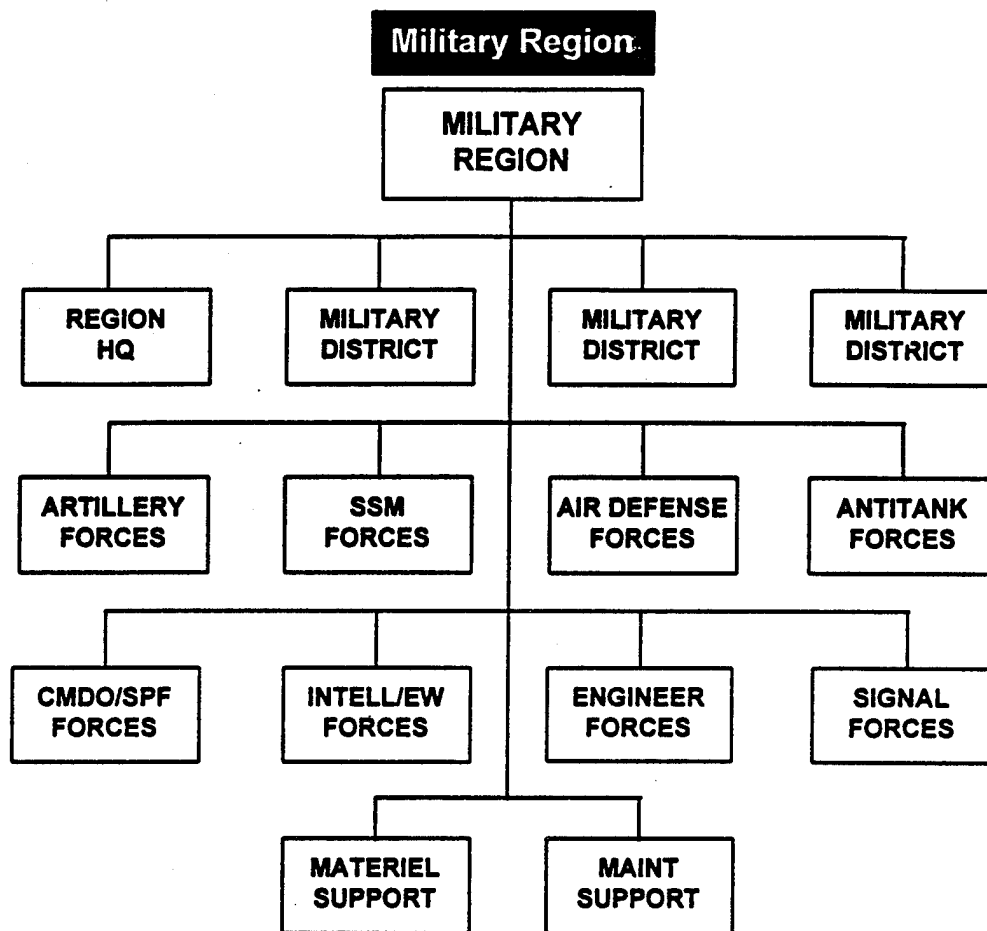

NOTES:

1. There is no set number of military regions, or how many districts should be subordinate to each. At a minimum, the country should have at least two regions, each with two subordinate districts. Three regions, each with three subordinate districts, is the norm.
2. Region headquarters are joint commands, whether or not the region has a standing army. This is the integration point for ground, air, naval, and special operations forces.
3. Unless the region has a standing army and/or districts with standing divisions, the region does not have all the combat support and combat service support assets which will be required in wartime. Even then, standing forces may have additional assets allocated to them. Depending on the region's mission, it may receive few of the assets listed above (primarily defensive missions) or a full complement (large-scale offensive operations). All of this type support would come from the national pool of assets controlled by the General Staff/National Headquarters, which allocates resources based on the missions of subordinate regions and/or their subordinate districts. In the above example, all forces other than those contained within subordinate districts were allocated to the region by the General Staff/National Headquarters.
4. In primarily defense operations, region headquarters can exercise control over subordinate district's forces without the formation of an additional tactical headquarters. Likewise, district headquarters can exercise control over subordinate brigades and other organic assets without an

additional tactical headquarters. Large-scale extraterritorial offensive operations, however, require one at both echelons.

5. The region may: have a standing army headquarters, with standing divisions in each/some of the subordinate districts; develop an army headquarters during the transition to war, mobilizing divisions in some/all subordinate districts; or, if districts have the sufficient forces organic to them, receive combat support and combat service support assets from the General Staff/National Headquarters, and develop army and division-level tactical headquarters solely for the purpose of controlling large-scale offensive operations. In any scenario, the country will only be capable of fielding one such army-level command, with no more than three subordinate division-level commands. In some scenarios, fielding this size force may mean pulling separate maneuver brigades from another region's districts.

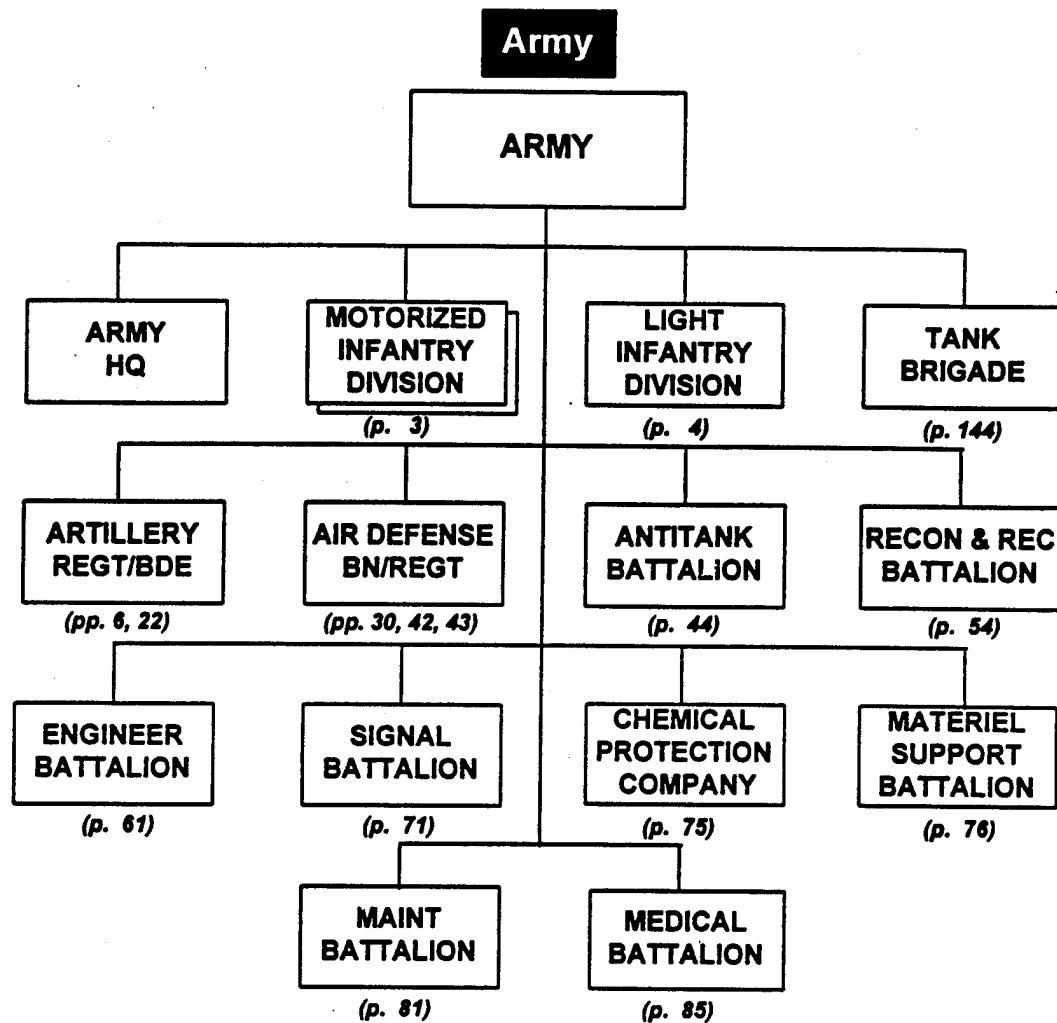

NOTES:

1. This is the standard army structure, whether standing (during peacetime) or developed during wartime mobilization.
2. The army should be composed of a mix of infantry divisions, not to exceed four; three is the standard. Combat support assets can be towed or self-propelled, depending on the mix of light/motorized or mechanized divisions which they support.
3. Standing armies are the exception, rather than the rule.

GENERAL STAFF/NATIONAL HQ (NATIONAL ASSET POOL)

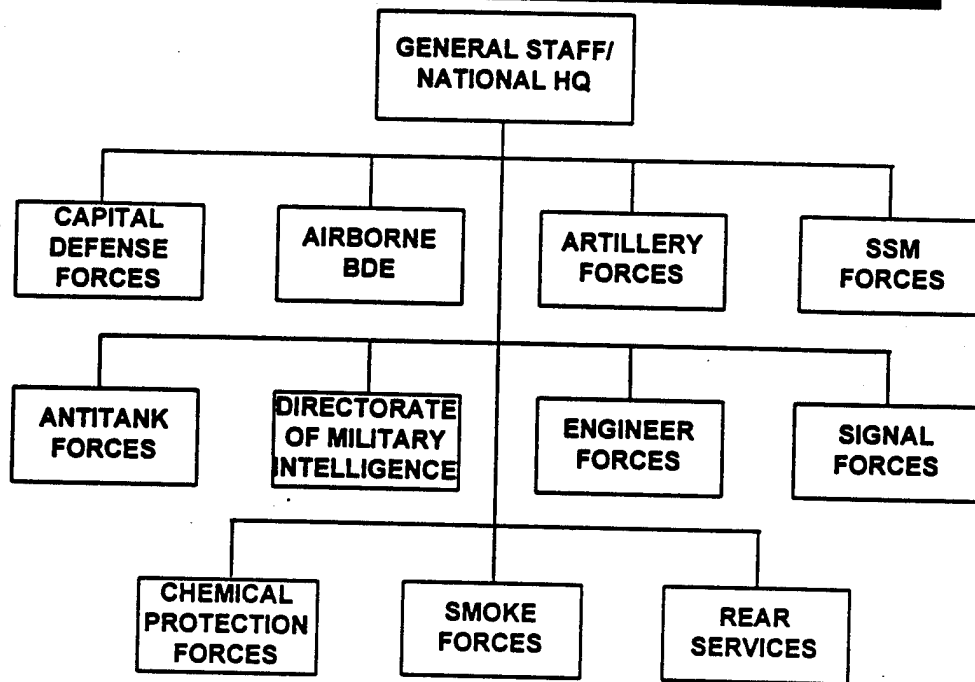

NOTES:

1. Centralization of assets at the national level allows the country to tailor support to subordinate regions based on specific missions and the perceived threat.
2. With the exception of the Capital Defense Forces, which have a very specific mission (as a strategic reserve), the national level assets depicted above provide a ready pool of forces which enable regions to form army-level forces capable of conducting large-scale offensive operations. Regions are the primary recipients of these assets; they may remain under region control, or may be further allocated to subordinate districts, depending on the mission and the forces already stationed in the district.
3. Capital Defense Forces are typically the best-equipped in the country, and could be composed of a single division, a division augmented by other forces, such as MP or engineer units, or by separate brigades. Separate brigades would be augmented by the requisite artillery, engineer, air defense, and service support assets. An example structure could include: two separate tank and/or mechanized infantry brigades, an artillery regiment/brigade, a commando battalion, an air defense regiment, an engineer brigade, an MP brigade/battalion (light infantry), and a materiel support battalion. The structure of the Capital Defense Forces is not illustrated further in this guide.
4. Of the forces depicted above, only the airborne brigade and Directorate of Military Intelligence are limited in number (one).
4. Rear Services is not a fixed structure, but rather a loose grouping of materiel support and maintenance battalions and brigades; they may be allocated to subordinate regions, or may remain centralized under General Staff control.

Airborne Infantry Brigade, National

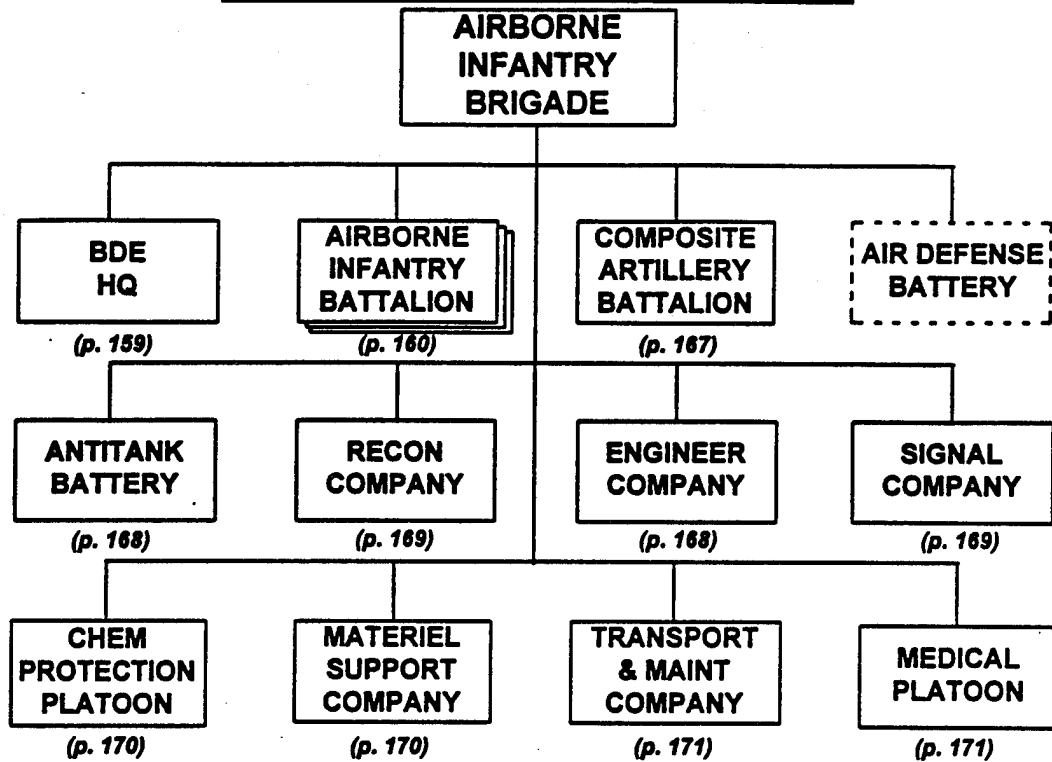

NOTES:

1. Should airborne forces require more traditional combat service support, such as wheeled transportation for infantry, these assets are provided through Rear Services.
2. Night observation device totals include only those within the airborne infantry battalions.
3. The air defense battery, if present, consists of three platoons similarly equipped to those subordinate to the airborne infantry battalion.
4. Equipment totals for the brigade headquarters and subordinate battalion headquarters reflect only the totals for the command element.
5. Individual weapons for personnel are counted only at the battalion and below.

AIRBORNE INFANTRY BRIGADE, NATIONAL												
Principal Items of Equipment	Brigade HQ	Airborne Inf Bn (3X)	Composite Arty Bn	Antitank Btry	Recon Co	Engineer Co	Signal Co	Chem Protection Plt	Material Support Co	Transport & Maint Co	Medical Plt	TOTAL
ARMORED VEHICLES												
ACV, BRDM-2U					1							1
ASC, BRDM-2					8							8
WEAPONS												
30-mm Auto Grenade Launcher, AGS-17		18										18
82-mm Mortar, M1937/2B9		18	6									24
122-mm Single-Tube Rocket Lch, BM-21-P		18	6									24
140-mm Multiple Rocket Launcher, RPU-14			6									6
73-mm Recoilless Gun, SPG-9				3								3
ATGM Manpack, AT-4/SPIGOT		18	6									24
SAM, SA-16/18	3	33	6									42
TRUCKS												
Truck, Utility	7	30	1	1		1	8		6	2		56
Truck, Light		72	26	5		4			8	38	2	155
Truck, Medium		3							25		2	30
Truck, Chem Recon, UAZ-69RKh		12						4				16
Truck, POL (4,000-L)			2						12			14
Van, Maintenance			1							9		10
Van, Signal		3	2				3					8
Ambulance		3	1								4	8
TRAILERS												
Trailer, Cargo, 1-Axle	3	6	12						2	4		27
Trailer, Generator										1		1
Trailer, Kitchen		9	4			1	1		4	1	1	21
Trailer, POL (900-L)		3	2						12			
Trailer, Water (900-L)		6	1			1	1		1	1	1	12
RADARS												
Radar, BS, Man-Portable, PSNR-1			3		2							5

AIRBORNE INFANTRY BRIGADE, NATIONAL (Cont)

<i>Principal Items of Equipment</i>	<i>Brigade HQ</i>	<i>Airborne Inf Bn (3X)</i>	<i>Composite Arty Bn</i>	<i>Antitank Btry</i>	<i>Recon Co</i>	<i>Engineer Co</i>	<i>Signal Co</i>	<i>Chem Protection Plt</i>	<i>Material Support Co</i>	<i>Transport & Maint Co</i>	<i>Medical Plt</i>	<i>TOTAL</i>
RADIOS												
VHF, Manpack, Low-Power	1											1
VHF, Portable, Low-Power		27	2	7	6	1						43
VHF, Portable, Very-Low-Power		108										44
VHF, Vehicle Mount, Medium-Power					8							8
HF, Manpack, Low-Power					1							1
HF, Vehicle Mount, Medium-Power			4		1							5
HF/VHF, Manpack, Low-Power		96	20			3	6		3	3	1	132
HF/VHF, Vehicle Mount, Medium-Power	8	3					3	4				18
HF/VHF, Vehicle Mount, High-Power							1					1
Ground-to-Air Radio Set	2	6					2					10
Burst-Transmission	2	15					3					20
Warning Receiver	1	6			1		1					9
MISCELLANEOUS												
Rangefinder, Stereoscopic			1									1
Periscope Aiming Circle			1									1
Collimator (Aiming Stakes)			6									6
Motorcycle					6							6
Mine Detector, DIM		3				1						4
Demolition Set		9				2						11
Boat, Zodiac-Type						2						2
Night Vision Goggles, Type-85		141										141
Night Vision Goggles, PNV-57		198			15							213
Night Vision Sight, PPN-3 (MG)		54										54
Night Vision Sight, NSP-3 (Small Arms)		237										237

Brigade Headquarters, Airborne Inf Bde, National

**BRIGADE
HEADQUARTERS**

PRINCIPAL ITEMS OF EQUIPMENT

Equipment	Total	Equipment	Total
SAM, SA-16/18*	3	Radios:	
ATGL, RPG-16D	2	VHF, Manpack, Low-Power	1
Truck, Utility	7	HF/VHF, Vehicle Mount, Medium-Power	8
Trailer, Cargo, 1-Axle	3	Ground-to-Air Set	2
		Burst Transmission	2
		Warning Receiver	1

FOOTNOTE: * Some headquarters may be equipped with 1 to 2 12.7-mm DShK machineguns.

Airborne Infantry Battalion, Airborne Inf Bde, National

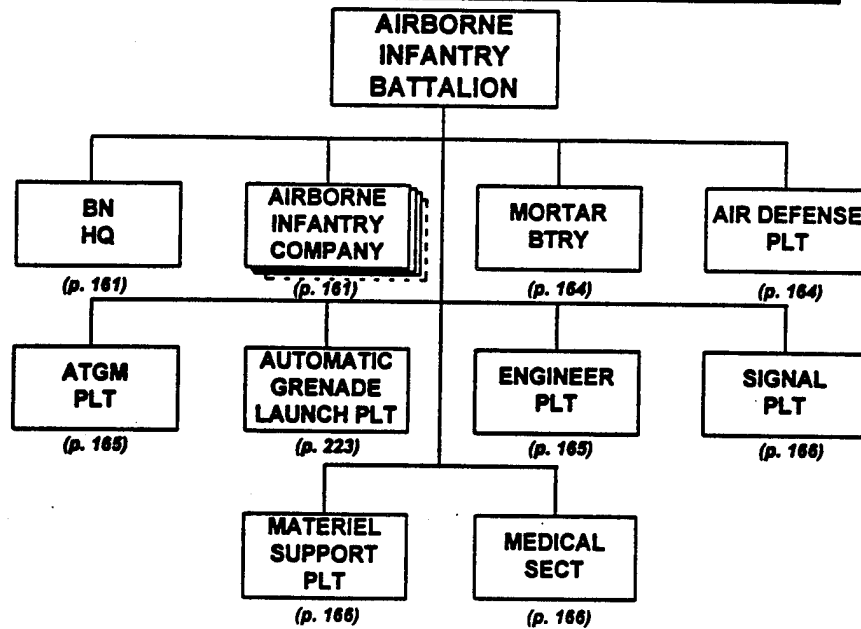

PRINCIPAL ITEMS OF EQUIPMENT

Equipment	Total
9-mm Pistol, PM.....	55
5.45-mm Assault Rifle, AKS-74.....	337
5.45-mm LMG, RPK-74.....	30
7.62-mm Sniper Rifle, SVD.....	27
7.62-mm GP MG, PKM.....	18
ATGM Manpack AT-4/SPIGOT.....	6
SAM, SA-16/18.....	11
ATGL, RPG-16D.....	34
82mm Mortar, M1937/2B9.....	6
122-mm Single-Tube Rocket Launcher, BM-21-P.....	6
30-mm Automatic Grenade Launcher, AGS-17.....	6
40-mm Under-Barrel Grenade Launcher, BG-15.....	66
Truck, Utility.....	10
Truck, Light.....	24
Truck, Medium.....	1
Truck, Chemical Recon, UAZ-69RKh.....	4
Ambulance.....	1

Equipment	Total
Van, Signal.....	1
Trailer, POL (900-Liter).....	1
Trailer, Water (900-Liter).....	2
Trailer, Kitchen.....	3
Trailer, Cargo, 1-Axle.....	2
Mine Detector, DIM.....	1
Demolition Set.....	3
Night Vision Goggles, Type-85.....	47
Night Vision Goggles, PNV-57.....	66
Night Vision Sight, NSP-3 (Small Arms).....	79
Night Vision Sight, PPN-3 (MG).....	18
Radios:	
VHF, Portable, Very-Low-Power.....	36
VHF, Portable, Low-Power.....	9
HF/VHF, Manpack, Low-Power.....	32
HF/VHF, Vehicle Mount, Medium-Power.....	1
Ground-to-Air Set.....	2
Burst Transmission.....	5
Warning Receiver.....	2

**Battalion Headquarters, Airborne Inf Bn,
Airborne Inf Bde, National**

**BATTALION
HEADQUARTERS**

PRINCIPAL ITEMS OF EQUIPMENT

Equipment	Total	Equipment	Total
9-mm Pistol, PM.....	4	Radios:	
5.45-mm Assault Rifle, AKS-74.....	4	VHF, Manpack, Very-Low-Power.....	2
ATGL, RPG-16D.....	1	VHF, Manpack, Low-Power.....	1
SAM, SA-16/18*.....	2	Burst Transmission.....	1
Night Vision Goggles, Type-85.....	2	Warning Receiver.....	1
Night Vision Sight, NSP-3 (Small Arms)....	2		

FOOTNOTE: * Some headquarters may be equipped with 1 to 2 12.7-mm DShK machineguns.

**Airborne Infantry Company, Airborne Inf Bn,
Airborne Inf Bde, National**

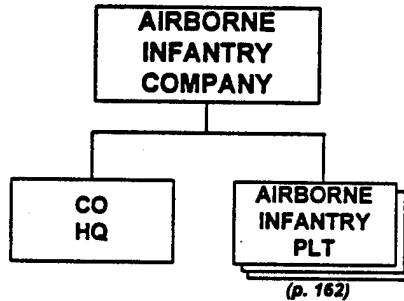

PRINCIPAL ITEMS OF EQUIPMENT

Equipment	Total	Equipment	Total
9-mm Pistol, PM.....	9	Night Vision Goggles, Type-85.....	13
5.45-mm Assault Rifle, AKS-74.....	63	Night Vision Goggles, PNV-57.....	10
5.45-mm LMG, RPK-74.....	9	Night Vision Sight, NSP-3 (Small Arms)..	20
7.62-mm Sniper Rifle, SVD.....	9	Night Vision Sight, PPN-3 (MG).....	6
7.62-mm GP MG, PKM.....	6	Radios:	
ATGL, RPG-16D.....	9	VHF, Manpack, Very-Low-Power.....	10
40-mm Under-Barrel Grenade Launcher, BG-15.....	18	VHF, Manpack, Low-Power.....	4
		Burst Transmission.....	1

**Airborne Infantry Platoon, Airborne Inf Co, Airborne
Inf Bn, Airborne Inf Bde, National**

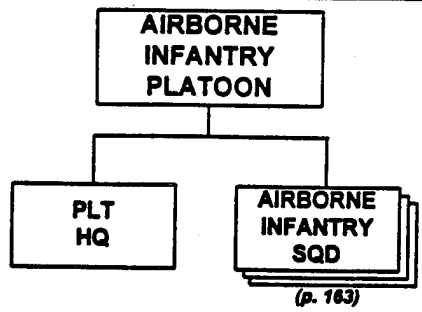

PRINCIPAL ITEMS OF EQUIPMENT

<u>Equipment</u>	<u>Total</u>	<u>Equipment</u>	<u>Total</u>
9-mm Pistol, PM.....	3	Night Vision Goggles, Type-85.....	4
5.45-mm Assault Rifle, AKS-74.....	21	Night Vision Goggles, PNV-57.....	3
5.45-mm LMG, RPKS-74.....	3	Night Vision Sight, NSP-3 (Small Arms)....	6
7.62-mm Sniper Rifle, SVD.....	3	Night Vision Sight, PPN-3 (MG)	2
7.62-mm GP MG, PKM.....	2*	Radios:	
40-mm Under-Barrel Grenade Launcher, BG-15.....	6	VHF, Manpack, Very-Low-Power.....	3
		VHF, Manpack, Low-Power.....	1

FOOTNOTE: * PKM machine guns are in the platoon headquarters section. Assistant machine gunners, as well as the platoon leader, are equipped with the AKS-74.

**Airborne Infantry Squad, Airborne Inf Plt, Airborne Inf Co,
Airborne Inf Bn, Airborne Inf Bde, National**

**AIRBORNE
INFANTRY
SQUAD**

Squad Leader.....AKS-74
Machine Gunner.....RPKS-74
Grenadier.....RPG-16D/PM
Asst Grenadier.....AKS-74
Rifleman (x 4).....AKS-74

PRINCIPAL ITEMS OF EQUIPMENT

Equipment	Total	Equipment	Total
9-mm Pistol, PM.....	1	40-mm Under Barrel-Grenade Launcher, BG-15.....	2
5.45-mm Assault Rifle, AKS-74.....	6	Night Vision Goggles, Type-85.....	1
5.45-mm LMG, RPKS-74.....	1	Night Vision Goggles, PNV-57.....	1
7.62-mm Sniper Rifle, SVD.....	1	Night Vision Sight, NSP-3 (Small Arms)....	2
ATGL, RPG-16D.....	1	Radio, VHF, Manpack, Very-Low-Power...1	

**Mortar Battery, Airborne Inf Bn, Airborne Inf Bde,
National**

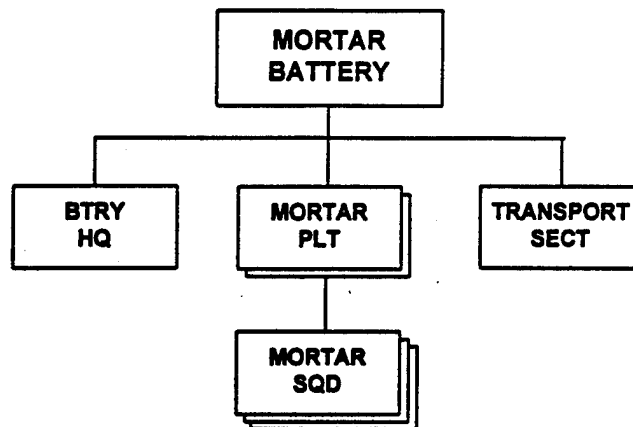

PRINCIPAL ITEMS OF EQUIPMENT

Equipment	Total	Equipment	Total
9-mm Pistol, PM.....	10	Rangefinder, Stereoscopic, DS-1	1
5.45-mm Assault Rifle, AKS-74.....	54	Periscopic Aiming Circle, PAB2A	1
ATRL, RPG-16D	3	Collimator (Aiming Stakes).....	6
82-mm Mortar, M1937/2B9.....	6	Night Vision Goggles, Type-85	2
40-mm Under Barrel-Grenade Launcher, BG-15.....	6	Night Vision Goggles, PNV-57	6
Truck, Utility.....	7	Night Vision Sight, NSP-3 (Small Arms)....	6
		Radio, HF/VHF, Manpack, Low-Power	6

**Air Defense Platoon, Airborne Inf Bn, Airborne Inf Bde,
National**

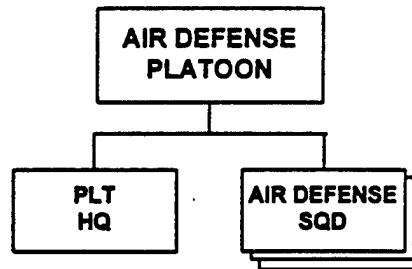

PRINCIPAL ITEMS OF EQUIPMENT

Equipment	Total	Equipment	Total
SAM, SA-16/18	9	Night Vision Goggles, Type-85	1
9-mm Pistol, PM.....	4	Night Vision Goggles, PNV-57	3
5.45-mm Assault Rifle, AKS-74.....	9	Radio, VHF, Portable, Very-Low-Power....	4
Truck, Light	3		

**ATGM Platoon, Airborne Inf Bn, Airborne Inf Bde,
National**

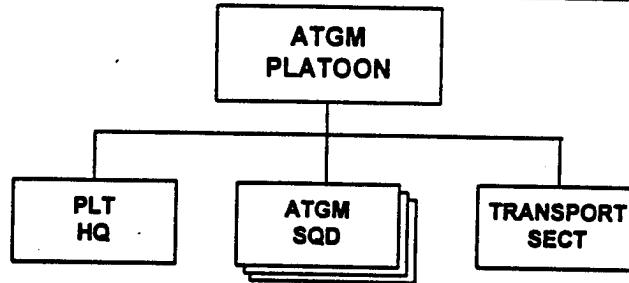

PRINCIPAL ITEMS OF EQUIPMENT

Equipment	Total	Equipment	Total
ATGM Manpack, AT-4/SPIGOT	6	Night Vision Goggles, Type-85	1
9-mm Pistol, PM	4	Night Vision Goggles, PNV-57	10
5.45-mm Assault Rifle, AKS-74.....	30	Night Vision Sight, NSP-3 (Small Arms)....	6
40-mm Under-Barrel Grenade Launcher, BG-15.....	6	Radios:	
Truck, Utility.....	1	VHF, Portable, Low-Power	7
Truck, Light	4	HF/VHF, Manpack, Low-Power.....	1

**Engineer Platoon, Airborne Inf Bn, Airborne
Inf Bde, National**

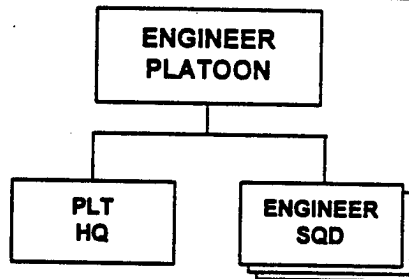

PRINCIPAL ITEMS OF EQUIPMENT

Equipment	Total	Equipment	Total
9-mm Pistol, PM	4	Mine Detector, DIM.....	1
5.45-mm Assault Rifle, AKS-74.....	25	Night Vision Goggles, Type-85	1
5.45-mm LMG, RPKS-74.....	3	Night Vision Goggles, PNV-57	9
ATGL, RPG-16D	3	Night Vision Sight, NSP-3 (Small Arms)....	3
Truck, Utility.....	1	Radios:	
Truck, Light	4	VHF, Portable, Low-Power	2
Trailer, Cargo, 1-Axle.....	1	HF/VHF, Manpack, Low-Power.....	4
Demolition Set	3		

**Signal Platoon, Airborne Inf Bn, Airborne
Inf Bde, National**

**SIGNAL
PLATOON**

PRINCIPAL ITEMS OF EQUIPMENT

<u>Equipment</u>	<u>Total</u>	<u>Equipment</u>	<u>Total</u>
9-mm Pistol, PM.....	1	Radios:	
5.45-mm Assault Rifle, AKS-74.....	16	HF/VHF, Manpack, Low-Power.....	3
Truck, Utility.....	1	HF/VHF, Vehicle Mount, Medium-Power	1
Truck, Light	1	Ground-to-Air Set	2
Van, Signal.....	1	Burst Transmission	1
Night Vision Goggles, Type-85	1	Warning Receiver	1
Night Vision Goggles, PNV-57	4		
Night Vision Sight, NSP-3 (Small Arms)....	2		

**Materiel Support Platoon, Airborne Inf Bn, Airborne
Inf Bde, National**

**MATERIEL
SUPPORT
PLATOON**

PRINCIPAL ITEMS OF EQUIPMENT

<u>Equipment</u>	<u>Total</u>	<u>Equipment</u>	<u>Total</u>
9-mm Pistol, PM.....	1	Trailer, POL (900-Liter)	1
5.45-mm Assault Rifle, AKS-74.....	20	Trailer, Kitchen	3
Truck, Light	10	Trailer, Cargo, 1-Axle.....	1
Truck, Medium	1	Night Vision Goggles, PNV-57	3
Truck, POL (4,000-Liter).....	2	Radio, HF/VHF, Manpack, Low-Power	4
Trailer, Water (900-Liter)	2		

**Medical Section, Airborne Inf Bn, Airborne
Inf Bde, National**

**MEDICAL
SECTION**

PRINCIPAL ITEMS OF EQUIPMENT

<u>Equipment</u>	<u>Total</u>	<u>Equipment</u>	<u>Total</u>
Ambulance	1	Radio, HF/VHF, Manpack, Low-Power	1
Night Vision Goggles, PNV-57	1		

Composite Artillery Battalion, Airborne Inf Bde, National

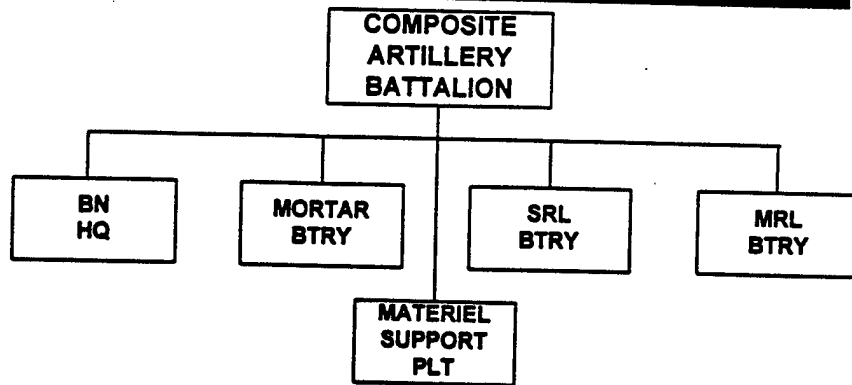

PRINCIPAL ITEMS OF EQUIPMENT

Equipment	Total
5.45-mm LMG, RPK-74	18
SAM, SA-16/18	6
ATGL, RPG-16D	9
82-mm Mortar, M1937/2B9	6
122-mm Single-Tube Rocket Launcher, BM-21-P	6
140-mm Multiple Rocket Launcher, RPU-14	6
Truck, Utility	1
Truck, Light	26
Truck, POL (4,000-Liter)	2
Ambulance	1
Van, Maintenance	1
Van, Signal	2

Equipment	Total
Trailer, Water (900-Liter)	1
Trailer, POL (900-Liter)	2
Trailer, Kitchen	4
Trailer, Cargo, 1-Axle	12
Rangefinder, Stereoscopic, DS-1	1
Periscopic Aiming Circle, PAB2A	1
Collimator (Aiming Stakes)	6
Radar, Battlefield Surveillance, Man-Portable, PSNR-1	3
Radios:	
VHF, Portable, Low-Power	2
HF/VHF, Manpack, Low-Power	20
HF, Vehicle Mount, Medium-Power	4

Engineer Company, Airborne Inf Bde, National

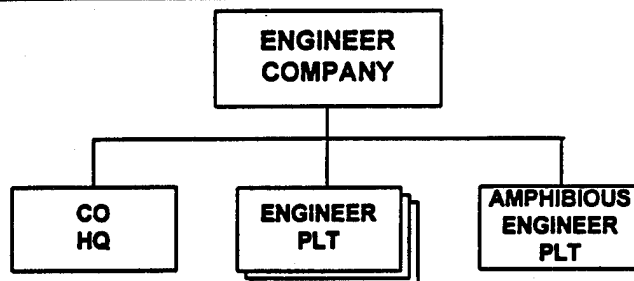

PRINCIPAL ITEMS OF EQUIPMENT

Equipment	Total	Equipment	Total
5.45-mm LMG, RPK-74.....	4	Demolition Set.....	2
ATGL, RPG-16D.....	4	Mine Detector, DIM.....	1
Boat, Zodiac-type.....	2	Radios:	
Truck, Utility.....	1	VHF, Portable, Low-Power.....	1
Truck, Light.....	4	HF/VHF, Manpack, Low-Power.....	3
Trailer, Water (900-Liter).....	1		
Trailer, Kitchen.....	1		

Antitank Battery, Airborne Inf Bde, National

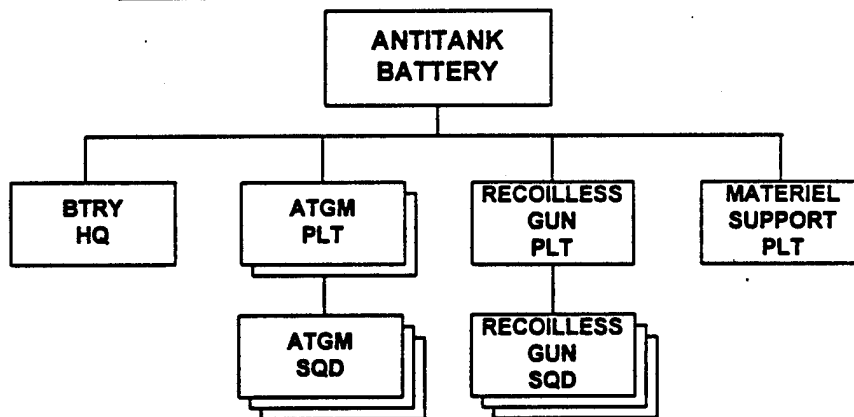

PRINCIPAL ITEMS OF EQUIPMENT

Equipment	Total	Equipment	Total
ATGM Manpack, AT-4/SPIGOT.....	6	Truck, Utility.....	1
73-mm Recoilless Gun, SPG-9.....	3	Truck, Light.....	5
5.45-mm LMG, AKSU-74.....	6	Radio, VHF, Portable, Low-Power.....	7

**Reconnaissance Company, Airborne Infantry Brigade,
National**

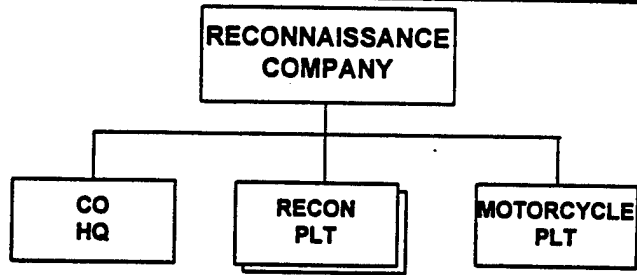

PRINCIPAL ITEMS OF EQUIPMENT

Equipment	Total	Equipment	Total
ACV, BRDM-2U.....	1	Radios:	
ASC, BRDM-2.....	8	VHF, Portable, Low-Power	6
5.45-mm LMG, RPKS-74.....	15	VHF, Vehicle Mount, Medium-Power	8
ATGL, RPG-7V	8	HF, Manpack, Low-Power.....	1
Motorcycle	6	HF, Vehicle Mount, Medium-Power	1
Night Vision Goggles, PNV-57	15	Warning Receiver	1
Radar, Battlefield Surveillance, Man-Portable, PSNR-1	2		

Signal Company, Airborne Inf Bde, National

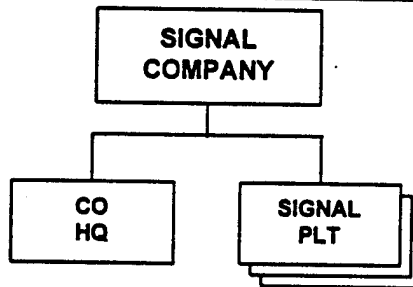

PRINCIPAL ITEMS OF EQUIPMENT

Equipment	Total	Equipment	Total
Truck, Utility.....	8	Radios:	
Van, Signal.....	3	HF/VHF, Manpack, Low-Power.....	6
Trailer, Water (900-Liter)	1	HF/VHF, Vehicle Mount, Medium-Power	3
Trailer, Kitchen	1	HF/VHF, Vehicle Mount, High-Power..	1
		Ground-to-Air Set	2
		Burst Transmission	3
		Warning Receiver	1

Chemical Protection Platoon, Airborne Inf Bde, National

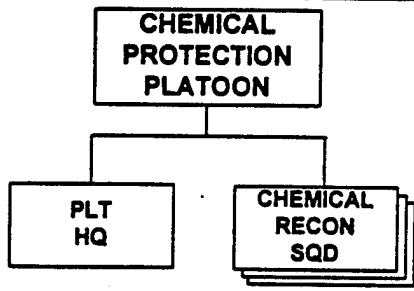

PRINCIPAL ITEMS OF EQUIPMENT

<u>Equipment</u>	<u>Total</u>	<u>Equipment</u>	<u>Total</u>
Truck, Chemical Recon, UAZ-69RKh	4	Radio, HF/VHF, Vehicle Mount, Medium-Power	4

Materiel Support Company, Airborne Inf Bde, National

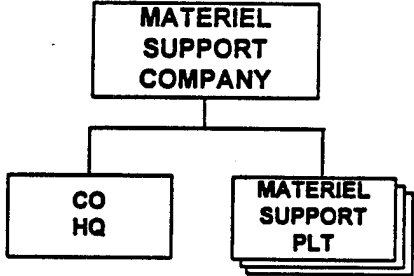

PRINCIPAL ITEMS OF EQUIPMENT

<u>Equipment</u>	<u>Total</u>	<u>Equipment</u>	<u>Total</u>
ATGL, RPG-16D	3	Trailer, Water (900-Liter)	1
Truck, Utility	6	Trailer, POL (900-Liter)	12
Truck, Light	8	Trailer, Kitchen	4
Truck, Medium	25	Trailer, Cargo, 1-Axle	2
Truck, POL (4,000-Liter)	12	Radio, HF/VHF, Manpack, Low-Power	3

**Transport and Maintenance Company, Airborne Inf Bde,
National**

**TRANSPORT
& MAINT
COMPANY**

PRINCIPAL ITEMS OF EQUIPMENT

<u>Equipment</u>	<u>Total</u>	<u>Equipment</u>	<u>Total</u>
ATGL, RPG-16D.....	4	Trailer, Kitchen.....	1
Truck, Utility.....	2	Trailer, Water (900-Liter).....	1
Truck, Light.....	38	Trailer, Generator.....	1
Van, Maintenance.....	9	Radio, HF/VHF, Manpack, Low-Power.....	3
Trailer, Cargo, 1-Axle.....	4		

Medical Platoon, Airborne Inf Bde, National

**MEDICAL
PLATOON**

PRINCIPAL ITEMS OF EQUIPMENT

<u>Equipment</u>	<u>Total</u>	<u>Equipment</u>	<u>Total</u>
Truck, Light.....	2	Trailer, Kitchen.....	1
Truck, Medium.....	2	Trailer, Water (900-Liter).....	1
Ambulance.....	4	Radio, HF/VHF, Manpack, Low-Power.....	1

Heavy Artillery Battalion, National

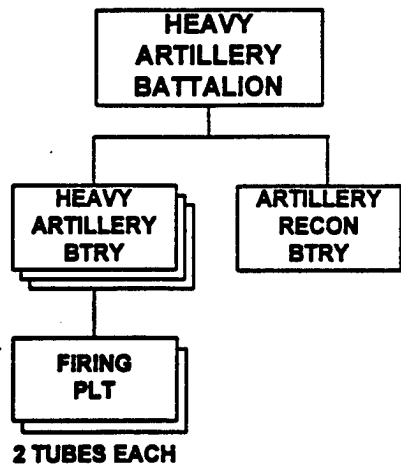

PRINCIPAL ITEMS OF EQUIPMENT

Equipment	Total
180-mm Gun-Howitzer, S23.....	18

NOTE: The heavy artillery battalion may be attached to an artillery brigade or regiment.

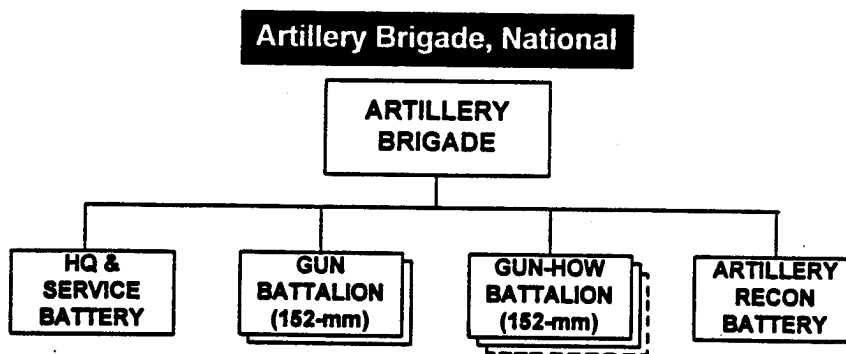

PRINCIPAL ITEMS OF EQUIPMENT

Equipment	Total	Equipment	Total
5 x 18-Tube Battalion		4 x 24-Tube Battalion	
152-mm SP Gun, 2S5	36	152-mm SP Gun, 2S5	48
152-mm Gun-Howitzer, D-20.....	54	152-mm Gun-Howitzer, D-20.....	48
ACRV, 1V110 (Battery FDC)	3	ACRV, 1V110 (Battery FDC)	3
ACRV, 1V18 (Battery COP)	3	ACRV, 1V18 (Battery COP)	3
ACRV, 1V19 (Battalion COP)	1	ACRV, 1V19 (Battalion COP)	1
ACRV, 1V111 (Battalion FDC).....	1	ACRV, 1V111 (Battalion FDC)	1
Mobile Recon Post, PRP-3/4*	6	Mobile Recon Post, PRP-3/4*	5
APC, Radar, MTLB (SNAR-10)**	1	APC, Radar, MTLB (SNAR-10)**	1
ACV, BTR (R-145BM)	6	ACV, BTR (R-145BM)	5
Truck, Light	25	Truck, Light	18
Truck, Utility.....	12	Truck, Utility.....	9
Van, Signal.....	1	Van, Signal.....	1
Van, Computer.....	1	Van, Computer.....	1
Trailer, Generator.....	7	Trailer, Generator.....	5
Sound Ranging Set.....	1	Sound Ranging Set.....	1
Radar, Countermortar/Counterbattery, ARK-1	1	Radar, Countermortar/ Counterbattery,ARK-1	1
Rangefinder, Laser, SAGE GLOSS.....	2	Rangefinder, Laser, SAGE GLOSS.....	2
Radar, Meteorological, END TRAY.....	1	Radar, Meteorological, END TRAY.....	1
Radar Intercept/Directon Finder	3	Radar Intercept/Directon Finder	3

NOTES:

1. Some brigades are composed entirely of the 152-mm SP Gun 2S5, for both variants.
2. Structures of five 18-tube battalions may be called an artillery regiment (rather than brigade).

FOOTNOTES:

- * This system includes the SMALL FRED battlefield surveillance radar.
- ** This system includes the BIG FRED battlefield surveillance radar.

Artillery Brigade, Army or National

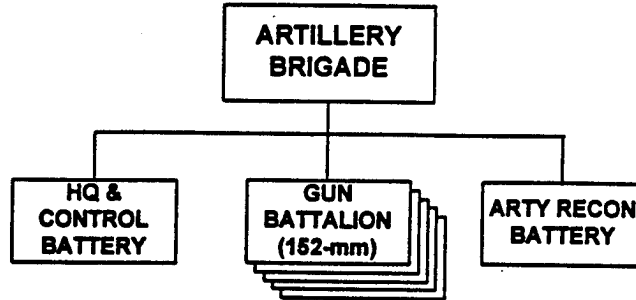

PRINCIPAL ITEMS OF EQUIPMENT

Equipment	Total	Equipment	Total
152-mm Field Gun, 2A36 or 152-mm SP Gun, 2S5	90	APC, Radar, MT-LB (SNAR-10)***	1
ACRV, 1V12/1V12M/1V21 or 1V17 Series*	40	Radars: Counter mortar/Counterbattery, ARK-1****	
ACV, BTR (R-145BM)	6	Meteorological, END TRAY	1
Mobile Recon Post, PRP-3/-4**	6		

NOTES:

1. A few battalions still have the older 130-mm field gun M-46.
2. Some organizations with the structure of five 18-tube battalions may be called an artillery regiment (rather than brigade).

FOOTNOTES:

- * Self-propelled artillery units use the tracked ACRVs of the 1V12/1V12M/1V21 series, while towed artillery units use the wheeled 1V17 series.
- ** This system includes the SMALL FRED or TALL MIKE battlefield surveillance radar.
- *** This system includes the BIG FRED battlefield surveillance radar.
- **** This system includes the RICE BAG counter mortar/counterbattery radar.

Rocket Launcher Brigade, National

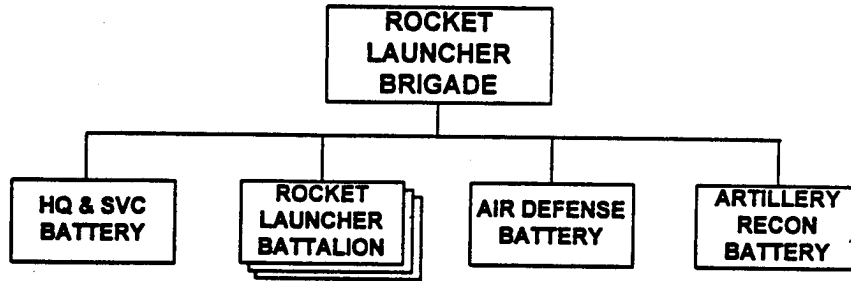

PRINCIPAL ITEMS OF EQUIPMENT

Equipment	Total	Equipment	Total
122-mm Rocket Launcher, BM-21 (Grad) or 220-mm Rocket Launcher, 9P140 (Uragan)*	54	Truck, Light	7
23-mm AA Gun, ZU-23	6	Truck, Utility	8
ACRV, 1V18 (Battery COP)	9	Van, Signal	1
ACRV, 1V19 (Battalion COP)	3	Van, Computer	1
ACRV, 1V110 (Battery FDC)	9	Trailer, Generator	7
ACRV, 1V111 (Battalion FDC)	3	Sound Ranging Set	1
APC, Radar, MT-LB (SNAR-10)**	1	Radar, Countermortar/Counterbattery, ARK-1	1
Mobile Recon Post, PRP-3/4***	1	Radar, Meteorological, END TRAY	1
ACRV, BTR (R-145BM)	3	Radar Intercept/Directon Finder	3
ACV, BTR (R-145BM)	3	Rangefinder, Laser, SAGE GLOSS	2

FOOTNOTES:

- * Previously known as the BM-22.
- ** This system includes the BIG FRED battlefield surveillance radar.
- *** This system includes the SMALL FRED battlefield surveillance radar.

SSM Brigade (SS-21), National

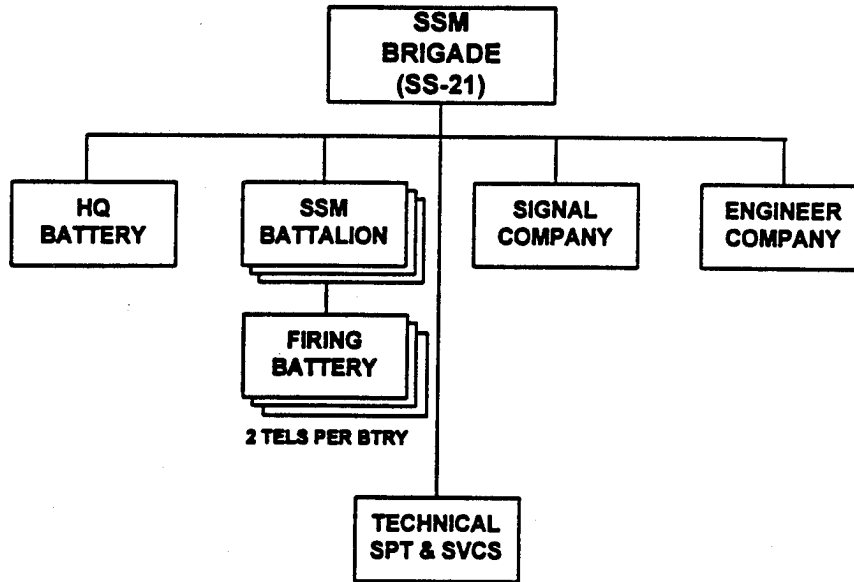

PRINCIPAL ITEMS OF EQUIPMENT

Equipment	Total
SSM, SS-21/SCARAB TEL	18

NOTES:

1. SS-21/SCARABs are also fielded in individual battalions. SSM brigades and separate battalions are always controlled by the General Staff/National Headquarters. When fielded as an individual battalion, the unit would have one END TRAY meteorological radar.
2. Some SSM units field the FROG-7, although these are being rapidly replaced by the SS-21/SCARAB.

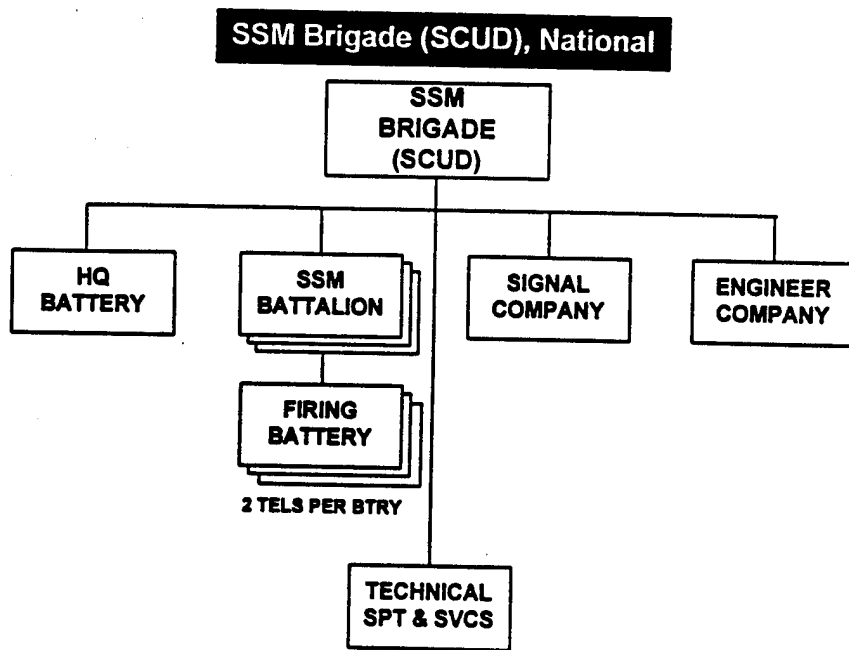

PRINCIPAL ITEMS OF EQUIPMENT

Equipment	Total
SSM, SS-1c/SCUD B TEL	12 or 18

NOTES:

1. An SSM battalion may consist of either two or three firing batteries; therefore, a battalion may have 4 or 6 TELs, and a brigade may have 12 or 18 TELs. There is at least one reload per TEL.
2. As with SS-21/SCARABs, individual SSM battalions may be fielded. If fielded in this manner, the battalion will always have three batteries.

Directorate of Military Intelligence, National

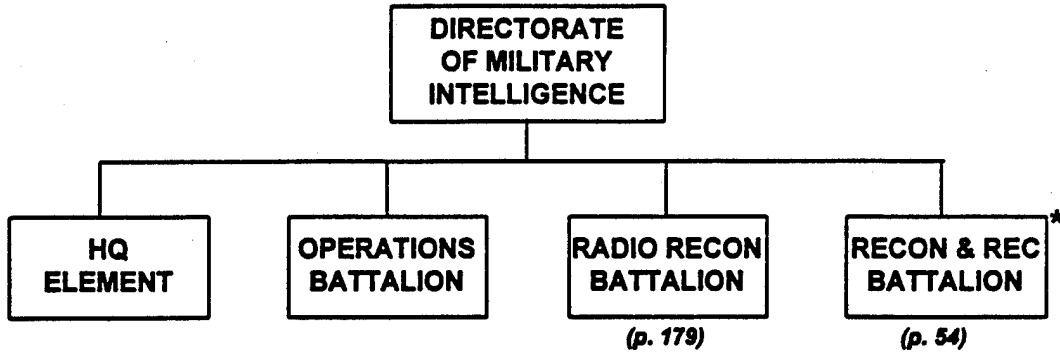

NOTES:

1. The above chart represents the portion of directorate assets which are allocated to subordinate forces in time of war. It is not intended to represent or define the intricate relationships between different national level intelligence structures and agencies.
2. The directorate has one Operations Battalion; however, the number of radio reconnaissance battalions and reconnaissance and radioelectronic combat battalions is not fixed.
3. The exact structure and number of subordinate units within the Operations Battalion is unknown. However, its functions include special information (propaganda), counterintelligence (both overt and covert collection), and interrogation. Elements from each of these disciplines are tailored into platoon and company-sized teams, which are then allocated to regions and districts based on their specific needs.
4. Radio reconnaissance battalions are normally retained under the control of the General Staff; however, they may be allocated to the regions.
5. Reconnaissance and radioelectronic combat battalions are identical to those organic to districts, standing divisions, and standing armies. These battalions are allocated to regions and their subordinate districts during mobilization for war (particularly to those preparing for division or army level offensive operations).

FOOTNOTE: * Some reconnaissance and radioelectronic combat battalions are now called reconnaissance and electronic warfare battalions. The REC company in these battalions, therefore, is now called the electronic warfare (EW) company.

Radio Reconnaissance Battalion, Directorate of Military Intelligence (National)

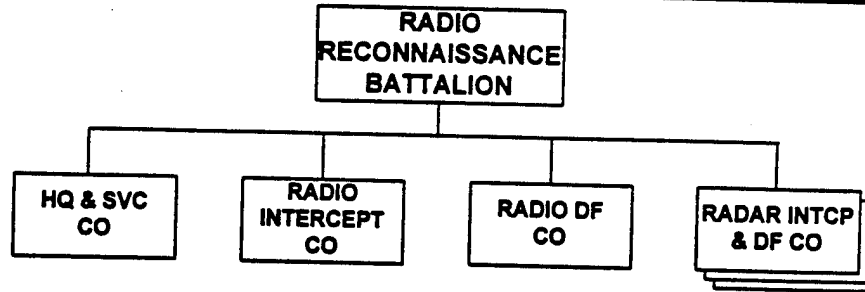

NOTES:

1. This battalion is also known as a radio and radar intercept and direction-finding battalion or as a radiotechnical reconnaissance battalion.
2. Exact composition and equipment strengths vary, however, equipment types are basically of the tactical support variety as shown in the reconnaissance and radioelectronic combat Battalions.
3. These battalions may be allocated as a whole to support a region or army, or individual companies may be allocated to support specific district or region operations. The latter case is more probable when the echelon requesting support has sufficient ground reconnaissance assets, but lacks the radioelectronic capabilities of the recon and REC battalion.

Combat Engineer Brigade, National

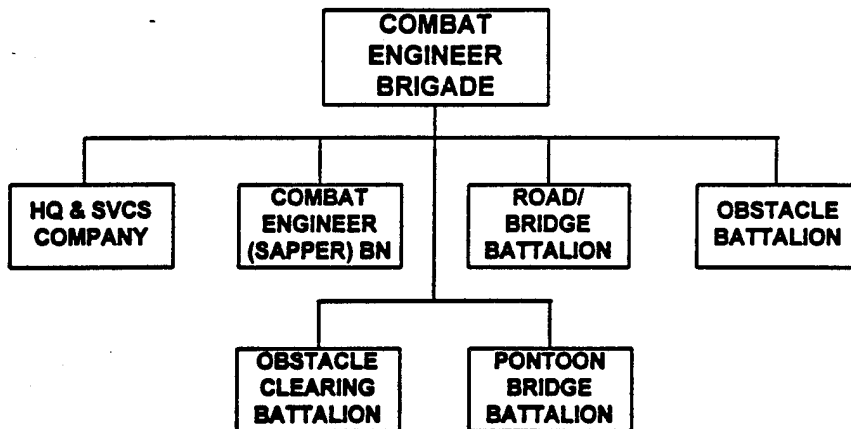

PRINCIPAL ITEMS OF EQUIPMENT

<u>Equipment</u>	<u>Total</u>	<u>Equipment</u>	<u>Total</u>
ACV, BRDM-2U	4	Tracked Ferry, GSP/PMM-2*	24
APC, BTR-60/70/80	6-13	Tracked Amphibian, K-61/PTS	28
Truck, Utility.....	19	Ditching Machine, BTM/MDK	12
Truck, Medium	82	Dozer.....	15
Truck, Heavy.....	25	Powerboat	15
Armored Recovery Vehicle	6	Minelayer, PMR.....	13
Bridge, Truck-Launched	20	Armored Engineer Tractor, IMR	6
Bridge, Tank-Launched	12-14	Mineclearer, MTK/MTK-2.....	8-13
Bridge, PMP Center*	32	Engineer Recon Vehicle, IRM.....	8-15
Bridge, PMP Ramp*	4		

NOTE:

1. The structure, numbers, and types of equipment may vary.
2. Brigades will either be structured as in the example above, or into brigades of battalions identical to those at the division and district level.

FOOTNOTE: * Both the pontoon bridge and the GSP ferry may be replaced by the PMM-2 amphibious bridging system. When the PMM-2 is used, there is no need for powerboats.

Pontoon Bridge Regiment, National

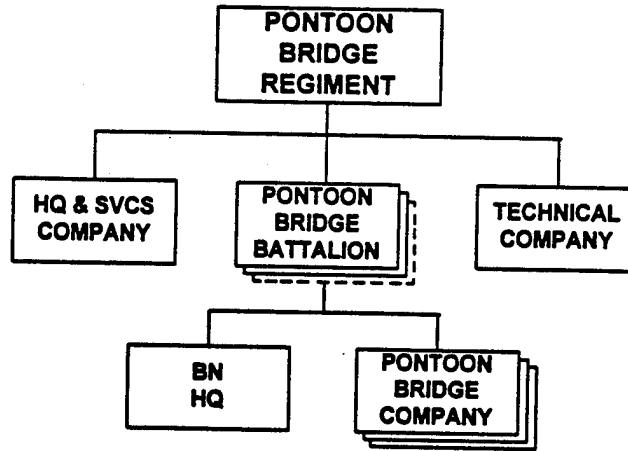

PRINCIPAL ITEMS OF EQUIPMENT

Equipment	Total	Equipment	Total
ACV, BRDM-2U	10	Bridge, PMP Ramp*	12
Truck, Utility	5	Tracked Amphibian, K-61/PTS	8
Truck, Medium	60	Ditching Machine, BTM/MDK	3
Truck, Heavy	5	Dozer	7
Armored Recovery Vehicle	3	Powerboat	36
Bridge, Truck-Launched	4	Engineer Recon Vehicle, IRM	1-8
Bridge, PMP Center*	96		

FOOTNOTE: * The pontoon bridge may be replaced by the PMM-2 amphibious bridging system. With the PMM-2, there is no need for powerboats.

Assault Crossing Battalion, National

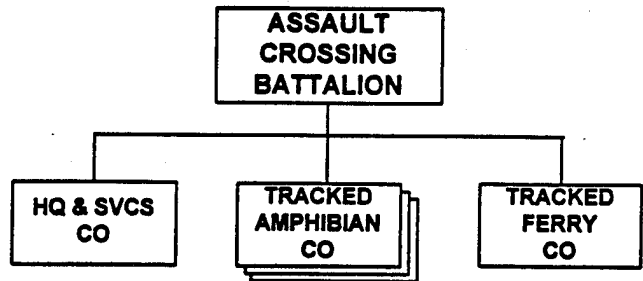

PRINCIPAL ITEMS OF EQUIPMENT

Equipment	Total	Equipment	Total
ACV, BRDM-2U	4	Tracked Ferry, GSP/PMM-2.....	40
Truck, Utility.....	2	Tracked Amphibian, K-61/PTS	36
Truck, Medium	10	Ditching Machine, BTM/MDK	3
Armored Engineer Tractor, IMR	3	Dozer.....	3
Armored Recovery Vehicle	3		

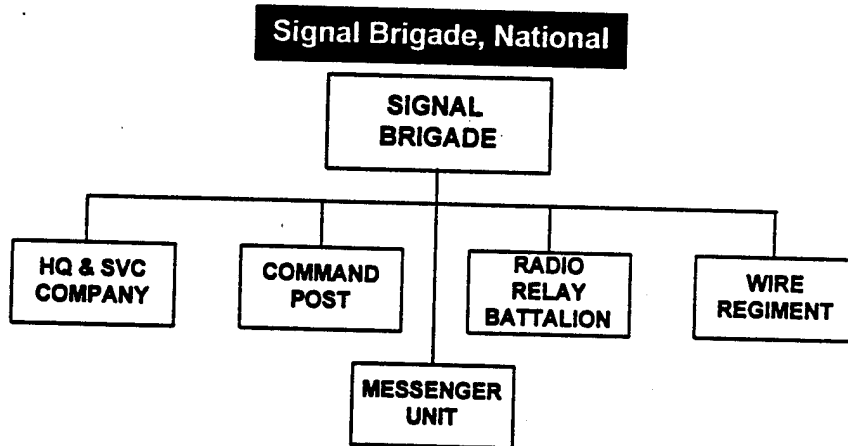
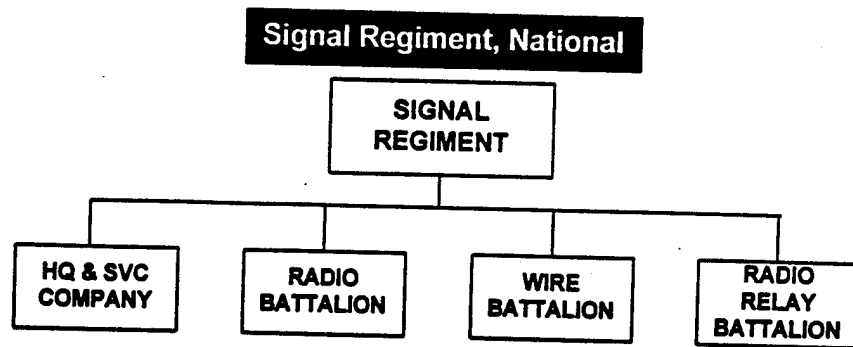

NOTE: Some signal brigades may be configured as in the above examples. However, most are configured with three to four battalions identical to those organic to divisions, which facilitates support to tactical units.

Chemical Protection Battalion, National

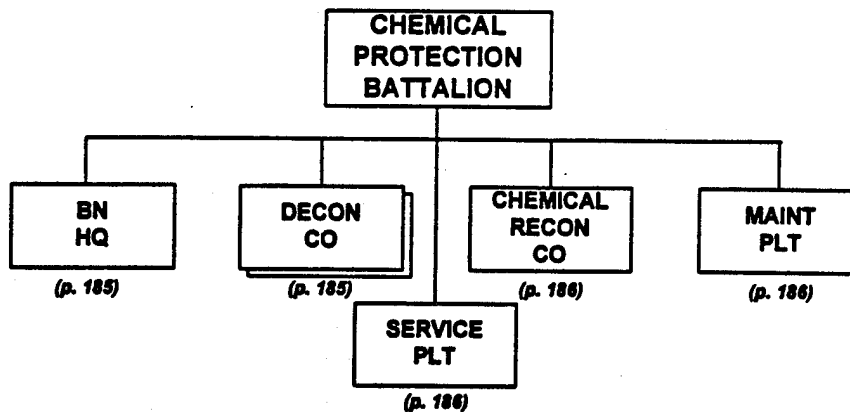

PRINCIPAL ITEMS OF EQUIPMENT

<u>Equipment</u>	<u>Total</u>	<u>Equipment</u>	<u>Total</u>
ATGL, RPG-7V	5	Tractor 1	
Truck, Utility	3	Trailer, POL (1,200-Liter)	2
Truck, Light	3	Trailer, Generator	3
Truck, Medium	19	Trailer, Cargo, 1-Axle	2
Chemical Recon Vehicle,		Trailer, Cargo, 2-Axle	4
BRDM-2RKh/RKhM	9	Trailer, Water (900-Liter)	2
Van, Light	1	Trailer, Kitchen	3
Van, Signal	1	Radios:	
Van, Maintenance	2	VHF, Vehicle Mount,	
Truck, POL (4,000 or 5,200-Liter)	4	Medium-Power	13
Truck, Decon, ARS-12U/14	20	HF/VHF, Vehicle Mount	
Truck, Decon, DDA-53/66	4	Medium-Power	1
Truck, Decon, DKV	2	HF, Manpack, Low-Power	2
Truck, Decon, TMS-65	2	Warning Receiver	1
Ambulance	1		

Battalion Headquarters, Chemical Protection Bn, National

BATTALION HEADQUARTERS

PRINCIPAL ITEMS OF EQUIPMENT

<u>Equipment</u>	<u>Total</u>	<u>Equipment</u>	<u>Total</u>
Truck, Utility.....	1	Radios:	
Van, Light.....	1	VHF, Vehicle Mount,	
Van, Signal.....	1	Medium-Power	1
		HF/VHF, Vehicle Mount,	
		Medium-Power	1
		HF, Manpack, Low-Power.....	1
		Warning Receiver	1

Decontamination Company, Chemical Protection Bn, National

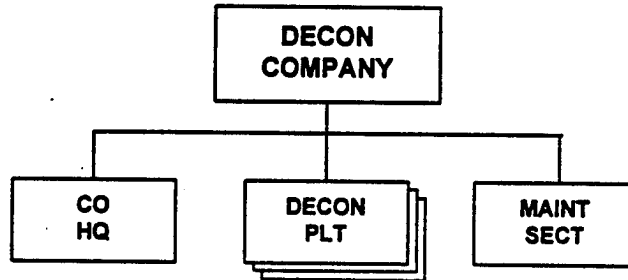

PRINCIPAL ITEMS OF EQUIPMENT

<u>Equipment</u>	<u>1st Co</u>	<u>2nd Co</u>	<u>Equipment</u>	<u>1st Co</u>	<u>2nd Co</u>
ATGL, RPG-7V.....	2	2	Truck, Water (2,000-Liter).....	3	3
Truck, Light.....	2	2	Trailer, Cargo, 1-Axle.....	2	0
Truck, Medium.....	6	6	Trailer, Cargo, 2-Axle.....	0	2
Truck, Decon, ARS-12U/14.....	10	6	Trailer, Water (900-Liter).....	4	2
Truck, Decon, DDA-53/66.....	2	2	Radio, VHF, Vehicle Mount,		
Truck, Decon, TMS-65.....	2	0	Medium-Power	1	1
Truck, Decon, DKV.....	0	2			

Chemical Reconnaissance Company, Chemical Protection Bn, National

**CHEMICAL
RECONNAISSANCE
COMPANY**

PRINCIPAL ITEMS OF EQUIPMENT

Equipment	Total	Equipment	Total
ATGL, RPG-7V.....	1	Radios:	
Truck, Utility.....	1	VHF, Vehicle Mount,	
Chemical Recon Vehicle,		Medium-Power	10
BRDM-2RKh/RKhM.....	9	HF, Manpack, Low-Power.....	1

Maintenance Platoon, Chemical Protection Bn, National

**MAINTENANCE
PLATOON**

PRINCIPAL ITEMS OF EQUIPMENT

Equipment	Total	Equipment	Total
Truck, Medium	5	Tractor 1	
Van, Maintenance	2	Trailer, Cargo, 2-Axle.....	3
Truck, Water (2,000-Liter).....	1	Trailer, POL (900-Liter)	2
Truck, POL (4,000 or 5,200-Liter)	4	Trailer, Generator.....	2
Truck, Decon, ARS-12U/14	2		

Service Platoon, Chemical Protection Bn, National

**SERVICE
PLATOON**

PRINCIPAL ITEMS OF EQUIPMENT

Equipment	Total	Equipment	Total
Truck, Utility.....	1	Trailer, Cargo, 2-Axle.....	1
Truck, Medium	6	Trailer, Generator.....	1
Truck, Decon, ARS-12U/14	2	Trailer, Water (900-Liter)	1
Ambulance	1	Trailer, Kitchen	3

Smoke Battalion, National

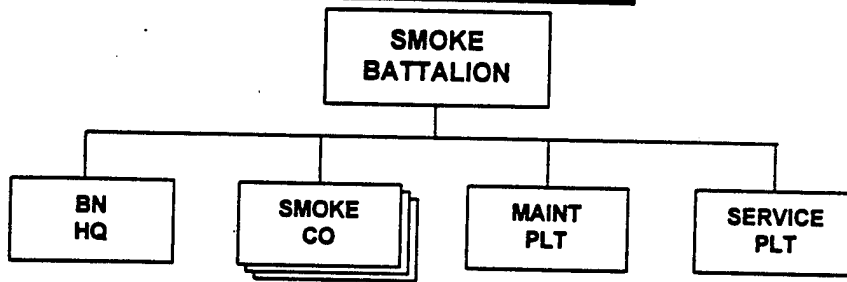

PRINCIPAL ITEMS OF EQUIPMENT

Equipment	Total	Equipment	Total
Truck, Smoke Generator, TDA-M.....	27	Trailer, Generator.....	3
Truck, Light	5	Radios:	
Truck, Medium	24	VHF, Manpack, Low-Power.....	3
Van, Maintenance	5	VHF, Vehicle Mount,	
Trailer, Cargo, 2-Axle.....	10	Medium-Power	29
Trailer, Water (900-Liter)	4	HF/VHF, Vehicle Mount,	
Trailer, Kitchen.....	6	Medium-Power	1
Trailer, POL (1,200-Liter)	2		

Smoke Company, Smoke Bn, National

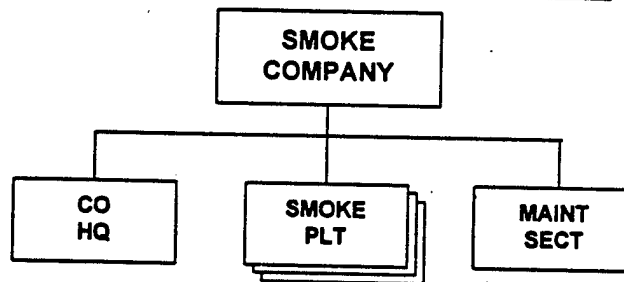

PRINCIPAL ITEMS OF EQUIPMENT

Equipment	Total	Equipment	Total
Truck, Smoke Generator, TDA-M.....	9	Trailer, Water (900-Liter)	1
Truck, Medium	4	Trailer, Kitchen	1
Van, Maintenance	1	Radio, VHF, Vehicle Mount,	
Trailer, Cargo, 2-Axle.....	2	Medium-Power	9

Material Support Brigade, National (Rear Services)

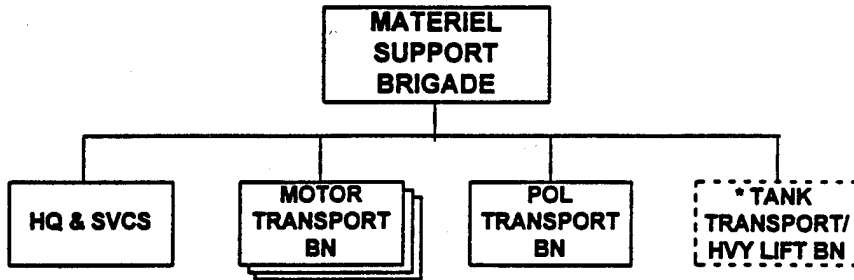

NOTES:

1. Materiel Support Brigades will be configured as above, or with four to five identical materiel support battalions. While the above configuration centralizes responsibility for given missions within a certain unit, the identical materiel support battalion concept facilitates support to tactical units.
2. Brigades configured as shown above will always remain at the national level, under control of the General Staff/National Headquarters.

Maintenance Brigade, National (Rear Services)

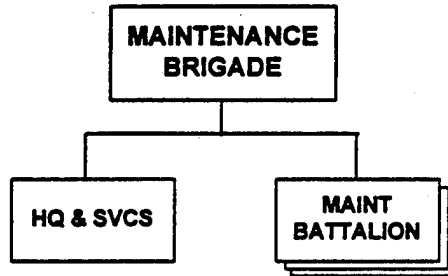

NOTE: Maintenance brigades are configured with 3-4 battalions identical to those found in divisions.

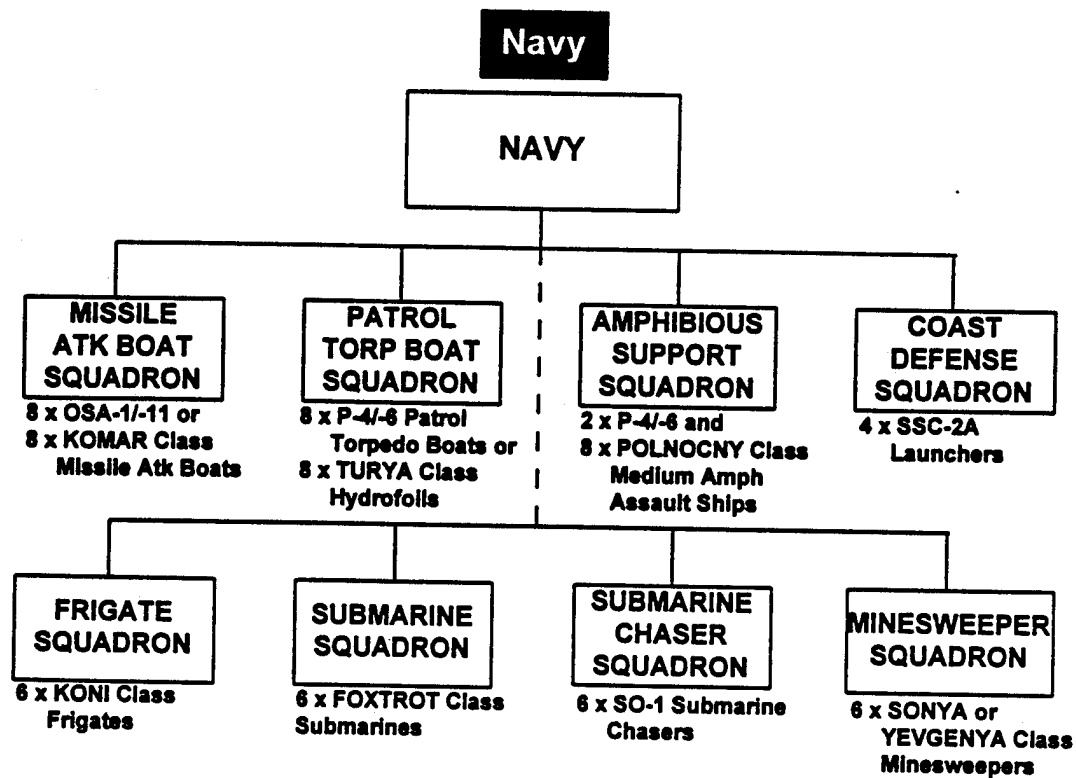

NOTES:

1. As with the Air Force, size and type of naval units depends on the size of the ground forces to be supported and the number and types of specialized missions to be conducted, such as the number of amphibious support squadrons needed for special operations support.
2. Squadrons may be regionally affiliated, as with air defense units. For example, each region may have a missile attack boat squadron and patrol torpedo boat squadron stationed in one of the region's ports.
3. The upper line of the organization chart represents the baseline, even for a "brown water" force. More capable navies would include organizations on the lower line.

Air Force and Air Defense Command

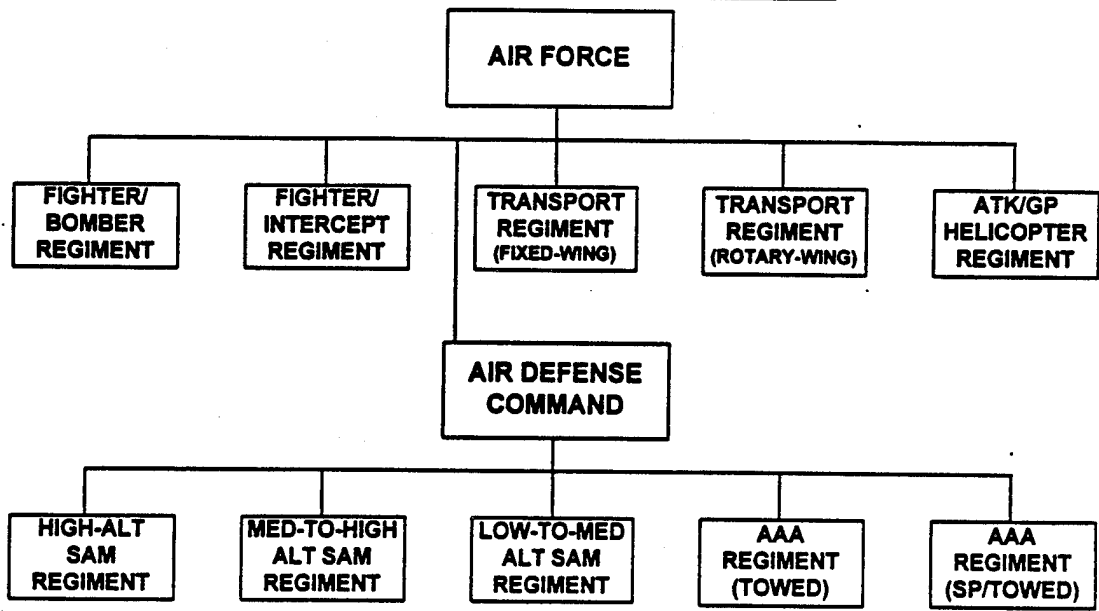

NOTES:

1. Air Force size and composition is dependent on both the size of the ground forces to be supported and the number and types of required specialized missions, such as support to airborne and special operations forces.
2. Types of Air Force regiments depicted above represent a baseline. Possible units are listed from page 191 to page 196.
3. Numbers and types and air defense regiments is dependent on the number and importance of air defense zones/regions to be defended. Assets may have a habitual regional affiliation or support may be tailored by the General Staff/National Headquarters as mission dictates.

Fighter-Interceptor Aviation Regiment, National (Air Force)

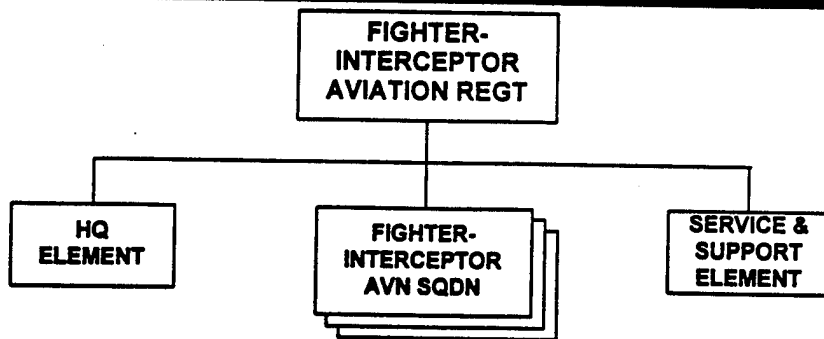

NOTE: This regiment normally contains pure squadrons of the MiG-21/FISHBED J and/or MiG-23/FLOGGER B/E/G fighter-interceptor aircraft. Each squadron has either 12 or 16 aircraft; although 16 appears to be the standard. More modernized air forces could have one squadron of MiG-31/FOXHOUND A.

Ground Attack Aviation Regiment, National (Air Force)

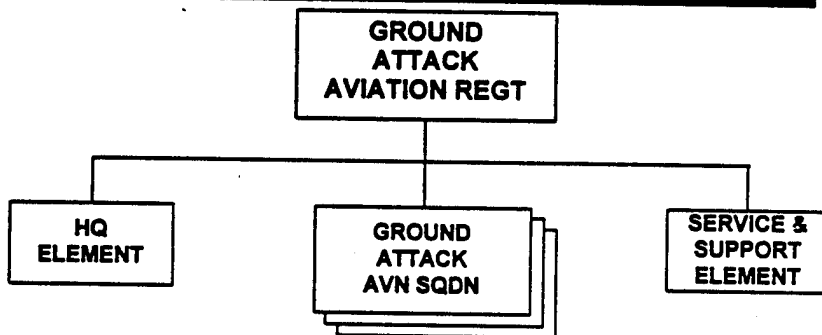

NOTE: This regiment normally contains pure squadrons of the MiG-17/FRESCO, Su-7B/FITTER A, Su-17/FITTER C/D/H, and/or the Su-24 FENCER A/C ground-attack aircraft. Each squadron has either 8 or 16 aircraft. More modernized air forces have at least one squadron of Su-25/FROGFOOT ground-attack aircraft, plus a number of Su-25UB trainers that can also serve as combat aircraft. Most Su-25/FROGFOOT squadrons have 8 aircraft.

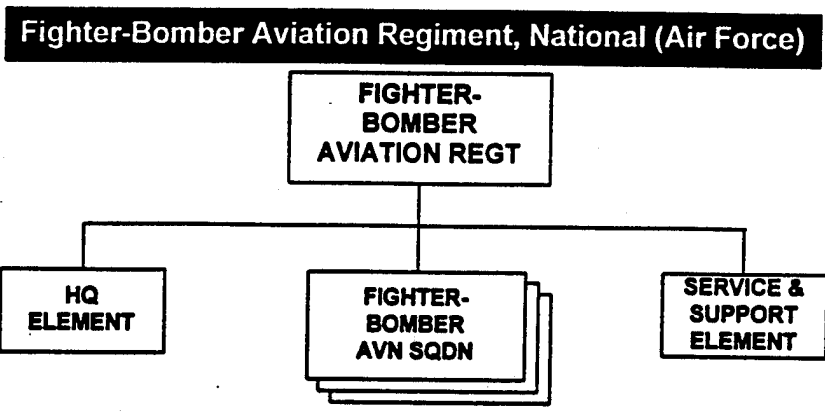

NOTE: This regiment normally contains pure squadrons of the MiG-21/FISHBED C, MiG-23/FLOGGER F, and/or Su-24/FENCER A/C fighter-bomber aircraft. Each squadron has either 12 or 16 aircraft; although 16 appears to be the standard.

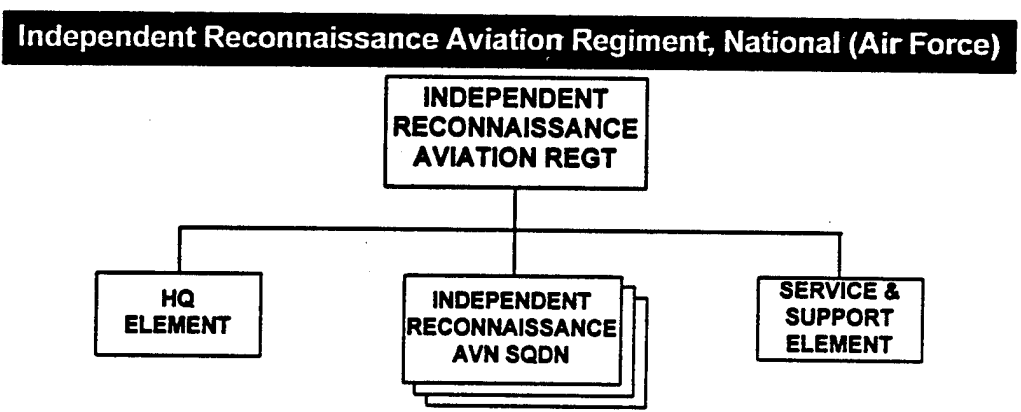

NOTES:

1. The reconnaissance aviation squadrons of this regiment may have reconnaissance variants of the following aircraft: Su-24/FENCER, Su-17/FITTER, or MiG-25/FOXBAT B/D. Each squadron has 16 aircraft.
2. This type of specialized regiment will only be found in larger Air Force structures.

**Independent Radioelectronic Combat Aviation Regiment,
National (Air Force)**

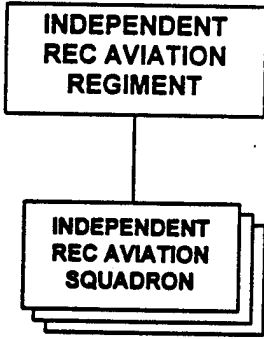

NOTES:

1. This regiment may have a squadron of Su-24/FENCER electronic countermeasures (ECM) variants and a squadron of Yak-28/BREWER E ECM variants. Each squadron has 12 aircraft.
2. As with other independent fixed- and rotary-wing regiments, this regiment will only be found in larger air force structures.

Transport Helicopter Regiment, National (Air Force)

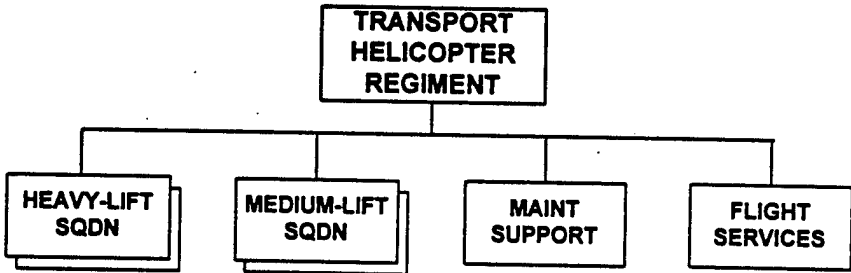

PRINCIPAL ITEMS OF EQUIPMENT

Equipment	Total	Equipment	Total
Heavy-Lift Helicopter, Mi-6A/HOOK or Mi-26/HALO A	24	Medium Helicopter, Mi-8T/HIP C or Mi-8MT(Mi-17)/HIP H	24

NOTES:

1. Some of the medium helicopters may be Mi-8S VIP variants or Mi-8VKP airborne command post variants.
2. Although uncommon, some regiments have substituted a light helicopter squadron for one of the medium-lift squadrons, using the Mi-2/HOPLITE.

Combat/Attack Helicopter Regiment, National (Air Force)

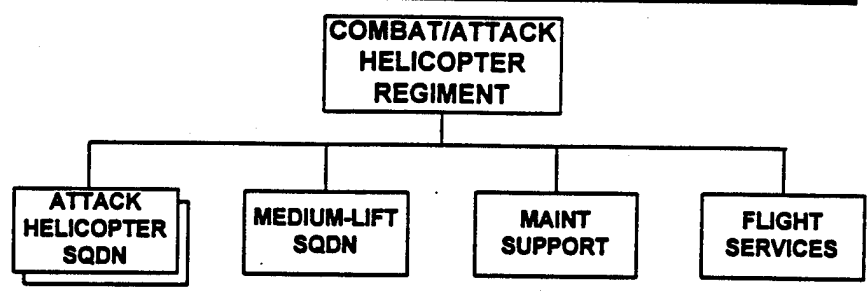

PRINCIPAL ITEMS OF EQUIPMENT

Equipment	Total	Equipment	Total
Attack Helicopter, Mi-24/HIND/D/E/F.....	30-40	Medium Helicopter, Mi-8T/HIP C/E or Mi-8MT(Mi-17)/HIP H	15-20

NOTES:

1. Some combat helicopter regiments also include six Mi-24R/HIND G1 NBC sampling helicopters and six Mi-24/HIND K G/2 photo reconnaissance helicopters.
2. Standard squadron strength is either 15 or 20 aircraft.
3. Some combat helicopter regiments have two squadrons of Mi-2/HOPLITE instead of the Mi-24/HIND. One or both could be configured as lightly armed helicopters. If so, these variants will carry a variety of armaments, although not simultaneously. These may include, on *each side of the fuselage*: a 16-shot 57-mm rocket pod; two AT-3/SAGGER ATGMs; one 50- or 100-kg bomb; or up to two SA-7/GRAIL missiles, which are for anti-air protection.

Independent Helicopter Squadron, National (Air Force)

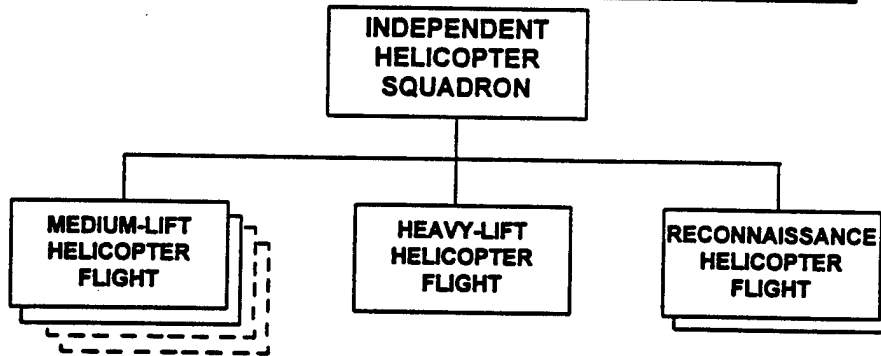

PRINCIPAL ITEMS OF EQUIPMENT

Equipment	Total	Equipment	Total
Medium Helicopter, Mi-8T/HIP C/E or Mi-8MT(Mi-17)/HIP H	6-12	NBC-Sampling Helicopter, Mi-24R/HIND G1	2
Heavy-Lift Helicopter, Mi-6A/HOOK or Mi-26/HALO A	1-2	Photo-Recon Helicopter, Mi-24K/HIND G2	2

NOTES:

1. Some independent helicopter squadrons may also have two or three Mi-8SMV or Mi-8PPA ECM (jamming) helicopters. Some squadrons may also have one or two Mi-8VKP airborne command post helicopters.
2. Some air force structures have an independent mixed aviation squadron with helicopter assets similar to those of an independent helicopter squadron (less the reconnaissance and ECM helicopters), plus 12 to 24 light-to-medium fixed-wing transport aircraft.
3. Some smaller air forces have organized their rotary-wing aircraft solely in this manner, vice the regimental structure predominant in larger forces.

**Independent Helicopter Radioelectronic Combat Squadron,
National (Air Force)**

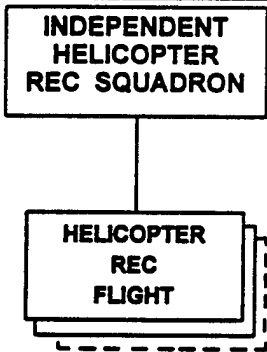

NOTES:

1. This squadron may have one or two Mi-8T/HIP C medium helicopters and 14 to 21 electronic countermeasure (ECM) variants of the types Mi-8PPA (HIP J) and Mi-8SMV (HIP K).
2. This type of specialized squadron will only be found in larger air force structures and/or structures heavier in rotary-wing aircraft.

Transport Regiment, National (Air Force)

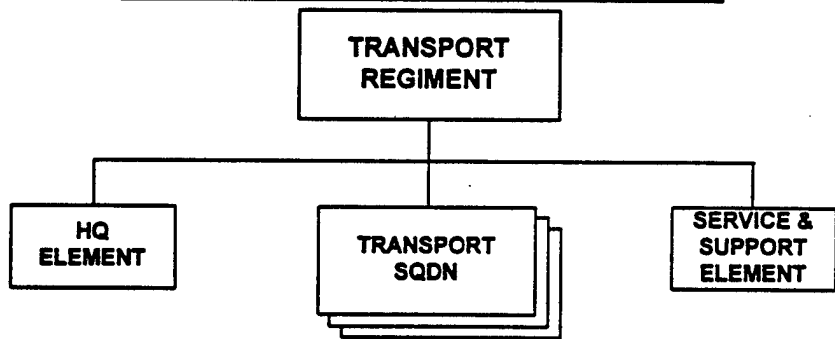

NOTE: This regiment normally contains pure squadrons of the An-2/COLT light transport, Il-18/COOT, and An-26/CURL light transport aircraft. Each squadron has either 16 or 20 aircraft. Some regiments have a squadron of An-12/CUB medium transports, which also have an electronic warfare and reconnaissance configuration.

SAM Brigade (SA-2), National (Air Defense Command)

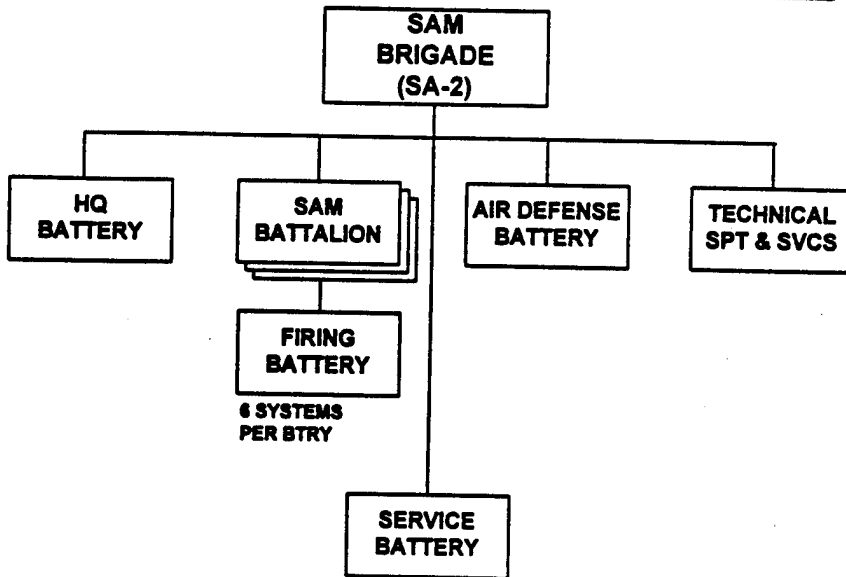

PRINCIPAL ITEMS OF EQUIPMENT

Equipment	Total	Equipment	Total
SAM, SA-2/GUIDELINE.....	18	Radars:	
23-mm AA Gun, ZU-23.....	6	Radar, Fire Control, FANSONG A/B....	3
		Radar, Target Acquisition,	
		SPOON REST.....	3

NOTES:

1. This chart depicts the major subunits of the SA-2 regiment; combat service support elements are not listed.
2. During wartime, SA-2 battalions could be organized with other SAM/AAA units to provide specialized support to a specific region, district, or command.

SAM Brigade (SA-3), National (Air Defense Command)

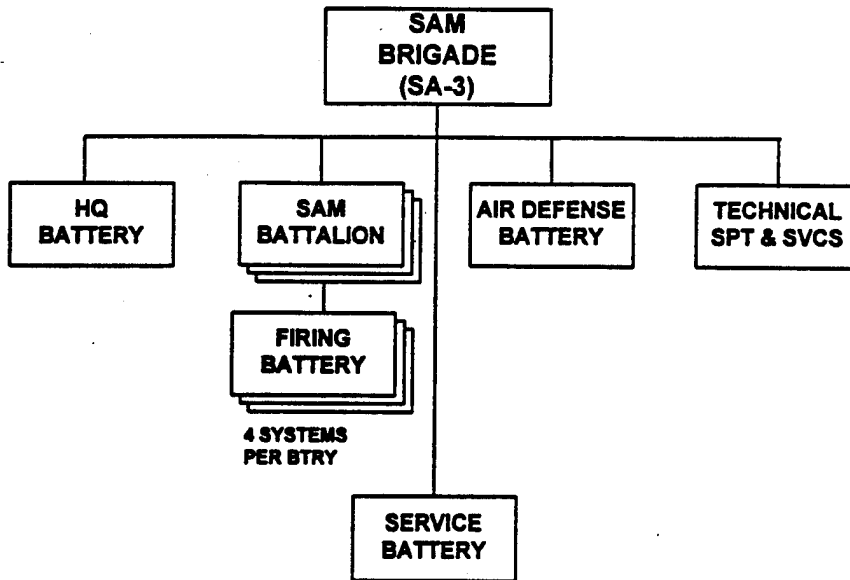

PRINCIPAL ITEMS OF EQUIPMENT

Equipment	Total	Equipment	Total
SAM, SA-3/GOA.....	36	Radars:	
23-mm AA Gun, ZU-23-2	6	Radar, Fire Control, LOW BLOW	9
		Radar, Aerial Surveillance/Target	
		Acquisition, FLAT FACE.....	9

NOTES:

1. This chart depicts the major subunits of the SA-3 regiment; combat service support elements are not listed.
2. During wartime, SA-3 battalions could be organized with other SAM/AAA units to provide specialized support to a specific region, district, or command.

SAM Regiment (SA-8), National (Air Defense Command)

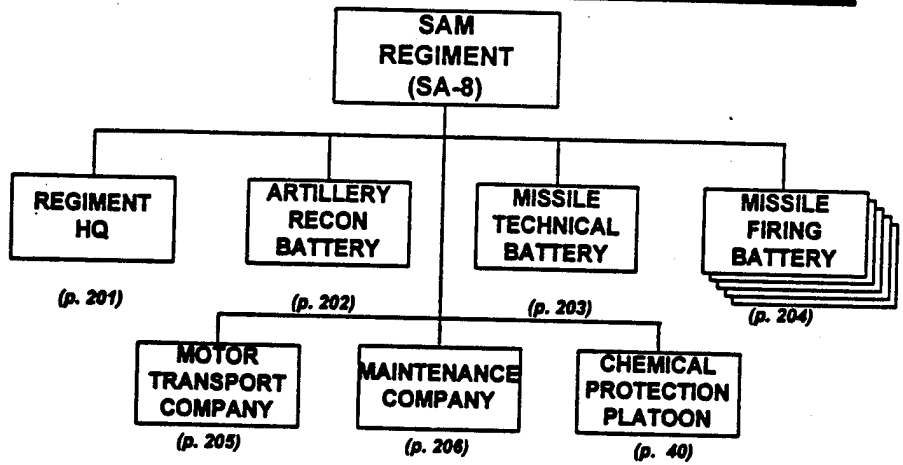

SAM REGIMENT (SA-8), National								
Principal Items of Equipment	Regt HQ	Arty Recon Btry	Missile Tech Btry	Missile Firing Btry (5x)	Motor Trans Co	Maint Co	Chem Protection Plt	TOTAL
	ARMORED VEHICLES							
Chemical Recon Vehicle, BRDM-2RKv/RKhM							3	3
ACV, BTR-60 (PU-12)	1			5				6
WEAPONS								
SAM, SA-8/GECKO				20				20
SAM, SA-7/14	3		3	15				21
TRUCKS								
Truck, Utility	1	3	1		1	1		7
Truck, Light	3	1	5	5	1	3		18
Truck, Medium			4		33	3		40
Truck, Decon, ARS-12U/14							3	3
Truck, Decon, DDA-53/66							1	1
Truck, Crane			2					2
Truck, POL (4,000/5,200-L)					15			15
Van	2			5	4			11
Van, Computer		1						1
Van, Maintenance		1			3	8		12
Van, Missile Testing			5					5
Van, Signal	4							4
Ambulance	2							2
TRAILERS								
Trailer, Cargo, 2-Axle		1	1	5	5	3		15
Trailer, Generator	2		1		3	7		13
Trailer, Kitchen	1	1	2	5	1	1		11
Trailer, POL (1,200-L)					7			7
Trailer, Van	4	1	1	5	2			13
Trailer, Water (1,200-L)					3	1		4
RADARS								
Aer. Surv/Tgt Acq, LONG TRACK		2						4
Radar, Height Finding, THIN SKIN		1						1
RADIOS								
VHF, Manpack, Low-Power	1	2	1	5	1	1		11
VHF, Portable, Low-Power			3					3
VHF, Vehicle Mount, Medium-Power	1	3		30			3	37
HF, Manpack, Low-Power		2					1	3
HF/VHF, Vehicle Mount, Medium-Power	4							4
HF/VHF, Vehicle Mount, High-Power	2							2
Radio Relay, VHF/UHF	1							1
Warning Receiver	2			5				7
MISCELLANEOUS								
SA-8 Transloader (TELAR)				10				10

Regimental Headquarters, SAM Regt, National (Air Defense Command)

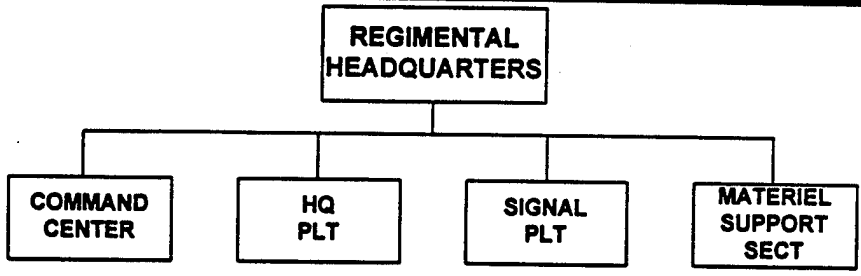

PRINCIPAL ITEMS OF EQUIPMENT

Equipment	Total	Equipment	Total
SAM, SA-7/14	3	Trailer, Kitchen	1
ACV, BTR-60 (PU-12).....	1	Radios:	
Truck, Utility.....	1	VHF, Manpack, Low-Power.....	1
Truck, Light	3	VHF, Vehicle Mount, Medium-Power ..	1
Van.....	2	HF/VHF, Vehicle Mount,	
Van, Signal.....	4	Medium-Power	4
Ambulance	2	HF/VHF, Vehicle Mount, High-Power..	2
Trailer, Van	4	Radio Relay, VHF/UHF.....	1
Trailer, Generator.....	2	Warning Receiver	2

**Artillery Reconnaissance (Target Acquisition/Early Warning)
Battery, SAM Regt, National (Air Defense Command)**

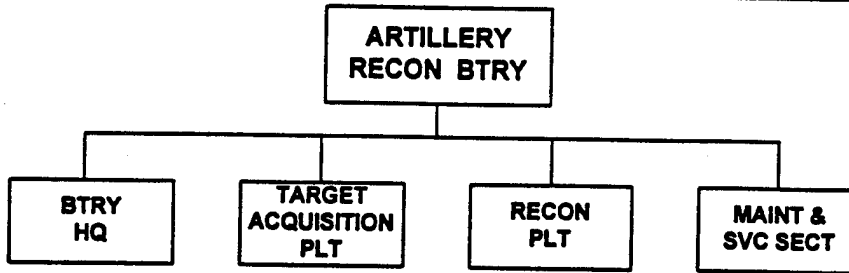

PRINCIPAL ITEMS OF EQUIPMENT

Equipment	Total
Truck, Utility.....	3
Truck, Light	1
Van, Maintenance	1
Van, Computer.....	1
Trailer, Cargo, 2-Axle.....	1
Trailer, Van.....	1
Trailer, Kitchen.....	1

Equipment	Total
Radars:	
Aerial Surveillance/Target Acquisition, LONG TRACK	2
Height Finding, THIN SKIN	1
Radios:	
VHF, Manpack, Low-Power.....	2
VHF, Vehicle Mount, Medium-Power ..	3
HF, Manpack, Low-Power.....	2

Missile Technical Battery, SAM Regt (SA-8), National (Air Defense Command)

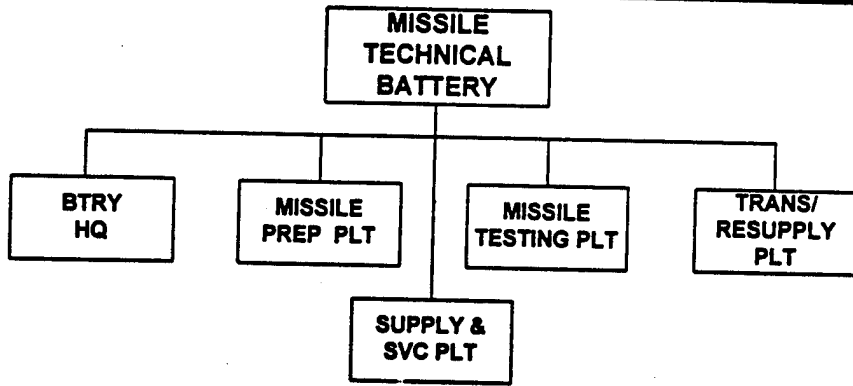

PRINCIPAL ITEMS OF EQUIPMENT

Equipment	Total
SAM, SA-7/14	3
Truck, Utility.....	1
Truck, Light	5
Truck, Medium	4
Truck, Crane	2
Van, Missile Testing	5
Trailer, Cargo, 2-Axle.....	1

Equipment	Total
Trailer, Generator.....	1
Trailer, Van	1
Trailer, Kitchen.....	2
Radios:	
VHF, Portable, Low-Power	3
VHF, Manpack, Low-Power.....	1

Missile Firing Battery, SAM Regt (SA-8), National (Air Defense Command)

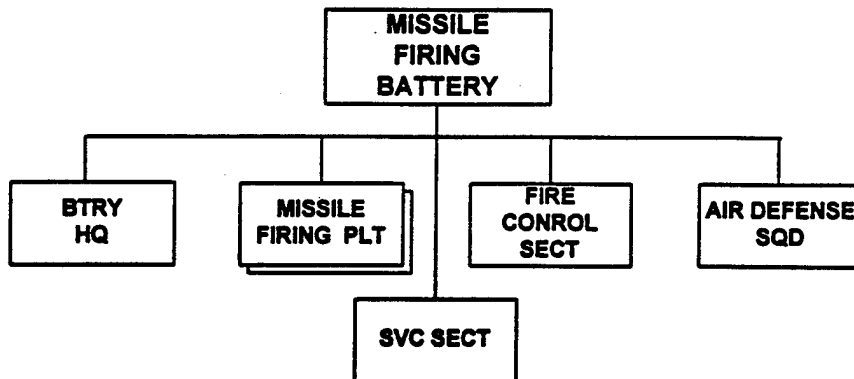

PRINCIPAL ITEMS OF EQUIPMENT

Equipment	Total	Equipment	Total
SAM, SA-8/GECKO TELAR*	4	Trailer, Cargo, 2-Axle	1
SAM, SA-7/14	3	Trailer, Van	1
ACV, BTR-60 (PU-12)	1	Trailer, Kitchen	1
Truck, Light	1	Radios:	
Van	1	VHF, Manpack, Low-Power	1
SA-8 Missile Transloader		VHF, Vehicle Mount, Medium-Power ..	6
(TELAR Chassis)	2	Warning Receiver	1

NOTE: * The TELAR includes the LAND ROLL fire control/target acquisition radar.

Motor Transport Company, SAM Regt, National (Air Defense Command)

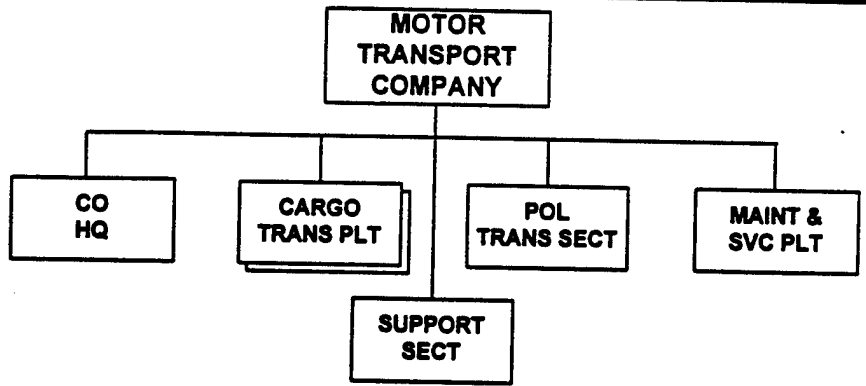

PRINCIPAL ITEMS OF EQUIPMENT

Equipment	Total	Equipment	Total
Truck, Utility.....	1	Trailer, POL (1,200-Liter)	7
Truck, Light	1	Trailer, Generator.....	3
Truck, Medium	33	Trailer, Water (1,200-Liter)	3
Truck, POL (4,000 or 5,200-Liter)	15	Trailer, Kitchen.....	1
Van.....	4	Trailer, Van.....	2
Van, Maintenance	3	Radio, VHF, Manpack, Low-Power	1
Trailer, Cargo, 2-Axle.....	5		

Maintenance Company, SAM Regt, National (Air Defense Command)

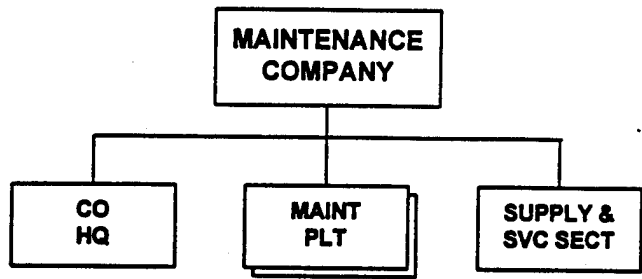

PRINCIPAL ITEMS OF EQUIPMENT

<u>Equipment</u>	<u>Total</u>	<u>Equipment</u>	<u>Total</u>
Truck, Utility.....	1	Trailer, Generator.....	7
Truck, Light	3	Trailer, Water (1,200-Liter)	1
Truck, Medium	3	Trailer, Kitchen	1
Van, Maintenance	8	Radio, VHF, Manpack, Low-Power	1
Trailer, Cargo, 2-Axle.....	3		

SAM Regiment (SA-6), National (Air Defense Command)

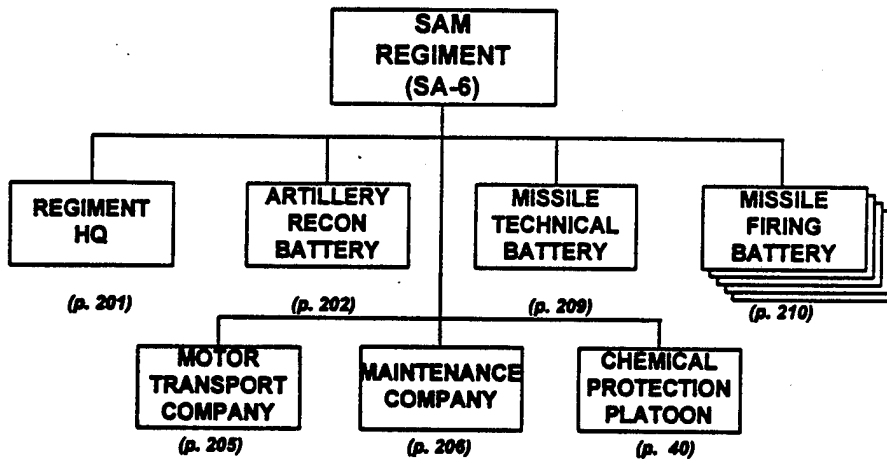

SAM REGIMENT (SA-6), National								
Principal Items of Equipment	Regt HQ	Arty Recon Btry	Missile Tech Btry	Missile Firing Btry (5x)	Motor Trans Co	Maint Co	Chem Protection Pnt	TOTAL
	ARMORED VEHICLES							
ACV, BRDM-2U				5				5
Chemical Recon Vehicle, BRDM-2RKbVRKbM							3	3
ACV, BTR-60 (PU-12)	1							1
WEAPONS								
SAM, SA-6/GAINFUL				20				20
SAM, SA-7/14	3		3	15				21
TRUCKS								
Truck, Utility	1	3	1		1	1		7
Truck, Light	3	1	6	5	1	3		19
Truck, Medium			5		33	3		41
Truck, Decon, ARS-12U/14							3	3
Truck, Decon, DDA-53/66							1	1
Truck, Crane			2					2
Truck, POL (4000/5200-L)					15			15
Van	2			5	4			11
Van, Computer		1						1
Van, Maintenance		1			3	8		12
Van, Missile Testing			6					6
Van, Signal	4							4
Ambulance	2							2
TRAILERS								
Trailer, Cargo, 2-Axle		1	1	5	5	3		15
Trailer, Generator	2		1		3	7		13
Trailer, Kitchen	1	1	2	5	1	1		11
Trailer, POL (1,200-L)					7			7
Trailer, Van	4	1	1	5	2			13
Trailer, Water (1,200-L)					3	1		4
RADARS								
Aer. Surv/Tgt Acq, LONG TRACK		2						2
Radar, FC, STRAIGHT FLUSH				5				5
Radar, HF, THIN SKIN		1						1
RADIOS								
VHF, Manpack, Low-Power	1	2	1	5	1	1		11
VHF, Portable, Low-Power			3					3
VHF, Vehicle Mount, Medium-Power	1	3		30			3	37
HF, Manpack, Low-Power		2					1	3
HF/VHF, Vehicle Mount, Medium-Power	4							4
HF/VHF, Vehicle Mount, High-Power	2							2
Radio Relay, VHF/UHF	1							1
Warning Receiver	2			5				7
MISCELLANEOUS								
SA-6 Canister Transporter			15					15
SA-6 Missile Transloader (Truck)			5	10				15

Missile Technical Battery, SAM Regt (SA-6), National (Air Defense Command)

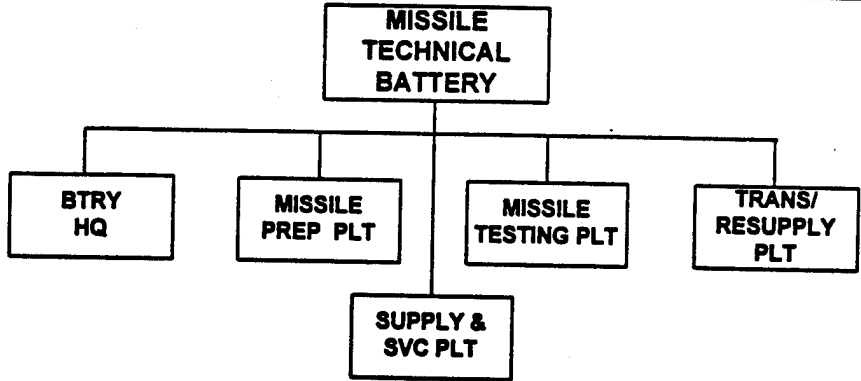

PRINCIPAL ITEMS OF EQUIPMENT

Equipment	Total	Equipment	Total
SAM, SA-7/14	3	SA-6 Missile Transloader (Truck)	5
Truck, Utility	1	Trailer, Cargo, 2-Axle	1
Truck, Light	6	Trailer, Generator	1
Truck, Medium	5	Trailer, Van	1
Truck, Crane	2	Trailer, Kitchen	2
Van, Missile Testing	6	Radios:	
SA-6 Canister Transporter (Tractor-Trailer)	15	VHF, Portable, Low-Power	3
		VHF, Manpack, Low-Power	1

Missile Firing Battery, SAM Regt (SA-6), National (Air Defense Command)

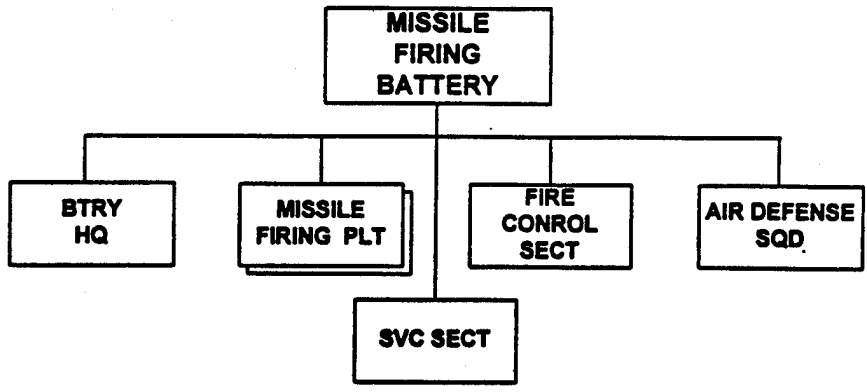

PRINCIPAL ITEMS OF EQUIPMENT

<u>Equipment</u>	<u>Total</u>	<u>Equipment</u>	<u>Total</u>
SAM, SA-6a/GAINFUL TEL or SA-6b/GAINFUL TELAR*.....	4	Trailer, Van.....	1
SAM, SA-7/14	3	Trailer, Kitchen.....	1
ACV, BRDM-2U	1	Radar, Fire Control, STRAIGHT FLUSH...1	
Truck, Light	1	Radios:	
Van.....	1	VHF, Manpack, Low-Power.....	1
SA-6 Missile Transloader (Truck).....	2	VHF, Vehicle Mount, Medium-Power	6
Trailer, Cargo, 2-Axle.....	1	Warning Receiver	1

FOOTNOTE: * The SA-6b system includes the FIRE DOME target engagement radar.

SAM Brigade (SA-11), National (Air Defense Command)

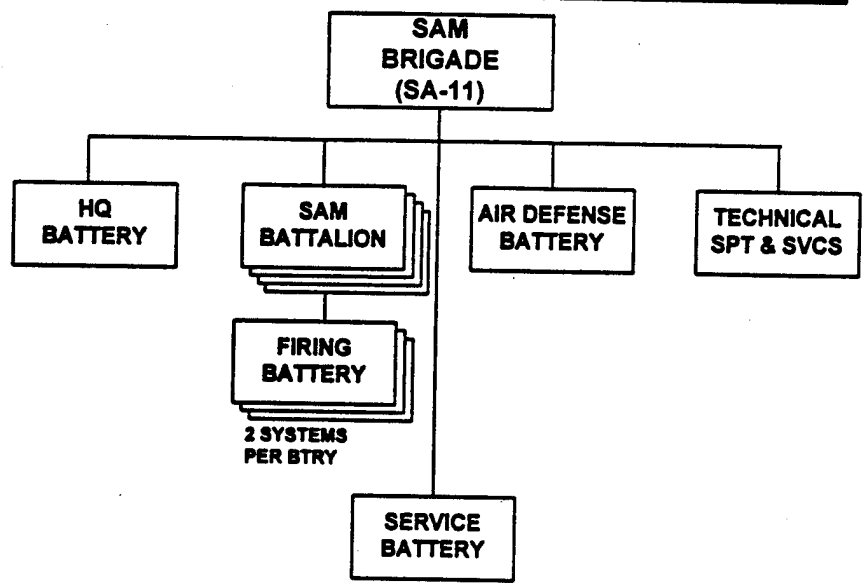

PRINCIPAL ITEMS OF EQUIPMENT

<u>Equipment</u>	<u>Total</u>	<u>Equipment</u>	<u>Total</u>
SAM, SA-11/GADFLY TELAR*	24	Radars:	
23-mm AA Gun, ZU-23	6	Radar, Target Acquisition,	
SA-11 Missile Transloader (TELAR		TUBE ARM or SNOW DRIFT	4
Chassis)	12		

NOTES:

1. Some structures may still have SAM brigades equipped with the older SA-4 system.
2. During wartime, SA-11 battalions could be organized with other SAM/AAA units to provide specialized support to a specific region, district, or command.

FOOTNOTE: * This system includes the FIRE DOME target engagement radar.

Special Operations Command, National

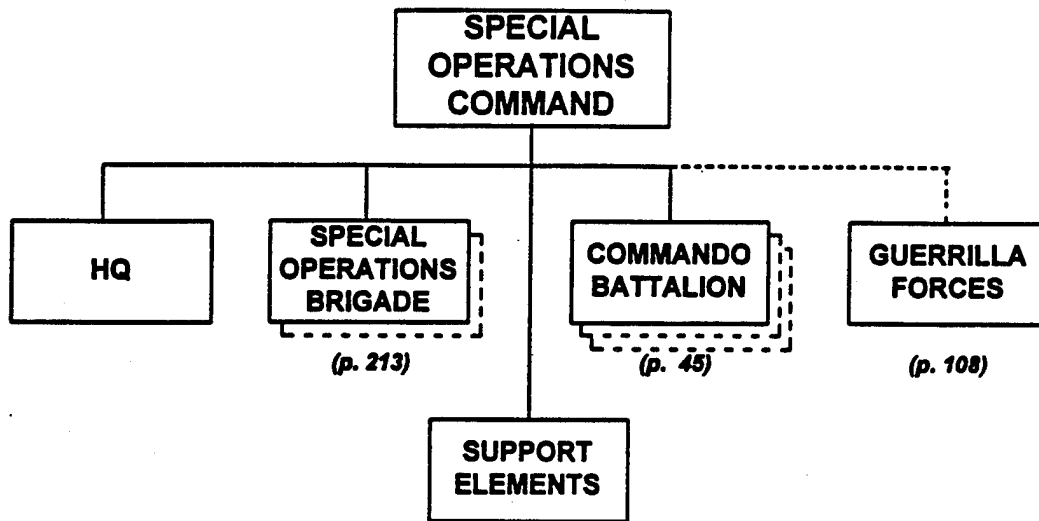

NOTES:

1. The number of special operations brigades and commando battalions is not fixed. Normally, the command would have one special operations brigade; the number of commando battalions located at the national level would depend on how many had been subordinated to heavily equipped military districts.
2. Although controlled by the Ministry of the Interior, active guerrilla forces may receive support from, conduct coordination with, and receive mission guidance from elements of the Special Operations Command.
3. Most support requirements from the special operations brigades and commando battalions are fulfilled with Air Force and Navy assets. More traditional combat service support requirements are fulfilled by Rear Services.

**Special Operations Brigade, National
(Special Operations Command)**

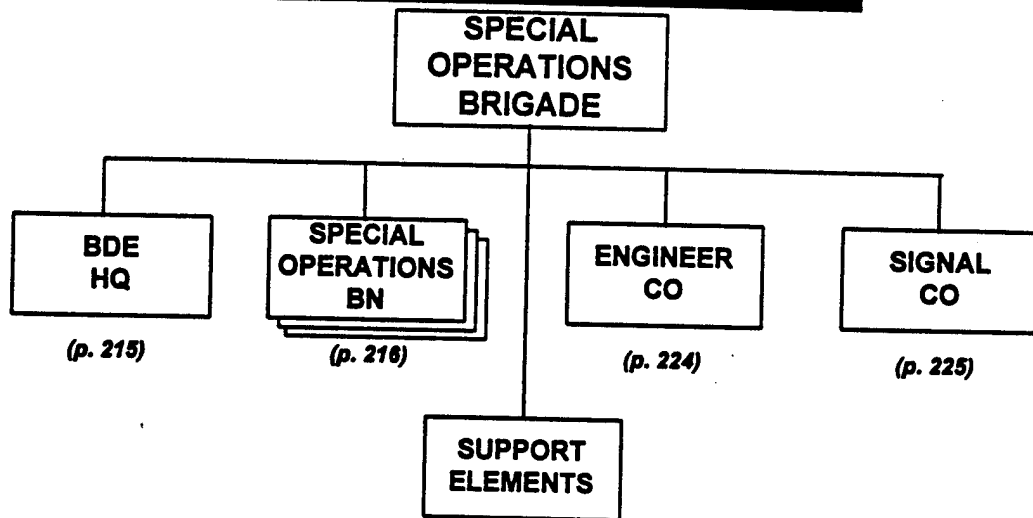

NOTES:

1. Support requirements for special operations missions can vary widely; most are fulfilled by resources outside the Special Operations Command. For example, air transportation requirements are fulfilled by Air Force assets and amphibious operations are supported by Navy assets. Should special operations forces require more traditional combat service support, these assets are provided through Rear Services.
2. Night observation device totals include only those within the special operations battalions. Additionally, night vision goggle totals do not include those for vehicle drivers.
3. Equipment totals for the brigade headquarters and subordinate battalion headquarters reflect only the totals for the command element.
4. Individual weapons for personnel are counted only at the battalion and below.

**PRINCIPAL ITEMS OF EQUIPMENT
SPECIAL OPERATIONS BRIGADE**

Equipment	Total
ACV, BTR (R-145BM)	12
9-mm Pistol, PM	51
5.45-mm Assault Rifle, AKS-74.....	1413
5.45-mm LMG, RPKS-74.....	168
7.62-mm Sniper Rifle, SVD.....	37
7.62-mm GP MG, PKM.....	86
14.5-mm Heavy MG, KPV	6
SAM, SA-16/18	86
ATRL, RPG-18/22.....	205
ATGM Manpack, AT-4/SPIGOT	9
82-mm Mortar, M1937/2B9.....	36
122-mm Single-Tube Rocket Launcher, BM-21-P	18
73-mm Recoilless Gun, SPG-9.....	6
30-mm Automatic Grenade Launcher, AGS-17	18
40-mm Under-Barrel Grenade Launcher, BG-15.....	159
Truck, Utility.....	2
Truck, Light	283
Truck, Medium	32
Ambulance	3
Trailer, Water (900-Liter)	6
Trailer, Generator.....	3
Trailer, 1-Axle.....	21
Van, Maintenance	6
Van, Signal.....	1
Boat, Zodiac-Type	4

Equipment	Total
Scuba Set.....	5
Air Compressor.....	2
Demolition Set	6
Mine Detector, DIM.....	10
Chain Saw	17
Carpenter Set.....	7
Pioneer Set	7
Night Vision Goggles, Type-85.....	54
Night Vision Goggles, PNV-57.....	348
Night Vision Sight, NSP-3 (Small Arms).....	348
Night Vision Sight, PPN-3 (MG)	84
Radios:	
VHF, Portable, Low-Power	136
VHF, Manpack, Low-Power.....	2
VHF, Vehicle Mount, Medium-Power	11
HF/VHF, Manpack, Low-Power.....	250
HF/VHF, Vehicle Mount, Medium-Power	62
HF, Portable, Very-Low-Power	3
HF, Van Mount, High-Power.....	1
Ground-to-Air Set	3
Burst Transmission	57
Radio Relay, VHF/UHF.....	2
Radio Telegraph.....	1
Warning Receiver	19

**Brigade Headquarters, Special Ops Bde,
National (Special Operations Command)**

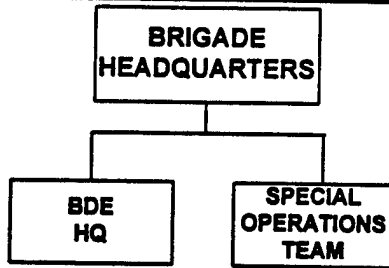

PRINCIPAL ITEMS OF EQUIPMENT

Equipment	Total	Equipment	Total
5.45-mm LMG, RPKS-74.....	2	Radios:	
7.62-mm Sniper Rifle, SVD.....	1	VHF, Manpack, Low-Power.....	2
SAM, SA-16/18*	2	HF/VHF Manpack, Low-Power	2
ATRL, RPG-18/22.....	1	Ground-to-Air Set.....	2
Truck, Light	3	Burst Transmission	2
		Warning Receiver	1

FOOTNOTE: * Some headquarters may be equipped with 1 to 2 12.7-mm DShK machineguns.

**Special Operations Battalion, Special Ops Bde,
National (Special Operations Command)**

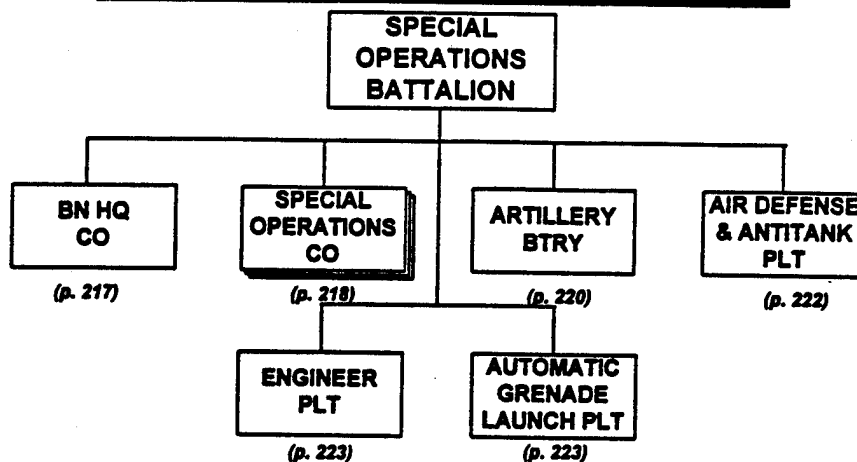

PRINCIPAL ITEMS OF EQUIPMENT

Equipment	Total
ACV, BTR (R-145BM)	3
9-mm Pistol, PM	17
5.45-mm Assault Rifle, AKS-74	471
5.45-mm LMG, RPKS-74	54
7.62-mm Sniper Rifle, SVD	12
7.62-mm GP MG, PKM	26
14.5-mm Heavy MG, KPV	2
SAM, SA-16/18	28
ATRL, RPG-18-22	64
ATGM Manpack, AT-4/SPIGOT	3
82-mm Mortar, M1937/2B9	12
122-mm Single-Tube Rocket Launcher, BM-21-P	6
73-mm Recoilless Gun, SPG-9	2
30-mm Automatic Grenade Launcher, AGS-17	6
40-mm Under-Barrel Grenade Launcher, BG-15	53
Truck, Light	92
Truck, Medium	9
Ambulance	1
Trailer, Water (900-Liter)	2

Equipment	Total
Trailer, Generator	1
Trailer, 1-Axle	4
Van, Maintenance	2
Mine Detector, DIM	1
Demolition Set	2
Chain Saw	3
Carpenter Set	1
Pioneer Set	1
Night Vision Goggles, Type-85	18
Night Vision Goggles, PNV-57	116
Night Vision Sight, NSP-3 (Small Arms)	116
Night Vision Sight, PPN-3 (MG)	28
Radios:	
VHF, Portable, Low-Power	42
VHF, Vehicle Mount, Medium-Power	3
HF/VHF, Manpack, Low-Power	75
HF/VHF, Vehicle Mount, Medium-Power	16
HF, Portable, Very-Low-Power	1
Burst Transmission	17
Warning Receiver	5

**Headquarters Company, Special Ops Bn, Special Ops
Bde, National (Special Operations Command)**

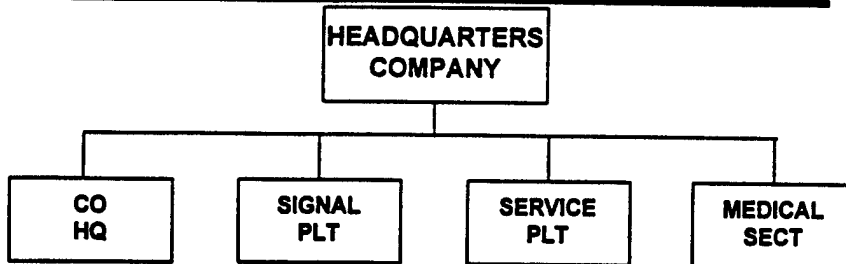

PRINCIPAL ITEMS OF EQUIPMENT

Equipment	Total	Equipment	Total
ACV, BTR (R-145BM)	3	Trailer, Generator.....	1
9-mm Pistol, PM.....	1	Trailer, Kitchen.....	1
5.45-mm Assault Rifle, AKS-74.....	35	Ambulance	1
5.45-mm LMG, Light, RPKS-74	2	Night Vision Goggles, Type-85.....	2
14.5-mm Heavy MG, NSV	2	Night Vision Goggles, PNV-57	9
40-mm Under-Barrel Grenade Launcher, BG-15.....	2	Night Vision Sight, NSP-3 (Small Arms)....	3
ATRL, RPG-18/22.....	4	Night Vision Sight, PPN-3 (MG)	2
SAM, SA-16/18*	3	Radios:	
Truck, Light	4	VHF, Portable, Low-Power	2
Truck, Medium	6	HF/VHF, Manpack, Low-Power.....	5
Truck, POL (4,000-Liter).....	1	HF/VHF, Vehicle Mount, Medium-Power	4
Van, Maintenance	2	Burst Transmission	2
Trailer, 1-Axle.....	2	Warning Receiver	1
Trailer, Water (900-Liter)	2		

FOOTNOTE: * Some headquarters may be equipped with 1 to 2 12.7-mm DShK machineguns.

Special Operations Company, Special Ops Bn, Special Ops Bde, National (Special Operations Command)

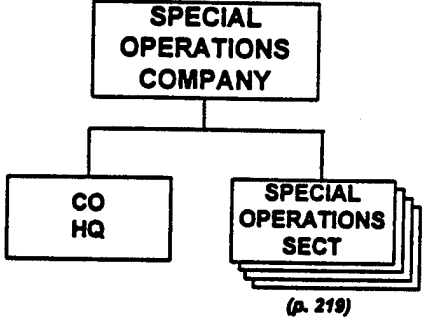

PRINCIPAL ITEMS OF EQUIPMENT

Equipment	Total
5.45-mm Assault Rifle, AKS-74.....	90
5.45-mm LMG, RPKS-74.....	16
7.62-mm Sniper Rifle, Sniper, SVD.....	4
7.62-mm GP MG, PKM.....	8
40-mm Under-Barrel Grenade Launcher, BG-15.....	17
SAM, SA-16/18.....	5
ATRL, RPG-18/22.....	16
Truck, Light.....	21
Night Vision Goggles, Type-85.....	5

Equipment	Total
Night Vision Goggles, PNV-57.....	22
Night Vision Sight, NSP-3 (Small Arms).....	35
Night Vision Sight, PPN-3 (MG).....	8
Radios:	
VHF, Portable, Low-Power.....	10
HF/VHF, Manpack, Low-Power.....	18
HF/VHF, Vehicle Mount, Medium-Power.....	2
Burst Transmission.....	5
Warning Receiver.....	1

Special Ops Section, Special Ops Co, Special Ops Bn, Special Ops Bde, National (Special Operations Command)

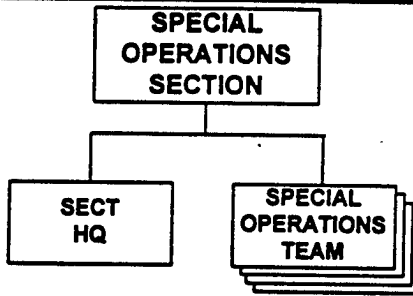

PRINCIPAL ITEMS OF EQUIPMENT

<u>Equipment</u>	<u>Total</u>	<u>Equipment</u>	<u>Total</u>
5.45-mm Assault Rifle, AKS-74.....	21	Night Vision Goggles, Type-85.....	1
5.45-mm LMG, RPKS-74.....	4	Night Vision Goggles, PNV-57.....	5
7.62-mm Sniper Rifle, SVD.....	1	Night Vision Sight, NSP-3 (Small Arms)....	8
7.62-mm GP MG, PKM.....	2	Night Vision Sight, PPN-3 (MG).....	2
40-mm Under-Barrel Grenade Launcher, BG-15.....	4	Radios:	
SAM, SA-16/18.....	1	VHF, Portable, Low-Power.....	2
ATRL, RPG-18/22.....	4	HF/VHF, Manpack, Low-Power.....	4
Truck, Light.....	5	Burst Transmission.....	1

Special Operations Team, Special Ops Sect, Special Ops Co, Special Ops Bn, Special Ops Bde, National (Special Operations Command)



PRINCIPAL ITEMS OF EQUIPMENT

<u>Equipment</u>	<u>Total</u>	<u>Equipment</u>	<u>Total</u>
5.45-mm Assault Rifle, AKS-74.....	5	ATRL, RPG-18/22.....	1
5.45-mm LMG, RPK-74.....	1	Night Vision Goggles, PNV-57.....	1
7.62-mm Sniper Rifle, SVD.....	*1	Night Vision Sight, NSP-3 (Small Arms)....	2
40-mm Under-Barrel Grenade Launcher, BG-15.....	1	Radio, HF/VHF, Manpack, Low-Power.....	1

FOOTNOTE: * One team per section has the SVD sniper rifle.

**Artillery Battery, Special Ops Bn, Special Ops Bde,
National (Special Operations Command)**

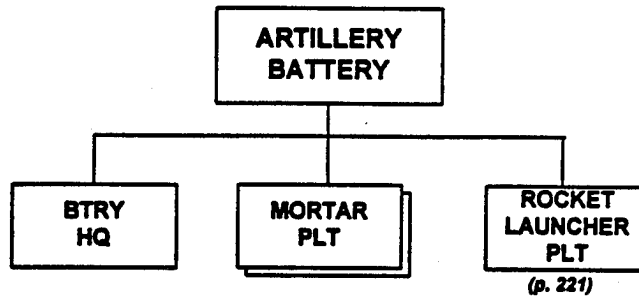

PRINCIPAL ITEMS OF EQUIPMENT

Equipment	Total	Equipment	Total
82-mm Mortar, M1937/2B9.....	12	SAM, SA-16/18	4
122-mm Single-Tube Rocket Launcher, BM-21-P	6	Truck, Light	16
9-mm Pistol, PM	3	Night Vision Goggles, PNV-57	18
5.45-mm Assault Rifle, AKS-74.....	60	Radio:	
ATRL, RPG-18/22.....	9	HF/VHF Manpack, Low-Power.....	12
		Warning Receiver	1

**Mortar Platoon, Arty Btry, Special Ops Bn, Special
Ops Bde, National (Special Operations Command)**

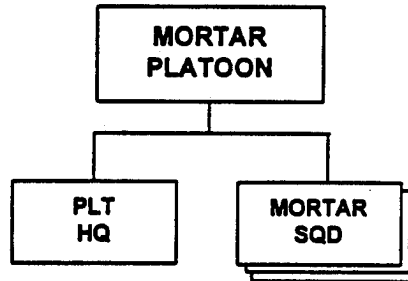

PRINCIPAL ITEMS OF EQUIPMENT

Equipment	Total	Equipment	Total
82-mm Mortar, M1937/2B9.....	6	Truck, Light	6
9-mm Pistol, PM	1	Night Vision Goggles, PNV-57	6
5.45-mm Assault Rifle, AKS-74.....	18	Radio:	
ATRL, RPG-18/22.....	3	HF/VHF Manpack, Low-Power.....	3
SAM, SA-16/18	1	Warning Receiver	1

Rocket Launcher Platoon, Arty Btry, Special Ops Bn, Special Ops Bde, National (Special Operations Command)

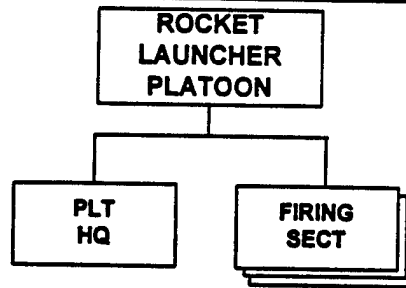

PRINCIPAL ITEMS OF EQUIPMENT

<u>Equipment</u>	<u>Total</u>	<u>Equipment</u>	<u>Total</u>
122-mm Single Tube Rocket Launcher, BM-21-P	6	SAM, SA-16/18	2
9-mm Pistol, PM	1	Truck, Light	3
5.45-mm Assault Rifle, AKS-74.....	21	Night Vision Goggles, PNV-57	3
ATRL, RPG-18/22.....	3	Radio, HF/VHF Manpack, Low-Power	4

Air Defense and Antitank Platoon, Special Ops Bn, Special Ops Bde, National (Special Operations Command)

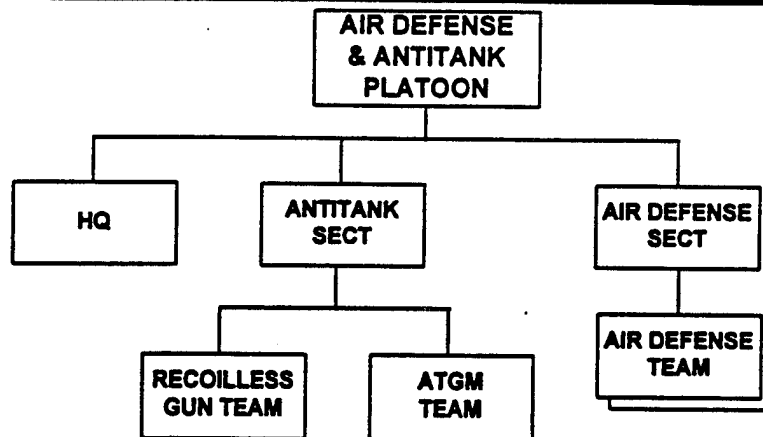

PRINCIPAL ITEMS OF EQUIPMENT

Equipment	Total	Equipment	Total
ATGM Manpack, AT-4/SPIGOT	3	Night Vision Goggles, PNV-57	5
73-mm Recoilless Gun, SPG-9	2	Night Vision Sight, NSP-3 (Small Arms)....	5
SAM, SA-16/18	6	Radios:	
9-mm Pistol, PM	3	VHF, Vehicle Mount, Medium-Power ..	3
5.45-mm Assault Rifle, AKS-74.....	15	VHF, Portable, Low-Power	4
Truck, Light	3	HF, Portable, Very-Low-Power	1

NOTE: Some units may not have an organic air defense/antitank platoon. Instead, the battalion may divide SAM, SA-16/18 and ATRL, RPG-18/22 assets among the companies.

Automatic Grenade Launcher Platoon, Special Ops Bn, Special Ops Bde, National (Special Operations Command)

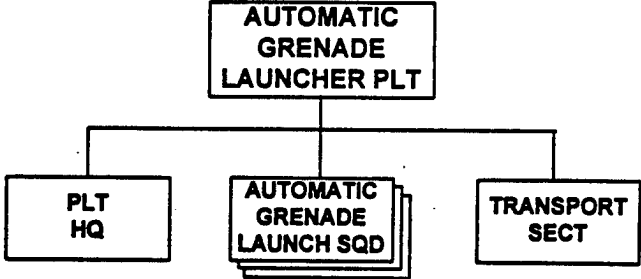

PRINCIPAL ITEMS OF EQUIPMENT

<u>Equipment</u>	<u>Total</u>	<u>Equipment</u>	<u>Total</u>
30-mm Automatic Grenade Launcher, AGS-17	6	Night Vision Goggles, PNV-57	3
9-mm Pistol, PM	7	Radios:	
5.45-mm Assault Rifle, AKS-74	12	VHF, Vehicle Mounted, Medium-Power	3
Truck, Light	3	VHF, Portable, Low-Power	4

Engineer Platoon, Special Ops Bn, Special Ops Bde, National (Special Operations Command)

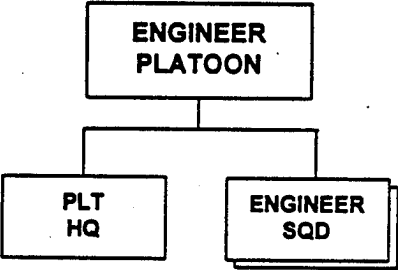

PRINCIPAL ITEMS OF EQUIPMENT

<u>Equipment</u>	<u>Total</u>	<u>Equipment</u>	<u>Total</u>
9-mm Pistol, PM	1	Chain Saw	3
5.45-mm Assault Rifle, AKS-74	10	Carpenters Set	1
5.45-mm LMG, RPKS-74	2	Pioneer Set	1
7.62-mm GP MG, PKM	2	Night Vision Goggles, Type-85	1
ATRL, RPG-18/22	3	Night Vision Goggles, PNV-57	6
Truck, Light	3	Night Vision Sight, NSP-3 (Small Arms)	3
Truck, Medium	3	Night Vision Sight, PPN-3 (MG)	2
Trailer, 1-Axle	2	Radios:	
Demolition Set	2	VHF, Portable, Low-Power	2
Mine Detector, DIM	1	HF/VHF, Manpack, Low-Power	4

**Engineer Company, Special Ops Bde, National
(Special Operations Command)**

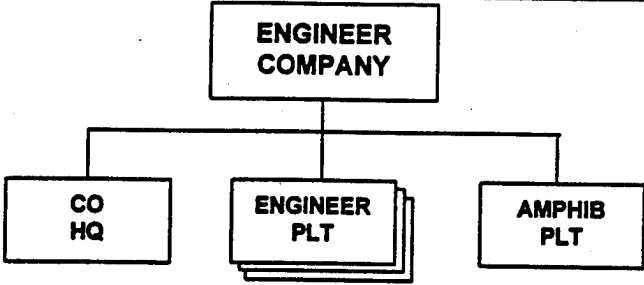

PRINCIPAL ITEMS OF EQUIPMENT

Equipment	Total
5.45-mm LMG, RPKS-74.....	4
7.62-mm GP MG, PKM.....	8
ATRL, RPG-18/22.....	9
Truck, Light	1
Truck, Medium	5
Trailer, 1-Axle.....	6
Boat, Zodiac.....	4
Scuba Set.....	5
Air Compressor.....	2

Equipment	Total
Demolition Set	4
Mine Detector, DIM.....	7
Chain Saw	8
Carpenter Set.....	4
Pioneer Set	4
Radios:	
VHF, Portable, Low-Power	10
HF/VHF, Manpack, Low-Power	12

**Signal Company, Special Ops Bde, National
(Special Operations Command)**

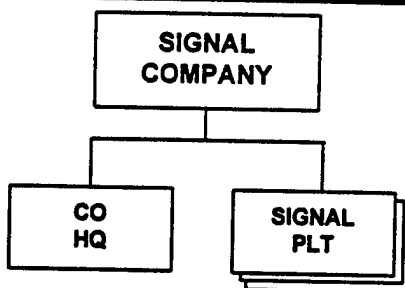

PRINCIPAL ITEMS OF EQUIPMENT

Equipment	Total
ACV BTR (R-145BM)	6
ATRL, RPG-18/22	4
Truck, Utility	2
Truck, Light	3
Trailer, 1-Axle	3
Van, Signal	1

Equipment	Total
Radios:	
HF/VHF, Manpack, Low-Power	11
HF/VHF, Vehicle Mount, Medium-Power	14
HF, Vehicle Mount, Medium-Power	2
HF, Van Mount, High-Power	1
Radio Relay, VHF/UHF	2
Radio Telegraph	1
Warning Receiver	3
Ground-to-Air Set	3
Burst Transmission	4

APPENDIX A: EQUIPMENT SUBSTITUTION MATRICES

The matrices contained in this appendix illustrate some of the different equipment options available to scenario and order of battle developers. Although FSU systems are used throughout this organization guide, the intent of the capabilities-based OPFOR is to allow users to tailor their orders of battle by substituting other foreign systems. Deviations from the baseline systems should be tied to specific training objectives. Examples include attempting to mirror the actual mix of equipment found in a particular region or to introduce a particular weapons capability or vulnerability.

The matrices list most of the major baseline systems contained in the organization guide and provide a number of potential substitutes for each. While the lists of substitutes are not all inclusive, they contain most common "gray" systems that have roughly comparable capabilities.

Users substituting systems from the matrices or considering other foreign weapons systems for use in an OPFOR order of battle should evaluate candidate substitutes against the following criteria:

- Is the system available to potential adversaries? This criteria would be satisfied if the system was in service with the armed forces of countries traditionally hostile to the United States or if it were widely exported on the world market.

- Has the system been produced in large enough quantities to justify training against it? At a minimum, total system production should at least equal the numbers contained in a proposed order of battle. Moreover, developmental systems that have not reached initial operational capability (IOC) should not be played.

- Does the mix and variety of systems in an order of battle conform to some logical pattern? Some users constructing a large order of battle may want to pattern the mix of system types and generations on some actual country. Others may wish to standardize systems throughout the order of battle for simplicity or ease in modeling. In any case, systems should be portrayed in unit sets generally of regimental or battalion size. Considering the logistical and training challenges involved in supporting a weapon system, excessive variety should be avoided.

MAIN BATTLE TANK SUBSTITUTION MATRIX		
Baseline Systems	Potential Substitutes	
T-80 (125-mm) (crew: 3)	LEOPARD II (120-mm) (crew: 4)	GM
	LECLERC (120-mm) (crew: 3)	FR
	CHALLENGER (120-mm) (crew: 4)	UK
T-72 (125-mm) (crew: 3) T-64 (125-mm) (crew: 3)	AMX-30S (105-mm) (crew: 4)	FR
	CHIEFTAN (120-mm) (crew: 4)	UK
	TYPE 69 II (100-mm) (crew: 4)	CH
T-62 (115-mm) (crew: 4) T-55 (100-mm) (crew: 4)	CENTURION (105-mm) (crew: 4)	UK
	AMX-30 (105-mm) (crew: 4)	FR
	TYPE 59 (100-mm) (crew: 4)	CH

APC/IFV SUBSTITUTION MATRIX

Baseline Systems	Potential Substitutes	
BMP-3 (30/100-mm)	WARRIOR (30-mm)	UK
	MARDER 1A3 (20-mm)	GM
BMP-2 (30-mm) BMP-1 (73-mm)	STORMER (25-mm)	UK
	WZ 501 (73-mm)	CH
	BVP M80A	YO
	AMX-10P	FR
	BMP-23	BU
BRDM-2 (14.5-mm)	BRDM-1 (7.62-mm)	FSU
	V-150 Commando (7.62-mm)	US
BTR-80 (14.5-mm) BTR-70 (14.5-mm) BTR-60 (14.5-mm)	BRDM-1 (7.62-mm)	FSU
	AMX-10RC (105-mm)	FSU
	SALADIN (76-mm)	FR
	MT-LB (7.62-mm)	UK
	VAB (12.7-mm)	FR
	FUCHS (20-mm)	GM
	V-300 Commando (14.5-mm)	US
	WZ 551 (25-mm)	CH
	OT-64C1 (14.5-mm)	CZ
	PSZH-1V (14.5-mm)	HU

TOWED ARTILLERY SUBSTITUTION MATRIX		
76-mm to 122-mm		
Baseline Systems	Potential Substitutes	
D-30 (122-mm)	SADDAM (122-mm)	IZ
	D-74 (122-mm)	FSU
	LG1 (105-mm)	FR
	SD-44 (85-mm)	FSU
	LT GUN (105-mm)	UK
	M56 (105-mm)	YO
152-mm to 155-mm		
Baseline Systems	Potential Substitutes	
2A65 (152-mm)	GNH-45 (155-MM)	AU
	MF-45 (155-mm)	CH
	G5 (155-mm)	SF
2A36 (152-mm)	FH-77B (155-mm)	SW
	TYPE 83 G (152-mm)	CH
	M84 (152-mm)	YO

SELF-PROPELLED ARTILLERY SUBSTITUTION MATRIX		
105-mm to 122-mm		
Baseline Systems	Potential Substitutes	
2S1 (122-mm)	ABBOT (105-mm)	UK
	TYPE 85 (122-mm)	CH
2S9 (120-mm)	TYPE 54-1SP (122-mm)	CH
152-mm to 155-mm		
Baseline Systems	Potential Substitutes	
2S19 (152-mm)	AS-90 (155-mm)	UK
	AU-F1 (155-mm)	FR
	G6 (155-mm)	SF
	PzH-2000 (155-mm)	GM
2S3 (152-mm)	Mk F3 (155-mm)	FR
	TYPE 83 GH (152-mm)	CH
	PAL-MARIA (155-mm)	IT

MULTIPLE ROCKET LAUNCHER (MRL) SUBSTITUTION MATRIX

Baseline Systems	Potential Substitutes	
<p>9A52 (300-mm)</p> <p>9P140(220-mm)</p>	<p>M-87 (262-mm)</p> <p>WS-1 (320-mm)</p> <p>TYPE 83 (273-mm)</p> <p>ASTROS II (300-mm)</p> <p>ASTROS II (180-mm)</p> <p>M1985/91 (240-mm)</p>	<p>YO</p> <p>CH</p> <p>CH</p> <p>BR</p> <p>BR</p> <p>KN</p>
<p>BM-21 (122-mm)</p>	<p>RM-70 (122-mm)</p> <p>BM-11 (P) (122-mm)</p> <p>122 MRS (122-mm)</p> <p>M-77 (128-mm)</p> <p>TYPE 90 (122-mm)</p> <p>TYPE 85 (130-mm)</p> <p>FIROS (122-mm)</p> <p>ASTROS II (127-mm)</p> <p>SAKR (122-mm)</p>	<p>CZ</p> <p>NK</p> <p>RO</p> <p>YO</p> <p>CH</p> <p>CH</p> <p>IT</p> <p>BR</p> <p>EG</p>
<p>RPU-14 (140-mm)</p>	<p>TYPE 70 (130-mm)</p> <p>M-63 (128-mm)</p> <p>TYPE 63 (107-mm)</p> <p>PRLS (107-mm)</p>	<p>CH</p> <p>YO</p> <p>CH</p> <p>IZ</p>

MAN PORTABLE SURFACE-TO-AIR MISSILE (SAM) SUBSTITUTION MATRIX		
Baseline Systems	Potential Substitutes	
SA-18	RBS-70 STINGER RMP MISTRAL	SW US FR
SA-16 SA-14	STINGER	US
SA-7	REDEYE BLOWPIPE HN-5A	US UK CH

SELF-PROPELLED ANTI-AIRCRAFT GUN (SPAAG) SUBSTITUTION MATRIX		
Baseline Systems	Potential Substitutes	
2S6 (4 x 30-mm) ZSU-23-4 (4 x 23-mm)	TWIN 37 (2 x 37-mm) GEPARD (2 x 35-mm) MARKSMAN (2 x 35-mm) TYPE 80 (2 x 57-mm)	CH GM UK CH
ZSU-57-2 (2 x 57-mm)	S530 (2 x 20-mm) M53/59 (2 x 30-mm)	FR CZ

TOWED ANTI-AIRCRAFT GUN (AAA) SUBSTITUTION MATRIX

Baseline Systems	Potential Substitutes	
<p>S-60 (57-mm)</p> <p>M1939 (37-mm)</p>	<p>TYPE 59 (57-mm)</p> <p>TYPE 85 (2 x 25-mm)</p> <p>M53 (30) (2 x 30-mm)</p> <p>ARROW (2 x 30-mm)</p> <p>GDF-005 (2 x 35-mm)</p>	<p>CH</p> <p>CH</p> <p>CZ</p> <p>GM</p> <p>SZ</p>
<p>ZU-23 (2 x 23-mm)</p>	<p>TYPE 80 (2 x 23-mm)</p> <p>76T2 (2 x 20-mm)</p> <p>GAI-D01 (2 x 20-mm)</p> <p>M55A4 (3 x 20-mm)</p> <p>Mk 1 (40-mm)</p>	<p>CH</p> <p>FR</p> <p>SZ</p> <p>YO</p> <p>UK</p>
<p>ZPU-2 (2 x 14.5-mm)</p>	<p>TYPE 56 (4 x 14.5-mm)</p> <p>TYPE 58 (2 x 14.5-mm)</p> <p>M53 (12.7) (4 x 12.7-mm)</p>	<p>CH</p> <p>CH</p> <p>CZ</p>

SURFACE-TO-AIR MISSILE (SAM) SUBSTITUTION MATRIX

Baseline Systems	Potential Substitutes	
SA-8 SA-6 SA-11	ROLAND RF-61A CROTALE	EURO CH FR
SA-13 SA-9	RAPIER TIGERCAT	UK UK

APPENDIX B: Cargo Truck, Trailer and Radio Substitution

Generic terminology has been used throughout the handbook to indicate truck and trailer capacity and radio capabilities. The following list, based on FSU equipment, provides a definition of terms. However, the reader may substitute any piece of equipment which falls within the range of capabilities for each system.

TRUCKS AND TRAILERS:

Utility Truck -- 4 x 4 drive vehicle with a 500 to 600 kg carrying capacity. Examples include the GAZ-69 (FSU) and the UAZ-469 (FSU), Land Rover Defender 130 (UK), and the IMR A-0.75 (YO).

Light Truck -- 4 x 4 drive vehicle with a 1 to 2.5 mt carrying capacity. Examples include the GAZ-66 (FSU), GAZ-3301 (FSU), TAM 110 T7 BV (YO) and the Renault TRM 2000 (FR).

Medium Truck -- 6 x 6 drive vehicle with a 2.5 to 7 mt carrying capacity. Examples include the ZIL-131/132 and the ZIL-157.

Heavy Truck -- 6 x 6 drive vehicle with a 7.5 mt or greater carrying capacity. Examples include the KrAZ-255B (FSU), KrAZ-260 (FSU), IVECO Magirus 160-23 ANWM (GM) or the AWD Bedford TM (UK).

Cargo Trailer, 1-Axle -- has a 0.5 mt carrying capacity. Examples include the GAZ-704 trailer used with the UAZ-469 (FSU), UAZ-8190 used with the UAZ-3151 (FSU) and the GKN Defence 1t Special Purpose (UK).

Cargo Trailer, 2-Axle -- has a 3.0 to 4.0 mt carrying capacity. Examples include the IAPZ-759V trailer used with the URAL-375D (FSU) and the 782V trailer used with the URAL-4320 (FSU) and the M104 Series (US).

RADIOS:

HF, Manpack, Low-Power -- An example is the R-104M, a transceiver operating in the 1.5 to 4.25 MHz frequency range with a 30 to 50 km range.

HF, Vehicle Mount, Medium-Power -- An example is the R-130, a transceiver/receiver operating in the 1.5 to 10.99 frequency range with a 50 to 70 km range.

VHF, Portable, Low-Power -- An example is the R-148, a transceiver operating in the 37.0 to 51.95 frequency range with range of 5 km.

VHF, Manpack, Low-Power -- An example is the R-107, a transceiver operating in the 20 to 52 MHz frequency range with a 6 to 25 km range.

VHF, Vehicle Mount, Medium-Power -- An example is the R-123, a transceiver operating in the 20 to 51.5 MHz frequency range with a 20 to 50 km range.

Warning Receiver -- An example is the R-311, a receiver operating in the 1 to 15 MHz band.

Radio Relay -- An example is the R-401, a VHF/FM transceiver operating in the 60 to 70 MHz band with a range of 40 to 50 km.

GLOSSARY

AA - Antiaircraft
AAA - Antiaircraft Artillery
AAICV - Amphibious Airborne Infantry Combat Vehicle
acq - acquisition
ACRV - Artillery Command and Reconnaissance Vehicle
ACV - Armored Command Vehicle
AD - Air Defense
Admin - administrative
Aer Surv - Aerial Surveillance
AGL - Automatic Grenade Launcher
AICV - Amphibious Infantry Combat Vehicle
ALT - altitude
Ammo - ammunition
Amphib - amphibious
APC - Armored Personnel Carrier
ARTY - artillery
ASC - Armored Scout Car
AT - Antitank
ATGL - Antitank Grenade Launcher
ATGM - Antitank Guided Missile
ATK - attack
AUS - Austria
Auto - automatic
AVN - Aviation

Bde - Brigade
BMP - Russian abbreviation for infantry combat vehicle
Bn - Battalion
BOS - Battle Operating System
BR - Brazil
BS - Battlefield Surveillance
BTR - Russian abbreviation for Armored Personnel Carrier
BTRY - Battery
BU - Bulgaria

CAA - Combined Arms Army
CAC - Combined Arms Command
CC&D - Camouflage, Concealment & Deception
CH - China
chem - chemical
CM/CB - Countermortar/Counterbattery
CMD - Command
CMDO - Commando
Co - Company

collect - collection
como - communication
Comb - combination
Const - construction
cont - control
COP - Command Observation Post
CS - Combat Support
CSS - Combat Service Support
CTC - Combat Training Center
CZ - Czechoslovakia

Decon - decontamination
Def - Defense
DF - Direction Finding
disinfect - disinfection
DIV - Division

ECM - Electronic Counter Measures
Eng - engagement
Engr - Engineer
EURO - Europe
evac - evacuation
EW - Early Warning

FAC - Forward Air Controller
FC - Fire Control
FDC - Fire Direction Center
FG - Field Gun
FLD - field
FM - Frequency Modulation
FO - Forward Observer
FOP - Forward Observation Post
FR - France
FSU - Former Soviet Union

GM - Germany
GND - ground
GP - Group ; general purpose [helicopter]
GP MG - General Purpose Machine Gun
Gren - Grenade

helo - helicopter
HF - High Frequency ; Height Finding
HHB - Headquarters & Headquarters Battery
HHC - Headquarters & Headquarters Company
How - howitzer
HQ - Headquarters
Hvy - heavy

IAB - Independent Airborne Brigade
IMRB - Independent Motorized Rifle Brigade
Indep - independent
Inf - Infantry
Intep - intercept
Intel - intelligence
IOC - Initial Operational Capability
IT - Italy
IZ - Iraq

K - kilo
kg - kilogram
km - kilometer
KN - Korea (North)
KS - Korea (South)

L - liter
LMG - Light Machine Gun

m - meter
maint - maintenance
man - Manpack
mat - material
MCAS - Mobile Computation and Analysis Station
mech - Mechanized
MED - medical ; medium
meteor - meteorological
MG - Machine Gun
mil - military
mm - millimeter
Mort - Mortar
mount - mounted
MP - Military Police
MR - Motorized Rifle
MRB - Motorized Rifle Battalion
MRC - Motorized Rifle Company
MRD - Motorized Rifle Division
MRL - Multiple Rocket Launcher
MRP - Motorized Rifle Platoon
MRR - Motorized Rifle Regiment
MTZD - Motorized

N/A - non applicable
NBC - Nuclear, Biological, and Chemical
NBDF - Nuclear Burst Direction Finding Battalion
NVD - Night Vision Devices
NVG - Night Vision Goggles
NVS - Night Vision Sight

OPFOR - Opposing Force
Ops/Opns - operations
optic - optical
Ord - ordnance

Plt - Platoon
POL - Petroleum, Oils, and Lubricants
port - portable
PRC - People Republic of China
prep - preparation
PSYOPS - Psychological Operations

R/T - Radio/Telephone
REC - Radioelectronic Combat
Recon - reconnaissance
Regt - Regiment
RF - range finder

SA - US designation for Russian Surface-to-Air Missiles
SAM - Surface-to-Air Missile
SECT - section
Sep - separate
SIG - Signal
SIGINT - Signal Intelligence
SF - South Africa
SP - self-propelled ; special
SPAAG - self-propelled Antiaircraft Gun
SPF - Special Forces
SPT - support
SQD - Squad
Sqdn - Squadron
SR & RR - Sound Ranging & Radar Reconnaissance
SSM - Surface-to-Surface Missile
Surveil/Surv - Surveillance
SVC/SVCS - service(s)
SW - Sweden

TB - Tank Battalion
TC - Tank Company
TD - Tank Division
Tech - technical
TEL - Transporter-Erector-Launcher
TELAR - Transporter-Erector-Launcher and Radar
Tgt - Target
Tgt Acq - target acquisition
TM - team
TOPO - topography
Torp - torpedo
Tow - towed
TR - Tank Regiment
trail - trailer
Trans or transp - transportation; transporter ; transloader

UK - United Kingdom
UHF - Ultra High Frequency

Veh - vehicle
VHF - Very High Frequency

Warn - warning
Wpn/Wpns - weapon

YO - Yugoslavia

INDEX

122-mm Howitzer Battalion, Light Inf Bde (Separate) and Mtzd Inf Bde (Sep), or Arty Regt, Light Inf Div and Mtzd Inf Div, or MD or Army or National, 10

122-mm Howitzer Battery, 122-mm Howitzer Bn, Light Inf Bde (Sep) and Mtzd Inf Bde (Sep), or Arty Regt, Light Inf Div and Mtzd Inf Div, or MD or Army or National, 11

122-mm SP Howitzer Battalion, Mech Inf Bde (Sep and Divisional) and Tank Bde, or SP Arty Regt, Mech Inf Div or MD or Army or National, 25

122-mm SP Howitzer Battery, 122-mm SP Howitzer Bn, Mech Inf Bde (Sep and Div) and Tank Bde, or Arty Regt, Mech Inf Div or MD or Army or National, 26

152-mm Howitzer Battalion, Arty Regt, Light Inf Div and Mtzd Inf Div, or MD or Army or National, 12

152-mm Howitzer Battery, 152-mm Howitzer Bn, Arty Regt, Light Inf Div and Mtzd Inf Div, or MD or Army or National, 13

152-mm SP Howitzer Battalion, SP Arty Regt, Mech Inf Div or MD or Army or National, 27

152-mm SP Howitzer Battery, 152-mm SP Howitzer Bn, Arty Regt, Mech Inf Div or MD or Army or National, 28

-A-

Air Defense and Antitank Platoon, Special Ops Bn, Special Ops Bde, National (Special Operations Command), 222

Air Defense Battery, Arty Regt, Light Inf Div and Mtzd Inf Div, or MD or Army or National, 17

Air Defense Battery, Light Inf Bde (Sep and Div) and Mtzd Inf Bde (Sep and Div), 103

Air Defense Battery, Mech Inf Bde (Sep and Div), 142

Air Defense Battery, SP Arty Regt, Mech Inf Div or MD or Army or National, 29

Air Defense Command, National, 190, 197-211

Air Defense Missile Bn (SA-8), Air Defense Regt, Mech Inf Div or Army or MD or National (Air Defense Command), 34

Air Defense Platoon, Airborne Inf Bn, Airborne Inf Bde, National, 164

Air Defense Platoon, Mech Inf Bn, Mech Inf Bde (Sep and Div), 139

Air Defense Platoon, Wpns Co, Light Inf Bn, Light Inf Bde (Sep and Div), 99

Air Defense Platoon, Wpns Co, Mtzd Inf Bn, Mtzd Inf Bde (Sep and Div), 121

Air Defense Regiment (S-60), Light Inf Div and Mtzd Inf Div, or Army or National (Air Defense Command), 43

Air Defense Regiment (ZSU-57-2), Mech Inf Div or Army or National (Air Defense Command), 42

Air Defense Regiment, Mech Inf Div or MD or Army or National (Air Defense Command), 30

Air Force and Air Defense Command, 190

Air Force, National, 190-196

Airborne Infantry Battalion, Airborne Inf Bde, National, 160

Airborne Infantry Brigade, National, 156

Airborne Infantry Company, Airborne Inf Bn, Airborne Inf Bde, National, 161

Airborne Infantry Platoon, Airborne Inf Co, Airborne Inf Bn, Airborne Inf Bde, National, 162

Airborne Infantry Squad, Airborne Inf Plt, Airborne Inf Co, Airborne Inf Bn, Airborne Inf Bde, National, 163

Ammunition Transport Company, Materiel Support Bn, Light Inf Div, Mtzd Inf Div, and Mech Inf Div or MD or Army or National (Rear Services, 77

Antiaircraft Artillery Battalion (S-60), Air Defense Regt, Mech Inf Div or MD or Army or National (Air Defense Command), 38

Antiaircraft Artillery Battery, Antiaircraft Arty Bn (S-60), Air Defense Regt, Mech Inf Div or MD or Army or National (Air Defense Command), 39

Antitank Battalion, Light Inf Bde (Sep), Mtzd Inf Bde (Sep), and Mech Inf Bde (Sep), or MD or Army or National, 44

Antitank Battery, Airborne Inf Bde, National, 168

Antitank Platoon, Heavy Wpns Co, Commando Bn, MD or National (Special Operations Command), 52

Antitank Platoon, Wpns Co, Light Inf Bn, Light Inf Bde (Sep and Div), 100

Antitank Platoon, Wpns Co, Mtzd Inf Bn, Mtzd Inf Bde (Sep and Div), 122

Army, 154

Artillery Battery, Special Ops Bn, Special Ops Bde, National (Special Operations Command), 220

Artillery Brigade, Army or National, 174

Artillery Brigade, National, 173

Artillery Organizations, National, 172-177

Artillery Reconnaissance (Target Acquisition/Early Warning) Battery, SAM Regiment, National (Air Defense Command), 202

Artillery Regiment, Light Inf Div and Mtzd Inf Div, or MD or Army or National, 6

Assault Crossing Battalion, National, 182

Assault Crossing Company, Engineer Bn, Mech Inf Div or MD or Army or National (Engineer Brigade), 64

ATGM Battery, Mech Inf Bde (Div), 143

ATGM Platoon, Airborne Inf Bn, Airborne Inf Bde, National, 165

ATGM Platoon, Light Inf Bde (Div) and Mtzd Inf Bde (Div), 103

ATGM Platoon, Mech Inf Bn, Mech Inf Bde (Sep and Div), 140

Automatic Grenade Launcher Platoon, Heavy Wpns Co, Commando Bn, MD or National (Special Operations Command), 53

Automatic Grenade Launcher Platoon, Special Ops Bn, Special Ops Bde, National (Special Operations Command), 223

-B-

Battalion Headquarters, Airborne Inf Bn, Airborne Inf Bde, National, 161

Battalion Headquarters, Chemical Protection Bn, National, 185

Battalion Headquarters, Commando Bn, MD or National (Special Operations Command), 46

Battalion Headquarters, Engineer Bn, Mech Inf Div or MD or Army or National (Engineer Brigade), 63

Battalion Headquarters, Light Inf Bn, Light Inf Bde (Sep and Div) and Mtzd Inf Bn, Mtzd Inf Bde (Sep and Div), 96

Battalion Headquarters, Maintenance Bn, Light Inf Div, Mtzd Inf Div and Mech Inf Div or Army or National (Rear Services), 82

Battalion Headquarters, Materiel Support Bn, Light Inf Div, Mtzd Inf Div, and Mech Inf Div or MD or Army or National (Rear Services), 77

Battalion Headquarters, Mech Inf Bn, Mech Inf Bde (Sep and Div), 133

Battalion Headquarters, Medical Bn, Mech Inf Div or Army, 86

Battalion Headquarters, Signal Bn, Mech Inf Div or Army or National (Signal Brigade), 72

Brigade Headquarters, Airborne Inf Bde, National, 159

Brigade Headquarters, Light Inf Bde (Sep and Div) and Mtzd Inf Bde (Sep and Div), 94

Brigade Headquarters, Mech Inf Bde (Sep and Div), and Tank Bde, 131

Brigade Headquarters, Special Ops Bde, National (Special Operations Command), 215

-C-

Cargo Transport Company, Materiel Support Bn, Light Inf Div, Mtzd Inf Div, and Mech Inf Div or MD or Army or National (Rear Services), 78

Chemical Protection Battalion, National, 184

Chemical Protection Company, Light Inf Div, Mtzd Inf Div, and Mech Inf Div, or Army, 75

Chemical Protection Platoon, Air Defense Regt, Mech Inf Div or MD or Army or National (Air Defense Command), 40

Chemical Protection Platoon, Airborne Inf Bde, National, 170

Chemical Protection Platoon, Arty Regt, Light Inf Div and Mtzd Inf Div, or MD or Army or National, and SP Arty Regt, Mech Inf Div, or MD or Army or National, or Mtzd Inf Bde (Sep and Div), Mech Inf Bde (Sep and Div) and Tank Bde, 20

Chemical Reconnaissance Company, Chemical Protection Bn, National, 186

Collection and Evacuation Platoon, Medical Bn, Mech Inf Div or Army, 87

Combat Engineer (Sapper) Company, Engineer Bn, Mech Inf Div or MD or Army or National (Engineer Brigade), 63

Combat Engineer Brigade, National, 180

Combat/Attack Helicopter Regiment, National (Air Force), 194

Commando Battalion, MD or National (Special Operations Command), 45

Commando Company, Commando Bn, MD or National (Special Operations Command), 46

Commando Platoon, Commando Co, Commando Bn, MD or National (Special Operations Command), 47

Commando Squad, Commando Plt, Commando Co, Commando Bn, MD or National (Special Operations Command), 47

Composite Artillery Battalion, Airborne Inf Bde, National, 167

-D-

Decontamination Company, Chemical Protection Bn, National, 185

Directorate of Military Intelligence, National, 178

Disinfection and Decontamination Platoon, Medical Bn, Mech Inf Div or Army, 87

Division Headquarters, Light Inf Div, Mtzd Inf Div, and Mech Inf Div, or MD, 5

-E-

Engineer Battalion, Mech Inf Div or MD or Army or National (Engineer Brigade), 61

Engineer Company, Airborne Inf Bde, National, 168

Engineer Company, Mech Inf Bde (Sep and Div) and Tank Bde, or Light Inf Div and Mtzd Inf Div, 70

Engineer Company, Special Ops Bde, National (Special Operations Command), 224

Engineer Organizations, National, 180-182

Engineer Platoon, Airborne Inf Bn, Airborne Inf Bde, National, 165

Engineer Platoon, Special Ops Bn, Special Ops Bde, National (Special Operations Command), 223

Engineer Reconnaissance Platoon, Engineer Bn, Mech Inf Div or MD or Army or National (Engineer Brigade), 68

-F-

Fighter-Bomber Aviation Regiment, National (Air Force), 192

Fighter-Interceptor Aviation Regiment, National (Air Force), 191

Firing Battery, Rocket Launcher Bn, Arty Regt, Light Inf Div and Mtzd Inf Div, or MD or Army or National, and Rocket Launcher Bn, SP Arty Regt, Mech Inf Div, or MD or Army or National, 15

-G-

General Staff/National Headquarters (National Asset Pool), 155

Ground Attack Aviation Regiment, National (Air Force), 191

-H-

Headquarters & Service Company, Recon & REC Bn, Light Inf Div, Mtzd Inf Div and Mech Inf Div, or MD or Army or National (Directorate of Military Intelligence), 56

Headquarters and Control Battery, Arty Regt, Light Inf Div and Mtzd Inf Div, or MD or Army or National and SP Arty Regt, Mech Inf Div or MD or Army or National, 9

Headquarters and Control Platoon, Rocket Launcher Bn, Arty Regt, Light Inf Div and Mtzd Inf Div, or MD or Army or National, and Rocket Launcher Bn, SP Arty Regt, Mech Inf Div, or MD or Army or National, 15

Headquarters Battery, Air Defense Regt, Mech Inf Div or MD or Army or National (Air Defense Command), 33

Headquarters Company, Special Ops Bn, Special Ops Bde, National (Special Operations Command), 217

Heavy Artillery Battalion, National. 172

Heavy Machine Gun Platoon, Heavy Wpns Co, Commando Bn, MD or National (Special Operations Command), 51

Heavy Weapons Company, Commando Bn, MD or National (Special Operations Command), 49

Howitzer Battalion (122-mm SP), Mech Inf Bde (Sep and Divisional) and Tank Bde, or SP Arty Regt, Mech Inf Div or MD or Army or National, 25

Howitzer Battalion (122-mm), Light Inf Bde (Separate) and Mtzd Inf Bde (Sep), or Arty Regt, Light Inf Div and Mtzd Inf Div, or MD or Army or National, 10

Howitzer Battalion (152-mm), Arty Regt, Light Inf Div and Mtzd Inf Div, or MD or Army or National, 12

Howitzer Battery (122-mm), 122-mm Howitzer Bn, Light Inf Bde (Sep) and Mtzd Inf Bde (Sep), or Arty Regt, Light Inf Div and Mtzd Inf Div, or MD or Army or National, 11

Howitzer Battery (152-mm), 152-mm Howitzer Bn, Arty Regt, Light Inf Div and Mtzd Inf Div, or MD or Army or National, 13

-I-

Independent Helicopter Radioelectronic Combat Squadron, National (Air Force), 196

Independent Helicopter Squadron, National (Air Force), 195

Independent Radioelectronic Combat Aviation Regiment, National (Air Force), 193

Independent Reconnaissance Aviation Regiment, National (Air Force), 192

-L-

Light Infantry Battalion, Light Inf Bde (Sep and Div), 95

Light Infantry Brigade (Divisional), 92

Light Infantry Brigade (Militia/Guerrilla), 108

Light Infantry Brigade (Separate), 89

Light Infantry Company, Light Inf Bn, Light Inf Bde (Sep and Div), 96

Light Infantry Division (Light Inf Div), 4

Light Infantry Platoon, Light Inf Co, Light Inf Bn, Light Inf Bde (Sep and Div), 97

Light Infantry Squad, Light Inf Plt, Light Inf Co, Light Inf Bn, Light Inf Bde (Sep and Div), 97

-M-

Machine Gun Platoon, Mech Inf Co, Mech Inf Bn, Mech Inf Bde (Div), 137

Maintenance Battalion, Light Inf Div, Mtzd Inf Div and Mech Inf Div or Army or National (Rear Services), 81

Maintenance Brigade, National (Rear Services), 188

Maintenance Company, Air Defense Missile Bn (SA-8), Air Defense Regt, Mech Inf Div or MD or Army or National (Air Defense Command), 37

Maintenance Company, Air Defense Regt, Mech Inf Div or MD or Army or National (Air Defense

Command), 41

Maintenance Company, Arty Regt, Light Inf Div and Mtzd Inf Div, or MD or Army or National, and SP Arty Regt, Mech Inf Div, or MD or Army or National, 19

Maintenance Company, Mtzd Inf Bde (Sep and Div), Mech Inf Bde (Sep and Div), and Tank Bde, 124

Maintenance Company, SAM Regt, National (Air Defense Command), 206

Maintenance Platoon, Chemical Protection Bn, National, 186

Maintenance Platoon, Engineer Bn, Mech Inf Div or MD or Army or National (Engineer Brigade), 69

Maintenance Platoon, Materiel Support Bn, Light Inf Div, Mtzd Inf Div, and Mech Inf Div or MD or Army or National (Rear Services), 79

Maintenance Platoon, Mech Inf Bn, Mech Inf Bde (Sep and Div), 141

Materiel Support Battalion, Light Inf Div, Mtzd Inf Div, and Mech Inf Div or MD or Army or National (Rear Services), 76

Materiel Support Brigade, National (Rear Services), 188

Materiel Support Company, Airborne Inf Bde, National, 170

Materiel Support Company, Arty Regt, Light Inf Div and Mtzd Inf Div, or MD or Army or National, and SP Arty Regt, Mech Inf Div, or MD or Army or National, 19

Materiel Support Company, Light Inf Bde (Sep and Div), Mtzd Inf Bde (Sep and Div), Mech Inf Bde (Sep and Div), and Tank Bde, 107

Materiel Support Platoon, Airborne Inf Bn, Airborne Inf Bde, National, 166

Materiel Support Platoon, Rocket Launcher Bn, Arty Regt, Light Inf Div and Mtzd Inf Div, or MD or Army or National, and Rocket Launcher Bn, SP Arty Regt, Mech Inf Div, or MD or Army or National, 16

Mechanized Infantry Battalion, Mech Inf Bde (Sep and Div), 132

Mechanized Infantry Brigade (Divisional), 128

Mechanized Infantry Brigade (Separate), 125

Mechanized Infantry Company, Mech Inf Bn, Mech Inf Bde (Sep and Div), 134

Mechanized Infantry Division (Mech Inf Div), 2

Mechanized Infantry Platoon, Mech Inf Co, Mech Inf Bn, Mech Inf Bde (Sep and Div), 135

Mechanized Infantry Squad, Mech Inf Plt, Mech Inf Co, Mech Inf Bn, Mech Inf Bde (Sep and Div), 136

Medical Battalion, Mech Inf Div or Army, 85

Medical Company, Light Inf Div and Mtzd Inf Div, or Medical Bn, Mech Inf Div or Army, 86

Medical Platoon, Airborne Inf Bde, National, 171

Medical Platoon, Arty Regt, Light Inf Div and Mtzd Inf Div, or MD or Army or National, and SP Arty Regt, Mech Inf Div, or MD or Army or National, or Light Inf Bde (Sep and Div), Mtzd Inf Bde (Sep and Div), Mech Inf Bde (Sep and Div) and Tank Bde, 21

Medical Platoon, Materiel Support Bn, Light Inf Div, Mtzd Inf Div, and Mech Inf Div or MD or Army or National (Rear Services), 79

Medical Section, Airborne Inf Bn, Airborne Inf Bde, National, 166

Medical Section, Mech Inf Bn, Mech Inf Bde (Sep and Div), 142

Military District (MD), 1

Military Region, 152

Ministry of Defense, 150

Ministry of the Interior, 151

Missile Firing Battery, Air Defense Missile Bn (SA-8), Air Defense Regt, Mech Inf Div or MD or Army or National (Air Defense Command), 36

Missile Firing Battery, SAM Regt (SA-6), National (Air Defense Command), 210

Missile Firing Battery, SAM Regt (SA-8), National (Air Defense Command), 204

Missile Technical Battery, SAM Regt (SA-6), National (Air Defense Command), 209

Missile Technical Battery, SAM Regt (SA-8), National (Air Defense Command), 203

Mobile Field Bakery, Materiel Support Bn, Light Inf Div, Mtzd Inf Div, and Mech Inf Div or MD or Army or National (Rear Services), 80

Mortar Battalion, Light Inf Bde (Div), 101

Mortar Battery, Airborne Inf Bn, Airborne Inf Bde, National, 164

Mortar Battery, Mech Inf Bn, Mech Inf Bde (Sep and Div), 138

Mortar Battery, Mortar Bn, Light Inf Bde (Div), 102

Mortar Battery, Mtzd Inf Bde (Div), 122

Mortar Platoon, Arty Btry, Special Ops Bn, Special Ops Bde, National (Special Operations Command), 220

Mortar Platoon, Commando Co, Commando Bn, MD or National (Special Operations Command), 48

Mortar Platoon, Heavy Wpns Co, Commando Bn, MD or National (Special Operations Command), 50

Mortar Platoon, Mortar Battery, Mtzd Inf Bde (Div), 123

Mortar Platoon, Mortar Btry, Mech Inf Bn, Mech Inf Bde (Sep and Div), 139

Mortar Platoon, Wpns Co, Light Inf Bn, Light Inf Bde (Sep and Div), 99

Mortar Platoon, Wpns Co, Mtzd Inf Bn, Mtzd Inf Bde (Sep and Div), 121

Motor Transport Company, SAM Regt, National (Air Defense Command), 205

Motor Vehicle Maintenance Company, Maintenance Bn, Light Inf Div, Mtzd Inf Div and Mech Inf Div or Army or National (Rear Services), 83

Motorcycle Platoon, Recon Co, Light Inf Bde (Sep), Mtzd Inf Bde (Sep), Mech Inf Bde (Sep), and Tank Bde, 105

Motorized Infantry Battalion, Mtzd Inf Bde (Sep and Div), 116

Motorized Infantry Brigade (Divisional), 113

Motorized Infantry Brigade (Separate), 110

Motorized Infantry Company, Mtzd Inf Bn, Mtzd Inf Bde (Sep and Div), 117

Motorized Infantry Division (Mtzd Inf Div), 3

Motorized Infantry Platoon, Mtzd Inf Co, Mtzd Inf Bn, Mtzd Inf Bde (Sep and Div), 118

Motorized Infantry Squad, Mtzd Inf Plt, Mtzd Inf Co, Mtzd Inf Bn, Mtzd Inf Bde (Sep and Div), 119

-N-

National Asset Pool, 155

National Headquarters, 155

National Structure, 150

Navy, 189

-O-

Ordnance Maintenance Company, Maintenance Bn, Light Inf Div, Mtzd Inf Div and Mech Inf Div or Army or National (Rear Services), 83

-P-

POL Transport Company, Materiel Support Bn, Light Inf Div, Mtzd Inf Div, and Mech Inf Div or MD or Army or National (Rear Services), 78

Pontoon Bridge Company, Engineer Bn, Mech Inf Div or MD or Army or National (Engineer Brigade), 67

Pontoon Bridge Regiment, National, 181

-R-

Radio Company, Signal Bn, Mech Inf Div or Army or National (Signal Brigade), 72

Radio Reconnaissance Battalion, Directorate of Military Intelligence, National, 179

Radio Telephone and Telegraph Company, Signal Bn, Mech Inf Div or Army or National (Signal Brigade), 73

Radio/Radar Reconnaissance Company, Recon & REC Bn, Light Inf Div, Mtzd Inf Div, and Mech Inf Div, or MD or Army or National (Directorate of Military Intelligence), 60

Radioelectronic Combat Company, Recon & REC Bn, Mech Inf Div or MD or Army or National (Directorate of Military Intelligence), 60

Reconnaissance and Radioelectronic Combat Battalion, Light Inf Div, Mtzd Inf Div, and Mech Inf Div, or MD or Army or National (Directorate of Military Intelligence), 54

Reconnaissance Assault Co, Recon & REC Bn, Light Inf Div, Mtzd Inf Div, and Mech Inf Div, or MD or Army or National (Directorate of Military Intelligence), 59

Reconnaissance Company, Airborne Inf Bde, National, 169

Reconnaissance Company, Light Inf Bde (Sep), Mtzd Inf Bde, Mech Inf Bde (Sep) and Tank Bde, 104

Reconnaissance Company, Recon & REC Bn, Light Inf Div or Mtzd Inf Div, or MD or National (Directorate of Military Intelligence), 57

Reconnaissance Company, Recon & REC Bn, Mech Inf Div, or MD or Army or National (Directorate of Military Intelligence), 58

Reconnaissance Platoon, Light Inf Bde (Div), Mtzd Inf Bde (Div) and Mech Inf Bde (Div) or Recon Co, Light Inf Bde (Sep), Mtzd Inf Bde (Sep) and Mech Inf Bde (Sep), and Tank Bde, 105

Recovery Platoon, Maintenance Bn, Light Inf Div, Mtzd Inf Div and Mech Inf Div or Army or National (Rear Services), 84

Regimental Headquarters, SAM Regiment, National (Air Defense Command), 201

Road/Bridge Construction Company, Engineer Bn, Mech Inf Div or MD or Army or National (Engineer Brigade), 66

Rocket Launcher Battalion, Arty Regt, Light Inf Div and Mtzd Inf Div, or MD or Army or National and SP Arty Regt, Mech Div, or MD or Army or National, 14

Rocket Launcher Brigade, National, 175

Rocket Launcher Platoon, Arty Btry, Special Ops Bn, Special Ops Bde, National (Special Operations Command), 221

-S-

SAM Brigade (SA-11), National (Air Defense Command), 211

SAM Brigade (SA-2), National (Air Defense Command), 197

SAM Brigade (SA-3), National (Air Defense Command), 198

SAM Regiment (SA-6), National (Air Defense Command), 207

SAM Regiment (SA-8), National (Air Defense Command), 199

Service and Supply Platoon, Maintenance Bn, Light Inf Div, Mtzd Inf Div and Mech Inf Div or Army or National (Rear Services), 84

Service and Supply Platoon, Medical Bn, Mech Inf Div or Army, 88

Service Company, Commando Bn, MD or National (Special Operations Command), 53

Service Platoon, Chemical Protection Bn, National, 186

Service Platoon, Engineer Bn, Mech Inf Div or MD or Army or National (Engineer Brigade), 69

Service Platoon, Mech Inf Bn, Mech Inf Bde (Sep and Div), 141

Signal Battalion, Mech Inf Div or Army or National (Signal Brigade), 71

Signal Brigade, National, 183

Signal Company, Airborne Inf Bde, National, 169

Signal Company, Light Inf Bde (Sep and Div), Mtzd Inf Bde (Sep and Div), Mech Inf Bde (Sep and Div), and Tank Bde, 106

Signal Company, Light Inf Div and Mtzd Inf Div, 74

Signal Company, Special Ops Bde, National (Special Operations Command), 225

Signal Platoon, Airborne Inf Bn, Airborne Inf Bde, National, 166

Signal Platoon, Engineer Bn, Mech Inf Div or MD or Army or National (Engineer Brigade), 68

Signal Platoon, Mech Inf Bn, Mech Inf Bde (Sep and Div), 140

Signal Regiment, National, 183

Smoke Battalion, National, 187

Smoke Company, Smoke Bn, National, 187

Sound Ranging & Radar Reconnaissance Battery, Arty Regt, Light Inf Div and Mtzd Inf Div, or MD or Army or National, and SP Arty Regt, Mech Inf Div, or MD or Army or National, 18

SP Artillery Regiment, Mech Inf Div or MD or Army or National, 22

SP Howitzer Battalion (152-mm), SP Arty Regt, Mech Inf Div or MD or Army or National, 27

SP Howitzer Battery (122-mm), 122-mm SP Howitzer Bn, Mech Inf Bde (Sep and Div) and Tank Bde, or Arty Regt, Mech Inf Div or MD or Army or National, 26

SP Howitzer Battery (152-mm), 152-mm SP Howitzer Bn, Arty Regt, Mech Inf Div or MD or Army or National, 28

Special Maintenance Platoon, Maintenance Bn, Light Inf Div, Mtzd Inf Div and Mech Inf Div or Army or National (Rear Services), 84

Special Operations Battalion, Special Ops Bde, National (Special Operations Command), 216

Special Operations Brigade, National (Special Operations Command), 213

Special Operations Command, National, 212

Special Operations Company, Special Ops Bn, Special Ops Bde, National (Special Operations Command), 218

Special Operations Section, Special Ops Co, Special Ops Bn, Special Ops Bde, National (Special Operations Command), 219

Special Operations Team, Special Ops Sect, Special Ops Co, Special Ops Bn, Special Ops Bde, National (Special Operations Command), 219

SSM Brigade (SCUD), National, 177

SSM Brigade (SS-21), National, 176

Supply & Service Platoon, Materiel Support Bn, Light Inf Div, Mtzd Inf Div, and Mech Inf Div or MD or Army or National (Rear Services), 79

Supply and Maintenance Platoon, Signal Bn, Mech Inf Div or Army or National (Signal Brigade), 73

-T-

Tank Battalion (31-Tank Variant), Tank Bde, 149

Tank Battalion, Mech Inf Bde (Sep and Div) and Tank Bde, 147

Tank Brigade, 144

Tank Company, Tank Bn, Mech Inf Bde (Sep and Div) and Tank Bde, 148

Tank/Track Maintenance Company, Maintenance Bn, Light Inf Div, Mtzd Inf Div and Mech Inf Div or Army or National (Rear Services), 82

Target Acquisition/Early Warning Battery, Air Defense Regt, Mech Inf Div or MD or Army or National (Air Defense Command), 40

Technical Company, Engineer Bn, Mech Inf Div or MD or Army or National (Engineer Brigade), 65

Transport and Maintenance Company, Airborne Inf Bde, National, 171

Transport Company, Air Defense Missile Bn (SA-8), Air Defense Regt, Mech Inf Div or MD or Army or National (Air Defense Command), 37

Transport Company, Air Defense Regt, Mech Inf Div or MD or Army or National (Air Defense Command), 41

Transport Helicopter Regiment, National (Air Force), 193

Transport Regiment, National (Air Force), 196

Transport Section, Medical Bn, Mech Inf Div or Army, 88

-W-

Weapons Company, Light Inf Bn, Light Inf Bde (Sep and Div), 98

Weapons Company, Mtzd Inf Bn, Mtzd Inf Bde (Sep and Div), 120

Weapons Squad, Light Inf Plt, Light Inf Co, Light Inf Bn, Light Inf Bde (Sep and Div), 98

Weapons Squad, Mtzd Inf Plt, Mtzd Inf Co, Mtzd Inf Bn, Mtzd Inf Bde (Sep and Div), 119

15 September 1994

The proponent of this pamphlet is the TRADOC Deputy Chief of Staff for Intelligence. This pamphlet is the definitive source for light OPFOR organization for use at the Combat Training Centers and TRADOC centers and schools. It will also serve as the coordinating draft for a subsequent edition of the guide in the form of a Department of the Army Information Pamphlet. Users are encouraged to send comments and suggested improvements on DA Form 2028 (Recommended Changes to Publications and Blank Forms) through channels to the TRADOC ODCSINT, Threat Support Division; ATTN: ATZL-CST, Fort Leavenworth Kansas 66027-5310. Suggested improvements may also be submitted using DA Form 1045 (Army Ideas for Excellence Program (AIEP) Proposal).

FOR THE COMMANDER:

OFFICIAL:

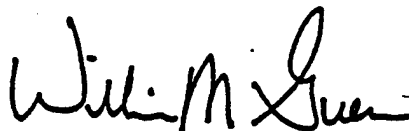

WILLIAM M. GUERRA
Colonel, GS
Deputy Chief of Staff
for Information Management

JOHN P. HERRLING
Major General, GS
Chief of Staff

DISTRIBUTION:
Special