

U.S. Army Training and Doctrine Command

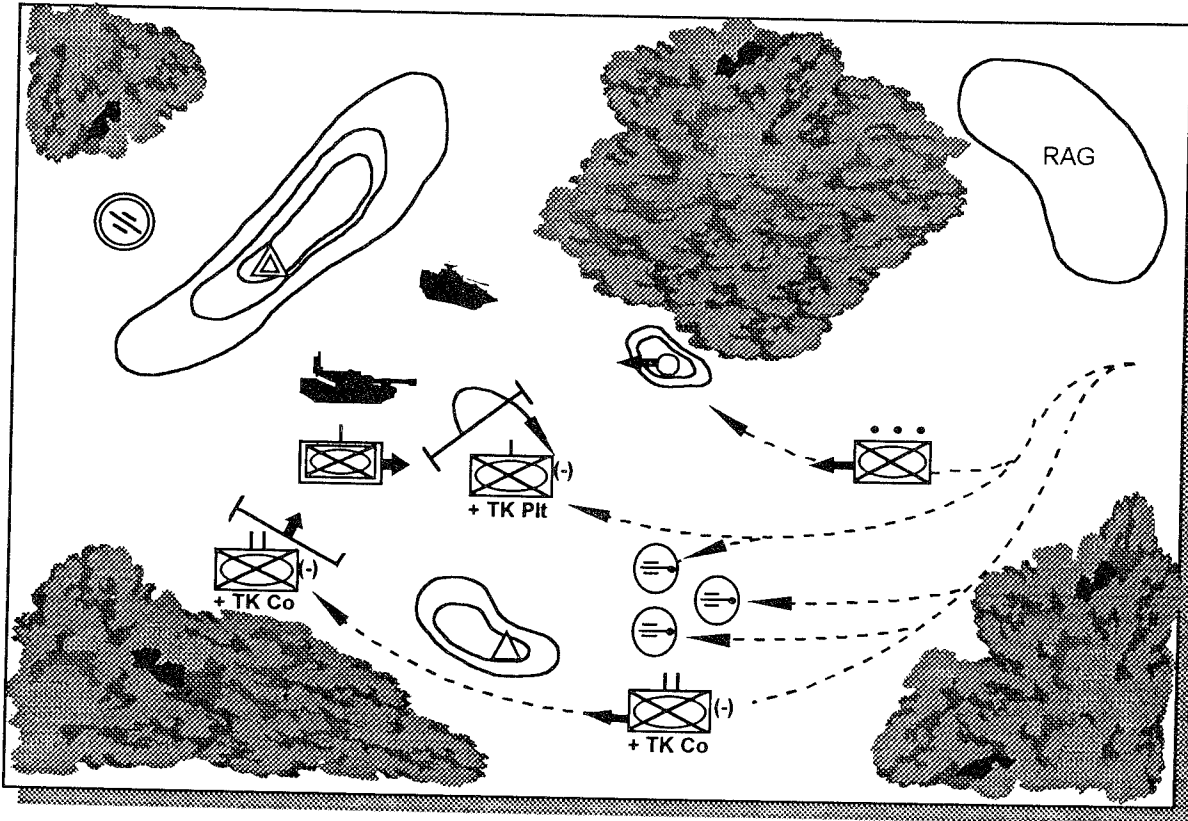

HEAVY OPPOSING FORCE (OPFOR) TACTICAL HANDBOOK

CONSTRUCTION OF OPFOR
Required at certain intervals
Distribution (limited)

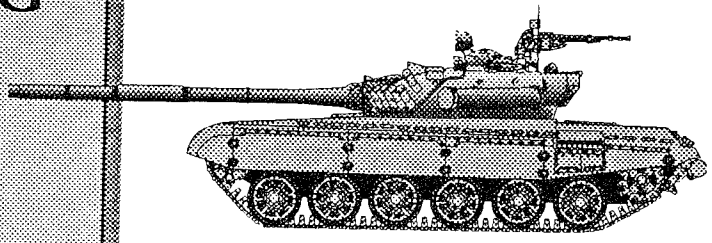

19960220 118

TRADOC
Deputy Chief of Staff for Intelligence

DRAFT

TRADOC Pamphlet 350-16

DEPARTMENT OF THE ARMY
HEADQUARTERS
U.S. ARMY TRAINING AND DOCTRINE COMMAND
Deputy Chief of Staff for Intelligence (DCSINT)
Fort Monroe, Virginia 23651-5000

15 September 1994

Training

Heavy Opposing Force (OPFOR) Tactics Handbook

Preface

This handbook is the fifth in a series of six Training and Doctrine Command Pamphlets that documents the capabilities-based OPFOR model. The capabilities-based OPFOR model will become the basis for the forces and doctrine used by the OPFOR units at the Combat Training Centers (CTC) and in the TRADOC Common Teaching Scenario.

The proponent for this pamphlet is the TRADOC Deputy Chief of Staff for Intelligence. This pamphlet serves as the **coordinating draft** for the handbook's final publication as a Department of the Army Information Pamphlet. Users are encouraged to send comments and suggested improvements on DA Form 2028 (Recommended Changes to Publications and Blank Forms) directly to the TRADOC ODCSINT, Threat Support Division, ATTN: ATZL-CST, Fort Leavenworth, Kansas 66027-5310. Suggested improvements may also be submitted using DA Form 1045 (Army Ideas for Excellence Program (AIEP) Proposal).

Unless otherwise stated, whenever the masculine gender is used, both men and women are included.

DISTRIBUTION RESTRICTION: Approved for public release; distribution is unlimited.

DRAFT

Introduction

Concept

This *Heavy OPFOR Tactics Handbook* is one in a series of six U.S. Army Training and Doctrine Command (TRADOC) Pamphlets which documents the capabilities-based Opposing Force (OPFOR) model. This model was developed to provide a flexible training threat which can be tailored to represent a wide range of potential threat capabilities and organizations. The model features a Heavy and a Light OPFOR package, each containing three handbooks: an organization guide, an operational art handbook, and a tactics handbook.

The capabilities-based OPFOR model represents a break from past practice in two principal respects. First, while the Heavy and Light packages are based on the doctrine and organization of foreign armies, they are not simply unclassified handbooks on the forces of a particular nation. The OPFOR packages are composites which were deliberately constructed to provide a wide range of capabilities. Second, the packages are not associated with a fixed order of battle but, rather, provide the building blocks from which a large number of potential orders of battle can be derived.

The capabilities-based OPFOR model will become the basis for the forces and doctrine used by the OPFOR units at the Combat Training Centers (CTC) and in the TRADOC Common Teaching Scenarios. The Heavy and Light packages were designed to accommodate the existing CTC OPFORs at the time of publication with relatively minor changes but have the flexibility to adapt to the changing training requirements of the force-projection Army.

Heavy OPFOR Package

The Heavy OPFOR is based in part on the military forces of the Former Soviet Union (FSU), with a well-documented military doctrine. While Russia and other countries emerging from the FSU may modify that doctrine, it will continue to be the basis for their doctrines and those of numerous other countries whose military forces have been patterned after those of the FSU. Organizationally, the Heavy OPFOR takes a “building block” approach, which provides a great deal of flexibility.

Heavy OPFOR Tactics Handbook

The *Heavy OPFOR Tactics Handbook* is the fifth volume of the OPFOR series of handbooks. This draft handbook provides the customer with an tactical overview of the Heavy OPFOR. The topics covered in the handbook include: combat formations; troop control; march; reconnaissance; offensive and defensive tactics; fire support (artillery, antitank, air, and air defense); engineer support; logistics; radioelectronic combat; and NBC and smoke.

Structure

The *Heavy OPFOR Tactics Handbook* depicts the forces of a country with standing divisions or brigades, and armies or army corps. Most of these formations are stationed within military districts in peacetime and would become subordinate to *fronts* during wartime. Armies, army corps, and *fronts* can vary widely in their strengths and capabilities. If a trainer finds that his scenario does not require a large array of standing forces, it may be that the Light OPFOR handbooks better suit his training needs.

Heavy Opposing Force (OPFOR) Tactical Handbook

Table of Contents

Preface		i
Introduction		ii
Chapter 1	Tactics and Combat Formations	1-1
	Military Doctrine.....	1-1
	Military Art.....	1-1
	Tactical Principles	1-3
	Modern and Future Warfare	1-6
	Combat Formation	1-8
Chapter 2	Troop Control	2-1
	Demands of the Modern Battlefield	2-1
	Troop Control System	2-3
	Troop Control Process	2-15
	Command and Control Posts.....	2-21
	Communications	2-25
Chapter 3	March	3-1
	Types of March.....	3-1
	Control Measures.....	3-6
	March Security.....	3-7
	Reconnaissance	3-9
	Division Tactical March	3-9
	Regiment Tactical March	3-14
	Support of the March.....	3-18
	March Under Special Conditions	3-20
Chapter 4	Reconnaissance	4-1
	Principles	4-1
	Resources	4-4
	Reconnaissance Elements	4-10
	Reconnaissance Detachment	4-11
	Reconnaissance Patrols	4-13
	Reconnaissance Patrol Methods	4-16
	Reconnaissance Data Collection	4-18
	Reconnaissance During Phases of Battle.....	4-19
	Reconnaissance Under Special Conditions.....	4-22

Chapter 5	Offense	5-1
	Surprise and Concentration	5-1
	Combined Arms Tactics	5-1
	Forms of Tactical Maneuver.....	5-2
	Elements of Combat Formation	5-4
	Tactical Formations.....	5-9
	Types of Offensive Action.....	5-18
	Attack Against a Defending Enemy	5-18
	Meeting Battle	5-50
	Pursuit	5-60
	Combat Under Special Conditions.....	5-67
Chapter 6	Defense	6-1
	Nature of the Defense	6-1
	Principles of Defense.....	6-2
	Transition to Defense	6-3
	Decision-Making Process	6-3
	Organization of Defense.....	6-7
	System of Fire.....	6-11
	Artillery Support	6-12
	Engineer Preparation.....	6-13
	Antitank Defense.....	6-14
	Defense Assumed Out of Direct Contact	6-14
	Defense Assumed in Direct Contact	6-25
	Counterattack	6-29
	Withdrawal	6-30
	Relief.....	6-32
	Special Conditions.....	6-33
Chapter 7	Fire Support	7-1
	Fire Superiority	7-1
	Artillery	7-2
	Air Support.....	7-2
	Targeting	7-3
	Target Priorities	7-4
	Phases of Fire Support	7-4
Chapter 8	Artillery Support	8-1
	Assets	8-1
	Organization for Combat.....	8-2
	Command and Control	8-3
	Fire Control	8-6
	Reconnaissance and Target Acquisition.....	8-7
	Equipment & Ammunition.....	8-7

	Tactical Deployment	8-8
	Methods of Fire.....	8-13
	Offensive Fires	8-15
	Defensive Fires.....	8-18
	Conduct of Fire.....	8-19
	Fire Planning.....	8-21
	The Offense	8-23
	The Defense.....	8-26
	Firing Norms.....	8-28
	Future Developments	8-35
Chapter 9	Antitank Support.....	9-1
	Antitank Weapon Systems.....	9-1
	Organization and Equipment	9-2
	Tactical Employment.....	9-2
	The Offense	9-6
	The Defense.....	9-8
Chapter 10	Air Support	10-1
	Organization	10-2
	Troop Control.....	10-2
	Planning and Preparation.....	10-3
	Missions.....	10-4
	Aviation Employment.....	10-5
	Offense	10-8
	ECM.....	10-14
Chapter 11	Air Defense Support.....	11-1
	Concepts.....	11-1
	Principles	11-1
	Equipment and Organization	11-2
	Special Missions.....	11-4
	Offense	11-5
	Employment.....	11-7
	Defense.....	11-8
	Employment.....	11-9
	Reconnaissance	11-10
	Electronic Countermeasures	11-11
	Signal Security	11-11
	Limitations.....	11-11
	Trends.....	11-11
Chapter 12	Engineer Support.....	12-1
	Engineer Troops	12-1
	Engineer Employment.....	12-2

	Missions.....	12-4
	Engineer Reconnaissance	12-8
	Fortifications.....	12-11
	Movement Support	12-13
	Movement Support Detachment.....	12-15
	Offense	12-16
	Defense.....	12-17
	Water Crossing	12-17
	Engineer Obstacles.....	12-21
	Obstacle Clearing.....	12-28
	<i>Maskirovka</i>	12-30
	Water Supply	12-32
Chapter 13	Logistics.....	13-1
	Centralized Planning.....	13-1
	Tailoring of Logistics Units.....	13-1
	Fixed Supply Priorities	13-1
	Tactical Logistics	13-3
	Supply.....	13-6
	POL.....	13-7
	Transportation	13-11
	Maintenance and Recovery.....	13-12
	Organizational Maintenance Services.....	13-13
	Maintenance Responsibilities	13-13
	Delivery and Repair During Combat.....	13-14
	Medical.....	13-14
	Logistic Trends	13-17
Chapter 14	Radioelectronic Combat	14-1
	Radioelectronic Combat (REC).....	14-1
	REC and the Division Battle.....	14-4
	Firepower	14-5
	Deception	14-5
	ECCM	14-5
	Implications	14-5
Chapter 15	NBC and Smoke Operations	15-1
	Preparedness	15-1
	Nuclear	15-2
	Nuclear From the Onset	15-2
	Transition to Nuclear	15-2
	Types of Strikes	15-3
	Offensive Employment	15-3
	Defensive Employment.....	15-4

Biological 15-4
Chemical 15-4
NBC Protection 15-7
Assets 15-8
Reconnaissance 15-8
Decontamination 15-9
Combat in an NBC Environment 15-10
Training 15-11
Smoke 15-12
Types of Smoke Screens 15-15
Meteorological Influences 15-16
Flame 15-17

Glossary Glossary - 1

Chapter 1

Tactics and Combat Formations

The OPFOR vision of victory on the modern battlefield depends on how the enemy uses its forces and assets, considers the effect of specific situation conditions, anticipates enemy maneuver, and preempts the enemy in actions that decisively affect success. The OPFOR believes victory goes to the side that effectively applies principles of military art, accomplishes missions creatively using initiative, and firmly controls unit actions.

This chapter focuses on the tactical level of military art. For a more comprehensive discussion of OPFOR military thought, see Chapter 1, in the *Heavy OPFOR Operational Art* handbook.

MILITARY DOCTRINE

Military doctrine is official state policy that provides general guidance for defense policies. Military doctrine comprises three components: political, military, and military-technical policies. Political policy provides national security interests, threat perceptions, and mission of the armed forces. Military policy provides guidance on force structure, training, manpower, and mobilization requirements, characteristics of future wars, and developments of military art. Military-technical policy provides guidance for industrial mobilization, research and development, and weapons acquisition strategy.

Military doctrine only provides general guidance; follow-on documents are required to provide greater details,

such as mobilization plans and combat regulations for each service branch.

MILITARY ART

Military art is the theory and practice of preparing and conducting military operations on land, at sea and in the air. All OPFOR discussions of military art emphasize the interaction among its three components: **strategy**, **operational art**, and **tactics**. These interrelationships are becoming more multifaceted and dynamic. OPFOR military art provides the conceptual framework for the development and application of military power.

Strategy

Strategy deals with the preparation and conduct of strategic operations and war as a whole. This is the highest sphere of military art, encompassing preparation of the country and armed forces for war and the planning and conduct of strategic operations and war. In accomplishing practical tasks, strategy is guided by provisions of **military doctrine**.

Under the guidance of the senior civilian and military leadership, which forms a Supreme High Command during wartime, the General Staff develops and executes strategic plans and operations. These strategic operations, in turn, direct operations at the operational art level of war.

Operational Art

Operational art is the second component of military art, covering the theory and practice of preparing for and conducting joint and independent combat operations by large formations (*fronts*, armies, or army corps). It holds an intermediate position between strategy and tactics.

Operational art, like strategy, develops continuously. Employment of new weapons and military equipment along with a growth in the intensity of warfare, impact the formulation of operational art. In turn, operational art determines the tasks and directions in the development of tactics.

Tactics

Tactics, the third component of military art, deals with the theory and practice of combat at division level and lower. The OPFOR term **subunit** applies to battalions and lower; **unit** equates to regiment or independent battalion level; and a **formation** is a division or brigade. There are specific tactical principles for each type of unit, weapon, and combat situation. Tactics change rapidly to conform with changes in weapons and are closely linked with the other components of military art. Military tactics occupy a subordinate position with respect to operational art and strategy.

Understanding what the OPFOR means by tactics, operations, and the words and verbal formulas that it associates with each concept is important. To the OPFOR, the word **operation** implies that the activity involves at least an army or army corps or a *front* that was probably tailored for the mission. **Tactics** refers to combat actions at division level and lower. Divisions fight **battles**; armies conduct operations. First-

echelon divisions usually pursue tactical missions in the enemy's tactical depth. Armies, using their second-echelon divisions, pursue operational missions in the enemy's operational depth.

The study of tactics involves the examination of the nature and content of battle, as well as the development of methods of preparing for and conducting combat. These provisions are reflected in regulations, manuals, textbooks, and works of OPFOR military theory. The practice of tactics encompasses the activity of commanders, staffs, and troops in preparing for and conducting battle. It includes--

- Updating situation data.
- Decision making.
- Communicating missions to subordinates.
- Organizing coordination of forces and assets.
- Comprehensive support of battle.
- Battle planning.
- Preparing troops for battle.
- Conducting combat operations.
- Exercising troop control.

Interrelationships

Like the other areas of military art, tactics are constantly evolving. Weapons and military equipment, the level of troop training, and the art of leading troops all determine the status and development of tactics. Separating OPFOR tactics from operational art is often difficult. The maneuver divisions are the tactical maneuver elements used by armies/army corps and *fronts* to achieve their operational missions. The two concepts are closely related in OPFOR military thinking and planning.

OPFOR tactical commanders understand the need to always keep the opera-

tional goal in mind. The overriding goal of the combined arms offensive is to turn tactical success into operational success rapidly through a combination of massive fire, maneuver, and deep strikes. Similarly, tactical and operational successes contribute to the accomplishment of strategic tasks.

Trends

In the OPFOR view, combat at the tactical level is directly dependent upon the strategic and operational context. The OPFOR believes future wars will be characterized by the scale of operations, the speed at which events develop, the intensity of combat, and the destructiveness of modern weapons. In such a war, the time factor is crucial. The achievement of surprise is crucial if the OPFOR is to dictate the course of events and maintain initiative. OPFOR tactical principles and practice are designed to meet the requirements of this overriding operational concept.

The OPFOR is currently developing commanders who try to outthink the enemy and stun him with unconventional action. It is now accepted by the OPFOR that, on the modern battlefield, commanders, at battalion level and below, may find operating independently with little time to ask senior commanders for orders. Junior commanders must possess not just initiative, but the ability to develop their own solutions to tactical problems and a willingness to take responsibility for their decisions.

Tactical Decision Making

The OPFOR decision-making process involves a thorough calculation of several variables: **distance, time, quantity, and capabilities**, including likely **changes, losses, buildup, restoration and maneuver**.

Combat experience teaches that deceiving and misleading the enemy is a Requirement for success in battle. For this, the OPFOR must thoroughly estimate the enemy's strong and weak points, take into account specific terrain features, and consider weather and meteorological conditions. For example, a maneuver on difficult terrain can ensure surprise in attacking the enemy from a direction where he does not expect it.

Tactical Training

OPFOR tactical combat training is critical to the overall success of a battle. Exercises and drills attempt to approximate the conditions of battle. A very important task of all OPFOR training is to master the methodology of conducting exercises and drills that create a near-real situation in all training activities.

TACTICAL PRINCIPLES

In OPFOR doctrine, tactics are subordinate to operational art. Success at the operational level is considered the key to victory. It is not surprising that OPFOR principles of operational art and tactics are similar. OPFOR **tactical principles** include:

Combat Readiness

The combat readiness of units determines the timeliness of their engagement and the creation of conditions for tactical victory. The essence of this principle is the capability to enter battle and successfully perform assigned missions at any time, in an organized manner, within prescribed time periods. The commander must ensure that his formation, unit, or subunit maintains this constant readiness. Highly intense, quality training under combat-like conditions is critical to OPFOR combat success.

Aggressiveness

To succeed in combat, commanders must be aggressive, bold, and resourceful. Formations, units, and subunits must act with maximum persistence, both night and day, in any weather. Aggressiveness relates closely to initiative. At the tactical level, this principle determines the OPFOR preference for the offense.

Decisiveness

Decisiveness of battle goals is determined by the OPFOR's mission by the increased capabilities of modern warfare. It is ensured by determining the methods, operations, and missions that permit maximum possible results in the shortest possible time, with the fewest losses. This requires initiative and aggressive, determined actions by commanders, as well as, bold use of unexpected tactics.

Coordinated Efforts

Modern warfare is truly a combined arms battle. The commander must understand the capabilities of all the types of troops likely to be under his control. He must combine their strengths, ensuring efforts are directed to the same objectives and coordinate their missions, axes, deployment lines and timings. Coordination of efforts of all forces and assets is organized and then is supported based on a common understanding of the concept of combined arms battle.

Surprise

Achieving surprise can gain a significant, even decisive, advantage over the enemy while preserving one's own combat effectiveness. A surprise attack can inflict

substantial losses on the enemy and lower his morale. It can confuse him and reduce his overall combat effectiveness. It can also allow success without an overwhelming superiority of forces. Even partial surprise can be effective.

Maskirovka

To achieve surprise, the OPFOR employs an organized *maskirovka* plan. This includes camouflage, concealment, and general deception techniques. Simultaneous use of deception practices against all hostile intelligence-gathering assets achieves the greatest effect. The OPFOR's ultimate deception goal is to mislead the enemy about--

- The presence and position of forces.
- Their composition, combat readiness, and actions,
- The plans of the command authority.

Concentration of Main Effort

Concentration has always been a basic OPFOR principle, but it is now accepted that concentration is not just physically massing troops on the main axis. Such groupings are too vulnerable to nuclear strikes and high-precision weapons. It is now essential for troops to remain dispersed for as long as possible, concentrating at the decisive point for the shortest possible time. Concentration relates to a particular time and place. Overwhelming, across the board superiority is not necessary and can rarely be achieved.

Maneuver

Maneuver allows the commander to strike the enemy when and where necessary. The OPFOR recognizes envelopment as the most successful form of maneuver. The es-

sence of maneuver is the swift, organized displacement of troops to important axes and sectors to create a more favorable ratio of forces and assets there and a more favorable situation with respect to the enemy. The maneuver must be accomplished covertly, to the enemy's surprise, and in a timely manner. The optimum number of forces and assets should be used to execute it in order to expend a minimum of time.

Maneuver permits seizing and holding the initiative, disrupting the enemy concept, and successfully conducting battle in the changed situation. It is possible to compensate for a shortage of forces and assets with the help of an aggressive maneuver, redeploying assets quickly to threatened sectors and to new positions and lines.

Maneuver by fire is even faster than maneuver by forces. The range and effectiveness of modern weapons make this increasingly more important.

Comprehensive Support

Comprehensive support of the battle is the organization and accomplishment of measures that maintain high troop combat readiness, preserve combat effectiveness and create favorable conditions for successful performance of the combat mission. Support is organized during preparation for battle and is maintained continuously throughout the course of the battle, based on the commander's decision. Comprehensive support has two aspects:

Combat support. This includes reconnaissance, defense against weapons of mass destruction and high-precision

weapons, *maskirovka*, engineer support, chemical support and security.

Combat service support. This includes the supply and maintenance of all types of combat systems, equipment, and ammunition. It also concerns the individual needs of troops, food, quartering, clothing, pay, and medical support.

Maintaining Combat Capability

The maintenance and restoration of combat capability are vital in modern combat. Many factors can affect combat capability. Modern weapons, for example can quickly destroy the combat capability of a force. The ability to maintain combat capability and to restore it quickly, when required, can mean the difference between success and failure.

Troop Control

To be effective OPFOR troop control must be firm and continuous. Effective troop control defines the goal of battle and establishes and maintains effective communications. It promotes sound battle plans, and ensures they are properly executed. Firm, continuous troop control achieves planned goals and assigned missions contributing to victory with the fewest possible losses and in the shortest possible time.

The commander's decision is the basis for troop control and should specify the goal of battle, its concept, and methods for achieving the goal. The decision should conform to existing capabilities and conditions. Commanders' high professional preparedness is necessary for firm, competent troop control.

MODERN AND FUTURE WARFARE

Future wars will be fought by smaller but more lethal armies. High-precision weapons, high-speed maneuver platforms, information warfare systems, and battlefield automation will impact how the OPFOR fights and defends. Flexibility will become increasingly important on the fast-paced, fragmented battlefield of the future. More importance will be attached to joint and multinational operations, and to a continuous, multi-dimensional combined arms approach to the conduct of warfare.

The OPFOR anticipates modern war will consist of a battlefield on which there will be no recognizable frontline, no secure flanks and no safe rear areas. Combat will be spread over an area of considerable width and depth, with the forces of both sides intermingled.

In addition, the pace of technological change is accelerating. Accordingly, OPFOR military theoreticians argue that operational art and tactics must not concern themselves merely with the weaponry of today. It is vital to forecast developments and adjust concepts to meet the demands of future wars.

Types of Combat

The OPFOR recognizes two types of combat: **offensive** and **defensive**. Traditionally, offensive combat is the only type that can ultimately bring victory. It is, therefore, the most decisive type of combat.

Offense

The goal of offense is the enemy's total defeat and the capture of important objectives. This goal is achieved by destroying

enemy nuclear and precision strike systems (including support elements), chemical attack weapons, artillery, and maneuver formations by the use of long-range missiles, aircraft, and artillery fire. This enables the swift advance of tank and motorized rifle (or infantry) units and formations in coordination with aviation and airborne assault forces. These formations defeat the enemy by assaulting his flank and rear, by encirclement, and by splitting his forces and defeating them in detail. See Chapter 5 for more information on the offense.

Defense

The defense is a battle with the objective of repelling an attack by enemy forces, inflicting considerable losses, and holding important terrain, allowing the buildup of forces in other sectors and creating favorable conditions for launching an attack. This objective is achieved by the fire of all available weapon systems; by a wide maneuver of fire; forces, and assets; and by stubborn holding of occupied positions, lines, and objectives in combination with conduct of counterattacks. See Chapter 6 for more information on the defense.

Combined Arms Battle

The OPFOR defines a **battle** as an organized armed struggle among units of various sizes and formations of different branches and services of the armed forces. A battle can occur on the ground, in the air, or on the sea. Ground battle goals are the destruction of enemy tactical formations and the capture, or retention, of important terrain. The OPFOR feels that the essence of the tactical ground battle is **combined arms combat**. In combined arms battles, OPFOR commanders coordinate the actions of tactical units of every branch of the armed forces

in terms of mission, place, and time, to achieve the rapid destruction of the enemy. The characteristics of modern OPFOR combined arms combat include--

- High maneuverability.
- Decisiveness.
- Nonlinearity.
- Potential use of weapons of mass destruction and high-precision weapons.
- Swift and radical changes in the combat situation.

This means that subunits and units of different combat arms and special troops, as well as of aviation, conduct combined arms combat by joint efforts. Different combat forces and assets aligned in combat formations take part in it, including motorized rifle (or infantry), tank, artillery, air defense, engineer, and chemical protection subunits. Close, continuous coordination of mixed forces and assets in a single combat formation permits the OPFOR to perform combat missions successfully. Its combat attributes and capabilities are mutually supporting, ensuring the most effective combination of **strikes, fire and maneuver.**

Strike

The OPFOR **strike** is a component part of battle. It consists of a simultaneous engagement of enemy groupings and targets by all available assets and forces. There can be nuclear strikes, fire strikes, troop strikes, as well as missile, artillery or air strikes.

An OPFOR troop strike is a combination of fire and movement by tank and motorized rifle (or infantry) subunits and units, or by airborne assault forces, to complete the enemy's defeat and take a desig-

nated objective. The strike is most typical of the offense. In the defense, it is usually used in a counterattack.

The force of a strike by subunits and units is determined above all by their firepower, rate of movement, and surprise in delivering it. It is manifested in the best case by a good choice of the place and time of delivering it (i.e., where the enemy has the fewest effective forces and assets and where he does not expect it). Tank and motorized rifle (or infantry) subunits, and units with effective artillery and air support and reliable cover by air defense weapons have the greatest force for a strike.

Fire

The OPFOR concept of **fire** is the engagement of the enemy by fire using all available weapons. It is conducted to annihilate, neutralize, or harass the enemy and to destroy targets. Fire differs in terms of intensity, direction, methods, and types. Fire is the chief factor in achieving success in battle, inflicting damage which deprives the enemy of combat effectiveness. Fire prepares and accompanies a troop strike, supports its development, and creates necessary conditions for executing a maneuver. In the defense, fire in combination with obstacles determines the possibility of repelling an enemy attack.

The effectiveness of OPFOR weapons, especially with the appearance of high-precision weapons, has led to a significant increase in depth and accuracy of fire delivery, to damage of targets in the shortest time periods, and to an increase in the level of instant losses. Use of high-precision weapons have significantly increased effectiveness of OPFOR antitank fire.

Maneuver

Maneuver is the third component of modern battle. It consists of the organized, concealed, rapid displacement of troops in the course of combat. It allows occupation of a favorable position with respect to the enemy and creates favorable groupings of forces and assets. It also allows the transfer or retargeting of strikes and fires for maximum effectiveness.

In the defense, the OPFOR maneuvers subunits to change a position for a more favorable one, cover a threatened axis more reliably, or to reinforce or replace units. Maneuver can also allow the OPFOR to an enemy strike, occupy a line of firing positions, or move to a counterattack position. The maneuver of forces, assets, and fire is a constant element of tactics employed in both defense and offense, in all stages of battle.

COMBAT FORMATION

Mission requirements and the commander's concept determine the tactical alignment of forces at division and below. The OPFOR term for this is **combat formation**.¹ The combat formation of a division, brigade, regiment, or battalion is the grouping created for the conduct of a particular battle. It normally includes a first echelon, either a second echelon or a combined arms reserve, and other reserves. For a division, brigade, or regiment, it would also include an artillery group and perhaps a forward detachment.

¹ In this context, the term **combat formation** does not refer to a force of a particular size (division or brigade). Rather, it describes how any tactical-level combat element organized and deploys its forces for combat. Thus, it is the tactical-level equivalent of the operational term **operational formation**.

Divisions are the basic building blocks of operational commanders. A division's organic assets are sufficient for it to attack or defend on a secondary sector. When fighting on the axis of main effort, a division requires additional combat and service support. Army commanders may reinforce some divisions at the expense of others, for example elements may be detached from second echelon divisions to reinforce a first-echelon formation. Second-echelon divisions may also find that the army commander takes direct control of a unit for a specific mission. In such cases the army commander will try to make up any losses before the division is committed into battle.

Division

A typical OPFOR division consists of four maneuver regiments, its organic combat and service support units, and any reinforcements attached by higher levels of command. The main elements within a division's combat organization are as follows:

Maneuver Regiments

The deployment of regiments is determined by the echelon structure of the division, usually in either one or two echelons. Two-echelon structures are appropriate when attacking or defending in the main sector of effort, against an enemy deployed in depth. Grouping three regiments in the first echelon and one in the second is the most commonly adopted variant. A two-and-two deployment is sometimes found in the defense, on an army's/army corps' most threatened sector.

Organic Support

Although a division would reinforce regiments from its combat support and com-

bat service support assets, the commander would always strive to keep some of these assets under his own control. He usually employs them to support the regiments on the main axis, but they are his personal means of influencing the battle and can be switched elsewhere as the situation develops. Some of these elements may be designated as reserves such as an antitank, engineer, or chemical protection reserve, but it is rare to find field artillery in a reserve.

Reinforcements

The exact composition of any reinforcements received by a division depends on its mission, the terrain, etc. Reinforcements may be retained under division control, allowing the division commander to push some of his own assets down to regiments, or may be allocated to regiments themselves. The most common form of reinforcement is artillery, allowing a division to create an artillery group while reinforcing regiments, particularly on its main sector.

Motorized Rifle Division

An OPFOR motorized rifle division (MRD) typically consists of three motorized rifle regiments (MRRs) and a tank regiment (TR), with its combat and service support. The MRR may either consist of two BMP-equipped regiments and one BTR-equipped regiment or vice versa.

Motorized rifle regiments. Because of its firepower and mobility, motorized rifle regiments are often found on the division's main axis in the attack or its most threatened sector in the defense. They are usually in the first echelon, although in the attack a BMP regiment may be considered for an exploitation role in the second echelon. Battalions of a BMP regiment are often

chosen for special missions by the divisional headquarters, for example, to act as forward or raiding detachments. BTR-equipped regiments are more suited to secondary sectors or those which favor wheeled vehicles. Infantry from BTR unit may often be chosen for heliborne operations because of their man-portable antitank weapons.

Tank regiments. Due to its lack of infantry, the TR is not suitable for use in the first echelon of MRDs when attacking reasonably strong defenses. It is better used in the second echelon, where it can rapidly exploit success. A TR might be in the first echelon against a weak defense, when the aim is to strike as deeply as possible before the enemy strengthens his position. In defense, the TR is also likely to be in the second echelon because its equipment and organization are better for a counterattack or counter-penetration role, rather than for holding ground. In any of these roles, the tank regiment would normally be reinforced with motorized rifle forces.

Tank Division

A TD is most suited to exploitation roles in the offensive and in defense is deployed in the second echelon of the army/army corps to provide a counterattack force. If a TD has to attack prepared defenses the BMP regiment would probably be in the first echelon. BMP-equipped regiments and battalions are also often considered for security and forward detachment missions.

Infantry Division

The OPFOR infantry division's primary maneuver elements are three infantry regiments, a light assault battalion, and an independent tank battalion. It is capable of

conducting independent ground operations or conducting operations as part of an infantry army, within the limitations of equipment, weather, and terrain. It can be augmented with additional tank, artillery, and engineer units, so that it has a combined arms capability.

Regiment

The regiment is the basic tactical and administrative unit in the OPFOR army. Regiments are not expected to operate independently of their parent unit without reinforcement, and then only for a limited time.

Motorized Rifle Regiment

A MRR in a MRD has three motorized rifle battalions (MRBs) and one tank battalion (TB). In a TD, the MRR has only two MRBs and a TB. It is rare for a MRR in a MRD to fight as four maneuver subunits. The most common options are--

- In a single-echelon formation, to allocate a tank company to each MRB. Sometimes one tank company (with the TB headquarters) is retained under regimental command.
- In a two-echelon formation, to allocate one or two tank companies to the two first-echelon MRBs, while retaining the rest of the TB under regimental headquarters. Tanks are not usually subordinated to second-echelon MRBs until they are about to be committed into battle.
- In defense, particularly in BMP regiments, four battalions may be deployed (two up, two back). Even in this case, the TB may lose a company to the first-echelon MRBs.

Of course, the regimental commander may choose to fight his TB as a single entity

if he feels the tactical situation requires it. This might happen in a meeting battle when a powerful armored fist is most necessary.

Tank Regiment

A TR in an MRD has three TBs as its only maneuver elements. In a TD, each TR has three TBs and a BMP-equipped MRB. TRs of TDs are most often organized with the BMP battalion split by companies among the TBs. In some circumstances, the BMP battalion may remain intact and even be reinforced with a tank company and other assets. This may happen if the BMP battalion is acting as the regiment's forward detachment, especially when chosen, because of its amphibious capability, to secure a river crossing. It is rare for the TR of an MRD to be reinforced with motorized rifle troops from another regiment.

Independent Motorized Rifle Brigade

The OPFOR also has independent motorized rifle brigades (IMRBs) that are not subordinate to divisions. Compared to a MRR, and IMRB has more maneuver battalions and expanded combat support and combat service support assets. This structure makes the IMRB well-suited for independent action, for example, army/army corps-lead as a combined arms reserve or forward detachment. In situations where the OPFOR has not had time to mobilize and deploy a division from its strategic reserve, an IMRB might have to perform missions normally performed by a division. The IMRB combat formation would most likely use two echelons. It would have three to four MRBs, each reinforced with a tank company, in the first echelon and a TB or TB(-) in the second echelon, along with any remaining MRB(s).

Battalion

Tactical grouping of OPFOR battalions never involves the exchange of subunits with other battalions, e.g., a MRB would not exchange a motorized rifle company for a tank company with a TB. Battalions are either reinforced with regimental assets or are themselves used as reinforcements. Within the battalion, the commander organizes his force in one or two echelons. He may use his own combat support assets, and any he receives from higher level, to reinforce subordinate companies (especially on his main axis), or he may retain these assets under his own control.

Chapter 2 Troop Control

The OPFOR tactical troop control system is an integral part of the operational-level system. Most aspects of the system reflect those at the operational. (See *Heavy OPFOR Operational Art* handbook, Chapter 7.) Tactical troop control deals with the leadership, planning, and management of OPFOR tactical organizations--divisions, brigades, regiments, and battalions--in combat.

The OPFOR division is the largest unit that conducts tactical activity. The functions of its control system determine the successful use of regimental and battalion combat power against the enemy. The division's control system integrates and employs the combat capabilities of organic and reinforcing units. It is capable of incorporating and managing additional nondivisional assets, such as army-level artillery or engineers.

DEMANDS OF THE MODERN BATTLEFIELD

The tactical troop control system shares many elements with the operational level. There are, however, numerous dimensions of the modern battlefield that have particular impact at the tactical level. Three of these are time, space, and coordination. These affect the survivability of the tactical troop control system and have dictated changes in the system.

Survivability

At division level and below, the elements of the OPFOR troop control system function closer to the enemy's weapon sys-

tems and reconnaissance assets. This increases the potential for disruption or destruction of key components of the system. Survivability of the troop control systems is of greater concern at the tactical level. These conditions dictate the following requirements for the tactical control system:

- High mobility.
- Physical and communications security measures.
- Physical protection of command and communications vehicles.
- Redundancy.

These qualities are necessary to make the system both survivable and flexible enough to maintain constant control of units in combat.

In offensive operations, the OPFOR emphasizes continuous a high rate of advance. This demands that the structure supporting the overall troop control process be highly mobile. Tactical command/control posts (CPs) and associated communications must relocate frequently to maintain uninterrupted control. This has a significant impact on the size and field configuration of the control organs, CPs, and the supporting communications structure.

Even at regimental level, the need for dispersion and for bold maneuver, combined with time constraints, prevents commanders from exercising the detailed, personal control over their subordinates that has been traditional in the OPFOR army.

A combined arms approach to combat is essential to success. Coordination is becoming an increasingly complex problem,

while the time available is decreasing. The entire troop control system is, therefore, increasingly vulnerable to physical and electronic attack.

Timeliness

Given the expected tempo of modern combat, commanders must expect the tactical situation to be subject to sudden, sharp changes, or to be shrouded in obscurity. Despite these limitations, higher headquarters still expect results. As a result, there may be inadequate time available to produce and disseminate intelligence and to formulate and issue orders and plans.

Timely accomplishment of all actions required to lead units in combat requires the commander to have constant knowledge of the situation and to react swiftly to changes. Decisions and missions assigned to subunits must be updated in a timely manner. High work efficiency is needed to prepare for battle quickly. Rapid intelligence collection, timely receipt of subordinate commanders' reports, and accurate information from the senior commander and adjacent units are all extremely important for maintaining efficiency of troop control.

The fast pace of modern combat imposes time constraints on the OPFOR decision making process and planning cycle. Despite recent emphasis on continuous combat, the division staff still concentrates on the short-term tactical task at hand, leaving detailed planning of long-range operations to the army/army corps and *front* staffs.

Staff Procedures

The flow of information has increased dramatically in modern war, while the time available for making and communi-

cating decisions has been shortened. To cope with the problem of giving commanders more time to prepare their forces for battle, OPFOR staff procedures are being streamlined. The timely issue of preliminary instructions (warning orders) outlining the broad concept for battle, along with the acceptance of low-level initiative, allows subordinate staffs to use **parallel planning**. This planning method can save 20 to 30 percent of the time previously used in sequential planning

Improved tactical reconnaissance systems have increased the volume of combat information to be processed and considered. Despite this information explosion, tactical commanders must still be able to make rapid decisions. This has driven the OPFOR to increase **automation** of the staff calculations required to support the decision making and planning process at division, brigade, regiment, and battalion. Automation extends the use of prepared "tactical calculations," nomograms, and formulas, and cuts the volume of paperwork. At battalion level, the commander's working map and programmable calculator may be the only planning tools used.

Normative Planning

The OPFOR has devoted a great deal of effort to analyzing past wars, modeling future ones and developing mathematical norms. These norms are expressed in calculations, charts, and nomograms and, increasingly, computer programs. The use of these tools speeds staff work and the commander's decision-making process.

Decentralized Battle Management

In the past, OPFOR commanders tended to issue detailed plans. They main-

tained rigid control over the execution of their plans, closely supervising subordinates and interfering in the details of execution. The practice is now to retain centralized operational control, but to avoid rigidity by allowing decentralized battle management. The conduct of battles is left to the tactical commanders fighting them. This should ensure a timely and effective response to rapidly developing and changing battlefield situations.

Initiative

As a consequence of the larger measure of freedom of action for tactical commanders, the OPFOR is fostering initiative down to battalion and even lower. In OPFOR thinking, however, initiative is more narrowly defined and structured than in the US Army. It could be described as the freedom to plan for uncommon or unusual responses. In other words, commanders must anticipate, or at least interpret correctly, their role in the higher plan and execute it without detailed guidance from higher.

Stability

Stability consists of knowing the situation, rapidly restoring disrupted troop control and communications, gathering situation data and making decisions in a timely manner. Stability also involves maintaining reliable communications with subordinate and coordinating units, and senior commanders, as well as reliably protecting the troop control facility against the enemy.

Continuity

Continuity consists of the commander influencing the battle by all means at his disposal. In battle, the commander must carefully follow the course of events, con-

tinuously reconnoiter the enemy, and promptly assign or update the missions of attached and supporting subunits. Constant knowledge of the battlefield situation, analysis of that situation, and anticipation of important changes are necessary conditions for maintaining troop control. This permits the commander to employ organic and attached weapons skillfully and to effectively exploit enemy vulnerabilities.

Maskirovka

On the modern battlefield, *maskirovka* is especially important in light of the increased role of surprise, the increased capabilities of enemy reconnaissance, and the use of high-precision weapons. Maintaining operational security is an important condition for troop control. It is achieved by using secure communications; ciphers and codes; tables of call signs and signals; and camouflage and concealment of CPs.

TROOP CONTROL SYSTEM

The OPFOR has designed a **troop control system** that is, at least in theory, well-tailored to suit the rigorous demands of a fluid, fast-changing battlefield. Centralization of control at the operational level keeps the focus on the overall operational goal and ensures the direction of resources toward the main effort. Should the control mechanism break down, the issue of the operational commander's decision and the insistence that **tactical commanders use their initiative within the framework of their superior's overall concept** should ensure that constructive direction of the battle continues. The streamlining of staff procedures and the ongoing spread of automation are increasing the ability of tactical headquarters to act quickly.

Organs of Control

Within the troop control system, the **organs of control** include the commander, his staff, the chief of staff, and the chiefs of branches of troops and services and their staffs. They perform the functions required to control the activities of troops in preparing for and conducting combat. The primary function of these organs is to **acquire and process information**. Evaluation and knowledge of the situational elements of combat is fundamental to the decision-making process and the direction of troops. **Decision-making and planning combat actions** are also troop control functions of the control organs. After the control organs have acquired and processed the information, they review the situation to determine if a decision is necessary. Any decision should be both scientifically derived and timely. After making the decision, the control organs must **organize, coordinate, disseminate, and support the missions of subordinates**. Additionally, it is their responsibility to train and prepare troops for combat, and to monitor the pre-combat and combat situations.

Commander

Under the principle of **one-man command**, OPFOR commanders have complete authority over their subordinates. This centralized authority enables the commander to act decisively and with initiative, to reduce decision making required of subordinates, and to maintain troop discipline and unity.

At every level, OPFOR commanders have sole responsibility for the fulfillment of the mission. Because of the stress on the operational level of command, tactical commanders are often young, but have tactical experience and time in command. Initiative

is not discouraged in junior commanders, but should be exercised in accordance with the senior commander's plan.

Staff

The commander controls and supervises subordinates through his staff. OPFOR commanders use their well-trained and experienced staffs to gain the time needed to prepare forces for battle. The staff provides rapid, in-depth planning for combat activity and then coordinates and monitors the execution of the resulting plans. This allows the commander to focus on the most critical issues in a timely manner and preserves his energies.

All OPFOR major headquarters have the same basic organization, although they differ in size and complexity. The higher the level, the larger and more complex the staff. The staff unifies and directs specific troop control tasks based on the commander's decisions, orders, instructions, and also the instructions of a higher staff. The work of the staff involves a precise distribution of tasks and functions among those who must carry them out, and also an exact estimate of the time at which all work should start and finish.

The staff releases the commander from having to solve administrative and technical problems, thereby allowing him to concentrate on the battle. It translates his decisions into plans and helps him to control the actions of his subordinates. It is also responsible for keeping the commander informed of developments and for providing advice as required. In the decision-making process, the staff--

- Prepares data and estimates which the commander uses to make decisions.

- Mathematically verifies the commander's plan and suggests necessary adjustments.
- Plans and implements combat support measures.
- Coordinates with subordinate, superior, and adjacent headquarters
- Monitors subordinate staffs.

Chief of Staff

Preeminent among OPFOR staff officers is the chief of staff position. The chief of staff is found at every level from the General Staff down to battalion. The chief of staff is the commander's closest assistant. He alone has the authority to sign orders for the commander, to issue instructions to subordinate elements in the name of the commander, and, in emergency situations, to make changes in the plans of subordinate commanders.

The chief of staff's key position in the troop control process dictates that he must **constantly be abreast of the situation and be able to predict likely changes**. This imposes the following responsibilities:

- To always be aware of the assigned missions of subordinates and adjacent units.
- To know the current situation, status, and capabilities of friendly and enemy units and the quantitative and qualitative correlation of forces.
- To know the current NBC situation and its effect on the accomplishment of the mission.
- To be ready at any time to report on the above and to brief his conclusions from his own estimate of the situation.
- To make proposals regarding possible decisions.

- To determine the measures for supporting combat operations and organizing troop control.

Thus, he must be intimately familiar with the commander's concept and the decision-making process.

To execute these responsibilities, the chief of staff organizes and directs the planning process and activities of the various staff members and chiefs of branches of troops and services. This includes but is not limited to--

- Defining times and methods of receiving situation data.
- Establishing priorities for information collection and analysis.
- Determining who reports situation data and conclusions to the commander and when.

The chief of staff also determines the method of disseminating orders to subordinate units and prepares reports for higher headquarters. He issues instructions focusing automated systems in the decision-making process, including what and whose calculations to use in the process and when. The chief of staff establishes CPs and determines the personnel and work schedules for them. In addition to the primary staff, he also monitors the work of the various chiefs of branches of troops and services and their staffs to ensure that their work corresponds in time and concept to the commander's requirements.

Chiefs of Branches of Troops and Services

Chiefs of branches of troops and services augment the primary staff at the regimental level and above, conforming to the needs of each level of command. These officers bring specialized knowledge and

skills to the control of the various elements of the combined arms unit or formation. Although the chiefs serve as an element of the commander's staff in advising him on the use of forces in their branch, in many cases they are also commanders. They are responsible for the artillery, engineer, or air defense subunits' readiness and performance. Like the primary staff, they interact continuously with the corresponding chiefs of branches of troops and services at both higher and lower levels of command. Directly subordinate to the commander of their own unit or formation, they also receive and issue instructions through a chain of special subordination within their branch of troops or service.

Each chief of one of the combat arms branches, special troops, or services has a **dual chain of command**. He is responsible to the commander (or the chief of staff) in whose headquarters he serves, but he also receives additional instructions and guidance from his own counterpart at the next higher level. This dual chain of reporting seems to work well. It reduces the administrative and technical burden on the commander, so he can concentrate on the combat actions of his maneuver elements. The commander at the highest level has centralized control over all the assets available to him.

Division

The division commander exercises troop control functions through his staff and subordinate maneuver commanders. The staff comprises two elements: the principal staff and the primary staff. **Principal staff** officers are directly subordinate to the commander. These officers include deputy commanders (for the rear, technical affairs, and armaments) and their staffs; chiefs of branches of troops and services and their

staffs; and the chief of staff. **Primary staff** officers are all those who are subordinate to the chief of staff and are actual members of the "staff" in their primary duties. For example, the chief of the operations section and the headquarters commandant are primary staff officers. Together, these headquarters elements include about 250 personnel, of which around 100 are officers.

Commander. The division commander is the focus for decision making at this level. He is normally a colonel or a one-star general. He directly controls the commanders of subordinate maneuver units and, through his staff and chiefs of branches of troops and services, controls the organic and reinforcing combat support and combat service support elements. The size of the combined arms structure at division level dictates heavy reliance on his staff. Unlike his operational-level counterparts, however, the division commander has more personal involvement in detailed planning. He is ultimately responsible for the achievements or failures of his division.

Chief of staff. As at higher levels, the division chief of staff, usually a colonel, is a vital figure in the troop control structure. His role is to serve as the director of staff planning and as coordinator of all staff inputs that assist the commander's decision making. He is the division commander's focal point for knowledge about the friendly and enemy situation. The chief of staff exercises direct control over the chiefs of reconnaissance and signal troops. This gives him a strong position in managing the collection and processing of information vital to the command, as well as structuring a communications system that effectively supports the commander's decision and concept of battle. During offensive combat, he is in charge of the divi-

sion main CP when the commander moves to the forward CP.

Principal staff. Figure 2-1 depicts the principal staff officers of a division headquarters. These officers are immediately subordinate to the division commander. Within the principal staff, the division **command group** consists of the division commander and those officers who work for him in a command relationship. These officers are the first deputy commander, the chief of staff, the deputy commander for the rear, the deputy commander for technical affairs, the deputy commander for armaments, and the commanders of the four maneuver regiments. The principal staff also includes the **chiefs of branches of troops and services**, who normally report to the commander through the chief of staff.

The **first deputy commander** is responsible for the division's combat readiness and mobilization, as well as maintenance of discipline and training. In combat, he runs the division alternate CP and can take charge of an independent element during battle. In the defense, for example, he can locate forward with the security zone force. In the offense, he can follow the supporting attack or accompany the second echelon, combined arms reserve, antitank reserve, or forward detachment. He is a key figure in battlefield reconstitution.

The **deputy commander for the rear** heads the non-equipment logistics system. He is responsible for managing the order, receipt, and distribution of supplies to sustain the division in garrison and in battle. Those responsibilities make this colonel the hub of the support effort, and a key figure at the rear CP during wartime. He is essentially the "installation commander" for the rear area, which contains small depots belonging

to the chiefs of branches troops and services and assets controlled by the deputy commander for technical affairs or the deputy commander for armaments. The deputy commander for the rear has no authority over the officers in charge of those elements; however, he is responsible for rear area organization and assigns locations in the rear area. He supervises communications, movement, security, and damage control within the rear area. He communicates directly with the division commander and chief of staff and also with his counterpart at army/army corps level.

The **deputy commander for technical affairs** oversees the supply and maintenance of the division's combat and technical equipment, to include armored and light vehicles, weapons, and electronic items. These responsibilities encompass the essential wartime tasks of organizing and controlling the divisional recovery, repair, and replacement system. He controls the division maintenance battalion and oversees maintenance training throughout the division. During combat, he keeps the commander informed on the status of the division's equipment.

The **deputy commander for armaments** has a role comparable to that of the deputy commander for technical affairs. He is responsible for the technical condition of armaments and related combat equipment and instruments. Entrusted with their combat readiness, he is also responsible for their supply, proper utilization, repair, and evacuation. His training responsibilities extend not only to his own subordinates but to all personnel concerned with the operation and maintenance of armaments, related equipment and instruments, rockets, missiles, and ammunition.

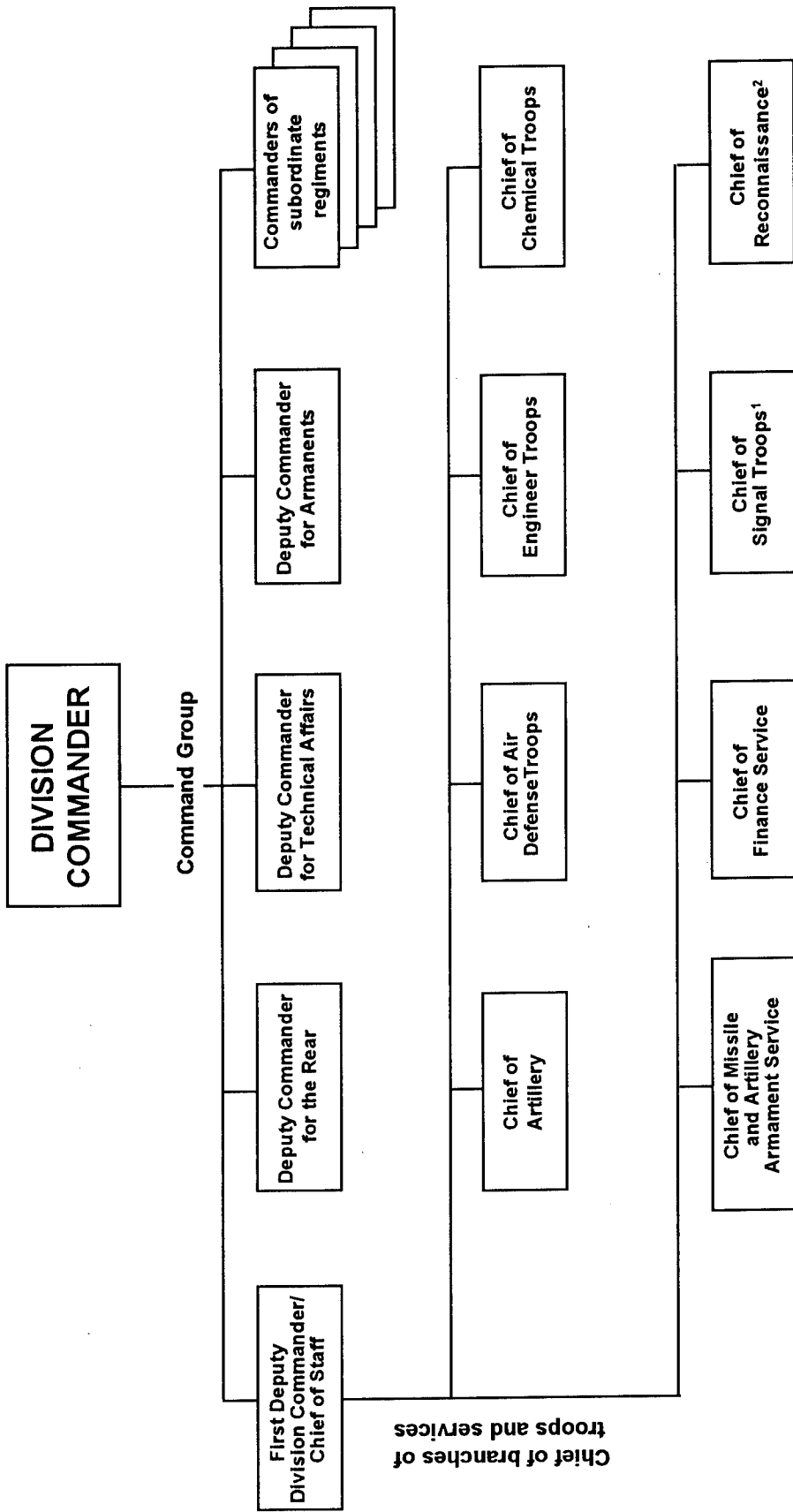

FOOTNOTES:

- ¹ Also serves as chief of communications section on primary staff.
- ² Also serves as chief of intelligence section on primary staff.

Figure 2-1. Principal staff organization (division).

The **regimental commanders** command the division's maneuver units. They are responsible for the combat readiness of their units, as well as their combat training. They are the instruments through which the division commander fights the battle.

The **chiefs of branches of troops and services** are also principal staff officers, who advise the commander on matters pertaining to their fields. There is an important difference between OPFOR chiefs of troops and services and US special staff officers. For example, the US division engineer advises the commander on engineer matters and also serves as commander of the division engineer battalion. In contrast, the OPFOR-system involves two officers. The OPFOR chief of engineer troops is a principal staff officer who coordinates division engineer matters and is senior to the division engineer battalion commander.

The **chief of artillery** serves as the division fire support coordinator. Once the commander issues orders concerning fire support, the chief develops a fire support plan supporting the commander's concept of the battle and scheme of maneuver. He works with the chief of reconnaissance for target development. He coordinates and supervises artillery fires of the division's organic and reinforcing artillery. The chief of artillery does not command the division's artillery regiment, or artillery units allocated from higher level. However, he does have operational control over them; he is responsible for their training and performance. He also exercises a degree of control over artillery units and staffs of subordinate regiments. The chief of artillery is responsible not only to the division commander and chief of staff; he is also responsible to the army/army corps commander of missile troops and artillery for artillery planning and

employment. Acting as the chief artillery advisor in combat, he is usually at the forward CP with the division commander.

The **chief of air defense troops** acts as a principal staff officer for air defense. He advises the commander on air defense tactics and employment. He has more direct control of division air defense elements than do other members of the principal staff in their respective services. He supervises the division's air defense units, monitors the division's inventory of air defense weapons and their state of repair, ensures an adequate supply of ammunition, and oversees air defense training and discipline.

The **chief of engineer troops** advises the commander on the personnel and equipment status, proper employment, and supply levels of engineer troops. He organizes engineer support for all the division's missions, including reconnaissance missions. He assigns tasks to engineer units based on the commander's concept of the battle. He also plans and supervises engineer work and training conducted by non-engineer units.

The **chief of chemical troops** has primary responsibility for the division's protection from NBC weapons. He is responsible for the supply and maintenance of NBC gear and equipment, for organization of NBC reconnaissance, and for all NBC training and work performed by division personnel.

The **chief of missile and artillery armament service** reports directly to the division commander. He has detailed responsibility for the condition, repair, and replacement of missile and artillery armaments and related components and for resupply of ammunition.

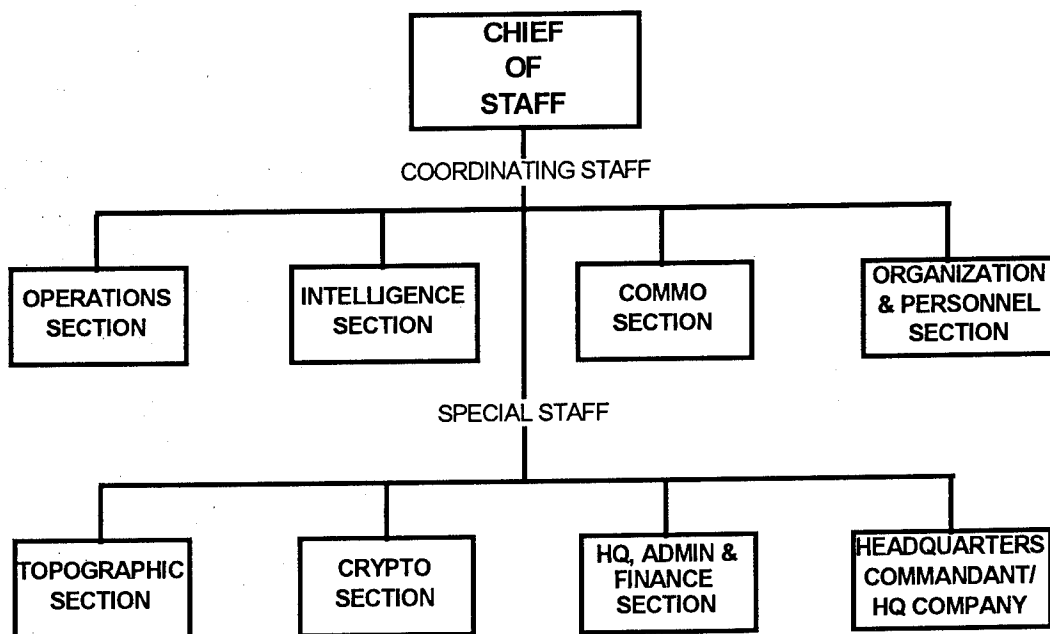

Figure 2-2. Primary staff organization (division).

The **chief of finance service** is directly subordinate to the division commander. His primary responsibilities are the organization and management of the division's financial affairs. This includes maintaining its financial accounts. The only individuals in the division who can authorize disbursement of funds are the division commander and his chief of staff.

The **chief of signal troops** is also the chief of the communications section. Likewise, the **chief of reconnaissance** is also the chief of the intelligence section. The following section on the primary staff describes their duties.

Primary staff. The primary staff is the division commander's planning body and the instrument through which he controls his forces. The chief of staff oversees the staff and is responsible for coordinating its work. The chiefs of the first four sections comprise the **coordinating staff**; the chiefs of the remaining four sections comprise the **special staff**. (See Figure 2-2.)

The **operations section**, is the most important coordinating staff section. The chief of operations is the first deputy chief of staff. He is responsible for training and the formulating of plans and orders. He monitors the work of all other staff sections, keeps abreast of the situation, and is ready to present information and recommendations concerning the tactical situation. He writes combat orders and important combat reports. In coordination with the intelligence section, the chief of the operations section keeps the commander informed on the progress of the battle. Specific duties of the operations section include--

- Collecting information concerning the tactical situation of friendly forces.
- Preparing and disseminating orders, operational plans and reports, summaries, and situation overlays.
- Providing liaison for the exchange of information within division headquarters and with higher, subordinate, and adjacent units.

- Organizing the main CP and insuring rear area antitank, antiaircraft, and NBC defense.
- Organizing troop movement and traffic control.
- Coordinating the organization of reconnaissance with the intelligence section.
- Controlling the distribution of maps.

The **intelligence section** is headed by the chief of intelligence, who is also the chief of reconnaissance. He is part of an intelligence chain of command originating at *front* level. In this context, division-level intelligence efforts fit into an overall intelligence plan. The chief of the intelligence section is subordinate to the chief of staff, but can report directly to the division commander. In coordination with the operations section, the intelligence section makes collection plans, collects information, and evaluates data on the battlefield situation. During combat, the division chief of intelligence/reconnaissance directs the efforts of subordinate intelligence sections and reconnaissance units. Specific responsibilities of the intelligence section include--

- Collecting and analyzing and disseminating information on the enemy, terrain, and weather to the commander and subordinate and adjacent units.
- Organizing reconnaissance missions, including requests for aerial reconnaissance, in coordination with the operations section.
- Preparing the observation plan, in coordination with the operations section.
- Preparing the intelligence portion of the division's combat order.
- Preparing periodic intelligence reports.
- Exploiting documents and materiel.

- Interrogating prisoners of war.
- Providing targeting data for artillery

The **communications section** is headed by the chief of communications, who is also the chief of signal troops. He organizes communications with subordinate, adjacent, and higher headquarters. The section must plan wire, radio, and mobile communications to ensure that the commander has continuous and uninterrupted tactical control. The term "mobile communications" includes all means of communications other than radio and wire. Specific responsibilities of the communications section include:

- Organizing division radio nets.
- Establishing callsigns and radio procedures.
- Organizing courier and mail service.
- Operating the division message center.
- Supervising the supply, issue, and maintenance of signal equipment.

The **organization and personnel section** is headed by the chief of personnel. It maintains daily strength reports and TO&E changes; assigns personnel; requests replacements; records losses; administers awards and decorations; and collects, records, and disposes of war booty. It keeps complete personnel files on company-grade officers, while regiments maintain files on enlisted personnel except for those working on division staffs. Levels higher than division maintain files on higher ranking officers.

The **topographic section** gathers and analyzes terrain data. It organizes geodetic, topographic, and photogrammetric services. The section provides division headquarters and subordinate units with a continuous supply of pertinent maps, benchmark catalogs, and map-related equipment.

The **cryptographic section** encodes and decodes the division's cryptographic communications. It designates the keys and codes to be used in communicating with subordinate units. It also supervises communications security procedures and cryptographic training. This section's activities are an integral part of a larger effort, coordinated by the chief of the intelligence section. The chief of intelligence, in turn, follows guidance from the army-level chief of intelligence.

The **headquarters, administration and finance section** organizes the administration and records necessary for providing quarters, food, supplies, and pay for division headquarters personnel. It is responsible for all division financial planning, accounting, auditing, and pay procedures. The division's finance officer supervises subordinate unit finance officers, who are responsible for the distribution of funds.

The **headquarters commandant** combines the functions (in US Army terms) of the division headquarters commandant and the division provost marshal. He is responsible for the proper siting, organization, support, and protection of the division headquarters and CPs, in garrison and in the field. He also directs the activities of the commandant's service (somewhat similar to US military police), encompassing traffic control and security patrols within garrison and CP sites and the division rear area. He enforces military discipline and operates the division's stockade. He may also be responsible for handling prisoners of war.

Brigade

The organs of control for an independent motorized rifle brigade closely resemble those for a division. This could facili-

tate the expansion of a brigade into a division.

Regiment

The regimental command and staff structure is similar to that at division level, but on a smaller scale. With approximately 35 officers and 50 soldiers, its capabilities are limited to those required for an organization focusing on the immediate tactical mission out to a depth of about 20 to 30 km. The regimental **principal staff** consists of a command group and the chiefs of branches of troops and services. The primary staff is similar to that at division level.

Commander

The regimental commander is usually a colonel (sometimes a lieutenant colonel). He is expected to maintain strict control over subordinate commanders; to inspect frequently the various training, administrative, and equipment maintenance aspects of his command in garrison; and to set a high personal example. In combat, he has considerable prerogatives in the way in which he organizes and executes his tactical mission. Most of his principal staff--the deputy commanders and chief of staff--are lieutenant colonels or majors. The commander draws a major part of his decision-making input from this group.

Chief of Staff

The chief of staff is usually a lieutenant colonel. He is the second-in-command of the regiment and is the only officer who may issue written orders in the commander's name. He is responsible for mobilization readiness and troop control. The chief of staff coordinates the work of the functional

staff groups and refines and presents staff products to the commander.

Command Group

The regimental command group consists of the commander, the first deputy commander, the chief of staff, and the deputy commanders for the rear, technical affairs, and armaments.

The **first deputy commander** is responsible for the regiment's combat readiness and mobilization, as well as maintenance of discipline and training. In combat, he can take charge of an independent element during battle. In the defense, for example, he can locate forward with the security zone fores. In the offense, he can follow the supporting attack or accompany the second echelon, combined arms reserve, antitank reserve, or forward detachment. He also is a key figure in battlefield reconstitution.

The **deputy commander for the rear**, normally a major or lieutenant colonel, is responsible for transport and for supplying regimental subunits both in garrison and in the field with ammunition, fuel, food, clothing, and equipment. During combat, he commands the rear CP.

The **deputy commander for technical affairs** is normally a major or lieutenant colonel and a graduate engineer. He is responsible to the commander for the serviceability and maintenance of the armored and automotive equipment in the regiment. He is the direct superior of the technical officers found in each subunit down to company level. During combat, he organizes the recovery, repair, or evacuation of disabled armored vehicles. Besides his other duties, the technical deputy is responsible for the mili-

tary and specialist training of all technical troops in the regiment.

The **deputy commander for armaments** has functions similar to those of his division-level counterpart. He is responsible for the technical condition, repair, and replacement of armaments and related equipment and instruments. His planning functions include participation in the development of rear service combat readiness and mobilization plans.

Chiefs of Branches of Troops and Services

At regimental level, the chain of special subordination established through the various chiefs of branches of troops and services continues to function. This subordination eases the workload of the commander and chief of staff and provides expertise in planning and coordinating the use of the branches of troops and services. The regimental chiefs, however, constitute only an ad hoc group to advise the commander on matters within their areas of expertise. They represent the same branches as at division level, with the addition of a chief of medical service.

Another small difference is that the chief of engineer service and chief of chemical service no longer have the designation "troops" in their titles. Unlike the situation at higher levels, these officers are the commanders of combat support and service support subunits that are organic or attached to the regiment. At this level, the competing requirements of effective command of their subunits, added to serving as advisors and staff officers to the regimental commander and chief of staff, places considerable stress on the chiefs of troops and services.

Battalion

The small size of the battalion staff reflects the OPFOR concept of battalion combat employment. Battalions execute battle drills and standard maneuvers as their basic form of tactical activity, adjusting to the combat situation by critical assessment of the time and place of employment. Such combat measures require discipline, timing, and rapid communications, but little in terms of the detailed planning for which large staffs are necessary. With increased OPFOR emphasis on combined arms tailoring at battalion level, the size of the battalion staff limits the battalion's ability to successfully integrate and coordinate an expanded combined arms team.

Battalion Commander

The battalion commander is normally a major or a captain. However, some battalion commanders may be lieutenant colonels. The commander is responsible for--

- The combat and mobilization readiness of the battalion.
- The combat training, education, discipline, political reliability, and morale of the battalion's personnel.
- The condition and security of weapons, combat and other equipment, ammunition, fuel, and other materiel of the battalion.
- The successful accomplishment of the battalion's missions.

Chief of Staff

The chief of staff is the commander's "right arm." Unlike his counterparts at regiment and division, he is the battalion commander's first deputy. Like the commander, he is normally a major or captain.

He has the authority to give orders to all subordinate elements, and he ensures compliance with orders from the battalion commander and higher commanders. The chief of staff draws up the combat and training plans for the battalion, based on the regimental plan and the battalion commander's guidance, ensuring they are carried out. He also makes sure subordinates prepare required reports and dispatch them on time to regimental headquarters.

Command Group

The OPFOR motorized rifle or tank battalion troop control system hinges on the battalion **command group**, which includes the battalion's five major personalities. These are the commander, the chief of staff, the **deputy commander**, the **deputy commander for the rear**, and the **deputy commander for armaments**.

The battalion deputy commander, unlike the deputy commander at regiment and division, is not the commander's first deputy. At battalion, this distinction falls to the battalion chief of staff. The deputy commander is responsible for the battalion's combat readiness, as well as discipline and training. In combat, he can take charge of an independent element during the battle. In the defense, for example, he can locate with the forward position. In the offense, he can accompany the second-echelon company or combined arms reserve. In a motorized rifle battalion, he can supervise the employment of the antitank platoon, automatic grenade launcher platoon, or mortar battery. The other two deputies perform logistics functions which mirror those of their counterparts at higher levels.

TROOP CONTROL PROCESS

Troop control is a continuous process at all levels of command. The OPFOR recognizes seven elements in this process:

- Acquiring and processing information.
- Decision making and planning.
- Disseminating missions and organizing coordination.
- Organizing and directing combat support.
- Preparing troops for combat.
- Organizing and maintaining control.
- Monitoring readiness and execution of missions.

For a more detailed discussion of all these elements, see *Heavy OPFOR Operational Art* handbook, Chapter 7. The following paragraphs concentrate on the key elements of decision making, mission dissemination, and monitoring execution, as they apply to the tactical level, with the focus on division.

The **commander's decision** is the basis for troop control. All other control activities either lead to, depend on, or support the commander's decision. In the OPFOR view, the decision is the result of the creative thought and will of the commander. It defines the objective of combat actions and the forces, resources, procedures, and times for achieving it. The decision must be detailed enough to establish the missions of subordinate forces, and to indicate the nature of coordination and support required to carry out those missions.

Since the conditions of modern warfare dictate quick decisions, the commander must use his staff effectively in his decision process. He usually focuses on the elements of the decision that he alone can develop, leaving other areas, like the organization of rear services or the communications struc-

ture, for his staff and deputies to formulate. The staff sorts out these decisions in detail and presents them to the commander for approval.

Timeliness and Quality

Regardless of the degree of staff involvement in decision making, the responsibility for the timeliness and quality of the decisions are the commander's. These two critical elements, timeliness and quality, underlie both the decision and the entire process of troop control.

The OPFOR employs formalized staff planning procedures using standardized formats in its combat documents. When time is available, as during preparations for a major offensive, the OPFOR follows a complete step-by-step process. During fast-moving combat actions, it may abbreviate all procedures.

Flexibility

The OPFOR has studied the troop control implications of the speed and intensity of modern warfare. Its assessment has had a significant impact on expanding the responsibilities of division commanders and staffs.

In the past, OPFOR division commanders were primarily responsible for coordinating their forces in the context of the operational-level plan, not for making a decision on their most effective use in combat. Operational troop control emphasized decision making and detailed planning of tactical activity. Tactical troop control emphasized using easily-implemented, quickly-executed schemes to carry out that plan. This system provided a high degree of predictability for the operational commander, enhancing his

control of the operation. With this system, victory depended on the ability to make correct operational employment decisions that assured rapid exploitation of tactical success to expand it to an operational scale. The division commander's role was to tailor the prescribed tactics to the terrain and specific enemy deployments in his zone of action.

OPFOR study of modern warfare, however, envisions a fluid battlefield, with more opportunity to maneuver. It also has the potential for sudden and severe changes to the combat environment. This image of modern warfare has led the OPFOR to conclude that it needs to supplement operational flexibility with more tactical flexibility. Since the division was the organizational level at which operational planning translated into tactical action, it was also the point chosen for expanding flexibility and responsiveness in the OPFOR troop control system. Developments in automated troop control have enabled a degree of decentralization of operational control to Division level.

Automation has the potential to provide a standard framework for decision making and planning. At the same time, these measures provide a common reference in the decision-making and planning process at operational and tactical levels. This gives the operational commander the confidence that a division commander can react quickly and well to a changing situation without receiving specific directives. This decentralization of decision making to the tactical level allows the division commander to meet the challenge of a changing enemy situation. In all cases, division decision making and planning must be within the context of missions and combat orders from army/army corps.

Division

Unlike a *front* or army/army corps commander, who concentrates on long-range planning, a division commander focuses on day-to-day combat activities. Since planned speeds of division combat action require quick development of the battle based on the division commander's initiative, he must remain aware of the situation and intentions of the army/army corps commander. There is probably only 2 to 4 hours of staff planning and command decision-making time between receipt of orders from the army/army corps commander and the start of division combat actions.

Decision-Making Process

Everything in the OPFOR system stems from the commander's decision. The decision-making process begins when the **commander receives a combat order or preliminary instructions (warning order)** from his senior commander. His first steps are to clarify the mission and assess the situation:

Clarification of mission. The commander must understand the senior commander's concept of battle and his own division's role in it. At this point he also makes a time assessment and, through his chief of staff, sets in motion any measures that are immediately required; this includes issuing preliminary instructions (warning orders) to subordinates.

The decision of the tactical commander at any level is driven by the operational or tactical guidance he receives from his direct superior. The tactical commander initiates the decision-making process according to that guidance, proceeding informally

through an evaluation and clarification of the situation.

Estimate of situation. The assessment is conducted in the sequence: enemy forces; own forces; flanking forces; terrain; NBC situation; weather and time of day. Each of these factors is considered as it impacts on the mission set by the higher commander.

The chief of staff organizes the staff to present information to the commander concerning the enemy, terrain, troops available, and weather. If time permits, the division commander makes a personal reconnaissance with staff members and subordinate commanders to better evaluate the situation. Given sufficient time, the staff prepares and coordinates written estimates for the commander. Otherwise, the staff provides oral input, from which the commander makes his estimate of the situation. The result of this estimation process should be a concept for the combat action of the division, which forms the essence of the commander's decision. The commander may have several variants of possible courses of action from which he must choose.

Determining and evaluating possible decision variants. The commander must consider the variants of enemy action in relation to his own, preparing responses during his assessment process. On the basis of the commander's guidance and estimate of the situation, the staff and subordinate commanders provide input to the operations section. When time is limited, the commander may require only specific information from the staff. The operations section prepares several possible courses of action for the commander's consideration, and the chief of staff indicates his preference. On the basis of the available data and the recommendations

from the staff, the commander makes a decision. The decision may be one of the recommended courses of action, a combination of two or more recommendations, or a new solution.

Selecting a variant and formulating the decision. Having clarified his mission, assessed the situation, and evaluated decision variants, the commander makes his decision and marks it on his map.

Decision Formulation

The decision-making process is complete when the commander has selected the optimal variant and formulated his decision in enough detail to report it to his higher commander. Simultaneously, the commander provides it to his staff for further planning and for dissemination of the finalized missions to the troops. The decision includes the concept, organization for combat, axes of advance, missions for major subordinates, and measures for support and troop control. Figure 2-3 illustrates the content of the commander's decision. The components of the decision are the following:

Concept of battle. The commander specifies which enemy groupings are to be destroyed, with what resources, and in what order. He identifies the axes for main and supporting attacks, as well as defensive sectors. He outlines the organization for combat (combat formation) and the general scheme of maneuver.

Tactical missions. The commander determines the tactical missions to be assigned to organic and reinforcing units and subunits. This part of the decision defines the roles of maneuver and combat support units/subunits within the combat formation.

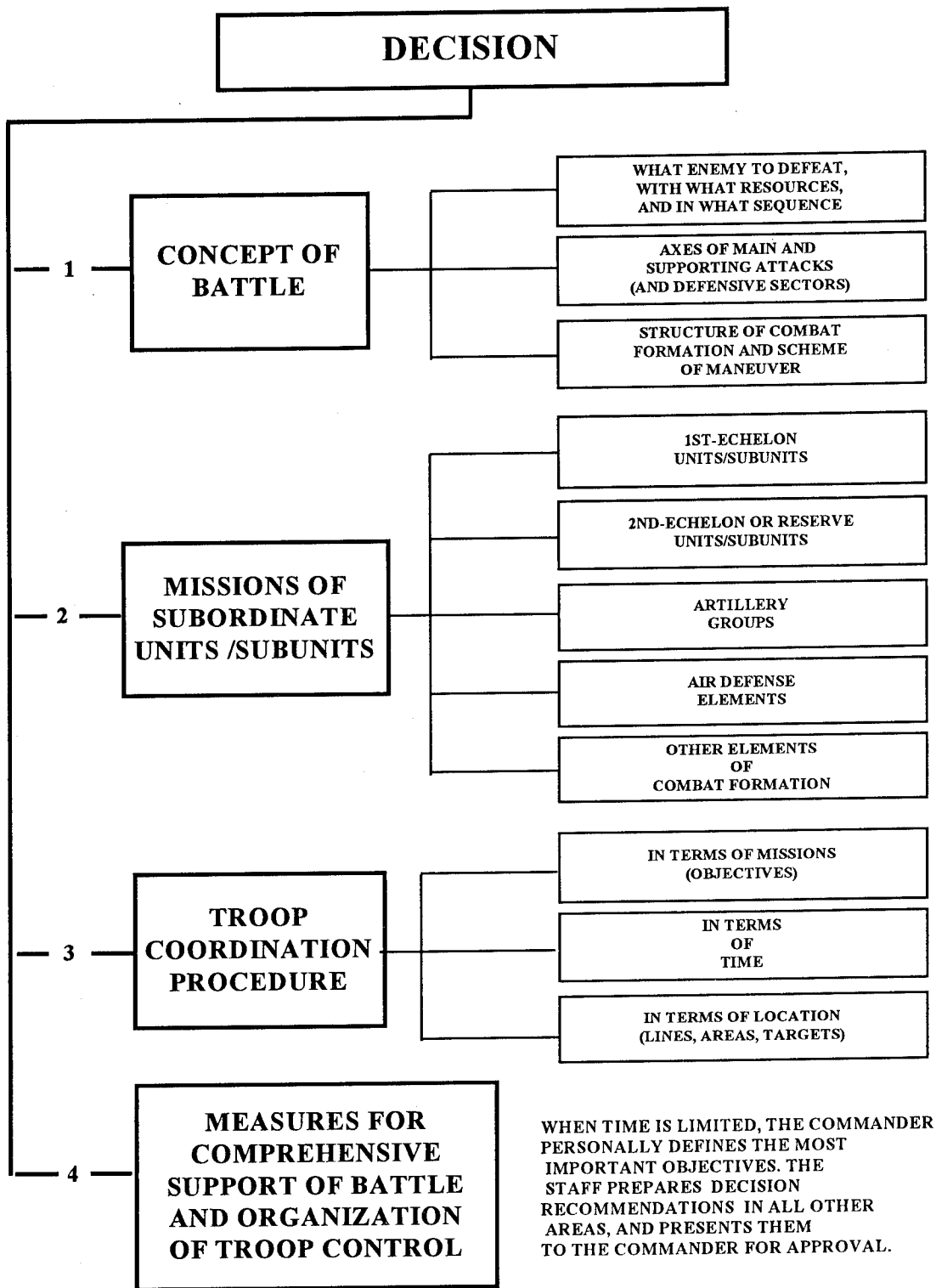

Figure 2-3. Content of the commander's decision.

Coordination. The commander indicates missions (objectives), phase lines, targets, and timings that are necessary to execute the battle concept.

Organization of support and troop control. Often these questions are left to the chief of staff. When time is limited, the commander confines himself to defining the most important objectives, leaving everything else to the staff, who produce their plans for the commander's approval.

Implementing the Decision

The decision must first be reported to the senior commander for his approval. Once this has occurred, the decision is passed to subordinates, and the chief of staff translates it into detailed plans and instructions. Up to this point, the commander has been working primarily from his map. If time permits, the decision is now refined on the ground. The commander may attend the senior commander's ground reconnaissance and conduct his own reconnaissance with his subordinate commanders.

In the OPFOR view, to conduct ground reconnaissance before making a decision would be wasting valuable time that the staff needs to implement the plan. The commander may modify his decision as a result of the ground reconnaissance and give verbal orders for this modification. The commander supervises the preparations of his subordinates, either personally or through his deputy commanders or chief of staff, issuing combat orders and instructions. At the appointed time, he reports his units' readiness to the senior commander.

Combat order. Time constraints necessitate heavy dependence on verbal dissemination of missions and planning guid-

ance. The division commander usually issues a formal, written order to supplement the verbal instructions he has already issued. It is also normal for division (and regiment) commanders to disseminate the contents of the final combat order orally to units and subunits.

The commander announces his final decision in the presence of the chief of staff, the chief of the operations section, and, when possible, other key personnel such as the coordinating staff, the chiefs of branches of troops and services, and the deputy and subordinate commanders. The operations section then publishes a formal document as a written record of the decision and produces the order. Combat orders of all tactical maneuver units follow a generally standard eight-paragraph format, regardless of how they are transmitted. (See Figure 2-4.)

The staff may also prepare and issue annexes to combat orders. If annexes are incomplete when the staff transmits the order, it sends them out separately to prevent delay in dissemination of the order. Types of annexes include coordination requirements, intelligence, security, signal, artillery, engineer, movement order, and counterattack plans.

The deputy commander for the rear and his staff write a separate order for logistics, subject to approval by the division commander. The order organizes the rear area, routes of movement for rear elements, supply routes, supply points, sequence and time of resupply, rear area security, and the location of the rear CP. It also designates general deployment areas to units located in the rear area.

Combat instructions. Tactical commanders at all levels issue combat in-

TRADITIONAL FORMAT	MODIFIED FORMAT
<ol style="list-style-type: none"> 1. Enemy Situation: a concise statement of the enemy forces and their disposition, as that information relates to the mission of the issuing unit. 2. Mission: a statement of the mission assigned to the issuing unit by its superior headquarters. 3. Missions of Higher and Adjacent Units: a description of the missions of higher and adjacent units, and their impacts on the mission of the issuing unit; includes coordination procedures for nonorganic/attached units. 4. Concept of Combat Action: a discussion of the commander's decision for fulfilling the mission of paragraph 2; includes the concept of maneuver and fire support. 5. "I Order...": establishes the combat missions of subordinate elements, normally in order of: first echelon, second echelon, artillery, air defense, and reserves. 6. Preparation Times: establishes the times by which individual subunits must be prepared for combat. 7. Control Coordination: provides special instructions for coordination of combat actions by subunits. 8. Command Continuity: indicates which of the subordinate officers is designated to assume control if the commander is incapacitated. 	<ol style="list-style-type: none"> 1. Enemy Situation: a concise statement of the enemy forces and their disposition, as that information relates to the mission of the issuing unit. 2. Mission: a statement of the mission assigned to the issuing unit by its superior headquarters. 3. Missions of Higher and Adjacent Units: a description of the missions of higher and adjacent units, and their impacts on the mission of the issuing unit; includes coordination procedures for nonorganic/attached units. 4. Concept of Combat Action: a discussion of the commander's decision for fulfilling the mission of paragraph 2; includes the concept of maneuver and fire support. 5. "I Order...": establishes the combat missions of subordinate elements, normally in order of: first echelon, second echelon, artillery, air defense, and reserves. 6. Expenditure Norms: provides the consumption norms for ammunition and fuel to be used during the combat action. 7. Preparation Times: establishes the times by which individual subunits must be prepared for combat. 8. Troop Control: contains all troop control-related information.

Figure 2-4. Format for a combat order.

structions during combat and the preparation for combat. Their purpose is to units or subunits to perform a specific task, or to adjust a mission previously assigned. Combat instructions are usually in a four-paragraph format and as brief as possible. The four-paragraph structure includes an estimate of the enemy situation, the new or revised mission, the support available from the commander for this mission, and a time by which the receiving unit must be ready to execute the task. Because they are time-sensitive, combat instructions are disseminated verbally.

Monitoring Execution

Issuing orders does not ensure they will be carried out or understood. The OPFOR places great emphasis on supervi-

sion after the order is issued. The chief of staff is responsible to the commander for the overall organization of staff supervision. Each staff section is responsible for checking on the execution of the orders it prepares and also ensuring that subordinates have correctly understood the orders. The chief of staff may issue additional orders, with the division commander's approval, to resolve any misunderstandings.

Proper supervisory control takes many forms. These include observation from air and ground observation points, and instructions and questions passed by radio or messenger. The best method, according to the OPFOR, is personal contact. The division commander may personally supervise the most important sector of a combat action. In fast-moving situations, control is

somewhat looser. Subordinate commanders then react as the situation dictates, realizing they are responsible for acting in accordance with the commander's concept.

Brigade

The troop control process for an independent motorized rifle brigade is basically the same as for the division. As at division level, the brigade commander receives his mission from the army/army corps commander to whom he is subordinate, and his own decision flows from that higher commander's operational concept. The main difference is that the brigade commander has only battalions, rather than regiments, to carry out his mission.

Regiment

After receiving a mission from the division commander, the regimental commander, assisted by his staff, makes an estimate of the situation. As soon as possible, the commander and staff send preliminary instructions to subunits. They also disseminate intelligence on the enemy and information on friendly units at this time. After weighing all factors and examining possible courses of action, the commander makes his decision.

Frequently, he marks details on a map, from which the staff formulates written combat orders. If time and the tactical situation allow, commanders prefer to issue orders at a meeting with subordinate commanders. If rapid deployment is necessary, the commander gives orders by radio and then has the supplementing schematics delivered to the subordinate commanders. The written and graphic combat order, sometimes finalized after verbal transmission to subordinates, provides an official record of the

commander's decision. The regimental commander may issue combat instructions over the radio to change, supplement, or elaborate on initial combat orders as the tactical situation changes.

Battalion

OPFOR motorized rifle and tank battalions, although still organically "pure" subunits, most often fight as small combined arms organizations, integrating the combat use of tank, motorized rifle, artillery, and air defense assets as organized by the parent regiment. In combat, maneuver battalions often have to fulfill several different missions in a single day. For example, a battalion may find itself conducting a meeting battle, switching to a temporary defense to support the success of an adjacent attack, and then disengaging from the enemy to prepare for further offensive action, in the course of a day's combat.

Since battalion-level combat is dynamic and frequently changing, there is no requirement for a written order. The commander's map is often the battalion's sole planning document.

COMMAND AND CONTROL POSTS

OPFOR tactical commanders organize a series of **command posts** and **control posts** (both abbreviated **CP**) to provide firm and continuous troop control. The number of these posts and their size decrease from division down to battalion level. Figure 2-5 shows the basic types of CPs employed at the tactical level.

From divisional level down, OPFOR CPs are generally smaller than the equivalent U.S. headquarters. In part, this is because

Formation	COP	Main CP	Alt CP	Fwd CP	Rear CP	Abn CP
Platoon	X					
Company	X					
Battalion	X					
Regiment		X		X	X	
Brigade		X		X	X	
Division		X	(X) ¹	X	X	X
Footnotes:						
¹ Does not normally exist in offensive operations.						

Figure 2-5. OPFOR command/control post system.

the logistics responsibilities of OPFOR CPs are handled differently than their US counterparts. It is also a consequence of the troop control system outlined above and the requirement for a trim, mobile CP to keep pace with maneuver units on a fast-moving battlefield. The structure and deployment of OPFOR CPs are geared to mobile offensive operations.

Division

OPFOR division commanders control their subordinates through a system of CPs. These posts are connected by redundant communications links over different paths operating with different transmission modes. Physically, these posts may be fixed survivable bunkers, temporary buildings or tents, command vehicles, groupings of trucks and vans, or a combination of these. Specially equipped helicopters provide the division commander with an airborne extension of his main CP. CPs on the ground are well dispersed and camouflaged. Figure 2-6 illustrates deployment of the division and regimental command posts.

Forward Command Post

During offensive combat actions, the division commander moves forward to a position where he can best influence operations. This forward CP is mobile, consisting of one or more armored command vehicles. It normally moves 2 to 5 km behind the forward edge of friendly troops, with a first-echelon regiment on the main axis. The commander has with him the operations officer, and the chief of artillery. He may select other chiefs of troops and services, depending on the needs of the situation.

Main Command Post

The division's main CP is the focus of control. The main CP is mobile, but is much larger than the forward CP. The chief of staff runs the main CP, and directs the division staff in translating the commander's decision into plans and orders. He also coordinates the movement and deployment of all subordinate groupings and monitors their progress and combat readiness including supply status. The main CP moves 10 to 20

Command Post	Distance from Forward Edge (km)	Number of Vehicles	Deployment Area (km ²)	Remarks
Div Fwd	2-5	About 10	Approx. 0.2	Moves constantly with first-echelon unit on main axis.
Div Main	10-20	About 70	Up to 10	Usually deploys between first and second echelons and moves up to 2-3 times daily.
Div Alt	10-20	About 3	Up to 0.8	Same as main CP. Often not formed in the offense.
Div Rear	30-40	About 16	Up to 5	Deploys with logistics elements and moves up to 2-3 times daily.
Regt Fwd	2-5	About 4	Approx. 0.1	Moves constantly with first-echelon subunit on main axis.
Regt Main	5-8	About 17	0.4	Usually deploys between first and second echelons. Moves in bounds.
Regt Rear	10-15	About 10	0.2	Deploys with logistics elements.

Notes:

1. Figures are yardsticks only. The distance of a CP from the forward edge and the frequency of its moves depend on the tempo of combat and enemy capabilities.
2. Within CPs, dispersion is practiced to reduce vulnerability. Communications centers are removed several km away to lessen the chance of enemy direction-finding activity leading to location of CP itself. CPs are sited so that no single tactical nuclear weapon could eliminate more than one.
3. Protection of CPs by air defense troops is a high priority, and engineer support is usually available to dig in and help camouflage key elements. Ideally, they are sited near second echelon/reserves to gain protection from ground or airborne attack.

Figure 2-6. Deployment of division and regimental CPs in the offense.

km behind the forward edge. Although it is entirely mobile, it makes use of dugouts, trenches, and buildings when possible.

Rear Control Post

During offensive actions, the division rear area would probably move two to three times a day. The deputy commander for the rear heads the rear CP and supervises the

division rear movement. This post usually deploys 25 to 40 km behind the forward edge and supervises logistics support of the division. It contains staff officers for the following services: fuel supply, medical, combat equipment repair, ammunition supply, clothing supply, food supply, prisoner-of-war, and others. It also includes the deputy commander for armaments. It interacts closely with the regiments to ensure sustained combat capabilities.

Alternate Command Post

Divisions do not always deploy this type of CP. The use of a forward CP eliminates the need for it during offensive actions. In a static situation, or in the defense, a division may establish an alternate CP to take command if the main CP is destroyed or disabled. Alternate CPs are also formed when operating in rough terrain, or if the division is dispersed over a wider area than usual and lateral communication is difficult. When formed, the alternate CP is run by the division first deputy commander.

Airborne Command Post

When operations become very fluid and spread over a wide area, or to maintain control when other CPs are displacing, a division may employ an airborne CP. Although higher-level commands may use fixed-wing aircraft, the airborne CP at division level is normally on a command post variant of the HIP medium helicopter.

Brigade

Brigades employ the same basic types of CPs as divisions. The exception is that they would not have an alternate CP or an airborne CP.

Regiment

The CP structure of OPFOR maneuver regiments is more austere than at division and higher. The regiment deploys two such posts: a main CP and a rear control post. Because of their proximity to the enemy and the high tempo of offensive combat, these posts can move as required by tactical conditions, up to 4 to 6 times in a 24-hour period.

Main Command Post

The main CP consists of several armored vehicles, including the commander's vehicle. In addition to the commander, it holds the chief of staff and the commanders of the regimental engineer and chemical protection subunits. The main CP moves in tactical bounds behind the forward edge of friendly troops. When in position, the CP is dispersed and camouflaged.

Forward Command Post

The regimental forward CP normally includes the regimental commander, the regimental artillery group commander, the forward air controller, the chief of reconnaissance, and the chief of operations. The normal grouping for this is likely to provide a three- or four-vehicle field signature similar to a battalion command observation post.

Rear Control Post

The rear CP consists of one or two vehicles. The deputy commander for the rear is responsible for organizing administrative and logistics support of the regiment and its subunits from this control post. This includes the receipt and issue of fuel, ammunition, food, and minor equipment. The rear CP also maintains staff control of vehicle and manpower replacements; maintenance, repair, and recovery of vehicles; medical services; and personnel services. An officer from the organic artillery battalion is in the rear CP for the purpose of coordinating ammunition supply for the artillery. During combat, the rear CP operates at least 10 to 15 km behind the forward edge. It is capable of taking temporary control of the regiment if the main CP is destroyed.

Battalion

At battalion level, the OPFOR uses only a single command location, the **command observation post (COP)**. The battalion commander and his small staff operate from three or four armored command vehicles in motorized rifle battalions. In tank battalions, the group of armored vehicles may include a command tank. An organic signal platoon provides the COP with communications support. The commanders of reinforcing subunits, especially artillery, are colocated with the COP of the battalion or company they are supporting.

COMMUNICATIONS

The organization of communications to meet tactical requirements is the responsibility of the commander at each tactical level. Prior to combat, the division chief of signal troops develops a signal plan. After approval by the division chief of staff, it becomes an annex to the division combat order for implementation by subordinate signal units. OPFOR communications reflect the concern of commanders to maintain uninterrupted troop control, flexibility, and security.

Electronic Means

Radio is the primary means of communication within OPFOR divisions. An integrated tactical radio system consists of lightweight manpack sets, vehicle-mounted radios, and transportable radio-relay systems. In defensive situations, a variety of cable-laying devices and switchboards are available to establish wire communications. Wire lines are also used extensively in assembly areas and along march routes.

Non-Electronic Means

While radio must, inevitably, be the principal means of communication in a fluid, mobile battle, the OPFOR is aware of the threat of enemy radio intercept/direction finding and communications jamming. In fast-moving tactical situations, the use of wire is often not practical either. Therefore, the OPFOR stresses the use of alternative means of communication.

During periods of radio silence or disruption of radio communications, the OPFOR employs messengers, liaison officers, and visual and sound signals. Messengers are the preferred method for delivering combat orders. Command liaison officers from the division staff may observe and supervise the execution of combat orders. Whenever possible, the OPFOR prefers personal contact between commanders or their representatives and subordinates. Subunits use visual and sound signals to pass simple messages and instructions.

Division

Both motorized rifle and tank divisions have signal units and communications equipment to provide redundant links between levels of command. They are capable of operating with alternate modes of communication under all conditions. The primary types of communications equipment are--

- High-frequency (HF) and very-high-frequency (VHF) radios.
- VHF and ultra-high-frequency (UHF) multichannel radio relay.
- Super-high-frequency (SHF) troposcatter systems.
- Wire or cable.

It is possible to extend mobile communications through radio and wire integration and

by interconnection with fixed military and civil communications facilities.

Nets

Normal radio nets in the division include command, staff, coordination, warning, and special-purpose nets. Division commanders also may establish other nets as required, when the necessary equipment is available.

Command. The command nets link the division commander, chief of staff, and alternate command post with regimental commanders and major support units. This net is duplicated when a forward CP is formed. The division commander can contact battalion commanders directly when emergency conditions dictate. This skip-echelon working enables the commander to exercise direct control over key subordinate groupings. These links may also be used to maintain control if an intermediate headquarters is put out of action.

Staff. The staff net provides the chief of staff communications with staff elements of the reconnaissance and REC battalion and the motorized rifle and tank regiments. Other principal staff officers, notably the chiefs of artillery, reconnaissance, air defense, chemical protection, and the rear, use their own dedicated nets to ensure the uninterrupted flow of information and orders. These also provide backup nets if the command net is interrupted or overloaded.

Coordination. The coordination nets link the division main CP with the division rear, with the division's second-echelon/reserve units/subunits, and with adjacent formations. They can also link the division with any groupings performing special missions in the division's area of re-

sponsibility, such as airborne, heliborne or amphibious landings, or an army-level forward detachment or operational maneuver group. The motorized rifle, tank regiments, and fire support units all monitor these nets.

Warning. The warning net consists of radio receivers set on a designated warning frequency throughout the division. This net is for tactical alert and air and NBC warnings.

Special-purpose. The special-purpose nets employ radiotelegraph and radio-relay equipment to communicate with units executing special missions (such as the division's forward detachment) and with airborne units behind enemy lines.

Procedures

Before making contact with the enemy, most radio and radio-relay systems, maintain a listening watch with transmission forbidden or strictly controlled. OPFOR units usually observe radio silence when defending or departing assembly areas. During radio silence, wire and courier are the primary communications means. While moving toward the enemy, units normally limit radio transmissions to various code words informing commanders they have accomplished assigned tasks or have encountered unexpected difficulties. The OPFOR also uses visual signals, such as flags and flares, to a great extent during movement. Usually only the commander and reconnaissance elements have permission to transmit.

In the offense, OPFOR units maintain radio silence until the outbreak of battle, when those authorized to transmit may do so without restriction. In an attack against a defending enemy, the OPFOR considers the battle to have begun with the artillery prepa-

ration. In the meeting battle, they lift radio silence when any element of the advancing OPFOR force, other than the combat reconnaissance patrol, makes contact with the enemy. When contact with the enemy occurs, units reinitiate normal radio procedures. Subordinate commanders inform the division commander--usually by code word when they reach phase lines, encounter NBC contamination, make contact with the enemy, or have important information to report.

The only authorized use of radio messages in the clear is for transmission of combat orders to elements already in contact, for small maneuver forces requesting artillery fire adjustment, or for damage reports to supporting aviation. Even in these instances, they transmit the identifying numbers of units, names of units, and major assignments of unit commanders in code.

Regiment

The motorized rifle and tank regiments use four types of communications systems to maintain troop control. These are radio, telephone, messenger, and audio and visual signals. The regiment organizes radio-relay stations for subunits on independent missions or those located a long distance from headquarters.

Nets

An OPFOR regiment uses a wide variety of radio nets. The **command net** usually operates on VHF, with an alternate net maintained on HF. Maneuver, combat support, and attached combat subunits are on the command net, though maneuver companies normally maintain a listening watch. The rear CP controls service support subunits on an **administrative net**. Regimental headquarters and maneuver subunit

headquarters have receivers operating on the NBC and air **warning net**. A **staff net** operates direct links between the regimental commander, the regimental headquarters, the reconnaissance company, the air defense battery/battalion, and the MRR's antitank battery/battalion.

Procedures

The regimental chief of communications is responsible for the production of communication plans and instructions for specific combat actions. He issues each battalion a block of frequencies and callsigns. The regimental headquarters has responsibility for establishing communications with subordinate, attached, and supporting subunits. The practice is to establish communications from left to right between lateral subunits of equal size. When loss of communications occurs during combat, all subunits out of contact attempt to reestablish them. It is standard procedure to provide communications from regimental headquarters to company level; allowing for continuance of combat action if the intervening (battalion) commander becomes a casualty.

Battalion

The battalion's organic signal platoon collocates with the battalion COP, providing additional HF radio capability along with wire and messenger service. Radio is the most important means of control available to the OPFOR battalion commander. The OPFOR insists that only the speed and flexibility of radio communications meet the demands for troop control in modern combined arms combat. It also stresses the importance of being able to employ other means of control to supplement or, if necessary, to replace radio communications. The

OPFOR trains extensively in the use of audio and visual signals and pyrotechnics.

Nets

In the battalion command group, both the commander and the chief of staff operate on the **regimental command nets** (both the VHF net and the backup HF net). The chief of staff has primary responsibility for maintaining these battalion stations in the two regimental nets. This leaves the battalion commander free to use both his time and his radios to control the battalion. The battalion commander also operates the net control station on his own VHF **battalion command net**, in which his chief of staff and organic company commanders operate.

The battalion chief of staff operates the net control station on the **battalion command and coordination net**. (The commander normally talks "down" to his subordinated, while the chief of staff normally talks "up," reporting to higher headquarters.) If companies are operating their own VHF command nets, the battalion commander is capable of communicating directly with any subordinate company's platoons or squads by turning to that company's net. Besides the commander, his chief of staff, and his organic companies, the battalion command and coordination net includes the deputy commander for technical affairs, the commanders of any reinforcing maneuver or fire support subunits, and the combat reconnaissance patrol. Organic support elements also operate stations in the battalion command and coordination net, but normally do not transmit unless called.

The deputy commander for technical affairs uses a second radio to control the **battalion technical support net**. Battalion repair and recovery elements monitor this

net, and disabled combat vehicles may tune to the net to request assistance.

Finally, the chief of staff maintains the only battalion station in the higher headquarters NBC and air **warning net**. He re-transmits any warning messages on the battalion command and coordination net.

Procedures

The battalion commander directs the combat actions of his subunit from his command vehicle located near his companies. In the defense, the battalion relies primarily on wire and telephone communications, but also makes extensive use of messengers, signal flares, and radios. Before contact with the enemy, there is radio silence, except for brief transmissions concerning reconnaissance reports and the crossing of phase lines. In an attack, the commander controls his battalion primarily by radio, although he also uses messengers, personal contact, signal flares, signal flags, and other means.

Below regiment level, the OPFOR does not employ significant quantities of secure-voice equipment. Therefore, from regiment to platoon level, it is routine to transmit commands by radio in clear text during combat. However, OPFOR radio operating procedures require the use of code names and callsigns in the interests of security.

During the ground reconnaissance phase of preparation for combat, the battalion commander and his signal platoon commander disseminate most information orally. At that time, the battalion commander assigns code names to major terrain features. This local encoding process is usually supplemented by an encoded map reference grid system. Pyrotechnic tables and brevity codes

are also generated locally, although some code assignments may come from higher headquarters. The battalion signal platoon commander issues station callsigns as part of the communications operating instructions. At that time, the battalion officers record on their maps the assigned code names, frequencies, callsigns, and perhaps even a simple radio net diagram.

Below Battalion

The battalion is the primary element for execution of maneuver. Consistent with that concept, the OPFOR centralizes control of radio communications at battalion level. In combat, the battalion commander attempts to maintain a position from which he can observe and direct the actions of all his companies. Requests for fire support almost always involve coordination at battalion level. The supporting artillery commander collocates with the maneuver battalion commander.

When individual motorized rifle or tank companies operate with their parent battalion, all of the battalion's combat vehicles may monitor the battalion command net and receive orders from the battalion commander. When tank companies reinforce a motorized rifle battalion (or vice versa), the company commander can monitor that battalion's command and coordination net and pass orders to his platoons on his own company command net.

Company commanders also have the authority to transmit on the battalion nets. They have the authority to call for supporting fire in combat, but such calls for fire must go through the battalion commander. While OPFOR tactical communications practices seem restrictive, they are adequate for the company commander's control authority; the fire control of his tanks, BTRs, or BMPs, and the deployment of his company in battle drills.

Chapter 3

March

The OPFOR march represents the organized column movement of troops along roads and cross-country routes to a designated area or line. The growth of combat equipment maneuver capabilities has given rise to an increase in the employment of the march. The need to make a march in varying situations make it the most common method of OPFOR unit and subunit movement. A formation, unit, or subunit may **conduct a march when:**

- Moving from a rear assembly area to a forward assembly area or attack position.
- Leaving an assembly area to launch an attack from the march.
- Moving forward in anticipation of a meeting battle.
- Conducting a pursuit.
- Conducting a passage of lines.
- Transferring laterally to a new area or large formation.

The OPFOR accomplishes rapid column movement in march formation, followed by deployment into prebattle and battle formation. Commanders ensure their troops are ready to perform a march with minimum warning and preparation. Formations, units, and subunits frequently rehearse the march, with commanders strictly controlling its conduct. Standard OPFOR battle drills include deployment from march column into prebattle and battle formation. These formations and drills allow a rapid transition into combat while maintaining maximum **security, speed, and firepower.**

TYPES OF MARCH

The OPFOR has two main types of marches -- **administrative** and **tactical**. The type of march employed depends on the probability of contact with the enemy. In the first case, when contact with the enemy is not likely, administrative marches dominate, although tactical considerations are never totally excluded. The risks of air or missile attacks and the possibility of enemy forces operating in the OPFOR rear are always present. Even administrative marches must be organized to allow a smooth and rapid transition to tactical march formations.

The second type of OPFOR march is the tactical march. Tactical marches are employed when contact with enemy ground forces is likely. They are organized to ensure the march formation is ready to enter battle with little notice.

Administrative Marches

Strategic Movement

Out of enemy contact, the OPFOR makes considerable use of rail, sea and air links to move troops and equipment. This type of movement preserves the marching capabilities of formations by minimizing fuel consumption and maintenance requirements. Heavy equipment transports may also be used when road movement is essential. By minimizing wear and tear on vehicles before an operation begins and by carefully planning routine maintenance during administrative road marches, the OPFOR hopes to limit the

fall-out rate to no more than one to two percent of vehicles per day.

March Planning

Administrative marches are planned on the map, using standard norms and staff tables. Routes are chosen to provide the best possible protection from enemy reconnaissance and possible enemy fire. The OPFOR attempts to conduct administrative marches at night or in periods of limited visibility whenever possible. The route is divided into sectors according to the type of terrain and allowable speed. Regular periods of rest allow for routine maintenance, refueling, feeding and sleep.

March Routes

Two or three routes are considered sufficient for a division on an administrative march, while a regiment moves on one or two routes. An alternative route is planned for each, in the event the primary route becomes unusable. Lateral routes are chosen to permit maneuver from one road to another. The OPFOR does not limit roads to those with hard surfaces -- secondary gravel or country dirt tracks will suffice.

March Formations

In an administrative march, columns are organized primarily for convenience. Vehicles of similar type, speed, and cross-country capability are kept together rather than being tactically grouped. Tracked and wheeled vehicles may use different routes. The deployment of certain subunits is determined primarily by tactical considerations, even on an administrative march.

Security Elements

Some form of march security is always deployed, even on administrative marches. In the deep rear, these elements may be patrols but they will increase in number and strength as the formation approaches its line of commitment. Security patrols and outposts are deployed around rest and assembly areas.

Air Defense

During an administrative march, primary responsibility for air defense lies with the higher formation whose rear area the tactical formation is marching through. The higher formation's air defense assets provide early warning and engage enemy aircraft at long range. Air defense subunits deploy throughout the tactical formation's march columns, or prepositioned along the route. They operate under radio silence until the formation is threatened. Priority in deployment of air defense assets is normally given to headquarters, missile and artillery units, and the first echelon. Actual priorities can vary, depending on the enemy threat and the mission. The higher formation also concentrates resources to cover obstacle crossings and other choke points.

Combat & Service Support

The OPFOR deploys engineer reconnaissance, route clearing, and obstacle crossing units throughout march columns. The primary responsibility for maintaining routes still lies with the higher formation's headquarters. Chemical reconnaissance and protection assets are also tactically deployed within columns, in case of enemy strikes during the march. Higher formation headquarters are responsible for

maintaining, refueling and feeding units marching in their rear areas. This ensures units on the march are committed into battle at full strength with their basic combat loads intact.

Deployment of Command Posts

Columns within regiments and battalions are led by command posts (CP). Within formations, one CP must always be deployed. The preferred OPFOR option is for the main CP to move simultaneously with the troops, in the first echelon, while march control is exercised from the forward CP situated in the next daily rest area. When the main formation moves into the rest area the forward CP moves on to the next one.

Traffic Control

The commandant's service exercises traffic control on both administrative and tactical road marches. The march route is divided into 50 to 80 km sectors, each being the responsibility of a subunit. Traffic control posts are established at all obstacle crossings, defiles, and population centers.

Communications

OPFOR march **communications security** is very tight. During marches, radios operate in the receive-only mode. Radio silence is only broken for air and chemical warnings. Within subunits, march control is by verbal orders and visual signals. Communication between headquarters is by mobile means, such as liaison vehicles and, at higher levels, helicopters.

Tactical Marches

The OPFOR conducts **tactical**

marches when contact with enemy ground forces is possible. Tactical marches begin in an assembly area where formations and units reorganize themselves from the order in which they completed the administrative march. In the assembly area, units carry out final maintenance and logistic checks. The new march order is determined by the mission, terrain through which they must march, and the nature of the enemy threat. The formation must permit a smooth and rapid deployment into battle in accordance with the commander's plan and must include sufficient security to prevent the enemy from disrupting that deployment.

Commander's Estimate

Having received an order to conduct a march, the OPFOR commander issues preliminary instructions (warning orders) to his subordinate commanders. He then makes an estimate of the situation. The **commander's estimate** includes the following information:

- Mission of the march.
- Time available.
- Locations of possible or anticipated enemy contact.
- Enemy strength and disposition.
- Disposition of friendly forces and missions of adjacent units.
- Attachments and supporting units.
- Terrain, weather, and light data.
- Possible march routes.
- NBC conditions.
- Control measures.
- Reconnaissance and security.

On the basis of his estimate, the commander selects and assigns routes, if not already specified by his senior commander. The commander's estimate also influences dispersion, rate of march, and order of march of units and subunits.

March Planning Factors

The commander and his staff conduct march planning in as much detail as time and information will permit. If possible, the commander orders a **route reconnaissance** to:

- determine route conditions.
- locate contaminated areas, choke points, or obstacles.
- determine requirements for engineer or decontamination support.

Route Allocation

The OPFOR applies the following **norms** to march routes:

- A division receives either a march zone or two to three march routes.
- A regiment normally receives one or two march routes.
- A battalion receives one march route.

A division normally has a zone of advance 15 to 30 km wide for a tactical march. Within that zone, it advances on three routes, with an alternate route allocated for each one. In normal terrain, regiments advance on one route until beginning their deployment into battle. A division's march columns are 80-100 km deep from the lead march security elements to the tail. A first-echelon regiment requires over 40 km of road space; a second-echelon regiment, with less march security deployed, needs 20-30 km.

Dispersion

March formations must maintain dispersion laterally and in depth. This dispersion is critical under nuclear or chemical conditions or when the enemy has high-precision weapons or the capability of

achieving local air superiority. A division normally marches on two to three routes. Each route is separated by 3 to 4 kms. The commander balances the requirement for dispersion in depth with that for timely commitment of his forces in case of enemy contact. Figure 3-1 shows typical OPFOR tactical march intervals. The **depth of a march formation** depends on three factors:

- The intervals between units, subunits, and vehicles in each column.
- The number of march routes.
- The organization of the forces on each route.

Rate of March

The terrain, weather, and combat situation determine the march rate. Wheeled vehicles move faster than tanks or mixed columns. Wheeled vehicles can attain average traveling speeds of 40 kilometers per hour or more, day or night, on roads. This average speed drops to about twenty kilometers per hour under less favorable conditions. Tanks and mixed columns average traveling speeds of 25 to 30 kilometers per hour, day or night, on most roads. Columns making contact with the enemy may move at maximum speeds. Figure 3-2 illustrates movement rates of march columns on different surfaces.

March capabilities

March capabilities are understood to mean the capability of subunits to move from one area to another in vehicles or dismounted. Average rate of movement and length of a day's march are the principal indicators of subunit march capabilities.

ELEMENTS INVOLVED	NORMAL INTERVALS	VARIATIONS
Vehicles in a company	25-50 m	Increased at high speeds, in contaminated or rugged terrain, or on icy roads. May decrease at night, or increase (to 100-150 m) when threatened by air or high-precision weapons.
Companies in a battalion	25-50 m	Up to 300 m or more under threat from nuclear, aviation, or high-precision weapons.
Battalions on the same route	3-5 km	Can vary as contact becomes imminent.
Regiments on the same route	5-10 km	
Regimental rear services and main force	3-5 km	
Division rear services and main force	15-20 km	

Figure 3-1. Typical OPFOR tactical march intervals.

Column Types	Paved Roads		Dry, Dirt Roads		Muddy, Hilly, Urban Roads	
	Day	Night	Day	Night	Day	Night
Motorized	30 to 40	25 to 30	20 to 25	18 to 20	10 to 15	8 to 10
Mixed	20 to 30	14 to 20	15 to 20	12 to 15	10 to 12	8 to 12

Figure 3-2. Average rates of march (km per hour).

Average rate of movement

Average rate of movement is the primary indicator of march capabilities. It is defined as the ratio of the entire route covered (or planned) to overall movement time, not counting time for halts:

Average rate of movement on the march is not a constant value. It depends on the mission to be performed, personnel march proficiency, the commander's ability to lead columns, mechanical condition of vehicles, condition of route and weather, and

organization and support of the march. The established average rate of movement on the march should be maintained for the entire march.

Length of A Day's March

The length of a day's march is the distance along the movement route from the start point to the farthest point of the designated area (line) to be covered by units in 24 hours. Route length is measured from a map. The amount of a day's march depends

Column Types	Paved Roads	Dry, Dirt Roads	Muddy, Hilly, Urban Roads
Motorized	250-350	180-300	80-180
Mixed	200-350	120-240	80-140

Figure 3-3. Daily march distances (km).

on average rate of movement and quality of the march. Figure 3-3 gives average daily preparation of combat and other vehicles for The march. Figure 3-3 gives average daily march performance data for motorized and mixed columns.

Order of March

The order elements within a march column depends on the combat situation and on the expectation of enemy contact. In any march, the commander locates combat and support elements within the column to ensure efficient transition into combat. He establishes the column organization before starting the march to minimize or preclude any reorganizing before commitment to battle.

The main body of the combat force employs reconnaissance and forward security forces in most situations. The reconnaissance forces move far ahead of the security force. They try to avoid contact while sending back intelligence to the main body commander. The security force is responsible for ensuring the unhindered movement of the main body. To accomplish this it may engage enemy forces. An engineer movement support detachment often moves either ahead of or behind this security force and supporting the movement of the main body.

Within the main body, tanks and motorized rifle units normally move at or near the head of the column. So do the commander and key staff officers. Attached and organic artillery elements move well

forward in the column, occasionally traveling ahead of the tanks and infantry combat vehicles. Air defense, engineer, AT, and chemical reconnaissance elements are dispersed throughout the march column.

The main body is responsible for its own flank security. Rear service elements normally bring up the rear of the column, followed at a distance by a rear security force.

CONTROL MEASURES

A start point indicates the beginning of a march. It must be far enough from assembly areas to allow columns to form and reach the required march speed as they pass it. Commanders establish **control lines** to ensure timely and orderly movement. The number of control lines depends on:

- distance to be covered.
- terrain and weather.
- time of day or night.
- road conditions.

Control lines usually indicate a period of 2 to 3 hours of movement. Elements of the force must cross these control lines or points at designated times.

Start Point

The start point is an arbitrary point established by the senior commander based on visible reference points, at which subunits begin performing the assigned march. It is normally 5 to 10 km from the assembly area, allowing subunits of the column to form up,

reach the prescribed rate of movement, and establish correct spacing between subunits.

Halts

Commanders plan halts and rests to preserve the strength of personnel and allow for maintenance of equipment. Short halts are scheduled for every 2 to 3 hours of movement and may last up to an hour. The column formation remains intact at the halt, with subunits maintaining their intervals.

Long halts occur on marches exceeding 24 hours. If used, long halts last no more than two hours. They occur at the beginning of the second half of a day's movement. Subunits disperse off the road in camouflaged positions and the soldiers use the time to perform any needed maintenance, resupply, or decontamination. They can also receive a hot meal at a long halt. Long halts are not scheduled at night, allowing maximum time for night movement.

Traffic Control

Traffic control posts are designated for every three to four hours of movement. They help regulate the rate of movement and keep the march organized. To assist movement and enforce march control, the headquarters company of each division has specific traffic control personnel. They will be augmented by traffic control personnel from subordinate levels. Before the march, they normally take up posts at critical points: **turns, intersections, choke points, and control lines**. The use of traffic regulators decreases reliance on maps and radio communications. Traffic regulators also enforce camouflage and light discipline among march units.

Communications

The OPFOR restricts the use of radios during the march to minimize the risk of detection, jamming, and enemy attack. OPFOR subunits march under radio silence, relying on hand and arm signals, flags, and light signaling devices. It practices these in battle drills. During long halts, it may use wire communications. The OPFOR also employs motorcycle-mounted couriers extensively. Traffic regulators operate separate wire and radio nets to aid movement of the march columns.

MARCH SECURITY

The main body of the march sends out **march security elements** to prevent surprise attacks by the enemy, keep the enemy's reconnaissance from penetrating to the main body and to assist the main body's deployment into battle. The distance of march security elements ensures time for deployment and organized engagement by the main body. The strength and composition of the march security elements depend on the intensity of the enemy threat and the type of terrain. The greater the threat and more difficult the terrain, the stronger the march security required. March security elements may be classified as **advance guard, rear-guard, security elements (forward, flank and rear)** and **patrols**. Figure 3-4 shows these elements in relation to the main body.

Advance guard

A regiment deploys an **advance guard** to ensure the security of its main axis. An advance guard consisting of a reinforced battalion may be sent out on each regimental route during an advance to contact. When exploiting a penetration or pursuit, each first-

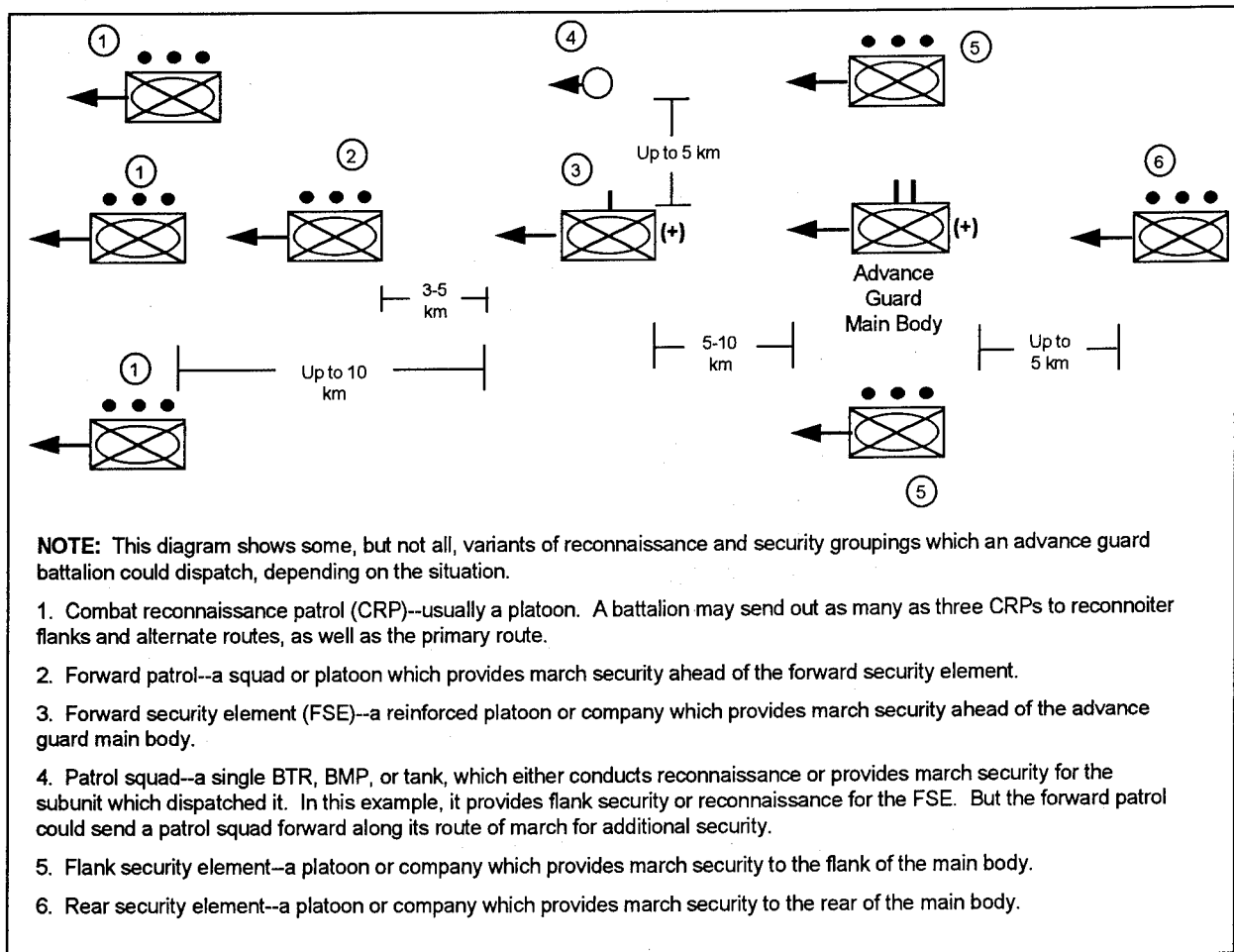

Figure 3-4. Elements of march security.

echelon regiment is likely to employ a reinforced battalion as an advance guard. The OPFOR prefers to use motorized rifle battalions for this role, but it also uses tank battalions. Typical reinforcements are a tank or motorized rifle company, an artillery battalion, an air defense platoon, a sapper platoon, and often a chemical reconnaissance section. When there is little chance of enemy contact divisions may use only a battalion as an advance guard.

Forward Security Element

This is a reinforced company sent forward on a regimental axis when the threat is weak but more commonly sent ahead of a first-echelon battalion or a battalion operat-

ing away from the main body, e.g., an advance guard, a forward or raiding detachment. Motorized rifle companies are often used in this role, even in tank units. Typical reinforcements include a tank platoon (or motorized rifle platoon for tank companies), an artillery or mortar battery, an antitank platoon (with motorized rifle companies). A sapper element, may accompany a forward security element, or a Movement Support Detachment (MSD) may be marching in the immediate vicinity.

Flank Security Element

A flank security element, in company strength, is deployed on a threatened flank. It can be reinforced with antitank and mine-

laying assets, or operate with an antitank reserve and a MOD. Static flank security elements are often used, for example, to block the exit from a mountain pass while the main body passes by. Mobile flank security elements usually march even with the head of the main body and about 5 km from the main route.

Rear Security Element

Rear security elements are a reinforced company in strength. They may be the rear element of a rearguard or of a division or regiment withdrawing when the enemy is not close. Rear security elements are also posted during mobile operations in the enemy depth.

Forward Patrols

The most common march security patrol is the **forward patrol**, found throughout a division's formation. The forward security elements of first-echelon battalions, advance guard, and forward detachments are led by forward patrols. Second-echelon battalions can also employ forward patrols. When the likelihood of contact with the enemy is low, forward patrols may be used instead of forward security elements. Forward patrols operate close to the main body, generally 3 to 5 km ahead, traveling along the main body's actual route. These patrols may attack from the march to destroy weak enemy forces or seize high ground for the subsequent commitment of the advance guard. They do not have to avoid contact with the enemy, but are not expected to attack an enemy who is stronger or in well-prepared defenses.

Flank and rear patrols are employed in appropriate tactical situations. Motorized Figure 3-4. The elements of march security.

rifle or tank platoons are used as march security patrols and may include engineer or NBC reconnaissance assets. The smallest form of patrol is the patrol vehicle. These may be sent ahead of platoons or companies operating independently, or even battalions deep in the main body of the division. Scout sections are frequently deployed on the open flanks of subunits.

Reconnaissance and Movement Support Detachments

A unit or formation can also send out reconnaissance elements and movement support detachments (MSDs). When not in contact with the enemy, the MSD moves ahead of the march security elements. When contact is possible, the MSD follows immediately after the advance guard or forward security element. Figure 3-5 shows the position of the movement support detachment in march columns.

RECONNAISSANCE

Reconnaissance on the march is conducted continuously for timely collection of information on the enemy and terrain in the direction of movement and on the flanks. The principal method of reconnaissance on the march is observation. Data on the terrain and enemy also may be collected using technical equipment. All-around observation is organized in each subunit for prompt detection of the enemy.

DIVISION TACTICAL MARCH

The basic formation for achieving maximum rates of advance or maneuver in the attack is the march formation. Motorized rifle or tank divisions use similar march formation. Elements of the division reconnaissance and REC battalion can precede in

front of the division's movement out to a range of 100 km. Ground reconnaissance elements concentrate on the major axes of advance and the most likely enemy concentrations. The division commander may dispatch a forward detachment for independent missions forward of the lead regiment's advance guards.

A forward detachment (FD) normally is a reinforced battalion. It seizes critical terrain objectives such as river-crossing sites. It may also conduct raids against important enemy sites: nuclear weapons systems, artillery positions, and CPs. The purpose of the FD is to speed the advance of the division. The division moves along as many as three march routes, with regiment reconnaissance companies and advance guards or forward detachments preceding the main body. There is no actual divisional advance guard; the lead regiment on each of the routes used by the division forms an advance guard. Each maneuver regiment provides flank security. Second-echelon regiments provide rear security for the division, as well as their own local security to the front and flanks.

Division Order of March

The division order of march is determined by the enemy situation, mission, terrain, and the commander's concept for deployment into combat. A variant of a motorized rifle division's tactical march formation is shown in Figure 3-6.

Mission

The division is advancing against a covering force screening a strong defensive position. It hopes to avoid deploying the main bodies of the first-echelon regiments during the covering force battle keeping them available for the penetration battle in

the main defensive position. The division is not operating on the army's main axis; if it was, the Army Artillery Group (AAG) and other reinforcements would be included in its columns. The terrain is standard and there are no major water obstacles to cross until the main defensive position has been breached.

Reconnaissance

The reconnaissance screen includes a reconnaissance detachment from the divisional reconnaissance battalion on the main axis and independent reconnaissance patrols from division and first-echelon regiments to cover the rest of the zone of advance.

Forward Detachment

A tank battalion from the Division's second-echelon tank regiment is acting as a forward detachment. The forward detachment's mission may be to seize key terrain for the main body's penetration battle or to disrupt the enemy's covering forces to facilitate the division's advance. The forward detachment will try to avoid battle before it reaches its objective and before it moves off the main routes of the divisional columns.

Advance guard

The advance guard consists of reinforced motorized rifle battalions from the first-echelon regiments. Their mission is to clear the covering force from the path of the main body. It is unlikely that strong positions will be assaulted frontally if this can be avoided. The preferred option is to envelope the position, forcing the defender to pull back and to attempt to destroy the withdrawing force on the move. The advance guard tries to move about one hour (20 to 25 kms) ahead of the main body,

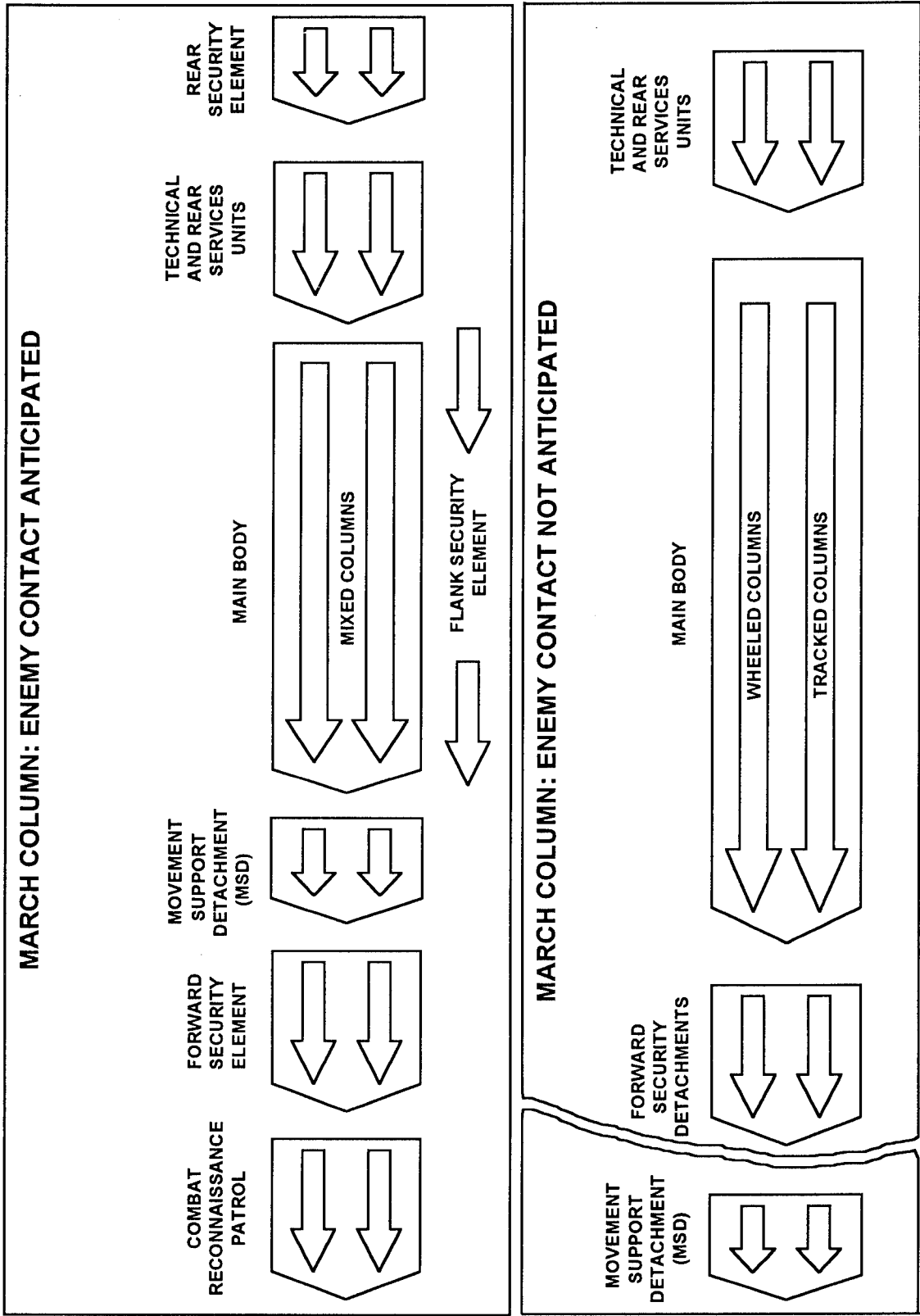

Figure 3-5. Position of the movement support detachment in march columns.

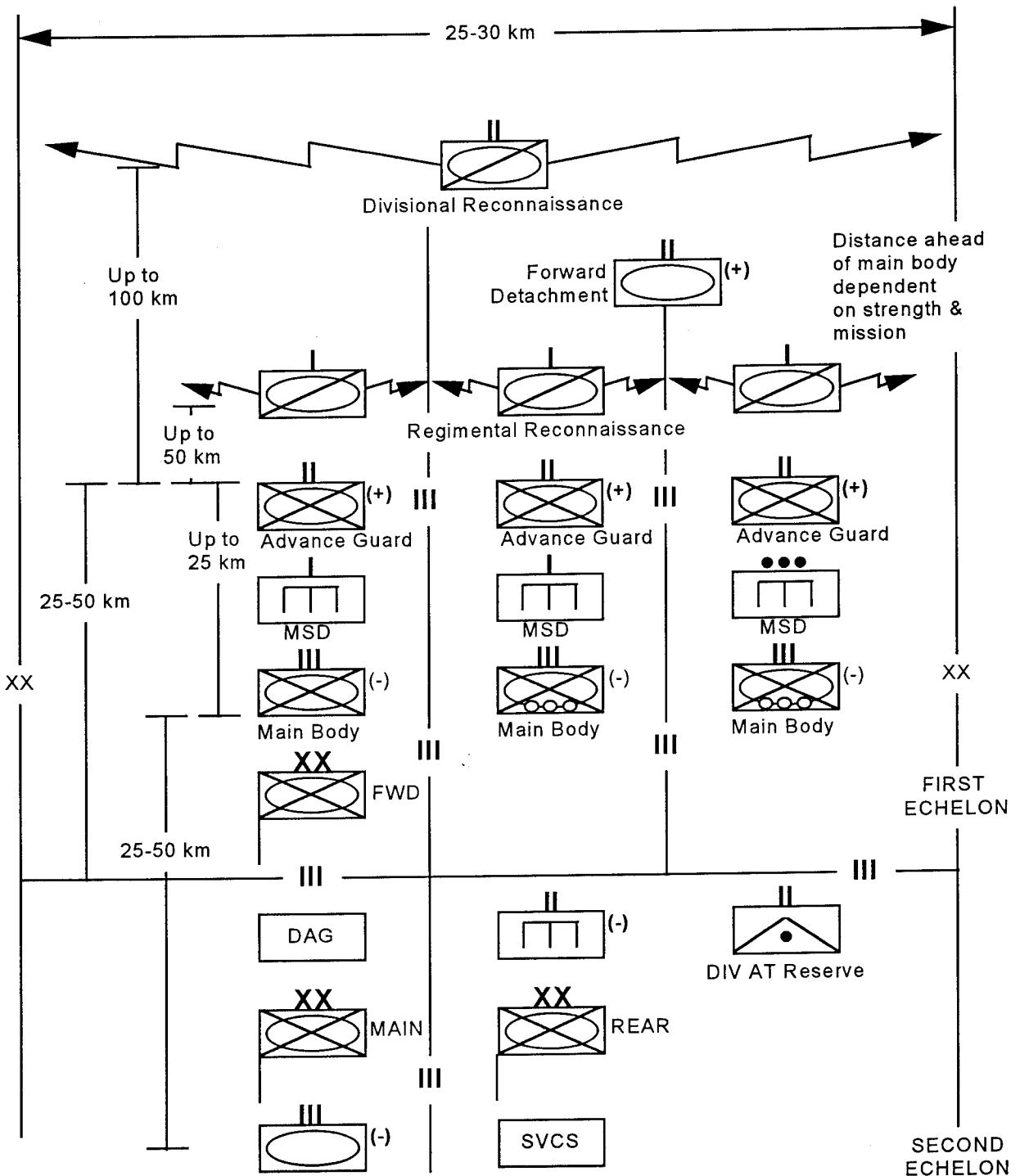

Figure 3-6. Disposition of a motorized rifle division in a tactical march formation.

but this may be reduced if resistance or obstacles are encountered.

Movement Support Detachments

Movement support detachments move immediately behind the advance guard. They try to clear routes through or around any obstacles so that the main body is not delayed.

Main Body of the First Echelon

Although the regiments are prepared to deploy into battle as rapidly as possible, they remain in march formation as long as possible. The decision to deploy, or to bypass an enemy too strong for the advance guard to dislodge, is approved by the division commander.

Divisional Command Posts

The division commander, in his forward CP, travels in the column of the main axis first-echelon regiment. He is normally close to the regimental CP ensuring quick reaction. The division's main CP accompanies the second-echelon regiment, also on the main axis. The rear CP leads the divisional rear services.

Divisional Artillery Group (DAG)

The DAG is composed of the organic and any reinforcing artillery of a division. It moves on the main axis immediately behind the first-echelon regiment so that it may support an attack from the march. The antitank reserve battalion moves to cover the most exposed flank.

Divisional Air Defense

If marching out of contact, the divisional SAM regiment, and lower-level assets, are likely to maintain radio silence, relying on army/army corps and *front* assets for long-range surveillance and early warning. Electronic sensors would become active in the event of a direct threat to the division. In this case, the SAM regiment is on full alert and possibly deployed with a battery accompanying each first-echelon regiment and other batteries on the flanks of the second echelon or reserve.

The divisional SAM regiment may move its medium-range SAM assets in a bounding overwatch configuration to keep the march columns under an air defense umbrella. During the march, medium to long-range SAM assets depend on visual detection for early warning. Radars are normally turned off, or only operated for short periods, to reduce vulnerability to anti-radiation missiles.

Second Echelon or Reserve Regiment

The second-echelon regiment or reserve generally moves on the main axis. Part of the second echelon may be designated as an anti-landing reserve.

Divisional Combat Support and Rear Services

Combat support and rear services are distributed in accordance with the terrain and tactical circumstances. In Figure 3-6, the bulk of the engineer assets, less route clearing elements, is kept in reserve in the second echelon of the division. If a water obstacle had to be crossed, assault crossing elements

would accompany the first echelon, or they might be with the forward detachment or advance guards. The divisional bridging subunits follow the first-echelon regiments. The chemical protection battalion provides chemical reconnaissance patrols throughout the divisional formation. If the NBC threat is high, decontamination assets may be split between first and second echelons. The bulk of the divisional rear services are shown in their traditional position at the end of the march formation. Maintenance and medical evacuation assets may be divided between the two echelons and, in a long march in difficult terrain, resupply facilities may also be split.

Variations in the Divisional March Formation

A second-echelon division may advance on two routes. In very difficult terrain, with poor lateral communications, the division may advance in one echelon, with a strong reserve. When exploiting a penetration, a motorized rifle division might employ its tank regiment in the first echelon. Other variations are possible, and OPFOR march formations should not be expected to follow limited stereotypes.

REGIMENT TACTICAL MARCH

Motorized rifle and tank regiments have march formations similar to a division. These formations provide reconnaissance and early warning to the regimental commander. Reconnaissance elements from the advance guard, in increasingly larger formations, will encounter the enemy or obstacles well before the main body, allowing each successive commander to minimize losses in a surprise encounter by meeting the enemy with the smallest possible force. This also permits the maneuver of follow-on forces. If

necessary, a regiment may send out a forward detachment to accomplish missions similar to those of the divisional forward detachment. An illustration of a regiment in tactical march formation is shown in figure 3-7.

The regiment's organic reconnaissance company may send out patrols that can operate up to 50 km ahead of the regiment. These specially trained reconnaissance patrols collect the following information:

- Nature and location of enemy nuclear and chemical delivery systems.
- Movement axes of enemy columns.
- Strength and composition of enemy forces.
- Deployment lines and routes.
- Location of contaminated areas.

The advance guard precedes the main force on the same route, providing movement security and warning. It normally comprises about one-third of the regiment's total combat power. The advance guard of a motorized rifle regiment is a motorized rifle battalion reinforced with tank, artillery, anti-tank, air defense, engineer, and chemical elements. The advance guard of a tank regiment is a similarly reinforced tank battalion.

The advance guard dispatches a forward security element (FSE) to its front. The FSE consists of about one-third of the advance guard's combat power. It is normally a reinforced company. A regiment may send an FSE forward for march security even if it does not send forward an entire advance guard.

The advance guard may also send out one or more combat reconnaissance patrols (CRPs). The CRP is a platoon reinforced with engineer and NBC reconnaissance elements. It reports intelligence information and makes the

initial contact with any enemy forces encountered. Flank and rear security elements for a regiment are normally platoon-size but can be up to company-size.

The regimental main body attempts to maintain uninterrupted forward movement as a result of the actions of the march security and reconnaissance elements. It remains in a close column to help maintain the speed of the march. A regiment in the second echelon of the main body would deploy flank and rear security and also some form of forward security (although less than an advance guard).

Regiment Order of March

Figure 3-8 portrays a motorized rifle regiment in a march formation. The following highlights its key points.

Reconnaissance

Even though divisional reconnaissance is moving ahead, the regimental commander has his own independent reconnaissance patrols reporting directly and immediately to his headquarters. A second-echelon regiment will not deploy such patrols until its mission is confirmed.

Main Body Battalions

The combat grouping of first-echelon battalions may differ between tank and motorized rifle regiments. A tank regiment often allocates a company of its motorized rifle battalion to each of its tank battalions. In motorized rifle regiments, the tank battalion (less any company allocated to the advance guard) is kept together on the march and placed at the head of the column after the command post. As commitment to battle approaches, the tank battalion's companies

may be split up and allocated to first-echelon motorized rifle battalions, with one tank company kept under regimental control. Second-echelon battalions, in both tank and motorized rifle regiments, receive little reinforcement before their commitment to battle.

Artillery Elements

A regiment's organic artillery battalion, or a regimental artillery group (RAG) if it is formed, may be allocated various positions in the column of march. When contact with the enemy is imminent, the artillery follows close behind the main CP at the head of the column. This arrangement is likely if a meeting battle is expected. In second-echelon regiments, and on other occasions when contact is not expected, the artillery may be farther to the rear. The air defense battalion will be distributed along the column, and some elements may be deployed in air defense ambushes on the flanks. A motorized rifle regiment's antitank battalion may cover an exposed flank or march well forward, depending on the tactical situation.

Battalion March

In the march, a reinforced motorized rifle or tank battalion may serve as one of the following:

- The forward detachment of a division or regiment.
- The advance guard of a regiment.
- Part of the regiment's main body.

A forward detachment may move in the same formation as an advance guard, dependent on the chance of contact with the enemy. As part of the main body, the battalion would move in a single column. The commander would be at or near the head of the battalion column.

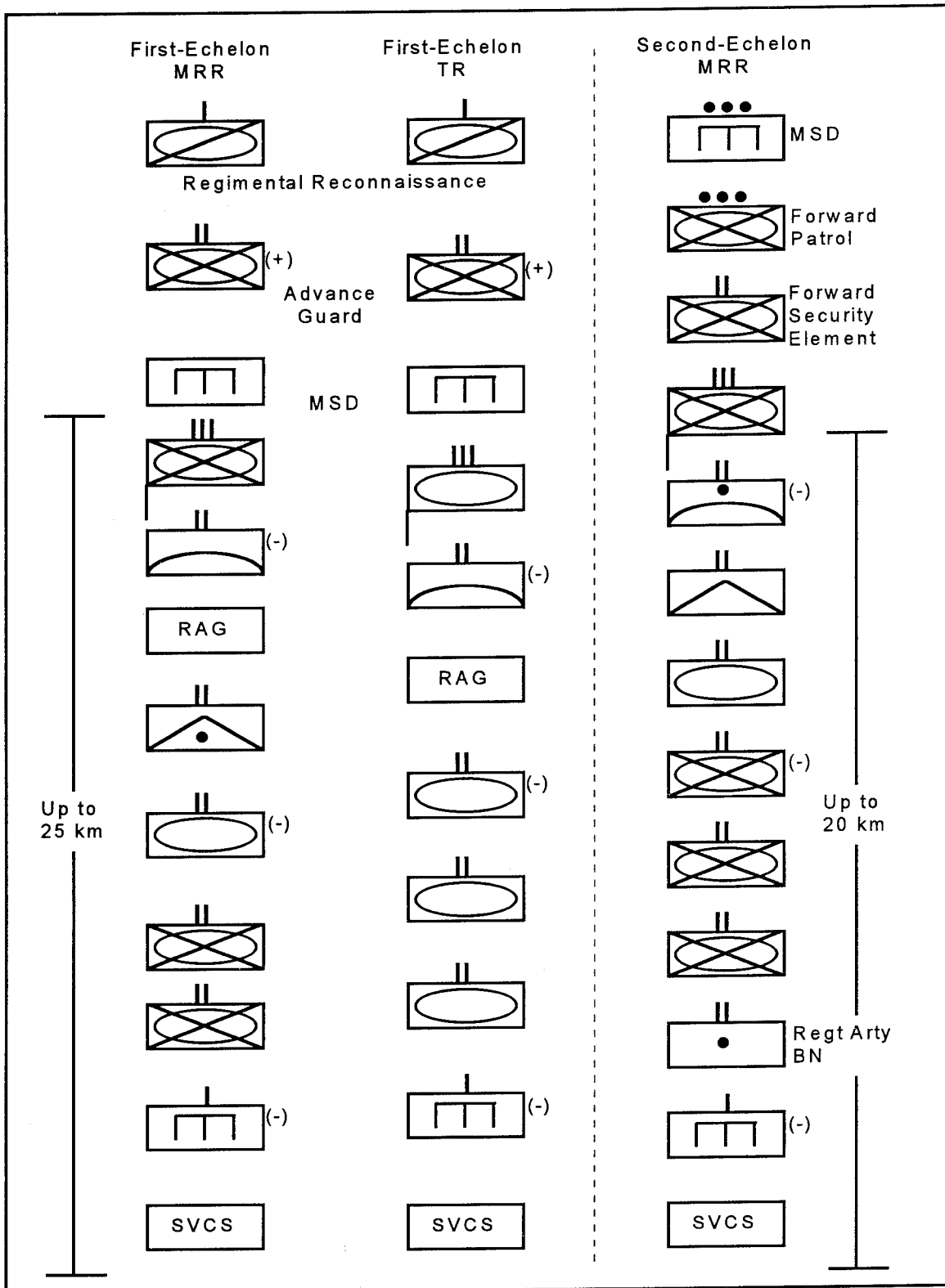

Figure 3-7. Regiments in tactical march formation.

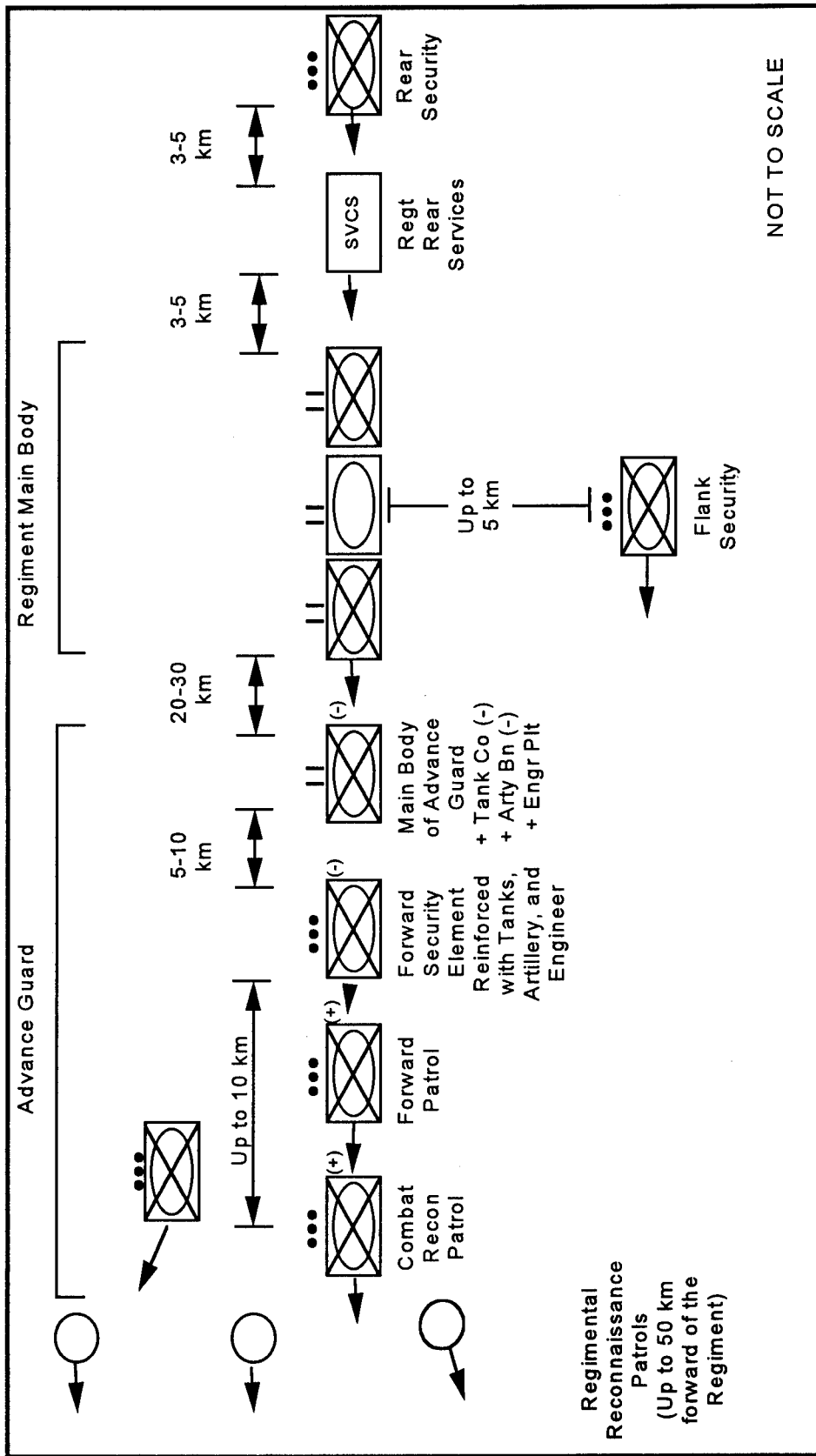

Figure 3-8. First echelon MRR of an MRD or TD in march formation

Battalions with independent missions, such as forward detachments, advance guards, and first-echelon battalions, all tend to receive similar reinforcements, and it is difficult to determine a battalion's role from its combat formation. The march formation of a reinforced tank battalion is shown in figure 3-9.

Company March

If a tank platoon is allocated to a motorized rifle company, the entire platoon marches at the head of the company column. A tank company allocated a motorized rifle platoon may use it as a forward patrol, if the tactical situation requires one. If not, the motorized rifle platoon can be split between the tank platoons, and individual vehicles follow the tanks of their assigned platoon.

SUPPORT OF THE MARCH

Air Defense

The commander plans air defense for the march in advance. His plan incorporates organic and supporting air defense weapons and aviation. The commander can position air defense weapons in the column or in stationary positions occupied in advance. He normally distributes the weapons throughout the column. When enemy aircraft are within range, and threatening the column, the commander gives the signal to open fire. Simultaneously, the column speeds up and drivers increase their interval to a distance of up to 150 meters between vehicles. If a large group of aircraft attacks, the column may have to disperse or seek off-road concealment.

Logistics Support

Logistics support of the march has two phases: before the march and during the march. Before the march, rear services elements move forward to replenish supplies, perform maintenance, and to evacuate the wounded. Refueling and maintenance elements then move ahead to halt or rest areas. Subunits make every attempt to replenish fuel reserves on vehicles before combat. During the march, subunits receive logistics support in rest areas or at halts. If vehicles break down between these areas, maintenance personnel move them off the road and repair them there. Wounded personnel receive medical aid in-place with medics evacuating the seriously wounded.

Control of rear services during the march relies on detailed planning and coordination between rear services chiefs, commanders of rear services elements, and the supported commander. At regimental and division levels, the deputy commander for the rear services establishes and heads a rear CP. This post normally moves at the head of the column of rear services elements, or on the main axis if there is more than one column. The deputy commander for the rear services locates the rear CP where he can maintain the best control.

Chemical support

Chemical support is organized to facilitate NBC decontamination and smoke screening missions. Radiological and chemical reconnaissance is accomplished using onboard radiation and chemical reconnaissance devices. Radiological monitoring, using dosimeters and radiation reconnaissance devices, is accomplished after exiting contaminated areas.

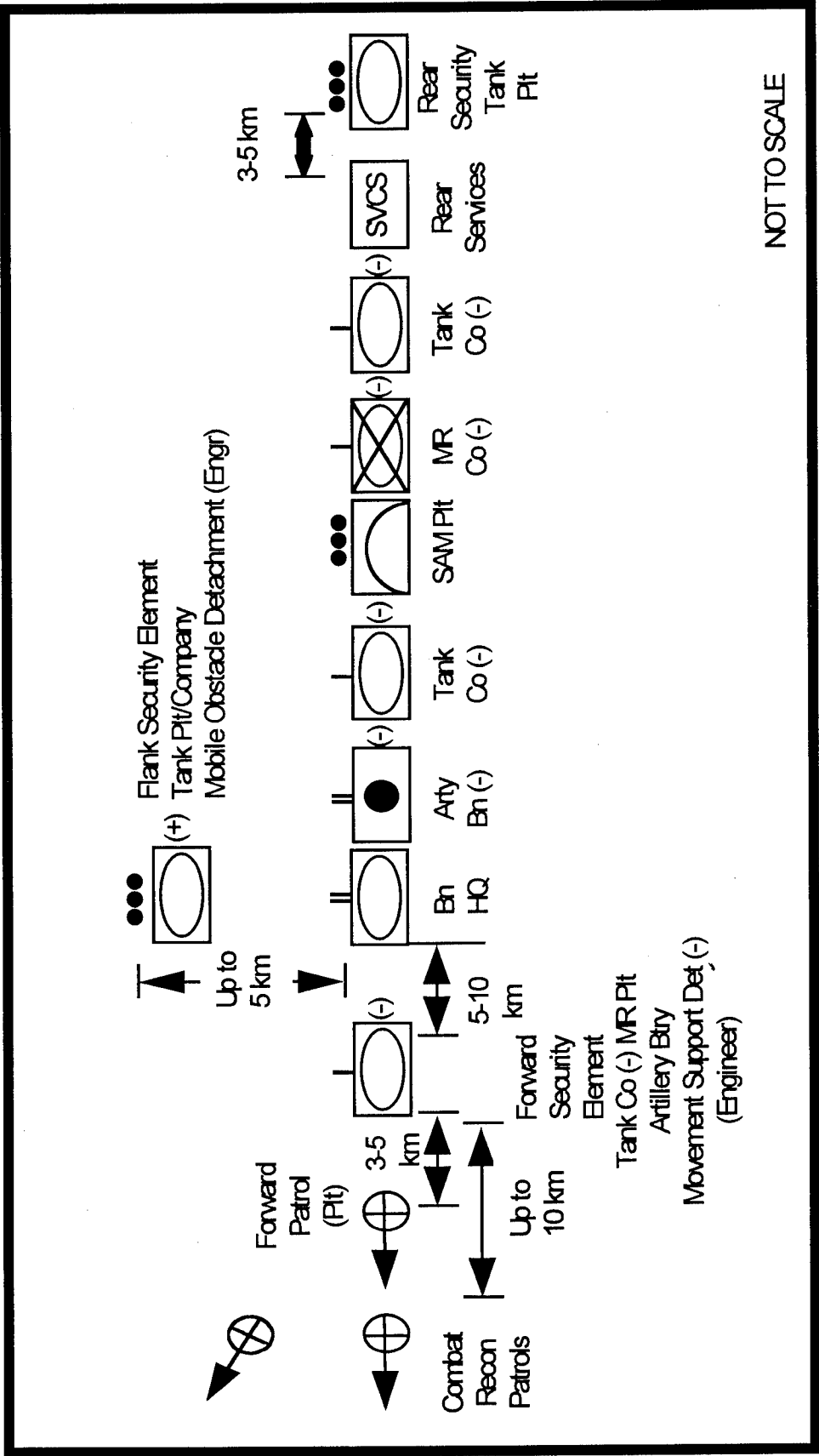

NOT TO SCALE

Figure 3-9. March formation, reinforced TB acting as advance guard or forward detachment.

Technical support

Technical support of the march is organized based on instructions of the senior commander. During preparation for the march, combat vehicles and tanks are serviced and maintained, and vehicles are filled with fuel and coolant. Serviceability of weapons, night vision devices, communications equipment, and blackout equipment is checked, and damaged weapons and equipment are repaired.

Servicing and maintenance are visually checked during halts on the march. Daily routine servicing and maintenance is performed in rest areas. Battalion servicing and maintenance assets and, when making a march as part of the main body, regimental maintenance company assets are brought in to help crews.

Engineer Support

Engineer support for the march allows the force to overcome or bypass those areas that would disrupt movement. Engineer subunits may form movement support detachments and mobile obstacle detachments.

Movement support detachment (MSD)

The movement support detachment (MSD) moves either before or after the advance guard and up to two hours ahead of the regimental main body, improving the axis of advance. It fills craters or constructs bypasses, bridges minor gaps, and clears and marks lanes through minefields. The work of the MSD is vital to a rapid advance and to security. If engineer tasks are not completed in time, the main body will be forced to halt,

disperse, and seek another route. Once the first echelon is committed to battle, the MSD follows behind it to prepare the route for the second echelon.

MSDs include engineer equipment such as bulldozers, cranes, dump trucks, tank- and truck-launched bridges, mine detectors and trucks to carry explosives and metal track. They may have motorized rifle and tank troops attached for protection. Chemical reconnaissance troops often form part of the MSD. With organic resources a division can form five to six MSDs of approximately company strength.

An MSD will be organized in two or three subgroups. They are the reconnaissance and clearance group (which can be one consolidated group or two separate ones), and the road-bridge group. Grouping depends on terrain and the tactical situation and will vary during the course of operations.

Mobile obstacle detachment (MOD)

The mobile obstacle detachment (MOD) protects advancing columns by mechanically laying minefields and creating expedient obstacles on likely enemy approaches.

MARCH UNDER SPECIAL CONDITIONS

March in the Mountains

Sharply rugged relief, limited number of roads, and sharp changes in road conditions have a substantial effect on marches in the mountains. As a rule, roads are narrow with a large number of steep ascents, descents, and turns. At higher altitudes, the output of vehicle engines decreases and fuel

consumption rates increase, making equipment movement difficult.

In contrast to ordinary conditions, the length of a day's march is shortened and column depth increases by one and a half to two times or more. Halts are designated, where possible in level sectors near water sources and away from potential landslides and avalanches. In preparing for the march, special attention is given to serviceability of vehicle engines, transmissions, and brakes.

March in the Desert

Sandy deserts are characterized by loose, moving dunes and poorly stabilized sands that are difficult to negotiate in dry conditions. Sand and dust penetrate the tiniest openings in vehicles and weapons, affecting operation, increasing wear, and causing maintenance problems. An acute water shortage is normal, and available water requires purification.

Vehicular movement in the desert is characterized by insufficient adhesion of tracks and wheels causing odometer readings to exceed the distance actually covered by 10 to 15 percent. The difficult conditions require thorough preparation of equipment for high temperatures, lack of roads, and dustiness.

March in Extreme Cold

Snow cover and low temperatures create difficulties in organizing and conducting a march in extremely cold areas. The com-

mander must provide personnel with adequate cold weather clothing and equipment. He must also ensure vehicles are prepared with winter diesel fuel and coolant. Vehicle halt locations should be placed on level sites, protected from the wind; hatches should be closed and covered with insulating mats. It is important to periodically warm-up vehicle engines and personnel. Other measures may include: constantly keeping an eye on coolant temperature readings, and taking measures to prevent tracks from freezing to the soil.

Contaminated Areas

When fighting under NBC conditions, units are likely to encounter contaminated areas. Bypassing such zones, however, reduces casualties and saves time spent on decontaminating personnel and equipment. Bypassing, however, may not always be possible since some zones could be too large to avoid. Two methods of crossing contaminated zones are possible. The first is immediate movement across the zone. The second is movement across the zone after waiting for a reduction in contamination levels. Crossing on primary routes ensures high speed and control. Troops may use other axes to reduce the distance traveled or to bypass highly contaminated areas.

March Completion

The march ends when the march formation crosses the last control line and enters a new assembly area. It can also end when subunits enter prebattle formation or combat.

Chapter 4 Reconnaissance

The OPFOR views reconnaissance as a critical element of combat support. Its vision of future combat is a battlefield developing unevenly and neither units nor formations being able to rely on the security of their flanks or rear. Friendly and enemy forces will become mixed, with the combat situation developing and changing quickly. Reconnaissance elements must warn commanders of developing threats and identify enemy strengths and vulnerabilities. Obtaining this information is critical to effective employment of the OPFOR troop control system. OPFOR reconnaissance can decisively influence the outcome of a battle, operation, or campaign.

Reconnaissance is especially important with OPFOR emphasis on the destruction of enemy nuclear and chemical delivery systems and high-precision weapons, and on the conduct of high-speed, continuous combined arms operations. OPFOR commanders are taught that it is necessary to locate 75 to 80 percent of possible targets before launching an attack in order to have a reasonable chance of success. Commanders attempt to locate 100 percent of the highest priority targets such as high-precision weapons and command posts. This degree of target location demands a high level of skill from all levels of reconnaissance troops.

PRINCIPLES

Reconnaissance represents all measures associated with organizing, collecting and studying information on the enemy, terrain and area of upcoming operations. The history of wars convincingly attests that only

where aggressive, continuous reconnaissance is conducted are combat missions performed timely with minimum losses. At the same time, a poor attitude toward reconnaissance was the cause of many failures.

With modern combat operations characterized by a high degree of maneuverability at high rates and to a great depth, the role of reconnaissance has increased in importance. Without decisive actions of reconnaissance forces and assets, it is impossible to preempt the enemy, seize the initiative and successfully conduct battle. The OPFOR uses the following **principles** to guide its reconnaissance activities:

- Focus.
- Continuity.
- Aggressiveness.
- Timeliness.
- *Maskirovka*.
- Accuracy.
- Reliability.

Because of the close interrelation of these concepts, units engaged in reconnaissance strive to satisfy all principles simultaneously and continuously.

Focus

Focus is the strict use of all reconnaissance measures to support preparation and successful conduct of battle and performance of missions in a phase of battle. The OPFOR achieves focus of reconnaissance by defining missions, areas, and targets, based on a thorough knowledge of the situation. The OPFOR executes a unified reconnaissance plan, with centralized command and control of assets, concentrating all

information collected on the enemy in a single entity, the staff.

The actions of reconnaissance units must meet the commander's needs. Focus emphasizes the monitoring of those elements and objectives that are critical to the accomplishment of combat operations. Each level of command develops a comprehensive reconnaissance plan in accordance with the unit mission. Reconnaissance resources are scarce, so the commander must carefully define and limit reconnaissance objectives. He must also maintain a reconnaissance reserve. The commander concentrates his reconnaissance assets on the critical sectors of the battlefield. He must be able to quickly redirect the reconnaissance effort, and even change the plan if the situation changes.

Continuity

The OPFOR achieves continuity of reconnaissance by constant conduct of reconnaissance during preparation for and in the course of battle. Continuous reconnaissance is essential on the modern battlefield. It ensures the uninterrupted flow of information under all conditions. Continuous reconnaissance provides constant coverage of the enemy situation. To ensure continuity, the OPFOR employs a variety of assets with deep overlapping coverage. OPFOR reconnaissance units attempt to maintain contact with the enemy at all times, and conduct reconnaissance in all directions, including the flanks and rear, in order to prevent surprise.

The OPFOR does not restrict reconnaissance efforts to a single phase of the battle or time of day. It collects information 24 hours a day, 7 days a week, in all weather conditions. Not only must OPFOR reconnaissance answer specific requests for information, but it must continuously collect in-

formation on all aspects of the enemy, weather, and terrain to meet future requirements. Commanders at all levels are responsible for organizing continuous reconnaissance. Reconnaissance is a combined arms mission, not solely the business of reconnaissance troops.

Aggressiveness

Aggressiveness of reconnaissance is the persistent effort of commanders, staffs and subunits conducting reconnaissance to collect intelligence under all conditions and by all methods. Aggressiveness of reconnaissance is achieved by skillful organization of reconnaissance forces and assets, wide use of initiative by all commanders, and bold, decisive actions of reconnaissance elements. Reconnaissance troops conduct intelligence collection creatively and energetically, bringing maximum assets to bear on the battlefield to ensure success. The OPFOR employs all its collection assets with vigor and adheres carefully to the reconnaissance plan. It must be prepared to alter the plan when its own initiatives or enemy actions dictate.

Although reconnaissance is their primary mission, all reconnaissance units are trained to defend themselves and conduct offensive operations. Reconnaissance units are not used for reconnaissance by battle. This is normally a maneuver battalion or larger combined arms force. The OPFOR stresses the need for initiative, resourcefulness, and daring in the conduct of reconnaissance. OPFOR reconnaissance troops attempt to penetrate enemy defenses, ambush and raid enemy forces, and as a last resort, draw fire to determine enemy positions. In short, reconnaissance troops aggressively do whatever is necessary to meet the commander's intelligence needs. The OPFOR reconnaissance elements would not hesitate

to conduct offensive actions against high-priority targets as determined by the commander. Such targets may include brigade-level and above commanders, nuclear delivery means or munitions or a attack helicopters on the ground.

Timeliness

Timely information is critical on the modern battlefield. Because of the high mobility of modern armies, there are frequent and sharp changes in the battlefield situation. As a result, information quickly becomes outdated. Timely reporting enables the commander to exploit temporary enemy vulnerabilities, adjusting his plans to fit a changing battlefield situation. The OPFOR achieves timeliness through increased automation for troop control and processing of information, near-real-time aerial downlinks, and satellite downlinks. The best intelligence is useless if it is not received in time.

Maskirovka

Concealment of reconnaissance consists of keeping all reconnaissance measures secret and misleading the enemy regarding the disposition and nature of operations of friendly forces, and the direction of concentration of their main effort. Concealment is also achieved by restricting the number of persons engaged in planning reconnaissance, conducting it across a broad frontage, concealing operations of reconnaissance subunits, and the use of measures for cover and concealment of assembly areas of reconnaissance forces and assets.

OPFOR commanders are aware that the enemy may learn a great deal about their intentions by discovering their reconnaissance plan. Commanders also accept that it is impossible to completely hide the conduct

of reconnaissance, but they do try to conceal the scale, missions, targets and nature of reconnaissance efforts. The commander's primary goal is not to reveal where they are concentrating their main strength.

Accuracy

The OPFOR uses all available reconnaissance means to verify the accuracy of reported information. An OPFOR commander bases his decisions on reconnaissance information; so, the more accurate and complete the information, the better the decision. By comparing and cross-checking reports, the OPFOR tries to overcome enemy deception and concealment. The OPFOR tries to achieve accuracy through the creation of overlapping coverage and improved technology. The OPFOR continues to upgrade equipment capabilities without significantly increasing personnel.

Reliability

Reliability of reconnaissance is achieved by the collection of intelligence tailored to the tactical situation and identifying and assessing diversionary and false enemy intentions, actions, and targets. Reliability is attained by selection and distribution of reconnaissance forces in terms of missions and targets in accordance with their capabilities, obtaining intelligence from different sources and by the study, comparison, recheck and follow-up of reconnaissance information collected. The accuracy and reliability of reconnaissance information are critical to the destruction of nuclear and high-precision weapons, logistics centers, C², and communications.

Zones of Reconnaissance Responsibility

Each headquarters, from division to battalion, has a zone of reconnaissance responsibility, subdivided into three parts. The parts are defined as follows:

Detailed Reconnaissance Zone

The depth of this zone is determined by the effective range beyond the forward edge of the weapon systems commanded by the headquarters.

General Reconnaissance Zone

Within this zone, the headquarters must be able to monitor sufficient enemy activity to ensure its own plans are not disturbed by unexpected enemy moves.

Rear Reconnaissance Zone

Within its own rear area, the headquarters must be able to monitor enemy activity, particularly the use of chemical strikes or airmobile forces. The width of the zone of reconnaissance responsibility broadly equates to the headquarters' frontage of operations, but the general reconnaissance zone may overlap into the zones of flanking elements.

RESOURCES

Tactical reconnaissance supports division and lower echelons. Divisions, brigades, regiments, and battalions carry out tactical reconnaissance; however, *fronts* and armies/army corps can provide tactical intelligence in support of division/brigade combat

activities. Figure 4-1 illustrates the employment of division tactical reconnaissance assets. The reconnaissance information of interest to an OPFOR division commander concerns the enemy and terrain directly opposite him on the battlefield out to a depth of 100 to 150 km. His own reconnaissance assets are not adequate to cover his entire area of responsibility. As a result, higher command support is vital to the performance of the division's missions. In addition to dedicated ground reconnaissance units, the OPFOR employs chemical, artillery, engineer, medical, remotely piloted vehicle (RPV), and radio intercept and direction-finding units to gather tactical reconnaissance information.

Reconnaissance Troop Control

In division, brigade and regimental headquarters, the chief of reconnaissance (COR) is responsible for organizing reconnaissance in accordance with the commanders' plan. In battalions, the chief of staff is responsible for planning and organizing reconnaissance, based on the commander's guidance. Divisions, brigades and regiments organize specific radio nets to link reconnaissance subunits with the headquarters. Battalions monitor this net, especially when operating independently of the main body, but do not usually maintain a specific reconnaissance net. Every level of command is expected to maintain a reconnaissance reserve to be tasked for missions that arise during the course of battle.

Chief of Reconnaissance

At the division or brigade level, the chief of reconnaissance works for and reports to the chief of staff. The chief of staff has overall responsibility for providing the

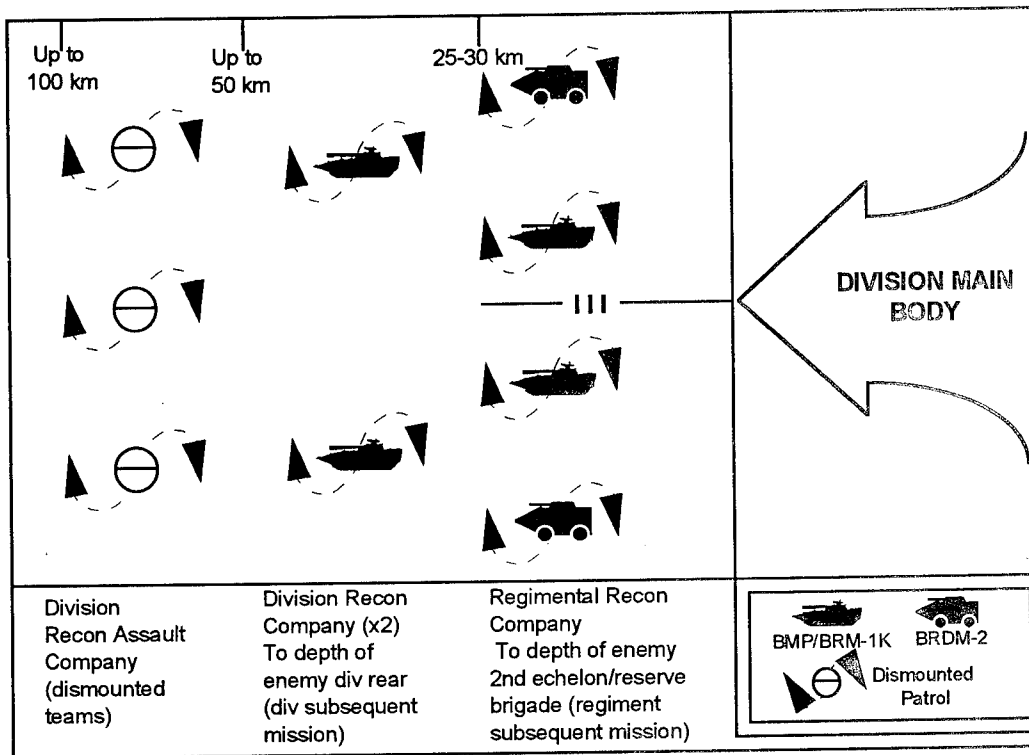

Figure 4-1. Employment of tactical reconnaissance assets (against partially prepared defense).

necessary information for the commander to make decisions. The chief of staff has a more clearly defined role in structuring the reconnaissance effort at this level than at higher levels. To assist him, MRDs and TDs and independent motorized rifle brigades (IMRBs) have a reconnaissance assets similar to an army/army corps but tailored to the size and mission of the division/brigades. Their organization provides the division/brigades commander with ground, target acquisition, air defense, chemical, engineer, and radioelectronic reconnaissance coverage throughout his area of operations.

Division Organizations and Assets

The reconnaissance resources organic to an OPFOR division are summarized below. Given the size of the division area of responsibility and the level of detail required,

commanders are always likely to feel a shortage of reconnaissance assets in their sector of responsibility.

Reconnaissance and REC Battalion

A MRD or TD has a reconnaissance and REC battalion, consisting of two reconnaissance companies, a reconnaissance assault company (also known as a long-range reconnaissance company or an airborne reconnaissance company), a radio and radar reconnaissance company and a REC company. It may also include an RPV squadron. The reconnaissance assault company operates in small teams at distances up to 100 km in advance of the division; these teams can be inserted by parachute, helicopter, vehicle or on foot.

The two reconnaissance companies may operate as a company, forming a reconnaissance detachment, or can be de-

ployed as platoon-sized reconnaissance patrols. The companies will operate across the divisional frontage and to a depth of up to 50 km. The reconnaissance patrols consist of two to three vehicles each, operating on multiple axes, in the area between the reconnaissance assault company and the regimental reconnaissance company. The size and vehicle mix of each patrol depends on the terrain, enemy strength, and the importance of the axis with the main axis receiving the primary reconnaissance effort.

RPV missions are planned by the division's chief of reconnaissance. Flight profiles vary according to the mission. For example, surveillance missions employ a figure eight or racetrack flight pattern, maintaining the RPV over its assigned surveillance area. (See Figures 4-2 and 4-3.) Reconnaissance, target acquisition, and battle damage assessment missions employ a zigzag or loop flight pattern allowing thorough coverage over a specific target area. (See Figures 4-4 and 4-5.) Some variance to these basic flight paths can be made at the discretion of the operators, who can take control of the RPV in order to change its altitude, speed, direction of flight, etc.

As it acquires priority point and area targets during these missions, the RPV immediately transmits their locations via secure radio communications directly to the unit's fire control center. As a rule, only general target location (within 1 to 2 km) is possible; occasionally, however, the RPV location, combined with terrain and map association, can make it possible to determine target location to within 100 meters.

Artillery Assets

There is a sound ranging and radar reconnaissance battery organic to the division's artillery regiment. This battery has battlefield surveillance radar mounted on mobile reconnaissance post vehicles. Each of the regiment's howitzer battalions also has a battlefield surveillance radar, and each howitzer and rocket launcher battalion have artillery command and reconnaissance vehicles. The division's surface-to-air missile regiment has an artillery reconnaissance (target acquisition/early warning) battery.

Engineer Assets

The divisional engineer battalion includes an engineer reconnaissance platoon. This platoon has wheeled armored personnel carriers for battlefield mobility.

Chemical Assets

The division's chemical protection battalion has a chemical reconnaissance company. It establishes chemical and radiological observation posts as well as radiation patrols. The chemical protection battalion can attach individual chemical and radiological specialists to elements operating in advance of the main forces, such as advance guards, security elements, or reconnaissance patrols.

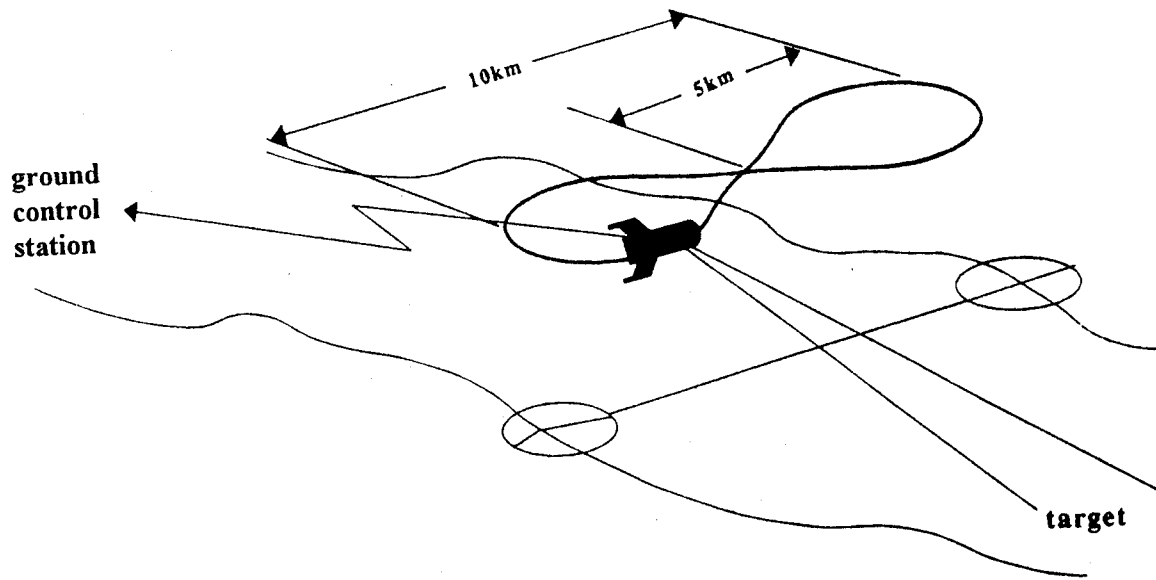

Figure 4-2. Figure eight flight path for RPV.

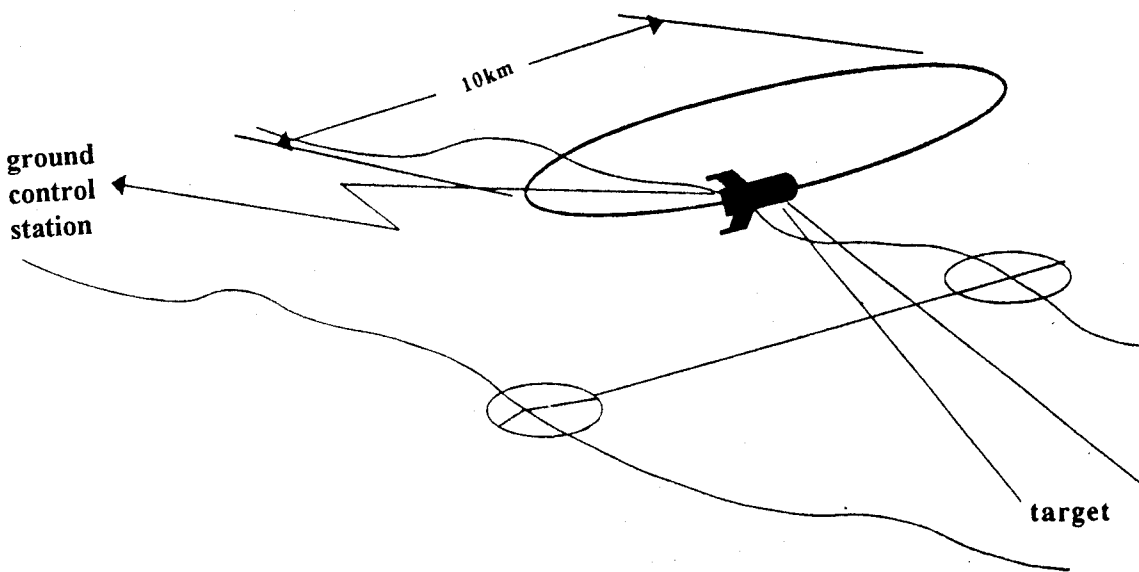

Figure 4-3. Racetrack flight path for RPV.

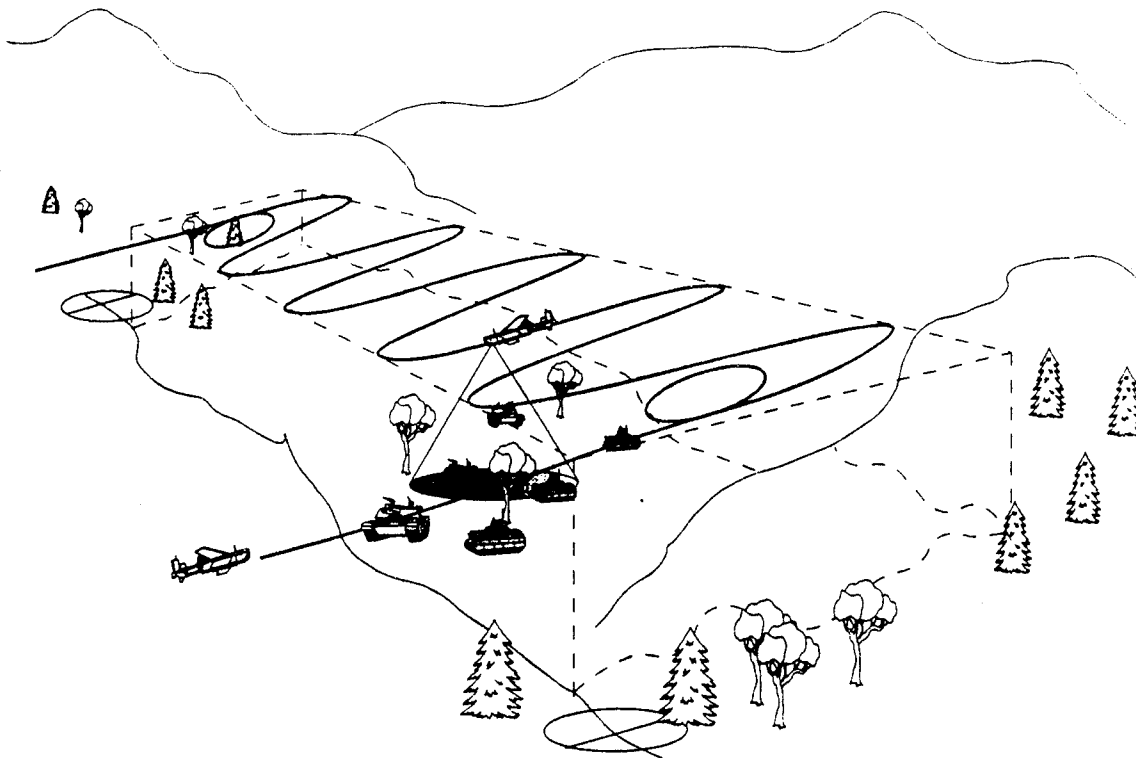

Figure 4-4. Zigzag flight path for RPV.

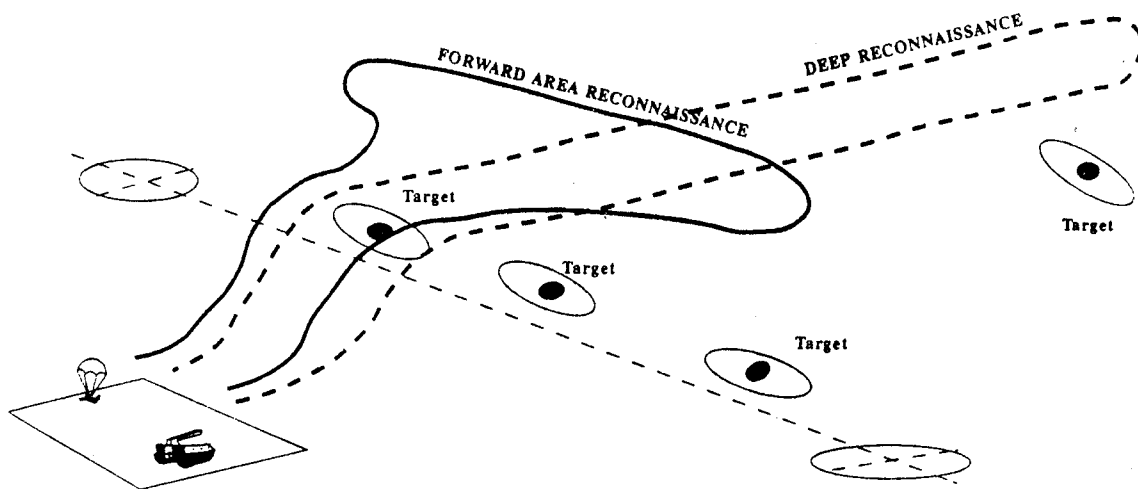

Figure 4-5. Loop flight path for RPV.

Regimental Organizations and Assets

OPFOR MRRs and TRs have organic reconnaissance subunits that include a reconnaissance company, reconnaissance elements of a howitzer battalion, an engineer company, and a chemical protection platoon. The regimental chief of reconnaissance plans and coordinates the reconnaissance effort in the same manner as the division/brigade chief of reconnaissance.

Reconnaissance Company

MRRs and TRs have an organic reconnaissance company with two to three reconnaissance platoons. This company normally operates 25 to 30 km forward of the regiment, and can operate out to a maximum distance of 50 km. Patrols of one to three vehicles conduct reconnaissance avoiding detection and engagement by the enemy. Patrols can fight and may be required to conduct reconnaissance by combat.

Artillery Assets

The howitzer battalion organic to a motorized rifle or tank regiment has its own reconnaissance assets. These include artillery command and reconnaissance vehicles and mobile reconnaissance post with a battlefield surveillance radars. When organized for combat, the regiment may have additional artillery battalions assigned to its regimental artillery group (RAG). These battalions have similar reconnaissance assets, and can bring additional radars from the sound ranging and radar reconnaissance battery of the parent artillery regiment. In addition, artillery reconnaissance assets may be made available from army/army corps level.

Engineer Assets

A regiment's combat engineer company normally does not have a separate reconnaissance unit. The regimental reconnaissance company often integrates engineer specialists into the different types of reconnaissance patrols as the situation requires. For example, frogmen may be attached to assist in the reconnaissance of water obstacles.

Chemical Assets

A regiment's chemical protection platoon employs three chemical reconnaissance squads. Each squad has an NBC reconnaissance vehicle. These squads may reinforce the reconnaissance patrols formed by the regimental reconnaissance company. Their role is to identify and mark areas of contamination finding routes around the contamination. They may also find the shortest route through it, and select certain areas for decontamination. They monitor the effects of chemical or nuclear weapons and provide warning of downwind hazards.

Battalion Organizations and Assets

Motorized rifle battalions have an organic reconnaissance platoon. However, some BTR-equipped MRBs do not have a reconnaissance platoon. In addition motorized rifle platoons may be used as reconnaissance patrols or combat reconnaissance patrols. Battalions have short-range portable ground radar capable of identifying vehicle movement to supplement their observation posts in static phases of battle. A tank battalion has limited reconnaissance resources and uses tank platoons to provide reconnaissance patrols, unless a motorized rifle subunit has been attached to it.

Battalions may deploy a variety of reconnaissance groupings. A patrol vehicle on the axis of advance is the absolute minimum, and, as the battalion approaches the enemy, a forward patrol usually forms part of the march security grouping. In mobile battles, for example after penetrating the enemy's tactical defense and in meeting battles, a combat reconnaissance patrol is formed. When the terrain or tactical situation warrants it two or three patrols may be formed from one battalion. In conducting reconnaissance, a battalion has a general reconnaissance zone to a depth of up to 10 km and a detailed reconnaissance zone to a depth of up to 5 km. The width of these zones corresponds to the battalion's total frontage.

Air Reconnaissance Assets

Divisions do not have their own helicopter assets. They do, however, have RPVs to support reconnaissance requirements. These support intelligence planning and targeting operations by providing real-time information to the intelligence section. Additionally, helicopters from army level are frequently used by engineer and chemical troops to assess routes and obstacles and areas of contamination behind the forward edge. This is not generally done within enemy airspace, though opportunities may arise in a highly fluid battle. Attack helicopters do submit normal intelligence reports during their missions. Dedicated reconnaissance helicopters conduct visual, radio intercept, thermal imaging, photographic and IR reconnaissance.

Reconnaissance Groupings

The OPFOR distinguishes between reconnaissance groupings and security groupings. An OPFOR commander may send out a subunit to perform either recon-

naissance or security, but not both at the same time. Of course, a march security grouping provides some reconnaissance information by reporting on what it encounters, but that is not its primary mission. Likewise, a reconnaissance grouping provides security indirectly; by reporting what it sees, it keeps the commander from being surprised. The reconnaissance grouping's primary missions cause it to avoid enemy contact whenever possible, in order to continue to collect and pass on information.

At the tactical level, the OPFOR ground forces employ a variety of small reconnaissance groupings, tasked and tailored to fit the specific needs of the OPFOR tactical commander in a situation. These elements vary in size and composition from a few scouts to a battalion. They may or may not have reinforcements as motorized rifle troops, tanks, artillery, combat engineers, NBC reconnaissance personnel, and other specialists.

RECONNAISSANCE ELEMENTS

A reconnaissance element is an organic or temporarily established subunit (team) with necessary reconnaissance equipment to perform a specific reconnaissance mission. Reconnaissance elements include observers, observation posts, patrol squads, reconnaissance and combat reconnaissance patrols, officer reconnaissance patrols, reconnaissance detachments, reconnaissance teams and teams for conducting probing reconnaissance patrols and reconnaissance ambushes.

Observer

Within a squad, platoon, or company, an observer is assigned to reconnoiter the ground and air, enemy and terrain, and for

observing the actions and position of his own subunits and adjacent units. He positions himself near the subunit commander and reports everything noticed during observation to him. The observer uses all observation devices available, such as binoculars and rangefinders, to conduct reconnaissance.

Observation Post

The observation post (OP) is a team with necessary equipment and documents assigned within a battalion for reconnoitering the ground and air enemy. The OP is also the place from which the team performs the assigned mission. It is intended for reconnoitering the enemy in a given sector. An observation post is assigned from reconnaissance, artillery, engineer, motorized rifle and tank subunits.

OPs are organized in the defense and when preparing an attack. They are positioned on the forward edge in subunit combat formations or on the flanks. An OP should have observation devices, a large-scale map or diagram of the terrain, observation log, compass, communications equipment, and equipment for giving warning signals.

Patrol Squad

A Patrol squad (patrol vehicle or tank) is, as the name implies, a single vehicle (or dismounted motorized rifle squad in operations on foot) with a reconnaissance mission. Patrol squads may be the only reconnaissance element deployed when the risk of meeting the enemy is low. Patrol squads may also be deployed to cover the flanks or rear of a subunit. All forms of patrol deploy patrol squads to the limit of visibility ahead of them.

Reconnaissance Team

The reconnaissance team is formed from specially trained personnel of the reconnaissance subunit, usually at squad strength. The reconnaissance team conducts operations in the enemy rear to discover nuclear and chemical attack weapons, high-precision weapons, C² facilities, reserves, airfields and other targets. A reconnaissance team may be inserted into the enemy rear by helicopters or aircraft with a parachute landing, on foot or in fighting vehicles.

Reconnaissance Ambush Team

The reconnaissance ambush team operates at squad or platoon strength. It is used in all types of battle: in the depth of the enemy disposition, on, and ahead of, his forward edge, and in his rear area. Observers, a capture element and a fire support element are assigned from the team to conduct the ambush.

RECONNAISSANCE DETACHMENT

The largest organization the OPFOR employs at the tactical level to supplement specialized reconnaissance is the reconnaissance detachment (RD). It is used during mobile phases of battles on the main axis, or to reconnoiter key objectives in depth. A motorized rifle division, or a regiment, may send out a battalion- or company-strength reconnaissance detachment. Company-sized detachments are the most common. Battalion-sized detachments reconnoiter objectives that can be advantageous to seize and hold for some time, for example a river crossing. Such a detachment may be based on a motorized rifle or tank battalion, or company. The detachment may receive reinforcements as

tanks (if it is not a tank subunit), artillery, combat engineers, or NBC specialists.

The reconnaissance detachment generally deploys along an axis or a given zone along the most important direction of the attack. Its mission is to acquire information on the terrain and the enemy's location or gaps in his defenses. It is employed primarily

in the attack but can be used during the march in anticipation of meeting battles. In the defense, in the absence of close contact with the enemy, a reconnaissance detachment may be sent out forward of the security zone to determine the enemy's composition and main avenue of attack. The march formation of a reconnaissance detachment is given in Figure 4-6.

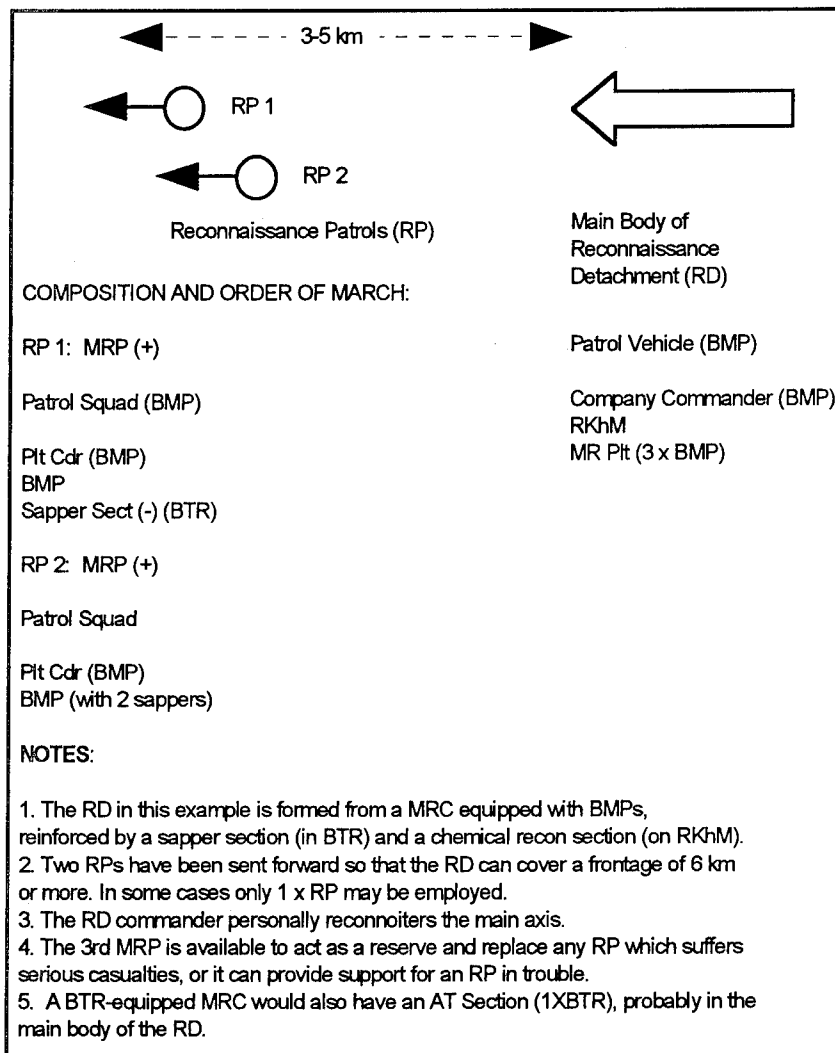

Figure 4-6. March formation of a reinforced MRC (BMP) as reconnaissance detachment.

The reconnaissance detachment dispatches platoon-size reconnaissance patrols to reconnoiter specific objectives along the detachment's axis. It is important to note that the reconnaissance detachment's primary mission is reconnaissance. If the reconnaissance patrol does encounter a weak enemy force, it may engage that force. When the detachment encounters the enemy's main forces, it assumes an observation mission, attempts to determine the composition and disposition of those forces, reports to the supported commander, and continues its mission.

RECONNAISSANCE PATROLS

The OPFOR distinguishes between various types of patrols that fit under the general heading of reconnaissance patrol (RP). Figure 4-7 illustrates the march formation of one of these patrols. Other than the specific types of reconnaissance patrol described below, the OPFOR uses the generic term reconnaissance patrol to describe a tactical reconnaissance element dispatched from a reconnaissance detachment in the process of accomplishing its mission. Up to a platoon in size, this patrol may operate several kilometers to the front or to the flanks of its parent regiment, brigade, or division. It accomplishes its mission through observation, ambushes, raids, and, when necessary, combat. The reconnaissance patrol operates up to 15 km from friendly subunits; one sent out from a reconnaissance detachment can operate up to 10 km from its main body.

Independent Reconnaissance Patrol

A division, brigade, or regiment may send out an independent reconnaissance patrol (IRP) with a specific mission to an objective. It is usually a platoon-sized element reinforced with engineer and other specialists. As with the reconnaissance patrol, the independent recon-

naissance patrol accomplishes its missions through observation, ambushes, raids, and combat, if necessary. However, it operates at a greater distance from the parent, brigade, division or regiment than the reconnaissance patrol and may stay out longer. Both types of reconnaissance patrols dispatch squads or individual armored vehicles to examine terrain features, detect enemy forces, or provide security. Figure 4-8 gives an example of an independent reconnaissance patrol conducting reconnaissance by observation.

Combat Reconnaissance Patrol

A motorized rifle, tank, or airborne battalion (or company) will organize and dispatch combat reconnaissance patrol(s). A motorized rifle or airborne battalion has on organic reconnaissance platoon; a tank battalion does not, nor do any subunits below battalion level. Therefore, most CRPs do not have dedicated reconnaissance specialists. Like the reconnaissance patrol or independent reconnaissance patrol (CRP), the combat reconnaissance patrol consists of a reinforced platoon. A CRP moves in front of or, on the flanks of, its parent battalion or company to reconnoiter and provide security. In the absence of direct contact, it normally moves no more than 10 km ahead of the next friendly company/battalion-sized element, so that the latter can observe it and provide fire support. The CRP is limited in the depth of its actions and has a greater security role than the types of reconnaissance elements mentioned earlier.

A maneuver battalion conducting an independent mission, such as a forward detachment or advance guard, may send out one or more CRPs. During combat or in the absence of direct contact with the enemy, any battalion may do so if the commander feels he has insufficient information about the situation. In the past, the normal pattern was

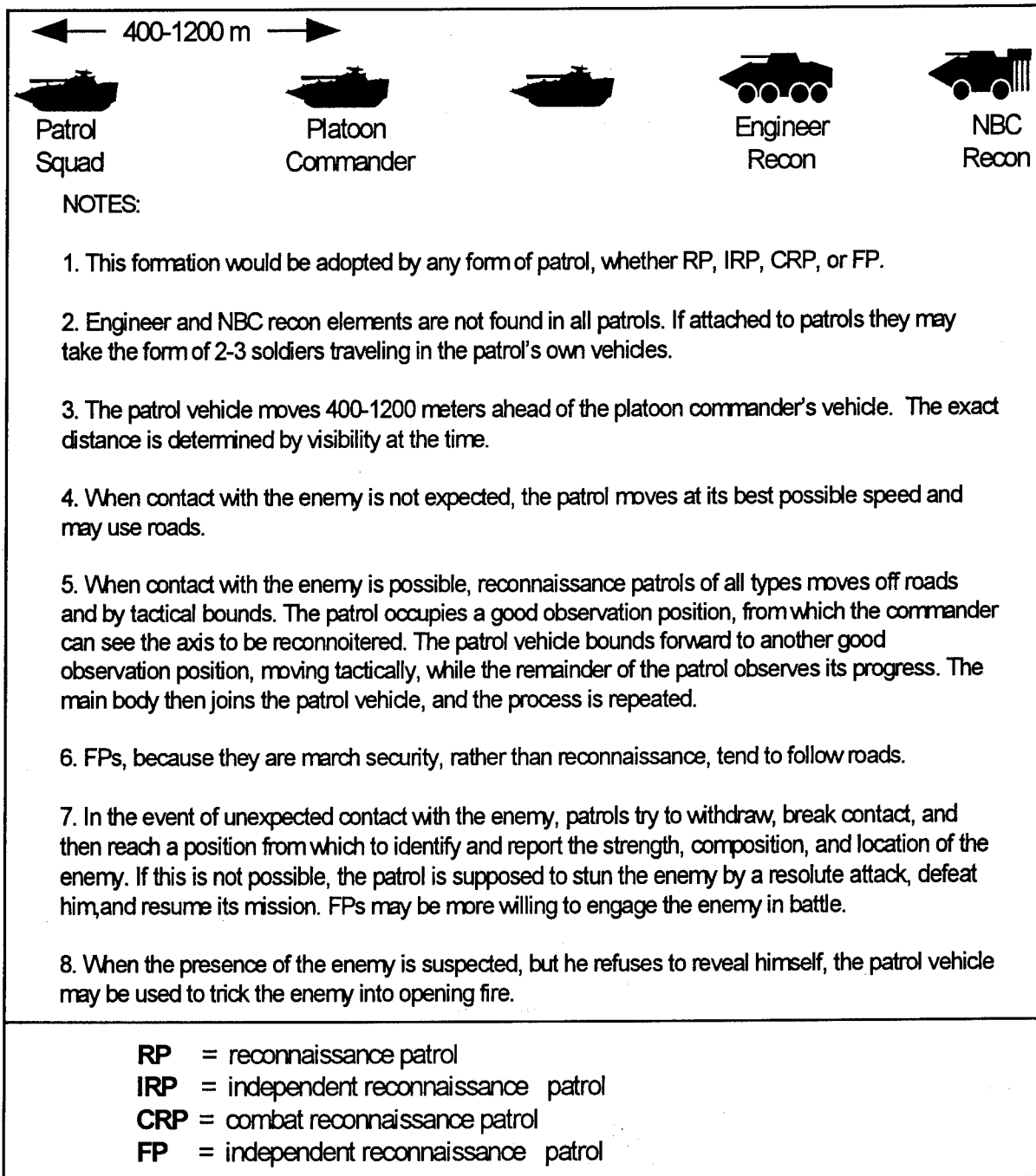

Figure 4-7. March formation of a patrol.

for the battalion to send out a single CRP to cover its route of march. The OPFOR uses a battalion employing two to three CRPs on alternate routes and the flanks.

A CRP employs the same techniques as other reconnaissance patrols. It may engage a weaker enemy force using an ambush, or it may avoid contact altogether, taking up a concealed observation point or maneuvering around superior enemy forces. If it encounters what it considers to be enemy scouts or security forces, it attempts to

penetrate them to locate the enemy's main force. The CRP's mission is reconnaissance, first and foremost. If it observes a threat to its parent unit, it can serve better by reporting on the enemy's activity than by sacrificing itself to stop the threat

Officer Reconnaissance Patrol

An officer reconnaissance patrol is sent out when there has been an abrupt, unexpected situation change. Its purpose is to

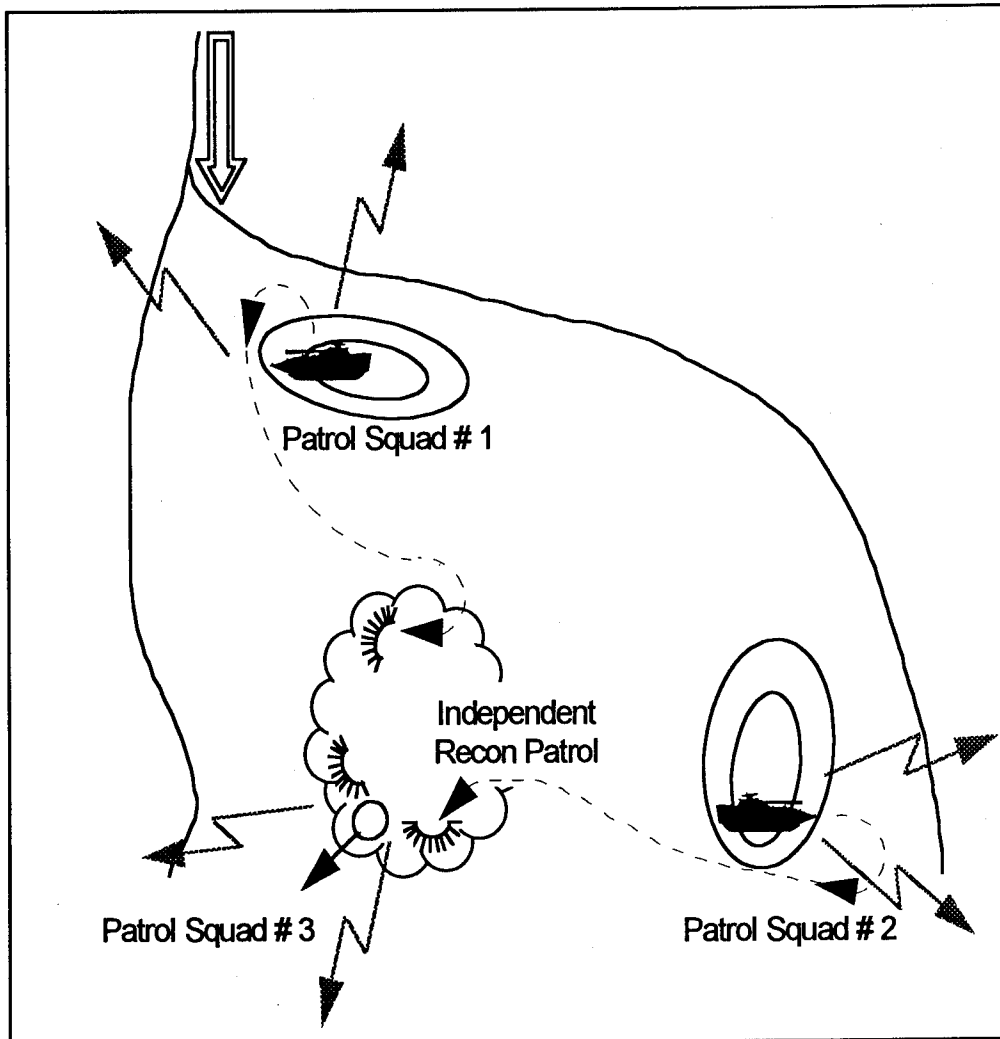

Figure 4-8. Independent reconnaissance patrol conducting reconnaissance by observation (example).

update information on the enemy and terrain in the battle operations area, determine the position of friendly troops, or to check contradictory situation data. Depending on assigned missions, one to three officers are assigned to an officer reconnaissance patrol and in addition three to five soldiers may be assigned for security. This patrol can move by helicopter, tank, BMP, BTR, motor vehicle, or motorcycle. The officer reconnaissance patrol allows the OPFOR commander to oversee and maintain tight control over the maneuver of his subordinate force. These patrols usually do not go outside the area under the immediate control of that commander's unit or formation.

Commander's Reconnaissance

Tactical commanders, battalion and above, conduct commander's reconnaissance, where possible, as part of the planning process. The commander takes his subordinate maneuver and fire support commanders to the field site to fine tune and coordinate his battle plan. Commander's reconnaissance is a vital part of the troop control process and is replicated at the operational level. The OPFOR takes elaborate measures to disguise the conduct and ranks of the participants.

Engineer Reconnaissance Patrol

The engineer reconnaissance patrol consists of a squad or a platoon of engineer specialists sent out to obtain engineer intelligence on the enemy and the terrain. In enemy territory, it deploys jointly with another ground reconnaissance element. It can also include one or two chemical reconnaissance specialists.

Chemical Reconnaissance Patrol

The chemical reconnaissance patrol determines the extent and nature of any NBC contamination. These patrols come from chemical reconnaissance elements of organic chemical protection subunits. They may operate independently or as part of other maneuver and reconnaissance elements. The normal size of a chemical reconnaissance patrol is a chemical reconnaissance squad with one special chemical reconnaissance vehicle.

RECONNAISSANCE PATROL METHODS

Whatever the designation of the patrol, its tactics are fairly standardized. On the move, a patrol sends a patrol vehicle forward to the limit of visibility and support by fire. This distance is determined by terrain, time of day, and weather, but it is usually 400 to 1,200 meters. When enemy contact is not expected, all the patrols' vehicles may be moving at the same time, but when contact is imminent, the patrol moves in bounds between overwatch positions. The patrol commander observes from an overwatch point while the patrol vehicle moves to the next position.

If the enemy is discovered in an unexpected position, the patrol commander immediately reports the location to his headquarters. If a patrol observes enemy reconnaissance or march security elements, its task is to avoid contact and continue on to locate the main force as rapidly as possible. In the event of a surprise encounter with a small enemy force, when evasion is impossible, the patrol acts decisively to destroy the enemy, capture prisoners, if possible, and continue its mission.

OPFOR reconnaissance patrols may gather information using a number of standard methods. These include--

- Observation.
- Raids.
- Ambushes.
- Reconnaissance by combat.

Other tactical reconnaissance elements may use some of the same techniques.

Observation

Observation is the most common and important methods of gathering reconnaissance information. In many cases, observation is the only source of information. Observation is the coordinated inspection of the enemy, terrain, weather, obstacles, and adjacent friendly forces during all types of combat activity. The OPFOR conducts observation from BMPs, BTRs, tanks, rotary- and fixed-wing aircraft, as well as from static ground positions.

The OPFOR has great confidence in the utility of observation, but it also recognizes the limitations. It is often difficult to determine enemy intentions through observation alone. To supplement observation, the OPFOR conducts raids and ambushes to capture information that can give a clearer picture of enemy strengths and intentions.

Raids

OPFOR reconnaissance tactics involve two methods conducting raids. The difference is in the purpose of the raid and the type of reconnaissance element performing it. The raids are classified as either a **reconnaissance** or **destruction** raid.

The first type of raid is the **reconnaissance raid**. It is intended to capture prisoners, documents, or weapons. A dedi-

cated reconnaissance patrol or a motorized rifle subunit up to platoon strength may conduct this raid. In either case, the patrol can have attached combat engineer, chemical protection, and communications personnel. The patrol is often organized into a squad to make the assault and capture prisoners, a squad to provide covering fire, and the remaining support personnel. The patrol can receive artillery or mortar support if the situation dictates. Patrols of this type operate at night or under other conditions of limited visibility. Their targets are selected in advance, and ideally they have time to study them before undertaking the mission. Typical targets are individual soldiers or small groups of soldiers near the forward edge of friendly troops. This type of raid normally takes place when the OPFOR is in direct contact with the enemy. Its primary goal is to obtain information; any damage or destruction of enemy installations is incidental

The second type of OPFOR raid is the **destruction raid**. The primary purpose of this raid is destroying targets in the enemy rear. The attack is sudden, and comes from an unexpected direction. The subunit conducting it is normally a team of reconnaissance or special-purpose forces inserted deep into the enemy's rear area. Regular ground force subunits or partisans may also execute this type of raid. Targets often include airfields, headquarters, small garrisons, and depots.

Ambush

Intelligence collection is the most common purpose of an ambush conducted by reconnaissance patrols. The patrols may also execute an ambush to delay reserves or to inflict damage on a target of opportunity. Reconnaissance ambushes are arranged in all kinds of battle, on any terrain, at any time or

year or day, and under various weather conditions, ahead of the front, on the flanks and in the rear of the enemy.

In setting up an ambush, a reconnaissance element selects a concealed position along a probable route enemy travel and then camouflages itself. It places observers to give early warning of approaching enemy personnel and vehicles. The observers continue to report on reinforcements after the ambush has occurred. In addition to observers, the team includes an assault group and a security group and blocking forces.

Combat

The OPFOR's most ambitious--and least preferred--ground reconnaissance tactic is reconnaissance by combat. When other means of gaining information have failed, a reconnaissance patrol can undertake reconnaissance by combat. The subunit that conducts reconnaissance by combat is normally a reinforced motorized rifle or tank company from the regiment, or a reinforced battalion from the division. Reinforcements include specially trained reconnaissance personnel, as well as engineer and artillery reconnaissance personnel. Subunits conducting the reconnaissance by combat receive support from artillery fire and, in some instances, aviation.

The subunit performing this mission penetrates enemy defenses to a depth sufficient to cause him to reveal his dispositions and firing systems in response to the penetration. Its primary purpose is to discover weak points in the enemy's defenses. This aggressive tactic carries with it a distinct risk. When used against an enemy prepared for it, or when attempted without sufficient

preparation or expertise, it can fail. Aside from resulting in heavy casualties, it could also reveal OPFOR intentions. Reconnaissance by combat is most often used to gather information for an attack when all other reconnaissance efforts have failed.

Reconnaissance Group

A reconnaissance group operates independently in the enemy's rear area. Within a division it is almost certain to come from the reconnaissance assault company (long-range reconnaissance company) of the division reconnaissance and REC battalion. Reconnaissance groups are usually squad strength and are particularly targeted on high-precision weapons, command and control posts, headquarters, and reserves.

RECONNAISSANCE DATA COLLECTION

Reconnaissance elements are tasked to acquire the following types of data:

Enemy Forces

The composition, capabilities, location and intentions of the enemy are vital information to the OPFOR commander. The location and readiness of high-precision, nuclear, and chemical weapons get the highest priority. Headquarters, communication centers, defended areas, and artillery positions are also important. Division, brigade, and regiment commanders also task reconnaissance to locate enemy reserves and second echelons. Every effort is made to discover boundaries and open flanks suitable for attack.

Topographical

Much of the OPFOR's reconnaissance effort is devoted to finding good routes for maneuver units through difficult terrain. The identification of lateral routes, vital ground, and possible sites for communications equipment and assembly areas is also important. Timely information on the nature and extent of obstacles is seen to be essential if the advance is to continue. Especially important in this context are possible sites for crossing water obstacles and assessments of enemy demolitions and minefields.

Contamination

Areas of contamination, resulting from both enemy and OPFOR strikes, have to be located. Reconnaissance also provides information to evaluate the degree of hazard involved in crossing them.

RECONNAISSANCE DURING PHASES OF BATTLE

The conduct of reconnaissance varies according to the phase of the battle. Reconnaissance may support a parent organization in its advance to contact (in a meeting battle or attack from the march) or in its penetration of enemy defenses. Other circumstances may dictate the use of reconnaissance by combat. Reconnaissance missions continue as the attacking force moves into the enemy depth. If the OPFOR adopts a defense, reconnaissance plays yet another role.

In the Advance

When advancing to contact and penetrating an enemy covering force, an OPFOR division covers its frontage with patrols, each patrol covering a sector of 2 to 3

km. A reconnaissance detachment advances on the main axis; with the remainder of the front covered by reconnaissance patrols. This screen avoids combat and moves to locate the main body of the enemy force. In a meeting battle, some patrols stay in contact with the leading enemy units as they approach the OPFOR formation, while other patrols attempt to penetrate the enemy main body. Figure 4-9 illustrates the conduct of reconnaissance in the advance.

If the enemy is preparing to hold a main defensive position, some patrols establish a line of static observation posts reporting on enemy defenses. Other patrols attempt to find gaps or open flanks in enemy positions. Reconnaissance patrols are also deployed on the flanks of the division with the number of these patrols determined by the proximity of friendly formations.

First-echelon regiments deploy their reconnaissance patrols behind the divisional patrols. The advanced guard battalions of these leading regiments, along with any forward detachments, deploy combat reconnaissance patrols and their own reconnaissance patrols. Battalions in the main body of first-echelon regiments can deploy forward patrols, but do not employ combat reconnaissance patrols unless they are about to contact the enemy. In second-echelon or reserve regiments, only patrol vehicles are likely to be used.

In the Penetration Battle

Much of the division's intelligence is acquired by observation posts in the front-line. Radar, direction-finding, and artillery reconnaissance assets are fully deployed. Figure 4-10 illustrates reconnaissance being conducted in the penetration battle. The division reconnaissance and REC battalion and

first-echelon regiments' reconnaissance companies try to find gaps through which reconnaissance patrols can be inserted. Raids can be mounted by reconnaissance or motorized rifle units to identify enemy units. A large proportion of the divisional reconnaissance assault company by now has been inserted into the depth of the enemy defenses.

Reconnaissance by Combat

If reconnaissance sources fail to provide the detailed targeting information needed for the success of the fire plan, the OPFOR may be forced to employ reconnaissance by combat. This is only employed when other methods have failed, because of the high casualties that may be sustained. Reconnaissance by combat is employed on the sector of the main attack but, in order not to reveal this sector, diversionary reconnaissance is conducted across the whole front.

Each effort involves a reinforced company or battalion, supported by a heavy fire plan (including air strikes) and deception measures to convince the enemy that a major assault is contemplated. The attacking force aims to penetrate 1 to 2 km and then launch raiding parties to capture prisoners or equipment. Every possible reconnaissance asset monitors the progress of the reconnaissance with commanders located in forward OPs to assess the enemy defenses. First-echelon forces will be ready to launch major attacks in the event reconnaissance reveals exploitable weaknesses in the enemy defenses.

In the Enemy Depth

Once an attack is launched on the enemy's main defenses, reconnaissance

elements are ready immediately behind the assaulting troops. First-echelon battalions place combat reconnaissance patrols immediately behind their first-echelon companies, committing them once the enemy's forward company positions have been overcome. Regiment and division-level reconnaissance patrols, and possibly a division-level reconnaissance detachment, are inserted once gaps have been created. Artillery strikes and smoke screens cover their commitment. When exploiting a penetration, units and subunits operate with open flanks, using additional reconnaissance and combat reconnaissance patrols to cover these flanks. An example of reconnaissance during this phase is shown in Figure 4-11.

In the Defense

In the defense, reconnaissance focuses on the security zone. There is considerable emphasis on the use of static OPs. Within each first-echelon battalion, these may include OPs, the battalion command observation post, numerous company and platoon OPs, artillery OPs posts, listening posts, and ground radar. When assuming the defense out of contact with the enemy, a combat reconnaissance or reconnaissance patrol can be pushed forward. If the division withdraws to occupy its defensive position, some reconnaissance groups of the reconnaissance assault company can be left as stay behind parties. If the division goes over to the defensive out of contact with the enemy, a reconnaissance detachment can be sent to establish contact with the attacking enemy monitoring his approach. Second-echelon regiments or reserves can also deploy assets into the intervals between defense lines.

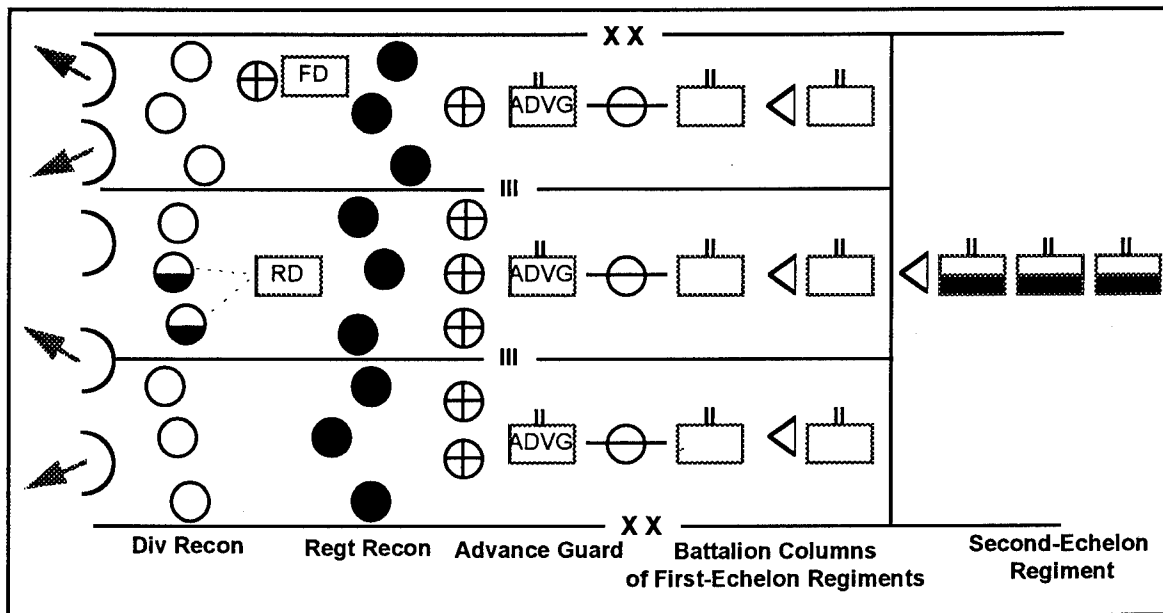

Figure 4-9. Reconnaissance in the advance.

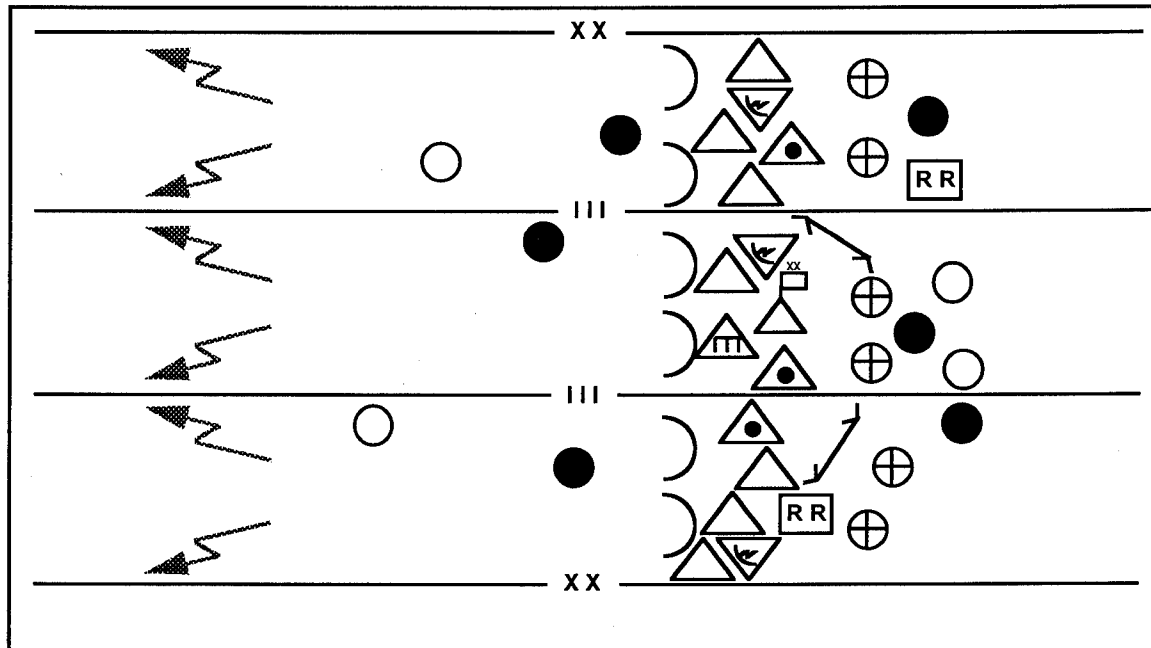

Figure 4-10. Reconnaissance in the penetration battle.

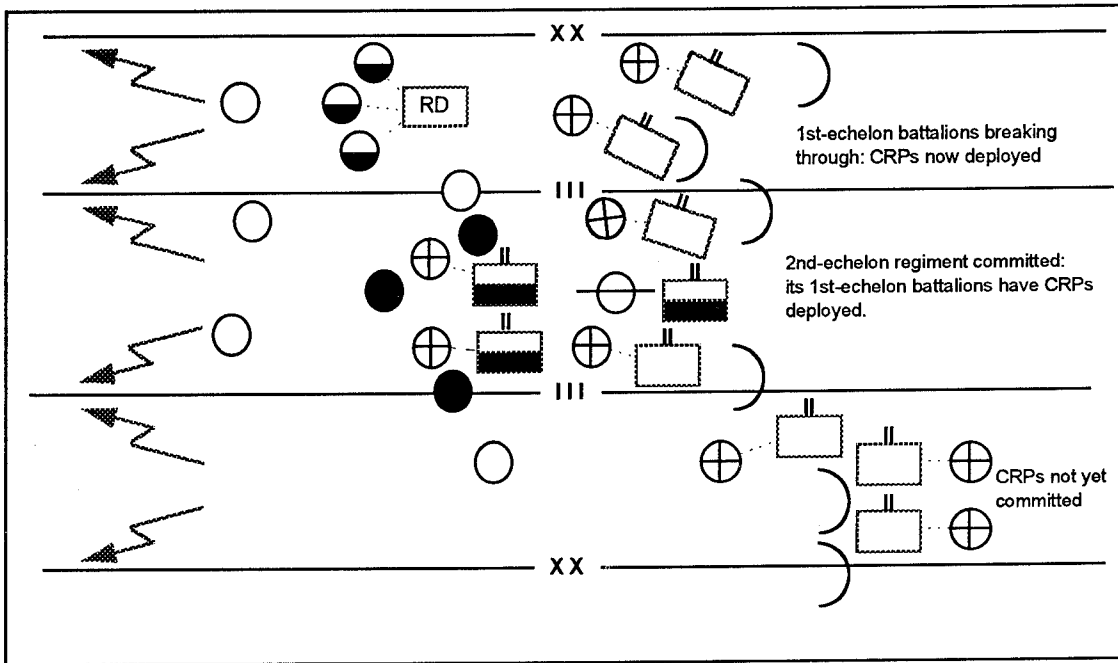

Figure 4-11. Reconnaissance during operations in the enemy depth.

RECONNAISSANCE UNDER SPECIAL CONDITIONS

The OPFOR is prepared to conduct reconnaissance under all conditions and types of terrain. In particular, the OPFOR trains to conduct reconnaissance in mountainous, wooded, desert, extreme cold and built up areas.

Mountains

The OPFOR modifies observation methods when conducting reconnaissance in mountainous regions, due to terrain features associated with them. For example, where two or three OPs could cover an area in level terrain, mountainous conditions can require additional posts. Employment of ground reconnaissance patrols is more important as a result of limitations imposed on OPs. The conduct of raids is difficult in mountainous

areas, but the OPFOR expects to successfully conduct ambushes. The restriction of enemy units to established road and trail networks decreases the possibility of the ambush team's detection and at the same time increases the number of targets that pass through an ambush site.

Forests

The limitations of wooded areas are similar to those found in mountainous regions. Terrain conditions in wooded areas can change drastically within a short period of time depending on the weather and season. Rolling, forested terrain allows raiding parties good concealment along the approach to their objective, increasing their chance of success. The OPFOR likes to infiltrate raiding parties through lightly defended forward areas and attack objectives in the enemy rear, where OPFOR troops are not expected and

where success can demoralize enemy forces. For that reason, OPFOR tacticians consider wooded terrain ideal for conducting ambushes.

Desert

Features of desert areas and the nature of combat and logistics support in desert areas place a number of additional requirements on reconnaissance. In addition to usual missions, reconnaissance must establish the degree to which of enemy troops are equipped and trained for desert operations; features of alignment of enemy combat formations and the degree of engineer preparation of positions. Reconnaissance also tries to determine the presence of water sources in the enemy disposition, their capacity, and the presence and capacity of pipelines; and convenient bypass routes to deliver strikes against the enemy from flanks and rear.

It is not the number of assigned forces and assets, nor methods of conducting reconnaissance, that is of decisive importance in performing reconnaissance missions in desert areas. Rather, it is the specific nature of preparation and training of personnel assigned to reconnaissance and their logistics support that is of decisive importance in performing reconnaissance missions in desert areas.

Northern Areas

In addition to usual missions, reconnaissance in northern areas must establish enemy organization, weapons and logistic support of enemy troops for combat in the given area; the enemy's special equipment; alignment of combat formations and presence of snow and ice obstacles. They also try to determine any structures for personnel shelter and warming; ice thickness and

strength on rivers and lakes, depth and density of snow cover and the freezing of marshes, and presence and trafficability of trails in lake and tundra areas in summer.

Cities

The OPFOR teaches that combat in cities differs significantly from tactical operations in normal field conditions. It has the following special characteristics: close and continuous contact with the enemy; independent actions by small units; constraints on troop control; difficulty in using tanks, BMPs, and BTRs; and problems conducting reconnaissance. The OPFOR places emphasis on precombat information gained from informers, refugees, special-purpose forces, maps, and aerial photography. The OPFOR uses information from town plans, tourist brochures, service facility charts, and aerial photographs to provide the latest information about the condition of communications systems, utilities, enemy defensive deployments, location of civilian concentrations, and other related data. The OPFOR reconnaissance emphasizes a three-dimensional perspective of cities. OPFOR reconnaissance attempts to gain information on conditions above (multi-story buildings) as well as below (sewers, subways, etc.) the city.

Reconnaissance patrols and reconnaissance by combat on a large scale, operate mainly in the terrain surrounding and along the immediate approach routes into the city. Once the battle within built-up areas begins, the OPFOR collects new intelligence information primarily by observation, patrols, and helicopters. It also increases the number of observation points and positions them in upper stories of buildings. This added elevation may give improved observation among the ruins where activity is usually more difficult to detect.



















	Reconnaissance Patrol		Battalion Column (Division second echelon)
	Independent Reconnaissance Patrol (Subordinate to Division)		Observation Post (OP)
	Independent Reconnaissance Patrol (Subordinate to Regiment)		Artillery Observation Post
	Combat Reconnaissance Patrol		Engineer Observation Post
	Forward Patrol		Radar
	Patrol squad		Division Commanders OP
	Reconnaissance Detachment		Sound Ranging Line
	Forward Detachment		Reconnaissance Area
	Radioelectronic (Radio and Radar) Reconnaissance assets		
	Advance Guard		
	Battalion Column (Division first echelon)		

Figure 4-12. Key to symbols used in this chapter.

Chapter 5

Offense

The OPFOR believes the offensive is the primary means to achieve decisive victory. The goal of the offense is to strike key points and into the full depth of an enemy defense. The OPFOR conducts an offensive with all available resources, at high speed and without pausing. The defense may have tactical advantages in the choice of terrain and time to prepare, but the OPFOR feels the attacker can seize the initiative and impose his will on the defender.

SURPRISE AND CONCENTRATION

In order to seize the initiative, the attacker ensures **surprise** by concealing the time, location, and strength of his attack. OPFOR doctrine emphasizes the importance of concealment and deception to disguise the location of the main effort.

The key to success is the **concentration** of sufficient combat power to overwhelm the enemy defense in the **strike sector** (penetration sector/sector of the main effort). Once the penetration has been achieved, it must be exploited, without pausing, until the mission is accomplished.

COMBINED ARMS TACTICS

The essence of the offense is combined arms cooperation. The basis for this cooperation is close and uninterrupted interaction of all forces to best exploit their capabilities. Each arm provides strength and protection where another arm is weak or vulnerable. (See Figure 5-1.) The tank is a critical element for combined arms coopera-

tion in the attack. However, the tank can be successful only if the OPFOR can protect it from air attack and, using fire support, neutralize enemy antitank systems.

Concern for the enemy **antitank threat** is the chief factor in coordinating the combined arms effort. The bulk of responsibility for neutralization of antitank weapons falls on artillery. Massive, continuous artillery fires in the attack are extremely intense. Even if these fires do not destroy enemy antitank weapons, they force the enemy gunners to keep their heads down.

Consistent with the principle of doing the unexpected to surprise the enemy, the OPFOR attacks through difficult terrain against lightly defended or undefended areas. An OPFOR commander considers an undefended wooded area a better avenue of approach than an open area dominated by enemy antitank guided missiles. Attacks by motorized rifle subunits along forest trails or ridge lines are likely, particularly if OPFOR reconnaissance identifies no resistance along these routes.

After penetrating the forward edge of an enemy defense, the OPFOR continues to attack further into the depths of the defensive position. It bypasses enemy strongpoints that it cannot reduce immediately. If it cannot bypass them, it would attack them preferably from the flanks or rear. The OPFOR uses massed fires to provide close and continuing fire support, and can use smoke and flame weapons against the strongpoints.

ARM	ENEMY TARGETS TO DEFEAT
Tanks	Antitank Weapons Tanks Infantry Fighting Vehicles
Motorized Rifle	Antitank Weapons Troops Infantry Fighting Vehicles Tanks (using AT weapons organic to MR unit/subunit)
Artillery	Antitank Weapons Troops Artillery Command Posts
Attack Helicopters	Tanks Infantry Fighting Vehicles
Fixed-Wing Direct Air Support	Targets beyond range of artillery and attack helicopters
Air Defense Weapons	Attack Helicopters Fixed-Wing Aircraft
Radioelectronic Combat	Communications Command and Control Intelligence Artillery

Figure 5-1. Combined arms team.

FORMS OF TACTICAL MANEUVER

Maneuver is a basic component of combat. It is an organized movement during combat that puts troops in a more advantageous position than the enemy. From this position, they can deliver a decisive attack. Maneuver has a significant role in the OPFOR concept of the combined arms battle.

However, maneuver alone does not achieve victory. The OPFOR expects that an effective fire strike can make maneuver possible. Unlike many other armies where fire

strikes support maneuver, OPFOR ground maneuver capitalizes on gains achieved by fire strikes. The "maneuver of fires" is also important in OPFOR tactics.

The commander uses maneuver to seize and hold the initiative and defeat enemy plans. Maneuver achieves the essential superiority of fire, forces, and equipment in the crucial sector, and increases the force of the strike. The most common forms of maneuver are **close**, **deep**, and **double envelopments**. The frontal attack, once one of the most frequently employed forms of offensive maneuver, has fallen into disfavor.

Frontal Attack

The frontal attack is directed against the enemy's frontline forces. Its goal is to penetrate his defenses along single or multiple axes. Its success depends on superiority of forces and firepower, the presence of sufficient reserves, and thorough planning. A unit conducting a frontal attack attempts to create openings for subsequent exploitation. The frontal attack, by itself, is the least preferred form of maneuver. Normally, it is used in combination with a close or deep envelopment.

Envelopment

A **close envelopment** is a flanking maneuver that strikes enemy forces in their flank or rear at a relatively shallow depth. The goal of the close envelopment is to attack the enemy from the flank, avoiding a frontal attack. It normally is initiated through gaps or breaches in enemy forma-

tions. Forces conducting the close envelopment and those conducting a simultaneous frontal attack coordinate fire support. (See Figure 5-2.)

A **deep envelopment** is a flanking maneuver executed at a greater depth. The goal of deep envelopment is either to attack the enemy from the rear or to seize key blocking positions; preventing the enemy's withdrawal and ensuring his destruction. The deep envelopment is conducted in tactical coordination with the forces advancing from the front. (See Figure 5-3.)

Forces assigned to conduct a deep envelopment receive additional fire support. This is because the depth of the envelopment exceeds the range of friendly fire support advancing from the front. The strength of the deep enveloping subunits can vary. In an attack against a defending enemy, a battalion- or regiment-sized forward detachment

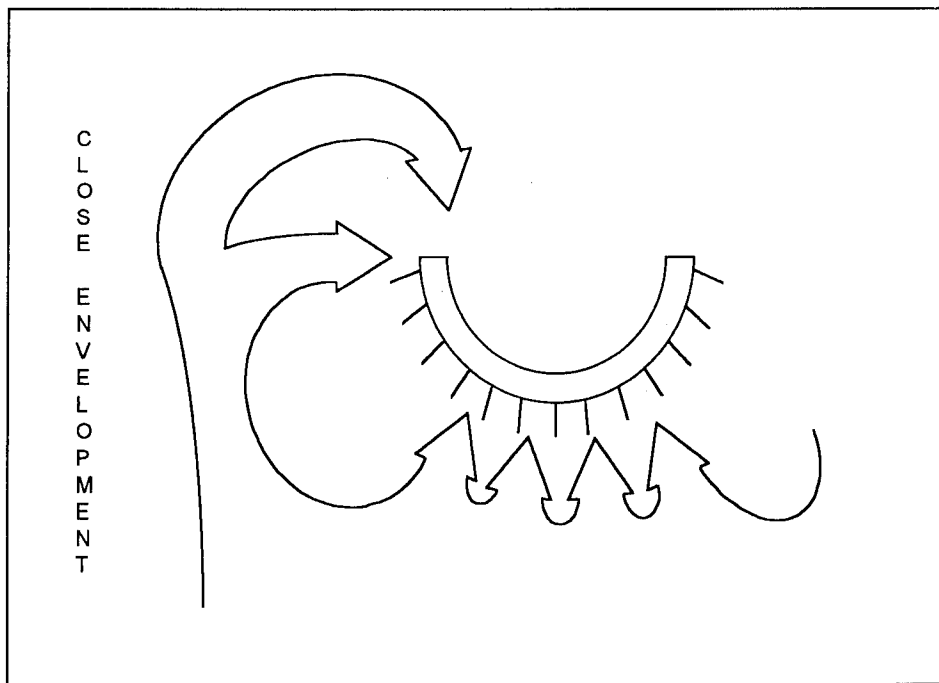

Figure 5-2. Close envelopment combined with frontal attack.

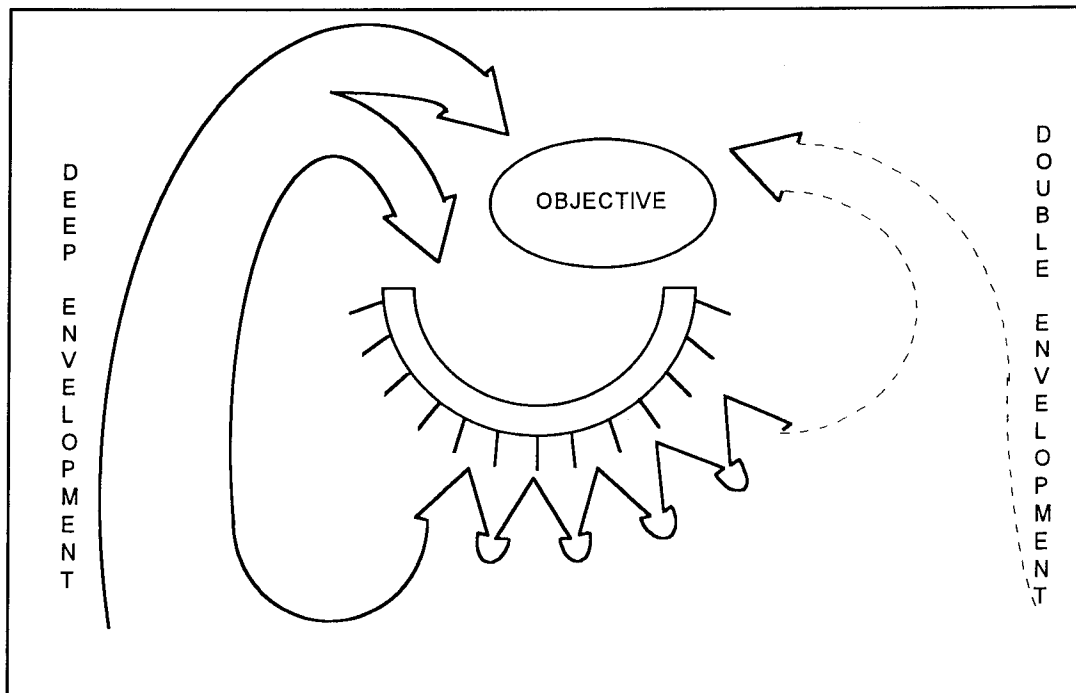

Figure 5-3. Deep envelopment combined with frontal attack.

(FD) could conduct a deep envelopment for a regiment or division; the FD would be inserted through a gap in forward enemy defenses after first-echelon forces in the main attack achieve a penetration. The depth of a deep envelopment for a motorized rifle or tank battalion can be more than 15 km. A regiment may conduct a deep envelopment to a depth of up to 50 km. That depth can be significantly greater in a meeting battle or in a pursuit of the enemy. A tactical commander may also employ airborne or heliborne forces for the deep envelopment.

The OPFOR prefers a **double envelopment**, which can be a combination of two deep envelopments, two close envelopments, or a deep and a close envelopment. It expects to achieve the most success with a deep envelopment of both flanks, encircling the enemy rear. Combining envelopments creates favorable conditions for attacking the enemy's flanks and rear. The OPFOR goal is to encircle enemy groupings, split them, and

then destroy them. Heliborne assault troops can also land simultaneously in the enemy rear. These troops can then assist in accomplishing a double envelopment. Forces carrying out close, deep, or double envelopments ordinarily maneuver in a march or prebattle formation when enemy resistance is light enough not to require the use of battle formation. The enveloping force can transition from march to prebattle to battle formation as the situation dictates.

ELEMENTS OF COMBAT FORMATION

OPFOR tactical commanders organize for combat by assigning units and subunits to function as elements of the **combat formation**. The combat formation corresponds to the situation and facilitates attaining the goal of battle. It should ensure--

- Successful destruction of the enemy.
- Achievement of the assigned mission.

- A combination of fire, movement, and maneuver in the course of the attack.
- Continuous troop control.

The following paragraphs describe the various elements of this OPFOR organization for combat.

Reconnaissance

Each maneuver division has an organic reconnaissance and REC battalion, each maneuver regiment has an organic reconnaissance company, and motorized rifle battalions have an organic reconnaissance platoon. The location of the reconnaissance objectives and the enemy disposition determine how far in front of their parent organization these reconnaissance assets move. In an attack against a defending enemy, they would typically reconnoiter the enemy force whose destruction is the parent organization's immediate mission; then they would move on toward the depth of the subsequent mission. In the march, their purpose is to give the senior combined arms commander maximum warning of enemy forces, in terms of time and distance and to establish the strength and disposition of enemy forces. They also identify terrain features that could slow the OPFOR rate of advance or hinder the accomplishment of the parent organization's mission. (For more information on tactical reconnaissance, see Chapter 4.)

Forward Detachment

A **forward detachment (FD)** is a combined arms force based on a reinforced maneuver regiment or battalion. Divisions commonly establish a regiment-sized FD, or more than one battalion-sized FD, to maneuver ahead of the lead regiments of an advancing division. Although any maneuver regiment can be assigned as an FD, OPFOR

commanders prefer to use BTR-equipped regiments/battalions as FDs (and advance guards), thus keeping the higher combat power of BMP and tank regiments for the main force. If the situation requires, a battalion or regiment from another unit/formation (e.g., from a second-echelon regiment/division or an adjacent division) may be temporarily attached as an FD.

In the march, the FD normally moves ahead of or parallel to the march security elements (advanced guard) of the lead regiments but behind the division's reconnaissance patrols. However, it could also move parallel to the advance guard. The commander of the FD can also dispatch his own reconnaissance patrols.

There is no set distance between the FD and the main body. A regiment-based division FD moves 2 to 4 hours ahead of the parent division's main body; in European terrain conditions, this may translate to a distance of up to 80 km. A battalion-based division or regimental FD moves 1 to 2 hours ahead of the parent organization's main body; this translates to 20 to 40 km.

The FD works for the division or regimental commander. Its mission is based on the location of its objective(s)--key terrain it is to seize and/or enemy groupings it is to destroy. After achieving its objective, the FD may be ordered to defend the objective until its parent organization's main body links up with it, or it may assume a new offensive mission. FDs ensure the unhindered advance of the division or regiment. Elements of FDs can also conduct raids against key targets en route to their objectives.

Unlike advance guards, FDs do not have to follow a specific axis of advance; but they do attempt to avoid enemy contact

while moving to their objective. Passes, defiles, road junctions, and water-crossing sites can be FD objectives. They may link up with airborne or heliborne forces that have landed on these objectives. FDs conduct reconnaissance as they move.

Echelons

OPFOR tactical combat formation in the offense is a response to increasing depth and preparedness of enemy defenses, and is intended to build combat power continuously on the line of contact. OPFOR commanders at divisional, brigade, regimental or battalion levels organize forces either in two echelons or in one echelon with a combined arms reserve. In normal terrain, companies and platoons always attack in a single echelon, without a reserve.

When attacking unprepared or partially prepared enemy defenses, divisions, brigades, regiments, and battalions are likely to attack in a single echelon with a small reserve. As the enemy defense tends from partially to fully prepared, the OPFOR is more likely to use a two-echelon formation. Within the division, the pattern of echelonment can vary at different levels of command. A division might deploy its regiments in two echelons, but some of the regiments might deploy their battalions in one echelon. The OPFOR does not consider a three-echelon combat formation to be normal, but sometimes use it when advancing in the mountains, when maneuver is restricted in an advance along a narrow valley.

Single-Echelon Formation

When attacking defenses that are weak, lacking in depth, or not well-prepared, divisions, brigades, regiments, and battalions normally deploy in a single echelon with a

small combined arms reserve. They would also use a single-echelon formation when attacking on a secondary axis. When using a single-echelon formation, the commander must keep a combined arms reserve; thus, he retains the ability to influence the battle. If he commits his reserve, he must create another one immediately. If the enemy has hurriedly assumed shallow defenses, he will not have a well-prepared defense in depth or strong reserves; and under these conditions, a single echelon may be sufficient to defeat him.

Two-Echelon Formation

A two-echelon combat formation is usual when attacking a defense prepared or at least partially prepared in depth and on the higher commander's main axis. The **first echelon** normally contains the majority of the combat power. Its mission is to destroy the enemy's forward defenses and achieve the immediate mission of the formation/unit/subunit. The commander's concept of the battle would then call for commitment of the second echelon to achieve the subsequent mission.

At the same time the commander issues missions to first-echelon forces, he assigns the **second-echelon** force a mission, a route of advance, and a likely line and time for its commitment. During commitment, the second echelon normally passes through gaps or at flanks to avoid passage of lines and intermingling of forces. Specific second-echelon missions can include--

- Conducting pursuit.
- Destroying bypassed enemy elements.
- Defeating a counterattack.
- Achieving the subsequent mission.

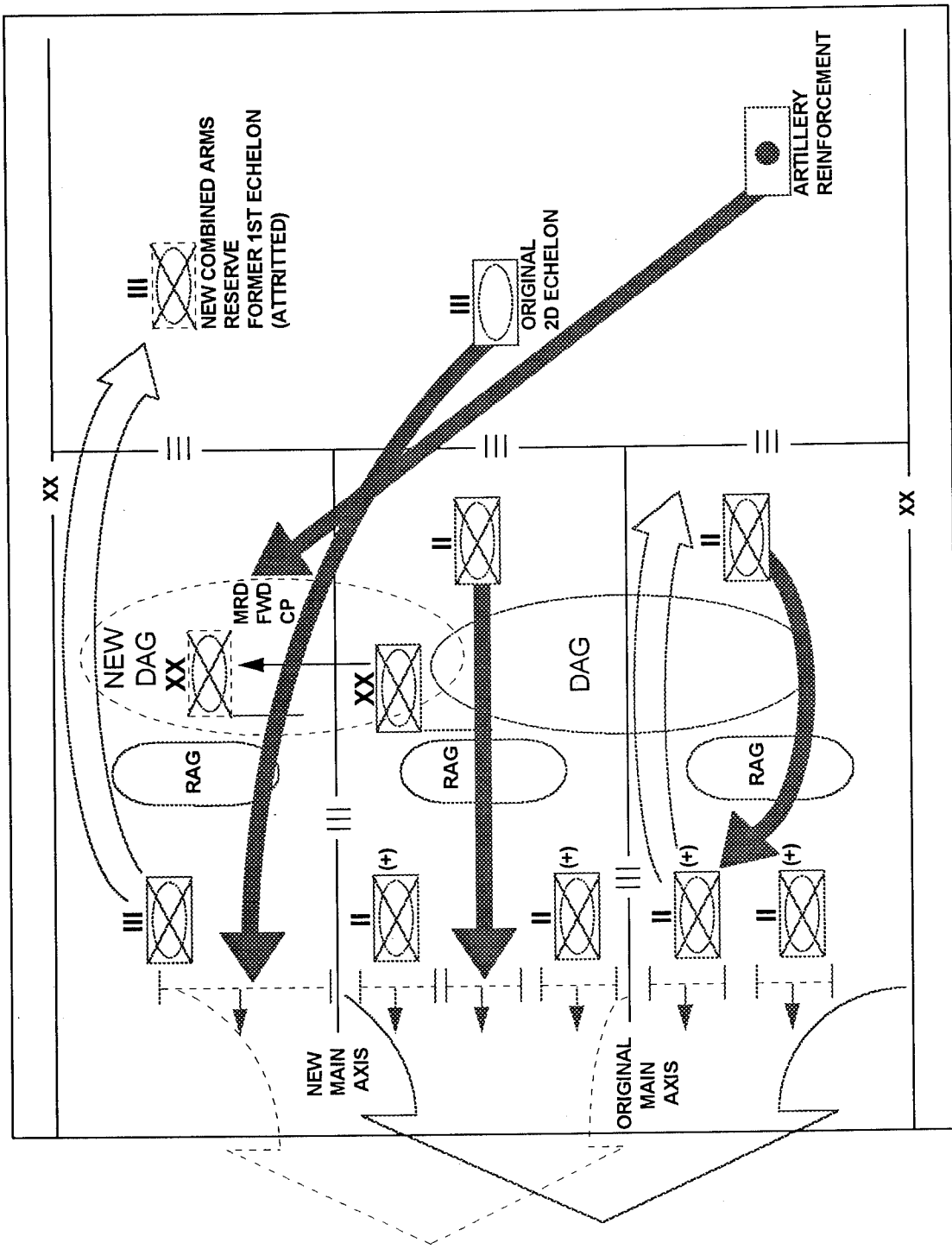

Figure 5-4. Commitment of second-echelon forces.

- Completing the missions of successful first-echelon forces which have been rendered combat-ineffective.

Once he commits the second echelon, he forms a combined arms reserve from elements of the first echelon; the remainder of the first echelon continues its attack to the degree that it is still able.

Although the commander pre-plans deployment lines and time for committing the second echelon, he retains **flexibility** in implementing them, depending on the progress of the battle. It is important to remember that a second echelon is an application of additional force, not a reinforcement for the first echelon. With the OPFOR view of only reinforcing success, the commander does not commit the second echelon to complete an unsuccessful portion of the first echelon's attack. However, the second echelon could be a replacement for a first-echelon force that has been successful, but at the cost of its own combat effectiveness. The second echelon's attack may be on an axis different from the one originally planned. (Figure 5-4 illustrates ways in which a regiment or division may commit its second-echelon forces.)

Combined Arms Reserve

Divisions, brigades, regiments, and battalions can form a combined arms reserve, but only if attacking in a single echelon. The combined arms reserve is small, and is directly subordinate to the commander. The commander does not assign the combined arms reserve a specific mission, but only a route and method of advance. The combined arms reserve is a **contingency force** used to meet unanticipated events and to deal with tasks such as exploiting unexpected success, repelling counterattacks, and covering the flanks of the parent organization.

Antitank Reserve

The commander employs the antitank reserve as a blocking force against an enemy counterattack during the offense, and it also can cover threatened areas and open flanks. It can be reinforced with engineer assets, usually in the form of a mobile obstacle detachment (MOD).

Special Reserves

A division or regiment can form special reserves depending on the tactical situation. These may include chemical protection or engineer reserves. Their primary roles are to reinforce efforts on the main axis and/or to cope with unforeseen problems requiring specialty skills.

Artillery Groups

In highly mobile, fluid battles, a significant proportion of the available artillery may be decentralized to lower commanders. With organic artillery and additional assets allocated from higher levels, tactical commanders form division artillery groups (DAGs), brigade artillery groups (BrAGs), regimental artillery groups (RAGs). Individual maneuver battalions can also receive up to a battalion of artillery in an attached or supporting role. See Chapter 7 for a detailed discussion of artillery allocation.

Air Defense Grouping

Priorities in deploying air defense assets are usually to protect command posts, then artillery groupings and first-echelon forces.

Raiding Detachment

At the tactical level, a raiding detachment is a highly mobile combined-arms unit or subunit, usually a reinforced battalion. Its primary mission is to destroy or capture important military targets; such objectives can include an artillery battalion, tactical missile batteries, elements of a reconnaissance-strike complex, a fire support helicopter forward base, a supply base/depot, or a river-crossing site. Its secondary missions can include seizing important terrain and blocking enemy reserves.

Like a forward detachment, a raiding detachment also sends out its own combat reconnaissance patrol(s) and seeks to avoid contact en route to its objective(s). Although its organization, movement methods, and objectives are similar to those of an FD, a raiding detachment differs in that it usually (but not always) has orders to rejoin its parent unit/formation after completing its mission. If not ordered to rejoin its parent organization, a raiding detachment could receive a new offensive mission or defend its objective until the parent organization links up. Reinforced companies and platoons can also conduct raids.

Enveloping Detachment

An enveloping detachment is a unit or subunit whose mission is to penetrate through gaps in the enemy's defense striking at enemy forces on their flanks or in their rear. The OPFOR stresses the importance of enveloping detachments in offensive battle in mountainous areas where typical missions include seizing important terrain features. In mountains, an enveloping detachment often acts in coordination with a tactical airborne or heliborne landing; in coastal regions, it could cooperate with an amphibious landing.

It could also be used in conjunction with a nuclear, high-precision weapon, or chemical strike.

Within maneuver battalions and companies, the OPFOR may use an **armored group** as a smaller-scale **enveloping group**. The armored group is a temporary grouping of 4 to 5 tanks, BMPs, BTRs, or any combination of such vehicles. In this role, BMPs or BTRs would deploy without their normally assigned infantry squad on board and fight away from their dismounted troops. The armored group can thus act on an independent axis to attack the enemy flank or establish a blocking force to his rear. It has significant direct-fire capability and serves as a mobile reserve attack force for the battalion or company commander.

TACTICAL FORMATIONS

Within each element of the combat formation, an attacking force can deploy into any of the three types of **tactical formation--march, prebattle, or battle--**depending on its mission and the combat situation. The OPFOR employs a standard drill for deployment into battle. This drill can be incorporated in almost any form of attack, but is most common in the attack from the march and the meeting battle. The drill proceeds from **march formation** (regimental and battalion columns), through **prebattle formation** (company and platoon columns), into **battle formation** (platoons deployed on line). The sequence of deployment and the distances of the lines of deployment from the enemy are determined by tactical considerations. Figure 5-5 illustrates this process, using the example of a reinforced motorized rifle battalion deploying for an attack from the march.

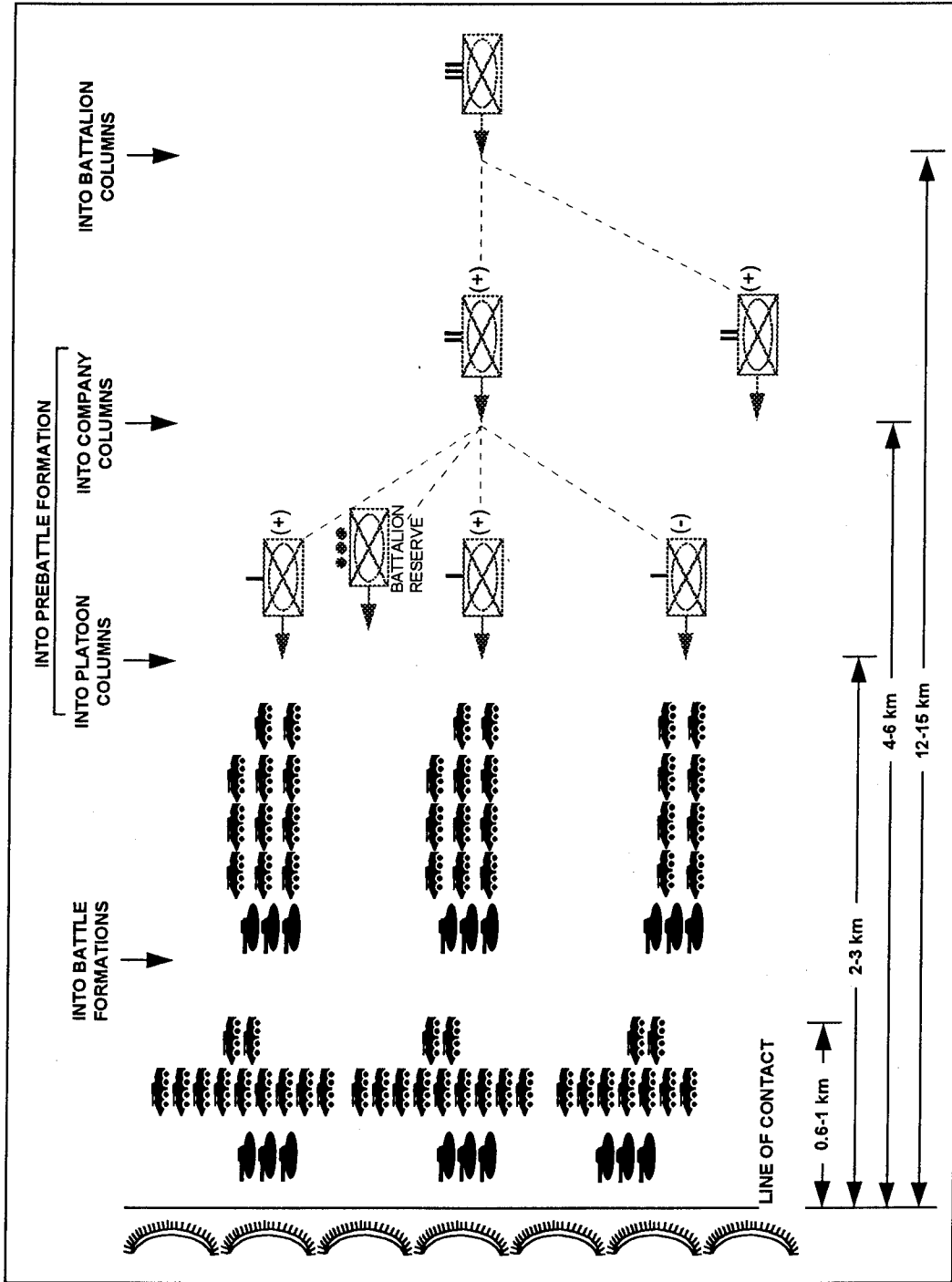

Figure 5-5. MRB deployment for attack from the march.

March Formation

The OPFOR prefers to remain in column or march formation as long as possible for the sake of speed. It resorts to lateral deployment only by necessity, such as when combat is imminent. Up to that point, the maneuvering force is in some sort of tactical march formation. Chapter 3 focused on division and regimental tactical marches; the following section narrows the focus to battalion and company level.

Prebattle Formation

When nearing the enemy's defensive line, the OPFOR uses prebattle formation as a **transition** between the march and battle formations. Prebattle formation focuses on **speed, dispersion, flexibility, and firepower** in an anticipated direction. When entering prebattle formation, the OPFOR deploys into **successively smaller unit and subunit columns**. These multiple columns increase forward combat power until forces reach the attack line and assume the battle formation. In prebattle formation, the columns have greater lateral dispersion, but less depth than in the march formation. The OPFOR uses prebattle formation when:

- Approaching the battlefield.
- Developing the attack into the depth of the battle area.
- Pursuing the enemy.
- Attacking a defending enemy whose defenses are weak or effectively suppressed.
- Crossing NBC-contaminated zones rapidly.
- Crossing areas with natural or artificial obstacles.
- Crossing areas that are burning.

Prebattle formation minimizes troop vulnerability to enemy artillery and air strikes as well as high-precision weapons or tactical nuclear strikes. It allows for rapid maneuver and quick deployment into battle formation. By remaining in a column, the OPFOR maximizes its speed, presenting a minimum number of targets for the enemy's forward direct-fire weapons systems. The disadvantage of remaining in columns is the OPFOR's inability to use all its fire systems against enemy positions directly to its front. Forces in prebattle formation either deploy into battle formation or return to march formation, depending on the tactical situation. A force might remain in this formation for a lengthy period of time. It normally would pass through some form of prebattle formation when moving from the march into full deployment for an attack.

Division

The division does not have an actual prebattle formation. Its formation results from the maneuver regiments assuming their own prebattle formations. Forward detachments and advance guards assume a prebattle formation when the chance of enemy contact increases or when they are about to attack an objective. **Not every element in a division, regiment, or battalion assumes a prebattle formation at the same time.** The main bodies of each respective element of the march remain in march formation until required to deploy into a prebattle formation. This applies to second-echelon forces as well. It helps maintain these forces' speed of advance, allowing rapid maneuver and subsequent employment.

Regiment

The regiment assumes a prebattle formation by deploying from a single regi-

mental column of battalions in its main body into **individual battalion columns**. The number of battalion columns depends on the tactical situation and the choice of echelonment that the situation dictates.

Deployment into battalion columns should begin beyond the range of the bulk of the enemy's artillery, at a line approximately **12 to 15 km** from the enemy forward edge. The artillery preparation of the attack is usually timed to begin as the attacking force reaches this line.

Battalion

In a similar manner, a battalion assumes prebattle formation by deploying from a single battalion column of companies into **individual company columns**. Figure 5-6 illustrates variations of battalion prebattle formations.

Within the battalion prebattle formation, each company moves in march column. In relation to one another, the company columns may be configured in a line, in a forward or reverse wedge, or echeloned left or right. To control both the movement and the battle, the battalion commander normally travels directly behind the lead company/companies in the prebattle formation. (An exception would be in the reverse wedge formation, in which he may travel at the head of the trailing company, because of its central location.)

Subunits from battalion down to platoon rehearse and drill to ensure that they can rapidly deploy from the march to the prebattle formation, then to the battle formation, and back. Movement in these formations serves as a battle drill for the subunit commander. It provides the basis for a rapid

reaction attack from the march or a planned attack against a defending enemy.

The **line of deployment into company columns** is set outside the maximum range of the defender's antitank weapons, tanks, and other direct fire systems. This is usually **4 to 6 km** from the enemy forward edge, depending on the terrain.

Company

The company prebattle formation is the final stage of deployment before battle formation. A company in prebattle formation does not laterally deploy beyond **platoon columns**. The intervals between company and platoon columns in prebattle formation should allow full deployment of the subunit into battle formation without further lateral expansion of the entire formation. To facilitate control, the company commander travels directly behind the lead platoon in the prebattle formation. Figure 5-7 shows the variants of prebattle formations for a motorized rifle or tank company.

The **deployment line into platoon columns** is ideally located in terrain that screens the deployment, particularly from the defenders' short-range antitank weapons. It would normally be **2 to 3 km** from the enemy forward edge.

Unlike higher-level organizations, the company does not necessarily have to use a prebattle formation. It can go directly from the march into battle formation, if the situation requires.

Battle Formation

The OPFOR uses battle formation (attack formation) when encountering **strong enemy resistance** during--

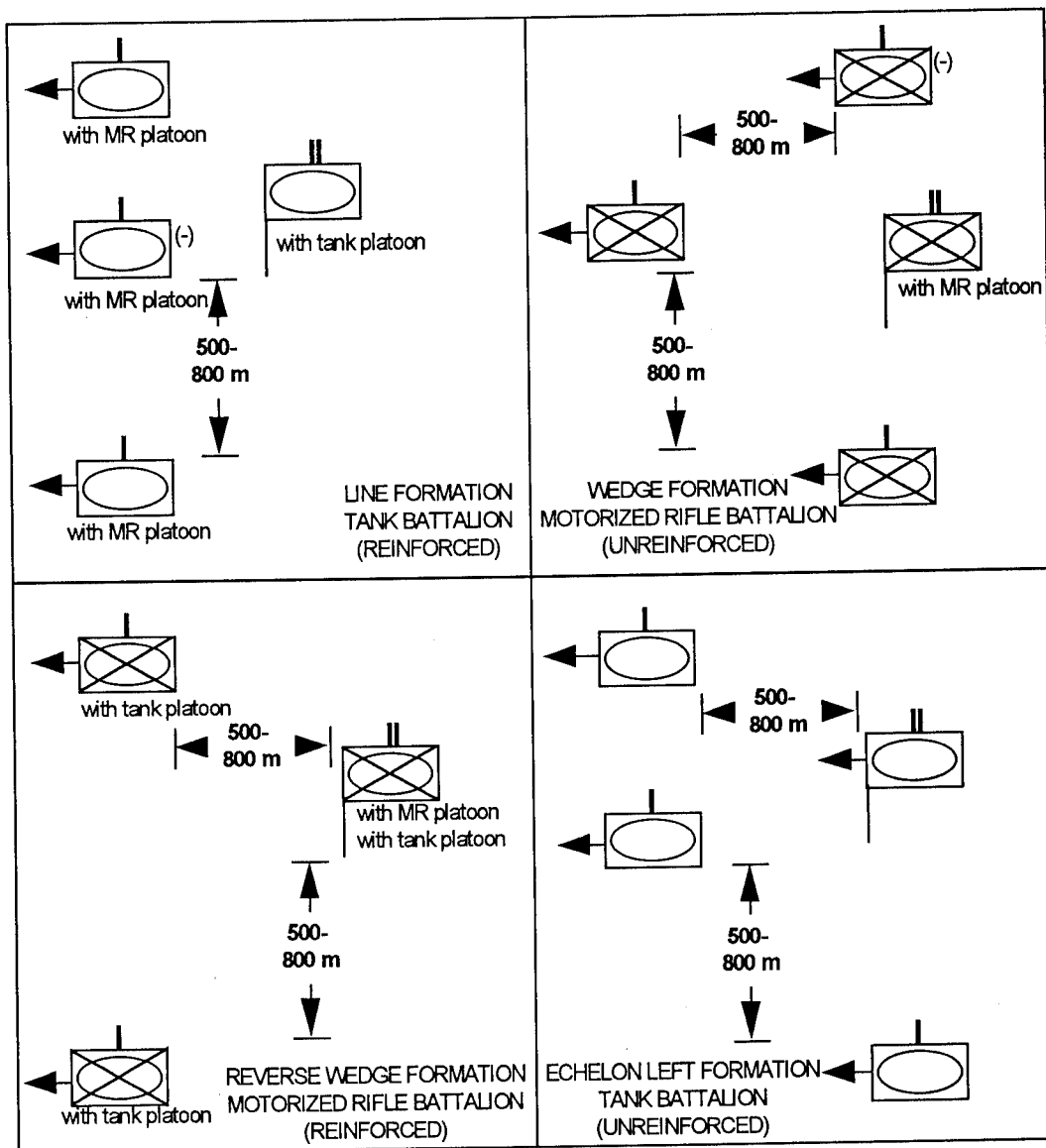

Figure 5-6. Battalion prebattle formations.

- The meeting battle.
- The attack against a defending enemy.
- The pursuit.
- The counterattack.

Only those elements in contact with, or expecting immediate contact with, the enemy deploy into the battle formation. Therefore, divisions and regiments do not have actual battle formations, but their subunits do.

Battalion

A maneuver battalion reaches battle formation when its **first-echelon companies deploy on line**. Its second-echelon companies remain in march or prebattle formation until they are actually committed. OPFOR maneuver battalions are reinforced with several combat and combat support subunits

MOTORIZED RIFLE COMPANY (BTR) WITH ATTACHED TANK PLATOON

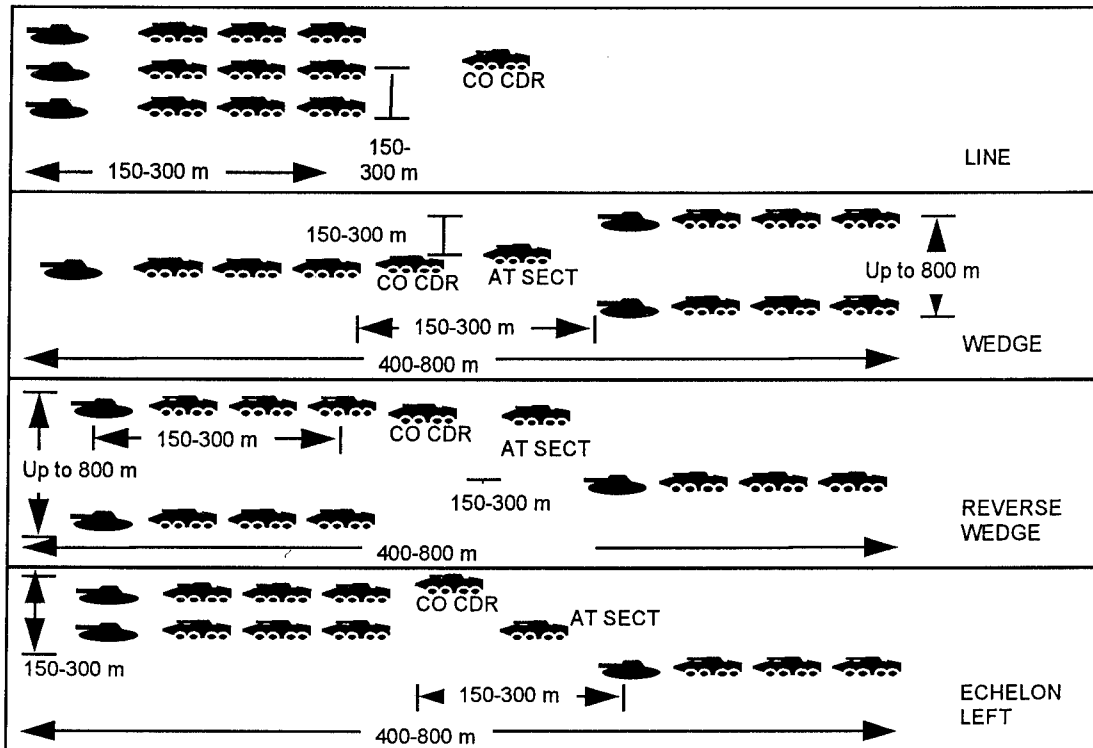

TANK COMPANY

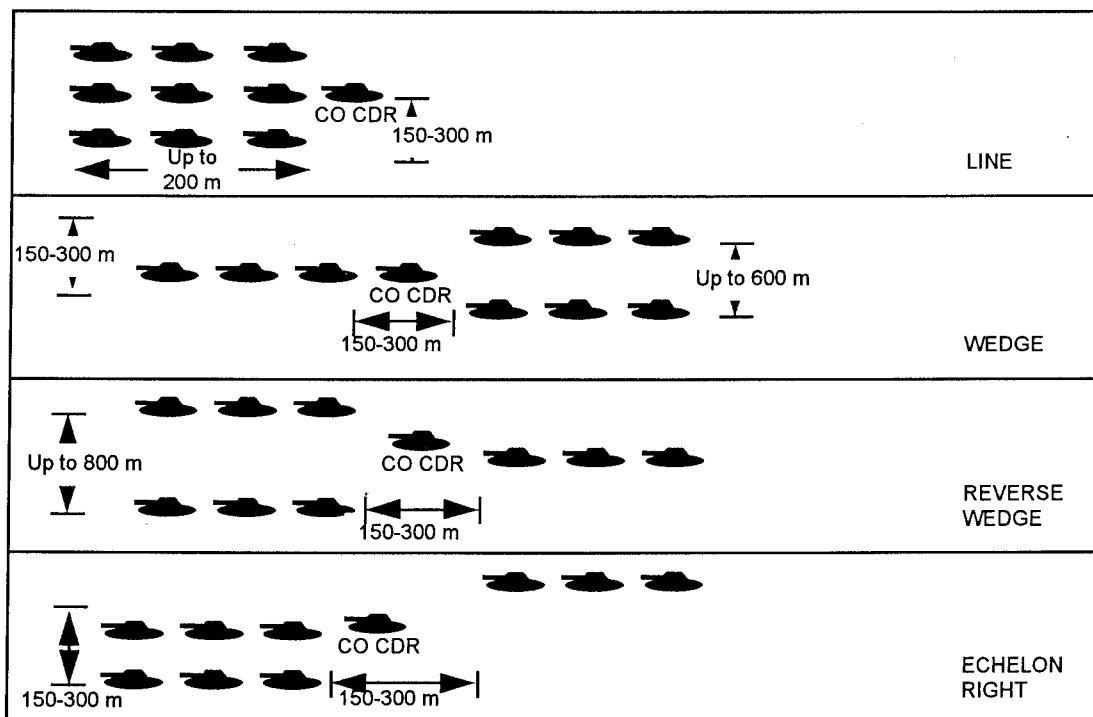

NOT TO SCALE

Figure 5-7. Company prebattle formations.

prior to contact with enemy forces. Reinforcement usually takes place in assembly areas or before reaching the start line for the march. These reinforcing subunits deploy to become part of the supported maneuver battalion's battle formation. Figure 5-8 shows two variations of a motorized rifle battalion battle formation.

Company

An OPFOR company assumes battle formation immediately before combat. When the company's **platoons and any reinforcing subunits disperse laterally into line formation**, the company is in battle formation. Within the company, platoons do not have to be formed on line but can be arrayed in wedge or echelon formations, based on the situation. However, an array of platoons on line is most common. Figure 5-9 gives examples of possible company battle formations.

Battle formation maximizes the firepower of the subunit by bringing to bear the greatest number of weapons systems. Conversely, it is the slowest moving and least controllable of all tactical formations. As a result, an OPFOR subunit would **assume battle formation only when necessary**.

The **line of transition to the attack** is the line by which the attackers deploy into battle formation, with platoons on line and tanks in front of the infantry vehicles. Its location depends on the preparation of the enemy defense and the degree of destruction inflicted by the attackers' artillery. The line should be outside the range of enemy anti-tank weapons and small arms and permit a rapid advance into the enemy positions. It is usually at least 600 meters from the enemy forward edge, but can be farther out (up to 1,000 meters). In any event, it is farther

forward than the supporting RAG (or BrAG), but still beyond the range of the enemy's short-range ATGMs.

Dismount Line

When the terrain is unfavorable for vehicular movement or when enemy antitank defenses are too strong, the motorized rifle squads dismount and advance on line. The regulation dismount line is never more than 1,000 meters from the forward edge of enemy troops; it should be as close to enemy positions as the terrain allows. If possible, it is in an area of some cover from enemy small arms and short-range antitank weapons, usually 300 to 400 meters from enemy defenses.

If troops dismount, they follow as closely as possible behind the tanks. Their BTRs or BMPs follow 100 to 200 meters behind the infantry, providing supporting fire. The vehicles may move on the flank of, or within, the skirmish line, depending on terrain conditions and intensity of enemy fire.

Safety Distances

The location of the dismount line also is closely related to the minimum safety distance from **friendly artillery fire**. The reason for this is that the final fires of the OPFOR artillery preparation for the attack would concentrate on the most forward enemy defensive positions, just in front of the advancing attackers. The safety distance from gun and howitzer fire is only 200 meters for tanks, but 300 meters for BMPs and BTRs and 400 meters for dismounted infantry. These distances may be reduced significantly if the OPFOR artillery uses air-burst flechette rounds. If the OPFOR uses multiple rocket launchers, the safety distance in

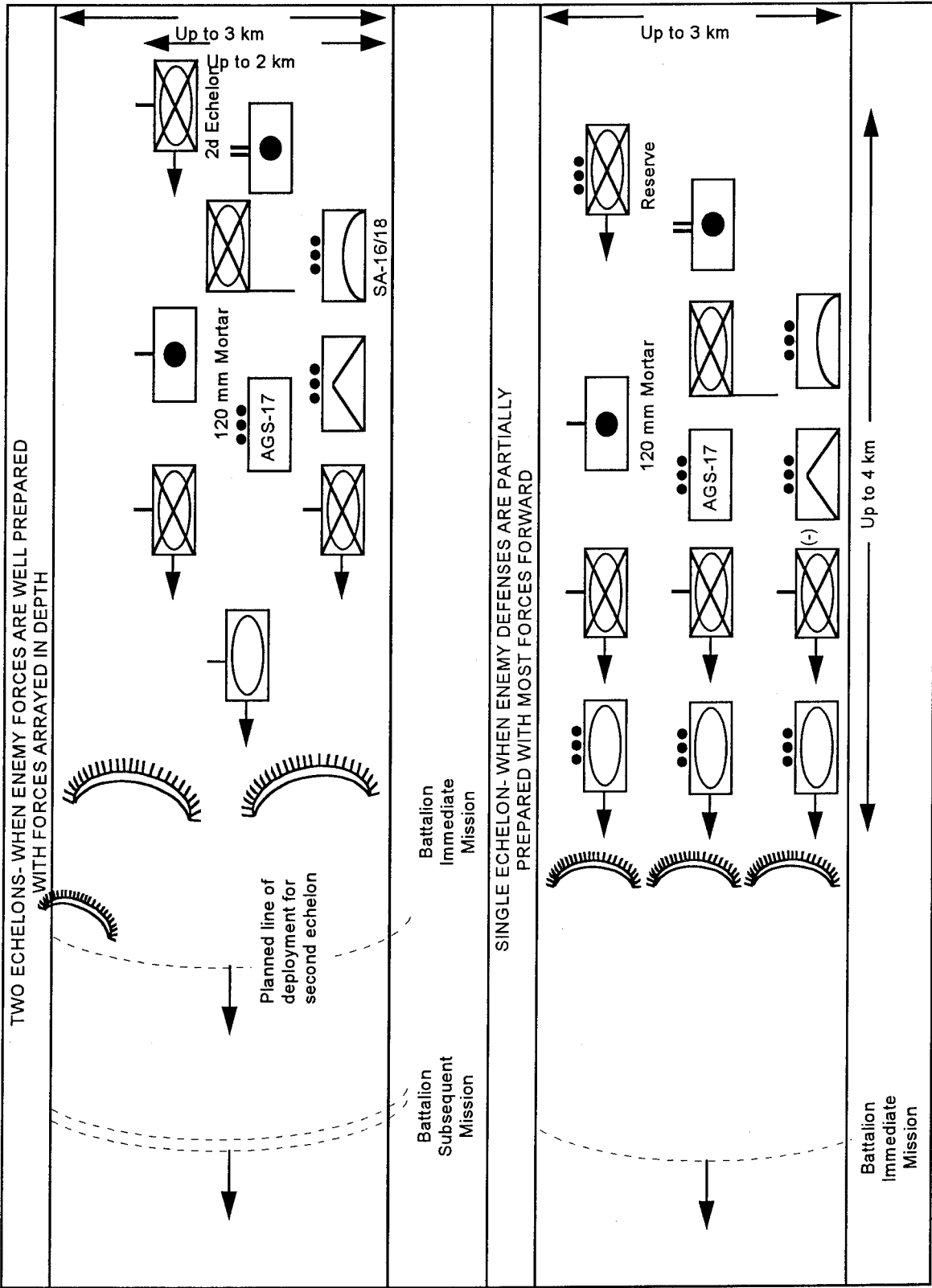
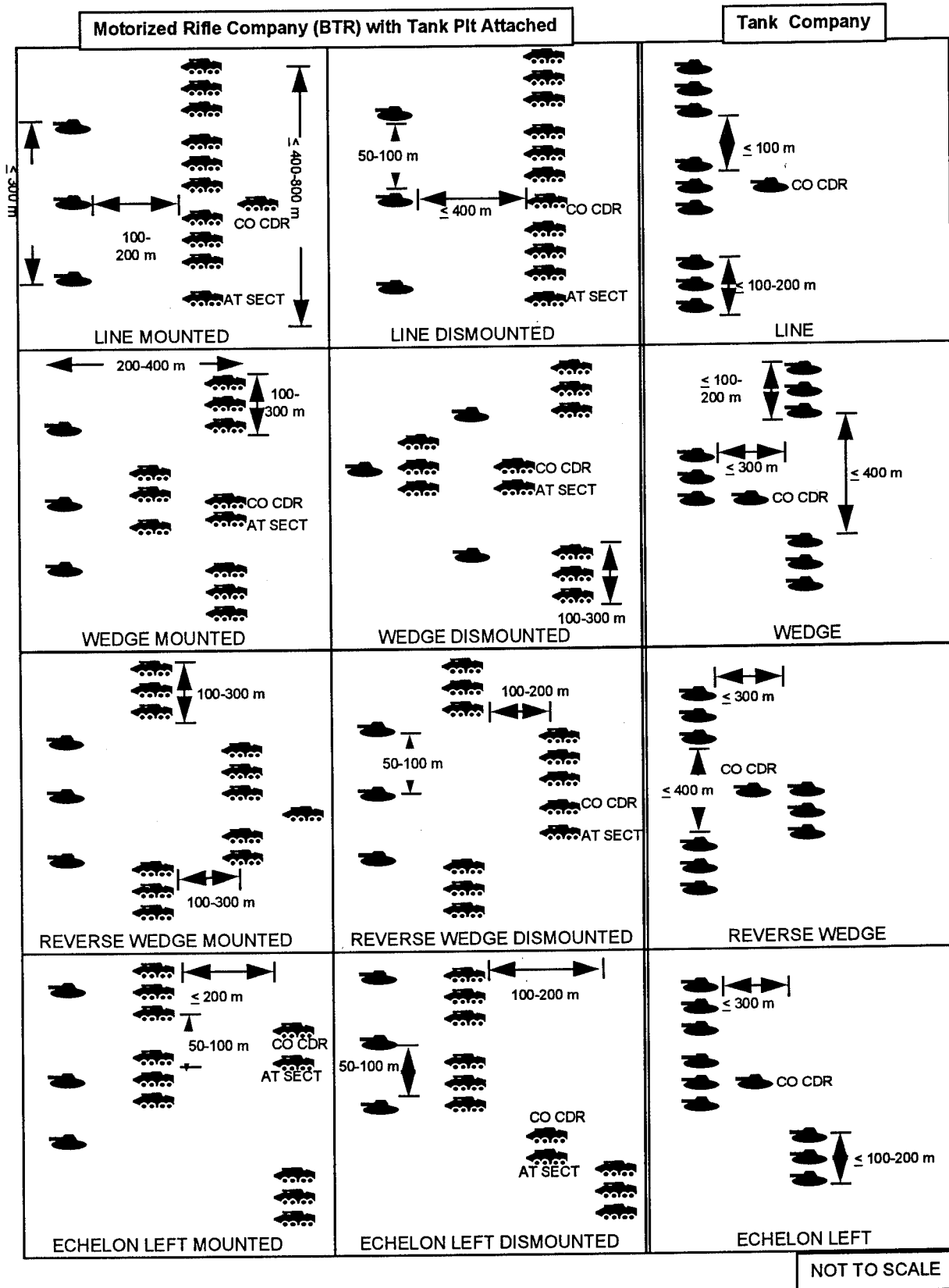

Figure 5-8. Battalion battle formations (reinforced MRB).



NOT TO SCALE

Figure 5-9. Company battle formations.

creases to 1,000 meters; for air strikes, it is 200 to 700 meters.

TYPES OF OFFENSIVE ACTION

OPFOR military art defines three basic types of tactical offensive action, distinguished by the enemy situation. If the OPFOR is attacking and the other side is defending, it is an **attack against a defending enemy**. If both sides are advancing and trying to attack, it is a **meeting battle**. If the enemy is trying to retreat and the OPFOR is attacking, it is a **pursuit**. In all cases, the method of launching an attack must ensure concealment of its preparation and the delivery of surprise and powerful strikes against the enemy.

ATTACK AGAINST A DEFENDING ENEMY

At the tactical level, the attack against a defending enemy is **the basic form of offensive combat**. An OPFOR commander employs the attack against a defending enemy when the enemy is in a defensive position and his location is known. The attack plan is based on available intelligence on enemy deployment and the factors of mission, terrain, troops, and time available.

It is incorrect to interpret the attack against a defending enemy as a "breakthrough" or "deliberate attack." These terms do not fully describe all the situations in which an OPFOR commander may conduct such an attack. As the OPFOR term states, the attack is executed against an enemy in a defensive position. It can occur in a variety of situations: envelopments, supporting attacks, penetrations of the enemy defense, and exploitation. The OPFOR

uses two methods to transition into an attack against a defending enemy:

- Attack from the march (also called advance from the depths).
- Attack from a position in direct contact with the enemy.

Figure 5-10 illustrates the difference between the two methods, using examples of a reinforced motorized rifle battalion performing each type of attack. For further examples, see the following sections.

Attack from the March

The attack from the march is the **preferred OPFOR method** of attacking a defending enemy. The attacking force is not in tactical contact with the defender beforehand. It prepares its attack in an assembly area, hidden from the enemy and out of range of his artillery. It moves out of the assembly area, toward the enemy, and deploys into battle formation under cover of artillery and air support. The deployment takes place in territory held by friendly forces in contact.

This method of attack limits the enemy's capability to maneuver and helps to achieve surprise. Advancing in march formation, subunits deploy laterally at designated control lines. They assume battle formation within approximately 1,000 meters of enemy defenses. The attack from the march is usually conducted through a friendly defending force. This defending force supports the attack providing security for the artillery buildup.

The OPFOR sees these **advantages** in an attack from the march:

- The unit/subunit is not committed before attack.
- The attack increases the chance of

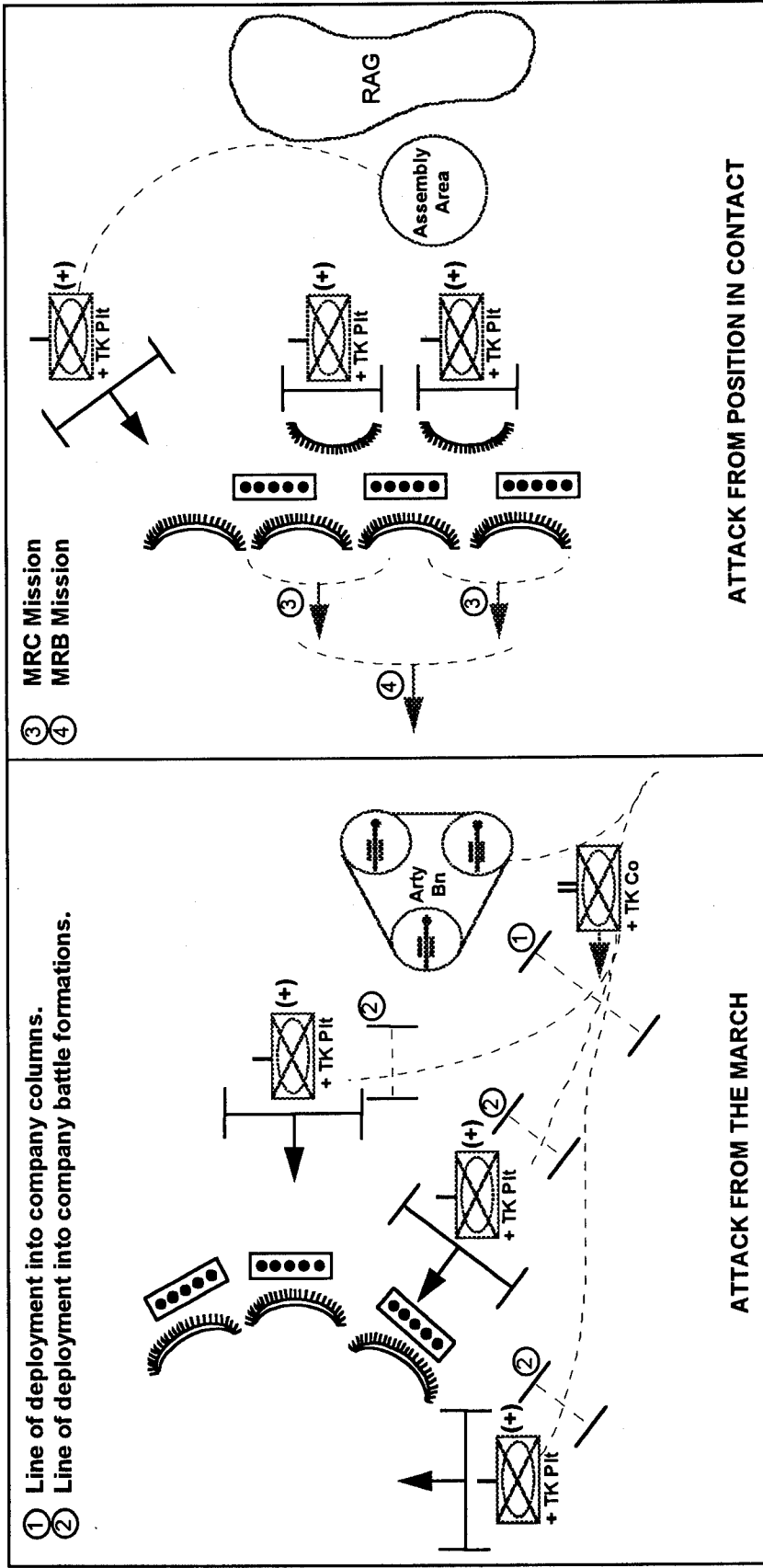

Figure 5-10. Attack against a defending enemy (reinforced MRB).

- surprise.
- It allows greater flexibility.
- The vulnerability to enemy artillery decreases.
- Momentum is enhanced.
- Preparation for combat takes place out of contact with the enemy.

The OPFOR realizes that an attack from the march also has disadvantages:

- Commanders may not be familiar with terrain and enemy dispositions.
- Coordination of fire, maneuver, and simultaneous combined arms efforts is more difficult.

Attack from a Position in Direct Contact

An attack from a position in direct contact occurs when the attacking force is already in contact with the enemy, typically with both sides holding defensive lines. The OPFOR launches this **less preferred attack** from a position that may be part of the OPFOR frontline defensive position, or an assembly area immediately behind it. It uses this form most often when changing over to the offense from the defense. It may also include maneuver of reserves from the depth.

An attack from a position in direct contact begins with the attacker in tactical contact with the defender. Such a position might occur as the result of an earlier unsuccessful attack, after which the OPFOR unit or formation had to go over to the defense on the line achieved.

The OPFOR feels there are certain advantages from an attack from a position in direct contact:

- It allows more thorough study of terrain and enemy disposition.

- It permits more refined organization of battle.
- It facilitates coordination of fire and maneuver.

The OPFOR also recognizes **disadvantages** in using this type of attack:

- The unit/subunit may already be committed.
- The unit/subunit is under threat of attack during preparation and is vulnerable to enemy observed fires.
- The unit/subunit has less chance of achieving surprise.
- The unit/subunit has less chance of building up momentum and of overcoming inertia.

Combination of Types of Attack

Obviously it is possible to combine the two types of attack against a defending enemy. After an unsuccessful first attack from the march, a regiment or division might try again, using first-echelon troops in an attack from a position of direct contact and new, second-echelon forces in an attack from the march.

Axes

In planning an attack, an OPFOR commander always selects an axis of main effort. He concentrates the bulk of his resources on the **main axis**, to ensure he obtains the ratio of forces required for success. An OPFOR commander never has more than one axis of main effort. Once they have chosen the main axis, OPFOR commanders make every effort to achieve overwhelming superiority on that axis. This superiority can best be secured if the main effort is made where the enemy least expects it.

Resources are never shared equally among subordinates; the OPFOR considers it a waste of resources to allocate to a **secondary axis** more than the minimum resources required there. If, during the course of the battle, the force on the main axis is not achieving the expected result, OPFOR commanders would not hesitate to strip assets away to support a secondary axis that appears to be achieving a greater success. In some types of terrain, such as mountain areas, secondary axes can receive more combat and service support than they would in normal terrain.

Attack Zones and Strike Sectors

Figure 5-11 lists average widths of **attack zones** (frontages) and **strike sectors** (penetration sectors/sectors of main effort) at the tactical level. These are no more than rules of thumb, and it is wrong to think that an OPFOR commander applies these to his map as a rigid template. The actual distances are determined by the calculation of **superiority ratios** and, to a lesser extent, by the **terrain** over which the attack is conducted.

Missions and Objectives

The OPFOR focuses more on the **destruction of enemy forces** than on key terrain when it assigns missions and objectives. In nonlinear combat and deep battle, OPFOR commanders may give subordinates **objectives** in the form of "goose eggs." Unlike his U.S. counterpart, however, the commander does not place this goose egg on key terrain, but rather

on the area occupied by a particular enemy force. In combat that is basically linear, OPFOR commanders assign their subordinates immediate and subsequent **missions**, in terms of the rear boundary of an enemy force they are to destroy. The depth of the immediate or subsequent mission depends on a number of factors, the numerical strength and combat capabilities of both OPFOR and enemy forces, their assigned mission, and the terrain. One of the most significant factors is the level of preparedness of the enemy's defense.

Enemy Preparedness

To the OPFOR, any defense with less than 8 hours' preparation is **unprepared**, since the enemy has had time to emplace only part of his covering force. Preparation in the first 6 to 8 hours is probably limited to basic primary fighting positions for individual soldiers, crew-served weapons, fighting vehicles, and artillery. The OPFOR defines a **fully prepared** defense as one with over 48 hours of preparation, with all defenses in place and fully engineered. This can include--

- Completion of trench lines (including communications trenches).
 - Construction of overhead cover for portions of the trench line, especially for weapons positions.
 - Improving primary fighting positions for vehicles and artillery (normally by the units themselves, rather than engineers).
 - Construction of alternate fighting positions.
- Anything in between these two extremes is **partially prepared**.

	ATTACK ZONE (km)	STRIKE SECTOR (km)
Division	15-25	4-18
Regiment	5-10	2-4
Battalion	Up to 3	0.4-1

Figure 5-11. Typical attack zone and strike sector widths.

While the OPFOR would prefer to attack an unprepared defense, it realizes that such opportunities will probably be rare. Likewise, it does not expect routinely to encounter and have to attack fully prepared positions. Therefore, under what the OPFOR considers “normal” conditions, it expects to surprise the enemy in a **partially prepared defense**. These are the conditions under which it hopes to conduct the majority of its attacks. In exceptional cases, the OPFOR may have to attack under less likely and less favorable circumstances; when it must attack a well-prepared enemy, it would have to reduce the depth of assigned missions.

OPFOR missions are related to the ratio of forces in the attack zone and the strike sector. This makes it possible to express their depth in terms of enemy deployments, rather than a fixed number of kilometers. For example, the immediate mission of a first-echelon battalion attacking through a **fully prepared**, heavily engineered defense (over 48 hours preparation) in a strike sector is the rear of an enemy first-echelon company. Its subsequent mission is the enemy first-echelon battalion's rear boundary. Against a **partially prepared** enemy defense, the normal immediate mission of an attacking battalion is the enemy battalion rear, and its subsequent mission is the rear of the enemy brigade reserve. This should also be the attacking regiment's immediate objective. These are **guidelines that can be modified** in light of the density and quality of the defense. These planning factors are common to both forms of attack on a defending enemy.

Linear Missions

An OPFOR commander usually assigns a subordinate a **mission** that is graphi-

cally represented by a line. This line often corresponds to the rear boundary of an enemy unit. The mission includes two elements: **destruction of the enemy within a zone and seizure of the assigned line**. The subordinate must achieve both of these by a specified time. This kind of mission is most common when combat is basically linear.

Nonlinear Objectives

In nonlinear combat and deep battle, commanders may give subordinates **objectives** in the form of “goose eggs.” The goose egg is normally force-oriented, rather than terrain-oriented. Second echelons usually are committed against lines, whereas reserves are committed against goose eggs. Forward detachments and heliborne or amphibious landings usually have goose-egg objectives.

Continuation of Attack

After accomplishing the assigned mission or objective, the attacking force **continues its attack** as long as it remains combat effective. The OPFOR commander could consider a temporary halt to the offensive, to reorganize his force, when his combat potential drops to 60 percent. Historically, however, OPFOR commanders have continued to fight the offense at 45 percent strength and defensively at 20 percent. The surviving enemy combat potential is a large determinant of whether or not the OPFOR commander can continue the mission, in its present form. It also depends on the length of time over which losses have occurred. In isolated combat, should the mission dictate, the OPFOR might continue to fight to the bitter end.

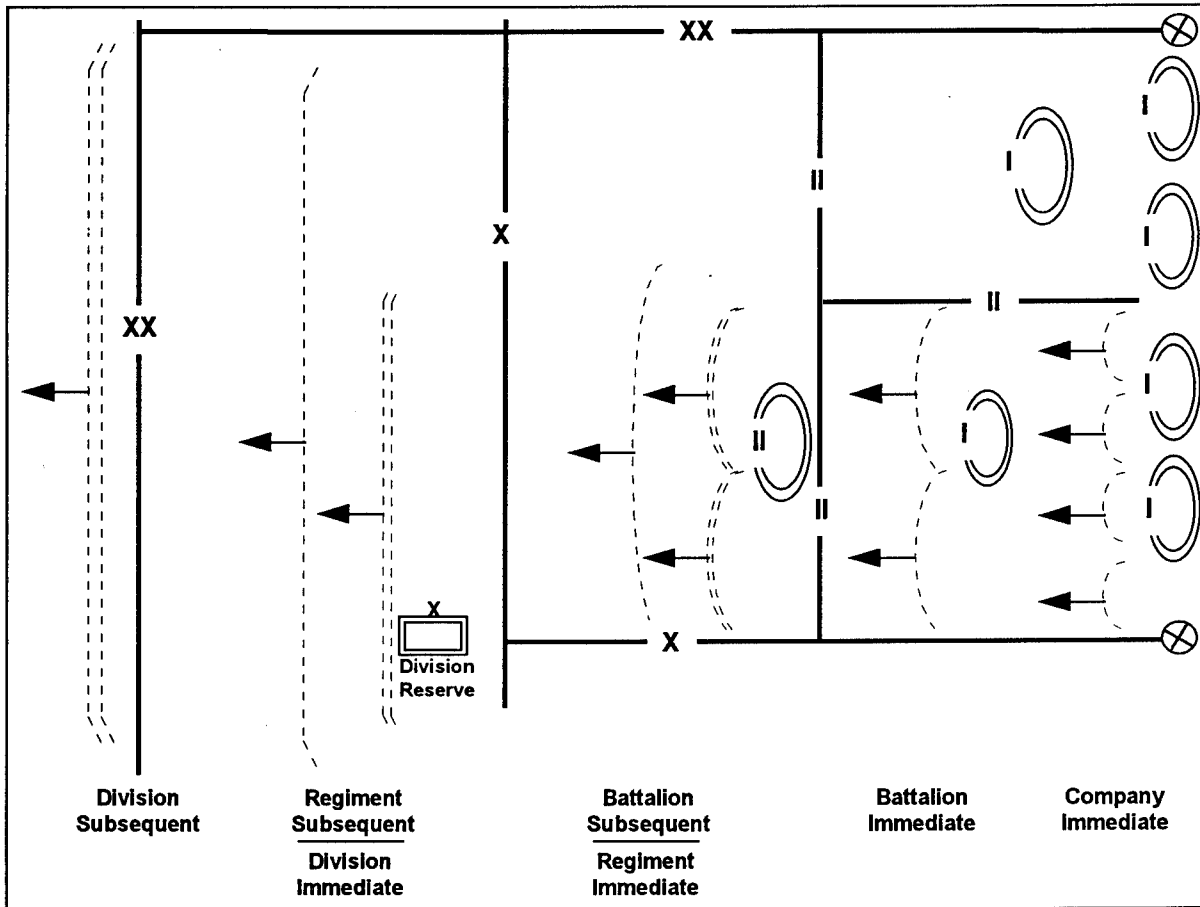

OPFOR First Echelon	IMMEDIATE	SUBSEQUENT	
	Destroy/Take Positions of	Complete Destruction of	Destroy/Take Positions of
DIVISION (Day 2-4)	Rear of Division	Rear of Division	Corps
DIVISION (Day 1)	Reserve Brigade of Division	Reserve Brigade of Division	Rear of Division
REGIMENT/BRIGADE	Rear of 1st-Echelon Brigade	Rear of 1st-Echelon Brigade	Reserve Brigade of Division
BATTALION	Rear of 1st-Echelon Battalion	Rear of 1st-Echelon Battalion	Rear of 1st-Echelon Brigade
COMPANY	Rear of 1st-Echelon Company	Direction of Advance (Toward Battalion Immediate Mission)	
PLATOON	Rear of 1st-Echelon Platoon	Direction of Advance (Toward Company Immediate Mission)	

Figure 5-12: Probable mission depths against partially prepared defense.

OPFOR First Echelon	IMMEDIATE	SUBSEQUENT	
	Destroy/Take Positions of	Complete Destruction of	Destroy/Take Positions of
DIVISION (Day 2-4)	Rear of 1st-Echelon Brigade	Rear of 1st-Echelon Brigade	Rear of Division
DIVISION (Day 1)	1st-Echelon Brigade Reserve	1st-Echelon Brigade Reserve	Rear of 1st-Echelon Brigade
REGIMENT/ BRIGADE	Rear of 1st-Echelon Battalion	Rear of 1st-Echelon Battalion	1st-Echelon Brigade Reserve
BATTALION	Rear of 1st-Echelon Company	Rear of 1st-Echelon Company	Rear of 1st-Echelon Battalion
COMPANY	Rear of 1st-Echelon Platoons	Direction of Advance (Toward Battalion Immediate Mission)	
PLATOON	1st-Echelon Squads, Tanks, and Other Assault Objectives	Direction of Advance (Toward Company Immediate Mission)	

Figure 5-13. Probable mission depths against fully prepared defense.

Types of Missions

The OPFOR breaks down a combat mission into **immediate** and **subsequent** missions. The immediate mission involves the destruction of the enemy's main forces and seizure of a line that the OPFOR can use to start an exploitation and begin completing the destruction of the enemy. The subsequent mission should result in the complete destruction of the enemy force, including his reserves, and it should include the seizure of another specified line deep in the enemy rear.

An OPFOR commander can assign a **subsequent direction of advance** to a subordinate, either in addition to or instead of a subsequent mission. This assignment depends on the size and function of the subordinate's force. The subordinate will follow this direction to assist in achieving his superior's subsequent mission. By setting the direction of further advance, the commander

ensures his subordinates maintain a high tempo of advance.

Figure 5-12 illustrates the depth of immediate and subsequent missions an OPFOR commander can assign when attacking a partially prepared enemy defense. Figure 5-13 illustrates the shallower missions he might assign if he must attack a fully prepared defense.

At the tactical level, **each organization's immediate mission corresponds to its subordinate's subsequent mission.** Companies and platoons do not receive a subsequent mission. They receive a subsequent direction of advance to help achieve the battalion's immediate mission. First-echelon regiments and battalions also receive a subsequent direction of advance to follow after they have achieved their subsequent missions. Divisions receive immediate and subsequent missions.

Even under favorable conditions, the subsequent mission for a first-echelon division falls far short of the army's/army corps' immediate mission. This is an exception to the pattern indicated above. It probably means that the OPFOR expects its first-echelon divisions to fight for 2 to 3 days and they may receive new missions each day until they achieve the army's/army corps' immediate mission. At that point, the army/army corps commits its second-echelon division(s) to achieve its subsequent mission.

Against a **fully prepared** defense, the OPFOR anticipates a major effort to reach the enemy's brigade rear boundary once it has destroyed the brigade's reserve. It is not only trying to reach its mission line, it is also trying to destroy the enemy forces within its zone of advance. The OPFOR expects that some enemy elements will have fallen back to subsequent positions within the zone in an attempt to reestablish a stable defense. Likewise, the OPFOR will have bypassed other enemy elements within the zone that may be fully capable of combat action. The destruction of these remaining enemy forces will require continued action even after the destruction of the enemy's reserve. This effort will probably require the commitment of the second-echelon forces.

Second-echelon units and subunits also receive missions. Against a partially prepared defense, for example, a first-echelon regiment's second-echelon battalion may receive an immediate mission to complete the destruction of an enemy first-echelon brigade. This battalion would act in conjunction with first-echelon battalions, who have that as their subsequent mission. The second-echelon battalion would then have a subsequent direction of advance instead of a subsequent mission. This direction of advance would support the accomplish-

ment of its parent regiment's subsequent mission.

First-echelon units and subunits that have accomplished their original immediate and subsequent missions and are still combat effective may receive new missions. In this case, however, they would receive only one (immediate) mission and a subsequent direction of advance.

Division

A division normally conducts an attack as part of its parent army's/army corps' offensive. In some circumstances, it may conduct an attack under control of a corps or *front*. The organization, concept, and conduct of a OPFOR division attack vary with the division's mission and the commander's estimate of the situation. Figure 5-14 shows the typical deployment of divisional elements in an attack. The sequence of action in the basic concept for an attack is:

- To strike enemy defenses with intensive fires.
- To find or create a gap.
- To slip through the gap.
- To drive deep at top speed.

An attacking division's mission contributes to the accomplishment of the army's/army corps' mission. Achievement of a division's mission is the culmination of fires and attacks by all its organic and attached elements.

Planning the Attack

Division-level planning for the attack depends on the missions assigned by the army commander. The division commander first assesses the situation, then outlines his concept and intentions, specifying prelimi-

ELEMENT	DEPLOYMENT
Division First Echelon	Concentrated to attack on main and supporting axes.
Division Second Echelon or Combined Arms Reserve	Moves by bounds 15-30 km behind the first echelon until committed.
Regimental Artillery Groups	1 to 4 km from the forward edge.
Division Artillery Groups	3 to 6 km from the forward edge.
Division Antitank Reserve	Between first and second echelons on the axis of the main attack or a threatened flank.
Division Main CP	Up to 15 km from the forward edge.
Division Forward CP	Up to 5 km from the forward edge.
Division Rear CP	Up to 30 km from the forward edge and located near the rear service elements.
Regimental Main CPs	Up to 5 km from the forward edge.
Logistics Units	The divisional medical, repair, and evacuation elements move behind the first echelon. The rest of the divisional logistics units move some 5 to 10 km behind the second echelon.

Figure 5-14. Deployment of divisional elements in an attack.

nary actions and missions, and directs the preparation of required information and planning. Finally, he passes preliminary instructions to subordinate and attached units, specifying where, when, and by what means to conduct the attack.

A strict timetable regulates the commander's preliminary actions; so, the less time available, the more rigidly it regulates his work. The OPFOR emphasizes concurrent or parallel planning and action at all levels. Even when less time is available for planning, it works out attack plans in great detail. On receipt of an order, the division commander and his chief of staff immediately assess the assigned tasks, calculating available and required time. They decide what information they need, what they already have, and what is lacking. Their analysis of the assigned mission centers on the role of the division in the attack. The commander determines where to concentrate his main effort, if it has not been determined by the

higher commander. The division commander determines what combat formation to use and what rates of advance are possible during the attack.

The division commander reviews the army's/army corps' offensive plan and reviews the allocation and procedures for employment of nuclear and chemical weapons and the role of the division in the army's/army corps' scheme. He notes the axes, missions, and groupings of flanking division(s). The basis for his attack planning stems from consideration of--

- Missions or objectives.
- Enemy dispositions.
- The army's/army corps' fire plan and the allocation of artillery.
- The terrain in the assigned attack zone.
- The weather and light conditions.
- Time of the attack.

- Combat effectiveness and supply situation of all elements of the division.

To the OPFOR timing is critical when planing an attack from the march and the movement of troops to the line of attack. The next higher commander specifies the start point and routes for the march, lines of deployment, and the line and time of attack. Planners measure the length of the routes and distances from a start point to other control lines breaking them down by 5-km segments. The OPFOR determines sector speeds based on the condition of the routes, the weather, the composition of the columns, and possible enemy action during movement. It then calculates average speeds developing schedules for troop movements.

The OPFOR stages an attack against a defending enemy from **assembly areas**. Forces stay in the assembly area only long enough to assign tasks to subordinate units/subunits, to check preparations, and to organize combat formations. The assembly area is far enough forward for first-echelon regiments to move to their lines of deployment and close enough that they can reach their attack lines during the artillery preparation.

Units disperse by battalions in assembly areas with their attached reinforcements. Their movement routes have prescribed control and deployment lines. These routes permit rapid, effective movement to the attack line. The combat order designates the attack line. This line should be as near as possible to the forward positions of the enemy defense. When a division occupies an assembly area, it is usually 60 to 75 km from the enemy's forward positions, covering an area of 300 to 600 square km. First-echelon regiments could occupy assembly areas as

close as 20 to 30 km from the enemy's forward edge. Figure 5-15 depicts a typical motorized rifle division assembly area.

Preparation of the Attack

Preparation of the attack begins in the assembly area. Some engineer preparation of the assembly area is desirable, to improve routes and provide protection for equipment and personnel. Logistics assets may be deployed in the assembly area by the senior commander prior to its occupation by the attacking force. Final maintenance and resupply are conducted and units and subunits will be regrouped tactically in accordance with their commanders' plans. Strict *maskirovka* discipline is enforced and radio silence maintained.

Air defense resources are fully deployed. Each unit and subunit provides its own local protection against ground attacks, including static posts and mobile patrols, both on foot and in vehicles. Reconnaissance elements, including commanders conducting their ground reconnaissance, move forward to observe the enemy position. Final orders are given and detailed planning completed.

Reinforcements

The type and number of reinforcements the division receives depends on the mission the division will be required to complete. A first-echelon division may receive the following reinforcements from army/army corps and *front* resources:

- Additional artillery battalions.
- Engineer companies or battalions.
- Air defense elements.
- Communications assets.
- Reconnaissance assets.

- Medical assets.
- Chemical protection assets.
- Materiel support assets.
- Direct air support sorties.

Attack Zone

The army/army corps assigns the division an **attack zone** for which that division is responsible. This attack zone is generally 15 to 25 km wide, with its width varying with the situation. The OPFOR can attack with forces massed across a **strike sector** as narrow as 4 km for a division, but it considers this a less desirable option, especially given a nuclear threat. The strike sector can be as wide as 18 km. Within the attack zone, the division commander designates a **main**

attack on an axis normally assigned by the army/army corps. He designates one or more secondary axes for **supporting attacks** in the rest of the division's attack zone. Each first-echelon regiment attacks on one of these axes. Spaces between regiments vary with the situation. Therefore, there would probably be no distinct, continuous division "attack frontage" within the attack zone.

March into Attack

Engineers are likely to be the first to move out of the assembly area. Working in concert with any additional engineer assets provided they clear routes and may begin to breach obstacles. Units in contact are responsible for clearing routes through mine

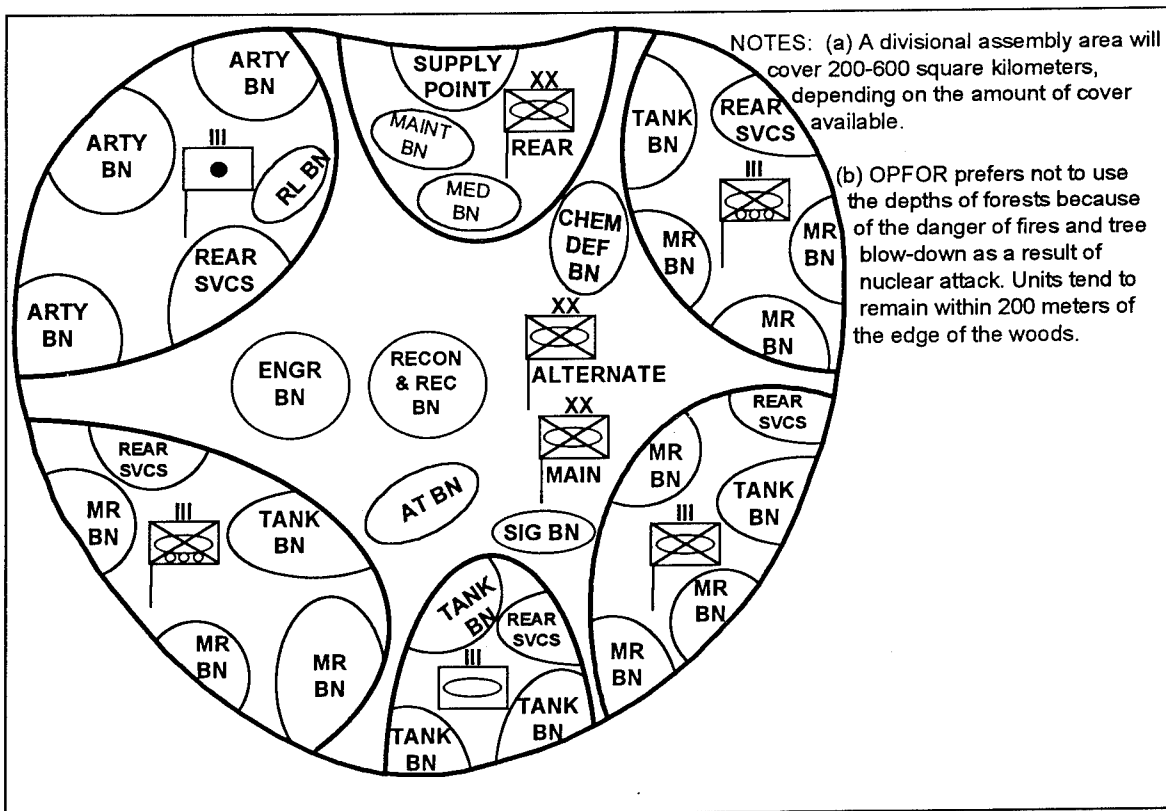

Figure 5-15. Assembly area of an MRD.

fields they have laid. Traffic control elements move out at the same time. Next to move would be the artillery. The DAG and the RAGs must occupy their fire positions at least 1 to 2 hours (6 hours at night) before they are due to open fire. Their positions have been reconnoitered beforehand and may have been prepared by the engineers. Some air defense assets also deploy in advance of the main body for route security and to protect the artillery groups. First-echelon units move from the assembly area in accordance with a timetable designed to bring them to the line of attack at H-Hour.

Combat Formation

The division commander determines the combat formation of his forces based on his assigned mission and the preparedness and depth of the enemy's defenses. A division normally attacks with most of its combat power in **one or two echelons**, but a three-echelon formation is possible in restrictive terrain. If the division attacks in a single echelon, it would normally form a **combined arms reserve**. The main difference between a second-echelon force and a combined arms reserve is that the former has an assigned mission while the latter does not. A combined arms reserve exploits developed or developing success, reacting to contingencies. The remaining forces form an **anti-tank reserve** (in motorized rifle divisions) and/or special **engineer or chemical protection reserves**.

Against covering force. If the enemy has established a covering force, first-echelon regiments can send out **advance guards**. These advance guards attempt to defeat the enemy's covering force and disrupt the establishment of the enemy's main defense positions. If successful, the main bodies of these regiments try to complete the

destruction of these positions from prebattle formation. The division can also send out one or more **forward detachments** if the situation requires it. The forward detachment's mission is to seize key objectives and to disrupt enemy defenses, facilitating the division's attack. It tries to avoid enemy contact until it reaches its objective.

Against main defense. Within the division's attack zone, one or two first-echelon regiments attack along the division's main attack axis. The massing of forces for the main attack is vulnerable to tactical nuclear strikes and other means of deep attack. To decrease these vulnerability, forces and fires must concentrate rapidly, creating a breach. Forces must disperse just as rapidly on the other side of the breach. Another first-echelon regiment conducts a supporting attack.

A **second-echelon regiment** continues the attack to the division's subsequent mission along the main attack axis. Commitment of a second-echelon regiment takes place after the division has achieved its immediate mission. The time of commitment depends on the success of first-echelon forces and how the enemy uses his reserves. The OPFOR division commander commits the second echelon when and where it best contributes to overall success.

Against fully prepared defense. The OPFOR tends to array the motorized rifle divisions (MRDs) and tank divisions (TDs) in a **two-echelon formation** against a fully prepared defense. A combat formation with two regiments up and two regiments back is normal when the division is conducting a **main attack**. A division conducting a **supporting attack** is more likely to be echeloned with three regiments up and one back. The first-echelon units are likely be

motorized rifle, since they are more balanced and better suited than tank units for penetrating a deep, prepared defense. The second echelon consists of motorized rifle regiments (MRRs) in the MRD or tank regiments (TRs) in the TD. These units are committed on axes into gaps opened by first-echelon forces.

Against partially prepared defense.

Against a partially prepared defense the OPFOR attempts to deploy forces farther forward than if the enemy were in fully prepared defenses. It tries to establish greater initial momentum, denying the enemy targets in the OPFOR rear area. The MRD or TD typically has three of the four maneuver regiments in the first echelon with the remaining regiment in the second. (See Figures 5-16 and 5-17 for **two examples** of possible combat formations.) By concentrating a larger amount of combat power in the first echelon, the OPFOR hopes to exploit some of the weaknesses (gaps) in the defense. A division can also use a **forward detachment** to exploit gaps in the enemy defense.

Against unprepared defense. The offensive situation the OPFOR prefers is an attack against an unprepared defense. In such a defense, the enemy has had time to emplace only part of its covering force. Attacks under these conditions quickly take the form of an extended meeting battle. The division establishes a single echelon that includes all its maneuver regiments and forms a small combined arms reserve. It also makes extensive use of forward detachments.

Combat Formation (Example)

Figure 5-18 shows **one example** of how an MRD might deploy for an **attack from the march**. In this example, an MRD

has deployed to attack a main defensive position in **two echelons**, with three regiments in the first echelon and one in the second. A single-echelon formation is unlikely against such a defense, except on a secondary axis. This division is attacking on the army's main axis and additional artillery and other assets have been given to the division. The army artillery group (AAG) is also engaging targets within the division's sector of attack. Two regiments are concentrated on the main axis, each attacking in two echelons. The regiment on the secondary axis attacks in one echelon, this enables it to cover a wider frontage.

Division artillery deployment. In this **example**, each first-echelon regiment is supported by a regimental artillery group (RAG), with the division artillery group (DAG) located on the main axis. The RAGs on the main axis have three battalions each, one organic to the regiment and two allocated from division. The RAG on the secondary axis has only two battalions. (The typical size of a RAG can vary from 2 to 4 battalions.) The DAG consists of the organic rocket launcher battalion and three tube artillery battalions. (The typical size of a DAG varies from 2 to 4 battalions; a division on the army/army corps main axis could conceivably have as many as 6 to 8 battalions, in which case it would form two DAGs.) The additional artillery required by the division to achieve the grouping outlined is drawn from army/army corps and even *front* resources. The army/army corps may use artillery assets of its second-echelon division(s) to supplement first-echelon DAGs.

Other division assets. In this **example**, the **surface-to-air missile (SAM) regiment** is deployed to cover the division sector, possibly with a battery in each first-

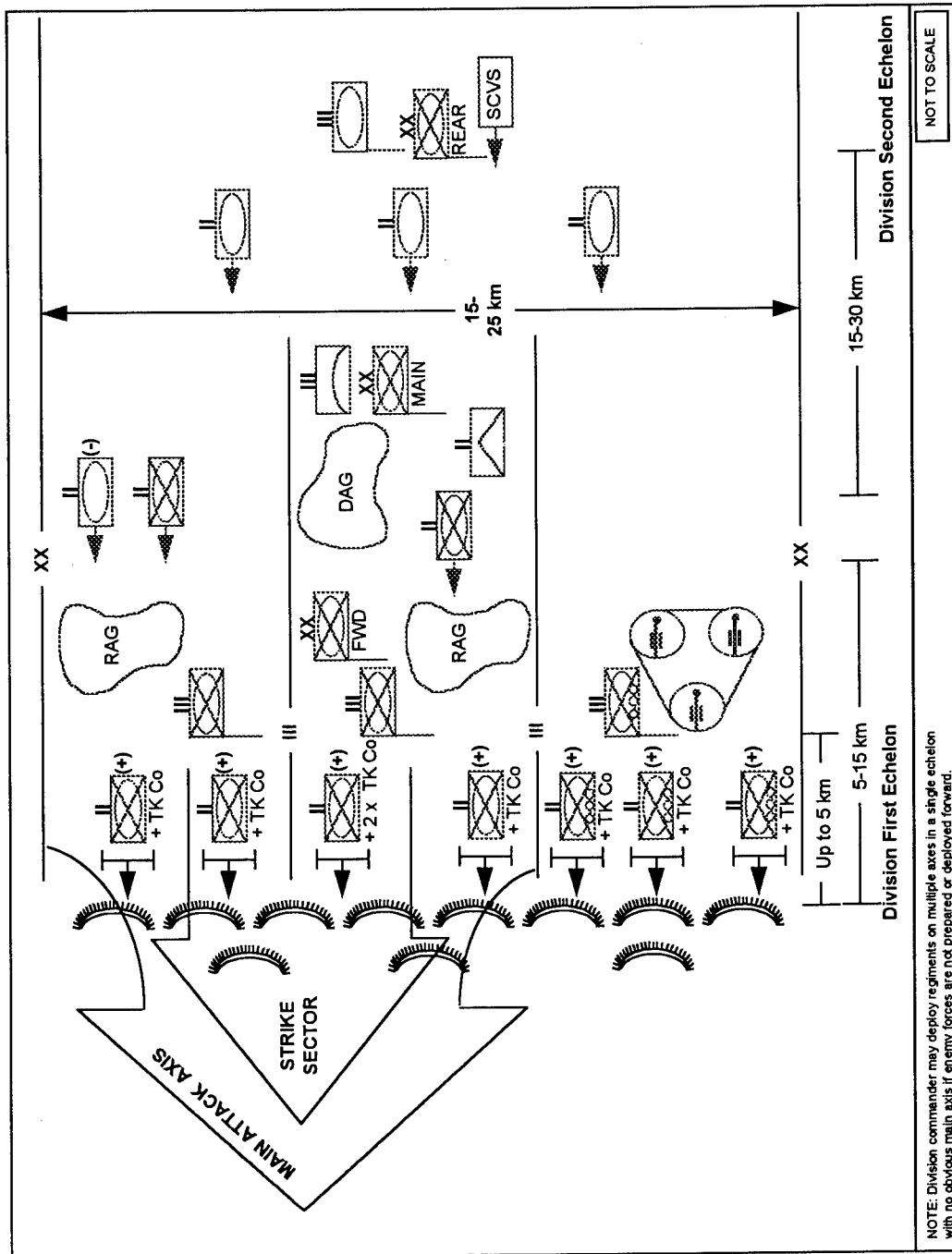

Figure 5-16. MRD combat formation for attack from position in direct contact against partially prepared defense (example 1).

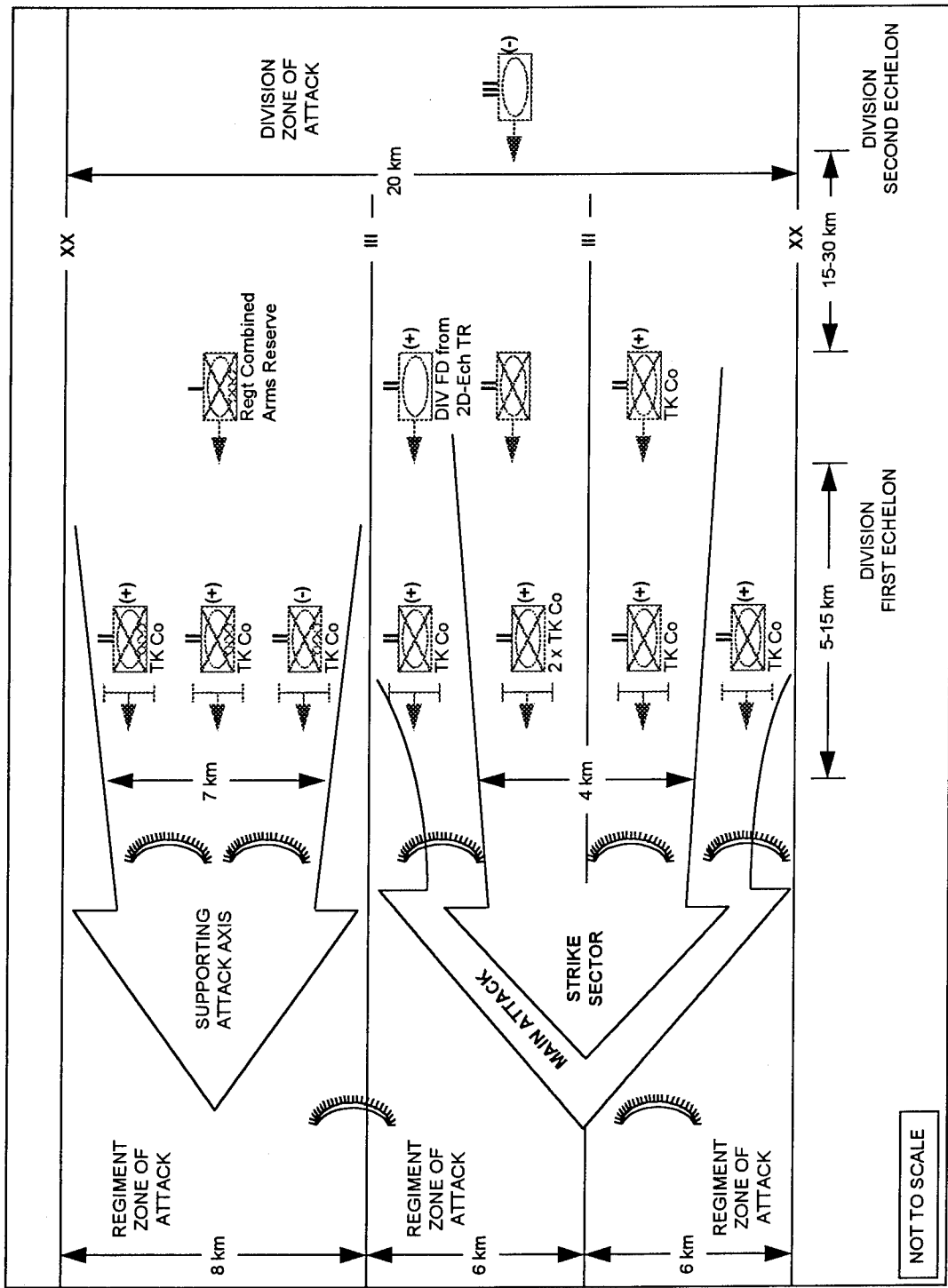

Figure 5-17. MRD combat formation for attack from position in direct contact against partially prepared defense (example 2).

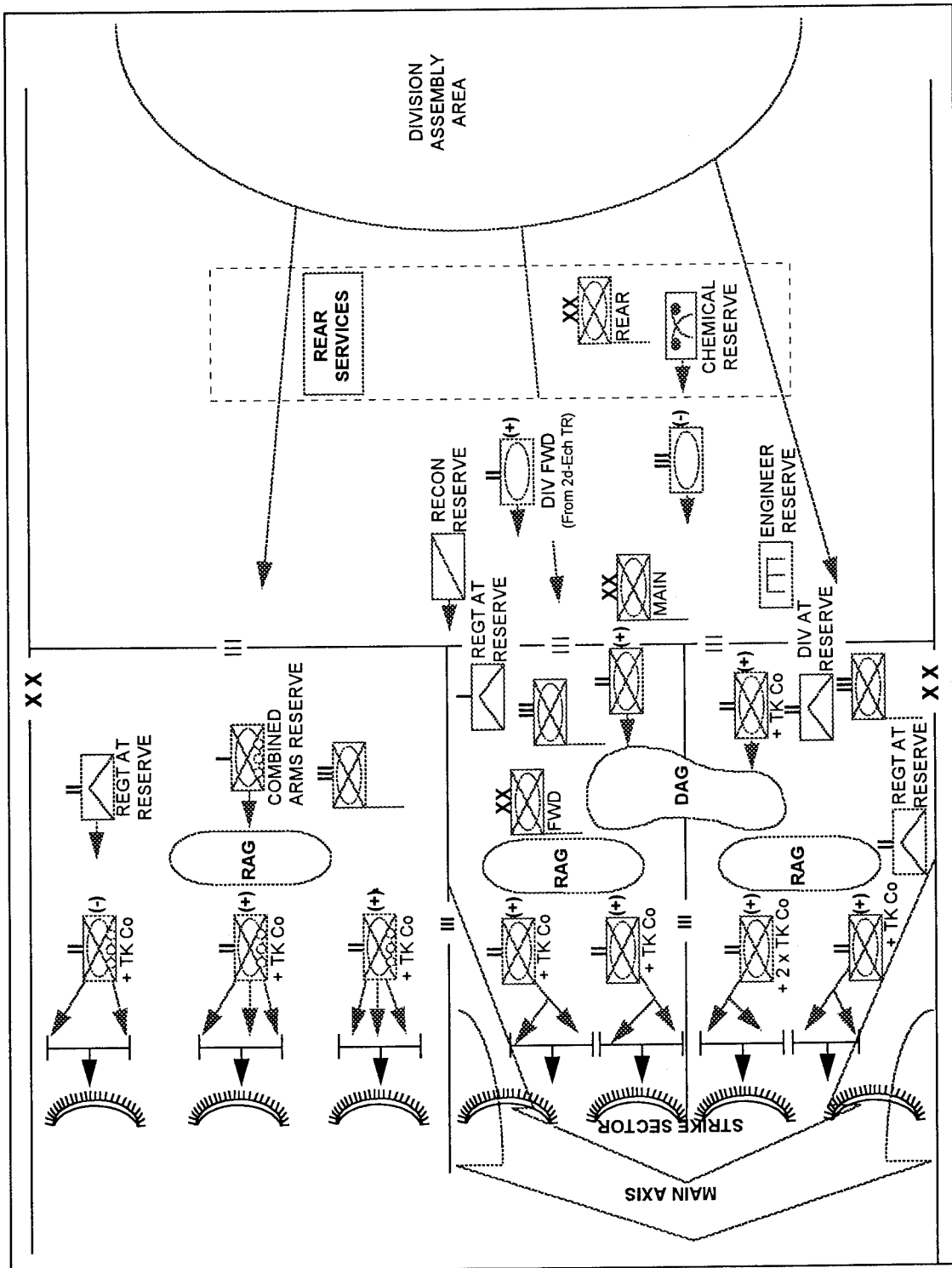

Figure 5-18. MRD combat formation for attack from the march (example).

echelon regiment's sector and the remaining battery/batteries covering the flanks in depth.

The MRD's antitank battalion forms the **antitank reserve** operating in conjunction with a **mobile obstacle detachment (MOD)** from the division's engineer battalion. If the division has an open flank, the antitank reserve and MOD can deploy to cover that flank. Otherwise they may be assigned a more central position with the primary role of covering a flank of the penetration against a possible enemy counterattack, or they could cover a boundary between regiments, where an enemy counterattack is likely to occur. Engineer assets not allocated to regiments or directly tasked in support of the penetration are kept in an **engineer reserve**.

A similar policy applies to the chemical protection battalion, which would form the basis for a **chemical protection reserve**. However, all available smoke-generating assets, including those with a dual decontamination capability, are employed in direct support of the attack or in a deception role. Some part of the reconnaissance and REC battalion is also likely to be held in a **reconnaissance reserve** until the penetration has been achieved.

Commitment of Second Echelon or Reserves

The division commander plans to commit his second echelon (see Figure 5-4) or combined arms reserve **upon achievement of the division's immediate mission**. This commitment must take place before the momentum of the advance decreases. The commitment of the division second echelon or reserve involves the intensification of reconnaissance activity, artillery fire, air

strikes, and the use of smoke to screen the force from enemy observation.

A second-echelon regiment or a divisional reserve converges in **battalion march columns** toward the penetration. It may remain in battalion columns for the sake of speed if enemy resistance is minimal. Otherwise, battalions assume prebattle formation or, if required by enemy actions, they assume battle formation. Ideally, the regiment passes through developed penetrations to drive swiftly into the enemy rear to achieve deep missions.

The division commander establishes a combined arms reserve from first-echelon forces or uncommitted combat assets as soon as he commits the original follow-on force. He attacks any surviving pockets of resistance with elements of the follow-on forces or destroys them with concentrated fires of artillery and aviation, including attack helicopters.

The OPFOR may encounter enemy defenses that are stronger than it had anticipated. If it cannot penetrate them with the first echelon, it may commit second-echelon or reserve forces earlier than it had planned. The OPFOR would not use the second echelon to reinforce failure but seek to employ it on another, more favorable axis. If, however, first-echelon forces succeed in penetrating enemy forward defenses and are able to continue toward deeper missions, the OPFOR commander may not commit second-echelon or reserve forces until much later in the battle.

The division commander commits his second echelon or reserve on the **axis of the most successful penetration**. A division's second echelon begins the attack with an assigned mission, which is normally to continue

the attack on the division's designated main attack axis. However, that axis could change during the course of the battle, and the commander can commit his second echelon on the new main axis. A division's combined arms reserve does not have an assigned mission at the beginning of an attack, but is prepared to attack along the most opportune axis at a time the division commander determines. If the attack continues successfully, this could lead to the parent army's/army corps' commitment of its own follow-on forces to develop the penetration further. The commitment of additional divisions would result in a widening and ever-deepening rapid penetration and exploitation.

The **antitank reserve** in a motorized rifle division moves with a mobile obstacle detachment (MOD). This combined force travels between the first and second echelons on the axis of the main attack. Planned commitment lines for the antitank reserve and MOD are across the most likely enemy counterattack routes.

Before their commitment, second-echelon or combined arms reserve units and subunits advance in march or prebattle formation. They move by bounds approximately 15 to 30 km to the rear of the first echelon. This distance varies with the situation. The commander keeps second-echelon or reserve forces far enough forward to influence the battle in a timely manner, but far enough to the rear to protect them from the bulk of enemy direct fire and direct support weapons.

In Depths of Defense

To assist in an attack against a defending enemy, a division attack could include a **vertical envelopment** by a heliborne force of up to a battalion in size. An organic

motorized rifle battalion, stripped of its combat vehicles and reinforced with air-transportable combat support, could conduct such an assault. This battalion (or company) could come from the division's second-echelon regiment or, if the heliborne landing is directed by the army/army corps commander, possibly from a second-echelon division. Heliborne assaults using motorized rifle troops can extend out to 20 km beyond the forward edge. Likely objectives are key locations such as bridges, or river-crossing sites. (For more detail on heliborne landings, see Chapter 16 in *Heavy OPFOR Operational Art* handbook.) The OPFOR routinely discusses using heliborne forces in coordination with forward detachments and enveloping detachments. A division could employ a forward detachment up to a reinforced battalion in strength to link up with a heliborne assault.

Forward Detachments

The OPFOR uses **forward detachments (FDs)** throughout an offensive operation, particularly after penetrating the enemy main defense area. A division or regiment may dispatch a forward detachment of **reinforced battalion size** on a swift, independent penetration into the enemy depths. A division can employ a **regiment-sized** FD in situations when--

- The FD must take immediate action (in a pursuit, for example), without time for reinforcement.
- The FD must maneuver and fight without support for an extended time.
- The force-oriented objective is an enemy battalion or larger.
- The size and duration of combat dictate a larger force.

Thus, the decision to use a regiment rather than a reinforced battalion as a division FD

depends primarily on the depth of the objective and enemy strength.

The FD's primary mission is to **seize and hold a tactical objective until the main forces arrive**. In addition, the FD has a secondary mission of reconnaissance; it can also conduct tactical raids. The OPFOR intends missions of FDs to **speed the advance of main forces and the dissolution of the enemy defense**. An FD is a deep-attack force detailed to achieve an independent mission. It is not restricted to the route of its main force. Typical objectives for an FD can include road junctions, bridges, command posts, tactical reserves, and withdrawing forces.

Divisions and regiments employ **forward detachments (FDs) as tactical maneuver forces**. Division FDs function during all types of offensive action: attack against a defending enemy, meeting engagement, or pursuit. The same applies to regimental FDs, except that employment in an attack against a defending enemy is normally only against an unprepared defense. Divisions serving as army operational maneuver groups (OMGs) can use a battalion-sized FD of their own, plus a battalion-sized FD for each of their subordinate regiments. Whatever the level, FDs are tailored forces, reinforced to allow independent operation. Depending on the enemy and the terrain, their nucleus can be either tank or motorized rifle forces; however, tank battalions and tank regiments are the most likely.

Against unprepared defense. The characteristics of the offensive are surprise, speed, and attempts to preempt or forestall the enemy. FDs from first-echelon divisions may attempt to strike deep into the enemy **tactical zone of defense** (main defense area) before enemy defenses are fully organized

and solidified. Reinforced battalions (or sometimes entire regiments) given such missions receive full support from artillery and direct-support aviation.

Against an unprepared defense, where the enemy has deployed only his covering force, FDs at all levels may initiate the attack. If the enemy has advanced during the night before the offensive, they would then attack on multiple axes across the OPFOR division's attack zone to penetrate **enemy covering forces** rapidly. They would then drive at top speed in prebattle or march formation to seize and hold key terrain within the enemy division's **main defense area**, thus preempting enemy occupation of positions there. There may also be battalion-sized **heliborne landings**, designed for linkup with the FDs. The purpose of such tactics in support of an operation would be to disrupt or preempt enemy defensive structure while opening multiple avenues for swift attacks by larger first-echelon forces. Figure 5-19 shows typical depths of FD missions against an unprepared defense.

Against partially prepared defense. More often, the OPFOR would find the enemy defense **partially prepared**, with the covering force in place and the tactical zone of defense partially occupied. A regimental FD would not attack under these conditions, but a division FD could, if provided heavy fire support. Its mission would be to overcome the covering force and penetrate into the tactical zone of defense to prevent the enemy from establishing a firm, continuous defense; it could also facilitate the commitment of main force (first- or second-echelon regiments). Figure 5-19 shows typical mission depths under such conditions, which would be one step shallower than for an unprepared defense.

During the attack, FDs use reconnaissance to detect gaps in enemy defenses occurring naturally or created by artillery fire. If a gap exists, or in fire support has neutralized sectors of the defense, the FD moves quickly through the gap to secure objectives in the enemy brigade or division rear.

Against prepared defense. If the OPFOR encounters a prepared, fully occupied defense, FDs would not participate in operations until first-echelon regiments have completed the penetration of enemy first-echelon brigades (the front of the tactical zone of defense). (In rare instances, a division FD could assist the main forces in penetrating the covering force or initiate subsequent attacks into the tactical zone of defense; however, it is unlikely that it would emerge still capable of further operations.)

Once the penetration operation is complete, FDs at all levels of command would lead the operational exploitation or pursuit, helping to envelope and destroy enemy forces. In this role, they would normally advance 30 to 60 km ahead of the main force.

Throughout the operation, strong FDs would probably continue to press the advance into the enemy rear on several axes.

Numerous deep penetrations by FDs early in the battle would result in an **intermingling of enemy and friendly forces**. This situation would complicate or forestall enemy use of tactical nuclear weapons. The OPFOR would probably accept heavy losses in such deep-penetration forces, if it could cause an early collapse of the enemy's defensive structure before he could resort to use of nuclear weapons.

Fire Support

OPFOR fire planning is highly centralized. It integrates conventional artillery and air strikes, missile strikes, and possible nuclear or chemical fires. The fire plan includes details specifying the time of assignments, groupings, and displacement of artillery. Combat instructions specify the missions of designated artillery subunits and identify the location of observation posts and firing positions. The orders specify the time for artillery to be ready to fire.

Fire planning for the attack is methodical and highly quantitative. This reflects the need to determine ammunition requirements and to distribute planned fires effectively. The chief of artillery must determine the availability of artillery and its or

AGAINST UNPREPARED DEFENSE

FD Subordination	Mission	Depth (km)
Division	rear of tactical zone of defense	30-50
Regiment	front of tactical zone of defense	20-30

AGAINST PARTIALLY PREPARED DEFENSE

FD Subordination	Mission	Depth (km)
Division	front of tactical zone of defense	20-30

Figure 5-19. Forward detachment missions.

ganization. Then he weighs these against the numbers and types of targets and the commander's decision for coordinated action in the attack. He also allocates targets to artillery, tanks, aircraft, and nuclear or chemical weapons. When time permits, he bases fire planning on thorough, detailed reconnaissance and careful study of the attack plan. In any attack, a systematic targeting effort underlies the fire plan at all levels.

Assets. OPFOR MRDs and TDs have organic artillery regiments. A first-echelon division receives additional artillery allocated from army/army corps and/or *front*. The division commander weights the main attack with artillery. He allocates additional artillery to the regiment(s) in the main attack. He also forms one or more division artillery groups (DAGs). The division chief of artillery ensures that the division's fire plan coordinates the fires of the division's organic and reinforcing artillery with the army's fire plan and with fire support from armed helicopters or ground support aircraft.

Deployment. Artillery subunits are among the first combat forces to deploy. Artillery allocated by higher headquarters joins the designated attacking force in the assembly area or links up on the march. Artillery designated to support or reinforce the attack occupies firing positions early enough to cover the advance of the division several hours before the attack is launched. Artillery attached to maneuver regiments moves at or near the head of the regimental main forces.

Phases. Fires in support of a division attack follow this sequence:

Phase I, **fire support of the movement forward**, consists of long-range fires. This phase is normally employed only when it is necessary to protect elements of the di-

vision as they move forward. This is primarily in an attack from the march and when any force must move up from an assembly area more than 20 km from the forward edge.

Phase II, **fire preparation of the attack**, normally begins when the first-echelon regiments deploy into prebattle formation (battalion columns). The fire preparation consists of concentrated fires to neutralize or destroy the enemy's main defense positions. These fires protect the attacking units during their deployment into prebattle and battle formation.

Phase III, **fire support of the attack**, begins at the same time as the attacking maneuver units begin their assault on the enemy forward defenses. As the attacking units advance, fires shift progressively deeper into the enemy's defenses. The time lapse between the shifting of fire and the attack by ground troops should not exceed two minutes. This phase attempts to maintain fire superiority, assisting the attacking maneuver forces as they advance to their immediate mission.

Phase IV, **fire accompaniment**, consists of fires throughout the depths of the enemy's defenses to support achievement of the attacking unit's subsequent mission.

Brigade

Since the primary function of an independent motorized rifle brigade (IMRB) is deep battle, it would rarely conduct an attack against a defending enemy.¹ Within an army/army corps offensive, it is most likely to serve in a special role, such as a forward detachment or a combined arms reserve. If

¹ The IMRB's primary form of offensive combat is the meeting battle.

the brigade finds itself in the first echelon of the army/army corps, it would most likely occupy a secondary sector.

Reinforcements

The IMRB is larger than a standard motorized rifle regiment, but smaller than a standard MRD. In addition to its organic assets, an IMRB may receive additional support assets (including artillery, antitank, and engineer battalions) from its parent army/army corps. The IMRB must task organize all organic and reinforcing assets to best fight the tactical battle.

As an example, the brigade commander could create four reinforced motorized rifle battalions (MRBs) by breaking up his tank battalion (TB) and attaching a tank company to each of the MRBs; this would leave one tank company for a brigade reserve. Alternatively, he could opt to stay with five maneuver battalions--four MRBs and one TB. Neither of these organizations is necessarily the preferred type, since the brigade commander must choose his task organization based on the tactical situation.

Combat Formation

Normally, an IMRB would deploy in either one or two echelons in offensive battles. If a single-echelon combat formation is chosen, the brigade would deploy the preponderance of its combat power forward. If deploying in a single echelon, the brigade would establish a combined arms reserve of company strength (or perhaps two companies).

In the offense, the IMRB attempts to maneuver deep inside enemy-held territory. These independent missions (as an army/army corps-level forward detachment)

force the brigade to fight at greater depth than would a regiment, and with exposed flanks, for extended periods of time.

An IMRB employs standard OPFOR regimental tactics both in normal and special conditions. Because of the brigade's unique organization, however, some modifications may be necessary. These involve increasing the size of the offensive area of responsibility for the subordinate battalions. Also, the distance between subunits could be expanded. The increased width of the battalion avenue of approach and battalion and company attack sectors allows for deceptive, high-speed maneuver forward of enemy positions and the employment of flanking and enveloping maneuvers.

Transition to the Attack

A IMRB can transition to the attack against a defending enemy either from the march or from a position in direct contact. The attack from the march is the preferred option.

Attack Zone

A IMRB's zone of attack can vary depending on the attack concept and the situation. The attack zone of the brigade is typically 5 to 12 km. The distance between echelons within the brigade can vary from about 5 to 15 km.

Mission Depth

The IMRB's first-echelon battalions should be expected to reach the same depth as those in a motorized rifle regiment. However, they could achieve this on a broader frontage (attack zone), since the IMRB has more battalions to possibly deploy in its first echelon. Therefore, the brigade's immediate

mission depth should be the same as that for a regiment. (See Figures 5-12 and 5-13.) With a second echelon/reserve potentially stronger than that of a regiment, the brigade could achieve a somewhat greater depth for its subsequent mission, or reach the same mission in shorter time.

In the initial period of war, conflict may start before either side is fully mobilized and prepared. Under such conditions, an IMRB held in a high state of readiness could strike quickly. Thus, against an unprepared or partially prepared enemy defense, it could possibly achieve mission depths that would normally require the forces of an OPFOR division.

Forward Detachment

An IMRB serving as an army/army corps forward detachment (FD) can use a battalion-sized FD of its own. The actions of that reinforced battalion would help retain the momentum of the entire brigade force.

Fire Support

With its two organic artillery battalions and additional battalions allocated to it by its parent army/army corps, the IMRB may form one or two brigade artillery groups (BrAGs). A BrAG would locate 1 to 4 km from the forward edge of first-echelon troops. The brigade commander can assign up to a battalion of artillery to each of his first-echelon battalions.

An IMRB fighting as part of an army corps could also receive support from the corps artillery group (CAG), if in the corps main effort; when fighting as part of an army, the IMRB would be less likely to receive support from the army-level artillery groups,

since the latter would most likely support divisions in the army's main effort.

The IMRB has its own antitank battalion and may receive an additional antitank battalion as reinforcement. This would allow it to form two antitank reserves, in order to protect both its flanks when performing independent, deep missions in the enemy rear.

Regiment

A maneuver regiment is a fully combined arms ground force element.² It is capable of limited independent action, but normally attacks as part of a parent division. The regiment receives an immediate mission, a subsequent mission, and a direction of further advance.

Transition to the Attack

A regiment transitions to the attack against a defending enemy either from the march or from a position in direct contact. The attack from the march is the preferred option.

Attack Zone

A regiment's zone of attack can vary depending on the attack concept and the situation. The attack zone frontage of the regiment is typically 5 to 10 km. Within that zone, one or two battalions could attack on a strike sector of 2 to 4 km.

Combat Formation

A regiment usually organizes for combat in **three reinforced battalions** advancing in **one or two echelons**. The com-

² Battalions normally fight as combined arms teams, but need reinforcement to do so.

mander determines the appropriate echelonment based primarily on the status of the enemy's defense. The regiment may also form one or more of the following reserves:

- A company-sized combined arms reserve, particularly in a single-echelon attack.
- An AT reserve in the MRR, based principally on the AT battery or battalion.
- Special engineer and chemical protection reserves.

On a **main axis**, a regiment normally deploys in **two echelons**. The distance between echelons within the regiment can vary from about 5 to 15 km. In a tank regiment, the MRB is likely to be split among the three TBs; in a motorized rifle regiment attacking with two MRBs forward, the TB can be allocated to the first-echelon battalions (two companies to the battalion on the main axis, one company to the second battalion). Alternatively, each first-echelon battalion can receive a tank company with the third company and battalion headquarters remaining directly subordinate to the regimental commander. Figure 5-20 shows an example of regimental deployment in an attack from the march.

Conduct of the Attack

In an attack from the march, the regiment advances out of assembly areas placed out of range of the majority of enemy indirect fire assets. This movement takes place during the fire support of the movement forward or fire preparation phases of artillery support. Subunits deploy into successively smaller march columns at the following distances from enemy forward defenses: 12 to 15 km in battalion columns, 4 to 6 km in company columns, and 2 to 3 km in platoon columns.

The regiment can conduct the attack in company columns. This facilitates speed and control if it has encountered poorly prepared enemy defenses, or if it has neutralized defenses sufficiently with fire. The OPFOR deploys laterally only when necessary. It reverts to prebattle or march formation if it encounters only light enemy resistance. The regiment deploys into battle formation against well-prepared enemy positions. Battle formation provides the maximum firepower forward and the regiment assumes it before reaching a designated line of attack, from about 600 to 1,000 meters from the forward edge of the enemy's defense. Ideally, all first-echelon subunits of a regiment cross the line of attack simultaneously, but this is not necessarily the case.

A first-echelon regiment can conduct an attack from a position in direct contact with the enemy. In this case, the regiment directs its first-echelon battalions to occupy assembly areas just behind the forward defensive positions with a portion of their forces. Unit boundaries adjust to concentrate fires and maneuver for the attack. Elements remaining in direct contact support the attack with direct fire. Artillery preparation fires support the battalions moving from the assembly areas and the regiment's second-echelon battalion(s) as they deploy to the final coordination line for the assault on the enemy defenses.

A first-echelon regiment that has successfully penetrated the enemy forward defenses may establish and secure the gap through which the division follow-on force subsequently attacks. The first-echelon regiment also could form a battalion-sized **forward detachment** to move ahead of the division to seize important objectives in depth. Such actions often take place in coordination with heliborne forces.

(Alternatively, if the division commander has planned the use of his own battalion-sized forward detachment, he may commit it at this time.)

A regiment in the second echelon of an attacking division moves in march formation 15 to 30 km behind the first echelon. The division commander defines the mission of the second echelon prior to the attack and refines it during the battle. He designates lines of commitment, preferably on the flanks, through gaps, or between two first-echelon units. This way he avoids the difficulties of passing through a first-echelon unit.

Fire Support

Each OPFOR motorized rifle and tank regiment has an organic howitzer battalion. When attacking in a division first echelon, a regiment receives additional artillery from division. The regimental commander can assign up to a battalion of artillery to each of his first-echelon battalions. The remaining artillery forms a RAG located 1 to 4 km from the forward edge of first-echelon troops. A first-echelon regiment can also receive support from attack helicopters from army/army corps level. The regimental chief of artillery plans the regiment's organic and supporting fires. He ensures coordination with the division fire plan. Fires in support of a regimental attack follow the same sequence as those for the division attack described earlier in the chapter.

Battalion

A battalion attacks as part of its parent regiment. It does not have the organic combat support or combat service support required for independent action, except when deployed as a security or enveloping de-

tachment, an advance guard, a raiding detachment, a forward detachment (FD), or a heliborne or amphibious landing force. Under these circumstances, the battalion receives the necessary reinforcements to sustain it for the duration of its mission. Further, when attacking as part of the regiment, the battalion is normally augmented to provide the capability for more independent actions. This will become more common on the nonlinear battlefield.

Missions

A first-echelon battalion receives an immediate mission, a subsequent mission (in coordination with adjacent battalions), and a subsequent direction of advance (toward the regiment subsequent mission). A second-echelon battalion receives an immediate mission (in coordination with first-echelon battalions, to complete the latter's subsequent mission) and a subsequent direction of advance (toward the regiment subsequent mission). OPFOR subunits normally do not stop on objectives or mission lines and consolidate; they continue the attack deeper into the enemy rear.

Combat Formation

An MRB or TB usually attacks in two echelons. If it attacks in a single echelon, the commander retains a small reserve, at least a platoon. When two echelons are employed, a normal distance between echelons is 1 to 3 km.

Attack Zone

A normal strike sector for an attacking battalion is 400 to 1,000 meters, within an attack zone of up to 3 km. Figure 5-21 shows an **example** of an MRB deployed for an attack from the march.

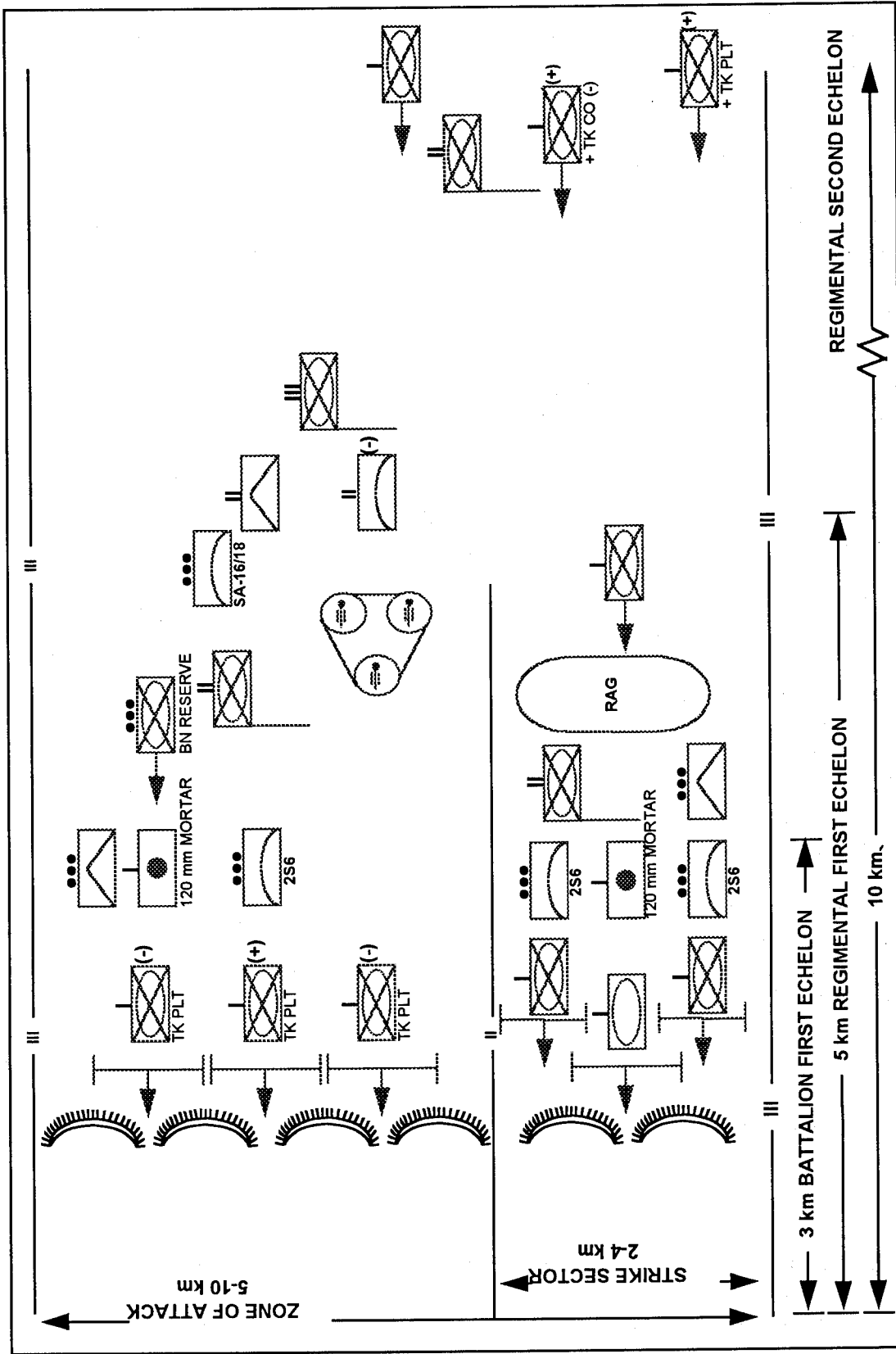

Figure 5-20. MRR deployment for attack from the march (example).

Conduct of Attack

A tank company (TC) attached to a MRB for an attack usually operates as a whole. It leads the attack by the first-echelon motorized rifle companies (MRCs). Under special conditions, such as restrictive terrain or urban combat, tank platoons may be attached to the MRCs. Conversely, an MRC attached to a TB is usually attached by platoon to the first-echelon TCs.

An MRB usually employs its antitank platoon as a whole. The antitank platoon can support the attack by the first echelon, support the commitment of the second echelon or cover the battalion's flanks. The battalion does not create special engineer or chemical reserves because of its limited assets.

In an attack from the march, an MRB or TB often serves as an **advance guard** for the parent regiment (or brigade). Advance guards are normally reinforced battalions, configured very much like FDs. Unlike FDs, however, advance guards do not avoid contact; rather, they seek to defeat all enemy forces encountered on their regiment's/brigade's axis, using only their own combat power. Figures 5-22 and 5-23 illustrate the sequence of attack by a reinforced TB acting as an advance guard. Its goal in fighting through all opposition is to free the regimental/brigade commander from deploying his main body, which would slow the advance.

When enemy defenses are suppressed or weak, the battalion can attack in prebattle formation (company or platoon columns) or march formation, maintaining a rapid tempo. A battalion commander does not necessarily attack an enemy frontally with all three companies. The OPFOR stresses maneuver and

the need to attack the enemy's flanks. The battalion commander may employ his companies so that one or two attack from the front and one or two attack from the flanks.

When first-echelon battalions of a first-echelon regiment have achieved a major penetration, they widen the area of penetration for exploitation by second-echelon forces. If they are still able, first-echelon battalions continue the attack into the enemy depth. Battalions revert to prebattle formation and advance rapidly to prevent the enemy from deploying his reserves and organizing a defense in new positions.

Fire Support

A battalion attacking in a regiment's first echelon may have up to a battalion of artillery reinforcing it. This artillery is under the operational control of the maneuver battalion commander and can employ direct fire. An MRB's organic fire support is concentrated on the main axis. The mortar battery deploys up to 500 meters behind the first echelon. The antitank platoon moves behind a first-echelon company on the flank most exposed to enemy armor. The air defense platoon moves behind the first-echelon companies and is usually not far from the battalion command observation post (COP).

Company

As a rule, a motorized rifle company (MRC) or tank company (TC) fights as part of an MRB or TB. However, it can also act independently as a reconnaissance detachment, a forward security element or flank security element, a heliborne landing force (raiding detachment), or an enveloping detachment.

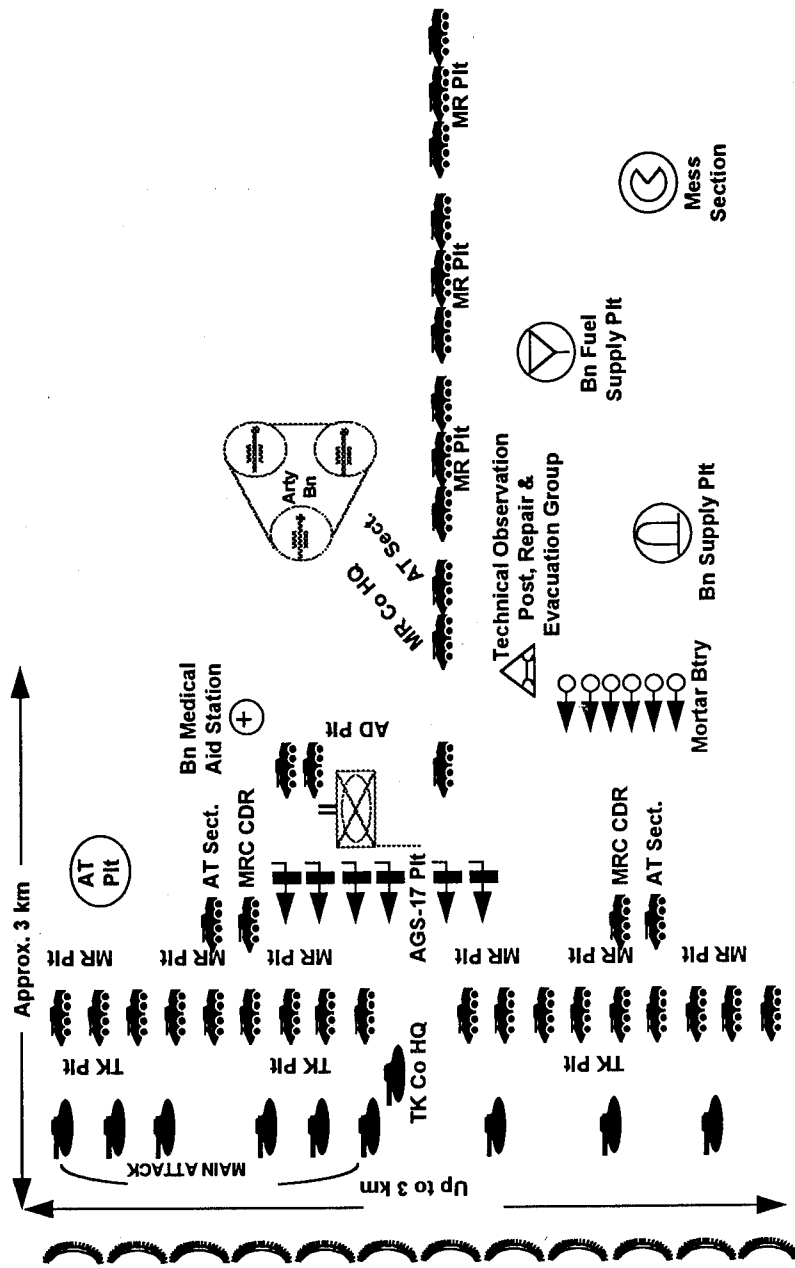

NOTES:

1. The battalion is shown attacking in two echelons. Against weak defenses and on secondary axes, one-echelon attacks are common. In a one-echelon attack, one MR platoon would be kept as a reserve, near the battalion headquarters.
2. A platoon of the reinforcing tank company may be kept directly under the battalion commander and deployed near battalion headquarters.
3. When attacking on a secondary sector, the battalion would probably not have a reinforcing artillery battalion, and the mortar battery would probably be deployed on the main axis.
4. The diagram is not to scale, and equipment symbols do not necessarily indicate the precise location of individual equipment.
5. The company headquarters and the antitank section each have one BTR.

Figure 5-21. MRB deployment in the attack (example).

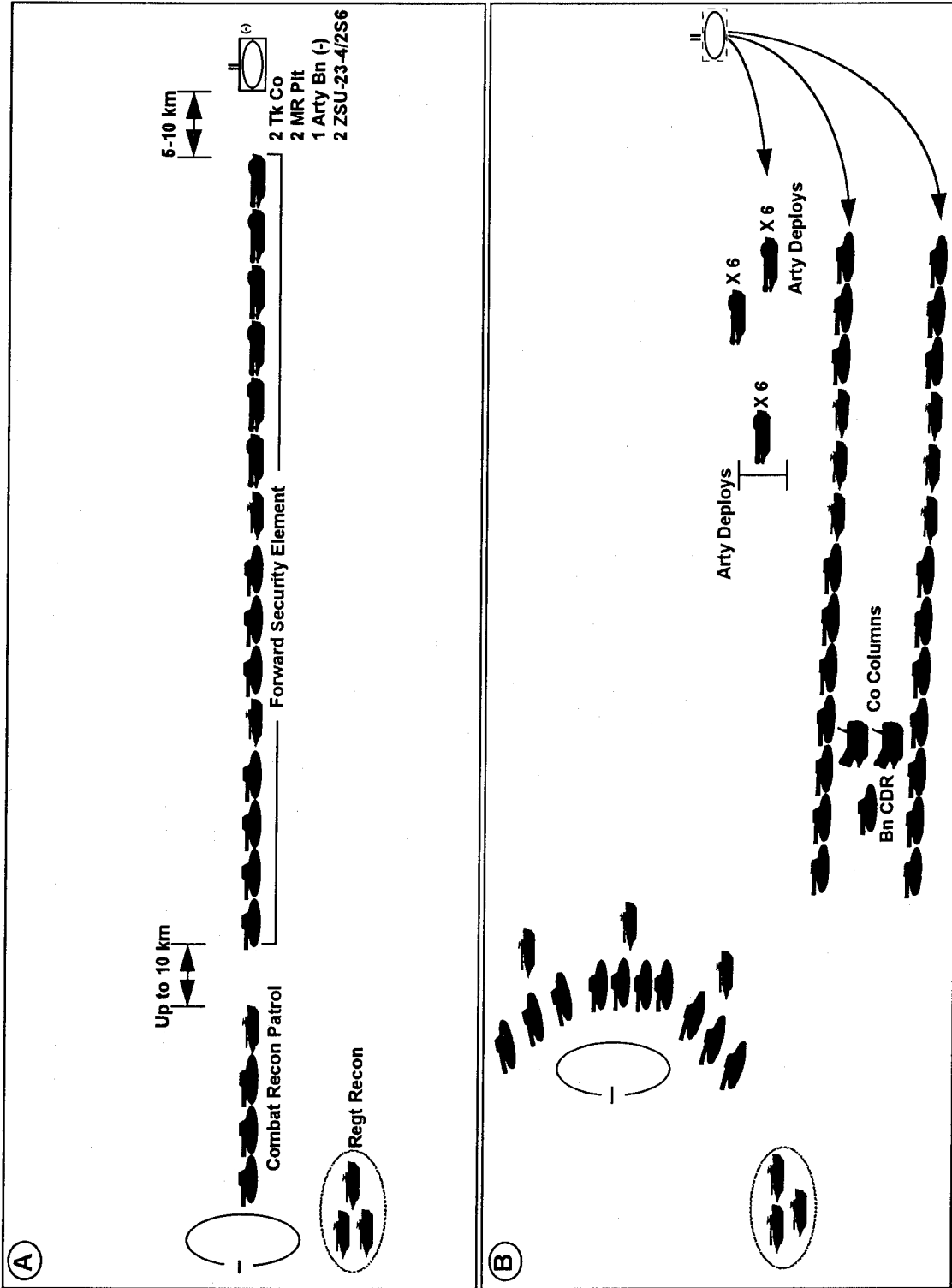

Figure 5-22. Sequence of attack from the march of TB acting as advance guard (part 1).

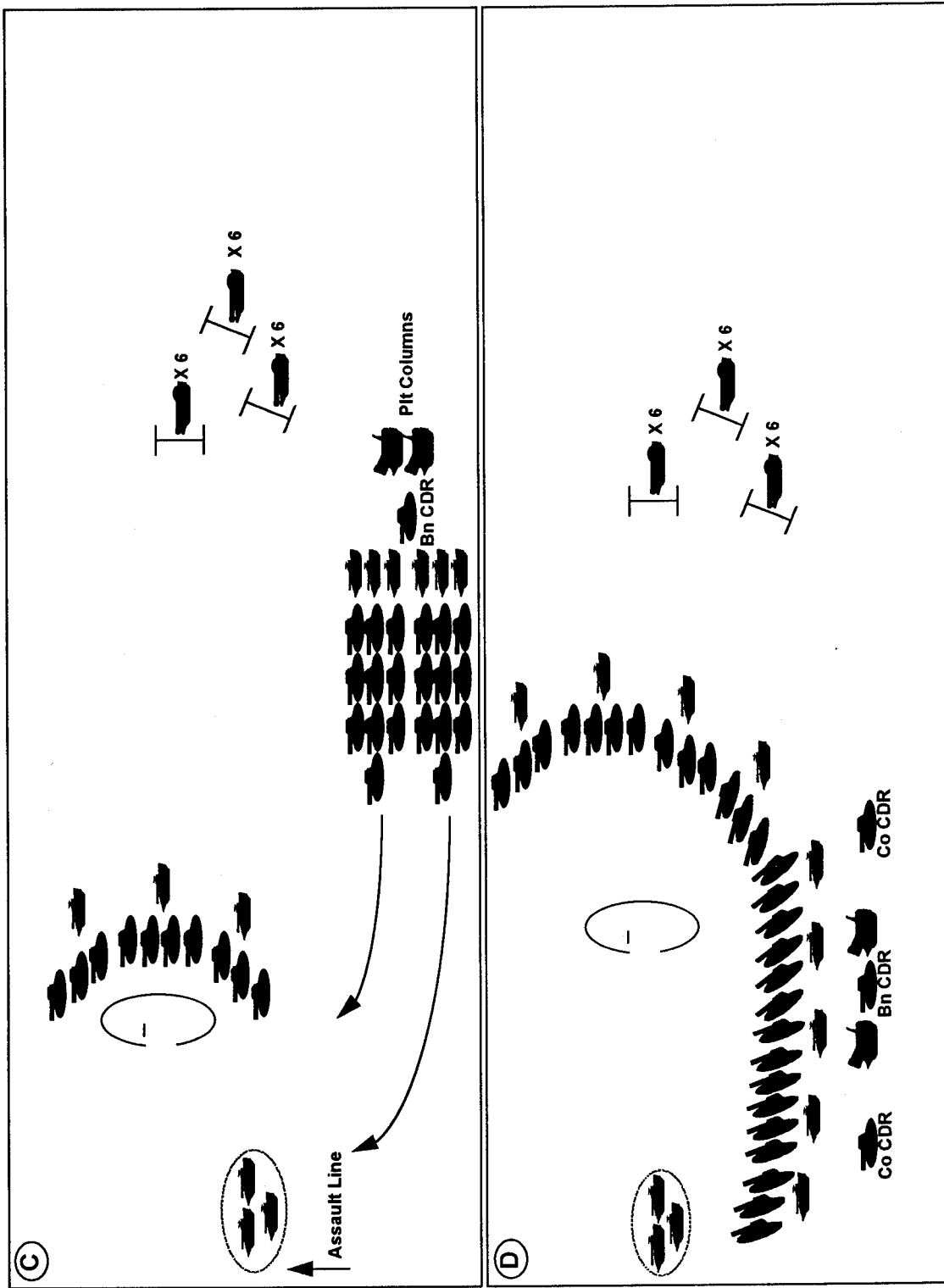

Figure 5-23. Sequence of attack from the march of TB acting as advance guard (part 2).

Attack Zone

A typical OPFOR company attack frontage varies from 400 to 1,000 meters for an MRC and from 400 to 800 meters for a TC. Tank platoons attack on a frontage of 100 to 200 meters, with 50 to 100 meters between vehicles. Motorized rifle platoons attack on a frontage of up to 300 meters; dismounted squads attack on a frontage of up to 50 meters each, with 50 to 100 meters between squads.

Missions

First-echelon companies receive an immediate mission and a subsequent direction of advance (toward the battalion immediate mission). Second-echelon companies receive an immediate mission (usually to work together with first-echelon companies to complete the latter's mission) and a subsequent direction of advance (toward the battalion subsequent mission).

There is little maneuver evident in platoon and company tactics. These subunits normally attack on line, in unison. The OPFOR considers this a strength, not a weakness. The battalion commander relies on his companies to act according to battle drills. This allows him more time to concentrate on maneuvering them and coordinating their actions rather than on giving them detailed instructions.

Assault Against Enemy Positions

The OPFOR conducts attacks on the enemies first positions by either mounted or dismounted assault. The OPFOR prefers motorized rifle subunits to conduct mounted assaults. Several factors favor use of the mounted assault:

- NBC-contaminated battlefield.
- Open terrain.
- Reduced enemy AT capability.
- Weak enemy defenses.

If an OPFOR commander plans a dismounted assault, he designates a dismount line within 300 to 400 meters from the enemy's forward edge. If possible, the dismount line is on terrain that allows his vehicles to be in defilade. This protects riflemen from machine gun fire and vehicles from anti-tank fires. Factors that favor use of the dismounted assault are as follows:

- Strong enemy AT capability.
- Well-prepared enemy defenses.
- Fords or bridges.
- Obstacles or minefields.
- Rough terrain with no high-speed avenues of attack.
- Need for maximum firepower.

Minefield Breaching

The OPFOR breaches minefields with a combination of tanks with mine rollers/plows, line charges, sappers, and possibly fuel-air explosives. Cover for the mine clearing effort includes smoke and intense fire on enemy defensive positions. Ideally, the OPFOR creates one lane per attacking platoon through an obstacle or minefield. One tank per tank platoon normally has a mine plow. In addition, each tank company may have a mine roller/plow. Mobile mine clearing vehicles hurl line charges out to several hundred meters to clear lanes several meters wide. Combat vehicles cover each other's passage through the minefield. If dismounted, riflemen follow in column behind tanks. (See Chapter 12 for more detail on mineclearing.)

Fire Support

The artillery preparation should end just before first-echelon elements reach the enemy's forward positions. Fires normally shift on the maneuver commander's orders when the lead elements are ready to begin the assault on the enemy forward defenses. While fighting through enemy defenses, maneuver elements follow in the path of intense artillery and mortar fires. Fixed-wing air strikes normally engage targets beyond artillery range. Attack helicopters provide direct air support for ground units in contact with the enemy.

Fire and Movement

In the assault on the enemy's first positions, there is little scope for fire and movement at the lowest levels. The emphasis is on generating and maintaining momentum, and even the briefest pause is forbidden. As the battle develops in depth, however, greater flexibility is expected, and fire and maneuver tactics may be employed within squads.

Action Following Penetration

The OPFOR expects a defending enemy to attempt rapid assessment of the direction and weight of the main attack; it also expects allocation of all available enemy forces to defeat the attack. Therefore, as the first-echelon battalions move to deeper missions, the regimental commander stays particularly alert for enemy counterattacks.

Action Against Counterattacks

Since enemy counterattacks are expected, an OPFOR commander must provide for their defeat in every plan of attack. The

goal is to defeat the counterattack and maintain the advance of the main body. Antitank assets concentrate on the threatened axis, and at regiment and division level the mobile obstacle detachment can surface-lay a minefield in the enemy's path. The force assigned to defeat the counterattack can fight from hastily occupied firing positions or may conduct a meeting battle.

If the counterattacking force is superior in strength, OPFOR commanders prefer to fight from a firing line on favorable ground, but they would rather fight an equal or weaker enemy in a meeting battle. In the former case, it is important to engage the enemy with artillery and mortars at the longest possible ranges. Every attempt is made to strip the infantry away from the enemy tanks and to destroy each element separately. Once the counterattack has been stopped, the blocking force would try to advance and complete its destruction.

Action On Success

When an attack has succeeded, the primary consideration is to keep up the momentum. If the enemy has been destroyed, units reform into march or prebattle formation. If the OPFOR detects an enemy withdrawal, it would send out additional reconnaissance and launch a pursuit.

Action on Failure

If the attack fails, there are two options available to the OPFOR commander. First, he can try to bypass the opposition and continue the advance, leaving the enemy to be dealt with by follow-on forces. This possibility assumes that the unit remains a viable fighting force. Alternatively, he could direct his subordinates to defend in contact pending a change in the situation that will enable

them to again transition to the offense. In the latter case, he would probably request reinforcement.

MEETING BATTLE

The OPFOR defines a **meeting battle** as an encounter between opposing sides both trying to fulfill their mission by offensive action.³ Figure 5-24 illustrates the circumstances under which a meeting battle may occur--

- When enemy forces are deploying forward.
- When the OPFOR encounters an enemy counterattack.
- When the OPFOR develops the attack into the depths of the enemy's tactical zone.
- During a pursuit.

The meeting battle is the basic form of offense used to meet and destroy enemy tactical reserves. In the defense, a meeting battle may occur during the conduct of a counterattack against an attacking enemy force.

The following conditions and requirements characterize meeting battles:

- Continuous and intense combat to seize and maintain the initiative.
- Rapid troop deployment from march or prebattle formation to battle formation.
- Rapid and sharp situation changes.
- Development of battle on a wide frontage with open flanks and great emphasis on maneuver.
- Speedy decision making and bold action to allow an inferior force to defeat a superior one.

³ Meeting battle is the tactical term. At the operational level, the OPFOR calls this type of offense a **meeting engagement**.

- Premium on deploying and firing first.
- Initiative and creativity by battalion, company, and platoon commanders.

The goals of the meeting battle are to destroy the enemy force and to continue developing the offensive. The side that seizes the initiative first through rapid deployment into battle or prebattle formations and through delivery of indirect and direct fires is most likely to win, even in the face of superior enemy forces. For the OPFOR commander, the correct decision is to take the initiative and execute a battle formation drill that will destroy the enemy first.

Characteristics

In the OPFOR view, the chief characteristics of the meeting battle are--

- Both sides are attacking from the march, leading to a close-quarter battle in which speed and surprise are the crucial factors.
- There is an intense struggle to seize the initiative, with each side trying to impose its will through offensive action.
- The battle is one of maneuver, with both sides accepting open flanks and gaps in their deployment as the action spreads over a wide area. Since neither side enjoys the advantage of having chosen and prepared the ground, everything is to be gained from bold maneuver.
- For most or all of the time, the situation remains fluid and obscure. Intelligence is limited and dates rapidly. Commanders cannot always wait until the situation is clear, but should attack vigorously into the gaps and flanks of the enemy deployment.

BEGINNING OF A WAR

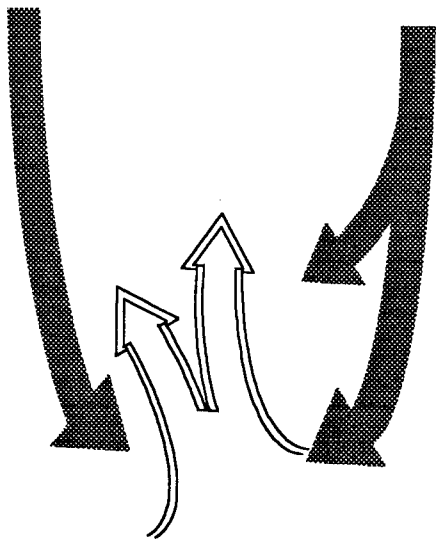

Could also occur at the outset of any attack when the two sides are not in initial contact, and both assume the offensive.

DURING PURSUIT

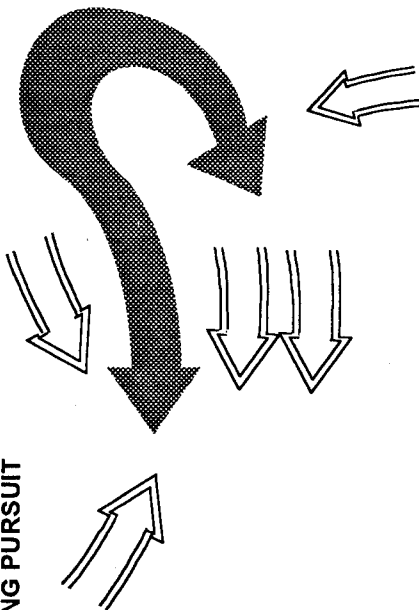

Meeting battle likely during counterattack by either side.

AFTER PENETRATION OF ENEMY'S FORWARD DEFENSE

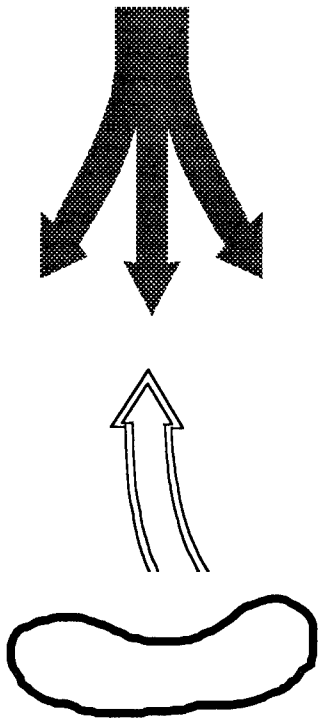

Would involve the penetrating force meeting the defender's advancing reserve elements.

DURING COUNTERATTACK

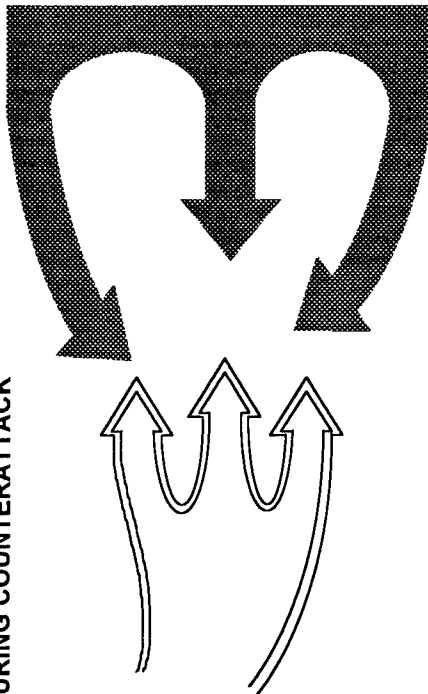

Strong possibility that the counterattacking force could be met head-on or from the flanks by the enemy.

Figure. 5-24. Circumstances under which a meeting battle may occur.

PHASE	ELEMENT IN MARCH	BASIC TASK	ACTIONS ON CONTACT
Initial Phase	Reconnaissance Patrols and Groups	Obtain data on enemy disposition and terrain along main routes of advance.	<ul style="list-style-type: none"> Disengage when possible. Report and/or continuously monitor the situation. Bypass enemy, continue to penetrate enemy positions, particularly nuclear-capable and high-precision weapon systems. In favorable conditions (or out of necessity), may attack advancing subunits, take prisoners, disorganize/disrupt enemy forces, and destroy enemy nuclear and high-precision weapons and C³I systems.
	Forward Detachment	Seize key terrain to facilitate the advance of the main body. May conduct raids en route to objective against key targets (nuclear and high-precision weapon systems, C ³ I centers)	<ul style="list-style-type: none"> Avoids contact as much as possible, moving rapidly to its objective. If necessary, conducts meeting battles like a battalion acting as an advance guard.
	Advance Guard	Move along route of main body to ensure uninterrupted advance of main body, overcoming enemy security/ reconnaissance forces and obstacles.	<ul style="list-style-type: none"> Reports enemy contact/disruption. FSE deploys and attempts to overcome enemy force based on information from CRP(s). If the FSE is not able to overcome the enemy, it assumes a defensive overwatch position to support maneuver of main body of advance guard. Main body of advance guard attempts a close envelopment or double envelopment to defeat the enemy unless his force is overwhelming in size. If successful, subunits reform and resume march or initiate pursuit. If unsuccessful, subunits hold positions/block enemy/continue attacking to support the subsequent maneuver and attack of the main body of the parent unit.
Actions of Main Body	Main Body	Deploy rapidly for the attack and defeat of the enemy, generally from the flanks.	<ul style="list-style-type: none"> Based on information from forward elements, commander maneuvers his forces and attempts to envelop. Subunits march rapidly to assigned sectors and deploy in prebattle/battle formations as needed to assault enemy forces.
Conclusion	Main Body	Develop the attack into the depths of the enemy rear.	<ul style="list-style-type: none"> If enemy withdraws, it initiates pursuit. If it decisively defeats the enemy, it resumes direction of march and overall mission. If it does not defeat the enemy, it continues to develop the attack and holds positions aggressively until higher headquarters can conduct its maneuver. If it is unsuccessful, it may go over to the defense in the course of the offense.

Figure 5-25. Phases of meeting battle.

- Given that there may be sudden and dramatic developments, special reserves and, in particular, antitank reserves are needed to meet the unexpected.
- Only a commitment to the offensive ensures that most of the surprises happen to the enemy.
- The time available for decision making and deployment is limited. Victory goes to the side that attacks first and builds up its combat power in the decisive area fastest. Thus, there is a premium on simple deployment drills.
- Meeting battles are expected to be decisive. The defeated side, outflanked and penetrated deeply from the front, with no prepared positions to fall back on, should find it difficult to go over to the defensive or withdraw. His force may very well cease to exist as a coherent combat grouping.
- The requirement for speed in his troop control procedures and the making and transmitting of decisions.
- Anticipation of enemy air and artillery strikes, and using that information in gaining fire superiority.
- Achievement of the initiative through immediately responsive deployment of maneuver forces.
- Adequate flank and rear security.

Planning

The OPFOR does not look upon the meeting battle as a purely chance occurrence. It trains commanders to anticipate such a battle, to identify a likely point of contact, to choose advantageous terrain, and to take the initiative. The OPFOR believes that the side that aggressively seizes the initiative with fire and maneuver wins the meeting battle. Figure 5-25 lists the phases of the meeting battle and the tasks the OPFOR associates with each element. The commander anticipating a meeting battle must consider the following factors in his planning and decision making:

- Continuous and thorough reconnaissance from his assets and the correct interpretation and use of reconnaissance information furnished from higher levels.

Division

An MRD or TD enters a meeting battle in march formation with a zone of attack 15 to 25 km wide. Within the division zone of attack are two, or possibly three, regimental axes. Subunits of the division reconnaissance and REC battalion scout all potential routes of advance for the division's lead regiments. The division's forward detachment (FD) uses data from these reconnaissance subunits to seize terrain critical to the division's advance. To reach this objective at the earliest opportunity, the FD normally avoids combat en route to its objective. It fights only to seize its key terrain objective.

Brigade

For an independent motorized rifle brigade (IMRB), the meeting battle is the primary form of offensive combat. Compared to a regiment, the IMRB can advance on a broader frontage, and the commander has more options of how to take on the approaching enemy force. He can maneuver in depth and engage the enemy column at much greater distance.

Regiment

Regiments are the maneuver units of a division; they actually fight meeting battles.

The first-echelon regiments of the division main body conduct the meeting battle using their advance guard/main body march formation.

Battalion

A motorized rifle or tank battalion is most likely to become involved in a meeting battle when acting as the advance guard of a regiment. (See Figure 5-26.) This is also true of a battalion acting independently as a forward detachment of a division or regiment. When performing such a role, a motorized rifle battalion is normally reinforced with tank, artillery, and engineer troops and possibly with antitank, air defense, or chemical protection elements. A tank battalion would be similarly reinforced, but with motorized rifle troops rather than tank or anti-tank elements.

Deploying through the successive stages of prebattle formation (company to platoon columns) is the norm, but there are occasions when a battalion's main body could conduct a simultaneous flank turn in the direction of the enemy, thus transitioning from battalion column directly into battle formation. Such a maneuver would require adequate terrain and an overriding need to develop combat power quickly.

Company

OPFOR maneuver companies fight meeting battles and defending enemies in the same manner. A motorized rifle or tank company normally fights as part of a battalion. However, it can also act independently as a forward security element of an advance guard or a forward detachment, or when its parent regiment has sent it out as a forward security element instead of an advance guard. A company in such a role receives

reinforcements from NBC reconnaissance, artillery, and a subunit of the other maneuver arm (tank or motorized rifle). It still executes one or more drill-like maneuvers to bring its combat power to bear on the encountered enemy.

Sequence of Meeting Battle

As the OPFOR regiment advances in tactical march formation, the action in a meeting battle usually follows the sequence described below. (See also Figure 5-22.)

Location and Identification of Approaching Enemy

First reports of an approaching enemy and the possibility of a meeting battle are likely to come from higher headquarters. An OPFOR commander's first reaction is to direct his reconnaissance assets to provide more detail of the enemy's location, movements, and intentions. For example, a regiment might be warned of the approach of an enemy force by its parent division and send out additional independent reconnaissance patrols to contact the enemy. Similarly, a battalion might learn of an advancing enemy battalion from its regimental command post, and the commander could decide to send out at least an additional combat reconnaissance patrol. In the worse case, a battalion acting as an advance guard or forward detachment might learn of an approaching enemy from a contact report from its own combat reconnaissance patrol or forward patrol.

Decision to Initiate Meeting Battle

A commander may be ordered to undertake a meeting battle or may have to make the decision on his own initiative. Meeting battles often arise in the course of a march, and a commander who has not con

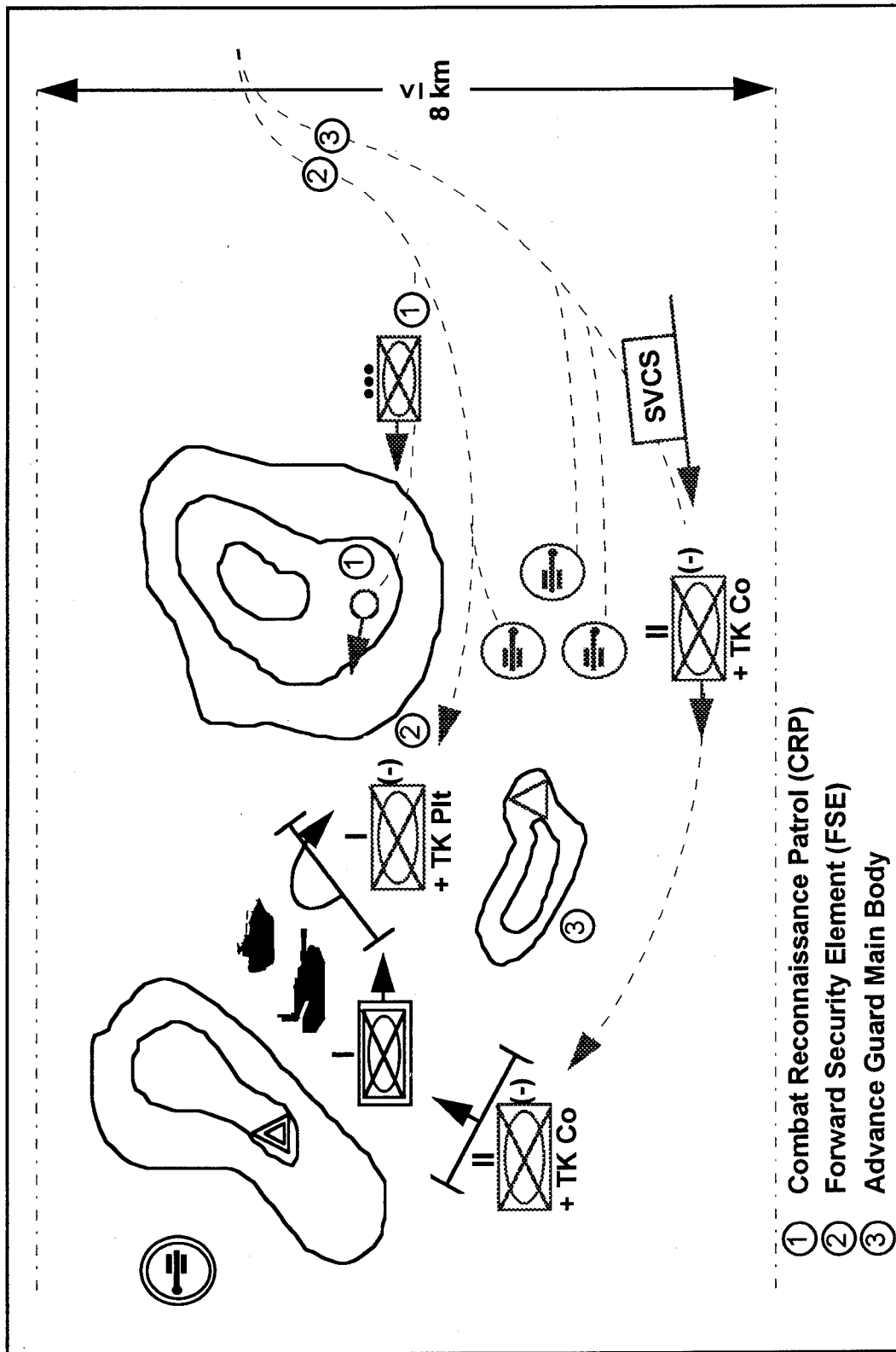

Figure 5-26. Reinforced MRB as advance guard in meeting battle.

sidered the possibility of a meeting battle in planning his march formation can be at a disadvantage. The mission to conduct a meeting battle can be received while waiting in an assembly area, allowing time for more detailed planning.

Selection of Point of Contact

The OPFOR commander assesses the locations of the opposing forces and their speed of advance. Using a nomogram or a mathematical calculation he can plot the line of likely contact on his map. (See Chapter 7 of *Heavy OPFOR Operational Art* handbook for an example of this calculation and the nomogram used as a shortcut.) From a map assessment, he determines the location of the key terrain in that area. It is vital to seize this ground before the enemy, and this task may be allocated to leading march security elements.

Engagement of Enemy

The intention is to assault the enemy's main body and destroy or disorganize his force. Speed of actions and shock are paramount. The forward security element can occupy a blocking position and begin engaging the approaching enemy. Attached artillery deploys as rapidly as possible and opens fire. Antitank elements should be well forward in the march formation, so that they may join in the task of engaging the enemy force.

The commander is likely to join his forward element to judge the situation for himself. The main body deploys to the selected assault position without delay and strikes the enemy's main body as it advances to support its forward elements. Ideally, the enemy is assaulted while he is on the move or deploying, preferably from a flank or even

both flanks. If flank attacks are impossible, a frontal attack can be launched, but the commander would still try to introduce an element of surprise. The main body should act together; this ensures an effective attack is delivered. A mounted attack is the rule in meeting battles.

Facing a Superior Enemy

The attacking force is not expected to attain the degree of force superiority over the enemy that is required in attacks against a defending enemy. A force that has parity with the enemy, or is even slightly inferior, can achieve victory if it holds the initiative. If the enemy is significantly superior in strength, or preempts the OPFOR unit in seizing the key ground, the OPFOR tries to deploy on a favorable firing line and stop the enemy advance. It then continues to disrupt the enemy's deployments, trying to create favorable conditions for a senior commander to introduce new forces into the battle.

Initial Phase

The initial phase of the meeting battle is that period of combat from the time of enemy encounter by the leading element--normally a combat reconnaissance patrol (CRP) or forward patrol) up to the commitment into battle of the main body. Elements of the **advance guard** carry out the initial phase. The subsequent employment of the regimental main body depends on the outcome of the initial phase.

With current reconnaissance capabilities, the initial enemy encounter by the CRP or forward patrol should not be a complete surprise. The use of reconnaissance reporting permits employment of long-range fires, both artillery and air, to inflict damage on the enemy and to delay his advance.

<p>ATTACK BY FORWARD SECURITY ELEMENT AND/OR ADVANCE GUARD SUCCESSFUL</p> <ul style="list-style-type: none"> * Enemy element destroyed. * Advance guard resumes march. * Main body of regiment does not deploy. 	
<p>NO IMMEDIATE SUCCESS BY ADVANCE GUARD</p> <ul style="list-style-type: none"> * Advance guard continues attack. * Main body continues march forward and prepares to deploy. 	
<p>ENEMY FORCES DENY FURTHER OFFENSIVE ACTION BY ADVANCE GUARD</p> <ul style="list-style-type: none"> * Advance guard shifts to defense. * Main body deploys and attacks. 	
<p>ADVANCE GUARD UNABLE TO HOLD ENEMY</p> <ul style="list-style-type: none"> * Main body defends on best terrain available. * Advance guard withdraws and joins defense. * Follow-on division forces committed to attack. * Division assumes defense if enemy force too powerful to attack. 	

Figure 5-27. Possible outcomes of advance guard action in meeting battle.

As the forward elements of the advance guard encounter the enemy, the regimental commander is at or near the head of the regimental main body, 20 to 30 km to the rear of the advance guard. This calculated spacing should give the commander about two hours to plan and execute his battle.

Combat Reconnaissance Patrol

If it makes the initial contact with the enemy, the CRP immediately reports the contact to advance guard commander. It then attempts to penetrate to enemy main force, bypassing his advance elements. It may also perform chemical and engineer reconnaissance, if specialized troops are attached. Most importantly, the CRP collects information on the enemy to expedite the commander's decision.

Forward Security Element

The forward security element (FSE) moves in column up to 10 km behind the CRP and 3 to 5 km behind its own forward patrols. Based on information from those patrols, it advances at maximum speed and engages the enemy with all weapons. It develops the fight, attempting to seize and hold a position until the advance guard main body arrives.

Advance Guard Main Body

At the time of initial contact, the advance guard main body is moving in march column 5 to 10 km behind the FSE. The advance guard commander defines the plan for engagement and issues orders to the commanders of the CRP and FSE. Then, the main body commander moves forward, with the commander of the reinforcing artillery subunit, at maximum speed to an observation point. After assessing the situation, he issues

orders for the deployment of the advance guard main body and launches the attack.

Regimental (Brigade) Main Body

While the advance guard engages the enemy, the **regimental (or brigade) main body** continues its forward movement. The deployment of the main body depends on the outcome of advance guard action. The advance guard action could have the following outcomes:

- The attack by FSE/advance guard is successful.
- The advance guard achieves no immediate success.
- The enemy forces deny further offensive action by advance guard.
- The advance guard is unable to hold the enemy.

(Figure 5-27 illustrates these possible outcomes.)

When the outcomes of the advance guard action require deployment of the main body, the regiment (or brigade) commander decides what form of maneuver to use. The **close and deep envelopments** are the favored forms of maneuver. The OPFOR prefers to attack the enemy's flank or rear whenever possible; however, when maneuver is not possible, a frontal attack may be necessary.

The time available to execute a maneuver can be a major factor in the commander's selection of a form of maneuver. Space could be the controlling factor for an envelopment. Terrain must be trafficable, providing covered or concealed routes for the enveloping force, open ground for deployment, and good fields of fire. The area adjacent to the original route of advance must allow for the concealed or unimpeded maneuver of the advance guard. Envelop-

ment by a regimental (or brigade) main body requires enough space for the concealed maneuver of one or more battalions to a point along the flank of the enemy force.

Forward Detachments

Tactical maneuver forces are particularly useful for securing maneuver in the open, fluid environment of a meeting battle. An OPFOR regiment (or brigade) that has engaged lead enemy elements with its advance guard may send out a **forward detachment** from its main body--

- To block enemy follow-on forces.
- To assist in fixing/blocking the lead enemy force.
- To ensure favorable conditions for the commitment of the rest of the main body.

The **division forward detachment** is extremely important in the meeting battle. If the enemy defenses are weak, the FD can penetrate the enemy's combat formation, avoiding contact. The detachment then seizes key terrain to hinder the enemy's maneuver or aid the movement of friendly forces. If the enemy defenses are strong, another force may have to effect the penetration for the FD. When a lead regiment has committed an FD in the course of maneuvering its main body, the division FD already in the enemy rear might change missions. It could either join in the attack on the flanks or rear of the enemy force, or become a reserve, depending on the situation. In the rapidly changing conditions of a meeting battle, an OPFOR commander may assign and withdraw FD missions on short notice, as appropriate for the conditions at the time.

Division Follow-On Forces

The preceding description of the meeting battle focused on the actions of a brigade or a first-echelon maneuver regiment. Unless the regiment has received an independent mission to pursue or to act as an FD, it marches as part of a division force. Consequently, the development of battle might require the commitment of the follow-on elements of the division. The procedures are essentially the same as those discussed in the example of the lead regiment.

Before his lead regiment is fully engaged, the division commander's forward command post is near the head of the division main body, most likely with the next following regiment. He monitors the action of the lead regiment and, after its commitment, he moves his command group to the best location to control subsequent deployments. The employment of division follow-on forces depends on the progress of the initial actions of the lead regiment. Figure 5-28 illustrates the employment of division follow-on forces under the various possible conditions.

Subsequent Action

The division's actions in a meeting battle appear here generally as a sequential, front-to-rear unfolding of combat. Many **other possibilities** can occur as formations move on a fluid battlefield and encounter one another. The meeting battle may not always unfold in the sequence of encounters by reconnaissance elements, advance guards, and main bodies, nor does it always begin with a head-to-head meeting. Whatever the pat

SUCCESSFUL ATTACK BY LEAD REGIMENT

- Lead regiment exploits success or resumes march.
- Follow-on regiment(s) initiate pursuit or resume march on one or multiple routes.
- Depending on the assigned mission and degree of success, regiments could consolidate positions and await orders, or resume march in new direction.

ENEMY GOES OVER TO DEFENSE

- Lead regiment attacks enemy defenses and, by fixing enemy force, facilitates commitment of division follow-on forces.
- Depending on availability of maneuver space and size of enemy force, follow-on regiment(s) flank and envelop the enemy.
- If follow-on forces succeed, exploitation or pursuit occurs.
- Alternatively, OPFOR may consolidate and regroup, then resume the march.

LEAD REGIMENT MUST GO OVER TO DEFENSE

- Lead regiment holds pending arrival of follow-on forces.
- Follow-on forces counterattack and attempt to envelope enemy; if successful, subsequent actions are as above.
- If follow-on forces are insufficient to mount counterattack, they may augment the defense.

LEAD REGIMENT UNABLE TO CONTAIN ENEMY ATTACK

- Follow-on forces conduct counterattack. If successful and enemy withdraws, exploitation or pursuit begins; alternatively, they may consolidate, regroup, and resume the attack.
- Follow-on forces establish defensive positions to or through which the lead regiment withdraws.
- Division holds pending commitment of army/army corps follow-on forces.

Figure 5-28. Employment of division follow-on forces.

terms and conditions, the OPFOR formula for a successful meeting battle requires surprise, rapid and decisive maneuver, and concentrated preemptive fires against the enemy. Fire support is vital to the successful outcome of a meeting battle.

The meeting battle ends when one side is destroyed or adopts a new tactic, such as establishing a defensive position or withdrawing. An attack from a position in direct

contact could then be mounted or, depending upon the situation, a pursuit or withdrawal.

PURSUIT

The OPFOR defines **pursuit** as a type of offensive conducted against a **withdrawing enemy**. The goal of a pursuit is to complete the destruction of, or capture the enemy force. The OPFOR considers pursuit

as one of the principal forms of exploitation. Exploitation is the development of the attack into the tactical and operational depth of the enemy. Pursuit slows down the enemy force, permitting the maneuver of forces and fire to complete the destruction of the enemy.

Pursuit offers swift and deep movements of forces to strike the enemy's most vulnerable areas. The basic requirements for a successful pursuit include planning and organization, detection of withdrawal, and maintenance of high tempo. An enemy can withdraw as a result of a meeting battle, or after a penetration of his defensive position. An enemy may deliberately withdraw when threatened with envelopment, making a redistribution of forces, attempting to draw the OPFOR into an engagement area (kill zone) or withdrawing for safety before launching a nuclear strike.

At the first indication of an enemy withdrawal, the OPFOR expects the commander at any level to initiate the pursuit without waiting for orders from higher headquarters. This helps ensure that the OPFOR does not allow the enemy to break contact and to conduct an orderly withdrawal. The scale of a pursuit depends on the size of the forces involved. Even though a lower-level commander can make the decision to initiate a pursuit, he must inform his higher commander that he is doing so.

Planning

An OPFOR commander anticipates an enemy withdrawal when he plans his offensive. His tentative planning for pursuit is part of the initial attack plan. The amount of detail that the commander includes in such planning depends on the anticipated actions of the enemy, the combat formation of at-

tacking troops, and the amount of planning time available. He must also consider:

- Possible enemy routes of withdrawal.
- The scheme of maneuver.
- Availability and condition of pursuit routes.
- Forces available.
- Critical terrain features.
- The use of forward detachments and heliborne landing forces.
- Allocation of nuclear weapons and delivery systems, high-precision weapons and aviation support.
- Combat support and combat service support resources.

To detect enemy withdrawal, the commander relies on active reconnaissance, an understanding of enemy tactics, and knowledge of the current tactical situation. He must pay special attention to the following signs of enemy preparation for withdrawal:

- Increased movement to the rear, especially artillery and reserves.
- Increased fires in individual sectors of the line of contact.
- Conduct of heavy fire concentrations in separate areas, not in accord with the developing situation. These concentrations may occur at a time when there appears to be a general reduction of fires.
- Intensified reconnaissance.
- Preparations for demolition and/or destruction of facilities, installations, and equipment.
- Limited local counterattacks.

OPFOR doctrine stresses that the decisive defeat of an enemy force can only be achieved by vigorous and continuous exploitation of tactical advantages. All OPFOR commanders have a duty to maintain contact

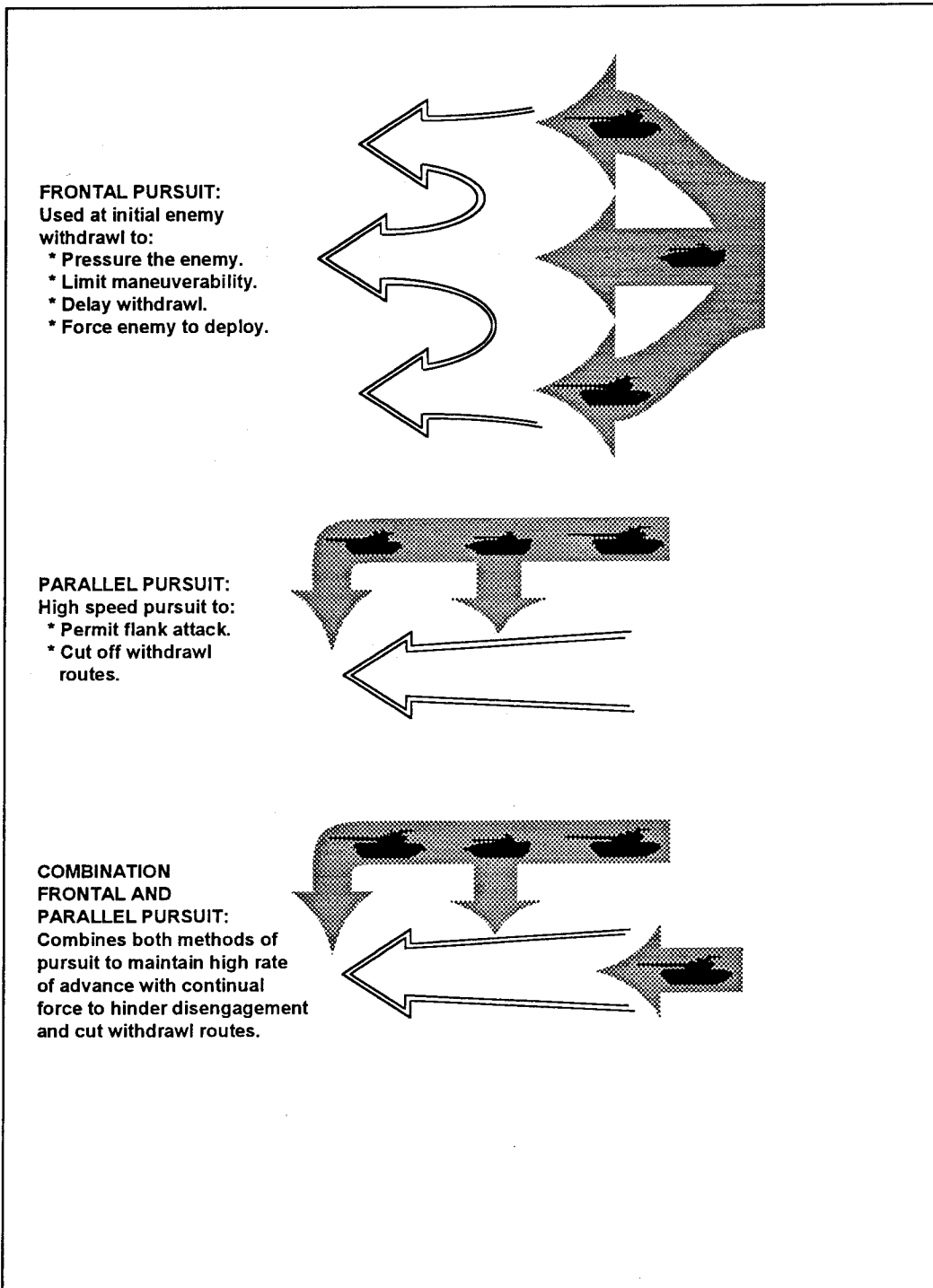

Figure 5-29. Forms of pursuit.

and are expected to take up the pursuit without further orders.

Forms

Once the OPFOR initiates pursuit, its success depends on the maintenance of a high rate of advance with continuous application of force. The forms of pursuit are **frontal**, **parallel**, and **combination frontal and parallel**. The OPFOR prefers the combination form and considers it to be the most effective. Figure 5-29 outlines the forms of OPFOR pursuit.

Frontal

A **frontal pursuit** is an attack that the pursuing force conducts along the same withdrawal route that the enemy is using. The frontal pursuit can help fix the enemy force by delaying enemy withdrawal, defeating the enemy's rear covering force and maintaining constant pressure on the enemy, restricting his ability to disengage and to move away rapidly in march formation.

Parallel

A **parallel pursuit** involves forces moving rapidly in march, or prebattle, formation along one or two axes parallel to the retreating enemy. Their goal is to outdistance the enemy and to conduct a close/deep envelopment, decisively encircling and attacking the retreating enemy force. Using a parallel axis permits the pursuing force to move rapidly in march formation to overtake the enemy force and surprise it with an enveloping maneuver. A parallel pursuit alone risks the loss of contact and the race with the enemy since reduced pressure permits the enemy to reorganize and regroup.

Combination

The most decisive results in the pursuit come from combining the frontal and parallel forms. In the **combination pursuit**, part of the attacking first echelon initiates a frontal pursuit immediately upon discovery of the enemy's withdrawal--

- To destroy the enemy's covering force.
- To slow the enemy.
- To maintain constant pressure.
- To support the main envelopment.

Other forces initiate a parallel pursuit on one or two axes of advance to overtake and envelop the enemy. Figure 5-30 depicts the combination of pursuit methods against a withdrawing enemy.

Conduct

The OPFOR believes that a timely and correct decision to initiate pursuit is critical to success. If the enemy is able to begin an undetected withdrawal, he can avoid the constant pressure that would disrupt his action. The OPFOR expects the enemy to attempt withdrawal at an advantageous time, usually at night; so it takes timely actions to maintain contact. Artillery fire and air strikes harass and disrupt the enemy's withdrawal. In the initial phase, tank and motorized rifle pursuit forces take up routes parallel to enemy withdrawal routes to help establish the combination frontal and parallel method of pursuit.

Forces in contact initiate frontal pursuit immediately on detection of withdrawal, moving in whatever formation they are in at the moment. As the situation permits, they reform into prebattle or march formation, deploying into battle formation only when

necessary. The actions of the frontal pursuit force should facilitate the commitment of a parallel pursuit force, which is preferably tank-heavy. The parallel force, with security elements in the lead, also uses march or pre-battle formations unless deployment for the attack is necessary.

The commander employs the maximum number of available combat troops in a pursuit. The pursuit occurs across a wide zone, up to 30 km for a division. The commander retains the tactical options to converge on the most important axis or to redirect the effort on a new axis. This flexibility is also necessary when engaging advancing enemy reserves or counterattack forces.

Centralized planning and decentralized execution characterize the pursuit. Preservation of control is a primary concern in such a fast-moving situation. At the same time, the OPFOR attempts to disrupt the enemy's command and control as an integral part of destructive pursuit. It achieves continuity in its own control by--

- Designating pursuit axes, phase lines, and objectives.
- Fixing times for completion of specific missions.
- Altering missions as subsequent developments require.
- Using two command groups. The commander would be at an observation post behind the leading combat elements. The second group, headed by the chief of staff, would be with the main body.
- Designating the phase lines from which the artillery must prepare to fire by specified times.

Reconnaissance

The reconnaissance effort during a

pursuit is intensive, concentrating on enemy withdrawal routes. As the pursuit develops, reconnaissance elements provide information on the disposition of retreating enemy formations and on the forward movement of his reserves. Because of the potential depth of the operation, aerial reconnaissance may be the primary means of identifying significant threats to pursuit forces. This intelligence is vital at the stage when a pursuit force faces the risk of becoming over extended, and it can be the basis for termination of the pursuit.

Forward Detachments

Before or during the course of pursuit, commanders may designate FDs to move ahead of the main pursuit. They may direct the detachments to operate independently to outdistance withdrawing enemy forces. These detachments avoid combat until they reach their assigned objective area. Their missions may include--

- Concurrent reconnaissance reporting.
- Seizure of critical points on withdrawal routes.
- Destruction of the enemy's means of nuclear attack.
- Linkup with tactical airborne or heliborne landings.

Heliborne or airborne forces may receive missions similar to those described for FDs. Vertical envelopment permits operations much deeper into enemy territory.

FDs of regimental or reinforced battalion strength can be widely used. In a division, up to a regiment might be sent out as an FD ahead of the main body. Regiments might send out reinforced battalions ahead on each pursuit axis. FDs have a limited combat power and seek to avoid becoming heavily engaged, pressing on to their designated objectives.

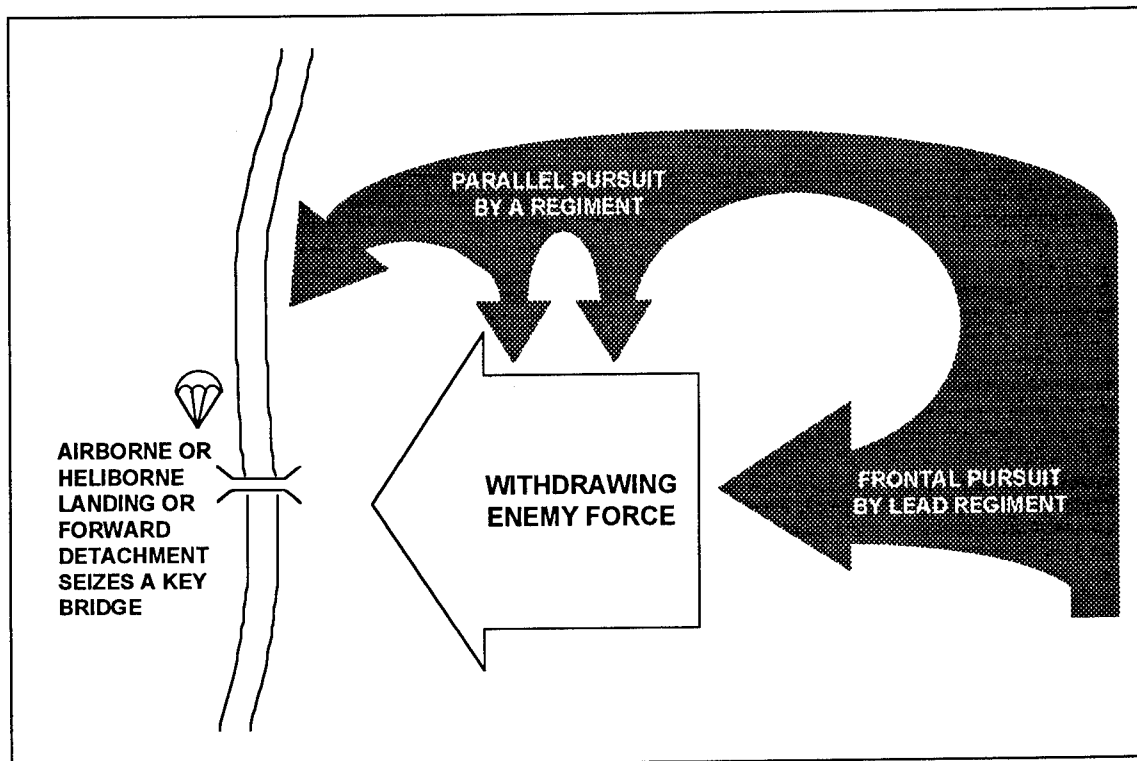

Figure 5-30. Division conducting combination pursuit (example).

Main Forces

Main forces advance in tactical march formation, moving as fast as possible. After a penetration, gaps between divisions and regiments are likely to increase, and each is given an axis of pursuit rather than a zone of advance. OPFOR commanders are very conscious of the vulnerability of their open flanks in this situation and, therefore, deploy antitank reserves and mobile obstacle detachments to the flanks. Regiments act with considerable tactical independence, and the division commander does not expect a uniform rate of advance on all axes. Some units may launch a pursuit while others are still engaged in a penetration battle, or meeting enemy counterattacks.

Division

Figure 5-30 illustrates an **example** of a combination pursuit conducted by a maneuver division. In this case, a lead regiment of the division executes a frontal pursuit. Other regiments then move on a parallel axis to envelop the enemy. When possible, these regiments move in march formation to facilitate rapid movement. The division can dispatch a forward detachment to seize key terrain or occupy a blocking position. It could also conduct a heliborne landing (or request an airborne landing), but this requires support from higher headquarters. When the situation is favorable, the pursuing forces conduct coordinated attacks in prebattle or battle formation against the enemy force. After it has captured, annihilated, or fixed the enemy force, the bulk of the division resumes the march formation continuing to develop the attack.

Brigade

An IMRB would conduct a pursuit in much the same manner as a division. The main difference would be the scope.

Regiment

The regiment may participate in the pursuit independently or as part of a division pursuit. The regimental pursuit would follow the divisional pattern on a smaller scale. Elements of the advance guard could conduct a frontal pursuit while the battalions of the main body march on one or two parallel routes. The regiment is not likely to dispatch a heliborne landing force; however, it may attempt a deep envelopment with a forward detachment to block the enemy withdrawal.

Battalion

The battalion generally acts as part of a regiment or division in the pursuit. There may be an occasion, however, where it would independently pursue a relatively small enemy force.

Fire Support

When an OPFOR commander initiates pursuit, he often forms the parallel pursuit force from uncommitted second-echelon or reserve elements. These are not normally marching with any fire support assets other than those organic to them. The commander must redistribute the fire support he had assigned to support the preceding combat actions.

Artillery

The commander of a maneuver regiment may decentralize the control of artillery

to his maneuver battalions. During pursuit, artillery missions include fire on columns and concentrations at road junctions, defiles, bridges, and crossings. They also include the repulse of enemy counterattacks, destruction or delay of enemy reserves, and destruction of enemy means of artillery support.

Air Support

Air support complements other fire support assets in the destruction and disorganization of the retreating enemy, particularly mobile targets. The situation during the course of a pursuit may become obscure. Air reconnaissance is an important factor in ensuring the success of the pursuit. It can determine--

- The beginning of the withdrawal of rear area forces.
- The composition of withdrawing forces and direction of movement.
- The composition and direction of reserve forces moving forward.
- The nature of obstacles and intermediate defensive positions.

Other Support

Obstacle-clearing groups, movement support detachments (MSDs) and mobile obstacle detachments (MODs) provided by engineer troops are instrumental in sustaining the rate of advance. In the initial phase, an MSD prepares the line of march and supports lateral dispersion of units transitioning into the attack and the commitment of the second echelon or reserve. First-echelon maneuver battalions, supported by engineers, form obstacle-clearing groups to breach enemy minefields and other obstacles during the attack. In the course of the pursuit, an MSD's mission is to provide bridging and road repairs. The MOD's mission in the pursuit is to block withdrawal routes of by-

passed units with mines, demolitions, and obstacles.

Requirements for fuel and maintenance increase with maximum commitment of forces. Priority of logistics goes to those units having the greatest success. The depth of pursuit depends on the capability for logistics support.

Termination of Pursuit

An OPFOR commander does not terminate pursuit on his own initiative, but only on the order of the next higher commander. Conditions under which the OPFOR may terminate pursuit include the following:

- The pursuing force has captured, destroyed, or fixed the enemy for follow-on forces.
- The pursuing force has outdistanced its logistics support.
- The pursuing force has overextended itself and is in danger of being cut off by the enemy.
- The pursuing force no longer has the advantage.

COMBAT UNDER SPECIAL CONDITIONS

The OPFOR classifies combat operations in **cities, mountains, deserts, forests,** and in **northern regions** as combat under special conditions. The changes in tactics that such specialized fighting requires are the subject of this section. There are certain elements common to all special conditions. Units and subunits tend to have greater tactical independence than in conventional operations. Key weapons, such as tanks and artillery, normally concentrated under central

command are allocated in small quantities to the lowest levels of command. Difficult terrain and limited visibility complicates troop control, calling for much greater initiative among junior commanders.

The OPFOR does not have special divisions for warfare under special conditions. Formations based in areas characterized by special conditions train accordingly. They may vary from the normal in organization and equipment. For instance, divisions in mountainous areas can have mortars and pack howitzers instead of the standard artillery weapons. Airborne formations, with lighter equipment, higher motivation, and low-level initiative are also seen as suited to combat in special conditions.

The standard OPFOR tactics previously described require modification in several types of special conditions. Attack frontages and depths of missions/objectives all vary from the norm. The most significant change in OPFOR tactical practice is that, in special conditions, it is necessary to decentralize decision making and control of assets to lower levels of command than is normally desirable. This section describes typical variations of combat in special conditions.

Cities

The OPFOR knows that fighting in towns and cities slows its rate of advance, requiring a high consumption of manpower and materiel. The OPFOR tries to avoid fighting in built-up areas whenever possible, either by bypassing defended localities or by seizing towns from the march before defenses can be repaired. Undefended towns may be exploited as avenues of approach or assembly areas.

Assault

When there is no alternative, the OPFOR reorganizes its combat formation to attack a built-up area by assault. Preparations begin with an intensive reconnaissance effort to determine the layout of the defense. Throughout the battle, commanders spend much more time in personal reconnaissance on the ground than they would for a normal battle.

Combat Grouping

The burden of combat in built-up areas falls on motorized rifle troops, supported by other arms. Tank units can be used to seal off pockets of resistance en route to the town or city, to envelop and cut off the built-up area or to provide reinforcements or mobile reserves for motorized rifle units. Artillery is decentralized for the direct fire role, and extra engineers are supplied from higher formations. Because of the fragmented nature of the fighting and the difficulty of regrouping, the reinforced motorized rifle battalion forms an **assault detachment**, as the basic combat organization. A battalion designated as an assault detachment can be reinforced by a tank company, an artillery battalion, an engineer company, antitank weapons, and air defense weapons. An assault detachment forms two or three **assault groups**, each built around a motorized rifle company with various reinforcements.

Assault group personnel are issued increased quantities of certain weapons, especially grenades, including antitank, smoke, and incendiary grenades. Specialized equipment, such as grapples, ropes, and ladders, is provided or acquired locally. Smoke is used extensively to cover the assault.

Echelonment

While divisions may attack built-up areas in one echelon, with a small reserve, the attack is always deeply echeloned from regimental level down. Not only regiments and assault detachments, but even assault groups form a second echelon or a very strong combined arms reserve.

Frontages

An assault group is usually given one street to clear, with a platoon advancing up each side of it. Its frontage can be 200 to 300 meters, and that of an assault detachment 400 to 600 meters. A regiment could be responsible for 2 to 3 km, though its attack frontage would be less.

Objectives

Assault detachments are allotted an immediate objective, perhaps one or two town blocks or a single strongpoint, and thereafter a direction of subsequent advance.

Artillery

Preparatory fire is usually intense, but short, with a strong emphasis on direct fire. Once the assault troops have closed with the enemy, indirect fire is shifted to pin down enemy reserves and positions to the flanks. Observation helicopters are important in adjusting fire.

Troop Control

Control by higher headquarters is difficult because of problems of observation and communication. As a result, responsibility is delegated downwards along with combat support resources. Considerable re-

sponsibility is placed on the shoulders of assault detachment commanders. They can, for instance, often commit their second echelon or organize enveloping detachments without seeking the approval of their regimental commander. At all levels of command, planning and orders have to be more detailed than in open country.

Command posts in built-up areas tend to be deployed much farther forward than in normal terrain. For example, assault detachment COPs deploy a mere 200 to 300 meters behind their forward groups.

Communications

Large numbers of extra manpack radios are needed, because vehicle sets are of limited use and because of the increased numbers of patrols and observation posts required in fighting in built-up areas. Maximum use is made of all non-radio communication means.

Logistics

The OPFOR recognizes that fighting in built-up areas leads to a sharp increase in logistics burdens and tries to meet this problem in timely fashion. There are particularly heavy demands for HE, smoke, and small arms ammunition, explosives, and mines.

Mountains

Success in mountain warfare depends on control of passes, road junctions, built-up areas, and the high ground that dominates them. The depth of objectives in mountainous terrain is less than the normal.

Organization for Combat

The main burden of this fight also

goes to specially trained infantry or motorized rifle troops, and to heliborne and special-purpose forces, as well as independent motorized rifle brigades. The OPFOR tries to get tanks into the least accessible areas in view of their utility in the fire support role. Artillery is also used in the direct fire role, and when possible, extra high-angle weapons, such as mortars are provided. In mountains, the battery is the basic fire unit because of restrictions on deployment. Engineer reinforcements are also required. Due to the difficulty of lateral movement, supporting arms units are broken down and allotted to maneuver units to form self contained combat groupings for each axis. Tank units are held in the rear to exploit suitable terrain when it is reached

Frontages and Echelonment

Zones of advance tend to be much wider in mountains, though actual attack frontages and strike sectors within them are much the same as on flat terrain. Divisions, brigades, and even regiments often advance in one echelon because of the difficulty in passing one echelon through another and in shifting axes. However, a two-echelon combat formation is also possible. In an advance along a narrow valley, the OPFOR may sometimes even use a three-echelon formation. The OPFOR maintains strong reserves in this environment.

Variations from Normal Attack

There are major differences from attacks on flat terrain. A thorough evaluation and subsequent exploitation of terrain are seen to be essential. Planning and orders require more detail. For these reasons, and because there are rarely sufficient routes and space for deployment, attacks from the march are uncommon. Most attacks are

from a position in direct contact, despite the loss of surprise and momentum. Attacks are led by dismounted motorized rifle troops, not tanks, and a sizable proportion of the assigned artillery is used in a direct fire role.

Planning

The most effective, and typical, tactic is to launch a main attack along an accessible axis, in coordination with one or more enveloping detachments (or groups) advancing on difficult and possibly unexpected axes. Thorough reconnaissance of all types is stressed; the OPFOR tries to fly about twice the normal number of aerial reconnaissance sorties. When possible, gaps are found in the defense and exploited to bypass strongpoints, breaking up the cohesion of the defense. If such gaps have not been found, then they have to be created by eliminating strongpoints and driving wedges into the defense. Purely frontal attacks are unlikely to succeed in mountains due to difficulty in deploying overwhelming fire and generating a high momentum of advance. Close and deep envelopments assume even greater importance.

Considerable use is made of heliborne raiding detachments to disrupt the defense and of air-delivered groupings to carry out the missions given to forward detachments on normal terrain. Greater reliance is placed on direct air support, both fixed-wing and helicopter, and aircraft are controlled at lower levels. Well prepared and defended positions can be attacked by assault groups, formed similar to the motorized rifle companies in built-up area operations.

Desert

Attacks in desert conditions are complicated by the shortage of trafficable

roads and the difficulty of hiding movement. It is also true that enemy defenses in the desert are dispersed over a wide frontage rarely consisting of a continuous line. This creates opportunities for infiltration and maneuver which the OPFOR would try to exploit.

Frontages

Formations and units are allotted wider zones of advance than on "normal" terrain, and formations may advance in one echelon, with a combined arms reserve. Substantial gaps are accepted, and combat support assets are more often decentralized. Regiments and subunits are often expected to act autonomously and are reinforced accordingly. In view of the increased effectiveness of enemy antitank weapons and air power, especially in the desert, a combined arms approach is stressed.

Objectives and Missions

Developed roads, road and track junctions, airfields, and sources of water are the geographical features of great tactical (sometimes operational) significance. Generally, missions are assigned in greater depth than on normal terrain.

Attack from the March

Attacks in the desert are usually executed from the march at high speed. Deployment into prebattle and battle formation takes place earlier than usual, since the terrain seldom affords much cover from long-range ATGMs. Company columns are formed 12 to 15 km, and platoon columns 3 to 5 km, from the enemy. Frontal attacks usually can, and would, be avoided. Smoke is used to conceal both approach marches and assaults.

Deep Battle

Desert warfare creates excellent conditions for carrying the struggle rapidly into the enemy rear through the use of forward, raiding, airborne, and heliborne detachments.

Forest

Forests may also sit astride important axes of advance. As potential redoubts, they may be fortified and defended by enemy forces. As is the case in built-up areas, the OPFOR would prefer to bypass such an area and isolate the defenders. When obliged to attack under these conditions, the OPFOR would plan the attack thoroughly, using available time to develop intelligence.

Organization for Combat

In general, the OPFOR prefers to use motorized rifle troops when fighting in forests. If possible, the riflemen remain mounted; however, when forced to dismount due to terrain or enemy antitank defenses, their BMPs/BTRs would follow immediately behind the dismounted squads to provide supporting fires.

Tanks of the MRR/TR would be attached down to motorized rifle companies and even platoons in a fire support role. In return, tanks would be protected by assigning a group of three or four riflemen and small engineer elements equipped with mine detectors and explosive charges. Thus, the enemy defenders can expect to see OPFOR tanks in areas the enemy would consider virtually impassable.

Movement

Movement is generally on poor roads with limited opportunity for detours. There is great likelihood of blockage, due either to enemy action or to vehicle breakdown. Flank security, assisted by mobile obstacle detachments, attempts to block enemy counterattacks from the flanks.

Platoons and companies use available roads and tracks, which often are widely separated. They would advance on narrow frontages to fix the defense, while the main force attempts to flank the position.

Variations from Normal Attack

The OPFOR can exploit the discontinuous front in forested areas by using a combination of penetrations and envelopments. Offensive actions in forests combine tactics to fix the defender with enveloping movements executed to either bypass the enemy or attack him from the rear. Where practicable, heliborne landings may seize critical areas ahead of the main effort.

Attacks in forests are executed at the battalion or company level. Subunits must use the normal crisscross pattern of trails and natural breaks found in forests. Strike sectors are quite narrow (50 meters for a platoon), but distances between available approaches may widen the overall attack zone of the subunit. Platoons are normally 150 to 200 meters apart, but could be separated by as much as 500 meters.

Troop Control

The unevenness of the advance of subunits in forests, as well as the wide intervals between platoons and companies, require special effort to maintain contact with

subordinates and with adjacent units/subunits. Commanders must also ensure security on open flanks.

Northern Regions

The OPFOR is aware of the problems of fighting in northern regions and in severe winter conditions. Its equipment is designed to withstand such conditions and training is often conducted during the winter.

Frontages

Where terrain and snow limit maneuver, formations and units would usually be allotted larger than usual zones of advance. Unit and subunit attack frontages may be restricted by conditions.

Echelonment

If lateral maneuver to shift axes is precluded, formations may advance in one echelon, with a reserve. Units, and even subunits, may have to attack in 2 or even 3 echelons because of limited off road mobility.

Objectives

Roads and tracks assume a crucial importance to both maneuver and speed of advance in northern conditions. Villages and towns are important, quite apart from their tactical significance, as sources of warmth

and shelter. They may be contested solely for this reason.

Tactics

Basic tactical concepts do not differ greatly from those in normal conditions, though there are modifications and shifts in emphasis.

Limitations on maneuver. Artillery and tanks may be limited to the roads. This can force OPFOR units to conduct successive frontal attacks as the only way to build up pressure. The OPFOR makes every effort to attack the enemy's flanks and rear. Even small enveloping detachments of company size are seen to have a great effect on the enemy. The OPFOR can take advantage of bad weather to achieve infiltration undetected and to achieve surprise in the attack.

Speed. Attacks take longer to mount in northern areas than in normal conditions. It is also much more difficult to generate momentum. To ease these problems, and to reduce fatigue and exposure to the elements, assembly areas are placed closer than normal to the enemy prior to an attack. Second echelons also move closer to the leading elements to reduce commitment times. Because the momentum of the advance is somewhat slow, there is greater emphasis than ever on carrying the battle into the enemy's depth to prevent his recovery from tactical reverses.

Chapter 6 Defense

OPFOR military doctrine considers defense the basic combat operation required to repel possible invasion inside the State border. The OPFOR sees the offensive as the decisive form of military maneuver, but recognizes conducting the defense is, at times, a necessity on the combined arms battlefield. Under these conditions, the goal for defense is to repel an attack by enemy forces, inflict maximum losses on him, hold important terrain and objectives creating favorable conditions for launching an attack.

Despite its preference for the offensive, the OPFOR accepts that there are times when it may have to conduct defensive operations. Such circumstances might occur--

- Before the outbreak of a war, or in its early stages to cover the mobilization and deployment of the main forces.
- In the face of overwhelmingly superior enemy forces.
- During an offensive, to economize force in one sector, and achieve superiority on the main axis.
- To defeat a counterattack during an OPFOR offensive.
- To consolidate lines or positions that forward detachments or other advanced forces have captured to facilitate the advance of the main forces.
- When a unit or formation has suffered serious losses and can no longer conduct offensive actions.

NATURE OF THE DEFENSE

The OPFOR can assume the defense on a forced or deliberate basis when an at-

tack is impossible or inadvisable. The defense can be prepared in advance or organized in the course of battle, in the absence of direct contact or in contact with the enemy. During the defense, the OPFOR attempts to engage an attacking enemy when he is moving forward and taking up an attack position, or when he is assaulting the forward edge. However, the OPFOR may also conduct defensive battle to hold defensive positions and lines deeper in its own rear.

As a rule, defending forces are numerically inferior to an attacking enemy. So the possibility of repelling an attack is determined by the ability of commanders and troops to exploit the advantages of being on the defense. Whenever possible, defending subunits choose the place of battle so they can use the terrain's protective features. To accomplish this, the OPFOR selects defensive positions behind natural obstacles and in other terrain sectors that provide a good field of view and fire toward the enemy to maximum range of available weapons. OPFOR commanders tend to avoid defending from "commanding terrain," since they could become easy targets for massed enemy fires, nuclear strikes, or high-precision weapons.

The OPFOR defenders also have long-range artillery, aircraft, and missiles capable of delivering preemptive strikes against the most important enemy targets, on routes of advance and on lines of deployment for an assault. These strikes can inflict considerable personnel and equipment losses on the enemy even before he arrives at the line of contact. The OPFOR realizes that, with the

introduction of high-precision weapons, the traditional distinctions between offense and defense have become blurred.

The OPFOR's use of various obstacles, especially minefields, is an important advantage in the defense. They reduce the rate of forward movement, deployment, and assault of enemy tanks and mechanized vehicles. They increase the effectiveness of both antitank weapons and artillery fire by canalizing attacking enemy forces into fire sacks and ambushes and/or preventing their escape from them. Mines and obstacles are also placed to protect the flanks of OPFOR positions. The OPFOR may attempt last-minute laying of minefields (by minelaying vehicles, helicopters, or MRLs). As a rule, minefields and obstacles are covered with direct and indirect fires.

Positional and Mobile Defense

The OPFOR defense can be positional or mobile. The form used depends on the mission received, the combat power of the two sides, the nature of the terrain, and the extent of engineer preparation.

Positional defense is the basic form. It meets the requirements of most defensive missions and inflicts maximum losses on the enemy. Its goal is to hold multiple subunit strongpoints within a defended area for a specified time. The OPFOR would use positional defense on most axes, but especially on those where it can least afford to lose ground.

In other cases, the OPFOR could use **mobile defense** to inflict losses on the enemy and gain time. It can preserve forces by fighting successive defensive battles at pre-planned lines at various depths in its defenses. Thus, mobile defense involves giving

ground and abandoning some areas. It can be used to repel an enemy invasion or when defending a security zone.

PRINCIPLES OF DEFENSE

The general principles of OPFOR defensive tactics are as follows:

Tenacity

An OPFOR unit ordered to hold a position must do so with the utmost stubbornness. It can give ground or withdraw only with the permission of the commander who gave it the original mission to defend.

Aggressiveness

The more aggressive the defense, the more stable it is. OPFOR commanders at all levels seize every opportunity to take local offensive actions during a defensive battle.

Maneuver

Tenacity in defense does not mean immobility. The OPFOR can maneuver forces and firepower from less threatened sectors to meet the enemy's main attack and disrupt his concept of battle. It can maneuver in front of the main defense and counterattack.

Firepower

The OPFOR deploys all available fire support assets at maximum ranges. It attempts to start engaging the attacker's forces from the earliest opportunity. Given the range of modern artillery, it is possible to concentrate the fires of dispersed weaponry on key sectors and so break up the enemy attack.

Concealment and Surprise

The OPFOR places emphasis on concealment of its own forces in order to mislead the enemy about the disposition of the defense. It also uses ambushes, obstacles, and any other tactical means available to surprise the enemy.

TRANSITION TO DEFENSE

To the OPFOR, conditions are understood to mean the entire diversity of the tactical situation in which subunits shift to a defense. These conditions depend on the enemy combat capabilities, nature of terrain, and weather conditions. The enemy is the determining factor dictating the method of shifting to the defense. Depending on enemy proximity and the nature of the battle, an OPFOR unit or subunit can shift to a defense before battle occurs or in the course of battle, and under conditions of direct contact or in the absence of contact. Figure 6-1 illustrates the two methods of transitioning to the defense, using a reinforced motorized rifle battalion (MRB) in the examples.

In Direct Contact

The OPFOR transition to the defense **in direct contact** occurs most often in the course of an attack. It can also occur when repelling counterattacks, consolidating captured lines and securing flanks of attacking troops, or with an unsuccessful outcome of a meeting battle. (See the section on "Defense in Direct Contact" later in this chapter for more detail.) The defense is organized under enemy fire in a short time period, not always on a favorable line, and often on a line with no engineer preparation. The OPFOR considers this transition to the defense as the most difficult.

When transitioning to the defense in direct contact, the OPFOR faces a situation in which subunits may have to perform several missions simultaneously:

- Conduct a firefight against a defending or counterattacking enemy.
- Repel strikes by air.
- Take measures to recover from enemy use of nuclear, chemical, high-precision weapons and fire strikes.
- Realign the combat formation.
- Replenish ammunition, fuel and other supplies.

The situation is complicated by a shortage of personnel, combat equipment and supplies due to losses suffered during the attack.

Out of Direct Contact

The OPFOR can assume a defense before the battle begins, **out of direct contact** with the enemy. (See the section on "Defense in Direct Contact" later in this chapter for more detail.) The main difference between defense in contact and defense out of contact is the absence of a **security zone** in the former. Under the latter condition, the transition to a defense is made to cover areas of possible contact, in order to repel a possible enemy strike or support the deployment of additional forces. Transition to a defense can occur where an attack is inadvisable or impossible for a number of reasons. Follow-on forces shift to a defense in the absence of contact.

DECISION-MAKING PROCESS

In the defense, the commander's decision is based on essentially the same process as in the offense. The main elements of this process are as follows:

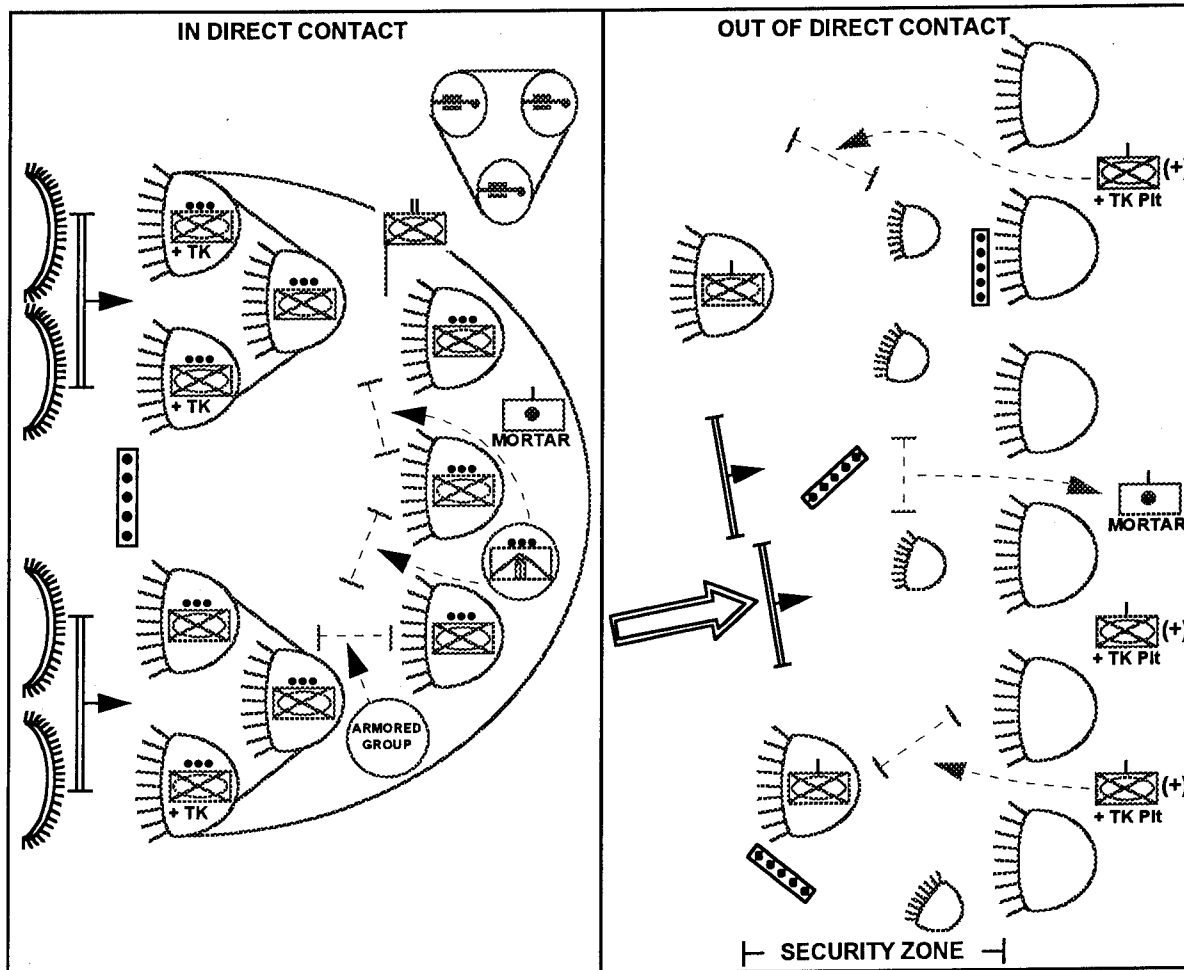

Figure 6-1. Transition to the defense (reinforced MRB).

Analyzing the Mission

In organizing and establishing the defensive battle, an OPFOR commander first analyzes the mission. He must understand the concept of his higher commander to determine his mission, timetable, and support from higher headquarters. The commander, or his chief of staff, then determines the time available for planning. The commander issues the necessary instructions to his staff and subordinate commanders and continues with his estimate of the situation.

Estimate of Situation

Once the commander has analyzed the mission, he conducts his estimate of the situation. In the defense, much of this estimate is accomplished using the map. If time permits, the commander conducts personal reconnaissance to help him reach a decision. First, he examines the enemy situation, since the enemy and his weapons systems influence the mix of weapons the OPFOR must use and the preparation needed. Whether or not the enemy is in contact determines the form the defense takes. Next, the commander examines his forces available, including attached and supporting troops and the mis-

sion and disposition of adjacent friendly units.

The OPFOR commander then examines the terrain and vegetation. He determines the effect of terrain on preparation of the defense and the movement of the enemy. He looks at how natural obstacles can be enhanced to lend stability to the defense. Finally, the commander examines other factors such as the possible use of chemical, nuclear and high-precision weapons or smoke

Commander's Concept

On the basis of the mission analysis, the time available, and the estimate of the situation, the OPFOR commander determines his concept of the defensive battle. The result of this will be the commander's battle plan for the defense. The following paragraphs discuss factors included in his concept.

Combat Formation

The commander decides how to organize the organic, attached, and supporting forces. He determines how he will situate them throughout the depth of the defense and how he will employ them.

Critical Terrain

The commander selects the terrain upon which the stability of the defense depends. When possible, he uses manmade obstacles to enhance the terrain. Desirable terrain can canalize and impede and even stop the enemy's movement. It also provides friendly troops with the advantage of fire and maneuver.

Destruction of Enemy

The commander determines how best to engage the enemy. He plans long- and short-range fires and fire sacks. He plans to defeat the enemy as far forward as possible, continuing through the depths of the defense.

Direction of Counterattack

The commander plans how best to employ his counterattack forces. He chooses initial positions for them, as well as counterattack routes and deployment lines for the destruction of enemy forces caught in fire sacks.

Priorities of Engineer Work

Given sufficient time, the priority of engineer support goes first to the forward defenses within the main defensive belt and then to the security zone, if one is established. From there, support goes backward through the defensive belt. Within the security zone, the priority of work goes first to the initial positions far forward, then back to the forward positions located nearest the main defenses.

Combat Orders

The commander issues a combat order containing information about the enemy, the mission, the concept of the operation, the location of the forward edge, and the positions his subordinates must occupy. Further detail (in the division commander's combat order, for example) specifies--

- For first-echelon regiments: reinforcements, missions, defense sectors, and axes and areas for concentrating main efforts.

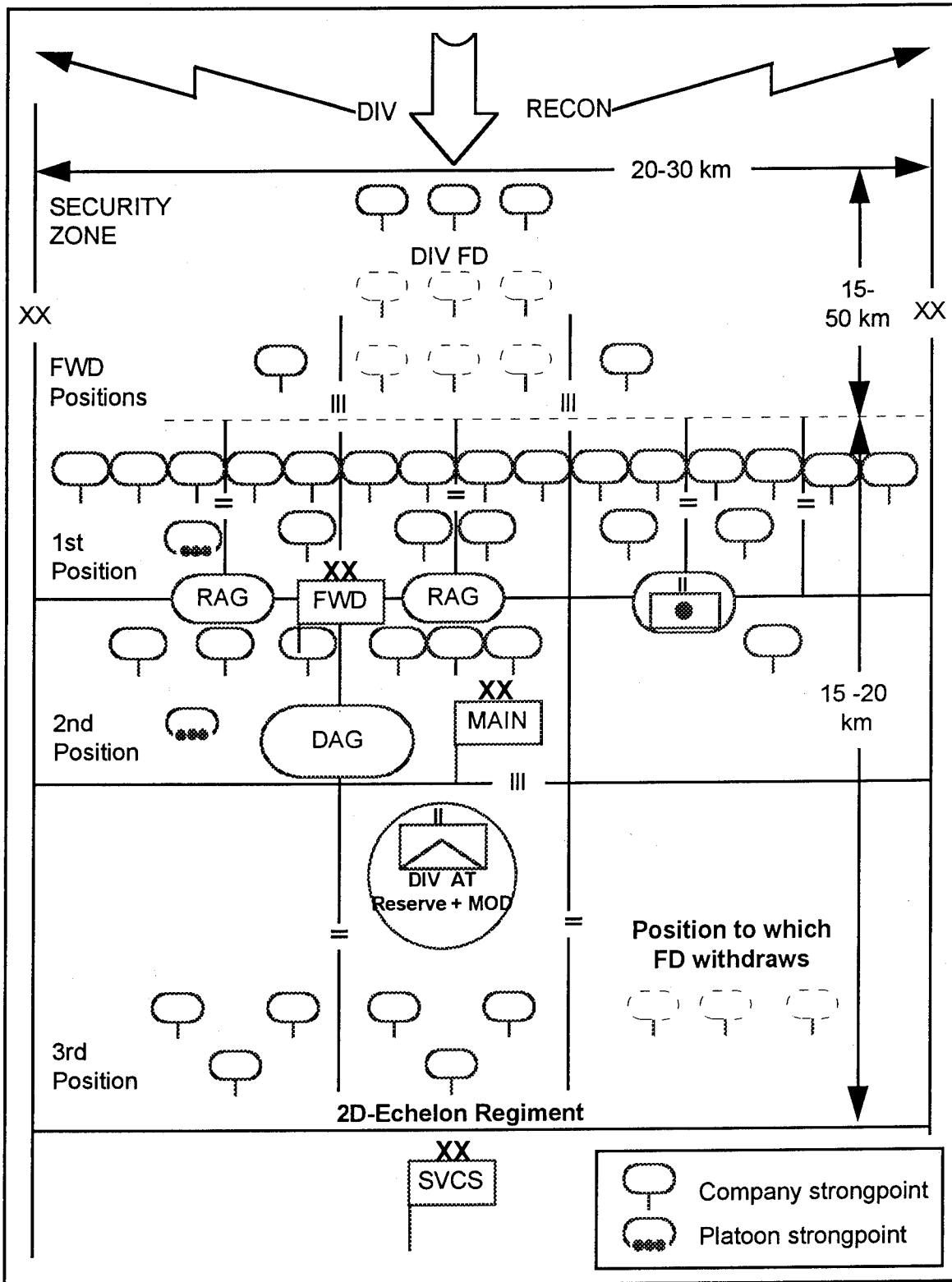

Figure 6-2. MRD in the defense (example).

- For second-echelon regiments: reinforcements, missions, and either defense sectors or axes and deployment lines for counterattacks.
- The time by which units must occupy their positions.
- Coordination requirements.

ORGANIZATION OF DEFENSE

OPFOR commanders follow the tenets of stability and activeness in planning the defense. The OPFOR achieves stability by the integration and coordination of all combat assets to defend against nuclear, chemical and high-precision weapons, artillery, tanks, aviation, and air insertions. Activeness in modern combined arms defense involves decisive counterattacks, maneuver of forces and fire, continuous operations, and artillery counter preparations. Frontages and depths vary considerably with the circumstances in which defense is adopted, the importance of the sector, the strength of the defending forces, and the assessment of the threat. Figure 6-2 depicts one example of a motorized rifle division (MRD) deployed in the defense. (See Figure 6-3 below for another example.)

Areas of Responsibility

In OPFOR terminology, a division or a brigade defends a **zone**, a regiment defends a **sector**, and a battalion an **area**. Companies and platoons defend **strongpoints**. The division defense is constructed from a series of **positions** deployed in depth. Each position consists of company strongpoints with integrated obstacles and a fire plan. The **first position** is the most strongly held. Positions in depth may be only partially occupied, but they provide a line to which forces defending further forward can be ordered to withdraw.

Combat Security Forces

The type of combat security force the OPFOR uses in the defense depends on the circumstances in which defense is adopted and the level of command involved. A combat security force is not always deployed, particularly when a unit goes over to the defensive in contact with the enemy. In this case, the defending force may have to occupy a line while in action and hold it to the best of its ability. Figure 6-3 shows the types of combat security forces the OPFOR can employ. The uses of the various types are described below.

Security Zone

A **security zone** is established when the defense is organized **out of contact** with the enemy. The decision to establish a security zone is made at the army/army corps or division level. It is deployed in front of the first-echelon divisions. If the depth of the army's deployment permits, second-echelon divisions can prepare a security zone between the rear of the first-echelon divisions and their own frontline. The division commander is responsible for the detailed organization of the security zone within his zone of defense. The security zone extends across the entire zone of responsibility. If established by the army/army corps, the security zone boundaries do not necessarily conform to lateral division boundaries. If established by division, however, it would match the division boundaries. The zone is at least 15 km deep and can extend to a depth of 50 km. It is at least far enough forward to prevent aimed direct fire from being placed on the main defensive belt; however, it normally extends beyond that.

Mission	Deployed When Defending		Command Level			Distance in Front of Forward Edge of Main Defense
	In Contact	Out of Contact	Directed By	Deploying Force	Fighting the Battle	
Forward Detachment in Security Zone	No	Yes	Army/ Army Corps/ Division	Division	Battalion	15 to 50 km
Forward Position	Yes	Yes	Division	Regiment	Company/ Company Plus	4 to 6 km
Combat Security Outpost	No	Yes	Regiment	Battalion	Platoon/ Platoon Plus	2 to 3 km

Figure 6-3. Types of combat security forces.

When transitioning to the defense in **direct contact**, the OPFOR may not have a security zone. However, it could still have a **covering zone**. This is a smaller, shallower version of the security zone, at least sufficient to keep the defense out of enemy direct observation and fire.

The security force's size and composition depend on the factors mentioned earlier. The security force deploys on the best terrain to inflict maximum damage on the attacking enemy and uses obstacles and barriers extensively. Prior to being faced with envelopment or decisive engagement, the forces in the security zone attempt to withdraw under cover of artillery fire returning to the main defensive belt.

Forward Positions

When the separation between the OPFOR and the enemy is not great enough for creating a security zone (or covering zone), **forward positions** are used. They are also used when a security zone is formed, to imitate the main defense, cause the enemy to conduct premature artillery preparations, and aid in the disengagement of the forward

detachment. These forward positions are deployed between 4 to 6 km in front of the first position. Forward positions are ordered by division but planned in detail by the first-echelon regiments. A forward position is created by each first-echelon regiment and manned by a company from the regiment's second echelon. The primary mission of a forward position is to mislead the enemy about the location of the forward edge of the defense. Forward positions are sometimes created when going over to the defensive in contact with the enemy. They are held on the line of contact while the main body of the regiment withdraws to a more favorable line for defense.

Combat Security Outpost

If forward positions are not deployed, first-echelon battalions can be ordered to organize **combat security outposts**. These outposts consist of a platoon positioned 2 to 3 km in front of the forward edge of the defense, on the most threatened axis. The combat security outpost's primary mission is to prevent enemy reconnaissance and small groups from penetrating to the battalion's position. It is supported by the

battalion's mortars and any available artillery and direct fires from the forward edge of the defense.. Once the enemy begins to deploy for a major attack, the outpost withdraws, generally under cover of smoke and artillery fire.

Main Defensive Belt

The **main defensive belt** relies on defense in depth. The basic element of the main defensive belt is the battalion defensive area. The battalion defensive area comprises company and platoon strongpoints. The OPFOR establishes strongpoints to protect terrain key to the defense. The subunits occupying the strongpoints prepare a defense with alternate and supplementary firing positions for all weapons. These subunits plan their fires to be mutually supporting and plan for the use of fire sacks. Using wire as the primary means of communication, the subunits construct a network of communication trenches linking weapon positions with supply, troop control, and fighting positions. Subunits dig in vehicles and other equipment to the maximum extent possible, including provision of overhead protection.

Echelons

As in the offensive, the OPFOR can deploy in **one or two echelons**. A two-echelon deployment is usual on the most threatened axis and a single-echelon deployment is used more on secondary axes. Single-echelon formations are also adopted when the defender has suffered heavy casualties. Within a formation, different levels of command can use different echelonment schemes. For example, even if a division deploys in two echelons, one or more of its regiments could be in a single-echelon formation; a regiment could deploy in a single

echelon, while its subordinate battalions could have two. A second-echelon regiment or battalion may or may not have the same number of echelons as the first-echelon counterpart.

In the defense, second echelons can be used for the following tasks:

- Hold their main position against an enemy penetration.
- Reinforce first-echelon units where the enemy threatens a penetration.
- Maneuver to firing lines or to launch counterattacks.
- Destroy enemy airborne or heliborne assaults.

Combined Arms Reserve

Forces deployed in one echelon retain a **combined arms reserve**. Unlike the offensive combat formation, a division or regiment in the defense can form both a second echelon and a small reserve. For a division, the reserve normally consists of at least a battalion, for a regiment a company, and for a battalion a platoon. However, a commander can retain a larger reserve--one-third or more of his combat power--if the situation warrants; this is especially common in very vague situations. Combined arms reserves can be given counterattack or counterpenetration missions, or they can be used to fill gaps in the defense.

Antitank Reserves

Antitank reserves are kept at every level from battalion upwards. They are generally built around an antitank subunit and operate in conjunction with a mobile obstacle detachment.

Antilanding Reserves

Because the OPFOR perceives a threat from airborne/airmobile troops, commanders commonly designate an **antilanding reserve**. A commander can designate part of the force's second echelon for this role or create a specific reserve. If the commander designates an antilanding reserve, he usually would not form a combined arms reserve.

Special Reserves

In addition to their mobile obstacle detachments, regiments, brigades, and divisions try to retain an **engineer reserve** of earthmoving and obstacle-creating equipment. This reserve can be deployed to strengthen defenses on a particularly threatened axis during the course of the battle. Divisions, brigades, and regiments may also retain a **chemical protection reserve**.

Armored Groups

Armored groups are formed at **battalion or company level** as additional maneuver assets in the defense. They are temporary, composite groupings of tanks and BMPs/BTRs, usually formed after the infantry has dismounted in a defensive strongpoint. After the basic work of preparing the position has been completed, the armored group is organized by withdrawing vehicles from their firing positions in strongpoints and concentrating them in concealed areas in dead space, woods or other cover behind the first-echelon positions. A company armored group can consist of one to two tanks and two to four BMPs/BTRs (or vice versa), commanded by an assistant platoon leader. A battalion armored group can have two to four tanks and four to six BMPs/BTRs (or

vice versa), commanded by a platoon leader from a second-echelon company. Armored group vehicles may be taken from first-or second-echelon subunits that are defending positions away from the most threatened axis.

As a rule, tanks and BMPs/BTRs designated for use in an armored group initially deploy in the strongpoints of their parent platoons, and their crews carry out preparations for the defense according to their platoon leader's plan.

Once formed, armored groups are assigned two or three firing lines to cover gaps between strongpoints and to the flanks. After moving to the concealed area, the fighting vehicle crews camouflage the armored group, and may establish dummy vehicles or false heat sources away from the position. They prepare routes to the firing lines and firing positions on them, as well as routes back to their original platoon strongpoints.

Once the battle begins, the armored group remains in its concealed area until ordered to occupy a firing line to block a threatened penetration. On receiving the order to move, the armored group forms into a column and moves forward swiftly, often under cover of smoke, to occupy firing positions. All or part of the armored group may be returned to its original platoon strongpoints, if that seems a more effective way to use the vehicles. Together with first-echelon subunits, the armored group concentrates fire against the bulk of tanks and other armored vehicles to inflict damage on the enemy ahead of the OPFOR forward edge. Subsequently, it can reposition (possibly to a flank) to destroy enemy forces that penetrate the defense or threaten to envelop the company strongpoint/battalion defensive area.

Ambushes

Ambushes are a features of any OPFOR defense. In size, they vary from individual weapon systems to a platoon and are generally formed from second-echelon subunits. Tanks, BMPs, antitank weapons, and helicopters are all used for ambushes. They are sited on likely axes of approach, on flanks and in gaps and between first- and second-echelon positions. The goal of the ambush is to reduce the enemy's strength before he reaches the main position and to slow his advance.

SYSTEM OF FIRE

An OPFOR commander constructs a **system of fire** bringing all available fires on the enemy as he approaches. The system provides continuous fire at the forward edge, and the flanks, and within the defensive position. In addition, it should allow rapid concentration of fire against threatened axes. The goal is to engage the attacker with a growing intensity of fire as he approaches the forward edge of the defense. It begins with artillery concentrations and barrages on likely axes, choke points and deployment lines. The OPFOR recognizes two fundamental considerations of fires in the defense: depth and dispersion.

Depth

The first consideration is that the defense must provide sufficient depth for effective fire and maneuver. OPFOR weapons engage the enemy at as great a range as possible, providing an increasing volume of fire as he nears the defensive positions. Fire support weapons are placed in position to shift fires against threatened axes within the defensive position. To counterattack enemy penetrations, units occupying positions in the

depth of the defense must be able to maneuver and concentrate rapidly.

Dispersion

Conducting a defense under the threat of enemy employment of high-precision weapons and weapons of mass destruction demands dispersion. **Platoon and company strongpoints** are the basis of the OPFOR defense. Increased dispersion between these strongpoints leads to problems in fire support coordination and troop control. An excessively dispersed defense does not offer sufficient resistance to accomplish defensive missions. As a result, the OPFOR cautions its commanders not to achieve dispersion at the price of effective defense.

OPFOR commanders may seek to achieve dispersion within company and platoon strongpoints, tank and BMP/BTR firing lines, and the like. This could be done by increasing intervals between individual vehicles, laterally and in depth, to 200 meters or more when confronted by modern enemy artillery-delivered high-precision and area saturation munitions.

Fire Sacks

The OPFOR ties all available obstacles into an integrated fire plan designed to destroy advancing enemy forces totally. This concept is called the **fire sack**. Fire sacks may be created by a maneuver of fire, weapons, and subunits in the course of a defensive battle. They may be either within the main defenses or forward of them in a security zone, but are always contained physically within the defensive positions. A fire sack can be up to 1,000 meters in depth, with a frontage of 900 to 1,000 meters when created ahead of the forward edge or 500 to 800 meters when created within the main

defenses. They are designed to be entered at cost.

The subunits covering a fire sack first bring direct fire weapons to bear as the enemy advances and then seal the penetration with indirect fires. The defenders attempt to trap the enemy, stop his advance, blunt his penetration, and then destroy him through fires and counterattacks.

The fire plan of direct and indirect fires ties into the existing strongpoints and obstacles. The OPFOR commander carefully chooses suitable natural obstacles that lend stability to the defensive positions. The addition of manmade obstacles, including minefields, enhances these natural obstacles. These obstacles on the edges of the fire sack serve to contain the enemy force, preventing his escape. The defenses in the fire sack are well camouflaged throughout and include the use of dummy weapons and positions to deceive the enemy as to the true locations of the strongpoints. Reserves carefully locate where they can counterattack effectively once the fires have been lifted.

ARTILLERY SUPPORT

In the defense, as in the offense, the fire planner utilizes all available fire support to carry out the commander's plan. Emphasis is on the integration of artillery, air, and antitank assets into an overall defensive fire plan. Several variations of the plan are produced, based on the approach and deployment options open to the enemy. Maneuvering massed firepower against key groupings at the crucial moment is critical. Primary artillery missions in defense are **counterpreparatory fires** and **fires against an attacking enemy**. Other defensive artillery missions include support of forces in the se-

curity zone and at forward positions, as well as covering gaps and open flanks with fire.

Counterpreparatory Fires

Counterpreparatory fires are rocket, missile, artillery, and air strikes intended to annihilate or neutralize enemy forces preparing to attack. These fires should surprise the enemy and should start before the enemy's preparation fires. The OPFOR would use all appropriate fire support to reduce the effectiveness of the enemy's preparatory fires.

Fires Against Attacking Enemy

Fires against an attacking enemy consist of four phases. They are as follows:

- Phase I: fire interdiction of advancing enemy troops.
- Phase II: fire to repel the enemy attack.
- Phase III: fire support of defending troops.
- Phase IV: fire destruction of the enemy during a counterattack.

Phase I. Fire interdiction of advancing enemy troops occurs when the enemy deploys into battalion columns. It continues until the enemy forces reach their line of attack. This may include preplanned fires on choke points, massed fires by artillery groups, and MRLs emplacing minefields. Attached or supporting artillery units may occupy temporary fire positions beyond the forward edge of defense; this allows them to strike the enemy at greater depth and support forward detachments and combat security outposts.

If the defensive is adopted when already in contact with the enemy, this phase would concentrate on the enemy's second echelon. Throughout the period before the

enemy's attack, the emphasis is on denying the enemy good target intelligence for his preparation. Much of the artillery remains silent until needed to repel a major attack, and batteries used prior to the main enemy attack fire from temporary fire positions or can be used as roving batteries to confuse enemy intelligence.

Phase II. Fire to repel the enemy attack is the most important phase of defensive artillery fire. The phase begins when the enemy crosses the line of attack and ends when he enters the first defensive positions. The OPFOR creates a zone of continuous fires in front of the defense. Fire to repel the enemy attack coordinates artillery fire with antitank weapons and all weapons of the maneuver units. The OPFOR employs fire on individual targets, fire concentrations, and barrage fires.

Phase III. Fire support of defending troops occurs when artillery attacks enemy forces that have penetrated the defensive positions of first-echelon maneuver battalions. Its purpose is to destroy the penetrating enemy and to prevent him from developing the attack further into friendly positions or flanks.

Phase IV. Fire destruction of the enemy during counterattack is the fifth, and last, phase. Its goals are to recover lost positions, to destroy the penetrating enemy forces, and to capture a line to launch offensive operations. This phase has three sub-phases for artillery support:

- Support for the forward movement of troops.
- Preparation of the counterattack.
- Support of the counterattack.

A successful counterattack requires a stabilized line of contact. This line allows enough

time for the second-echelon forces to advance and deploy for the counterattack.

ENGINEER PREPARATION

The OPFOR divides preparation of the defense into three stages: the first and second stages, and further work. Obstacles, both natural and manmade, play an important role in the defense.

First Stage

Barbed wire and other obstacles are emplaced in front of the position and fields of view and fire are cleared. Pits or trenches are prepared at the primary position of each fighting vehicle, crew-served weapon, and individual infantryman. Command observation posts and medical posts are dug in. The OPFOR normally allows 5 to 6 hours for this work.

Second Stage

During the second stage of preparation of the position, fighting vehicles and weapons systems are provided with alternate fire positions. Trenches are linked until they run continuously across the battalion frontage. Communication trenches are prepared. The OPFOR allows an additional 5 to 6 hours for this phase.

Further Preparation

Further preparation of the position includes improvement of existing trenches and positions, laying further obstacles and preparation of firing lines and routes for anti-tank reserves and second echelons. Communication trenches may be improved for use as fighting trenches. Dummy positions

are prepared in intervals between strongpoints.

Obstacles

The OPFOR's intent is for obstacles to break up the enemy's assault, strip away the infantry's supporting armor, and force the enemy into areas where concentrated fires of all weapons can destroy him. Obstacles placed within the main defensive area confine the enemy within fire sacks and support the employment of the reserves. Minefields can be emplaced by hand, mobile obstacle detachments with mechanical minelayers, artillery, and rotary- and fixed-wing aircraft.

Natural and manmade obstacles slow, disorganize, and canalize the enemy force, either alone or with preplanned fire concentrations. The OPFOR stresses the use of natural obstacles: lakes, rivers, marshes, escarpments, and densely forested areas. Manmade obstacles may include minefields, antitank ditches, wire entanglements, and abatis. The depth of the obstacle plan depends on the time and engineer resources available.

ANTITANK DEFENSE

The OPFOR considers the correct employment of antitank (AT) assets essential to the defense. The OPFOR AT defense system comprises the following elements:

- Subunit strongpoints containing well-sited AT weapons.
- Tank ambushes set up throughout the defense.
- AT reserves placed to respond to enemy tank penetrations.
- Tanks within the second echelon to bolster the first echelon or to counterattack.
- Mobile obstacle detachments.

- Artillery in the direct fire role, in forward positions and from positions in the depths of the defense.
- AT obstacles covered by fire and complementing the maneuver of fires and forces.
- Maneuver by AT forces and weapons.

The OPFOR concentrates AT guns and antitank guided missiles (ATGMs) by platoon and battery. It plans multilayered crossfires, long-range fires, and fires to the flanks and rear. The OPFOR considers cooperation between guns and ATGM systems to be essential for adequate AT defense. An OPFOR commander positions his AT reserve to undertake multiple missions: blocking, counterattacking, reinforcing, and providing rear area security.

Attack helicopters mounting rockets and ATGMs provide mobile, quick reaction, AT reserves. The OPFOR emphasizes use of these assets to defeat tank penetrations or flanking maneuvers.

DEFENSE ASSUMED OUT OF DIRECT CONTACT

When required to defend, the OPFOR prefers to establish a defense when out of direct contact with the enemy. This method of transitioning to the defense offers the OPFOR commander more security and allows him to make better use of the terrain when planning his defense. The primary difference between transitioning to the defense in direct contact with the enemy is the existence of a security zone when out of direct contact. Given time and resources, a defense in direct contact with the enemy can develop into one out of contact with the enemy. This occurs as defensive positions are

better prepared in depth and fewer forces are left in contact with the enemy.

Division

When a division receives orders to assume the defense, the commander makes his decision based on a map reconnaissance. If time allows he clarifies his mission with a personal reconnaissance on the ground. He determines the following factors:

- Key terrain.
- Enemy avenues of approach and probable main attack axis.
- Areas for possible nuclear, chemical and high-precision weapon strikes.
- Organization for combat.
- Maneuver requirements.
- Organization of strongpoints.
- Probable counterattack axes.
- Location of command posts and command observation posts

OPFOR commanders make maximum use of the terrain. They avoid establishing stereotyped patterns that would make enemy templating and targeting easier. A maneuver division typically defends a sector 20 to 30 km in width and 15 to 20 km in depth. The commander organizes the main defensive area in one or two echelons and may create a combined arms reserve.

The first echelon's primary mission is to repel attempted enemy penetrations of the forward defenses. It tries to inflict losses on the enemy, forcing him to concentrate, and canalizing him into fire sacks. The second echelon's primary mission is to stop and destroy enemy penetrations of the forward defenses. It does this by conducting decisive counterattacks. It can also reinforce or replace troops of the first echelon as needed. There is no rigid requirement for the composition of echelons. Normally, at least two

regiments make up the division's first echelon. Figure 6-4 illustrates an **example** of a motorized rifle division (MRD) aligned for the defense.

Forward Detachments

When assuming the defense out of contact with the enemy, an OPFOR division fights its assigned portion of the security zone. This zone may extend 15 to 50 km forward of the main defensive belt. Forward detachments (FDs) can be employed in the security zone, along with reconnaissance patrols from the divisional reconnaissance and REC battalion. In the defense, the FD has the mission of delaying, disrupting, or destroying the advancing enemy. A division may employ one or two FDs, up to reinforced battalions in size. Forces for the FD come from the division's second echelon.

An FD in the division's portion of the security zone establishes a series of defensive positions sited on enemy main avenues of approach. If the terrain permits, the FD commander positions his companies on a major avenue to provide mutual support. Because they must cover a broad frontage, he usually deploys the battalion in a single echelon with a strong combined arms reserve of up to a company. If there are multiple avenues of approach, he may have to divide the FD to cover them with individual reinforced company positions. He covers gaps or intervening terrain between the company positions with obstacles, reconnaissance patrols, and fires.

The FD prepares several successive positions, as the terrain and space allow. These positions and the avenues they control receive extensive engineer preparation, including emplacement of obstacles and minefields. Of course, the division commander

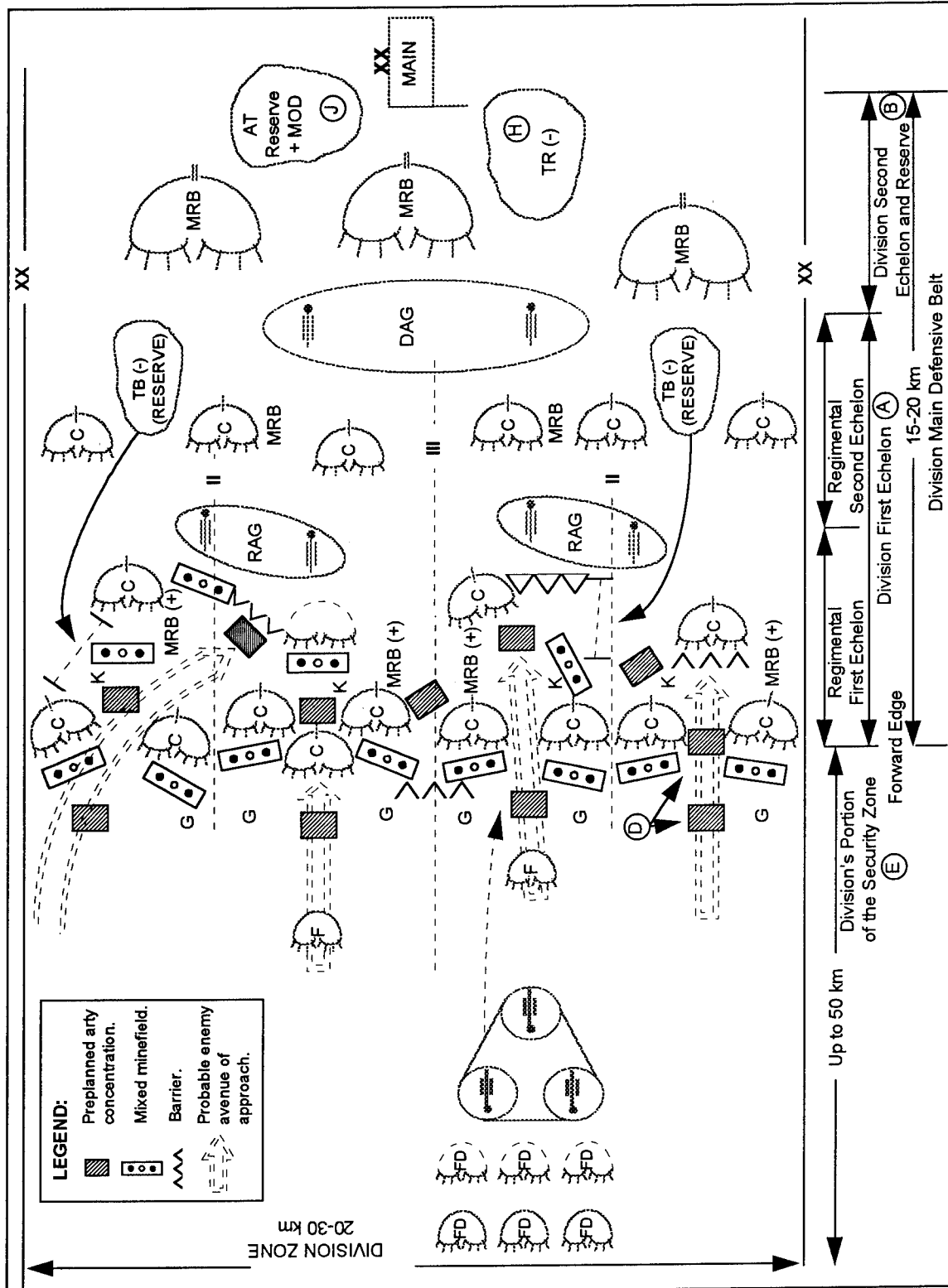

Figure 6-4. MRD in the defense (example 2).

Explanatory Notes to Figure 6-4. MRD in defense (example 2).

1. The division main defensive belt is organized into two echelons. The first-echelon regiments form along a defensive line and comprise the main defensive belt (A). Their mission is to stop the enemy in front of their forward edge. The division allocates 1/2 to 3/4 of its combat power to its first echelon. The division second echelon (B), 1/4 to 1/2 of available strength has the mission to destroy or repel any penetration of the main belt.
2. The defense in both echelons is built upon company-sized strongpoints (C) unified into battalion defensive areas. Strongpoints are planned for all-around defense and sited so deliberate, pre-registered gaps (D) exist between them.
3. Divisions form a security zone (E) in front of their main defensive belt when assuming the defense out of direct contact. Reinforced battalions taken from second-echelon regiments are designated as forward detachments (FD); these establish a series of reinforced company-sized strongpoints sited on enemy main avenues of approach. These security zone strongpoints are to delay, disrupt, and destroy advancing enemy units. First-echelon regiments may establish a forward position (F) 4-6 km from the main defensive belt. This company-sized position imitates the main defense, causes the enemy to conduct premature artillery preparations, and aids the disengagement of the FD. Regiments and battalions deploy combat security outposts (platoon strength) (G) in the security zone forward of their sectors.
4. The division can form a combined arms reserve (H), not more than 1/9 of its total combat power, as the commander's contingency forces. An MRD holds its AT battalion, combined with an engineer mobile obstacle detachment as an AT reserve (J) to block penetrations of the first echelon and support the counterattack with fire.
5. The fire plan is based on antitank fires and integrates ATGM, AT gun, tank, BMP, attack helicopter, and indirect and direct artillery fires on accessible terrain in front of and between first-echelon strongpoints and into fire sacks (K) throughout the defensive sector.

has to consider the tradeoff in allocating engineer effort. If he allocates more resources to the security zone; he delays the enemy longer, and gets more time to prepare the main defensive belt. On the other hand, if the commander limits the engineer effort in the security zone, he frees assets to prepare the main defensive belt more quickly or extensively.

An FD's initial position is the one at the far edge of the security zone. If possible, it is on a favorable natural line; that is, a natural obstacle or defensible terrain. Subsequent positions to the rear are far enough apart to preclude the enemy from engaging one and then another without displacing his indirect fire weapons. They are close enough to allow the FD to maintain coordinated, continuous fires on the enemy while moving from one to another.

The final position the FD may occupy in the security zone is the **forward position**, about 4 to 6 km forward of the main defensive belt. Depending on the pressure the FD is receiving from the attacking enemy force, it may occupy a prepared forward position, or it may pass through the forward position. In the latter case, its disengagement and rearward passage of lines may be covered by companies from first-echelon regiments occupying the forward positions. The forward position deceives the enemy about the location of the forward edge of the main defensive area. It receives extensive engineer preparation to assist in this deception.

The separation of the FD's positions from the division's main defensive belt requires the division commander to place artillery and air defense subunits in the security zone to support the FD's mission. These

forces also occupy prepared and camouflaged positions.

The FD engages the advancing enemy at long range, initially with the supporting indirect fire assets. It then engages him with direct fire systems as he closes. It may launch local counterattacks if the situation dictates. The object is to strip away the enemy's reconnaissance and force him to deploy to attack the position and to expend indirect fires; this can slow and disorganize his advance. Normally, the FD relocates to a subsequent position rather than become decisively engaged or bypassed. By repeating these actions, the detachment may be able to exhaust and disorganize the enemy before he reaches the main defensive belt. This keeps the enemy from penetrating the defense and makes him vulnerable to counterattacks.

The division commander expects the FD to defend aggressively. He retains control over its successive redeployment. Without his specific permission, this FD cannot relocate. The commander may need to gain time to permit the establishment of the main defensive belt. If needed, he can require the FD to continue defending its position, even if this means it becomes decisively engaged or encircled.

If the battle in the security zone is not successful in destroying or halting the attacking enemy, the FD occupies a forward position as a last measure before returning to its parent second-echelon regiment. The OPFOR expects that, even if all goes well, the FD would take losses and would not be at full capability. The FD moves off the enemy main avenue of approach and occupies a forward position in a less-threatened, secondary sector. The enemy, advancing along his main avenue, can still encounter forward positions. These positions are occupied by

outposts of the first-echelon regiments instead of the FD.

Command and Control Posts

The OPFOR commander controls the defense through a series of command posts and control posts (both abbreviated CP). At division level, there normally are four types:

- Main CP.
- Forward CP.
- Rear CP.
- Alternate CP.

The **main CP** is located in the rear of the defensive area/sector/zone. It contains the bulk of the staff. The chief of staff directs its operation.

The division commander establishes a **forward CP** with a small group of selected staff members. The composition of this group varies but usually includes the operations officer and chief of artillery. This post may be as close as 3 km from the forward edge of the main defensive belt. Besides the CPs, the commander can establish **command observation posts (COPs)** controlled from the forward CP. These posts have radio and wire communications and permit the commander and his staff better observation of different sectors of the battlefield. The deputy commander for the rear establishes and controls a **rear control post**. There is no rigid guidance or structure for the location of CPs. The commander uses terrain to camouflage CPs and locates them according to his mission concept. The OPFOR avoids establishing CPs on distinguishing terrain features.

The OPFOR expects radio communications to be difficult and often im-

possible or undesirable in combat. During training exercises, it drills using radio, wire, visual signals, sound, and courier communications. The standard procedure is to employ wire communications in a defensive position or an assembly area. This means of communication--including quick restoration of destroyed lines--receives heavy emphasis in tactical exercises.

Brigade

An independent motorized rifle brigade (IMRB) does not routinely defend in a positional defense, but may do so in an emergency. An IMRB normally conducts a mobile defense, in conjunction with frontier forces, immediate reaction forces, and airborne or heliborne forces; its goal is to attrit the enemy force and shape the battlefield. In a positional defense, an IMRB may serve as an army/army corps forward detachment in the security zone or as a combined arms reserve.

Regiment

A regiment normally defends in the first or second echelon of the division defenses. As part of a division's first echelon, the regiment prevents penetration of the main defenses by repelling enemy assaults with intense fire and counterattacks by its reserve. When defending in the division's second echelon, a regiment attempts to defeat any enemy penetration of the division's first echelon. The OPFOR has always considered tank regiments to be ideal counterattack forces. A tank division often holds at least one of its regiments in the second echelon for this mission. Figures 6-5 and 6-6 show **examples** of regiments in the defense.

Combat Security Outposts

First-echelon regiments on main avenues often form **combat security outposts**, and each forward battalion can establish such an outpost. A combat security outpost for a battalion is normally a reinforced platoon. This platoon occupies a position 2 to 3 km forward of the main defenses. Combat security outposts have the missions to delay, inflict losses on, and to deceive the enemy about the true location of the main defenses. Given time, these outposts form strongpoints forward of the main defenses. They take over the mission to delay the enemy's main effort when the divisional forward detachment (FD) shifts to a secondary axis. Ideally, a combat security outpost forces the enemy to deploy in a position short of the main defensive belt, believing it actually is the main defensive belt.

As with the FD, artillery subunits firing in support of the combat security outpost may have to occupy temporary firing positions farther forward than normal, even in front of the forward edge. The combat security outposts described above should not be confused with company or battalion-sized elements placed into forward positions by second-echelon regiments and/or divisions when required by the situation. These forces, too, have a mission similar to that of the FDs in the security zone.

If the enemy threatens to bypass or overrun the combat security outpost, the regimental commander may order it to withdraw to its position in the main defensive belt. Cover for its withdrawal can include planned fire from regimental assets, fire from the outpost's platoon and fire from tanks in ambush. The withdrawal plan provides the combat security outposts passages through the main defensive belt's obstacle system.

Security Zone Frontages

If the **security zone** is defended by a **regiment** the regiment's frontage will usually equate to the division's zone (20 to 30 km). However, if the regiment defends in a security zone established at army/army corps level, the boundaries of the regiment do not necessarily conform to those of the division behind it. When a **battalion** is assigned to fight the security zone battle it will cover only the most threatened axis within the division's zone. A battalion in the security zone can defend an area 5 to 10 km wide; a **company** defends between 1.5 and 3 km. These larger than normal frontages are achieved by accepting larger intervals between strongpoints, and by slightly increasing the size of individual platoon strongpoints. **Platoons** assigned to defend in the security zone, including combat security outposts, may have frontages of up to 500 meters, rather than the "normal" 300 to 400 meters.

Dispersion and Location

Regimental subunits normally disperse to the extent that a single low-yield nuclear strike can destroy no more than one company. The commander limits dispersion to ensure the stability of the defense and to maintain the capability to mass fires. The defensive frontage for a regiment is normally 7 to 15 km. The depth may vary from 7 to 10 km.

Reserves

A regimental **combined arms reserve** normally occupies a position near the regiment's second echelon. It is usually company-sized and tank-heavy. Its mission

Forward positions deceive enemy as to exact position of main defenses, and protect main position from surprise attack. Platoons from first-echelon battalions may deploy as combat security outposts (CSOPs).

First defensive position. First-echelon regiments normally deploy two battalions up. Some companies will be reinforced with a tank platoon.

Regimental antitank reserve with MOD between first and second echelons. Up to 4 positions are preplanned.

Firing line dug between first and second defensive position on flank of most likely enemy thrust. Occupied by counterattack force as thrust develops; often used as start line.

Counterattack force will attack when thrust held by antitank reserve; may be reinforced from second echelon MR battalion. Attack can only be launched with approval of divisional commander.

NOTE: Tank battalion may be distributed to MR battalions, in which case the 2nd-echelon battalion provides the counterattack force.

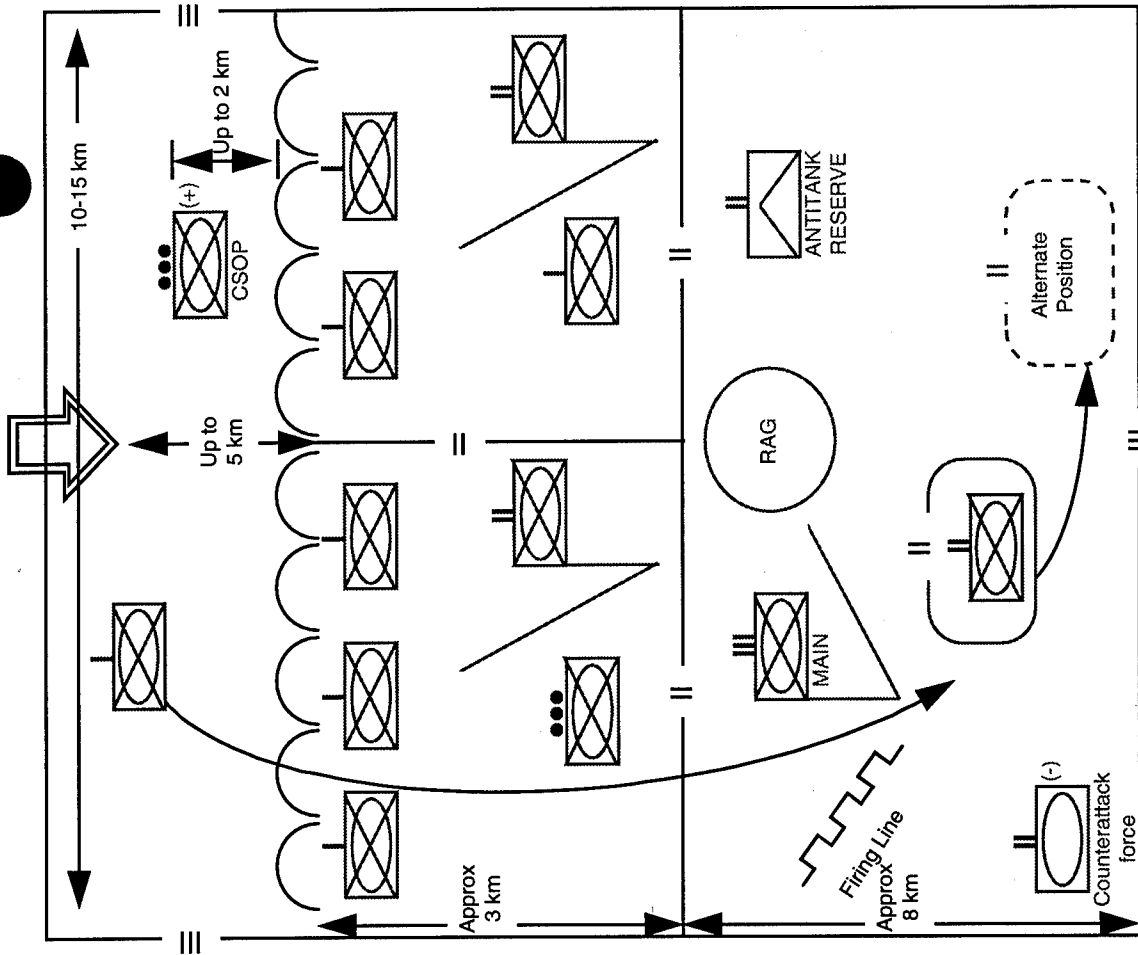

Figure 6-5. Motorized rifle regiment in defense.

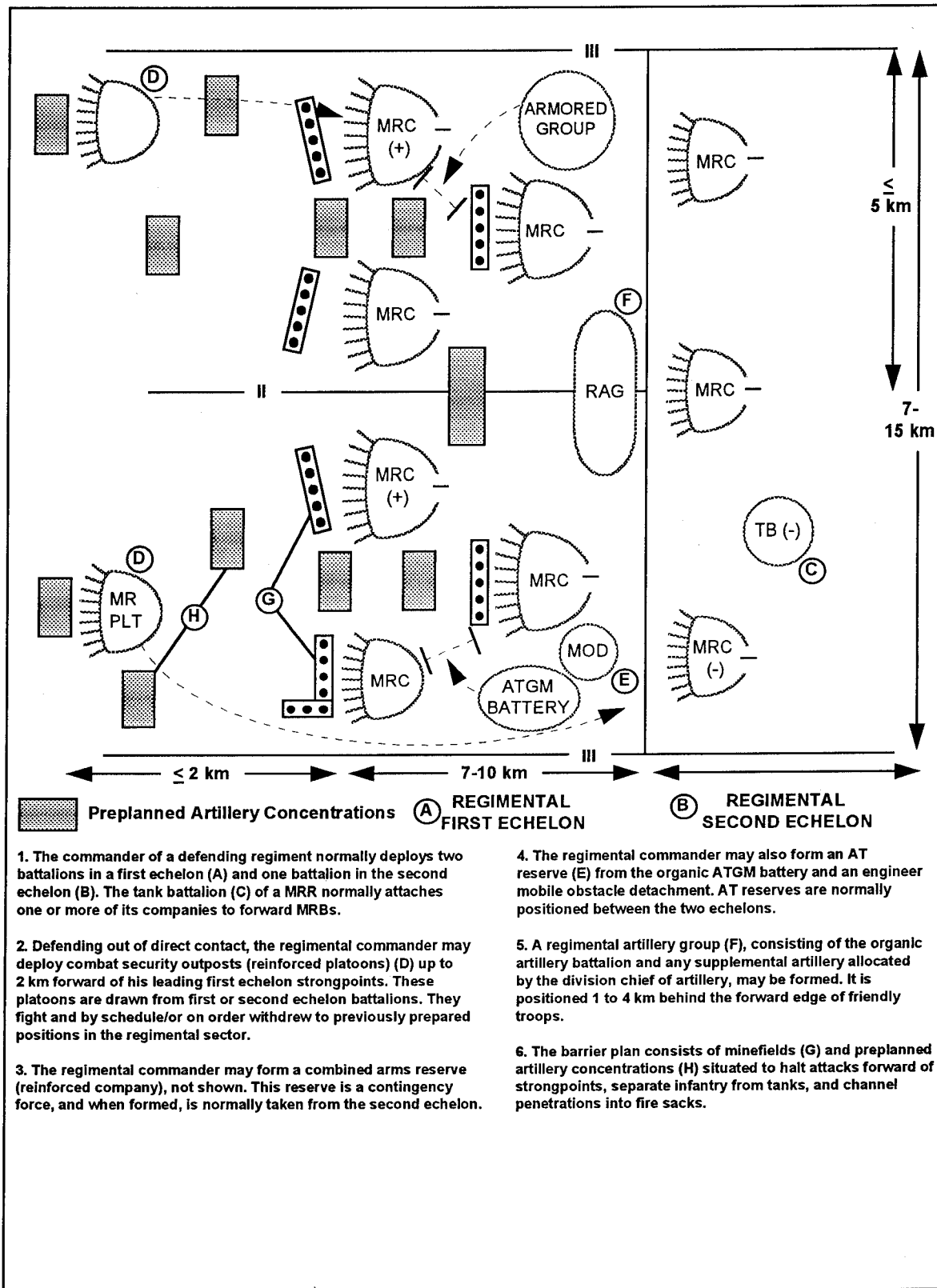

Figure 6-6. Motorized rifle regiment defending out of direct contact.

is to conduct counterattacks against an enemy penetration.

A regimental **antitank reserve** normally includes--

- The antitank battalion or battery (found only in MRRs).
- Part of the engineer company (mine warfare platoon).
- Possibly either a tank or motorized rifle platoon.

The engineers operate as a mobile obstacle detachment, emplacing hasty minefields and obstacles. The antitank reserve occupies an assembly area near the regimental CP.

Command and Control Posts

A regiment in the division's first echelon locates its **main CP** centrally, between its first and second echelons. A regimental **forward CP** may be farther forward, in the area of one of the subordinate battalions. Regimental logistics units and the **rear CP** occupy positions to the rear of the regimental second echelon. The regiment establishes communications between the CPs. Wire is the primary means, supplemented by messengers, signals, and radio.

Regimental Fire Planning

The regimental fire plan is similar to that of its parent division, but it has more limited resources. Regiments, like divisions, prepare detailed barrier plans. OPFOR commanders site their minefields and fire concentrations to exploit available natural barriers. They supplement nature with antitank ditches and nonexplosive antipersonnel/antitank obstacles. The regiment's organic counterattack assets consist of the combined arms reserve or, occasionally, the second-echelon battalion. Company-level commanders plan for regi-

mental counterattacks and reconnoiter counterattack routes. Counterattacks at this level generally aim at restoring defensive integrity by destroying the enemy penetration.

Battalion

Motorized rifle and tank battalions (MRBs and TBs) perform a variety of missions in the defense. **Company strongpoints** form the basis of battalion defensive positions. Antitank fires are the basis of the fire plan. The OPFOR calculates frontages based on its assessment of the capabilities of a platoon and company in the defense; these frontages dictate regimental and divisional defensive frontages. Within the main defense belt, a typical battalion defensive area is 3 to 5 km wide and 2 to 2.5 km deep. The battalion takes up a narrower frontage, the deeper it defends. Figure 6-7 shows an **example** of a possible defensive area of a motorized rifle battalion.

Organization for Combat

After receiving the mission from his regimental commander, a battalion commander begins organizing his assigned area. The regimental order is as complete as possible. At a minimum, it contains the battalion's mission, location of the forward edge, and battalion boundaries. The commander may use artillery, tanks, engineers, and chemical protection troops attached to the battalion to reinforce the companies. This allocation depends on the number and types of attachments received by the battalion and the importance of the strongpoints the companies are defending. Although it can provide direct fire support to the companies, artillery usually occupies firing positions that

provide the best fire support for the entire battalion.

When defending with a single echelon, the battalion commander positions a small reserve, normally a platoon, where it can most rapidly and effectively stabilize the defense in the event of an enemy penetration. Key terrain and likely enemy avenues of attack are factors that determine where the battalion reserve position would be.

The battalion's rear service elements take up covered and concealed positions within the battalion area. Rear service elements are responsible for their own security and change locations frequently to avoid destruction from enemy air and artillery fire.

Combat Security Outposts

Combat security outposts forward of the first-echelon company strongpoints confuse the enemy as to the true battalion defensive position, provide early warning, cause enemy attrition, and force full enemy deployment. The regimental commander chooses locations for his battalions' combat security outposts, but each battalion commander refines his given location. These positions are supportable by direct antitank fire from first-echelon strongpoints. Planned artillery and mortar fire concentrations along with barrier fire lines support the outpost in combat and withdrawal. Outpost withdrawal is on order of the battalion commander, with the regimental commander's agreement.

Defensive Area

A battalion usually defends in **one or two echelons**. Single-echelon deployment permits the greatest concentration of firepower, but also reduces defense in depth. Reserves take up positions behind the first

echelon. When a battalion defends on a narrow frontage and/or needs greater depth, it may deploy in two echelons, with two companies in its first echelon and one in its second echelon. As in the offense, a battalion cannot normally field both a second echelon and a reserve. The distance between the first and second echelons can be up to 2 km.

A **company** occupies a strongpoint 1,000 to 1,500 meters in width (depending on echelonment) and up to 1,000 meters in depth. Normally, all three platoons of a company defend in one echelon. A reinforced **platoon** defends a frontage of 300 to 400 meters. Gaps between platoons in a company normally do not exceed 300 meters. Distances between **platoon vehicles** normally do not exceed 150 meters. However, in special conditions, such as desert warfare or when the threat of enemy high-precision weapons is high, distances may increase. In every situation, the OPFOR would make every effort to ensure that vehicles within a platoon remain in close visual contact with at least one other vehicle of the platoon strongpoint; this would normally be a distance of no more than 250 meters. Figure 6-8 shows an **example** of a motorized rifle company strongpoint.

Battalion Fire Planning

The battalion commander conducts centralized planning of defensive fires, beginning as far to the front of the forward edge as possible. He concentrates fires on likely enemy avenues of approach, using a series of designated fire lines. The distance between these lines is 400 to 600 meters on high-speed avenues; with a smaller distance on less-likely avenues of approach. The commander plans artillery fire to separate attacking enemy infantry from their tanks approximately 700 to 1,000 meters from the

forward edge. He plans final protective fires within 300 to 400 meters of the forward edge, with concentrations to halt the advance of enemy forces that have penetrated the defenses.

Priority targets for the battalion are tanks and other armored vehicles. Antitank weapons engage enemy tanks at an effective range up to 4 km in front of the forward defenses. The normal distance between tanks and antitank weapons in defensive positions is about 100 to 150 meters. On open terrain, 200 to 250 meters may separate tanks in defensive positions. The terrain is a dominant factor in positioning tanks and antitank weapons, with each tank and antitank weapon having a primary and secondary sector of fire as well as primary and alternate positions.

Barrier plans and the system of fire complement each other. Both antitank and antipersonnel minefields may be in front of the forward edge and throughout the depth of defensive positions. Direct and indirect fires cover antitank obstacles.

The **mortar battery** of an MRB deploys in accordance with the overall fire plan. It assumes a position from which it can provide close-in fires for the company strongpoints.

The MRB's **grenade launcher platoon** usually remains under the control of the battalion commander. It normally supports the first-echelon companies as a platoon. It can be assigned to a single company defending on a main avenue of approach into the battalion area. Under certain conditions (broken terrain, critical space in a company strongpoint), individual weapon squads may be assigned to first-echelon motorized rifle companies.

DEFENSE ASSUMED IN DIRECT CONTACT

They OPFOR realizes there are times when it cannot avoid assuming the defense in direct contact with the enemy. The same factors of mission, enemy, troops available, terrain, and time available considered in a defense out of contact are the primary considerations in establishing a defense in contact. The main differences when in direct contact are the following:

- There is no security zone, or a very small one.
- The mission to defend in contact can last only until the OPFOR is able to resume the offensive or develop the defense into one out of contact with the enemy.
- The enemy situation is likely to be clearer; an enemy attack may be imminent.
- The terrain may be unfavorable for the defense; favoring the attacker.
- Time for preparation can be short.

Reverse-Slope Defense

Establishing the defense when in contact with the enemy poses problems, since forces may have to dig in while under enemy fire and observation. For this reason, terrain permitting, an OPFOR commander can use a reverse-slope defense. Part of the force remains in contact with the enemy on the forward slope, while the remainder of the force prepares the position on the reverse slope. The OPFOR recognizes the following advantages of a reverse-slope defense:

- It hinders or prevents enemy observation of the defensive position.

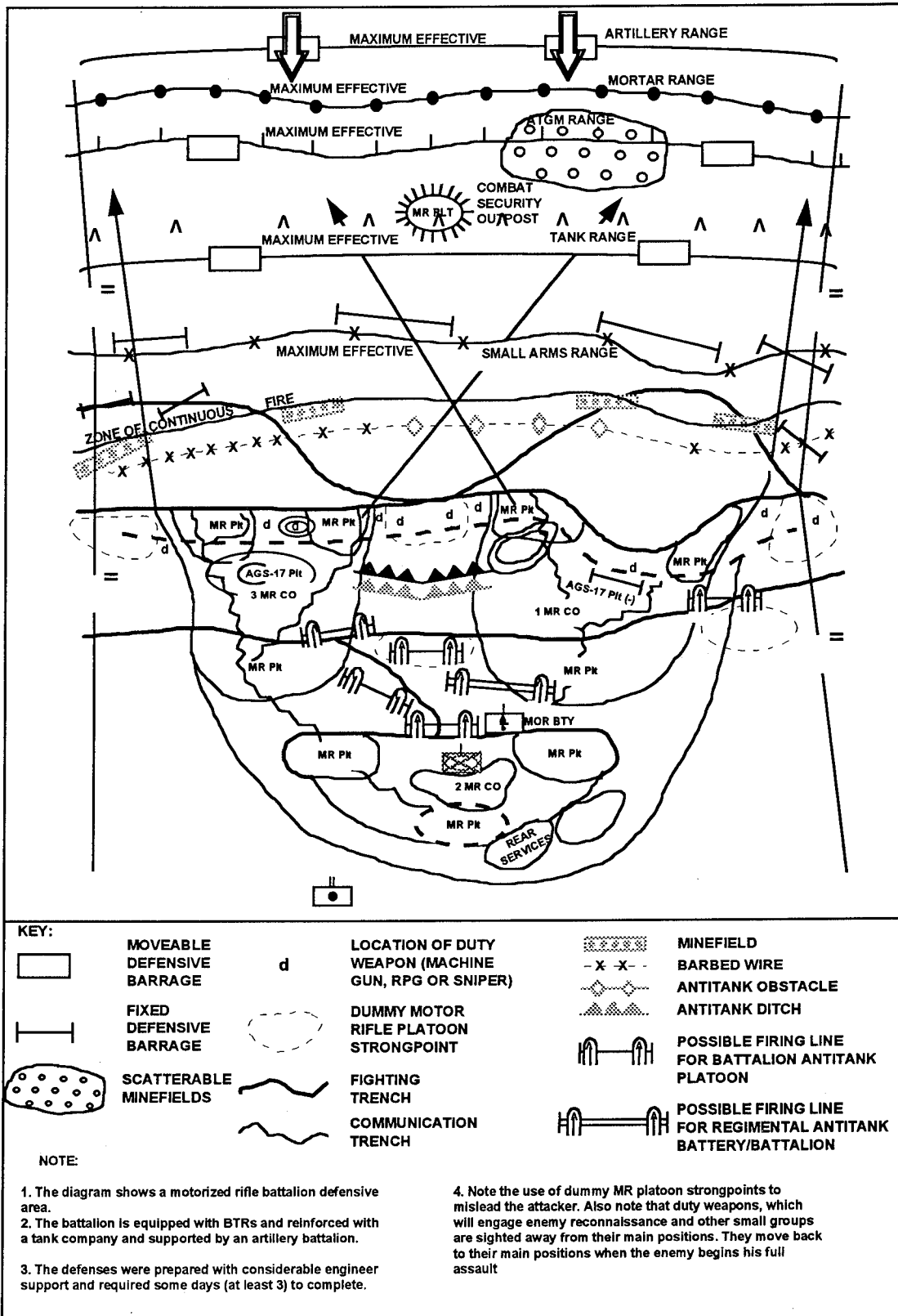

Figure 6-7 MRB defensive area (example).

- Attacking forces are not able to receive direct fire support from following forces.
- Enemy long-range AT fires are not effective.
- Attacking enemy forces silhouette themselves crossing the crest of the hill.
- Engineers can conduct their work out of direct fire and observation from the enemy.

One disadvantage of this type of defense is that all weapon systems cannot exploit their maximum range. When possible, the OPFOR would use both a forward and a reverse-slope defense to take maximum advantage of the terrain.

Security Zone

When the force going over to the defensive is in contact with the enemy, establishing positions within a security zone is difficult. If there is a security zone, its depth is not nearly as great as it is when the force is out of contact. Long-range fires do not play the part they do when

out of contact, because the enemy is, for the most part, within direct fire range. Achieving deception is difficult, since friendly forces may be under direct observation of the enemy. The OPFOR may emplace obstacles, but not as extensively as in a defense out of contact with the enemy.

Combat and Combat Service Support

For support elements, differences in mission arise from the temporary nature of a defense in contact with the enemy. Combat

support **remains configured for continued offensive action.** Artillery groupings may retain an organization designed to support the next offensive phase. This is particularly true if the OPFOR intends to go back on the offensive as quickly as possible.

Engineer mobile obstacle detachments lay minefields across critical avenues of approach. They employ armored minelayers, armored engineer vehicles, and earth-moving equipment to prepare obstacles and firing positions. The sequence of engineer work ensures readiness to repel an enemy attack.

Combat service support also remains configured to support offensive action. Its primary effort is to prepare units for future offensive actions. The priority of support goes to units selected to initiate offensive actions.

Division

The defense in direct contact generally occurs as a result of a stalled offensive. The frontage that the division occupies is initially equal to that division's zone of attack. The most obvious difference in the division battle formation is the absence or shallowness of a security zone. The top priority for elements in contact is the quick assumption of favorable defensive positions. This often requires local attacks to seize these positions. As the situation permits, the division gradually develops the defensive frontage and depth discussed above (for a defense assumed out of direct contact). Those divisional units not in contact immediately begin constructing second-echelon positions.

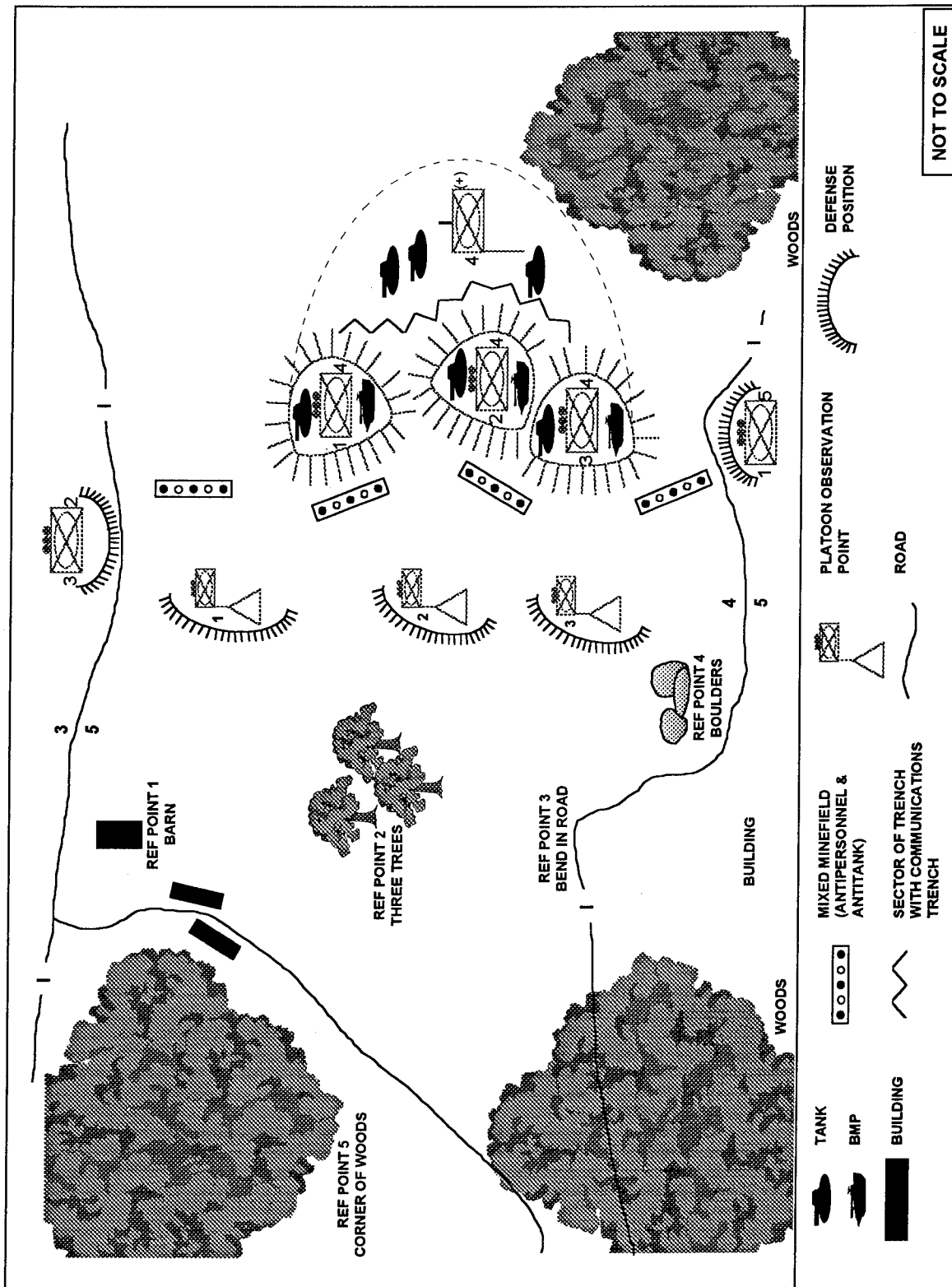

Figure 6-8. MRC (BMP) stronghold (example).

Regiment

Regiments are also likely to assume a defense in direct contact following unsuccessful offensive action. Local attacks are commonly used to seize the best defensive ground and regroup into a defensive zone from the former narrow zone of advance. Regiments do not form combat security outposts in this type of defense.

Battalion

When assuming the defense in direct contact, a battalion initially halts with subunits occupying the positions they occupied when the order to defend was given. Its first priority is to seize favorable terrain. Though the enemy is in close proximity, the battalion would set up local security, if the opportunity occurs. Unless the halt was a temporary holding action, the battalion commander gradually transitions his forces into defensive positions out of direct contact, if the mission and situation permit. Platoons may be left in positions to establish a combat security outpost in front of the new defense..

COUNTERATTACK

Defending first-echelon battalions are prepared to counterattack under favorable conditions; for example, they counterattack opportunity for a counterattack by forces of when a much weakened enemy stalls in partial occupation of the defensive strongpoints. The enemy's forces and fires can overwhelm the OPFOR first-echelon defenses and prevent a counterattack. If this happens, subunits must hold their positions, strike the enemy with all available fires, and create the the next higher command. As the enemy advances into the depths of the OPFOR defense, he may face better-prepared positions. He also encounters a progression of obsta-

cles, second-echelon defenses, and tank-heavy counterattack forces.

Planning

OPFOR commanders at battalion level and above plan counterattacks to restore the defense, should the enemy succeed in breaching forward defensive positions. Commitment of the counterattack force requires the authority of the next higher commander. This force generally attacks from the enemy's flank. Tanks normally spearhead the counterattacks, following an intense air and artillery preparation, and with the support of fires of adjacent units. Against greatly superior enemy forces, the counterattack would be by fire only, and not by maneuver forces.

Conduct

A successful counterattack requires the same superiority ratios as an ordinary attack. The main features of OPFOR counterattacks are as follows:

- The enemy's attack must have been halted or, at the very least, the momentum of the attack must have been broken. Antitank reserves and mobile obstacle detachments are used to achieve this.
- The enemy must be unable to commit a reserve into the penetration, either because it has already been committed, or because it has neutralized by long range strikes.

The second-echelon company of a battalion, usually in conjunction with regimental counterattack forces, may counterattack enemy forces that have penetrated the forward and rear platoon strongpoints of a first-echelon company. Portions of first-echelon companies (or armored groups) may

also participate in the counterattack. If the penetrating enemy force is superior to the counterattack force, the counterattack may be made by fire only. The goal of a counterattack is to destroy the penetrating enemy and restore the original line of the defense.

If a counterattack is attempted, lower levels of command join in with all available maneuver elements. Although a battalion might not launch a counterattack independently, it would support a regimental or division counterattack. A battalion can provide direct support on the flanks of the main attack, or act as diversions to confuse the enemy.

WITHDRAWAL

An OPFOR commander can use a withdrawal to execute a specific combat task in the rear of his own troops. Examples of this are--

- Withdrawal as a result of an unsuccessful meeting battle.
- Withdrawal during breakout from encirclement.
- Withdrawal to execute an anti-nuclear or anti-high-precision-weapon maneuver.
- Withdrawal as part of a ruse to draw enemy forces into a trap.
- Withdrawal to return to friendly lines after a raid.
- Withdrawal from a superior enemy force.
- Withdrawal from a contaminated region.
- Withdrawal to a successive position in the security zone.

This maneuver could ensure favorable conditions for the main forces to carry out successful, decisive battles against enemy troops.

Within the context of defense, the OPFOR views the withdrawal as a combat action designed to disengage troops from attack by superior enemy forces. It allows them to occupy a more effective defensive line or position. On the modern battlefield, a withdrawal could bring the full application of the enemy's combat power to destroy withdrawing units. Because of this the OPFOR, when withdrawing, resorts to deception and to movement at night and during periods of reduced visibility. It also uses covert preparations to avoid alerting the enemy. Figure 6-9 shows the sequence of withdrawal for an MRD.

The OPFOR commander's withdrawal order is detailed. It includes--

- The mission.
- Routes.
- Assembly areas.
- Formation to be used.
- Delay positions.
- Control measures.
- Information on the new defensive position.

The OPFOR organizes and executes withdrawals under strict secrecy and security. The mission is to disengage the force in a timely, organized manner without losing its combat capability. The force executing the withdrawal comprises three groups: the covering force, the rear guard, and the main body.

Covering Force

The covering force has the mission to deceive the enemy and to cover the initial withdrawal of the main body. This force comes from subunits along the forward edge of the defense. It usually consists of a reinforced platoon from each forward-deployed company.

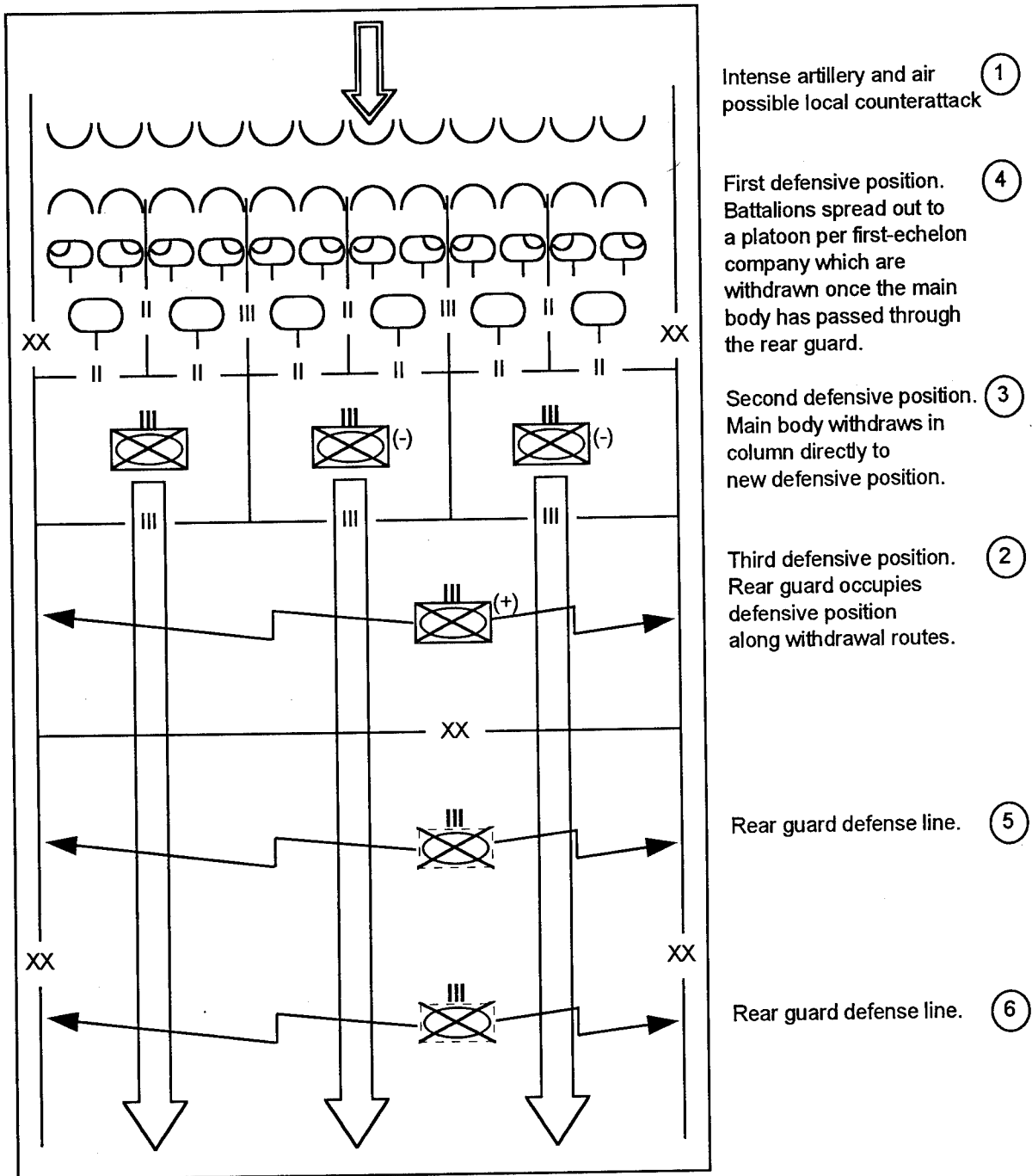

Intense artillery and air possible local counterattack (1)

First defensive position. Battalions spread out to a platoon per first-echelon company which are withdrawn once the main body has passed through the rear guard. (4)

Second defensive position. Main body withdraws in column directly to new defensive position. (3)

Third defensive position. Rear guard occupies defensive position along withdrawal routes. (2)

Rear guard defense line. (5)

Rear guard defense line. (6)

Figure 6-9. MRD sequence of withdrawal.

Rear Guard

The rear guard covers movement of the main body. It fights a delaying action if the enemy attempts to maintain contact in the pursuit. Its organization enables it to fight independently of the main body and covering force. It is a combined arms force consisting of tank, motorized rifle, artillery, and engineer elements. A company or smaller force normally performs this duty for the battalion. It makes maximum use of artillery, mortar, and long-range antitank fires, fighting through a series of delay positions and preventing enemy interference in the withdrawal of the main body.

Main Body

The main body breaks contact and attempts to withdraw without disclosing its intentions to the enemy. It attempts to deceive the enemy by withdrawing under the cover of darkness or in adverse weather conditions. It may also deceive by using supporting fires to cover noise or by employing a ruse. The main body conducts a route reconnaissance and a reconnaissance of the new positions it will occupy, posting guides to expedite movement. It takes advantage of coordinated and planned air strikes and artillery support to cover its withdrawal.

Conduct

A regiment conducts a withdrawal in the following sequence. First-echelon battalions designate platoons to act as covering forces that present a normal defensive posture to the enemy. The regimental commander designates a rear guard, normally a reinforced second-echelon battalion.

On order, the main body, minus covering forces, withdraws through the rear

guard in the following order: first, the second-echelon forces and rear services; then, artillery and combat support elements; and, finally, the first-echelon forces. The main body proceeds on multiple routes, all the way back to a new defensive position or assembly area.

Once the main body has passed through the rear guard, the covering force breaks contact on order. It withdraws through the rear guard to join the main body. The covering force conducts minimum radio communications or observes listening silence. The rear guard fights a delaying action and leapfrogs to successive positions, using--

- Smoke.
- Mobile obstacle detachments laying minefields and creating obstacles across enemy avenues of approach.
- Artillery fire concentrations.
- Ambushes.
- Attack helicopters.
- Fixed-wing air strikes.

If the enemy does not pursue, the rear guard assumes march formation and joins the main body as quickly as possible.

RELIEF

OPFOR doctrine stresses the temporary nature of the defense. It emphasizes the need for counterattacks as soon as possible to initiate a renewed offensive. The relief can achieve this end.

Concept

The OPFOR concept of relief of troops involves an organized transfer of positions, areas, and zones in a combat situation from one unit to another. The units being relieved have usually sustained considerable losses and are on the defense.

A relief can also enable a fresh unit to occupy the defensive positions of the relieved unit in preparation for a renewed offensive. Because units being relieved are usually in direct contact with the enemy, they are subject to enemy fire and ground attacks. Because of this, the OPFOR organizes relief carefully, executing it quickly and secretly. It attempts to preserve as much of the unit's combat capability as possible. As a rule, a relief occurs at night or during periods of reduced visibility.

Conduct

A **battalion relief** begins with the regimental commander establishing the relief sequence. The battalion commander relieving and the one being relieved conduct a joint reconnaissance of the defensive position. During this reconnaissance, the commanders coordinate routes to and from the relief areas, traffic control posts, locations for guides to meet the relieving units, and the sequence of relief. They also determine the time to start and complete the relief, security measures, and actions in the event of an attack during the relief. In addition, the battalion commanders review the present system of fire and observation and obstacles and minefields supporting the position.

Should the enemy attack during the relief, all available subunits, including the relieving battalion, attempt to repel the attack. All of these subunits fall under the control of the commander being relieved. The reserve of the subunit being relieved may counterattack. It is the last element to withdraw from the defensive area.

At the appointed time, the relieving battalion moves to the relief area by concealed routes. It carries out the relief successively by platoons. The first forces to

move are motorized rifle and antitank subunits, followed by mortar, artillery, and tank subunits. If the relief involves battalions of the same MRR, tanks may remain in place, transferring their attachment. Once in position, the relieving subunits establish observation posts and their system of fire.

Relieved commanders transfer their positions and provide information on enemy activities and routines. They acquaint relieving commanders with the locations of obstacles and minefields and with the primary directions of fire. Established communications remain intact, and wire lines remain in place, passed on to relieving subunits. The relieving subunit thoroughly checks and verifies all engineer installations, including minefields and obstacles, with respect to boundaries, passages, and degree of readiness.

The relieving battalion commander checks the locations and weapon positions of his subunits to ensure that his forces are ready for combat. The relieving battalion attempts to maintain the same routine and level of activities that existed before the relief. The relieving commander reports to his superior that the relief is complete. This action officially terminates the relief. The relieved battalion then withdraws to assigned assembly areas to carry out its subsequent assigned mission.

SPECIAL CONDITIONS

As in the offensive, OPFOR tactics are modified to meet the requirements of combat in special conditions. One characteristic of these operations is that considerable effort is required to overcome the physical difficulties of terrain and climate. Tactical features of the defense in special conditions include greater decentralization of resources to lower levels of command in order to form

more capable combined arms groupings. The possibility also exists of units and subunits defending wider frontages than on normal terrain.

Cities

When defending in cities or other built-up areas, a battalion's or company's combat formation can be in one or two echelons, with two-echelon formations as the most common. The combat formation may include a reserve (even in a two echelon formation), and armored groups to provide mobile firepower and ambushes. Battalions can form assault groups in their second echelon, identical in strength and structure to those used in the attack. These are used to recover any key buildings captured by the enemy.

The forward edge of the defense is established on the outskirts of the town, or out into the country if it is required to hold dominating ground. A security zone is often organized outside the town. The MRB and MRC are the basic building blocks of the defense, and they receive strong reinforcements. Tanks and most of the supporting artillery are given to motorized rifle elements to provide direct fire from strongpoints, covering any reasonable field of fire.

Antitank weapons are positioned to cover road junctions and to fire along streets. Engineer assets are incorporated down to company level to assist in fortifying buildings, creating obstacles and improving routes between strongpoints. Strongpoints are expected to continue to resist even when encircled; additional reserves of ammunition and other supplies can be pre-dumped in them to provide a considerable measure of tactical independence.

Mountains

In mountain areas, the defender can hold a wider frontage than in normal terrain, but also faces extra difficulties in organizing his defenses. In particular, the lack of roads restricts maneuver, and the defense is based on separate strongpoints established to hold vital ground such as commanding heights, passes, road junctions and river crossings. On plateaus and in wide valleys the defense is organized normally.

Combat Formation

A two-echelon defense is standard in mountain areas, although in sectors unsuitable for armored movement the defense may be organized in one echelon, with a reserve. A minimum of resources is allocated to terrain unsuitable for any movement. Strongpoints are organized for all-around defense. The intervals between them are covered by reconnaissance, patrols, obstacles, demolitions, and ambushes.

The OPFOR makes effective use of ambushes in mountain operations, not only in gaps between positions, but in front of them and in depth. Mountain passes are covered by holding the ground dominating the approaches, with part of the defending force deployed in the pass itself. Obstacles and mines are laid on the road through the pass and covered by crossing fire. Narrow canyons are covered by crossing fire from either side. Part of the second echelon is designated as an antilanding reserve to guard against the enemy use of airborne or airmobile forces to bypass forward defenses.

Fighting in Depth

If the enemy succeeds in penetrating the defense, the OPFOR expects strong-

points to continue their resistance on the flanks, even if totally encircled. Counterattacks are attempted, even with small forces, using prepared routes and attacking from higher ground whenever possible. The OPFOR considers that mountain areas favor attempts by the defender to strike into the enemy's depth. Special-purpose forces, raiding and other detachments are infiltrated into enemy-held areas by ground or helicopter.

Deserts

Deserts offer mixed terrain, with areas capable of supporting high rates of movement interspersed with soft sand, and dunes that restrict movement. Defense sectors are often wider than usual. The OPFOR practice is to cover the most likely axes with battalion defensive areas and company strongpoints, organized for all-around defense, and accept greater intervals than usual between them. Strong second echelons or reserves are held to counterattack or reinforce threatened sectors. The improvement of maneuver routes is a vital engineer task in desert warfare.

Tactical Variations

The openness of desert terrain offers longer fields of view and fire. Reconnaissance is organized in greater depth than normal, and direct fire weapons are effective at longer ranges, making it possible to increase subunit frontages. High-precision weapons are more effective in such terrain, and special attention must be paid to camouflage and concealment.

Defenses are organized in greater depth in the desert. Distances between echelons are greater and forces more dispersed. Reserves, mainly tank-heavy, are

held in greater depth than usual and may be employed to counter enemy enveloping movements. MRC and MRB frontages in the forward area are similar to those in the normal defense. MRCs normally organize in a single echelon. Divisions and regiments may defend independently. Mined sectors and areas of limited trafficability may be lightly defended; they may be covered only by mobile patrols or outposts.

Engineer Work

Fortification work is much more difficult in deserts. Soft sand needs reinforcement, and there is generally a shortage of local material to use in preparing defenses. Strong winds blowing sand and dust mean that great care is required to keep all equipment and weapons serviceable. Laying mines is difficult in many sectors, and even when minefields are laid, they must be inspected regularly to check to see that they have not been exposed by the wind.

Northern Regions

As is often the case in defense in special conditions, a sector in a northern area can be held with weaker forces than on normal terrain. Wider frontages are achieved by accepting larger intervals between platoon and company strongpoints. Strongpoints are positioned to cover roads, dominant high ground, defiles, and river crossings. Gaps are covered by obstacles, patrols, and ambushes. Strongpoints are made as logistically self-sufficient as possible, so they can continue to operate, even if cut-off by the enemy or the climate. Fortifications may have to be built above ground level, but where snow cover is deep enough, trench systems are dug.

Chapter 7

Fire Support

The OPFOR concept of fire support covers all combat support provided to ground forces by missiles, artillery and aviation forces. The term "artillery" includes the following weapon systems:

- Surface-to-surface missiles (SSMs).
- Free flight rockets.
- Field artillery multiple rocket launchers (MRLs).
- Guns, howitzers, gun-howitzers, 82-mm automatic mortars and mortars 120-millimeter and larger.
- Antitank artillery.

OPFOR military doctrine distinguishes between fire support and nuclear attack, but the two are closely related. Fire support units must plan and deliver nuclear strikes. They also adjust the fire plan to account for the effects of nuclear strikes on the enemy. These strikes affect the tempo of combat activity. This tempo, in turn, influences the type of fire support required. It also impacts on the type of logistics support needed, such as fuel or ammunition.

The OPFOR has spent considerable time and resources modernizing and expanding its conventional artillery forces. OPFOR military doctrine states strategic nuclear and conventional forces will work together to achieve maximum results. Due to its improved conventional capabilities, the OPFOR believes future conflicts may not require a nuclear exchange. This view is strengthened as the OPFOR continues to develop high-precision weapons with improved lethality and accuracy. At the same time, however, the OPFOR would be prepared to employ

nuclear weapons at any phase of a future conflict.

FIRE SUPERIORITY

The OPFOR defines fire superiority as a firepower advantage over the enemy in a given battle or operation. It is a unit's ability to execute its own fire missions successfully while suppressing enemy counterfire. To gain and keep fire superiority, the OPFOR maintains continuous fire on the enemy's fire support systems, specifically his artillery. The OPFOR believes that fire superiority is relatively assured for the side that--

- Opens fire first.
- Achieves surprise.
- Delivers accurate and effective fire.
- Masses fires effectively, through maneuver by fire or maneuver of the fire support means. (See Chapter 8, Artillery Support for specifics on maneuver by fire.)

An extensive fire preparation in the offense can win fire superiority. The OPFOR expects this advantage to continue during the entire battle. In the defense, OPFOR fire planners try to achieve fire superiority by quickly massing fires in selected sectors for a given period of time. For example, fire planners may fire in a sector selected for a counter preparation or in support of a counterattack force.

The OPFOR stresses that fire support systems should combine air assets and artillery into a simultaneous attack throughout the enemy's defenses. The combined arms commander increases the volume of air

strikes and artillery fire to destroy enemy antitank systems during preparatory fires. This provides continuous fire support for maneuver units while they move through enemy defenses.

OPFOR military planners stress that massed firepower is the key to success in combat. This enables OPFOR ground forces to attack successfully and quickly, exploiting weaknesses caused by such overwhelming fires. Commanders try to accomplish their missions by fire and then by rapid exploitation with maneuver forces. The OPFOR continues to expand and upgrade its fire support systems to achieve massed firepower.

ARTILLERY

OPFOR divisional and nondivisional artillery units have expanded and modernized. They now have more self propelled artillery weapons at the tactical level. Divisions have more large-caliber self propelled guns, howitzers, mortars, and long-range MRLs to employ than they had previously. The commander can provide more area and counterbattery fire support to subordinate units and subunits as they move in the enemy's rear.

Entire battalions now fire missions previously fired by individual batteries. This provides delivery of the same volume of fire within a shorter time period. Improvements in target acquisition radar enables the OPFOR to achieve greater surprise and to deliver shorter, more intense fire preparations. Battalions and batteries can initiate fire missions without registration. OPFOR artillery battalions have also fielded electronic field artillery computers. The automation of gunnery computations reduce mission times for OPFOR artillery and allow

more flexibility in deploying artillery firing batteries.

AIR SUPPORT

Air support is important for maintaining a high rate of advance. Maneuver units can out run their artillery support and artillery units can, in turn, out run their logistic support. To compensate for this shortfall maneuver units need air support to cover and support their advance. The OPFOR tries to integrate air support into the total fire support effort. Major field exercises feature joint air and ground operations. The result is OPFOR commanders have an increased quantity and quality of fire support available.

Helicopters have become increasingly important in execution of both the close and long-range fire support battles. Combat helicopters provide fire support to tank and motorized rifle units during both the offense and defense. Helicopters also support reconnaissance and heliborne operations. They provide observation platforms for artillery forward observers and are mobile means of control and communications.

Newer helicopters are equipped with antitank guided missiles having greater standoff range. Attack helicopter tactics closely support ground maneuver unit tactics. Helicopters provide a majority of the air support to the ground forces.

The OPFOR understands the value of real time reconnaissance that remotely piloted vehicles (RPVs) can provide. RPV data is ideal for target identification, adjustment and battle damage assessment (BDA). The OPFOR knows RPV data is highly critical and perishable. There emphasis is placed on its immediate use and on quickly disseminating the collected data.

The OPFOR deployment of a wide variety of mobile air defense missile and gun systems have given ground forces greater freedom of maneuver. This deployment of air defense assets simultaneously frees aircraft from air defense missions so they can be employed for ground support roles.

TARGETING

Basis of Fire Planning

The OPFOR tries to solve battlefield problems through the use of mathematical formulas, and fire support is no exception. Study of past wars and of improvements in weapon systems have led the OPFOR to establish "norms" for the numbers of rounds required to achieve different effects on targets. When ordered to inflict a specific level of damage on a target, the artillery commander refers to his tables to find out how much ammunition to expend. The levels of destruction that may be ordered are summarized below.

Target Damage Criteria

Target damage is the effect of fires on a given military target. It results in total, partial, or temporary loss of the target's combat effectiveness. The OPFOR categories of target damage are as follows: annihilation, destruction, neutralization, and harassment.

Annihilation

Annihilation fires render targets combat-ineffective, and incapable of reconstitution or token resistance. For a point target such as an antitank guided missile launcher, the OPFOR expends enough rounds to assure a 70 to 90 percent probability of kill.

For area targets such as platoon strongpoints or artillery assets, the OPFOR fires enough rounds to destroy 50 to 60 percent of the targets within the group. Annihilation is costly in ammunition, requiring three times the expenditure involved in neutralization of a target. Because of this the OPFOR rarely uses annihilation except against high value targets such as nuclear weapons and elements of high-precision deep-strike systems.

Destruction

The OPFOR uses the term destruction in reference to engineer works such as fortifications, bridges, and roads. Destruction requires enough rounds to damage the target so that it cannot be reconstituted without a significant expenditure of time and resources and is capable of only sporadic and uncoordinated resistance.

Neutralization

Neutralization fire inflicts enough losses on a target to cause it--

- To temporarily lose its combat effectiveness or-
- To restrict or prohibit its maneuver or-
- To disrupt its command and control capability.

To achieve neutralization, the OPFOR delivers enough rounds to destroy 30 percent of a group of unobserved targets. For example, achieving this level of destruction on a typical platoon position covering four to six hectares in area, requires 800 to 1,200 122 mm rounds or 600 to 900 152 mm rounds at ranges up to ten kilometers. The expectation is that the target is severely damaged but will be capable of eventual coordinated resistance after the fire is lifted.

Harassment

The OPFOR uses a limited number of artillery pieces and ammunition within a prescribed time to deliver sporadic harassment fires. The goal of these fires is to put psychological pressure on enemy personnel in locations such as concentrated defensive areas, command posts, and rear installations. Successful harassment fires impede troop movement in the open, lower morale, interrupt rest, and as a result weaken enemy combat readiness

TARGET PRIORITIES

OPFOR target priorities, with the exception of nuclear weapons and high-precision weapons, vary according to the stage of the battle. The general order of their importance is:

In the Offense

- Nuclear and high-precision weapons and their associated elements and delivery means.
- Conventional artillery and air defense.
- Tanks and antitank guided missiles.
- Defensive strong points.
- Command and control.

In the Defense

- Nuclear and high-precision weapons delivery means.
- Precision weapons and their associated elements.
- Conventional artillery and command and control.
- Attacking groupings.
- Penetrations.

Zones

The OPFOR distinguishes between close and long-range **fire support zones**. The close-range fire support zone extends as far as the range of the attacker's direct fire weapons, approximately 3 km into the enemy's defenses. The close-range fire support battle must destroy forward defending troops and their supporting weapons.

As the OPFOR modernizes fire support assets the depth of the long-range fire support zone continues to increase. At division and below, the long-range fire support zone extends out to the limit of a division's subsequent objective. Today, critical enemy targets such as nuclear weapons and their delivery systems, and high-precision deep-strike systems deep in the enemy's rear area make domination of the long-range fire support battle very important.

PHASES OF FIRE SUPPORT

Offensive

The OPFOR goal of fire support in the offense is to provide continuous supporting artillery fires through the depth of the enemy defense. The duration of these fires varies with circumstances. The OPFOR coordinates the fires of rocket, SSM, artillery, and air assets into the integrated fire destruction of enemy forces through the depth of the attack corridor. Fire support in an offensive begins when the OPFOR unit leaves the assembly area and continues after the supported unit completes the penetration. This **offensive fire support plan** has four phases:

- **Phase I:** fire support for the movement forward of troops.
- **Phase II:** fire preparation for the attack.

- **Phase III:** fire support of the attack.
- **Phase IV:** fire accompaniment.

Phase I: Fire Support for the Movement Forward

Phase I applies to conventional support of any uncommitted force moving towards commitment against the enemy. This phase is normally employed only when an offensive is being conducted from the line of march and when it is necessary to protect forces moving up from assembly areas more than 20 km from the forward edge. This phase may also cover a follow-on force's movement forward before commitment.

This phase targets enemy long-range weapons that might strike the supported unit while it is still a considerable distance from the forward edge of enemy defenses. These targets will consist of enemy long-range artillery, SSMs, aircraft on airfields and combat helicopters. The OPFOR uses aviation, tactical and tactical-operational SSMs, long-range guns, and MRLs to destroy or suppress deep targets.

The goal of this phase is to protect advancing columns by destroying or harassing enemy systems that could interfere. Fires in this phase are likely to be conducted from temporary fire positions, with the artillery shifting to its main positions for the next phase. It ends when the maneuver units are ready to deploy into battalion columns.

Phase II: Fire Preparation for the Attack

Phase II, fire preparation, can apply to the attack or the counterattack, or can precede the commitment of second-echelon or reserve forces. The artillery preparation

should suppress and/or destroy a defending enemy with organized, planned, massed fires, that deny the enemy the opportunity to organize resistance. The fire preparation should destroy and suppress enemy weapon systems, C² elements, and troops in the tactical and immediate operational depth of the enemy's defenses. Targets for the preparation are assigned according to their type, size, degree of hardness, mobility, and depth in the enemy's defenses. The duration of the preparation depends on the enemy's disposition, fire support assets used, and type of ground attack to be conducted. The organization of the preparation reflects--

- The overall attack plan.
- The nature of the enemy's defenses.
- The type and density of fire support means being used for the preparation.

The preparation can begin twenty to thirty minutes before the supported force reaches the forward edge of enemy defenses. The OPFOR may repeat this fire against well fortified, deeply echelon defenses. Because of the mobility of potential targets and the threat of enemy counter battery fire, the OPFOR strives to increase the intensity of fire. It tries to reduce the length of this phase by adding more artillery, with special emphasis on MRL units, to the force structure.

Phase III: Fire Support of the Attack

This phase begins when the attacking forces reach the line of deployment into battalion columns and may last up to 50 minutes. In this phase, first priority goes to maintaining fire superiority. The advance fire is planned on sequential lines moving progressively deeper into the enemy's deployment, and to the flanks of the advance. Emphasis is on the continuity of support,

ensuring the fire of the artillery and the advance of the maneuver units do not get out of phase. This also hastens the forward movement of assaulting units.

This phase should prevent the enemy from restoring fire, C², and observation systems disrupted during the preparation. Fires continue to suppress enemy troop activity and weapon systems. The artillery fires on the enemy that is directly in front of, and on the flanks of, attacking OPFOR troops. The fires shift in bands progressively deeper into the enemy's defensive positions. Artillery support tries to keep the fire superiority attained during the artillery preparation phase, while suppressing enemy defenses.

Phase IV: Fire Accompaniment

Fire accompaniment is the **fourth and final phase**. It includes artillery and air strikes against troops and weapon systems opposing the attacker's advance and against enemy reserves deep in the rear. Artillery units support maneuver units with on-call fires as they exploit their success. The OPFOR constantly refines the artillery accompaniment plan during the attack.

During this phase artillery units displace with the units they support. They fire on newly acquired targets or targets that have survived the preparation and support phases. Artillery and combat aviation units coordinate mutually supporting fires with each other and with the supported maneuver unit. They support the commitment of the attacker's second-echelon forces to ensure a high rate of advance. Fires must keep the enemy from using his reserves for counterattacks.

Defensive

In the defense, OPFOR fire support planning is highly centralized. Fires are organized to be mutually supporting and provide fire sacks. The fire planner utilizes all available assets to carry out the commander's plan. Several variations of the plan are produced, based on the approach and deployment options open to the enemy. Effective fires in the defense are achieved by surprise, accuracy and massed fires. Primary fire support missions in defense are **counterpreparatory fires** and **fires against an attacking enemy**. Other missions are the support of maneuver forces in the security zone and at the forward positions, covering gaps and open flanks with fire. Missions may also include providing illumination to locate and dazzle the enemy and orient counterattacking forces and combat airborne, airmobile, and seaborne landings.

Counterpreparatory fires can include rocket, missile, artillery, and air strikes. The intent is to disorganize and weaken enemy forces preparing to attack. This defensive fire mission should surprise the enemy and should start before the enemy's preparation fires.

To facilitate centralized control and effectiveness, the OPFOR divides **fires against an attacking enemy** into four phases. These are:

- Phase I: fire interdiction of advancing enemy troops.
- Phase II: fire to repel the enemy attack.
- Phase III: fire support of defending troops.
- Phase IV: fire destruction of the enemy during a counterattack.

Phase I: Fire Interdiction

Fire interdiction of advancing enemy troops occurs when the enemy deploys into battalion columns. It continues until the enemy forces reach their line of departure. Attached or supporting artillery units can occupy temporary fire positions beyond the forward edge of defense. Fire on distant approaches is carried out by fixed-wing aviation, SSMs and long-range artillery. Where possible, enemy units are destroyed as they move up, but if target intelligence is inadequate, disruption and delay is inflicted by all available assets.

If the defensive is adopted already in contact with the enemy, this phase concentrates on the enemy's second echelon. Throughout the period before the enemy's attack, attention is paid to denying the enemy good target intelligence for his preparation. As much artillery as possible remains silent until needed to repel a major attack. Batteries used before the main enemy attack will fire from temporary fire positions or be used as roving batteries to confuse enemy intelligence.

Phase II: Fire to Repel the Enemy Attack

This is the most important phase of defensive artillery fire. The phase begins when the enemy crosses the line of departure and ends when he enters the first defensive positions. Fires create a zone of continuous fire in front of the defense. Fire to repel the enemy attack coordinates artillery fire with antitank weapons and all weapons of the maneuver units.

OPFOR artillery tries to break up attacks and split armor from the infantry with planned linear and box concentrations in

front of the forward edge positions, and minefields in gaps between strongpoints, and eventually in depth. Guns and multiple rocket launchers start to engage the enemy 15 to 25 km from the line of contact and howitzers will fire when the enemy is within 10 to 15 km. Short but intense fire strikes, no more than fifteen to twenty minutes in duration are fired, followed by displacement to alternate fire positions to avoid counter-battery fire.

Phase III: Fire Support of Defending Troops

Fire support of defending troops occurs when artillery units attack enemy forces that have penetrated the defensive positions of first-echelon maneuver battalions. Its goal is to destroy the enemy pockets, preventing him from developing the attack. Some batteries may enter preselected direct fire positions.

The enemy is expected to penetrate the defense, but to pay an appropriate price and be canalized. The artillery supports defensive positions in depth, tries to separate enemy infantry from armor and fighting troops from their logistic support. If necessary, artillery may even be used in the direct fire role against armored breakthroughs. The artillery plays a key role in creating suitable conditions for the launching of a counter-attack

Phase IV: Fire Destruction of the Enemy During Counterattack

The final phase of defensive fires is the destruction of the enemy during the counterattack. Its goals are to recover lost positions, destroy penetrating enemy forces, and to capture a line to launch offensive op-

erations. This phase has three sub phases for artillery support:

- Support for the forward movement of troops.
- Preparation of the counterattack.
- Support of the counterattack.

A successful counterattack requires a stabilized line of contact. This line allows enough time for the second-echelon forces to advance and deploy for the counterattack. Fires are delivered to cover the forward movement of OPFOR troops while also engaging weapons systems that could impede the move forward.

Fire Support Advances

The OPFOR is concerned with advanced enemy fire support systems. These systems are designed to increase combat power by looking deep into the OPFOR area of operations. The OPFOR wants to neutralize enemy precision reconnaissance and weapon systems to maximize its own offensive capabilities. These systems include enemy--

- Long-range nuclear and conventional weapons.
- Command and control facilities.
- Long-range minelaying capabilities.
- Air defense assets.
- Weapon guidance systems.

The OPFOR technological advances in reconnaissance, target acquisition, and weapon delivery systems has allowed it to introduce a new strike concept into its fire control and support capabilities. This concept incorporates these advances into a greatly accelerated strike system known as reconnaissance-fire/reconnaissance-strike complexes.

Reconnaissance Fire Complex

The reconnaissance-fire complex (RFC) has tube artillery or MRLs under the control of a tactical commander. The complex attacks similar enemy systems. The OPFOR preselects the artillery units in the RFC while planning offensive and defensive operations. The reconnaissance units locate targets that have priority over the preplanned targets of the RAG or DAG. The RFC staff calculates the firing data and sends it to the firing units. The reconnaissance unit observes the results and controls any additional necessary fires. The artillery units remain in the RFC as long as required. When these units complete the requirements, the senior artillery commander returns them to their parent units.

A division (for example) may have several RFCs, not just one. Any high-priority target that has not been located previously is a potential target for an RFC.

Reconnaissance Strike Complex

The operational-level commanders control the reconnaissance-strike complex (RSC). They target enemy nuclear delivery systems such as air and artillery assets. They also target enemy high-precision deep-strike systems. Any high-priority target that has not been located previously is a potential target for an RSC. In order to attack enemy targets, these complexes can use MRLs with antipersonnel submunitions and mines, SSMs with terminally homing submunitions and mines, tactical aircraft, and helicopters.

Artillery groups with long-range weapons in forward-echelon units attack these enemy assets to ensure the advance of the attacking ground forces. Motorized infantry units in the forward detachments may

drive quickly to destroy ground elements of these assets. The RSC can also fire artillery delivered scatterable mines when its ground surveillance radars locate moving targets.

Chapter 8

Artillery Support

OPFOR planners emphasize fire-power as the principal means to neutralize enemy combat forces. The OPFOR plans to deliver massive amounts of accurate fire-power quickly and then exploits the results of these fires using ground forces. Fire superiority is an essential condition of victory. The principal source of achieving fire superiority is by the use of artillery. The importance attached to artillery is evidenced by the constant improvement in OPFOR indirect fire systems. OPFOR artillery battalions organic to high-readiness maneuver regiments have replaced their 122-mm howitzers with self-propelled howitzers. New types of ammunition for guns and multiple rocket launchers (MRLs) have also been procured, including improved conventional munitions (ICM), laser-guided and course-corrected shells, as well as artillery-delivered mines, jammers, and sensors. The OPFOR depends on artillery to destroy, or at least neutralize, enemy defenses.

ASSETS

OPFOR artillery assets include --

- Surface-to-surface missiles (SSMs) and free-flight rockets.
- Field artillery.
- Antitank artillery.

Motorized rifle and tank organizations from division to battalion have organic field artillery. These assets normally consist of an artillery regiment for a division, an artillery battalion for a regiment, and a mortar battery for a battalion. The same is true of the tank division except that the tank battalion has no organic artillery or mortar unit.

SSM support is concentrated in two SSM brigades at army level and one brigade at *front* level. Some divisions may receive dedicated SSM support for an operation.

A recent development has been the creation of OPFOR independent motorized rifle brigades (IMRBs). These IMRBs, which can be subordinated to an army or army corps, may have three or four motorized rifle battalions and one or two howitzer battalions.

Allocation

OPFOR regiment- and division-sized battles require artillery support exceeding the capabilities of organic artillery resources. A higher headquarters allocates artillery to a maneuver force to execute the following operations:

- *Front*, and army/army corps allocate artillery battalions according to the importance of the army and division missions.
- A division can allocate some of its organic and attached artillery to leading regiments.
- A brigade or regiment can attach artillery to leading maneuver battalions.
- The regiments in a division's second echelon normally retain their organic artillery.
- The army may temporarily attach second-echelon divisional artillery to first-echelon divisions.
- Second-echelon divisions, brigades, regiments, and battalions are not reinforced with additional artillery until they are committed.

Deployment

Two factors govern deployment, continuity and dispersion. The need for continuity of fire support leads to groups being deployed well forward to eliminate the need to relocate. Dispersion is the requirement to space batteries and battalions so that they cannot be destroyed by a single nuclear burst.

ORGANIZATION FOR COMBAT

The OPFOR forms temporary, mission-oriented groupings to ensure flexibility in concentrating artillery fire. Army, corps, division, brigade, and regimental artillery groups provide continuous artillery support to maneuver commanders, and allow the required degree of centralized control. The strength of artillery groupings depends on the mission of the supported unit, the strength of the enemy, and the importance of the axis. The guiding principle is the achievement of maximum concentration on the decisive axis. Artillery groups usually consist of a least two battalions of similar or mixed-type units: field guns, howitzers, gun-howitzers, and MRLs. A designated commander and staff provide the group's command and control. The commander and staff of the organic artillery regiment or battalion usually form the core of the group's command and control element. Figure 8-1 illustrates how the OPFOR forms artillery groups.

Army Artillery Group

The army artillery group (AAG) is formed from *front* assets allocated to an army and the army's own assets, less any decentralized to divisions. The *front* commander usually distributes *front* artillery assets to committed armies according to the

assigned tasks. An army could have 4 to 8 battalions for the army's primary counterfire mission. With closer to 4 battalions, the army would form one AAG; with closer to 8, it would probably form two AAGs. The AAG uses longer-range systems to attack deep targets such as nuclear weapons, headquarters, air defenses, and reserves.¹

Army Group of Rocket Artillery

An army would not normally allocate the MRLs from its organic rocket launcher regiment to its subordinate divisions. With these and additional rocket battalions possibly allocated to the army from the *front*-level rocket launcher brigade, the army commander would form an artillery group of rocket artillery (AGRA). The 3 to 7 artillery battalions in the AGRA do not include any SSM units. With closer to 7 battalions, the army might form 2 AGRAs. It is normally reserved to support the army's main attack axis.

Division Artillery Group

The division commander allocates artillery to form a division artillery group (DAG). The division may organize more than one DAG if necessary due to span of control, number of battalions available, and assigned missions. The DAG can vary in size from two to four battalions. With as many as 6 to 8 battalions, a division would normally form two DAGs. Its mission is to provide supporting fires for the division. The DAG assists the army with the counter-battery mission; when possible, it may perform this mission itself.

¹ An army corps would form a corps artillery group (CAG) to serve the same function, but on a smaller scale. It might comprise 4 to 6 battalions and include the corps' organic rocket launcher battalion.

Regimental Artillery Group

The regimental artillery group (RAG) provides fire support to first-echelon maneuver regiments and battalions. A RAG has artillery battalions from organic, attached, and supporting nondivisional artillery units. Normally, RAGs have two to four artillery battalions and, temporarily, the numerical designation of the supported regiment. The RAG destroys targets that hinder the advance of the attacking forces or supports the defense of the regiment. After a successful penetration, usually during the exploitation or pursuit phases, battalions of the RAG may be directly subordinated to leading maneuver battalions. In this case, the commander of the RAG is able to return the artillery battalions to central control, for example to defeat an enemy counterattack.

Brigade Artillery Group

If an independent motorized rifle brigade replaces a division in an army/army corps structure, it may form a brigade artillery group (BrAG). The two to four artillery battalions in this group provide support to first-echelon brigades and destroy targets that hinder the advance of attacking forces. The BrAG is organized and deploys similarly to a RAG.

COMMAND AND CONTROL

At regiment and above, there is an artillery officer responsible for planning and coordinating artillery fires on the staff of maneuver unit commanders. His title is chief of artillery at regiment and division level and the commander of missile troops and artillery (CMTA) at army/army corps and *front* level. This officer controls, but

does not command, the artillery units organic or attached to his maneuver unit. The commander of the organic or attached artillery unit commands and is directly responsible for the performance of his unit. At maneuver battalion level, the commander of an attached artillery subunit is the battalion commander's fire support coordinator. He advises the commander on how best to use available fire support assets.

In combat, the artillery groups form the framework for the control of artillery fires in the division. Centralized decisions govern the employment of artillery. The division commander exercises control over all organic and allocated artillery within the division. He bases his decision on the recommendations of his chief of artillery. The following procedures apply to this process--

- The division commander specifies the artillery organization for combat and the tasks for the artillery.
- The chief of artillery conducts and coordinates fire planning.
- The DAG commanders report directly to the chief of artillery.
- RAG commanders report directly to the supported maneuver regimental commander, but retain contact with the division chief of artillery.
- Artillery battery and battalion commanders keep their supported maneuver commanders informed and report to their controlling artillery headquarters.
- The chief of artillery coordinates with intelligence section and the chief of reconnaissance for targeting data.

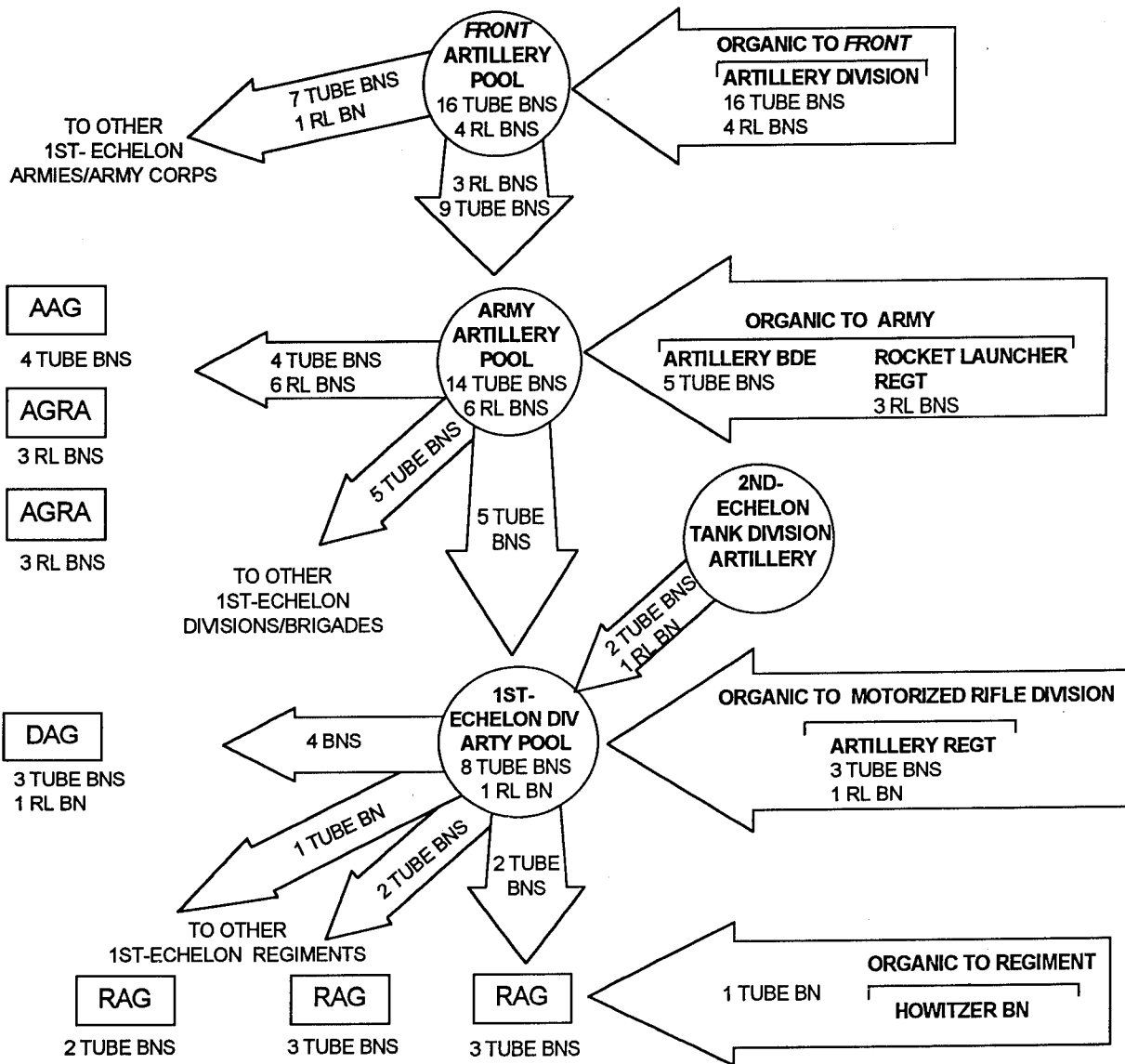

NOTES:

1. The distribution of artillery battalions shown above is only an example. Actual allocation patterns depend on the situation and the mission of the receiving organization.
2. Higher command may allocate a *front* one or more artillery divisions with 20 battalions of field guns, gun-howitzers, howitzers, and rocket launchers. It may also allocate a high-powered artillery brigade (not shown here).
3. The army in this example is in the *front's* main attack, and the motorized rifle division is in the army's main attack.
4. It is not necessary that all 2d-echelon divisions give up artillery assets to reinforce 1st-echelon divisions. This is only an option the army/army corps commander could use.
5. The regimental artillery is part of the RAG. An artillery battalion or battery in the RAG may also be temporarily subordinated to maneuver battalions for specific missions.

Figure 8-1. Formation of artillery groups (example).

Command Relationships

The maneuver commander has operational control of an attached artillery battalion or battery. The parent artillery organization retains control of a supporting artillery battalion or battery. It delegates its fires to a particular maneuver force.

Attached

The division commander may attach an artillery battalion to a first-echelon maneuver battalion during a penetration, deep attack, meeting engagement, or some defensive actions. The maneuver battalion commander gives orders to an attached artillery battalion. He can allocate batteries to support his maneuver companies. He may assign missions to the artillery units during critical times: when they accompany the advance guard or forward detachment; when they penetrate enemy defenses; when they support the commitment of second-echelon forces; or, when they repel a counterattack. If designated as attached, the artillery battalion no longer belongs to an artillery group. This artillery battalion may support both the maneuver battalion and regiment.

Supporting

A supporting battalion remains subordinate to the parent artillery unit or the artillery group. If a battalion in the RAG has no regimental missions, it can fire missions for the battalion that it supports. The maneuver battalion commander cannot task its batteries separately to support his subordinate companies, even though supporting and supported commanders may be colocated. A supporting artillery battalion carries out missions for the maneuver battalion only if the artillery group commander permits or specifically directs the action.

Fire Plans

The fire plan of an attached battalion reflects the specific support of the battalion to which it is attached. The fire plan of a supporting battalion reflects the tasks of the parent maneuver force and its artillery group. The senior commander allocating the artillery can change the mission of attached or supporting artillery during the course of combat. The period of attachment normally covers the time needed to accomplish a particular tactical mission. This period could vary from a matter of hours to several days.

Coordination and Communications

The artillery commander colocates near the commander of the maneuver unit he supports and usually has face-to-face **coordination**. He can also enter the command net of the supported unit. Artillery commanders retain rigid control of the deployment of weapons and observation posts, except when subunits have special missions. This allows them to provide continuous artillery support in all phases of combat.

Radio and wire are the primary means of **OPFOR communication**. OPFOR artillery units also use messengers, visual, and sound devices. Senior and supporting units establish communications to subordinate and supported units. Radio is the primary means in fluid combat situations. Wire is a backup mode and is especially important in static combat. The OPFOR uses wire communications whenever subunits remain in one location for any length of time; normally in assembly areas or defensive positions. To provide redundancy, artillery wire nets parallel the wire nets of the supported units.

FIRE CONTROL

The OPFOR uses an extensive system of observation posts (OPs) to provide fire support to the maneuver forces. These OPs are mobile in order to accompany rapidly moving forces. They may be wheeled, tracked, or in the air. The configuration depends upon the level of command and the type of units. The most important types of OPs are discussed below.

Command Observation Posts

The command observation post (COP) serves as both an OP and command post (CP). Since the battalion is regarded as the basic fire unit, its COP is the place where decisions are made and from which orders stem. The artillery commander locates the COP to observe his zone or sector of fire. From it, he studies the target area and terrain, follows the progress of friendly forces, and directs or coordinates artillery fires. In most cases, the artillery commander collocates his COP with the forward CPs of the supported maneuver unit commander.

The COP normally contains the artillery commander, and fire direction, communications, and reconnaissance personnel. Both battalions and batteries have fire direction centers (FDCs) at the firing position. The COP and the FDC conduct fire direction computations simultaneously. Often, the succession of command is COP, FDC, and then per order or SOP. The COPs and FDCs are mounted in tracked or wheeled **artillery command and reconnaissance vehicles (ACRVs)** which are equipped with--

- Day/night observation and range-finding equipment.
- Topographic survey equipment.
- Artillery fire direction computer equipment (manual and electronic).

- Communications equipment.

Forward Observation Posts

Artillery commanders can establish one or more forward observation posts (FOPs) to supplement the COP. At the battery and battalion levels, the FOPs contain the intelligence officer (or headquarters platoon leader), a scout, and a radio man. An FOP may be with the supported unit commander or with one of the advance maneuver elements. The FOP assures continuous close fire support for the maneuver forces when the COP is displacing. The FOP will usually be mounted in a tracked **mobile reconnaissance post (MRP)** vehicle which has a battlefield surveillance radar as well as observation and rangefinding equipment. In the offense, the MRP may advance closely behind or within lead motorized rifle or tank subunits. They conduct reconnaissance and fire missions on the move or during short halts. During a march, MRPs move as part of an artillery reconnaissance patrol in the forward security element of the supported motorized rifle or tank unit. This single vehicle can perform reconnaissance and adjust artillery fire on targets while located with these units. In the defense, MRPs may form part of the combat outposts in the forward security zone.

Lateral Observation Posts

The artillery commander may establish a lateral observation post (LOP) in order to cover areas not observable from the command and forward observation posts. At battalion level and higher artillery echelons, the LOP accurately locates targets, reference and registration points, and can adjust fire. The LOP is usually on the flank of the supported unit and should have a good view of the artillery subunit's zone of responsibility.

The artillery subunit or the division's artillery regiment may send reconnaissance and communication personnel to form the LOP.

Dummy Observation Posts

The OPFOR uses a dummy OP to confuse the enemy about the actual position of the COP. After the commander establishes a functional COP, scout observers construct a dummy COP. Dummy OPs simulate radio antennas and other equipment to give the impression the position is occupied. They normally have applications only in static situations.

RECONNAISSANCE AND TARGET ACQUISITION

Artillery reconnaissance patrols have the primary mission of locating enemy artillery units. The patrols can also set up OPs behind enemy lines to adjust artillery fire and to report on enemy organization and deployment. Other OPs and stations send intelligence data to the COP. The commander determines if they are to be engaged and if so the COP relays them to the firing position.

The artillery regiment of the OPFOR MRD and TD has an organic artillery sound-ranging and radar reconnaissance battery. This battery provides the bulk of the division's artillery intelligence. The battery subunits include the--

- Sound-ranging platoon.
- Radar reconnaissance platoon (with a countermortar/counterbattery section and two surveillance radar sections.
- Topographic survey platoon.

EQUIPMENT & AMMUNITION

OPFOR field artillery consists of

mortars, howitzers, field guns, gun-howitzers, and MRLs. Formerly, a majority of OPFOR field artillery was towed with the exception of its MRLs, which are primarily truck-mounted. Towed guns are lightweight, low-cost, simple, and extremely mobile on hard surfaces. Their disadvantages are a lack of cross-country mobility and no gun crew protection against nuclear, chemical, or conventional counterbattery strikes. The OPFOR will continue to employ towed weapons, especially in nondivisional artillery units, but its current emphasis is on acquiring self-propelled artillery systems.

Howitzers

Tracked, self-propelled howitzers greatly enhance the OPFOR's ability to provide continuous support to motorized rifle and tank regiments. The OPFOR's cross-country mobility and speed allows it to keep pace with combined arms operations. These self-propelled howitzers do have ammunition resupply limitations because they depend on wheeled vehicles for logistics support.

Multiple Rocket Launchers

The OPFOR uses MRLs to deliver strikes at decisive moments in battle. The MRL is an excellent area coverage weapon, and its rapid ripple fire is an excellent delivery system for chemical agents, high explosives (HE), submunitions, fuel-air explosives, smoke, and scatterable mines.

Mortars

Each motorized rifle battalion also has an organic 120-mm or 82-mm mortar battery. These indirect fire support weapons help the regiment to maintain fire superiority.

Ammunition Types

OPFOR of conventional shells are HE, fragmentation, and fragmentation-HE. They are the standard projectiles for all howitzers and guns. The OPFOR uses HE shells to destroy fortifications and fragmentation shells against personnel and equipment in the open. Fragmentation-HE shells have fuses for either instantaneous or delayed detonation. A time fuse is available for air-burst effects. Special ammunition includes--

- Nuclear and high-precision.
- Chemical.
- Antitank.
- Smoke.
- Illuminating.
- Concrete-piercing.
- Rocket-assisted projectile (RAP).
- Scatterable mines.
- Improved conventional munitions (ICM).
- Flechettes.

Unit of Fire

The **unit of fire** is a fixed number of rounds per weapon, or weapon system, for planning and accounting purposes. It is not an authorized allowance or a daily expenditure rate; nor is it similar to the U.S. basic load. Unit of fire is the basic factor to plan ammunition requirements in each action.

Ammunition distribution and stockage also have units of fire as a basis of measurement.

TACTICAL DEPLOYMENT

On the basis of the fire plan, artillery deploys to provide preparatory fires and the initial fire support of the attack. Table 8-2 provides tactical deployment guidelines for OPFOR artillery.

Artillery Battalion

Battalion firing positions normally are a large triangle with three batteries dispersed to each of the three points of the triangle. Figure 8-3 shows an example of a standard artillery battalion combat formation. Batteries in the battalion area locate 500 to 1500 meters apart with a 20 to 50 meter interval between guns. The triangle forms a forward or reverse wedge pointed toward or away from the enemy. The battalion chief of staff operates the battalion fire direction center (FDC) which is inside the triangle of batteries and located 300 to 500 meters from one of the batteries.

The artillery battalion commander can select the battery firing location, but it is normally the responsibility of the battery commander. Both consider local factors in

DISTANCES	MORTARS	GUNS AND HOWITZERS	MRLs
Between weapons	20-50 meters	20-50 meters	50-60 meters
Between batteries	-----	500-1500 meters	1000-2000 meters
From the forward edge of enemy defenses	500-1000 meters	3-6 km (DAG) 1-4 km (RAG, BrAG) 4-8 km (AAG)	3-6 km (DAG) 4-8 km (AGRA)

Figure 8-2. Tactical deployment guidelines for OPFOR artillery.

concealing firing positions: wooded areas, foothills, and thickets. The OPFOR conceals the entrance to, and exit from, all gun positions as much as possible. For an unconcealed or open gun position, the battery must have enough range to accomplish a direct fire mission at the weapons' maximum effective direct fire range. The battery senior officer/gun position officers select individual fire positions. The fire position affords cover for the gun crews and their ammunition; and it should have interlocking fires with adjacent weapons.

An artillery battalion utilizes primary, alternate, and temporary gun positions in the offense. The temporary position enables the artillery unit to accomplish short-term or emergency missions. Such missions may include roving fire support or defending a forward position. The defense requires primary, alternate, temporary, and dummy locations.

Artillery Battery

Because of the increased mobility of self-propelled artillery, the OPFOR moves artillery batteries, platoons, and individual guns within an assigned firing position area to escape enemy counterbattery fire. Within his assigned area, the battery commander selects a primary position and one or more alternate or secondary firing positions. Each position is at least 500 meters away from the previous position. The battery/platoon fires a mission of three to four minutes duration and then moves to a secondary position. This technique is used during a long offensive preparation or in the defense when forward or rearward movement is limited.

Figure 8-4 is an example of a howitzer battery deployment in standard for-

mation. The battery often forms a straight line with equal intervals between guns. This pattern of deployment reduces emplacement/displacement time. It also simplifies the computation procedures required for battery fire missions. The reduced computation and mission time enable batteries to complete missions and relocate more quickly. This lessens their exposure to enemy fire and compensates for the vulnerability inherent in the formation. The senior officer of the battery operates the battery FDC which is centered 100 to 200 meters behind the line of artillery weapons.

OPFOR artillery uses formations that vary the interval between guns and disperse the guns in depth with the aid of electronic field artillery computers. Figures 8-5 and 8-6 give some examples of the variants a battery might use. Even with computers, the OPFOR may retain the linear formation for speed and simplicity. Its goal is to reduce the time that a firing battery remains in position after the first round fires. Given the tempo of operations, OPFOR artillerymen must now deliver effective fire from emergency positions without firing a registration. Under these conditions and with redundant artillery assets, the linear deployment retains its utility and attractiveness to artillery commanders.

Battery firing positions consist of two firing platoons of three guns each. The platoons may be separated a few hundred meters for greater survivability. Each platoon has a platoon headquarters and three gun sections. The platoon leader of the first firing platoon is the senior firing position officer. The battery commander is normally at the COP with the supported unit commander.

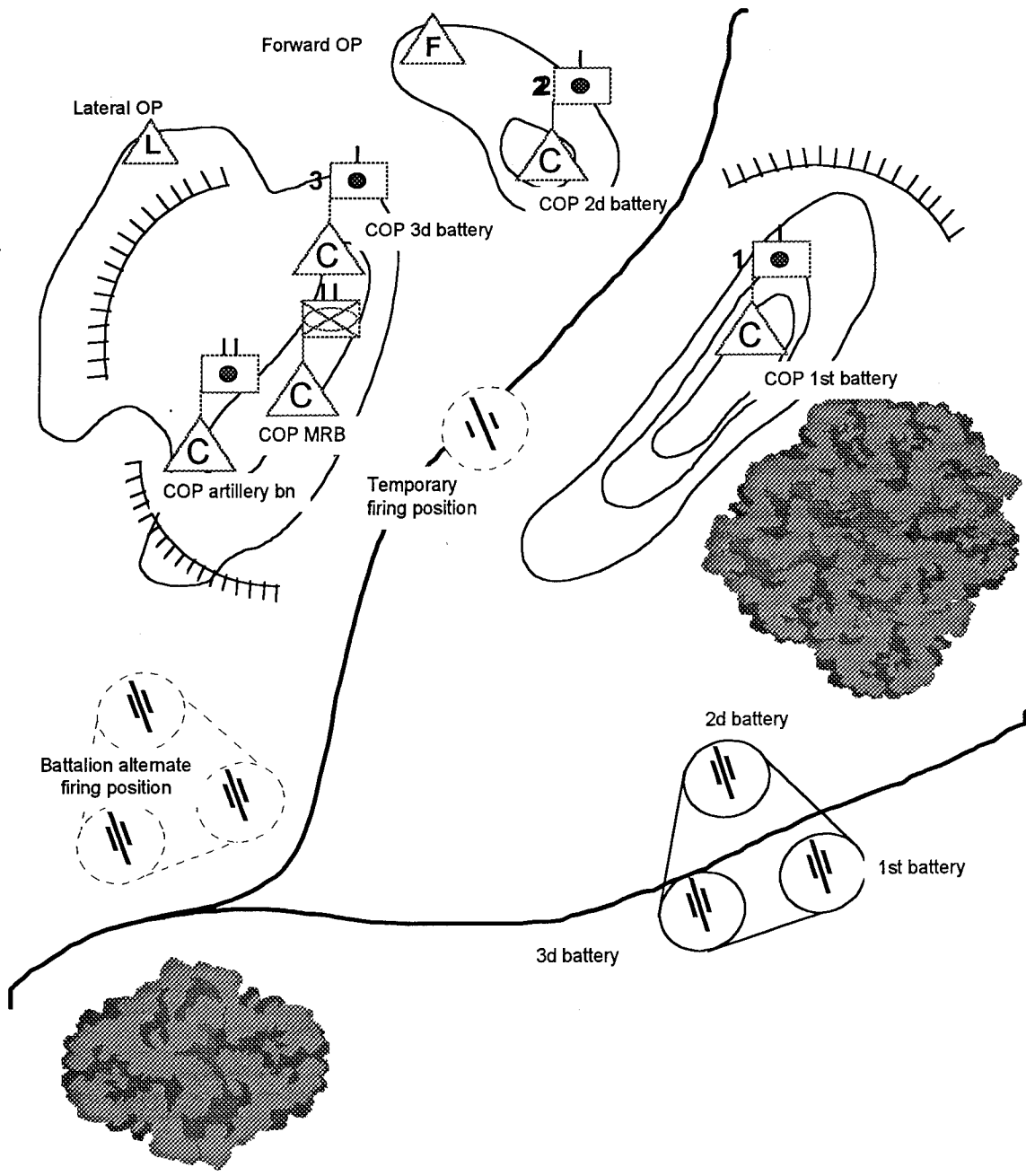

Figure 8-3. Artillery battalion combat formation.

Multiple Rocket Launchers

The multiple rocket launcher (MRL) places heavy fire on important targets at decisive moments in a battle. The OPFOR also employs MRLs in roving gun missions and counterattacks. Rocket launcher (RL) batteries move forward 1 to 5 kilometers from their camouflaged positions to occupy fire

areas to support operations. The launchers usually remain loaded, and one or more ammunition trucks accompany each one to these fire areas. To evade counterbattery fire, rocket launchers normally move to either a camouflaged position or to a new fire area immediately after firing. Figure 8-7 illustrates a typical RL battery deployment.

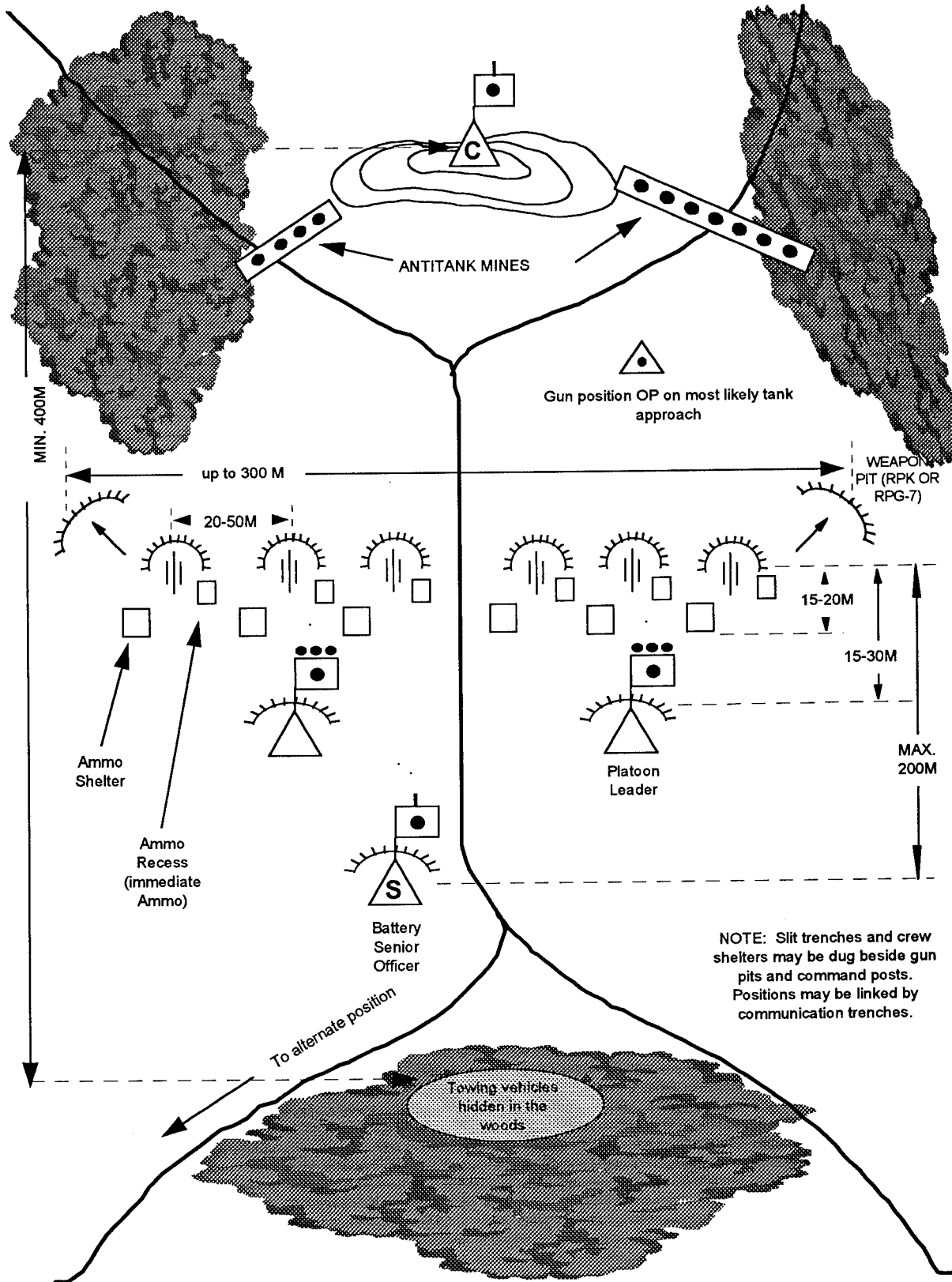

Figure 8-4. Howitzer battery deployment (standard formation).

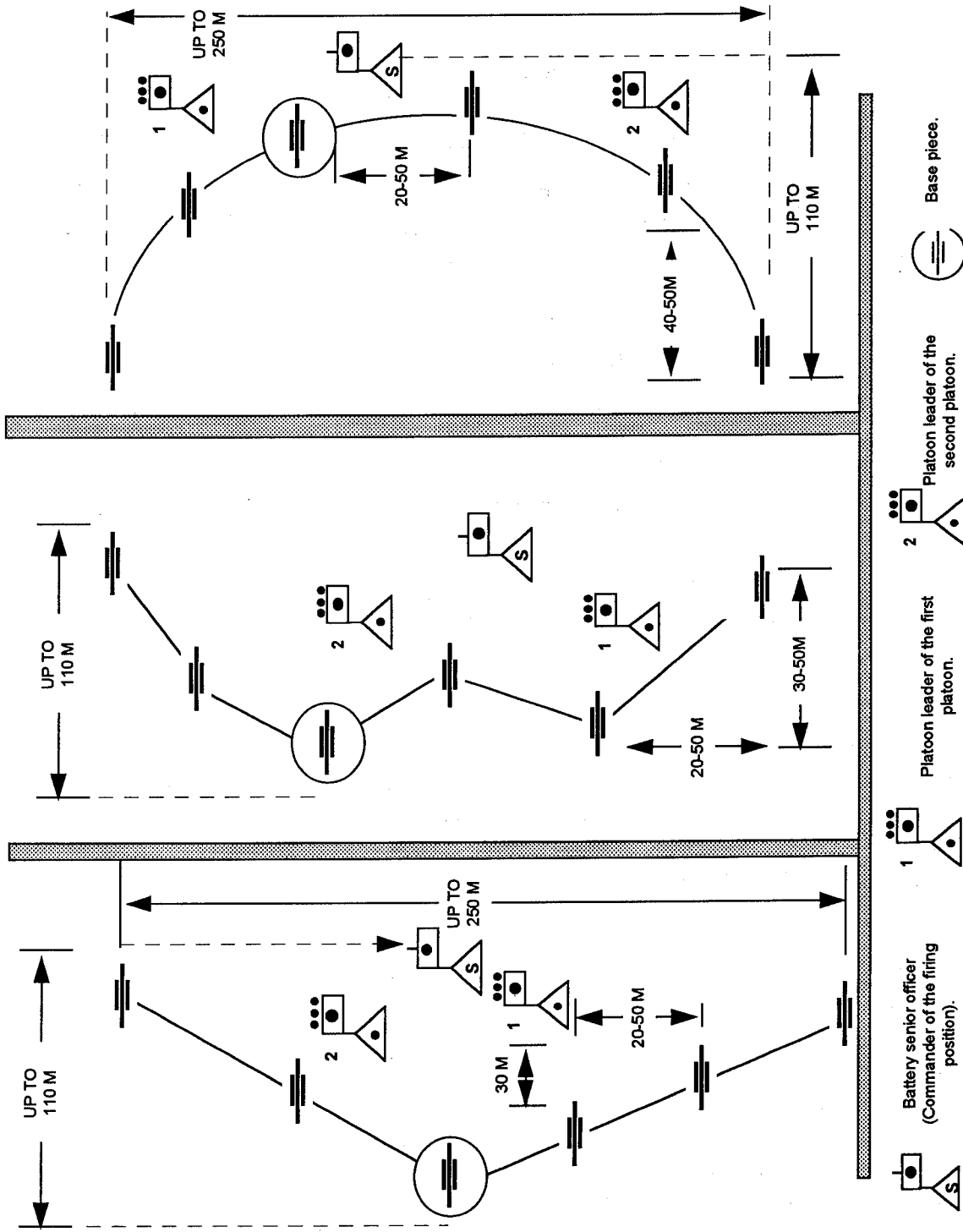

Figure 8-5. Deployment of a howitzer battery (variants).

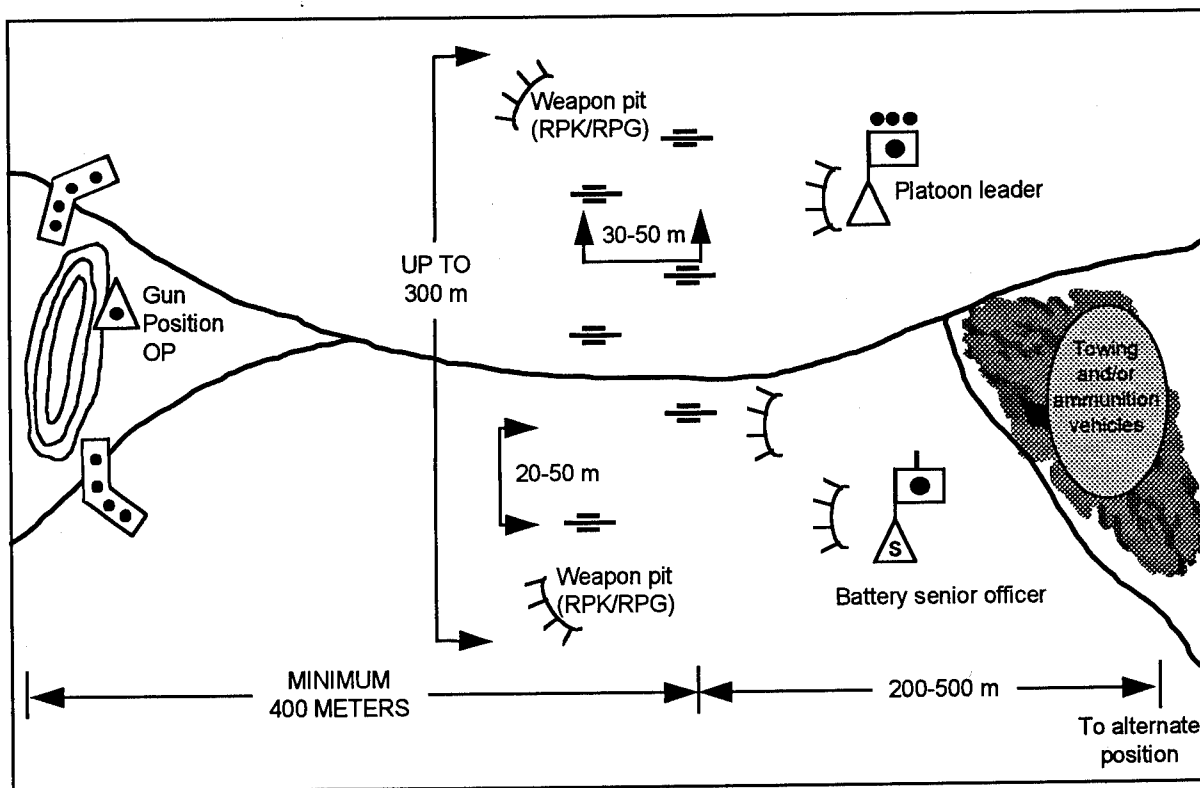

Figure 8-6. Variant of artillery battery firing position.

METHODS OF FIRE

The OPFOR uses various types of fires on the enemy. The methods of fire it employs can have different purposes in the offense and defense, and it can also conduct different types of fire for both. An OPFOR fire planner selects methods based upon desired coverage, effects, and fire density. The following section defines types of fire and methods the OPFOR employs.

Rapid Fire

Rapid fire is a method to conduct artillery fire by firing the weapon as quickly as possible. The weapon does not exceed its maximum rate of fire or sacrifice accuracy. When the commander orders rapid fire, each individual weapon crew begins to fire independently when ready.

Systematic Fire

Systematic fire is a method that fires every round, or salvo, on command at a set interval. The OPFOR uses this method for firing on observed targets during registration or when the unit is firing a destruction mission. The OPFOR also uses systematic fire against unobserved targets under the following circumstances:

- In the course of fire assaults of a given duration.
- During controlling fire.
- During harassing fire, usually alternating with rapid fire.

The tempo of systematic fire against observed targets depends on the capabilities and equipment of the observer. The time allotted for the expenditure of an amount of

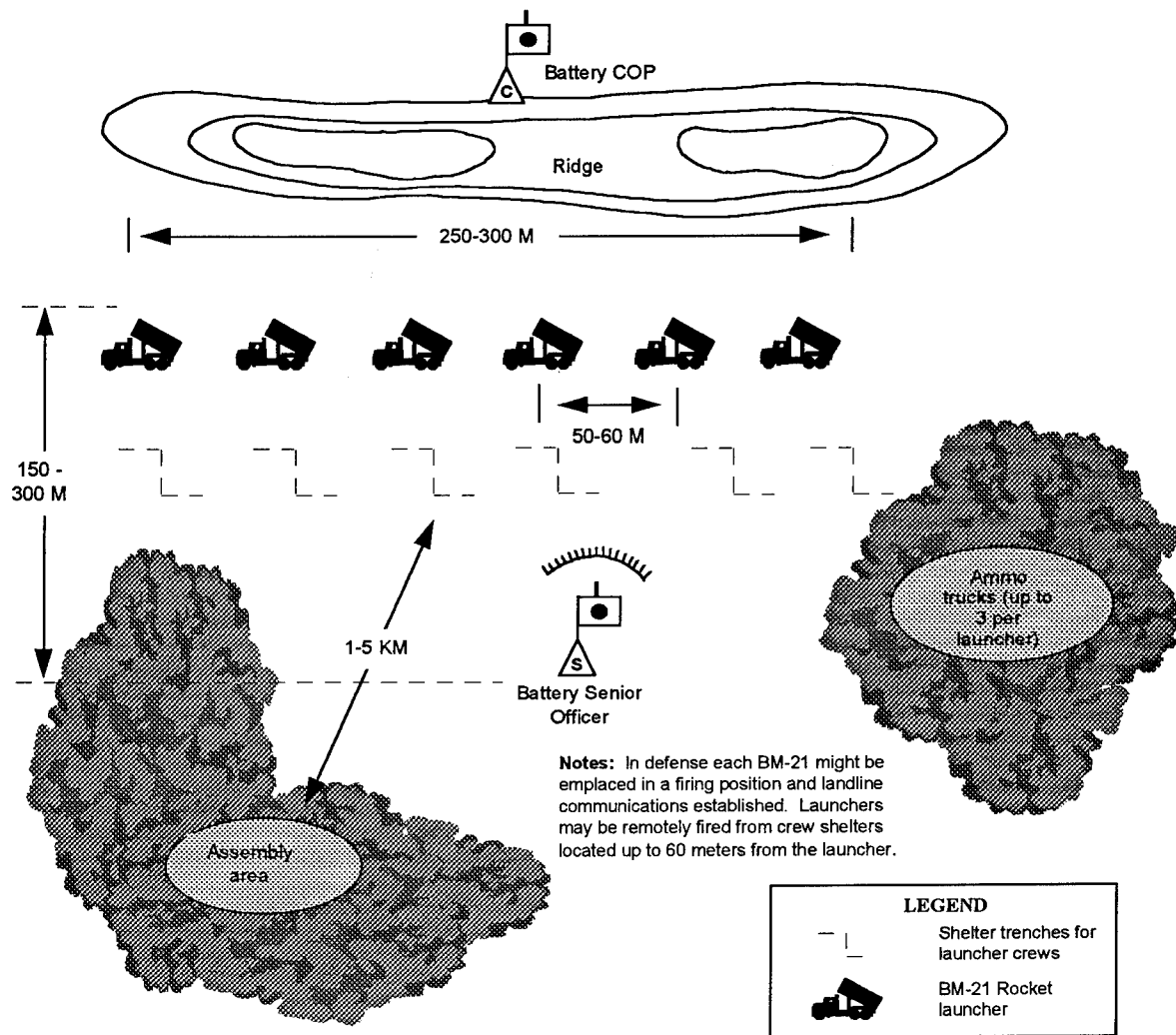

Figure 8-7. Rocket launcher battery deployment.

ammunition determines the tempo of fire against an unobserved target. The tempo of systematic fire is constant during a fire assault, but harassing fire may have an intermittent tempo. A single weapon, a firing platoon, or an entire battery may fire systematic fire. On receiving the mission, the firing unit also receives a rate of fire and an ammunition expenditure requirement.

Counterbattery Fire

Counterbattery fire accomplishes the annihilation and/or neutralization of enemy artillery batteries. Combat with enemy art-

illery is one of the OPFOR's most important missions as it enables the OPFOR to achieve fire superiority on the battlefield. Combat with enemy artillery now requires more than counterbattery fire. It requires the destruction of the enemy command and control centers as well as his artillery. To be effective, it also requires the cooperation of the other combat arms and combat aviation.

Maneuver by Fire

Maneuver by fire occurs when a unit shifts fire from one target, or group of tar

gets, to another without changing firing positions. This is a combined arms concept in which the artillery plays a critical role. Maneuver by fire masses fires on the most important enemy objectives and troop formations. Its goal is to destroy the enemy in a short period of time or to redistribute fires to destroy several targets simultaneously. The method also may shift the main combat effort from one direction to another.

In the offense, maneuver by fire in the depth of the enemy's defenses--

- Suppresses enemy strongpoints.
- Repulses counterattacks.
- Covers the attacking unit's with protective fires.

In the defense, maneuver by fire --

- Destroys the enemy as he deploys to attack.
- Repulses the attack.
- Supports a counterattack force.
- Protects gaps in the defenses.
- Seals off enemy penetrations.

Wide use of maneuver by fire helps the defending commander achieve fire superiority at the critical time in decisive sectors. The defensive fire plan normally includes plans for maneuver. In such planning, artillery units have several supplementary assigned sectors of fire. These sectors cover areas along the supported unit's flanks and the gaps between units.

Fire with Direct Aiming

This type of fire is often confused with "direct fire." The gunner of the artillery weapon can aim the piece using direct visual contact with the target. An artillery gunner who can sight directly on the target will usually engage it with direct fire. Because of the target's range or characteristics of the

weapon, he may instead engage it with indirect fire. A mortar crew, for example, could sight directly on a target but has to engage it with indirect fire.

OFFENSIVE FIRES

The OPFOR plans offensive fires to support the attack and complete the destruction of the enemy. Discussion of the types of OPFOR offensive fire follows.

Fire Assault

Surprise and a high density of fire on the target characterize the offensive fire assault. It consists of several batteries or battalions firing against an individual target. Fire assaults are the major subelements of an artillery preparation for an attack. All, or at least the larger part of, the artillery of a division or army carry out these assaults simultaneously on a large group of targets. Fire assaults may annihilate or neutralize targets. Factors determining the number of fire assaults on a target are--

- The area/nature of the target to be destroyed.
- The number of rounds allocated for its annihilation/ neutralization.
- The range to the target.
- The number of tubes available.
- The types of ammunition available.
- The time required for artillery to prepare and expend the rounds allocated.

The tactical situation and the maximum rate of fire of the weapons firing the mission determines the duration of the fire assault. A fire assault of a given duration typically begins with rapid fire of two to four rounds per weapon. After one minute, it continues a deliberate fire at a rate that uses the allocated ammunition in the time allotted

for the mission. To destroy a target in the shortest possible time, the OPFOR does not fix the duration of the assault. It conducts the mission at rapid fire until it expends the allocated ammunition.

Controlling Fire

OPFOR artillery directs controlling fire at an enemy target in the intervals between fire assaults on the same target. Controlling fire denies the enemy the freedom to conduct combat activity and prevents escape before the next fire assault. The planner uses this method when the interval between fire assaults exceeds 15 minutes. A single battery usually conducts this fire at a systematic rate of fire, rapid fire, or a combination of the two. This ensures a smooth transition for supporting fires.

Fire Concentration

Several batteries or battalions may simultaneously conduct a fire concentration against a common target. The dimensions of the fire concentration target area depend on the fire mission and the firepower of the artillery subunit firing the mission. Batteries and battalions conduct fire concentrations with all weapons firing at once on the center of the target area. All weapons may fire on the same elevation and deflection settings, or some units may use different settings. This depends on factors such as target disposition and whether the target is observed.

Massed Fire

OPFOR artillery masses fire against an enemy objective with all or most of a given formation's artillery, with the goal of destroying it in the shortest possible time. This massed fire can be one large fire concentration or several large fire concentrations

fired simultaneously. Before conducting massed fire, target areas are assigned to each firing unit. If the dimensions of the target area do not exceed 800 by 800 meters, all participating artillery groups fire simultaneously on the center of the target area, applying the principles used for fire concentrations. If the target area is larger than 800 by 800 meters, the target has subdivisions of numbered targets or target sectors. The fire planners designate targets or target sectors to the assigned artillery groups or subunits to annihilate or neutralize with fire concentrations. The artillery units fire the mission simultaneously to the extent possible.

Successive Fire Concentrations

OPFOR artillery fires successive fire concentrations in the attack when the supported maneuver unit begins the final assault on enemy defensive positions. Figure 8-8 shows an example of a successive fire concentration. The artillery fires concentrations for the successive neutralization or annihilation of specific targets, or target groupings deployed to the front and on the flanks of attacking troops. Successive fire concentrations primarily support the offense, but can support counterattacks in the defense. Successive fire concentrations may be fired on one, two or three lines simultaneously. In a single successive fire concentration, an artillery unit fires initially on the single line of targets closest to the attacking troops. It shifts the single fire concentration to progressively deeper lines or groups of enemy targets as the supported attacking troops advance. The principal weight of fire concentrates on neutralizing the enemy's forward defensive positions.

A double successive fire concentration requires two elements of an artillery group to fire simultaneously. The first ele

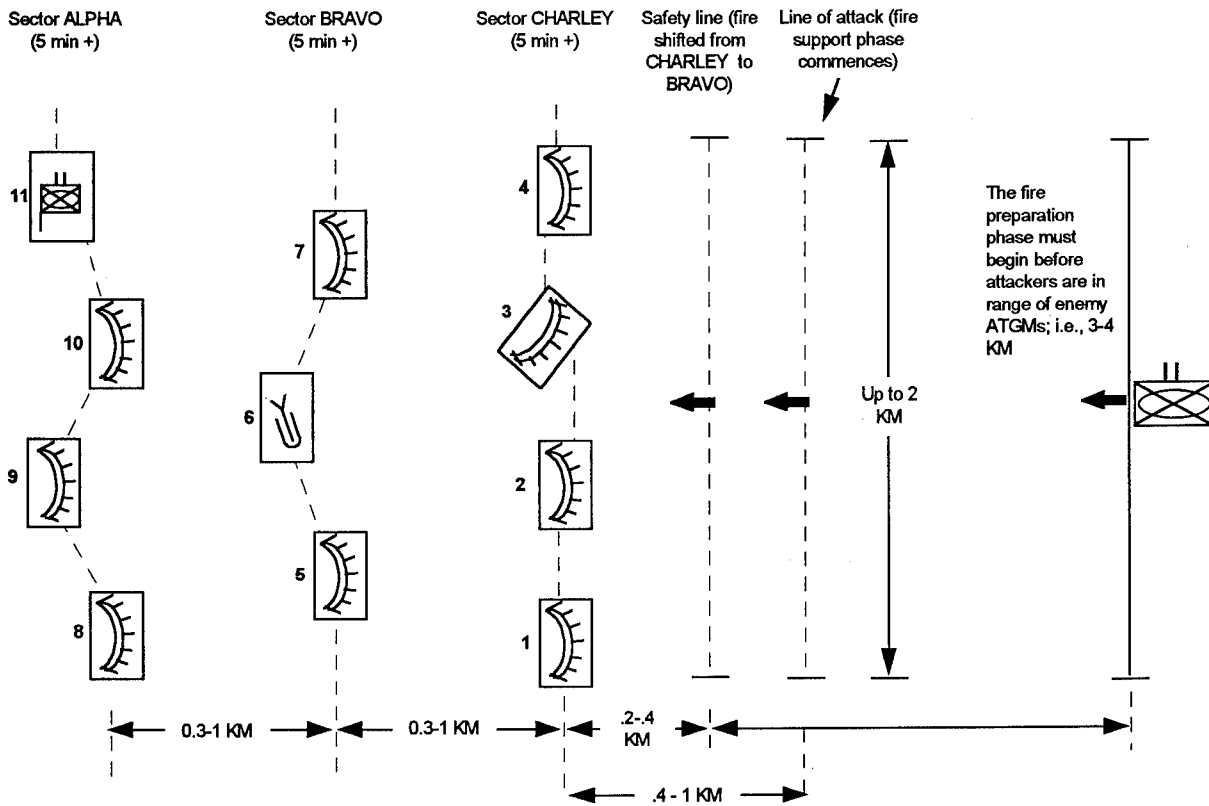

NOTES:

1. Up to one artillery battalion may engage an average target size 200 X 300 meters.
2. Preparatory fire has engaged targets.

Figure 8-8. Successive fire concentrations.

ment fires on the line of targets closest to the supported attacking troops. The second element fires on the next line of targets. The first group then shifts its fires from the first line of concentration to the second line. The second group shifts its fires from the second line to the third and so on. In a double successive fire concentration every line of targets, except the first, receives fire twice.

The first line of concentration covers the defender's forward positions. Subsequent lines of concentration are 300 to 1,000 meters apart through the depth of the enemy's defenses. On each successive fire concentration, the fire planner assigns concen-

tration sectors to every battalion or battery firing the mission. Attacking troops normally deploy into a battle formation at the line of attack. Here, preparatory fires become supporting fires. The time required for troops to travel from here to the troop safety line is important as it determines the duration of fire on the initial line of targets (concentrations).

The maneuver commander signals initiation of this fire when the ground assault begins. The supported maneuver regiment or battalion commander gives a signal to shift fire to each subsequent line of concentration. The OPFOR can also use fire sup

port helicopters attacking beneath the trajectories of artillery rounds during these concentrations.

Rolling Barrage

The support phase of the attack uses the rolling barrage. The rolling barrage is a continuous curtain of fire. It shifts fires from one phase line to another in front of attacking troops. Like the successive fire concentration, it may be fired against a single line or against two lines simultaneously. The supported maneuver commander orders the fires to shift to support the advance. The rolling barrage differs from the successive fire concentration in that it assumes a uniform distribution of targets throughout the target area. It then shifts fire between uniformly spaced phase lines while the successive fire concentration focuses on targets that require concentrated fires. The rolling barrage may have a fire concentration superimposed to ensure the destruction of the most important targets.

In the rolling barrage, phase lines are planned every 400 to 800 meters. The spacing depends on the density of targets in the target area. Planned intermediate phase lines are every 100 to 300 meters. Artillery units will fire on each phase line for at least five minutes at a rate of four to six rounds per 100 meters per minute. They fire on each intermediate line for one to two minutes at the same rate. A rolling barrage has battalion and battery sectors with standard widths as outlined in Figure 8-9.

The division, brigade, or regimental commander gives the order to shift from a phase line. Fires shift automatically from intermediate lines in accordance with a timed firing program. The depth of a rolling barrage depends on the nature of the enemy's defenses, the attack plan, and the availability of artillery and ammunition. Normally, there is a rolling barrage through the depth of the defenses of the enemy's first-echelon battalions. The rolling barrage requires a great deal of ammunition and is not, therefore, the most likely method of offensive fire.

DEFENSIVE FIRES

The OPFOR plans defensive fires to disrupt the enemy's attack. **Barrier fires** are the primary type of OPFOR defensive fires. Barrier fire is a continuous curtain of defensive fire across the approach of attacking enemy forces. Although normally used in the defense, it also has applications in offensive operations against enemy counterattacks. Barrier fire is useful with fire concentrations, massed fires, and directly aimed fire from tanks and guns. The types of barrier fire are--

- Standing barrier fire.
- Rolling barrier fire.

Standing Barrier Fire

Standing barrier fire uses a single line of concentration to disrupt an enemy attack.

TYPE OF WEAPON	WIDTHS (in meters)		
	per Weapon	per Battery	per Battalion
Field guns	20-25	150	450
Howitzers	35	200	600-650

Figure 8-9. Sector widths for rolling barrage.

The OPFOR plans standing barrier fires well in advance. It projects artillery fires for likely tank avenues of approach. A ground observation point observes these fires planned in front of, and to the flanks of, the defensive positions. All the artillery in a formation except MRLs fires the standing barrier fire. The fire planner assigns each battalion or battery a sector on the line of fire concentration. The width of each unit's sector is computed based on no more than 50 meters of coverage per gun (howitzer) or mortar.

The line of concentration for the standing barrier fire must be no closer than 300 to 400 meters from friendly troops for safety. This allows gunners to fire antitank weapons in direct fire at enemy tanks and armored vehicles as they come through the barrier fires. Standing barrier fires begin when enemy tanks and infantry approach the planned line of fire concentration. The fires continue at rapid fire until they cut off enemy infantry from their tanks and halt their attack. If the enemy maneuvers around the fire concentration line, the fires shift to the new approach.

Rolling Barrier Fire

Rolling barrier fire lands on several lines of concentration. Each line lies successively closer to OPFOR defending troops. Lines of concentration for the rolling barrier fire should impact on terrain that a ground observation point can see. Distances between lines of fire concentration will be 400 to 600 meters or more. The final line of concentration closest to friendly troops will be 700 to 1000 meters from forward defensive positions. The fire planner assigns every battalion or battery participating in the fire mission a sector of fire on each of the lines of fire concentration. He bases the width of

each sector on 25 meters of coverage for each gun (howitzer) or mortar.

Each individual line of concentration has a number in sequence, beginning with the one farthest from the defensive positions. The rolling barrier fire begins the moment the lead tanks or armored vehicles approach the initial line of fire concentration. The fire continues on that line until the bulk of the advancing force has moved out of the zone where rounds impact. Then the fire shifts to the next line of concentration. Fires continue to shift until surviving enemy armored vehicles or tanks have passed through the last line of concentration.

CONDUCT OF FIRE

To achieve surprise and to increase effectiveness of fires, OPFOR artillery tries to be short but violent in the offense and more prolonged in the defense. The fires delivered are massive and concentrated on critical points in the offense and more dispersed, but still concentrated on the enemy, in the defense. This requires not only a numerical superiority in artillery pieces but also rapid fire, long range, and mobility. Above all, the OPFOR stresses the importance of thoroughly integrated fire and maneuver plans.

The regimental artillery battalion provides the flexibility and responsiveness required in a fluid combat situation. Numerous longer-range tube artillery and rocket launcher battalions from division, army/army corps, and *front* provide massive reinforcing fires when required. The OPFOR seeks to achieve the densities of fire that it believes necessary without sacrificing the mobility that artillery units need to survive and to perform their mission on the modern battlefield.

Movement

In planning deployment of its units, OPFOR artillery commanders follow the "rule of a third." When only a third of the maximum range of their artillery remains in front of the attacking OPFOR troops, they move a third of their force forward. Once redeployment starts, no more than a third of the available guns is moving at any one time. This leaves two-thirds of the artillery in position to support operations. Redeployment is by **battalions** whenever possible; with a typical bound being 5 to 10 km long.

In the offensive, an artillery battalion leapfrogs its **batteries** forward individually in bounds of some 3 to 4 kilometers. By day, it takes a towed howitzer battery about 35 minutes to move, from receipt of the movement order until it is ready to fire the first round in its new position. At night, the same move requires about 45 minutes. On the average, a self-propelled battery requires up to 10 minutes and a towed artillery battalion up to 12 minutes to leave a location and move out into a march column.

The senior commander determines the length of a day's march column and the average speed. An artillery march column has 25 to 50 meter intervals between vehicles and 100 meters between batteries. An artillery battalion occupies 1.5 to 2.5 km of road space, depending on vehicle spacing. At

night a column of tracked and wheeled vehicles can move at a speed of up to 25 kilometers per hour. During the day the column has an average speed of 25 to 30 kilometers per hour.

Firing Procedures

Electronic fire direction computers enable fire direction personnel to make numerous time-consuming corrections in elevation and deflection more quickly. They can do this for each firing platoon and possibly for each weapon during these frequent moves. Table 8-10 gives the average reaction times from receipt of fire orders to first rounds on the ground (on preplanned targets).

The command "to battle" conveys the same urgency in an OPFOR firing battery as the command fire mission does in a U.S. firing battery. The individual steps to fire on the target, however, differ significantly. The battery commander in the COP chooses the targets of opportunity for firing. He also decides how to attack the targets relayed to him by the maneuver forces he is supporting.

Firing Data

There are four individuals responsible for the preparation of firing data:

- The battery commander.

UNIT	TIME (in minutes)
Mortar battery	1 to 1.5
Artillery battalion	2 to 3
Rocket launcher battery	4
RAG	4
DAG	5

Figure 8-10. Reaction times.

- The battalion chief of staff.
- The computer located in the COP.
- The computer located in the firing position.

The battalion chief of staff computes the firing data as does the computer (a staff member, with or without an electronic computer) positioned in the firing position. The senior officer in the firing battery relays the data to the gun platoons and the gunners set the data on the gun in preparation to fire. The battery commander and the computer in the COP also solve the gunnery problem, providing a separate check on the data supplied by the firing battery computer. If for some reason the data from the COP is ready before that of the firing positions, the battery commander transmits his data directly to the firing position.

If a difference exists between the firing data supplied by the two computers, the battery commander decides which to fire. This system demands that the battery commander be as proficient in computing gunnery problems as the computers. The OPFOR feels the independent computation of each gunnery problem by four different individuals significantly reduces the chances for a large error. This technique also ensures that a fire direction system is readily available if either the fire direction capability at the COP or the firing position is destroyed or suppressed.

When the artillery battalion controls the conduct of fire, it conducts the observation, computation, and firing similar to battery level. The battalion commander is at the battalion COP near the CP of the supported commander. Target acquisition and fire direction computation personnel assist him in acquiring targets, computing fire missions, and adjusting fire. Normally the battalion

chief of staff is in charge of the battalion firing position and the battalion FDC. Depending on the type of mission, battalion dispersion, and time available, battalion fire direction personnel may compute the gunnery problem for the entire battalion or run check computations while each battery computes its own data. The battalion commander gives the order to fire. He can require each battery commander to adjust fire for his own unit by weapon or by battery salvos.

Forward ground or air observation posts supplement battery and battalion COPs. Observation teams can locate forward in armored vehicles. Forward and air observers transmit target data to the battalion chief of staff, at the battalion FDC, for computation.

The OPFOR also integrates electronic computers into its field artillery battalions to exploit this new capability for firing procedures. The battalion probably still has centralized control of fire mission computation and fire control. It can give battery fire direction personnel fully computed data that is ready to pass to the guns. Centralizing electronic computation at battalion level is consistent with establishing the battalion as the basic firing unit in OPFOR artillery. The battalion and battery may run check computations manually on a routine or random basis.

FIRE PLANNING

The OPFOR initiates and accomplishes fire planning at the highest possible levels. The highest level of participating units coordinates and approves the fire plan with input from subordinate units. The artillery has targets for each phase of the battle based on the following data: target type, dimensions, degree of fortification, mobility,

and depth into the enemy's defense. The fire planning process includes--

- Target acquisition.
- Organization for combat.
- Assignment of tactical missions.
- Determination of ammunition requirements.
- Formulation of a detailed fire plan.

Density of Fire

OPFOR doctrine stresses that it must not only deliver the required numbers of rounds, but that it should be done as quickly as possible. This maximizes surprise and prevents mobile targets from escaping before the mission is accomplished. This also enables batteries to make minor adjustments to their fire positions to escape counterattack. For these reasons, fire missions now consist overwhelmingly of short, intense concentrations, with lengthy barrages being largely a thing of the past.

Principles

Planners follow specific principles when developing offensive fire plans. Their plans are also influenced by targeting priorities. The single, coordinated fire plan includes nuclear fires, chemical strikes, high-precision weapons, conventional fires, fixed-wing aircraft, and fire support helicopters. The OPFOR uses fire preparations before all major offensive actions. Fires of tanks and antitank artillery may be used during these preparations.

Target Priorities

Target priorities vary according to the stage of the battle. The general order of importance is as follows:

In the Offense

- Nuclear delivery means.
- High-precision weapons and their associated elements.
- Conventional artillery and air defense.
- Defensive strongpoints.
- C² facilities.
- Reserves and logistics support.

In the Defense

- Nuclear delivery means.
- High-precision weapons and their associated elements.
- Conventional artillery and C².
- Attacking groupings.
- Penetrations.
- Key terrain.

Fire Plan

The fires of all artillery units and subunits within a division are incorporated into the army/army corps or *front* fire plan. The artillery commander at each level coordinates the fires under his control. He determines new requirements and missions and with the chief of artillery or chief of missile troops and artillery (depending on the level), and makes suggestions to the combined arms commander about adjustments in tactical organization as the situation develops.

The division commander, his chief of artillery, and other staff members establish the basis for division artillery fire planning during the reconnaissance of the area of anticipated action. During this reconnaissance, the commander refines the organization for combat and means of coordination. The maneuver commander gives the artillery repre-

sentative the information base to determine the following:

- Targets for artillery to fire upon.
- Priority of each target.
- Sequence in which to attack targets.
- Time to attack each target.

Fire planning for an attack is a deliberate and precise process. Planners consider weapons and ammunition, target characteristics, and the plan of the maneuver commander in terms of target damage criteria. Figure 8-11 illustrates an example fire plan for an OPFOR 122-mm howitzer battalion.

If the ammunition available is limited, the maneuver commander may have to accept a lower level of damage. If time is available, the OPFOR will position on the ground the ammunition planned for use during the preparation. It keeps ammunition loaded on battery and battalion (and possibly regimental) transports for later use.

Senior commanders give artillery orders and amendments to orders while moving. Units initially engaging the enemy conduct detailed fire planning. As the battle develops and additional artillery is deployed, the artillery staff refines the fire plan. It also enlarges it to provide maximum fire at critical points. The artillery commander positions accompanying artillery to facilitate prompt fires for each maneuver unit as the maneuver commander commits it. Supporting artillery displaces at a greater distance to be in the best location to support the battles with fire.

THE OFFENSE

The OPFOR has specific phases of artillery support for an attack against a defending enemy. It also plans to achieve cer-

tain density norms for artillery, depending on the situation.

Phases

The OPFOR goal of offensive fire support is to provide continuous supporting artillery fires through the depth of the enemy defense. The duration of these fires varies with circumstances. The OPFOR coordinates the fires of rocket, SSM, artillery, and air assets into the integrated fire destruction of enemy forces through the depth of the attack zone. Fire support in an offensive begins when the OPFOR unit leaves the assembly area and continues after the supported unit completes the penetration. The offensive fire support plan has four phases:

- Phase I: fire support for the movement forward.
- Phase II: fire preparation for the attack.
- Phase III: fire support of the attack.
- Phase IV: fire accompaniment.

Phase I: Fire Support for the Movement Forward

Phase I is normally employed only in an attack from the march or to cover a unit's movement from an assembly area more than 20 km from the forward edge of the enemy defense. This phase may also cover a follow-on force's movement forward before commitment.

This phase targets enemy long-range weapons that might strike the supported unit while it is still a considerable distance from the forward edge of enemy defenses. These targets consist of enemy long-range artillery, SSMs, aircraft on airfields, and combat helicopters. The OPFOR uses aviation, tactical and operational-tactical SSMs, long-range

Preparatory Fires					
Time	Method of Fire and Targets	Signals	1st Battery	2nd Battery	3rd Battery
H-40 to H-27 (13 min)	FIRE ASSAULT: Artillery and mortar batteries, CPs, radar, platoon strongpoint of companies in first echelon of defense.	Green flares SNOWSTORM 2121 (Radio/telephones)	TGT 60 90 rds Sector 11 120 rds	TGT 18 140 rds Sector 11 90 rds	TGT 40 80 rds Sector 11 120 rds
H-27 to H-17 (10 min)	FIRE ASSAULT: Platoon strongpoints within deeper defensive positions; destruction of targets by direct fire; controlling fires against artillery and mortar batteries.	Star flares HAIL 3131 (Radio/telephone)	Sector 16 120 rds TGT 69 14 rds	Sector 16 165 rds	Sector 16 165 rds
H-17 to H-5 (12 min)	FIRE ASSAULT: Platoon strongpoints within companies of first echelon of defense.	Yellow flares RAIN 4141 (Radio/telephone)	Sector 11 120 rds	Sector 11 150 rds	Sector 11 150 rds
H-7 to H-1	OVERLAPPING FIRE: 1st Battery fires at artillery and mortar batteries. (Overlaps H-Hour transition from preparatory to supporting fires).	Yellow flares RAIN 4141 (Radio/telephone)	Target 60 60 rds	TOTAL ROUNDS PREPARATORY 1584	
Supporting Fires *					
Time	Method of Fire and Targets	Signals	1st Battery	2nd Battery	3rd Battery
H-Hr to H-5	SUCCESSIVE FIRE CONCENTRATIONS On line 1 WOLF (Sector 11)	Line 1 WOLF Green flares HURRICANE 5555 (Radio/telephone)	Overlapping Fires, as above	45 rds	45 rds
ON CALL	5 minute fires on line 2 RAT (Sector 21)	Line 2 RAT Start flares THUNDER 6666 (Radio/telephone)	50 rds	50 rds	50 rds
ON CALL	5 minute fires on line 3 TIGER (Sector 16)	Line 3 TIGER Yellow flares TYPHOON 7777 (Radio/telephone)	32 rds	32 rds	32 rds
ON CALL	FIRE CONCENTRATIONS Individual targets BARRAGE FIRES	Readiness to open fire on targets 20, 25, 32, 33, 69, 71 Targets A and B			
* These fire concentrations and barrage fires are contingency plans to use depending on the progress of the attack.					

Figure 8-11. Illustrative fire plan, 122-mm howitzer battalion.

guns, and MRLs to annihilate or neutralize deep targets. The goal of this phase is to protect advancing columns by destroying or harassing enemy systems that could interfere. Fires in this phase are likely to be conducted from temporary fire positions, with the artillery shifting to its main positions for the next phase. It ends when the maneuver units are ready to deploy into battalion columns.

Phase II: Fire Preparation for the Attack

Phase II, fire preparation, can apply to the attack or the counterattack, or can precede the commitment of second-echelon or reserve forces. The artillery preparation should neutralize and/or annihilate a defending enemy with organized, planned, massed fires, that deny the enemy the opportunity to organize resistance. The fire preparation should engage enemy weapon systems, command and control elements, and troops in the tactical and immediate operational depth of the enemy's defenses. Targets for the preparation are assigned according to their type, size, degree of hardness, mobility, and depth in the enemy's defenses. The duration of the preparation depends on the enemy's disposition, fire support assets used, and type of ground attack to be conducted. The organization of the preparation reflects--

- The overall attack plan.
- The nature of the enemy's defenses.
- The type and density of fire support means being used for the preparation.

Depending on the combat situation, the preparation may take as little as 10 minutes, or it may extend to over an hour. However, it typically begins 20 to 30 minutes before the supported force reaches the forward edge of enemy defenses. The OPFOR may repeat this fire against well fortified, deeply-echeloned defenses. Be-

cause of the mobility of potential targets and the threat of enemy counterbattery fire, the OPFOR strives to increase the intensity of fire. It tries to reduce the length of this phase by adding more artillery to the force structure, with special emphasis on rocket launcher units.

Phase III: Fire Support of the Attack

Phase III, fire support of the attack, begins immediately following the preparatory phase and continues until defending first-echelon battalions are overrun. In this phase, first priority goes to maintaining fire superiority. To help the advance, fire is planned on sequential lines moving progressively deeper into the enemy's deployment, and to the flanks of the advance. Emphasis is on the continuity of support, ensuring the fire of the artillery and the advance of the maneuver units do not get out of phase. This also hastens the forward movement of assaulting units.

This phase should prevent the enemy from restoring fire, command and control, and observation systems disrupted during the preparation. Fires continue to neutralize enemy troop activity and weapon systems. The artillery fires on the enemy that is directly in front of, and on the flanks of, attacking OPFOR troops. The fires shift in bands progressively deeper into the enemy's defensive positions. Artillery support tries to keep the fire superiority attained during the artillery preparation phase, while neutralizing enemy defenses.

Phase IV: Fire Accompaniment

Fire accompaniment is the fourth and final phase. It includes artillery and air strikes against troops and weapon systems

opposing the attacker's advance and against enemy reserves deep in the rear. Artillery units support maneuver units with on-call fires as the latter exploit their success. The OPFOR constantly refines the artillery accompaniment plan during the attack.

Artillery units displace with the units they support during this phase. They fire on newly acquired targets or targets that have survived the preparation and support phases. Artillery and combat aviation units coordinate mutually supporting fires with each other and with the supported maneuver unit. They support the commitment of the attacker's second-echelon forces to ensure a high rate of advance. Fires must keep the enemy from using his reserves for counterattacks.

Density Norms

The OPFOR plans to achieve certain density norms for artillery. These norms depend on the tactical situation. For example, the OPFOR wants high numbers of tubes per kilometer of frontage to penetrate well-prepared enemy defenses. However, modern artillery and methods of fire control allow lower densities than previously experienced. Some average guidelines for desired densities are as follows:

- Attack of a well-prepared defense, on the main attack axis: 60 to 100 tubes per kilometer of frontage.
- Attack on a hasty defense on the main attack axis: 60 to 80 tubes per kilometer of frontage.
- Attack on a supporting axis: 40 tubes per kilometer of frontage.

These densities include all calibers of guns, howitzers, and mortars. Densities computed in number of tubes may increase by 50 to 75 percent when the fire planners

include multiple rocket launchers. Density figures can be reduced if direct air support is available.

THE DEFENSE

In the defense, the fire planners allocate fire strikes by all available means against the likely avenues of approach to defense positions. The chief of artillery closely coordinates all available artillery, and supporting aircraft. Intelligence efforts concentrate on determining enemy formations and locating their artillery systems.

Types of Fire

Counterpreparatory fires are an intense delivery of rocket, missile, artillery, and air strikes. The intent is to disorganize and weaken enemy forces preparing to attack. This type of the defensive fires should surprise the enemy and should start before the enemy's preparation fires. The intelligence necessary to achieve this is not easy to acquire, and the time required to organize it may be lacking. When accomplished successfully, however, it can be devastatingly effective.

As in the offense, **maneuver by fire** in the defense means shifting concentrated fires. An essential part of this is the ability to shift fires on new targets as the enemy maneuvers. This delivers a high volume of fire against the enemy's most important target groupings and against targets in the enemy's rear areas. It also covers friendly flanks with fire.

In the defense fires are organized to be mutually supporting and provide **fire sacks**. The fire planner utilizes all available assets to carry out the commander's plan. Several variations of the plan are produced,

based on the approach and deployment options open to the enemy. Effective fires in the defense are achieved by surprise, accuracy and massed fires.

Phases

To facilitate centralized control and effectiveness, the OPFOR divides defensive fire support into four phases. These are--

- Phase I: fire interdiction of advancing enemy troops.
- Phase II: fire to repel the enemy attack.
- Phase III: fire support of defending troops.
- Phase IV: fire destruction of the enemy during a counterattack.

Phase I: Fire Interdiction

Fire interdiction of advancing enemy troops occurs when the enemy deploys into battalion columns. It continues until the enemy forces reach their line of departure. Attached or supporting artillery units can occupy temporary fire positions beyond the forward edge of defense. Fire on distant approaches is carried out by fixed-wing aviation, SSMs, and long-range artillery. Where possible, enemy units are destroyed as they move up, but if target intelligence is inadequate, disruption and delay is inflicted by all available assets.

If the defensive is adopted already in contact with the enemy, this phase concentrates on the enemy's second echelon. Throughout the period before the enemy's attack, attention is paid to denying the enemy good target intelligence for his preparation. Artillery remains silent, as possible, until needed to repel a major attack. Batteries used before the main enemy attack will fire

from temporary fire positions or be used as roving batteries to confuse enemy intelligence.

Phase II: Fire to Repel the Enemy Attack

This is the most important phase of defensive artillery fire. The phase begins when the enemy crosses the line of departure and ends when he enters the first defensive positions. Fires create a zone of continuous fire in front of the defense. Fire to repel the enemy attack coordinates artillery fire with antitank weapons and all weapons of the maneuver units.

OPFOR artillery tries to break up attacks and split armor from the infantry with planned linear and box concentrations in front of forward edge positions, and minefields in gaps between strongpoints, and eventually in depth. Guns and MRLs start to engage the enemy 15 to 25 km from the line of contact and howitzers will fire when the enemy is within 10 to 15 km. Short but intense fire strikes, no more than 15 to 20 minutes in duration are fired, followed by displacement to alternate fire positions to avoid counterbattery fire.

Phase III: Fire Support of Defending Troops

Fire support of defending troops occurs when artillery units attack enemy forces that have penetrated the defensive positions of first-echelon maneuver battalions. Its goal is to create fire sacks that destroy the enemy, preventing him from developing the attack. Some batteries may enter preselected direct fire positions. The defender fires against individual targets.

The enemy is expected to penetrate the defense, but to pay an appropriate price and be canalized. The artillery supports defensive positions in depth, tries to separate enemy infantry from armor and fighting troops from their logistics support. If necessary, artillery may be used in the direct fire role against armored penetrations. The artillery plays a key role in creating suitable conditions for the launching of a counterattack.

Phase IV: Fire Destruction of the Enemy During Counterattack

The final phase of defensive fires is the destruction of the enemy during the counterattack. Its goals are to recover lost positions, destroy penetrating enemy forces, and to capture a line to launch offensive operations. This phase has three subphases for artillery support:

- Support for the forward movement of troops.
- Preparation of the counterattack.
- Support of the counterattack.

A successful counterattack requires a stabilized line of contact. This line allows enough time for the second-echelon forces to advance and deploy for the counterattack. Fires are delivered to cover the forward movement of OPFOR troops while also engaging weapons systems that could impede the move forward.

Organization for Combat

The artillery organization for combat in the defense resembles that in the offense. The artillery planner locates artillery groups so that they can execute their primary mission and still be able to mass fires in support of forward positions, especially against ar-

mor. Fire planning supports the defensive mission of the force.

Artillery weapons deploy in concealed and dispersed positions. This allows units to employ flanking, interlocking, and suppressive fires at very close ranges with great intensity. Each battery prepares primary, alternate, and night-firing positions. Selected artillery units can occupy temporary firing positions to provide fire support to units in the security zone. These positions are well forward.

Roving batteries and guns confuse the enemy about the deployment and fire plans for friendly artillery. The chief of artillery plans in detail the deployment of a roving unit. The plans include positions, missions, method of fire and number of rounds to fire from each position, itinerary, and duration of the mission. The roving unit may leave camouflaged decoys in a position to create the impression that it is still occupied. Figure 8-12 shows an example of a roving battery being used in a motorized rifle battalion's conduct of the defense.

FIRING NORMS

OPFOR fire planners establish firing norms for--

- Ammunition expenditure.
- The area coverage expected.
- Effect on the target.
- The density of fire over time.

When establishing these norms, planners consider several variables. The norms change as any one or more of the variables change. These variables include--

- Type of target; for example, equipment or personnel, deliberate or hasty defensive positions, hard- or soft-

skinned vehicles, point or area, and disposition.

- Type, caliber, and number of weapons engaging the target.
- Range to the target.
- Whether the target is under direct observation during the artillery attack.
- Types of ammunition available.
- Time available to prepare for firing.

Ammunition Expenditure

A general table of ammunition expenditure norms (see Figure 8-13) provides ammunition expenditures for subsequent tables in this section. It does not consider time. These norms can apply to any of the methods of fire described. These are unobserved targets at a range of 10 km or less from the artillery. The data assumes that batteries that have made deliberate occupation of their firing positions to fire the rounds and are laid based on survey data. They fire with meteorological data that is no more than three hours old.

The ammunition expenditure rate decreases by 25 percent when the artillery uses observed fire or adjusts from a known point. This expenditure increases by ten percent for each additional kilometer at ranges beyond 10 km. (See Figure 8-14) The expenditure for MRL does not increase with this longer range. Multiplication of the ammunition required for neutralization by three or four determines annihilation ammunition expenditures. The number of rounds required for neutralization times two or three gives the expenditures for targets in the open.

Coverage

The OPFOR follows specific guidelines to achieve the optimum coverage in a battalion concentration. Figure 8-14 shows how the OPFOR calculates fire coverage. These guidelines address three issues: target area, target unobserved, and target observed.

Target Area

The OPFOR may not always fire all the ammunition required to neutralize a target 100 percent. This can occur because of time, target importance, and available ammunition. Also, more than one artillery unit may engage the target. These conditions affect the percentage of the neutralization norm which artillery unit's fire.

Target Unobserved (Corrections Not Possible)

Sometimes the observation posts cannot see the targets because of battlefield conditions. If corrections are impossible, the OPFOR fire planner can use these methods to plan fires. Figure 8-15 illustrates the distribution of rounds on an unobserved target.

Range settings. If the target is 100 meters deep or less, all tubes fire on a single elevation setting. If the target is deeper than 100 meters, all tubes fire on three different elevation settings. The interval between settings is equal to one-third of the depth of the target.

Deflection settings. Each battery fires on a single deflection setting that ensures coverage of the entire frontage of the battalion's target. As a result, each of the three batteries in the battalion superimposes its fire on that of the other two.

TARGET	REQUIRED EFFECT	RIFLED BARREL							MORTARS				ROCKET ARTILLERY		
		CALIBER IN MILLIMETERS													
		76	85	100	122	130	152	203	82	120	160	240			
(Missile) Launcher	Target annihilation	800	720	540	300	280	200	70			140	60	510	360	200
Battery (platoon) of armored self-propelled artillery (mortars)	Target neutralization	1000	900	720	450	360	270	120		450	220	120	560	400	240
Battery (platoon) of unarmored self-propelled or dug-in towed artillery (mortars)	Target neutralization	540	480	360	240	220	180	100	400	240	160	100	400	320	180
Battery (platoon) of towed artillery in the open	Target neutralization	250	220	150	90	80	60	30	180	90	40	20	150	120	60
SAM Battery	Target neutralization	250	240	200	150	150	100	60						200	100
Signal and radar vans or radar control point in the open	Target neutralization	420	360	280	180	180	120	60	350	180	80	40	300	240	120
Dug-in troops and weapons in prepared defense strongpoint positions	Neutralization of 1 hectare of target area	480	450	320	200	200	150	60		200	100	50	320	240	100
Dug-in troops and weapons, tanks, infantry fighting vehicles, and APCs in hastily prepared defensive positions, and assembly areas	Neutralization of 1 hectare of target area	400	350	250	150	150	110	45	300	140	85	45	240	180	80
Troops and weapons in assembly area in the open	Neutralization of 1 hectare of target area	50	45	30	20	20	15	5	35	10	8	4	10	8	5
Command post in dug-out shelter or other overhead cover	Neutralization of 1 hectare of target area	480	450	320	200	200	150	60		200	100	50	320	240	100
Command post in the open (or mounted in vehicle)	Neutralization of 1 hectare of target area	120	100	80	50	50	40	15		25	20	10	30	20	15
ATGM, antitank gun or other individual target in the open	Target neutralization	250	240	180	140	140	100	90	240	140	80	35			

Figure 8-13. Ammunition Expenditure Norms .

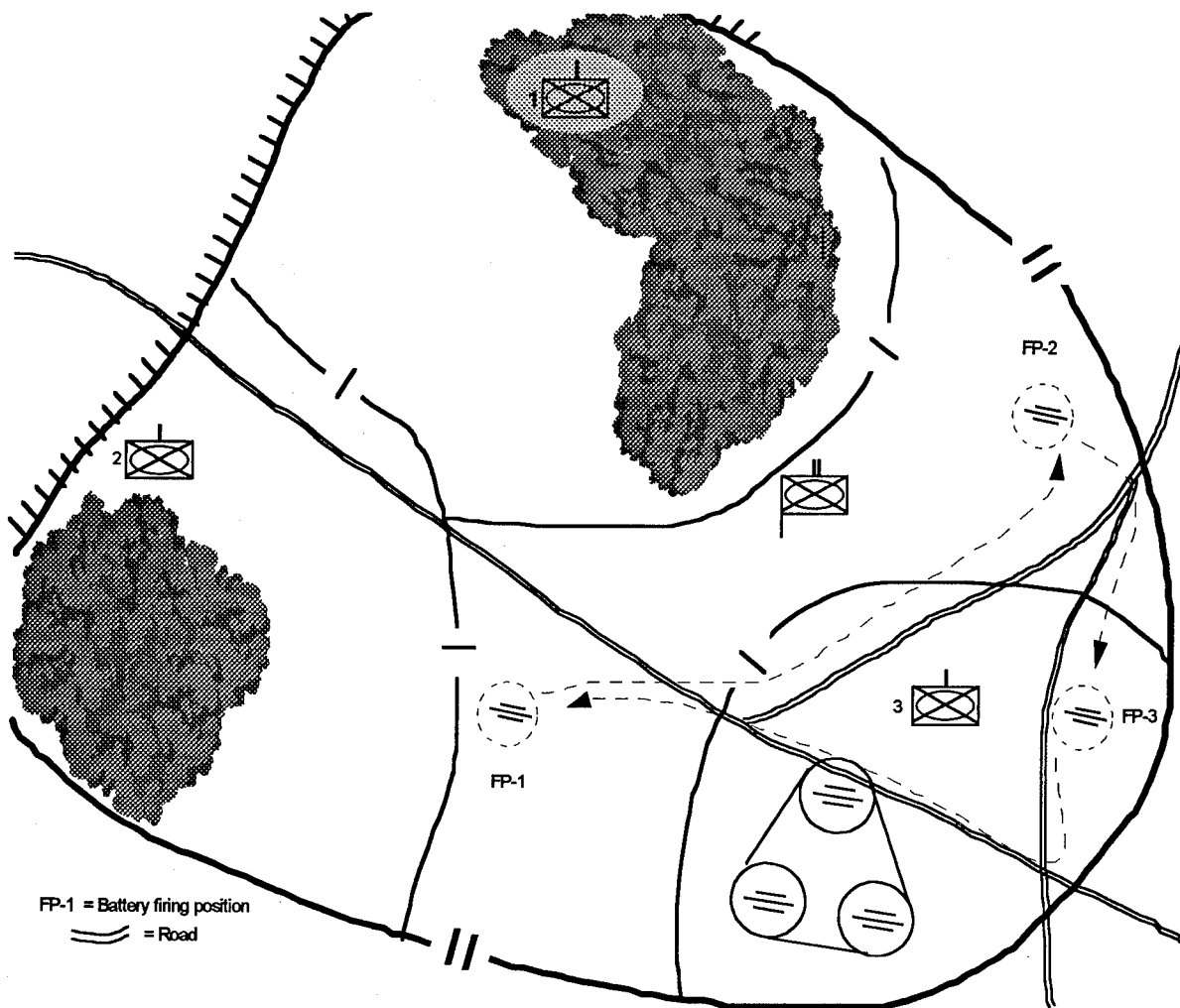

Figure 8-12. Roving battery employment plan in an MRB defense.

Target Observed (Fire Adjusted)

When artillery can adjust on an observed target, the battalion target area can have subdivisions of three roughly equal target groupings. Two batteries have target groups side by side across the target's frontage. The third battery attacks targets in the depth of the target area. Figure 8-16 shows battery target groupings firing on an observed target.

Range settings. Each battery fires on a single elevation setting if the depth of the target is 100 meters or less. If the depth of the tar-

get exceeds 100 meters, each battery fires on three different range settings. The interval between fires of concentration is equal to one-third of the depth of the target.

Deflection settings. If the target coverage per weapon is 25 meters or less, each battery fires all tubes on a single deflection setting. If the target coverage (sheaf) per weapon is 25 meters to 50 meters, then the battery fires on two different deflection settings. Mortar batteries always fire on a single deflection setting. Dividing the target frontage by the number of weapons in the firing battery yields the target coverage per piece.

CALCULATION OF FIRE COVERAGE

FIRE COVERAGE IS CALCULATED IN NUMBER OF ROUNDS PER HECTARE. A HECTARE IS 10,000 SQUARE METERS, THE EQUIVALENT OF 2.47 ACRES.

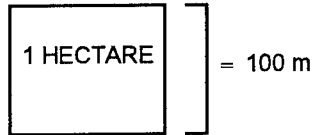

ANNIHILATION

POINT TARGET - Target is no longer combat effective.

AREA TARGET - At least 50 percent of the elements comprising the target are no longer combat effective and/or destroyed (rendered ineffective for combat).

NEUTRALIZATION

AREA TARGET - At least 30 percent of the elements comprising the target grouping are no longer combat effective or maneuverable, or can communicate.

Minimum Target Size:

NEUTRALIZATION

By:	RANGE	RANGE
	Up to 6 km	Over 6 km
Battery of 122 mm Howitzers	100 m x 150 m (1.5 hectares)	100 m x 200 m (2 hectares)

At ranges of 10 km or less, the table Figure 8-13 determines the coverage. To compute the ammunition expenditure on unobserved targets at distances greater than 10 km, the OPFOR use the following formula:

$$N_d = \frac{D N_{10}}{10}$$

WHERE:

N_d = The number of rounds of ammunition expended per hectare of target area at a given distance beyond 10 km.

D = The actual distance to be fired, rounded off to the nearest km.

N_{10} = The number of rounds to be fired per hectare of area norms established for the same weapon system at a distance of 10 km or less.

Based on expenditure norms, the OPFOR establish minimum target dimensions for firing batteries. The minimum target size varies with range to target and weapon dispersion factors.

A target smaller than the minimum is attacked with the same amount of ammunition required for the minimum size target.

Each weapon is assumed to be able to neutralize an area, given in hectares, the size of which depends on the time allotted and the type of target.

Figure 8-14. Calculation of fire coverage.

Time

Until recently, the time required for mission accomplishment was not a major consideration in OPFOR artillery planning; it was only a factor in coordination with sup-

ported maneuver units. The OPFOR now recognizes the need to move quickly after firing artillery missions. The OPFOR has incorporated this into its training and maneuvers. The OPFOR wants to reduce the time required for fire missions. The follow

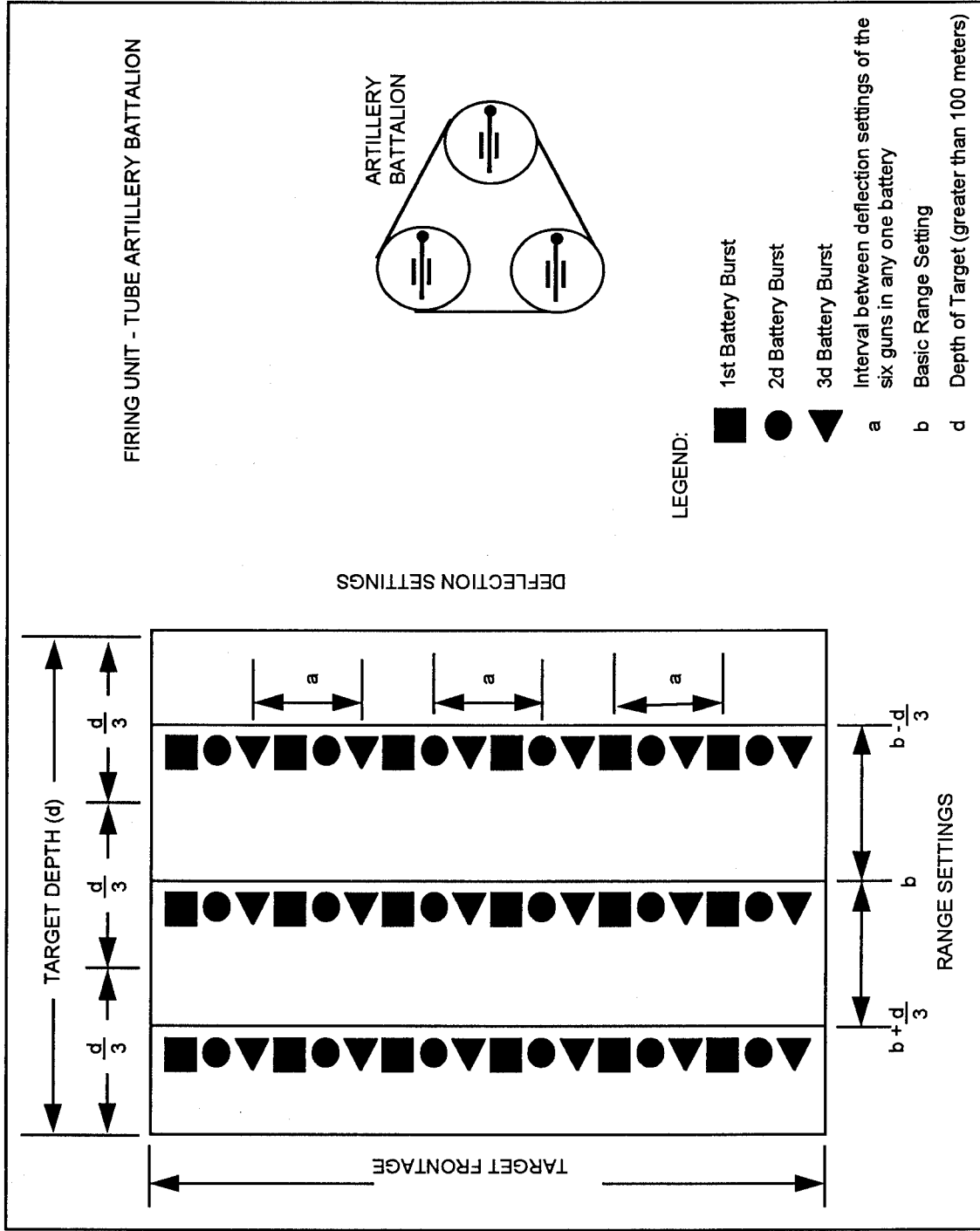

Figure 8-15. Distribution of rounds on an unobserved target area.

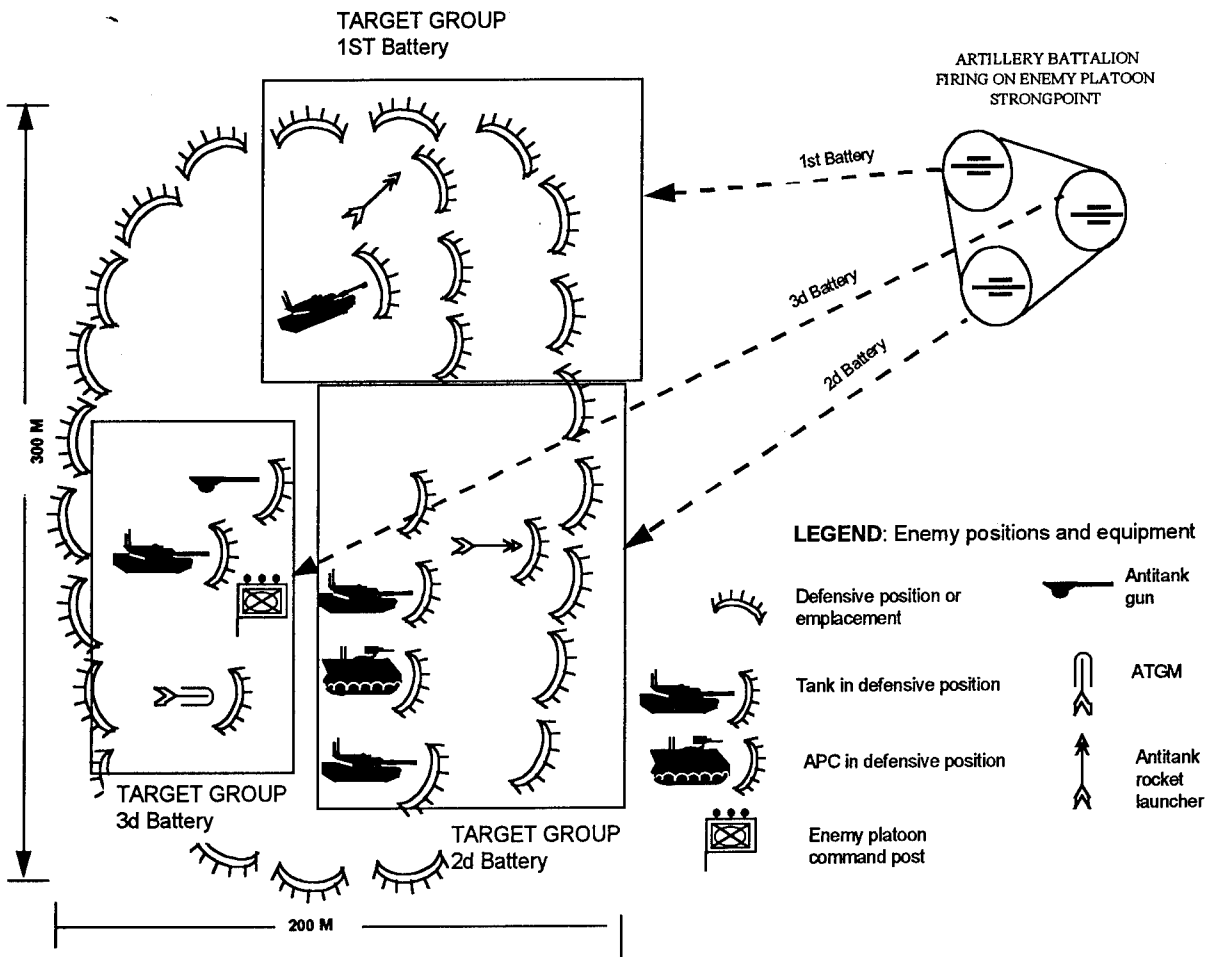

Figure 8-16. Battery target groupings assignments for an observed target (example).

ing are the most important reasons for this:

- **Target mobility.** Targets on today's battlefield are armored and highly mobile. They can relocate within minutes from the time they come under fire.
- **Increased effectiveness of fire.** The same ammunition allocation is more effective against a target when units fire the entire allocation within short period of time. This is especially true for the initial fire assault of a long fire preparation and for short, intense fire preparations.
- **Increased survivability.** The OPFOR believes that enemy target

acquisition capabilities have improved considerably. This allows enemy artillery to acquire and fire on OPFOR artillery batteries within four minutes from the time OPFOR fires its first round.

As a result of this perception of the threat, OPFOR artillery planners are trying to try to reduce mission times to four minutes. This goal is especially important for the accompaniment phase. However, in a large-scale attack, the preparation and support phases must often be longer. When the enemy is defending and the OPFOR has overwhelming fire superiority, it perceives its

own vulnerability to enemy counterbattery fire to be greatly reduced.

FUTURE DEVELOPMENTS

The OPFOR is introducing qualitative and quantitative changes in field artillery equipment and organizations. It is also revising its deployment doctrine. The density of artillery fire support assets in combined arms formations has greatly increased. Improved munitions, weapons, electronic fire direction computers, and target acquisition assets have enhanced mobility. The OPFOR has also improved reaction time of artillery fire support. The OPFOR is developing technical, operational, and organizational ways to reduce mission times and increase fire density.

Technical

- Increase the rate of fire of new generations of artillery weapons.
- Use improved rangefinders to reduce adjustment time on the target and to eliminate the need for registration for many types of missions.
- Use electronic computers to reduce mission computation time.
- Increase availability of effective munitions to achieve results with fewer rounds.
- Increase use of artillery-delivered high-precision munitions.
- Increased dissemination of aerial reconnaissance (RPV or helicopter).

Operational

- Fire accurately from emergency occupied positions.
- Fire for effect without registration.

- Use entire battalions to fire missions that were previously fired by individual batteries.

Organizational

- Use more artillery to accomplish the same mission. This is the reason for designating the battalion as the basic firing unit.
- Expand and modernize divisional and nondivisional artillery units.
- Provide more large-caliber and long-range artillery weapons.

The OPFOR considers that these measures will ensure its artillery fire superiority. They simultaneously contribute to the battlefield survivability of OPFOR artillery and the destruction of the enemy's artillery. More automated systems for intelligence analysis and firing data computation will help achieve mobility and firing norms.

Chapter 9

Antitank Support

The OPFOR believes that antitank (AT) fires should include all weapons in an integrated fire plan. The most effective way to destroy enemy tanks is direct fire from AT guns, antitank guided missiles (ATGMs), and tanks. The OPFOR fire planner analyzes the terrain to identify armor approaches. This allows him to place AT weapons in depth and organize surveillance and early warning systems.

Because the tank is the mainstay of offensive action, the OPFOR's first priority in the defense is antitank defense. It is, of course, as critical during the advance. As it maneuvers, OPFOR regiments and divisions accept open flanks as a matter of course. The OPFOR plans to use effective antitank fire support to stop counterattacks.

ANTITANK WEAPON SYSTEMS

OPFOR planners believe that antitank fire will play a decisive role in repelling enemy armor attacks. They feel the high density of armored vehicles and improved employment techniques on the battlefield demand special attention. It is necessary to completely integrate AT weapon systems, at every level, into the AT fire support plan. The OPFOR develops this plan in detail and coordinates it at the highest level. Mutually supporting AT weapons emplaced in depth cover flanks and likely armor approaches. During tactical moves, AT elements are deployed throughout march columns. The OPFOR divides AT weapons into two categories: **general** and **special**.

General Weapons

General AT weapon systems include **missiles, aircraft, tanks, and artillery**. The purpose of these systems is to destroy a wide array of battlefield targets, but they can be fire successfully against tanks and other armored vehicles. According to the OPFOR, any artillery-type weapon (over 20 millimeters) should have an antiarmor capability. All conventional artillery up to 152-millimeter is effective for direct fire AT use and carries some armor defeating ammunition. The 122-millimeter towed and self-propelled howitzers and the 152-millimeter self-propelled howitzer are particularly effective in this role. The AT forces often include direct-fire field artillery.

Special Weapons

Special AT weapon systems consist of **ATGMs, AT guns, grenade launchers, and recoilless guns**. The OPFOR design of these weapons is to destroy tanks by direct fire. The OPFOR considers ATGMs to be an effective AT weapon, but limited by minimum ranges, low rates of fire, and visibility requirements. OPFOR AT forces have a mix of ATGMs and direct-fire weapons. The direct-fire weapons provide quick-response fires at medium, short, and point-blank ranges, on broken ground, and under favorable visibility conditions. The OPFOR feels that direct fire from AT guns, ATGMs, and tanks is the principal and most reliable way to destroy tanks.

ORGANIZATION AND EQUIPMENT

Divisions

The antitank battalion in a motorized rifle division normally has an ATGM battery and two AT gun batteries. A gun battery has two platoons and a fire control section. When possible, engineer units reinforce the battalion to help construct AT obstacles. There are no AT guns in OPFOR tank regiments or at tank division level. The only ATGMs in the tank divisions are in their motorized rifle regiment. Motorized rifle regiments have an AT missile battery. Some motorized rifle regiments may have an antitank battalion rather than just an ATGM battery (See the *Heavy OPFOR Organizational Guide*).

Support Helicopters

The OPFOR continues to add ATGMs to its helicopters, using this asset to increase its AT capability. The OPFOR has also improved the survivability of these attack helicopters on the battlefield. All attack helicopters likely to operate near the forward combat areas have active and passive self-protection jammers and flares. Some helicopters have additional armor to protect the crew or vital helicopter components and engine emission filters to reduce the danger from heat-seeking SAMs. The OPFOR recognizes that helicopters firing ATGMs play an important part in the coordinated destruction of the enemy.

TACTICAL EMPLOYMENT

During the fire preparation of the attack antitank weapons may be included in the fire plan, attacking armored targets in the

enemy's frontline defenses. Once the attack begins antitank weapons are most likely to be used in an antitank reserve, operating with a mobile obstacle detachment, (MOD), to block any enemy counterattacks.

Antitank Reserve

In motorized rifle divisions and regiments the antitank battalion usually forms the antitank reserve. Most motorized rifle battalions have an antitank platoon, that can be used in the same role. Tank formations and units, lacking special antitank elements, use a tank subunit in the role. The basic missions of the AT reserves are:

- To screen the advance of friendly units moving to attack.
- To repel enemy tank counterattacks.
- To screen the deployment of second echelon and reserves.
- To secure the flanks.

This AT reserve has application for both the offense and defense. It may consist of guns and guided missiles and generally includes an engineer detachment to lay hasty minefields. The AT reserve can also include tanks to deploy rapidly and meet tank threats. When the AT reserve has additional assets (flame-throwers, tanks, or combat engineers) attached, these elements are normally subordinate to the AT artillery commander. Command relations of AT units under conditions of attachment or support are comparable to those of field artillery units. The combined arms commander assigns missions to the AT unit commander if this AT unit is a reserve force for the maneuver unit. The commander of the combined arms reserve assigns these missions if the AT artillery unit is part of the combined arms reserve.

Mobile Obstacle Detachment

Mobile Obstacle Detachments (MODs) are a temporary engineer grouping intended to create minefields and obstacles. MODs are generally equipped with mine-layers and trucks carrying mines, explosives and other equipment. They are sometimes reinforced with motorized rifle troops for close protection and extra labor.

Formations

Antitank units may deploy in **one line, two lines, or echeloned right or left**. They can also form a horseshoe or circle; or establish an "L"--shaped ambush. Platoons within a battery or the batteries of a battalion can adopt these formations. Defense in depth and mutually supporting fires are the principles that guide the placement of the weapons within a platoon or battery. Figure 9-1 gives examples of possible antitank battery formations.

The most common formation for the AT battalion is two lines of batteries. There are two batteries in the first echelon and one in the second positioned to provide mutual support. Battery fire positions are up to 1,000 meters apart. Alternate fire positions for the battery in the second line are normally on the flanks. The echelon right (or left) battle formation covers tank approaches from both the front and one of the flanks.

Weapons employed at the top of a horseshoe formation open fire at extreme ranges, inviting enemy tank attacks so that the other guns can open flank fire. If enemy tanks penetrate the kill zone of a horseshoe, all weapons deliver fire simultaneously.

The OPFOR can also use an "L"-shaped ambush system. It combines the fires

of antitank guns with antitank guided missiles. The antitank gun platoon is on the longer portion of the "L" firing flank shots. The ATGMs, with increased range capabilities, are on the short leg of the "L". This type of ambush maximizes the capabilities of both weapon systems.

Deployment

Divisional Antitank Battalion

Ideally, the battalion is concealed in a hide and deploys to fire positions on each likely tank approach. The usual layout of the battalion has the two antitank gun batteries forward and the ATGM battery with its longer range in the second echelon, providing depth. The regimental antitank battalion consists of one antitank gun battery and one ATGM battery. Batteries are generally deployed up to 1,000 meters apart and positioned to provide mutual support. The terrain dictates the precise shape of deployment. Figure 9-2 gives examples of possible antitank battalion formations.

The antitank battalion and antitank missile battery commanders control fire from command observation posts collocated with one of the firing positions. The battery reconnaissance section deploys as a forward observation post to give warning of approaching enemy tanks.

Antitank Batteries

Antitank gun batteries and platoons are usually 300 to 500 meters apart, with terrain, dictating spacing up to 1,000 meters apart. Antitank guns usually are about 100 meters apart laterally; and may occasionally be up to 300 meters apart. The ground, the direction of the threat and the need for mu

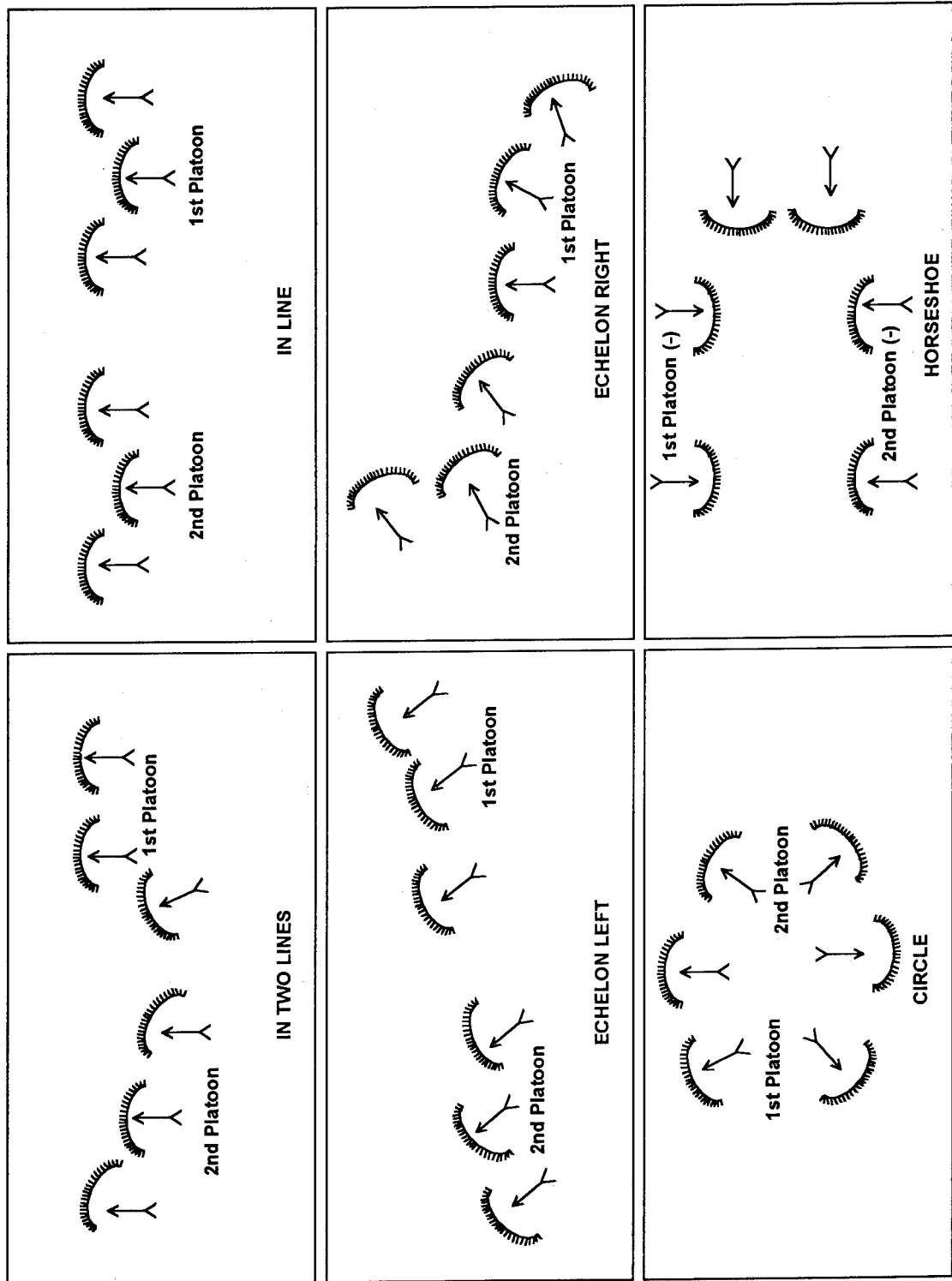

Figure 9-1. Antitank battery formations.

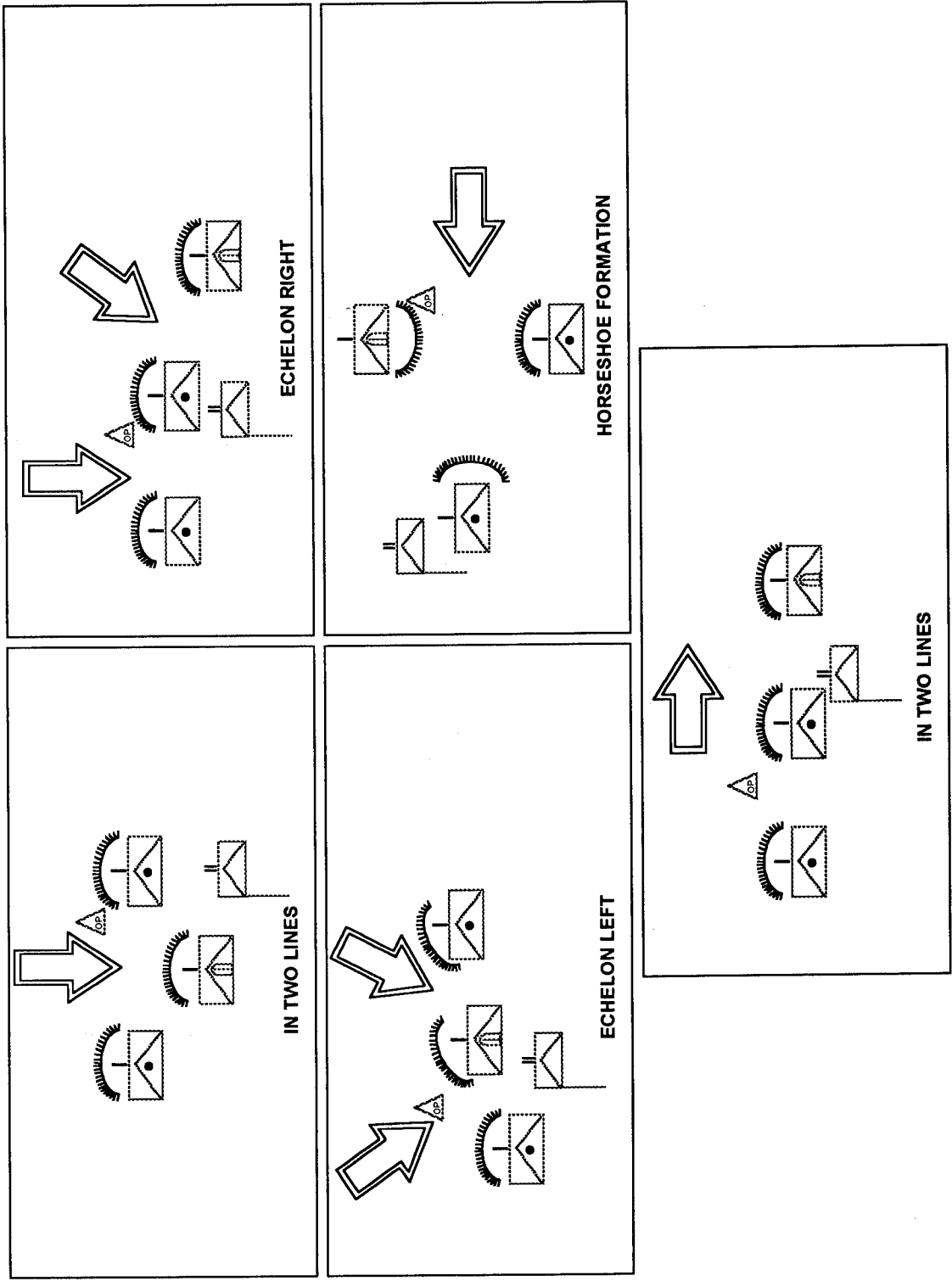

Figure 9-2. Antitank battalion formations.

tual support determine the details of the layout.

An antitank guided missile battery deploys with distances of 100 to 200 meters between ATGM launchers and up to 1,500 meters between platoons. Normal frontage-sare 500 meters per platoon and 1,500 meters per battery. Battery and platoon commanders control the fire of the launchers from observation points that usually are slightly to the rear and preferably on high ground. Within platoons, vehicles may be one-up, two-up, or echeloned to a flank. Whenever possible, ATGMs are on high ground, clear of close or wooded country.

THE OFFENSE

In the offensive, antitank units are usually combined with a MOD and can be reinforced by tank or motorized rifle troops to form an antitank reserve. Tank regiments and divisions have to detach tanks from their units/subunits to form such a reserve. The antitank reserve moves parallel to the main body on an open flank, within the main body ready to deploy to either flank, or behind units advancing in battle formation. The goal is to position it wherever it can quickly counter any armored threat to the advance or to cover the deployment of the main body. Attack helicopters provide a very flexible and potent antitank reserve or flank protection force.

The OPFOR recognizes the effect enemy AT capabilities can have on offensive operations. Therefore, the OPFOR plans to destroy these weapons early to expedite its forward movement. The OPFOR feels the enemy will locate these AT weapons within 1.5 km of the forward edge of its own defenses. To locate these systems, the OPFOR conducts a thorough reconnaissance, with a

goal of neutralizing 70 to 80 percent of them during the artillery preparation. The OPFOR tank forces plans to move immediately to exploit the artillery fires on these AT weapons and carry the attack to the depth of the enemy defenses.

During an attack, the AT reserve usually moves behind advancing first-echelon tanks and infantry in the most exposed direction of attack, ready to repulse enemy armored counterattacks. The combined arms commander or the artillery fire planner chooses successive firing lines and alternate locations to cover likely tank approaches. The AT unit commander selects the firing positions. Figure 9-3 illustrates the deployment of an antitank battalion in the offense.

In preparation for an attack, AT units locate on the most likely enemy armor approaches or well forward to participate in the artillery preparation phase of the attack. They can conduct fire with direct aiming against the enemy's armored vehicles. The AT guns can conduct indirect observed fire, particularly when there is insufficient artillery.

During the artillery preparation phase, AT units are responsible for the following missions--

- Containing enemy armor.
- Covering the deployment of the attacking units.
- Engaging armored and AT targets on the forward edge of the enemy defense as part of the preparatory fires.

During the **support phase** of the attack, AT subunits cover the flanks and support the deployment of the second echelon and reserve. During the accompaniment

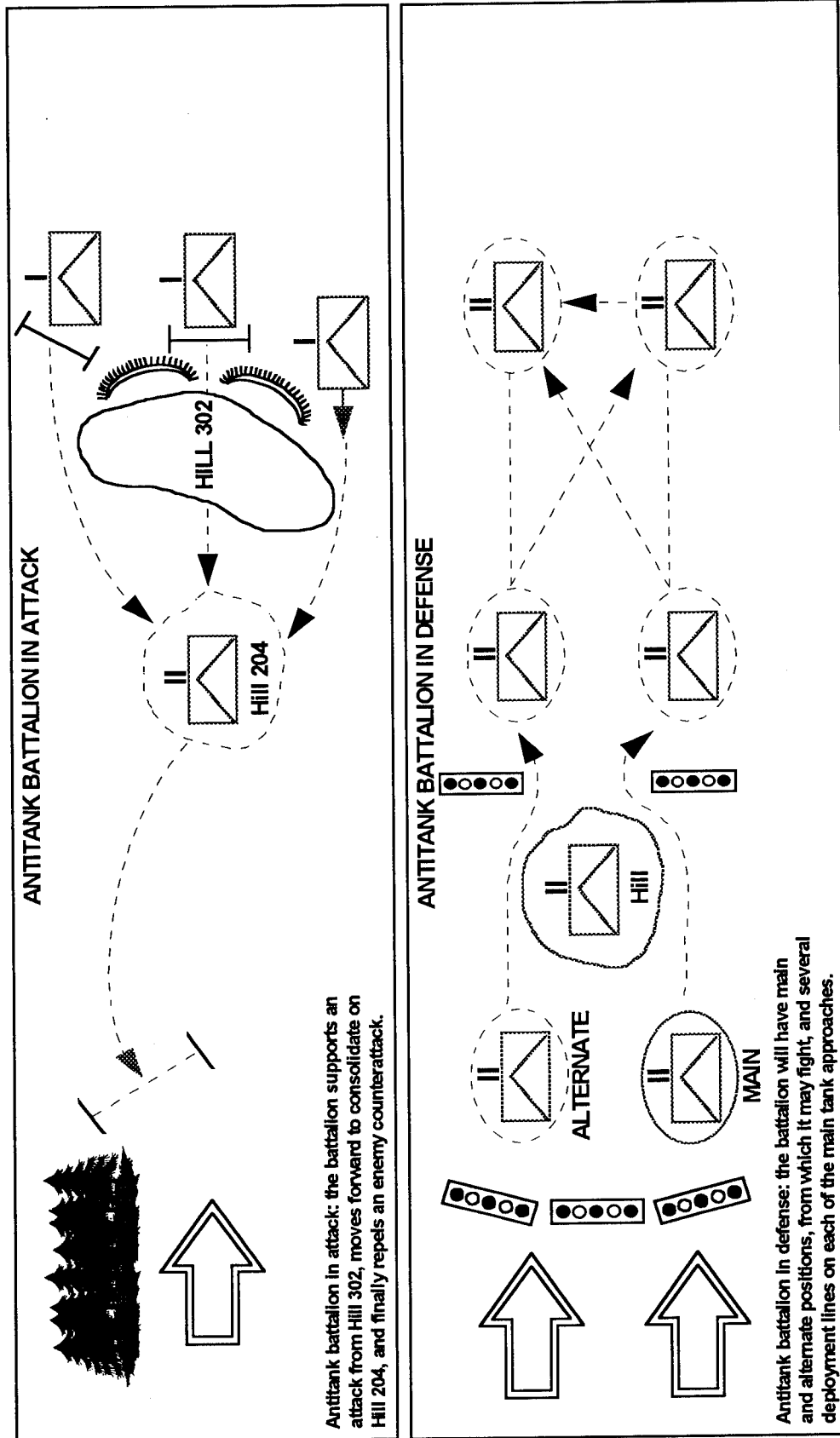

Figure 9-3. Antitank battalion deployment.

phase, the OPFOR selects fire positions in the depth of the enemy positions from which to defeat armored counterattacks. If ordered to deploy to one of these positions, the AT unit commander leads his weapons forward, puts out OPs, and moves himself to a position from which he can direct fire. He maintains close contact with the maneuver force commander and the MOD.

In anticipation of a meeting engagement/battle, AT subunits march with the advance guard or at the head of the main force. They prepare to deploy immediately to provide fire support. At the beginning of a meeting engagement/battle, these units deploy in the threatened sector on an assigned firing line, covering the deployment of the combined arms force.

THE DEFENSE

The antitank support plan has greater detail in the defense than in the offense. The OPFOR believe that the basic system of fire in the defense is antitank fire. The antitank fire plan should place an enemy armored force under continuous fire from the point of its first detection until it is destroyed in a first-echelon kill zone. Figure 9-4 illustrates an integrated motorized rifle battalion antitank defense. In the defense, AT units have these **missions**--

- Destroy enemy tanks and APCs forward of the first echelon.
- Destroy tanks and APCs that have penetrated the first defensive echelon.
- Cover gaps in the defense.
- Support the counterattack.

The antitank fire plan is crucial to the success of the defense. Organic weapons within company strongpoints, including tanks attached to motorized rifle companies, are emplaced with interlocking fires to ensure

continuous antitank coverage of the front. In vital sectors reinforced antitank strongpoints can be set up and may contain additional antitank weapons. Special antitank elements in motorized rifle units will be deployed as follows:

Motorized Rifle Battalion Antitank Platoons

These may be deployed within platoon strongpoints, either by sections or as a platoon. It is also usual for the battalion commander to retain the platoon under his direct control and assign it firing lines to be occupied as the enemy attack develops.

Motorized Rifle Division and Regimental Antitank Battalions

In normal terrain these are unlikely to be deployed in forward defensive positions but are used as antitank reserves, generally in cooperation with a MOD. The tactics they employ will be similar as those described in an offensive context. When faced by an adverse air situation OPFOR commanders prefer not to deploy their antitank reserve in a hide initially, due to the risk it might suffer heavy casualties while deploying. In such cases it is preferable for the antitank reserve to dig in on a well camouflaged firing line covering the most threatened axis. Alternate firing lines are planned and the MOD still operates from a hide, only laying its mines at the last moment to achieve surprise.

Employment

Employment in defense consists of a network of company strong points, with interlocking fields of fire integrated with a barrier plan. In emplacing these strong

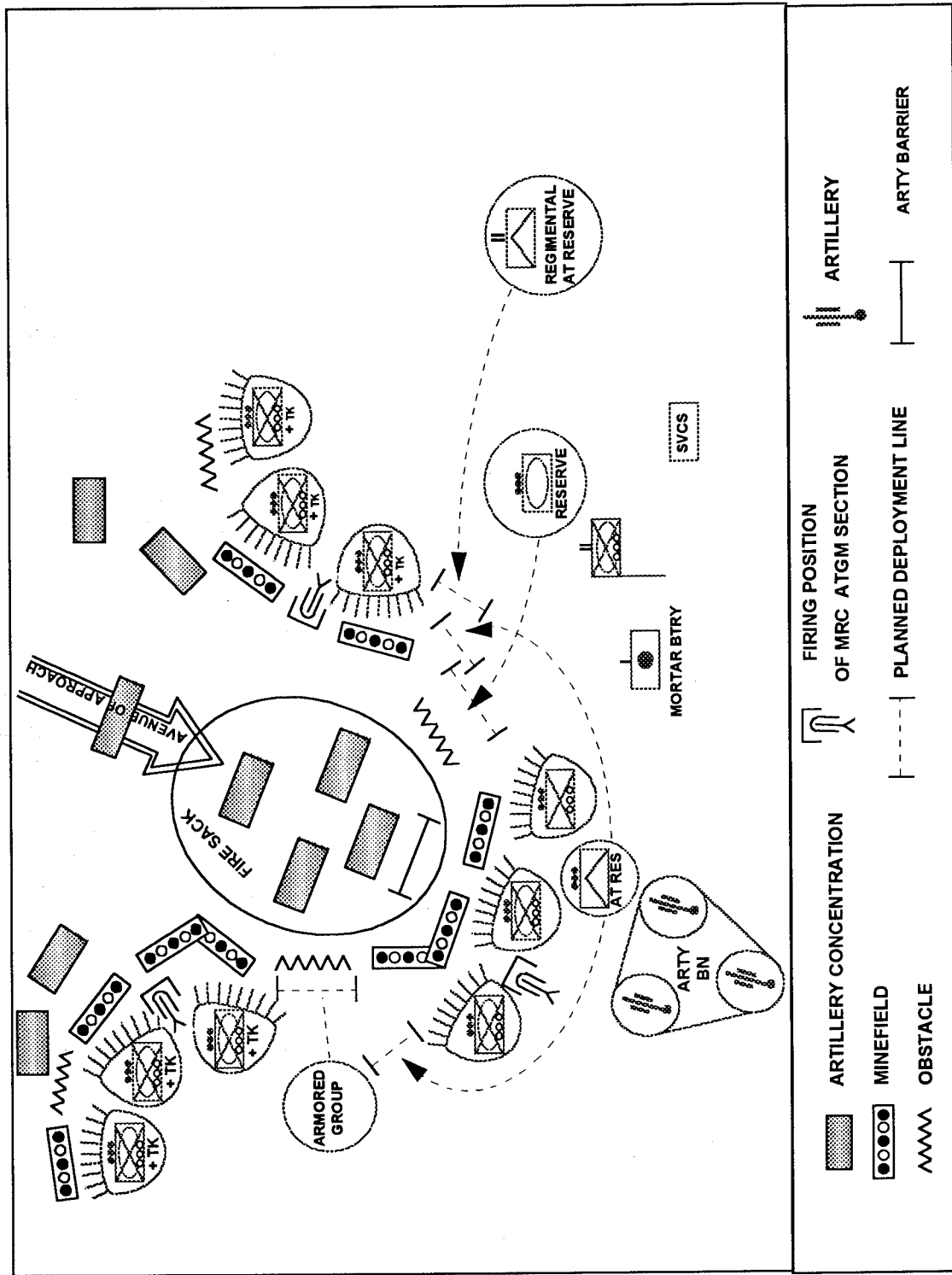

Figure 9-4. Integrated motorized rifle battalion antitank defense.

points, priority is given to the tank threat. In a motorized rifle unit defensive position, the organic antitank capability can be reinforced by tanks, howitzers or antitank systems from higher level. The mission of the strongpoints is to cause casualties, disrupt the cohesion of the enemy attack and canalize the enemy into prepared killing zones. Regiments and division antitank reserves, often working in combination with a MOD, which can be used for counter penetration or to dominate possible killing zones. This allows the OPFOR to keep the bulk of the tank strength held back to destroy the enemy's armor in a counterattack.

At the start of a defensive action, the AT reserve normally occupies camouflaged positions from which it can cover the most likely tank approaches. The OPFOR states that each tank, ATGM, or AT gun firing from a prepared camouflaged defensive position can defeat two to three attacking tanks. The commander selects from one to three firing lines to which his weapons may deploy on each possible approach. If time allows, subunits will then conduct reconnaissance and begin engineer preparation of routes and fire positions.

The maneuver commander may integrate an AT unit into the defensive first echelon and designate positions to occupy in either a battalion defensive area or company strongpoint. This type of deployment is usually by platoon, with the separation between platoons ensuring mutually supporting fires. Battle formation depends on the mission and terrain and must--

- Concentrate fire on tanks by direct sighting along armor avenues of approach.
- Cover approaches to AT barriers by fire.
- Closely coordinate the weapons of

the AT subunits and the AT weapons of the company strongpoint or the battalion defense area.

- Ensure all-round defense of each platoon.

The mission and terrain determine the AT subunit's tactical deployment. As the AT reserve for a defending combined arms formation, the subunit must--

- Coordinate and concentrate fires on armor approaches.
- Echelon the firing positions in depth.
- Conduct flanking fire on enemy tanks.
- Maneuver the unit within the area of deployment and to firing lines.

If the defending units must withdraw, ATGMs and AT guns cover the withdrawal of forward elements. The AT units break contact and withdraw to a new firing position when enemy armor has closed to 500 meters.

Fire Support

In the defense, ATGMs have an engagement zone that extends out to 3 km from the forward edge. Tanks firing from defilade positions first engage attacking tanks 2 to 3 km in front of the defensive positions. The engagement zone for AT guns extends out to about 1,500 meters. Mounted AT grenade launcher or hand-held grenade launcher weapons can engage enemy armor at ranges less than 1,000 meters.

Fixed-wing aviation, helicopters, SSMs, and massed artillery may fire against detected armor concentrations in assembly areas. Aircraft, especially ATGM-equipped attack helicopters, are the most effective weapons to engage moving armor forces at greater ranges. Mine laying helicopters may

lay hasty AT minefields. The long-range rocket launcher can fire rockets with scatterable-mine warheads deep into the enemy's forward defensive positions and along his axes of advance.

Indirect field artillery fires include MRLs. These fires can effectively isolate tanks from supporting forces and cause tank crews to secure the hatches. Such fires increase the vulnerability of attacking tanks to special AT weapons by stripping them of their supporting forces. The smoke and dust of the explosions can simultaneously degrade the effectiveness of direct-fire support weapons by impairing gunner visibility.

Chapter 10

Air Support

Air support control is echeloned, with fixed-wing controlled at the front-level and rotary-wing at army. Both can provide aerial support to OPFOR ground forces. The OPFOR has steadily modernized its fixed- and rotary-wing aircraft while increasing their numbers.

The flexibility and maneuverability of aviation assets give them a key role in OPFOR combat operations. According to the OPFOR, aviation has the advantage over ground forces because it can--

- Conduct across-the-FLOT operations.
- Execute rapid, wide maneuvers.
- Combat enemy air and ground forces.
- Concentrate forces quickly for the execution of unexpected missions.
- Redirect assets to different targets after launch.
- Execute missions under diverse tactical and environmental conditions.

One of the primary missions for frontal and army aviation is to provide cover for maneuver forces. Aviation assets can provide continuous fire support to mobile ground maneuver formations and can respond quickly to changes in the battlefield situation. Aviation assets can be used to strike targets out of artillery range and to support maneuver to the tactical and operational depth of the enemy.

The OPFOR has developed a very high-tech and efficient fixed-wing air force to provide air defense for the homeland and maneuver forces. Other missions include gaining air superiority over regional air

forces and providing fire and reconnaissance support to the ground forces.

The role of OPFOR helicopters continues to expand concurrent with the expansion in their number. Helicopters perform a variety of logistics, intelligence, liaison, and communications functions. This increase in the use of helicopters has freed fixed-wing aircraft to attack deeper targets.

With fixed-wing aircraft attacking targets early in the long-range fire-strike operation, they are unavailable for use in direct support of ground operations. Ground force commanders rely on attack helicopters and ground-attack aircraft to fill this initial fire support role. Integrated fires of artillery, attack helicopters, and missiles create corridors through the enemy's forward air defenses. These corridors, and suppression of enemy air defenses, allows deep employment of other air assets.

In addition to strategic missions to establish air superiority and provide air defense, OPFOR doctrine calls for **air support of ground forces**. The OPFOR recognizes stages of air support within an offensive and defensive operation. These stages are described in detail later in the chapter. Direct air support is a practiced element of OPFOR tactics. Air power, with its speed, flexibility, range, and accuracy, can provide effective fire support for a deep, high speed advance. The other primary means of fire support, artillery, is often unable to keep pace with ground maneuver forces.

The OPFOR possesses a formidable

aviation threat and expects to be capable of achieving at least local air superiority. If, however, they are faced with a superior enemy, the challenge will be especially hard felt by the *frontal* commander. He will be forced to hold more aircraft in reserve, and to redirect aircraft from ground support to air defense operations.

ORGANIZATION

Specified levels of OPFOR command have their own aviation forces to meet mission requirements. This organization tries to eliminate the wait for aviation support from higher headquarters and supports the OPFOR's quickly moving offensive doctrine. The OPFOR aviation organization centralizes control over most fixed-wing aircraft and decentralizes some control over attack helicopters. Aviation operating in direct support of OPFOR ground forces is classified as "*frontal*" or "army" aviation.

Frontal Aviation

Frontal aviation consists of fixed-wing fighter, fighter-bomber aircraft and heavy transport helicopters subordinate to a *front* headquarters. Fixed-wing aircraft are targeted against enemy helicopters and their bases, command and control systems, reserves and other targets in the depth of the enemy corps area. They may also be used against airborne or ground forces in the OPFOR rear area.

Army Aviation

The OPFOR has organized an increasing number of independent combat helicopter regiments. These helicopter regiments are a principal component of what the OPFOR refer to as **army aviation**. Army commanders operationally control their heli-

copter regiments. Typical missions include--

- Destruction of enemy tanks and other armored targets.
- Strikes against enemy air-mobile forces.
- Reconnaissance and observation across the forward edge.
- Special missions such as correcting artillery fires or laying minefields.

TROOP CONTROL

Aviation Control Element

The army and division usually have an **aviation control element**. At army, this element consists of several dozen individuals. Aviation control elements at division level are similar to, but smaller than, those at army level.

The mission of aviation control elements is to advise commanders on the use of air assets. They transmit air support requests to aviation organizations and maintain communication and control with aircraft in the battle area. They also advise the commander of air reconnaissance information. The aviation control element has two sections. One section chief collocates with the commander, the other with the chief of staff.

Forward Air Controller

Ground force regiments have a **forward air controller** (FAC) attached when fixed-wing aircraft or attack helicopters support their missions. The FAC requests air support for the supported ground unit commander. The FAC, usually a senior helicopter pilot--

- Advises the regimental commander on air matters.
- Serves as the communication link to

the division's aviation control element.

- Directs attacking aircraft to their targets.
- Refines target details.

A ground force battalion seldom has an air representative. However, a battalion can have a FAC to provide air support in certain situations, for example when acting as a forward detachment or as a heliborne landing force. Normally, though, a ground battalion commander has no direct communications with air support assets.

Coordination

Air and ground force commanders work out coordination procedures before the launch of combat air missions. These procedures can inhibit quick reaction to changing combat situations. Problems also arise because some ground force commanders lack adequate knowledge of aviation capabilities. As a result, ground force commanders sometimes hesitate to call for air support, unless it has been pre-planned. Air force commanders, conversely, are often unfamiliar with ground combat except in general terms.

The plans for mutual cooperation worked out before air operations begin are often incomplete; accounting only for the situation at the forward edge of enemy forces. Lower-level ground force commanders do not always know what fighter-bomber and attack helicopter resources have been allocated for immediate missions. Combined arms commanders do not always know the location and condition of aviation during the battle and may be unaware of the types of air strikes available. A failure by higher headquarters to supply damage assessment data to ground commanders can cause unneces-

sary firing at previously destroyed targets. At the tactical level, the OPFOR uses the following measures to try to overcome its coordination problems. The OPFOR attempts to deploy FACs at regiment and sometimes at battalion level to control both fixed-wing and helicopter direct air support.

Separation

The OPFOR FACs goal is to apply artillery, fixed-wing and rotary-wing aircraft simultaneously in the same area. If successful, strikes coincide in time, with different target sectors allocated.

Air Defenses

Ground-based air defense weapons may be put at "weapons tight" in certain sectors or along predesignated flight corridors during an air mission.

Night and Weather Conditions

The OPFOR continue to improve air support operations in bad weather and at night. Although OPFOR helicopters are equipped for navigation during darkness and limited visibility, they are not equipped to deliver precision guided ordnance during these conditions. Despite this modern equipment, the OPFOR believes that pilots must be able to navigate by land, search for targets visually, and determine distances to targets technical aids.

PLANNING AND PREPARATION

Before an offensive begins, the *front* commander issues his concept of the operation to the air army of the *front*. The air staff then formulates plans to support the operations. If time is very short, the army staff(s) may concurrently develop plans for their ap-

appropriate level, based upon notification from the *front*. The *front* commander has overall responsibility to integrate air support with ground combat missions. To achieve a coordinated combat plan, *frontal* aviation sends personnel and communications equipment to the armies.

With this information, the combined arms commander and his aviation control staff reconcile the allocated air assets with the air support requirements of the ground force divisions. A maneuver division commander consults his aviation staff and develops detailed plans for targets in his area of responsibility. If they plan to use attack helicopters, the planners will coordinate with frontal aviation to ensure target deconfliction and to limit fratricide. Their plan depends on the targets, flight distances, and disposition of enemy air defenses. These plans are approved and integrated with the *front* fire support plan. Proper integration of fires increases the effectiveness of air support by using artillery to neutralize or suppress enemy air defenses.

The aviation commander issues specific orders to his aviation divisions and regiments covering targets, number of sorties, air approach corridors, and mission timing. The air representatives at army, division, brigade and regiment confirm for their commanders the air resources allocated to them. The commander of the frontal air army can hold a percentage of his forces in reserve to meet unforeseen demands.

In some situations a higher headquarters may assign specific air assets, usually helicopters, to a division or regiment. If this occurs, the supported commander explains his objectives to the commander of the supporting air unit, and to the FAC, and seeks their recommendations.

The OPFOR normally maintains strict centralized control of air support resources. The combined arms commander does not always have operational control of the aviation supporting his forces. Instead, planning may divide air support resources into regiment-flights or aircraft sorties with the required quantity of munitions. The combined arms commander also may not know which unit or formation will accomplish the missions he requested.

This centralized control allows a rapid reallocation of air resources to accomplish missions that arise during operations. Air force units that were not originally assigned to ground support may take part in delivering air strikes against ground objectives. Operations on separate and disconnected axes may use decentralized employment of aviation. The OPFOR considers helicopters key in this role. In that case, aviation assigned for air support transfers to the operational control of the combined arms commander, who employs it according to his needs.

Army aviation tends to operate from forward arming and refueling points within 40 to 50 km of the forward edge. A flight of helicopters held at the highest **state of readiness** should reach its target in 15 to 20 minutes; a full squadron requires up to 25 minutes. Preparation of a second strike could take as little as 15 to 20 minutes depending on the number of helicopters involved and whether pressurized hoses are used during refueling. *Frontal* aviation, if at the highest readiness state, should reach its target in 20 to 30 minutes.

MISSIONS

The OPFOR recognizes the importance of air support for the ground forces. It

uses three types of air support missions to meet the needs of ground support: **on call**, **preplanned**, and **immediate**.

On-Call

Planners may designate a target for on-call attack by aviation assets, but the maneuver commander can time the strike at his discretion. This gives him flexibility to move quickly if the target no longer threatens the attack. This also allows OPFOR ground forces to take advantage of opportunities without stopping for an unnecessary air attack. By using this method of engagement, the commander can conserve his air assets for use when needed.

Immediate

The ground commander submits a request for immediate air support to the next higher headquarters, and his request moves up the chain of command. If a request for air support does not exceed the division commander's allocated assets, he can order the air strike through his aviation control element. If it does exceed his allocation, army or *front* must approve the request, depending on the size of support the maneuver division requested. As with preplanned support, the aviation control element at each command level participates by evaluating each air support request and coordinating the mission.

Aircraft designated for immediate missions can be airborne in holding areas or on the ground at airfields. Occasionally, an armed aircraft on reconnaissance patrol can respond to an air support request within its area of operations. The OPFOR recognizes three levels of combat readiness for frontal aviation aircraft and crews (see figure 10-2). Aircraft in categories one and two respond to ground force requests for immediate air

support. Before takeoff, pilots are briefed on a checkpoint to proceed to and, possibly, the target location. On reaching the checkpoint, the pilots contact the air representative of the ground force unit being supported, who gives them target designation or confirmation. Approach, attack, and recovery control procedures remain the same as in preplanned air support missions.

Preplanned

Air crews study preplanned target assignments closely to determine the best tactical approach. They use large-scale maps for reference. In some cases, they use scale models of the terrain and targets to learn the terrain in their sector. This helps crews to determine ingress and egress routes and to plan tactical maneuvers. Once airborne, the aircraft proceed to a designated checkpoint behind friendly lines and confirm their target assignment with ground control. The OPFOR emphasizes strict adherence to predetermined timing and flight paths. This indicates the OPFOR probably use "safe" corridors through friendly air defenses.

Aviation control elements and FACs maintain communications with attack aircraft either directly or through radio-relay aircraft. As the aircraft approach the target area, FACs establish communications, making sure pilots correctly identify the targets. When the pilots see the target, and the FAC confirms it, the flight leader assigns individual targets and orders the attack.

AVIATION EMPLOYMENT

The OPFOR believes its aviation assets can exert a tremendous influence on the battlefield. It emphasizes that aviation can provide responsive and continuous fire support using the following principles:

- Early attainment of air superiority.
- Coordination and integration with other arms.
- Employment in mass.
- Strict, centralized control.

Air-Ground Coordination

The coordinated use of battlefield airspace and aerial delivery of ordnance close to friendly troops are two problems the OPFOR faces. Achieving air superiority early on can simplify the airspace management problem. To reduce air-ground coordination problems, OPFOR planners try not to use attack helicopters, fixed-wing ground attack aircraft, UAVs, and artillery simultaneously in the same fire zone. The OPFOR will, however, consider the use of attack helicopters and UAVs during artillery firing. Attacks by fixed-wing aircraft and artillery fire can coincide in time, but are on separate target sectors.

The OPFOR emphasizes that the elements of the combined arms forces must be familiar with each other's tactics and equipment. The OPFOR establishes these relationships in peacetime to maintain effective cooperation and coordination during combat. The OPFOR desire is to establish a peacetime organization of air assets that closely aligns the aviation troop control structure with that of ground maneuver formations. It is hoped that this will ensure effective and continuous combined arms coordination.

The OPFOR establishes control and target identification posts as necessary to exercise control of aircraft in a designated air sector. These posts support the introduction of aviation into an area of combat operations and can also direct ground strikes. The posts accomplish direct co-

ordination between ground-attack and fighter aircraft and ground air defense units. These posts are equipped with radar, communications, and automated equipment and can be ground or air-based.

Reconnaissance and Targeting

Air reconnaissance is the principal OPFOR method to gather deep target intelligence. The *front* commander's staff prepares an overall reconnaissance plan detailing tasks for operational and tactical aviation assets. The division conducts its own tactical reconnaissance. The army and *front* assets can also provide intelligence support for division combat actions.

Air crews on any mission report enemy activity, with dedicated reconnaissance aviation regiments having the primary responsibility for air reconnaissance. These regiments have specially equipped reconnaissance aircraft that transmit target intelligence by radio to ground command posts. The classification and location of these targets are the bases for planning air strikes. Targets are classified as **single**, **multiple**, **line**, or **area**. Figure 10-1 shows the OPFOR classification of targets, and attack techniques.

Mission Execution

Air strikes in direct support of ground maneuver forces are primarily pre-planned. The combined arms commander identifies the targets, times, and desired damage for air strikes. The aviation commander determines the force, size, ordnance, and attack technique that will accomplish the strike mission. The staff plans these strikes in great detail and integrates them with other forms of fire support.

CLASSIFICATION	EXAMPLE	ATTACK TECHNIQUE
Single (or Point)	Rocket launcher, tank or armored vehicle, parked aircraft, or helicopter. Radar firing point, observation point, or bunker.	Single aircraft using lower-level or dive delivery of ordnance. ARM employed against radars. Single helicopter using ATGM or rockets.
Multiple	Group of 10-20 single targets, occupying an area of 1-1.5 km.	Attack by a small group (2-8) of aircraft or helicopters with the appropriate ordnance.
Line	Tactical march column (usually 1 km or longer), train, runway.	Attack by a single aircraft or a small group along the long axis of the target. Helicopters attack column from the flank.
Area	Dispersal or assembly areas of a battalion or larger unit, supply depot, large C ² center, forward airfield.	Massive and concentrated air strikes, delivered from various altitudes and directions.

Figure 10-1. Classification of air strike targets.

The plan for preplanned strikes normally covers the first one to two hours of combat operations, but can cover a period of up to 24 hours in a static situation. The plan specifies:

- Targets.
- Strike force.
- Time.
- Location.
- Attack technique.
- Ordnance.
- Communication codes.
- Approach and departure routes.

The combined arms commander holds a portion of available air assets in readiness to execute immediate missions

against unexpected targets. Maneuver force commanders have discretion to time the on-call strikes against predesignated targets. Aircraft and helicopters designated for on-call missions can be airborne in holding areas or on the ground at forward airfields.

The OPFOR recognizes three levels of combat readiness for fighter-bomber aircraft and crews. These categories probably also apply to other types of ground-attack aviation assets. Aircraft in categories one and two respond to on-call missions. Figure 10-2 lists the categories and shows their duration and time before assets can be in the air.

The OPFOR prefers to use helicop-

ters for immediate, time-sensitive strikes close to friendly forces. Attack helicopters have reduced logistics requirements compared to fixed-wing aircraft, allowing their deployment close to the main battle area. This close proximity to forward ground forces enhances their ability to respond to on-call missions. Helicopters have two other major advantages over fixed-wing aircraft: their ability to concentrate and maneuver undetected for a strike and the capability of their pilots to rapidly evaluate battlefield conditions. The OPFOR is concerned about the vulnerability of helicopters to enemy fighters and air defense. It prefers to employ helicopters in ground support only to the range of its air defense umbrella.

Conversely, it employs fixed-wing aircraft more frequently in strikes on previously reconnoitered, fixed or semifixed targets, in the immediate rear, or at greater depths. Fixed-wing aircraft are vulnerable to ground-based air defenses when executing ground attacks. This necessitates a low-altitude, high-speed target approach and minimum time in the target area. Under such conditions the pilot's ability to properly identify the target is extremely limited.

Survivability

The OPFOR emphasizes the importance of deception and surprise to paralyze hostile air defenses and enhance aircraft survivability. Aircraft approach the target area at the lowest permissible altitude, given weather and terrain restrictions, and maintain minimum radio transmissions. The OPFOR exploits detected gaps in enemy radar coverage and use decoy flights in advance of attacking aircraft to distract defending air defense systems. If more than one pass is necessary to destroy the target, attacking flights

approach the target from different directions or from bright sunlight, minimizing air defense effectiveness, visual detection, and recognition.

As long as modern air defense systems rely on radioelectronic equipment, the OPFOR considers neutralizing it through interference a major way to reduce aircraft losses. Most OPFOR aircraft are equipped with radioelectronic jamming equipment to help overcome enemy air defenses. The OPFOR also expects ground troops to fire upon and destroy enemy air defense weapons, to reduce its aircraft losses. Ground-based jamming facilities can also create interference in enemy air defense control systems.

OFFENSE

The OPFOR has steadily increased the offensive air capabilities of its fixed-wing and helicopter assets to support its fast-moving ground forces. The OPFOR continues to improve the quality and quantity of all aircraft to achieve tactical, operational, and strategic goals

Phases

OPFOR air support of ground forces corresponds to the phases of fire support. The major difference between the phases is their time of employment, although there are some differences in targeting, command, and delivery. The **four phases of air support** within an offensive operation are:

- **Phase I:** Support for movement forward.
- **Phase II:** Air preparation.
- **Phase III:** Support of the attack.
- **Phase IV:** Air accompaniment.

Category	Crew and Aircraft	Duration of Readiness	Time Before Takeoff
One	Aircraft are fully serviced and armed. Combat crews are briefed on their mission and are in the aircraft ready to start engines. Ground personnel are assisting the combat crews.	1-2 hours	3-5 minutes
Two	Aircraft are fully serviced and armed. Combat crews are briefed and are in the vicinity of aircraft ready to take off within a specified short period of time after receiving a mission order.	2-4 hours	15 minutes
Three	Aircraft are refueled and serviced. Cannons are loaded. External systems (bombs, rockets, missiles, fuel tanks, etc.) are not loaded. Combat crews are designated, but not on standby; they have not been briefed on the air and ground situation, but will be, before takeoff.	2-4 days	1-2 hours

Figure 10-2. Levels of combat readiness

Phase I: Support for Movement Forward

Phase I protects units as they move up from assembly areas. OPFOR air support strikes deep targets such as aircraft on air

fields, and combat helicopters. This phase targets the most dangerous enemy long-range weapons capable of striking the supported unit while it is still far from the forward edge of enemy defenses.

Phase II: Air Preparation

Phase II occurs prior to the onset of a ground offensive across a specified frontage. It can be simultaneous with the preparation fire of both the artillery and missile units. It requires close, detailed coordination with these forces with regard to targeting and timing. Air strikes in the preparation phase generally extend no farther than the enemy's immediate operational depth. The targets are those that conventional artillery and missiles cannot destroy because of their distance, mobility, or hardening. The plan for this phase specifies the same factors as the plan for preplanned strikes.

Phase III: Support of the Attack

This phase provides an opportunity to use the advantages of aviation during circumstances when artillery begins to lose its effectiveness. In this situation, ground forces require air support to continue the offensive. Targets include enemy command and control posts, weapons systems, and reserves at tactical and immediate operational depths. The majority of air strikes are preplanned. Ground force commanders may request immediate air attack missions against centers of resistance within the limitations of their allocated resources.

Air assets (primarily helicopters) are held on call either in the air, or at forward sites, for strikes on tanks, other armored targets, anti-tank weapons and to deal with counterattacks. Some transport helicopters are readied to transport mobile obstacle detachments others are prepared to lay minefields in the path of enemy counterattacks.

The air support stage closely follows the operational plan prepared before the onset of the offensive. It is an extension of the

strong artillery fires associated with OPFOR offensive operations. As in Stage II, the targets are generally beyond the destruction capabilities of artillery and missiles.

Phase IV: Air Accompaniment

OPFOR ground forces have air accompaniment as they penetrate deeply into enemy defenses. This phase occurs during the advanced stage of offensive operations when the progress of the ground forces has outpaced the prepared fire support plan. This causes the OPFOR commander to reassess and reallocate air resources. After allocating air resources before an offensive, the *front* commander plays little further direct role in the conduct of air support unless large reallocations are required. In accompaniment, however, the *front* commander again has the primary role. He reallocates significant air resources to support maneuver forces as the combat situation develops.

In this phase the OPFOR prefers to keep aviation assets on the ground and at a high state of readiness to execute on call missions against high-priority targets. Keeping assets airborne while on call wastes resources, except in the case of a crucial deep battle, for example to assist a forward detachment to seize a river line.

ATTACK HELICOPTERS

Attack helicopters now provide most of the close air support to the ground forces during the offense and provide an excellent fire and maneuver capability to the supported OPFOR commander.

Army-level helicopter assets present a serious challenge to opposing maneuver commanders, especially when used in a ground-attack or insertion role. These sys-

tems are highly survivable and effectively organized to present a major challenge to the enemy.

Command and Control

Army-level aviation control and communications are closely aligned with the ground force to ensure effective and continuous combined arms communications. This group is responsible for coordination and deconflicting of air missions. Since helicopter assets are not normally retained at the front level, their primary function is to support subordinate units, and monitor employment of army and division-level assets.

Army and Division

Army and division commanders have aviation control elements on their staffs. These staffs monitor all aircraft operating within their areas of operation. Aviation command posts are normally collocated with the army and division forward command posts.

Control and target identification posts (CIPs) are established as necessary to exercise control of attack helicopters as well as other aircraft within a designated area. CIPs coordinate the use of airspace and support the introduction of aviation assets into their sector. They may also direct air strikes. CIPs may be ground-based or operate from aircraft.

Regiment and Battalion

At the regimental-level and below, forward air controllers (FACs) are attached as necessary. FACs are senior helicopter pilots from the independent combat helicopter regiment. They serve as the communications link between the ground forces and the

supporting attack helicopters, passing messages directly to the flight leader.

FACs control all aspects of the attack helicopter's missions. They plan air missions to support the ground commander's scheme of maneuver (based on aircraft allocations from higher headquarters) and establish control procedures. Control procedures normally include--

- Establishing an initial point (IP) 15 km behind the forward edge of friendly forces.
- Establishing attack positions (AP), normally at maximum effective weapons range.
- Issuing control graphics.
- Marking friendly troop locations.
- Authorizing the flight to move from the IP to the AP.
- Directing the flight to climb, acquire the target, and attack (FAC must maintain constant visual contact with the target to authorize attack).

Most attack helicopter missions are replanned, but some immediate missions are possible. Ground force commanders can request them through the FAC who communicates through his parent unit or the CIP, if established. The FAC normally operates from a vehicle-mounted command post near the supported ground commander.

Tactics

Helicopters can attack as a flight of four or break down into pairs. Both simultaneous and successive attacks can be conducted from either one or two directions depending on the situation and target area. Figure 10-3 depicts typical attack maneuvers and profiles.

Attacks normally begin with a high-speed, low-level run-in from the IP to the AP using either running or hovering fire. Once the AP is reached, the FAC directs the helicopters to climb and acquire the target. When the target is identified, the helicopters execute a shallow dive towards the target and engage it as directed by the FAC. At the end of the firing run, all aircraft dive down and away from the target area, leaving at minimum altitude and again using terrain masking. The FAC then directs the flight to return to the same AP, a different AP, the IP, or a refueling point. If more than one pass is needed, helicopters may approach from the direction of the sun to hinder visual identification. Helicopter attacks are normally conducted during daylight. Attacks during periods of limited visibility can be conducted with the use of flares.

OPFOR tactics incorporate both running and hovering fire. Although running fire is the most common, hovering fire is also an option. Using hovering fire, helicopters make use of terrain masking during flight up to the AP. At the AP, the helicopters either hover or land, depending on the speed and distance of the approaching enemy. When the enemy is in range, the helicopters pop-up and launch one to two ATGMs each before dropping down. The FAC then directs the flight to engage the enemy again from the same AP or to disengage.

Tactical Missions

The primary tactical attack helicopter missions are: direct air support, anti-tank support, security for helicopter landings, and armed reconnaissance. Other missions can include: commando insertion, armed rescue, transport of antitank squads,

support of river crossings, anti-helicopter operations, and minelaying.

Direct air support is the most common mission. It is normally flown by a flight of four aircraft using either ATGM or rocket/gun attack. The typical exposure time for an attack is 20 seconds. In the direct air support role helicopters are often considered "flying artillery," and their fires are used to augment ground-based artillery. These attacks can be usually running attacks but a hovering attack is also possible if the weapon load is light.

Antitank missions use two to four aircraft per mission. Helicopters are exposed and vulnerable during missile flight. Minimum aircraft exposure times, at maximum effective ranges are: 25 seconds for the AT-3/SAGGER, 23 seconds for the AT-2/SWATTER and, 11 seconds for the AT-6/SPIRAL. Helicopters can attack using running or hovering fire and can also employ 57-mm or 80-mm rockets in lieu of ATGMs.

Security for helicopter landings is normally accomplished by using Mi-24 HINDs to prepare the landing zone, and to provide armed escort and direct air support for the landing force. The number of helicopters employed depends on the size of the heliborne landing, the degree of protection desired, and the expected enemy resistance.

Attack helicopters are used for **armed reconnaissance** when visibility is limited, target information is incomplete, or enemy flanks are unprotected. In these circumstances attack helicopters, in flights of two or four, conduct high-speed, low-altitude penetration of enemy lines. Targets

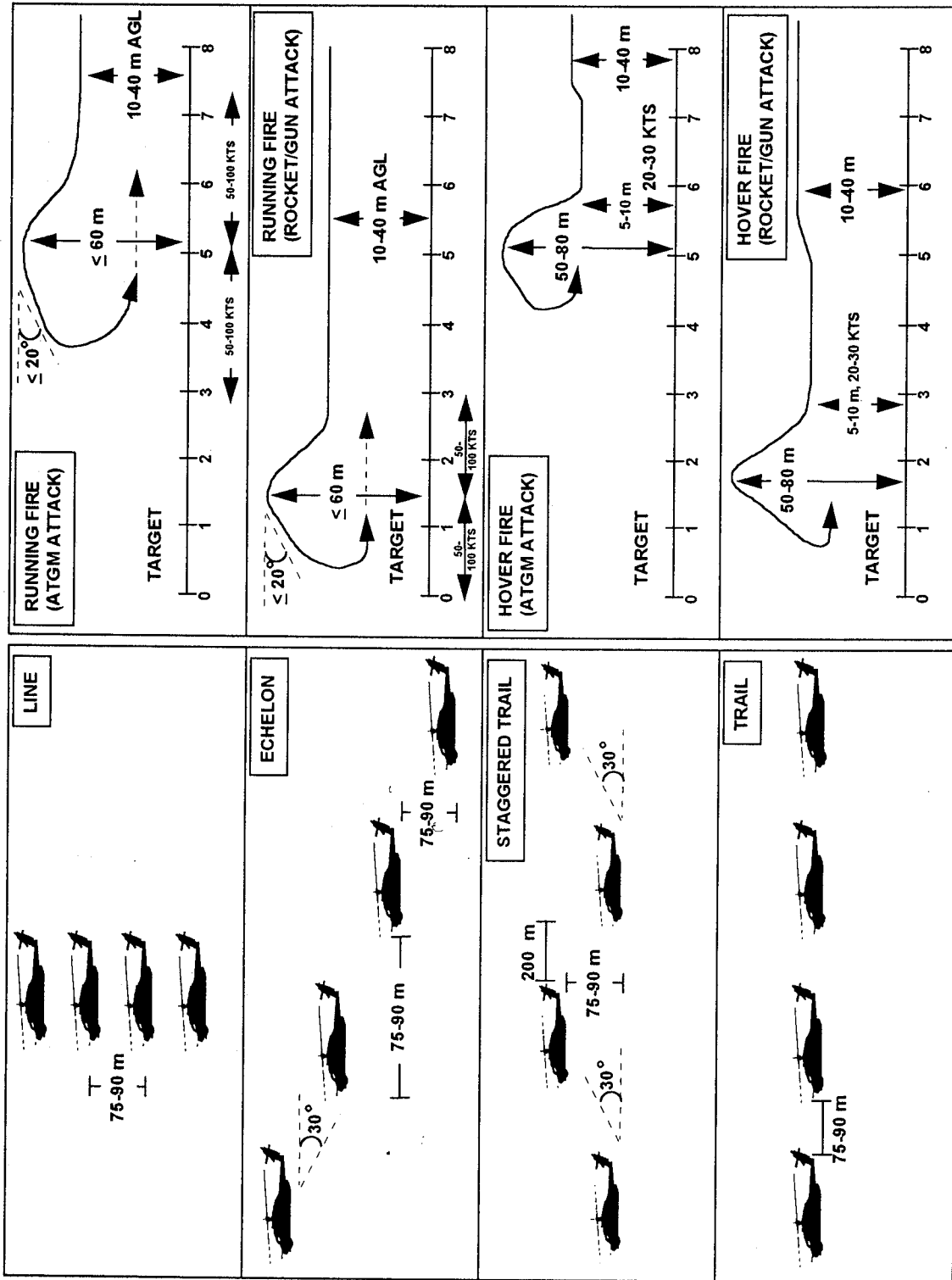

Figure 10-3. Typical helicopter formations and attack profiles.

of opportunity such as radars, communication nodes, missiles launchers, and antitank weapons are engaged at the discretion of the flight leader. Because these missions are considered hazardous, they are normally reserved for very experienced pilots.

Airspace Coordination

Coordinated use of airspace is a difficult problem. To facilitate control, fire planners normally employ attack helicopters after the completion of the artillery preparation. They may, however, use both simultaneously. In such a situation, the helicopters have entrance and exit corridors parallel to, and between, artillery fire concentrations, and under the trajectory of artillery rounds. These corridors are normally approximately 500 meters wide. The minimum safety distances between friendly troops and helicopter strikes is 200 to 700 meters in peacetime. In combat, this distance may decrease.

Maskirovka

The OPFOR emphasizes surprise and deception to overcome enemy air defenses. Helicopters approach the target at the lowest possible altitude using terrain masking as much as possible and exploiting known gaps in the enemy's radar coverage. Radio transmissions are reduced to a minimum, and decoy flights may be used to distract air defense systems.

ECM

Electronic countermeasures (ECM) also play an important part in neutralizing enemy air defenses. OPFOR helicopters employ self-screening jammers, chaff dispensers, and sometimes radar warning detectors.

Meeting Engagement

In a meeting engagement, air support assets, especially attack helicopters, screen and support OPFOR units as they maneuver into position. Air strikes attack enemy columns moving forward to reinforce engaged units. OPFOR exercises frequently have attack helicopters employed in flanking attacks against reinforcing or counter-attacking enemy armor columns.

Pursuit

In a pursuit, air support assets attack withdrawing enemy units through armed reconnaissance and in ambushes along withdrawal routes. These assets may be either fixed wing aircraft or helicopters. Attack helicopters can also support forward detachments outside the range of artillery fire.

Defense

In the defense, attack helicopters are normally held in reserve as a mobile counterattack force. They can also be used to block major enemy penetrations or to supplement mobile obstacle detachments by laying mines along threatened flanks and gaps.

Tactics used by OPFOR helicopters in the defense are similar to the offense except that hovering fire is utilized more often. Additionally, APs will be chosen to provide flanking fire on advancing enemy formations.

Fire Planning

The overall OPFOR defensive fire plan integrates all air fire support available. The air fire support plan extends to the immediate operational depth of the enemy seeking to disrupt his attack plans. The air

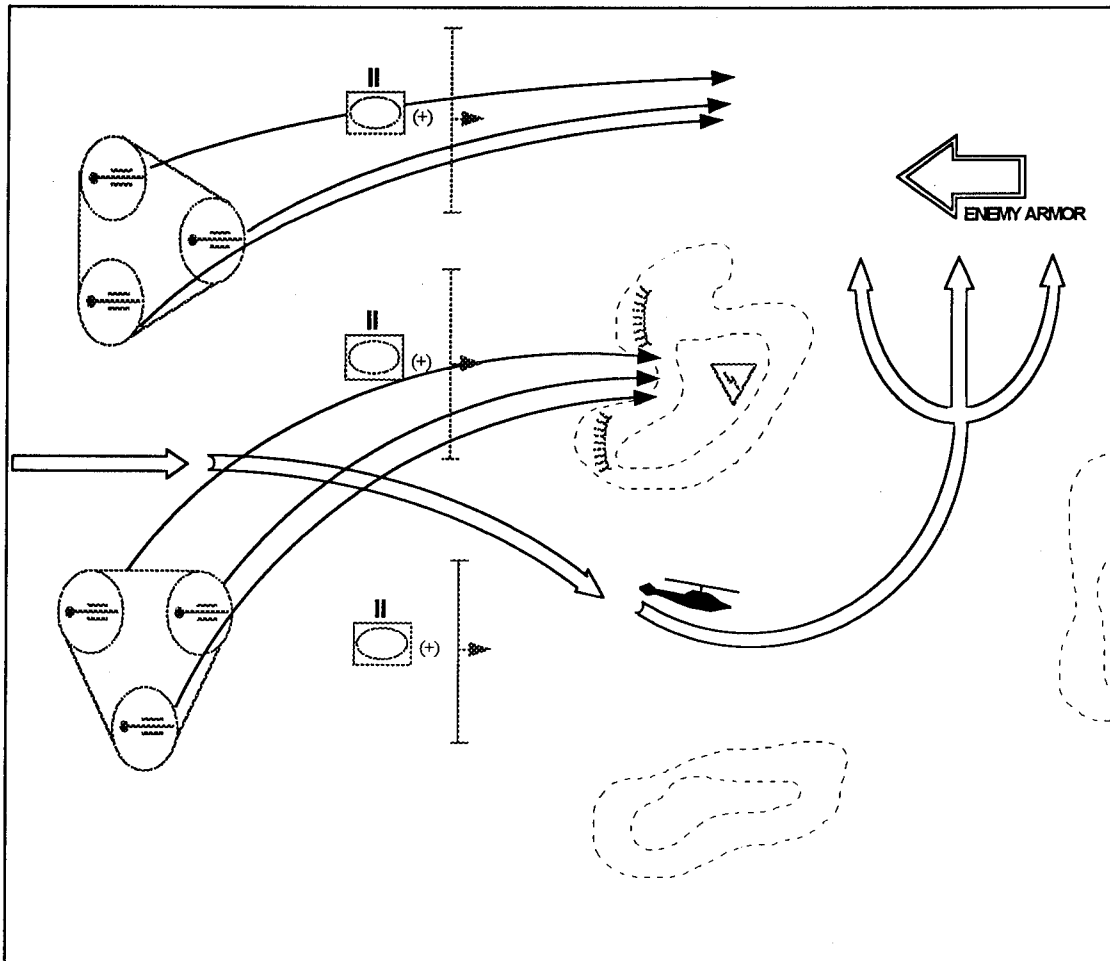

Figure 10-4. Coordinated helicopter and artillery fire strikes against a counterattacking enemy armor formation.

fire support plan contains several detailed variations. These variations take into account the anticipated actions of the enemy and his most probable avenues of approach. The OPFOR covers air strikes against attacking enemy forces that are out of range of artillery and tactical rockets. The OPFOR also plans to use all fire support weapons concentrating fires on forces that have reached, or penetrated, forward defensive positions.

There is an aviation counterpreparation plan for each variation of the defensive fire plan. Its objective is to launch a power-

ful, surprise, concentrated strike of short duration to preempt the enemy's plan. The targets of the counter-preparation are--

- Artillery in firing positions.
- Aviation on airfields.
- Armored or mechanized forces preparing to attack.
- Headquarters, and communications centers.
- Water obstacle crossing sites, ammunition and fuel dumps.

The flexibility and maneuverability of aviation can be exploited for many tasks in

the defense. The following paragraphs describe some typical ways in which OPFOR aviation is employed in the defense.

Interdiction of Enemy Movement, Deployment and Support of Covering Forces

The covering force battle provides opportunities to use the helicopters of army aviation, because the enemy will present many targets in the open and has not been able to build a dense air defense system. Helicopters generally operate from forward sites or from ambush positions in this phase. While the defense is being prepared, helicopters reconnoiter likely ambush positions covering the most likely enemy routes. Air delivered mines are considered very useful in this phase. Figure 10-4 demonstrates a variant of coordinated helicopter and artillery fire strikes against a counterattacking enemy armor formation.

Repulse of the Enemy Attack

The OPFOR considers this one of the less favorable times to use aviation. Every available direct and indirect fire ground-based system is in action during this phase and at some of them will have to check fire as OPFOR aviation approaches the line of contact. It is possible, however, that some air resources will be kept on call during this phase to provide a quick reaction strike force wherever the enemy threatens to penetrate the forward defenses.

Support of Counterattacks

The OPFOR considers this an excellent role for air assets. Massed air strikes by *frontal* aviation can be used to blast a corridor into the enemy's combat formation.

Helicopters provide close support for the advance of the counterattacking forces. This support can be while the helicopters are on call in the air or from forward operating sites.

Helicopters with ATGMs can be used to counterattack armored or mechanized forces. The helicopter force seeks routes allowing undetected approach to the flanks of the enemy force. If terrain variations do not provide adequate concealment for the force, the helicopters can use smoke to conceal their approach.

Reconnaissance Strike Groups

Defense in particular is considered an excellent time to use reconnaissance strike groups. These are an OPFOR tactical grouping, combining fixed-wing ground attack aircraft with attack helicopters. These groups may be used against approaching enemy columns, to reinforce defending forces or to block penetrations and out-flanking moves.

Chapter 11

Air Defense Support

The OPFOR feels that over 50 percent of the firepower in a tactical zone of operations may be air delivered. Just as it puts a high value on the impact its air power, the OPFOR stresses the need to prevent the enemy from using his air force to hinder ground operations. The goal of the OPFOR tactical air defense system is to **reduce the effectiveness of enemy air attacks**. The OPFOR achieves this goal in two ways:

- By forcing enemy aircraft to expend ordnance while they are beyond the effective or optimum ranges of their weapon systems.
- By destroying enemy aircraft as soon as they are within effective range of OPFOR air defense weapons.

CONCEPTS

There are two important concepts in OPFOR tactical air defense. First, air defense is an integral element of the combined arms concept and, second, it uses a variety of weapons and equipment to defend ground forces. The tactical air defense forces protect ground forces and other potential targets from attacks by enemy ground attack aircraft and helicopters. The OPFOR does not need to destroy every attacking enemy aircraft. The OPFOR can accomplish its mission if it succeeds at one of the following tasks:

- Preventing enemy air crews from pressing their attacks.
- Forcing enemy crews to expend their ordnance prematurely.

The OPFOR air defense of maneuver units comprises **three phases of support**.

All three phases may overlap, or occur simultaneously. The phases are discussed below, however, this chapter focuses primarily on phase three.

- **Phase I** includes all actions to destroy enemy aircraft that are still on the ground at airfields or in marshaling areas. Aviation resources and surface-to-surface missiles (SSMs) play the major role in this phase.
- **Phase II** includes actions to destroy enemy aircraft while they are in flight, but still some distance from OPFOR ground forces. OPFOR aviation, along with medium-range air defense missiles is the primary means of support in this phase.
- **Phase III** is the destruction of enemy fixed-wing aircraft and helicopters that penetrate the air space of OPFOR maneuver elements. This accomplishment of this phase belongs to OPFOR tactical air defense forces.

PRINCIPLES

The OPFOR follows **basic principles in conducting air defense**. The basic principles are--

Firepower

The OPFOR uses a variety of air defense weapons, including missiles and anti-aircraft guns. The OPFOR's force structure provides an adequate number of these weapons with a suitable mix of capabilities to ground force commanders.

Surprise

The OPFOR stresses surprise in operations and air defense is no exception. It is aware of the physical destruction that can be achieved by attacking an unsuspecting enemy. The OPFOR also understands the psychological effect of violent and unexpected fires on aviation crews. Even though these effects are often temporary, they can reduce the effectiveness of attacking air crews at critical moments.

Mobility

All OPFOR tactical air defense systems are extremely mobile. The mobility of the OPFOR tactical air defense systems allow air defense units to maneuver with tank and motorized rifle forces. They can quickly change positions after firing or after enemy reconnaissance detect them. This mobility enables air defense assets to keep pace with ground force operations.

Continuity

Only constantly moving air defense units with adequate logistical support can ensure comprehensive air coverage. These units must provide continuous air defense: day or night, in any weather conditions, when the enemy uses electronic warfare, and during quick changes in the air or ground situation.

Initiative

OPFOR air defense commanders must exploit the full capabilities of their equipment to complete their missions. This demands **aggressive action, initiative, and originality**. The modern battlefield is a fluid and volatile environment where air defense commanders have to quickly respond to sup-

port changes in the tactical situation. The commander must also be aware of the tactics employed by enemy air forces.

Coordination

The OPFOR stresses coordination between supported maneuver and supporting air defense units. It sees **air defense as a single system** composed of various parts, not as a series of different actions bearing no relation to each other or the conduct of the ground battle. The OPFOR views air defense as an integral element of the ground battle.

Security

The OPFOR recognizes that enemy air assets can attack from any direction. As a result OPFOR air defense assets must provide security for units at any depth and from any direction.

EQUIPMENT AND ORGANIZATION

The OPFOR inventory of tactical air defense weapons includes a variety of **missiles, guns, and support equipment**. There are air defense weapons at nearly every level. As with its other weapon systems, the OPFOR has incorporated technological developments into its air defense weapons. In addition, the OPFOR has developed a variety of air defense missiles and continues to develop anti-aircraft artillery (AAA). The overall effectiveness of these weapons is on a broad early warning system.

The OPFOR has extensive and effective **radar target detection and fire control systems**. Its radar falls into two general categories, **surveillance and fire control**.

Surveillance includes early warning, target acquisition, and height-finding radar. Some fire control radars also have limited target acquisition capability. OPFOR radars work as systems rather than as separate units. The majority of target acquisition radar are concentrated above division level. Army and *front* air defense operations centers accumulate and process most target information and pass it down to divisions.

Commanders select the weapon system to best engage a given target. *Front*, army, and division target acquisition radars detect and monitor the targets. Most target information comes down from army level. Radars provide the necessary data for engagement. They attempt to do this without unnecessarily exposing the air defense firing battery and radar to detection by enemy forces.

Division

The motorized rifle and tank divisions have organic air defense systems. These systems provide significant protection to the entire division. The newer surface-to-air missiles (SAM) in the divisional SAM regiment significantly improve the divisional air defense mobility and firepower. These missiles are highly mobile, with variants on a nonamphibious tracked vehicle and an amphibious wheeled vehicle.

SAM Regiment

The regiment can provide cover for the entire division area, overlapping into flanking divisions' areas. It concentrates on defending, in general order of priority, the divisional command post, main axis maneuver units, division artillery group, second echelon and minor axis units and the regiments logistics tail. Typically, two or three

elements can be forward with the first echelon regiments, coming as close as 5 km to the forward edge, with the remaining elements protecting other targets. If the battle becomes highly mobile and fragmented, or if units are dispatched on independent missions, division air defense assets can be placed under the command of maneuver units. The more flexible surface-to-air systems may be used in pairs or individually for specific missions, such as ambushes.

Air Defense Battalion

The air defense battalion of the motorized rifle regiment consists of a battalion headquarters, a 2S6 battery, a SAM battery (SA-13), and a SAM battery (SA-16/18).

The 2S6 battery is composed of a battery headquarters, transportation section and 3 air defense missile and artillery platoons. Each platoon has 2 30-mm SPAA 2S6s.

The SAM battery (SA-13) of the air defense battalion consists of a battery headquarters, transportation section and three SAM platoons. Each platoon has 2 SA-13/GOPHER TELARs.

The SAM battery (SA-16/18) consists of a battery headquarters, transportation section, and three SAM platoons. Each platoon has 6 SA-16/18s.

The OPFOR may have a air defense battery (variant) composed of a battery headquarters, maintenance section, transportation section, a SAM platoon, and a air defense platoon. The SAM platoon consists of either 4 SA-9/GASKIN TEL or 4 SA-GOPHER TELAR. The air defense artillery platoon consists of 4 23-mm SPAA Gun,

ZSU-23-4. (See the *Heavy Organization Guide*)

Battalion Air Defense Platoon

The motorized rifle battalion's air defense platoon is normally deployed by squads to cover first-echelon companies and the battalion command post. The squads move behind the companies they are supporting. The OPFOR positions the command post in the key sector of the battalion's area in the defense to provide an element of protection. Regimental or divisional assets can also reinforce the battalion's air defense platoon.

SPECIAL MISSIONS

Protection of March Columns

The OPFOR anticipates that enemy attack helicopters may conduct heavy attacks on march columns. Division air defense weapons and the regiment's own organic air defense weapons protect the moving regiment. Air attack is more likely at choke-points where terrain and other obstacles impede rapid movement, such as bridges, mountain passes, and built-up areas.

All vehicles in a march column have designated air observers. Air defense elements deployed to cover the column is ready to engage targets at all times. They do not use radar on vehicles to identify targets unless the requirement for use outweighs the risk of detection. This reduces the likelihood that enemy electronic intelligence will detect the column. Additional radar from the division's air defense regiment can provide increased radar coverage. The OPFOR usually uses two radar's at critical points along the

march route, with only one radar moving at a time. If the commander decides not to use the additional radar during the march, he places one radar in the advance guard and the other in the main force of the unit. Both remain ready for use at any time.

Regimental air defense weapons play a major role in the defense of units making tactical marches. This is particularly true of the self propelled anti-aircraft gun, such as the ZSU-23-4 and 2S6. While one or two pairs of ZSU-23-4s (up to three pairs for 2S6) may protect units on the march, use of all four ZSUs or all six 2S6s seems to be the rule. Pairs of ZSU-23-4s or 2S6s are 1,000 to 2,000 meters from each other to ensure mutual support. Individual guns maintain at least fifty meters between themselves and other vehicles to ensure an unobstructed field of fire to engage low-flying aircraft.

When the threat of air attack is great, or when the commander directs, the division's surface-to-air missile regiment's weapons protect the march columns. These weapons provide large engagement envelopes. The envelopes can have a great impact on enemy aircraft using limited-range, standoff weapons. The SAM batteries can also protect columns moving up from the rear.

Air defense batteries relocate as necessary to provide continuous and effective protection to the supported unit. OPFOR commanders maintain protection by leaving at least one battery in firing position to cover for the one(s) moving. Air defense elements reinforcing a maneuver unit usually move as a part of that unit if the air threat is high. These air defense assets may move separately to a new location if there is no air threat.

Ambushes and Roving Units

OPFOR commanders employ special techniques to increase flexibility and effectiveness in their air defense plan. Among these are **air defense ambushes** and **roving air defense elements**. Air defense elements for both of these techniques are similar in task organization and usually consist of a single antiaircraft gun, section, or platoon.

Air defense ambushes and roving units cover gaps in OPFOR air defenses. They provide air defense coverage on less likely approach routes of enemy aircraft. Both techniques can deceive the enemy as to the disposition of other air defense elements. These tactics are especially valuable when the air defense assets are inadequate.

Air defense ambushes usually consist of one or more ZSU-23-4s/2S6s or SA-16/18 SAMs. The ZSU-23-4/2S6, with its mobility and high rate of fire, is especially suited for both ambushes and roving units. When necessary, radar elements of the divisional air defense regiment can support a unit operating from ambush. Air defense assets engage only those targets that approach on the designated route or in self-defense. The units reposition themselves immediately after engagement or on discovery by the enemy.

Roving air defense elements function much like the ambushes. There is, however, one difference: an ambushing unit lies in wait for approaching enemy aircraft while a roving unit moves to the most likely areas of enemy air attack. There it occupies a series of designated positions in the supported unit's area. The roving unit occupies these positions according to a prearranged schedule or on order of the air defense commander.

OFFENSE

The OPFOR expects ground force air defense weapons to fully support fast-moving tank and motorized rifle forces in offensive operations. If necessary, some mobile strategic systems can deploy to provide support. The OPFOR has an extensive air defense system to protect the attacking maneuver units. The air defense units of this system are a vital part of the combined arms operation. Figure 11-1 illustrates a variation of air defense support for a motorized rifle battalion assault.

Regiment

Support of the OPFOR maneuver regiment involves the most complex air defense actions. As the supported unit performs its assigned missions, it continuously changes its location and combat formation. The air defense commander must respond to these changes; redeploying his own weapons to provide continuous and effective protection to the regiment's elements.

The OPFOR allocates more air defense units to support maneuver units in areas where the threat is the greatest. For example, one or more missile firing batteries of the division's SAM regiment usually provide additional air defense support to regiment in the division's first echelon. These batteries do not have to operate in the maneuver regiment's formation. The range of their radar and missiles allow them to provide support to the first echelon from locations further to the rear. The location of these missile batteries also increases their survivability by reducing the chance that enemy ground fire or aircraft will destroy them.

Battalion

The ZSU-23-4s/2S6s from the maneuver regiment's air defense battery/battalion support a motorized rifle battalion attacking in the regiment's first echelon. In his combat order, the regimental commander tasks a pair of ZSU-23-4s or 2S6s to support a particular battalion for a specified period. This period can precede the attack and begin before a battalion moves into an assembly area. In this case, the air defense element provides protection to the battalion during the road march to the assembly area. The ZSU-23-4/2S6 pair may join the maneuver battalion after it is already in the assembly area, though the OPFOR prefers to have both subunits arrive at the

assembly area at the same time. In either case, the air defense section or platoon leader reports to the maneuver battalion commander and establishes direct communications.

The platoon maintains communications with the regimental air defense battery and the divisional air defense target identification and warning network. This communications system provides information on the tactical air situation. The maneuver battalion commander and the ZSU-23-4 section or 2S6 platoon leader work to integrate their weapons into an effective air defense plan. As the battalion occupies the assembly areas, air defense weapons deploy according to this plan.

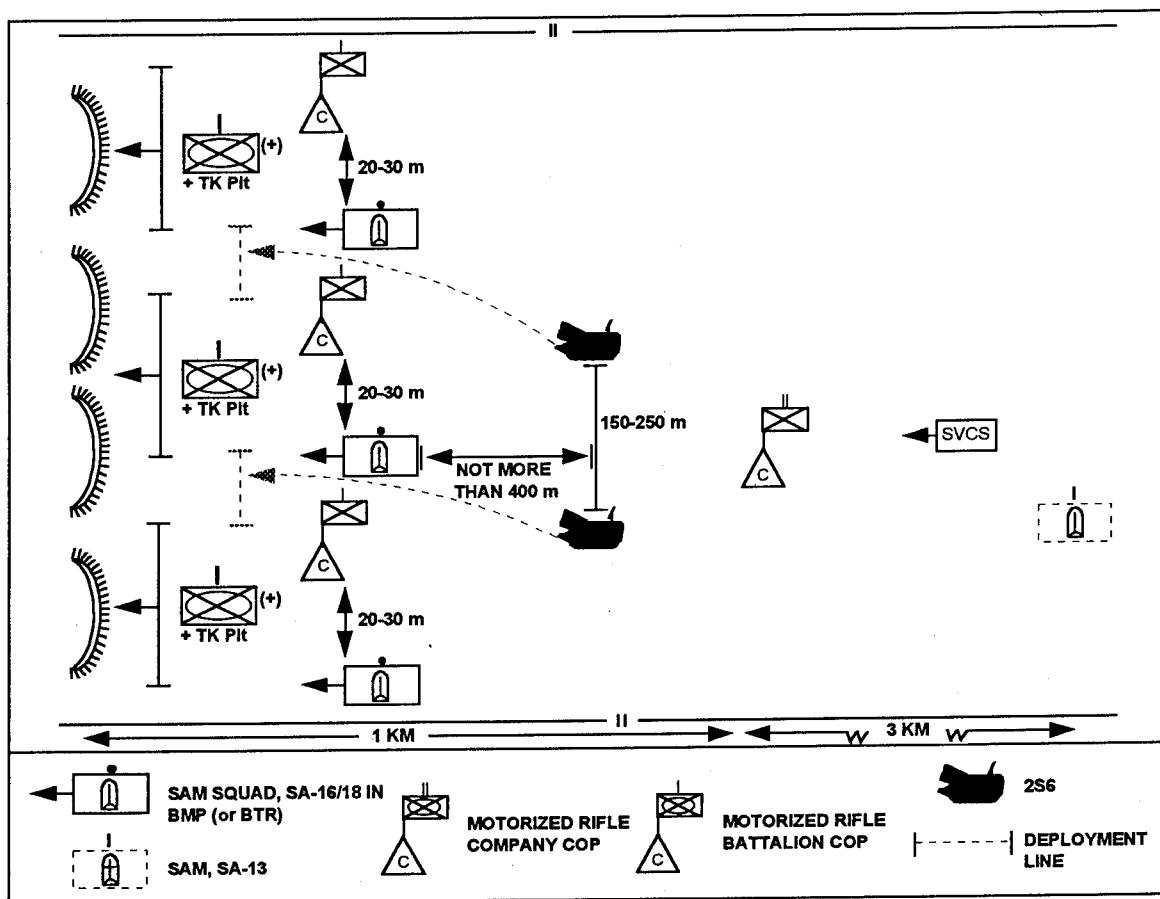

Figure 11-1. Air defense support for an MRB assault.

The battalion commander gives guidance on placing the ZSU-23-4s/2S6s and the SA-16/18 SAMs. The observation posts and firing positions provide effective observation and interlocking fires on potential approach routes aircraft and helicopters. When the commander employs more than one pair of ZSU-23-4/2S6s, the pairs are within mutually supporting range.

The SA-16/18 SAM squads of the MRB may be attached to each of the three motorized rifle companies to supplement the coverage that the ZSU-23-4 section or 2S6 platoon provides. The gunners of one company's SA-16/18 section may be near the ZSU-23-4 section or platoon. The ZSU-23-4/2S6 subunit leader can have some degree of control over these gunners in this situation. The SA-16/18 gunners are at locations similar to that in an air defense ambush covering gaps in coverage.

To attack the battalion in its assembly area, enemy aircraft must first penetrate the engagement envelopes formed by missile units of front, army, and divisions. The attacking aircraft then comes within range of the regimental and battalion defense systems. The ZSU-23-4s/2S6s engage enemy aircraft immediately as they come within range. The SA-16/18 gunners engage enemy aircraft that maneuver to avoid ZSU-23-4/2S6 fires or to pass over the SA-16/18 firing positions. Finally, small arms and vehicle-mounted weapons engage enemy aircraft that pass over the maneuver battalions' positions.

EMPLOYMENT

In an attack, the exact location of tactical air defense weapons depends on--

- The mission of the supported subunit.

- The commander's chosen attack formation.
- The terrain, fields of fire, and observations.

If the maneuver battalion attacks on a broad frontage, groups of two ZSU-23-4s or 2S6s usually deploy in a line formation protecting dispersed elements of the supported battalion. When attacking on a narrow frontage, the two ZSU-23-4s/2S6s deploy in column, providing greater control and increased concentration of platoon fire. A single battalion operating on a very narrow frontage may have only one ZSU-23-4/2S6.

When two maneuver battalions attack on line in the first echelon of a regiment, a pair of ZSU-23-4/2S6 normally supports each one. The ZSU-23-4/2S6 pairs remain within mutually supporting range but are far enough apart to reduce the chances that they will simultaneously be destroyed. The two guns of each pair are usually from 150 to 250 meters apart, ensuring adequate freedom of fire to engage low flying targets.

The SA-16/18 gunners ride in BTRs or BMPs until the infantry dismount. The gunners then usually also dismount and follow the motorized rifle troops. One SAM section usually reinforces each motorized rifle company. These SA-16/18 gunners deploy in a group, within 20 to 30 meters of the company commander and from 15 to 20 meters of each other. This system offers greater control and increases the chances of a target's destruction. It also reduces the possibility of firing on a friendly aircraft.

Meeting Engagement

Basic employment techniques for air defense weapons in a meeting engagement and attack are very similar. The ZSU-23-

4s/2S6s of the air defense battery/battalion are usually in a regiment's advance guard. The SAMs and any reinforcing elements from the division's SAM regiment most likely remain with the maneuver regiment's main force. All vehicles have air observers. The SA-16/18 gunners prepare to engage targets in their sectors of observation and fire.

Pursuit

The motorized rifle regiment air defense elements, or possibly a battery from the division's SAM regiment, can augment a motorized rifle battalion in a pursuit. Air defense during pursuit is especially important since the enemy can use air power to reduce the rate of advance and the strength of pursuing OPFOR forces.

DEFENSE

Given the static nature of defensive operations air defense must provide 360 degree security. The OPFOR coordinates fires between all air defense units and supported maneuver units to form a comprehensive defensive fire plan, providing an integrated air defense. Air defense units provide coverage to all levels of the organization and integrate this coverage with the defensive ground battle to ensure continuous air defense. Figure 11-2 shows an example of an integrated air defense plan for a motorized rifle battalion in the defense.

Regiment

The OPFOR believes that the battalions in a division's defending first-echelon regiments are priority targets for attacking enemy aircraft. To defend these battalions regimental air defense weapons deploy well forward, with the ZSU-23-4 platoon or at

least two 2S6 platoons usually supporting first-echelon battalions. The SA-9/13 SAM platoon/battery is probably at the rear of the first-echelon battalions or in the forward area of the second echelon, protecting the regiment's artillery battalion and command post. If the air threat is great, maneuver regiments can have batteries of the divisional SAM regiment allocated for support. The remaining division air defense batteries protect the division's main command post, artillery, rocket, and missile units.

Battalion

In defensive operations the maneuver battalion commander has overall responsibility for the organization and conduct of air defense by his battalion and any attached elements. The regimental air defense battery/battalion commander normally orders a ZSU-23-4 section/2S6 platoon leader to provide protection to a specific maneuver battalion or battalions for a given period of time. During this time, the section/platoon leader reports directly to the maneuver battalion commander. The section/platoon leader also maintains communications with his battery headquarters and the division's air defense target identification and warning network.

When the section/platoon leader reports to a maneuver battalion commander, he receives the battalion's mission and disposition and the commander's tactical plan. The commander may give him further instructions, and they may conduct a joint terrain reconnaissance. The platoon leader identifies likely routes of approach for enemy aircraft, paying special attention to routes suitable for low-flying aircraft and helicopters. He also reconnoiters positions for air defense weapons.

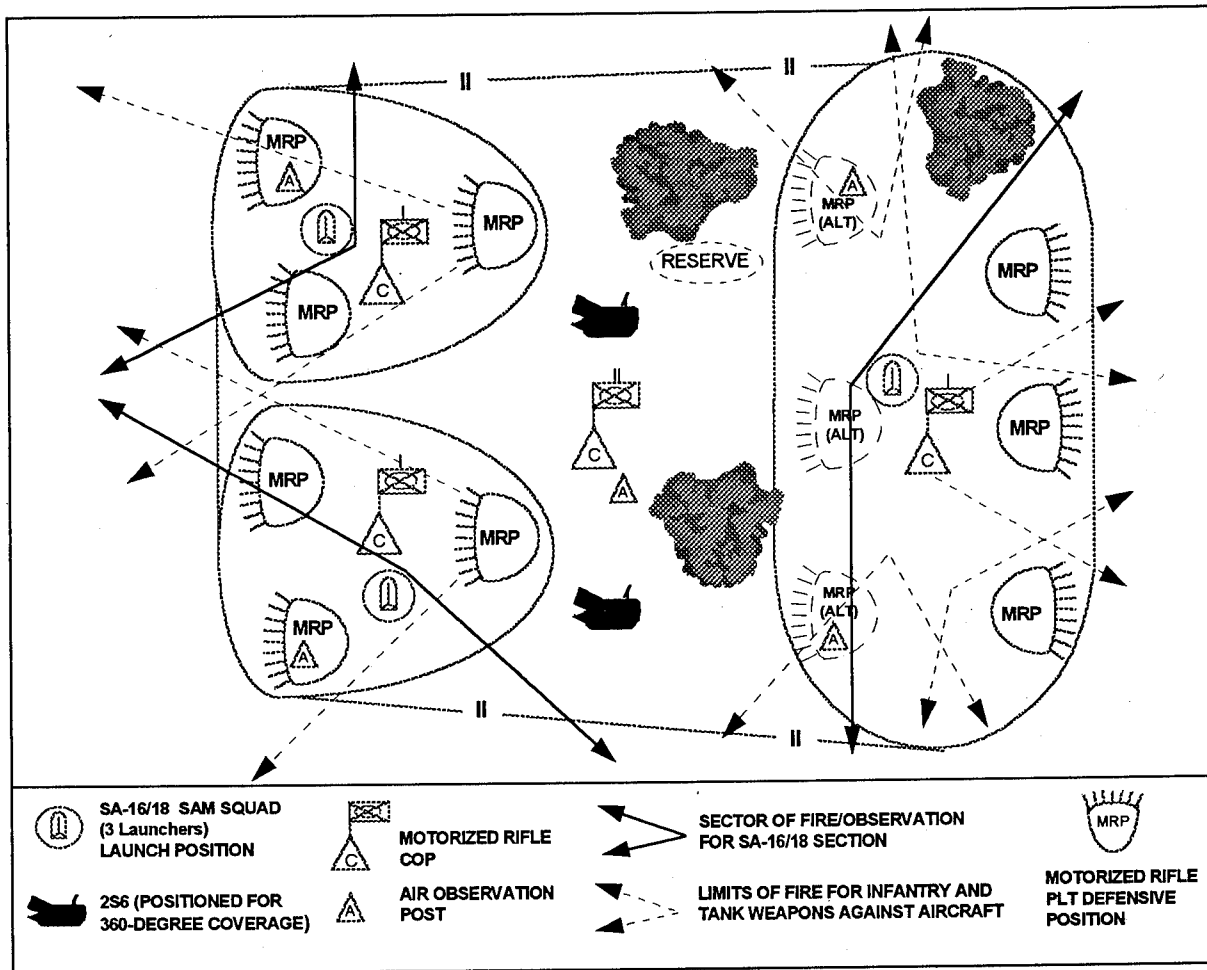

Figure 11-2. Air defense of an MRB in a defensive posture.

Company

Battalion air defense preparations begin at the company level. Each company area has air **observation post (OP)** close to the **command observation post (COP)**. These OPs are on terrain with good visibility and usually on likely routes of enemy air approach. They designate sectors of observation and fire for each post to maintain 360-degree observation of the air space surrounding the battalion's defensive area. Each motorized rifle company area has firing positions for the SA-16/18 SAMs allocated from the parent battalion. These positions often colocate with air OPs near the perimeters of the companies' position, extending the en-

agement envelope as far as possible. While tank subunits have no organic SAMs, they do establish air OPs as part of the battalion's air defense warning system.

EMPLOYMENT

In the defense, as in other combat actions, the ZSU-23-4s/2S6s can deploy in pairs, or sections. The pairs of guns are 1,000 to 2,000 meters apart. Positions for the ZSU-23-4s/2S6s are usually well within a battalion's defensive area. This protects them from enemy observation and direct ground fire and allows better protection for the entire battalion. Air observation posts are in the battalion rear area and at the battal-

ion command observation post. The ZSU-23-4 section/2S6 platoon command post is usually near the battalion COP.

The battalion's air defense capabilities are only part of an overall air defense fire plan. The battalions primary preparation is against low-flying aircraft that are capable of penetrating the air defense network and attacking the battalion. In the conduct of the defense, the OPFOR prefers to engage enemy aircraft prematurely and waste some ammunition as opposed to waiting to fire from an advantageous position and allowing the aircraft to expend its ordnance. The OPFOR fires on aircraft continuously and as long as they remain in range. On a priority basis, the OPFOR engages aircraft posing the greatest threat. The preferred technique is to fire at an already engaged target rather than to switch from target to target. This continues unless a later acquired target threatens the air defense elements. Air observers and weapon crews outside the attacked sector maintain observation and readiness to fire. This prevents enemy success through simultaneous air attacks from several directions.

Second-echelon battalions of a regiment locate several km behind the forward edge of the enemy's defense and usually do not have attached air defense elements. They benefit from the efforts of all air defense elements located to their front.

Second-echelon maneuver regiments develop their air defense plan in coordination with the division's chief of air defense. It is also likely that one or more of the division's missile firing batteries will locate in the defensive areas of these second-echelon regiments. In all cases, second-echelon regiments employ both active and passive air defense measures. These measures include--

- Establishing air OPs.
- Planning surface-to-air missile and massed unit fires.
- Employing camouflage measures.

RECONNAISSANCE

The OPFOR concept of reconnaissance in air defense includes **airspace surveillance** and **evaluation of terrain** suitable for weapon positions. Continuous monitoring of the surrounding air space ensures current data on the enemy air situation. The commanders of the supported unit and the supporting air defense element conduct terrain reconnaissance to tentatively identify positions to deploy air defense weapons in defensive areas. They try to locate positions along routes of march or in areas they feel the advancing OPFOR could seize. The OPFOR stresses identification of all potential attack routes for enemy aircraft. Routes of approach suitable for attack helicopters and positions from which these helicopters can employ ATGMs are of special concern.

OPFOR technical reconnaissance improvements have not reduced the importance of visual reconnaissance. Commanders have learned that an effective visual surveillance system often provides the first warning of an enemy air attack. All units operating close to enemy forces or in areas where enemy air attack is likely have posted air observers. They conduct visual air surveillance on a 360-degree basis. According to the OPFOR, an observer can detect aircraft at ranges from 2 to 5 km when he is assigned a 60 to 90 degree sector of observation. The OPFOR feels an observer with a 30 degree sector can detect aircraft at ranges of 6 to 7 km. Of course, terrain and visibility affect these distances.

The OPFOR also uses **electronic observation** to conduct air surveillance, with radar providing an all weather detection capability. When possible, higher-level radar units pass preliminary targets to air defense commanders and their firing batteries. This reduces the vulnerability of battery radar, radar equipped guns and missile launchers to electronic countermeasures.

ELECTRONIC COUNTERMEASURES

The OPFOR is aware of the developments in enemy ECM and radar homing ordnance. Radar personnel receive training in countermeasures against enemy aircraft that use chaff, jamming devices, and radar homing weapons. OPFOR air defense units employ the following measures to combat the effects of ECM:

SIGNAL SECURITY

The radar of the SAM and anti-aircraft systems that move forward to cover the initial assault remain silent until after the assault begins.

Frequency spread

Each of the air defense systems operates within separate radar frequency bands.

Frequency diversity

OPFOR tracking and guidance radar change frequencies to overcome jamming.

Multiple and interchangeable missile guidance systems

Some OPFOR systems work on pulsed radar; others work on continuous

wave. Some radar tracking systems also possess optical tracking for continued operations in a high ECM environment. Other systems use infrared homing.

LIMITATIONS

Impressive as it seems, OPFOR air defense systems have limitations. Potential weaknesses in the OPFOR air defense system are:

Continuity

Failures in communication, of weapons to keep up with the advance, or in planning are likely to lead to holes in the air defense umbrella. This is particularly likely in a high speed advance.

Airspace Management

The OPFOR coordination of air and air defense efforts will be very difficult. Even with a simple "switch-on, switch-off" policy for ground forces weapons, the OPFOR is in danger of engaging its own aircraft.

Logistics

Ammunition, very bulky in the case of SAMs, can be expended at a rate that will cause problems in resupply. This is particularly likely in the event of failures in the centralized command and control system and/or if ECM is very effective. This could force SAM units into firing salvos to engage targets rather than single missiles.

TRENDS

The most evident trend in OPFOR **tactical air defense development** is the progressive increase in the size of the engagement

envelope and the lethality of the weapons. The air defense forces continually receive new weapons systems and modify previously fielded systems. The more recently fielded weapons systems have redundant missile guidance features that provide an enhanced ability to conduct successful engagements in a sophisticated countermeasures environment.

Overall, the division's air defense capabilities have progressed from a point defense system to an area defense system. The area defense weapons of *front* and army and the division's point defense weapons combine capabilities. This combination gives OPFOR ground forces a comprehensive, overlapping, and mobile area air defense system. The OPFOR is now combining ground-based air defense assets with fixed-wing aircraft forces to provide an integrated air defense umbrella to ground forces.

Chapter 12

Engineer Support

The OPFOR recognizes that engineer support is vital for the successful execution of combined arms operations. Due to the fluid nature of modern combined arms combat, effective engineer support is essential for ground forces to maintain high speed operations.

ENGINEER TROOPS

The OPFOR classifies engineer troops as "special" troops. This means they carry out unique special functions in their area of expertise for all elements of the OPFOR armed forces. At the operational level (Army and above), a staff officer called the Chief of Engineer Troops is responsible for planning the employment engineer assets. At the tactical level (Division and Regiment) staffs include a Chief of Engineer Services to perform the same function. The maneuver regiment is the lowest level with an organic engineer unit. This unit, an Engineer company, supports all regimental efforts. Under certain circumstances, the regimental commander may require some of these engineers to support the maneuver battalions for a specific mission.

Engineer troops include two basic types of engineers: **combat engineers**, also known as sappers, and **special category engineers**. Sappers perform tasks that can require direct contact with the enemy, while special category engineers do not normally engage the enemy. Together, these engineer troops perform the engineer support missions necessary for the OPFOR to succeed on the modern battlefield.

Engineer troops form elements of combined arms organizations--*fronts*, armies/army corps, divisions, brigade, and regiments and range in size from brigades to sections. Divisions have an engineer battalion made up of a combat engineer (sapper) company, assault crossing company, technical (construction) company, road/bridge construction company, pontoon bridge company, reconnaissance platoon, signal platoon, and maintenance material support platoons and a headquarters platoon. Airborne divisions have a smaller engineer battalion, with no heavy vehicle-launched bridging equipment, ferries, or pontoon bridge sections.

OPFOR maneuver regiments have an organic engineer company. The regimental engineer company contains a mine warfare platoon, a technical platoon, and a bridge platoon. The company has armored personnel carriers, and assorted mine clearing and mine laying equipment. Regiments rely heavily on their organic engineer company to:

- Provide obstacles.
- Execute route reconnaissance and obstacle breaching.
- Support crossing of water and dry gaps.
- Provide earth-moving capability for road work and entrenchments.
- Execute camouflage and demolition measures.

The maneuver battalion has no organic engineers. However, OPFOR maneuver units do have some engineer related equipment to give them an rudimentary autonomous capability to perform some en-

gineer type tasks. For instance, many tracked vehicles, especially those with a T-64/72 tank-based chassis, have an integral self-entrenching blade. That means tanks, artillery, and other tracked vehicles can dig a hasty fighting position on their own when going into the defense. Additionally, during river crossings, a large portion of the OPFOR fleet is amphibious, thereby allowing infantry fighting vehicles, air defense, artillery, and other vehicles to cross without extensive engineer preparation. In the area of mine warfare, every member of the OPFOR learns how to emplace landmines by hand as a common task. Lastly, the bulk of the mechanical mine clearing assets belong to the maneuver battalions. Each tank platoon, and some motorized rifle platoons, have one vehicle with a track-width mine plow continuously attached. That means that one in three tanks has a mine plow. Additionally, there is one mine-roller set assigned to each tank company which is attached to a tank only when required. Until then, it is transported by the regimental engineers and mounted using an engineer crane at a pre-planned assembly area.

If necessary, the maneuver battalion commander will receive additional engineer support from his senior commanders to enable him to accomplish his mission and to augment the battalion's limited autonomous capabilities. This enhances the battalion's ability to cross natural and man-made obstacles, and to construct defensive positions and barriers.

ENGINEER EMPLOYMENT

As with artillery, OPFOR engineer units normally do not deploy as complete entities. Instead, engineers are task oriented and perform multiple missions simultaneously. In this way route clearing assets per-

form one function, while others perform demolitions, minelaying or obstacle construction, prepare defensive fighting positions, or set up water purification sites. The tactical employment of engineers does not follow strict organizational lines. Instead, engineer assets are grouped together to perform specific missions and functions based upon METT-T (mission, enemy, terrain, time, troops available). Occasionally, additional non-engineer assets, such as chemical, tank or motorized rifle troops, may be attached to these groupings also. Typical task oriented engineer groupings are listed below:

- Mobile obstacle detachment (MOD).
- Movement support detachment (MSD).
- Engineer reconnaissance patrol.
- Engineer observation post.
- Engineer photography post.
- Obstacle-clearing group.

Training

The OPFOR maintains its combat engineers at the highest possible state of readiness. Based on combat experience the OPFOR expects all ground forces to take advantage of the terrain, to dig in for protection against enemy fire, and to cross obstacles and barriers. To support this objective, engineer troops are highly integrated in all military activities.

OPFOR engineer training stresses **simplicity, repetition, and realism**. Following successful completion of basic soldier training, the conscript is formally inducted for service and assigned to a unit for duty. Soldiers assigned to engineer units then learn engineer specific tasks ranging from individual skills through unit level training. As the soldier masters individual skills, he then learns crew or section tasks, finally progressing up to sub-unit battle drills and missions.

This three-phase training procedure applies to each engineer task.

Troop Control

Each combined arms commander has a Chief of Engineer Service (Troops) on his staff to provide advice, coordination, and supervision of organic and attached engineer assets. This staff officer is responsible for determining the best employment of engineer assets, available to the command, to support the mission, intent, and objectives of the combined arms commander. He determines the priority of effort, organizes the necessary engineer support, then tasks engineer unit commanders, and monitors the execution of the directed missions. The Chief of Engineer Services provides input to the commander's combat orders and battle plans, the reconnaissance plan, the obstacle plan, crossing of water obstacles and other barriers, the line of march, and defensive plans. On the other hand, engineer unit commanders are responsible for the supervision of the unit, accomplishing assigned missions, maintenance the equipment, and the welfare, training, and care of the personnel. Since OPFOR doctrine reinforces success and concentrates massed resources to quickly and decisively influence the battle, the Chief of Engineer Services (CES) usually focuses engineer efforts in support of the main offensive effort, or in a critical defensive sector. The main steps performed by the CES in support of combat actions are:

- Deciding appropriate organization of engineer support and reporting it to the combined arms commander.
- Participation in the reconnaissance conducted by the combined arms

commander.

- Planning the execution of engineer support and tasking engineer units.
- Controlling/directing engineer groupings and monitoring the completion of tasks during the preparation for, and conduct of, combat operations.
- Organizing engineer technical support.
- Reporting the status of engineer support to the combined arms commander.

The **basic missions** of OPFOR combat engineer support have both tactical and technical parameters. The **nine technical tasks** that engineer troops perform in support of combined arms operations are--

- Reconnaissance.
- Preparation of fortifications.
- Prepare and maintain routes of movement.
- Obstacle clearing.
- Equip and maintain gap crossings.
- Establish engineer obstacles.
- Carry out engineer camouflage measures.
- Extract and purify water and establish supply points.
- Carry out engineer measures to eliminate after effects of nuclear strikes.

The three tasks that are primarily combat engineer tasks are **reconnaissance, obstacle clearing, and establishing engineer obstacles**. The remaining six are considered special category engineers. However, even though some may have a given specialty, all engineers are continually cross trained in all the engineer functions so they

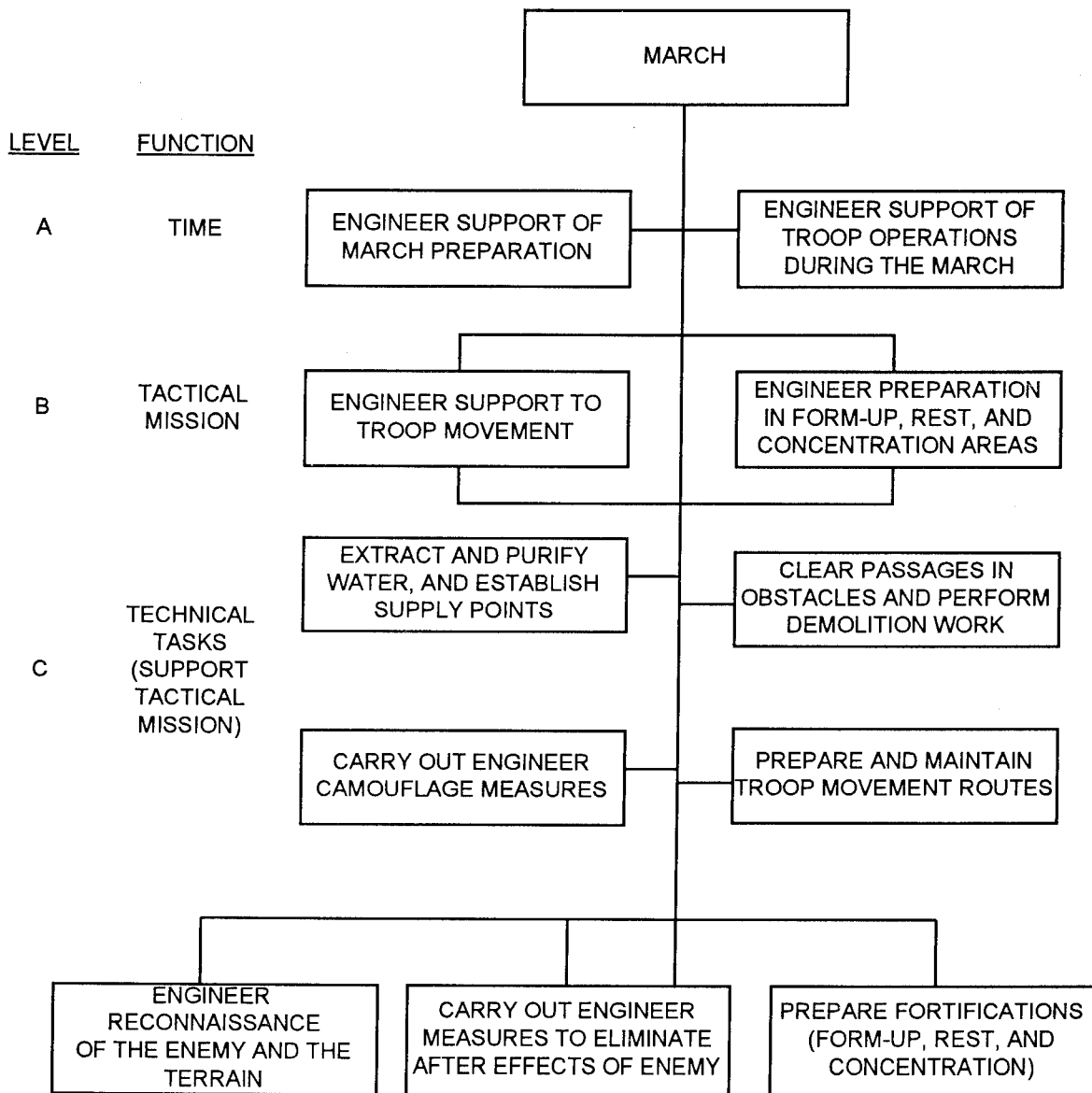

Figure 12-1. Combat engineer tactical missions and technical tasks on the march.

can perform secondary or augmentation missions as necessary.

MISSIONS

Engineer support missions and their related technical tasks vary according to the activity or tactical operation of the supported maneuver units. The three major phases of tactical operations are the **March**, the **Of-**

fense, and the **Defense**. Figures 12-1, 12-2, and 12-3 reflect the missions and required technical subtasks engineer troops perform in support of each tactical operation. The combined arms commander specifies the tactical operation and mission(s), the start time and duration of the operation, and the area the operation will take place. With this information, the chief of engineer service determines the required engineer missions sup

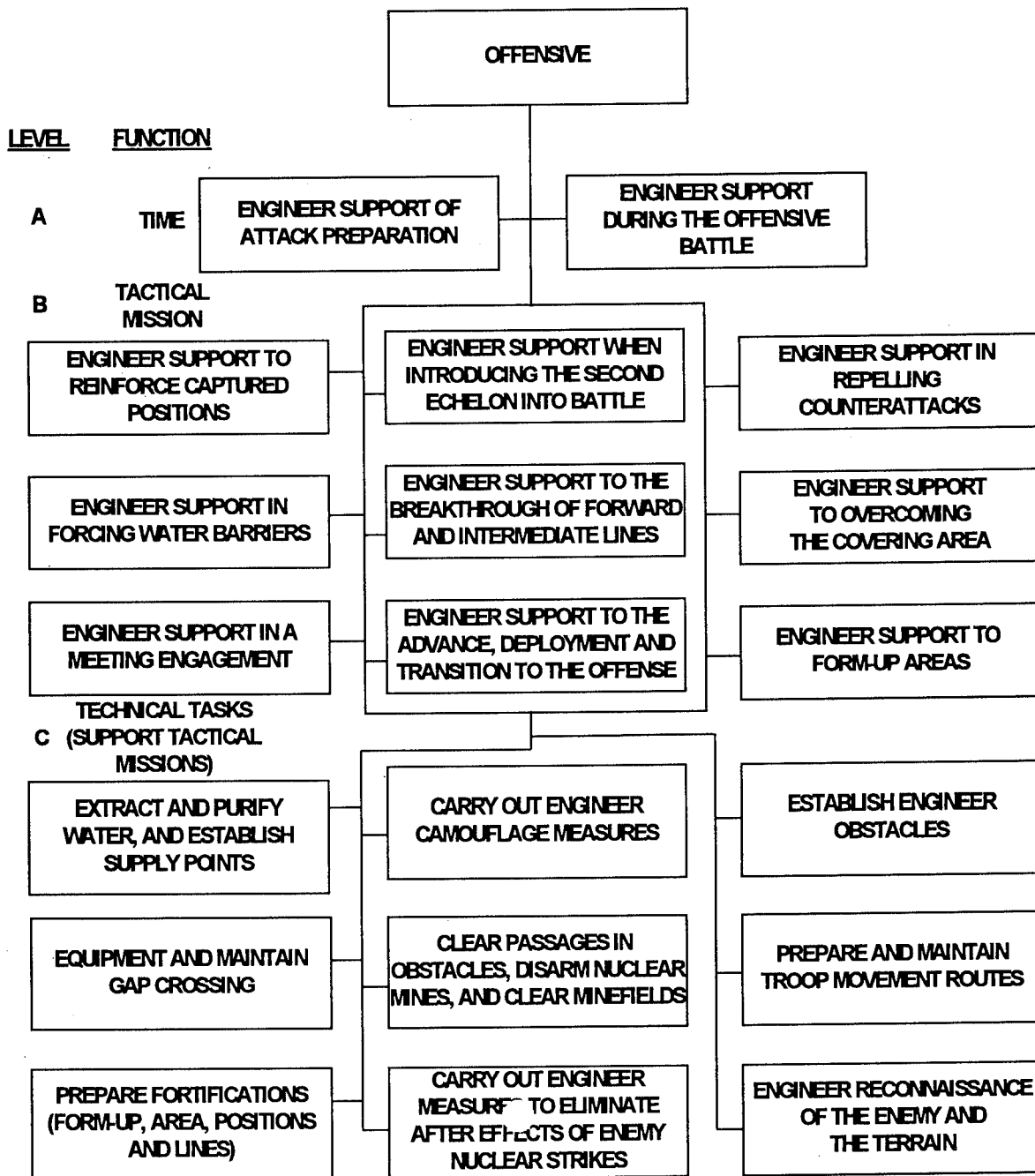

Figure 12-2. Combat engineer tactical missions and technical tasks in the offense.

porting the operation (level A and B) and prioritizes engineer efforts to execute the technical tasks (level C) necessary to accomplish the mission. He can then determine appropriate the mix of troops, equipment, and materials necessary to perform the tasks under current conditions.

March

In support of the march, combat engineers are responsible for accomplishing the technical tasks shown in Figure 12-1. The time at which these tasks are performed de

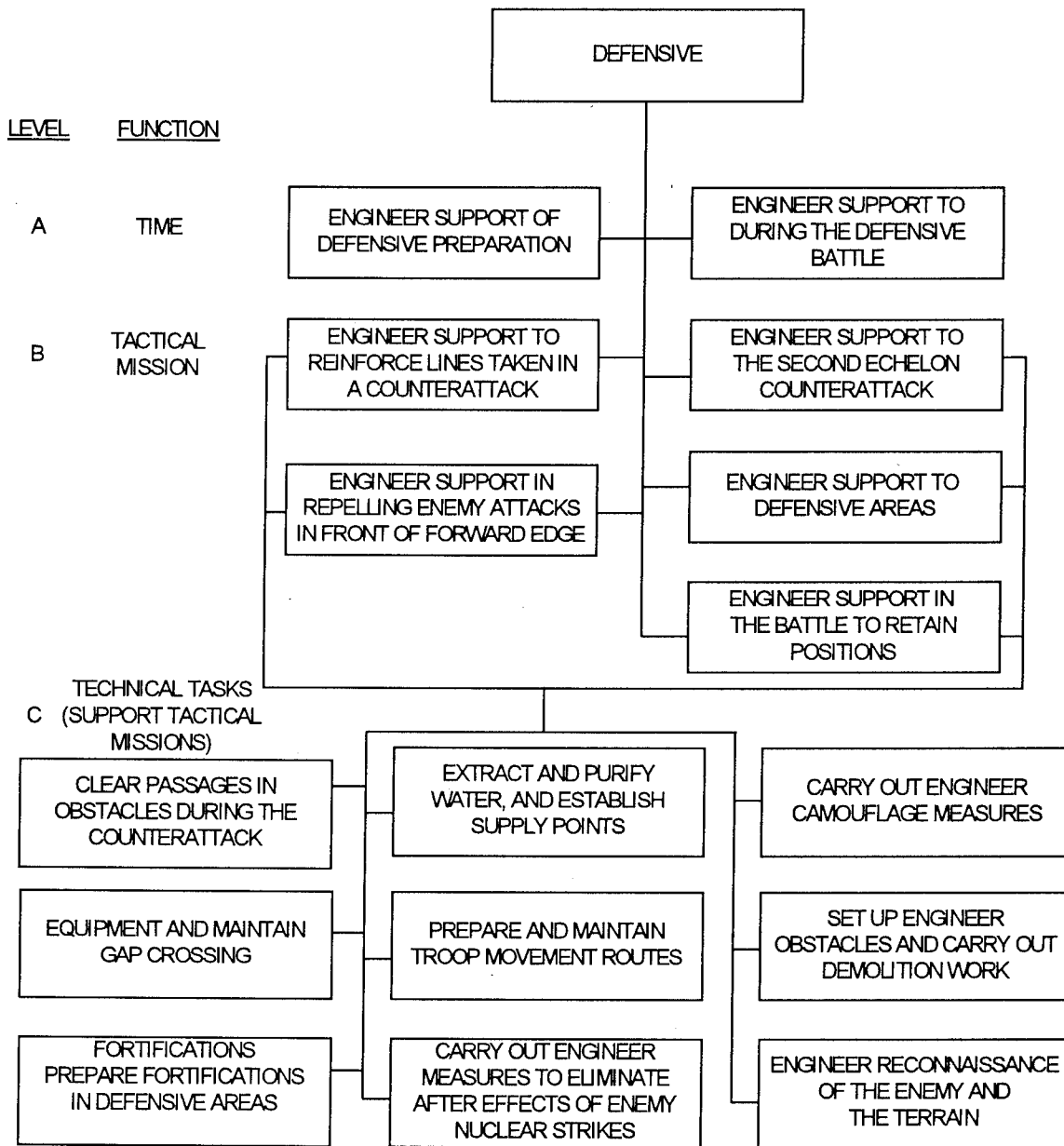

Figure 12-3. Combat engineer tactical missions and technical tasks in the defense.

termines if they are in support of march preparation or in support of troop activity during the march (level A). On the march, there are two principal tactical missions (level B): engineer preparation in form-up, rest, and concentration areas, and engineer support to troop movement. All seven technical tasks identified in Figure 12-1, level C, may be necessary to support the march.

Offense

In support of the offense combat engineers are responsible for providing the troops, equipment, and materials required to satisfy the nine tactical missions, specified in Figure 12-2, level B. Level C of that figure identifies the nine technical tasks that the

combat engineers must perform in support of the offensive operation.

In the offense, the engineers primary mission is to support the attack and assist in maintaining a high tempo of combat operations. During this phase, the engineer emphasis is focused on three major activities:

- Preparation of routes for the advance and employment of combat forces.
- Setting up passages in obstacles and minefields.
- Equipping crossings over water barriers.

Occasionally, some engineer assets may be required to create additional obstacles to assist in flank protection and protection against counterattacks, while other assets provide force protection support to units in assembly areas. Ongoing engineer reconnaissance is can be performed independently or with other reconnaissance elements and plays a critical role in achieving high rates of movement. Basic engineer tasks also include the support of logistic operations in the rear area.

Support During the Conduct of Offensive Operations

Engineer troops continue to perform tasks contributing to a high speed advance once the attack has started. These tasks can provide support to:

- Form-up areas.
- Advance, deployment, and transition to the offense.
- Meeting battle.
- Overcoming the covering force zone.
- Breakthrough of forward and intermediate lines.
- Forcing water barriers.
- Repelling counterattacks.

- Introducing the second echelon into the battle.
- Reinforce captured positions.

Commitment of Second Echelons

The OPFOR views commitment of a second echelon as one of the most critical and vulnerable periods of combat. Engineer troops play a vital part in ensuring its success. They ensure timely arrival on the line of commitment, and provide support for OPFOR deployment and protection against flank attacks. Tasks include:

Reconnaissance. Engineer reconnaissance is performed in the area of the advance and the sector of committal. This is usually a map reconnaissance backed up by a ground or aerial survey of the routes.

Movement Support. Engineer support of second echelon movement is focused on preparing routes and breaching obstacles for the advance and deployment of the combat formation. These can be entirely or in part roads used by the first echelon during its advance. In its move to its line of deployment, a division requires two to three routes, and simultaneously one to two reserve routes should be created. Ideally, engineer work for the commitment of second-echelon forces should be completed by the first echelon engineer resources. This allows the second echelon's organic (attached) engineers to remain fresh, properly deployed, and unburdened for upcoming combat action once the hand-off occurs. When the second-echelon forces reach their line of commitment they need more routes to deploy for battle: at least two for each first-echelon regiment. The preparation of these, together with associated minefield breaching and gap crossing, is the responsibility of the formation being committed to battle.

Defense

Engineer support for defensive operations focuses on reconnaissance, fortifying friendly troop positions, carrying out engineer camouflage measures, and adapting the terrain for defense. This last item includes preparing lateral routes, terrain decontamination, mine clearing, minefield and obstacle emplacement, plus water supply functions. Defensive planning measures ensure extensive use of obstacles, integrated with preplanned direct and indirect fires affect to the enemy's advance and facilitate his destruction. Figure 12-3, level B, identifies five specific tactical missions supported by combat engineer efforts. The performance of nine technical tasks specified in Figure 12-3, level C, satisfies the requirements of engineer troops in the tactical mission.

The extent of engineer preparation depends on the conditions under which the defense is assumed. If it is during the course of the offensive, support begins with the protection of threatened axes by MODs and antitank reserves and the route work needed for regrouping. If the defense is assumed out of contact with the enemy, support begins with the creation of defense works and the improvement of routes for the formation to deploy. In both cases, the goals and missions of engineers are to--

- Support development of the defensive area by
 - ◇ Protecting personnel and equipment from the effects of conventional fire and weapons of mass destruction.
 - ◇ Enhancing the effectiveness of weapons.
 - ◇ Create or improve obstacles.
 - ◇ Extract/purify water supply.
- Support battle and transition to the offense.

- ◇ Provide reconnaissance of enemy and terrain.
- ◇ Repel enemy attacks in front of forward edge.
- ◇ Repel counterattacks or penetrations into defensive sector.
- Support retention of positions.
- Support second echelon counterattack.
- Reinforce lines taken in counterattack.

ENGINEER RECONNAISSANCE

Engineer reconnaissance is done by subunits of engineer forces independently, or in the composition of intelligence collection and combat reconnaissance elements. If the CES needs unique specific engineer data for planning and preparation, he may use engineer assets to form engineer reconnaissance patrols and groups, observation posts, and photographic reconnaissance posts to gather the specific data he needs to support the combined arms commander. Together, this information is used to determine enemy courses of action and posture, the nature of the terrain, and to determine necessary engineer effort required for combat operations. When enemy forces are within visible range, the OPFOR may simply establish engineer observation posts to overwatch critical sectors. If visibility is restricted, the OPFOR supplements these with listening posts. These engineer reconnaissance elements are usually used to gather the following information:

- Enemy engineer preparation of fighting positions.
- Location, type, and composition of enemy obstacles.
- Conditions of roads, bridges, river crossing sights, and routes.
- Presence of local building materials and water supplies.

- Protective and camouflaging properties of the terrain.

Raids and direct observation is useful to gain knowledge of terrain or to assess enemy equipment and fortifications. Ground photography provides information on the enemy defensive posture and engineer preparations within range and direct line of sight. Aerial photography provides information deep within the area of operations.

Elements

To provide engineer expertise, the OPFOR can attach engineer specialists to accompany a division or regimental tactical reconnaissance formation, such as a combat reconnaissance patrol. If needed, there is also an engineer reconnaissance platoon in the engineer battalion of a motorized rifle or tank division which has unique instruments and equipment to provide highly specialized data. Additionally, reconnaissance units of motorized rifle or tank troops can also provide limited engineer related information, although with less technical precision. However, under most conditions, the missions of all these recon elements preclude them from concentrating solely on engineer requirements. Therefore, NIS may form his own engineer recon elements to provide the specific data he needs for planning.

Engineer reconnaissance patrols (groups) can vary in strength from a squad to a platoon. Engineer patrols assess the routes chosen by the staff, checking the validity of plans made from the map. They report on obstacles, the effort required to overcome them, conditions of crossing sites on water obstacles and the general nature of the terrain. Engineer advice is an important element in the combined arms staffs selection of routes and crossing points. The engineer

reconnaissance patrol can also include one or two chemical reconnaissance troops.

Engineer observation posts are normally comprised of two to three sappers equipped with observation instruments, maps, compasses, etc. It is usually located close to the forward edge of friendly troops in terrain which provides natural camouflage, protection, unobstructed viewing, and communications to the rear. With modern equipment, an engineer observation post can overwatch a sector 1-2 km along the front, and 5-6 km in depth.

Routes

When OPFOR engineers reconnoiter routes, one of their goals is to identify anything that could impede mobility. Engineers report information on the condition of the road, obstacles and bypasses, bridge locations, etc., to the chiefs of engineer service (troops) and the commanders of the engineer units. If attempting to assess a large number of features, the commander can increase the size of his reconnaissance party and divide it into smaller teams in order to cover several points simultaneously in the shortest amount of time.

If the march takes place in the rear of friendly forces, combined arms commander can send the engineer reconnaissance patrol in advance to obtain the required data. When they conduct a march in anticipation of contact, engineer reconnaissance may be limited to reports from troop reconnaissance elements reporting on the engineer aspects of the route.

When **reconnoitering routes**, engineers attempt to:

- Verify the condition of the line of march.

- Determine aspects of off-road terrain.
- Identify all obstacles and locate by-passes or recommended breach sites.
- Inspect bridges and hydrotechnical structures.
- Identify suitable rest and concentration areas.

Water Obstacles

When the OPFOR route of advance encompasses potential water obstacles, engineer reconnaissance patrols try to find spots to set up ferrying operations, and bridge crossings, plus assembly or preparation areas. If bridges exist, engineers gather information on the support structure, load capacity, and the presence of mines and demolitions on the approaches and on the bridge itself. The reconnaissance of a water obstacle includes determining the depth, width, and stream velocity, slope of the banks, soil condition on the bottom, presence of underwater obstructions or mines, and the camouflage potential of the area.

Depending on the scale of the operation, a water obstacle can be reconnoitered by an engineer recon patrol, or the recon element of a Movement Support Detachment. The divisional engineer battalion has qualified divers with scuba gear, plus specialized vehicles and equipment to analyze soil data, stream velocities, and depth, plus mine detection equipment. This information is transmitted to the CES for planning purposes and recommended sites, by-passes, routes, and critical areas are marked for the follow-on engineer elements who will be responsible for establishing the crossing.

Water Supply

The OPFOR organizes water-supply points on the basis of data concerning the

location and quality of ground and surface water. Water supply reconnaissance parties can consist of engineer, chemical, and medical personnel.

Reconnaissance in the Offense

Engineer reconnaissance during preparation for offensive operations tries to obtain information on the nature of enemy fortifications and defensive positions, the composition and types of equipment and obstacles of the opposing forces. The basic methods for obtaining this information are **raids, observation and aerial or ground photography.**

Engineer observation posts from subunits in direct contact with the enemy and from troops going into an attack from the march carry out reconnaissance by observation. Engineer photographic reconnaissance posts photograph enemy defenses from the ground. Forces of higher-level commanders conduct aerial photography.

During the offensive, the primary engineer reconnaissance mission is to obtain more precise information on:

- Enemy obstacles and destruction created both during attack preparation and during the attack.
- Troop movement routes and trafficability of off-road terrain for attacking combat units.
- Locations where the enemy established obstacles during his withdrawal.
- Water obstacles on the main axis of advance.

Once offensive operations have started aerial reconnaissance and assets of higher-level commanders continue to reconnoiter obstacles deep in the enemy's defen-

sive area while engineer and maneuver troops confirm this information through the course of battle.

Reconnaissance in the Defense

During actual defensive combat, engineer observation posts monitor enemy engineer activity, evaluate zones of destruction, and report areas where the enemy is breaching defensive obstacles. At least one of the posts provide detailed photography of the area of interest. The posts forward all information to the combined arms commander and the chief of engineer service. When the OPFOR is on the defensive, engineer reconnaissance elements continue to reconnoiter terrain and the enemy situation to determine routes best suited for a return to offensive action.

FORTIFICATIONS

Preparing fortified positions, to include command posts, is a task for engineers on the march, in the attack, and in the defense. Fortified positions increase weapons effectiveness and protect personnel, weapons, and materiel from enemy targeting and reconnaissance assets, and the effects of enemy attack. Although engineers have the bulk of specialized equipment for constructing sophisticated survivability positions, the responsibility for developing and improving these positions is distributed throughout the force. Subunits of all arms of services are required to exert maximum effort to prepare positions taking advantage of protective and camouflaging properties of the terrain, local building materials, engineer technical equipment, explosives, and prefabricated installations.

Levels of Fortification Protection

OPFOR field fortifications are categorized according to purpose and divided into structures for firing, observation, and protection for personnel, equipment, and materiel. The OPFOR also classifies fortified structures according to the level of protection provided against direct and indirect fire, as indicated below.

Open

These structures include emplacements for motorized rifle squads and fighting equipment, fighting trenches, communication trenches, slit trenches, and the simplest installations for observation and vehicle pits. These positions protect personnel and equipment from flat trajectory fire and reduce the effects from blasts of conventional and nuclear munitions by a factor of 1.5 to 2 times over unprotected positions.

Semi-Closed

These structures comprise partially covered sections of fighting trenches and communications trenches consisting of light overhead trench covers with a layer of dirt, and also partially covered pits for the fighting and transportation equipment.

Closed

Closed structures include trenches, dugouts, shelters and permanent weapon emplacements which provide protection for the personnel from all types of enemy fire and from all destructive factors of nuclear weapons or incendiaries.

March

During the march the OPFOR establishes rest, halt, and assembly areas to protect the unit from attack. In doing so, engineers check the entire area for mines and prepare routes within the vicinity. They erect protective covers for personnel and materiel, and as a minimum dig positions for air defense weapons. They erect security structures at control points, identify water sources, and take camouflage measures.

Rest Areas

The OPFOR does not usually fortify rest areas because they are extremely temporary and last only an hour or more. Troops use organic camouflage nets to augment natural vegetation for concealment. The amount of engineer preparation at rest areas depends on the length of time a unit plans to remain at that location.

Halt Areas

When the unit is to be in a halt area for a day or more it can spend ten to twelve hours carrying out engineer tasks. These tasks include preparing covered slit trenches and partially dug shelters for all personnel. They can also prepare hasty or prefabricated shelters for command posts and medical stations and covered revetments for supply stockpiles.

Offense

The OPFOR approaches field fortification in a manner that benefits the offensive by allowing a smooth and protected movement to contact with the enemy. The OPFOR locates assembly areas far enough behind the friendly lines to deny the enemy ground observation and lessen direct fire ef-

fects. The OPFOR tries to prepare a separate assembly area for each battalion sized unit, using engineer equipment to construct positions for vehicles shortly after they arrive at their assigned location. Within one to two hours, engineers dig fighting positions for all personnel. They prepare prefabricated structures for battalion command and observation posts and carefully camouflage all structures.

Defense

OPFOR field fortification of defensive positions involves individual and crew served fighting positions, entrenchments, communication ditches, firing positions for tanks, infantry fighting vehicles, air defense and other weapon systems, and also protection for logistical or command and control sites. This process is performed simultaneously throughout the force, with infantry using shovels and armored vehicles using integral self-entrenching blades, if available. Meanwhile, specialized engineer equipment digs positions for critical sites such as medical facilities and command and control centers. As engineer equipment becomes available, it is then tasked to support maneuver units by augmenting and improving on the work they have already begun. The amount, sequence and time for the fortification of an area is determined by the combined arms commander depending upon the projected time of stay, the conditions of the terrain, and the upcoming combat tasks.

Priorities

Commanders assign fortification priorities to tasks that provide the best level of protection at all times against a possible enemy attack. The normal priority is from "front to rear", beginning with the primary fighting positions, then the temporary posi-

tions, alternate positions, and if possible dummy positions.

One of the greatest factors influencing the level and sequence of fortification preparation is whether the transition to the defense will be in-contact, or out-of-contact with the enemy. If first echelon maneuver units are in direct contact with the enemy, in both observation and direct fire range when forced into the defense, they will likely prepare their own hasty positions as best as possible, given the conditions. Meanwhile, the combined arms commander will use his limited engineer equipment to strengthen the depth of his defense, maximize the effectiveness of his weapons, and prepare alternate positions for front line troops to withdraw to when necessary. Preferably, engineer preparations occur at night or under other conditions of reduced visibility.

The development of fortifications in the defensive area is done in a sequence which guarantees the constant combat readiness of the personnel while simultaneously providing an increase in protection from enemy weapons. During this process, extensive use of camouflage is employed to hide OPFOR activities from ground and air observation. Under optimum conditions, the development of defensive fortifications for a motorized rifle (tank) battalion is as follows:

First: Sectors of observation and fire are cleared and individual emplacements are hastily prepared for personnel, tanks, antitank, air defense, and other weapons. Open slit trenches are used for personnel, and dug outs are made for command-observation and medical points using covered slit trenches. Camouflage measures are also performed.

Second: Covered slit trenches and dug outs are prepared for the personnel, individual placements are connected into squad sections, and emplacements for alternate fighting positions are prepared.

Later: Squad, platoon, and company strongpoints are connected with one another, shelters are built (one per MRC), niches for ammunition are prepared in trenches, overhead protection is improved, and communication trenches are excavated to the rear.

MOVEMENT SUPPORT

The OPFOR combined arms commander uses information gathered as a result of earlier engineer reconnaissance to select appropriate line of march. The line of march selected should require the least amount of engineer preparation and employment of engineer assets for route clearing.

Lines of March

The OPFOR defines a line of march as any military road or cross-country road used for the movement of ground forces. A military road is an existing or newly built road equipped for the movement of fighting equipment and truck transportation. A cross country road is a sector, selected in the terrain and prepared or equipped for the one-time passage of military columns. The OPFOR categorizes a line of march by direction (frontal and lateral), significance (primary and secondary), and by vehicle type (tracked, wheeled, and mixed).

Military Road

A military road must be 3.0 to 3.5 meters wide for one-way motor vehicle traffic and 4.0 to 4.5 meters wide for tanks. For two-way traffic, the widths are 6 to 7 meters

and 8 to 9 meters, respectively. The cross slope must not exceed 3 percent, and the lengthwise slope cannot be more than 9 percent. This provides for movement of mixed columns at 25 to 30 km/hr and 30 to 40 km/hr for truck columns.

Column Tracks

The width of a one way cross-country track in rugged terrain is 3.5 meters for wheeled traffic and 4.5 meters for tanks. The steepest longitudinal slopes are 9 percent and 20 percent, respectively, and the minimum turning radius is 25 meters.

March Routes

A march route is the direction assigned and designated for the movement of troops. A march route can follow any line of march and may include existing roads, cross country roads, and off-road areas.

Route Preparation and Maintenance

An OPFOR combined arms commander determines the march route. After careful consideration of reconnaissance data, and consultation with the Chief of Engineer Services, he then specifies the particular lines of march his force will use. The CES is then responsible for planning and coordinating engineer support to prepare and maintain the specified lines of march. He prepares the engineer support plan for the commander, then issues orders, missions, and requirements to the organic and attached engineer unit commander for execution. If non-engineer personnel are required to support the line of march, such as armor assets with mine roller/plow sets, chemical troops, etc., then the CES coordinates with the other appropriate staff elements to attach this sup-

port. Depending on the situation, he may concentrate work on one section of road, or divide the line of march into critical sections assigning an element to work on each.

The capability of engineer assets to prepare and maintain routes depends on the amount of work to be done. Optimally a road construction company can maintain up to 80 to 100 km of road per day in moderate terrain. These figures assume minimum earth moving and obstacle-reduction requirements. If the roads receive severe damage, this capability drops to 20 to 40 km per day.

One engineer company can prepare up to 50 to 70 km of cross-country routes per day. The OPFOR reduces these planning figures by 25 percent to 30 percent at night, by 20 percent to 25 percent in the spring and autumn, and by 15 percent to 20 percent in winter. It increases the capabilities by a factor of 1.5 to 2.0 when preparing cross-country routes for tracked vehicles only.

Route Marking

The OPFOR uses standard fabricated signs to control traffic along a line of march. On cross country routes, the OPFOR places markers every 75 to 100 meters, enabling a driver to see two markers simultaneously. The OPFOR uses fewer markers on paved roads. The three basic types of signs the OPFOR uses for lines of march are indicators, warnings, and prohibitions. Indicator signs are erected on the right side on a route of movement, or in pairs along both sides of prepared routes. They are within visual range indicating the direction of traffic and the intended user. Warning signs set up on the right side of the route, 50 to 70 meters from a hazard. Their goal is to get the driver's attention and call for a reduction in

speed. Prohibition signs designate sites where traffic is forbidden.

MOVEMENT SUPPORT DETACHMENT

To support the preparation of lines of march, the Chief of Engineer Services will create a **movement support detachment (MSD)** before the march. Its mission includes--

- Route reconnaissance.
- Minefield clearing and obstacle reduction along the line of march.
- Reinforcement of bridges and minor repairs to roads.
- Creation of column tracks.
- Construction of bypasses.
- Construction of passages through debris and regions of destruction.
- Route marking.

The MSD usually has an engineer officer appointed as the detachment commander who reports the status and progress of his element to the CES and engineer unit commander. The engineer unit commander ensures the detachment commander receives whatever resupply he requires, while the CES advises the combined arms commander on the progress of work and the status or condition of the line of march.

The composition of an MSD is not fixed and varies depending upon the condition of the terrain, character of enemy actions, the amount of work to be done, the assigned rate of movement for the columns, and the availability of engineer troops and equipment. It is strictly a task oriented temporary grouping to support route clearance and movement of the force in preparation for, and during, the march. Once the tactical situation changes and the force transitions into the offense or defense, the MSD is

desolved and the equipment resubordinated with new taskings. When the force assumes the march again, a new MSD will be created, with much of the same equipment, to again support the movement of the force.

Since the MSD performs several technical tasks during its mission, it will frequently consist of several subgroups to perform simultaneous actions. Each subgroup has someone in charge who reports to the MSD commander who, in turn, reports their progress up the chain. Typical subgroups are a reconnaissance and mine clearing group, plus one or two road/bridge construction and repair groups. In addition, it can have at least one motorized rifle or tank platoon attached to provide security and to operate mine plows and rollers. It can also have chemical scouts detailed to monitor the chemical and radiological situation.

Normally, the MSD commander will travel with the reconnaissance and mine clearing group, or else accompany the group completing the most complex tasks. This first group is responsible for making immediate assessments of the terrain and obstacles, identifying bypasses, creates and marks passages through obstacles, determines the character of destruction along the route, and locates building materials. This section will usually have a sapper squad, mine detection equipment, explosives, mine clearing vehicles such a tank with roller and plows, an IMR obstacle clearing vehicle, and possibly and IRM/IPR amphibious engineer recon vehicle.

The road/bridge construction and repair group follows behind the reconnaissance and obstacle reduction group. It makes crossings over obstructions, builds and reinforces bridges, equips fords and bypasses, strengthens the route in swampy sections, and removes damage. This section

will usually have armored or truck launched bridges, float bridges or ferries, BAT route clearing vehicles, one or more engineer squads, plus cranes and road graders. This group also completes the marking of the route which was begun by the reconnaissance and mine clearing group.

Since motorized rifle and tank regiments constitute the maneuver element of the division, the regimental engineer company provides the core of engineer support along the regiment's lines of march. Typically, lead regiments will receive additional engineer reinforcement from division assets, especially if they are supporting the division's main effort. Second-echelon regiments, and those regiments not in the division's main effort may not receive additional reinforcement and may have to rely on their organic engineer company alone. If the division is in the army's first echelon and is participating in the main effort, the army may reinforce the division with an additional combat engineer battalion. A combat engineer platoon is the basis of the movement support detachment, along with motorized rifle subunits, radiation and chemical reconnaissance squads, and subunits from other branches.

The division engineer battalion can form two or three MSDs that are employed on main routes, and, when possible, under the protection of an advance guard or FSE. On other routes, the regiments provide MSDs from their own organic engineer resources. A typical MSD for an unreinforced regiment might consist of only an engineer platoon with attached security subunits.

During the march, the MSD travels in advance of the main body preparing the route so the main force can continue its advance unimpeded. Normally, the lead elements of the MSD appear in the vicinity of

the forward security element (FSE) to begin work in their assigned sectors. To insure the unimpeded movement of the main force, the MSD must complete all engineer preparation before the passing of the remainder of the advanced guard and the arrival of the main force. Once one section of work is completed, the MSD then proceeds to the next critical sector on the line of march and begins again.

The location of the MSD in relation to the FSE depends upon the possibility of enemy contact. If supporting a lead regiment with enemy contact likely, the MSD may follow the forward security element (FSE). If supporting a second echelon regiment, or when enemy contact is minimal, the MSD may be ahead of the FSE and behind the combat reconnaissance patrol (CRP).

It is critically important to the OPFOR that engineer personnel and equipment not performing reconnaissance functions with the guard force, not serving as part of a movement support detachment, and who are not committed to performing a specific task be properly positioned throughout the column. Additionally, special engineers with recovery equipment should be sent ahead and stationed at bridges, dams, and rugged sectors of the route in case they are needed.

OFFENSE

The methods and means of preparing and maintaining routes when on the march generally apply to the offense. In preparation for an attack from the march, the road net includes frontal and lateral routes in the assembly area and in the zone of advance to the forward edge. On the march, one frontal route serves one or several subunits; and there routes for subunits to get from rest and

concentration areas to the primary frontal route. In an attack from the march each battalion should have one frontal route and one lateral route; with cross-country routes for the battalion to advance from their own area to the frontal route.

A battalion usually moves from its assembly area on one frontal route until it reaches the line for deployment into company columns. It moves from that line to the platoon column deployment line using one route per company. From this line there are designated directions to lanes in obstacles in front of the forward edge. There can be lateral routes at the lines for deployment into company and platoon columns. With favorable conditions and enough existing roads, a battalion may have a secondary frontal route. Route preparation and marking begins immediately after subunits occupy their assembly areas and ends two to three hours before movement begins.

Support of Offensive Operations

For an attack from a position in direct contact, motorized rifle and tank subunits prepare routes with designated lanes across natural and man-made obstacles. They prepare cross-country tracks in the battalion assembly area. On these tracks BMPs/BTRs leave their entrenchments and areas, and tanks leave their firing positions to advance toward lanes in obstacles in front of the forward edge. During the attack, each first-echelon battalion should have a prepared battalion column route. Forces of the senior commander prepare a frontal routes for movement of second-echelon battalions, reserves, and artillery. Although not serving as a formal MSD, some of the same route clearing equipment will be tasked with supporting the transition to the offense and

movement support for the commitment of the second echelon.

DEFENSE

In the defense, the OPFOR prepares and maintains lines of movement as it does in the offense, however, damage from enemy attacks may require continual repair work. Defensive route preparation is peculiar in that it is necessary to prepare both frontal and lateral routes on the sole basis of usage time, regardless of who uses them.

In the defense, the OPFOR prepares one frontal route for each battalion from the closest lateral route. The OPFOR prepares cross-country tracks from the battalion rear area to company strongpoints. It also prepares routes of advance to the counterattack deployment line for second-echelon subunits, and routes to firing lines for tank subunits on the basis of one or two per battalion.

At regiment level, organic assets prepare all routes. Higher echelons construct battalion frontal and lateral routes, usually for two-way traffic. Engineers prepare routes for the rapid and concealed deployment of counterattack or blocking forces. They clear, improve, and mark existing roads. Engineer elements of the senior combined arms commander usually prepare maneuver routes to the front and flanks and supply evacuation routes.

WATER CROSSING

Crossing of water obstacles always requires some measure of engineer preparation, even if it is only limited to engineer reconnaissance at the crossing site. Whenever possible, OPFOR divisions attempt to cross water obstacles from the march, with minimum delay, and press the attack into the en-

emy's depth without first halting to consolidate on the far shore. If crossing from the march is not feasible, additional preparation and effort will be required.

The width of the water obstacle affects the method of crossing, the type of crossing, the need for reinforcement, and the length of time to conduct the crossing. In terms of width, obstacles are categorized as narrow (less than 100 m), medium (100-250 m), wide (250-600 m), and large (greater than 600 m).

Narrow water obstacles are crossed by fording, on truck mounted, and low water bridges. Medium obstacles require amphibious assaults, plus ferry equipment and bridges. Wide and large obstacles require amphibious assaults, ferry equipment, floating bridges, or float bridges with fixed approach spans. Although narrow obstacles, canals are placed in a special category because their high water depth and steep banks make it difficult to use assault crossings, ferries, and standard bridging equipment. Therefore, it is often necessary to erect piers and special constructions to negotiate them.

In terms of depth, shallow obstacles are up to 1.5 meters in depth, deep obstacles are 1.5 to 5 m in depth, and very deep obstacles which are over 5m deep.

The OPFOR identifies two methods of overcoming water obstacles: Forcing (when expecting enemy contact) and crossing (when not expecting enemy contact). Crossing is also the generic term identifying the site of a river crossing or the act of crossing. Crossing involves using bridges, ferries, or amphibious combat equipment. An "assault crossing," is a forced crossing when the enemy occupies the far bank. The assault crossing is normally executed in

waves using organic amphibious combat equipment and engineer assault crossing equipment to carry non-amphibious combat material. This type of crossing strives for secrecy, surprise, and high speed supported by obscurity and massive direct and indirect fire. To preserve the secrecy of the intended crossing operation and its location, the OPFOR generally uses minimal preparation or construction prior to its execution. The OPFOR describes two types of forcings: from the march and from positions in direct contact.

OPFOR planners consider forcing a water obstacle from the march to be the principal water crossing method. The OPFOR expects the enemy to use rivers and other water obstacles for defensive purposes. Forcing is then the primary method of overcoming rivers, with the assault crossing as the normal mode for the forcing. Other modes of crossing follow the initial assault crossing, depending on the capabilities of the enemy, the time available, and the characteristics of the river.

Tactical March Formation

The OPFOR march formation when approaching a water obstacle is determined by the mission, enemy and the terrain. Approaching a water obstacle engineer assets are deployed well forward. Motorized rifle units lead and adequate fire support must be pushed forward to overcome expected enemy resistance on the line of the obstacle.

Crossing from the Line of March

As in an ordinary attack this involves the deployment from march configuration to battle formation as late as possible and immediately before assault on the water obstacle. This tactic is used by forward detach-

ments and advance guards and, if the opposition appears to be weak, by the first echelon.

Forward Detachments

When there is an opportunity to seize a bridgehead over an undefended or poorly defended obstacle, or bridge, the division or regimental commander may send out a forward detachment ahead of the main body. A motorized rifle battalion, preferably with BMPs and reinforced by a tank company, an artillery battalion, an air defense platoon and engineer assets, is most often employed in this role. The forward detachment will attempt to pass enemy resistance forward of the obstacle.

Tactical Airborne Landing

A tactical airborne landing is often employed in cooperation with a forward detachment. Typically this consists of a motorized rifle company or battalion inserted by helicopters. The landing may be to seize the crossing site or an existing bridge. It is also common to use the landing force to seize key ground dominating the crossing site or to block the approach of enemy reserves.

Advance Guard

First-echelon regiments can have a reinforce battalion serving as an advance guard or forward detachment. This element will usually do a hasty crossing in two echelons, sending two motorized rifle (tank) companies in the first echelon, and one company in the second echelon. In this case, amphibious infantry fighting vehicles and other amphibious assets cross, while engineer amphibious transporters convey non-amphibious equipment. Tanks attached the battalion can cross on engineer ferries.

Whenever possible, a reinforced battalion should cross in no less than three waves, if circumstance permit.

Main Body

A division can deploy two or three regiments in its first echelon. A tank division is likely to use its two motorized rifle regiments in the first echelon, retaining its tank regiments in the second echelon. A motorized rifle division commander will usually use his BMP regiments in the first echelon due to the BMP's superior fire-power and crossing capabilities. Division ferries travel with first-echelon regiments and hook up with first-echelon battalions 2 km or more from the obstacle.

The division pontoon bridging company marches in front of second-echelon regiments. First-echelon battalions may be reinforced with a company of tanks for direct fire in support of the crossing. Artillery subordinate to first-echelon battalions will march behind the tank company or the first motorized rifle company. The regiments remaining artillery assets will follow first echelon battalions while divisional artillery precedes second-echelon regiments.

Sites

The number of crossing sites depends on terrain, combat formation and the tactical situation. As a rule each first-echelon battalion requires two to three crossing points in a crossing sector, and two alternate sites. If the battalion crosses in one echelon, three main and three alternate sites is required. If possible a tank fording or snorkeling site may be employed. Normally, amphibious transporters are used to cross light vehicles, trucks, towed artillery, and similar equipment. On the other hand, ferries are used to

cross tanks and heavy equipment. At least one bridging site is required for each divisional route.

Crossing with Extensive Preparation

This is usually used against a large, well-defended water obstacle, but can also become necessary if a crossing from the line of march has failed.

Advance Guard

When an assault from the line of march fails, or is not tried because of the strength of the opposition, the advance guard clears the near bank and holds it. Combat reconnaissance patrols and engineer recon elements endeavor to identify enemy obstacle efforts, plus locate enemy positions and determine the character of their defenses.

Main Body

When faced with a well-defined obstacle, the main body moves into regimental concentration areas some 15 to 20 km back from the water obstacle, beyond artillery range.

Motorized Rifle Battalions

Motorized rifle battalions lead the assault, crossing in battalion waves on a regimental frontage of about 5 km. A motorized rifle battalion crosses either in prebattle or battle formation, depending on the width and entry and exit slopes of the crossing sites and on the strength of the enemy. Infantry vehicles enter the water at H hour, and on reaching the far bank the infantry dismounts. Attached engineers then begin clearing obstacles from the far bank if some have been

identified. They are supported from the near bank by direct fire from tanks and artillery.

Tank Battalions

They will not snorkel against strong opposition until a firm bridgehead has been established on the far bank. Tanks from first-echelon regiments are will attempt to cross by ferry, or ford if possible, so they can fire their main guns if necessary.

Bridges

Construction of bridges starts as soon as the enemy is denied the ability to subject the crossing to direct or observed fire. If the air situation is unfavorable bridges may only be used during periods of limited visibility and tucked into the bank and camouflaged at other times.

Artillery

RAGs will be within 3 km of the river with DAGs another 3 to 5 km back. Howitzers can be used in the direct fire role to support the crossing. Artillery crosses the obstacles by batteries, one crossing while two remain deployed.

The preparatory fire for a well-defined water obstacle will be similar to that for an attack from a position of close contact. Intensive air attacks take place shortly before H hour and, depending on visibility, smoke may be used.

Second Echelon and Rear Services

The second echelon and rear services may temporarily move to a hide if the advance is delayed by a water obstacle. Even with optimistic target times, construction of the division bridge, on which these troops

will cross, is unlikely to begin before H+30 minutes and won't be completed before H+60 or H+90 minutes. As soon as it crosses, the second echelon continues the division's advance and is not usually used to consolidate or expand the division's bridgehead.

ENGINEER OBSTACLES

OPFOR engineer obstacles include any actions taken to inflict losses and to delay and impede enemy movement. The creation of engineer obstacles and executing of demolition activities are critical engineer functions in all phases of the battle. In the attack and in meeting engagements obstacles protect flanks, disrupt counterattacks, block reinforcements, and strengthen captured positions. In the defense, engineer obstacles strengthen the defense, disrupt enemy operations, canalize the enemy into fire sacks, and cover gaps between defenders.

The OPFOR divides engineer obstacles into three categories: **explosive**, **non-explosive** and **combination obstacles**. Of the three categories, explosive obstacles are the most common. This is because minefields can be emplaced easier and quicker when compared to the construction effort for non-explosive obstacles. Additionally, scatterable mines frequently have self-destruct or self-neutralization times which can be planned for, and conventional mines can be laid with remote control devices to activate or deactivate the minefield at will. This minimizes the adverse affect of friendly minefields on future operations and reduces the need for the OPFOR to breach its own obstacles. This is not the case with non-explosive obstacles, however, which not only are time and resource intensive to install, but are equally intensive to eliminate. For these reasons, mines and explosive obstacles are

usually the first type of obstacle emplaced, eventually being supplemented by the construction of non-explosive obstacles if time and resources permit. When this occurs, combination obstacles are created which represent the next most common type of obstacle. It is extremely rare for a non-explosive obstacle to be used in isolation without any mines, explosives, or booby traps. A brief description of each category follows.

- **Explosive obstacles**--minefields, groups of mines, and objects prepared for demolition.
- **Nonexplosive obstacles**--antitank ditches, escarpments, abatis, wire barriers, and water obstacles.
- **Combination obstacles**--a combination of explosive and nonexplosive obstacles.

Mobile Obstacle Detachment

Engineer mine warfare platoons usually operate as a mobile obstacle detachment (MOD). The MOD is an engineer task organized grouping whose mission is to quickly emplace obstacles in response to enemy actions in order to decisively alter the battle. The greatest concern to the OPFOR commander is armored attacks and penetrations. Therefore, the MOD is prepared to emplace antitank obstacles along routes of advance that are suitable for tanks if a threat is perceived. The OPFOR has designed and created the MOD to maximize mechanical minelaying and explosive obstacle support for maneuver forces during combat operations. Figure 12-4 shows the actions of a MOD in a meeting battle.

An MOD varies in size according to the tactical situation and the needs of the maneuver commander. The OPFOR employs MODs at the regiment, division, and army levels. The core of every MOD is the

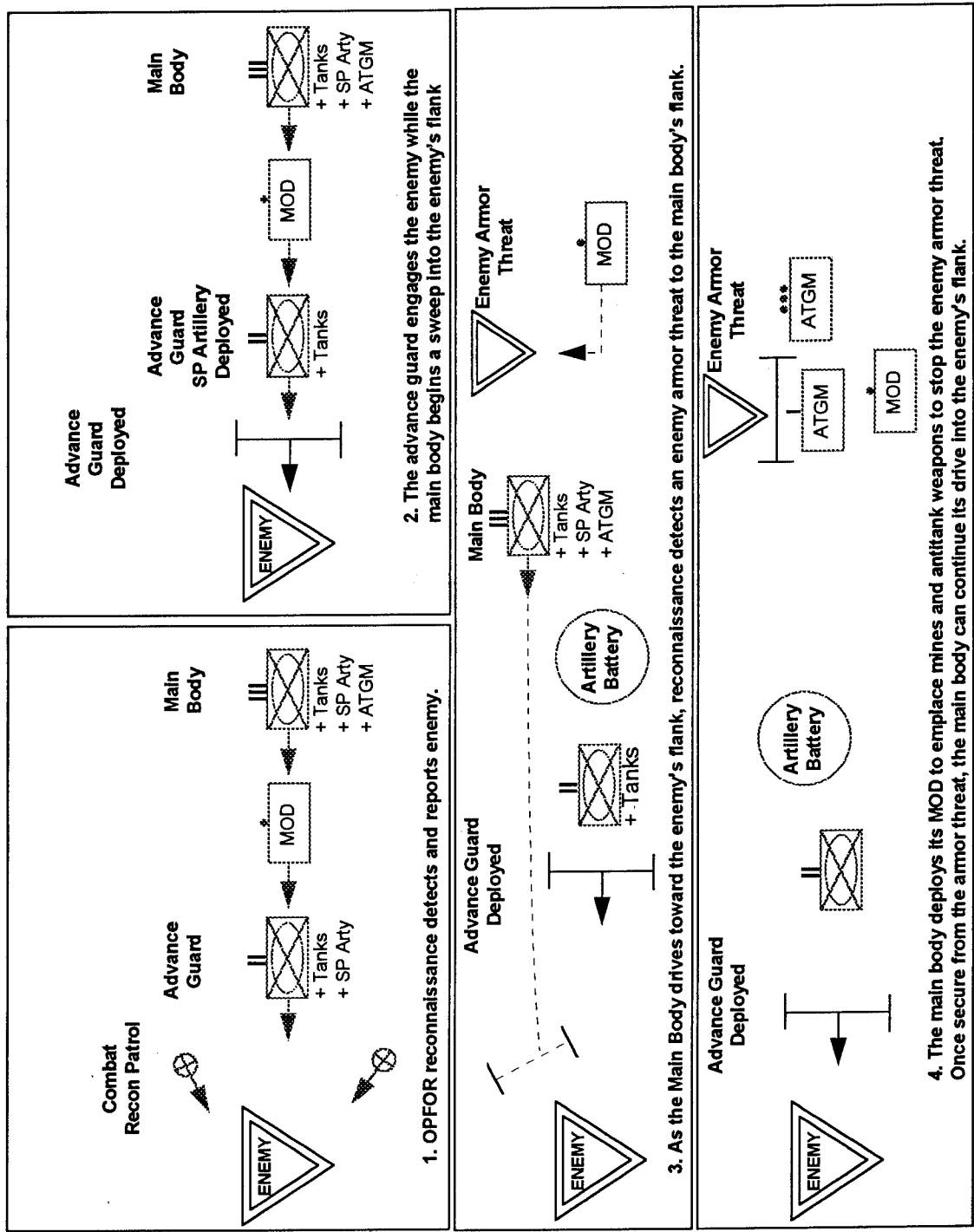

Figure 12-4. MOD in a meeting battle.

mine warfare platoon from the regimental engineer company, or the minelaying platoon from the combat engineer company assigned to the division engineer battalion. These minelayers provide the rapid response and obstacle creation ability, desired by the commander, that other systems or techniques can't provide.

The MOD reports directly to the Chief of Engineer Services who assigns their priorities, areas of concern, and task organization. Although it can operate independently, the CES may attach the MOD to operate with the antitank reserve. This arrangement provides the commander with an organization capable of emplacing antitank obstacles as well as overwatching antitank fires.

Organization

The primary engineer system in the MOD is the mechanical minelayer. The division has three GMZ minelayers in its engineer battalion, plus each maneuver regiment has three minelayers, either the PMR towed minelayer or the GMZ armored tracked minelayer. The division can use its three minelayers to reinforced an existing MOD in a critical regimental sector, or can be used form an additional MOD. In addition to minelayers, MODs may have other engineer resources to support critical obstacle development. If available, the MOD may be supplemented with sappers for demolitions work, ditchers to create antitank ditches, plus other engineer systems. This reinforcement does not normally occur until other tasks, such as preparing fortifications, are completed by the earthmoving equipment.

Employment

Under all circumstances, the MOD must be positioned so that it can deploy to seal a critical sector in response to enemy actions, or to provide time for the commander to shift his forces and fires if necessary. The combined arms commander, the CES, and other staff sections monitor the progress of the force and plan possible enemy courses of action. Locations to emplace obstacles and battle positions are then identified. If reconnaissance assets report enemy activity along a given sector which confirms a course of action, the MOD and antitank reserve are then dispatched to the appropriate battle position to conduct operations.

During the march, the MOD ordinarily travels behind the advance guard and in front of the main body. In a meeting battle, the MOD operates on the axis that supports the deployment of the main body for the attack. In the offensive, the MOD usually moves forward with the antitank reserve, either on an open flank or in a central position ready to deploy to a threatened direction. In the defense, the MOD lays minefields to close gaps in defense, across the axis of an enemy armored advance, blocks enemy breakthroughs or counterattacks, and in front of an enemy air assault in the rear area. Normally, they are in covered and concealed positions on a threatened axis or flank, or in a central position, often between the first and second echelon.

Minefields

Minefields are engineer obstacles that are used extensively during all phases of combat. There are five basic types of OPFOR minefields:

- Antitank.
- Antipersonnel.

- Mixed.
- Decoy.
- Antilanding.

The OPFOR stresses the importance of covering minefields with both direct and indirect fires, particularly with long-range AT weapons. Minefields are used to inflict damage on attacking enemy forces and to slow and canalize enemy forces into kill zones or fire sacks covered by massed fires. Whenever possible, the OPFOR will endeavor to contain enemy forces in a window of vulnerability, for the longest length of time possible, to facilitate their destruction.

Conventional OPFOR minefields generally conform to doctrinal standards. Scatterable minefields, however, are much less predictable in pattern. This standardization insures that engineers and combat personnel follow consistent uniform practices. Subunit commanders will use combat soldiers to emplace protective minefields around fighting positions, while engineers shape the battlefield for the combined arms commander. Subunit commanders emplacing mines prepares minefield records in three copies, one for the unit, one to the regiment, and one to the division. The CES at division and regimental level then use those records to prepare combined obstacle overlays for the combined arms commander. Minefields are a fundamental part of the total obstacle plan which incorporates barriers and terrain features.

Antitank

Antitank minefields are the primary type of OPFOR engineer obstacle. The OPFOR emplaces AT minefields on likely avenues of approach for enemy tanks or other armored vehicles. The OPFOR usually emplaces AT minefields on a frontage of 200

to 300 meters or more and to a depth of 60 to 120 meters. They lay mines in three or four rows with approximately 20 to 40 meters separating each row. The normal spacing between antitank mines in the rows are 4-5.5 m for pressure activated mines, and 9 to 12 m for full width attack mines. The normal mine outlay for 1 km of front in AT minefields is usually 300 to 400 full width attack mines, or 550 to 750 pressure activated mines. This mine outlay can reach 1,000 AT mines or more per km of frontage on major avenues of approach. The OPFOR refers to this density of mines as a "minefield of increased effectiveness." In urban environments, the OPFOR may place groups of AT mines on narrow streets and alleys. It calculates emplacement of anti-vehicular mines at the rate of one mine per 100 meters of street. Figure 12-5 illustrates the general emplacement of an AT minefield.

Antipersonnel

The OPFOR can set up conventional antipersonnel (AP) minefields on the forward edge of friendly defensive positions, in front of AT minefields, or along dismounted avenues of approach. These minefields can consist of blast mines, fragmentation mines, or a mixture of the two. The OPFOR emplaces AP minefields on a frontage of 30 to 300 meters or more with a depth of 10 to 50 meters or more. AP mines are usually laid in two to four rows with a distance of five meters or more between rows. Two thousand to three thousand blast and 100 to 300 fragmentation mines may be emplaced per kilometer of front. An AP minefield of increased effectiveness may have as much as three times the normal outlay of antipersonnel mines. Intervals between mines in a row are at least one meter for blast mines and up to twice their destructive radius for fragmenta

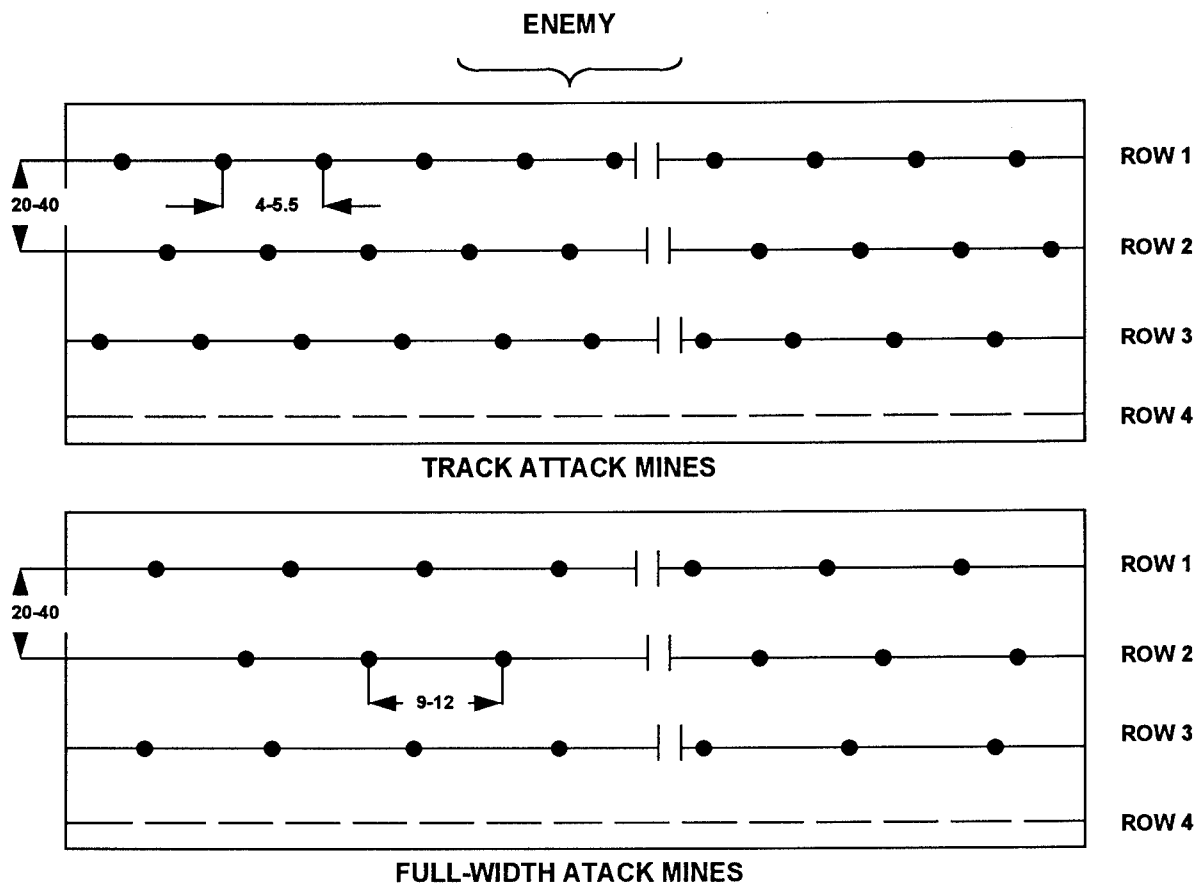

Figure. 12-5. OPFOR antitank minefield configuration.

tion mines. Figure 12-6 shows variations of the employment of AP minefields

Emplacement of minefields with increased effectiveness are more likely on dismounted avenues of approach. In urban environments, the OPFOR can emplace two to three fragmentation mines for every 50 to 100 meters of street. It prefers to use blast mines and fragmentation mines within buildings.

Mixed

Mixed minefields contain both AT and AP mines. However, the OPFOR does not mix AT and AP mines within a mine row. Instead, a mixed minefield is, in fact, a

minefield with pure homogenous rows of either AP or AT mines. The AT mine requirements govern the mixed minefield's parameters, outlay, and density. In areas that are not suitable for tank operations, AP mines may constitute the majority of mixed mine obstacles.

Decoy

The OPFOR uses decoy, or false minefields to mislead the enemy as to the locations of actual minefields. Decoy minefields are part of OPFOR tactical *maskirovka*. Decoy minefields typically give the impression of mining activity, usually scarification of the soil, mine laying debris, minefield fences and markers, et cetera.

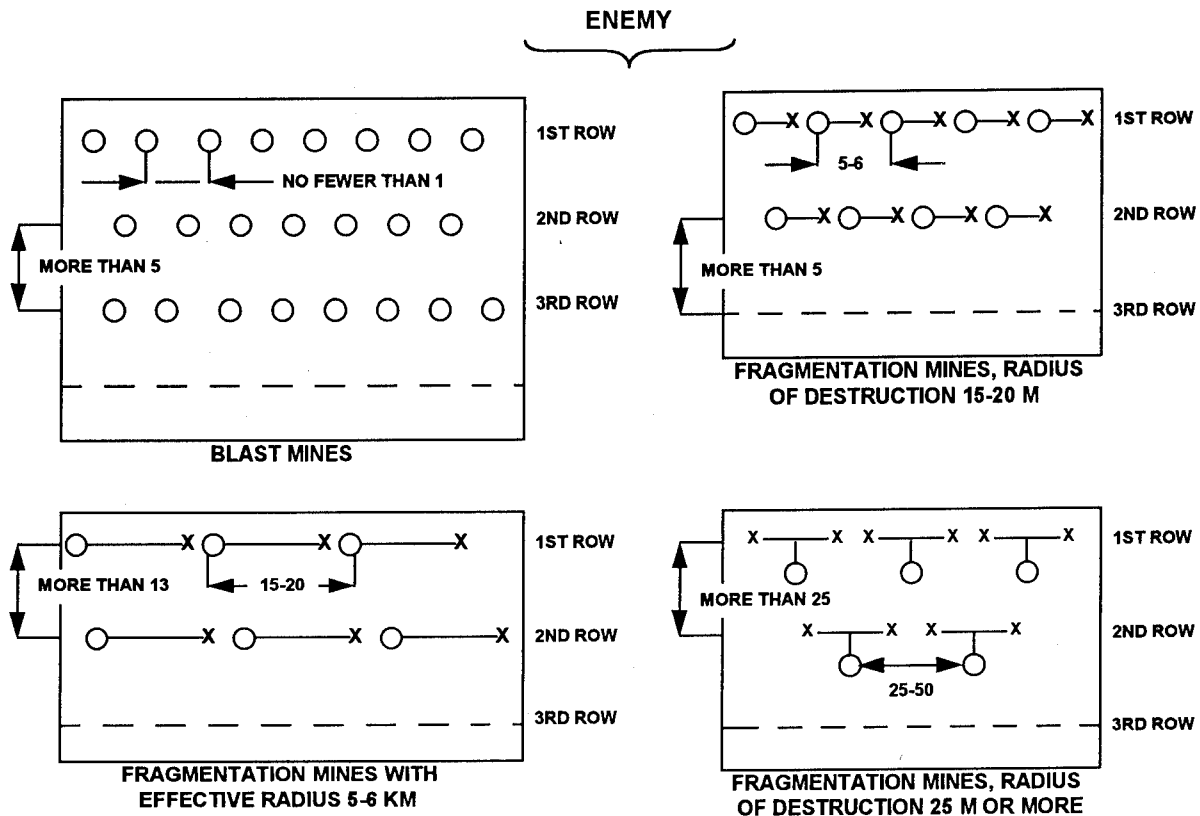

Figure 12-6. Generalized antipersonnel minefield configuration.

Antilanding

The OPFOR uses antilanding mines when conducting combat along the seacoast or inland water features or at possible landing or drop zones. It employs explosive, nonexplosive, and combination obstacles. Minefields established in the water consist of bottom and anchored mines and, at shallower depths, waterproof mines. The OPFOR can use all types of mines above the shoreline, emplacing them following normal minefield doctrine. At landing and drop zones they use fragmentation and directional AP mines.

Minelaying

The OPFOR method and extent of laying the minefields described above depends on:

- The tactical situation.
- Terrain characteristics.
- The type of mine.
- The time available.
- The engineer support available.

Taking these factors into account, the means of emplacing minefields can be manual, mechanical, or remote. Since mine laying is a common task skill, manual emplacement can be performed by anybody, and is the method employed by maneuver units. However, manual mine laying is time consuming and is not possible during high-speed maneuver operations. Mechanical mine layers belong to the engineer forces and can quickly emplace both buried and surface laid minefields. Remote mine laying may be accomplished by missile artillery, aircraft,

and engineer ground scattering dispensers, if available.

With the high tempo of the modern mobile battlefield, remotely delivered mines will increase in frequency. However, in volume, they will never exceed the use of conventional landmines. Scatterable mines can be used to isolate enemy forces so the OPFOR can maintain superior force ratios, can disrupt the attacking forces causing them to deploy and expend mine clearing assets, can disrupt and delay enemy second echelons, reserves or counterattack forces, can paralyze enemy artillery during counterbattery fire, can interdict lines of communications, can prevent the use of a logistic site, can protect flanks, and can seal breaches or gaps in friendly obstacles.

Conventional minefields are more suited to protecting defensive positions that the OPFOR intends to maintain for some time. In this case, it takes greater time to bury and camouflage the mines, and integrate the minefields into the total defensive scheme. Mine density in these types of fields is also greater and is more likely to have a mix of antitank and antipersonnel mines. In setting up a fully prepared defense, troops of all units take part in preparing obstacles and laying mines.

Manual

The OPFOR can manually emplace a minefield when there is no contact with the enemy or when mechanical minelayers are unavailable or their use inadvisable because of terrain restrictions. An engineer platoon can manually lay 200 to 300 AT mines in one to two hours. A mine warfare platoon can recover about 200 AT mines an hour, if they are not equipped with self-destruct or anti-handling devices.

Mechanical

OPFOR engineers rely extensively on mechanized mine planters such as the GMZ vehicle, the PMZ and PMR trailers. Both types of mine layer can bury or surface lay antitank mines. For three row minefields, the OPFOR normally uses the mine warfare platoon with its three mechanical minelayers, one squad per system. The layout of mechanically emplaced minefields is the same as those emplaced by hand.

The normal sequence for mechanically laying mines is to emplace the most forward minefield first and to work progressively back to friendly defensive positions. Typically, the mine laying platoon will line up abreast one another and assume an echelon formation perpendicular to the enemy. By dispensing mines simultaneously as they travel, they ensure that no mine will be directly behind another when approached by the enemy. This increases the probability for a mine encounter by insuring that if an attacker misses the first mine, he should still encounter one in subsequent rows.

Remote

The OPFOR continues to develop methods of remote minelaying, including delivery by minelaying helicopters, fixed-wing aircraft, multiple rocket launchers, or surface to surface missiles. Remote mining provides the OPFOR with the capability to strike targets and project mines deep in enemy territory. Remote minelaying is useful against columns and areas of enemy concentrations, command posts, firing positions, and other objectives.

Multiple rocket launchers are the primary means of remote mine laying. Although aircraft provide another method of

delivering ordinance, they will usually be limited to use along the flanks. The principal advantages of MRL mine delivery is its ability to quickly emplace large minefields in a single volley, while minimizing exposure to enemy targeting and weapon systems. This provides the OPFOR commander with the responsiveness and tactical flexibility that he desires. For instance, a single battery volley from a 220-mm multiple rocket launcher can emplace over 2,300 antitank mines in a minefield approximately 3 km wide.

Demolitions

The OPFOR emphasizes the importance of roads as high-speed avenues of attack for both friendly and enemy forces. It views the creation of obstacles by the use of demolitions on roads as significant ways to disrupt enemy movement. Approaches to water obstacles, overpasses and bridges, ravines, intersections, bypasses, and roadways through urban or rough terrain are critical points at which the OPFOR uses demolitions.

Nonexplosive Obstacles

Nonexplosive obstacles fall into three categories: Antitank, antipersonnel, and antilanding. Nonexplosive antitank obstacles include ditches, Dragon's Teeth and various other man-made and natural barriers. Antipersonnel obstacles include concertina and barbed wire. Antilanding obstacles include Dragon's Teeth, antitank ditches, or wire obstacles placed at landing sites at water obstacles or on airborne or heliborne drop or landing zones.

OBSTACLE CLEARING

The OPFOR anticipates it may have to overcome obstacles during all phases of

combat to include the march, the offense, and in the defense. In the offense, troops expect to cross obstacles in assembly areas, on movement routes, plus in front of and in the depths of the enemy defense. Although creating passages for the advance of the force is an engineer task, tank and motor rifle subunits also have both equipment and trained personnel to conduct limited independent countermine operations. The methods for creating breaches and passages depend on the situation and on the type of barriers the enemy use.

Explosive Obstacles

Of the obstacles the OPFOR expects to encounter, mines are the most significant. The development of remotely delivered, scatterable mines increases the threat to the rear area; and has made clearing explosive obstacles a primary task for the MSD during the march. The OPFOR has three basic means of breaching a minefield. The primary means are explosive and mechanical. The least common is by hand. Explosive line charges, and mechanical mine clearing plows or plow/roller combinations mounted on combat vehicles, provide the main countermine capability.

Scatterable Minefields

An OPFOR subunit may find itself "straddled" by a scatterable minefield during movement in columns. When this happens, it stops, reports its location, and initiates a self-extraction. This is normally done by having outside elements bypass the minefield, by having elements near the edges self-extract to the perimeter, and by having interior elements by gravitate to a central extraction lane. As stated earlier, tanks and some BMPs have been issued one permanently mounted mine plow per platoon. If the

straddled unit does not have plows, or if the mines are full width attack fuzes which negate the effectiveness of the track width plows, crewmen dismount and clear passage lanes by hand. Platoons or companies not on the central lane use their own forces to create passages to it. Follow on elements attempt to bypass known scatterable minefields or use the established, marked lanes created by first-echelon subunits. If engineer assets are available, they can clear scatterable minefields by hand, with explosive line charges, or with obstacle and route clearing vehicles with full width blades.

Two features of scatterable minefields make effective use of explosive breaching systems difficult. The first is that the irregular and less dense perimeter of a scatterable minefield is more difficult to detect. The second is that the dimensions of such a minefield can exceed the breaching depth of the explosive breaching system, even if it has a multiple shot capability. Mechanical means, not limited to a specific depth, are better tools to defeat scatterable mines. Even if explosive means are available to create initial breaches, maneuver forces use their own mechanical means to "proof" the resulting lanes.

Passages in Friendly Minefields During Transition to the Offense

Before launching an attack from positions in direct contact, the OPFOR must clear lanes in its own minefields. This usually occurs one or two hours before the attack, preferably at night. As a rule, the engineer subunits that established the obstacles clear them. This is usually the engineer company of the division's engineer battalion. The company commander receives a mission from the combined arms commander or the chief of engineer service to clear minefields

in a specific area. He then creates teams to clear breach lanes manually using probes, hand held mine detectors, and shovels. In one night, a sapper squad usually clears one lane, a platoon clears three, and a company clears up to nine.

Breaching Minefields in Enemy Defenses

In front of the forward edge of the enemy defenses and within the enemy's defensive area, breaching is a combined arms effort involving all services of troops and a combination of mechanical and explosive means. Normally, the OPFOR commander will create obstacle clearing groups comprised of tanks and motor rifle elements from the lead battalions, reinforced with engineer support.

Normally, engineers reconnoiter the minefield, determine its characteristics, attempt to locate a bypass, and mark the best breach locations if a bypass is unavailable. If possible, sappers will attempt to infiltrate the minefields and manually prepare a breach lane. When possible, this breaching or marking is done at night or under cover of smoke and artillery fire.

Normally, one tank in each platoon will have a mine plow attached. Additionally, each tank company also has a mine roller set, which can be mounted using engineer cranes, when needed. Recently, some OPFOR BMPs have also had mine plows. Engineers can prep breach lanes using bangle torpedos and rocket propelled line charges, or can assemble explosive line charges to be towed behind the breaching tanks. Although, an OPFOR commander would prefer each platoon breach to be successful, he plans to achieve a minimum of six to eight lanes for each of the first-echelon

battalions. Engineers then expand successful breach lanes to facilitate the passage of the force with the goal of making gaps a minimum of 6 to 8 meters wide.

Traffic Control

Once there are cleared lanes with flags or lighted markers, the remainder of maneuver units/subunits begin crossing. Sappers provide traffic control through the cleared lanes. They man traffic control points at the entrance of each lane and, if necessary, at the exit point. They widen, mark, maintain, guard, and reclear the breach, as required. The combined arms commander designates a crossing commander from the sapper company to supervise the crossing of the maneuver elements.

Nonexplosive Obstacles

During the attack, the obstacle clearing group create gaps in both nonexplosive and explosive obstacles. In this case, additional engineer reinforcement will be required beyond just countermine equipment. Obstacle clearing vehicles may be employed to knock down berms, et cetera, as well as tank launched bridges to cross antitank ditches.

On the march, the MSD is organized to reduce obstacles along the route of march and to make the route usable by the maneuver force. To accomplish this, the division engineer battalion has specialized obstacle clearing and route clearing equipment complete with large full width articulated dozer blades and crane/booms with grabbing arms. These can overcome rock barriers and Dragon's Teeth (concrete pillars or iron posts) with explosive charges or mechanical equipment. Sappers can breach wire obstacles after examining them for boobytraps and

electrification. Tree barriers may require the use of bulldozer blades or explosives.

Obstacle Clearing Limitations

Mine plows will be of limited value against mines with influence or anti-disturbance fuzes. The limited number, reliability and lengths of hoses of armored mine clearers limit their effectiveness against deep tactical minefields. Off-route and remotely delivered mines also pose tough problems. OPFOR ground forces will also have difficulty in clearing usable routes quickly through areas subjected to massive preparatory bombardments. The OPFOR hopes to avoid these and other problems by outmaneuvering the enemy and by advancing so fast that the enemy cannot make adequate preparations.

MASKIROVKA

Maskirovka is an OPFOR term referring to techniques of performing camouflaging and deception operations. This term includes concealment, simulation, camouflage and disinformation as ingredients of the *maskirovka* concept. *Maskirovka* is not divided into wartime and peacetime functions, but is a continuous process monitored at the highest level.

March

The OPFOR carries out *maskirovka* in preparation for and during a march, to hamper or prevent the enemy from discovering the true deployment of units, their actions, and intentions. These measures include:

- Demonstration actions.
- Selection of terrain with natural screens.

- Selection of routes of march that minimize tracks and dust.
- Construction of artificial screens
- Movement at night or under other conditions of low visibility, including smoke screens created by use of obscurants.
- Convoy and light discipline.
- Concealed rest halts enhanced by individual vehicle screens.

Offense

During the offense, the goals of *maskirovka* are essentially the same as on the march. Offensive measures include:

- Selection of terrain for its screening effect.
- Use of obscurants (smoke screens).
- Use of artificial and natural camouflage screens.
- Simulation of characteristic defensive measures-- to "mine" the terrain in view of the enemy with decoy minefields or to give the appearance of reinforced defensive positions.
- Use of concealed routes for movement of supplies and reserves.

Defense

The OPFOR uses various *maskirovka* measures to mislead the enemy about size and location of forces and weapon systems and about the nature of defensive engineer preparations. Defensive measures include:

- Use of screening properties of terrain, darkness and other conditions of limited visibility during engineer preparation of defensive positions and positioning of forces.
- Camouflage painting of materiel.
- Use of local materials and standard issue camouflage screens.

- Strict camouflage discipline.
- Construction of false strong points, decoy positions, and equipment.
- False actions to draw attention.
- Assimilation of minefields and obstacles to the terrain.

Artificial Screens/Nets

The OPFOR employs artificial camouflage as a supplement when natural screens cannot guarantee the concealment of forces and combat materiel. It includes both natural camouflage, the cutting and repositioning of tree branches and other natural materials, and manufactured camouflage. The OPFOR uses camouflage nets extensively. The OPFOR is improving multispectral screening by using camouflage nets, covers, and individual camouflage equipment.

Decoys

The OPFOR uses deception activities and equipment to counter enemy reconnaissance. All OPFOR engineer units receive special training in constructing decoys from locally available materials. They may use obsolete equipment for deceptive purposes. Their emphasis is on tactical systems and measures that provide effective concealment and deception.

The OPFOR plans to employ mock-ups and decoys as an integral part of future operations. Simulations can cause the enemy to waste effort destroying decoys as well as obscuring OPFOR operational intentions. The engineers bear a major responsibility for constructing simulations. The OPFOR places emphasis on those engineer camouflage measures that it can transport easily and construct rapidly.

The OPFOR feels the following conditions must exist in order for decoy equipment to be successful: placement must be in areas where the enemy would reasonably expect to find that type of actual equipment in use; dimensions of simulated equipment must approximate that of actual equipment and they must "animate" decoy equipment to give the impression it is mobile. The animation or movement of simulated equipment should suggest movement patterns characteristic of real equipment. Engineers can supply simulation teams to accomplish this.

The simulations that engineers construct can represent any type equipment in the OPFOR inventory. Actual equipment that is not functional due to combat damage or mechanical malfunction can be made to appear operational by repainting it to conceal damage or by constructing components to simulate destroyed parts. Engineers may also construct large area simulations such as dummy/decoy airfields or logistic facilities in rear areas. Extensive animation activities, such as the movement of vehicles within these false installations, can add credibility to the simulation.

Positions

Engineers can create false excavations to simulate revetments, hull-defilade vehicle trenches, or individual fighting positions. These false excavations may be only half the depth of actual excavations although they may create the appearance of greater depth by adding dark materials such as branches, grass, or soil to the bottoms. Troops can temporarily occupy these simulated positions and fire from them to aid deception.

River Crossings

To aid in river crossings, engineers can construct simulated crossing sites before or at the same time they are building actual ones. They try to draw the enemy's attention too simulated crossing sites while real ones remain carefully camouflaged. They give authenticity to simulated crossings by deploying vehicles on roads and other approaches to them, by moving simulated vehicles across them, and by positioning construction and bridging equipment near simulated sites.

WATER SUPPLY

Water supply is a OPFOR engineer function. The maneuver unit's organic engineer subunit locates and extracts water and assists in water purification. The chief of the chemical service and the senior regimental surgeon maintain control over water quality. The chief medical officer of the battalion monitors water sources. Using units must protect and maintain their water distribution points and equipment.

Norms

The OPFOR dictates precise water use norms. For combat personnel, their norm is ten liters per day, in high temperatures fifteen liters; and eight liters in the winter. A division can use up to 150,000 liters of drinking water daily. Under adverse conditions--especially in contaminated or arid areas--issue of water is at the minimum rates of 2.5 liters per person, for no more than five days in moderate conditions, and 4 liters for no more than three days in hot weather.

Nonpotable water is useful for decontamination and disinfection of weapons,

equipment, and supplies. The OPFOR has water norms for these tasks, ranging from half a liter for cleaning an assault rifle with damp cloths to 600 to 1,000 liters to decontaminate a vehicle with a water jet.

Supply and Distribution Points

Engineers can set up water supply points at water sources in unit areas. In the defense, it is expedient to create supply points in the various company or battery areas, inside or near the defensive perimeter. When arid conditions, scarcity, or contamination make it impossible for units to have individual water supply points, troops receive water from centralized water distribution points located along the axis of advance.

Criteria for selecting a water supply point include not only the quantity and quality of the water, but also the availability of suitable roads and terrain. Although subsurface sources are preferable, surface sources (lakes, streams) are most common. Soldiers set up a sanitized protective zone with a radius of 50 to 100 meters around each point. Markers and/or signs indicate the points, distribution locations, and access routes. There are control posts on the approaches.

Storage Equipment

For water storage, OPFOR forces use flat containers of rubberized fabric. They disinfect these tanks and set them up at water distribution points in enclosed sites on level areas clear of objects that might puncture the fabric.

Purification

The MAFS-1 automatic filtration station is one of several items the OPFOR uses to purify ground and surface water.

This purification system can supply up to 2,000 cubic meters of water per hour and requires a five-man crew and driver, pumping water from the source to rubberized fabric tanks where coagulation and sedimentation take place. It is then pumped to the MAFS-1 unit where it is filtered, decontaminated, chlorinated or dechlorinated if necessary, and stored in other rubberized fabric tanks for distribution.

Chapter 13

Logistics

The OPFOR believes future combat operations will be characterized by the lack of a clearly defined front line. Combat will spread over a deep and wide area, while encounters with the enemy will be limited to a series of intense but short battles and engagements rather than a steady attrition. The OPFOR logistics system is based on this concept of combat and on the principles of echelonment and centralization of command and control. The result is a flexible logistics system designed to meet the demands of the OPFOR concept of operations.

CENTRALIZED PLANNING

Centralized planning requires concurrent tactical and logistical planning as well as coordination with civilian industry and transportation. The bulk of supplies and transport resources are concentrated at higher formation levels. This enables commanders to concentrate support where it is needed most, if necessary switching axes rapidly to take advantage of unexpected opportunities. Centralized planning also ensures coordination of civilian production with military requirements.

TAILORING OF LOGISTICS UNITS

Tailoring allows allocation of logistic resources to the combat elements that are essential to the success of the mission. This enables the OPFOR commander to assign priorities for logistic support.

FIXED SUPPLY PRIORITIES

The OPFOR logistics system operates on the following sequence of priorities:

- Ammunition of all types.
- POL.
- Technical supplies.
- Rations and clothing.

These supply priorities can change with the combat situation. For example, a unit advancing rapidly with no opposition has a greater need for POL than for ammunition. Non-essential supplies may not be delivered if it reduces the ability to provide essential combat supplies.

Delivery Forward

It is the responsibility of higher commanders to keep their subordinates supplied, using their own means. Supplies and services are delivered directly to subordinate units using organic transportation assets of the higher headquarters. For example, an army headquarters uses its own trucks to deliver supplies to its subordinate divisions. In emergencies, one level may be bypassed in supply delivery. A division may deliver supplies directly to subordinate battalions, or a regiment may deliver directly to subordinate companies. Delivery forward does not prevent a subordinate unit from using its own assets to obtain supplies from its higher headquarters, especially in critical situations.

Continuous Supply Base Support

Supply bases and repair facilities are established as far forward as possible to ensure the flow of supplies from central logistics levels directly to combat units. The echelons of bases from the rear areas to deployed battalions assure continuous support for tactical elements.

Maintenance of Stock Levels

A division goes to war with 3 to 5 days of supplies, depending on the intensity of combat, as mobile stocks on vehicles. These stocks are replenished daily or left untouched if an army can deliver in advance supplies that are needed. This enables divisions to survive a temporary severance of their supply lines and continue fighting.

Standardization of Equipment

The OPFOR system of equipment standardization is both extensive and effective. Extensive standardization has reduced the volume of repair parts and improved the OPFOR's ability to repair forward through cannibalization. Obsolete vehicles and weapons can also be retained for training purposes without having to keep a huge stockpile of repair parts.

Complete Use of Transportation

The OPFOR logistics system uses rail transport whenever possible to move supplies from its rear areas to *front* or army level depots. Other transportation assets, primarily motorized, are used from that point forward. The OPFOR has three separate groups of transportation personnel: railroad troops, motor transport troops, and pipeline troops. OPFOR doctrine calls for using tactical combat vehicles to move additional

POL and ammunition stocks, especially in the preparation phase before offensive action.

Complete Mobile Support

From division to company, materiel and servicing facilities operate from wheeled vehicles. Critical supplies such as ammunition are boxed and uploaded on support and combat vehicles. These measures are designed to support a continuous, rapid offensive.

Forward Positioning of Support Elements

The OPFOR expects medical, equipment recovery and repair facilities to keep up with the advance. To accomplish this such facilities attempt to locate in areas of greatest need with emphasis on quickly returning lightly wounded personnel and repairable equipment to the combat elements. Personnel and equipment requiring additional attention are evacuated to the next-level facility.

Use of All Possible Resources

OPFOR troops are taught to forage for food in local areas and to use captured stocks of food, ammunition, and equipment. While food preparation and clothing supply procedures have improved, the OPFOR supply priorities discussed above may require the use of enemy materiel.

Force Restoration

OPFOR commanders are sensitive to personnel loss rates. Too high a level of casualties over a short time span (e.g., 35 percent within 48 hours) will be such a shock to the system that the whole unit will become

combat ineffective. Commanders prefer to replace units before they reach the danger point and reorganize them as smaller organizations, combine them with others or reconstitute them with personnel from the hospitals and repaired equipment. Units are rarely kept up to strength by the return of their own wounded and a trickle system of replacements.

Personnel Replacements

The personnel replacement system is significant to the OPFOR because of the size of its forces. OPFOR personnel replacement procedures are structured on four levels: individual, incremental, composite unit, and whole unit.

Individual Replacements

The OPFOR uses this system in both peacetime and wartime. It appears to be most applicable in the officer, some NCO, and specialist assignments. The sources of replacement personnel are school graduates, reserve assignments, medical returnees, and normal reassignments.

Incremental Replacements

This system replaces entire small units such as weapon crews, squads, and platoons. Replacements can be obtained from training units or from follow on forces.

Composite Unit Formations

When continuity of the mission is of paramount importance, composite units may be formed from other units reduced by combat operations. Composite units may be constituted up to division or corps level.

Whole Unit Replacement

Within this concept the OPFOR can bring entire units forward from second-echelon or reserve forces to replace first-echelon forces rendered ineffective. Passage of large units through other forces to forward positions is a complex operation that requiring detailed planning and effective control.

OPFOR planners realize that personnel replacement requirements will encompass all of the above procedures. The OPFOR trains in both individual and bulk replacement operations. In its troop rotation exercises, thousands of troops are moved by both air and rail transport. OPFOR personnel services and replacement procedures are exercised and evaluated frequently

TACTICAL LOGISTICS

At the tactical level, OPFOR logistics support is fully mobile. Streamlined logistics elements support tactical units with ammunition, POL, and rations to ensure continuous combat operations. Supply elements deliver materials to the rear of combat supply elements deployed on the forward edge. Figure 13-1 shows the average locations of OPFOR tactical logistic elements in the offense and defense.

Division

The division logistics base is usually located 25 to 40 km from the forward edge in the offense, and up to 50 km in the defense. Logistics elements are organized similar to logistics elements at army level. The logistic base is headed by a logistics officer, assisted by branch depot chiefs, and subordinate to the deputy commander for the

UNIT	LOGISTIC ELEMENT	DISTANCE FROM FORWARD EDGE (OFFENSE)	DISTANCE FROM FORWARD EDGE (DEFENSE)
COMPANY	Ammunition Supply Point Rations Supply Point Medical Point		100-150 meters up to 1 km 100 meters
BATTALION	Ammunition Supply Point Repair Point Rations Supply Point Medical Point	4 km 5 km 5 km 1.5-3 km	2-3 km 3-5 km 3-5 km 1.5-3 km
REGIMENT	Ammunition Supply Point Repair Point POL Supply Point Rations Supply Point Medical Point Damaged Motor Vehicle Collection Point	10-15 km up to 15 km 10-15 km 10-15 km 5-7 km 5-7 km	10-20 km up to 20 km 10-20 km 10-20 km 6-10 km 6-10 km
DIVISION	Supply Dump (ammo, POL, rations) Repair Point (tanks, weapons) Repair Point (wheeled motor vehicles) Medical Point	25-30 km 20-40 km 10-14 km 10-14 km	35-50 km 35-50 km up to 20 km up to 20 km

Figure 13-1. Locations of tactical logistics elements.

rear. Maintenance operations are the responsibility of the deputy commander for technical matters. A medical section, and a mobile field bakery are organic to the division. Supplies are delivered to regiments and battalions. Figure 13-2 illustrates the positioning of division rear service support assets

Regiment

At regimental level, supplies are loaded on vehicles to maintain equal mobility with combat elements. The regimental chief of rear services is responsible for all supply actions and at this level has no branch depot chiefs to assist him. Maintenance functions are the responsibility of the deputy commander for technical mat-

ters. Located up to 20 km from the forward edge, regimental logistics elements directly supply subordinate battalions, and when required, can also supply line companies.

Battalion

Battalion logistics support is self-contained. Supplies are maintained with the supply and maintenance platoon and transported on battalion vehicles. Prescribed norms of supply are maintained for all classes of materiel, with resupply provided directly by regiment or division logistic elements. The battalion chief of staff is the organizer of rear service func-

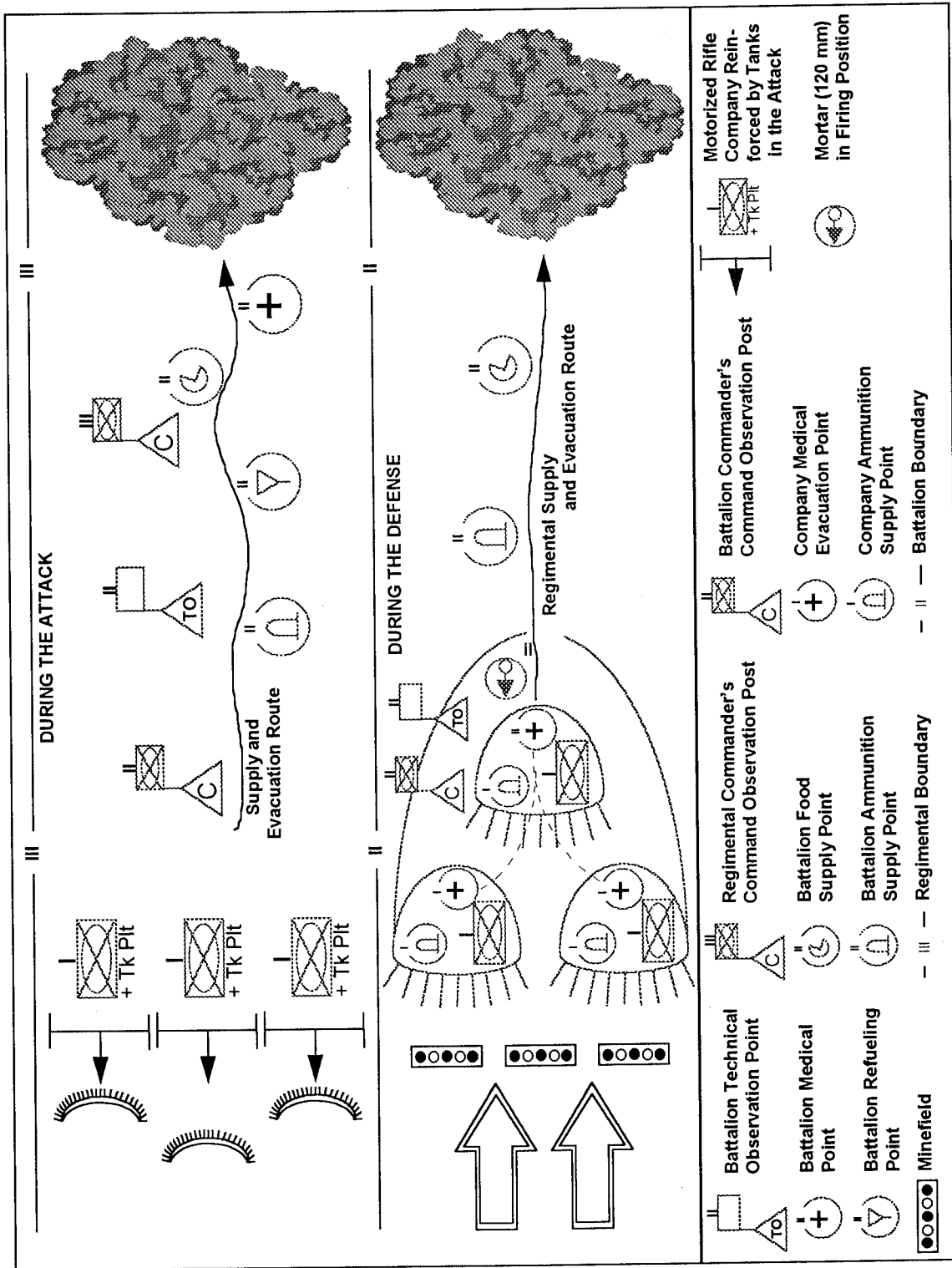

Figure 13-2. Rear service support elements.

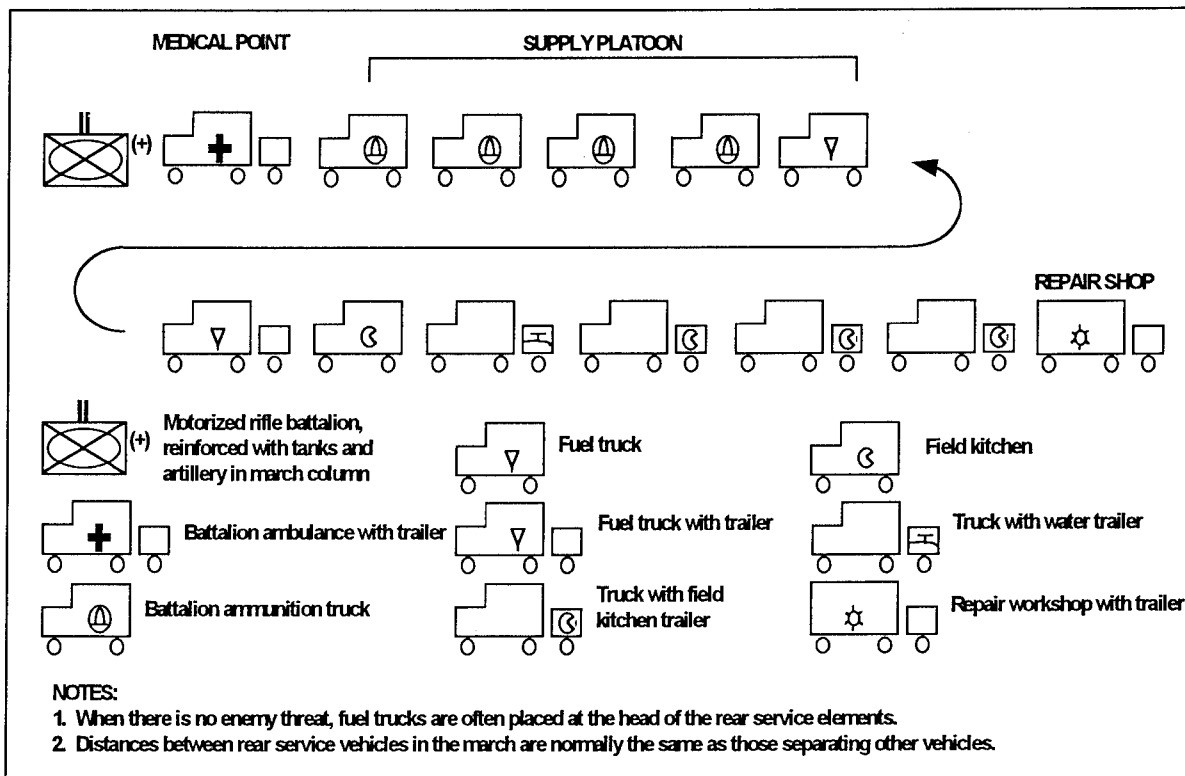

Figure 13-3. Motorized rifle battalion rear service support elements during the march.

tions and the deputy commander for technical matters and the deputy commander for the rear area are in charge of maintenance support. The supply platoon commander is responsible for receipt, storage, and delivery of supplies to companies. He deploys and operates battalion ammunition, fuel, and ration points. The battalion physician's assistant is chief of the battalion medical section and is responsible for gathering and evacuating wounded personnel from the companies and the battlefield. Figure 13-3 shows rear service support elements of a motorized rifle battalion during the march.

Company

The company commander is responsible for organization of his rear services. The deputy commander for technical matters is responsible for organization of company-

level maintenance. The company first sergeant is responsible for accountability and maintenance of the unit's weapons, ammunition, fuel, food, etc. Medical and sanitary matters are supervised by the unit commander and the battalion physician's assistant.

SUPPLY

Division staffs reflect the organization of the higher unit in logistics matters. Supply elements at division are subordinate operationally to their counterparts at the next higher headquarters. To simplify logistics planning and to standardize ordering and issuing procedures, the OPFOR divides the major classes of supplies into specific quantities or distribution lots. These quantities are called units of fire for ammunition, refills for fuel, daily ration for food, and set for spare

PLACE	Arty	Tank	APC	ATGM	Sm. Arms
With weapons	1.5	1	1	1	.5
In Bn & Rgt Tpt	3	2	2	2	1.5
In Div Tpt	1	1	1	1	1
TOTAL	5.5	4	4	4	3

Figure 13-4. Ammunition holdings with a division (in units of fire).

parts and accessories. These amounts originally are computed based on physical conditions or limitations. Once a specific quantity has been prescribed as the unit of issue, the quantity itself is no longer referred to, and all future references are given in multiples of the unit of issue.

Ammunition

The chief of artillery plans the supplies and estimates the expenditure of all types of ammunition. The ammunition officer or his staff calculates expected usage. He orders appropriate amounts by type and keeps a running account of the amounts on hand in units and in depot stocks. The chief of rear services integrates the ammunition order into his supply transport plan. He allocates transportation assets to move ammunition between depots and user units. Planning is based on the unit of fire for each weapon. OPFOR planners use the unit of fire to compute ammunition and transportation requirements. Figure 13-4 gives typical ammunition holdings within a division in units of fire.

An OPFOR unit's basic load is a multiple of the unit of fire. It includes the amounts hauled in the unit trains and stored in the depot at the next higher headquarters. It varies with the unit's mission, degree of enemy resistance, etc. A multiple of the unit of fire is assigned for weapons before each major operation or phase. The multiple assigned changes with the situation and assignment is based on the mission, the enemy,

and the availability of ammunition. Figure 13-5 gives the standard units of fire for common OPFOR weapons systems.

POL

Fuels and lubricants are second only to ammunition in resupply to OPFOR forces. Advance bases are established near division rear boundaries when the distance between army depots and first-echelon divisions exceeds 100 km. Divisions carry a 3 to 5 day stock of mobile fuel. Divisions use fuel tankers, fuel trailers, drums, and cans for supply. Tactical pipelines may deliver fuel as far forward as division rear areas. Motorized rifle and tank divisions usually carry sufficient reserves to refuel their units twice. Figure 13-6 shows the POL held in units to meet these refuel requirements.

Computation of fuel requirements is based on refills. A unit's refill is the total requirement for all vehicles in the unit. For tracked vehicles, one refill is that amount carried aboard in internal fuel tanks. For wheeled vehicles, one refill is equivalent to the fuel required for a 500 km range. A division starts with 3 refills, one in the vehicles themselves, one in regimental and one in divisional transport. Figure 13-7 gives examples of POL refills for basic OPFOR units.

Army, division, or regimental fuel service trucks may deliver fuel to battalion refueling points or directly to vehicles. Units on the move refuel their vehicles during rest

Weapons	No. of Rounds per Unit of Fire	Wt. per Unit of Fire (Metric Tons)
7.62-mm Sniper Rifle, DRAGUNOV	100	0.003
7.62-mm Assault Rifle, AKM	300	0.007
7.62-mm LMG, RPK	1,000	0.02
7.62-mm GPMG, PK/PKS	2,500	0.075
12.7-mm HMG, DSHK	120	0.02
14.5-mm HMG	100	0.06
AT Rocket Grenade, RPG-7	20	0.11
73-mm AT Gun, SPG-9	80	0.65
ATGM, AT-4 and AT-5	4	0.08
100-mm AT Gun, T-12/MT-12	60	1.75
120-mm Mortar	80	1.8
160-mm Mortar	60	1.35
240-mm Mortar	40	2.18
122-mm Howitzer	80	3.2
122-mm MRL	120 (3 salvos)	12
130-mm Field Gun	80	6.2
152-mm Howitzer	60	3.75
240-mm MRL	32	8.9
23-mm ZSU-23-4	2,000	1.4
57-mm AAA S-60	200	2
FROG-7	1	3
SA-6, SAM	3	2.1
SA-8, SAM	4	0.05
SA-9, SAM	4	0.2
T-64/72 Tank, 125-mm	40	1.7
1 x 7.62-mm MG	2,500	0.075
1 x 12.7-mm MG	200	0.035
BRDM-2		
1 x 14.5-mm MG	500	0.145
1 x 7.62-mm MG	2,000	0.06
AT-5	25	0.27
BMP-1 (Troop Carrier Version)		
1 x 73-mm Gun	40	0.325
1 x 7.62-mm MG	2,000	0.06
BTR-60PB		
1 x 14.5-mm MG	500	0.145
1 x 7.62-mm MG	2,500	0.075

Figure 13-5. Standard units of fire.

Unit	In Vehicles (Metric Tons)	In Unit Logistics Base or Train Metric Tons
Combined Arms Army	5,000	17,500
Tank Army	4,000	11,000
Motorized Rifle Division	700	1,450
Motorized Rifle Regiment	90	160
Motorized Rifle Battalion	9	11
Tank Division	800	1,700
Tank Regiment	120	240
Tank Battalions	25	40
NOTE: Motorized rifle and tank divisions normally carry sufficient reserves to refuel their units twice.		

Figure 13-6. POL held in units.

Unit	Diesel	Gas	Total
MRR (BTR-Equipped)	67,860	59,990	127,859 liters
	57.7	45	102.7 metric tons
MRR (BMP-Equipped)	101,737	40,896	142,632 liters
	86.5	30.6	117.1 metric tons
Tank Regiment	115,350	31,763	147,113 liters
	98.1	23.8	121.9 metric tons
Antitank Bn (MRD)	2,835	6,132	8,967 liters
	2.4	4.6	7 metric tons
Arty Regt (DIV)	2,756	38,472	41,228 liters
	2.3	28.8	31.1 metric tons
Arty Regt (Army)	28,010	14,121	42,131 liters
	23.8	10.6	34.4 metric tons
NOTE: A unit's refill is the total requirement for all vehicles in the unit.			

Figure 13-7. POL refill.

halts, probably from tanker trucks and trailers. Wheeled vehicles may refuel from cans carried on board.

Rations

Rations are issued based on meals per man per day. Norms are based primarily on expenditure of energy for caloric requirements of personnel. Basic ration norms determine the amount of food products issued to feed one man for a 24 hour period. Supplemental norms determine the amount of rations to be issued in excess of the basic ration norms. They are based on conditions under which the men are serving or the nature of their service. Dry rations are issued on the basis of 1 kilogram per man per day while fresh rations are based on 2 kilograms per man per day. Divisions carry a five day food supply.

Clothing

OPFOR soldiers receive military clothing at the time of induction. Supplementary clothing, including field clothing, is issued after they have arrived at their unit. Subsequent reissues occur at specified intervals and are issued from the unit depot.

Vehicles

Procurement and resupply of vehicles and end items are the responsibility of the various chiefs of service arms or technical services. The OPFOR does not have a resupply procedure for unit end items while the unit is engaged tactically. The unit in combat is replaced by another unit when attrition reaches a certain level.

Mobile contact teams fix repairable equipment and return it to action as soon as

possible. This is the only way to replace equipment end items. Damaged equipment is not repaired in the field if it requires more than a few hours work. The OPFOR keeps a certain number of wheeled and tracked vehicles in storage during peacetime to preserve them. A minimum number of vehicles are kept for normal training and administrative uses, generally from 15 to 35 percent of the vehicles authorized.

Water Supply

The water supply in the field is planned by engineers in cooperation with the medical service. When time permits, a water supply plan is drawn up and includes a survey, a water supply chart, and a work schedule. The location of existing water resources in the expected zone of operations is established for the survey. The water supply chart indicates which wells to use, where to dig new wells, and how to deploy water supply stations. The work schedule designates water points and the soldiers assigned to them. The schedule also shows daily water requirements, transportation requirements for hauling the water, and equipment for handling it.

The normal rate of water consumption per man is about ten liters per day. This includes water for drinking, food preparation, washing, laundry, and bathing. Under restricted water conditions, the daily allowance is reduced to about five liters per day which eliminates use of water except for personal consumption and cooking.

Supply Distribution System

The peacetime military district, or the wartime front, receives its supplies from the national storage depots or in some cases di-

rectly from the industrial production line. *Front* delivers the items directly to army depots. In turn, army delivers equipment to supported divisions, and the divisions deliver to the regiments. If necessary, intermediate echelons may be bypassed to deliver items directly to the user.

At division level, supply bases are as close to the ongoing battle as possible. Critical ammunition and POL are uploaded and sent forward as required. Supplies are moved in bulk by rail and pipeline and also by road from the strategic rear into the operational rear where dumps are established or replenished. Fuel is sent to the tactical rear by tanker or pipeline, or is held in fuel dumps to replenish second-echelon forces before they are committed.

The conditions of the ongoing battle dictate the location of supply dumps and stockpiles. Being highly mobile, divisions do not create stockpiles but maintain mobile stocks as far forward as possible. At division level, replenishment depots are set up at a convenient road junction, but supplies remain uploaded whenever possible. The replenishment depot is under the command of a deputy commander for resupply, who is subordinate to the division chief of the rear. Usually division supply points are well dispersed.

Air resupply may be considered on a small or moderate scale when other methods have failed or when extreme speed is essential. High-value cargo has high priority for air supply.

TRANSPORTATION

The OPFOR transportation services include traffic management, railroad operations, railroad maintenance and construction,

highway construction and maintenance, highway regulation, and operation of all transport modes including pipelines.

Rail Transport

Railroads are the principal means of transporting military hardware for the initial stages of an operation. During battle operations the military rail transport staff of the front chief of the rear plans and directs rail shipments and movements. *Front* logistics bases are probably located near large rail centers. The chief of rail transport at *front* level is responsible for dispatch of supplies from rail stations to army logistic bases.

Motor Transport

Extensive use of motor transport begins at *front* level. Transport units are organic to OPFOR ground forces from division to battalion levels. The normal sizes of the units are as follows:

- Division. Materiel support battalion.
- Regiment. Materiel support company.
- Battalion. Motor transport section with the supply platoon.
- Company. No specific motor transport section.

The primary means of delivery below army level is by truck. The priority given to the movement of ammunition is shown by the two ammunition transport companies in the materiel support battalion at division level. These trucks have all-wheel drive, giving them an off-road capability that is well suited for front-line ammunition delivery.

The petroleum, oils, and lubricants (POL) transport company has the same basic truck as the ammunition company. The POL version has a 5,200-liter tank with a 1,200-

liter tank mounted on a trailer.

The other company in the battalion is the cargo transport company. Its mission is to deliver items of supply other than ammunition and bulk fuel.

A major strength of OPFOR transport is the great quantity and extensive use of trailers. Loaded trailers are pulled forward to fighting units and exchanged for empty trailers. The empty trailers are returned to rear logistic bases for reloading. In this manner, fighting units maintain maximum quantities of critical supplies such as ammunition and fuel.

Second-echelon unit logistics elements support first-echelon units. This practice increases the transport capability for logistic support to the first-echelon regiments and divisions. Logistics bases can be located deeper in the *front* or army rear areas. This placement reduces congestion in the main combat area, but requires long lines of communication that could be likely targets for enemy air interdiction strikes.

MAINTENANCE AND RECOVERY

Forward positioning of maintenance and recovery operations provides effective support for the high speed tempo of OPFOR combat operations. Lower-level units have a limited maintenance capability and depend on higher-level maintenance units to provide direct and backup support. A regiment collects its damaged vehicles and does what light repairs it can before continuing the advance. A division works in a similar fashion, leaving unfinished work to army. The bulk of repair resources are based at army level and are assigned to key axes.

Maintenance Facilities

Maintenance facilities in the field are provided for the following items of equipment:

- Tracked vehicles.
- Wheeled vehicles.
- Artillery and ordnance.
- Engineer equipment.
- Signal equipment.
- Chemical equipment.

Service for these items is provided by fixed and mobile repair facilities that extend repair capabilities forward into the battle area.

Vehicle Repair

The OPFOR classifies vehicle repairs as routine, medium, or capital.

Routine Repairs

Replacement, adjustment, or repair of individual components that can be made within a short time. Major components are not disassembled. This category is performed at levels below division.

Medium Repairs

Major overhaul of at least two basic assemblies. This category of maintenance is performed at regiment or division level.

Capital Repairs

Major overhaul or complete disassembly of a piece of equipment. This is the most extensive category of maintenance and can be performed at army and *front* levels.

Technical Services

The OPFOR also uses periodic checks of equipment known as technical services. These services are performed at usual intervals on most OPFOR equipment. Examples of a technical services for a tank are:

- Routine inspection. Conducted before tank movement as a preoperational check and takes 40 minutes.
- Preventive maintenance service number 1. Conducted after tank movement and at 100 to 150 km intervals during a long road march. This service takes between 9 to 12 hours.
- Preventive maintenance service number 2. A 6 to 7 hour thorough inspection performed every 1,000 km.
- Preventive maintenance service number 3. A 9 to 12 hour comprehensive inspection of all vehicle systems performed every 2,000 km.

ORGANIZATIONAL MAINTENANCE SERVICES

Division Level

The division maintenance battalion is composed of a battalion headquarters, a tank/track vehicle maintenance company, a motor vehicle maintenance company, an ordnance maintenance company, a material support platoon, a recovery platoon and a special maintenance platoon. Within the companies and platoons, there are vans, supply trucks, and recovery vehicles. These companies and platoons are capable of performing both routine and medium repairs. In combat, they establish damaged vehicle repair and collection points that are similar to regimental repair and evacuation groups (REGs).

Regimental Level

The regimental maintenance company performs routine and some medium repair functions. Motorized rifle and tank regiments have both wheeled and tracked vehicle workshops. Each of these elements may form repair and evacuation groups to provide support to subordinate battalions.

Battalion Level

The battalion repair workshop contains a shop truck and mechanics who can make routine repairs on tracked and wheeled vehicles. In combat, this repair workshop can be reinforced with a vehicle recovery section.

Company Level

The only maintenance conducted at company level is driver and crew preventive maintenance and routine inspections.

MAINTENANCE RESPONSIBILITIES

The chief of artillery at regiment and above is responsible for the maintenance of small arms, automatic weapons, mortars, artillery, and missiles. Motorized rifle and tank regiments usually have two or three armorers to perform light repair on small arms and some automatic weapons. Armorers in artillery regiments can do routine maintenance on artillery pieces as well as on small arms. Artillery repair in tank regiments is done by the tank workshop.

At division level, routine-to-medium repairs are made in the artillery maintenance company of the maintenance and repair battalion. Artillery repairs at regiment and divi-

sion consist primarily of replacing parts from available stocks.

A signal company is found at regimental level. The operators repair signal equipment, when possible. Radio, telephone, and radar units generally have some testing equipment and spare parts for routine repairs. Medium communication repairs are done at division level. Signal repair units perform capital repairs at army level and higher. Engineer and chemical equipment maintenance and repair are accomplished in the same manner as signal equipment at division and higher echelons.

RECOVERY AND REPAIR DURING COMBAT

During combat operations, a technical observation point (TOP) is established in the forward area of each combat battalion. The purpose of the TOP is to monitor the battlefield for damage, to assist crews, and to call repair and recovery units forward. It is composed of several vehicle operators, one or more mechanics, a medic, battalion NBC personnel, and at least one combat engineer. It is supervised by the deputy commander for technical matters. The entire group is mounted in an armored vehicle with radios and night vision devices.

The TOP maintains radio contact with the battalion commander and recovery and repair elements. Company TOPs may be established if the battle area is beyond observation range of the main TOP. The chief of the TOP assesses the nature of damage and status of the crew of an out-of-service vehicle and initiates action to recover the vehicle and accomplish repairs. If repairs can be made in five hours or less, the battalion REG repairs the vehicle on site or evacuates it to the repair and evacuation site

A REG is usually composed of one tracked recovery vehicle, a tank repair workshop van, and a parts truck. Regimental REGs may be used to support a specific battalion if required. REG repair priorities are based on the required repair time, with equipment requiring the least time for repairs being completed first. The division evacuates vehicles or equipment damaged beyond the repair capability or capacity of the regiment to the division's damaged vehicle collection point. If the division is unable to repair the damaged item, it is evacuated to either army or *front* for necessary maintenance. Higher-level unit transportation assets accomplish the evacuation.

If evacuation from lower to higher echelons is not possible, vehicles can be left along specified evacuation routes to await mobile maintenance teams providing direct or backup support. The higher unit's team will remain to complete repairs as the lower units move forward in support of continuing combat operations. A major goal of the evacuation process is to clear damaged equipment from avenues of approach of follow on combat units.

MEDICAL

The two principal missions of the medical service in combat are the evacuation and treatment of casualties, and the prevention of disease in the area of operations. The medical service is further responsible for the combat readiness of the military medical staff of the armed forces. In combat operations each OPFOR command level from company to *front* has organic medical support units or personnel. At each level, medical support units are subordinate to both the combat unit commander and the next higher level of the

medical service. For example, the battalion physician's assistant is subordinate to both the battalion commander and the regimental senior physician. This system responds to the needs of combat units and allows close coordination between medical levels for the treatment and evacuation of casualties.

Medical Doctrine

OPFOR medical doctrine divides the range of medical treatment into three categories. The first category of procedures includes only mandatory lifesaving measures. The second category includes procedures to prevent severe complications of wounds or injuries. The final category of treatment includes procedures that are accomplished only when there is a low casualty load and reduced enemy activity.

The focus of OPFOR combat doctrine on high-speed offensive operations calls for a highly mobile medical support system. Its component units must be capable of repeated forward deployment with a minimum loss of efficiency. Repeated forward redeployment of medical units and continuous rearward evacuation of casualties demand close coordination between medical levels and medical and combat commanders.

OPFOR combat medical doctrine stresses the timely return of recuperated sick and wounded to their units. At each stage of evacuation medical personnel detain and accommodate those casualties whose expected recovery period falls within prescribed limits. Only casualties whose prognoses indicate extended recovery periods reach a *front* or home country hospital. Medical personnel also supervise the selection and preparation of grave sites to preclude health hazards. Responsibilities for burial, however, fall on

other rear services personnel.

The basic principle of OPFOR combat medical support is multistage evacuation with minimum treatment at each level. From company through *front*, each level has specific responsibilities for the care of the sick and wounded. As casualties move through the combat evacuation system, medical personnel at each level make effective use of medical facilities by repeated sorting of the wounded (triage). Medical personnel treat the lightly wounded who can be returned to combat and those casualties who would not survive further evacuation without immediate medical attention. The OPFOR emphasizes that major medical treatment should be performed at an army-level mobile field hospital.

Division Medical Support

The primary combat mission of the medical battalion is the deployment and operation of the division medical point. Before reaching this level, casualties receive only the most basic medical treatment. Even at division level, only minor surgical operations can be performed due to limited personnel and facilities. Any major operations must be deferred until the casualty reaches an army-level mobile field hospital.

The division senior physician commands the medical battalion of each combat division. As with the regimental physician, the division senior physician occupies an administrative post, assuming responsibility for the overall supervision of division medical support and serves on the division commander's staff. His immediate subordinate, the chief of the division medical point, serves on the staff of the deputy commander for the rear.

The division medical battalion contains the following elements--

- Headquarters.
- Medical company.
- Collection and evacuation company.
- Disinfection and decontamination platoon.
- Transportation section.
- Materiel support platoon.

The medical company forms the operational core of the division medical point and is designed to handle up to 400 casualties per 24-hour period. Casualties are expected to reach the division medical point from the battlefield within 12 to 18 hours. The division medical point deploys approximately 12 km from the forward edge during offensive operations or some 20 or more km when in defense. It deploys along the main supply route and uses existing structures when possible.

The division medical point maintains close contact with advancing combat units. OPFOR doctrine calls for movement by echelon to accomplish the necessary forward deployment while still providing an acceptable level of care for the incoming wounded and non-transportable casualties. As many of the personnel and as much equipment as can be spared are moved to the next deployment area. The division senior physician coordinates with the army chief of medical service in arranging for the transfer of the casualty flow to another division medical point or an independent medical detachment.

Regimental Medical Support

At regimental medical points, the seriously wounded are examined and provisionally treated by a physician. The regimen-

tal senior physician is a member of the commander's staff and serves as the administrative medical officer for the regiment. He usually does not practice as a physician at the regimental medical point. The chief of the medical point is subordinate directly to the regimental senior physician. He directs and participates in the medical treatment of casualties. There are two additional officers, a junior physician and a dentist. Additional medical personnel assigned to the regimental medical point include physicians' assistants, medical corpsmen, pharmacist, orderlies, and ambulance drivers. Support personnel serving the medical point include mechanics, radio operators, and a field kitchen staff.

The major elements of the regimental medical point are reception and sorting, dressing, and evacuation. Other elements are a disinfection/decontamination area and an isolation area. The physician at the receiving and sorting element is usually the chief of the medical point. As he receives casualties who have passed through the sorting point, he divides them into four categories: those who require immediate medical attention at the regimental medical point; those who are to be evacuated to the next medical echelon with little or no treatment; those who are lightly wounded who will remain at the medical point and return to duty within 3 to 5 days; and those for whom medical treatment is futile.

Company and Battalion Medical Support

Company and battalion medical personnel make up the immediate battlefield support. Their primary concerns are locating and collecting casualties and providing first aid before evacuation to the regimental medical point. Each company or battery normally has one medical corpsman. A phy-

sician's assistant may be attached to the company when heavy casualties are anticipated. The company commander or platoon leaders, with the assistance of the medical corpsman, select and train enlisted personnel to serve as orderlies or stretcher bearers.

Medical personnel accompany the combat units in a combat vehicle or other available transport. If separate medical transport is not available, the medical corpsman accompanies the command element. The soldiers trained as orderlies travel with their squads or crews. If the regimental senior physician has allocated additional personnel and evacuation transport to a battalion, the battalion commander may in turn augment company medical personnel and transport.

Duties of the company medical corpsman includes monitoring personal hygiene, inspecting the company area for health hazards, and supervising sanitary and anti-epidemic measures. He also instructs the troops in first aid and the use of their individual medical equipment. Before a combat operation, the battalion physicians assistant informs the corpsmen of arrangements for the evacuation of the wounded. This information includes the location of casualty collection points and the coordination of available medical evacuation transport.

A physician's assistant, a medical corpsman, an orderly, and a driver form the nucleus of the battalion medical point. The point is located 1 to 3 km behind the line of contact. Depending on the number of additional medical transport vehicles assigned, several driver and orderly teams also may serve the battalion.

Battalion medical personnel collect casualties from the companies and provide

minimum treatment before evacuation to the regimental medical point. Casualties remain at the battalion medical point for a very short time. The battalion physician's assistant serves as the chief of the battalion medical point and organizes and supervises battlefield medical operations. Besides monitoring the health conditions in the battalion, he directs ambulance teams in the evacuation of wounded from the company collection points.

The battalion medical corpsman's duties are demanding. He provides medical treatment to the wounded and supervises the orderlies at the battalion medical point. He also participates in medical reconnaissance for the battalion, assists in removing the wounded from the battlefield, and monitors radiation levels at the battalion medical point. He directs decontamination operations, carries out anti-epidemic measures, and distributes supplies under the physician assistant's direction.

LOGISTIC TRENDS

The major improvements in the OPFOR logistics system have been to increase mobility, efficiency, and standardization. The OPFOR has tried to bring new technology and improved management techniques into its service support operations. Prepackaging and containerization of supplies into standard units of issue has been initiated to reduce handling and delivery time. Computers have been introduced to allow the chief of the rear at operational and strategic levels to evaluate resources and assets quickly for a proposed operation. He can formulate support plans that support the commander's concept of operations and respond to the support requirements generated by the rapid changes in the battlefield situation.

Chapter 14

Radioelectronic Combat

The OPFOR is keenly aware of the dependence of modern military forces on **command, control, and communications (C³)**. Effective communications ensure sound troop control; loss of communications is the loss of troop control. The loss of troop control in combat operations ultimately ends in defeat. The OPFOR hopes to control the electromagnetic spectrum and deny it to its enemy during combat actions. As a result, the OPFOR has worked to develop systems to degrade the C³ assets of enemy forces.

RADIOELECTRONIC COMBAT (REC)

The OPFOR recognizes the importance of what its enemy calls electronic warfare (EW). In U.S. terms, the OPFOR has a wide variety of assets for signals intelligence (SIGINT), including both communications intelligence (COMINT) and electronic intelligence (ELINT). All components of the OPFOR have made technical advancements in SIGINT and electronic countermeasures (ECM). Specifically measures employed to neutralize enemy communications and electronics through jamming and deception. The OPFOR also places emphasis on electronic counter-countermeasures (ECCM). The OPFOR accomplishes this by strict enforcement of signal security, equipment redundancy, system design, and operator skill. The OPFOR has developed its EW capabilities into an integrated system called **radioelectronic combat (REC)**.

Radioelectronic combat is a vital part of all OPFOR offensive planning. The REC

concept includes detection and location of enemy electronic systems, their physical destruction or jamming and defensive measures to protect OPFOR systems. Most REC assets are held at army and *front* level, but a growing range of systems is available to the OPFOR divisions.

REC Concept

The OPFOR views REC as an integrated program of C³ countermeasures combining **reconnaissance, jamming, fire-power, and deception** to attack enemy organizations and systems. The purpose of REC is to limit, delay, or nullify the enemy's use of his C³ systems, and at the same time protect OPFOR C³ systems. A goal of the system is to destroy or to disrupt a majority of the enemy's command, control, and weapon system communications, either by jamming or by destructive fires.

The OPFOR accepts that it is not possible to completely deprive enemy forces of their means of control for extended periods of time. Accordingly, OPFOR REC planners have established models to estimate "critical times" in command and control procedures. This critical time is defined as the total of the time needed to complete a series of steps in control:

- Collection and reporting of data.
- Evaluation and decision.
- Issuance of orders and preparation.
- Completion of action.

The aim of REC is to disrupt the enemy's critical time phasing, making the information they use to formulate decisions

obsolete. The OPFOR emphasizes the destructive aspects of REC near the forward edge, probably within the division. More elaborate applications of REC, such as large deception plans, are prepared at army level, or higher, with divisions implementing them.

Target Priorities

The OPFOR assigns enemy communication and control points a priority according to the expected impact on the battle. The OPFOR selects targets with the intention of eliminating them either by **physical destruction** or by **jamming**. Although REC target priorities depend on the command level and can change as the tactical situation develops, they generally are:

- High-precision weapons systems.
- Command and control systems.
- Artillery, tactical aviation and air defense systems.
- Reserves.
- Logistics centers.
- Point targets that jeopardize advancing forces.

Radio/Technical Reconnaissance and Jamming

The OPFOR categorizes electronically derived intelligence differently than most forces. Its overall term for this type of intelligence is radioelectronic reconnaissance. Subcategories include radio reconnaissance and radiotechnical reconnaissance. The former, sometimes called radio intercept and direction-finding (DF)--is the equivalent of communications intelligence (COMINT), the latter, sometimes called radio and radar intercept and direction-finding (DF)--is similar to combination of COMINT and ELINT. Although radio and radiotechnical reconnaissance organizations are separate from the

REC structure, their function is an integral part of the REC system.

Intelligence Requirements

Essential to the success of OPFOR REC objectives is the collection of accurate and timely intelligence. The OPFOR requires information on the enemy's electronic order of battle, equipment types, emission characteristics, and locations. It obtains some technical intelligence information concerning enemy electronic equipment from open source material, such as technical manuals and field manuals. The OPFOR obtains other information by reconnaissance, target acquisition, and intelligence assets available at the various command levels. The primary means of locating targets of specific interest to the REC effort are through the use of electronic intercept and DF measures.

Intercept

The OPFOR defines radio intercept as the ability to monitor and understand message content. It has an extensive intercept capability for both radio transmissions and radar emissions. Intercept units move forward immediately behind leading regiments and have the capability to intercept enemy transmissions within these distances from the forward edge:

- Artillery ground radar -- about 25 km.
- VHF -- about 40 km.
- HF ground waves -- about 80 km.
- HF skywave -- unlimited.

Direction Finding

The purpose of radio and radar direction finding is to locate transmitting stations and radar emitters. The OPFOR DF capa-

bility is equivalent to that for intercept. Various types of mobile antenna systems serve in a DF role. Forward area mobile elements include a VHF tactical radio direction finder, as well as the POLE DISH radar direction finder. OPFOR DF elements can pick up tactical FM radios operating on low power at distances in excess of 10 km and detect high-power signals at distances up to 40 km. Operational accuracies are usually within plus or minus 3.5 degrees.

The OPFOR use direction finding to--

- Provide approximate locations of enemy electronic emitters.
- Provide locations that, when applied with intercept, terrain analysis, or other means, can be refined to a target area of sufficient accuracy for artillery fires.
- Develop a picture of the battlefield to reveal the locations and intentions of enemy units.
- Provide adequate locations for firing on most radar and jammers.

Because of the length of transmission, the peculiarity of their signal, and power output, it is easy to locate jammers and identify them as targets for attack by suppressive fires. Due to signal characteristics, DF can locate ground radar with greater precision than it can for radio emitters, often within 50 to 200 meters. It is possible to evaluate information from DF resources quickly, but usually requires further confirmation by other sources. DF targets within conventional artillery range, that are time sensitive and are considered as a serious threat, receive priority and are candidates for immediate engagement. If an enemy net remains active for at least 25 seconds, the OPFOR targeting sequence can continue even if communications

cease.

Besides the targets located by direction finding, the OPFOR expects to develop other targets. The OPFOR feels it can achieve this due to lax enemy signal security and poor electronic counter-countermeasures. This implies that good security procedures and ECCM will limit the effectiveness of OPFOR radio and radiotechnical reconnaissance. OPFOR intercept and DF equipment are also vulnerable to deception because it only locates electronic emitters, not necessarily units.

Jamming

Another part of the OPFOR REC system is the requirement to jam enemy command and control and weapon systems communications that cannot be destroyed by firepower. The OPFOR views these missions as jamming in support of air defense operations and jamming in support of ground operations. The primary OPFOR means of jamming are--

- Radar jamming by using barrage and spot noise, pulse, chaff, and decoys.
- Electronic jamming of command guidance systems-using pulse and simulation techniques.
- Radio noise jamming of AM and FM signals.

The OPFOR supplements its communications jamming capability with a considerable number of ground-based radar-jamming sets. It continues to modernize its radar jamming assets in response to enemy advances in radar technology. This effort emphasizes the OPFOR intentions to disrupt enemy airborne radar and support its own air operations and air defense of high-value rear area targets.

Assets

The OPFOR continues to modernize the equipment used to support REC at all echelons of its military services. When the OPFOR combines its radioelectronic reconnaissance and jamming resources with combat forces, it can achieve an effective capability to disrupt enemy C³.

Ground-Based

Units dedicated to radioelectronic reconnaissance and jamming are organic at various command levels from *front* to division. A motorized rifle or tank division has a reconnaissance and REC battalion, giving the division a limited intercept and direction-finding capability. Division-level REC assets usually deploy 2 to 3 km behind forward maneuver units. However, REC assets of higher formations can be all over the battlefield.

Air Forces

The OPFOR air force continues to upgrade REC assets. Modern fighter aircraft have internally mounted self-protection ECM systems that reduce drag over externally mounted systems, providing free space on the wings and fuselage to carry additional ordnance. The OPFOR has even equipped cargo aircraft with infrared countermeasure flares for self-protection and could equip it with jamming equipment if the mission dictated.

To complement advances in ground-based communications jamming systems, the OPFOR has also deployed heliborne jamming platforms. These heliborne systems give the advantages of increased range, mission flexibility, mobility, and overall jamming power. All factors that

limit the effectiveness of ground-based jamming systems

Airborne radioelectronic reconnaissance platforms provide an improved ability to intercept radio and radar signals on a more frequent basis and at greater distances than ground-based systems. The goals of these airborne platforms are the detection and location of enemy battlefield surveillance radar, command posts, and communication centers.

Space

OPFOR military satellites perform a wide variety of reconnaissance and collection missions. Reconnaissance satellites have improved intelligence collection processing capabilities. ELINT satellites can lock onto intercepted signals providing information about target location.

REC AND THE DIVISION BATTLE

REC will influence the divisional battle in a variety of ways--

Defensive Measures

OPFOR divisions make extensive use of corner reflectors to confuse enemy radar. These are particularly likely to be used to protect assembly areas and river crossings.

Offensive Use

REC strikes will be targeted against identified headquarters and communication centers as part of the preparation of the attack. Strikes are coordinated with the start of major attacks and will subsequently be used to assist the commitment of second

echelons, forward and raiding detachments.

FIREPOWER

Integral to the OPFOR REC system is the use of physical destruction means. The OPFOR can physically attack in three ways: **indirect fire**, **ground attack**, and **air attack**.

Indirect Fire

Indirect fire includes artillery, mortars, rockets, and surface-to-surface missiles.

Ground Attack

The OPFOR may attempt to destroy C³ elements by using special-purpose forces, airborne and heliborne forces, or other elements operating behind the front lines.

Air attack

The OPFOR can decide to attack with fixed-wing aircraft or attack helicopters. These aircraft can use conventional ordnance or high-precision munitions, such as anti-radiation missiles (ARMs).

DECEPTION

Deception in REC is part of an overall program the OPFOR calls *maskirovka*. In the area of REC, the purpose of deception is to cause delays. This deception can take the form of disinformation or counter-reconnaissance techniques. Disinformation includes the transmission of false information to confuse the enemy. Counter-reconnaissance techniques can mask troop movements and deployments.

The OPFOR hopes the enemy is unable to distinguish between real and decoy targets, and the resulting confusion will lead to confusion about OPFOR intent, deployments, and troop movements. The OPFOR conceals military equipment against detection by radar using a technique called radar *maskirovka* or antiradar camouflage. Depending on the radar visibility of the objects to be camouflaged, the OPFOR plans to achieve antiradar camouflaging by creating false targets or by blending into the terrain background those objects that might serve for orientation. When possible the OPFOR conceals equipment behind local features or makes use of the camouflaging properties of the ground relief. Mock-ups of military equipment can also serve as antiradar reflectors.

ECCM

OPFOR commanders are aware of the EW threat, and they try to enforce a high level of ECCM consciousness in their subordinates and equipment operators. They practice major moves in conditions of radio or even electronic silence, and the use of battle drills lessens their dependence on long radio orders in the attack. They also practice the use of false positioning of different types of emitters and establish dummy nets for deception purposes.

IMPLICATIONS

Intelligence

The OPFOR expects to gain a high proportion of its intelligence from EW and from air and ground reconnaissance tasked on the basis of EW supplied information.

Jamming and Physical Attack

Jamming is unlikely to affect many units, though where it is used it may become critical unless operators are trained in ECCM skills. More likely is the threat of attack by air or ground forces after DF and traffic analysis has given the OPFOR a good idea of a target's location and value.

High Tempo of Operations

If OPFOR ground forces generate the desired rates of advance, the effectiveness of its EW units will be reduced. This will be due to its need to relocate frequently to support combat operations.

Chapter 15

NBC and Smoke Operations

The OPFOR classifies modern warfare as either nuclear or nonnuclear. When referring to the capability of a specific system the OPFOR distinguishes between conventional, nuclear, biological, and chemical weapons. It classifies nuclear, chemical and biological weapons as weapons of mass destruction, relating to measures taken to protect troops and equipment.

PREPAREDNESS

To allow its own troops to conduct operations under NBC conditions, the OPFOR emphasizes :

- NBC reconnaissance, detection and warning.
- Individual and collective protection.
- Decontamination.

Survivability

OPFOR ground forces train to protect themselves against NBC weapons and to operate in a potential NBC environment. The OPFOR feels that any future war involving the use of NBC weapons could lead to significant casualties. It insists that the timely use of **protective equipment**, correct employment of **reconnaissance assets**, and quick **decontamination procedures** can reduce a unit's vulnerability.

Multiple Options

The OPFOR continues to improve its nuclear, chemical and biological warfare systems, concurrent with the improvements

in its conventional fire support capabilities. This force modernization gives OPFOR commanders a range of options to conduct combat operations. Confident that it can fight decisively with or without nuclear weapons, the OPFOR feels that a major conflict may be nonnuclear initially, or may remain nonnuclear for the duration.

Influence on COFM

In past wars, the **correlation of forces and means (COFM)** in a particular sector could be changed only by a slow process of providing more men and equipment. Nuclear, chemical and biological weapons can bring a sudden change of great magnitude to the balance. Their use can change the COFM on any axis of advance and in the entire depth of enemy positions. This constitutes both a threat and an opportunity for the OPFOR commander and strongly reinforces the OPFOR policy to preempt enemy use of nuclear, chemical or biological weapons.

OPFOR planning and preparation for combat always assumes the possibility of enemy use of nuclear weapons. It develops **plans and doctrine** maintaining dispersion and mobility. The OPFOR plans to detect and destroy enemy nuclear weapons and delivery systems is a top priority. Planning assumes that whatever the level of conflict (nuclear, chemical, biological or conventional), all types of weapons will be employed in an integrated manner to accomplish the objectives of the war.

NUCLEAR

The OPFOR prefers to avoid nuclear warfare. It will probably do so as long as its objectives are being achieved and there are no indications that the enemy was "going nuclear." The OPFOR perceives that its decision to go nuclear must be made early so that sufficient nonnuclear power remains to follow up and to exploit the gains of nuclear employment with an immediate, high-speed air and ground offensive.

The OPFOR believes a theater war is the most likely to start with a phase of non-nuclear combat. It emphasizes the destruction of as much as possible of the enemy's nuclear capability during this phase. To accomplish this, it uses air and rocket attacks, airborne, heliborne, and special-purpose forces, and rapid, deep penetrations by ground forces. The OPFOR hopes these attacks will deny the enemy a credible enemy nuclear option.

If nuclear use becomes necessary, the OPFOR intends to preempt an impending enemy escalation to nuclear combat with its own massed nuclear strike against enemy air, nuclear, command and control, and ground forces' targets.

Possible nuclear attacks by the enemy prohibit concentration in mass. At the same time, the availability of friendly nuclear strikes and the longer ranges of conventional artillery reduce the requirement for massed artillery formations. Improved troop mobility permits both the rapid concentration and quick dispersal essential to the survival of tank and motorized rifle formations as they maneuver on a nuclear threatened battlefield.

In this context, the OPFOR now stresses that the quality of mass must com-

pensate for the reduced quantity formerly provided by concentrations of troops and equipment. This quality takes the form of intense strikes with conventional air, artillery and possibly weapons of mass destruction.

NUCLEAR FROM THE ONSET

In a war that is nuclear from the beginning, OPFOR nuclear strikes are directed against the strongest sectors of the enemy's defenses and throughout his operational depth. Divisions, in "nuclear-dispersed" formations, attack through gaps lead by forward detachments advancing into the depth of enemy defenses. Their goal is to seize or to neutralize remaining enemy nuclear weapons and delivery systems and command, control, and communications facilities. They would try to split and to isolate the enemy by attacks from different directions and across a broad front.

TRANSITION TO NUCLEAR

Even if nuclear weapons are not used from the beginning, OPFOR commanders deploy troops based on the assumption that the enemy may strike with nuclear weapons at any moment. The OPFOR constantly updates its own plans for nuclear employment so it will be prepared if it has to preempt such an attack. The OPFOR has developed its combined arms concept to fit nuclear engagement as well as a nonnuclear phase. As a result, OPFOR commanders do not have to make a complex transition from nonnuclear to nuclear war-fighting modes.

Planning

Although the opening stages of an OPFOR offensive are likely to be conventional, planning focuses on the necessity to counter enemy employment of nuclear

weapons, to maintain the initiative and momentum of the offensive, and to maintain fire superiority over the enemy. The fire plans for divisions and higher include contingency plans for nuclear strikes.

The decision to initiate tactical nuclear warfare is made at the highest level of the OPFOR government. In deliberately planned operations, nuclear fires are planned in detail. In more mobile situations, as in meeting engagements, exploitation, and pursuit, some nuclear weapon systems are kept in high readiness to fire on targets of opportunity.

Targeting

OPFOR targeting analysts work on the assumption of high reliability of nuclear delivery means, relying on one device per target. If a target is considered to require more than one nuclear device, coverage is overlapping. The suitability of targets is determined by their priority category, missions, the current tactical situation, and the nuclear weapons available for use.

TYPES OF STRIKES

The OPFOR categorizes nuclear strikes as **group strikes**, **massed strikes**, and **individual strikes**. The category depends on the number of targets hit and the number of nuclear munitions used.

Group Strike

A group nuclear strike employs several nuclear munitions simultaneously. It focuses on one or several enemy targets.

Massed Strike

A massed nuclear strike employs a large number of nuclear munitions simultaneously or over a minimum time interval. Its goal is the destruction of a single large enemy troop concentration or several troop groupings. A massed strike can involve a single armed forces service, as in a nuclear missile strike, or the combined forces of different services.

Individual Strike

An individual nuclear strike may hit a single target or group of targets. A single nuclear munition, such as a missile or bomb, carries out the strike.

OFFENSIVE EMPLOYMENT

Once the OPFOR makes the decision to release nuclear weapons, their use is governed by two principles: **mass** and **surprise**. The initial nuclear strike is accomplished suddenly, throughout the depth of the enemy's combat deployment, and in coordination with nonnuclear fires. Nuclear fires are employed to support the main attack while other fire support means support secondary or supporting attacks. The enemy's forward defenses are targeted and destroyed rather than avoided and bypassed. Nuclear strikes in effect are the main attack. The OPFOR then exploits the results of these strikes by a high-speed air and ground offensive.

Subsequent nuclear strikes are integrated with the maneuver and fire support plans and employed to reinitiate an offensive that is slowed or stopped by organized enemy resistance. Nuclear strikes also may be used to eliminate the threat of a counterattack. In pursuit, nuclear strikes are planned

on choke points when retreating enemy forces present lucrative targets.

DEFENSIVE EMPLOYMENT

If an enemy offensive can be severely degraded by the impact of nuclear weapons, the defender may gain the opportunity to switch quickly to an offensive role. This drastic change in force correlation is sought when nuclear weapons are employed on the defense. Primary uses are:

- Destruction of enemy nuclear delivery means.
- Destruction of main attacking groups.
- Counter preparations.
- Elimination of penetrations.
- Support of counterattacks.
- Denial of areas to the enemy by use of surface bursts.

BIOLOGICAL

Current information points strongly to OPFOR biological research and development activities exceeding those expected just for biological warfare protection purposes. If the OPFOR employs biological weapons, it would probably target rear area objectives such as food supplies, water sources, troop concentrations, and urban and rural population centers, rather than against front line forces. The OPFOR realizes that if biological agents are employed against rear area targets they can disrupt and degrade mobilization plans as well as the subsequent conduct of a war.

Biological weapons are extremely potent and provide wide area coverage. BW agents include pathogens, toxins, and bioregulators. Pathogens cause diseases such as anthrax, cholera, smallpox, yellow fever, and plague. These weapons would be

used against strategic targets such as food supplies, port facilities, and population centers to create panic and disrupt mobilization plans.

Toxins are produced by pathogens, and also by snakes, spiders, sea creatures and plants. Toxins are faster acting and more stable than live pathogens. Most toxins are easily produced through genetic engineering. Toxins produce casualties rapidly and can be used against tactical and operational targets.

The OPFOR researches BW related areas such as aerobiology, cloud physics, airborne infections and disease agent stabilization, and has established installations with BW agent production and weaponization capabilities. The OPFOR is believed to have developed anthrax, tularemia, plague, cholera, botulinum toxin, and possibly other agents for BW purposes. Delivery systems include artillery, aerial bombs, missiles, and aerosol generators.

CHEMICAL

The OPFOR trains to conduct offensive and defensive chemical warfare and continues to improve its chemical warfare capabilities. The OPFOR believes an army using chemical weapons must be prepared to fight in the environment it creates. Therefore, the OPFOR views chemical protection as part of a viable offensive chemical warfare capability. The OPFOR is equipped with individual and collective protection and decontamination equipment and has confidence in its effectiveness.

Chemical Warfare Agents

The OPFOR classifies chemical agents according to the effect they have on the organism. The OPFOR identifies six

major types: **nerve, blood, blister, choking, psycho-chemical, and irritant.**

Nerve Agents

Nerve agents are fast-acting chemical agents. Practically odorless and colorless, they attack the body's nervous system causing convulsions and eventually death. Nerve agents are further classified as either G or V agents. The V agents are quicker acting and more persistent than the G agents.

Blood Agents

Blood agents cause death by blocking the oxygen transferal mechanisms in the body. A common blood agent is hydrogen cyanide

Blister Agents

Blister agents, such as mustard (H) or lewisite (L) and combinations of the two compounds, can disable or kill after contact with the skin, or after being inhaled into the lungs or ingested. Contact with the skin can cause painful blisters or blindness after eye contact. These agents are especially lethal if inhaled.

Choking Agents

Choking agents, such as phosgen and diphosgene block respiration by damaging the breathing mechanism, which can be fatal. Poisoning from choking or blood agents comes through inhalation, since both types of agents are nonpersistent.

Psycho-chemical

Psycho-chemical (incapacitants) disrupt a victim's mental and physical capabili-

ties. Consciousness may not be lost and the effects usually wear off without leaving permanent physical injuries.

Irritants

Irritants, also known as riot-control agents, cause a strong burning sensation in the eyes, mouth, skin, and respiratory tract. The effects of these agents, the best known being tear gas, are also temporary. Victims recover completely without having any serious after effects.

Chemical Agent Classification

OPFOR chemical agents are classified as **persistent** or **nonpersistent**. Persistent agents, such as V-agents, some G-agents, and the blister agent mustard, can retain their disabling or lethal characteristics depending on environmental conditions for days, weeks, and in some cases, years. Nonpersistent agents generally last a shorter period of time, depending on weather conditions.

Chemical Weapons

Virtually all weapons systems, from mortars and howitzers to aerial bombs to missiles, can be used to deliver chemical warfare agents. Chemical munitions are fitted with long or short bursters, according to the agent properties and the chemical strike planner's intended effect. A sarin-filled munition with a long burster releases the agent as a vapor or fine aerosol. This creates an immediate inhalation hazard with some of the fragmentation effect of a conventional munition. A 152mm howitzer battalion one-minute fire of GB could effect an area of 650 meters by 450 meters.

WEAPON SYSTEM	AC	H/L	GB	VX
122-mm howitzer		x	x	
130-mm gun			x	x
152-mm howitzer		x	x	
122-mm rocket	x		x	x
140-mm rocket			x	
220-mm rocket			x	x
300-mm rocket			x	x
SS-21				x
SCUD				x
Aerial bomb 100 kg		x		
Aerial bomb 250 kg			x	x
Aerial spray		x		

Figure 15-1. Chemical munitions and delivery systems.

A blister or persistent nerve agent-filled munition with a short burster is used to contaminate terrain or equipment. The short burster disperses the agent in droplets or a coarse aerosol, creating a skin hazard. The agent will evaporate more slowly and its effects remain on target longer.

The OPFOR is believed to have the chemical munitions in Figure 15-1. When firing a chemical fire mission, the OPFOR will generally employ not less than a battalion of tube artillery, or a battery of multiple rocket launchers.

Targeting

Airfields, nuclear storage sites, and nuclear delivery systems are targets for chemical attacks since these targets can be neutralized without the necessity of pinpoint strikes. Also, contamination of key points along rear area lines of communication can disrupt rear area resupply and reinforcement, while keeping those points intact for subsequent use by the OPFOR.

Offensive Employment

The OPFOR sees chemical weapons as having a unique role and their use is not dependent on initiation of nuclear warfare. It is possible that the OPFOR would use chemical weapons early in an operation or from its onset. The OPFOR would direct chemical attacks principally against enemy positions in the forward battle area. The OPFOR would use non-persistent agents on selected targets across the front of an OPFOR attack and use persistent agents to protect its flanks.

The basic OPFOR principle of chemical warfare is to achieve surprise. Simultaneously with strikes across the front, chemical strikes could also be expected throughout the depth for enemy defenses. These chemical strikes combine with other forms of conventional attack to neutralize enemy nuclear capability, command and control, and aviation. Subsequent chemical attacks might be conducted against logistics facilities.

Initially, the OPFOR use of chemical weapons is subject to the same level of decision as nuclear weapons, but chemical weapons may be used more freely once the initial authority for employment has been given.

Defensive Employment

In defense, persistent chemical agents are employed to deny the enemy use of certain terrain and to canalize attacking forces. Chemical agents are employed against an attacking force to impede effective command and control and to destroy the momentum of the attack by causing the attacking troops to adopt protective measures.

NBC PROTECTION

The OPFOR believes that the best means of protection against weapons of mass destruction is the destruction of enemy delivery systems, and these systems are priority targets. Other operational-tactical responses to the threat are--

- **Dispersion.**--Concentrations must last for as short a time as possible.
- **Speed of Advance.**--If the advance generates enough momentum, enemy targeting will be difficult and enemy systems kept on the move.
- **Concealment.**--Camouflage and deception complicate enemy targeting.
- **Continuous Contact.**--As long as friendly and enemy units are mixed they cannot be attacked.

Chemical Troops

The OPFOR sees chemical troops as essential to continuing operations in NBC conditions. It recognizes a need for special reconnaissance in addition to the all arms efforts in the area, and for trained troops to

handle chemical munitions. The OPFOR does not believe its forces can continue operations for any length of time while contaminated.

Like engineer and signal troops, chemical troops are considered a vital element of combat support. Although all troop branches of the ground forces can be expected to perform NBC protection-related activities, chemical troops are tasked with primary responsibility for ensuring combat units function as capably as possible in an NBC environment.

Chemical troops have two primary missions: NBC reconnaissance and NBC decontamination. Their basic missions include--

- Reconnoitering known or likely areas of NBC contamination.
- Warning troops of the presence of NBC contamination.
- Monitoring changes in the degree of contamination of troop positions.
- Monitoring the NBC contamination of personnel, weapons, and equipment.
- Performing decontamination operations.

Handling Chemical Munitions

Artillery chemical rounds are filled in the field. Chemical troops are probably responsible for the delivery and filling of munitions. They may also fulfill a similar role for the air force.

Non-NBC Related Tasks

The chemical troops also have tasks outside the realm of chemical defense. These are the use of smoke and flame equipment.

ASSETS

The basic chemical protection unit is the chemical protection platoon organic to tank, artillery, and motorized rifle regiments. At division level, there is a chemical protection battalion.

The reconnaissance and decontamination elements of chemical protection units are **rarely employed as whole units**. Commanders divide their chemical protection assets and assign them to various maneuver units in a direct support role. No chemical protection units are subordinate to maneuver battalions or companies. Each tank and motorized rifle company has an NBC noncommissioned officer heading a small team of extra duty NBC specialists. Company and battalion level NBC specialists are capable of checking unit NBC equipment and conducting NBC training. They also help decontaminate equipment and perform limited NBC reconnaissance when regimental NBC support is unavailable.

RECONNAISSANCE

Chemical protection personnel assigned to reconnaissance elements of chemical protection units perform NBC reconnaissance. This involves two general types of activity - **NBC observation posts** and **NBC reconnaissance patrolling**.

NBC Observation Posts

Although usually staffed by chemical troops, NBC observation posts can be manned by combat troops who have received NBC training. The functions of NBC observation posts are to detect NBC contamination, determine radiation levels and types of toxic substances, to monitor the drift of radioactive clouds, to notify higher headquar-

ters of NBC information, and to give the general alarm to threatened troops. An NBC observation post normally consists of three or four observers located near the command post of a combat unit. During movement, the NBC observation post moves in its own vehicle in close proximity to the combat unit commander.

NBC Reconnaissance Patrols

When operating in chemical reconnaissance patrols, chemical protection personnel travel in reconnaissance vehicles specially equipped with NBC detection and warning devices. The OPFOR also uses helicopters to perform NBC reconnaissance. Helicopters equipped with chemical and radiological area survey instruments are particularly useful for performing reconnaissance of areas with extremely high contamination levels.

Before an NBC patrol begins its mission, personnel check their individual NBC protection equipment and detection instruments. They also examine the NBC and communication equipment located on their reconnaissance vehicle. As they begin their reconnaissance, patrol members don their individual protective gear.

If only one route is to be covered, it is divided into 1 to 2 km segments and reconnoitered by the patrols in leapfrog fashion. When performing NBC reconnaissance of multiple routes, one patrol is assigned to each route. If NBC reconnaissance is being conducted in support of a march, the patrol operates well in front of the main body. The patrol may operate as part of a forward security element or combat reconnaissance patrol, or can move along a separate route.

As a patrol performs its mission, a designated crewman observes the readings of the onboard NBC survey meters. If radioactive or chemical contamination is discovered, the patrol determines the radiation level or type of toxic substance present. The patrol leader then plots contaminated areas on his map, reports to his commander, and orders his patrol to mark the contaminated area. The patrol designates bypass routes around contaminated areas or finds routes through the area with the lowest levels of contamination.

DECONTAMINATION

The OPFOR tries to decontaminate personnel and equipment as soon after exposure as possible. The divide decontamination methods into two types, **partial** and **complete**.

Partial Decontamination

OPFOR doctrine dictates that in the event of contamination, a combat unit should conduct a partial decontamination with organic equipment no later than one hour after having been exposed to contamination. This entails a halt while troops decontaminate themselves and their clothing, individual weapons, crew-served weapons, and combat vehicles. If a unit is forced to conduct partial decontamination in the contaminated area, personnel remain in NBC protective gear while doing so. Following the completion of partial decontamination, the unit resumes its mission.

Complete Decontamination

Complete decontamination of a maneuver unit is performed by chemical protection troops. As with chemical reconnaissance elements, decontamination units of

chemical protection companies and battalions can operate either as a whole or in smaller elements. Decontamination units deploy to areas where contaminated combat units are located. They set up near movement routes or establish centrally located decontamination points to serve several troop units.

Site Selection

Before deploying his equipment, the commander of a decontamination unit dispatches a reconnaissance group to select a favorable site, mark off areas for setting up the various pieces of equipment, and establishes and marks routes of entry and exit for the site. Sites are selected that provide natural concealment, good approach routes, and sources of uncontaminated water. After decontamination stations are set up, the decontamination unit commander orders security measures against enemy observation or attack. This normally includes making use of natural concealment, employing camouflage, and digging trenches. If natural concealment is insufficient, a smoke screen may be generated.

Individual Protection

Basic personal protective measures begin with NBC protective equipment. This protective equipment, when used correctly, provides protection against NBC agents. OPFOR NBC protective equipment enables combat troops to operate on contaminated terrain, allowing the continuous conduct of combat operations. Troops don protective masks and suits the instant an NBC attack occurs.

A significant characteristic of most NBC protective suits, including OPFOR models, is the physical burden associated with prolonged wear, especially in warm

temperatures. The suits are bulky and uncomfortable. When worn fully buttoned-up for an extended period of time in hot weather, soldiers become fatigued quickly and combat efficiency is lowered.

Collective Protection

Besides extensive training, the OPFOR advocates the use of protection systems, such as shelters and combat vehicles equipped with filter and ventilation systems. When riding in NBC protected combat vehicles, personnel do not need to wear protective suits, masks, gloves, or boots. One drawback of collective protection systems is that personnel exiting a shelter or vehicle cannot return until they completely decontaminate or remove their protective clothing to avoid contaminating the shelter or vehicle.

COMBAT IN AN NBC ENVIRONMENT

A maneuver unit commander receives much of his initial information regarding the NBC situation in combat orders issued by a higher unit. He supplements this information with intelligence acquired by his own reconnaissance assets. Based on his estimate, the commander issues instructions to his subordinates. These instructions include missions for attached and organic NBC reconnaissance elements, special measures to be taken while crossing contaminated terrain, the subunits responsible for conducting rescue work in the event of enemy NBC attack, and signals to be used for warning of the enemy NBC attack.

March

Before conducting a march, the commander issues his march order, which designates those subunits assigned to con-

duct NBC reconnaissance, signals used to warn of NBC attack or contaminated areas, and recovery procedures following an NBC attack.

Offense

If a force occupies an assembly area before initiation of an attack, personnel and equipment are dispersed to ensure maximum protection against enemy use of NBC weapons. Commanders notify subordinates of NBC warning signals and the measures to be taken under NBC attack. Contingency plans are developed governing the restoration of control, reconstitution of combat units, and evacuation of personnel and equipment.

If a defending enemy force conducts a withdrawal, attacking units commence pursuit operations. Close contact during pursuit restricts a withdrawing enemy's use of NBC weapons since, in using them, he would endanger his own troops.

Defense

Before occupying defensive positions, chemical reconnaissance squads survey the area and mark any contaminated sectors. Chemical observers are assigned to company and battalion command posts and to artillery firing positions. To attain reliable NBC protection, chemical observation posts of two or three observers are established throughout a defensive position at a ratio of one post for each 2 to 3 km of defensive area. During bad weather, more chemical observation posts normally are set up. Observers periodically switch on their NBC detection instruments and make reports as prescribed in the commander's combat order.

If a defending force is subjected to an NBC attack, chemical reconnaissance squads

determine the type and intensity of contamination and mark contaminated sectors. Partial decontamination and first aid are performed, and a defensive structure is reestablished.

Recovery Operations

Commanders at all levels must include in their plans provision for the restoration of units that fall victim to NBC strikes. This involves restoring command and control, reconnoitering the target area, conducting rescue work, including vehicle repair, evacuation of wounded, and extinguishing fires, and decontaminating personnel and equipment.

Recovery detachments are detailed for second-echelon or reserve groupings or are provided by higher headquarters from their reserve. They include chemical reconnaissance and decontamination assets, engineers, medical and vehicle repair personnel and motorized rifle troops for labor. Priority for help goes to personnel and equipment that can be quickly returned to combat, the aim being to form a new unit or subunit or, if the damage is too severe, to add effective elements to other units.

TRAINING

Training of OPFOR ground forces in NBC protection is comprehensive and realistic. It covers recognition and detection of NBC agents, operation of NBC measuring and monitoring instruments, procedures for warning troops of NBC attack self-protection, self-administration of antidotes, and decontamination. Realism is emphasized to the extent that live, albeit diluted, agents are occasionally used during training exercises.

Unit

Following basic training and on assignment to a unit, an OPFOR soldier's training builds from simple to complex and from theory to practice. This is particularly true of NBC protection training, which begins with classroom instruction on NBC weapons and how to defend against them. It continues with training drills conducted both in classrooms and field training sites where troops rehearse individual training topics. This three-tiered training program culminates with field exercises aimed at testing ground force capability to perform in an NBC environment.

Chemical Troops Training

NBC protection training given to chemical troops is more detailed and wider in scope than that presented to regular ground force troops. Following classroom instruction, chemical troops are divided into groups according to specialty and taken to training areas where they practice their particular skills. When training with a large and complex piece of equipment experienced service personnel first demonstrate how to set it up and put it into operation. Then the trainees themselves do the work sequentially at a slow pace.

After chemical protection trainees acquire competence in individual tasks, they perform the drill at a normal pace without interruption within a prescribed time limit. Next, they learn to work with their instruments in complicated conditions, such as while wearing NBC protective gear. Once proficiency is attained in this manner on a particular piece of equipment, cross-training within crews and between squads is practiced.

In combat, chemical protection troop units would be divided and would provide support directly to combat units. To train for such a role, chemical protection troops participate in the field training exercises of motorized rifle and tank units. Accordingly, NBC reconnaissance specialists constitute part of a forward detachment or advance guard of motorized rifle and tank units conducting march and offensive training. Decontamination units often set up their stations and practice decontamination of troops.

SMOKE

The OPFOR plans to employ smoke extensively on the battlefield. It distinguishes between **toxic** and **neutral** smokes in its doctrine. This distinction drives OPFOR planning on when to mask. The OPFOR intends to force the enemy to use his chemical protective systems and lower his effectiveness. Smoke system characteristics are outlined in Figure 15-2.

Assets

The OPFOR can use a number of different smoke agents together. For instance, chloride obscurants are particularly effective liquid obscurants. Obscurants such as fog oil block portions of the electromagnetic spectrum more fully when seeded with chaff. The vast quantities of white phosphorus (WP) on the battlefield also suggest that random mixtures of this agent will combine with other obscurants, both man-made and natural.

Delivery Systems

The OPFOR has ample equipment for the use of smoke. Its munitions and equipment include:

- Smoke grenades.

- Smoke barrels, drums, and pots.
- Large area smoke generators (ground and air).
- Mortar, artillery, and rocket smoke rounds.
- Vehicle Engine Exhaust Smoke Systems (VEESS).
- Spray tanks (ground and air).

Artillery

OPFOR artillery is used to fire white phosphorus rounds, that have a moderate degrading effect on thermal imagers and a major one on lasers. Smoke-filled artillery projectiles are also common. Seven to ten percent of all OPFOR artillery units of fire are smoke rounds. These are mostly WP and, more recently, plasticized white phosphorus (PWP). The OPFOR maintains that when artillery in a position covered with smoke fires at targets outside the smoke, it is 10 times less effective. When the smoke conceals only the targets, effectiveness decreases four to five times. Munition expenditures are addressed in Figure 15-3.

Aircraft

The OPFOR employs smoke bombs or pots dropped by either fixed-or rotary-wing aircraft.

Smoke Pots

The OPFOR has smoke pots in its equipment inventory, and makes considerable use of this capability.

Armored Fighting Vehicles

All tanks and BMPs can generate smoke through their exhaust systems. A

System	Placement				Uses					
	On Friendly	In Between	On Enemy	Blinding	Camouflage	Protective	Decoy	Signal		
Smoke Grenade	X	X		X	X	X	X	X		
Smoke Generator	X	X			X	X	X	X		
Smoke Pot	X	X			X	X	X	X		
VEESS	X				X	X	X			
Vehicle Dust	X				X	X	X			
Helicopter	X	X	X		X	X				
Mortar/Artillery Smoke		X	X	X	X			X		
Rocket		X	X	X						
Aerial Bomb		X	X	X						
Aircraft Spray	X	X	X	X	X					
Mortar/Artillery HE Dust		X	X	X						

Figure 15-2. Smoke system characteristics.

Weapon	Wind Direction					
	Head or Tail		Oblique (45%)		Flank	
	Number of tubes	Number of rounds	Number of tubes	Number of rounds	Number of tubes	Number of rounds
82-mm Mortar	12	900	8 to 12	750	8	600
120-mm Mortar	8	450	8	350	4	250
122-mm Howitzer	8	300	8	220	4	150
152-mm Howitzer	13 to 14	200	10	150	6 to 7	100

NOTES:

- Assuming the wind speed is 3 to 5 meters per second.
- If the wind speed is 6 to 7 meters per second, multiply the ammunition consumption by 1.5.
- An artillery battery of 6 to 8 pieces, regardless of the caliber of its weapon, can produce a smoke screen of:
 - * Over a 500 to 700 meter frontage if a crosswind
 - * Over a 150 to 200 meter frontage if head or tail wind
 If a frontage exceeds these dimensions, divide it among the batteries.
- When there is a layer of snow over 20 centimeters in depth, multiply the ammunition consumption by a factor of 1.5 to 2.

Figure 15-3. Munition expenditure norms for producing 1 km smoke screen for 15 minutes.

Weapon	Head Winds		Flanking Winds (Meters per Second)			
	Up to 5	More than 5	Up to 2	3 to 5	6 to 7	More than 7
	Required Rounds		Required Rounds			
82-mm Mortar	108-180	162-270	N/A	72-120	108-180	144-220
120-mm Mortar	54-90	81-135	N/A	36-60	54-90	72-120
122-mm Howitzer	36-60	54-90	N/A	18-30	27-45	36-60

Munition expenditure norms for producing a 120 to 200 meter smoke screen for 15 minutes

Figure 15-4. Wind effects on smoke operations.

platoon can produce a screen that can cover a battalion frontage for four to six minutes.

In addition, their forward firing smoke grenade dischargers can produce a screen up to 300 meters ahead of the vehicle.

TYPES OF SMOKE SCREENS

The OPFOR recognizes three types of smoke screens: **blinding**, **camouflage**, and **decoy**. Classification of each type as frontal, oblique, or flank in nature depends on the placement of the screen. Smoke screens are either stationary or mobile depending on prevailing winds and the dispensing means used. Each basic type can serve a different tactical purpose, but simultaneous use of all types is possible.

Blinding

Blinding smoke is laid directly in front of enemy positions, especially of anti-tank weapons and observation posts. Blinding smoke screens can mask friendly forces from enemy gunners and target acquisition systems. They can also restrict the enemy's ability to engage the OPFOR effectively. Blinding smoke rounds are part of the artillery preparation for an attack and the fires in support of the attack.

Targets for this type of smoke screen are enemy defensive positions, rear assembly areas, counterattacking forces, fire support locations, and subsequent objectives. The screening properties of a blinding smoke screen can couple with dust, HE combustion effects, and incendiary effects of phosphorus. This creates an environment in which fear and confusion add to the measured effectiveness of the smoke.

Camouflage

Camouflage smoke is used to cover maneuver. It can also force attack helicopters to fly above or round a screen exposing themselves to attack. Camouflage smoke is not just used on the line of contact. It can be used to cover assembly areas and forming up areas. It is also used to cover the approach of attacking forces from the depth, or cover a withdrawal, with successive lines extending many kilometers to the rear.

Camouflage smoke provides freedom of movement for units. It conceals the location of units and the nature and direction of an attack. The camouflage smoke screen is useful on, or to the front of, friendly troops. These screens are normally effective to the point where forces deploy into attack formations. The number, size, and location of camouflage smoke screens vary depending on terrain, weather, and the tactics conducted. Establishing camouflage smoke screens normally requires use of:

- A combination of smoke grenades.
- Smoke barrels.
- Smoke pots.
- Combat VEES.
- Decontamination vehicles.
- Vehicles mounting smoke generating devices.
- Aircraft.

The VEES and the TMS-65 decontamination vehicle can establish a camouflage smoke screen quickly, but they are vulnerable to detection. Consequently, they are usually useful only when they are well behind friendly lines or when cover is available. Depending on the wind, smoke generating vehicles may start at the center of a line and travel in opposite directions along that line. They may also stay stationary or move in the same direction.

Two vehicles can lay a smoke screen long enough to cover a battalion advancing to the attack. For larger smoke screens, the OPFOR divides the line into segments and assigns two vehicles to each segment. The OPFOR states that camouflage smoke screens should cover an area at least five times the width of the attacking unit's frontage.

Decoy

A decoy smoke screen can deceive an enemy about the location of friendly forces and the probable direction of attack. The site and location of decoy screens depend upon the type of combat action, time available, terrain, and weather conditions. An example of the use of decoy screens is a river crossing in which several possible crossing sites receive screening simultaneously. If the enemy fires into the decoy screen, black smoke devices and fires will ignite to simulate burning vehicles or equipment. Other disinformation may include speakers that simulate the sound of tanks operating.

METEOROLOGICAL INFLUENCES

Local meteorological conditions greatly affect the employment of smoke. The command and control of troops maneuvering in smoke is extremely difficult. This is true even when commanders have planned the use of smoke and have conducted reconnaissance and prepared their troops. When weather conditions are ignored, smoke unexpectedly covering friendly forces can lead to disorientation, loss of command and control, and tactical disaster. Careful analysis of weather conditions in the planning process is important. The conditions that most effect the employment of smoke are wind and lower atmospheric stability in conjunction

with temperature, relative humidity, and precipitation. Further information on wind effects are in Figure 15-4.

Employment

The OPFOR follows general guidelines in its use of smoke. Artillery, mortar, and aircraft are the OPFOR's primary means of smoke dissemination. Artillery and aircraft are useful in spreading screening smoke throughout the tactical depth of the enemy's defense. They are also useful in screening the flanks of attacking units. The OPFOR will place smoke on enemy firing positions and observation points before and during an attack. The OPFOR can place two to three hours' worth of screening smoke along a wide frontage to cover units conducting water obstacle crossing operations. The OPFOR may also place floating pots and barrels in the river. As the situation dictates, the OPFOR will screen other important locations and possible targets, including--

- Troop concentrations.
- Bridges.
- Railroad junctions.
- Unloading areas.

The OPFOR will also screen avenues of approach to such locations. It will try to eliminate reference points that could aid enemy aviation in targeting a screened location. Camouflage, blinding, and decoy smoke screens are useful in concealing the direction and time of attack. They also help to minimize losses. Screens set down on a broad frontage can also cover maneuver forces.

Reliable communications and continuous coordination between units using smoke and the forward air warning and air defense posts is essential.

FLAME

The OPFOR has not neglected flame weapons. Flame weapons are also a chemical troops responsibility and sections armed with flame-throwers can be attached to assaulting units or to antitank reserves. They are seen to be of great value in reducing

strong points and in built up areas. Each division has a company with man portable flame weapons, firing a napalm warhead. At higher formation level, *fronts* have separate flame-thrower tank units that can be decentralized as appropriate.

GLOSSARY

- AA** - anti-aircraft
AAA - anti-aircraft artillery
AAG - army artillery group
ACRV - artillery command and reconnaissance vehicle
ADVG - advance guard
AGL - above ground level
AGRA - artillery group of rocket artillery
AMMO - ammunition
AP - anti-personnel
AP - attack position
APC - armored personnel carrier
ARM - anti-radiation missile
ARTY - artillery
AT - anti-tank
ATGM - anti-tank guided missile
- BN** - battalion
BrAG - brigade artillery group
BTRY - battery
BW - biological warfare
- C³** - command, control, and communications
C³I - command, control, communications and intelligence
CAG - corps artillery group
CDR - commander
CIP - control and target identification post
CMTA - commander of missile troops and artillery
CO - company
COFM - correlation of forces and means
COMINT - communications intelligence
COMMO - communication
COP - command observation post
COR - chief of reconnaissance
CP - command post/control post
CRP - combat reconnaissance patrol
- DAG** - division artillery group
DET - detachment
DF - direction finding
DIV - division
- ECCM** - electronic counter-countermeasures
ECM - electronic countermeasures
ELINT - electronic intelligence
ENGR - engineer
EW - electronic warfare
- FAC** - forward air controller
FD - forward detachment
FDC - fire direction center
FOP - forward observation post
FP - firing point/position
FP - forward patrol
FSE - forward security element
FWD - forward
- HF** - high frequency
HQ - headquarters
HVY - heavy
- ICM** - improved conventional munitions
IMRB - independent motorized rifle brigade
IP - initial point
IRP - independent reconnaissance patrol
- KM** - kilometer (s)
KTS - knots
- LOP** - lateral observation post
LT - light
- MED** - medium
MG - machinegun
MOD - mobile obstacle detachment
MR - motorized rifle
MRB - motorized rifle battalion

MRC - motorized rifle company
MRD - motorized rifle division
MRL - multiple rocket launcher
MRP - mobile reconnaissance post
MRP - motorized rifle platoon
MRR - motorized rifle regiment
MSD - movement support detachment

NBC - nuclear, biological, and chemical

OMG - operational maneuver group
OP - observation post
OPFOR - Opposing Force

PLT - platoon
POL - petroleum, oils, and lubricants
PWP - plasticized white phosphorus

RAG - regimental artillery group
RD - reconnaissance detachment
RECON - reconnaissance
REG - repair and evacuation group
REGT - regiment
RES - reserve
RFC - reconnaissance fire complex
RL - rocket launcher
RP - reconnaissance patrol
RPV - remotely piloted vehicle
RR - radioelectronic reconnaissance
RSC - reconnaissance strike complex

SAM - surface-to-air missile
SECT - section
SHF - super high frequency
SIGINT - signals intelligence
SM - small
SSM - surface-to-surface missile
SVC/SVCS - service(s)

TB - tank battalion
TC - tank company
TD - tank division
TK - tank
TOP - technical observation point
TP - tank platoon

TPT - transport
TR - tank regiment

UHF - ultra high frequency

VEESS - vehicle engine exhaust smoke
systems

VHF - very high frequency

The proponent of this pamphlet is the TRADOC Deputy Chief of Staff for Intelligence. This pamphlet is the definitive source for heavy OPFOR tactics for use at the Combat Training Centers and TRADOC centers and schools. It will also serve as the **coordinating draft** for a subsequent edition of the handbook in the form of a Department of the Army Information Pamphlet. Users are encouraged to send comments and suggested improvements on DA Form 2028 (Recommended Changes to Publications and Blank Forms) to the TRADOC ODCSINT, Threat Support Division, ATTN: ATZL-CST, Fort Leavenworth, Kansas 66027-5310. Suggested improvements may also be submitted using DA Form 1045 (Army Ideas for Excellence Program (AIEP) Proposal).

FOR THE COMMANDER:

OFFICIAL:

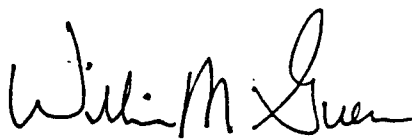

WILLIAM M. GUERRA
Colonel, GS
Deputy Chief of Staff
for Information Management

JOHN P. HERRLING
Major General, GS
Chief of Staff

DISTRIBUTION:
Special