

Helmet-Mounted Display Symbology and Stabilization Concepts

Richard L. Newman

19960124 011

CONTRACT NAS2-13811
June 1995



National Aeronautics and
Space Administration

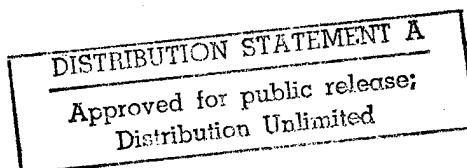

DTIC QUALITY INSPECTED 1



US Army
Aviation and Troop Command

Aeroflightdynamics Directorate
Moffett Field, CA 94035-1000

Helmet-Mounted Display Symbology and Stabilization Concepts

Richard L. Newman

Crew Systems
P. O. Box 963
San Marcos, Texas 78667

Prepared for
Ames Research Center
CONTRACT NAS2-13811
June 1995



National Aeronautics and
Space Administration

Ames Research Center
Moffett Field, CA 94035-1000



US Army
Aviation and Troop Command

Aeroflightdynamics Directorate
Moffett Field, CA 94035-1000

CONTENTS

	Page
LIST OF FIGURES	v
LIST OF TABLES	v
ABBREVIATIONS.....	vii
POINTS OF CONTACT.....	xi
SUMMARY.....	xiii
A BACKGROUND	1
(1) Statement of the Problem	1
(2) The Real Problem.....	2
B PROBLEMS WITH VIRTUAL DISPLAYS	5
(1) Lessons Learned from HUD Developments	5
(2) Problems Unique to HMDs	7
(3) Summary.....	9
C DEFINITIONS.....	11
(1) Frequently Used Terms.....	11
(2) Stabilization Terms.....	12
D HMD SYSTEMS	13
(1) Operational and Developmental HMDs.....	13
(2) Research HMDs	13
(3) HMD Simulators.....	14
(4) Helicopter HUD Systems.....	15
E HMD SYMBOLOGY SUMMARY	17
(1) Operational HMDs	17
(2) Rotorcraft HMDs Under Development.....	18
(3) Helicopter HUDs.....	21
(3) Proposed Fixed-Wing HMDs	21
F SYMBOLOGY STABILIZATION.....	33
(1) General Comments	33
(2) Coordinate Systems.....	33
(3) Symbol Orientation	34
(4) Symbol Location.....	34

G	HMD LESSONS LEARNED TO DATE	39
	(1) Training.....	39
	(2) Operations.....	39
	(3) Research.....	40
	(4) Observations.....	41
H	RESTATEMENT OF THE PROBLEM.....	43
I	THE HELMET-MOUNTED DISPLAY DESIGN GUIDE.....	45
	(1) Previous Design Documents.....	45
	(2) Strawman HMD Design Guide.....	46
	(3) Database Development.....	48
J	POTENTIAL BENEFITS.....	51
	(1) Reduced Design Cost	51
	(2) Civil Operators.....	51
	(3) Military Operators	51
	(4) External Load Operations	52
	(5) Other Uses of HMDs.....	52
K	RESULTS AND RECOMMENDATIONS	53
	(1) Results.....	53
	(2) Recommendations.....	53
L	REFERENCES	55
	APPENDIX A: HUD/HMD GLOSSARY	61
	(a) Optical Definitions	62
	(b) Symbology Definitions.....	72
	(c) Systems Definitions.....	86
	(d) Weapons Definitions	91
	(e) Abbreviations.....	92
	APPENDIX B: HMD BIBLIOGRAPHY.....	95
	APPENDIX C: STRAWMAN HMD DESIGN GUIDE.....	107

LIST OF FIGURES

		Page
Figure 1	<i>Apache</i> Hover Symbology	23
Figure 2	<i>Apache</i> Cruise Symbology.....	23
Figure 3	<i>Comanche</i> Hover Symbology.....	24
Figure 4	<i>Comanche</i> Cruise Symbology	24
Figure 5	ANVIS/HUD Hover Symbology	25
Figure 6	ANVIS/HUD Cruise Symbology.....	25
Figure 7	MH-53J Symbology.....	26
Figure 8	<i>LifeSaver</i> Symbology.....	26
Figure 9	Comparison of HMD Fields-of-View	27
Figure 10	<i>CH-3E (MARS)</i> HUD Symbology	28
Figure 11	AH-1S HUD Symbology.....	28
Figure 12	Bell 230 HUD Symbology.....	29
Figure 13	AFAL Symbology.....	30
Figure 14	<i>Theta</i> Symbology	30
Figure 15	McDonnell-Douglas Symbology	31
Figure 16	C-130 ANVIS/HUD Symbology.....	31
Figure 17	Screen- and World-Referenced Symbology.....	36
Figure 18	Screen- and World-Fixed Symbology.....	37
Figure 19	<i>Comanche</i> Cruise Symbology.....	38
Figure 20	Proposed Database Arrangement	49
Figure 21	Binocular and Monocular Fields of View	63
Figure 22	Aperture Stop and Entrance and Exit Pupils	66
Figure 23	Real and Virtual Images.....	69

LIST OF TABLES

		Page
Table 1	Helmet-Mounted Display Characteristics	16

Abbreviations

A-7D/E	Military Fighter, <i>Corsair II</i>
ACIDTEST	Aircraft Cockpit Information Display Tenets Expert System Tool
ADI	Attitude director indicator
ADS	Aeronautical Design Standard
AFAL	Air Force Armstrong Laboratory
AFDD	Aeroflightdynamics Directorate
AGARD	Advisory Group for Aeronautics Research and Development
AH-1S	Military Helicopter, <i>Cobra</i>
AH-64	Military Helicopter, <i>Apache</i>
AHP	Advanced Helicopter Pilotage
ANVIS	Aviator's Night Vision System
ARI	Army Research Institute
ATC	Air traffic control
C-130	Military Transport, <i>Hercules</i>
CH-3E	Military Helicopter, <i>Jolly Green Giant</i>
CH-46E	Military Helicopter, <i>Sea Knight</i>
CH-47	Military Helicopter, <i>Chinook</i>
CONDOR	Covert Night/Day Operations in Rotorcraft
CRT	Cathode ray tube
CSRDF	Crew Station Research and Development Facility
ELVIRA	Extremely Low Visibility Rotorcraft Approaches
EMI	Electromagnetic interference
EMS	Emergency Medical Service
F-4	Military Fighter, <i>Phantom</i>
F-16A	Military Fighter, <i>Fighting Falcon</i>
F/W	Fixed-wing
FAA	Federal Aviation Administration
FLITE	Flight Laboratory for Integrated Test and Evaluation
FOHMD	Fiber Optic Helmet-Mounted Display

FOR	Field-of-regard
FOV	Field-of-view
FPM	Flight path marker
FSWG	Flight Symbology Working Group
HDD	Head-down display
HIDSS	Helmet Integrated Display Sighting System
HMD	Head-/helmet-mounted display
HSI	Horizontal situation display
HUD	Head-up display
IFR	Instrument flight rules
IHADSS	Integrated Helmet and Display Sighting System
IP	Instructor pilot
IPD	Interpupillary distance
IR	Infrared
LOS	Line-of-sight
MARS	Mid-Air Retrieval System
MD-80	Civilian Transport
MH-53J	Military Helicopter, <i>Sea Dragon</i>
NAH-1	Experimental Helicopter, <i>Cobra</i>
NASA	National Aeronautics and Space Administration
NAWCAD	Naval Air Warfare Center, Aircraft Division
NOE	Nap-of-the-earth
NVD	Night vision device
NVG	Night vision goggles
PC	Personal computer (IBM compatible)
R/W	Rotary-wing
RAH-66	Military Helicopter, <i>Comanche</i>
RASCAL	Rotorcraft Aircrew-Systems Concepts Airborne Laboratory
RPM	Revolutions per minute
SCTB	Simulator Complexity Test Bed
SPIRIT	Simulation Program for Improved Rotorcraft Integration Technology

TLAR	That looks about right.
UH-1N	Military Helicopter, <i>Huey</i>
UH-60	Military Helicopter, <i>Blackhawk</i>
UK	United Kingdom
US	United States
USAF	US Air Force
USASC	US Army Safety Center

Points of Contact

During the course of the Phase I study, the following organizations and individuals were contacted. Some of the contacts occurred during professional meetings and symposia.

- 1 Advanced Aviation Concepts
 Mr. Richard Adams

- 2 Air Methods
 Capt. Leroy Jackson
 Capt. Andy McJohnston

- 3 Boeing Helicopter
 Mr. Ryan Wilkins

- 4 CAE Electronics
 Dr. Ronald Kruk

- 5 Federal Aviation Administration
 Mr. Peter Hwoschinsky
 Mr. Paul Erway
 Mr. Stephen Hickok
 Dr. Garry Headley

- 6 Flight Visions
 Mr. Mark Phillips
 Mr. Herb White

- 7 GEC Avionics
 Mr. Steve Brown
 Mr. Robin Sleight

- 8 Hoh Aeronautics
 Mr. Roger Hoh

- 9 Honeywell
 Mr. Robert North
 Mr. Jeff Radke

- 10 Kaiser Electronics
 Mr. Joseph Garcia

- 11 Petroleum Helicopters
 Mr. Vern Albert

- 12 Research Triangle Park
 Mr. Malcolm Burgess
- 13 Sextant Avionique
 Mr. Luc Baron
 Dr. Alain Leger
 Mr. Roger Parus
- 14 Sikorsky
 Mr. Nick Lappos
 Mr. Robert Warren
- 15 STC Corporation
 Dr. Donald Richardson
- 16 US Air Force (Wright-Patterson AFB)
 Mr. Eric Geiselman (University of Dayton)
 Mr. Dean Kocian
 S/L Robert Munns
 Dr. Robert Osgood
- 17 US Army (Fort Rucker)
 CW3 John Armbrust
 CW2 Neil Caldwell
 CW2 Rick Korycinski
 CW3 Steven Paris
 Cpt Douglas Sperandio
- 18 US Army (Fort Belvoir)
 Maj Brian Gillespie
- 19 US Navy/Marine Corps (Patuxent NAS)
 L/C Andy Lahaszow

Summary

The helmet-mounted display (HMD) presents flight, sensor, and weapon information in the pilot's line of sight. The HMD was developed to allow the pilot to retain aircraft and weapon information and to view sensor images while looking off boresight.

The only operational helicopter HMD system today is installed in the *Apache*. This system incorporates a movable infrared sensor which is slaved to the pilot's line of sight. The sensor image is shown on the HMD reticle with symbology embedded in the image. The system was developed to allow contact flight at night. While *Apache* system meets this design objective, the combination of sensor image and symbology can be confusing and present misleading flight information.

The present study reviewed the current state-of-the-art in HMDs and identified a number of issues applying to HMDs. Several are identical to Head-Up Display (HUD) issues: symbol standardization, excessive clutter, and the need for integration with other cockpit displays and controls. Other issues are unique to the head-mounted display: symbol stabilization, inadequate definitions, undefined symbol drive laws, helmet considerations, and field-of-view (FOV) vs. resolution tradeoff requirements.

In particular, symbol stabilization is a key issue for HMDs. In addition to requiring further experimental studies, it was found to impact the definition and control law issues. Part of the problem is there is no agreed upon set of definitions or descriptions for how HMD symbols are driven to compensate for pilot head motion. A candidate set of definitions is proposed to address this.

Symbol stabilization is critical. In the case of the *Apache* helicopter, the lack of compensation for pilot head motion creates excessive workload during hovering and nap-of-the-earth (NOE) flight. This high workload translates into excessive training requirements. At the same time, misleading symbology makes interpretation of the height of obstructions impossible.

The underlying cause is inadequate of design criteria for HMDs. The existing military standard does not reflect the current state of technology. In addition, there are generally inadequate test and evaluation guidelines. The situation parallels the state-of-the-art for HUDs several years ago. The major recommendation of this study is the development of an HMD design guide similar to the HUD design guide. A further recommendation calls for the creation of a HMD database in electronic format.

There are several specific areas where additional simulation and flight experiments are needed. These include development of hover and NOE symbology which compensates for pilot head movement and the tradeoff between FOV, sensor resolution and symbology.

HELMET-MOUNTED DISPLAY

FLIGHT SYMBOLOGY AND STABILIZATION CONCEPTS

A BACKGROUND

Virtual image displays present collimated flight symbology and sensor images (infrared, radar, etc.) in the pilot's view of the world. This allows simultaneous viewing of flight information, sensor information, and the real world. These displays come in two varieties: head-up displays (HUDs) and helmet-mounted displays (HMDs).

HUDs are fixed displays usually mounted at the top of the instrument panel. HUDs are becoming the primary fixed-wing flight reference for use during both visual and instrument meteorological conditions. HMDs were developed to accommodate the need for larger field-of-regard (i. e. to look off boresight).

These displays allow presentation of flight-critical information in a variety of new and useful formats and can combine the information from a large number of sources. This can be both a blessing and a curse.

HMDs offer many advantages in terms of weapon delivery and maneuvering in close proximity to obstacles. They offer advantages in terms of weapon delivery and maneuvering in close proximity to obstacles. At the same time, HMDs present many significant challenges which must be addressed.

As the technology matures, HMDs will be found on more aircraft. At this time, HMDs are found on one operational aircraft (AH-64, Apache), although there are a number of candidate systems being proposed.

(1) Statement of the Problem

The present standard for the HMD describes the symbology for the Apache(1). This standard represented the best information available at the time of its publication in 1984, but has not kept up with the technology.

In the Apache, the symbology does not compensate for pilot head motion. There have been difficulties reported with this symbology, both in terms of mission degradation and in terms of excessive training costs. In addition, the use of non head-tracked horizon information can result in a flight hazard. For these reasons, a new standard should be prepared. The Aeroflightdynamics

Directorate (AFDD) is preparing an Aeronautical Design Standard (ADS) to address these topics.

(2) The Real Problem

The real problem is not so much with the existing standard, rather it is an indictment of the display design process. The development of most electronic flight displays does not follow a consistent and logical path. Rather the display formats are developed using a "That looks about right" (TLAR) approach.

The display complexity can be looked at as a global to specific hierarchy: at the top, we can consider the general informational requirements, followed by overall systems issues. As we move down the hierarchy, issues become more specific, first arrangement and dynamics of the display, then the icons, and finally the details of the icons. Most symbology development heretofore has concentrated on the bottom end -- defining the icons.

The most important aspect of display design, in our opinion, determining the information requirements has relied on the use of expert pilot opinion. Traditionally, display designers have sought pilot opinion for guidance during the development of new flight displays. While user input is helpful, pilots tend to have diverse (and strongly held) opinions. In addition, pilots with limited background in display evaluation often limit the design of novel systems to those concepts with which they are familiar (i. e., TLAR).

This would be an acceptable, if inefficient, design methodology if there were valid test criteria and a well-developed test protocol. Unfortunately, neither has been in place. Recently a design handbook has been developed for head-up displays(2). A similar procedure should be developed for HMDs as well.

The display design must consider why the pilot needs the data and what the pilot is expected to do with the data. According to Singleton(3), a number of questions should be considered during the development of a display:

- o Does the pilot's need justify the display?
- o What data does the pilot need that has not been provided?
- o Can the average pilot obtain what is required easily?
- o Does the display conform ...
 - to the real world?
 - to other cockpit displays?
 - with previous pilot habits and skills?
 - with required decisions and actions?(3)

The development of any display must start with the basic principle of analyzing the mission requirements. The information required by the pilot and crew must be cataloged. Only then can the display symbology be designed. Head-down instruments did not change greatly for many years. As a result, designers forgot this basic principle and concentrated on matching the format of the "basic T."

The final set of questions concerning conformity should not be taken as an absolute requirement for duplicating previous displays or the real world. Rather, it means that the display should not be in conflict with the pilot's experience and training nor with the external cues. It would be foolish to insist that HUDs and HMDs conform exactly to early round-dial instruments or electronic head-down displays.

In 1969, Ketchel and Jenney studied the requirements for electronic displays(4). While their study is technologically dated, the underlying principles of determining the information requirements are still valid today. Their report covered information requirements, symbology design, and display characteristics.

Newman prepared a design handbook for head-up displays which describes a design methodology, presents specific design criteria, and outlines evaluation criteria(2). This handbook also lists the "lessons learned" from a history of HUD symbology.

Following completion of the display design, its evaluation must be based on objective, performance based criteria and measures of the display's effect on mission performance. It is up to the evaluation team to determine what appropriate flight tasks and performance measures are. These should reflect the intended mission of the aircraft and must include all mission segments.

B PROBLEMS WITH VIRTUAL DISPLAYS

(1) Lessons Learned from HUD Developments

- (a) Symbol Standardization: With any electronic aircraft display, head-up, head-down, or helmet-mounted, there are two divergent forces. On the one hand, there is a great clamor for standardization of symbology. At the same time, there is an extraordinary desire to make every aircraft application different. Any student of head-up display (HUD) history will testify to this.

"It is a most interesting fact that one of the first things a pilot exhibits on being exposed to HUD flying is an insatiable drive to redesign it in his/her own image. It borders on a religious experience."(5)

HUDs are see-through, virtual image displays. As such, they are fundamentally different from panel mounted displays. In spite of the differences, HUD symbology often mimics head-down displays. This has resulted in confusion over control techniques, in excessively cluttered displays, and in displays which do not make the best use of the HUD.

Similarly, some proposed HMD symbology formats appear to be copied inappropriately from HUD symbologies.

- (b) Lack of Criteria: What has been lacking is any organized set of development, test, and evaluation criteria for displays. As a result, HUD development usually progress through a series of personal preference choices by either the manufacturer's project pilot or the customer's pilot.

As decisions are made, the rationale for the choices aren't documented. This forces new systems to go through the same process time and again.

- (c) Clutter: One of the primary goals for a see-through display is to present the pilot an uncluttered display. Since the pilot will necessarily being looking through a HUD to view the real world, there is an paramount requirement to minimize display clutter. Both Newman(2) and Hughes(6) emphasize this. Hughes expressed this principle that not one pixel should be lit unless it "buys" its way onto the screen by providing a demonstrable improvement in performance(6).*

This issue may be more pronounced if a raster sensor image is displayed in conjunction with stroke symbols. No criteria have been generated dealing with raster/symbology combinations.

* This has been referred to as Hawkeye's Principle.

- (d) **Symbol Control Laws**: HUD control laws and algorithms which drive the various symbols have not been well described. The absence of specifications and of documentation has created problems with HUDs where the symbols were excessively noisy (lateral motion of the F-16A FPM) or led to pilot uncertainty about the origin of the data (aircraft reference symbol in the MD-80).

Historically, there have been no requirements to deliver the display code as part of the data package. This makes it quite difficult to determine exactly what is displayed and how the symbols are driven. Manufacturers treat the source code as proprietary data. The only algorithms publicly available, to our knowledge, are for the A-7D/E HUD. (7) The USAF has attempted to "reverse engineer" the F-16A symbol generator code. This problem has been described previously(8).

- (e) **Integration**: Many HUDs are installed as "add-ons." If inadequate attention is paid to integrating the HUD with existing systems, excessive pilot workload can result. This may not be apparent in most situations, but can become overwhelming with a small addition to external workload. In a recent flight test(9), poor system integration did not become apparent until operational trials. The difference between various ATC workloads resulted in a display being rated as "satisfactory" during low workload situations and "unacceptable" when, for example, the pilot was asked to "maintain 180 knots to the marker" and vectored through the localizer before final intercept.
- (f) **Software Validation**: A major constraint is the need to validate the software which performs the algorithms driving the symbols. This can require a considerable amount of time. Usually the validation is well underway before the display evaluation is begun. As a result, there is an extreme reluctance to modify any symbol or control law since it will require revalidation and a large increase in cost. It can be said that there is no such thing as "changing one line of code."

The display symbology thus becomes "frozen" before test and evaluation. It is expensive to change even a minor item, such as the shape of a symbol, not because of the effort to make the change, but because of the lengthy validation and verification of the software.

(2) Problems Unique to HMDs

- (a) Symbol Stabilization: HMDs present unique symbology problems not found in HUDs. Foremost among these is the issue of maintaining spatial orientation of the symbols. All previous flight displays, round dial instruments, HDDs, and HUDs, have been fixed in the cockpit. With the HMD, the flight display can move through a large angle. If improperly implemented, this can lead the pilot into incorrect control inputs or aggravate spatial disorientation.

As an example of these problems, the Apache hover symbology is presented as a "God's eye" view of the helicopter(10). The aircraft's velocity is shown as a vector indicating its drift over the ground. This symbology is not stabilized with respect to the aircraft, but is fixed in the display field-of-view (FOV). Thus, when the pilot looks to the side, he must mentally perform two coordinate rotations -- one to rotate the display from the side to the forward direction and one to rotate it from the forward view to the vertical (plan) view.

Additionally, the raster image from the infrared (IR) camera is shown as a "pilot's eye" view. This awkward combination of coordinates tends to make orientation difficult and leads to excessive training requirements.

The HMD is not a HUD with a large field-of-view. In addition to the three degrees of freedom for the HUD (the three aircraft axes), the HMD has three more (two for LOS direction and one for head tilt).

- (b) Lack of Definitions: Many of the terms used in HMD studies have not been well defined. We need to have a common language to ensure that system descriptions are communicated.

As an example, the term "stabilized" has been widely used with two meanings. "Roll-stabilized" has been used to mean a symbol which rotates to indicate the roll or bank of the aircraft. "World-stabilized" and "head-stabilized" have both been used to indicate symbols which move to remain fixed with respect to external objects.

- (c) Symbol Drive Laws: The symbols drive algorithms for electronic displays are an integral part of the description. As with HUDs, the laws themselves and the assumptions used in their development have not been documented. This problem is more critical with HMDs since the motion of the symbols is affected by head movement as well as aircraft movement. During the course of this study, reviews of HMD symbologies were hampered by poor or nonexistent descriptions of symbol motion.

- (d) **Helmet Considerations**: The need to place the display on the pilot's head creates a design goal of minimizing head-borne weight. While the weight is important, the location of the helmet center-of-gravity is also important. This problem may be more critical for aircraft equipped with ejection seats than for helicopters.

The helmet must, of necessity, be attached to the aircraft via cables. Both power to the display and image/symbology signals must be transmitted. At present, the most critical installation type would be a binocular CRT system which requires high voltage power supplies and separate signal inputs. Cabling must be shielded to prevent electromagnetic interference (EMI) and, at the same time, be flexible enough not to interfere with pilot head movement.

The helmet position must be tracked with respect to the direction of the pilot's line-of-sight (LOS) and head-tilt. Both infrared (IR) trackers and magnetic trackers have been used. The trackers (used in the Apache) use a IR beam reflected off the helmet to track pilot LOS. IR trackers generally do not account for head-tilt. Magnetic head trackers follow a source on the helmet and generally sense head-tilt. Both systems require helmet modifications.

- (e) **Field-of-View Issues (FOV)**: The issue of how wide should the field-of-view (FOV) be for HMDs is unresolved. One of the arguments against the use of night vision goggles (NVGs) is the narrow FOV which blocks the pilot's use of peripheral vision cues.

Experiments are planned using the Flight Laboratory for Integrated Test and Evaluation (FLITE) research vehicle to determine how much FOV is required for unaided vision. This experiment will present restricted FOV visors and measure pilot performance. While this will be true for unaided vision, one must be careful in interpreting the results. Most sensors will limit the resolution. While it seems clear that there will be a trade-off between resolution and FOV, what the tradeoff is not at all certain.

Further, symbology can assist the pilot in overcoming restricted FOV. For example, it would be difficult for a pilot to land an airplane looking through the same FOV as a typical HUD. Yet with symbology along, the pilot can land more precisely than with an unrestricted FOV.

These issues require resolution (pun intended).

- (f) **Registration:** Another issue is the effect of raster image accuracy on viewing real-world images and symbology. In particular, the fairly large eye-sensor distance for the Apache creates mis-registration for close objects viewed ninety degrees off-axis. This mis-registration may have implications for symbology choices. If there is mis-registration, should the symbology be changed from what it would be in the ideal case?
- (g) **Monocular vs. Bi-ocular:** Many workers have implicitly assumed that bi-ocular HMDs are superior to monocular simply because they are more complicated. In fact, pilots report (anecdotally) some advantages to monocular HMDs. To date, this has not been studied and performance/cost trade-off data obtained.
- (h) **Advanced NVG Considerations:** Similarly, many researchers assume that future HMDs will have some form of symbology fixed with respect to the real world and that head-trackers will allow both imagery and symbology to move and compensate for pilot head motion. This may not be true. There has been an interest in incorporating flight and other symbology into advanced night vision goggles (NVGs). If symbology could be merged with the NVG images and be mission effective, such symbol-enhanced NVGs could prove to be considerable benefit to helicopter pilots and serve as low-cost HMDs.

The point of this discussion is that there may be a place for symbology fixed on the HMD screen as an adaptation of the NVG. The adaptation of symbology to the Aviator's Night Vision System (ANVIS/HUD) is an example of such a system. Care must be taken, however, since many of the deficiencies in the Apache symbology apply to the ANVIS/HUD or other advanced NVG symbology.

(3) Summary

These are not trivial issues. They have not been fully resolved for HUDs which have over 20 years of operational use. It would be naive to think that HMDs, which are much more complex, will not require some effort to avoid the same type of problems as have been experience by HUD users over the years.

C DEFINITIONS

Before we can discuss stabilization, optical, or other characteristics of helmet-mounted displays, we need a common language. A HUD Glossary was prepared as part of an earlier study (11), and has been extended to include HMD-related definitions (12). This glossary is attached as Appendix A to this report.

(1) Frequently Used Terms

Some terms are used frequently in this study and are listed here to aid the reader.

- (a) Bi-ocular HMD: A helmet-mounted display presenting the same image to each eye.

Bi-ocular implies one sensor displaying to both eyes; binocular implies a separate sensor for each eye.

- (b) Binocular: Vision using both eyes.

- (c) Binocular HMD: A helmet-mounted display presenting different images to each eye.

- (d) Conformal Display: A see-through display (HMD or HUD) in which the symbols, when viewed through the HMD, appear to overlies the objects they represent.

- (e) Contact Analog: A display which is a representation of the real world.

Note: a contact analog format need not be conformal.

- (f) Field-of-Regard (FOR): The spatial angle in which a sensor can view.

For helmet-mounted displays, the spatial angle in which the display can present usable information.

- (g) Field-of-View (FOV): The spatial angle in which the symbology can be displayed measured laterally and vertically.

- (h) Line of Sight (LOS): A line from the pilot's or observer's eyes in the direction of viewing.

- (i) Elevation Ladder: A set of reference symbols showing increments of angles to the horizon.

The term "elevation" is used to distinguish these angles from pitch angles. Pitch angles apply to the attitude of the aircraft about the lateral axis. Elevation applies to the pilot's LOS and is used for directions away from the nose of the aircraft.

- (j) **Flight Path Marker (FPM)**: The symbol showing the aircraft velocity vector.

The difference between FPM and velocity vector is that the FPM is projected along the forward view while the velocity vector symbol may not (as in hover symbology). In addition, the FPM is used for direct aircraft control, while the velocity vector usually is not

- (k) **Horizon Line**: A symbol indicating a horizontal reference or zero pitch.

Bowditch(13) defines several different horizons: the **sensible horizon** (a horizontal plane passing through the eye of the observer), the **geoidal horizon** (a horizontal plane tangent with the geoid directly below the observer), the **geometrical horizon** (the observer's LOS tangent to the geoid), and the **visible horizon** (the demarcation between surface and sky).

The difference between the geometrical horizon and the visible horizon is caused by atmospheric refraction and by the elevation of the terrain.

The difference between the sensible horizon and the visible horizon is called the dip correction. This is not a problem at typical helicopter altitudes. (At 100 ft, the dip correction is 2.8 mr.) In addition, the sensible horizon is usually obscured by hills, trees, etc. making any discrepancy irrelevant.

(2) **Stabilization Terms**

Other terms dealing with symbol stabilization will be discussed in Section F, beginning on page 33.

D HMD SYSTEMS

Table 1 lists the optical and other characteristics of the various helmet-mounted displays.

(1) Operational and Developmental HMDs

Several helmet-mounted display (HMD) systems have been proposed. At this writing, only the Integrated Helmet and Display Sighting System (IHADSS) in the Apache is operational.

The Helmet Integrated Display Sighting System (HIDSS) is in development for the RAH-66 (Comanche).

Night vision goggles (NVGs) are not normally considered to be HMDs. Nevertheless, they share many of the issues and problems which are characteristic of other HMDs. NVGs present imagery (amplified light) as a binocular display from self-contained sources. There is a program (ANVIS/HUD) to add symbology to the NVG. This is being developed for several helicopters and for the C-130.

(2) Research HMDs

The remainder of the systems are research programs (such as Condor, Rascal, or Spirit) or have been proposed by vendors.

- (a) CONDOR: Covert Night/Day Operations in Rotorcraft (CONDOR) is a joint US/UK research program. The object is to develop a color HMD for flight test in both the UK and US. The US flight test will be conducted in RASCAL beginning in 1994. The UK flight system will be installed in a Lynx and flown beginning in 1995(14).

No symbology has been defined for the CONDOR program.

- (b) RASCAL: The Rotorcraft Aircrew/Systems Concept Airborne Laboratory (RASCAL) is a joint NASA and US Army research aircraft. The airframe is a UH-60 modified to incorporate advanced control systems and guidance displays(15).

Included in the display suite will be a color helmet mounted display. This is intended to be a low-technical-risk flight-worthy helmet/display

No symbology has been defined for the RASCAL program.

- (c) SPIRIT: Simulation Program for Improved Rotorcraft Integration Technology (SPIRIT) is a joint US/Canada research program. A fiber optic HMD (FOHMD) is being developed as part of this program. The system will be flight tested in the FLITE aircraft(14).

No symbology has been defined for the SPIRIT program.

- (d) **AHP**: The Advanced Helicopter Pilotage (AHP) is an Army research program with the goal of developing technology to allow the helicopter pilot to have "day-like" visual cues and enhance mission effectiveness and pilot confidence and decrease workload(14).

No symbology has been defined for the AHP program.

- (e) **FLITE**: The Flight Laboratory for Integrated Test and Evaluation (FLITE) is a NAH-1 (*Cobra*) aircraft modified for display research and development. The aircraft was originally modified by Northrop as a training surrogate for the *Apache*(16). The aircraft is equipped with an IHADSS and an IR sensor which tracks the pilot's head-motion.

(3) HMD Simulators

A number of simulators have been used to study helmet-mounted displays. In fact, the use of simulator-specific HMDs is a technique used to simulate external scenes(17). While the use of large fixed displays is the most common form of scene generation in simulators, HMDs are becoming increasingly popular. This is partly because of the difficulty of designing fixed displays with a sufficiently large FOV and a large exit pupil to allow for pilot head motion.

- (a) **CSRDF**: The Crew Station Research and Development Facility (CSRDF) is a facility located at the Ames Research Center. It is dedicated to performing simulation research directed to resolving pilot/cockpit interface issues for future rotorcraft(18). The CSRDF can simulate single-pilot as well as two crew helicopters.

The system includes lightweight helmet(s) with two sets of fitted optics. Both coarse scene and detailed scene images are presented. Symbology can be presented as well. The fiber-optic HMD has a FOV of 120° by 67°. The scene can be blanked at certain viewing angles to allow for direct view of the cockpit.

The system includes head motion rate sensors to provide lead compensation to the visual scene.

Simulated sensor images can be included which mimic IR sensor noise, resolution, gain control, polarity reversal, blooming, etc.

- (b) **Army Research Institute (ARI)**: The Army Research Institute (ARI) operates a research simulator (Simulator Complexity Test Bed, SCTB) based on the *Apache*. The HMD used in the SCTB is essentially the same as the CSRDF simulator.

- (c) **Air Force Armstrong Laboratory (AFAL)**: The Air Force Armstrong Laboratory (AFAL) has a facility to study fixed-wing HMDs. This is a fixed-base cockpit mock-up which uses a large head-mounted display (called "the bug that ate Dayton"). The simulation visual system is entirely contained in this display. This facility is suitable for a screening facility, but not for definitive research(19).
- (d) **Luftwaffe**: The German Luftwaffe operates a fixed-wing air-to-air training simulator based on the F-4. The HMD used in this simulator replaces the conventional dome projection and is essentially the same as the CSRDF simulator.

(4) **Helicopter HUD Systems**

For completeness, there are three head-up displays (HUDs) which have been developed for helicopter. These were developed for the CH-3E (MARS), the AH-1S, and the Bell 230. System descriptions are shown in Table 1.

- (a) **CH-3E (MARS)**: The CH-3E HUD was developed for the Mid-Air Retrieval Systems (MARS) (20). This was a specialized mission involving in-flight retrieval of reconnaissance drones being parachuted. The display showed an aiming symbol designed to bring the helicopter directly over the parachute at an appropriate altitude to engage the recovery hook.

The HUD was an electromechanical system which used glowing wires as the image source for the aiming symbol and horizon line. The optics were based on a single collimating mirror which also served as the combining glass. The system was developed from the Sundstrand Visual Approach Monitor.(21)

- (b) **AH-1S**: The AH-1S HUD was developed as a weapon aiming sight with limited flight symbology (22).
- (c) **Bell 230**: This HUD was developed for the Chilean Navy as an IFR flight display. It has also been certified by the FAA as a primary flight display. System details are estimated from the fixed-wing HUD characteristics (23).

Table 1. Helmet-Mounted Display Characteristics

Display	A/C	Eyepieces	Colors	Field-of-View (deg)		Eye Relief (mm)	Exit Pupil (mm)	Transmissivity	Resolution			Pointing Accuracy (mr)	Weight (lb)	Vendor
				Vert	Hor				Overlap	Lines(VXH)	Cy/mr(VXH)			
IHADDS	AH-64	Monocular	Monochr	30	40	N/A	10						4.0	Honeywell
HIDSS	RAH-66	Binocular	Monochr	35	52	18	25	'High'	960	0.8	20/40	3-8	4.2	Kaiser
ANVIS/HUD	R/W	Binoc NVG Monoc Sym	Monochr	60	60		20		525X525					Elbit
CONDOR	R/W	Bi-ocular	Full	50	100	20 to	15	65%	1024X1280	0.51X0.53	20/70	4.5	5.0	Kaiser
RASCAL	RASCAL	Binocular	Full	40	60	20	15	50%	1024X1280				4.2	CAE
FOHMD	FLITE	Bi-ocular		49	100	25	15	10%	1024		20/60		4.5	CAE
AHP	R/W	Bi-ocular									20/40			
FOHMD-AT	Generic	Bi-ocular		49	100	25	38	10%	1024		20/60		4.5	CAE
FOHMD-FL	"	Bi-ocular		49	100	25	38	10%	1024		20/60		4.5	CAE
EL-OP	"			20	30		11						4.1	Elbit
IHS	"			40	80		15						4.0	Ferranti
Cat's Eyes	F/W	Binoc NVG		30	30		25							GEC
Falcon Eye	Generic			30	30		10							GEC
I-Nights	"			22.5	30		12							GEC
INVS	"	Bi-ocular		35	35					0.8	20/40			Honeywell
MH-53J	"													Honeywell
Agile Eye	F/W	Monocular		20	20		46		525X875			3 to 8	2.3	Kaiser
Strike Eye	Generic	Binocular	Monochr	35	35	35	20	50%				3 to 8	4.5	Kaiser
Wide Eye	"	Binocular	Monochr	40	60		25	50%	1024			4.9	4.2	Kaiser
Dragonfly	"													Rochester
OPSS	R/W												3.2	Sextant
Bell230		HUD	Monochr	9	9	N/A	N/A		Stroke				N/A	Flt Visions
AH-1S		HUD	Monochr	15	15	N/A	N/A		Stroke				N/A	Kaiser
CH-3E		HUD	2-color	12	22	N/A	N/A	70%	Stroke				N/A	Sundstrand

E HMD SYMBOLOGY SUMMARY

It is often difficult to match modes from one system to another. One system's "cruise" will be another's "navigation." For this reason, we have grouped the symbologies into two generic modes: hover and cruise. Some HMDs have a transition mode, but this is usually similar to the hover mode.

In addition, it was often difficult to determine exactly how the symbol stabilization functioned in some displays. The descriptions were often imprecise and may have been mis-interpreted.

No attempt was made to draw all symbologies (Figures 1 through 7) to the same scale. They are drawn to the same scale for comparison in Figure 9

(1) Operational HMDs

- (a) AH-64 (Apache): The Apache's Integrated Helmet and Display Sighting System (IHADSS) is the only operational HMD in service today. This is a monocular raster display with embedded symbols. While there is a head-tracker, it is used only to direct the sensor, not orient the display. All symbologies are screen-fixed. There are three operating modes: Hover, Transition, and Cruise(10).

This HMD appears to have been simply adapted from what would have been presented on a fixed HUD.

- i General: Altitude is shown both digitally and with a thermometer scale. Vertical speed is shown as a moving caret. All altitude information is on the left. Airspeed is shown digitally on the left.

Aircraft heading is shown as a conventional tape and lubber line at the top of the display. Side-slip information is shown in a ball-bank format at the bottom of the display

A fixed aircraft head-tracker symbol is shown aligned to the aircraft axis. A sensor location within the field-of-regard (FOR) is shown at the bottom of the FOV. This shows a box representing the sensor FOR with a smaller box showing the sensor LOS within it.

- ii Hover Mode: The Apache hover symbology is shown in Figure 1.

The hover symbology is a screen-fixed plan view (God's eye view) of the scene. The velocity vector is shown emanating from a reticle. There is also an aiding cue (a small circle) showing accelera-

tion. The scaling of the velocity vector is full length equals six knots groundspeed.

There is also a station-keeping variant of the hover symbology. In this format, a ground-fixed box is superimposed denoting a fixed hover point. This box is driven by Doppler radar signals.

The transition symbology is similar to the hover symbology, except for scaling of the velocity vector and the addition of the screen-fixed horizon line. The scaling of the velocity vector is full length equals sixty knots groundspeed (i. e., ten times the hover symbology).

- iii **Cruise Mode**: The cruise symbology is a screen-fixed primary flight display and is shown in Figure 2.

(2) **Rotorcraft HMDs Under Development**

It should be emphasized that these systems are still under development and that these descriptions may or may not match what is finally fielded.

- (a) **RAH-66 (Comanche)**: The Helmet Integrated Display Sighting System (HIDSS) is the HMD being developed for the *Comanche*. It is a bi-ocular display. Portions of the display are aircraft-fixed/-referenced and portions are world-fixed/-referenced.* There are three operating modes. In addition to Hover and Cruise, there is also an Approach mode which is not described(24).

It is not clear from Reference (24) how the pitch ladder and pitch symbol are stabilized. We assumed the pitch ladder was aircraft-fixed/world-referenced and that the horizon line was world-fixed. This was confirmed by conversations with pilots who participated in the *Comanche* simulator trials.

- i **General**: Barometric altitude is shown digitally. Vertical speed is also shown digitally. The vertical velocity digits also move vertically to present an analog indication. Radar altitude is shown both digitally and with a thermometer scale. All altitude information is on the left. Airspeed is shown digitally on the right.

The switching of the airspeed from left to right and altitude from right to left is unconventional and controversial.

* See discussion on stabilization in Section F (page 33).

Both an aircraft reference symbol (pitch marker) and a flight path marker (FPM) are displayed. The forward-view FPM is removed with airspeeds below 10 KIAS.

Line-of-sight (LOS) azimuth is shown as a tape with a lubber line at the top of the display. Aircraft heading is shown digitally just above the LOS azimuth tape. Sideslip information is shown as a pendulum at the bottom of the display. Sideslip is blanked below 40 KIAS and will not normally appear in hover.

Torque is shown as a moving index on the left, below the altitude display.

- ii **Hover Mode:** The hover symbology (shown in Figure 3) contains a world-stabilized plan view (God's eye view) of the scene.

The velocity vector is shown emanating from a circle. Aircraft acceleration along the velocity vector is shown by an arrowhead which indicates the acceleration. If no acceleration is present, the arrowhead is a "T" at the end of the velocity vector. Acceleration transverse to the velocity vector is not shown.

Nap-of-the-earth (NOE) symbology appears similar to the hover symbology.

- iii **Cruise Mode:** The cruise symbology is a world-stabilized primary flight display shown in Figure 4. Both a FPM and an aircraft reference symbol are displayed. The FPM is a pilot's eye view of the trajectory which shows the projected impact point.

The pitch ladder is similar to the F-18, i. e. canted to indicate the direction of the nearest horizon.

- (b) **ANVIS/HUD:** The ANVIS/HUD is an adaptation of advanced night vision systems which adds flight symbology to the basic night vision goggles. The term "HUD" is a misnomer, the system is worn on the head. The symbology is presented to the right eye only while the imagery (I²) is shown binocularly.

The ANVIS/HUD system is scheduled for implementation in UH-60, CH-47, UH-1N, and CH-46E aircraft(25). It is also being evaluated for the C-130.

- i **General:** No head tracker incorporated, so all symbology is screen-fixed. The airspeed and baromet-

ric altitude are shown digitally. Radar altitude is shown digitally and in a tape scale.

Heading is shown as a conventional tape scale across the top of the FOV. A roll scale and sideslip cue are shown at the bottom.

Engine data is shown digitally on the left side. Torque is below and slightly outboard of the air-speed. Engine temperatures are shown with navigation data above and outboard of the airspeed.

A horizon line is present in all modes. A fixed reticle (cross) is also present in all modes.

- ii **Hover Mode**: In addition to the previous symbols, the hover symbology (shown in Figure 5) shows a screen-fixed plan view of the velocity vector.
 - iii **Cruise Mode**: The ANVIS/HUD cruise symbology (shown in Figure 6) is similar to the hover symbology with the omission of the velocity vector symbol.
- (c) **MH-53J**: The symbology (shown in Figure 6) was largely derived from USAF fixed-wing studies. This was an AFAL demonstration of their HMD technology for a Special Forces helicopter(26).

The significant differences between the MH-53J symbology and others is the roll scale and heading both at the top. Airspeed is shown as an error cue -- a vertical tape from the aircraft reference.

It is not clear from Reference (26) how the symbols are stabilized.

- (d) **LifeSaver**: *LifeSaver* is a Honeywell system designed to detect wires and other obstructions(27). *LifeSaver* is a generic display for R/W aircraft. The symbology is shown in Figure 8.

Airspeed and torque are shown digitally on the left. Altitude is shown digitally and in a tape on the right. The source of the altitude data (barometric or radar) is not specified.

Sideslip is shown at the bottom of the FOV and heading at the top. The aircraft reference symbol is a flight path marker (FPM).

Head-tracker and sensor coverage symbols are also shown.

It is not clear from the description how the symbols are stabilized(27).

- (e) **Comparison:** Figure 9 shows *Apache*, *Comanche*, and ANVIS/HUD fields-of-view drawn to the same scale for comparison. No information was available for the MH-53J HMD.

(3) Helicopter HUDs

For completeness, there are three head-up displays (HUDs) which have been developed for helicopters. These were developed for the CH-3E (MARS), the AH-1S, and the Bell 230.

- (a) **CH-3E (MARS):** The CH-3E HUD was developed for the Mid-Air Retrieval Systems (MARS) (20). This was a specialized mission involving in-flight retrieval of reconnaissance drones being parachuted. The symbology is shown in Figure 10.

Airspeed is displayed as a fast/on-speed/slow cue on the left with vertical speed and a pitch scale shown on the right of the FOV. Sideslip is critical to the mission and is shown on the bottom of the FOV.

- (b) **AH-1S:** The AH-1S HUD was developed as a weapon aiming sight with limited flight symbology. The center of the FOV contains weapon information with engine torque, aircraft heading, and radar altitude are shown digitally around the periphery (28). The symbology is shown in Figure 11.

The US Marines use a modified HUD with additional flight information. The Marine symbology was not available at this writing.

- (c) **Bell 230:** This HUD was developed for the Chilean Navy as an IFR flight display. It has also been certified by the FAA as a primary flight display. The symbology was developed from the fixed-wing HUD installed in the Beech King Air(29). Vertical tapes for engine torque and engine temperature were added on the left and right side of the FOV. The symbology is shown in Figure 12.

(4) Proposed Fixed-Wing HMDs

- (a) **Air Force Armstrong Laboratory (AFAL):** A baseline HMD symbology used by AFAL is shown in Figure 13(19).

Airspeed and altitude are shown digitally on the left and right side respectively. Vertical speed is shown as a fixed tape/moving caret inboard of the altitude.

Heading is shown as an abbreviated scale at the top. A non-conformal attitude scale is shown at the bottom.

- (b) **Theta:** The *Theta* display (shown in Figure 14) was developed by Geiselman and Osgood (30) and uses a pitch sphere sym-

bology to maintain attitude awareness on the part of the pilot.

Airspeed is shown digitally on the left side. Altitude is shown in a counter-pointer on the right side. Vertical speed is shown as a tape scale inboard of the altitude.

Heading and altitude are shown in an attitude ball at the bottom of the display FOV.

- (c) **McDonnell-Douglas**: A "typical" HMD symbology was described by Adam (31) and is shown in Figure 15.

This display is distinguished by a non-conformal "basic T" symbology set at the bottom of the FOV with airspeed, altitude, heading, and pitch.

A tape scale at the top shows pilot LOS azimuth. LOS elevation is shown digitally above the azimuth tape.

A "performance data block" to the left of the aiming reticle shows Mach number, angle-of-attack, and normal acceleration.

- (d) **ANVIS/HUD**: The symbology developed for the ANVIS/HUD for the C-130 is shown in Figure 16 (32).

Airspeed and altitude are shown digitally in the upper left and upper right of the FOV. Radar altitude is shown as a vertical tape (moving caret) on the left, below the airspeed. Digital radar altitude is boxed below the tape.

Heading is shown as a conventional horizontal tape scale with the digital heading shown beneath it. A waypoint caret indicates the heading to the next waypoint.

The pitch ladder and aircraft reference symbol are displayed in the center with a bank scale beneath. A sideslip "ball" is shown at the bottom of the FOV.

Vertical velocity is shown as an arc with a moving caret emulating the panel instrument. Engine torque is shown as a circular scale as well. Both are located below the barometric altitude digits on the right side of the HUD FOV. Engine torque is below the altitude digits with vertical velocity at the bottom.

Navigation data, master warning, and threat warning are also displayed in the upper center, lower right and bottom of the FOV.

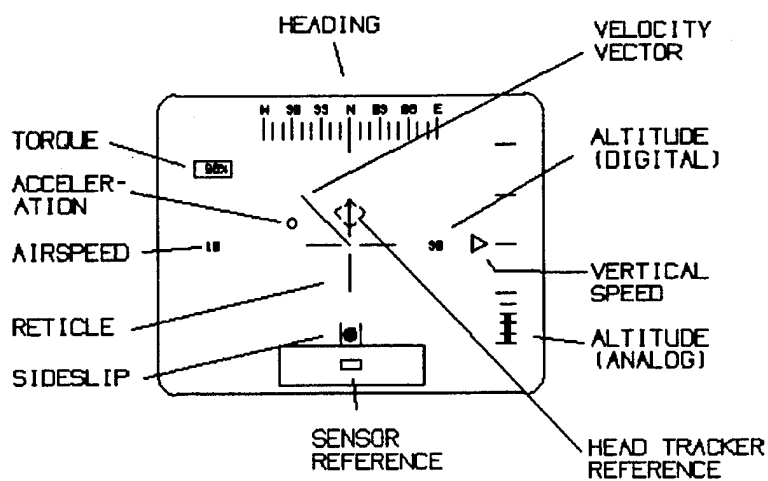

Figure 1. Apache Hover Symboly

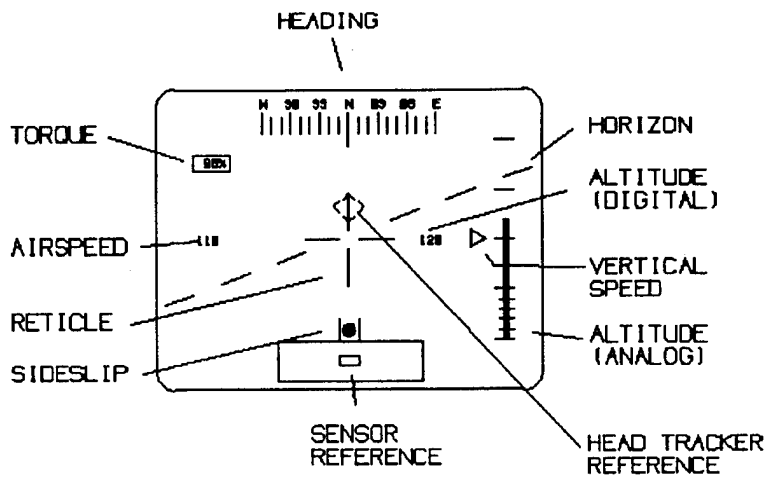

Figure 2. Apache Cruise Symboly

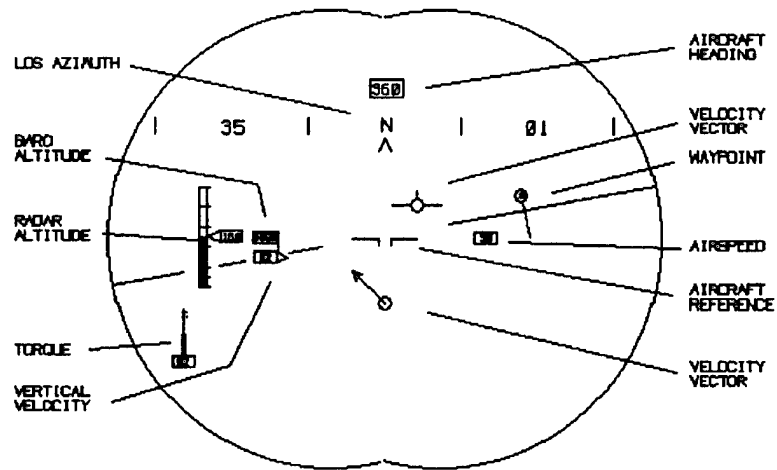

Figure 3. Comanche Hover Symbology

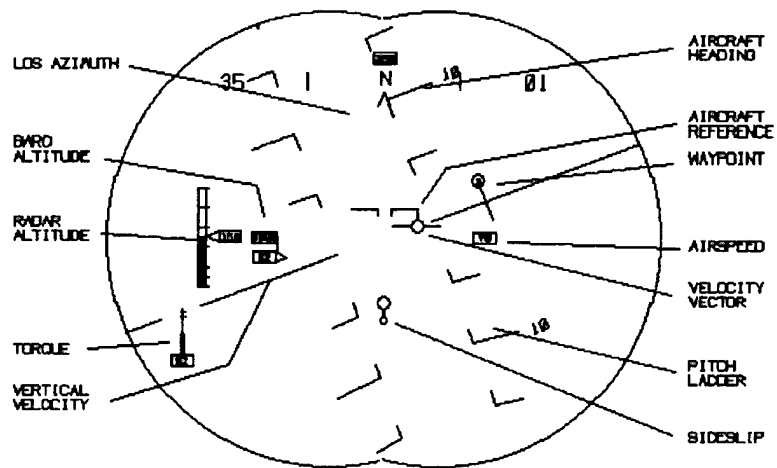

Figure 4. Comanche Cruise Symbology

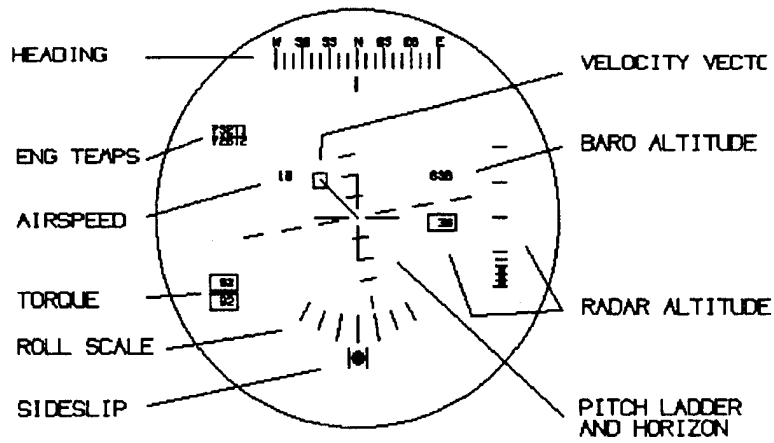

Figure 5. ANVIS/HUD Hover Symbology

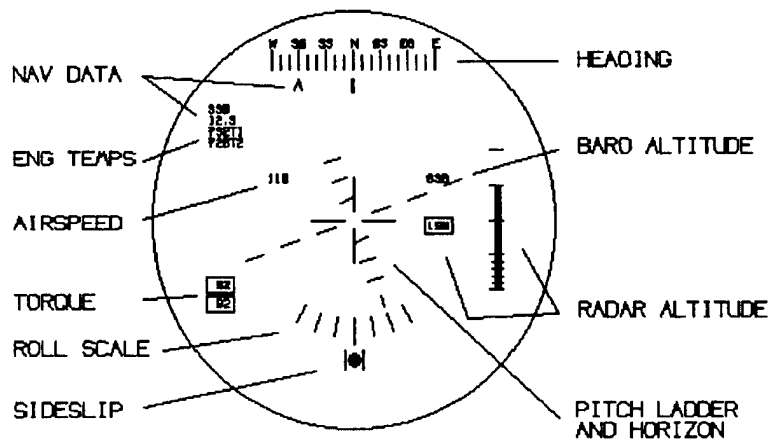

Figure 6. ANVIS/HUD Cruise Symbology

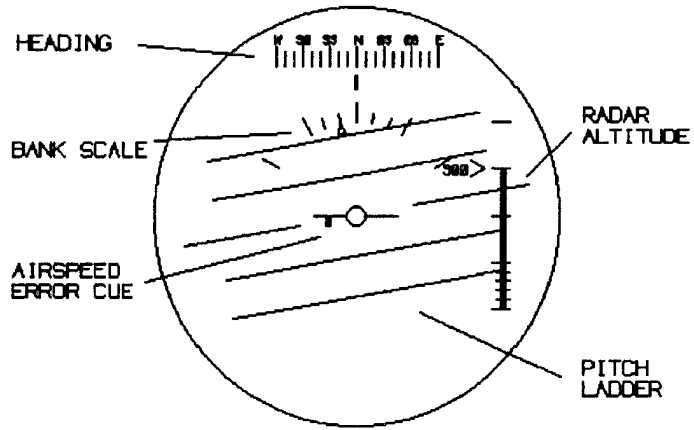

Figure 7. MH-53J Symbology

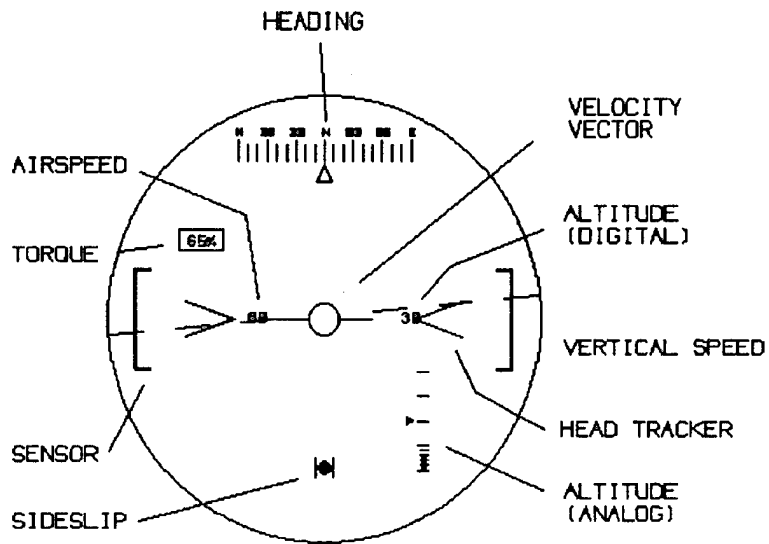
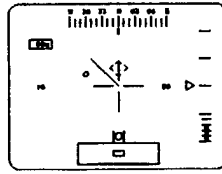
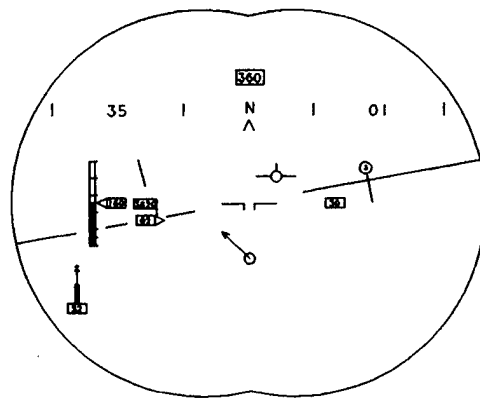

Figure 8. LifeSaver Symbology



(a) Apache



(b) Comanche

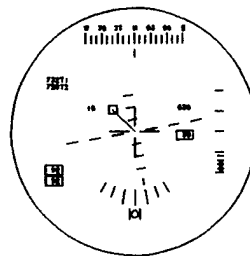

(c) ANVIS HUD

Figure 9. Comparison of HMD Fields-of-View

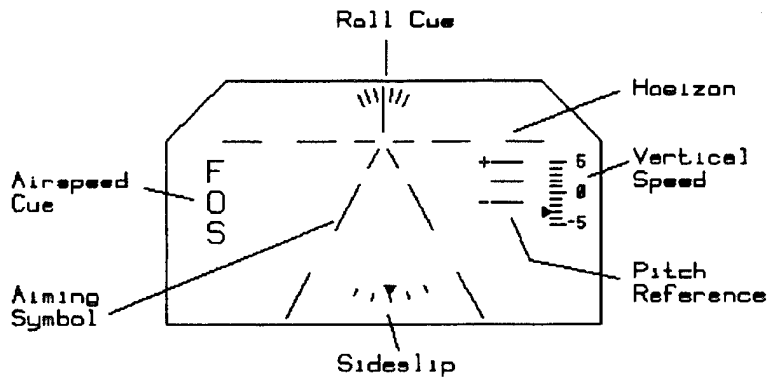

Figure 10. CH-3E (MARS) HUD Symbology

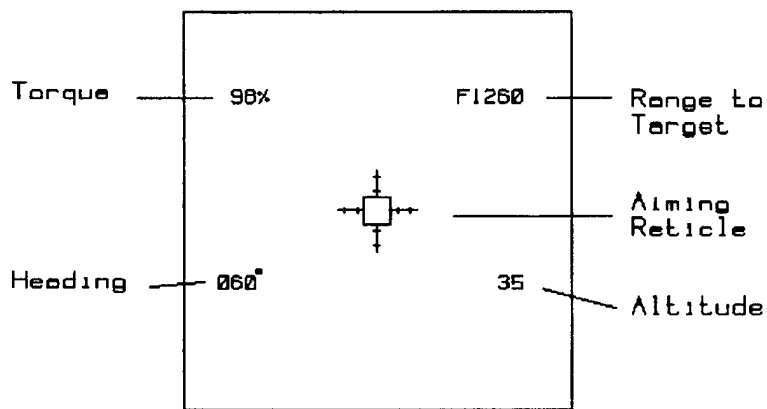

Figure 11. AH-1S HUD Symbology

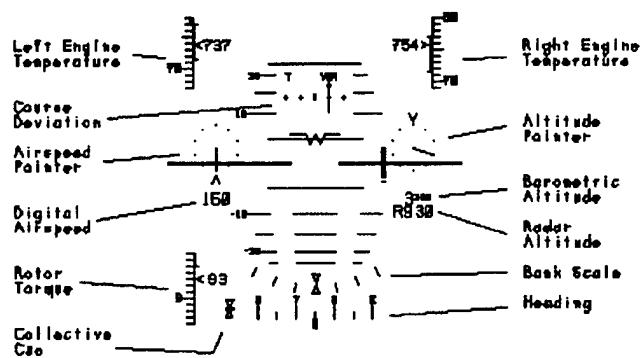

Figure 12. Bell 230 HUD Symbology

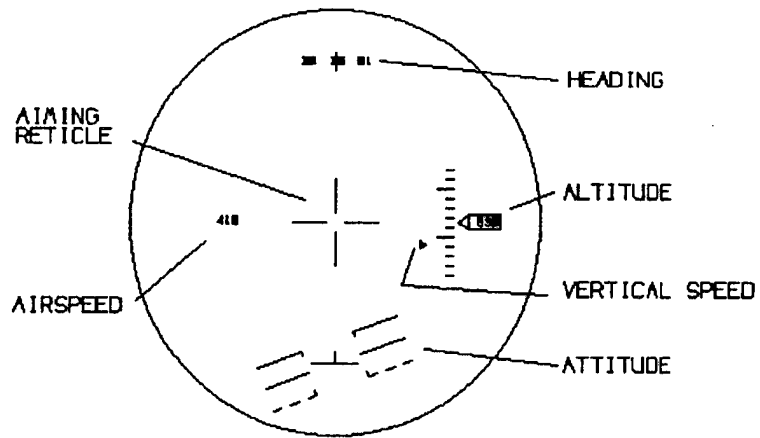

Figure 13. AFAL Symbology

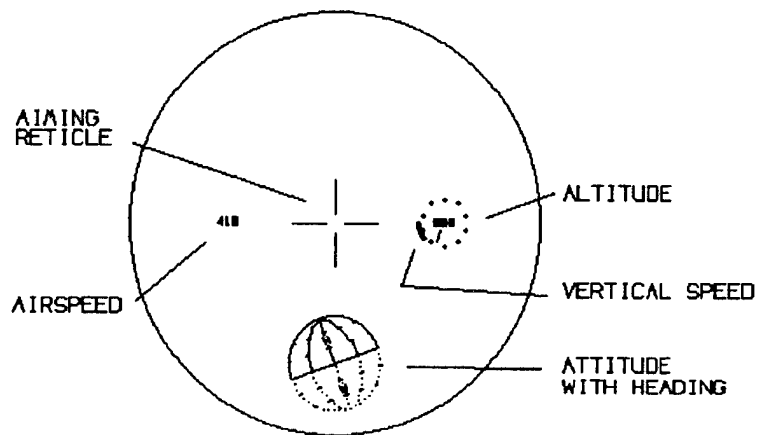

Figure 14. *Theta* Symbology

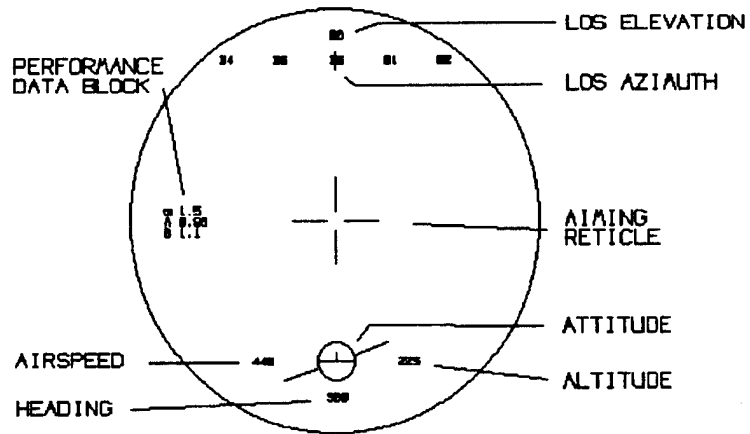

Figure 15. McDonnell-Douglas Symbology

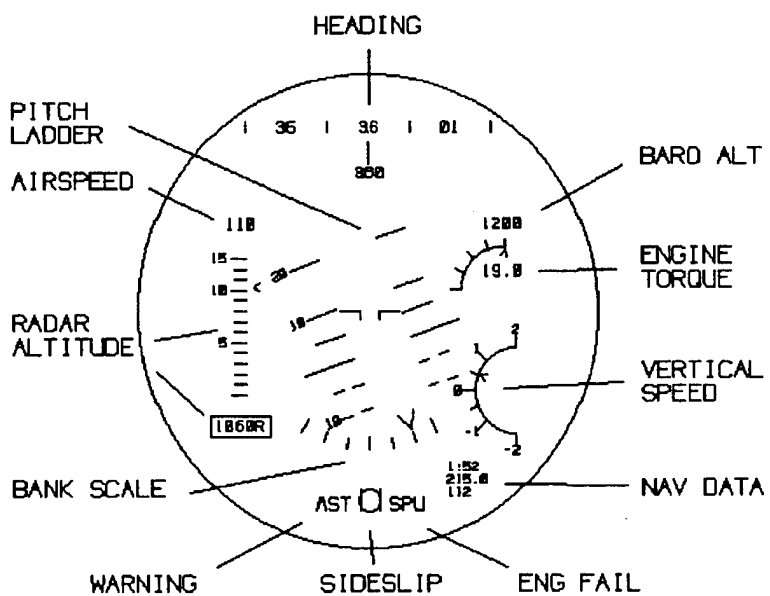

Figure 16. C-130 ANVIS/HUD Symbology

F SYMBOLGY STABILIZATION

(1) General Comments

Prior to the advent of see-through displays, flight displays were fixed in the cockpit. There was little need to create a display format which remained fixed in its orientation as the aircraft maneuvered.

The HUD, with its ability to place display symbols directly overlying the real world image, required the display designer to keep some symbols fixed relative to these real world cues. Many HUD symbols are corrected for aircraft motion -- the FPM, the horizon line, target symbols, to name a few.

With the HMD, the display itself can move. As the pilot's head moves, the display orientation changes. Some cues, particularly targeting cues, must be corrected to compensate for both aircraft motion and pilot head movement.

We have already mentioned the Apache's hover symbology which compensates for aircraft orientation, but not for pilot head movement. As long as the pilot looks forward, the display correctly indicates the aircraft velocity relative to the direction the pilot is looking. However, when the pilot moves his head, the orientation of the display does not agree with the relative direction of pilot line-of-sight (LOS) is incorrect. The display shows left/right and fore/aft motion relative to the aircraft nose, not the direction of the pilot's LOS.

More critical is the presentation of the horizon line. In the Apache, the horizon line is presented conformal to the real horizon only if the pilot is looking forward with his head level. If he looks to the side, it still registers the bank as if he were looking forward. More critical, if the pilot looks up, the horizon moves with his LOS indicating obstruction clearance where there may be none!

The first requirement is to be able to describe symbology stabilization. That is, we must be able to define various characteristics.

A number of definitions have been proposed to describe how symbols are stabilized. These can be found in the HUD/HMD Glossary(12) prepared as part of this study (attached as Appendix A).

(2) Coordinate Systems

Several coordinate systems are present with flight displays. These systems, defined in Appendix A, are **world coordinates, aircraft coordinates, head coordinates, display coordinates, and screen coordinates.**

We normally consider orthogonal coordinate systems, although other coordinates, such as polar coordinates, could be used. Generally, the sign convention is positive forward, right, and down.

(3) Symbol Orientation

- (a) **Definitions:** The term "reference" has been adopted to indicate how a symbol has been rotated to compensate for misalignment between the world, aircraft, and display coordinates.

World-referenced means that the symbol is rotated to compensate for differences between display coordinates and world coordinates. These differences could be caused by aircraft motion or, in the case of HMDs, by pilot head motion.

Aircraft-referenced means that the symbol has been rotated to compensate for misalignment between display coordinates and aircraft coordinates. This would be caused by head movement and only applies to HMDs.

These compensations are normally thought of as accounting for misalignment of all three axes. In fact, they are often applied to one or two axes only such as roll-referenced symbols.

- (b) **Examples:** The *Apache* symbology is screen-referenced and screen-fixed. That is it does not correspond to the direction of the pilot's LOS. Figure 17 (a) shows the effect of this on various views from the pilot station. In the figure, the helicopter is drifting forward and to the right at a 45° angle to the north heading. The figures show the view as the pilot looks forward, to the right at relative angles of 45°, and 90° to the right.

Haworth and Seery evaluated a world-referenced *Apache* hover symbology(33). In this symbology, the aircraft velocity vector rotates to match the aircraft heading. Figure 17 shows the difference between screen-referenced and world-referenced symbols clearly.

(4) Symbol Location

- (a) **Definitions:** The term "fixed" has been adopted to indicate that the location of the symbol has been moved (on the screen) to compensate for aircraft/head motion and allow the symbol to overlay a cue in the external visual scene.

World-fixed means that the symbol is rotated/moved to compensate for aircraft and head motion. **Aircraft-fixed** means the symbol has been rotated/moved to compensate for head movement only. **Screen-fixed** means that no compensation has been applied.

The term "stabilized" should be avoided since it has two meanings in earlier work. "Roll-stabilized" has been used to mean "roll-referenced". "World-stabilized" has meant "world-fixed".

It is entirely feasible for a symbol to be world-referenced and screen-fixed. Such a symbol is the horizon line on the Apache HMD. Its reference point is fixed in the center of the display, but moves vertically to indicate aircraft pitch and rotates to indicate aircraft bank. This is shown in Figure 18 (a).

- (b) **Examples:** Figure 18 shows the Apache symbology overlaying a stylized real-world scene. In this figure the transition symbology is shown with a horizon line. Figure 18 (a) shows the standard Apache symbology with a screen-fixed, but world-referenced horizon line. Note that the horizon does not overlay the real horizon when looking off-axis (or when looking up or down).

Haworth and Seery (33) also examined world-fixed horizon lines. As shown in Figure 18 (b), their modified horizon line is world-fixed in that it moves to indicate the location of the real horizon. In this case, the horizon line overlays the real world horizon and correctly indicates objects at the same elevation as the aircraft.

The Comanche cruise symbology shows a world-fixed horizon with an aircraft-fixed/world-referenced pitch ladder, shown in Figure 19. Note that the aircraft-fixed pitch ladder disappears from the FOV as the pilot turns his head off-axis. The world-fixed horizon line remains in the FOV (provided the pilot's LOS is horizontal).

- (c) **Discussion:** A world-fixed horizon line (and elevation ladder) can be used to maintain situational awareness and provide information about the relative elevation of targets and obstructions. It appears to provide insufficient cues to allow for flying the aircraft, although definitive experiments have not been performed.

A screen-fixed horizon symbol can be used to provide aircraft flight information (at least in fixed-wing aircraft), but provides misleading elevation cues. The fixed-wing HMDs avoid these misleading cues by not attempting to make the horizon line appear conformal, i. e. by compressing the symbol.

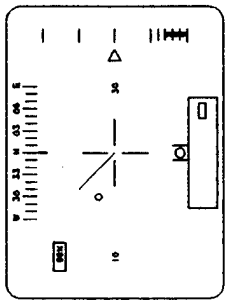

Head 90 Left

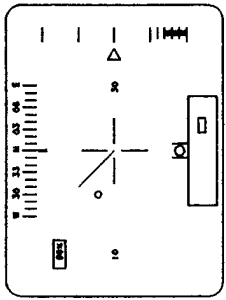

Head 45 Left

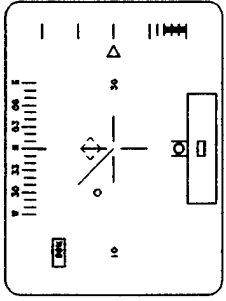

Head forward

(a) Screen-Referenced Symbolology

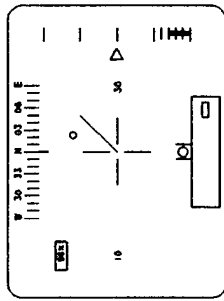

Head 90 Left

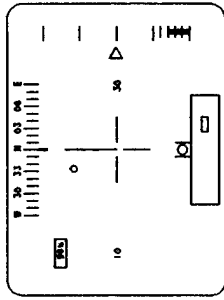

Head 45 Left

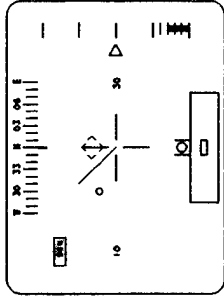

Head forward

(b) World-Referenced Symbolology

Figure 17. Screen- and World-Referenced Symbolology

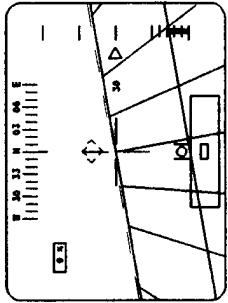

Head 90 Left

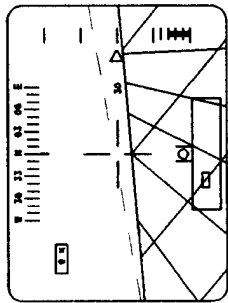

Head 45 Left

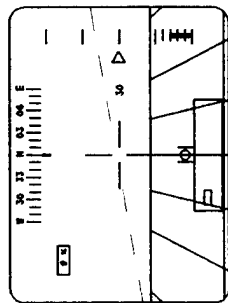

Head forward

(a) Screen-Fixed Horizon Line

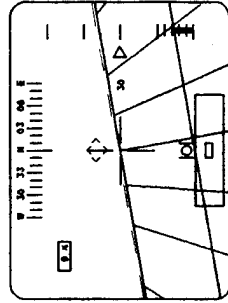

Head 90 Left

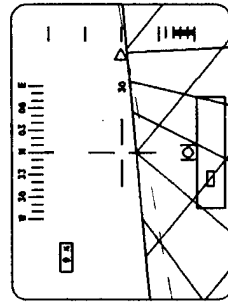

Head 45 Left

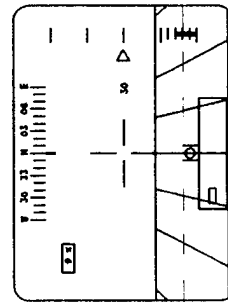

Head forward

(b) World-Fixed Horizon Line

Figure 18. Screen- and World-Fixed Symbolology

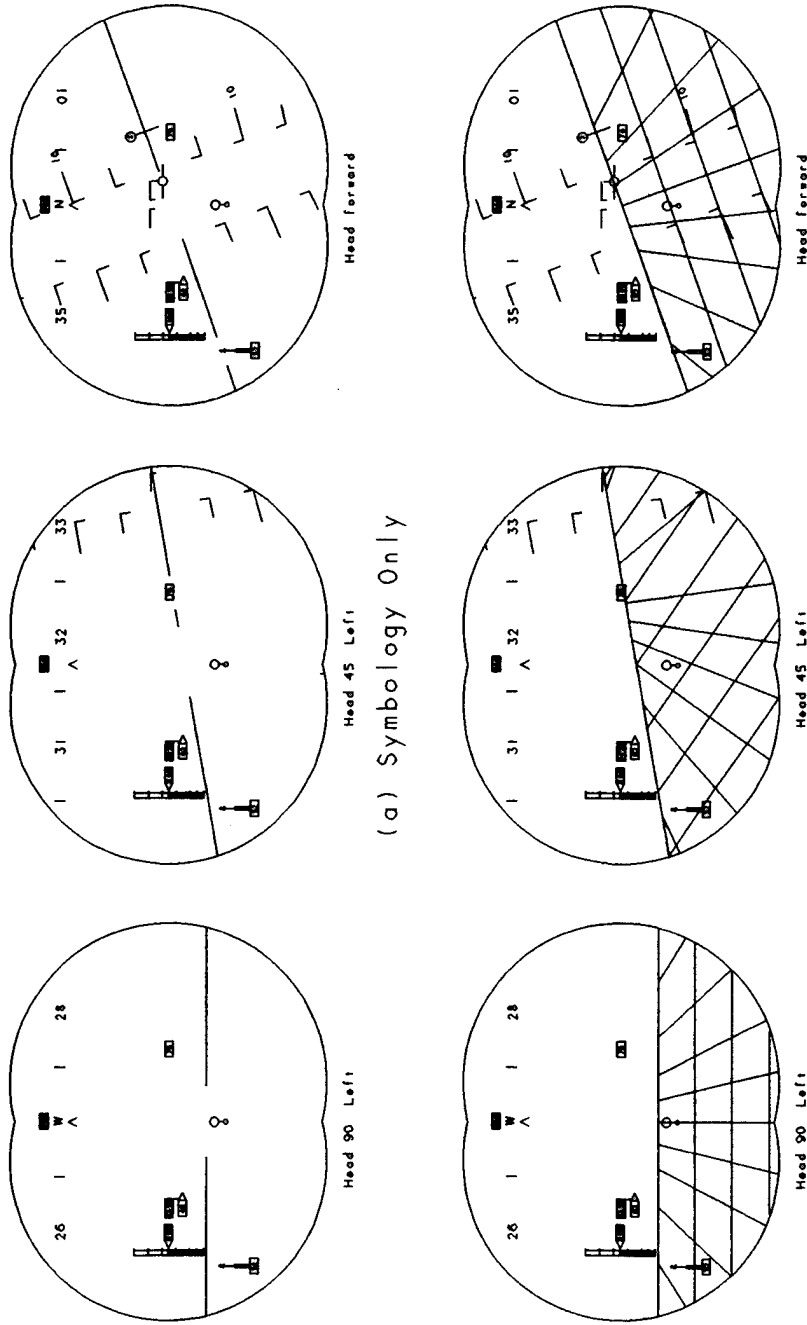

(a) Symbology Only

(b) Symbology and Scene Together

Figure 19. Comanche Cruise Symbology

G HMD LESSONS LEARNED TO DATE

(1) Training

The Apache training unit at Fort Rucker report Apache student pilots require a fairly lengthy period (of the order of twenty-five hours) to adapt to the HMD(34). The conflicting motion cues between the symbology and the IR cue were cited as contributing to this.

Several anecdotal reports were made of students who were extremely reluctant to move their heads while hovering using the IHADSS for reference.

The instructor pilots (IPs) generally did not criticize on the orientation of the symbology during hover. They did, however, comment unfavorably on the difficulties with relating it to the infrared image. To quote one pilot, "IR sucks."

The syllabus consists of about 12 hours of contact flying followed by the instrument/night portion. There is apparently no doctrine on when to introduce the use of the IHADSS. One IP says that he encourages, but does not insist, on the student's use of the HMD. He felt that students who used the HMD during the contact portion of the syllabus had less trouble during the instrument/night portion.

One IP reported, anecdotally, that Apache pilots who don't fly for a month or two appear to have lost the ability to fly using the IHADSS and must be essentially retrained. It is also reported that new Apache pilots are only minimally qualified upon arrival at their units and require extensive further training.

The difficulty of using a monocular display was downplayed by all pilots. They cited some advantages with a monocular display as well as some disadvantages. One pilot (who wears glasses) commented that the eye relief is too short for use with glasses. He reported an inability to see the entire FOV of symbology.

Additionally, there are reported difficulties because of drifting of the hover box.

(2) Operations

Operationally, there are reported difficulties because of the differing motion cues for the IR image and the symbology and the need to correlate the God's eye view (based on aircraft heading) with the pilot's eye view (based on direction of sight). The major problem is combining symbol/image cues, not necessarily with the symbol reference.

The lack of conformality of the horizon line with the real world horizon presents misleading elevation cues. This creates a hazard because the horizon cue as shown does not compensate for pilot

head motion and the pilot may conclude he has adequate obstacle clearance when, in fact, he has none.

The US Army Safety Center (USASC) studied a variety of potentially hazardous visual problems associated with the use of night vision devices (NVDs)(35). While most of these incidents involved ANVIS, Apache pilots reported some problems. Incidents occurred during all phases of flight, but were generally found during good weather, over open desert terrain, and periods with limited ambient illumination. Degraded visual cues were the most common report with loss of visual horizon and degraded resolution most frequently mentioned.

The USASC has summarized all Apache accidents in a briefing(36). A common accident scenario is the inability of the pilot to detect drifting during hovering operations or an inability to estimate distance to obstructions, such as trees. Another frequently mentioned accident scenario is misjudging obstruction height or the inability to detect slow descent during hover and low-level flight.

(3) Research

- (a) Rotary Wing: Haworth and Seery evaluated the effect of world- versus screen-stabilization on Apache hover symbology(33). Their results indicate that neither the standard Apache nor the world-referenced version were satisfactory in recovering from a drifting hover to a stabilized hover. The world-referenced version did provide a better reference for spatial awareness tasks.

NASA has sponsored a number of studies to determine the minimum visual cues for satisfactory rotorcraft flight. These studies include both simulated ground texture and symbology(37-38).

NASA-Ames has studied the effect of scene texture reduction on the ability of the pilot to fly by reference to the external visual scene. This has implication for the required resolution for HMD raster images. The results indicate that the absence of resolution (specifically high frequency content) in the scene can be partially compensated for by HUD symbology. The symbology did interfere with the visual scene information(39).

Other NASA studies examined the trade-off between field-of-view (FOV) and visual scene. A reduction in FOV degrades pilot/aircraft performance, but the actual trade-off is not clear(40-41).

One pilot who participated in the Comanche evaluations reported mixed reactions to the hover symbology. He felt the Apache's reticle symbol conveyed aircraft drift better than the Comanche's circle(34). He also felt that the Apache's

acceleration cue was much more useful. The *Comanche's* acceleration cue only provides information concerning acceleration along the velocity vector axis and does not include any transverse acceleration.

He did comment favorably on the world-stabilization of the *Comanche's* hover symbology.

It would be desirable to review the results of the symbology studies conducted for the *Comanche* development. These were not available because of proprietary restrictions. The inability to review this report restricts the observations that can be made in this section.

- (b) **Fixed-Wing:** Armstrong Laboratory (AFAL) has been evaluating several HMD symbologies. While the results are preliminary, incorporation of a screen-stabilized attitude display with no attempt at conformality appears satisfactory for F/W weapons delivery (both air-to-ground and air-to-air). Reduced FOV did have an adverse effect(19, 42-44).

These studies have not included low altitude flight, however. Nor have they considered hovering or NOE flight

(4) **Observations**

The following observations are presented as first impressions. They have not been tested, but should be considered as an initial "expert opinion" regarding HMD symbology.

- (a) **Information Requirements:** The first question to be asked is why is an HMD needed? Considering up-and-away flight, the obvious answer is to allow the pilot to view targets or obstructions located off-axis.* If this is the only requirement, then the flight information presented should be designed to allow the pilot to maintain control while looking for a target, not fly the complete mission.

This seems to lead one toward screen-fixed displays. Initial impressions suggest that screen-fixed symbols allow the pilot to maintain control while looking off-axis. Thus there is a place for the much less expensive screen-fixed displays, such as ANVIS/HUD.

In addition, the pilot may require estimation of elevation, or at least of the local horizontal. The use of a conformal, world-fixed horizontal reference line is useful for this information task. It is not, however, useful for controlling

* While this answer may seem obvious, the question is not. One should always ask why a display is need. During a recent HUD meeting, the question was asked why a sensor image was needed for low visibility landing. No one at the meeting had an answer other than "We need one".

aircraft attitude. (It may be useful in maintaining an aircraft attitude briefly.) This argues for two types of horizon reference: a conformal, world-fixed zero-elevation cue and a screen-fixed aircraft control cue. The latter cue would probably best be drawn as a compressed symbol with no attempt to make it conformal.

During NOE or hover, this may not be true. Observations by Fort Rucker Apache pilots suggests that the problem is not so much with the symbology as with differing motion cues presented by sensor images and symbology.

- (b) Comanche Symbology: Some of the features of the *Comanche* HMD seem to have been picked up from fixed-wing HUDs and adopted without regard for the needs of the R/W pilot. For example, the pitch ladder makes use of "bendy bars," in which the pitch lines are canted to indicate the direction of the horizon. These were incorporated in fixed-wing fighters to allow for unusual attitude recovery when the horizon is no longer in view. "Bendy bars" make accurate determination of specific elevations difficult and promote roll-estimation errors(45). They do not seem appropriate for rotary-wing applications.

The *Comanche* symbology also does not use occlusion windows to prevent one symbol from over-writing another. The mutual interference of the pitch ladder and the azimuth tape is apparent in Figure 4.

The airspeed/altitude switch placing the airspeed on the right and the altitude on the left is unusual. While one of the subject pilots commented that there were no problems(34), this change should be evaluated very carefully to ensure that no hazard will result. In our opinion, an overwhelming performance benefit must be shown to justify this switch.

- (c) C-130 ANVIS/HUD: Lahaszow(32) used the techniques recommended in the HUD Design Handbook(11) and the HUD Coloring Book(6) in developing the C-130 ANVIS/HUD symbology. The initial symbology was similar to that in Figure 6 and evolved into the final version shown in Figure 16.

While he states that the methods of References (6) and (11) were used, the result appears quite cluttered. Without access to the details of the development study, it would seem that the informational requirements were studied, but not the details of specific symbols. It should be mentioned that the display test and evaluation has not yet taken place.

- (d) HMD Descriptions: Without belaboring the point, the HMD descriptions, particularly motion descriptions, used to create the figures in this report were not easy to follow.

H RESTATEMENT OF THE PROBLEM

The problem is the use of inappropriate symbology in helmet-mounted displays. However, simply stating "inappropriate symbology" is to address the symptoms, not the root cause.

The underlying causes are (1) the absence of a logical, organized design methodology and (2) the absence of test and evaluation criteria.

The result is fielded HMDs with unstabilized symbology which present cues in conflict with sensor imagery and which can actually lead the pilot into unsafe conditions. This also results in excessive training requirements.

A design criteria document for HMDs is needed. This should follow the general outline of the present head-up display design guide(11) with the addition of HMD-specific sections.

I THE HELMET-MOUNTED DISPLAY DESIGN GUIDE

What is needed is a design criteria handbook that replaces the two present design approaches to display development: TLAR* or a slavish adherence to a standard. It is essential that a rational and effective design procedure be prepared.

(1) Previous Design Documents

Several reports and papers have been written examining the overall display design problem. In chronological order, these are Jenney and Ketchel(4), Singleton(3), Buchroeder and Kocian(46), Gard(47), Weintraub and Ensing(48), Hughes(6), Newman(11), and Rogers and Myers(50).

Jenney and Ketchel(4) reviewed the informational requirements of electronic displays in 1968. They outlined the general need for an informational requirements study and reviewed sixteen such studies. They charted the information requirements for each study and summarized them for selected phases of flight (takeoff, en-route, and landing). In their review, the needs of the pilot were assumed to be proportional to the number of times in each data item was mentioned -- a vote base. Jenney and Ketchel do mention that such a summation is no substitute for a detailed analysis, but only as an approximation of the needs.

As an example, Jenney and Ketchel mention a pull-up warning to avoid terrain. This was only listed twice (out of sixteen reports), but is obviously an important information item. This points out a major limitation of pilot surveys or summaries in determining informational requirements and the need for careful consideration of all relevant issues.**

Singleton(3) described a generic approach to display design. The basic questions to be asked during the information requirements portion of the analysis were listed previously (page 2). Singleton recommends (1) Justifying the display need; (2) Determining what data is required; (3) Ensuring that an average pilot can use the display; and (4) Ensuring compatibility of the display with the environment and pilot.

Buchroeder and Kocian(46) reviewed the design trade-offs for a helmet-mounted display for the Army's Light Attack Helicopter. The study concentrated on the optical and physical integration issues.

* TLAR = That looks about right.

** Jenney and Ketchel mentioned sideslip information and concluded that it was of limited importance to fixed wing aircraft. This may reflect a large proportion of fighter aircraft in their survey sample. It may also reflect no thought for engine-out control.

Gard(47) reviews installation characteristics of many HUDs, concentrating on the optical design. Gard's book concentrates on single-seat fighter HUDs and is a good background volume for a HUD designer although it doesn't qualify as a design guide.

Weintraub and Ensing(48) reviewed the human factors issues involved in HUD design. Their review concentrates on human visual performance and related topics, such as cognitive sharing.

Hughes(6) outlines many symbology considerations for HUD designers, again primarily for single-seat fighter aircraft. Hughes concentrates on symbology issues, not the informational requirements. He does stress the need to minimize the scene content to allow sighting of external targets. Hughes stated the principle that every pixel must improve mission performance (Hawkeye's Law, see page 5)

Newman(11) prepared a HUD design handbook which was the result of two Air Force sponsored HUD studies to develop generic specifications for head-up displays. The study concentrated on symbology and systems integration issues and drew heavily on lessons learned from past programs. Newman also recommended a detailed informational studies (adapted from Singleton) and called for a logical test and evaluation protocol which was adapted from Haworth and Newman(49).

Rogers and Myers(50) have developed an expert system approach to display design. This system, ACIDTEST, is designed to provide support for the display designer. The system provides guidelines to the designer to ensure all informational requirements have been considered. It also lists display "rules" and guidelines. Where conflicts exist, the system identifies these to the designer. ACIDTEST has not been used at this writing.

What is really needed is a combination of the systems integration of Newman(11); the informational studies of Jenney and Ketchel(4), Singleton(3), and Newman(11);, the optical design of Gard(47) or Buchroeder and Kocian(46); and the test/evaluation protocol of Newman(11) or Haworth and Newman(49).

(2) Strawman HMD Design Guide

A strawman HMD Design Guide outline has been developed using the HUD Design Handbook as a pattern. The outline is attached as Appendix C.

There are a number of outstanding issues for which additional research is required. these are outlined below

I Symbology Issues:

Symbology stabilization
for hover/nap-of-the-earth flight
for up-and-away flight

Display of aircraft control symbols off-axis
 off-axis horizon line
 off-axis pitch (elevation) ladder
Display of LOS azimuth and aircraft heading
Airspeed and altitude
Symbology combined with raster image
 clutter
 differences in relative motion

An initial review of the symbology issues indicates that the hover symbology (both format and stabilization) requires a research and development effort including flight/simulation experiments.

The up-and-away symbology (at least our initial impression) is less critical. The fixed-wing results to date indicate that a non-conformal, screen-fixed attitude display may be satisfactory. This must, however, be confirmed for low altitude and NOE flight.

The display of off-axis pitch/elevation/horizon information requires a solution. The horizon line is used for two purposes. One is as a reference for aircraft control. It is also used to estimate the elevation angle of objects. Off-axis, these two purposes conflict. A screen-fixed horizon line assists the first purpose, a conformal horizon line serves the second. The issue is how best to display horizon information off-axis.

The display of pilot's LOS azimuth and heading information has not been resolved. There are conflicting requirements. To maximize aircraft control, an aircraft heading tape seems to be preferred; however, it may be easier to locate a target using a tape showing azimuth. This has not been resolved in either F/W or R/W HMDs.

While the choice of displaying airspeed on the left and altitude on the right or vice versa was resolved for head-down displays many years ago, researchers continue to develop reversed displays. It is essential that the rationale for such a display choice be thoroughly documented prior to introduction into service. The experiments to support this rationale must be clear and conclusive.

The symbology must be examined both with and without a backup raster image. Symbology clutter can impact negatively on the raster image. Apache pilots report the differences in relative motion between the image and the screen-fixed symbology is confusing. The implication is that the raster is

interfering with the symbology -- the symbology should be aiding the image interpretation.

II Optical Issues:

- Field-of-view requirements
- Need and amount of binocular overlap
- Resolution requirements for imagery
- Symbology combined with raster image
 - registration differences
 - brightness differences
- Need for color

The helmet display must be examined to determine the trade-off in performance as various optical parameters are degraded. All of these requirements are "good" -- large FOV is good, high resolution is good, etc. The question is how good is good enough and is the cost worth it.

There is limited information about where the "knee of the curve" is on the performance improvement as, say, field-of-view is increased. Experiments must be conducted to obtain this data. Without this type of data, the designer and the procurement officer have no way to determine if a specification is reasonable.

(3) Database Development

It would be extremely valuable to develop a database dealing with the various HMD systems and symbologies. This development should be started as soon as possible while the amount of data is still small.

The difficulties associated with the additional degrees of freedom of the display makes the use of electronic multimedia-based databases quite attractive. This would allow the symbology to be displayed on a screen showing the effect of aircraft motion and orientation and of pilot LOS. Figure 20 shows a proposed database arrangement.

The material to be included under the major headings is similar to those developed in the HUD Design Handbook and will for the HMD Design Guide. The definitions should include keywords with which to cross-reference the various groups.

In addition, the "display modes" for different aircraft should be easily cross-referenced from one system to another. The displays should also be cross-referenced with the information and stability requirements.

It would also be quite beneficial to use a multi-media capability and show actual sensor images and the corresponding stroke sym-

bology. The database user could "maneuver" the aircraft to view the effect of different aircraft attitudes and head positions.

It is recommended that such a database be developed during Phase II of this program.

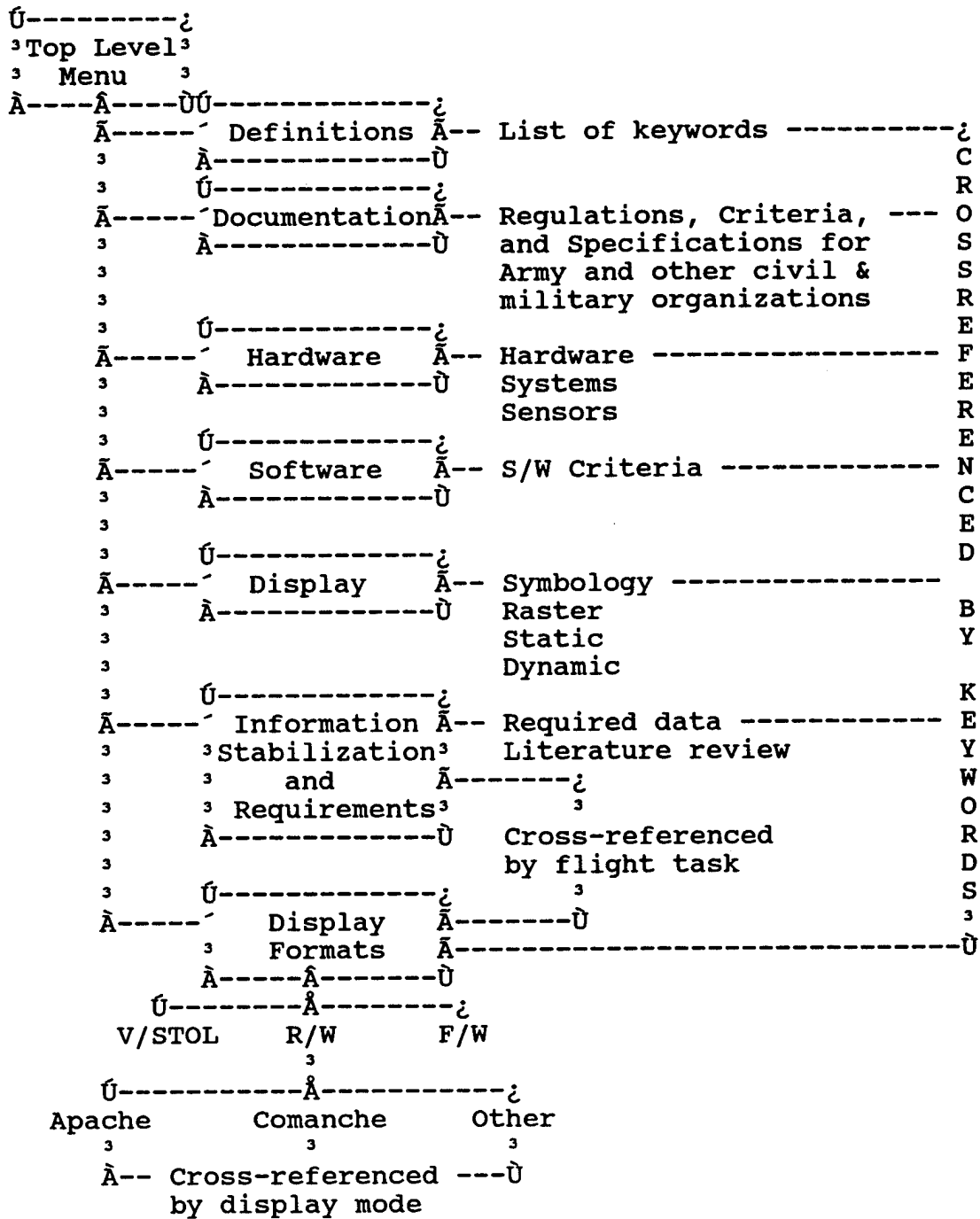

Figure 20: Proposed Database Arrangement

J POTENTIAL BENEFITS

As helmet-mounted display (HMD) technology matures, HMDs will be found on more and more aircraft. For the military, HMDs offer significant advantages in terms of off-boresight weapon delivery. For both civil and military operators, the HMD will enhance safe operations when maneuvering in close proximity to obstacles in conditions of reduced visibility.

(1) Reduced Design Cost

By developing a more rational and effective design procedure, developmental and evaluation costs will be reduced since the designers will make use of the historical knowledge gained in the development and fielding of similar systems.

In addition, proper information requirements analysis can lead to lower cost systems which are effective by avoiding unnecessary design features which are not supported by defined needs. Examples from the fixed-wing HUD community are the use of inexpensive air-mass HUDs in place of more expensive inertial HUDs for executive and trainer aircraft.

(2) Civil Operators

A recent FAA-sponsored conference (ELVIRA) produced many presentations on the advantages of improving the capability of civil helicopters to operate at austere sites in non-visual conditions.⁽⁵¹⁾ Emergency medical service (EMS) helicopters could greatly benefit from these displays. Three EMS organizations attended the ELVIRA conference; these three companies operate over 700 EMS helicopters. NVGs have been studied as a means to assist these operators, but questions of civil certification have blocked widespread use in the civil community.

In addition to the EMS community, civil law-enforcement departments can make good use of the sensor capability of HMDs.

(3) Military Operators

Improvements in HMD design technology can certainly improve operational mission effectiveness and improved flight safety. However a more significant benefit will be overall reduced costs.

A second, perhaps more significant, savings will be reduced training requirements. The present training costs for Apache pilots are excessive. A more-user friendly HMD interface would permit pilots to checkout in less time. This would allow them to become mission-ready in a shorter time. At the same time, recurrent training costs should be reduced. There should no longer be as rapid a loss of proficiency with time not flying as happens now.

(4) External Load Operations

Since the HMD can display sensor images even if the aircraft structure is in the pilot's LOS, there may be a benefit for external load operations. The pilot can look down and actually see the sling load using, for example, a television camera. This could reduce the number of crew required. Some external load helicopters carry a special pilot station just for the pick-up/drop-off phases. A HMD could eliminate this need.

(5) Other Uses of HMDs

In addition to aviation applications, HMDs have been proposed to assist operators of tele-robotic systems. A helmet-mounted display can be used to provide a television (or other sensor) image of the remote operation. As with aviation operations, embedded symbology may be required to augment the imagery.

Applications of this technology were studied for the space station by Radke and others.(52) Four unique benefits to head-mounted displays were identified: private viewing, head-tracked display, hands-free operation, and an additional display surface. Fourteen candidate space station applications were identified.

The use of head-mounted displays has been proposed as a means of providing simulation images.(17) Such an approach could reduce the cost of visual scene generators for simulators and could certainly allow for smaller systems. In particular, the use of a head-mounted virtual reality display could be used as a simulation tool for operational squadrons. The use of HMDs could permit training facilities at operating locations or on-board ships.

K RESULTS AND RECOMMENDATIONS

(1) Results

This report is the final Phase I report. The goal of Phase I was to identify major issues and present limitations for helmet-mounted display symbologies and to identify new symbology concepts for future HMDs.

- (a) Review HMD Symbologies and Implimentations: Current and proposed HMD symbologies and installations were reviewed in Sections D through G. The current Apache symbology has resulted in a number of operational problem areas (discussed in Section G. Unfortunately, the proposed Comanche symbology does not appear to be able to solve these problems.
- (b) Outline Strawman HMD Design Guide: Based on a review of present state-of-the-art, a number of issues regarding symbology and image requirements, such as tradeoffs between FOV vs. image resolution, contact analog vs. abstract symbology, and the need for conformality. Operationally the main issue is how to present off-axis flight control information.

A organization of a HMD Design Guide is presented in Section I. This handbook should contain a design methodology coupled with test and evaluation criteria. The Design Guide is outlined in Appendix C. The Design Guide should make use of an electronic database described in Figure 20.

At this writing, no clear choice of HMD symbologies can be selected as the baseline for future HMDs. In the absence of such a clear choice, the Apache format should be used as the starting point for future research. Specific issues requiring resolution are described on pages 46 to 48.

(2) Recommenations

A program will be proposed to develop a design guide for helmet-mounted displays for rotorcraft which will be suitable for both military systems and for civilian helicopters. A database of HMD systems and symbologies will be incorporated as part of this program. The use of a multi-media electronic database will be proposed.

A series of developmental experiments are proposed to design symbologies suitable for low altitude, NOE, and hovering flight. A protocol for test and evaluation of symbology should be documented.

- (a) Objectives: The objective for the proposed program is to develop a design methodology coupled with a test and evaluation criteria. The result will be a design handbook which can be used in conjunction with the Aeronautical Design Standard (ADS). This design handbook will incorporate a pro-

cess known to be successful and which makes use of the lessons learned from past programs.

The design handbook should make use of an HMD database which will make these "lessons learned" easier to see. This database will be developed using software similar to Hypercard, but compatible with PC operating systems.

(b) **Creation of a Helmet-mounted Display Database:** An HMD database should be developed in a format suitable to use on a PC computer. This database should include the following areas:

- 0 HMD concepts (such as stabilization
- 0 Glossary of HMD terms
- 0 Description of existing/planned systems
 - o Head/helmet components
 - o optical characteristics
 - o sensor descriptions
 - o physical packages
 - o software descriptions
 - o symbology
- 0 Bibliography of the HMD literature

The descriptions of existing/planned systems should include entire (i. e. complete) systems, such as IHADSS, as well as individual components, such as proposed helmet/display hardware.

The database should include the effect of mission/flight phase on the symbologies and other topics (if appropriate).

The development of this database should be coordinated with similar programs to ensure maximum ability to interchange data.

(c) **Symbology/Image Requirements:** Based on a review of present and on-going display research, simulation and flight experiments should be carried out to define symbology and image requirements. Examples of such issues include tradeoffs between field-of-view vs. image resolution, contact analog vs. abstract symbology, and the need for conformality.

(d) **Prepare Helmet-Mounted Display Design Handbook:** The final recommendation is the preparation of an HMD Design Handbook. This Design Guide will provide background information and a standard protocol to be followed by the HMD designer in developing a display format for a particular aircraft/mission.

While the Design Guide will make use of the database outlined in section (2), it is not anticipated that an electronic "expert system" approach will be followed. Rather, the Design Guide will be patterned after the HUD Handbook.(11) The material should include the best features of other guides.(2-4, 6, 11, 47)

L REFERENCES

- (1) Military Standard: Human Factors Engineering Design Criteria for Helicopter Cockpit Electro-Optical Display Symbology, MIL-STD-1295A, 1984
- (2) R. L. Newman, Head-Up Displays: Designing the Way Ahead, Hampshire, England: Ashgate Publishing, in press (expected publication date January 1995)
- (3) W. T. Singleton, "Display Design: Principles and Procedures," Ergonomics, 12, 1969, 519-531
- (4) J. M. Ketchel and L. L. Jenney, Electronic and Optically Generated Aircraft Displays: A Study of Standardization Requirements, JANAIR Report 680505, May 1968; AD-684849
- (5) B. Best, quoted in T. A. Demonsthenes, "Situation vs. Command Guidance Symbology for Hybrid Landing Systems Applications," in Enhanced Situation Awareness Technology for Retrofit and Advanced Cockpit Design, SAE SP-933, 1992, pp. 33-57
- (6) R. E. Hughes, The HUD Coloring Book: Recommendations Concerning Head-Up Displays, Naval Air Systems Command, 1991
- (7) L. L. Crews and C. H. Hall, A-7D/E Aircraft Navigation Equations, NWC TN-404-176, March 1975
- (8) R. L. Newman, Operational Problems Associated with Head-Up Displays During Instrument Flight, AFAMRL TR-80-116, 1980
- (9) M. W. Anderson et al., Flight Testing a General Aviation Head-Up Display, submitted to SETP European Symposium, June 1994
- (10) Symbol Display Format, Hughes Helicopters Drawing 7-2L9800012A, 13 January 1983
- (11) R. L. Newman, Design Handbook for Head-Up Displays (HUDs) for Fixed-Wing Aircraft, FSWG TR-92-01, December 1992
- (12) R. L. Newman, Head-Up and Helmet-Mounted Display Glossary, Crew Systems TR-93-11, August 1992; attached as Appendix A
- (13) N. Bowditch, American Practical Navigator, An Epitome of Navigation, US Navy Hydrographic Office HO 9, 1966, pp. 384-387
- (14) L. A. Haworth and W. Stephens, Army Helmet Mounted Display Programs, briefing at Patuxent River, May 1993

- (15) R. A. Jacobsen et al., An Integrated Rotorcraft Avionics/Controls Architecture to Support Advanced Controls and Low-Altitude Guidance Flight Research, NASA TM-103983, October 1992
- (16) F. S. Doten, "Northrop's Surrogate Trainer (Simulating AH-64A Helicopter)," Proceedings 29th Symposium, Society of Experimental Test Pilots, Beverly Hills, September 1985, pp. 67-92
- (17) E. C. Haseltine, "Displays in Visual Simulation," Digest of Technical Papers, Society for Information Display, May 1993, pp. 749-752
- (18) L. A. Haworth and N. M. Bucher, "Helmet-Mounted Display Systems for Flight Simulations," SAE Transactions, Journal of Aerospace, Section 1, 98, 1989, 1809-1820
- (19) R. K. Osgood, "HMD Symbology Research," presented at Displays Conference, Edwards AFB, March 1993
- (20) System Specification: Head-Up Display (HUD) Air Retrieval System, Sundstrand Data Control 070-0936-001B, December 1976
- (21) System Specification: Visual Approach Monitor for the B-737 Aircraft System No. 960-2008, Sundstrand Data Control 060-1624, January 1977
- (22) AH-1S Cobra Attack Helicopter Head-Up Display System Description, Kaiser Electronics Brochure 78-3945, October 1979
- (23) A Safer Approach, Flight Visions Brochure, 1989
- (24) Sikorsky Report 2000-730-002B, January 1992, pp. 6.16-1 to 6.16-24
- (25) D. Troxel and A. Chappell, "ANVIS/HUD. An Operational and Safety Enhancement for Nap-of-the-Earth Night Flight," US Army Aviation Digest, March/April 1993, pp. 53-57
- (26) MH-53J Helmet-Mounted Display Flight Demonstration, AFAL Briefing to Tri-Service Flight Symbology Working Group, Moffett Field, August 1993
- (27) LifeSaver Symbology, briefing material provided by Honeywell at FAA ELVIRA Conference, Santa Fe, August 1993
- (28) Heads-Up Display System (HUDS), US Army Aviation Center, Student Handout, 43/44-1834-3, February 1987
- (29) Introducing the First Head-Up Display for Your Helicopter, Flight Visions Brochure, ca. 1994

- (30) E. E. Geiselman and R. K. Osgood, "Toward an Empirically Based Helmet-Mounted Display Symbology Set," to be presented at 37th Annual Meeting of the Human Factors and Ergonomics Society, Seattle, October 1993
- (31) E. C. Adam, "Head-Up Displays vs. Helmet-Mounted Displays: The Issues," Digest of Technical Papers, 1993 International Symposium, Society for Information Display, Seattle, May 1993 pp. 429-432; paper 28.1
- (32) A. Lahaszow, Briefing on C-130 ANVIS/HUD Program, NAWCAD briefing to Tri-Service Flight Symbology Working Group, Moffett Field, August 1993
- (33) L. A. Haworth and R. E. Seery, "Helmet Mounted Display Symbology Integration Research," Presented at 48th Annual Forum of the American Helicopter Society, Washington, June 1992
- (34) R. L. Newman, "Trip Report: Visit to Fort Rucker," Crew Systems Memo C307-23, July 1993
- (35) D. T. Fitzpatrick, Human Factors of Night Vision Device Use in Southwest Asia: Reports of Sensory Illusions and Other Adverse Effects, USASC TR-92-1, January 1992
- (36) D. K. Hebert, History of AH-64 Accidents, "The First Ten Years," FY 81-90, US Army Safety Center Briefing, January 1991
- (37) W. W. Johnson et al., "The Visually Guided Control of Simulated altitude," Proceedings of the Fourth International Symposium on Aviation Psychology, 1987, pp. 216-222
- (38) B. P. Dyre and G. J. Anderson, "Perceived Change in Orientation from Optic Flow in the Central Visual Field," Proceedings of the 32nd Annual Meeting of the Human Factors Society, 1988, pp. 1434-1438
- (39) M. S. Brickner, "Apparent Limitations of Head-Up Displays and Thermal Imaging Systems," Proceedings of the Fifth International Symposium on Aviation Psychology, 1989, pp. 703-707
- (40) M. S. Brickner and D. C. Foyle, "Field-of-View Effects on a Simulated Flight Task with Head-Down and Head-Up Sensor Imagery Displays," Proceedings of the 34th Annual Meeting of the Human Factors Society, 1990, pp. 1561-1571
- (41) D. C. Foyle and M. K. Kaiser, "Pilot Distance Estimation with Unaided Vision, Night-Vision Goggles, and Infrared Imagery," Digest of Technical Papers, 22nd Society for Information Display International Symposium, 1991, pp. 314-317

- (42) R. K. Osgood and M. J. Wells, "The Effect of Field-of-View Size on Performance of a Simulated Air-to-Ground Night Attack," presented at Symposium on Helmet-Mounted Displays and Night Vision Goggles, Pensacola, AGARD, April/May 1991
- (43) M. J. Wells and R. K. Osgood, "The Effect of Head and Sensor Movement on Flight Profiles During Simulated Dive Bombing," Proceedings of the 35th Annual Meeting of the Human Factors Society, 1991, pp. 22-26
- (44) R. K. Osgood and E. E. Geiselman, "A Comparison of Three Aircraft Attitude Display Structures During an Attitude Maintenance Task," Proceedings of the 36th Annual Meeting of the Human Factors Society, 1992 , pp. 1450-1454
- (45) J. C. Penwill and J. R. Hall, A Comparative Evaluation of Two HUD Formats by All Four Nations to Determine the Preferred Pitch Ladder Design for EFA, Royal Aircraft Establishment (Bedford) FM-WP(90)022, 1990
- (46) R. A. Buchroeder and D. F. Kocian, Display System Analysis for the LHX Helicopter Application, AAMRL TR-89-001, January 1989
- (47) J. H. Gard, HUDs in Tactical Cockpits: A Basic Guide Book, Kaiser Electronics, Second Edition, November 1989
- (48) D. J. Weintraub and M. Ensing, Human Factors Issues in Head-Up Display Design: The Book of HUD, Crew System Ergonomics Information Analysis Center CSERIAC SOAR-92-2, May 1992
- (49) L. A. Haworth and R. L. Newman, Techniques for Evaluating Flight Displays, USAAVSCOM TR-92-A-006, February 1993; NASA TM-103947
- (50) S. P. Rogers and L. D. Myers, "Development of an Intelligent System to Air in Avionics Display Design", presented at AIAA/IEEE Digital Avionics System Conference, Fort Worth, October 1993
- (51) Extremely Low Visibility IFR Rotorcraft Approach (ELVIRA) Workshop, Santa Fe, August 1993
- (52) K. Radke, P. Jamer, and L. Levitan, Head-Ported Display Analysis for Space Station Application, IEEE Publication CH2359-8/86, 1986
- (53) K. R. Boff and J. E. Lincoln (eds.), Engineering Data Compendium. Human Perception and Performance, Armstrong Aerospace Medical Research Laboratory, 1988
- (54) O. S. Heavens and R. W. Ditchburn, Insight into Optics, New York: Wiley, 1991

- (55) C. P. Gibson, "Binocular Disparity and Head-Up Displays," Human Factors 22, 1980, 435-444
- (56) W. J. Smith, "Image Formation, Geometrical and Physical Optics," Handbook of Optics, W. G. Driscoll and W. Vaughan (eds.), New York: McGraw-Hill, 1978, chapter 2
- (57) R. L. Newman, Improvement of Head-Up Display Standards. II. Evaluation of Head-Up Displays to Enhance Unusual Attitude Recovery, AFWAL TR-87-3055, Vol. 2, June 1987; AD-A194601
- (58) J. R. Hall, C. M. Stephens, and J. C. Penwill, A Review of the Design and Development of the RAE Fast-Jet Head-Up Display Format, Royal Aircraft Establishment (Bedford) FM-WP(89)034, 1989
- (59) D. F. Bitton and R. H. Evans, Report on Head-Up Display Symbology Standardization, AFIFC TR-91-01, 1990
- (60) FDI Model 1000 Head-Up Display System Specification, Flight Dynamics Document 404-0249, February 1989
- (61) Definitions and Abbreviations, Federal Aviation Regulations Part 1, n. d.
- (62) System Design Analysis, FAA AC-25.1309-1A, 1988
- (63) Military Standard: System Safety Program Requirements, MIL-STD-882C, n. d.
- (64) Criteria for Approval of Category III Landing Weather Minima, FAA AC-120-28C, 1984
- (65) Crew Stations and Passenger Accommodations, Aeronautical Systems Division Design Handbook AFSC-DH-2-2, n. d.
- (66) Military Specification: Flying Qualities of Piloted Airplanes, MIL-F-8785C, 1979

Appendix A

HUD/HMD Glossary

One of the problems in head-up and helmet-mounted display literature has been a lack of standardization of words and abbreviations. Several different words have been used for the same concept: for example, flight path angle, flight path marker, velocity vector, and total velocity vector all refer to the same thing.

In other cases, the same term has been used with two different meanings, such as binocular field-of-view which means the field-of-view visible to both left and right eyes according to some or the field-of-view visible to either the left or right eye or both according to others.

This glossary, adapted from the HUD Design Handbook, (11) was expanded to include HMD-related definitions. It contains terms relating to optics and vision, displays and flight information, weapons, and aircraft systems.

A list of HUD/HMD related abbreviations is also included.

This glossary and abbreviation list should be reviewed by workers in the field and updated for inclusion in the proposed HMD database.

(a) Optical Definitions

Abduction: The outward rotation of an eye away from the midline.

Achromatic: Corrected to have the same focal length for two selected wavelengths.

Accommodation: A change in the thickness of the lens of the eye (which changes the eye's focal length) to bring the image of an object into proper focus on the retina.

Accommodation describes the adjustment to distance which are internal to the eye. Vergence describes the relative pointing differences between the two eyes.

Alert Eye Position (AERP): The location of the pilot's eye when he is looking for critical external visual cues.

The AERP is usually assumed to be somewhat forward of the Design Eye Reference Point (DERP). For fighter aircraft, the AERP may be above the DERP.

Aperture Stop: An internal limitation on optical rays.

See **Exit Pupil**.

Astigmatism: Refractive error due to unequal refraction of light in different meridians caused by nonuniform curvature of the optical surfaces of the eye, especially the cornea.

Bi-ocular HMD: A helmet-mounted display presenting the same image to each eye.

Bi-ocular implies one sensor displaying to each eye; binocular implies a separate sensor for each eye. See **Binocular HMD**.

Binocular: Vision using both eyes.

Binocular HMD: A helmet-mounted display presenting different images to each eye.

See **Bi-ocular HMD**.

Binocular Instantaneous Field-of-View (IFOV): The field-of-view visible to both left and right eyes.

Two binocular IFOVs can be described: combined IFOV and intersecting IFOV. Figure 21 illustrates the difference between combined and simultaneous IFOVs.

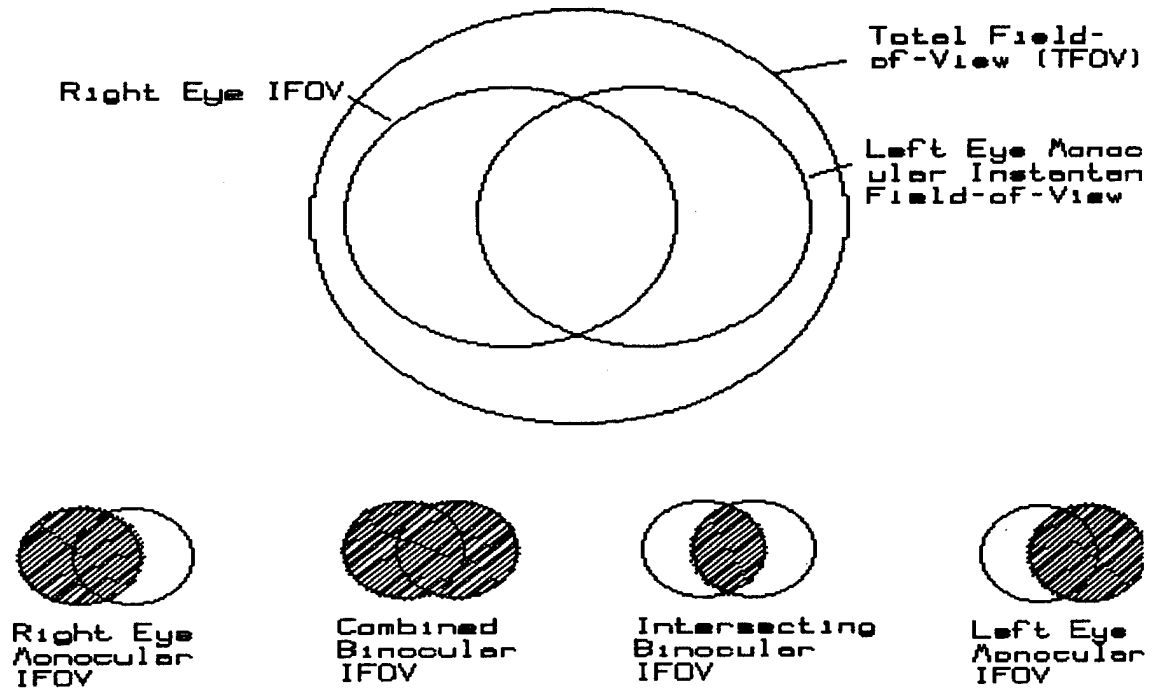

Figure 21. Binocular and Monocular Fields of View

Binocular Rivalry: The difficulty eyes have in simultaneously perceiving different stimuli presented to each eye because of the dominance of one eye.

See **Retinal Rivalry.**

Binocular Suppression: The perception of the image of one eye in preference to the other.

Boresight: The reference axis looking forward through an optical assembly or other non-visual sensor; the view with no directional adjustment. As a verb, to align a system with the reference axis of the airplane.

Brightness: The subjective attribute of light sensation by which a stimulus appears more or less intense. (53)

Catadioptric: Describing an optical system with an odd number of reflecting surfaces.

Candela (cd): The intensity of blackbody radiation from a surface of $1/60 \text{ cm}^2$ at $2045 \text{ }^\circ\text{K}$.

Chromatic Aberration: An error in which a lens has different focal lengths for different wavelengths of light.

Collimation: The act of making rays of light travel in parallel lines.

Collimator: The optical components used to collimate the display image.

Combined Binocular IFOV: The envelope of both left and right eye monocular IFOVs.

This is the field-of-view visible to both eyes. It is called ambinoocular IFOV by some authorities and binocular IFOV by others. The use of the adjective "combined" is recommended.

The IFOV which is visible to one eye, but not both is included in the combined IFOV. Figure 21 (page 64) illustrates the difference between combined and intersecting IFOVs.

Combiner: The component located in the pilot's forward field of view providing provides superposition of the symbology on the external field of view.

Contrast: The difference in luminance between two areas in a display.

Contrast Ratio: The ratio of display symbology brightness to the external visual cue brightness.

Contrast ratio must specify the ambient brightness level.

Conventional Collimator: See **Refractive Collimator**.

Convergence: The shifting of an observer's eyes inward to view a nearby object; i. e., crossing the observer's eyes.

Convergent Disparity: The horizontal component of disparity making the optical rays appear to emanate from a point closer than infinity.

Dark Focus: The point of accommodation of the eye in the absence of visual stimuli.

The dark focus is of the order of 1 meter in most persons.
See **Empty Field Myopia**.

Design Eye Reference Position (DERP): The location of the pilot's eye used to calculate fields of view and to make other comparisons between HUDs.

Dichoptic: Referring to viewing conditions in which the visual displays to the right and left eyes are not identical.

Diffraction Collimator: A collimator using one or more diffraction gratings for collimation (and often for superposition as well).

Since the diffraction gratings are usually produced using holograms, these are sometimes referred to as "holographic" collimators.

Diopter: The reciprocal of the focal length (in meters) of a lens.

Diplopia: A condition in which a single object appears as two objects because the left and right eyes do not fall on corresponding portions of the retinas.

Dipvergence: The shifting of an observer's eyes vertically, one up and one down.

Dipvergent Disparity: The vertical component of disparity.

Disparity: Misalignment of the images or light rays seen by each eye.

Displacement Error: The difference in apparent position of a real world visual cue caused by optical effects (such as refraction) when viewed through the combiner.

Distortion: Variation in apparent geometry of real world objects when viewed through the combiner.

Divergence: The shifting of an observer's eyes outward.

Divergent Disparity: The horizontal component of disparity making the rays appear to emanate from a point further than optical infinity.

Double Vision: See **Diplopia**.

Empty-Field Myopia: A situation where the resting focus of the eye moves to a near point in the absence of visual stimuli.

Exit Pupil: A small disk containing all of the light collected by the optics from the entire FOV.

Figure 22 shows a simple optical system. The aperture stop is shown by P_0 . The rays of light passing through the system will be limited by either the edges of one of the components or by the internal aperture, P_0 . The image of P_0 on the entrance side is the entrance pupil, P_1 ; that on the exit side is the exit pupil, P_2 . All rays that pass through P_0 must also pass through the entrance and exit pupils. (54)

By locating the observer's eyes within the exit pupil, the maximum FOV is obtained. As the observer's eyes move back from the exit pupil, the IFOV becomes smaller, although the TFOV is available by moving the eye's transverse to the optical axis.

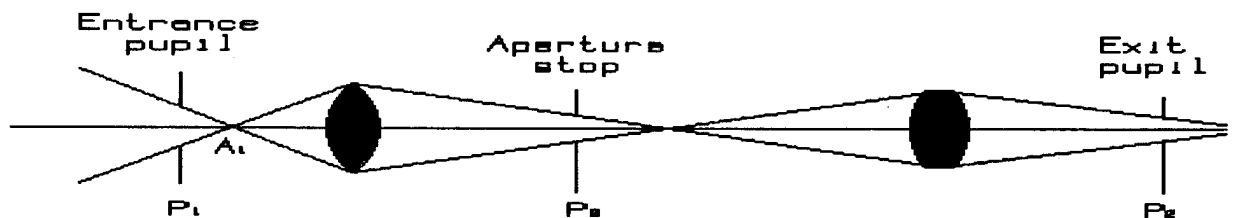

Figure 22. Aperture Stop and Entrance and Exit Pupils

Eye Reference Position (ERP): See Design Eye Reference Point.

Eye Relief: The distance from the HUD combiner to the exit pupil.

Eyebox: A three dimensional envelope within which the pilot's eyes are assumed to be.

Field-of-Regard (FOR): The spatial angle in which a sensor can view.

For helmet-mounted displays, the spatial angle in which the display can present usable information.

Field-of-View (FOV): The spatial angle in which the symbology can be displayed measured laterally and vertically.

Fixed Combiner: A combiner fixed in the pilot's view.

Foot-Lambert: A unit of illuminance equal to one lumen per square foot.

Hyperopia: A situation where the image of the eye's lens falls behind the retina, making it difficult to focus on nearby objects.

Hyperopia is sometimes called "far sightedness."

Illuminance: The amount of light intercepting a surface.

Image Intensifier (I²): A device to amplify light intensity by allowing the light to strike a screen which emits several photons for each photon from the original light source.

Instantaneous Field-of-View (IFOV): The spatial angle in which the symbology is visible from a single eye position.

The IFOV is the spatial angle of the collimator exit aperture as seen from the eye.

Intensity: A measure of the rate of energy transfer by radiation.

For a point source emitter, the units of intensity are watts per steradian. For a surface receiving incident flux, the units of intensity are watts per square meter.

For an extended source (one with finite dimensions as opposed to a point source), intensity is expressed in terms of energy per unit solid angle per unit area, or watts per steradian per square meter.

In photometry, special units are often used to account for the spectral sensitivity of the eye. The intensity of a light source is sometimes measured in candelas which is based on blackbody radiation at a specified temperature. See **Candela**.

Interpupillary Distance (IPD): This distance between the centers of the pupils of the eyes when the eyes are parallel (converged to optical infinity). (53)

Intersecting Binocular IFOV: The envelope within the combined binocular IFOV which is common to both left and right eye monocular IFOVs.

This is the FOV in which the symbology is visible to both eyes simultaneously. This is called binocular IFOV by some authorities. The use of the adjective "intersecting" is recommended.

The use of the adjective "simultaneous" is not recommended.

The IFOV which is visible to one eye, but not both is not included in the intersecting IFOV. Figure 21 (page 64) illustrates the difference between combined and intersecting IFOVs.

See **Overlap**.

Knothole Effect: The apparent limitation of the TFOV by the exit aperture.

This is an analogy of the TFOV which is the world beyond the "knothole" and the IFOV is the "knothole." By shifting one's eye, the view of the real world beyond the "knothole" can be viewed, though not all at once. Gibson(55) calls this the "porthole."

Line of Sight (LOS): A line from the pilot's or observer's eyes in the direction of viewing.

Line Width: The width at 50 percent of peak luminance of the line luminance distribution.

Lumen: A unit of luminous flux equal to one candela per steradian.

Luminance: Luminous flux reflected or transmitted by a surface per unit solid angle of projected area in a given direction.

The unit of measurement is the foot-lambert.

Monocular Combiner: A combiner intended to be viewed with one eye.

Monocular IFOV: The spatial angle in which the symbology is visible viewed from a single eye (left eye, right eye, or single ERP) position.

Myopia: A situation where the image of the eye's lens falls in front of the retina, making it difficult to focus on objects at a distance.

Myopia is sometimes called "near sightedness."

Optical Axis: The axis of symmetry of an optical system(56).

Optical Infinity: Located at such a distance that rays of light appear parallel.

Overlap: The lateral angle subtended by the intersecting binocular IFOV.

Photon: The fundamental quantum of light energy.

Real Image: An image formed when the rays from an external object meet at an image point.

A real image may be recorded by placing a photographic film at this point.(54) Real images are formed on the opposite side of the lens from the objects they represent. Figure 23 shows the geometry of real and virtual images.

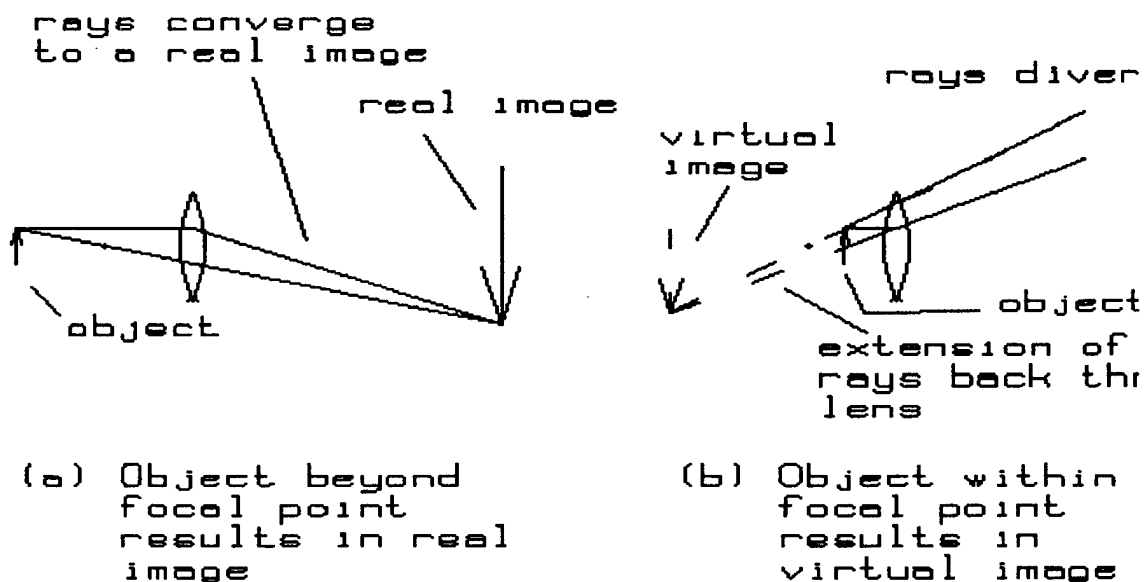

Figure 23. Real and Virtual Images

Reflective Collimator: A collimator using mirrors (perhaps in conjunction with lenses) for collimation (and often for superposition as well), i. e. using the principle of reflection.

Refractive Collimator: A collimator using only lenses for collimation, i. e. using the principle of refraction.

Refractive collimators are sometimes referred to as "conventional" collimators.

Resolution: The ability to distinguish to fine detail.

Resolution can be expressed in terms of the separation required to detect two objects (lines or points) or in terms of numbers of lines or points per degree of the FOV. Some displays are described in terms of the number of lines or points across the display.

Resolution has also been described in terms of equivalent visual acuity, i. e. a resolution of 2 arc min could be described as 20/40. See **Snellen Visual Acuity**.

Retinal Rivalry: The difficulty eyes have in simultaneously perceiving two dissimilar objects independent of each other because of the dominance of one eye.

Snellen Visual Acuity: Visual acuity measured by recognition of standard letters.

The observer's task is to recognize (i. e. read the letters). The "standard" visual acuity is 1 arc min (line width). The result is usually expressed in terms of the observer's acuity relative to this nominal value expressed as a fraction whose numerator is 20. For example, 20/200 implies a visual acuity of 10 arc min and that the observer can read at 20 feet the letter that the "standard" observer can at 200 ft.

Spatial Frequency: For a periodic visual target (such as a pattern of equally spaced bars), the reciprocal of the spacing between the bars (i. e., the width of one cycle -- one dark bar plus one light bar), generally expressed in cycles/mm or cycles/deg.

Stowable Combiner: A combiner that can be deployed for use or retracted out of view.

Total Field-of-View (TFOV): The total spatial angle within which symbology can be viewed.

When a HUD is viewed from the exit pupil, symbology within the TFOV can be seen. As the observer moves back, only the symbology which can be seen through the exit pupil is visible. The angle restricted by the exit pupil is the IFOV.

The area covered by the IFOV may not be the entire display. By moving his head, the pilot may be able to see more symbology. The TFOV represents the total symbology available by moving the eye position.

Transmittance of Combiner: The percent of ambient light from an external source passing through the combiner.

The wavelength spectrum of the light from the external source must be specified. Normally, the spectrum of sunlight is usually assumed.

Vergence: The angle between light rays; the angle between the eyes of an observer.

When referring to the angle of the observer's eyes, the convention measures the angle looking from the observer toward the source of the light rays.

Vignetting: Partial loss of illumination caused by some of the light rays being blocked by the aperture stop.

Virtual Image: An image which can be seen by an observer, but is not a real image.

A virtual image is formed when the projection of the rays (from an external object) cross, although the rays themselves do not.⁽⁵⁴⁾ Virtual images are formed on the same side of the lens as the objects they represent. Figure 23 (page 70) shows the geometry of real and virtual images.

Visual Acuity: The ability of an observer to distinguish fine patterns.

Visual acuity can be expressed in terms of the angular separation required to see that two or more objects are separate. It can be expressed in terms of the angular size necessary to detect a small target.

Visual acuity has also been expressed in terms of reading standard letters or determining the orientation of small symbols. The most commonly used of these is the Snellen letters. See **Snellen Visual Acuity**.

Visual Disparity: The difference in apparent position of an image as presented to each eye.

Windshield Combiner: An area of the windshield which functions as the combiner.

(b) Symbology Definitions

Absolute Altitude: The altitude above the terrain.

Aircraft Coordinates: A coordinate system with the origin at the aircraft center-of-gravity.

For displays, the convention is x lying along the lateral axis, y along the vertical axis, and z along the longitudinal axis. The sign convention is positive right, up, and forward.*

Aircraft-Fixed: A symbol in which the angular elements are moved to correct for head movement. An example is the head-tracking reference in the Apache HMD.(1)

In aircraft-fixed formats, the display elements appear to be stationary relative to the aircraft. All HUDs and panel instruments are aircraft-fixed since they do not move relative to the aircraft.

Aircraft Reference Symbol (ARS): The cue by which the pilot flies the airplane.

The ARS can be the pitch marker, the flight path marker, or the climb-dive marker. It is used relative to the pitch ladder. Secondary cues (such as Angle-of-attack error) are referenced to the ARS.

Aircraft Referenced: A symbol in which the angular elements are rotated to correct for head movement. An example is the LOS reference in the AFAL HMD symbology.(19)

Airspeed: The magnitude of the speed with which the aircraft moves through the air.

Airspeed, Calibrated: See Calibrated Airspeed.

Airspeed, Indicated: See Indicated Airspeed.

Airspeed, True: See True Airspeed.

Air-Mass Symbols: Flight path symbols defined using the air-mass velocity vector.

* This sign convention will usually be different from the sign convention used by the aircraft designer. The typical airframe design convention is x, y, and z axes lying along the longitudinal, lateral, and vertical axes. The z-axis sign convention is usually positive down.

See definitions for **Climb-Dive Marker**, **Flight Path Angle**, **Flight Path Marker**, and **Velocity Vector**.

Alphanumeric Information: Information presented as letters and numerical digits, such as text messages.

Altitude: The height of the aircraft above sea level or some other reference.

Altitude, Barometric: See **Barometric Altitude**.

Altitude, Radar: See **Radar Altitude**.

Analog Information: Information presented as a continuously moving symbol, such as the hands on a watch, as opposed to discrete information.

Angle-of-Attack (AOA or α): The angle between an aircraft longitudinal reference (FRL or ACRL) and the air velocity vector projected on the plane defined by the aircraft longitudinal reference and the aircraft vertical axis.

Angle of Sideslip (β): The angle between the aircraft longitudinal reference (FRL or ACRL) and the air velocity vector projected on the plane defined by the aircraft longitudinal reference and the aircraft lateral axis.

β is the left-right equivalent of α .

Articulation: The canting of pitch ladder lines to indicate the nearest horizon.

Aspect Ratio: The ratio of horizontal to vertical dimension of a display.

Augie Arrow: A roll referenced symbol consisting of an arrow referenced to the flight path marker. The Augie arrow automatically appears during unusual attitudes and indicates the roll attitude to aid recovery. (57)

Bank: The angle between local vertical and the plane defined by the aircraft's vertical and longitudinal axes.

Barometric Altitude: The altitude calculated from measuring the ambient static pressure through the pitot-static system.

Cage: To constrain the flight path marker to the center of the field-of-view.

Calibrated Airspeed (CAS): Indicated airspeed corrected for pitot-static system position error.

Climb-Dive Marker (CDM): The symbol showing the aircraft flight path angle, i. e. the velocity vector constrained laterally.

Climb-Dive Marker, Air-Mass: The climb-dive marker defined using the air-mass velocity vector.

Climb-Dive Marker, Inertial: The climb-dive marker defined using the inertial velocity vector.

Coding Characteristics: Readily identifiable attributes associated with a symbol by means of which symbols can be differentiated; i. e. size, shape, color, etc.

Combined Steering Cue: A multiple axis steering cue which, when followed, will place the aircraft on a trajectory to intercept and maintain a preselected computed path through space.

Compression: An angular relation where an angle within the display corresponds to a greater angle in the real world.

Compressed scales can not be conformal.

Conformal Display: A see-through display (HMD or HUD) in which the symbols, when viewed through the HMD, appear to overlies the objects they represent.

Contact Analog: A display which is a representation of the real world.

Note: a contact analog format need not be conformal.

Course Deviation: An indication of aircraft displacement (left-right) from a desired track (VOR or TACAN radial, ILS or MLS localizer, INS track, etc.).

Deviation: An indication of aircraft displacement (left-right, up-down) from a desired track.

Deviation Box: An indication of aircraft displacement (left-right, up-down, or both) from a desired track. Normally shown as a box or circle, the steering box shows the displacement compared to a maximum or nominal displacement (such as the ILS Category II limits).

Digital Information: Quantitative information presented as numerical digits, such as an automobile odometer or digits on a watch.

Digital information uses the numbers to show the magnitude of the information and will change as the source information changes.

Directed Decision Cue: A displayed command directing the pilot to a specific action, such as "SHOOT," "GO-AROUND," or "BREAK-AWAY."

Direction Cue: A symbol depicting the location of a particular line of position (LOP), such as a VOR radials or runway centerline extensions.

Discrete Information: Information presented in defined steps or intervals, such as the digits on a digital watch, as opposed to analog information.

Display Coordinates: A coordinate system oriented with the display.

For HUDs, the origin is at the design eye reference point. The convention is x and y lying transverse to the display boresight and z lying along the boresight. The x axis is horizontal and y vertical.

For HMDs, the origin is at the exit pupil for monocular HMDs and mid-way between the exit pupils for bi-ocular and binocular HMDs.

For panel displays, the origin is at the center of the display.

Note: for HUDs and HMDs, the display coordinate system is parallel to the aircraft coordinate system. For HMDs, the display coordinates coincide with the head coordinate system.

Display Reference: The orientation of the angular information in a display reference to the information in the real world.

DME: A symbol showing the distance in nautical miles to a TACAN or DME navigation station. Also the distance measuring equipment itself.

Elevation Ladder: A set of reference symbols showing increments of angles to the horizon.

The term "elevation" is used to distinguish these angles from pitch angles. Pitch angles apply to the attitude of the aircraft about the lateral axis. Elevation applies to the pilot's LOS and is used for directions away from the nose of the aircraft.

See Pitch Ladder or Climb-Dive Ladder.

Embedded Symbol: A symbol embedded in the raster image.

Error Information: Information presented which enables the user to assess the deviation of some parameter from its desired value without requiring attention to a numerical value, such as left/right ILS deviation.

Fixed Aircraft Reference (\emptyset): A symbol which represents an extension of the fuselage reference line (FRL) or other longitudinal aircraft reference line (ACRL).

The symbol indicates relative pitch and roll angles of the aircraft when compared to the horizon (either artificial or real world) or to a displayed pitch ladder. It is sometimes called the waterline or pitch marker.

Fixed Symbol: A display symbol which is moved to correct for aircraft, sensor, or head movement.

The term "fixed" is used vice "stabilized" or "referenced" to avoid confusion and to emphasize that the image is being corrected for aircraft, sensor, or head motion.

See **Aircraft-Fixed**, **Screen-Fixed**, or **World Fixed**.

Flare Cue: A symbol indicating the desired vertical flight path during the landing flare.

The flare cue is usually a vertical steering cue.

Flight Director: Steering information which, when followed, will place the aircraft on a trajectory to intercept and maintain a preselected computed path through space.

Flight Path Angle (FPA or γ): The velocity vector component projected on the plane defined by the aircraft FRL (or ACRL) and the aircraft vertical axis.

The FPA is the velocity vector constrained laterally.

Flight Path Angle, Air-Mass: The FPA defined using the air-mass velocity vector.

Flight Path Angle, Inertial: The FPA defined using the inertial velocity vector.

Flight Path Marker (FPM): The symbol showing the aircraft velocity vector.

The difference between FPM and velocity vector is that the FPM is projected along the forward view while the velocity vector symbol may not (as in hover symbology). In addition, the FPM is used for direct aircraft control, while the velocity vector usually is not

Flight Path Marker, Air-Mass: The FPM defined using the air-mass velocity vector.

Flight Path Marker, Inertial: The FPM defined using the inertial velocity vector.

Flyback: The return trace from the end of one raster image to the start of the next.

Framing: An effect where vertical and horizontal lines and tape scales present a false "pseudo-horizon" sense to the pilot.

Framing Reference: A display format which presents angular/attitude information oriented in the same direction as the display.

Framing displays are intended to provide an orientation cue in the same perspective as the pilot's LOS. Examples of framing referenced displays are attitude indicators and HUD pitch ladders.

See **Non-Framing Reference**.

Geometrical Horizon: The pilot's LOS tangent to the surface of the earth. (13)

Ghost Horizon: A line parallel to the horizon drawn near the edge of the field-of-view to indicate the nearest horizon.

Ghost Velocity Vector: See **Velocity Vector, Ghost**.

Glideslope (GS): The vertical reference for an instrument landing system (ILS) or a microwave landing system (MLS) approach generated by a ground-based navigation transmitted signal.

Grid Heading: The horizontal angle made with grid north.

Groundspeed (GS): The magnitude of the speed with which the aircraft moves with respect to the surface.

Head Coordinates: A coordinate system with the origin at the midway between the pilot's eyes. The convention is x and y lying transverse to the his LOS and z lying along the LOS. The x-axis is horizontal and y-axis vertical.

Heading: The horizontal angle made by the longitudinal reference (FRL or ACRL) with a reference direction.

Heading Referenced: A symbol in which the angular elements rotate to compensate for changes aircraft heading. The horizontal situation indicator (HSI) is an example.

Heading Scale Compression: A form of compression in which the heading angles are compressed.

Heading compression quite common in fighter HUDs to prevent blurring of the heading scale. While a compressed heading scale will not be conformal, the balance of the HUD may be.

Horizon, Geometrical: See **Geometrical Horizon**

Horizon Line: A symbol indicating a horizontal reference or zero pitch.

Hughes(6) makes the point of emphasizing that this may not overlie the "true" horizon (the pilot's LOS tangent to the earth) at high altitude.

Bowditch(13) defines several different horizons: the sensible horizon (a horizontal plane passing through the eye of the observer), the geoidal horizon (a horizontal plane tangent with the geoid directly below the observer, the geometrical horizon (the observer's LOS tangent to the geoid), and the visible horizon (the demarcation between surface and sky).

The difference between the geometrical horizon and the visible horizon is caused by atmospheric refraction and by the elevation of the terrain.

The difference between the sensible horizon and the visible horizon is called the dip correction. This is not a problem at typical helicopter altitudes. (At 100 ft, the dip correction is 2.8 mr.) In addition, the sensible horizon is usually obscured by hills, trees, etc. making any discrepancy irrelevant.

See **Geometrical Horizon, Sensible Horizon, or Visible Horizon.**

Horizon, Sensible: See **Sensible Horizon**

Horizon, Visible: See **Visible Horizon**

Inertial Symbols: Flight path symbols defined using the inertial velocity vector.

See **Climb-Dive Marker, Flight Path Angle, Flight Path Marker, or Velocity Vector.**

Indicated Airspeed (IAS): The airspeed calculated from the dynamic pressure of the impact air pressure from the pitot-static system.

IAS is uncorrected for position error.

Lateral Acceleration: The measure of the sideforces generated aerodynamically by sideslip.

Lateral Steering Cue: Single axis steering information which, when followed, will place the aircraft on a trajectory to intercept and follow a preselected computed ground track.

Mach Number: The ratio of the TAS to the ambient speed of sound.

Magnetic Heading: The horizontal angle made with magnetic north.

Non-Framing Reference: A display format which presents angular/attitude information in a different orientation as the display.

Examples of non-framing referenced displays are horizontal situation indicators (HSI's) and the Apache hover symbology.(1) In the case of an HSI, the pilot views the display facing forward, while the display represents the view from directly overhead. This requires the pilot to mentally rotate the display coordinates while viewing the display.

See Non-Framing Reference.

Normal Load Factor: The ratio of the lift to the aircraft weight.

Normal load factor is sometimes called normal acceleration and is referred to by pilots as "g's".

Orange Peel: A symbol consisting of a segment or an arc surrounding the flight path marker. The length of the arc indicates the pitch attitude (zero pitch is a 180° arc). The center of the arc is oriented to show vertical (down).

Pitch Attitude: The angle above or below the horizon made by the aircraft reference line.

This is sometimes called pitch angle.

For directions away from the nose of the aircraft, the term elevation angle is sometimes used in place of pitch.

Pitch Index: A symbol on the HUD positioned at a predetermined pitch angle used to represent a desired flight path angle or pitch attitude.

Pitch Ladder: A set of pitch reference symbols showing increments of angles to the horizon.

Some authorities(58-59) refer to this as the climb-dive ladder since most HUDs do not use pitch as the primary aircraft symbol. The terms climb-dive ladder and pitch ladder are synonymous. We will use the term pitch ladder because of historic use and economy of syllables.

Pitch Marker: The symbol which shows the fixed aircraft reference.

Pitch Reference Frame: One or more symbols which represent fixed angles in space and are used as references for aircraft pitch and flight path symbols.

Pitch Referenced: A symbol in which the angular elements move to indicate aircraft pitch. The pitch cue on the VAM is an example. (21)

A symbol in which the angular elements rotate to indicate aircraft pitch and bank, such as the pitch ladder on most HUDs, can be described as being both pitch and roll referenced.

Pitch Scale Compression: A form of compression in which the pitch angles are compressed, but roll angles are not.

Pitch compression is sometimes called "Gearing."

Pixel: A dot composing one of a number of picture elements.

Potential Flight Path (PFP): A cue, normally calculated from longitudinal aircraft acceleration which shows the velocity vector achievable for the aircraft by balancing existing thrust and drag.

Predictive Information: Information predicting the future condition or position of the aircraft or a system.

Pull-up Cue: A symbol used to indicate an approaching pull-up requirement during air-to-ground weapon delivery.

Qualitative Information: Information presented which enables the user to assess the status of the aircraft or system without requiring a numerical value.

Quantitative Information: Information presented which enables the user to directly observe or extract a numerical value.

Radar Altitude: Absolute altitude measured from the time for a radar signal to return. It is sometimes called radio altitude.

Range: A symbol showing the distance to a specified waypoint, ground location, or target.

Raster: A CRT image composed of a series of parallel lines which trace a path over the face of the image tube.

These parallel lines are modulated to create the image. Raster lines are written even when no symbols are to be displayed. This is sometimes referred to as a video image.

Raster/Stroke: Stroke symbols drawn during the flyback.

Reference Airspeed: The desired airspeed on final approach to landing, normally 1.3 times the stall speed.

Reference Angle-of-Attack: The desired angle-of-attack on final approach to landing.

Roll Referenced: A symbol in which the angular elements rotate to indicate aircraft bank. A bank pointer or the Augie arrow(57) are examples of roll referenced symbols.

Previous literature has used the term "roll stabilized" to denote this.

Rollout Guidance: An indication of aircraft displacement (left-right) from the runway centerline used for instrument take-offs and low visibility landings.

Rollout Steering Cue: A lateral steering cue which, when followed during the takeoff or landing ground roll, will place the aircraft on a trajectory to intercept and follow the runway centerline.

Runway Distance Remaining: A symbol showing the distance in to the end of the runway.

Runway Symbol: A symbol depicting the location of the runway.

Scales: Secondary symbol suites showing airspeed, altitude, and heading.

Screen Coordinates: A two-dimensional coordinate system with the origin at the center of the display screen. For HUDs and HMDs, this is the center of the CRT or other image source. This coordinate system is used to define the signals to the CRT.

Screen-Fixed: A symbol in which the angular elements are not moved to correct for aircraft, sensor, or head movement. An example is the hover symbology for the Apache HMD(1) or the gun cross on most fighter HUDs.

Sensible Horizon: A horizontal plane passing through the pilot's eye.(13)

Sensor Search Area: A symbol showing the areas of sensor coverage, such as radar or FLIR.

Situation Information: Information indicating present condition or position of the aircraft or a system.

Speed Command: Steering information which, when followed, will cause the aircraft to maintain a desired airspeed.

Stair-stepping: Distortion caused by forcing a symbol to follow raster lines.

Steering Information: Information presented which shows the control inputs necessary to fly a particular trajectory, such as the flight director pointers during an ILS approach.

Steering information differs from situation information by indicating the desired control inputs only and not the current aircraft condition or position. It is called command or director information in different publications.

Stroke: Symbols which consists of cursive lines drawn on the face of the image tube.

Stroke images are written only where symbols are to be displayed.

Symbol: An individual representation of information.

Symbology: The collection of symbols shown in a display.

Symbol Location: The term "fixed" has been adopted to indicate that the location of the symbol has been moved (on the screen) to compensate for aircraft/head motion and allow the symbol to overly a cue in the external visual scene.

World fixed means that the symbol is rotated/moved to compensate for aircraft and head motion. Aircraft fixed referenced means that the symbol has been rotated/moved to compensate for head movement. Screen fixed means that no compensation has been applied. "Rigid" could be used vice "fixed".

The terms "stabilized" has been avoided since it has meant both referenced and fixed in previous definitions. In the past, "roll stabilized" has meant "roll referenced" (in the proposed nomenclature). "World stabilized" has meant "world fixed" (in the proposed nomenclature).

It is entirely feasible for a symbol to be, for example, world referenced/screen fixed. An example is the horizon line on the Apache HMD. Other combinations are possible.

Symbol Orientation: The term "reference" has been adopted to indicate how a symbol has been rotated to compensate for misalignment between the world, aircraft, and display coordinates.

World referenced means that the symbol is rotated to compensate for differences between display coordinates and world coordinates. These differences could be caused by aircraft motion or, in the case of HMDs, by pilot head motion.

Aircraft referenced means that the symbol has been rotated to compensate for misalignment between display coordinates

and aircraft coordinates. This would be caused by head movement and only applies to HMDs.

These compensations are normally thought of as accounting for misalignment of all three axes. In fact, they are often applied to one or two axes only.

Symbol Reference: The point defining the origin of the symbol's coordinate system.

The reference can be the center of rotation, such as the origin of the velocity vector for the Apache hover velocity vector. (1)

For tape scales, the reference is the lubber line or index against which the tape is read. For thermometer scales, the reference is usually the base of the thermometer.

The reference point of a symbol can be another symbol. For most HUDs, the pitch ladder and climb dive marker use the same reference point. The climb dive marker is moved away from this reference point to indicate climb-dive angle.

Synthetic Runway: A contact analog symbol presented as a perspective figure depicting the location of the runway.

Tapering: Shortening of the pitch ladder lines as the angle from the horizon increases.

Time to Go: A symbol showing the predicted time of arrival at a preselected waypoint, ground location, or target.

True Airspeed (TAS): The actual aircraft speed through the air.

True Heading: The horizontal angle made with true north.

Unreferenced Display: A display format which presents no angular information, such as an airspeed indicator or an altimeter.

While the information may be useful in maintaining situational awareness, it is presented in scalar, not perspective format.

Update Rate: The rate at which the output data is recalculated.

Velocity Vector: The linear projection of the aircraft velocity originating at the aircraft center-of-gravity or some other well-defined location on the aircraft.

The use of a location forward of the aircraft center-of-gravity is often used to provide pitch rate quickening to the velocity vector symbol. Some HUD systems refer to the velocity vector as the flight path marker.

Velocity Vector, Air-Mass: The linear projection of the aircraft velocity through the air-mass.

The inverse of the air-mass velocity vector is the relative wind.

Velocity Vector, Ghost: A symbol, shown as a dashed version of the CDM, showing the location of the velocity vector.

Velocity Vector, Inertial: The inertial velocity vector is the linear projection of the aircraft velocity relative to the ground.

The inertial velocity vector is sometimes called the ground-referenced velocity vector.

Vertical Deviation: An indication of aircraft displacement (up-down) from a desired track (ILS or MLS glideslope, target altitude. etc.).

Vertical Steering Cue: A single axis steering cue which, when followed, will place the aircraft on a trajectory to intercept and follow a preselected vertical flight path, such as the ILS glideslope or target altitude.

Vertical Velocity: The rate of ascent or descent, usually calculated from the rate of change of barometric altitude.

Vertical velocity is sometimes called vertical speed.

Visible Horizon: The demarcation between the earth's surface and the sky. (13)

Warning Information: Information intended to alert the pilot to abnormal or emergency conditions.

Waterline: The symbol, usually shown by a winged W, which shows the fixed aircraft reference.

Waypoint: A symbol depicting the location of a particular navigation location.

World Coordinates: A coordinate system fixed with respect to the earth. The location of the origin and the direction of the x- and y-axes depend on the mission. Normally, the z-axis is vertical.

World-Fixed: A symbol which is moved to correct for aircraft attitude or heading. Examples are the horizon line on the FDI HUD(60) or target designator symbols.

With world-fixed symbols, they (the symbols) appear to be stationary relative to the outside visual cues.

Some symbols may be fixed in only one or two axes. HUD pitch ladders are usually described as world-fixed, but this is not strictly true as they do not move to compensate for heading changes. They should properly be described as being pitch/roll fixed.

World Referenced: A symbol which is rotated to indicate for aircraft attitude or heading.

World referenced symbols present the same angular orientation as the pilot sees along his LOS. Non-framing referenced symbols rotate to preserve the same relative angular orientation as the aircraft turns.

Some symbols compensate for aircraft motion along one or two axes. For example, the pitch ladder on most HUDs compensate for pitch and roll, but not for heading. The pitch symbols on a 3-axis ADI is an example of a world referenced symbol.

(c) Systems Definitions

Aircraft Reference Line (ACRL): A line defining a reference axis of the aircraft established by the manufacturer.

See **Fuselage Reference Line.**

Business Aircraft: A passenger aircraft with a gross takeoff weight less than 30,000 lb.

Category I: Landing minimums associated with conventional ILS approaches, typically 200 ft decision height (DH) and 1/2 mile visibility.

Category II: ILS landing minimums between 100 ft and 200 ft, typically 100 ft DH and 1/4 mile visibility.

Category II minimums were originally based on a requirement for sufficient visual cues for "see-to-flare."

Category III: Landing minimums below 100 ft.

Category III landing minimums are typically divided into Category IIIa, IIIb, and IIIc. Category IIIa minimums are typically 50 ft DH and 700 ft runway visual range. Category IIIa were originally based on sufficient visual cues for "see-to-rollout." Category IIIb were originally based on sufficient visual cues for "see-to-taxi." Category IIIc is true blind landing.

Certification Authority: The agency with the authority to determine airworthiness of the system.

In the case of civil aircraft, the certification authority is the Federal Aviation Administration (FAA) or its foreign equivalent. In the case of public or military aircraft, this agency is the appropriate government or military organization. The certification authority will be responsible for minimum or maximum acceptable values for many of the HUD system specifications.

Civil Aircraft: An aircraft not operated by a government agency. (61)

Decision Height (DH): The lowest altitude permitted for continuing a precision landing approach without acquiring visual cues for landing.

See **Category I, Category II, and Category III.**

Display Electronics: The electronic unit which produces the visible image of the symbols and which monitors the symbols.

Display Control Panel (DCP): The assembly which houses the HUD controls, such as brightness, mode selection, etc.

Electronic Unit (EU): The assembly which consists of the signal processor, the symbol generator, and the display electronics.

Electronic units may be combined into fewer physical units or they may be merged with other systems.

Enhanced Vision (EVS): A system which uses visual or non-visual sensors (such as FLIR or MMWR) to augment the pilot's view of the external scene.

Normally, enhanced vision implies simply displaying a sensor image with no sensor fusion or computer enhancement.

See **Synthetic Vision**.

Extremely Improbable: For civil aircraft, extremely improbable means less than once per billion hours.(62) For military aircraft, extremely improbable means that the probability of occurrence cannot be distinguished from zero and that it is so unlikely that it can be assumed that this hazard will not be experienced in the entire fleet.(63)

The definitions of some reliability terms, such as "extremely improbable," etc., will be specified by the certification authority.

Fail-Obvious: A display designed such that a single failure will allow the pilot to readily determine the failure and take appropriate action.

The appropriate action may included switching the source of the data or using another display.

Fail-Operational: A system designed such that a single failure will allow the system to continue operation with no loss in performance.(64)

Fail-Passive: A system designed such that a single failure will cause a system disconnect leaving the airplane in trim with no control hardover.(64)

Frame Time: The interval during which calculations are made by the signal processor.

Fuselage Reference Line (FRL): A line defining a reference axis of the aircraft established by the manufacturer.

See **Aircraft Reference Line**.

Glidepath Intercept Point (GPIP): The point on the runway where the final approach course and glidepath intersect the runway surface.

Head Tracker: A device or system used to locate the direction of the pilot's LOS.

Hands-on-Collective-and-Cyclic (HOCAC): The HOTAS philosophy applied to helicopters.

Hands-on-Throttle-and-Stick (HOTAS): The operating philosophy which allows the pilot to control all essential mission related functions through control buttons on the control stick and throttle.

Head-Up Display (HUD): A display which presents flight control symbols into the pilot's forward field of view.

The symbols should be presented as a virtual image focussed at optical infinity.

Helmet-Mounted Display (HMD): A display, mounted on the pilot's helmet, which presents flight control symbols into the pilot's field of view.

The symbols should be presented as a virtual image focussed at optical infinity.

The term "head-mounted display" is sometimes used.

Image Source: The component providing the optical origin of the symbology, such as a cathode ray tube (CRT) screen or laser source.

Instrument Meteorological Conditions (IMC): Flight conditions precluding the use of the external visual scene to control the aircraft.

Line Replaceable Unit (LRU): System components intended to be replaced by line mechanics and repaired by support organizations.

Mode: The operational state of the display: A selected group of display formats, input selections, and processing algorithms.

Night Vision Device: A image intensifier (I²) or sensor which allows crewmembers to see objects at night.

Night Vision Goggles (NVG): An image intensifier system worn by a crewmember.

Night Vision System: A night vision device installed in an aircraft.

Operator: The organization responsible for issuing the final HUD system specification and which will be the ultimate user of the equipment.

The operator will have the final decision on specifications based on the recommendations contained in this document, subject to the airworthiness requirements set by the certification authority. Note: For military and public aircraft, the certification authority and the operator may be the same organization.

Pilot Display Unit (PDU): The assembly consisting of the image source, the collimator, and the combiner.

Primary Flight Reference (PFR): A display which displays information sufficient to maneuver the aircraft about all three axes and accomplish a mission segment (such as takeoff or instrument approach).

The amount of data displayed obviously depends on the mission segment to be performed. As a guide, the data displayed in the basic "T," i. e. airspeed, pitch attitude, altitude, heading, and lateral deviation (or their substitutes) should be displayed in a primary flight reference. Other data which is critical for immediate use, such as glideslope deviation during a precision instrument approach, should be included for those mission segments where it is required. A PFR must have at least the reliability specified by the certification authority.

Primary Visual Signal Area (PVSA): The area of the instrument panel enclosed by 12 inch arc centered on the intersection of the crewmember's vertical centerline plane and the top of the instrument panel.(65)

Public Aircraft: An aircraft operated by a government, including the military.(61)

Refresh Rate: The rate at which the displayed image is redrawn.

Sampling Rate: The rate at which input data is sampled.

Digital computers require a finite time interval (frame time) within which to accomplish the necessary calculations. As a result, the input data (and output signal) is changed at intervals. This introduces an artifact into the displayed symbols.

The effect is different from (and generally more critical for handling qualities) than a pure time delay.

See **Frame Time**.

Signal Processor: The electronic unit which performs any calculations, filtering, etc. of the raw data to generate parameters to be displayed.

An example of such calculations is the calculation of the inertial velocity vector from the raw data of three velocities from the inertial platform.

Symbol Generator: The electronic unit which generates the actual symbols to be displayed on the HUD.

The symbol generator converts the values of the variables into shapes and locations of symbol elements to be drawn on the display unit, usually a CRT.

Synthetic Vision (SVS): A system which uses visual or non-visual sensors to augment the pilot's view of the external scene.

Normally, synthetic vision implies image-enhancement, sensor fusion, computer or a means of tagging symbology to the image location in the display.

See **Enhanced Vision**.

Tactical Aircraft: An aircraft defined as Class IV in MIL-F-8785C.(66).

Tactical aircraft also includes aircraft used to train for tactical aircraft.

Trainer Aircraft: An aircraft designed or used for primary and basic training.

Transport Aircraft: An aircraft defined as Class III in MIL-F-8785C.(66)

Visual Meteorological Conditions (VMC): Flight conditions allowing the use of the external visual scene to control the aircraft.

(d) Weapons Definitions

Aiming Reticle: A symbol used as a weapon aiming cue.

Azimuth Steering Line (ASL): A left right steering cue used in air-to-ground weapon delivery.

Bombfall Line (BFL): A symbol indicating the approximate trajectory of a weapon following release.

Breakaway Symbol: A symbol displayed at minimum weapon release range and/or reaching the minimum safe pullout altitude during air-to-ground weapon delivery.

The breakaway symbol indicates the need for an immediate pull-up of the aircraft.

Continuously Computed Impact Line (CCIL): A symbol used to display the locus of bullet impact points, usually with bullet time-of-flight points indicated.

Continuously Computed Impact Point (CCIP): A symbol indicating the predicted impact point of a weapon.

Gun Cross: A symbol indicating the gun boresight axis.

Solution Cue: A symbol indicating a release solution for a computed weapon delivery.

Standby Reticle: A backup display intended for manual aiming in the event of HUD or other system failure.

Target Aspect: A symbol indicating the orientation of the target vehicle (aircraft, ship, or ground vehicle).

Target Designator: A symbol showing the location of the target.

Target Range: A symbol showing the range to the target.

Target Range Rate: A symbol showing the rate of change of the target range.

Weapon Boresight: A symbol indicating the weapon boresight axis.

(e) Abbreviations

$\bar{\alpha}$	Angle-of-attack
$\bar{\beta}$	Angle-of-sideslip
	Flight path angle
$\bar{\theta}$	Aircraft pitch attitude
ACRL	Aircraft reference line
ADI	Attitude director indicator
AERP	Alert eye reference position
AFAL	Air Force Armstrong Laboratory
AOA	Angle-of-attack
ARS	Aircraft reference symbol
ASL	Azimuth steering line
BFL	Bombfall line
CAS	Calibrated airspeed
CCIL	Continuously computed impact line
CCIP	Continuously computed impact point
CDM	Climb-dive marker
CRT	Cathode ray tube
DCP	Display control panel
DERP	Design eye reference position
DH	Decision height
DME	Distance measuring equipment
ERP	Eye reference position
EU	Electronic unit
EVS	Enhanced vision system
FAA	Federal Aviation Administration
FDI	Flight Dynamics, Inc.
FLIR	Forward looking infrared
FOR	Field-of-regard
FOV	Field-of-view
FPA	Flight path angle
FPM	Flight path marker
FRL	Fuselage reference line
GPIP	Glidepath intercept point
GS	(1) Groundspeed (2) Glideslope
HMD	Helmet-mounted (or head-mounted) display
HOCAC	Hands on collective and cyclic
HOTAS	Hands on throttle and stick
HSI	Horizontal situation indicator
HUD	Head-up display
I ²	Image intensifier
IAS	Indicated airspeed
IFOV	Instantaneous field of view
ILS	Instrument landing system
IMC	Instrument meteorological conditions
INS	Inertial navigation system
IPD	Interpupillary distance
LOP	Line of position
LOS	Line of sight

LRU	Line replaceable unit
MIL	Military specification/standard
MLS	Microwave landing system
MMWR	Millimeter wave radar
NVG	Night vision goggles
PDU	Pilot display unit
PFP	Potential flight path
PFR	Primary flight reference
PVSA	Primary visual signal area
SVS	Synthetic vision system
TACAN	Tactical air navigation (system)
TAS	True airspeed
TFOV	Total field of view
VAM	Visual Approach Monitor(21)
VHF	Very high frequency
VMC	Visual meteorological conditions
VOR	VHF omnirange (navigation system)

Appendix B

Helmet-Mounted Display Bibliography

- 0001 D. L. Vickers, Sorcerer's Apprentice: Head-Mounted Display and Wand, Thesis: University of Utah, May 1963
- 0002 F. H. Dietz, Evaluation of the Helmet Mounted Sight, Final Report ADC/ADMC Project 69-19, December 1971
- 0003 D. D. Strother and H. W. Upton, Head-Mounted Display/Control System in V/STOL Operations, AHS Preprint 532, May 1971
- 0004 L. M. Biberman, "Perception of Displayed Information," Proceedings of a Symposium on Visually Coupled Systems, Brooks AFB, AMD TR-73-1, November 1972, pp. 149-158; AD-916572
- 0005 R. A. Birt and H. L. Task (eds.), Proceedings of a Symposium on Visually Coupled Systems, Brooks AFB, AMD TR-73-1, November 1972; AD-916572
- 0006 L. J. Catanzaro, "Operational Aspects of VTAS," Proceedings of a Symposium on Visually Coupled Systems, Brooks AFB, AMD TR-73-1, November 1972, pp. 33-37; AD-916572
- 0007 G. Chaikin and T. Enderwick, "Field Test of Air-to-Ground Target Acquisition Performance with a Visually Coupled System," Proceedings of a Symposium on Visually Coupled Systems, Brooks AFB, AMD TR-73-1, November 1972, pp. 97-123; AD-916572
- 0008 J. B. Chatten, "Fovial Hat. A Head Aimed TV System with Fovial/Peripheral Image Format," Proceedings of a Symposium on Visually Coupled Systems, Brooks AFB, AMD TR-73-1, November 1972, pp. 423-446; AD-916572
- 0009 B. J. Cohen and J. I. Markoff, "Minimization of Binocular Rivalry with a See-Through Helmet Mounted Sight and Display," Proceedings of a Symposium on Visually Coupled Systems, Brooks AFB, AMD TR-73-1, November 1972, pp. 159-173; AD-916572
- 0010 T. L. Coluccio and K. A. Mason, "The Viewing Hood Oculometer: A Sighting Control and Display Feedback System," Proceedings of a Symposium on Visually Coupled Systems, Brooks AFB, AMD TR-73-1, November 1972, pp. 469-498; AD-916572
- 0011 C. D. Eliason, "Pilot Acceptance of Visually-Coupled Systems (VCS)," Proceedings of a Symposium on Visually Coupled Systems, Brooks AFB, AMD TR-73-1, November 1972, pp. 38-48; AD-916572

- 0012 G. L. Harmon, D. B. Jones, and H. C. Will, "Helicopter Flight Test of Helmet Sight Acquisition and Automatic Optical Pattern Tracking," Proceedings of a Symposium on Visually Coupled Systems, Brooks AFB, AMD TR-73-1, November 1972, pp. 55-67; AD-916572
- 0013 W. J. Haywood, "A New Precision Electro-Optical Technique for Measuring Pilot Line of Sight in Aircraft Coordinates," Proceedings of a Symposium on Visually Coupled Systems, Brooks AFB, AMD TR-73-1, November 1972, pp. 384-397; AD-916572
- 0014 W. J. Kenneally et al., "Operational Evaluation of HMD Characteristics," Proceedings of a Symposium on Visually Coupled Systems, Brooks AFB, AMD TR-73-1, November 1972, pp. 68-96; AD-916572
- 0015 D. F. Kocian and P. D. Pratt, "Development of a Helmet-Mounted Visor Display," Proceedings of a Symposium on Visually Coupled Systems, Brooks AFB, AMD TR-73-1, November 1972, pp. 225-267; AD-916572
- 0016 J. Kuipers, "The SPASYN, A New Transducing Technique for Visually Coupled Systems," Proceedings of a Symposium on Visually Coupled Systems, Brooks AFB, AMD TR-73-1, November 1972, pp. 398-418; AD-916572
- 0017 D. R. McMillan, "Utilization of Visually Coupled Systems for Aircraft in a Digital Communications Environment" Proceedings of a Symposium on Visually Coupled Systems, Brooks AFB, AMD TR-73-1, November 1972, pp. 542-574; AD-916572
- 0018 J. Merchant, R. Morrissette, and J. L. Porterfield, "Aerospace Medical Research Laboratory/Honeywell Remote Oculometer," Proceedings of a Symposium on Visually Coupled Systems, Brooks AFB, AMD TR-73-1, November 1972, pp. 499-521; AD-916572
- 0019 F. J. Perrin, "F-4 Visual Target Acquisition System," Proceedings of a Symposium on Visually Coupled Systems, Brooks AFB, AMD TR-73-1, November 1972, pp. 15-32; AD-916572
- 0020 R. T. Sawamura, "The Ultrasonic Advanced Helmet-Mounted Sight," Proceedings of a Symposium on Visually Coupled Systems, Brooks AFB, AMD TR-73-1, November 1972, pp. 363-383; AD-916572
- 0021 E. G. Schone, A. L. Foote, and D. F. Adamski, "A Head Coupled TV for Remotely Manned Driving and Manipulation Tasks," Proceedings of a Symposium on Visually Coupled Systems, Brooks AFB, AMD TR-73-1, November 1972, pp. 447-468; AD-916572

- 0022 H. C. Self, "The Construction and Optics Problems of Helmet-Mounted Displays," Proceedings of a Symposium on Visually Coupled Systems, Brooks AFB, AMD TR-73-1, November 1972, pp. 174-203; AD-916572
- 0023 W. H. Stobie, G. W. Zirkle, and J. G. Curtin, "Weapons Airborne Training and Testing System," Proceedings of a Symposium on Visually Coupled Systems, Brooks AFB, AMD TR-73-1, November 1972, pp. 576-591; AD-916572
- 0024 H. W. Upton and D. D. Strother, "Design and Flight Evaluation of a Head-Mounted Display and Control System," Proceedings of a Symposium on Visually Coupled Systems, Brooks AFB, AMD TR-73-1, November 1972, pp. 124-145; AD-916572
- 0025 D. L. Vickers, "Sorcerer's Apprentice: Head-Mounted Display and Wand," Proceedings of a Symposium on Visually Coupled Systems, Brooks AFB, AMD TR-73-1, November 1972, pp. 522-541; AD-916572
- 0026 R. N. Winner, "A Color Helmet Mounted Display System," Proceedings of a Symposium on Visually Coupled Systems, Brooks AFB, AMD TR-73-1, November 1972, pp. 334-362; AD-916572
- 0027 R. A. Woodson, "Specifying Imaging Optics of Helmet-Mounted Displays," Proceedings of a Symposium on Visually Coupled Systems, Brooks AFB, AMD TR-73-1, November 1972, pp. 204-224; AD-916572
- 0028 R. L. Hughes, L. R. Chason, and J. C. Schwank, Psychological Considerations in the Design of Helmet Mounted Displays and Sights: Overview and Annotated Bibliography, AFAMRL TR-73-16, August 1973
- 0029 R. N. Winner and J. H. Brindle, "Holographic Visor Helmet Mounted Display System," Conference on Display Devices and Systems, New York, October 1974
- 0030 A. M. Poston and W. B. DeBellis, Helmet-Mounted Display Implications for Army Aviation, Human Engineering Laboratory TN-7-15, March 1975
- 0031 W. F. Moroney and J. F. Barnette, "Human Factors Considerations in the Design and Evaluation of a Helmet Mounted Display Using a Light Emitting Diode Matrix," Proceedings of 22nd Annual Meeting of the Human Factors Society, Detroit, October 1978, pp. 227-229; A79-19214
- 0032 C. M. Tsoubanos and M. B. Kelley, "Pilot Night Vision System (PNVS) for Advanced Attack Helicopter (AAH)," Proceedings 34th American Helicopter Society Annual National Forum, Washington, May 1978; AHS 78-16; A79-18142

- 0033 B. J. Cohen, J. R. Bloomfield, and K. J. McAleese, Helmet Mounted Displays: An Experimental Investigation of Display Luminance and Contrast, AMRL TR-79-60, July 1979
- 0034 S. N. Roscoe and J. E. Eisele, "Integrated Flight Displays," in Aviation Psychology, Ames: Iowa State University Press, 1980, pp. 48-61
- 0035 S. N. Roscoe (ed.), Aviation Psychology, Ames: Iowa State University Press, 1980
- 0036 S. T. Donley and T. A. Dukes, "Helmet Mounted Display Symbolology for Helicopter Landing on Small Ships," Proceedings 5th Advanced Aircrew Display Symposium, Patuxent River, September 1981, pp. 216-240; A83-16134
- 0037 R. M. Herrick, Helmet Mounted Display in the Navy Vertical Takeoff and Landing (NAVTO LAND) Program, Essex Report 30981, March 1981
- 0038 S. J. Mountford and B. Somberg, "Potential Uses of Two Types of Stereographic Display Systems in the Airborne Fire Control Environment," Proceedings 25th Annual Meeting Human Factors Society, Rochester, October 1981, pp. 235-239; A83-26314
- 0039 G. R. Barnes, G. T. Turnipseed, and F. E. Guedry, Effects of Character Stroke Width on the Visibility of a Head-Coupled Display, NAMRL-1297, December 1982; AD-A132046
- 0040 R. J. Milelli, G. W. Mowery, and C. Pontelandolfo, "Definition of Display/Control Requirements for Assault Transport Night/Adverse Weather Capability," Helicopter Handling Qualities, April 1982, pp. 97-107
- 0041 R. A. Buchroeder, An Optical Analysis of the Farrand VCASS (Visually Coupled Airborne Systems Simulator) Helmet-Mounted Display, AFAMRL TR-83-072, October 1983; AD-A136649; N84-19350
- 0042 D. J. Rotier, "HMD: Global HUD Solution," Proceedings, Specialists' Meeting on Advanced Cockpit Design, Grapevine, Texas, October 1983; A86-18460
- 0043 A. M. Spooner, "Area of Interest in Visual Simulation, The Next Twenty Years, Proceedings of the 20th Space Congress, Cocoa Beach, April 1983, pp. 1B1-1B12
- 0044 I. Mansfield, "Visually Coupled EO System for the RAE Sea King XV371," Presented at 10th European Rotorcraft Forum, The Hague, August 1984; A86-26130

- 0045 T. A. Stinnett, Sensor Coupled Visual System (SCVS) Flight Test to Evaluate Different Fields-of-View, Westinghouse Human Systems TR-204, 1984
- 0046 H. D. von Boehm and R. D. von Reth, "Evaluation of Nose, Roof, and Mast Mounted Sensor Platforms for Piloting and Sighting, Integrated in Future Combat Helicopters," AGARD Helicopter Guidance and Control Systems for Battlefield Support, August 1984; N85-16808
- 0047 R. D. von Reth and M. Kloster, "Mast Mounted Visual Aids," Vertica, 8 [2], 1984, pp. 183-195; A84-46274
- 0048 Military Standard: Human Factors Engineering Design Criteria for Helicopter Cockpit Electro-Optical Display Symbology, MIL-STD-1295A, 1984
- 0049 J. De Maio et al., "Evaluation of Helmet Display Formats," Proceedings of the 1985 National Aerospace and Electronics Conference (NAECON '85), May 1985, p 929-936; A86-285
- 0050 F. S. Doten, "Northrop's Surrogate Trainer (Simulating AH-64A Helicopter)," Proceedings 29th Symposium, Society of Experimental Test Pilots, Beverly Hills, September 1985, pp. 67-92; A86-44941
- 0051 E. J. P. Schweicher, "Review of Industrial Applications of HOEs in Display Systems," Progress in Holographic Applications: Proceedings of the Meeting, Cannes, December 1985, pp. 66-80; A87-19821
- 0052 D. F. Kocian, "Design Considerations for Virtual Panoramic Display (VPD) Helmet Systems," The Man-Machine Interface in Tactical Aircraft Design and Combat Automation, AGARD CP-425, October 1987, Paper 22
- 0053 B. McLean and S. Smith, "Developing a Wide Field of View HMD for Simulators," Proceedings of the Meeting on Display System Optics, Orlando, May 1987, pp. 79-82
- 0054 F. J. Malkin, AH-64 Helmet Mounted Display Lessons Learned, US Army Human Engineering Laboratory Discussion Paper 40, December 1987
- 0055 J. E. Melzer and E. E. Larkin, "An Integrated Approach to Helmet Display System Design," Proceedings of the Meeting on Display System Optics, Orlando, May 1987, pp. 83-88
- 0056 D. Naor, O. Arnon, and A. Avnue, "A Lightweight Innovative Helmet Airborne Display and Sight (HADAS)," Proceedings of the Meeting on Display System Optics, Orlando, May 1987, pp. 89-95
- 0057 W. A. Sylvester, "Helmet Mounted Displays for Tactical Aircraft," SAFE Journal, 17, Summer 1987, pp. 24-28

- 0058 T. A. Stinnett, Helmet-Mounted Display Concerns, Westinghouse Human Systems TM-87-04, 1987
- 0059 T. Williams, M. Komoda, and J. Zeevi, "Eyetracking with the Fiber Optic Helmet Mounted Display," Proceedings 19th Summer Computer Simulation Conference, Montreal, July 1987
- 0060 The Man-Machine Interface in Tactical Aircraft Design and Combat Automation, AGARD CP-425, October 1987
- 0061 Proceedings of the Meeting on Display System Optics, Orlando, May 1987, A88-41361
- 0062 L. A. Haworth, N. M. Bucher, and R. T. Hennessy, "Wide Field of View Helmet Mounted Display System for Helicopter Simulation," Proceedings Flight Simulation Conference, Atlanta, September 1988, pp. 1-9; AIAA Paper 88-4575; A88-53627
- 0063 P. A. Lypaczewski, "An Advanced Facility for Cockpit Studies," Proceedings 8th Digital Avionics Systems Conference, San Jose, October 1988, pp. 558-563; AIAA Paper 88-3966
- 0064 M. J. Wells, R. K. Osgood, and M. Venturino, "Using Target Replacement Performance to Measure Spatial Awareness in a Helmet-Mounted Simulator," Proceedings 32nd Annual Human Factors Society Meeting, Anaheim, October 1988, pp. 1429-1433
- 0065 Proceedings Flight Simulation Conference, Atlanta, September 1988; A88-53626
- 0066 R. A. Buchroeder and D. F. Kocian, Display System Analysis for the LHX Helicopter Application, AAMRL TR-89-1, January 1989
- 0067 L. A. Haworth and N. M. Bucher, "Helmet-Mounted Display Systems for Flight Simulations," SAE Transactions, Journal of Aerospace, Section 1, 98, 1989, 1809-1820; SAE Paper 892352
- 0068 T. A. Stinnett, "Human Factors in the Super Cockpit", in Aviation Psychology, Brookfield, VT: Gower Publishing, 1989, pp. 1-37
- 0069 M. Venturino and R. J. Konze, "Spatial Awareness with a Helmet Mounted Display," Proceedings of the 33rd Human Factors Society Annual Meeting, Denver, October 1989, pp. 1388-1391
- 0070 B. Wanstall, "HUD on the Head for Combat Pilots," Interavia, 44, April 1989, 334-338
- 0071 M. J. Wells, M. Venturino, and R. K. Osgood, "The Effect of Field-of-View Size on Mission Performance at a Simple Simulated Air-to-Air Mission," Helmet-Mounted Displays, SPIE Volume 1116, 1989

- 0072 J. Beesley, "Head-Steered FLIR," Proceedings of 22nd European Symposium, Society of Experimental Test Pilots, Arles, May 1990
- 0073 P. J. Bennett and J. J. Cockburn, "Pilot Monitoring of Display Enhancements Generated from a Digital Data Base," Fault Tolerant Design Concepts for Highly Integrated Flight Critical Guidance and Control Systems, AGARD, April 1990; N91-12685
- 0074 J. R. Burley and J. A. Larussa, "A Full-Colored, Wide-Field-of-View Holographic Helmet-Mounted Display for Pilot/Vehicle Development and Human Factors Studies", Proceedings, SPIE 1990 Technical Symposium on Optical Engineering and Photonics in Aerospace Sensing, Orlando, April 1990
- 0075 A. L. Carlson and J. Droessler, "Binocular Visor Projection Helmet-Mounted Display Development: Issues and Performance", Proceedings of the Society for Information Display Conference, Anaheim, May 1991, paper 8.4
- 0076 R. K. Osgood and M. J. Wells, "The Effect of Field-of-View Size on Performance of a Simulated Air-to-Ground Night Attack," presented at AGARD Symposium on Helmet-Mounted Displays and Night Vision Goggles, Pensacola, April/May 1991
- 0077 R. K. Osgood, E. E. Geiselman, and C. C. Calhoun, "Attitude Maintenance Using an Off-Boresight Helmet-Mounted Virtual Display," presented at AGARD Symposium on Helmet-Mounted Displays and Night Vision Goggles, Pensacola, April/May 1991
- 0078 A. G. Rodgers, "Advances in Head-Tracker Technology: A Key Contributor to Helmet Vision System Performance and Implementation", Proceedings of the Society for Information Display Conference, Anaheim, May 1991, paper 8.3
- 0079 J. W. Sellers, "Helmet-Mounted Display Electronics for Evaluating Virtual Display Systems", Proceedings of the Society for Information Display Conference, Anaheim, May 1991, paper 24.4
- 0080 M. Shenker and P. Weissman, "Aberrational Effects in Binocular Helmet-Mounted Displays", Proceedings of the Society for Information Display Conference, Anaheim, May 1991, paper 15.7
- 0081 H. L. Task, "Optical and Visual Considerations in the Specification and Design of Helmet Mounted Displays", Proceedings of the Society for Information Display Conference, Anaheim, May 1991, paper 15.1

- 0082 B. H. Tsou, M. Beard, and B. M. Rogers-Adams, "Distance Perception and Ocular Accommodation in Helmet-Mounted Displays", Proceedings of the Society for Information Display Conference, Anaheim, May 1991, paper 15.5
- 0083 M. J. Wells and R. K. Osgood, "The Effects of Head and Sensor Movement on Flight Profiles During Simulated Dive Bombing," Proceedings of 35th Annual Human Factors Society Meeting, 1991
- 0084 "Helmet Displays Are Near a Breakthrough", Interavia Aerospace, February 1991, pp. 43-45
- 0085 Helmet-Mounted Visual Display for Flight Simulation: Optical Fibers Transmit Wide-Angle Images in Response to Motions of the Head, NASA ARC-12160, Jan 1991; NTN91-0048
- 0086 J. C. Antonio, "USAF/USN Fixed-Wing Night Vision: The Mission," Helmet-Mounted Displays III, Proceedings of SPIE Meeting, Orlando, April 1992; SPIE 1695, pp. 21-25
- 0087 P. T. Bapu et al., "Quick Disconnect Harness System for Helmet-Mounted Displays," Helmet-Mounted Displays III, Proceedings of SPIE Meeting, Orlando, April 1992; SPIE 1695, pp. 91-99
- 0088 C. P. Benedict and R. G. Gunderman, "Helmet-Mounted Systems Test and Evaluation Process," Helmet-Mounted Displays III, Proceedings of SPIE Meeting, Orlando, April 1992; SPIE 1695, pp. 8-12
- 0089 H.-D. V. Böhm and H. Schreyer, Helicopter Integrated Helmet Requirements and Test Results, MBB Paper, ca. 1992
- 0090 G. C. Bull, "Helmet-Mounted Display with Multiple Image Sources," Helmet-Mounted Displays III, Proceedings of SPIE Meeting, Orlando, April 1992; SPIE 1695, pp. 38-46
- 0091 H. W. Chapman and G. J. N. Clarkson, "Advent of Helmet-Mounted Devices in the Combat Aircraft Cockpit: An Operator's Viewpoint," Helmet-Mounted Displays III, Proceedings of SPIE Meeting, Orlando, April 1992; SPIE 1695, pp. 26-37
- 0092 J. S. Crowley, C. E. Rash, and R. L. Stephens, "Visual Illusions and Other Effects with Night Vision Devices," Helmet-Mounted Displays III, Proceedings of SPIE Meeting, Orlando, April 1992; SPIE 1695, pp. 166-180
- 0093 L. H. Gilligan, "Intensified CCD Sensor Applications for Helmet-Mounted Displays," Helmet-Mounted Displays III, Proceedings of SPIE Meeting, Orlando, April 1992; SPIE 1695, pp. 83-90

- 0094 P. S. Hall and B. L. Campbell, "Helmet-Mounted Systems Technology Planning for the Future," Helmet-Mounted Displays III, Proceedings of SPIE Meeting, Orlando, April 1992; SPIE 1695, pp. 2-7
- 0095 L. A. Haworth and R. E. Seery, "Helmet Mounted Display Symbolology Integration Research," Presented at 48th Annual Forum of the American Helicopter Society, Washington, June 1992
- 0096 L. A. Haworth and R. E. Seery, Helmet Mounted Display Flight Symbolology Research, AIAA Paper 92-4137, August 1992
- 0097 L. A. Haworth and R. E. Seery, Rotorcraft Helmet Mounted Display Symbolology Research, SAE Paper 921977, October 1992
- 0098 R. A. Jacobsen et al., An Integrated Rotorcraft Avionics-Controls Architecture to Support Advanced Controls and Low-Altitude Guidance Flight Research, NASA TM-103983, October 1992
- 0099 D. R. Jones, T. S. Abbott, and J. R. Burley, "Evaluation of Conformal and Body-Axis Attitude Information for Spatial Awareness," Helmet-Mounted Displays III, Proceedings of SPIE Meeting, Orlando, April 1992; SPIE 1695, pp. 146-153
- 0100 R. S. Kalawsky, "Realities of Using Visually Coupled Systems for Training Applications," Helmet-Mounted Displays III, Proceedings of SPIE Meeting, Orlando, April 1992; SPIE 1695, pp. 72-82
- 0101 M. A. Karim (ed.), Electro-Optical Displays, Dekker: New York, 1992
- 0102 G. Kelly, M. Shenker, and P. Weissman, "Helmet-Mounted Area of Interest," Helmet-Mounted Displays III, Proceedings of SPIE Meeting, Orlando, April 1992; SPIE 1695, pp. 58-63
- 0103 J. Kimberly and S. Mueck, Integrated Helmet Display System (INVS) Assessment, Army Airborne Electronics Research Detachment Research Report NV-1-92, March 1992
- 0104 R. Leinenwever, L. G. Best, and B. J. Ericksen, "Low-Cost Monochrome CRT Helmet Display," Helmet-Mounted Displays III, Proceedings of SPIE Meeting, Orlando, April 1992; SPIE 1695, pp. 64-67
- 0105 R. Leinenwever, L. G. Best, and B. J. Ericksen, "Low-Cost Color LCD Helmet Display," Helmet-Mounted Displays III, Proceedings of SPIE Meeting, Orlando, April 1992; SPIE 1695, pp. 68-71
- 0106 T. M. Lippert (ed.), Helmet-Mounted Displays III, Proceedings of SPIE Meeting, Orlando, April 1992; SPIE 1695

- 0107 J. E. Melzer and K. W. Moffitt, "Color Helmet Display for the Tactical Environment: The Pilots Chromatic Perspective," Helmet-Mounted Displays III, Proceedings of SPIE Meeting, Orlando, April 1992; SPIE 1695, pp. 47-51
- 0108 S. A. Nelson and J. A. Cox, "Quantitative Helmet-Mounted Display System Image Quality Model," Helmet-Mounted Displays III, Proceedings of SPIE Meeting, Orlando, April 1992; SPIE 1695, pp. 128-137
- 0109 C. E. Rash and R. W. Verona, "The Human Factors Considerations of Image Intensification and Thermal Imaging Systems," in Electro-Optical Displays, Dekker: New York, 1992, pp. 653-710
- 0110 K. Robinette, "Anthropometry for HMD Design," Helmet-Mounted Displays III, Proceedings of SPIE Meeting, Orlando, April 1992; SPIE 1695, pp. 138-145
- 0111 P. J. Rogers and M. H. Freeman, "Biocular Display Optics," in Electro-Optical Displays, Dekker: New York, 1992, Helmet-Mounted Displays III, Proceedings of SPIE Meeting, Orlando, April 1992; SPIE 1695, pp. 417-445
- 0112 B. E. Rogowitz, Human Vision, Visual Processing, and Digital Display III, Proceedings of the International Society for Optical Engineering Meeting, San Jose, February 1992, SPIE 1666
- 0113 J. P. Sauerborn, "Advances in Miniature Projection CRTs for Helmet Displays," Helmet-Mounted Displays III, Proceedings of SPIE Meeting, Orlando, April 1992; SPIE 1695, pp. 102-116
- 0114 J. A. Stiffler and L. L. Wiley, "I-Nights and Beyond," Helmet-Mounted Displays III, Proceedings of SPIE Meeting, Orlando, April 1992; SPIE 1695, pp. 13-20
- 0115 R. W. Verona, "Comparison of CRT Display Measurement Techniques," Helmet-Mounted Displays III, Proceedings of SPIE Meeting, Orlando, April 1992; SPIE 1695, pp. 117-127
- 0116 S. A. Viken and J. R. Burley, "Predictive Nosepointing and Flightpath Displays for Air-to-Air Combat," Helmet-Mounted Displays III, Proceedings of SPIE Meeting, Orlando, April 1992; SPIE 1695, pp. 154-165
- 0117 R. J. Whitecraft, "Helmet-Mounted Display for the Night Attack Mission," Helmet-Mounted Displays III, Proceedings of SPIE Meeting, Orlando, April 1992; SPIE 1695, pp. 52-56
- 0118 M. J. Wells and M. Haas, "The Human Factors of Helmet-Mounted Displays," in Electro-Optical Displays, Dekker: New York, 1992, pp. 743-785

- 0119 E. C. Adam, "Head-Up Displays vs. Helmet-Mounted Displays: The Issues," Digest of Technical Papers, 1993 International Symposium, Society for Information Display, Seattle, May 1993, pp. 429-432; paper 28.1
- 0120 B. D. Adelstein and S. R. Ellis, "Effect of Head-Slaved Visual Image Roll on Spatial Situation Awareness," Presented at 37th Annual Meeting of the Human Factors and Ergonomics Society, Seattle, October 1993
- 0121 D. R. Baum, "Virtual Reality: How Close Are We?," Digest of Technical Papers, 1993 International Symposium, Society for Information Display, Seattle, May 1993, pp. 754-757; paper 30.3
- 0122 H. D. V. Böhm et al., "Modern Visionics for Helicopters," Presented at Looking Ahead, International Symposium on Head-Up Display, Enhanced Vision, Virtual Reality, Amsterdam, October 1993
- 0123 E. E. Geiselman and R. K. Osgood, "Toward an Empirically Based Helmet-Mounted Display Display Symbology Set," Presented at 37th Annual Meeting of the Human Factors and Ergonomics Society, Seattle, October 1993
- 0124 E. C. Haseltine, "Displays in Visual Simulation," Digest of Technical Papers, 1993 International Symposium, Society for Information Display, Seattle, May 1993, pp. 749-752; paper 30.1
- 0125 L. A. Haworth and W. Stephens, Creation of an Aeronautical Design Standard for Helmet Mounted Display Information, SAE Paper 932516, September 1993
- 0126 P. J. Hezel and H. Veron, "Head-Mounted Displays for Virtual Reality," Digest of Technical Papers, 1993 International Symposium, Society for Information Display, Seattle, May 1993, pp. 909-911; paper 41.3
- 0127 D. Learmont, "More Than Meets The Eye," Flight International, 8 September 1993, pp. 48-49
- 0128 T. Lucas, "HUDs and HMDs in Military Aviation," Avionics, November 1993, pp. 22-28
- 0129 R. Osgood, "HMD Symbology Research," Presented at Displays Conference, Edwards AFB, March 1993
- 0130 J. A. Ross and D. Kocian, "Hybrid Video Amplifier Chip Set for Helmet-Mounted Visually-Coupled Systems," Digest of Technical Papers, 1993 International Symposium, Society for Information Display, Seattle, May 1993, paper 28.3

- 0131 K. R. Sarma et al., "Miniature Color Display," Proceedings of the 1993 Society for Information Display (SID) Symposium, May 1993, pp. 1005-1008; Paper 47.4
- 0132 D. Troxel and A. Chappell, "ANVIS/HUD. An Operational and Safety Enhancement for Nap-of-the-Earth Night Flight," US Army Aviation Digest, March/April 1993, pp. 53-57
- 0133 G. Warwick et al., "Looks Can Kill," Flight International, 3 February 1993, pp. 33-35
- 0134 Guidelines for Helmet Mounted Display Symbology in Helicopters, Rotary Wing Symbology Working Group, June 1993
- 0135 T. J. Sharkey, Obstacle Avoidance System (OASYS) Symbology Development: Full Mission Simulation, Monterey Technology TR-910505-002, (in preparation)

Appendix C

Helmet-Mounted Display Design Guide

-Outline-

- I Introduction
 - a. Purpose
 - b. Scope
 - c. Display Design
 - d. The Evaluation Process

- II Historical Review
 - a. HUD History
 - b. HMD Development
 - c. Operational Problems
 - d. Spatial Disorientation

- III A Review of HMD Technology
 - a. Typical Arrangements
 - b. Optical Designs
 - c. Data Processing
 - d. Examples of HMD Designs

- IV Symbology Lessons Learned
 - a. Standardization
 - b. General Format
 - c. Stabilization
 - d. Reference Symbol
 - e. Horizon Line
 - f. Pitch Ladder
 - g. Airspeed
 - h. Altitude
 - i. Heading
 - j. Orientation Cues
 - k. Hover Symbology
 - l. Power/Torque
 - m. Digital Data
 - n. Warnings and Cautions
 - o. Other

- V Design Methodology
 - a. General
 - b. Review of Mission Requirements
 - c. Review of Flight Tasks
 - d. Information Requirements
 - e. Review of Lessons Learned
 - f. Development of Display
 - g. Integration into Aircraft
 - h. Test and Evaluation
 - i. Documentation

- VI Primary Flight Reference Criteria
 - a. General
 - b. Data Requirements
 - c. Relation to Other Displays
 - d. Mission Task vs. Primary Flight Displays
 - e. HMD Symbology
 - f. Reliability
 - g. HMD Mode Switching

- VII Hardware Criteria
 - a. Field-of-View
 - b. Binocular/Monocular
 - c. Optical Quality
 - d. Design and Construction
 - e. Parts and Materials
 - f. Reliability
 - g. Documentation

- VIII Software Criteria
 - a. Design
 - b. Reliability
 - c. Augmentation
 - d. Documentation

- IX Interface Criteria
 - a. Sensor Requirements
 - b. Head Tracking
 - c. HMD Controls
 - d. Installation Criteria
 - e. Helmet Criteria
 - f. Power Requirements
 - g. Documentation

- X Display Criteria
 - a. Compatibility with Other Displays
 - b. Clutter
 - c. Symbol Accuracy
 - d. Dynamic Response
 - e. Fault Alerts
 - f. Pitch Scaling Considerations
 - g. Reference for Error Displays
 - h. Directed Decision Cues
 - i. Symbol Priority
 - j. Size/Shape of Symbols/Characters
 - k. Documentation

- XI Raster Criteria
 - a. Raster Brightness
 - b. Registration of Raster Image
 - c. Effect of Sensor Range
 - d. Raster Update Rate
 - e. Raster Clutter
 - f. Reduced Raster Field-of-View
 - g. Symbol Characteristics

- XII Recommended Standard Symbology
 - a. Recommended Symbols
 - b. Basic Mode
 - c. Enroute
 - d. Hover
 - e. Transition
 - f. NOE
 - g. Approach/Landing

- XIII Display Evaluations
 - a. Evaluations
 - b. Subjective Data
 - c. Objective Data
 - d. Flight Tasks
 - e. Choice of Pilots
 - f. Documentation

- XIV Conclusions
 - a. Conclusions
 - b. Recommendations

- XV Glossary

- XVI HMD Symbologies
 - a. Production HMDs
 - b. Experimental HMDs

- XVII References Cited

- XVIII Bibliography

REPORT DOCUMENTATION PAGE

Form Approved
OMB No. 0704-0188

Public reporting burden for this collection of information is estimated to average 1 hour per response, including the time for reviewing instructions, searching existing data sources, gathering and maintaining the data needed, and completing and reviewing the collection of information. Send comments regarding this burden estimate or any other aspect of this collection of information, including suggestions for reducing this burden, to Washington Headquarters Services, Directorate for Information Operations and Reports, 1215 Jefferson Davis Highway, Suite 1204, Arlington, VA 22202-4302, and to the Office of Management and Budget, Paperwork Reduction Project (0704-0188), Washington, DC 20503.

1. AGENCY USE ONLY (Leave blank)	2. REPORT DATE June 1995	3. REPORT TYPE AND DATES COVERED Contractor Report	
4. TITLE AND SUBTITLE Helmet-Mounted Display Symbology and Stabilization Concepts		5. FUNDING NUMBERS NAS2-13811	
6. AUTHOR(S) Richard L. Newman			
7. PERFORMING ORGANIZATION NAME(S) AND ADDRESS(ES) Crew Systems, P. O. Box 963, San Marcos, TX 78667 Aeroflightdynamics Directorate, U.S. Army Aviation and Troop Command, Ames Research Center, Moffett Field, CA 94035-1000		8. PERFORMING ORGANIZATION REPORT NUMBER A-950073	
9. SPONSORING/MONITORING AGENCY NAME(S) AND ADDRESS(ES) National Aeronautics and Space Administration Washington, DC 20546-0001 and U.S. Army Aviation and Troop Command, St. Louis, MO 63120-1798		10. SPONSORING/MONITORING AGENCY REPORT NUMBER NASA CR-196697 USAATCOM TR-94-A-021	
11. SUPPLEMENTARY NOTES Point of Contact: Loran Haworth, Ames Research Center, MS 243-3, Moffett Field, CA 94035-1000 (415) 604-6944			
12a. DISTRIBUTION/AVAILABILITY STATEMENT Unclassified-Unlimited Subject Category - 06		12b. DISTRIBUTION CODE	
13. ABSTRACT (Maximum 200 words) <p>The helmet-mounted display (HMD) presents flight, sensor, and weapon information in the pilot's line of sight. The HMD was developed to allow the pilot to retain aircraft and weapon information and to view sensor images while looking off boresight.</p> <p>The present study reviewed the current state-of-the-art in HMDs and identified a number of issues applying to HMDs. Several are identical to Head-Up Display (HUD) issues: symbol standardization, excessive clutter, and the need for integration with other cockpit displays and controls. Other issues are unique to the head-mounted display: symbol stabilization, inadequate definitions, undefined symbol drive laws, helmet considerations, and field-of-view (FOV) vs. resolution tradeoff requirements.</p> <p>The existing military standard does not reflect the current state of technology. In addition, there are generally inadequate test and evaluation guidelines. The situation parallels the state-of-the-art for HUDs several years ago. The major recommendation of this study is the development of an HMD design guide similar to the HUD design guide. A further recommendation calls for the creation of an HMD database in electronic format.</p>			
14. SUBJECT TERMS Helmet-mounted display, Symbology		15. NUMBER OF PAGES 114	
		16. PRICE CODE A06	
17. SECURITY CLASSIFICATION OF REPORT Unclassified	18. SECURITY CLASSIFICATION OF THIS PAGE Unclassified	19. SECURITY CLASSIFICATION OF ABSTRACT	20. LIMITATION OF ABSTRACT