

AD-A286 756

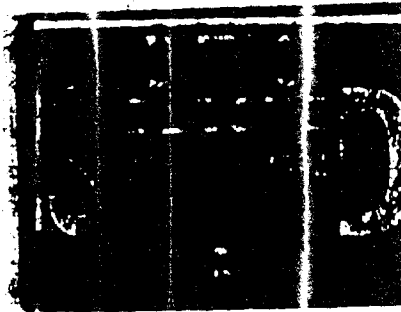

This document has been approved
for public release and sale; its
distribution is unlimited.

Reproduced From
Best Available Copy

**Best
Available
Copy**

MEDICAL DEPARTMENT, UNITED STATES ARMY

BLOOD PROGRAM IN WORLD WAR II

Prepared and published under the direction of
Lieutenant General LEONARD D. HEATON
The Surgeon General, United States Army

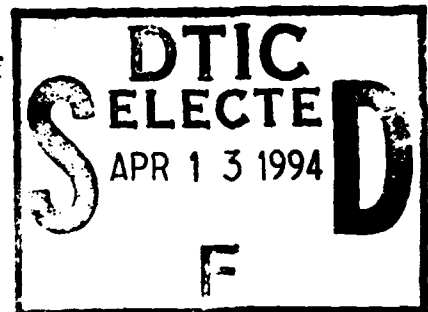

Editor in Chief

Colonel JOHN BOYD COATES, Jr., MC, USA

Associate Editor

ELIZABETH M. McFETRIDGE, M.A.

Accession For	
NTIS CRA&I	<input checked="" type="checkbox"/>
DTIC TAB	<input type="checkbox"/>
Unannounced	<input type="checkbox"/>
Justification	
By	
Distribution	
Dist	Special
A-1	

Nine Hundred Fifty Four
9540 **95-01213** *BD*



OFFICE OF THE SURGEON GENERAL

DEPARTMENT OF THE ARMY

WASHINGTON, D.C., 1964

This document has been approved for public release and sale; its distribution is unlimited.

BLOOD PROGRAM IN WORLD WAR II
Supplemented by Experiences in the Korean War

The Historical Unit, United States Army Medical Service

Colonel JOHN BOYD COATES, Jr., MC, USA, Director

CHARLES J. SIMPSON, Executive Officer

Lieutenant Colonel WILLIAM P. CHAMBERS, MSC, USA, Special Assistant to Director

Lieutenant Colonel FREDERICK BELL, Jr., MSC, USA, Chief, Special Projects Branch

CHARLES M. WILTSE, Ph. D., Litt. D., Chief, Historians Branch

ERNEST ELLIOTT, Jr., Chief, Editorial Branch

Lieutenant Colonel JEROME RUDBERG, MSC, USA, Chief, Information Activities Branch

RODERICK M. ENGERT, Chief, General Reference and Research Branch

HAZEL G. HINE, Chief, Administrative Branch

Library of Congress Catalog Card Number: 64-60006

For sale by the Superintendent of Documents, U.S. Government Printing Office
Washington, D.C. 20402

BLOOD PROGRAM IN WORLD WAR II

by

Brigadier General DOUGLAS B. KENDRICK, MC, USA

Accession For	
NTIS CR/21	<input checked="" type="checkbox"/>
DTIC TAB	<input type="checkbox"/>
Unannounced	<input type="checkbox"/>
Justification	
By	
Distribution/	
Availability Codes	
Dist	Avail and/or Special
A-1	

DTIC QUALITY INSPECTED 2

MEDICAL DEPARTMENT, UNITED STATES ARMY

The volumes comprising the official history of the Medical Department of the U.S. Army in World War II are prepared by The Historical Unit, U.S. Army Medical Service, and published under the direction of The Surgeon General, U.S. Army. These volumes are divided into two series: (1) The administrative or operational series; and (2) the professional, or clinical and technical, series. This is one of the volumes published in the latter series.

VOLUMES PUBLISHED

ADMINISTRATIVE SERIES

Hospitalization and Evacuation, Zone of Interior
Organization and Administration in World War II
Personnel in World War II

CLINICAL SERIES

Internal Medicine in World War II:

Vol. I. Activities of Medical Consultants

Vol. II. Infectious Diseases

Preventive Medicine in World War II:

Vol. II. Environmental Hygiene

Vol. III. Personal Health Measures and Immunization

Vol. IV. Communicable Diseases Transmitted Chiefly Through Respiratory and Alimentary Tracts

Vol. V. Communicable Diseases Transmitted Through Contact Or By Unknown Means

Vol. VI. Communicable Diseases: Malaria

Vol. VII. Communicable Diseases: Arthropodborne Diseases Other Than Malaria

Surgery in World War II:

Activities of Surgical Consultants, vol. I

Activities of Surgical Consultants, vol. II

General Surgery, vol. II

Hand Surgery

Neurosurgery, vol. I

Neurosurgery, vol. II

Ophthalmology and Otolaryngology

Orthopedic Surgery in the European Theater of Operations

Orthopedic Surgery in the Mediterranean Theater of Operations

The Physiologic Effects of Wounds

Thoracic Surgery, vol. I

Vascular Surgery

Miscellaneous:

Cold Injury, Ground Type

Dental Service in World War II

Veterinary Service in World War II

Wound Ballistics

Foreword

In medicine, as in life, there is usually small profit in attempting to assign full praise or full blame for a success or a failure to any single action or circumstance. On the other hand, if any single medical program can be credited with the saving of countless lives in World War II and in the Korean War, it was the prompt and liberal use of whole blood.

The development of the concept of the liberal use of whole blood and the—regrettably delayed—implementation of the concept represent one of the great pioneering achievements of World War II. The same concept was applied in the Korean War, fortunately more rapidly, with equally spectacular results. It has been carried over into civilian life, again with brilliant results, though sometimes, one fears, almost too casually, as one sees blood administered when it is not actually needed and apparently without thought of its possible consequences.

The story told in this volume of the history of the U.S. Army Medical Department in World War II is one that must be told. When that war broke out in September 1939, a whole-blood service had already been successfully provided during the 3-year Spanish Civil War, and the British immediately put into operation the program which they had developed 6 months before. Yet, it was not until May 1940 that the United States took the first steps in what later became the whole-blood program, and when this country was precipitated into World War II in December 1941, the plasma program, at least from the standpoint of commercial production, was still in its early stages.

The British experience with whole blood in North Africa, before the United States entered World War II, gave rise to discussions in the United States as to the need for provision of whole blood for combat casualties, but these discussions were not much more than academic until after the Allied invasion of North Africa in November 1942. It was that invasion and the casualties that it produced which brought the true situation sharply home, both to medical officers overseas and to the numerous persons and agencies in this country who were studying shock. Our experience in North Africa made it quite clear that plasma, in spite of its virtues and advantages, could not take the place of whole blood. Plans for its provision were worked out in both the Mediterranean and European theaters, and, by May 1943, the Office of The Surgeon General had formulated a plan, frankly a compromise with the ideal, for supplying whole blood to forward hospitals from base sections. By November of 1943, however, an entirely workable plan had been prepared in the Transfusion Branch of that Office to fly blood from the Zone of Interior to oversea theaters. The Surgeon General at this time considered the plan both impractical and unnecessary, and it needed the casualties of the first weeks of the Normandy invasion to demonstrate that the reliance placed upon local supplies of whole blood was completely unrealistic. Then, in August 1944, the same plan and the same airlift that had

been rejected in November 1943 were utilized to fly blood to the European theater. A similar airlift to the Pacific Ocean areas was instituted in November 1944.

The blood program in World War II was a brilliant success in spite of the delays and frustrations that attended its inception. After the war, however, the program was allowed to lapse, and, when the Korean War broke out, less than 5 years after World War II had ended, planning for whole blood in a future war had only just been instituted, and the implementation of the planning had to be effected during the active fighting.

It is hard, in retrospect, to understand why the United States was so slow to grasp the implications of the use of whole blood in World War I, limited though that experience was; why it did not take advantage of the successful blood program used during the Spanish Civil War; and why it did not immediately make use of the British experience in the early months of World War II, when the necessity and value of whole blood for combat casualties were so clearly proved. It is even harder to understand why, between World War II and the Korean War, all plans for a supply of whole blood in possible future wars were allowed to lapse, so that the United States entered the Korean War with a plan, it is true, but with no arrangements for implementing it.

Brig. Gen. Douglas B. Kendrick, the author of this book, carried the chief responsibility for the Army blood program during World War II and during much of the Korean War. I note that in his preface he is somewhat apologetic for the detail with which the story is told. He should not be. He is quite correct in emphasizing that behind the drama of transfusion, and its almost miraculous results in both those wars, lay an elaborate mechanism of procurement, storage, delivery, and other monotonous but highly necessary details. Furthermore, as he has pointed out, it is only by the strictest and most precise attention to such details that blood is able to achieve its life saving miracles, and, equally important, can be prevented from becoming a lethal agent.

I am also glad that, contrary to the usual practice in this historical series, the story of the whole-blood program has been carried over from World War II into the Korean War, even though, as already stated, the story, at least in the beginning, reflects no credit upon our foresight. Our thoughtless negligence makes it the more important to record the facts. Like my predecessors in the Office of The Surgeon General, I have taken the position that this history must be written with complete candor and frankness, not only because a history is worthless if it is not honest but also because we must spell out the errors of the past so clearly that the same mistakes cannot be made again.

I do not believe that these gigantic errors are likely to be repeated. There is now in my Office a special transfusion officer whose business it is to see that they are not. No matter what form future conflicts may take, there is no conceivable kind of injury which will not require blood, plasma, or both. These agents, in fact, will be needed even more than in World War II and in the Korean War, for future wars will surely involve civilians as well as military personnel, and probably in even greater numbers.

In this book will be found the key to salvation in future wars as far as blood is concerned. Blood is not a commodity that can be collected and stored, at least by present techniques. It must be collected as the need arises, and the point of collection is seldom the point of administration. It cannot be collected when the need for it arises, nor can it be taken to the area of need, unless there has been careful advance planning for its procurement and transportation. A blood program cannot be improvised on the spur of the moment. Some technical details may change as knowledge increases, but the basic principles of the World War II blood program and the Korean War blood program are biologic principles and they are unlikely to change materially from the facts set forth in this book.

Medical officers who, like myself, served overseas in World War II, and who observed the management of casualties with and without the use of whole blood, are peculiarly qualified to appreciate the achievements of the whole-blood program. Its results unfolded before our eyes. In forward hospitals, we saw men saved from death and, sometimes, almost brought back from the dead. In fixed hospitals, we received wounded men who once would have died in forward hospitals, or even on the battlefield. We received casualties with the most serious wounds in good condition. With the aid of more blood, we performed radical surgery upon them, and we watched them withstand operation and, with still more blood, recover promptly from it.

There are more than the usual reasons for the preparation and publication of this volume on the whole-blood program. A major reason, of course, is the impact this therapeutic advance has had upon medical care, civilian as well as military. Another reason is to keep faith with the multiple personnel who planned and operated the whole-blood program, and with the millions of American citizens whose gifts of their own blood saved the lives of so many American soldiers, who otherwise would have died.

As in previous forewords, I desire again to express my thanks to the authors and editors of all of these volumes and to the personnel of my own office, who are helping me to carry out this extremely important phase of my mission as The Surgeon General.

LEONARD D. HEATON,
Lieutenant General,
The Surgeon General.

Preface

In World War I, between 8 and 11 of each 100 wounded men who reached forward hospitals alive died in them. In World War II, the number was reduced to 4.5 per hundred. In the Korean War, it was further reduced to 2.6 per hundred. The explanation is simple, that the mortality rate in combat wounds is inversely proportional to the availability of prompt and adequate resuscitation, in the routine of which whole blood and plasma play major roles.

The lessons learned in World War II furnished convincing evidence of the soundness of that concept—but they had to be learned in the course of the war. When the Korean War began, the concept of the essentiality of whole blood in the management of shock was firmly established in the minds of both clinical and administrative personnel and had been accepted by statisticians. The fly in the ointment was that administrative personnel had not yet learned that whole blood is best handled out of supply channels, as a separate supporting service.

In 1939, at the outbreak of the Second World War, the United States found itself with no organized blood bank system, and, indeed, with no plans for supplying whole blood or so-called blood substitutes to wounded casualties. By 1941, when this country was precipitated into that war, the plasma program was beginning to evolve, but the whole blood program was not yet even in the planning stage. Both programs developed by a series of expedients, almost on a trial-and-error basis. The end result was brilliantly successful, but the success was achieved at the cost of delay, inefficiency, and far greater expense than should have been incurred. Moreover, there was only a small capitalization on the tremendous research potentialities afforded by the collection of millions of units of blood and its clinical use in war casualties, partly as whole blood and partly in the form of plasma and serum albumin.

It is distressing to relate that when the Korean War broke out in June 1950, less than 10 years after the United States had entered World War II and just 5 years after World War II had ended, planning for a blood bank system had been instituted, but so shortly before the beginning of hostilities that, as in World War II, planning and implementation again were carried out on a basis of expediency.

It is doubly distressing to recollect that this situation was entirely unnecessary: At the end of World War II, well-founded, detailed recommendations for a transfusion service had been prepared and submitted through channels to the proper authorities. Time, manpower, effort, money, and lives could all have been spared in Korea if these recommendations had been utilized as a basis for postwar planning. As it was, the newly developed plans were not ready for implementation when the Korean combat began.

The essentials of a blood program for oversea theaters may be described as material. In addition to donors, they include equipment, refrigeration,

preservatives, and an airlift. Basic to the program, however, is the acceptance of the concept of the need for whole blood for combat casualties. It was failure to recognize this need, and to face and overcome the associated logistic problems promptly, that was the real reason for the delay in supplying whole blood to oversea theaters in World War II.

When World War II began, the concept of shock was still vague, and, in the light of World War II experiences and investigations, it was found to be in error in many of its aspects. Transfusion was still a dramatic and heroic procedure, resorted to more often than not only when the situation was critical or desperate. Direct techniques were just beginning to give way to indirect techniques. Reactions, due chiefly to the presence of pyrogens, were still alarmingly frequent. Plasma was still in the experimental stage. The fractionation of plasma proteins had not yet become a practical reality, and the clinical use of byproducts of that process was not yet even imagined.

Many of the problems of shock still remain to be solved, but a great deal was learned about them in World War II, not only by clinical observation but also by the careful studies carried out on them in theaters of operations, particularly in the Mediterranean theater by the Board for the Study of the Severely Wounded. Though much remains to be clarified, there is now full realization that the fundamental cause of shock in the wounded man is diminution of the amount of circulating blood. Logically, therefore, the objective of all therapy is the restoration of the diminished blood volume to its approximately normal status, so that the wounded soldier may withstand the measures—which are often heroic—necessary to care for his wounds.

In spite of the attention paid to plasma in the early months of World War II, there were many whose eyes, from the beginning, were fixed upon whole blood. It is interesting and significant that it was a biochemist, not a clinician, who, some years after the war, vigorously called attention to this fact. Dr. Edwin J. Cohn, in recounting the history of the World War II National Research Council Subcommittee on Blood Substitutes to the similar committee which took its place in 1949, stated that he “* * * wanted the group to realize that at a very early point in the history of the earlier Subcommittee, Dr. DeGowin had started writing and talking about the necessity of using whole blood instead of blood fractions, and for the need to start immediately to develop a service to supply blood to the Armed Forces.”

The subcommittee, Dr. Cohn continued, had repeatedly recommended the use of whole blood for combat casualties, but no specific action was taken on these recommendations until reports from the North African theater indicated the need for blood. Then, concerted efforts were made to supply it, but there were delays while logistic problems, which had not yet been evaluated, were solved. At first, many authorities outside of the Subcommittee on Blood Substitutes considered it impractical to extend the dating period beyond 8 days, let alone to fly blood overseas. It took persistence, faith in the concept and in the possibility of its implementation, and a great deal of hard work to set up the plan, but, by November 1943, the same airlift was available

that was belatedly put into effect in August 1944. One can only regret the lost months and, as a corollary, the lost lives, that resulted from the delay.

In retrospect, it is difficult to understand why the United States was so slow in setting up a whole blood program in World War II. We could have learned some lessons from World War I. O. H. Robertson, for instance, and Ohler both stated unequivocally from their experience in it that, when blood is lost, it must be replaced by blood. We could also have learned from the very successful program in effect in the Spanish Civil War.

Above all, we could have learned from the British, who, to quote Brigadier Sir Lionel E. H. Whitby, RAMC, entered the war with a "firm policy," decided upon 6 months earlier, that there would be a completely distinct and separate transfusion service in their Army because the transportation of potentially dangerous biologic fluids over long distances would require close personal supervision and could not be trusted to the usual supply routes emanating from a base medical supply store. The British policy was remarkably successful. It was carefully planned before hostilities began. It was based on the concept that blood is a perishable substance, as potentially dangerous as it is potentially useful, and therefore is to be handled only in special channels and only by specially trained personnel. We followed that plan only partially in World War II, and not much more effectively in Korea, and, in both wars, we paid the penalty for our folly.

In the face of these facts, one can only wonder why the United States did not have a special transfusion service planned before we entered World War II; why the recommendation of the Subcommittee on Blood Substitutes, National Research Council, for such a service was not adopted during the war; why it was not until 4 years after the war ended that such a special service was established; and why we had been engaged in World War II for almost 3 years before the proposal, made many months before, was adopted and blood was flown overseas to the European theater and to the Pacific areas.

Once the oversea airlift was instituted, it was clearly demonstrated that blood can be collected thousands of miles from its point of use; can be safely transported over those miles; and can be used with safety and benefit if there is proper planning, proper handling, proper timing, and adequate airlift, trained administration, and careful coordination. The successful use of whole blood reached a high point on Okinawa in World War II. Planning—in which, naturally, there were some mistakes—was detailed and timely. Blood was provided in ample quantities. There were 40,000 casualties, and their treatment involved the use of approximately 40,000 pints of whole blood, 1:1. All the blood used on Okinawa was flown from the United States, a distance of 8,000 miles. With the dating period set at 21 days, it required careful timing to insure provision of adequate quantities of whole blood with a minimum amount of wastage from outdating. There were two reasons why the operation was successful: First, the blood supply from the United States to Okinawa via Guam was highly efficient. Second, the commanding general, with the full concurrence of the surgeon of the task force, assigned to a trained transfusion

officer full responsibility for the supply, distribution, and correct use of all the whole blood brought onto the island.

Although whole blood is usually the fluid of choice in the resuscitation of wounded casualties, it would be fatuous not to grant that there are military situations—and there probably will be civilian situations—in which it cannot be provided and, as a matter of expediency, fluid of a longer shelf life must be used. Plasma met this requirement admirably in World War II. It was useful in the field, forward of hospitals; in the initial phases of landing operations, in which it was difficult logistically to supply a perishable item like whole blood, which always requires special care; and aboard ship, where, however, the Navy found serum albumin equally useful, because the procurement of water, which usually had to be administered with this agent, was no problem.

During World War II, an abundance of plasma was available to the Armed Forces of the United States, so much that an extensive clinical trial was possible, unhampered by considerations of supply or cost. The purity and excellence of the product supplied, and the disposable, sterile, pyrogen-free dispensing sets and distilled water supplies with it, permitted the administration of large quantities without fear of reaction. How many casualties plasma kept alive until they reached installations in which whole blood could be administered and surgery performed is not a fact that can be reduced to statistics, but it is safe to say that it was in the hundreds of thousands.

Plasma was used most effectively when its indications and limitations were clearly realized. In addition to its use for resuscitative purposes, it was the agent of choice in crushing injuries, in burns, in injuries from blunt instruments, and in other injuries in which there was no great loss of blood. It was built up beyond its capabilities early in World War II; it was often used to excess and unwisely, though that criticism must be tempered by the fact that very often, in the early days of the war, the choice was plasma or nothing. In the Mediterranean and the Pacific, in those days, medical units and hospitals went in with little or no provision for the collection and administration of blood, chiefly because there was lack of logistic support in the Zone of Interior to make the necessary equipment available.

When it became evident that plasma was carrying the virus of hepatitis, its use in the Korean War had to be discontinued, but that unfortunate development has nothing to do with its essential value. When this problem has been solved—and there is no doubt that it will be solved eventually—plasma can resume its proper and valuable place as an agent of resuscitation to be used to supplement whole blood.

No matter what form future conflicts may take, casualties will result, and there is no conceivable kind of wound which will not require blood, plasma, or both. It is quite possible that more blood and plasma will be needed in a future conflict than have been needed in the past, because future wars will involve civilians as well as troops, and will involve them in far greater numbers

than were affected in the countries that bore the brunt of the air raids in World War II.

Since the need for blood will arise whenever combat commences and whatever form it may take, it is imperative, before it commences, to maintain supplies and equipment, to train personnel, and to plan adequately for the provision of whole blood for any forces that may be placed in the field and for civilians who may be part of the conflict at home. Although research done on the long-term storage of blood by freezing with glycerol indicates that this technique offers a realistic and practical approach to the problem, whole blood, at least as yet, is not a commodity that can be generally stored on a long-term basis. Nor can it be collected as the need for it arises unless there has been prior planning for its procurement.

There was no such provision when World War II broke out, and it was not until late in the war that the correct equipment for collecting it and using it was made available in oversea theaters. That situation was only partially rectified when the Korean War broke out. Neither contingency must be permitted to happen again.

War has very little left of glamour, but if, in World War II, there was anything dramatic and glamorous, it was the miracles wrought by the use of whole blood. Since this is so, readers may wonder, and perhaps complain, that this book contains a great many prosaic, repetitious, monotonous details. It does indeed, and their inclusion has been deliberate. It is extremely important—in fact, it is imperative—to recognize that behind the drama of transfusion in World War II lay an elaborate mechanism of procurement, storage, delivery, and many other mundane details. It was only by the strictest attention to such matters that blood was able to achieve its miracles, and, equally important, was prevented from becoming a deadly agent. It must never be forgotten that without proper care, blood can be lethal.

Many agencies were involved in this gigantic enterprise, including:

The Department of Surgical Physiology, Army Medical School, and the similar division of the Naval Medical School.

The Office of The Surgeon General, U.S. Army.

The Medical Departments of both the Army and the Navy.

The American Red Cross.

The Division of Medical Sciences, National Research Council, with its various committees, permanent and ad hoc, particularly the ill-named Subcommittee on Blood Substitutes. The actions of this subcommittee occupy considerable space in this book, as they should, for it was the advice of its membership that guided the Army and the Navy Medical Departments in many aspects of the blood-plasma program. This subcommittee anticipated events by an early recommendation that whole blood be supplied for combat casualties and by an early recommendation for an airlift of blood to the European theater. It is a great pity that these recommendations were not accepted when they were made. Considering the fact that its petition was never granted

that it be permitted to visit combat zones and determine personally what the circumstances and needs were, it is remarkable that this subcommittee was able to accomplish what it did.

The National Institute of Health.

The Army Medical Procurement Agency.

The biologic processing plants that participated in the program and pioneered in new and untried fields.

And, finally, the millions of U.S. citizens who donated their blood.

As to the individuals who participated in the program, it is difficult to single out any for mention without omitting others who should be included. Four exceptions, however, might be made:

Dr. G. Canby Robinson, who directed the American Red Cross Blood Donor Service.

Maj. Earl S. Taylor, MC, who served as Technical Director of the Service.

Dr. Walter B. Cannon, who, at the first meeting of the Committee on Transfusions, National Research Council, suggested that some "outstanding biochemist" be brought into the program.

Dr. Edwin J. Cohn, who was brought into the program in response to that suggestion, and in whose Department of Biochemistry at the Harvard Medical School the fractionation of blood plasma was successfully accomplished and the serum albumin program was translated into reality.

Surgeon Vice Admiral Sir Edward Greeson, RN, wrote in the preface to one of the volumes of the history of the Royal Naval Medical Service in World War II that no one has ever written "the" history of anything. The best that can be accomplished is "a" history. He made that statement in advance, he frankly admitted, to take care of the adverse criticisms he knew the volumes he was editing would receive.

This volume, which is concerned with the blood-plasma program in World War II and in the Korean War, is intended as "a" history of that program. It is a chronicle built upon personal knowledge of what happened and upon a mass of material almost exasperating in its voluminousness and equally exasperating in its lack of many essential details. A great deal of the story is necessarily—and quite properly—built upon personal knowledge of what happened, what actions were taken, and why and in what circumstances they were taken.

World War II was the first war in which the United States was engaged in which blood was used with any frequency, and the first in which plasma and serum albumin were used at all. The attempt has therefore been made to record the whole story, and, in particular, to omit no errors and no failures. A major failure was the attempt—which seemed so near success—to use bovine albumin instead of human blood. So many problems would have been solved if only the attempt had succeeded. It may be that one day the project will be revived and the difficulty solved. No more practical man ever lived than the

late Dr. Cohn, and he believed that this might happen, though it was he who, against the desire of some clinicians, insisted upon an immediate stop to clinical testing when it became evident that the bovine albumin developed in his laboratory was not a safe agent.

The preparation of this book according to the principles just laid down has presented certain major difficulties. World War II was a global war, and the blood and plasma program was an essentially global program. On the surface, as has been suggested for many of this series of volumes, it seems perfectly simple to present what might be termed "a linear chronologic account," with the events in all theaters presented synchronously as they occurred. Actually, this would be an impossible task, and, granting the possibility of its accomplishment, it could result only in confusion.

After considerable experiment, it was decided that the most logical mode of presentation would be first by subjects and then by theaters. By this plan, the book falls into the following divisions:

1. A historical note, for which no apology is offered, if only because the chronicle makes clear how far we still had to go in World War II, as well as—to our discredit—what had been accomplished in the Spanish Civil War and by the British before the United States entered the war.

2. Two background chapters, dealing with shock and with the evolution of the whole-blood concept.

3. The provision of blood for blood transfusions and for conversion into plasma. This group of chapters deals with administrative considerations; the American Red Cross, which was the collecting agency; the donors who provided the blood; the equipment used to collect and administer it; transportation and refrigeration; and the laboratory studies necessary before blood could be used safely and accurately.

4. A group of chapters dealing with plasma, serum albumin (bovine and human), byproducts, so-called blood substitutes, and other intravenous agents.

5. Separate chapters dealing with the Mediterranean and European Theaters of Operations and the Pacific areas.

6. A final clinical section dealing with reactions and with principles of replacement therapy.

7. A chapter on the blood and plasma program in the Korean War, which is included, contrary to the usual practice in this historical series, because this war furnished an opportunity to study the application of the lessons learned in World War II, some of which, unfortunately, had to be learned over again.

No matter what the plan of presentation, a certain amount of repetition would be inevitable in this volume. The plan adopted perhaps calls for an undue amount, though some of it is deliberate and necessary. As much repetition as possible, however, has been eliminated by the copious use of cross-references.

One other item might be mentioned in conclusion: the number of veterans of World War II and Korea who have given blood since those wars in gratitude for the blood they themselves had received in them. One man, a recent newspaper story related, had just given his sixty-fifth pint; he lost a leg on Guam but, thanks to the blood he received, he did not lose his life. No one appreciated the value of whole blood more than GI Joe, and not the least of its benefits was its effect upon his morale.

DOUGLAS B. KENDRICK,
Brigadier General, MC, USA.

Acknowledgments

Although this book is credited to a single author, it owes much to other persons, and it is a pleasure to acknowledge that debt:

It was my good fortune, during a large part of my wartime experience, to work with Capt. Lloyd R. Newhouser, MC, USN (Ret.), who was my opposite number in the Navy. I count myself equally fortunate in his having read this entire book. His familiarity with the blood-plasma program both in World War II and in the Korean War, enabled him to pick up errors which had been overlooked, add items which had been forgotten, and make many other helpful suggestions.

It was my similar good fortune to have Dr. Robert C. Hardin read the section dealing with the European theater. As Lieutenant Colonel Hardin, MC, he served as Transfusion Officer in that theater and directed the blood service in it. He clarified many points on which no written records existed, and of which I had no personal knowledge; corrected errors of fact and interpretation; and added a number of interesting and useful items. This is a better section because of his comments.

Col. R. L. Parker, MSC (Ret.), also read the section on the European theater. He had personally participated in the supply phase of the program in that theater, and, like Dr. Hardin, he performed a useful task of clarification, correction, and addition.

My grateful appreciation is due to a number of persons in The Historical Unit, U.S. Army Medical Service, beginning with the Director, Col. John Boyd Coates, Jr., MC, who is Editor in Chief of the history of the U.S. Army Medical Service in World War II. Colonel Coates read the entire manuscript and made many useful comments, particularly in the section on the European theater, of which he had personal knowledge from his service in it as Medical Executive Officer, Third U.S. Army.

The General Reference and Research Branch in that unit supplied much of the material on which this volume is based. The Assistant Chief of the branch, Mrs. Esther R. Rohlader, not only was largely responsible for producing this material but also performed the monotonous, time-consuming, often difficult, and always important task of tracking down the facts that invariably get away.

Maps were prepared by Miss Elizabeth P. Mason, Chief, Cartographic Section, and Miss Jean A. Saffran, Cartographic Draftsman, of the Special Projects Branch, The Historical Unit.

Mrs. Hazel G. Hine, Chief, Administrative Branch, The Historical Unit, supervised the final typing of the manuscript.

Mrs. Martha R. Stephens, Editor, of the Editorial Branch, The Historical Unit, performed the publication editing for the volume.

My grateful appreciation is due to Mrs. Ethel Bauer Ramond, who served as assistant to the Associate Editor and who typed the entire original manuscript with notable speed, accuracy, and real medical intelligence.

Finally, no expression of appreciation would be complete without grateful acknowledgment of the services of the Associate Editor, Miss Elizabeth M. McFetridge, for her untiring efforts in seeking out and compiling the information for this book and for organizing the text. Without the application of her vast experience in medical writing and editing, this volume would not have been possible. I want to express my thanks and appreciation to her for her invaluable services and, in particular, for her sympathetic understanding of the vagaries of medical editors and authors.

DOUGLAS B. KENDRICK,
Brigadier General MC USA.

Contents

	<i>Page</i>
FOREWORD	IX
PREFACE	XIII
ACKNOWLEDGMENTS	XXI
 <i>Chapter</i>	
I Historical Note	1
Transfusion Before World War I.....	1
Blood Transfusion in World War I.....	5
Spanish Civil War (1936-39).....	11
Blood for Britain.....	13
The British Blood Program in World War II.....	15
The Soviet Union Blood Program in World War II.....	21
The German Experience in World War II.....	22
Other Sources of Blood.....	23
 II Shock	 29
Historical Note.....	29
Observations Between the World Wars.....	29
Initial Concepts of Shock and Shock Therapy in World War II.....	30
Studies on Shock, National Research Council.....	33
Evolution of the Concept and Therapy of Shock in the Mediterranean Theater.....	37
Special Studies.....	38
The Board for the Study of the Severely Wounded.....	40
Ebert-Emerson Study.....	42
 III The Evolution of the Use of Whole Blood in Combat Casualties	 47
Development of the Concept.....	47
The Role of the National Research Council.....	49
The Evolution of the Concept of Whole Blood Replacement in the Mediterranean Theater.....	54
Comment.....	57
 IV Administrative Considerations in the Zone of Interior	 61
Army Medical School.....	61
Office of The Surgeon General.....	67
National Research Council.....	73
National Institute of Health.....	81
Legal Aspects of the Blood and Plasma Program.....	81
Training.....	85
Office of Civilian Defense.....	91
Plasma for Allied Nations.....	93
Offers From Other Countries.....	95
Supplies of Plasma for Zone of Interior Hospitals.....	95
Provision of Whole Blood in Zone of Interior Hospitals.....	97
Recommendations.....	97

<i>Chapter</i>	<i>Page</i>
V The American National Red Cross.....	101
The First Steps of the Program.....	101
Implementation of the Program.....	102
Organization and Personnel.....	104
Reorganization.....	106
Blood Donor Centers.....	111
Mobile Units.....	114
Conferences.....	118
Campaigns for Blood Donors.....	119
Other Aspects of the Program.....	128
The Total Program.....	130
The End Result.....	137
VI Blood Donors and the Technique of Collection of Blood.....	139
Requirements for Blood Donors.....	139
Donors With Special Diseases.....	141
Routine of Donation.....	145
Technique of Collection of Blood.....	148
Reactions to Donations.....	153
Regeneration of Hemoglobin.....	158
VII Plasma Equipment and Packaging, and Transfusion Equipment.....	163
Part I. Plasma Equipment and Packaging	
Original Packages.....	163
Development of Standard Package.....	165
Components of the Plasma Package.....	169
The Larger Plasma Package.....	172
Packaging of Dried Plasma for Zone of Interior Use.....	175
Proposed Changes.....	177
Part II. Transfusion Equipment for the Oversea Program	
General Considerations.....	177
Development of Equipment.....	180
Design of Field Transfusion Unit in European Theater.....	185
Expendable Transfusion Equipment.....	195
Part III. Albumin Packaging	
VIII Transportation and Refrigeration.....	203
Preliminary Specifications.....	203
Transportation in the Zone of Interior.....	204
Status of Refrigeration, 1943-August 1944.....	206
The Airlift to the European Theater.....	208
Studies on Unrefrigerated Blood Flown to the European Theater.....	211
Expendable Refrigeration Containers for the Oversea Airlifts.....	213
IX Preservative Solutions.....	217
Definitions and Criteria.....	217
Historical Note.....	217
Transportability of Whole Blood.....	220
Development of Preservative Solutions.....	221
Tests of Efficiency of Preservative Solutions.....	229
Special Studies.....	229

<i>Chapter</i>	<i>Page</i>
X Laboratory Techniques and Special Laboratory Studies	233
Blood Typing of Military Personnel.....	233
Development of Typing Sera.....	236
Typing Errors.....	241
The Rh Factor.....	245
Screening Test for O Blood.....	251
Hematocrit Determinations.....	252
Dye Measurement of Blood Volume.....	258
Titration of Blood.....	258
Studies on A and B Substances.....	260
Studies of Cell Survival After Transfusion.....	260
Serologic Testing for Syphilis.....	261
XI The Plasma Program.....	265
Historical Note.....	265
General Considerations.....	267
Forms of Plasma.....	268
Frozen Plasma.....	270
Liquid Plasma.....	274
Concentrated Plasma.....	275
Dried Plasma.....	275
Commercial Processing of Dried Plasma.....	280
Additives.....	283
Filters.....	287
Mass Production of Dried Plasma.....	289
Expansion of Requirements.....	290
Equipment for the Plasma Program.....	293
Other Production Difficulties.....	295
Testing.....	296
Inspection of Processing Laboratories.....	298
Yields of Plasma From Blood.....	299
Accounting Practices.....	300
Losses.....	305
Disposition of Surplus Plasma.....	310
Offers and Proposals.....	312
Red Blood Cell Residua.....	312
XII The Bovine and Human Albumin Programs.....	325
Part I. Bovine Albumin	
Development of Program.....	325
Progress of Program.....	327
Clinical Testing.....	328
Termination of Program.....	333
Later Developments.....	334
Part II. Human Serum Albumin	
Historical Note.....	335
Laboratory Development.....	336
Clinical Testing.....	337
Recommendation of Serum Albumin to the Armed Forces.....	339

<i>Chapter</i>	<i>Page</i>
XII The Bovine and Human Albumin Programs—Continued	
Part II. Human Serum Albumin—Continued	
Commercial Production.....	341
Army Requisitions for Serum Albumin.....	347
Techniques of Plasma Fractionation.....	348
Refrigeration.....	349
Additives.....	349
Further Clinical Studies.....	354
Termination of Program.....	355
XIII Byproducts of Plasma Fractionation.....	359
General Considerations.....	359
Hemoglobin.....	361
Globin.....	361
Immune Serum Globulin.....	362
Fibrin Foam and Fibrin Film.....	363
XIV Blood Substitutes and Other Intravenous Fluids.....	371
Part I. Blood Substitutes	
General Considerations.....	371
Gelatin.....	373
Pectin.....	377
Other Blood Substitutes.....	379
Part II. Other Intravenous Fluids	
Salt Solution.....	383
Gum Acacia.....	384
Sodium Bicarbonate.....	384
Complaints.....	384
XV The Mediterranean (Formerly North African) Theater of Operations.....	391
Part I. Fifth U.S. Army	
Evolution of Policies.....	391
Early Experiences.....	392
First Planning for a Theater Blood Bank.....	396
Establishment of Blood Bank at 15th Medical General Laboratory.....	400
The 6713th Blood Transfusion Unit (Overhead).....	404
Training.....	412
Transportation and Refrigeration.....	414
Air Transportation.....	417
Distribution.....	420
Donors.....	421
Selection of Type O Blood.....	424
Technique of Collection of Blood.....	426
Laboratory Tests.....	428
Facilities.....	431
Equipment.....	432
Preservatives.....	437
Statistical Data.....	437
Hospital Experiences.....	442
Survey of Blood Program.....	443
Comment.....	445

<i>Chapter</i>	<i>Page</i>
XV The Mediterranean (Formerly North African) Theater of Operations—Con.	
Part II. Seventh U.S. Army	
Organization	445
Personnel	446
Operations	446
Air Transport	448
Forward Distributing Section	449
Base Bleeding Section	451
Transfer to ETOUSA	452
Donors	452
Equipment	453
Refrigeration and Transportation	454
Statistical Data	455
Clinical Considerations	457
XVI The European Theater of Operations	459
Part I. General Considerations	
Special Circumstances in the European Theater	459
Education and Indoctrination	459
Part II. Initial Activities in the Zone of Interior for an Oversea Transfusion Service	
Background of Project	461
First Proposal, October 1943	461
Actions on Proposal	464
Revival of Proposal, April 1944	466
Request for Oversea Mission	467
Recommendations by Surgery Division, OTSG	468
Part III. Initial Activities in the European Theater	
Initial Provision of Blood and Plasma	469
Training in British Blood Supply Depot	470
Appointment of Consultant on Transfusion and Shock	472
Hospital Blood Banks	473
Increasing Awareness in the European Theater of the Need for Whole Blood	474
D-day and After	484
Implementation of the Whole Blood Proposal	487
Comment	489
Part IV. Definitive Actions in the Zone of Interior for an Oversea Transfusion Service	
Revival of Proposal for Airlift of Blood to Europe	490
Preparations for Airlift	491
First Shipments	494
Part V. The European Theater Blood Bank	
<i>Section I. Establishment</i>	
Preliminary Planning	496
Organization and Function	496

<i>Chapter</i>	<i>Page</i>
XVI The European Theater of Operations—Continued	
Part V. The European Theater Blood Bank—Continued	
<i>Section II. 152d Station Hospital Blood Bank, United Kingdom Section</i>	
Conversion of 152d Station Hospital to Blood Bank Purposes.....	498
Personnel.....	499
Operational Structure.....	500
Progress Report.....	508
Further Planning for Operation OVERLORD.....	509
Major Elements of the Final Plan.....	510
The Invasion.....	512
<i>Section III. 127th Station Hospital Blood Bank, United Kingdom Section</i>	
Authorization.....	513
Conversion of Facilities and Personnel.....	513
Training.....	514
Operation.....	514
<i>Section IV. 152d Station Hospital Blood Bank, Continental Section</i>	
Movement to the Continent.....	515
Permanent Location.....	516
Operations.....	516
<i>Section V. Activities of the European Theater Blood Bank Detachments</i>	
152d Station Hospital Blood Bank.....	518
127th Station Hospital Blood Bank.....	522
Part VI. Blood Donors in the European Theater	
First Provisions for Blood Donors.....	523
Formal Planning for the Blood Supply.....	524
Initial Results.....	526
Postinvasion Donations.....	526
Blood and Plasma Donations to British.....	528
Prisoner-of-War Donors.....	530
Payment of Donors.....	530
Compensation for Accidents.....	530
Part VII. Practical Considerations of the Blood Program in ETOUSA	
Preliminary Planning for the Airlift to the Continent.....	531
Airlift to the Continent After D-day.....	534
Other Means of Transportation.....	537
Airlift From the Zone of Interior.....	538
Reports and Estimates.....	541
Refrigeration and Transportation.....	541
Field Transfusion Units.....	543
Role of the Supply Division in the Whole Blood Program.....	545
Security Measures.....	548
Housekeeping Arrangements.....	549
Early Operational Difficulties.....	550
Inquiry Into Efficiency of Airlift to European Theater.....	551
Clinical Problems.....	553

<i>Chapter</i>	<i>Page</i>
XVI The European Theater of Operations—Continued	
Part VIII. Statistical Data	
Quantitative Use of Blood.....	556
Critique on the Use of Blood on the Continent.....	558
Airlift to the European Theater.....	559
Production of ETOUSA Blood Bank.....	560
Use of Blood in Army Installations.....	561
Losses of Preserved Blood.....	566
Odd Bloods.....	567
Serologically Positive Blood.....	568
Summarized Statistical Experiences.....	568
Part IX. Special Experiences	
Field Hospitals.....	569
General Hospitals.....	570
Part X. Statement of the Theater General Board	
Contents.....	574
Recommendations.....	574
Comment.....	574
XVII The Pacific Areas and the China-Burma-India Theater.....	581
The New South Wales Red Cross Blood Transfusion Service.....	581
Planning for Local Supplies of Blood.....	582
Blood Supply From Australia.....	586
27th General Hospital Blood Bank.....	589
Staff Visit to Pacific Areas by Army and Navy Consultants in Shock and Transfusion.....	590
Donors.....	595
Equipment.....	598
The Airlift of Blood to the Pacific.....	599
Advance Base Blood Bank Facility No. 1.....	614
Leyte.....	616
Luzon.....	619
Iwo Jima.....	622
Okinawa.....	622
Termination of Airlift.....	629
Statistical Data.....	629
Clinical Considerations.....	633
Plasma.....	636
Other Replacement Agents.....	637
Conclusions.....	638
Operation OLYMPIC.....	639
China-Burma-India Theater.....	642
XVIII Reactions to, and Complications of, Blood and Plasma Transfusions.....	649
General Considerations.....	649
Allergic Reactions.....	650
Pyrogenic Reactions.....	651
Hemolytic Reactions.....	653
Special Theater Experiences.....	659
Reactions From Contaminated Blood.....	665

<i>Chapter</i>		<i>Page</i>
XVIII	Reactions to, and Complications of, Blood and Plasma Transfusions—Con.	
	Lower Nephron Nephrosis.....	665
	Southwest Pacific Area.....	668
	Plasma Transfusion Reactions.....	668
	Homologous Serum Jaundice.....	674
XIX	General Considerations of Shock Therapy.....	683
	Principles of Resuscitation.....	683
	Resuscitation.....	687
	Technical Considerations.....	693
	Use of Blood in Zone of Interior Hospitals.....	694
	Plasma Therapy.....	696
	Serum Albumin Therapy.....	699
	Management of Special Types of Wounds.....	703
	Administrative Considerations.....	706
XX	The Blood, Plasma, and Related Programs in the Korean War.....	713
	Part I. Administrative Background	
	General Considerations.....	713
	The Interim Between the Wars.....	714
	Initial Steps in the National Blood Procurement Program.....	717
	Report of Task Group.....	718
	Implementation of Task Group Proposals.....	721
	National Research Council.....	724
	The American Red Cross Participation.....	726
	Part II. The Whole Blood Program	
	Section I. Blood Procurement in Japan	
	Initiation of Program.....	727
	Subsequent Developments.....	729
	Japanese Donors.....	729
	Publicity.....	730
	Statistical Data.....	731
	Section II. The Development of the Whole Blood Program in the Zone of Interior	
	The First Year.....	733
	The Armed Forces Blood Donor Program.....	734
	The National Blood Program.....	735
	Section III. The Oversea Airlift to Korea	
	General Considerations.....	739
	Processing Laboratory, Travis Air Force Base.....	739
	Laboratory Routine.....	743
	Statistical Data.....	747
	Section IV. The Whole Blood Oversea Experience	
	Estimate of Needs.....	752
	Distribution.....	752
	Survey of Whole Blood Experience, Far East Command.....	755
	Statistical Data.....	757

<i>Chapter</i>	<i>Page</i>
XX The Blood, Plasma, and Related Programs in the Korean War—Continued	
Part II. The Whole Blood Program—Continued	
Section V. <i>Equipment and Refrigeration for Airlift</i>	
Plastic Containers.....	758
Refrigerated Shipping Containers.....	760
Refrigeration Facilities in the Far East.....	766
Section VI. <i>Techniques of Preservation</i> •	
Preservative Solutions.....	766
Red Blood Cell Preservation.....	769
Exchange Resins.....	769
Freezing.....	771
Part III. The Plasma Program	
Plasma Supplies Between the Wars.....	772
Stockpiles and Future Requirements.....	772
Procurement of Plasma.....	773
Serum Hepatitis.....	776
Part IV. The Plasma Fractionation Program	
Serum Albumin.....	782
Globin.....	783
Gamma Globulin.....	783
Red Blood Cells.....	785
Cadaveric Blood.....	785
Part V. The Plasma-Expanders Program	
Bibliography.....	785
Gelatin and Oxypolygelatin.....	786
Polyvinylpyrrolidone (Periston, PVP).....	787
Dextran.....	790
Fat Emulsions.....	795
Part VI. Clinical Considerations	
Therapeutic Principles and Practices.....	796
Investigations.....	802
APPENDIXES	
A Circular Letters, Mediterranean Theater.....	811
B Circular Letters, European Theater.....	813
C Circular Letters, Pacific Areas.....	815
INDEX	817

Illustrations

<i>Figure</i>	<i>Page</i>
1 Experimental blood transfusion apparatus (Blundell), 1818.....	2
2 Clinical transfusion with Blundell gravitator.....	3
3 World War I blood transfusion apparatus.....	10
4 British and Canadian equipment for replacement therapy.....	18
5 Plasma administration in the field.....	58
6 Brig. Gen. Charles C. Hillman, MC.....	62
7 Col. (later Brig. Gen.) George R. Callender, MC.....	63
8 Experimental blood studies, Army Medical School, 1941.....	64
9 Exhibit by Blood Research Division, Army Medical School, 1941.....	66
10 Preparation of liquid plasma, Army Medical School.....	68
11 Lt. Col. (later Col.) B. Noland Carter, MC.....	70
12 Army and Navy representatives, Blood and Plasma Program.....	72
13 Laboratory technicians in training, Army Medical School.....	86
14 Dried plasma arriving at emergency landing field during maneuvers, 1941.....	88
15 Dried plasma ready for immediate use during maneuvers, 1941.....	89
16 Demonstration of plasma administration, 1943.....	90
17 Dr. G. Canby Robinson.....	105
18 Dr. (later Major, MC) Earl S. Taylor.....	106
19 American Red Cross blood donor centers.....	113
20 Committee room, Fort Worth Red Cross Blood Donor Center.....	114
21 Red Cross mobile units.....	115
22 Setup of Red Cross mobile units.....	116
23 Red Cross recruiting posters.....	122
24 Red Cross recruiting pamphlets.....	123
25 Outdoor recruiting posters contributed by commercial firms.....	124
26 Cadets from Marquette University at Milwaukee Red Cross Blood Donor Center.....	127
27 Release signed by blood donors.....	141
28 Reception and registration rooms, Red Cross blood donor centers.....	146
29 Registration card for blood donors.....	148
30 Hemoglobin and blood pressure determinations.....	149
31 Fileroom, San Antonio Red Cross Blood Donor Center.....	150
32 Collection of blood, Red Cross blood donor centers.....	151
33 Canteens, Red Cross blood donor centers.....	152
34 Canteen kitchen, Fort Worth Red Cross Blood Donor Center.....	153
35 Steps in collection of blood.....	154
36 Final step in collection of blood.....	155
37 Shipping room at a Red Cross blood donor center.....	156
38 Dried plasma containers early in World War II.....	164
39 Standard Army-Navy 250-cc. plasma package.....	166
40 Stoppers used in blood and plasma program.....	167
41 Filters used in plasma program.....	170
42 Large plasma package, 1943.....	174
43 Plasma package used in Zone of Interior hospitals.....	176
44 Collecting and giving set devised at Army Medical School.....	178
45 Improvised equipment for oversea collection of blood.....	181
46 Maj. (later Lt. Col.) Richard V. Ebert, MC, and Maj. (later Lt. Col.) Charles P. Emerson, MC.....	186
47 Evolution of donor bottle in Ebert-Emerson transfusion set.....	187
48 Ebert-Emerson technique of collection and administration of blood.....	188
49 Improvised suction equipment in Ebert-Emerson technique.....	189

<i>Figure</i>	<i>Page</i>
50 Technique of cleansing Ebert-Emerson transfusion set.....	190
51 Ebert-Emerson transfusion set packed for use.....	191
52 Hose hub needle.....	194
53 Disposable giving set standardized for Army-Navy use.....	197
54 Standard Army-Navy albumin package.....	199
55 Church container for transportation of blood.....	205
56 Aluminum refrigerator (Chrysler) developed by Army Air Forces.....	207
57 Preservation of blood with Alsever's solution.....	223
58 Technique of testing for Rh factor.....	252
59 Copper sulfate technique of measuring specific gravities of blood and plasma...	254
60 Portable kit for copper sulfate technique of measuring specific gravities of blood and plasma.....	255
61 Preparation of liquid plasma, 1942.....	272
62 Equipment for cold-trap technique of drying plasma.....	278
63 Shell-frozen plasma.....	280
64 Plasma shell-freezing machine.....	281
65 Equipment for freezing plasma.....	282
66 Typical plasma shell-freezing tray.....	283
67 Equipment for Emery technique of shell-freezing plasma.....	284
68 Wyckoff-Lagsden technique of drying plasma.....	285
69 Drying plasma at Army Medical School.....	286
70 Vacuum diffusion process for drying plasma.....	287
71 Diagrammatic sketch of plasma drying chamber.....	288
72 Schematic drawing of plasma freeze-drying equipment.....	289
73 Edwin J. Cohn, Ph. D.....	326
74 Commercially prepared fibrin foam and thrombin.....	366
75 Closures for bleeding, plasma, and intravenous solution bottles (Baxter).....	386
76 Col. Edward D. Churchill, MC.....	392
77 Administration of blood plasma just behind frontlines, Sicily, 1943.....	393
78 Administration of blood plasma to German casualty, Italy, 1945.....	394
79 Administration of blood plasma after bomb hit, Italy, 1943.....	395
80 Administration of blood plasma in open field, Italy.....	396
81 Transfusion with British equipment and blood, Italy, 1944.....	399
82 Sikh receiving British blood serum, Italy, 1944.....	400
83 Col. Virgil H. Cornell, MC.....	401
84 Maj. John J. McGraw, Jr., MC.....	402
85 GI blood donors, Italy, 1944.....	403
86 Taking blood for typing, Italy, 1944.....	404
87 Postoperative transfusion, Italy, 1944.....	406
88 Preparation of donor sets, Italy, 1944.....	409
89 Laboratory examinations, Italy.....	410
90 Blood typing, Italy, 1944.....	411
91 Blood typing, Italy, 1944.....	412
92 Reading Kahn tests, Italy.....	413
93 Preparation of dried plasma for use in field, Italy, 1945.....	414
94 Refrigerator truck for delivery of blood, Italy, 1944.....	415
95 Insulated box for shipment of blood, devised in Italy.....	416
96 Loading blood for shipment to Anzio beachhead.....	417
97 Unloading blood plane, Italy, 1944.....	418
98 Bleeding room, Italy, 1944.....	427
99 Completion of individual donation, Italy, 1944.....	428
100 Preparation of blood sample for laboratory studies, Italy.....	429
101 Daily worksheet, Italy.....	430

<i>Figure</i>	<i>Page</i>
102 Blood donations, Italy.....	431
103 Creation of slight negative pressure in blood bottle.....	432
104 Introduction of glucose-saline solution into blood bottles.....	433
105 Whole blood collections, Italy, 1944.....	434
106 Arrival of DUKW with blood and penicillin, southern France.....	449
107 Plasma transfusion during transportation from frontline, southern France, 1945.....	456
108 Transfusion in forward hospital, southern France, 1944.....	456
109 Administration of albumin to wounded civilian, southern France.....	457
110 Inventory of liquid plasma, England, 1943.....	470
111 Col. (later Brig. Gen.) Elliott C. Cutler, MC, Lt. Col. (later Col.) Ralph S. Muckenfuss, MC, and Lt. Col. Robert C. Hardin, MC, summer, 1944....	471
112 Solutions room, European Theater Blood Bank.....	502
113 Loading autoclave with materials for blood collection, European Theater Blood Bank, 1944.....	503
114 Movement of blood from refrigerated storage via truck to waiting plane, United Kingdom, 1944.....	504
115 Preparation of transfusion equipment for reuse, European Theater Blood Bank, 1944.....	505
116 Labeling bottles of blood, European Theater Blood Bank, 1944.....	506
117 Processing of blood donations, European Theater Blood Bank.....	507
118 Shipment of blood from Continental Section, European Theater Blood Bank, 1944.....	508
119 Loading blood for shipment to European Theater Blood Bank, 1944.....	533
120 Blood packed in ice for shipment, 1944.....	534
121 Plane loaded with whole blood in refrigerated cans for shipment to France, 1944.....	535
122 Unloading of blood from plane, France, 1944.....	536
123 Blood plane returning wounded from Continent, 1944.....	537
124 Delivery vehicle with refrigerator.....	538
125 Refrigerator truck being loaded with blood at Continental Section, European Theater Blood Bank, 1944.....	539
126 Blood being unloaded from refrigerator truck, Belgium, 1944.....	540
127 Preparation of plasma, Rendova, 1943.....	583
128 Administration of plasma, Leyte, 1944.....	584
129 Administration of plasma, Manila, 1945.....	585
130 Administration of plasma, Manila, 1945.....	586
131 Administration of plasma, Luzon, 1945.....	587
132 Blood bank in hospital dispensary, New Guinea, 1945.....	589
133 Brig. Gen. Guy B. Denit, MC.....	593
134 Blood transfusion, Leyte, 1944.....	596
135 Blood donors, Biak Island, 1945.....	597
136 Navy processing laboratory for blood for Pacific, Oakland, Calif.....	602
137 Blood distribution center, Guam.....	608
138 Movement of blood at distributing center, Guam.....	610
139 Icing Navy shipping cases, Guam.....	611
140 Loading Navy shipping containers, Guam.....	612
141 Lt. Herbert R. Brown, Jr., MC, USNR.....	613
142 Col. (later Brig. Gen.) William A. Hagins, MC.....	617
143 Lt. Col. Frank Glenn, MC.....	619
144 Blood distribution center, USN, Okinawa, 1945.....	624
145 Administration of plasma, Okinawa, 1945.....	625
146 Administration of plasma, Okinawa, 1945.....	626
147 Administration of plasma, Okinawa, 1945.....	627

<i>Figure</i>	<i>Page</i>
148 Blood transfusion, Leyte, 1944.....	634
149 Stored blood and plasma, Ledo, 1944.....	643
150 Processed serum, Calcutta Blood Bank, 1944.....	644
151 Lt. Gen. (later Gen.) Joseph W. Stilwell, USA, and Col. (later Brig. Gen.) Isidor S. Ravdin, MC, Assam Base Hospital, 1944.....	645
152 Blood donors, K'un-ming, 1945.....	646
153 Form used in hepatitis survey in Zone of Interior general hospitals, 1945....	677
154 Administration of replacement therapy, France, 1944.....	685
155 Transfusion in shock ward, Belgium, 1945.....	686
156 Transfusion in shock ward, Germany.....	687
157 Form used in shock ward.....	688
158 Transfusion during operation, France, 1944.....	689
159 Plasma administration on beach in Normandy, 1944.....	690
160 Care of wounded in battalion aid station, France, 1944.....	691
161 Plasma administration, Holland, 1944.....	692
162 Care of civilian injured by landmine, Germany, 1944.....	693
163 Reconstitution of dried plasma.....	699
164 Administration of serum albumin.....	704
165 Interior of shock ward.....	708
166 Setup of shock ward.....	709
167 Blood donors from U.S. Navy, Tokyo, 1950.....	728
168 Japanese mothers giving blood, Tokyo, 1952.....	731
169 Official poster of Armed Forces Blood Donor Program, 1951.....	735
170 Shipments of blood from military installations in Zone of Interior.....	736
171 Inspection of blood for transshipment from San Francisco Airport to Japan, 1950.....	737
172 Collection of blood by mobile units from Louisville Regional Blood Donor Center, 1950.....	738
173 Personnel of Travis Air Force Base Blood Processing Center.....	742
174 Laboratories at Travis Air Force Base Blood Processing Center.....	745
175 Whole blood ready for airlift to Korea from Travis Air Force Base Processing Center.....	746
176 Blood being loaded on plane for airlift from Travis Air Force Base to Tokyo Blood Bank.....	747
177 Blood flown from Travis Air Force Base to Japan.....	749
178 Blood flown from United States via Tokyo on arrival in Korea.....	750
179 Transportation of blood by helicopter in Korea.....	751
180 Standardized plastic equipment introduced during Korean War.....	760
181 Demonstration of use of plastic equipment.....	761
182 Insulated box used in early airlift to Korea.....	762
183 Whole blood shipments arriving in Korea in insulated box originally used in airlift to Korea.....	763
184 Trunk type of insulated container developed during Korean War.....	764
185 Refrigerated container developed after Korean War.....	765
186 Refrigerator units for storage of blood, Korea, 1951.....	766
187 Refrigeration facilities for blood, Korea, 1953.....	767
188 Refrigerator used in field hospitals in Korea.....	768
189 Technique of plasma production during Korean War.....	777
190 Administration of plasma in Korea.....	797
191 Administration of albumin in Korea.....	798
192 Withdrawal of stored blood for use at front, Korea, 1950.....	799
193 Blood transfusion in Korea.....	800
194 Transfusion during operation in Korea.....	801
195 Rapid blood transfusion, Korea, 1952.....	802

Tables

<i>Number</i>		<i>Page</i>
1	American Red Cross blood donor centers.....	112
2	Summarized data on activities of American Red Cross blood donor centers..	130
3	Production report of American Red Cross blood donor centers, 1941-45....	131
4	Production report of American Red Cross blood donor centers, 1941-43....	132
5	Production report of American Red Cross blood donor centers, 1941-44....	134
6	Errors in blood grouping determinations.....	243
7	Results of testing commercially produced lots of plasma in Army Medical School.....	296
8	Distribution of causes of losses in total bloods collected in World War II....	306
9	Results of clinical testing of bovine albumin, 1941.....	329
10	Accepted production of normal human serum albumin, 1942-43.....	346
11	Summarized report of albumin production to 1945.....	348
12	Effect of storage temperatures on stability of crystalline human albumin...	350
13	Effect of storage temperatures on viscosity of crystalline human albumin..	351
14	Production of 6713th Blood Transfusion Unit (Ovhd.), 1944-45.....	439
15	Distribution of bloods collected by 6713th Blood Transfusion Unit (Ovhd.), 1944-45.....	441
16	Blood shipments by 6825th Blood Transfusion Company (Non-T/O), 1944-45.....	455
17	Use of blood in Italy, 1943-44.....	483
18	Estimated demands for whole blood, April 1944.....	484
19	Response to request for type O blood donors in United Kingdom, spring 1944..	526
20	Consolidated report of monthly shipments of blood to ETOUSA, Army Whole Blood Procurement Service, 1944-45.....	559
21	Production and distribution of blood, ETOUSA Blood Bank, 1944-45.....	561
22	Delivery of blood to using hospital units, ETOUSA, 1944-45.....	562
23	Ratios of bloods delivered to admissions to forward hospitals, First U.S. Army, 1944-45.....	563
24	Ratios of bloods delivered to admissions to forward hospitals, Third U.S. Army, 1944-45.....	563
25	Ratios of bloods delivered to admissions to forward hospitals, Seventh U.S. Army, 1944-45.....	564
26	Ratios of bloods delivered to admissions to forward hospitals, Ninth U.S. Army, 1944-45.....	564
27	Ratios of blood delivered to admissions to forward hospitals, all U.S. Armies, ETOUSA, 1944-45.....	565
28	Reactions to transfusions in field hospitals, ETOUSA.....	661
29	Reactions to transfusions in evacuation hospitals, ETOUSA.....	662
30	Reactions to transfusions in general and station hospitals, ETOUSA.....	662
31	Influence of local preparation of transfusion sets on pyrogenic reactions..	663
32	Development of hepatitis in hospitalized patients, European and Mediterranean theaters, 1944.....	676
33	Survey of hepatitis in Zone of Interior general hospitals, 1945.....	678
34	Authorized collection of blood from Japanese nationals and other short donors.	730
35	Type distribution of blood collected in Japan, 1951.....	732
36	Receipts of blood, Tokyo Blood Depot, 1951-52.....	733
37	Ratio of blood issued to wounded in action, 1951-52.....	753
38	Remaining usable days of blood received from Zone of Interior and shipped to Korea, 1951.....	755
39	Distribution of blood by Tokyo Blood Depot, 1951-52.....	757

<i>Number</i>		<i>Page</i>
40	Results of inoculation of volunteers with serum from six donors suspected of having hepatitis.....	778
41	Results of ultraviolet irradiation of infected pooled plasma.....	779
42	Results of heating infected pooled plasma at 60° C.....	780

Charts

<i>Number</i>		
1	Organization chart, Transfusion Branch, Surgical Consultants Division, Office of The Surgeon General, 1944.....	71
2	Organization chart, American Red Cross Blood Donor Service, 1941.....	107
3	Organization chart, American Red Cross Blood Donor Service, 1942.....	108
4	Line chart for calculating plasma proteins, hemoglobin and hematocrit from specific gravities of blood and plasma.....	256
5	Line chart for calculating percentages of normal plasma proteins and hemoglobin from specific gravities of blood and plasma.....	257
6	Hemolytic effect of various diluting solutions.....	316
7	Fractionation of plasma.....	360
8	Diagram of blood transfusion service for field army, North African theater, 1944.....	405
9	Operations chart, Whole Blood Service, European theater, 1943.....	497
10	Procurement and distribution of whole blood, European theater, 1944-45..	517
11	Structural organization of blood and blood derivatives program, 1949.....	722
12	Structural organization of blood and blood derivatives program, 1950.....	723
13	Structural organization of blood and blood derivatives program, 1952.....	724
14	Organization for distribution of whole blood for Korea.....	754

Maps

<i>Number</i>		
1	Movement of whole blood in Mediterranean theater.....	419
2	Flight plan of airlift of blood from Zone of Interior to the European Continent.....	495
3	Operations map showing movement of ADSEC mobile blood depots on the European Continent.....	519
4	Distribution of blood in Southwest Pacific.....	588
5	Itinerary of Army-Navy blood and plasma personnel in Pacific areas, 1944..	592
6	Flight plan for distribution of blood to Pacific from U.S. west coast.....	601
7	Flight plan for airlift of blood from Zone of Interior to Korea.....	748

CHAPTER I

Historical Note

TRANSFUSION BEFORE WORLD WAR I

Although the concept of the therapeutic value of blood dates back to antiquity, transfusion in the modern sense of the term was a practical impossibility until William Harvey, in 1616, announced his discovery of the circulation of the blood.¹ This discovery opened the way for serious experiments on the infusion of various substances into the bloodstream and eventually led to the use of whole blood for transfusion.

Claims to priority are various and confusing. It is clear, however, that Richard Lower, inspired by the previous experiments of Sir Christopher Wren in infusion technique, performed the first successful animal transfusion in 1665, when he transferred blood from the carotid artery of one dog to the jugular vein of another. In November 1667, Lower transfused Mr. Arthur Coga, "a mildly melancholy insane man," with the blood of a lamb. Mr. Coga, according to Pepys, described his experience in Latin before the Royal Society of Medicine and stated that he was much better. He impressed Pepys as "cracked a little in his head."

The next animal-to-human transfusions were also performed on generally the same indications, by Jean Baptiste Denis, physician to Louis XIV. When Denis' fourth attempt ended fatally, he was charged with murder. He was eventually exonerated, but, 10 years later, the procedure was prohibited by law in France as well as in Italy and was also forbidden by the Royal Society of Medicine in England.

For the next 150 years, there was little interest in transfusion, but it is significant that Nuck in 1714 and Cantwell in 1749 declared that this procedure would be of value in severe hemorrhage. When interest in transfusion was revived by James Blundell (5-7) in 1818, it was on the basis of replacement of lost blood in puerperal hemorrhage and after a series of experiments in which he had demonstrated that human blood loses none of its "vital properties" by passage through transfusion equipment (figs. 1 and 2). Blundell failed in his first four desperate attempts to save women on the point of death from postpartal hemorrhage, but he succeeded in five of the next six attempts.

¹ The following brief historical account of the development of blood transfusion is necessary for an understanding of the medicomilitary employment of this measure, a use not suggested up to World War I. The material included, unless otherwise indicated, is derived from (1) the detailed historical account in Kilduffe and DeBailey's "The Blood Bank and the Technique and Therapeutics of Transfusions" (1), which has an appended list of 207 (183 numbered) references, and (2) Lewisohn's (2, 3) and Ottenberg's (4) accounts of the contributions of Mount Sinai Hospital in New York to this therapeutic technique.

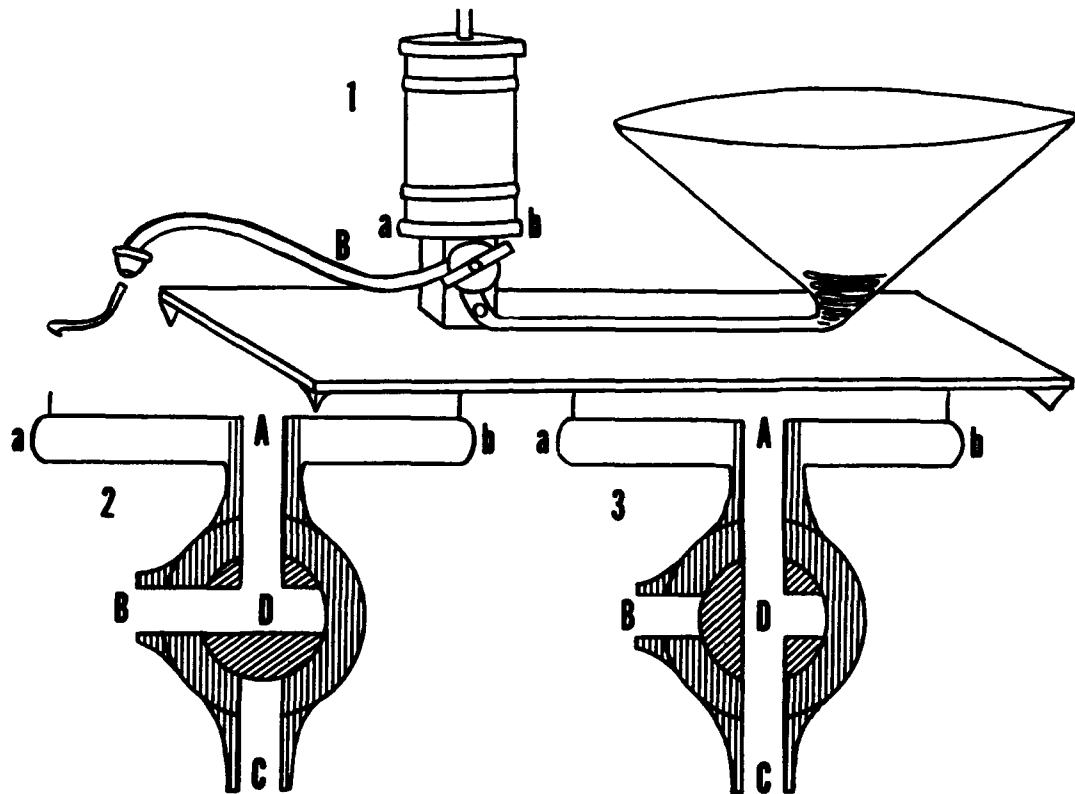

FIGURE 1.—Apparatus used by Blundell for experimental blood transfusion, 1818. 1 (Blundell's original numbers and letters are retained). Syringe, etc. 2, 3. Structure of double-way cock. Aab. Head of syringe. ADB (fig. 2). Channel by which blood is expelled while ADC is closed. ADC (fig. 3). Channel by which blood enters while ADB is closed. Change is effected by giving plug D a quarter-turn (2).

In 1859, in reporting a successful transfusion, Benedict (8) laid down the conditions under which this operation should be practiced. He considered it applicable to no pathologic state save that

* * * which is commonly called 'collapse,' induced by hemorrhage, by certain exhausting discharges, or by utter inability to receive or retain nutriment; and the only transfusion now sanctioned, either by physiology or by common sense, is that of *human venous blood into human veins, identical, as nearly as possible, with that which has been lost, and in quantity just sufficient to arrest the tendency toward death.*

Benedict (9) could find only 21 cases recorded up to 1853 in which transfusions had been "practiced under these conditions." There were 19 survivals in the 21 cases.

In 1875, Landois (10), in a comprehensive monograph on transfusion, collected 347 cases in which human blood had been used and 129 cases in which animal blood had been used. By this time, important studies on the physiology of the blood were being performed by a number of qualified observers, and some



FIGURE 2.—Clinical transfusion with Blundell gravitator for transmitting "blood in a regulated stream from one individual to another" (3).

physicians, such as Fordyce Barker, advocated transfusion " * * * not exclusively in those desperate cases where favorable results are hardly looked for but * * * before patients have arrived at, and fallen into, this desperate condition."

Techniques in use included transfusion with defibrinated blood, mediate transfusion with pure blood, immediate transfusion from vein to vein, and immediate transfusion from artery to vein.

Although the indications and rationale of blood transfusion were by this time apparently quite well understood, the indications during the last quarter of the century again became vague and irrational, the procedure was employed indiscriminately, and the number of severe reactions and fatalities increased. As a result, transfusion again began to be considered as a hazardous, and even a disreputable, procedure, to be employed only as a last resort and in desperation.

Special Problems

During the first years of the 20th century, a blood transfusion was frequently a more difficult technical procedure, and sometimes a procedure fraught with greater risks, than a major operation. Its development as an

effective and safe therapeutic method required the solution of a number of special problems:

1. *Blood coagulation.* First efforts to overcome this difficulty were made in 1835, with the use of defibrinated blood by Bischoff, and terminated in 1914, with the successful use of sodium citrate by Hustin, Weil, and Lewisohn (2, 3) (p. 218).

2. *Agglutination and hemolysis from admixture of incompatible bloods.* The way was opened to the solution of this special problem in 1900, when Landsteiner (11) published his epochal work on the identification of blood groups, based on his previous demonstration of the presence of isoagglutinating and isoagglutinable substances in the blood. Jansky in 1907 and Moss 3 years later, without knowledge of Jansky's studies, worked out the reciprocal agglutinating reactions of the four blood groups and classified them accordingly. The confusion that arose because of differences in nomenclature was eliminated after World War I, when the numbers previously used to designate blood groups were replaced by the letters A, B, AB, and O, each group thus being designated by the agglutinogens in Landsteiner's original scheme.

Communications in the early years of the 20th century were often slow, and foreign medical literature had only a limited circulation in the United States. No practical use, therefore, was made of Landsteiner's work until 1907, when Ottenberg (4), at Mount Sinai Hospital in New York, first matched donor and recipient before giving blood and thus made transfusion a safe procedure from the standpoint of compatibility. The validity of Ottenberg's work was not immediately realized; his offer to perform compatibility tests for the surgeons at his own hospital had no general acceptance for almost 5 years because such tests were considered unnecessary or misleading.

In 1911, Ottenberg demonstrated that it was safe to use as a donor a person whose serum agglutinated the recipient's red cells but unsafe and dangerous to use one whose red cells were acted upon by the recipient's serum. This demonstration eventually led to the widespread employment of group O donors as universal donors, since the red blood cells of this blood group are not agglutinable by the serum of any other blood group.

3. *Technical difficulties.* Until 1913, direct transfusion was used to the exclusion of any other technique. This was a difficult and time-consuming method, requiring a specially trained team to carry it out and totally unsuited for use in sudden emergencies. In 1892, von Ziemssen of Munich had performed transfusion by the syringe technique, but his report attracted no attention and when Lindeman (12) described it in 1913, it was, for all practical purposes, a new method. With this technique, no dissection of blood vessels was necessary in either donor or recipient, and the exact quantity of blood transfused was known. The technique, however, required a trained team of at least four persons and the use of a large number of expensive syringes. Also, rapid injection of the blood was mandatory. In 1915, Unger (13) introduced an apparatus based on the principle of the two-way stopcock, which

overcame many of these difficulties. Dozens of variations of this apparatus were introduced during the next 15 years.

4. *Infection.* Infection ceased to be a major problem after first antiseptic, and then aseptic, techniques came into general use and as long as transfusion was employed only in hospitals and on what amounted to elective indications. The open containers originally used to collect blood for indirect transfusion first became impractical, and then a real source of danger, when indications for transfusion were extended.

BLOOD TRANSFUSION IN WORLD WAR I

The British Experience

In June of 1918, an editorial writer in the *Lancet* doubted that as recently as 4 years earlier any surgeon could have been found to perform "the operation" of transfusion in England (14). In the next issue, Sir Berkeley Moynihan (15) took exception to that statement: He and his associates in Leeds had been performing transfusion regularly for 10 years, first by the direct, and later by the indirect, technique.

The editorial writer's statement was, however, generally true. Blood transfusion was not practiced by the majority of surgeons in Great Britain before World War I, and its use in the last 2 years of the war was chiefly derived from the work which had been done on it in the United States.

Techniques.—Direct transfusion, as might have been expected, proved a completely impractical method in military surgery. The elaborate preparation required in the Kimpton-Brown technique makes one wonder how it could have been employed at all in a busy casualty clearing station, but Fullerton and his associates (16), using improvised equipment, employed the method in 19 casualties at the Boulogne base in 1916. The 15 deaths were not too discouraging, since the blood was given only to patients whose condition was considered desperate. In 1917, U.S. Army medical officers introduced the standard Kimpton-Brown equipment into British hospitals, and numerous patients were treated by this technique in casualty clearing stations of the British Second Army.

In a series of reports between 1916 and 1918, Bruce Robertson (17-20), of the Canadian Army, explained the advantages of the syringe-cannula technique, which he had introduced into the British Second Army area. The method was far simpler than the Kimpton-Brown technique, but at that it was not simple, and it required a team of three persons to carry it out.

The use of preserved blood was introduced into a casualty clearing station in the British Third Army during the battle of Cambrai in November 1917 by Capt. (later Maj.) Oswald H. Robertson, MORC, USA (21, 22). His reasoning was that if blood had to be collected as casualties arrived, the number of transfusions given would necessarily be limited. The solution seemed to him to be the use of human red blood cells collected and stored in advance of the need.

Only group O (then termed group IV) blood was used. The 500 cc. taken from each donor was collected in the Rous-Turner glucose-citrate solution (p. 217) and stored in an icebox. After the blood had settled for 4 or 5 days, the cell suspension contained no more citrate than would be used in ordinary citrated transfusions. The majority of transfusions were given within 10 to 14 days after the blood had been collected, but in some instances they were given with 26-day-old blood. The length of time the blood was kept did not seem to influence the results. The blood arrived in good condition, with no evidence of hemolysis, after transportation by ambulance for 6 to 8 miles over rough roads, a demonstration later repeated by Capt. Kenneth Walker, who carried a bottle of preserved blood with him during a journey from Arras to London. The 22 transfusions with preserved blood reported by Robertson in June 1918 were carried out on 20 patients, of whom 9 died but all of whom, it was thought, would have died unless they had received blood.

In 1918, transfusions were carried out farther forward than casualty clearing stations, chiefly due to the efforts of Captain Walker, Capt. Norman M. Guiou (23) of the Canadian Army, and Major Holmes-à-Court of the Australian Army (22). The syringe technique, Guiou claimed, could "easily" be applied in advanced dressing stations and in the average regimental aid post. If casualties were given blood in these areas, he continued, they would be kept alive until they reached the casualty clearing station, where they could be treated surgically.

The official history of the British Medical Service in World War I concluded that whatever the merits of the various techniques of transfusion in civil life, there was no doubt of the superiority of the citrate method in wartime. It could be employed in circumstances in which other methods were impractical. It was simpler than other methods. It permitted the transportation of blood from donor to recipient without interrupting an operation and further congesting an already overcrowded operating tent. A skilled "transfuser," devoting himself entirely to the task of drawing and citrating blood, could supply a dozen patients in need of blood, leaving to anesthetists the "simple task" of administering the blood (22).

Donors.—There was no difficulty in procuring blood donors. Up to the middle of 1918, the spirit of comradeship was sufficient to supply them. Later, a 3-week leave in England after the donation secured many offers from lightly wounded men. Dental patients and soldiers with minor injuries, sprains, and flat feet were also used as donors. Syphilitic and malarial subjects were rejected, as well as those with other infectious diseases, such as trench fever. A healthy donor, it was thought, could withstand the loss of 700–1,000 cc. of blood.

Blood grouping.—Early in the war, the precaution of blood grouping before transfusion was frequently omitted because it was impractical. A number of reactions were attributed to this omission, and by June 1918, Bruce Robertson (19) had observed three cases of fatal hemoglobinuria in 100 transfusions. Later in the war, preliminary blood grouping became the rule, but, when there were no facilities for laboratory work, his suggestion of a test

injection was generally used, particularly in emergences. If no symptoms occurred within 1 or 2 minutes after the injection of 15 to 20 cc. of donor blood, it was thought safe to proceed with the transfusion.

In November 1917, Maj. Roger I. Lee, MC, USA, writing in the *British Medical Journal* (24), described what he termed the "minimum procedure" to assure that the recipient's serum did not agglutinate the donor's cells. This extremely simple test continued to be useful until avid grouping serum became available after the war.²

Indications.—Indications for transfusion in the British Expeditionary Force included:

1. Preoperative preparation in severe hemorrhage and shock, in which blood replacement was considered the proper treatment for loss of blood. The time of the transfusion officer was not properly spent on casualties who were moribund. Although there was considerable argument about the relative effects of gum acacia and blood in shock, the most experienced surgeons considered transfusion far more efficacious. Captain Walker found that 70 percent of the casualties resuscitated by gum acacia infusions in field ambulances required blood when they reached the casualty clearing station. In rush periods, when time could not be taken, or facilities were not available, the need for transfusion was determined by the casualty's general appearance, pulse, and blood pressure. In severe hemorrhage, large amounts of blood (900 to 1,000 cc.) were recommended; 500 to 600 cc. was considered adequate in shock.³

2. During operation.

3. After operation, after a delay to determine whether the depression might be due to the anesthetic, especially if an anesthetic other than gas-oxygen had been used.

4. Carbon monoxide poisoning.

5. Septicemia and chronic wound infection.

Bruce Robertson (20) emphasized the importance of the timing of transfusion. It was a temptation, he said, to use other measures first, but clinical observation showed that transfusion was not so effective after the "exsanguinated condition" had persisted for several hours and degenerative changes had occurred in the organism. Properly timed transfusions could revive inoperable patients and bad-risk patients to a degree that permitted radical surgery, with a good chance of recovery. Gordon Watson, in a note attached to one of Robertson's papers (20), stated that there was no comparison between the results of transfusion, which were instantaneous and permanent, and those secured by infusions of saline, which were "a flash in the pan" and followed by more serious collapse.

Transfusion program.—To resuscitation teams (a nomenclature later employed in World War II) was delegated the task of collaborating with surgeons at casualty clearing stations by relieving them of the special measures necessary in poor-risk casualties both before and after operation. Teams of

² The use of plasma in place of blood was suggested by Gordon R. Ward (25), in March 1918, to avoid the risk of hemolysis of the recipient's plasma by the donor's corpuscles, but the suggestion was not acted upon in combat areas during the remainder of the First World War. In November 1918, however, Lt. Frank W. Hartman, MC, USN, used liquid plasma which he had prepared at the U.S. Naval Medical School for patients with severe influenza (26).

³ The World War II concept of hemorrhage as the cause of shock in military injuries was not one of the theories advanced to explain shock in World War I (p. 37).

sisters and orderlies experienced in this work were developed and proved very useful.

A formal transfusion program was instituted in the British Third Army as experience showed that transfusion forward of casualty clearing stations could save many lives (22). A center was set up in connection with a group of casualty clearing stations, and instruction in transfusion techniques was given in it to field ambulance and regimental medical officers. When they had completed their courses, they were provided with the necessary equipment, and several divisions thus had one or more officers especially skilled in the treatment of severely wounded casualties.

The officer in charge of this center, in addition to his teaching duties, made a point of being present during any large trench raid in the army area, so that transfusions could be given as indicated in aid posts or advanced dressing stations. Whatever the clinical results achieved—and many lives were undoubtedly saved by these arrangements—the morale effect of his presence on the men going over the top was so good that the combatant services soon got into the way of sending back word of impending raids to the shock center. When several battalions were to participate in the operation, it was possible, with such advance notice, to select a central site to which badly wounded men could be sent from various aid posts for resuscitation and transfusion. It was also possible, with advance notice of military actions, to prepare a store of preserved blood at the center to supply the needs of forward areas. When the blood was supplied, even a poorly equipped aid post could be used for transfusions.

The United States Experience

Replacement fluids.—By the time the United States entered World War I, it was realized that the injection of physiologic salt solution or Ringer's solution was only temporarily effective in shock and hemorrhage and that the "internal transfusion" accomplished by hypertonic salt solution, which withdrew fluid from the tissues and thus increased the blood volume, was equally ineffective (27). It had been concluded from Bayliss' studies that gum acacia was capable of replacing blood plasma and that it had a number of desirable properties (p. 384). There was considerably less agreement, however, about its clinical value. Maj. O. H. Robertson's survey of forward hospitals in October 1918 showed that some resuscitation teams praised it, some were indifferent to it, and some condemned it. The poorest results with it were reported in very severe hemorrhage and in shock that had been untreated for 15 to 20 hours.

Maj. W. Richard Ohler, MC (28), who had had an extensive wartime experience as a resuscitation officer, made the unqualified statement after the war that hemorrhage is the most important single factor in shock and that the amount of hemorrhage determines the degree of shock. When, therefore, the need is for oxygen-carrying corpuscles, no other intravenous solution will serve the purpose. When the United States entered World War I, physicians with

the most experience in trauma took the position that when hemorrhage played a large role in the production of a circulatory deficiency, blood was preferable to any "indifferent" fluid. It was not until March 1918, however, that a committee representing the laboratory and surgical services of the U.S. Army Medical Department officially adopted transfusion with citrated blood as the method for combating shock and hemorrhage in hospitals of the American Expeditionary Forces.

Donors.—Hospital personnel were classified in blood groups for emergency use, but donors were chiefly secured from lightly wounded and gassed patients who, on admission, were sent to wards near the shock wards. Patients with scabies and convalescents who were nonfebrile and in good condition also served as donors. No rewards were offered and all donations were voluntary, without compulsion of any kind. Not more than 600 cc. was drawn at any one time, and the same donor could not be used twice within one week.

Technique.—Equipment for blood transfusion (fig. 3) consisted of a 1,000-cc. bottle with two rubber stoppers, each with two perforations; appropriate glass and rubber tubing; and two transfusion needles, a larger one for bleeding the donor and a smaller one for giving blood to the recipient. A satisfactory suction and pressure pump could be made from an ordinary Davidson syringe; suction or pressure was created as necessary by reversing the ends. The equipment was either sterilized in the autoclave or boiled in distilled or previously boiled water. The needles were sterilized just before they were needed, in boiling liquid petrolatum or Albolene, and were left in the medium until used. Great care was taken in cleansing the apparatus after the transfusion.

The blood was drawn into a solution of 0.6-percent sodium citrate in 700 cc. of physiologic salt solution. It was ordinarily used as soon as it was collected, but it could be kept for several hours. The container was kept in water at about body temperature during the transfusion. No provisions were made for transfusion during operation, but precautions were taken to lose as little blood as possible.

Postwar evaluation of replacement therapy.—A questionnaire circulated in advance of the 11th session of the Research Society of the American Red Cross in France, held on 22–23 November 1918 and attended by representatives of the Medical Departments of the Allied and U.S. Armies, produced the following information on replacement therapy (not all officers queried replied to all questions) (29):

1. All 31 officers who voted on this question preferred blood to gum acacia-salt or salt solution.
2. No serum reactions were reported by 29 officers when blood was properly grouped. Five others reported slight or rare reactions.
3. Difficulties in transfusion therapy included the length of time necessary to collect the blood, clotting in the needle during administration of the blood, inability to secure donors; keeping donors under careful control, and the inconvenience of having corpsmen who served as donors off full duty for 24 to 48 hours after their donations.

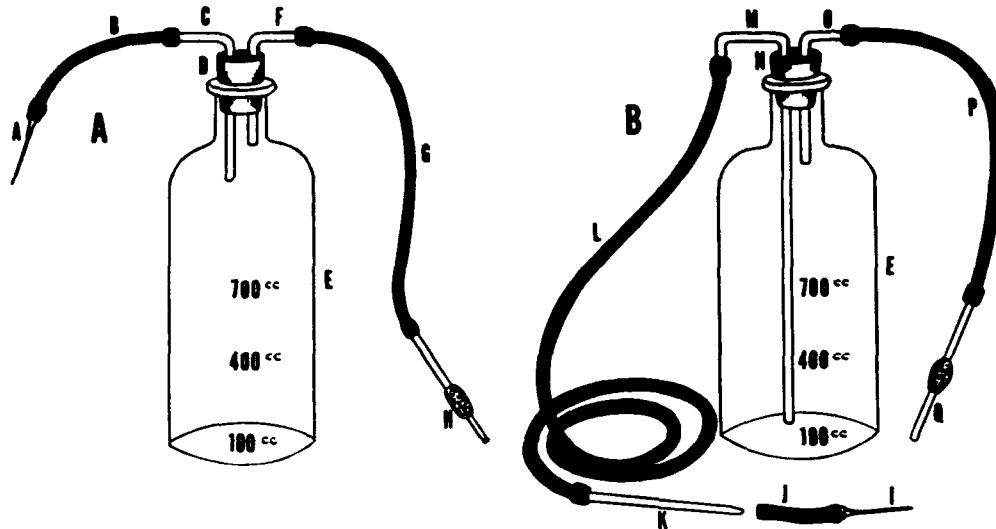

FIGURE 3.—Blood transfusion apparatus used in World War I.

- A. a. Transfusion needle.
 b. Rubber tube.
 c. Glass tube.
 d. Rubber stopper.
 e. 1-liter bottle.
 f. Glass tube.
 g. Rubber tube.
 h. Glass tube for suction, with cotton in bulb.
- B. i. Transfusion needle.
 j. Rubber tube.
 k. Glass tube.
 l. Rubber tube.
 m. Glass tube.
 n. Rubber stopper.
 o. Glass tube.
 p. Rubber tube.
 q. Glass tube for exerting compression (cotton in bulb) (27).

4. Seven hospitals had no experience with blood transfusion in prolonged infections; 43 reported definite improvement after its use, 2 temporary improvement, and 10 no improvement.

5. Twenty-six medical officers preferred the sodium citrate technique of blood transfusion. Three preferred the paraffin-tube technique, and the Kimpton-Brown and the syringe techniques received one vote each.

6. Because of numerous unfavorable reactions and some deaths after its use, one hospital was "very positive against" gum acacia-salt solution, and others considered it very dangerous or found nothing to recommend it.

SPANISH CIVIL WAR (1936-39)

Barcelona Blood Transfusion Service

The Spanish Civil War (30-31), which ended in January 1939, almost 3 years before the United States entered World War II, proved conclusively, and for the first time in military history, the practicability of supplying wounded men in forward medical installations with stored blood secured from a civilian population. Franco's armies, following the practice of the German Army (p. 22), supplied blood at fully equipped medical centers in the rear. The Republic Army Medical Corps supplied it at advanced medical units in the field.

In the 2½ years of its operation, from August 1936 through January 1939, the Barcelona Blood Transfusion Service collected more than 9,000 liters of blood in 20,000 bleedings, prepared more than 27,000 tubes of blood for forward use, maintained a list of 28,900 donors, and also prepared all necessary grouping sera.

Blood was kept under refrigeration, which was provided by electric ice-boxes whenever current was available. It was supplied to classification stations in heat-insulated wood or canvas boxes, with thick cord linings.

Transfusion data were recorded on special cards provided with all blood containers. The records were so complete that it was possible to trace every container to its point of origin in the collection center and to identify every forward hospital in which blood had been given, the data including the name of the person who had performed the transfusion. Blood was prescribed by surgeons but administered by personnel of specially trained transfusion teams.

Donors were between 18 and 50 years of age. All blood was collected into a closed system, under strictly aseptic precautions. Citrate and glucose were added after collection, and bloods of the same group were mixed.

Clinical considerations.—Only badly shocked casualties received blood at classification posts. Most transfusions were given in No. 1 hospitals, where very few seriously wounded patients did not receive them. Occasionally, if stored blood was not available or if the sector was particularly quiet, direct transfusions were given. The members of the hospital staff had previously been grouped and serologically tested against such emergencies.

Indications for blood and plasma administration were as follows:

1. Casualties with serious hemorrhage were given only blood, which was injected as rapidly as possible, because cardiac function soon deteriorates when systoles contract on a vacuum.

2. Casualties suffering from primary shock and hemorrhage were given both blood and plasma. If improvement followed the use of 2 pints of blood, a pint of plasma was given to "stabilize the improvement." Thereafter only plasma was used. If the response to the first transfusion was not satisfactory, a third pint of blood was given before plasma was used.

3. Casualties suffering only from shock were given 2 pints of plasma as quickly as possible, followed, if there was no improvement, by a pint of blood, also given quickly. If there was still no improvement, another pint of plasma and another pint of blood were given over the course of an hour.⁴

The concept of blood replacement was that in "posthemorrhagic" shock, at least 40 percent of the lost fluid must be restored promptly. There were, however, no quick or reliable methods for estimating the amount of blood loss. Generally speaking, 500 cc. of blood or blood derivatives was required for each fall of 10 to 20 mm. Hg in the blood pressure. Failure of the transfusion to raise the blood pressure was assumed to mean continued bleeding and indicated the need for control of hemorrhage as well as additional transfusion.

Quick administration of blood and plasma was regarded as desirable and without risk of cardiac embarrassment, since most casualties were young and healthy. The rate of administration could be regulated from a slow drip up to 100 cc. per minute. Although most casualties received the first pint of blood more quickly than the remainder, no instance of dilatation of the right heart was recorded. As Whitby pointed out in 1945, failure to restore the blood volume was a greater risk than overloading the circulation (32). In less urgent cases, speed of transfusion was not so important as administration of the necessary amounts of blood. The amounts given before and after operation varied with individual needs. Trueta usually gave from 1,000 to 1,500 cc. per casualty. Patients with infected wounds required several transfusions to restore the hemoglobin to normal values.

Madrid Blood Transfusion Institute

In September 1937, Saxton (33), a member of the British Ambulance Unit in Spain, reported on the Madrid Blood Transfusion Institute, organized by the Sanidad Militar of the Spanish Republic, which was then supplying about 400 liters of preserved blood per month and whose output was steadily increasing. The full-time personnel consisted of five physicians; five nurses; five members of the secretariat, including interpreters; and a domestic staff.

For practical reasons, only donors of groups II and IV (Moss) were utilized. The donors, all volunteers, were between 18 and 50 years of age. They were given cards that permitted them to buy extra food and were sometimes also given small quantities of rice, condensed milk, or other staples at the time of the donation. They were liable to call not oftener than every 3 weeks, and they usually gave 500 cc. at a time. Blood storage was limited to 3 weeks.

Saxton's suggestion that the Sanidad Militar organize a large-scale supply of cadaver blood by the technique of Yudin (p. 24) does not seem to have been acted upon.

⁴ The persisting distinction between shock and hemorrhage should be noted (p. 31).

BLOOD FOR BRITAIN

Origin of Program

The project in New York City hospitals which came to be known as Blood for Britain (34, 35) originated in June 1940, when Dr. Alexis Carrel, who had recently returned from France, made known the great need there for plasma for the treatment of shock in battle casualties. The idea of shipping plasma to France and England was suggested to the president of the Blood Transfusion Association of New York, and a meeting to discuss the possibility was called for 12 June 1940. It was attended by the trustees of the association; its Board of Medical Control; Dr. Carrel; experts in the field representing the Army, the Navy, NRC (National Research Council), and Rockefeller Institute; and representatives of a number of large pharmaceutical and biological firms.

It was the sense of the meeting that, even though the use of plasma was still in an experimental stage, enough knowledge was available to justify an effort at quantity production. The cooperation of the New York chapter of the American Red Cross was secured as soon as it was pointed out to its officials that the experience to be gained from this project would be of great assistance in the National Defense Program, one phase of which was the supply of plasma for the Armed Forces. At the suggestion of Col. (later Brig. Gen.) Charles C. Hillman, MC, Chief, Professional Services, Office of The Surgeon General, Army, close cooperation was established with the Subcommittee on Blood Substitutes, NRC, which had just been appointed (p. 74) and by whose advice the Army Medical Department was being guided in replacement therapy.

The program became operational on 15 August 1940, at the Presbyterian Hospital in New York, and terminated on 17 January 1941. All the plasma collected went to Great Britain, France having fallen shortly after the 12 June meeting. The program, which represented the first effort in the United States to collect large amounts of blood from voluntary civilian donors for military use, had great popular appeal, and during its existence, 14,556 donations were made.

Technique of Collection and Shipment

Liquid plasma was selected for processing rather than dried plasma, partly because the time element was vital and partly because of the expense of installing drying equipment, whose performance at this time was still inadequate and far from satisfactory.

Originally, the system by which the blood was collected was not completely closed. Later, it was realized that a completely closed system was imperative.

The plasma was separated by either sedimentation or centrifugation. To reduce viscosity, it was diluted with equal amounts of sterile physiologic salt solution; the solution, under 13 inches of water vacuum, was in the Baxter

bottle (Plasmavac) in which it was finally dispensed. Merthiolate was added in quantity sufficient to guarantee dilution of 1:10,000 in the final plasma-saline mixture.

The finished product was shipped in 1,000-cc. bottles, six to a carton. Larger packages were not practical because the shipments were made by Clipper planes—this was long before the existence of a transatlantic airlift.

Laboratory Tests and Losses From Contamination

Exactng bacteriologic and toxicity controls were required before any lot of plasma was dispensed. These tests were carried out not only in the laboratories of the participating hospitals but also in a central laboratory, under the direction of Dr. Frank L. Meleney. When the material reached England, samples from each carton were also checked bacteriologically before they were released for use. The latter precaution was instituted when it was found that certain pools of plasma that were free from bacteria when examined within 3 to 7 days after collection and processing were later found to be contaminated. Up to 1 November 1940, 1,950 liters of plasma were sent abroad as sterile after examination in Dr. Meleney's laboratory and 30 liters had been discarded because of contamination. The delayed contamination just described was discovered soon after this analysis had been made, and more rigid bacteriologic controls were at once set up. The total figures show that of 6,151 liters of plasma produced, 361 liters were found contaminated at the various hospitals and 160 liters were found contaminated in the central laboratory, the combined loss from contamination (exclusive of the amounts found contaminated in England) being 8.5 percent. The total loss from all causes was 581 liters, 9.4 percent; 151 bloods were rejected because of serologic evidence of syphilis (1.03 percent).

Analysis of Operation

The original opinion that the collection of blood and the separation of plasma would be "as simple as mixing a cocktail" promptly proved fallacious. The mass production of liquid plasma and its shipment abroad were very different from the production of small quantities for immediate local use. There were long debates on the size and shape of the collecting bottles, the stopper, the collection of blood by vacuum versus suction versus simple venous pressure, and the technique of removal of supernatant plasma. There were also discussions about the criteria for donors. Eventually, the age range was set at 21 to 60 years inclusive, the systolic blood pressure at 110 mm. Hg, and the hemoglobin level at 80 percent. Fasting was considered desirable, but the requirement proved impractical.

To set up criteria for production, to develop standard techniques, and to insure the safety of the final product involved far more difficulties than could be solved by volunteer part-time workers, and Dr. Charles R. Drew, later

Assistant Professor of Surgery, Howard University, was appointed full-time medical supervisor of the project shortly after it was initiated.

The New York experience with liquid plasma led to the later decision that dried plasma would best solve the problem of so-called blood substitutes for the Armed Forces because of its greater stability; the simplicity of its packing, storage, and transportation; and reduced losses from breakage.

The Blood for Britain project was a most valuable introduction to the later development of the American Red Cross Blood Donor Service (p. 102). The experience of the New York chapter served as a pattern for the organization and operation of the blood donor service which was to supply plasma for the Armed Forces and blood for oversea shipment. This chapter was ready to begin operations as soon as the Surgeons General of the Army and the Navy requested the American Red Cross to be responsible for the blood donor program.

There were many mistakes made in the operation of the blood and plasma program during the United States participation in World War II, but far more would have been made without the trial-and-error experience of the Blood for Britain project. The chief lesson learned was that blood and plasma, if they are to remain uncontaminated and safe for use, must be handled in a completely closed system. The vacuum system devised by Elliott in 1936 ended this particular problem (36). The gravity system of bleeding may be less damaging to red blood cells than a vacuum system, but only the completely closed system possible with a vacuum bottle insures sterility.

THE BRITISH BLOOD PROGRAM IN WORLD WAR II

The Association of Voluntary Blood Donors founded in Great Britain in 1922 later became the British Red Cross Transfusion Service, the first organization of its kind in the world and the forerunner of a number of similar associations in Great Britain and elsewhere (37). Blood banks were in operation in various hospitals in that country for at least 6 years before the outbreak of World War II.

In the months after the Munich crisis in 1938, recent advances in transfusion techniques, especially the use of stored blood on the field in the Spanish Civil War, were under constant discussion in Great Britain (32, 37, 38). The Medical Research Council, on behalf of the Ministry of Health, established four blood depots in the outer suburbs of London. Arrangements were also made to establish an Army Transfusion Service, which would enroll all available donors in the South-Western Countries and which would also supply civilian needs in that area.

In short, as Brigadier (later Sir) Lionel E. H. Whitby, RAMC, who headed the British blood program, expressed it, the British began the war with a firm policy, decided upon 6 months earlier, that there would be a completely distinct and separate transfusion service in the Army (38). Returning to the subject at a meeting of Allied medical officers on shock and transfusion in May 1945,

he pointed out that the transportation of potentially dangerous biologic fluids over long distances requires close personal supervision and cannot be trusted to the usual supply routes from a base depot medical store (32).

The British blood program was a remarkably successful operation for the two reasons just indicated: (1) that it was carefully planned before hostilities began, and (2) that it was based on the concept that blood is a perishable fluid, as potentially dangerous as it is potentially useful, and therefore to be handled in special channels by specially trained personnel. The daily, almost hourly, care that trained British officers and men gave to the blood they handled reduced accidents to a minimum. The British also regarded it as essential that their armies be self-contained as regards blood. The success of the attempt in World War II, first made by the British in the Western Desert, to bring surgeons forward to casualties, was due in large part to the successful operation of the Army Transfusion Service.

A similar separate service was recommended by the Subcommittee on Blood Substitutes, NRC, for the U.S. Armed Forces early in U.S. participation in the war (p. 76). Such a service was later set up in Italy, and time, expense, and lives would have been spared if it had been put into operation when it was proposed.

Functions of the Army Transfusion Service

The chief function of the British Army Transfusion Service was to supply blood and other fluids, including crystalloid solutions, with equipment for their use, to the entire British Army overseas and in the United Kingdom, and also to supply civilian needs in the areas of the United Kingdom in which it operated. Liquid plasma was used in temperate climates and was safely exported as far as India; it was kept cool but not under refrigeration.

Dried human grouping serum was prepared by the Army Transfusion Service. It was selected because it did not require refrigeration. It was colored with acriflavine for group A and with methylene blue for group B. The minimum titer was 1:32 against A₂ cells and 1:64 against B cells.

Organization

The British Army Transfusion Service (fig. 4) was organized on three levels: a home depot, which was chiefly a production and training center; a base transfusion unit, which was chiefly concerned with distribution, in each theater of operations; and field transfusion units, which worked in forward areas. The home depot, in addition to supplying transfusion fluids, was responsible for the mobilization, equipment, and training of transfusion units for service overseas and for the training of all ranks of the Royal Army Medical Corps in resuscitation work. The courses of instruction, which were begun in 1940, were attended by officers from the British Army, Navy, and Air Force; personnel from other Allied forces; members of the civilian Emergency Medical

Service; and, later, many U.S. Army medical officers (p. 171). In addition to instruction in blood work, the courses included preparation and assembly of crystalloid solutions, the maintenance and repair of transfusion equipment, refrigeration maintenance and repair, and autoclaving.

Bleeding was carried out by 15 mobile, fully equipped, self-contained teams, each consisting of a medical officer, who frequently was a woman, 4 VAD's (Volunteer Aid Detachments); 2 ATS (Army Transfusion Service) drivers; and an ATS orderly. Each team had two vehicles, one a lorry equipped with an icebox, and the other a four-seated car. With the equipment carried, any room could be converted into a miniature hospital ward for bleeding within 20 minutes. For steady work, each team was expected to obtain 70 to 90 pints of blood daily. In emergencies, over short periods, these amounts were exceeded, and some teams collected as much as 300 pints daily.

The 440 cc. which made up each bleeding was collected in a bleeding bottle (fig. 4) into 100 cc. of 3-percent sodium citrate solution. Later, with special equipment, 20 cc. of 10-percent dextrose was introduced into each bottle, so that it was filled to the top and its contents were not agitated during transportation. Capping was done with a special machine.

Only group O blood was used for oversea troops. It was tested by the Kahn test and doublechecked for group before it was dispensed. Brigadier Whitby had no knowledge of the dispensing of any incorrectly typed blood during the entire war (32).

Base transfusion unit.—The base organization overseas was the link between the home depot and the forward transfusion units. Its function was to estimate needs for replacement fluids; obtain supplies and equipment from the home depot; distribute them to forward areas; produce crystalloid solutions; assemble apparatus; service and repair refrigerators; and exploit local resources, usually base troops, for blood donations.

When the base unit was within reasonable distance of the home depot, as it was in France, the home unit was responsible for the supply of whole blood. Otherwise, the base unit was responsible. Blood collected locally was sent forward to field units by road in refrigerated trucks, by air in insulated boxes, or along the coast in the refrigerators of hospital ships. Personnel of the unit were equipped to give transfusions, but their multiple duties usually prevented any large-scale performance of this function.

Field transfusion units.—Field transfusion units, which were the smallest units in the British Army, were entirely self-contained and were fully equipped for transfusion in the field. Their personnel consisted of an officer and three men, one of whom drove the truck and was entirely responsible for the operation of the refrigerator, upon the efficiency of which the safety of the blood depended. These units, which were attached wherever they were most needed during a campaign, usually operated with field surgical units, the combined units forming complete surgical centers at field ambulances, field dressing stations, and casualty clearing stations. Surgeons came to rely heavily upon



FIGURE 4. British and Canadian materials and equipment for replacement therapy. A. British (right) and U.S. Army dried plasma units. B. British dispensing set for plasma.

these field transfusion teams; many of them delegated the selection of their operating lists to them. The optimum time for surgery, Brigadier Whitby pointed out, was often "a fleeting moment indeed," and the teams working on the wards, with their skill in resuscitation, were often best equipped to pick that moment (32).

Experience in France, 1910

During the so-called phony war, the personnel of the Transfusion Service utilized the time developing a large donor panel, which eventually included

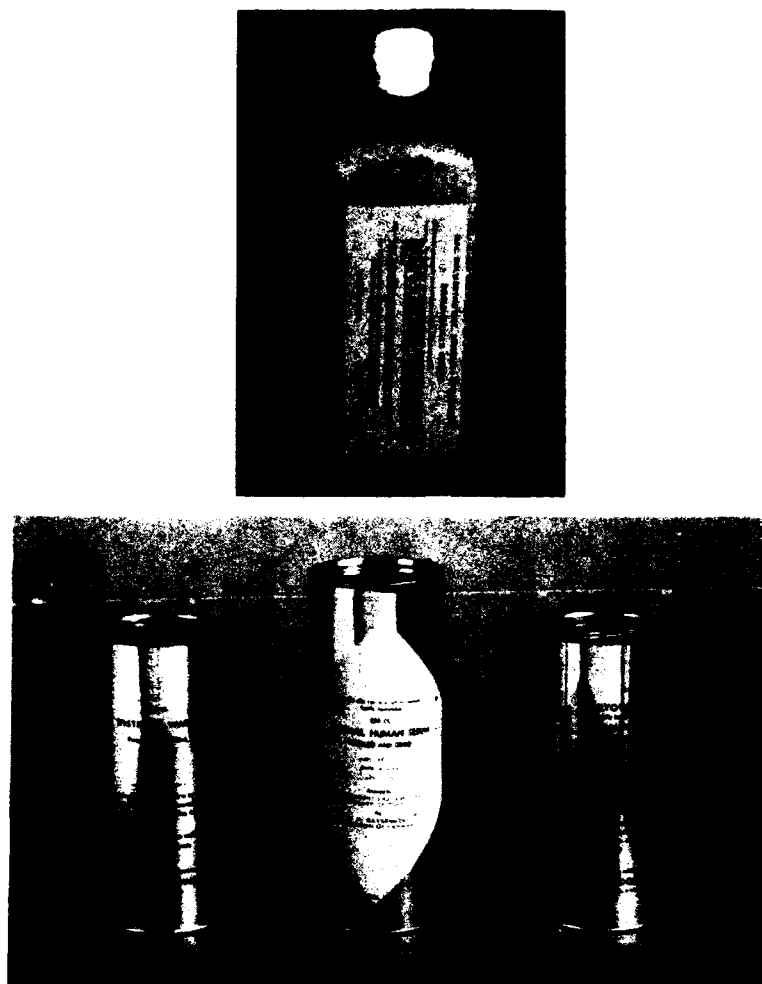

FIGURE 4.—Continued. C. Original British dried human serum unit, prepared at University of Cambridge. D. Canadian dried human serum unit (center), shown with distilled water and dried plasma units of U.S. Army. The Canadian package, which contained 250 cc. of serum, was as large again by a third as the U.S. plasma unit.

more than 350,000 names; carrying out studies on the keeping properties of blood, especially when it was transported overseas; determining the merits of various blood substitutes; and developing a technique for the filtration of plasma.

This was a difficult period for the Transfusion Service. It was necessary to bleed donors to provide for possible needs, but at the same time impractical to build up a reserve. Blood was sent to France by air, and later was flown to Norway, where it was flown directly to transfusion units operating in forward zones.

About 400 units of stored blood seem to have been used on the Continent between the invasion of the Low Countries on 10 May and the Dunkirk evacuation. In an editorial in the *British Medical Journal* on 10 August 1940, a

request was made for information concerning the use of whole blood, plasma, and crystalloid solutions during the campaign in Flanders and in France, when conditions prevented the collection of data (39). What was desired was not data "that would satisfy medical statisticians" but information that would permit the evaluation of various replacement fluids. In particular, data were requested that would throw light upon the length of time blood could safely be stored. During this period, medical officers frequently had no choice but to use such blood as they had, and other physicians might find themselves in similar circumstances in the frontline at any time, whether or not they were serving with the Armed Forces.

The reply to this request, from W. d'A. Maycock (40) in a letter to the *Journal*, 5 October 1940, is a remarkable statement of what was accomplished in casualty clearing stations subject to aerial bombardment, limited in numbers because of the highly mobile type of warfare, and manned by overworked medical officers:

The rapid response of the Army blood supply depot at Bristol to requests made immediately after the invasion of the Low Countries permitted the stocking of mobile refrigerators, in which only small supplies of blood had previously been stored, at the casualty clearing stations. Within 4 or 5 days, each of the eight teams attached to these stations and the teams attached to the medical base at Boulogne had received 60 to 80 pints of blood, with some plasma. Glucose-saline solutions had already been stockpiled. One casualty clearing station designated as an advanced blood depot was provided with extra quantities of blood and was given transport to distribute it as necessary to other stations. Some forward units could not function at all.

The provision of apparatus for transfusion with each bottle of blood was ideal for active service and permitted transfusion under almost any conditions. The knowledge that there would be no further supplies of blood made officers use what was available very conservatively, and it was withheld from casualties who in happier circumstances would surely have received it. Transportation of blood for long distances over rugged roads did not seem to increase hemolysis, and there was no known instance of serious infection after a transfusion, even though the blood was often injected without regard to asepsis or antisepsis. No serious reactions were reported after transfusions with blood 3 weeks old and, in one instance, 7 weeks old, and amazingly good results were often obtained in apparently moribund casualties.

Clinical Considerations

At the Conference on Shock and Transfusion, 25 May 1945, Brigadier Whitby noted that between that date and 1939, the pendulum had swung back and forth on a number of points (32):

1. Early experience with air raid casualties suggested that the necessary volume of transfused fluid was often almost incredibly large. Then came a wave of apprehension that these quantities were producing pulmonary edema, as in some instances they were. The

amounts administered in shock and hemorrhage had now become stabilized, but seriously wounded casualties, especially those with massive wounds of the extremities, still required very large volumes of replacement fluids.

2. It was now well understood that plasma had its optimum usefulness in forward areas, to restore and maintain the efficiency of the circulation. Only whole blood transfusions, however, could render a casualty fit for surgery.

3. Speed in administration was essential. If a casualty was exsanguinated, an experienced resuscitation officer would have blood going into two veins at once. There was no danger of pulmonary edema at this time.

4. Blood and plasma were supplied so generously to the Armed Forces that if a casualty were wounded at all, he was fortunate to "escape" transfusion, even if he did not need it. It had been learned that, at least in wounds of the chest and of the central nervous system, blood, if given at all, should be administered with great moderation. In extremity wounds, although transfusion was needed, it introduced the risk of fat embolism.

Col. Frank B. Berry, MC, Consultant in Surgery, Seventh U.S. Army, supported Brigadier Whitby's warning about the unwise use of blood by the specific illustration of a casualty with blast injuries of the head and lungs whose life was saved in these circumstances only because he had a hemorrhage from the iliac artery.

THE SOVIET UNION BLOOD PROGRAM IN WORLD WAR II

While not a great deal is known about replacement therapy in the Soviet Union during World War II, all reports indicate that blood was the chief replacement fluid (41-43). This might be expected because of the large civilian population; its proximity to the frontlines; the cold climate, which eliminated many of the difficulties of preservation and storage; and, perhaps, the lack of facilities for processing blood to plasma or serum (p. 95).

The nationwide transfusion service that existed in the Soviet Union before the war was organized in Moscow in 1926, by Lt. Col. Andre Arkadievich Bagdasarov. This officer later directed transfusions under fire during the border warfare with the Japanese in 1939 and during the war with Finland in 1940-41.

The Central Institute for Blood Transfusion in Moscow was at the head of several subordinate institutes and about 1,500 blood donor centers. When Russia entered World War II, this organization became, in effect, a system of factories for collecting and preserving blood and delivering it to the front as it was needed.

About 2,000 persons a day gave blood in Moscow, about the same number who donated at the two blood centers in New York. All possible methods of "sanitary" propaganda were used to attract donors. About 95 percent of the donors were women, as compared with 50 percent in the United States. Donations ranged from 225 to 450 cc. A second donation was permitted in 4 to 6 weeks, but only if the blood picture had returned to normal. With these precautions, some donors had given blood for periods of 12 to 15 years with no ill effects.

A standard four-cornered container was used to collect and administer blood. The bottles were transported, preferably by plane, in specially constructed isothermic boxes, suitable for use in both warm and cold weather. Blood was also put up in 200-cc. ampules which could be carried by medical corpsmen and used well forward.

The Russians used type O blood for most battlefield transfusions and also used large amounts of type-specific, unpooled plasma. The institute worked out a method which permitted the preservation of blood for 3 or 4 weeks without loss of its biologic properties and also devised a technique for drying plasma that insured its solubility without turbidity or precipitation.

Transfusions were given at all points up to the regimental medical aid station (battalion aid station) but were most widely used at the medical sanitary battalion service level (collecting station). The most important indication was hemorrhage with shock, especially in wounds of the abdomen and extremities. The combined experience of the institute and the army was that only large transfusions, from 1,000 to 1,500 cc., given rapidly, were effective in shock.

THE GERMAN EXPERIENCE IN WORLD WAR II

When the blood program originated in Germany is not entirely clear. A civilian program was set up in 1940 by an administrative law which permitted donations of only Aryan blood and which provided for payments of 10 marks for the first 100 cc. and 5 marks for each additional 100 cc. (43).

The military procurement program was apparently an outgrowth of this civilian program. The Laboratory for Blood Transfusion in Berlin, which directed the military program, was disrupted by heavy bombings, and all the evidence suggests that the supply of blood was insufficient and that containers and technical equipment were in short supply.

Donors included medical personnel, nursing sisters, staff assistants, and slightly wounded men. An endeavor was always made to rule out tuberculosis, malaria, and syphilis in donors, but serologic examinations were seldom practical and the donor's statement that he had not had syphilis usually had to be accepted. Blood groups entered in the soldiers' pay books were frequently incorrect, and new determinations had to be made before each transfusion. If this was not possible, a test injection of 10 cc. of blood was made.

The German experience with preserved blood was chiefly between 1940 and 1942. There were so many serious reactions that medical officers lost interest in it. Those who reported satisfactory results were usually in favorable positions, along the lines of transportation. Some medical officers had never seen preserved blood used in the field without "deleterious" chills. Plasma and serum were seldom used, although officers who used captured U.S. stocks of plasma were enthusiastic about it.

Special report.—After the German surrender in Italy on 1 May 1945, an unusual opportunity arose to study German management of battle casualties

(44). On the instruction of the Fifth U.S. Army Surgeon, Lt. Col. (later Col.) Howard E. Snyder, MC, visited a number of German medical installations, including the equivalents of U.S. field, base, and convalescent hospitals. In his report, which is included in detail in another volume of this historical series (44), Colonel Snyder emphasized that observers could not judge the standards of German medical practice in the first years of the war in the light of what they found in May 1945, after the total collapse of the Army, nor could they judge the quality of German medical practice elsewhere in Europe in the light of what they found in Italy.

The German management of shock and hemorrhage was thus in sharp contrast to the U.S. practices, by which plasma was always available, and was used in the quantities indicated, in all forward medical installations, while banked blood was available in adequate quantities in field hospitals adjacent to division clearing stations. The extreme pallor of many of the wounded observed in German hospitals, and the moderate pallor of most of the others, supported the deduction that they had received little if any blood.

OTHER SOURCES OF BLOOD

To complete the record of the status of transfusion at the beginning of World War II, three other possible sources of whole blood should be briefly mentioned; namely, blood secured from the patient's own blood, that is, autotransfusion; cadaveric blood; and placental blood.

Autotransfusion.—Autotransfusion (autohemofusion, autoinfusion) was first suggested by Highmore in 1874, as a sort of afterthought in a fatal post-partal hemorrhage (45). Halsted, in 1884, treated several patients with carbon monoxide poisoning by drawing blood from the victims, defibrinating it, and then reinfusing it. Autotransfusion was apparently first employed in trauma by Duncan of Edinburgh in 1885, in an amputation for a crushing injury of the leg (1). The patient, who was close to death at the end of the operation, made a rapid recovery.

In 1923, Burch (46) collected from the literature 164 cases, chiefly from Germany, in which this method had been used, and several other large collections were made during the next several years. Autotransfusion proved particularly useful in ruptured ectopic pregnancy. Most of the unfavorable reactions and some of the fatalities could be explained by the fact that the blood had been in serous cavities for periods up to 72 hours before it was used.

In World War I, according to Yates (47), the large amounts of blood and "colored fluid" removed in massive hemothoraces suggested the possibility of autotransfusion, but tests showed that the attendant risks were prohibitive and the method was not used.

Autotransfusion, naturally, became less necessary as blood banks were set up, but early in World War II, when blood was still in short supply, it proved a valuable method in occasional severe chest injuries in which it was certain that there was no injury of the abdominal viscera.

Cadaveric blood.—In 1928, Shamov reported the experimental use of cadaveric blood and demonstrated the absence of toxicity (48, 49). At this time, Yudin was in charge of the entire surgical and accident department of the Sklifosovsky Institute, the central hospital for emergency surgery in Moscow, in which from 8,000 to 10,000 patients were treated every year. The admissions also included many patients who died promptly from acute cardiac disease or severe trauma. In other words, the patients who needed transfusion and the bodies from which, in the light of Shamov's demonstration, the necessary blood could be secured, were both at hand.

Yudin reported his first seven transfusions with cadaveric blood at the Fourth Congress of Ukranian Surgeons at Kharkov in September 1930. The work was investigated by two commissions, one legal and the other military, both of which recognized its scientific foundation, and he was given a special permit to collect blood from fresh cadavers before autopsy.

With the discovery that cadaveric blood could be stored safely, time was provided for both serologic tests and bacteriologic examinations. In November 1932, Yudin reported to the Société Nationale de Chirurgie in Paris on 100 transfusions with cadaveric blood kept for 3 weeks, and in one instance 4 weeks. In 1937, he reported in the *Lancet* that he had performed a thousand transfusions by this method, chiefly for internal hemorrhage and traumatic shock and in operations for gastrointestinal disease, particularly cancer.

In Yudin's first 200 transfusions, all performed with citrated blood, there were 40 reactions, all moderate. In the next 800 transfusions, all performed with noncitrated blood, the incidence of reactions fell to 5 percent. The five fatal cases in the series were explained in three instances by technical errors, including the transfusion of incompatible blood. The fourth death was due to embolism and the remaining death to anaerobic infection.

Cadaveric blood was apparently never used widely, even in Russia. It was not mentioned to Dr. George K. Strode (42) of the Rockefeller Foundation, who visited the Central Blood Transfusion Institute of Moscow in October 1941, and no statement in the literature suggests that it was used during the war. It is doubtful that transfusions with blood secured from cadavers could ever have been employed in any country in the world except Russia, for the idea, in spite of its logic, is revolting.

Placental blood.—In February 1938, J. R. Goodall of Montreal, with a group of his associates, published a communication whose title proclaimed "an inexhaustible source of blood for transfusion" (50). This source was the placenta, from which amounts of blood ranging from 100 to 150 cc. had been collected under sterile precautions. The preservative used was the solution proposed by the Moscow Institute of Hematology (sodium chloride, sodium citrate, potassium chloride, magnesium sulfate, double-distilled water), and the blood had been kept in a refrigerator as long as 60 days at temperatures of 33° to 38° F. (1° to 3° C.). Serologic tests were not necessary, as they had been run on the mothers. Cultures were not considered necessary: the reason-

ing was that at the low storage temperature, contamination, if it was present, could not propagate and would be so attenuated as to be innocuous.

The Goodall report gave no definite figures but stated that "many" transfusions had been accomplished with placental blood with no reactions of any kind. It was concluded that the maternity section of a general hospital could provide blood for the whole hospital, supply other institutions, and also prove a source of income, since private patients could be charged for the transfusions. In the opinion of the Montreal group, placental blood could be regarded as a "safe, constant, efficient, and lucrative" source for transfusion.

Boland and his associates (51), reporting in the *Lancet* in February 1939, were considerably less enthusiastic about placental blood. They had experienced several serious reactions with it and found contamination in 30 percent of 40 specimens of fetal blood collected by the Goodall technique.

Placental blood was never used in the United States, and it was not employed in World War II.

References

1. Kilduffe, Robert A., and DeBakey, Michael: *The Blood Bank and the Technique and Therapeutics of Transfusions*. St. Louis: C. V. Mosby Co., 1942.
2. Lewisohn, R.: *The Development of the Technique of Blood Transfusion Since 1907; With Special Reference to Contributions by Members of the Staff of the Mount Sinai Hospital*. *J. Mt. Sinai Hosp.* 10: 605-622, January-February 1944.
3. Lewisohn, R.: *Blood Transfusion: 50 Years Ago and Today*. *Surg. Gynec. & Obst.* 101: 362-368, September 1955.
4. Ottenberg, R.: *Reminiscences of the History of Blood Transfusion*. *J. Mt. Sinai Hosp.* 4: 264-271, November-December 1937.
5. Blundell, J.: *Experiments on the Transfusion of Blood by the Syringe*. *M. Chir. Tr.* 9: 56-92, 1828 (London).
6. Blundell, J.: *Observations on Transfusion of Blood. With a Description of His Gravitator*. *Lancet* 2: 321-326, 31 June 1828.
7. Blundell, J.: *Successful Case of Transfusion*. *Lancet* 1: 431-432, 3 Jan. 1829.
8. Benedict, N. B.: *Transfusion in Yellow Fever—A Successful Case*. *New Orleans M. News and Hosp. Gaz.* 5: 721-727, January 1859.
9. Benedict, N. B.: *On the Operation of Transfusion—Being the Report of a Committee*. *New Orleans M. & S. J.* 10: 191-205, September 1853.
10. Landois, L.: *Die Transfusion des Blutes*. Leipzig: F. C. W. Vogel, 1875.
11. Landsteiner, K.: *Zur Kenntniss der antifermentativen lytischen und agglutinierenden Wirkungen des Blutserums und der Lymphe*. *Zentralbl. Bakt.* 28: 357-362, 23 Mar. 1900.
12. Lindeman, E.: *Simple Syringe Transfusion with Special Cannulas. A New Method Applicable to Infants and Adults. Preliminary Report*. *Am. J. Dis. Child.* 6: 28-32, July 1913.
13. Unger, L. J.: *A New Method of Syringe Transfusion*. *J.A.M.A.* 64: 582-584, 13 Feb. 1915.
14. Editorial, *Transfusion of Blood in Military and Civil Practice*. *Lancet* 1: 773-774, 1 June 1918.
15. Moynihan, B.: *The Operation of Blood Transfusion*. *Lancet* 1: 826, 8 June 1918 (Correspondence).
16. Fullerton, A., Dreyer, G., and Bazett, H. C.: *Observations on Direct Transfusion of Blood, With a Description of a Simple Method*. *Lancet* 1: 715-719, 12 May 1917.

17. Robertson, L. B.: The Transfusion of Whole Blood. A Suggestion for Its More Frequent Employment in War Surgery. *Brit. M. J.* 2: 38-40, 8 July 1916.
18. Robertson, L. B., and Watson, C. G.: Further Observations on the Results of Blood Transfusion in War Surgery. With Special Reference to the Results in Primary Haemorrhage. *Brit. M. J.* 2: 679-682, 24 Nov. 1917.
19. Robertson, L. B.: A Contribution on Blood Transfusion in War Surgery. *Lancet* 1: 759-762, 1 June 1918.
20. Robertson, L. B., and Watson, C. G.: Further Observations on the Results of Blood Transfusion in War Surgery; With Special Reference to the Results in Primary Hemorrhage. *Ann. Surg.* 67: 1-13, January 1918.
21. Robertson, O. H.: Transfusion With Preserved Red Blood Cells. *Brit. M. J.* 1: 691-695, 22 June 1918.
22. Makins, G. H.: Injuries to the Blood Vessels. *In History of the Great War Based on Official Documents. Medical Services Surgery of the War.* London: His Majesty's Stationery Office, 1922, vol. II, pp. 170-206.
23. Guiou, N. M.: Blood Transfusion in a Field Ambulance. *Brit. M. J.* 1: 695-696, 22 June 1918.
24. Lee, R. I.: A Simple and Rapid Method for the Selection of Suitable Donors for Transfusion by the Determination of Blood Groups. *Brit. M. J.* 2: 684-685, 24 Nov. 1917.
25. Ward, G. R.: Transfusion of Plasma. *Brit. M. J.* 1: 301, 9 Mar. 1918 (Correspondence).
26. Hartman, F. W.: New Methods for Blood Transfusion and Serum Therapy. *J.A.M.A.* 71: 1658-1659, 16 Nov. 1918.
27. Cannon, W. B.: Wound Shock. *In The Medical Department of the United States Army in the World War.* Washington: Government Printing Office, 1927, vol. XI, pt. I, pp. 185-213.
28. Ohler, W. R.: *Treatment of Surgical Shock in the Zone of the Advance.* *Am. J. M. Sc.* 159: 843-853, June 1920.
29. Collective Surgical Experiences at the Front and at the Base. *In The Medical Department of the United States Army in the World War.* Washington: Government Printing Office, 1927, vol. XI, pt. I, pp. 130-165.
30. Trueta, J.: *The Principles and Practice of War Surgery With Reference to the Biological Method of the Treatment of War Wounds and Fractures.* St. Louis: C. V. Mosby Co., 1943.
31. Jolly, Douglas W.: *Field Surgery in Total War.* New York: Paul B. Hoeber, Inc., 1941.
32. Conference on Shock and Transfusion, 25 May 1945.
33. Saxton, R. S.: The Madrid Blood Transfusion Institute. *Lancet* 2: 606-607, 4 Sept. 1937.
34. Report of the Blood Transfusion Association Concerning the Project for Supplying Blood Plasma to England, Which Has Been Carried on Jointly With the American Red Cross from August, 1940, to January, 1941. *Narrative Account of Work and Medical Report.* New York: Blood Transfusion Association, 31 Jan. 1941.
35. Stetten, D.: The Blood Plasma for Great Britain Project. *Bull. New York Acad. Med.* 17: 27-38, January 1941.
36. Elliott, J.: A Preliminary Report of a New Method of Blood Transfusion. *South. Med. & Surg.* 98: 643-645, December 1936.
37. Proger, L. W.: Development of the Emergency Blood Transfusion Scheme. *Brit. M. J.* 2: 252-253, 29 Aug. 1942.
38. Whitby, L. E. H.: The British Army Blood Transfusion Service. *J.A.M.A.* 124: 421-424, 12 Feb. 1944.
39. Editorial, War Surgery: Information Wanted. *Brit. M. J.* 2: 196, 10 Aug. 1940.
40. Maycock, W. d'A.: Blood Transfusion in the B. E. F. *Brit. M. J.* 2: 467, 5 Oct. 1940 (Correspondence).

41. Phalen, J. A.: The Blood Plasma Program. Division of Medical Sciences, NRC, Washington: Office of Medical Information, 25 July 1944.
42. Strode, G. K.: Blood Transfusion and Donorship in the U.S.S.R. New York: Rockefeller Foundation, 14 Nov. 1941.
43. Blood Procurement Programs in Other Countries. Distribution 74427, American Red Cross Blood Donor Service.
44. Snyder, H. E.: Fifth U.S. Army. *In* Medical Department, United States Army. Surgery in World War II. Activities of Surgical Consultants. Volume I. Washington: U.S. Government Printing Office, 1962.
45. McClure, R. D., and Dunn, G. R.: Transfusion of Blood. History, Methods, Dangers, Preliminary Tests, Present Status. Report of One Hundred and Fifty Transfusions. Bull. Johns Hopkins Hosp. 28: 99-105, March 1917.
46. Burch, L. E.: Autotransfusion. Surg. Gynec. & Obst. 36: 811-814, June 1923.
47. Yates, J. L.: Wounds of the Chest. *In* The Medical Department of the United States Army in the World War. Washington: Government Printing Office, 1927, vol. XI, pt. I, pp. 342-442.
48. Yudin, S. S.: Transfusion of Stored Cadaver Blood. Practical Considerations: The First One Thousand Cases. Lancet 2: 361-366, 14 Aug. 1937.
49. Minutes, meeting of Subcommittee on Blood Substitutes, Division of Medical Sciences, NRC, 24 Feb. 1943.
50. Goodall, J. R., Anderson, F. O., Altimas, G. T., and MacPhail, F. L.: An Inexhaustible Source of Blood for Transfusion and Its Preservation. Surg. Gynec. & Obst. 66: 176-178, February 1938.
51. Boland, C. R., Craig, N. S., and Jacobs, A. L.: Collection and Transfusion of Preserved Blood. An Improved Technique. Lancet 1: 388-391, 18 Feb. 1939.

CHAPTER II

Shock

The development of the concept of whole blood transfusion in the management of battle casualties was intimately related to the development of a correct concept of shock. The confused and incorrect concept of this condition held in many quarters at the onset of World War II accounted, in large part, for the delayed development of the whole blood program in the Zone of Interior and for the trial-and-error period of shock therapy overseas.

HISTORICAL NOTE

Attempts to study shock during World War I by the special committee appointed for that purpose, while generally unsuccessful, at least discredited such existing theories as the reflex vasomotor paralysis theory, the theory of exhaustion of the vasomotor center, the apnea theory, and the theory of adrenal exhaustion (1, 2). Cannon's (3) conclusion that the absorption of toxins from injured tissues was the primary cause of traumatic shock, which was based on his own clinical and experimental studies for the Shock Committee, was supported by other observers. In retrospect, however, it is clear that this theory was not supported by adequate proof and that the attempt to distinguish between shock and hemorrhage was equally fallacious.

OBSERVATIONS BETWEEN THE WORLD WARS

Even in an increasingly mechanized age, severe shock associated with trauma is not often encountered in civilian practice in peacetime, nor, with really rare exceptions, such as the Cocoanut Grove disaster (p. 697), is it ever encountered en masse. Isolated clinical observations are possible in peacetime, but the circumstances of war, with its mass casualties and wide variety of wounds, provide the only really propitious material for the clarification of shock and other problems associated with wounding.

It is not surprising, therefore, that after World War I, the problem of shock was transferred to experimental laboratories, in which attempts were made to study it by physiologic and chemical techniques under a wide variety of experimentally induced conditions.

The theory of toxemic shock persisted until the late twenties, when Blalock (4), and a little later Parsons and Phemister (5), demonstrated that shock produced by trauma to the limbs is not the result of toxemia but of a local loss of blood and fluid and of circulating blood volume. Experiments by a number

of other observers also failed to identify toxic substances in the bloodstream of shocked animals and persons.

Between the wars, a number of misconceptions developed concerning shock. For years, some observers continued to insist that the only explanation of so-called true shock was a generalized increase in capillary permeability, a concept introduced with the theory of traumatic toxemia and based on the observation that red blood cell counts from the capillary bed were high, particularly in comparison with counts from the venous blood. In World War II, this phenomenon was found to be both a late and a very infrequent development. Actually, the explanation of the hemoconcentration was fluid shift. The erroneous concept just described, however, was so widely accepted that it was included in the manual on shock prepared under the auspices of the Committee on Surgery, Division of Medical Sciences, NRC (National Research Council) (6).

In 1936, Freeman and his associates (7) were able to show that in shock there is a reduction of the volume flow of blood in the hand from the normal rate of 7 cc. per minute per 100 cc. volume to 1.3 cc. The result is a progressive tissue asphyxia, which goes on to tissue death if the increasing oxygen debt is not repaid. The rate of blood flow decreases much sooner than the blood pressure falls or hemoconcentration occurs. From their observations, Freeman and his group concluded that the blood volume is a more reliable index of shock than the blood pressure. At this time (1936), there was no practical method of determining blood volume under field conditions. The Freeman group suggested that, as an expedient, it might be useful to make a rough calculation of the time necessary to refill the veins of the forearm and hand after they were stripped; normally, they fill immediately.

INITIAL CONCEPTS OF SHOCK AND SHOCK THERAPY IN WORLD WAR II

When the United States entered World War II, the following concepts of shock were generally accepted:

1. The reduction in blood volume present in peripheral circulatory failure is the most important single factor, if not the initiating factor, in the production of the clinical picture seen in shock. It results from the loss of plasma, at first locally and then generally, into the extravascular tissue spaces. Most therapeutic efforts in shock must be directed toward overcoming this loss of blood volume.

2. The reduction in the rate of blood flow is associated with a diminished venous return, which results in a decreased cardiac output, though the heart and the nervous energies that control it are not incapacitated.

3. The vasomotor center remains active.

4. Hemoconcentration is usually present in shock not associated with hemorrhage (burns, crushing injuries) and tends to reflect the amount of plasma lost.

In 1920, Maj. W. Richard Ohler, MC (8), had expressed the firm opinion, based on his World War I experience, that the most important single factor in shock is hemorrhage and that the degree of shock depends upon the amount of blood lost (p. 8). The therapeutic need, he said unequivocally, is therefore for oxygen-carrying corpuscles, and no intravenous solutions can replace them. It would have been desirable, he continued, to have a method of calculating the total hemoglobin and blood volume, but the use of citrated blood, even without this precise knowledge, was both simple and efficacious.

Between this time and the outbreak of World War II, numerous other observers had arrived at the same point of view, but they did not make their voices heard. Most of them did not even try. The rather general belief at the outbreak of the war that plasma alone could compensate for the loss of whole blood in shock simply reflected the prevailing point of view that blood loss was not necessarily the primary cause of shock. It is not easy, in looking back, to understand how these concepts were ever accepted, yet some of the most competent physicians in the country believed that plasma alone could compensate for the massive blood losses which occurred in trauma. It was a belief which did a disservice to the true and important role of plasma in the therapy of shock. Also, as pointed out elsewhere (p. 9), many observers who believed that only whole blood was effective in shock did not believe that it would ever be practical to provide it for forward areas.

Attempts to transfer controlled laboratory studies to combat conditions led to confusion, as might have been expected, for they were based upon faulty premises. As Beecher (1) pointed out, the belief that plasma would be as effective as whole blood in the management of hemorrhagic shock seems to have been derived from laboratory experiments so set up that the number of variables could be strictly limited. There was, of course, no real resemblance between a combat soldier who had suffered a serious wound or wounds and a rabbit lying quietly in its cage after experimental deprivation of 75 percent of its blood volume. The very management of the wounded soldier, including his successive removal rearward from the battlefield through the chain of evacuation, produced additional trauma, which was further increased by physical and roentgenologic examinations, anesthesia, and operation. Transfer of laboratory conclusions to a combat situation with its additional and widely different variables was simply unsound reasoning, which led to therapeutic confusion.

Nomenclature

The prewar confusion in the concept of shock was in no wise diminished by the confusing nomenclature employed to designate the condition and the loose use of the term.

In 1918, Mann (9) defined shock as a term used by surgeons to describe a definite clinical condition probably due to a number of causes but always occurring in one or the other of two groups of cases: (1) those in which clinical manifestations followed some time after the occurrence of conditions incidental to shock, or (2) those in which a severe or fatal condition

supervened immediately upon receipt of the active agent. The vagueness of the definition, propounded, as it was, by a physician of Mann's ability and experience, is indicative of the vagueness of the concept of shock at that time.

In 1930, Parsons and Plemister (5) stated that it was more correct to speak of hemorrhage than of shock, or to speak of shock due to hemorrhage when acute loss of blood in wounds, whether closed or open, was the cause of marked circulatory embarrassment or failure. At the same time, these observers cited Blalock's criticism, in 1927, of the current loose use of the term. Shock, in Blalock's opinion, should be considered not as a disease but as a group of symptoms which might be produced by a number of factors, including acute hemorrhage, wounds, and anesthesia. Later, Blalock (4) was to be the first to use the term "peripheral circulatory failure" for shock.

In 1938, Moon (10) defined shock as a circulatory deficiency, of neither cardiac nor vasomotor origin, characterized by decreased blood volume, decreased cardiac output (reduced blood volume flow), and increased hemoconcentration.

In 1941, Janeway (11) described primary shock as a condition of vascular collapse in which the tone of the peripheral vessels was diminished reflexly as a result of psychic stimuli. Primary shock, in his opinion, was difficult to distinguish from secondary shock, another term used very loosely indeed early in World War II. If there was not prompt improvement after such measures as warmth, hot fluids, morphine, and the shock position (considered useful because gravity played such an important part in the pooling of the blood), then true secondary shock was undoubtedly present. In secondary shock, by Janeway's definition, the volume of blood was insufficient to maintain an adequate peripheral circulation, not because of vasodilatation (as a matter of fact, vasoconstriction was usually present) but because of blood loss. In secondary shock, whole blood was a more desirable replacement fluid than plasma because both red cells and plasma had been lost.

It is significant that, in his excellent study on casualties in the Battle of El Alamein, Lt. Col. W. C. Wilson, RAMC, began with a definition (12):

There is so much variation in the use of the term "shock" that some kind of definition is required. The term is sometimes used to describe any form of circulatory failure after injury. * * * This practice is objectionable in that the label of "shock" is given to many varieties of circulatory collapse, including those caused by peritonitis, other forms of bacterial infection, asphyxia, pneumothorax, and other complicated effects of intrathoracic injury. In this report the term "wound shock" is used in a restricted sense. It does not include circulatory failure from peritonitis, bacterial infection, or intrathoracic injury; nor, unless specially stated, does it refer to the shock which follows burns or injury to the central nervous system. It embraces all other forms of circulatory failure which arise within a few hours as a result of wounding. As a matter of convenience, the term shock is used as a synonym for circulatory failure and the cause is added when this is known, e.g., "shock from hemorrhage."

The ETMD (Essential Technical Medical Data) for NATOUSA (North African Theater of Operations, U.S. Army), for March 1944 (13) suggested that the definition of shock should be extended to include the inability of the organism to meet the demands commonly within the normal physiologic range and should not be limited to a descriptive index of abnormal findings.

By the end of the war, the accepted definition of traumatic shock was a situation produced initially by a decrease in the peripheral circulatory blood volume that is followed by a diminished venous return, an inadequate cardiac output, and depleted physiologic functions. The most usual cause of these changes is gross hemorrhage. This is still (1962) an acceptable definition.

As a matter of convenience, the confusion that arose in the Mediterranean theater because of the mistaken concept of shock and the loose use of the term is discussed under another heading (p. 37).

STUDIES ON SHOCK, NATIONAL RESEARCH COUNCIL

When the Committee on Transfusions, Division of Medical Sciences, NRC, held its first meeting on 31 May 1940 (14) (p. 73), it appointed a Subcommittee on Anesthesia and Shock (hereafter called the Subcommittee on Shock), with Dr. Alfred Blalock, Professor of Surgery, Vanderbilt University School of Medicine, as Chairman, and a distinguished membership of surgeons and anesthesiologists.

During the war, this subcommittee supervised a large number of research studies dealing with special components of shock and certain variations in its treatment, including an investigation of agents other than whole blood and plasma. All of these studies were undoubtedly of some value but most of them were of value from the negative aspect; that is, the investigators tested and eliminated a large number of agents that had to be tried before they could be discarded. Reports of these investigations can be found in the minutes of the subcommittee, 1940-45.

From a practical standpoint and for the purposes of this history, the significant activities of the Subcommittee on Shock are included in the conferences on shock held under its auspices and in certain of its official reports.

First Conference on Shock

The first Conference on Shock (15) was held under the auspices of the Subcommittee on Shock on 28 June 1941, 6 months before the United States entered the war. The announcement of the meeting carried the statement that emphasis would be placed upon measures of immediate use to the Army and Navy Medical Departments. The agenda included a wide range of subjects but did not include specific presentations on the use of blood or plasma in shock.

Shock Report No. 1

At a conference on 28 June 1941, a committee was appointed to make general recommendations concerning shock. It consisted of Drs. Blalock, Henry K. Beecher, Oliver Cope, Robert F. Loeb, and Stafford Warren. Its report (Report No. 1) (16), issued on 16 July 1942, covered the recognition of shock, its prevention, and its control.

Prevention.—The remarks on prevention in this report began with the following statement:

Since the major single cause of the state of shock seems to be a decrease in the circulating medium (whole blood, plasma, or water and electrolytes, or a combination of these), therapy is based upon checking such losses and replacing body fluids by the best means at hand.

Preventive measures were listed as control of hemorrhage; application of a tourniquet; splinting; postural measures; fluid therapy in traumatic shock, burns, and dehydration; the application of heat; treatment of exposure to cold and immersion; and precautions in regard to analgesia and anesthesia.

Therapy.—The important therapeutic recommendations by the ad hoc committee on shock were as follows (it should be remembered that they were made in July 1942):

1. When shock is imminent or present, blood, plasma, or albumin should be injected as promptly as possible. If massive hemorrhage has occurred or signs of serious anemia are present, whole blood is preferable to blood substitutes.
2. In the absence of evidence of blast injuries and pulmonary irritation, blood or blood substitutes can be given intravenously, as rapidly as 1 pint of isotonic fluid in 10–15 minutes.
3. If the blood pressure has fallen below 80 mm. Hg, an effort should be made to restore it to normal as soon as possible.
4. If blood is available, it should be used in initial amounts of 500 to 1,000 cc. The first injection of reconstituted plasma should be two units and of concentrated albumin, one unit (25 gm.). Not more than 10 units of albumin should be given in 48 hours. If albumin is used, severely dehydrated patients require additional water and salt. When sterile physiologic salt solution is available, concentrated albumin can be diluted in the ratio of two units (50 gm.) to one liter of salt solution.
5. If the desired effect on the blood pressure is not obtained in 15–30 minutes, the dose of blood or blood substitute should be repeated.
6. If anemia appears in the course of treatment with large amounts of plasma or albumin, whole blood transfusions are indicated.
7. Salt and glucose solutions are not recommended in shock. The temporary rise in blood pressure and blood volume which they produce is only temporary and gives rise to a sense of complacency. Their only value is to correct dehydration. They are contraindicated in head injuries and pulmonary damage.
8. Within reasonable limits, there is little risk of injecting too large quantities of replacement fluids immediately after wounding. It is important to watch for fresh bleeding when the blood pressure, in the course of therapy, begins to approach normal.

Second Conference on Shock

At the second Conference on Shock (17) on 1 December 1943, the agenda had become more realistic, in the light of military developments. It included field blood volume determinations by the Phillips-Van Slyke copper sulfate method; the comparative therapeutic effects of whole blood, plasma, albumin, saline solutions, and gelatin in clinical shock; and a vigorous discussion of the use and value of blood and blood substitutes. The proceedings were thus in marked contrast to the proceedings of the first conference, which had been held almost 6 months before Pearl Harbor.

On the other hand, the discussion of shock was still not entirely realistic, for it was divided into early and late shock. The discussion of early shock included infection as an initiating agent, possible techniques for early recognition, and prevention and treatment. The discussion of late shock covered intermediate metabolism, visceral damage, acidosis, vitamin-coenzyme systems, and succinate and Pitressin therapy. Acidosis was stated to be a possible

criterion of the severity of shock but was not considered a cause. Neither succinate nor Pitressin therapy was regarded as promising.

In a report at this session by Dr. E. I. Evans on the comparative therapeutic effects of whole blood and blood substitutes in shock, the following points were made:

1. In patients seen soon after wounding, saline solution seemed to have a beneficial effect, even when the blood loss was quite severe. A marked reduction in the incidence of severe shock could be produced by giving saline solution prophylactically. When saline solution was given to a patient already in severe shock, there might be temporary improvement, with elevation of the blood pressure, but it seldom lasted more than 30 minutes.

2. Both plasma and whole blood were effective in moderately severe shock, but studies of the blood volume after the initial treatment usually indicated the need for whole blood. All patients in shock who had not been given whole blood eventually showed moderate or severe anemia.

Quotation at the conference of a recent letter from Maj. (later Lt. Col.) Henry K. Beecher, MC, then in North Africa, brought the discussion down to a realistic level:

One of the chief problems is concerned with *supplying blood in forward areas*. Somewhere along the planning line somebody seems to have forgotten that plasma lacks oxygen-carrying power. Much too often the following sequence of events takes place: A man receives a bad wound; he bleeds; hours later his "blood" volume and pressure are restored by plasma infusion; the surgeon decides he is now ready for surgery; there is further loss of the too-small quantity of hemoglobin available in his body, as a result of the surgery; the patient's circulatory system collapses and it is impossible to revive him. Plans are now being worked out for supplying whole blood for the forward areas.

At this second Conference on Shock, Dr. Loeb, chairman of the Subcommittee on Blood Substitutes, made the highly significant announcement that it was the conviction of his group that the ideal treatment of shock due to hemorrhage and skeletal trauma was replacement of lost blood with blood and that every means possible should be utilized for increasing the use of blood in the prevention and treatment of these conditions in various theaters of war (p. 53). It was, however, recognized by his committee:

1. That whole blood could not always be made available.
2. That in crushing injuries, burns, and abdominal wounds, plasma was more desirable than blood at certain stages of treatment.
3. That plasma is more desirable than whole blood when dehydration, for one reason or another, is marked.
4. That plasma has the advantage of convenience of transportation to areas to which whole blood cannot be taken but that there are certain situations in which serum albumin is more practical than plasma.¹

Shock Report No. 17

Shock Report No. 17 (18), dated 4 March 1944, was a revision of Shock Report No. 1 (16), dated 16 July 1942. Some of the members of the committee

¹ This statement does not represent the view of those intimately concerned with the blood program or of medical officers with a special interest in, and knowledge of, resuscitation. In their opinion, there were no circumstances in which albumin was more practical than plasma because of the almost universal necessity of supplying additional fluids when albumin was used.

which prepared the second report had also served on the first committee. The current status of the shock problem was set forth as follows:

1. The establishment of a close correspondence of circulatory changes in experimental and clinical shock has given confidence in the clinical application of results obtained in experimental studies, especially on dogs.

2. Reduction in the circulating blood volume is the most important factor in the initiation of shock. The reduction, whether the injury is mechanical or thermal, is due to loss of blood or fluid at the site of injury. Except possibly in very late stages, there is no notable increase in capillary permeability in nontraumatized areas of the body. The reduction in the circulating blood volume makes its restoration to normal the primary consideration of therapy.

3. The most reliable criteria of the degree of circulatory disturbance underlying shock are cardiac output and blood volume. As shock progresses, cardiac output continues to decrease, even if there is no further reduction in circulating blood volume. The level of arterial pressure is not a reliable criterion of the degree of circulatory impairment in early shock, nor does the hematocrit, considered alone, indicate the relative degree of loss of blood or plasma.

4. After a critical point has been reached in diminution of the blood volume, progressive tissue anoxia leads to metabolic changes and to damage to certain organs, such as the brain, and perhaps the heart and liver. The state which then develops is termed "irreversible shock."

The following prophylactic and therapeutic points were stressed:

1. The consequences of inadequate circulatory volume emphasize the very great importance of early, adequate treatment of shock. Treatment should not be delayed until its manifestations appear.

2. Operation should be carried out as promptly as possible after resuscitation, or sometimes before it is completely accomplished, with blood replacement as indicated during the procedure.

3. Fluid therapy is the most important measure in the therapy of shock. It should take the form of whole blood, which may be required in amounts up to 3,000 cc.

4. The first 500 to 1,000 cc. of blood should be given rapidly. Subsequent administration should be at the rate of 500 cc. per hour or less. Prophylactic transfusions should also be given slowly.

The great difference between these recommendations, in March 1944, and those of July 1942 is the unequivocal advice to use whole blood without delay. The altered concept of shock should also be noted. The advice to inject the blood slowly was founded on the old idea that rapid injection of blood might give rise to speed shock. As a matter of fact, early in the war, it was found that the rapid injection of blood was not only harmless but essential and beneficial. It was not unusual to inject 500 cc. of blood in 5 minutes, and occasionally as much as 20 pints of blood were injected into four different veins in a period of 3 hours. Had members of the various committees of the National Research Council been permitted to visit combat zones, as was several times requested (p. 79), their recommendations would have been more closely related to the facts of military medicine.

EVOLUTION OF THE CONCEPT AND THERAPY OF SHOCK IN THE MEDITERRANEAN THEATER

In the first months of active U.S. participation in World War II, the confusion that attended the condition that came to be appreciated as the most important single complication of wounding seriously affected the management of wounded casualties. Until the concept of shock was clarified, they were treated with skill and devotion, but they were often not treated entirely correctly, even though, by the time North Africa was invaded in November 1942, it was generally accepted that decreased circulating blood volume was the most important deviation from normal physiology seen in shocked casualties.

The necessary clarification of the concept of shock, with the application of the correct concept to shocked casualties, was accomplished in the Mediterranean theater. Until June 1944, this was the only theater in which large numbers of ground troops were in constant contact with the enemy. For nearly 2 years, the battle casualty rates in it were continuously above 50 per thousand per annum, and for nearly 2 months of this period they were above 100 per thousand. With casualties requiring treatment in such numbers, policies of management had to be established, even in the absence of any proved scientific rationale for them.

The situation began to change when Col. Edward D. Churchill, MC, reported for duty in North Africa on 7 March 1943 as Consultant in Surgery to the theater surgeon. Before he left the Zone of Interior he had been well briefed on the British experience in shock and transfusion (p. 55) and had been informed of the research under way in this field at the Army Medical School and elsewhere.

Colonel Churchill's first official report to the theater surgeon, 2½ weeks after his arrival and after a period of temporary duty on the southern Tunisian front, was a memorandum on blood transfusion (19). On 16 April, after the collection of additional data, he set forth several conclusions, the most important of which was that a significant number of wounded went into shock from loss of blood and that plasma was not a total treatment for these casualties (p. 55).

In his first report, Colonel Churchill was critical of both the nomenclature and the concept of shock. He found that in field medical records, histories, and autopsy reports, shock was used with vague significance and often with no definition at all (p. 32). The disturbance of the peripheral circulation which the term indicated might range from slight pallor to impending death.

Further confusion was introduced by the use of the term "irreversible shock," a use which amounted to the assumption that at one moment restoration of the blood volume could halt the process of death while at the next, it could not. Even the most carefully controlled laboratory experiments could not identify this precise baseline. If this held true in a controlled experimental

laboratory, identification of the onset of irreversible shock seemed even more impossible when the medical officer was confronted with the results of random trauma sustained by soldiers under combat conditions.

In the records of battle casualties who died in forward areas, shock or irreversible shock was almost invariably found to be recorded as a secondary cause of death, whether the primary condition was a craniocerebral wound, an overwhelming peritonitis, a fulminating gas gangrene infection, or uncontrollable hemorrhage. In Colonel Churchill's opinion, the terms "shock" and "irreversible shock," as they appeared in records and autopsy protocols in NATOUSA, were completely irrelevant. He therefore found it impossible to comment on the occurrence of shock during the Tunisian campaign in terms that would be helpful to those engaged in research on the subject.

An analysis of 1,263 casualties had shown no deaths from so-called wound shock under terms of the restricted definition in which hemorrhage could be excluded as the important causative factor. The same observations were made in the clinical study of large numbers of wounded. Colonel Churchill therefore concluded:

1. That wound shock, if it occurred among surviving casualties, apparently responded to treatment. Irreversible shock therefore did not appear to be a problem of pressing importance.
2. That wound shock could not be identified as a cause of death in conditions prevailing in the management of battle casualties during the period of the survey.
3. That shock as it was observed in the Tunisian campaign could be controlled by the application of accepted methods of treatment, without the need for the development of additional methods.

These conclusions were amply confirmed in the following months by simple, direct observations on battle casualties properly treated by methods already available, including the replacement of blood losses by whole blood. Clinical observations were later confirmed by a number of special studies. The management of shock in the last year of the Italian campaign, when there was a general appreciation of the need for whole blood and when the blood needed was available in ample quantities from a theater blood bank, was very different from the makeshift management and often complete lack of blood in the Tunisian and early Italian campaigns. Appreciation of the need of blood, however, preceded its supply by many months.

SPECIAL STUDIES

Lalich Study

The first planned studies on shock in the Fifth U.S. Army were made by Capt. Joseph J. Lalich, MC, on the Cassino front in December 1943 and on the Anzio beachhead in March 1944 (19, 20). Studies on the hematocrit, on the plasma protein, nonprotein nitrogen, and chlorides of the blood, and

on the carbon dioxide combining power of the blood supported his thesis that blood loss is the chief factor in shock.

On the basis of his clinical observations alone, Captain Lalich had already advocated that battle casualties in shock be divided into three categories, according to the following criteria:

1. The patient has a normal blood pressure and no significant abnormalities of pulse volume or pulse rate, but his wounds are sufficiently numerous and sufficiently severe to make it reasonable to anticipate circulatory failure. Experience showed that unless patients in this group were treated by replacement therapy, usually in the amount of 500 cc. of plasma and 500 cc. of blood, varying degrees of circulatory failure were likely to occur during operation.

2. The blood pressure ranges from 90 mm. Hg down to the lowest level at which it can be measured. Resuscitation requires at least 1,000 to 2,000 cc. of blood.

3. The blood pressure cannot be determined by auscultation. A patient in this state should receive from 500 to 1,500 cc. of blood, the precise amount depending upon how much is required to raise the systolic pressure to about 100 mm. Hg. After this level has been attained, an additional 500 to 1,000 cc. of blood should be given before surgery is undertaken. If the systolic pressure fails to rise to at least 50 mm. Hg after 1,500 cc. of blood has been given over a period of 15-30 minutes, operation should be resorted to without further delay, for factors other than serious blood loss or continuing hemorrhage are probably contributing to the persistence of shock. Among these factors are gross contamination and infection of the pleural or peritoneal cavities, or both, or toxemia from clostridial myositis. Even when these conditions are chiefly responsible for the state of shock, blood loss may also play some part in the patient's status.

There were numerous variations in this classification, but, on the whole, it represented the consensus of the surgeons and shock officers in the Mediterranean theater.

Stewart-Warner Study

The second study on shock was begun in January 1944, by Maj. (later Col.) John D. Stewart, MC, and 1st Lt. (later Capt.) Frank B. Warner, Jr., MC, when Mobile Unit No. 3, 2d Medical General Laboratory, was operating beside the 3d Platoon of the 11th Field Hospital at Cassino (19, 20). The hospital was doing first priority surgery, and the objective of the investigation was the response of seriously wounded men in respect to shock, hemorrhage, and dehydration. Surgeons caring for the patients investigated were kept informed of the results of the laboratory studies and were able to utilize the information in their management.

The final report on 2 January 1945 covered 100 casualties, of whom (the figures are overlapping) 48 had penetrating abdominal wounds, 32 penetrating thoracic wounds, and 55 compound fractures. Seventeen died during the course of the investigation.

Colonel Stewart and Captain Warner, who had been promoted in the interim, were particularly impressed by the variability of both the vasomotor and the cardiovascular response to wounding and also by the fact that reactions to shock and hemorrhage were considerably less stereotyped than they were usually supposed to be. Their other findings were as follows:

1. A reduction in blood volume was characteristic of untreated shock.
2. Hemoconcentration was not encountered, but decreases in plasma protein concentration and hematocrit values were evident shortly after wounding. Later, both components were lowered.
3. Dehydration and azotemia were common in the early recovery period.
4. Urinary reactions were indicative of a rather mild base deficiency.
5. No evidence of the excessive use of plasma or whole blood was detected in any patient.

Beecher-Burnett Study

The third study, by Major Beecher, Consultant in Shock and Anesthesia to the Surgeon, MTOUSA, and Capt. Charles H. Burnett, MC, was made at Cassino and on the Anzio beachhead and chiefly concerned the timing of surgery in relation to resuscitation (19, 21).

Most medical officers who had made special studies of shock or who had a large clinical experience believed that it was wiser to resuscitate the casualty as completely as possible before surgery unless there was some indication, such as continued hemorrhage or peritoneal contamination, for emergency operation. As a result of their own investigations, Major Beecher and Captain Burnett took the position that surgery should be considered a phase of the routine of resuscitation and given an earlier place in it (p. 584). Specifically, when the systolic blood pressure had reached 80 mm. Hg and the patient was warm and had a good color, they believed that operation should be proceeded with. Whatever additional replacement therapy was indicated could be carried out during operation.

While there was no universal acceptance of this concept, comparative figures seem significant (21): In November and December 1943, resuscitation in the field and evacuation hospitals below Venafro and Mignano on the Cassino front often required 6-8 hours after seriously wounded casualties had been admitted. In 1944, on the Anzio beachhead, even extremely bad surgical risks were prepared for operation on an average of 2 hours and 20 minutes after wounding. The readier availability of whole blood in 1944 had much to do with the reduction in the timelag, but the change in concept of the optimum time for operation undoubtedly also played a major role.

THE BOARD FOR THE STUDY OF THE SEVERELY WOUNDED

In August 1944, the appointment of a board to study the treatment of severely wounded casualties was recommended by the theater surgeon, then Maj. Gen. Morrison C. Stayer, to the Commanding General, NATOUSA, Lt.

Gen. Jacob L. Devers (19). There were two reasons for General Stayer's request: (1) that the concept of blood loss as the etiologic factor in shock must be documented by cold, hard facts; and (2) that similar proof was required for the use of whole blood as an essential element in the management of wounded men and not as an agent which could be replaced by other substances. Without such proof, shock and its associated problems would be left, at the end of World War II, in the same inconclusive state in which they had been left at the end of World War I. On 3 September 1944, General Devers appointed a Medical Board to Study the Treatment of the Severely Wounded (usually known as the Board for the Study of the Severely Wounded) to operate directly under the theater surgeon. Its membership was composed of Major Beecher; Major Burnett; Capt. Seymour L. Shapiro, SnC; Lt. Col. (later Col.) Fiorindo A. Simeone, MC; Capt. Louis D. Smith, SnC; Maj. (later Lt. Col.) Eugene R. Sullivan, MC; and Lt. Col. Tracy B. Mallory, MC.

In view of this action, it is interesting to recall that the minutes of the first meeting of the Committee on Transfusions, NRC, in May 1940 (14), contained the suggestion that "a group of men be allowed to work in the Army, freed from any of the obligations of Army officers, who would study cases of shock as investigators. This would give opportunity to observe shock on a big scale, an opportunity to get an insight into the nature of shock." More than 4 years after this recommendation, upon which no action was taken, it was, in effect, implemented by the appointment of the Board for the Study of the Severely Wounded. Great advances might have been made, and many lives might have been saved, if this or some similar board had been appointed earlier.

Observations and Conclusions

The 186 patients who were studied during the investigation were carefully selected and directly observed by the medical officers who made up the board (19). The experience proved that a mobile laboratory unit could function competently close to the frontlines—indeed, at time, within them—and that it could perform comprehensive, accurate biochemical studies in such situations. The major consideration was at all times, of course, that the studies must not delay or otherwise interfere with the treatment of the casualties under investigation.

From the standpoint of the relation of blood loss to shock, the board made the following observations:

1. A wounded man could recover after the loss of about 75 percent of his circulating blood volume, a considerably larger amount than had generally been supposed. The quantitative relation demonstrated between the degree of clinical shock and the loss of blood volume or hemoglobin lent further support to the theory that the major cause of shock in wounded men is hemorrhage.

2. Certain visceral changes were found in casualties who had been in shock, but they were not evident until a minimum of 18 hours after injury, in which interval many wounded men had already succumbed to loss of blood.

If infection were not a complication, a return to normal could be demonstrated from the fourth day onward. Pulmonary edema was too inconstant and too late a development to be considered an important factor in the initiation of shock. Pulmonary fat embolism was absent or minimal in most cases and of uncertain significance in the remainder.

This investigation and the other studies of shock conducted in the Mediterranean theater did not settle all the problems of shock or all phases of any problem. They did, however, clearly establish that blood loss, with the resultant decrease in blood volume, is the most important cause of death in battle casualties. Thus, at the end of World War II, in contrast to the situation at the end of World War I, there was a clear understanding of why shock occurs and an equally clear understanding of the rationale of resuscitation therapy and of the necessity for whole blood replacement. Two other factors in the reduction of the mortality from shock should also be mentioned:

1. The skill and fine judgment developed by shock officers and others who supervised the resuscitation and preoperative preparation of casualties (the so-called learning curve described by the chest surgeons of the 2d Auxiliary Surgical Group) (22).

2. The planning and organization of the blood bank at Naples (p. 400), which provided a superior type of banked blood in quantities sufficient to meet all Fifth U.S. Army demands.

EBERT-EMERSON STUDY

Materials and Methods

By the time active fighting began in the European theater, two concepts concerning shock were generally accepted: (1) that the pathogenesis of traumatic shock is a reduction in the circulating blood volume, and (2) that an essential feature of shock therapy is the correction of this deficiency by blood replacement.

From the practical standpoint, a major therapeutic problem was still the determination of the degree of blood volume deficiency. Clinical estimations alone were imprecise. Blood volume measurement, with the techniques then available, was obviously impossible as a routine therapeutic control in the field. Transfusion requirements in any given case were still, therefore, based almost exclusively on the clinical symptoms and signs present and on their response to therapy.

Studies to evaluate the relative importance and reliability of these clinical manifestations were undertaken in July 1944, in a First U.S. Army field hospital, by Maj. Richard V. Ebert, MC, and Maj. Charles P. Emerson, MC, 5th General Hospital (23). A preliminary study on 55 nontransportable casualties was limited to serial determinations of hemoglobin concentration and arterial pressure in relation to their clinical condition and course during resuscita-

tion.² The data, like those collected in the Mediterranean theater (p. 41), indicated that the magnitude of the blood loss sustained by casualties in severe shock was far greater than had been generally appreciated.

A second study was carried out in September 1944, during the campaign on the German border, on 112 casualties with serious abdominal, thoracic, and extremity wounds. About half were in severe shock. The investigation included, in addition to routine physical examination:

1. Serial determinations of either (a) the hemoglobin concentration, by the acid-hematin technique with the Sahli-Hellige hemoglobinometer, or (b) hematocrit determinations, obtained after rapid centrifuging of oxalated samples in 4-cc. tubes.
2. Determinations of plasma volume by the Gibson-Evans dye technique.
3. Plasma protein concentration determinations by the copper sulfate technique of Phillips et al.

Measurements of the plasma volume, plasma protein concentration, and hematocrit were completed in 57 cases. Multiple blood volume determinations were made in 33 cases, either during transfusion or before or after operation.

Observations and Conclusions

The data which these observers had set out to secure and the conclusions derived from them may be summarized as follows:

1. The degree of blood volume deficit in shock and the extent to which clinical signs could be correlated with varying degrees of oligemia.

The arterial blood pressure proved the most reliable clinical index to blood volume deficiency. All casualties with initial systolic pressures below 85 mm. Hg, except those with spinal transections, were found to have significant degrees of oligemia, the deficit averaging 40 percent of the expected normal blood volume.

2. The degree of spontaneous hemodilution following extensive hemorrhage.

Blood volume and plasma protein determinations indicated that some degree, usually small, of spontaneous hemodilution with low plasma protein values occurred in oligemic shock. It was concluded that a normal hematocrit reading or the demonstration of only a mild anemia within a few hours after injury should not be interpreted to mean that severe blood loss had not occurred. Serious anemia could be produced by the administration of plasma to markedly oligemic patients.

3. The relative importance of losses of whole blood and plasma and the total blood loss resulting from various types of wounds.

The majority of the casualties in the series presented no evidence of excessive losses of plasma in proportion to losses of red blood cells. In a few severe

² A First U.S. Army report mentions that this study was carried out during a pressure period, when casualties were heavy, and that the investigating officers frequently found themselves administering blood and plasma rather than making the detached observations they had planned.

abdominal wounds, a disproportionate plasma loss was demonstrated, with resulting mild erythroconcentrations. The average blood loss estimated to have occurred before admission to the hospital was 63 percent per severely shocked casualty. Hemorrhage was most profuse in extremity wounds and least profuse in uncomplicated chest wounds.

4. The relative requirements for whole blood and plasma in shock and the effect of transfusion on blood volume.

Serial blood volume determinations indicated that hemorrhage had occurred during the course of transfusion in 12 of 23 patients studied. This complication was encountered most often in severe wounds of the extremities; the majority of these patients suffered losses averaging 40 percent of the blood and plasma transfused.

5. The causes of therapeutic failure in the treatment of traumatic shock.

Measurements of plasma protein before and after the injection of blood diluted with equal volumes of preservative solution indicated that retention of the solution in the bloodstream was only transient and not sufficient to produce significant hemodilution.

Casualties in whom clinical evidence of shock was not corrected by appropriate therapy, including restoration of the blood volume to normal, included those with severe infection; lesions involving the central nervous system; anoxia associated with pulmonary damage; and a persistent combination of anemia, oligemia, and hypotension, with terminal signs of myocardial insufficiency.

The case fatality rate for all casualties admitted in severe shock was 32 percent. When, however, the arterial pressure on admission exceeded 85 mm. Hg, the case fatality rate was only 10 percent. The majority of deaths occurred in casualties with abdominal wounds.

References

1. Beecher, H. K.: The Physiologic Effects of Wounds. *Arch. Surg.* 80:366-373, March 1960.
2. Cannon, W. B.: Wound Shock. *In* The Medical Department of the United States Army in the World War. Washington: Government Printing Office, 1927, vol. XI, pt. I, pp. 185-213.
3. Cannon, W. B.: Traumatic Shock. New York and London: D. Appleton and Co., 1923.
4. Blalock, A.: Principles of Surgical Care, Shock and Other Problems. St. Louis: C. V. Mosby Co., 1940.
5. Parsons, E., and Plemister, D. B.: Haemorrhage and "Shock" in Traumatized Limbs. An Experimental Study. *Surg. Gynec. & Obst.* 51:196-207, August 1930.
6. Freeman, N. E., Blalock, A., and Strumia, M. M.: Shock. *In* Burns, Shock, Wound Healing, and Vascular Injuries. Prepared under the auspices of the Committee on Surgery, Division of Medical Sciences, NRC. Military Surgical Manuals. Philadelphia and London: W. B. Saunders & Co., 1943.
7. Freeman, N. E., Shaw, J. L. and Snyder, J. C.: The Reduction in Circulation Through the Hand Resulting From Pain, Fear, Cold, and Asphyxia, With Quantitative Measurements of the Volume Flow of Blood in Clinical Cases of Surgical Shock. *J. Clin. Invest.* 15:651-664, November 1936.

8. Ohler, W. R.: Treatment of Surgical Shock in the Zone of the Advance. *Am. J. M. Sc.* 159: 843-853, June 1920.
9. Mann, F. C.: Further Experimental Study of Surgical Shock. *J.A.M.A.* 71: 1184-1188, 12 Oct. 1918.
10. Moon, V. H.: Shock and Related Capillary Phenomena. New York and London: Oxford University Press, 1938.
11. Janeway, C. A.: War Medicine, With Special Emphasis on the Use of Blood Substitutes (Medical Progress). *New England J. Med.* 225: 371-381, 4 Sept. 1941.
12. Report, Consultant in Surgery to the Surgeon, NATOUSA, 2 July 1943.
13. ETMD, NATOUSA, for March 1944.
14. Minutes, meeting of Committee on Transfusions, Division of Medical Sciences, NRC, 31 May 1940.
15. Minutes, Conference on Shock, under the auspices of the Subcommittee on Shock, Division of Medical Sciences, NRC, 28 June 1941.
16. Shock Report No. 1, *General Recommendations Concerning Shock*, Subcommittee on Shock, Division of Medical Sciences, NRC, 16 July 1942.
17. Minutes, Conference on Shock, Subcommittee on Shock, Division of Medical Sciences, NRC, 1 Dec. 1943.
18. Shock Report No. 17, *General Recommendations Concerning Shock* (Revision by Subcommittee on Shock of Report No. 1, issued 16 July 1942), Division of Medical Sciences, NRC, 4 Mar. 1944.
19. Medical Department, United States Army. *Surgery in World War II. The Physiologic Effects of Wounds.* Washington: U.S. Government Printing Office, 1952.
20. Snyder, H. E.: Fifth U.S. Army. *In Medical Department, United States Army. Surgery in World War II. Activities of Surgical Consultants. Volume I.* Washington: U.S. Government Printing Office, 1962.
21. Beecher, H. K.: Resuscitation, Control of Pain, and Anesthesia. *In Medical Department, United States Army. Surgery in World War II. Vol. II, General Surgery.* Washington: U.S. Government Printing Office, 1955.
22. Burford, T. H.: Evolution of Clinical Policies in the Mediterranean Theater of Operations. *In Medical Department, United States Army. Surgery in World War II. Thoracic Surgery, Volume I.* Washington: U.S. Government Printing Office, 1963.
23. Emerson, C. P., and Ebert, R. V.: A Study of Shock in Battle Casualties. Measurements of the Blood Volume Changes Occurring in Response to Therapy. *Ann. Surg.* 122: 745-772, November 1945.

CHAPTER III

The Evolution of the Use of Whole Blood in Combat Casualties

DEVELOPMENT OF THE CONCEPT

Since the importance of whole blood in the resuscitation of wounded casualties was realized almost from the beginning by many of the personnel and agencies connected with the program, it is hard to understand why its procurement, distribution, and utilization got off to such a slow start in the U.S. Army in World War II. The success of the transfusion service in the Spanish Civil War (p. 11) and the similarly successful and long operational program in the British Army when the United States entered the war (p. 15) make the delay even more mystifying.

Any attempt at explanation must be a mixture of fact and opinion. Perhaps the chief reason was that overenthusiasm for the potentialities of plasma as an effective blood substitute tended to reduce the attention which might otherwise have been devoted to the development of methods for making the use of whole blood practical. A second reason was that even those who considered whole blood essential in the treatment of battle casualties thought its supply to forward units in a combat zone—let alone its transportation overseas—an entirely impractical project. The discussion at the first meeting of the Committee on Transfusions, Division of Medical Sciences, NRC (National Research Council) ¹ on 31 May 1940 (1) clearly showed that the feasibility of such a program had to be grasped before any means for its implementation would be developed. The lack of the acceptance of the concept as a possibility was far more important than (1) the current lack of means to store the blood and transport it safely over long distances, and (2) the fact that an oversea airlift did not exist when World War II began. Moreover, at this time, blood had only a 6- to 8-day dating period, which was scarcely long enough to get it into a combat zone even if an airlift had been available.

In short, the hard fact of the matter was that in 1940 and 1941, when the need arose, there was no real choice: If plasma had not been recommended and used, there would have been no agent at all for the treatment of large numbers of wounded casualties. It was just 5 years before the United States entered World War II that Elliott (2) had pointed out the military advantages of plasma, some of which Ward had called attention to in World War I (p. 265). Because of its small bulk, it was practical to carry it well forward and thus

¹ Committee on Transfusions, Division of Medical Sciences, NRC, acting for the Committee on Medical Research, Office of Scientific Research and Development (hereafter termed Committee on Transfusions, NRC).

treat shock many miles closer to the actual scene of wounding. Reduction of the timelag ("this valuable time element," as Elliott called it) might well mean the difference between life and death.

Another reason for delay in setting up an oversea blood program was the rather general failure to appreciate the difference between the use of blood in civilian medicine and its use as a military necessity. DeGowin and Hardin (3) (Maj. Robert C. Hardin, MC, who later served as Transfusion Officer in the European Theater of Operations, U.S. Army) differed from most other observers in their appreciation of this distinction. In an article in *War Medicine* in May 1941, these observers pointed out that since shock and hemorrhage are acute conditions, they must be treated at the earliest possible moment. The goal of any service supplying blood and plasma should be to make them available as far forward in the combat zone as possible. The value of every step in the processing and administration of these substances should be weighed in terms of their use at the front. Each detail of technique should be visualized as it would have been carried out in some such setting as a British casualty clearing station under air bombardment in the Battle of Flanders.

To meet these requirements, it would be necessary to collect blood in many centers, transport it to a small number of points for processing, and then deliver it to forward units. This is precisely what was done when the blood program was developed in the Mediterranean theater, which supplied its own blood throughout the war, and when the plasma program in the United States was extended to provide blood for theaters of operations.

In spite of the imaginative planning of DeGowin, Hardin, and their associates, the concept of the provision of whole blood for forward areas in oversea theaters was a very gradual development. In the Zone of Interior, this concept was first of all part of the development of the concept that whole blood was necessary for severely wounded men in shock and that plasma, valuable as it had proved, was simply an interim measure, with a supplemental and not a definitive role in their management.

Lt. Col. (later Col.) B. Noland Carter, MC, Assistant Director, Surgical Consultants Division, Office of The Surgeon General, expressed the general point of view in a comment on ETMD (Essential Technical Medical Data) NATOUSA (North African Theater of Operations, U.S. Army), for 1 July 1944 (4). Early in the war, he said, the lack of appreciation of the need for whole blood for seriously wounded men was shared by his own office, though at the time he was then writing (September 1944), the necessity was recognized in the Zone of Interior as well as in all combat zones. The complete recognition of this need, he concluded, was now evident in the Office of The Surgeon General in the establishment of tables of organization and equipment for blood transfusion units and in the recently instituted airlift of blood to Europe.

The need of combat casualties for whole blood in large quantities was learned by experience in the Mediterranean theater (p. 392). In the European theater, as information concerning the Mediterranean experience was supplemented by theater experience, it became clear that the procurement of blood

from Army personnel in the theater simply would not meet the needs. Only a brief combat experience was required to make it clear that blood would be needed in much larger quantities, and for many more casualties, than had originally been contemplated. As time passed, there were increasingly frequent expressions of the necessity for, and the possibility of, securing blood by airlift from the Zone of Interior (p. 474).

As has already been pointed out, there was always a considerable number of observers in both the Zone of Interior and oversea theaters who believed that whole blood was necessary, and had no substitute, in the treatment of severely wounded men. Their voices were simply not loud enough—or perhaps they did not speak out loudly enough—to carry conviction until events in combat theaters furnished overwhelming proof of the need. Moreover, even those who believed from the beginning that whole blood was essential for combat casualties were at first faced with the major problem of how to place it where it could be used.

THE ROLE OF THE NATIONAL RESEARCH COUNCIL

Much of the basic work which led up to the use of whole blood in combat casualties in forward installations was directed, or actually carried out, by members of the Subcommittee on Blood Substitutes of the Committee on Transfusions, National Research Council.² The development of the concept, which was linked with the practical aspects of its implementation, is most conveniently described chronologically.³

1940

31 May.—The first meeting of the Committee on Transfusions (1), of which Dr. Walter B. Cannon was chairman, was attended by the full membership, by Dr. Lewis H. Weed, chairman of the Division of Medical Sciences, NRC, and, by invitation, Col. (later Brig. Gen.) George R. Callender, MC; Col. (later Brig. Gen.) Charles C. Hillman, MC; Capt. (later Col.) Douglas B. Kendrick, MC; and Cdr. C. S. Stephenson, MC, USN. Maj. Gen. James C. Magee, The Surgeon General, was present for part of the meeting.

Dr. Weed explained that the committee had been organized because of a request from General Magee that NRC (p. 75) assemble a civilian committee that could act informally in an advisory capacity to the Army Medical Corps, as well as to the Navy Medical Corps, with special reference to surgical shock, blood transfusion, and blood banks. When Dr. Cannon took the chair, he stated that many trained investigators in various medical fields had offered their services to the committee, and, if representatives of the Army and the

² Subcommittee on Blood Substitutes, Committee on Transfusions, Division of Medical Sciences, NRC, acting for the Committee on Medical Research, Office of Scientific Research and Development (hereafter termed Subcommittee on Blood Substitutes, NRC).

³ Unless otherwise indicated, all of the following data are included in the minutes of the Committee on Transfusions or the Subcommittee on Blood Substitutes for the appropriate dates.

Navy would formulate their problems, the Division of Medical Sciences, NRC, would act as an agency for their investigation and for transmission of information concerning them.

In reply, General Magee stated that from his standpoint there were two chief problems:

1. Blood transfusions, particularly the use of dried plasma and the proper containers for plasma.⁴

2. Shock, including its prevention, and hemorrhage.

In the discussion that followed, these points were covered:

1. Blood banks. Colonel Hillman stated that if combat in a future war should be chiefly outside the United States, the Army would probably discourage the use of blood banks. If war should come closer, it might be possible to use blood transported by plane or under specially devised refrigeration. If blood could not be collected locally, either liquid or dried plasma would have to be used.

2. Preserved blood. At this time, the safe storage of whole blood was not generally thought to exceed 5 days. Dr. Everett D. Plass stated that he had used blood more than 30 days old without serious reactions. He believed that by improving the preservative fluid, the period of safe storage could be increased materially, though he granted that as the proportion of glucose, presently the preservative in use, was increased, difficulties of administration would also be increased.

3. Plasma. Commander Stephenson explained the Navy's preference for plasma rather than whole blood: Plasma could be used in any form without reactions. If it were dried immediately, it could be kept for 4 or 5 months without refrigeration. If the circulation were embarrassed, it could be given in concentrated form. Also, the task of accumulating stocks could be begun a year or more in advance of the time the plasma might be needed. Refrigerator space was not a problem for the Navy, and distilled water for the reconstitution of plasma was available on many parts of ships.

Other points concerning plasma discussed at this meeting included the possibility of making a synthetic preparation or of using plasma from a lower animal instead of human plasma, the best techniques of preparing dried plasma, and a request to drug firms to prepare and distribute dried plasma to certain institutions for testing purposes.

4. Shock. The chairman asked that various methods of handling shock and hemorrhage be described, including the potentialities and limitations of whole blood; concentrated plasma and wet and dried plasma, with due note of the refrigeration needed; deterioration of blood after transportation; and the

⁴ It will be observed that at this and several succeeding meetings, the chief emphasis was on the use of plasma, which was readily accepted as a substitute for whole blood by a surprising number of experienced civilian clinicians and Army and Navy medical officers. The meeting of the Subcommittee on Blood Substitutes on 19 April 1941 (5) actually discussed whether whole blood was within its frame of reference; it was decided that it was. It should be pointed out again, however, that at this time, no matter how firmly one might have believed that whole blood was the transfusion medium of choice, its use was not practical because of the short dating period, the frequent reactions, sterilization problems, lack of refrigeration, and lack of an airlift.

possibilities of preservation of blood and plasma. A system was needed that would be practical for both Army and Navy.

As Dr. Cannon saw it, the problem before the committee was possible ways and means of restoring blood losses in wounded men at different places in an organized line. Some agents could be used in fixed hospitals but certain others that could be easily transported, without refrigeration, must also be available. General Magee mentioned the mobile field hospital, which had completed tests and which he thought would be well adapted for shock treatment, a statement that was to prove prophetic.

Colonel Hillman was asked to discuss the question of blood donors with the American Red Cross. Dr. Plass, who had special facilities at the State University of Iowa College of Medicine for testing whole blood, was asked to work out a means of transportation for it. It was thought that airlines and trucking firms might be interested in cooperating in this project.

24 July.—When the Committee on Transfusions made its report on this date to the Committee on Surgery, NRC (6), it advanced two chief reasons for the use of plasma rather than of whole blood in shock. The committee position can perhaps be interpreted as concessions to the position taken at the May meeting by representatives of the Army and the Navy:

1. Plasma is considerably easier to preserve and transport than blood.
2. Matching and typing are not necessary when pooled plasma, in which isoagglutinins are suppressed, is used.

Two other reasons, which have already been commented on, were also advanced for the use of plasma rather than blood in shock:

1. The belief that most shock is associated with hemoconcentration (p. 30) and that a given quantity of plasma would therefore be more effective than an equal quantity of blood. This belief could be traced back to the observations made in World War I that led to the erroneous concept that shock is an entity distinct from hemorrhage.

2. The belief, drawn from laboratory experiments under controlled conditions (p. 31), that plasma is approximately as effective as whole blood in the treatment of hemorrhage.

There were other fallacies in this approach:

1. It placed undue emphasis upon a single physicochemical property of blood, the osmotic activity of its plasma proteins, and ignored the important function of the red blood cells as oxygen carriers, as well as their contribution to the total blood mass under abnormal circumstances.

2. The magnitude of the initial loss of whole blood at wounding was not properly estimated, and the loss occasioned by continuing seepage of blood and its fluid components into the tissue spaces was also underestimated.

3. The effort to restore and maintain blood bulk by colloid preparations derived either from human proteins or from other sources presupposed a space bounded by a semipermeable membrane rather than a space in which large areas of the containing membrane might have been rendered freely permeable by the direct effects of trauma.

30 November.—At this meeting of the Subcommittee on Blood Substitutes (7), the principal discussion concerned the feasibility of preserving and transporting whole blood, with special attention to the studies, which proved this point, by Dr. Plass and Dr. Elmer L. DeGowin at the State University of Iowa College of Medicine. They are reported in detail elsewhere (p. 220).

1941

19 April.—At this meeting of the Subcommittee on Blood Substitutes (5), after a discussion of plasma and serum, the chairman, Dr. Robert F. Loeb, stated:

I take it that the consensus of the committee is that either serum or plasma reduced to either a frozen or a dried state is acceptable and the production should proceed at once with the understanding that in time other recommendations may be made.

This statement was agreed to by all the committee. The Army and the Navy accepted plasma because studies with it were much further advanced at this time than studies with serum and because the yield was greater—15 to 20 cc. per pint of blood—than the yield of serum.

It would be unfair not to emphasize again the entirely practical reasons for which the Subcommittee on Blood Substitutes recommended plasma to the Armed Forces in April 1941:

1. Supplying whole blood to the Armed Forces in the quantities likely to be needed, together with its safe storage and transportation, presented logistic problems of enormous proportions. They could not be solved in the light of either the knowledge or the facilities available in 1940-41. Preservative solutions which would permit long storage periods were just being developed. Thoroughly dependable, avid grouping sera were just being developed. The development of adequate equipment for the collection, storage, and dispensing of whole blood had barely begun. Refrigeration equipment for use in the field under varying conditions of heat, cold, and humidity had not yet been manufactured. Finally, an airlift capable of delivering blood to the far reaches of the battlefield was still almost 3 years off.

2. Plasma is a homologous protein fluid, the osmotic equivalent of blood, which can be administered without typing or crossmatching and which is almost entirely free from the reactions which, in 1941, were still frequent and serious after blood transfusion.

3. The protein content of plasma tends to hold transfused fluid in the vascular bed because its components are of high molecular weight and size as compared with the components of saline and dextrose solutions, which readily leak through the capillary walls or are excreted via the kidneys and which therefore have only temporary therapeutic value.

4. The use of plasma solved serious logistic problems. Separated from its cellular components, it could be frozen and dried to less than 1-percent moisture content. In this state, it could be packaged under vacuum and preserved for years without refrigeration and without being affected by extremes of heat and cold. The equipment necessary for its reconstitution and intravenous administration could be incorporated in a small package, which could be made available under almost all conditions of war. Plasma could be used in circumstances in which the procurement of whole blood would be completely impractical.

5. Finally, and most important of all in the light of immediate needs, plasma could be easily and safely produced commercially in the large quantities which would be needed.

The inherent organic characteristics of plasma, particularly the ease with which it could be manufactured, stored, and transported, clearly made it a

practical and desirable agent. The reasons for its selection in 1941, while perhaps not fully explaining the failure to attempt to supply whole blood to field units at this time, did take cognizance of obstacles which went far toward discouraging even the most ardent advocates of whole blood as a replacement fluid in Zone of Interior hospitals. These reasons were considerably more valid in the consideration of plasma as a feasible and practical agent for blood replacement in oversea hospitals.

3 November.—At this meeting—a little over a month before the United States was precipitated into World War II—the Subcommittee on Blood Substitutes unanimously expressed the opinion that the Armed Forces should use whole blood in the treatment of shock whenever this was possible (8). Unfortunately, this clear-cut expression of opinion was omitted from the minutes of the meeting, and the omission was not realized until the meeting of 24 September 1943. All present at the later meeting were in agreement that this opinion had been expressed unequivocally at the 3 November 1941 meeting, and it was the sense of the 1943 meeting that the minutes of the earlier meeting be corrected to show the facts.

1942

20 October.—Two important proposals were made at this meeting of the Subcommittee on Blood Substitutes (10). The first was that stored blood be used in the Armed Forces whenever the practice was feasible and fresh blood could not be used effectively. The second was that universal donor blood (O) be employed, to eliminate the necessity for crossmatching. These recommendations were passed on to the parent Committee on Transfusions, for submission to the Surgeons General of the Army and the Navy through National Research Council channels.

At this meeting, it was also recommended that supervision of the administration of all parenteral fluids be considered within the scope of the transfusion service which had been proposed at the 25 August 1942 Conference on Transfusion Equipment (11) and that replacement therapy be considered as a medical specialty. These recommendations were later implemented, at least in part, by the appointment of a Special Assistant on Shock and Transfusions in the Office of The Surgeon General (p. 69).

15 December.—This meeting of the subcommittee (12) accepted the proposals for a special shock and transfusion service in the Armed Forces, which had been drawn up by Dr. DeGowin, Major Kendrick, and Cdr. (later Capt.) Lloyd R. Newhouser, MC, USN, and recommended that they be transmitted through channels to the Surgeons General of the Army and the Navy. These proposals were never implemented.

1943

23 March.—A conference on blood grouping on this date was participated in by a number of members of the Subcommittee on Blood Substitutes (13).

Dr. DeGowin opened the discussion by asking those present if they would be willing to recommend that the Armed Forces employ group O blood as a universal donation, without crossmatching, if there was assurance that blood grouping had been accurately performed. After a vigorous discussion of various aspects of the proposal, the conference participants agreed to it, with the understanding that either blood with low titer agglutinins would be used or that A and B specific substances would be added to the blood.

At the 13 May 1943 meeting of the Subcommittee on Blood Substitutes (14), it was recommended that provisions for the storage, transportation, and administration of whole blood in the Armed Forces proceed with all possible speed.

For all practical purposes, the two recommendations just stated marked the beginning of the whole blood program for oversea theaters, though for various reasons it was not until August 1944 (p. 487) that they were translated into action.

Note.—Other actions of the Subcommittee on Blood Substitutes are described in appropriate places in this chronicle.

THE EVOLUTION OF THE CONCEPT OF WHOLE BLOOD REPLACEMENT IN THE MEDITERRANEAN THEATER

The British Experience

Reports of the transfusion service which the British had set up before the outbreak of the war in 1939 have been cited elsewhere (p. 15). Their early experiences clearly indicated the need for large quantities of whole blood in the management of wounded casualties, and their foresight put them in a position to provide it.

The British experiences in North Africa were made available to the Office of The Surgeon General, through Col. Frank S. Gillespie, RAMC, British Medical Liaison Officer, who was stationed at the Medical Field Service School, Carlisle Barracks, Pa., during the early months of the United States participation in the war. As the British experience accumulated, Colonel Gillespie made every effort to keep Colonel Kendrick, The Surgeon General's Special Representative for Blood Plasma and Transfusions, fully informed of changing concepts in the care of battle casualties. The development of the U.S. program was painfully slow, but the British experience had a far-reaching effect on all the planning. Colonel Kendrick was exceptionally fortunate in having Colonel Gillespie's cooperation and support at a time when U.S. Army medical intelligence was relatively limited.

The whole British experience in North Africa proved that while plasma was extremely valuable in providing temporary circulatory support for patients who had suffered multiple extensive wounds, associated with massive hemorrhage, it was not enough. Whole blood, which had the oxygen-carrying

property lacking in plasma, was essential during anesthesia and initial wound surgery.⁵

Evaluation of Plasma in U.S. Army Casualties

Because he had been so well briefed on these matters by Colonel Gillespie, Colonel Kendrick was able to have extended discussions with the personnel of the Surgery Division, Office of The Surgeon General, on the value of whole blood versus plasma in battle casualties. He considered it essential that the same information should be in the possession of Col. Edward D. Churchill, MC, who had been ordered to North Africa in January 1943, to serve as Consultant in Surgery, Fifth U.S. Army, and that he should have it before the fighting in that theater extended to Sicily and Italy.

The opportunity to discuss these matters with Colonel Churchill arose during his predeparture briefing in the Office of The Surgeon General, while he was reviewing the film strips which had been prepared by Colonel Kendrick on first aid in the field and on resuscitation, including the use of plasma and whole blood. Colonel Churchill was also informed that an important function of the Department of Surgical Physiology, Army Medical School (p. 65), was to investigate and evaluate solutions and equipment by whose use blood could be stored and shipped long distances with expedition and safety.

It was suggested to Colonel Churchill that upon his arrival in North Africa, he undertake a study of the whole problem, to determine:

1. With plasma readily available, was whole blood really needed?
2. If whole blood was really needed, how best could it be provided?

Colonel Churchill assumed his consultant duties in North Africa on 7 March 1943. His first official report, 2½ weeks later (15, 16), after a period of temporary duty with II Corps on the southern Tunisian front, was a memorandum to the Army Surgeon on whole blood transfusions. In this report, and in a number which followed it, he made the following points:

1. Plasma and other preparations that do not contain red blood cells are incorrectly named blood substitutes. While invaluable for certain specific purposes and under certain specialized conditions, they are merely fractions of blood. Plasma may be preferable to whole blood in crushing injuries, in the early stages of burns, and in extreme heat dehydration, but all of these conditions are numerically insignificant in war.

2. The development of plasma was undoubtedly a great contribution to military medicine, but the early enthusiasm that accompanied its development

⁵ In North Africa and Italy, as well as later in Normandy, the British supplied some of the whole blood used for American casualties. At the meeting of the Southern Surgical Association in 1944, Colonel Gillespie was asked to comment on a communication dealing with the management of battle casualties and thought to himself, as he wrote after the war, "Here's my chance for another crack at the whole blood battlefield." So he said: "I have often wondered at the physiological differences between the British and American soldier. The former, when badly shocked, needs plenty of whole blood, but the American soldier, until recently, has got by with plasma. However, I seemed to observe a change of heart when I was in Normandy recently and found American surgical units borrowing 200-300 pints of blood daily from British Transfusion Units, and I'm sure they were temporarily and perhaps even permanently benefited by having some good British blood in their veins."

had pushed aside sound clinical judgment and had led to the widespread misconception that it was an effective substitute for blood in shock. In fact, the organization and development of effective methods for the management of shock had been handicapped to an embarrassing degree by this misconception, which was firmly entrenched in both administrative and professional minds.

3. The real circumstances were these (17): Even in hematopneic shock, the liberal use of plasma could restore the circulating blood volume and thus tide a casualty over the critical period required for his evacuation to some installation in which whole blood was available. When plasma was used liberally, certain casualties recovered from shock in the sense that the blood pressure was brought to normal or nearly normal and the peripheral circulation was reestablished by the improvement in the blood volume deficit. Neither of these groups of casualties, however, were in a state to tolerate major surgery without more support. In both, the blood pressure was extremely labile and would fall rapidly if operation were undertaken. Further hemorrhage might occur, or some blood would be lost at operation, and the additional losses could not be tolerated by a casualty with profound secondary anemia, for the oxygen supply to the tissues was not adequate. He might improve temporarily with oxygen administration, but additional plasma would be of little benefit.

4. The North African experience showed that some casualties would die because of the very nature of their wounds or the complications of their wounds. Others would die from the damage caused by their state of shock. The lethal sequelae of shock had become more apparent as surgery and resuscitation had improved. Basically, these sequelae were attributable to the asphyxia of organs or tissues during the prolonged period of reduced volume flow of blood. Often, they were masked by the presence of serious complications arising from the wound itself. They were sometimes not recognized at all in casualties who succumbed to such rapidly fatal results of trauma as fulminating infection, cerebral lacerations, or respiratory insufficiency. The brain, the kidneys, and possibly the liver might show irreparable and ultimately lethal damage from shock. Kidney damage was probably the most frequent of these sequelae, and also the most easily overlooked.

5. An inexperienced surgeon, seeing the beneficial results of plasma therapy and not realizing its limitations, might be encouraged to undertake surgery in a patient not prepared to tolerate it. Indeed, restoration of the blood pressure and volume flow under conditions in which hemorrhage could not be arrested at once by surgery might lead to further loss of red blood cells and terminate in disaster. Once the patient had been resuscitated, he must not be allowed to go into shock again. If surgery had to be delayed, plasma would keep him alive until it could be undertaken, but there must be no attempt to establish full circulatory compensation. Meantime, all shock-producing factors must be eliminated, which meant the relief of pain, the immobilization of fractures, and the control of hemorrhage.

Conclusions

In view of these facts, Colonel Churchill made the following points clear in his first memorandums and in subsequent reports:

1. That whole blood was the agent of choice in the resuscitation of the great majority of battle casualties.

2. That whole blood was the only therapeutic agent that would prepare seriously wounded casualties for the surgery necessary to save life and limb.

3. That both the mortality rate and the incidence of wound infection were reduced by the use of whole blood at the time of initial wound surgery.

4. That plasma should be looked upon as a first aid measure for dire surgical emergencies and as a supplement for whole blood, not as a substitute for it.

Thus, Colonel Churchill concluded, actual experience had clearly delineated both the indications for, and rationale of, plasma and whole blood replacement. Both agents were extremely valuable in the management of shock, but each had its own individual and specific purposes, and, if they were to be used efficiently, both limitations as well as indications must be borne in mind.

Months were to pass before an organized system of providing blood for casualties in forward areas was set up in the North African theater; by the time a central blood bank had been established (p. 400), however, plasma had assumed its proper place in resuscitation and whole blood, collected locally, was being used in increasing quantities. When active combat began in the European theater, the experience in North Africa, Sicily, and Italy was already at hand. The amount of whole blood that would be needed on the Continent was underestimated, but the need for blood was realized, and plasma was generally used only according to its capabilities.

COMMENT

Nothing that has been said in this chapter should be taken to mean any derogation of the value of plasma. Its capacity was seriously overestimated in many quarters early in World War II. The almost fantastic hopes originally pinned to it were never realized. A more realistic estimate of its capacities would have prevented many misunderstandings and disappointments. Later in the war, its capabilities were somewhat underestimated. The truth lies somewhere between.

An interesting sidelight is thrown on the real value of plasma by an indignant letter from a young medical officer, in charge of a battalion aid station in North Africa, who apparently had difficulties with supply. It was necessary, said the writer, to beg, borrow and steal plasma from various hospital units and from medical supply depots, which irked him by their strict adherence to distribution regulations and which seemed to have no concept of conditions at a battalion aid station.



FIGURE 5. Plasma administration in the field. A. Administration of plasma to wounded U.S. soldier on back of jeep trailer en route to portable surgical hospital, Galahad Force, Myitkyina, Burma, July 1944. B. Plasma administered on the run to casualty being taken to L-5 plane for quick evacuation to Cotabato, Mindanao, Philippine Islands, May 1945.

He had "managed to scrape up" five units of plasma and had used four of them with excellent results, three for shock and one for burns. A high Army officer, who had been injured in the area and who was in mild shock, was treated with the fifth unit. The lack of plasma for him "would have been most embarrassing."

The writer waxed more indignant as he continued. Plasma was nowhere more essential, he pointed out, to prevent impending, and treat primary, shock than in the frontlines. It was more sensible to provide it there and not wait until the casualty went into secondary shock. He might easily die on his way to the clearing station, usually 3-5 miles, and sometimes 12-15 miles, to the rear. If practical considerations were brought in, plasma could be given under the most severe battle conditions. He himself had administered it with shells and bombs landing only a few yards away and had seen casualties respond to it under his eyes.

On the other side of the world (fig. 5), plasma was reported as equally effective. The Naval medical officer in charge at Tarawa, Capt. French R. Moore, MC, USN, said that 6,000 pints of plasma went ashore with the invading troops and "4,000 pints came back in the veins of wounded Marines."

In his book, "More Than Meets the Eye" (18), Carl Mydans wrote of "combat medics on bouncing jeeps," who

* * * kneeling and balancing and clinging miraculously with one arm, raised the other high, as one would a torch, holding a bottle of plasma, pouring life back into a broken body. I think I have never seen a soldier kneeling thus who was not in some way shrouded with a godlike grace and who did not seem sculptured and destined for immortality.

To those who saw what plasma achieved in World War II, this quotation is not an exaggeration.

References

1. Minutes, meeting of Committee on Transfusions, Division of Medical Sciences, NRC, 31 May 1940.
2. Elliott, J.: A Preliminary Report of a New Method of Blood Transfusion. *South. Med. & Surg.* 98: 643-645, December 1936.
3. DeGowin, E. L., and Hardin, R. C.: A Plan for Collection, Transportation and Administration of Whole Blood and of Plasma in Warfare. *War Med.* 1: 326-341, May 1941.
4. ETMD, NATOUSA, for July 1944.
5. Minutes, meeting of Subcommittee on Blood Substitutes, Division of Medical Sciences, NRC, 19 Apr. 1941.
6. Blalock, A.: Report of Committee on Transfusions, Division of Medical Sciences, National Research Council, to Committee on Surgery, Division of Medical Sciences, National Research Council, 24 July 1940.
7. Minutes, meeting of Subcommittee on Blood Substitutes, Division of Medical Sciences, NRC, 30 Nov. 1940.
8. Minutes, meeting of Subcommittee on Blood Substitutes, Division of Medical Sciences, NRC, 3 Nov. 1941.
9. Minutes, meeting of Subcommittee on Blood Substitutes, Division of Medical Sciences, NRC, 24 Sept. 1943.
10. Minutes, meeting of Subcommittee on Blood Substitutes, Division of Medical Sciences, NRC, 20 Oct. 1942.

11. Minutes, Conference on Transfusion Equipment and Procedure, Division of Medical Sciences, NRC, 25 Aug. 1942.
12. Minutes, meeting of Subcommittee on Blood Substitutes, Division of Medical Sciences, NRC, 15 Dec. 1942.
13. Minutes, Conference on Blood Grouping, Division of Medical Sciences, NRC, 23 Mar. 1943.
14. Minutes, meeting of Subcommittee on Blood Substitutes, Division of Medical Sciences, NRC, 13 May 1943.
15. Report, Consultant in Surgery to the Surgeon, NATOUSA, 2 July 1943.
16. Medical Department, United States Army. Surgery in World War II. The Physiologic Effects of Wounds. Washington: U.S. Government Printing Office, 1952.
17. Memorandum for The Surgeon General, 20 June 1944, subject: Annual Report, Transfusion Branch, Surgery Division, Fiscal Year 1944.
18. Mydans, Carl: More Than Meets the Eye. New York: Harper & Bros., 1959.

CHAPTER IV

Administrative Considerations in the Zone of Interior

The blood and plasma program of the U.S. Army Medical Department in World War II involved the cooperation of a number of agencies, both in and out of the Department, including the Army Medical School; NRC (National Research Council); the Office of The Surgeon General; the National Institute of Health; the U.S. Navy; the American Red Cross; and the millions of donors who gave their blood to supply blood, plasma, and byproducts of blood for the Army, including the Army Air Forces, and the Navy. It was a magnificent national endeavor, and it saved countless lives.

The activities of these various agencies occurred, for the most part, at the same time, but they are most conveniently described under special headings (1).

ARMY MEDICAL SCHOOL

Organization of the Blood Research Branch

The first steps in the plasma and blood program in World War II were taken early in 1940 by Col. (later Brig. Gen.) Charles C. Hillman, MC, Chief, Professional Services Division, Office of The Surgeon General (fig. 6). His first action was to request Col. (later Brig. Gen.) George R. Callender, MC, Commandant, Army Medical School (fig. 7), to organize a blood research branch in the Division of Surgical Physiology at the school.

At the same time that Colonel Hillman made this request, he, acting for The Surgeon General, also requested the Division of Medical Sciences, NRC, to assemble a civilian committee to act informally, in an advisory capacity to the Surgeons General of the Army and the Navy. The Committee on Transfusions (p. 73) was appointed in response to this request.

The Division of Surgical Physiology at the Army Medical School had been set up in 1936, by Capt. (later Col.) Sam Seeley, MC, but it had ceased to function in 1938, after 2 years of very active operation, when he was transferred elsewhere. When it was reactivated in the spring of 1940, Capt. (later

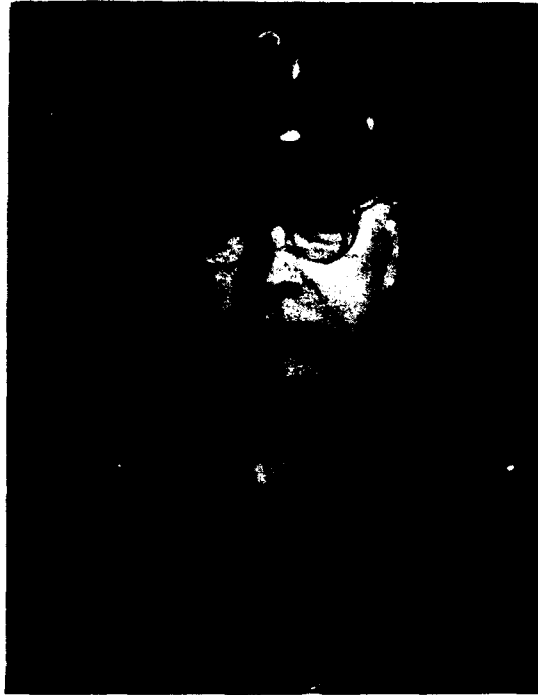

FIGURE 6.—Brig. Gen. Charles C. Hillman, Chief, Professional Services Division, Office of The Surgeon General.

Col.) Douglas B. Kendrick, MC, was selected to head it, because of his earlier training and experience.¹

Personnel

The original personnel of the division consisted of Captain Kendrick (fig. 8) and an enlisted man who served as technical assistant. The number of its personnel varied from time to time, but the list for July 1944 may be taken as typical of the roster for the greater part of the war:

Officers:

- One lieutenant colonel, MC, whose chief duties were administrative.
- Two captains, MC, whose chief duties concerned production and research.
- One captain, SnC, whose chief duty was research.

¹ During a civilian surgical residency at Grady Hospital, in Atlanta, under Dr. Daniel C. Elkin, Captain Kendrick had a considerable experience in traumatic surgery, with its attendant problems, including shock. He also served under Dr. Fred Rudder, who was greatly interested in the use of whole blood in shock and who devised an ingenious apparatus for direct transfusion.

After his service at Grady Hospital, Captain Kendrick entered the Army Medical Corps and, because of his previous experience, he was sent for a year to the Institute of Experimental Medicine at the Mayo Clinic, Rochester, Minn., where he worked on gas gangrene; the special uses of the sulfonamides; anesthesia (under Dr. John S. Lundy); shock; and replacement fluids. The plan had been that on his return to the Army Medical School, Captain Kendrick should continue Captain Seeley's work. Funds for research, however, proved so inadequate that this plan could not be carried out. Captain Kendrick was therefore assigned to the orthopedic service, Walter Reed General Hospital, Washington, D.C., and he was transferred from it when, at Colonel Hillman's request, the Department of Surgical Physiology, Army Medical School, was reactivated, with research in blood and blood substitutes as its chief objective.—J. B. C., Jr.

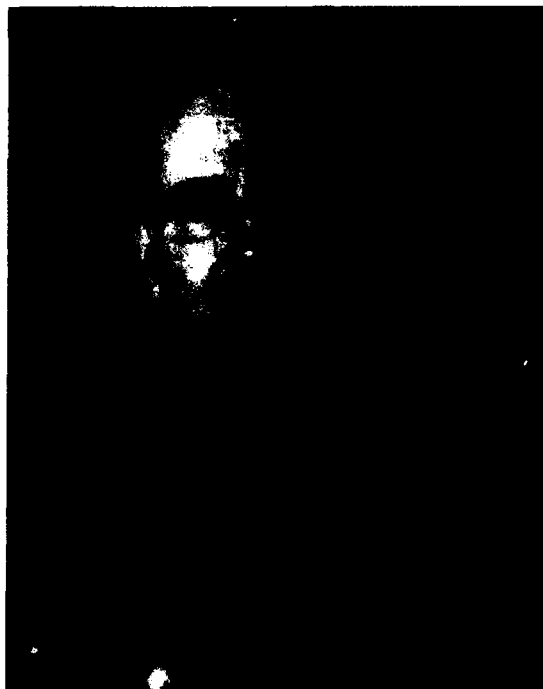

FIGURE 7.—Col. (later Brig. Gen.) George R. Callender, MC, Commandant, Army Medical School.

Enlisted male personnel:

One technical sergeant; one technician, fourth grade; one technician, fifth grade; one private, first class. Three-quarters of the time of these enlisted personnel was spent on production and the remainder on research.

Enlisted female personnel:

One technician, fifth grade, and four privates, first class, whose time was similarly divided.

Civilian personnel:

One laboratory technician, P-2, used for research.
Two clerk-typists, CAF-4, used for office work.
One laboratory helper, SP-1, used for utility purposes.

Liaison

As long as he was connected with the blood program (from 1940 until 18 November 1944), Colonel Kendrick served as chief of the research program at the Army Medical School. Even when he was given additional duty in the Office of The Surgeon General, in 1943, as Special Representative on Blood and Plasma Transfusions, it seemed wiser for him to continue to operate under the table of allowances at the School, so that he might continue to have free access to the research facilities needed in the program. Policies for the blood and plasma program were established in the Office of The Surgeon General, but all operations were conducted at the Army Medical School. The arrangement proved highly efficient.



FIGURE 8. -Early experimental studies on blood, Division of Surgical Physiology, Army Medical School, Army Medical Center, Washington, D.C., July 1941, by Capt. (later Col.) Douglas B. Kendrick, MC. The plasma collecting bottle is the Baxter Plasmovac. The large bottle containing dried plasma is the original Sharp & Dohme ampule.

During Colonel Kendrick's connection with the blood program, there was always the closest possible cooperation between the Army Medical School and the Office of The Surgeon General. Colonel Callender at the School, General Hillman in the Office of The Surgeon General, and Col. (later Brig. Gen.) Fred W. Rankin, MC, Chief Surgical Consultant, Office of The Surgeon General, and his staff gave unlimited support to him in all his activities, and all matters concerned with blood, shock, and resuscitation were referred to him as a matter of routine. From the beginning of the blood program, although he was not officially appointed in that capacity until late in 1943, Colonel Kendrick, for all practical purposes, served as consultant to The Surgeon General in these matters.

Development of the Program

The first activity of the blood research program was a survey and analysis of the relevant literature and the building up of a large reprint file. At this time, the literature on shock was voluminous (and confusing), but the literature on plasma and other blood substitutes was rather scanty, and contributions on liquid plasma were just beginning to appear.

Information on these subjects was also collected, by personal visits, from the following sources:

Mr. (later Captain SnC) John Elliott, Chief of Laboratory at the Rowan Memorial Hospital, Salisbury, N.C., who had developed a technique of processing sterile, pyrogen-free plasma in liquid form. When Mr. Elliott later entered the U.S. Army, he was assigned to the Army Medical School, where he instructed personnel in the processing of the liquid plasma used in Zone of Interior hospitals. He also contributed to the development of the vacuum bottle manufactured by the Baxter Co. and used, with certain modifications, for both plasma and whole blood during the war.

Dr. Max M. Strumia, pathologist at the Bryn Mawr Hospital, who had done special work on dried plasma.

Dr. John Reichel, of the Reichel Laboratories, Kimberton, Pa., who had worked with Dr. Strumia on the development of equipment for drying plasma.

Dr. Stuart Mudd, Professor of Bacteriology, University of Pennsylvania School of Medicine, Philadelphia, Pa., and Dr. Earl W. Flosdorf, an experienced refrigeration engineer, who had worked with Dr. Mudd as his research assistant in freezing and drying plasma and in the preparation of serum.

Information was also secured from Sharp & Dohme, a firm which had long been interested in the preparation of antisera and other immunizing agents. This company had done considerable work with typhoid and other vaccines, and, with the help of Dr. Reichel, had pioneered in the development of vacuum-drying equipment.

The activities of the Division of Surgical Physiology (fig. 9) included, in addition to the blood research program, studies on, or supervision of studies on, dried and liquid plasma and its production for use in the Zone of Interior (fig. 10); studies on human serum albumin and on bovine albumin; studies on various proposed blood substitutes, such as gelatin, pectin, synthetic plasma, and globin; studies on group O blood; studies on the Rh factor; studies on typing sera; and studies on blood preservatives. The design and testing of plasma and transfusion equipment were also part of the work of the division. These various activities are described under appropriate headings.

One of the functions of the Division of Surgical Physiology was the review of manuscripts and the evaluation of suggestions submitted by interested lay persons as well as by medical personnel. For various reasons, many papers were not considered suitable for publication in their current form. The suggestions covered a wide range: one physician suggested the treatment of shock by ultraviolet therapy. Another declared that if the technique he



FIGURE 9.- Exhibit by Blood Research Division, Division of Surgical Physiology, Army Medical School, at annual meeting of District of Columbia Medical Society, Washington, D.C., 1941. A. Plasma drying equipment actually in use. Shell-freezing unit far left. Vacuum pump next to it, and next to it refrigeration trap to remove moisture from drying plasma. Metal cylinder in left foreground serves as drying chamber. Left, Capt. Douglas B. Kendrick, MC. Right, Cdr. Lloyd R. Newhouser, MC, USN. B. Closeup showing various types of plasma and plasma packaging.

proposed for the surgical treatment of anuria resulting from transfusion incompatibility were not adopted, there would be thousands of deaths from uremia in crushing injuries and from the transfusion kidney during the invasion of the Continent. One manuscript was chiefly concerned with condemnation of the apparatus that had been used with great satisfaction for indirect transfusions for almost 3 years. Another was based on the false premise that the treatment of shock would be carried out by untrained enlisted personnel; the adoption of the apparatus described by the author for entering the veins would, in his opinion, solve this problem.

The interest behind these suggestions was greatly appreciated, but most of them were entirely impractical and quite unsuited for field use. They were always acknowledged, and in these letters it was pointed out to the physicians and others who had made the suggestions that the circumstances of warfare permitted the use of only simple, proved, and accepted methods of treatment.

Personnel of the Division of Surgical Physiology during the course of the war prepared and published a large number of papers on the various phases of the blood and plasma program. They are cited in appropriate places in this volume.

The training courses conducted at the Army Medical School are described elsewhere (p. 86).

OFFICE OF THE SURGEON GENERAL

In 1939, before the outbreak of World War II, a blood transfusion service was organized in the British Army, headed by Brigadier (later Sir) Lionel E. H. Whitby, RAMC (p. 15). In sharp contrast, the Office of The Surgeon General did not organize a section devoted to this specialty until November 1943, and never, during the entire war, was there a single medical officer in the office whose entire time was devoted to matters concerned with blood and plasma transfusion (2). It is true that, for a brief period in 1943, Col. Charles F. Shook, MC, served as Special Representative of The Surgeon General for the Blood Plasma Program. His service in this capacity, however, did not parallel that of Brigadier Whitby; it was chiefly concerned with production and supply and not with the professional aspects of the problem.

The initial responsibility for the blood and plasma program, as just described, was given to the Division of Surgical Physiology, Army Medical School. In late 1942, it was transferred to the Surgery (later the Surgical Consultants) Division, Office of The Surgeon General, and Lt. Col. (later Col.) B. Noland Carter, MC (fig. 11), was made responsible, in addition to his other duties, for all matters connected with fluid replacement therapy in shocked casualties.



FIGURE 10. Preparation of liquid plasma. Blood Research Division, Division of Surgical Physiology, Army Medical School. A. Liquid plasma being dispensed into bottles, to be shell-frozen and dried for storage. Drums in foreground are drying cabinets, which are hooked up by metal tubes to refrigeration traps and vacuum pumps. Device on right was used to measure cabinet pressure. This plasma was used only in the continental United States. B. Liquid plasma collected under closed system and stored at room temperature at the Army Medical School. It was dispensed on requisition to hospitals in the Zone of Interior. At one time, five centers were preparing and dispensing liquid plasma.

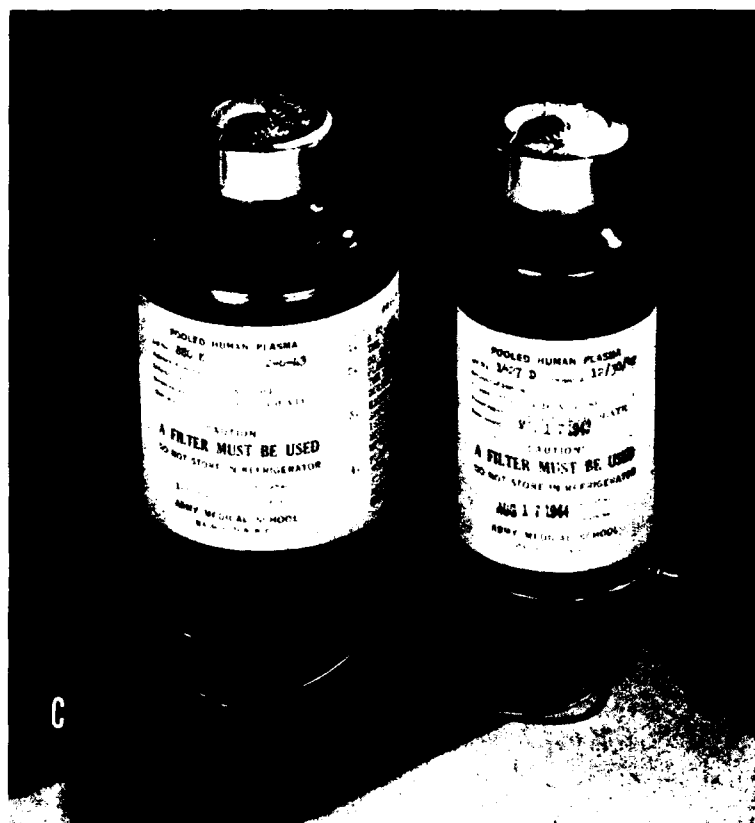

FIGURE 10.—Continued. C. Bottles of pooled liquid plasma ready for clinical administration. Note caution against refrigeration, which was not necessary.

Establishment of the Transfusion Branch

On 24 November 1943, a Transfusion Branch was created in the Surgery Division, Office of The Surgeon General, with Colonel Carter serving as Chief, again in addition to his other duties in the division, and Maj. Frederic N. Schwartz, MAC, as Operations Officer. The establishment of this branch was the outgrowth of a memorandum from General Rankin to The Surgeon General on 5 July 1943, in which General Rankin pointed out the necessity for such a branch because of the tremendous growth of the plasma and albumin programs and their increasing complexity (3).

Shortly after this branch was established, Colonel Kendrick was appointed Special Representative to The Surgeon General on Blood and Plasma Transfusion. On 18 November 1944, when Colonel Kendrick left the Zone of Interior on permanent change of station (p. 603), he was succeeded by Maj. John J. McGraw, Jr., MC, who had had a wide experience in this field in the Mediterranean theater (p. 402).



FIGURE 11.—Lt. Col. (later Col.) B. Noland Carter, MC, Assistant Chief, Surgical Consultants Division, Office of The Surgeon General.

Functions

The Transfusion Branch eventually carried the entire responsibility for the blood procurement program from the collection of the blood to the point at which it was placed on planes for oversea shipment (chart 1). Major Schwartz had performed many of the same functions in his previous assignment in the Supply Division, Office of The Surgeon General.

The functions of the chief of the Transfusion Branch were as follows (4):

1. To act as liaison officer with the American Red Cross and as adviser to the director of its blood donor program, including the publicity and recruiting phases of the program and changes in donor quotas to fulfill existing contracts.
2. To provide and maintain a force of 60 medical officers for duty in the blood donor centers.
3. To assist in procurement of equipment and supplies for the blood donor centers and the processing laboratories.
4. To maintain contact with Selective Service, so as to secure deferment and retention of essential technical personnel.
5. To maintain data on bleedings, finished units, issues, and stocks.
6. To act as liaison officer between the Office of The Surgeon General and the Blood Substitutes Subcommittee, NRC; the National Institute of Health; the representative of

CHART 1.—Final evolution of organization chart, Transfusion Branch, Surgical Consultants Division, Office of The Surgeon General, July 1944

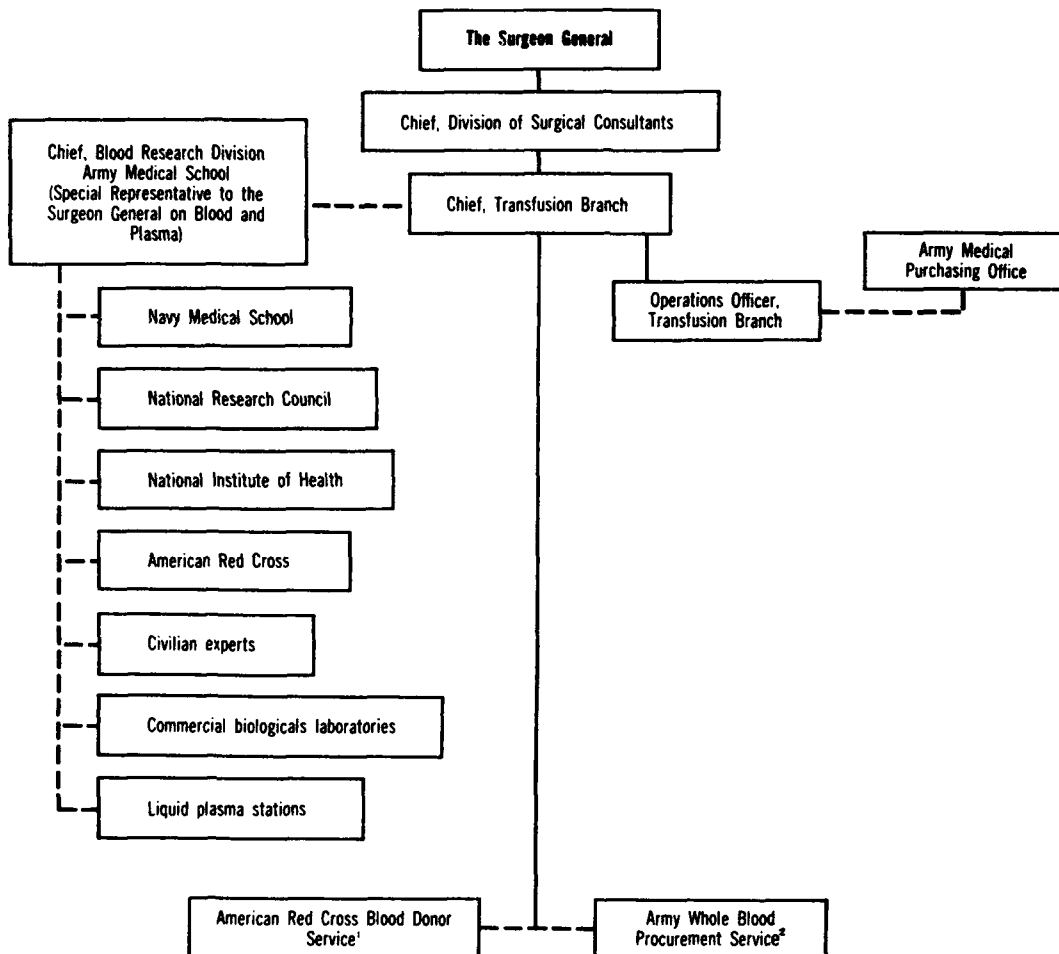

¹ Sixty officers assigned to Army Medical Purchasing Office for duty with Red Cross Donor Centers to bleed donors.

² Eleven officers and a group of technicians assigned to Army Medical Purchasing Office for duty with Red Cross Centers to process whole blood.

the Navy on blood, plasma, albumin, and byproducts; and the albumin pilot laboratory at the Harvard Medical School under Dr. Edwin J. Cohn.

7. To coordinate with the commercial biological laboratories all technical matters pertaining to the production of plasma, albumin, byproducts, and intravenous solutions, and, by repeated inspection of these laboratories and testing of their products, to insure adequate production of acceptable material for the Armed Forces.

8. To secure from the Legal Division, Office of The Surgeon General, advice on any legal questions that might arise in connection with the control and use of plasma, albumin, and byproducts processed from blood collected by the American Red Cross and turned over to the Army for its use.

9. To coordinate action in the various divisions of the Office of The Surgeon General on all matters pertaining to plasma, albumin, blood substitutes, and intravenous solutions.

10. To represent The Surgeon General in transactions with military missions and purchasing agencies concerned with plasma and other products.

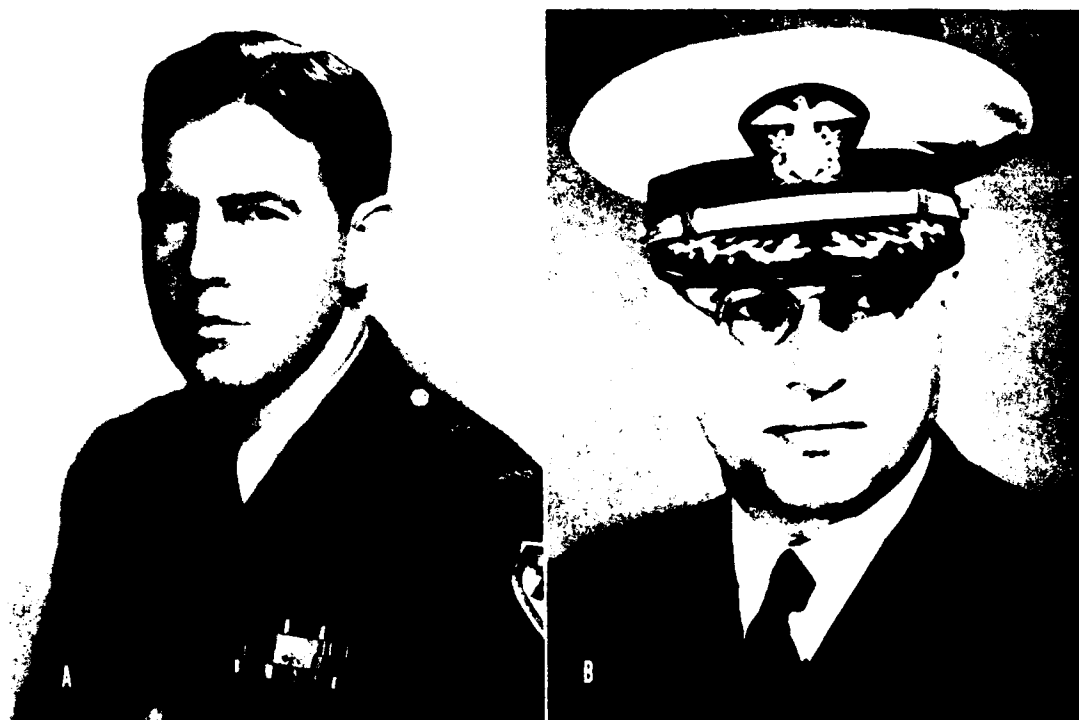

FIGURE 12.—Army and Navy representatives, Blood and Plasma Program. A. Col. Douglas B. Kendrick, MC. B. Capt. Lloyd R. Newhouser, MC, USN.

The Transfusion Branch was also responsible for the preparation of circular letters and other publications concerned with blood, plasma, albumin, and byproducts. Among these publications were:

1. Circular Letter No. 108, Office of The Surgeon General, 27 May 1943, subject: Transfusion of Whole Blood in the Theaters of Operations (5) (p. 463).
2. War Department Technical Bulletin (TB MED) 204, 24 Oct. 1945, subject: Complications of Blood Transfusion (6).
3. A laboratory manual of technical procedures, standard at all blood centers, and issued in March 1945 by the Army Whole Blood Procurement Service (7).

Liaison With the Navy

In April 1940, shortly after Captain Kendrick had been assigned to the Division of Surgical Physiology, Army Medical School, Lt. Cdr. (later Capt.) Lloyd R. Newhouser, MC, USN, was assigned, with comparable duties, to the National Naval Medical Center, Washington, D.C. (fig. 12). They encountered each other in the course of their work, and, since both were trying to accomplish the same purposes, it seemed only sensible to pool their efforts. This they did from 1940 until late in 1944, when both were assigned to oversea duty. Their collaboration, while entirely unofficial, was approved and encouraged by their superior officers in both services.

This association proved extremely fruitful. From the beginning, Captain Kendrick and Commander Newhouser kept each other closely informed of their plans and their projects, and this exchange of information eliminated many duplicating and overlapping activities. Many items were standardized jointly by the Army and the Navy, and most orders could be placed with a consideration of joint needs. The intimate liaison was an important factor in the maintenance of a smoothly running program for the procurement of plasma, albumin, and, finally, whole blood. It was out of this informal arrangement that formal plans were eventually consummated for the Navy to assume the responsibility of flying blood to the Pacific (p. 599), since the Army was already occupied with the task of flying blood to Europe (p. 494).

NATIONAL RESEARCH COUNCIL

Historical Note

In 1916, when U.S. involvement in World War I began to seem imminent, the National Academy of Sciences offered its services to the Government (8). The offer was immediately accepted by President Wilson, who requested the academy to organize the scientific agencies of the country, not only in the interests of national defense but with the ultimate object of advancing scientific and industrial progress. The National Research Council was accordingly constituted by the academy and rendered noteworthy service in various fields during World War I.

In 1918, President Wilson, by Executive order, requested the academy to take the necessary steps to perpetuate the council, so that its services could be utilized in time of peace. This was done. As a result, when World War II broke out, the council was already organized for immediate action, and it did much useful work before the United States entered the war in December 1941. In fact, the activities of the council before this date furnished one more piece of evidence that the President and his advisers were aware that, for all practical purposes, the country was already at war.

Organization of Committees

Committee on Transfusions.—The Committee on Transfusions, Division of Medical Sciences, NRC, which held its first meeting on 31 May 1940 (9)² consisted of:

Dr. Walter B. Cannon, Chairman, Professor of Physiology, Harvard Medical School.

² It is impossible to overemphasize the importance of the establishment of this committee at this time, 18 months before the United States was precipitated into World War II. It meant that significant advances could be made in the blood and plasma programs before the actual need for them arose. This committee and its subcommittees, as already noted, were established at the request of The Surgeon General (Maj. Gen. James C. Magee), and representatives of the Army and the Navy were present at all meetings to present the needs and interests of the services.

Dr. Alfred Blalock, Professor of Surgery, Vanderbilt University School of Medicine.

Dr. Everett D. Plass, Professor of Obstetrics and Gynecology, State University of Iowa College of Medicine.

Dr. Strumia, Assistant Professor of Pathology, University of Pennsylvania Graduate School of Medicine.

Dr. Cyrus C. Sturgis, Professor of Internal Medicine, University of Michigan Medical School.

Subcommittee on Shock.—At its initial meeting on 31 May 1940, the Committee on Transfusions appointed a Subcommittee on Anesthesia and Shock (usually called the Subcommittee on Shock), consisting of:

Dr. Blalock, Chairman.

Dr. Henry K. Beecher, Professor of Anesthesia, Harvard Medical School.

Dr. Norman E. Freeman, Assistant Professor of Research Surgery, University of Pennsylvania School of Medicine.

Dr. Paul D. Lamson, Professor of Pharmacology, Vanderbilt University School of Medicine.

Dr. John S. Lundy, Professor of Anesthesia, University of Minnesota Graduate School of Medicine.

Dr. Leo Eloesser, Clinical Professor of Surgery, Leland Stanford University School of Medicine.

Dr. Ralph M. Waters, Professor of Anesthesia, University of Wisconsin School of Medicine.

Dr. John Scudder, Instructor in Surgery, Columbia University College of Physicians and Surgeons.

Subcommittee on Blood Substitutes.—The Subcommittee on Blood Substitutes appointed by the Committee on Transfusions at its initial meeting consisted of Dr. Sturgis, chairman, Dr. Plass, Dr. Strumia, and Dr. Oswald H. Robertson, Professor of Medicine, University of Chicago School of Medicine.

Dr. Sturgis and Dr. Plass resigned from this subcommittee on 19 April 1941 but continued to serve on the Committee on Transfusions. The Subcommittee on Blood Substitutes finally consisted, in addition to Dr. Robertson, Dr. Scudder (secretary), and Dr. Strumia, of the following:

Dr. Robert F. Loeb, Chairman, Professor of Medicine, Columbia University College of Physicians and Surgeons, who served until 2 June 1944, when he was succeeded by Dr. Joseph T. Wearn (10).

Dr. Edwin J. Cohn, Professor of Biological Chemistry, Harvard University Medical School.

Dr. Elmer L. DeGowin, Associate Professor of Internal Medicine, State University of Iowa College of Medicine.

Dr. Cornelius P. Rhoads, Director, Memorial Hospital, New York, N.Y.

Dr. Owen H. Wangensteen, Professor of Surgery, University of Minnesota Medical School.

Subcommittee on Blood Procurement.—The Subcommittee on Blood Procurement appointed by the Committee on Transfusions consisted, in addition to Drs. Rhoads and Strumia, of:

Dr. Warfield M. Firor, Associate Professor of Surgery, Johns Hopkins University School of Medicine.

Dr. Carl W. Walter, Associate Professor of Surgery, Harvard Medical School.

Ad hoc committees.—The Subcommittee on Blood Substitutes, like other NRC committees, promptly realized the impracticability of committee action on matters of detail and delegated the responsibility for special projects to individual members or ad hoc committees.

All of the members of these NRC committees, it should be noted, were experienced clinicians or had played an active part in the investigation of blood and plasma or had figured in both roles.

Functions and Activities

Although the Subcommittee on Blood Substitutes had come into existence at the request of The Surgeon General, almost a year earlier, it was not until 19 April 1941 that its functions were formally outlined, as follows (11):

1. To continue research work on the various blood substitutes and to establish their relative merits by clinical trials.
2. To determine the best techniques of preparing the various blood substitutes.
3. To standardize the best techniques of collecting and dispensing plasma and serum.
4. To select the type of container (containers) for preserving and dispensing plasma and serum.

All the emphasis at this time, it should be noted, was on blood plasma and so-called blood substitutes. Nothing was said about the possible functions of the committee in connection with blood. At the meeting of the subcommittee on 18 July 1941 (12), however, it was recommended that an adequate study of blood substitutes, especially human albumin, be made by a member of the Army Medical Corps at an institution at which an adequate number of cases would be treated to permit definite conclusions as to the efficacy of these substitutes in the prevention and treatment of shock. No action was taken officially on this recommendation of the subcommittee.

Summary of activities to 24 February 1943.—As a matter of convenience, the actions of the Subcommittee on Blood Substitutes on such matters as whole blood, plasma, albumin, bovine albumin, and byproducts are discussed in detail under appropriate headings. The summarized report of the subcommittee, however, of 24 February 1943, on its activities during the first 2

years of its existence is worth citing as an indication of the far-reaching scope of its activities and accomplishments (13). They included:

1. A study of the relative merits of the various preparations of human plasma and serum, with a recommendation to the Armed Forces that dried plasma be used.
2. Development of packaging and dispensing equipment for dried plasma.
3. Improvements in the methods of drying plasma, a study of the effects of these methods upon the products obtained, the development of equipment for drying plasma for use by hospitals as well as by large processors, and the recommendation to the Armed Forces that 0.1-percent citric acid be used as the diluent for dried plasma.
4. Recommendations to the American Red Cross covering: (a) the control of blood procurement centers by professional personnel, (b) techniques for blood procurement, (c) standardization of equipment at these centers, and (d) blood grouping.
5. Recommendations to the Surgeons General, Army and Navy, for the establishment of sections on shock and transfusion in their medical departments.
6. Preparation of a concentrated solution of human serum albumin which was stable over a wide range of conditions; which occupied little space in packaged form; which could be given with facility and without diluent; and which had been prepared to meet certain specific requirements of the Armed Forces, particularly the Navy. This product had been recommended to the Armed Forces and was then in preparation in large amounts for their use.
7. A study, then in progress, of the possible use of globulin byproducts of human albumin production for the control of measles, mumps, and other diseases, which gave hope of widespread practical application in the Armed Forces.
8. A study of the possible use of human fibrinogen and thrombin, also byproducts of albumin production, in the local treatment of burns.
9. Studies, still in progress, on the possible use of blood substitutes of other than human origin, including bovine albumin, gelatin, pectin, aldobionic acid, and glutamyl polypeptide.
10. Conferences to consider progress in these various studies and to examine their extension to various groups of workers.
11. Preparation of manuals on blood transfusion and blood plasma for the Office of Civilian Defense (p. 93).

As time passed, work on various aspects of these projects was extended, but the really important investigations to which the Subcommittee on Blood Substitutes devoted its major efforts are included in this 1943 summary.

Proposal for Intravenous Therapy Service for Armed Forces

At the Conference on Transfusion Equipment and Procedure on 25 August 1942 (14), it was the sense of the meeting that the question of using preserved blood for the Armed Forces was primarily one of feasibility. Dr. DeGowin was requested to draw up a statement and propose a plan for an intravenous therapy service which could be submitted to the Surgeons General of the Army and the Navy for their consideration. These proposals, which were drawn up in collaboration with Colonel Kendrick and Commander Newhouser, were handed to the membership of the Subcommittee on Blood Substitutes at the meeting on 10 November 1942 (15), and it was requested that comments and suggestions concerning them be sent to Dr. DeGowin by mail.

At the meeting of the subcommittee on 15 December 1942 (16), Dr. DeGowin reported that favorable comment on the proposals had been received

from all the members. It was voted that the memorandum containing the proposal and the justifications for it be included in the minutes of the meeting and submitted to the Surgeons General of the Army and the Navy through channels. This was done on 20 January 1943.

Although the recommendation for a separate intravenous therapy service in the Armed Forces was never acted upon during World War II, the arguments for it were entirely valid and are worth recording. In substance, they were as follows:

1. Intravenous therapy is a medical specialty, training in which is not provided in a routine medical education. The complexity of the problems involved in the manufacture, processing, and preservation of blood, blood substitutes, and other parenteral fluids is little known to the average physician, nor has he acquired the knowledge to design equipment and to test it for efficiency in the collection and administration of these fluids. He also does not understand the techniques of typing and crossmatching of blood.

2. The average physician is not a specialist in intravenous therapy. When he orders infusions and transfusions in a civilian hospital, he trusts to the special knowledge of experts in the field to manufacture pyrogen-free solutions. He accepts apparatus designed and tested by persons with special knowledge. He relies on a special department for proper cleansing and sterilization of the apparatus used. He depends on the laboratory for the typing and cross-matching of blood. The discussion of transfusion reactions in medical textbooks is inadequate, and the civilian physician, if all goes smoothly, is completely unaware of the organization and painstaking control that make the use of parenteral fluids safe. When, however, he enters the Medical Corps, he is called upon to practice more intravenous therapy than he employed in civilian life. He will be unable to perform this work satisfactorily without personal instruction in the procedures involved and the apparatus required for them.

3. Military medicine presents special problems in intravenous therapy as compared with civilian practice: the incidence of shock, hemorrhage, and burns is many times greater, as is their severity. In their treatment, the methods of civilian medicine must be modified by considerations of transport, equipment, and environment. Determination of the blood group of an occasional civilian patient is far removed from the mass typing of thousands of men entering the Armed Forces. Special techniques must be devised that are both rapid and accurate. Only specialists are logically qualified to evaluate and select them. The testing and procurement of proper typing sera is a major procedure in itself.

4. If a medical officer were to attempt to accumulate a store of whole blood, he would find that none of the methods in use in civilian practice could be applied directly to his military problem without modifications in equipment and technique.

5. Commercially available transfusion and infusion equipment is designed for civilian use. Military equipment must be designed with emphasis on portability, compactness, expendability, and conservation of critical material,

already in increasingly short supply. There are no textbooks to serve as guides, and few medical men in the country are qualified in this field. The development and testing of suitable plastics and synthetics to replace rubber tubing and stoppers require the combined knowledge of the chemist, the production engineer, and the medical expert in intravenous therapy.

6. A global war requires the adaptation of medical equipment and techniques in many situations and environments. The only practical methods of treating shock may be, variously, plasma or serum albumin, fresh blood, or banked blood. The procedures for their administration, however, are sufficiently simple to permit the average medical officer, with proper instruction, to become proficient in them. The issuance of directives is only supplementary to specific personal instruction, not a substitute for it.

Great progress, the subcommittee memorandum continued, had been made in the development of blood substitutes by the cooperation of appropriate committees of the National Research Council and by liaison with Army and Navy officers, but many delays could have been eliminated, and much more could have been accomplished before the United States entered the war, if the armed services had had well-organized sections on shock and transfusion, composed of experts in the field, with authority to act on problems of equipment, products, and procedures. With the rapid expansion of personnel in the military organization, the needs in the future would be even greater than they had been in the past.

In view of these considerations, it was the recommendation of the Subcommittee on Blood Substitutes that the Army and the Navy Medical Corps should recognize, as the Royal Army Medical Corps had recognized, that intravenous therapy is a medical specialty and that they should organize, as the British had organized, sections composed of experts in the field who were to be charged with the responsibility, and endowed with the authority, to act on:

1. Devising, testing, and authorizing techniques in this field.
2. Training medical personnel in intravenous therapy in the most practical possible manner.
3. Designing, and authorizing the production of, equipment and apparatus.
4. Supervising the procurement and processing of blood substitutes.
5. Participating in research in the field of intravenous therapy and cooperating with NRC in appropriate studies.

It is unfortunate that the recommendations of the Subcommittee on Blood Substitutes, NRC, for a separate transfusion service were not adopted. Both medical officers and technicians trained in the handling and care of whole blood continued in short supply throughout the war. As late as January 1945, officers and men necessary to handle the blood supply for the Pacific had to be trained on an emergency basis and used as cadres for the transfusion teams to be sent to that theater (p. 605).

To the end of the war, those in charge of the program continued to hold the view that blood banks should be operated only by specially trained personnel, who had a profound respect for the potential risks of blood transfusion and who

believed that the careless submission of a wounded man to the inherent dangers of this form of therapy was totally unwarranted (1).

Dissemination of Information

At a meeting of the Subcommittee on Blood Substitutes on 19 April 1941 (11), arrangements were made for the subcommittee to issue a monthly bulletin for its own information as well as that of others with a concern in the blood program. This proved a very useful plan.

Limitations on the use of paper during the war sometimes made the publicizing of the results of various investigations sponsored by the National Research Council a good deal of a problem. In March 1944, for instance, such a shortage delayed the publicizing of important recent developments on the preparation and use of byproducts of human blood plasma. It was essential that medical officers be familiar with this work, and in the course of several weeks the dispute was resolved favorably, but it was not the first time such difficulties had developed, nor was it to be the last.

At a meeting of the Subcommittee on Blood Substitutes on 20 October 1942 (17), there was a considerable discussion on an editorial on the toxicity of plasma that had appeared in the *Journal of the American Medical Association* for 19 September 1942 (18) and that was based on an article by Levine and State (19), which appeared in the same journal the following week. Dr. Strumia's extensive experience, reported at this meeting, was in sharp contrast to these authors' observations; he had had only five reactions in 2,200 transfusions with human plasma. It was agreed that the editorial contained numerous errors of fact, and a communication was sent to the editor of the *Journal*, asking for a retraction and pointing out that the publication of such data might cause serious difficulties in the blood procurement program. Dr. William Thalhiner had already prepared an article in which the misstatements concerning the supposed toxicity of plasma were refuted.

As had been feared, the editorial in the *Journal* made serious trouble for the Blood Plasma Section, Office of Civilian Defense, and also interfered with blood procurement by the American Red Cross. At the meeting of the subcommittee on 23 March 1943 (20), galley proof of the retraction requested was available and it was agreed to take no further action in the matter, though the statement was not considered entirely satisfactory.

This experience, like others related elsewhere, is indicative of the highly sensitive character of the blood and plasma program and of the matters with which the Subcommittee on Blood Substitutes had to concern itself.

Proposed Field Investigations

It has already been mentioned that nothing ever came of the proposal made at the first meeting of the Subcommittee on Blood Substitutes on 31 May 1940, that a group of physicians be allowed to work in the Army, freed

from any of the obligations of Army officers, to investigate shock on a large scale (p. 41). The matter was brought up again at the meeting of the Subcommittee on Blood Substitutes on 30 November 1940 (21), by Dr. Sturgis, who proposed that a team, financed by the Red Cross, be sent to study transfusion in England. Dr. Lewis H. Weed did not think that the proposal was feasible at this time, because of the situation abroad, but stated that it would be discussed with British authorities.

There was no further discussion of a field investigation until the meeting of 9 April 1943 (22), at which it was decided that the subcommittee had reached a point at which it could no longer function effectively without more precise information concerning field problems and the conditions imposed on therapy by the military requirements of the war.

A considerable portion of the present knowledge of the mechanism of shock and its treatment had come about through the physiologic studies of specially qualified and completely integrated groups of investigators in the field (Cannon, for instance, Bayliss, Keith, and Robertson, among others). The Medical Research Council of Great Britain had continued to support this policy. The National Research Council had not.

It was therefore the unanimous recommendation of the Subcommittee on Blood Substitutes, to be transmitted to Dr. Weed for submission to The Surgeon General, that a qualified fact-finding group be appointed, without special function of command, which should report its findings through official channels, these findings to be transmitted subsequently to the subcommittee, to serve as a basis for continued investigation. It was further recommended that the research group in the field should receive, through official channels, reports of recent significant developments in Zone of Interior research and should transmit this information, through official channels, to medical officers in the field.

The study which the subcommittee proposed was to cover plasma, albumin, crystalloid solutions, and whole blood, with respect to their requirements, use, effectiveness, and limitations.

The subcommittee specified that professional personnel for the proposed investigative group should be chosen from the best informed and best qualified personnel, irrespective of their present military or civilian status.

This recommendation was duly transmitted to the Surgeons General of the Army and the Navy, through channels, and was repeated at the meeting of the Subcommittee on Blood Substitutes on 24 September 1943 (23), when it was found that no action had been taken on it. At the same time, the subcommittee reiterated its recommendation that intravenous therapy be considered as a special branch of military medicine (p. 76).

These recommendations, as such, were never acted upon. The recommendation that replacement therapy be studied in the field was, however, implemented to some extent in June 1944, when General Rankin, Chief Surgical Consultant, Office of The Surgeon General, arranged for Colonel Kendrick to

visit the Pacific areas and study shock, transfusion, supply, and all other phases of replacement therapy (p. 590).

Both during and after the war, comments were frequently heard to the effect that the studies of NRC committees and subcommittees were conducted from an ivory tower and in a sort of nonmilitary vacuum. The criticism is not justified in view of the repeated endeavors of the Subcommittee on Blood Substitutes to secure its information at first hand and to base its recommendations on the information thus secured. The subcommittee was frustrated in its endeavors, and DeBakey (24), in 1946, wrote quite correctly of "the barrier between military surgeons and civilian investigators that was never completely crossed on either side."

NATIONAL INSTITUTE OF HEALTH

The NIH (National Institute of Health) played little part in the blood and plasma program until 1941, when Dr. Cohn, at the Harvard Medical School, succeeded in fractionating plasma protein and, at about the same time, dried plasma was prepared successfully. No question of interstate commerce had previously been involved. With these achievements, the products, under strict interpretation of the law, became biologicals, with whose manufacture, storage, and utilization NIH was intimately concerned. It was unlawful to produce and sell biologicals, which included serum, albumin, dried plasma, and byproducts of plasma, without a license from this agency.

Throughout the war, close liaison was maintained by the Army, the Navy, and the Subcommittee on Blood Substitutes, NRC, with Dr. Milton V. Veldee, Chief, Laboratory of Biologics Control, National Institute of Health. The excellent cooperation between NIH and the Army, the Navy, and NRC offers one more explanation of the success of the blood-plasma program.

Minimum specifications were prepared by Dr. Veldee and his associates for the processing and packaging of plasma and the products of plasma fractionation (25). Later modifications in both apparatus and techniques for the program were made only after consultation with, and approval by, Dr. Veldee, Captain Newhouser, and Colonel Kendrick. Representatives of NIH frequently visited the commercial laboratories producing plasma and other blood derivatives, aiding them in the establishment of techniques and assisting them in the solution of special problems.

LEGAL ASPECTS OF THE BLOOD AND PLASMA PROGRAM

Ownership of Blood and Its Components

The matter of ownership of the blood donated for use of the Armed Forces at the Red Cross blood donor centers seems to have been handled by default until the meeting of the Subcommittee on Blood Substitutes on 23 June 1942 (26), when the proposal to release a certain amount of plasma to OCD (Office

of Civilian Defense) came up for discussion (p. 92). It was the sense of the meeting that the responsibility of the Red Cross for the blood collected ceased as soon as the blood was delivered to the processing laboratories. It was also brought out that, at this time, none of the interested parties (American Red Cross, Army, Navy) exercised any supervision over losses in the plant. While it was not clear who owned the material from the time the blood was delivered to the processing laboratories by the Red Cross until the laboratories delivered it to the Armed Forces as dried plasma, the assumption was, since the laboratories could not hold title to it, that it must indeed be the property of the Armed Forces.

A formal resolution was passed at this meeting to the effect that the blood collected by the Red Cross should "become as heretofore the property of the armed forces from the time it enters the processing plant." It was further resolved that the Armed Forces assume responsibility and authority for the processing, preparation, and disposition of the blood and plasma as "safe and effective therapeutic material."

Before the legal aspects of the disposition and ownership of red blood cells and other byproducts of the plasma program became an issue, the policy had been to permit commercial processing houses to furnish red blood cells to adjacent hospitals, with the specification that the Office of The Surgeon General be furnished reports of the studies made with them. It was further understood that the laboratories should not charge the hospitals; that the hospitals should not charge the patients treated, who, preferably would be those unable to pay; and that the hospitals should agree to indemnify the Government for any claims which might arise out of the use of the red blood cells.

At the Conference on Blood Grouping on 23 March 1943 (27), it was agreed that the arrangements made up to this time were no more than temporary expedients, that the question of charges and other problems would recur as other byproducts were developed, and that a group of experts must formulate a policy that would be legal and that would meet the obligations to the donors of the blood. It was the sense of the meeting that Dr. Weed call a conference on the subject, to be attended by representatives of the Army, the Navy, and American Red Cross, as well as by Dr. Cohn, Dr. Rhoads, and Dr. Veldee.

Statement of the Problem

On 6 April 1943, Dr. Cohn, in whose laboratory at the Harvard Medical School most of the work on byproducts had been done, prepared a statement of the problem for Dr. Weed, as follows (28):

1. Clearly, these byproducts could not become a source of profit to commercial houses. At the present time, these substances, which were considered the property of the Government, were being retained "in the cold," under the most favorable conditions to permit the preservation, for protracted periods

of time, of some—though not all—of their properties. All of these byproducts (red cells, fibrinogen, thrombin, isohemagglutinins, measles protective antibodies) could be brought into more stable states, including the dry state, although additional processing would be required.

2. The present problem was more clearly exemplified in connection with fraction II, which contained the highly promising measles antibodies. Under optimum circumstances, the amounts which could be processed would presumably be greatly in excess of any needs the Armed Forces might have for this byproduct. The results of tests with small amounts released on the authorization of The Surgeon General, Navy, for experimental purposes to commercial laboratories, under controlled conditions, had been hopeful. The material must not be allowed to deteriorate, and the excess, beyond what was needed for the Armed Forces, should be used for "social value." The Red Cross, Dr. Cohn thought, might well be put in the position of making "a public restitution" of the byproducts not needed by the Armed Forces.

Recommendations

Dr. Cohn's letter was read at the Conference on Albumin and By-Products called by Dr. Weed on 10 May 1943 (28). In the discussion, it was brought out that the largest byproduct of plasma processing, in point of bulk, was the red blood cells, but that the globulin fractions would probably prove to be of greater importance. The problem was financial as well as legal: the Red Cross considered it better that it should take title to the byproducts than have another agency do it; but the estimated cost, on the assumption that the entire quantity of globulin now available would be worked up into forms suitable for military and civilian use, would be about \$1¼ million.

At the meeting of the Subcommittee on Blood Substitutes on 13 May 1943 (29), it was reported that the Red Cross Medical and Health Advisory Committee had met since the conference on 10 May and had requested that the subcommittee make specific recommendations concerning the ownership of the byproducts of the blood and plasma program. The organization was willing to exercise ownership, supervise the processing of the byproducts under conditions which "would give prior lien" on all material to the Armed Forces, and arrange for the financing and distribution "for the public good" of the material not required by the Armed Forces.

Although some doubt was expressed as to the legality of the proposed arrangements, the following recommendations were made:

1. Title to the byproducts of the blood procurement program shall be transferred from the Army and the Navy to the American Red Cross if there are no legal impediments to this arrangement.
2. The Red Cross shall assume responsibility for financing the program and for the processing, control, and redistribution of these byproducts.
3. To carry out the program, the Red Cross, acting on the advice of its National Medical and Health Advisory Committee, shall appoint a small group of representative technical

experts (Army, Navy, Public Health Service, National Research Council, Committee on Medical Research) to supervise and control the processing of these byproducts by contract with university or pharmaceutical laboratories.

4. The Army and the Navy shall have priority in requisitioning such quantities of these byproducts as they may need. The excess shall be used for civilian purposes, foreign relief, or such experimental procedures as may be considered essential by the supervisory group. The Red Cross (or some other designated agency) shall arrange the best method of distribution of the excess.

5. As the value of each new byproduct is established, subordinate groups shall be appointed, of not more than three members each, representing, respectively, the National Institute of Health, the National Research Council, and the Armed Forces.

Dr. Cohn stated that he had already asked for an appraisal group for each byproduct of the albumin program.

Further Actions

The ownership of these byproducts was discussed by letters and at meetings during the remainder of 1943 from all points of view. One of the principal objections to the proposed plan was that the Red Cross might not be able to obtain the necessary equipment for processing the byproducts.

The Navy believed that all contracts for byproducts from the albumin program should be let by the Navy, which was already handling all albumin contracts. Dr. Cohn agreed, on the ground that plasma fractionating is an integrated process. At the meeting of the Albumin and By-Products Group on 28 July 1943 (30), he pointed out that the settlement of the issue was pressing, since measles antibodies (fraction II), thrombin, and fibrin film had been thoroughly tested and were ready for appraisal. At the meeting of the Subcommittee on Blood Substitutes on 24 September 1943 (23), Captain Newhouser reported requests from civilian physicians for allocation of serum albumin for the treatment of their patients.

At the meeting of the subcommittee on 6 October 1943 (31), it was announced that a red blood cell suspension service had been set up at Halloran General Hospital, Staten Island, N.Y., and the recommendation was made that, for administrative purposes, it would be a good idea to give the Red Cross ownership of red blood cells, since similar services would shortly be set up in other cities. On 7 January 1944, Maj. Gen. George F. Lull, Deputy Surgeon General, approved this arrangement (32). This information was duly conveyed to the processing laboratories, which were directed to release the cells at the times and in the amounts specified by the Red Cross. These laboratories had previously been reminded (27 August 1943) that all blood received from the Red Cross and all plasma processed from it remained the property of the Government and none of its byproducts should be released without written authorization by responsible authorities.

On 27 May 1944, Maj. Gen. Norman T. Kirk notified the Director, Medical and Health Service, American Red Cross, that the Navy had agreed to turn

over to it all immune serum globulin in excess of requirements of the Armed Forces, to be distributed to the civilian population through the state health agencies designated by the Red Cross. General Kirk gladly concurred in this arrangement (33).

Note.—As a matter of convenience, certain other legal aspects of the blood program are discussed elsewhere in this volume. The accounting problems of the processing laboratories are discussed in connection with the plasma program.

TRAINING

In any consideration of the training of medical officers and enlisted men in the handling and use of plasma and blood, it must be borne in mind that when the United States entered World War II, plasma was an almost unknown agent and the use of blood transfusion was far from general. Both theory and demonstration were therefore equally important phases of all training programs.

National Research Council

The Subcommittee on Blood Substitutes recognized the importance of training in intravenous therapy by suggesting at its first meeting on 31 May 1940 (9) that (1) there should be some center in every Army organization at which men would receive training in caring for shocked casualties, and (2) there should also be centers in which men could be trained in all aspects of intravenous therapy. At a later meeting, on 9 April 1943 (22), a visitor from the Canadian Army who was present pointed out that the British had found it necessary to have medical officers with specialized training in charge of transfusions. Colonel Kendrick made the same point at the meeting of the subcommittee on 17 November 1943 (34), when he stated, in reply to an inquiry concerning oversea training, that the Office of The Surgeon General would issue a memorandum on the technique of transfusion and on methods of preserving blood but had no authority to recommend techniques to surgeons in theaters of operations.

Questions concerning training were also raised at the meeting of the subcommittee on 19 April 1941 (11) and at the Conference on Transfusion Equipment on 25 August 1942 (14). Some medical officers, it was stated, had not yet even seen dried plasma, let alone having had any instruction in its use. Dr. Cannon, basing his remarks on his own observations, stated that it was more important to teach men to needle veins than to provide them with blood substitutes, since the substitutes could not be used without training in venipuncture. It was reported that, in the summer of 1940, Dr. (later Major, MC) Robert C. Hardin had taken several enlisted men of a National Guard unit to the State University of Iowa Hospital and instructed them in this procedure. Although they had had no previous medical training, they all learned readily.



FIGURE 13. Laboratory technicians in training, Army Medical School, Walter Reed Army Medical Center.

Army Medical School

Two formal training courses (fig. 13) were conducted at the Army Medical School, listed in Army Service Forces Manual M3 for November 1944 (35) as:

1. Course MO-20, Red Cross Blood Donor Center, Operation of. This course lasted for 2 weeks and was intended for medical officers who were to be sent to liquid plasma processing centers in Zone of Interior hospitals (p. 274). Instructions included (a) general plans of organization and operation and (b) techniques of bleeding donors. The course was concluded with several days of supervised practice at the Washington, D.C., Red Cross Blood Donor Center.

2. Course ME-12, Blood Plasma Bank Technique. This course lasted 4 weeks and was planned for medical technicians who had already had some portion, or all, of the Army basic course for technicians and who were to be sent to the liquid plasma processing centers. The material included the technical procedures used in the operation of a blood donor center and methods of preparing and storing liquid plasma.

In all, 23 officers completed Course MO-20 and 15 spent at least a month of temporary duty learning to operate liquid plasma centers, each of which eventually had 3 officers assigned to it. Forty-three technicians completed Course ME-12.

In addition to the supervision of these formal courses, Captain Kendrick taught the principles and practices of resuscitation, along with the management of war wounds, to the classes of officers who attended the Army Medical and Dental Schools. He also lectured on the same subjects at the Medical Field Service School at Carlisle Barracks, Pa.

Field Training

Training in the use of plasma was also conducted during maneuvers before the United States entered the war and in the Zone of Interior during the war (figs. 14, 15, and 16).

Training Aids

A training film (FS 8-51), with appropriate comments, was prepared at Carlisle Barracks by Major Kendrick in January 1942. In February 1943, a manual was prepared to be used in conjunction with it. It contained a statement of general principles and a detailed, fully illustrated, description of each step of the use of the plasma package and the administration of the plasma (p. 698). The material was essentially the same as that contained on the instruction sheet enclosed in all plasma packages except for those issued at the very beginning of the program. When demonstration packages of plasma became available, they were distributed with each copy of the film.

Demonstration Packages of Plasma

Practically all of the packages of dried plasma distributed in the United States were for training purposes only (36). The question of providing them came to a head in October 1942, when the Director, Biological Division, Lilly Research Laboratories, wrote General Hillman that he had received a number of requests from medical officers, particularly those in charge of replacement training centers, for demonstration packages of the standard Army-Navy dried plasma. Up to this time, he had simply sent dummy packages, filled with contaminated plasma and marked *Not for human use*. A recent request for 12 packages for a single installation, however, indicated that such an informal method of supply could no longer be used; if all camps were to make such requests, the number of packages necessary would run into the hundreds.

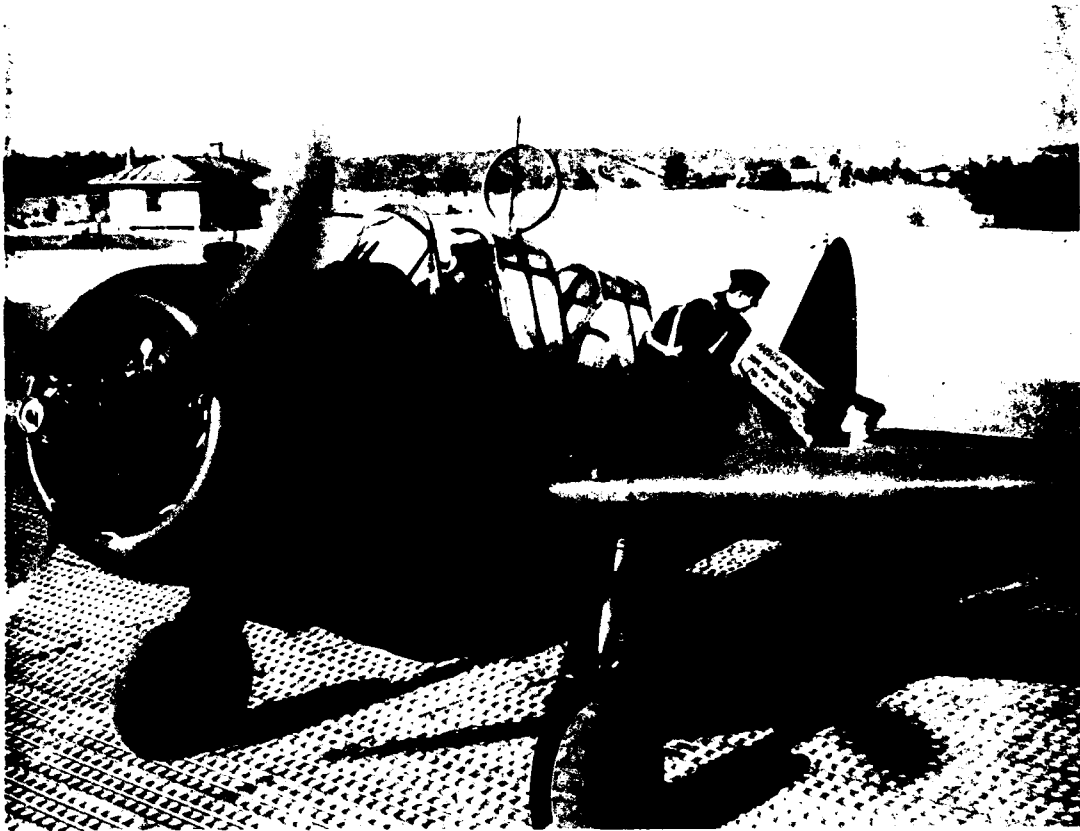

FIGURE 11. Dried blood plasma arriving for emergency use at emergency landing field, Hoffman, N.C., during maneuvers in the Carolinas, November 1941.

This letter was the beginning of a correspondence, chiefly with Colonel Carter in the Surgery Division, Office of The Surgeon General, which continued until July 1943.

There was complete agreement on the part of all concerned that in the program of instruction being planned for medical officers in station and general hospitals in the Zone of Interior and for those attached to Ground Forces, it was imperative that there be actual demonstrations of the reconstitution of plasma, which was, as already pointed out, a new technique. There were, however, a number of problems to be solved.

Form of package.— The first problem was what to use in the plasma bottle. The use of contaminated plasma was not desirable, partly because it might, through some mischance, be used clinically and partly because research had shown that it could be safely converted into albumin (p. 303). The use of any colored material would destroy the realism of the demonstration. Horse serum had obvious risks. Shell-frozen dextrose became so powdered when it was dried that it collapsed in the bottle and did not look like plasma. Also, it tended to clump when water was introduced and did not go into solution readily.



FIGURE 15.- Boxes of dried plasma ready for immediate use in operating tent during maneuvers, Rockingham, N.C., November 1941.

The addition of dextran made it possible to shell-freeze glucose and the final demonstration package, prepared in this manner, contained 25 gm. of glucose and 3 gm. of dextran. In solution, this combined material had the approximate color and haziness characteristic of normal human plasma. If it were inadvertently used clinically, it would cause no reactions, especially as it was decided that, for added safety (though at an increased cost), all packages must be sterilized.

All labels used were marked in red *Not for human use. For demonstration use only.*

The Red Cross was supplied with a number of these demonstration packages for display at blood procurement centers and for mobile units.

Procurement.—When the form of the demonstration package had been settled, problems of procurement arose. Army rules did not permit the acceptance of the offer of Eli Lilly and Co. to make up a number of packages at once, without waiting for bids. Instead, it was necessary to set up separate contracts for them. When bids were requested, in July 1943, for 10,000 demonstration packages, seven of the nine laboratories then processing plasma were not interested because they were changing over to the 500-cc. plasma



FIGURE 16.—Demonstration of administration of blood plasma as part of field training program set up by medical group at Camp Ellis, Ill., 1943, and designed to acquaint other branches of the service with methods and equipment used in field hospital units. A. Demonstration without gas mask. B. Demonstration with posed casualty and corpsmen wearing gas masks.

package within the next 3-4 weeks and they had no excess equipment to make up the smaller demonstration package. In addition, cans could be ordered only in 25,000 lots. The necessary number of demonstration sets was finally produced by Eli Lilly and Co., which continued to make the smaller package of plasma.

Instructions for use.—Circular Letter No. 55, Office of The Surgeon General, Services of Supply, War Department, 22 February 1943 (37), was entitled "Instruction of medical officers in the reconstitution and use of the Standard Army-Navy Package of Normal Human Plasma, Dried." It explained that the demonstration packages (which were not then available for distribution) were designed to accompany Film Strip 8-51, dealing with the same subject. After it had been shown, the instructor should demonstrate the reconstitution and use of one package and then distribute others to small groups of students, so that they might become familiar, individually, with the technique of reconstituting plasma.

OFFICE OF CIVILIAN DEFENSE

Planning

Provision of blood and plasma for the Office of Civilian Defense was not the responsibility of the Armed Forces program, but, as was inevitable, there was some cooperation between the two programs, and it is remarkable that there was so little conflict.

The question was first brought up at the Blood Procurement Conference on 14 February 1942 (38), at which it was pointed out that throughout the country there were feelings of restlessness and anxiety lest blood or a blood substitute be needed for a civilian catastrophe arising from enemy action or accidents in industrial plants and there be no provision for the care of casualties.

At this conference, Dr. (later Major, MC) Earl S. Taylor, Technical Director, American Red Cross, reported that on a recent trip to the Pacific coast, he had found a disturbing situation, apparently related to this sense of apprehension: Blood and plasma banks were being set up without the affiliation of either the Red Cross or the Office of Civilian Defense. The directors of some of these banks clearly lacked the qualifications necessary for the preparation of safe products, and he feared that their continued growth would lead to great waste of blood or serious accidents.

On 11 April 1942, the sum of \$292,500 was allotted to the U.S. Public Health Service, from an emergency fund controlled by the President, to be expended in emergencies affecting the national security and defense and for setting up reserves of liquid, frozen, or dried blood plasma or serum albumin for the treatment of casualties from enemy action. These grants were to be made to public or private hospitals located not more than 300 miles from the oceans or the gulf coast. On 17 April 1942, the Federal Security Agency set up regulations governing these grants (39).

Provision of Plasma

The question of plasma for the Office of Civilian Defense came up again at the meeting of the Subcommittee on Blood Substitutes on 23 June 1942 (26). Dr. G. Canby Robinson, National Director, American Red Cross Blood Donor Service, speaking for the Red Cross, proposed that letters be written to The Surgeon General, U.S. Army, from his agency, the U.S. Public Health Service, and the Office of Civilian Defense asking that the limits of the programs of the Red Cross and the Office of Civilian Defense be clarified in respect to blood donors. He made the suggestion because, since the Japanese attack on Dutch Harbor in the Aleutians earlier this year, a number of communities had attempted to collect blood for local use, and their efforts had interfered with the Red Cross National Blood Procurement Program to obtain blood for the Armed Forces.

It was proposed that 55,000 of the 96,762 units of plasma then held in the frozen state in various processing plants be released and distributed as follows:

25,000 units to be transferred to the Red Cross, for delivery to the Office of Civilian Defense for distribution to suitable civilian hospitals in exposed areas, with the understanding that cities in which the Red Cross had blood donor centers would all be protected in this manner.

30,000 units to be placed at the disposal of the chief medical officer, OCD, or one of the regional medical officers, to be used in grave emergencies, with the understanding that the Office of Civilian Defense would thereafter refrain from collecting blood within a radius of 75 miles from the (seven) Red Cross blood donor centers presently in operation.

The considerable discussion that followed the introduction of these proposals covered the mechanics of such a transfer and the legal aspects of ownership of the plasma (p. 81). A motion was finally passed, as already noted, to the effect that the blood collected by the American Red Cross remained "as heretofore the property of the armed forces from the time it entered the processing plant." A second motion was then passed requesting The Surgeon General, U.S. Army, to release 55,000 units of frozen plasma to the Office of Civilian Defense for the allocation and use just specified. It was hoped that the announcement of the release of such a large amount of frozen plasma to OCD would relieve public apprehension caused by fears of inadequate supplies in case of an enemy attack and would enable the Red Cross to continue to concentrate on the needs of the Armed Forces, which might be tripled within the coming year.

Some anxiety was expressed over the actions taken: Dr. Loeb, chairman of the subcommittee, pointed out that OCD was undertaking a grave responsibility in assuming control of a large amount of frozen plasma, with its problems of supervision, storage, and administration. If, through lack of proper controls, unfortunate accidents should occur, they might, entirely unjustifiably,

reflect on the Red Cross procurement program. Fortunately, no such accidents occurred.

It should be noted that the distribution of plasma proposed at this time was possible only because the Red Cross was collecting blood equal to, or in excess of, the current combined drying facilities of the processing laboratories (p. 120).

Of the 88,000 donations procured by the Red Cross and used for plasma made available to the Office of Civilian Defense, 29,000 units were secured from the backlog of frozen plasma held in processing laboratories (40). Another 50,000 units were processed for this special purpose, most of it in a processing laboratory equipped for this type of work but not yet in production for the Army. The balance was provided by the Army from reserve stocks late in 1942. Some of this lot was returned to the Army later, to meet potential emergency needs in the Pacific.

As a result of these arrangements, the initial confusion, that could have had rather serious consequences, was completely eliminated early in the war. Fortunately, it was never necessary to use OCD supplies of plasma for casualties from enemy action. At the end of the war, by act of Congress, the U.S. Public Health Service was authorized to make OCD stocks available for civilian use. And so, to quote Dr. Robinson, "It was eventually returned to the American public who had donated it" (40).

Preparation of Manuals

The only other activity of the Office of Civilian Defense that concerned the blood-plasma program dealt with the preparation of manuals for OCD use by members of the Subcommittee on Blood Substitutes. The manual on plasma (38, 41) was the responsibility of Dr. Strumia and the manual on blood banks (41) of Dr. DeGowin (42). The subcommittee informed responsible OCD authorities that these manuals represented the best practice at the time they were prepared (1942) but warned that the procedures described in them should be undertaken only by technically qualified and adequately trained personnel.

PLASMA FOR ALLIED NATIONS

There was never any question about the emergency use of plasma provided by the Red Cross for soldiers of other nations. When it came to providing a stockpile for troops of Allied nations, however, generous instincts came into conflict with the realities of the situation (4, 43, 44). For one thing, supplies of plasma, particularly early in the war, were not inexhaustible, and they had to be kept for the needs of the U.S. Armed Forces. More important, the blood from which the plasma was made had been donated for that special purpose. The legal as well as the moral right of the Red Cross and the Armed Forces to utilize it for other purposes, however worthy they might be, was

limited by the representations made to the public when the donations were secured and the releases signed by the donors, which included the statement that the blood was to be used for the Armed Forces.

There could be no legitimate criticism of the transfer of certain amounts of plasma to the British for use in their hospitals, since many U.S. soldiers were cared for in them. Later in the war, arrangements were made for the British to purchase plasma from one of the commercial laboratories which had excess capacity after fulfilling its Army contracts. The blood was procured from professional donors, without newspaper advertising or any other solicitation that would interfere with the Red Cross program.

The British needs were always small, for their own fine blood transfusion service furnished almost all of the blood and plasma needed for their own casualties. The supply of plasma for the Free French was another and more difficult problem.

The Free French, up to the liberation of Paris, at least, had no home population from which to procure blood. The idea of the French Military Medical Mission to the United States that they should process their own plasma in North Africa was discouraged by those in charge of the blood program in the Office of The Surgeon General, because of the cost, the lack of trained personnel, and the delay that would be inevitable in training personnel and procuring equipment.

The first plasma supplied to the Free French was delivered under Lend-Lease arrangements and made from blood purchased from professional donors, as just described. When the U.S. Army supply program began to include medical equipment and supplies for the French Army, the plasma included in U.S. supplies was removed from the maintenance units. It was realized, however, that the U.S. Army and the Red Cross would be open to serious criticism if an agent publicly proclaimed as lifesaving were withheld from Allied troops, even though the blood from which the plasma was made had been donated specifically for U.S. Armed Forces.

The whole subject was discussed at a conference in the Office of The Surgeon General on 8 June 1943 (45), and two plans were considered:

1. That the Red Cross ask for blood donations designated for the Free French, with the donors asked to sign a special release to that effect. If the blood were treated as fungible, it would not be necessary to segregate these particular donations but merely to make sure that the amount of plasma given to the Free French did not exceed the amount of blood donated for it.

2. That the plasma, as previously, be made from blood purchased in commercial channels. Procurement of blood in this way would not interfere with the Red Cross Blood Donor Program, and two commercial laboratories were then in a position to undertake the processing of the necessary amounts of plasma without interference with their contracts for plasma for the U.S. Armed Forces.

The latter plan was eventually put into effect, with the assistance of the A med Services Medical Procurement Agency, Brooklyn, N.Y.

A number of the countries in South America were desirous of making dried plasma for their own use and consulted the personnel of the U.S. blood program about their plans. They were always advised to use liquid plasma: The U.S. experience had shown that the production of dried plasma was an onerous and complex problem, quite aside from the difficulty of procuring equipment and the length of time it took to procure it.

The Russian experience illustrates the procurement difficulties just mentioned (46). In September 1943, at the request of the Russian Red Cross, an outline of current methods of drying plasma was drawn up, and, a little later, Soviet Red Cross representatives were shown the various drying equipment in use in Zone of Interior commercial laboratories.

When the Soviet authorities decided to proceed with the drying of plasma, all possible cooperation was given to them by the Office of The Surgeon General, through Colonel Kendrick, the Special Representative on Blood and Plasma Transfusions; the American Red Cross; and the National Research Corp. of Boston, through which the equipment was ordered. The equipment was not completed, however, and the necessary testing was not carried out, until the spring of 1945. The war in Europe was over before the departure date of Capt. (later Maj.) John Reichel, Jr., MC, who had been designated to supervise the equipment in the Soviet Union and instruct medical officers and technicians in its use. Later, he spent several weeks in the Soviet Union on this mission.

OFFERS FROM OTHER COUNTRIES

During the war, a number of friendly nations conceived the idea of setting up projects for the collection of blood and the processing of plasma, some or all of which they would make available to the United States (47). The stumbling block to the acceptance of these offers was always the same: Scarcities of essential materials and high priorities of other branches of the Armed Forces were making it difficult for the U.S. blood and plasma program to procure equipment for its own needs. Moreover, the processing of plasma was such a delicate operation and required such careful supervision that, until a laboratory was well equipped with apparatus and operated by trained personnel, satisfactory qualitative and quantitative results were impossible.

SUPPLIES OF PLASMA FOR ZONE OF INTERIOR HOSPITALS

Liquid Plasma

The details of the program by which liquid plasma was supplied to Zone of Interior hospitals during the war is part of the story of plasma and is related under that heading (p. 274). The Blood Research Division, Army Medical School, acted as the Blood Plasma Coordinating Center; it exercised general control of the program, and after March 1944, on requisition from the surgeons

of the various service commands, it supplied all the plasma used in Zone of Interior hospitals.

This was a highly successful program from every standpoint (40). Of the 310,135 blood donations delivered to military hospitals in the Zone of Interior from the blood donor centers, 295,200 were used for liquid plasma. The Washington center, which continuously used some of its donations for this purpose, devoted 88,387 bloods to this program. The Denver center, which opened 14 September 1942, delivered its entire output to Fitzsimons General Hospital, Denver, Colo. When this center was closed on 15 September 1945, it had delivered to the hospital 150,880 donations, 140,578 of which were processed into liquid plasma.

There were no confirmed reports of the distribution of contaminated plasma, and the incidence of posttransfusion reactions was very small, probably because of continuous policing of every phase of the program.

No special training was required for the administration of liquid plasma. When bulk was undesirable, it could be given undiluted. In these circumstances, the ordinary rate of 8 to 10 cc. per minute was reduced to 5 cc. or less per minute until it was found that so-called speed shock did not really exist and that the rate of administration made no difference unless there were clinical contraindications to fluid administration.

Liquid plasma contained Merthiolate 1:10,000 or phenylmercuric borate 1:25,000 as a preservative. For this reason, it was the practice to limit the quantity given over a 24-hour period to 2,000 cc. When dried plasma was employed, quantities up to 4,000 cc. per 24-hour period could be used, since the concentrations of Merthiolate or phenylmercuric nitrate in it were, respectively, 1:35,000 and 1:50,000.

The safety and efficiency of liquid plasma were evident almost as soon as the program was started. Also, it soon became evident that original dating periods had been set much too low and that, if liquid plasma were prepared under proper conditions of sterility and kept in the frozen state, it would last almost indefinitely. The inconvenience, expense, and personnel required for the production of dried plasma for Zone of Interior hospitals therefore did not seem justified.

Dried Plasma

Dried plasma prepared at the Army Medical School was, however, given to smaller hospitals, whose needs were limited, and in which the turnover of liquid plasma would be very slow. In April 1945, the amounts of liquid plasma being requisitioned by Zone of Interior hospitals exceeded the amounts being produced with current facilities. At the same time, the quantity of dried plasma on hand exceeded oversea requirements. When stocks of liquid plasma were exhausted, therefore, dried plasma was supplied to the hospitals in the United States, which were informed at the same time that one form of plasma was no more useful than the other (48).

PROVISION OF WHOLE BLOOD IN ZONE OF INTERIOR HOSPITALS

Until well into 1944, all hospitals in the Zone of Interior were responsible for the collection of their own supplies of whole blood. By that time, however, it became apparent that certain hospitals were located in areas so sparsely populated, and had so few service troops attached to them, that it was impractical for them to maintain donor lists to meet even their limited requirements. In March 1944, therefore, by agreement with the American Red Cross and with the concurrence of the Transfusion Branch, Office of The Surgeon General, arrangements were made to supply blood to such hospitals when the location of bleeding centers made this plan practicable (49). It was possible for 23 hospitals to take advantage of this plan, their supply coming from 16 of the 35 blood donor centers then in operation.

Only type O blood was supplied, in 500 cc. amounts, and it was supplied only as oversea surpluses permitted (50). The transportation of the blood and equipment between the centers and the receiving hospitals, as well as the return of all equipment sent to the hospitals, was the responsibility of the receiving hospitals. The receiving hospitals were also responsible for retyping and crossmatching of the blood, for its serologic investigation, for reporting all unsatisfactory (that is, positive) tests, for the administration of the blood, and for the recording of clinical results. The blood was furnished according to a prearranged schedule, running parallel with the delivery of red blood cells (p. 313). Emergency needs were not supplied.

In June 1945, 556 pints of O blood were shipped to Halloran, England (Atlantic City, N.J.), Tilton (Fort Dix, N.J.), Lovell (Ayer, Mass.), and Torney (Palm Springs, Calif.) General Hospitals and to the Chelsea Naval Hospital, Chelsea, Mass. In August 1945, 804 pints were delivered to these and other hospitals and to the Philadelphia Naval Hospital. Once the availability of this service was realized, there were numerous requests for it from hospitals all over the country. The reply was always the same, that other hospitals would be included in the distribution as soon as possible if demands from overseas were not too heavy. The end of the war, with the termination of the Red Cross blood collection program, ended this particular service.

RECOMMENDATIONS

Basic Recommendations

In his formal report at the end of the war on the blood-plasma program (1), Colonel Kendrick made the following recommendations:

1. The Transfusion Branch, Surgical Consultants Division, Office of The Surgeon General, should be discontinued as not necessary in peacetime. In the light of postwar events, his opinion at the present time (1962) is that even

in peacetime, there should be a knowledgeable consultant on transfusion and allied matters in this office.

2. The position of Special Representative to The Surgeon General on Blood and Plasma Transfusions should be retained, but with a less cumbersome title, perhaps Transfusion Consultant or Transfusion Service Consultant.

3. This consultant should be responsible for providing the Medical Department with the most recent information on advances in fluid replacement therapy.

4. In the event of future mobilization, a transfusion branch should at once be established in the Office of The Surgeon General, the chief of the branch to serve as Transfusion Consultant, with the rank of colonel, and to have an adequate staff for the functions assigned to him.

References

1. Kendrick, D. B.: History of Blood and Plasma Program, United States Army During World War II, 1 Aug. 1952.
2. Annual Report of the Activities of the Transfusion Branch, Surgical Consultants Division, Office of The Surgeon General, fiscal year 1945.
3. Memorandum, Brig. Gen. Fred W. Rankin for Maj. Gen. Norman T. Kirk, 5 July 1943, subject: Establishment of a Transfusion and Intravenous Solutions Branch of the Surgery Division of the Surgeon General's Office.
4. Memorandum, Col. Tracy S. Voorhees, JAGD, for Maj. Gen. Norman T. Kirk, 23 Oct. 1943, subject: Use for the Armed Forces of our Allies of Plasma from Donated Blood, and Use of By-Products of Plasma and Albumin Programs.
5. Circular Letter No. 108, Office of The Surgeon General, U.S. Army, 27 May 1943, subject: Transfusion of Whole Blood in the Theaters of Operations.
6. War Department Technical Bulletin (TB MED) 204, 24 Oct. 1945, subject: Complications of Blood Transfusion.
7. Army Whole Blood Procurement Service. Laboratory Manual, March 1945.
8. National Research Council. *In* The Surgeon General's Office, The Medical Department of the United States Army in the World War. Washington: Government Printing Office, 1923, vol. I, pp. 566-573.
9. Minutes, meeting of Committee on Transfusions, Division of Medical Sciences, NRC, 31 May 1940.
10. Minutes, meeting of Subcommittee on Blood Substitutes, Division of Medical Sciences, NRC, 2 June 1944.
11. Minutes, meeting of Subcommittee on Blood Substitutes, Division of Medical Sciences, NRC, 19 Apr. 1941.
12. Minutes, meeting of Subcommittee on Blood Substitutes, Division of Medical Sciences, NRC, 18 July 1941.
13. Minutes, meeting of Subcommittee on Blood Substitutes, Division of Medical Sciences, NRC, 24 Feb. 1943.
14. Minutes, Conference on Transfusion Equipment and Procedure, Division of Medical Sciences, NRC, 25 Aug. 1942.
15. Minutes, meeting of Subcommittee on Blood Substitutes, Division of Medical Sciences, NRC, 10 Nov. 1942.
16. Minutes, meeting of Subcommittee on Blood Substitutes, Division of Medical Sciences, NRC, 15 Dec. 1942.
17. Minutes, meeting of Subcommittee on Blood Substitutes, Division of Medical Sciences, NRC, 20 Oct. 1942.
18. Editorial, Toxicity of Human Plasma. J.A.M.A. 120: 206-207, 19 Sept. 1942.

19. Levine, M., and State, D.: A and B Substances as a Cause of Reactions Following Human Plasma Transfusions. *J.A.M.A.* 120: 275-277, 26 Sept. 1942.
20. Minutes, meeting of Subcommittee on Blood Substitutes, Division of Medical Sciences, NRC, 23 Mar. 1943.
21. Minutes, meeting of Subcommittee on Blood Substitutes, Division of Medical Sciences, NRC, 30 Nov. 1940.
22. Minutes, meeting of Subcommittee on Blood Substitutes, Division of Medical Sciences, NRC, 9 Apr. 1943.
23. Minutes, meeting of Subcommittee on Blood Substitutes, Division of Medical Sciences, NRC, 24 Sept. 1943.
24. DeBakey, M. E.: Military Surgery in World War II. A Backward Glance and a Forward Look. *New England J. Med.* 236: 341-350, 6 Mar. 1947.
25. Minimum Requirements for Unfiltered Normal Human Plasma, NIH, 20 Feb. 1941.
26. Minutes, meeting of Subcommittee on Blood Substitutes, Division of Medical Sciences, NRC, 23 June 1942.
27. Minutes, Conference on Blood Grouping, Division of Medical Sciences, NRC, 23 Mar. 1943.
28. Minutes, meeting of the Albumin and By-Products Group, Division of Medical Sciences, NRC, 10 May 1943.
29. Minutes, meeting of Subcommittee on Blood Substitutes, Division of Medical Sciences, NRC, 13 May 1943.
30. Minutes, Conference of Albumin and By-Products Group, Division of Medical Sciences, NRC, 28 July 1943.
31. Minutes, meeting of Subcommittee on E Substitutes, Division of Medical Sciences, NRC, 6 Oct. 1943.
32. Letter, Lt. Col. Douglas B. Kendrick, MC, to The Surgeon General, 7 Jan. 1944, subject: Release of Red Blood Cells to American Red Cross for Transfusions. Approved Maj. Gen. George F. Lull, Deputy Surgeon General.
33. Letter, Maj. Gen. Norman T. Kirk to Dr. G. Foard McGinnes, 27 May 1944, subject: Use of By-Products of Plasma by Civilian Population.
34. Minutes, meeting of Subcommittee on Blood Substitutes, Division of Medical Sciences, NRC, 17 Nov. 1943.
35. Army Service Forces Manual M3, Courses of Instruction Given in Schools of Army Service Forces. Headquarters, Army Service Forces, November 1944.
36. Correspondence concerning demonstration packages of plasma, 22 Oct. 1942-16 July 1943. [On file, General Reference and Research Branch, Historical Unit, AMEDS, Walter Reed Army Medical Center, Washington, D.C.]
37. Circular Letter No. 55, Office of The Surgeon General, Services of Supply, War Department, 22 Feb. 1943, subject: Instruction of Medical Officers in the Reconstitution and Use of the Standard Army-Navy Package of Normal Human Plasma, Dried.
38. Minutes, Blood Procurement Conference, Division of Medical Sciences, NRC, 14 Feb. 1942.
39. Regulations Governing Grants to Hospitals for Establishing Reserves of Blood Plasma. Federal Security Agency, U.S. Public Health Service, 17 Apr. 1942.
40. Robinson, G. C.: American Red Cross Blood Donor Service During World War II. Its Organization and Operation. Washington: The American National Red Cross, 1 July 1946.
41. A Technical Manual on Citrated Human Blood Plasma Detailing Its Procurement, Processing, and Use. Washington: U.S. Office of Civilian Defense, November 1942.
42. The Operation of a Hospital Transfusion Service. A Technical Manual. Washington: Medical Division, Office of Civilian Defense, March 1944.
43. Minutes, meeting of Subcommittee on Blood Substitutes, Division of Medical Sciences, NRC, 10 Mar. 1942.

44. Correspondence and memorandums concerning supply of plasma to Allied nations, 25 Nov. 1942-31 Jan. 1944. [On file, General Reference and Research Branch, Historical Unit, AMEDS, Walter Reed Army Medical Center, Washington, D.C.]

45. Memorandum re Conference at Surgeon General's Office, 8 June 1943, concerning Use of Plasma and Albumin for Other United Nations, and Disposition of By-Products from Plasma and Albumin Processing, 8 June 1943.

46. Correspondence and memorandums concerning supply of plasma-drying equipment to Russia, September 1943-June 1944. [On file, General Reference and Research Branch, Historical Unit, AMEDS, Walter Reed Army Medical Center, Washington, D.C.]

47. Correspondence and memorandums concerning Cuban proposal to supply dried plasma for Allied use, 18 Sept. 1942-31 Oct. 1945. [On file, General Reference and Research Branch, Historical Unit, AMEDS, Walter Reed Army Medical Center, Washington, D.C.]

48. Letters, Maj. Gen. Norman T. Kirk and Brig. Gen. Fred W. Rankin to Commanding Generals, all Service Commands, 27 Apr. 1945, subject: Dried Plasma for Hospitals in Zone of Interior.

49. Letter, Lt. Col. Douglas B. Kendrick, MC, to Dr. G. Canby Robinson, 11 Mar. 1944.

50. Memorandum, Maj. Earl S. Taylor, MC, subject: The Methods to be Employed in Furnishing Whole Blood to Military Hospitals.

CHAPTER V

The American National Red Cross¹

THE FIRST STEPS OF THE PROGRAM

At the first meeting of the Committee on Transfusions, NRC (National Research Council), on 31 May 1940 (3), part of the discussion concerned the establishment of blood banks, the use of dried and liquid plasma, and the sources of supply for blood and plasma. The questions were not answered.

The same questions arose at the first meeting of the Subcommittee on Blood Substitutes, on 30 November 1940 (4), after discussion of the Blood for Britain project of the New York Blood Transfusion Association (p. 13). Dr. Max M. Strumia, with remarkable prescience, recommended the plan that was, in effect, carried out later; namely, the standardization of equipment and techniques, the establishment of centers for collecting blood, and the commercial preparation of dried plasma.

Dr. William DeKleine, then the medical assistant to the Vice Chairman in Charge of Domestic Operations, American Red Cross, stated that the Red Cross would be glad to assist in such a program but that the Army and the Navy must decide whether they wished his agency "to organize the problem." After further discussion, the following recommendations were made:

As a matter of National Defense the Surgeon General of the Army and Navy request the Red Cross to take steps immediately looking forward to the formation of civilian groups to provide human blood so that in case of a definite National emergency local units would be in a position to supply the blood needed by the armed forces.

It is recommended to the American Red Cross that its support in the matter of providing blood donors for a study of the use of blood and of blood substitutes be continued and extended. In the opinion of this committee this assistance is essential to the solution of the problem. The committee expresses its appreciation.

As a matter of fact, as the second of these recommendations implied, steps to collect blood had already been taken by the Red Cross. In addition to the participation of the New York Chapter in the Blood for Britain project:

1. On 14 June 1940, The Surgeon General, U.S. Army, had requested the Red Cross to procure about a thousand volunteer donors for a research project undertaken by a number of investigators, including Cdr. Lloyd R. Newhouser, MC, USN, and Capt. Douglas B. Kendrick, MC, to determine the best methods of processing and preserving dried plasma and its clinical use. Mr. Norman H. Davis, Chairman, American Red Cross, had assented to the proposal, realizing that this project was the forerunner of the large-scale operations that would

¹ Unless otherwise indicated, all data in this chapter are from Dr. G. Canby Robinson's final report of the Red Cross Blood Donor Service in July 1946 (1) or report of Col. James A. Phalen MC, on the Blood Plasma Program in July 1944 (2).

be necessary "in the event of war involving the United States." A similar request, in September 1940, by The Surgeon General, Navy, was also acceded to.

2. In September 1940, the Southeastern Chapter of the American Red Cross, in Philadelphia, undertook to procure donors for the studies on plasma then being conducted by Dr. Strumia, at the Bryn Mawr Hospital, under the auspices of the Committee on Transfusions, NRC (3).

IMPLEMENTATION OF THE PROGRAM

The Surgeons General of the Army and the Navy sent identical letters to Mr. Davis on 7 January 1941, requesting the cooperation of the American Red Cross in the collection of blood for plasma, as follows:

The national emergency requires that every necessary step be taken as soon as possible to provide the best medical service for the expanded armed forces. Even though the need for proper blood substitutes may not be immediate, there seems every reason to take steps now which shall provide in any contingency for an adequate supply of these substances for use in individuals suffering from hemorrhage, shock, and burns.

To this end, in order to assure this adequate supply of the blood substitutes for the use of the United States Army, I am asking the American Red Cross and the Division of Medical Sciences, National Research Council, to organize a cooperative undertaking which shall provide the armed services with human blood plasma. In this cooperative effort, I request the American Red Cross to secure voluntary donors in a number of the larger cities of this country, to provide the necessary equipment, to transport the drawn blood rapidly to a processing center, to arrange for separating the plasma and for storing the resulting product in refrigerated rooms.

I am also requesting the Division of Medical Sciences, National Research Council, to assume general supervision of the professional services involved in this collection and storage of blood plasma, and to provide competent professional personnel, both for a national supervising group and for the local collecting agencies. I am also urging that the National Research Council continue to encourage investigation of the various methods of preparation of blood substitutes, preferably in dried form.

While it is impossible to estimate the requirements of the armed forces at the present time, because of the uncertainties of the international situation, I feel strongly that a large quantity, a minimum of 10,000 pints, of blood plasma should be placed and maintained in refrigerated storage. This feeling is based upon the fact that not only will the plasma be of greatest service if a military emergency arises, but also of ultimate use in any national catastrophe.

I am also writing to the National Research Council making this identical request, and am expressing the hope that the cooperative undertaking may receive approval, with prompt organization of the whole enterprise.

On 9 January 1941, Mr. Davis replied as follows:

The American Red Cross will be glad, as requested in your letter of January 7th, to cooperate with the Division of Medical Sciences of the National Research Council and the Army and the Navy in providing the armed services with human blood plasma.

Representatives of the Red Cross will confer with representatives of the National Research Council and the Army and the Navy immediately in order to formulate the necessary plans for getting the project underway.

On 7 January 1941, Maj. Gen. James C. Magee and Vice Adm. Ross T McIntire, MC, USN, wrote Dr. Lewis H. Weed, Chairman, Division of Medical

Sciences, NRC, requesting the cooperation of his agency in this project. On 9 January, Dr. Weed replied as follows:

I wish to acknowledge receipt of your letter of yesterday requesting that the American Red Cross and the Division of Medical Sciences, National Research Council, cooperate in an undertaking which will lead to the procurement of large quantities of human blood plasma.

I can assure you at once that the Division of Medical Sciences will do everything possible to make this cooperation effective. In fact, I am sure that I speak for the members of the Division in telling you that every effort will be made to accelerate the whole mechanism of obtaining and processing the necessary blood.

The Division of Medical Sciences has already taken the initial steps leading to the formation of an operating subcommittee under the general Committee on Transfusions and will probably select Dr. C. P. Rhoads of Memorial Hospital as the chairman of this committee. No time will be lost in undertaking the necessary organization so that a supply of human plasma may be in storage for the use of the armed forces.

On 12 May 1941, a formal agreement was signed by Dr. Weed for the Division of Medical Sciences, NRC, and Mr. Davis for ARC (American Red Cross). This agreement listed specific details concerning the nature of the project, the plan of operation, the joint responsibilities of the two agencies, the responsibilities of NRC through its Division of Medical Sciences, the national and chapter responsibilities of ARC and the functions of the Army and the Navy.

This agreement, which served as the charter of the Blood Donor Service, ARC, was completed only after numerous conferences among all the organizations and personnel concerned. It contained the following provisions:

1. The joint responsibilities of the Red Cross, National Research Council, and Army and Navy consist of the determination of principles and policies of operation; the establishment of budgets for technical operations; the designation of cities in which collecting centers are to be set up; and the control of publications.

2. The Red Cross agrees to establish and maintain facilities in selected cities to procure blood from voluntary donors, to recruit and enroll these donors, to arrange for the proper handling of the blood drawn, and to transport it under proper precautions to laboratories selected by the Army and the Navy for processing into dried plasma.

3. The Red Cross also agrees to provide, on a national scale, the necessary funds for all technical and other personnel needed in the collection of the blood, its transportation, and other technical operations. Red Cross chapters participating in the program will provide the necessary funds for personnel and for other expenses incurred in recruiting and enrolling volunteer donors. The Red Cross also assumes responsibility for maintaining direct contact between the national organization and chapter operations, for keeping the National Research Council informed of problems and progress, and for obtaining adequate monthly reports from participating chapters and processing laboratories.

4. The Division of Medical Sciences, NRC, assumes the general supervision of the professional services involved in the collection of blood and the provision of competent professional personnel for a national supervisory group and for local collecting facilities. It also assumes responsibility for determining the type of equipment to be used for collecting blood and for maintaining direct contacts with the technical supervisors of the program in each community.

5. The Army and the Navy agree that their representatives will work closely with the National Research Council on the technical aspects of each project and with the Red Cross in connection with the quantities of blood needed, its delivery, and other phases of Red Cross concern.

At a meeting of the Subcommittee on Blood Procurement, NRC, on 18 August 1941 (5), the principal agenda dealt with the best methods of bleeding donors and collecting blood for plasma on a nationwide scale. Decisions were reached concerning equipment, examination and handling of donors, technique of bleeding, organization of the technical staff, handling and transportation of blood, and publicity. These various points are discussed in detail under the proper headings. This conference was attended by members of the Subcommittee on Blood Substitutes; representatives of the Red Cross Blood Donor Service; Dr. G. Canby Robinson, National Director, ARC Blood Donor Service; the technical supervisors of the Red Cross collection centers then in operation; representatives of the Army and the Navy; representatives of the National Institute of Health; and personnel of two of the seven commercial laboratories then participating in the plasma program.

The decisions made at this meeting were published in September 1941, in ARC Manual 784, "Methods and Technique of Blood Procurement as Prescribed by the National Research Council for Use in the Red Cross Blood Procurement Centers" (6). In the ensuing months, a number of supplements and special directives were issued, but the practices prescribed in it remained in effect until January 1943, when a revision, "Methods and Technique Used in Red Cross Blood Donor Centers" (7), was issued. The first of these manuals was based largely on theory. The second was based on a very extensive practical experience.

ORGANIZATION AND PERSONNEL

In the agreement drawn up between the Red Cross and the Division of Medical Sciences, NRC, in May 1941, a national supervisory group was provided for. The Subcommittee on Blood Substitutes became this supervisory body. It originally acted chiefly through its own Subcommittee on Blood Procurement, which was appointed on 19 April 1941 and which served until 12 May 1942, when it was voted out of existence (8).

The initial phases of the program were directed and supervised for the Red Cross by Dr. DeKleine. In July 1941, he was succeeded by Dr. Robinson (fig. 17) with the title of National Director, Blood Donor Service. At the same time, Dr. Earl S. Taylor (fig. 18) was appointed Technical Director. Dr. Taylor, who was a qualified general surgeon, had worked in the blood bank at the Presbyterian Hospital, New York City, and therefore came to his duties with a wide experience in this field. When he was later commissioned in the Medical Corps in April 1943, he retained his position as Technical Director of the ARC Blood Donor Service so that medical officers, who were then working in the blood collection centers (p. 109), would be under the supervision of another medical officer. On 15 August 1944, in response to his request for oversea duty, Major Taylor was replaced as Technical Director by Lt. (later Lt. Cdr.) Henry S. Blake, MC, USN, who served until the end of the war.



FIGURE 17.—Dr. G. Canby Robinson, National Director, Blood Donor Service, American Red Cross.

Dr. William Thalhimer was appointed Associate Technical Director of the Blood Donor Service on 1 December 1942 and served until 1 December 1944.

Initial Organization

In following the activities of the Red Cross Blood Donor Service, it must be borne in mind that the American Red Cross is not a cohesive organization with a unified central direction. It consists of a group of chapters which are largely autonomous and each of which is governed by its own board of directors.

As the Blood Donor Service was set up in the summer of 1941 (chart 2), it consisted of the following personnel (9):

1. A national director.
2. A technical director.
3. An assistant national director.
4. Area managers.

Under the original plan of organization, before the United States entered World War II, the national technical director served on a part-time basis, while continuing to serve as technical supervisor of the New York Blood Donor Center. Through liaison with the local technical supervisors, he directed the initial technical operations of each new center as it was organized and thus standardized all operations to conform with the techniques agreed upon in August 1941. With the outbreak of the war, however, and the rapid expansion



FIGURE 18.—Dr. (later Major, MC) Earl S. Taylor, Technical Director, American Red Cross Blood Donor Service, July 1941–August 1944.

of the Blood Donor Service, it became necessary for the technical director (Dr. Taylor) to assume full-time duties in the national organization.

The Subcommittee on Blood Substitutes appointed competent professional personnel who served in a voluntary capacity for the technical supervision of the collecting facilities in each of the blood donor centers. Each chapter selected its own executive and technical directors and its own publicity personnel, none of whom was directly responsible to the National Director, Blood Donor Service. National Red Cross Headquarters, however, paid the medical directors and nurses. General supervision of chapter activities was conducted by National Headquarters through area directors, who were not responsible to the National Director, Blood Donor Service.

REORGANIZATION

As the Blood Donor Service expanded and became more complex, certain weaknesses in the original structure and operation became apparent, particularly the need for greater centralization. Changes under discussion for some time

CHART 2.—Organization chart, American Red Cross Blood Donor Service, 1941

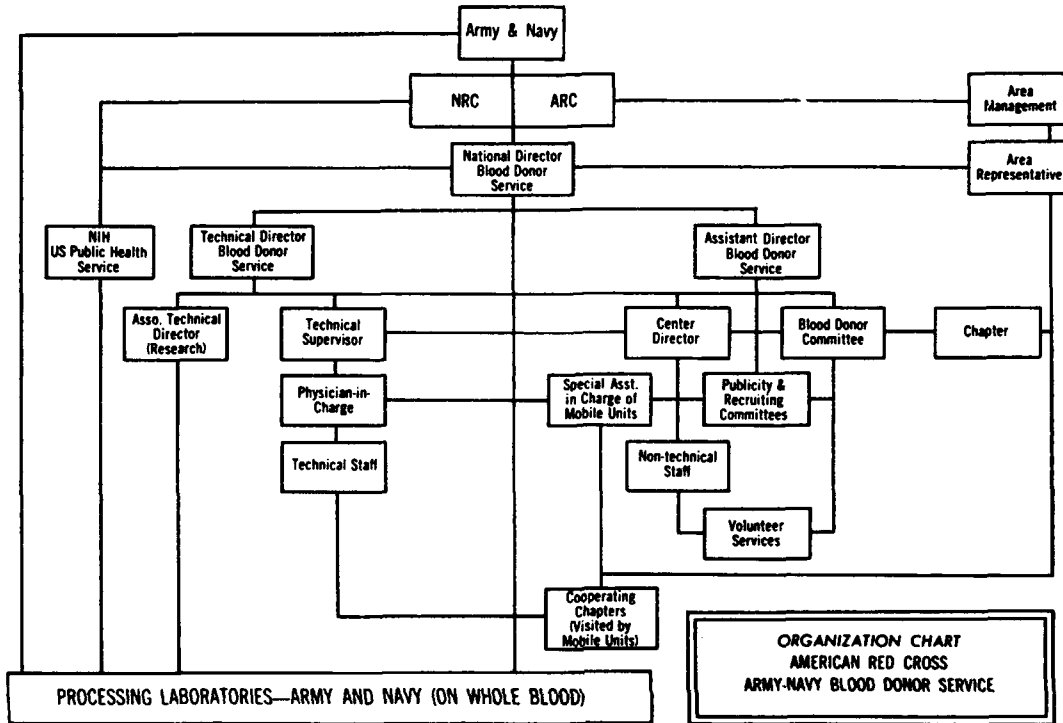

(9) and put into effect in November 1942 (chart 3) were described in the manual issued in December 1942 (10) entitled "The Organization and Operation of the American Red Cross Blood Donor Service." These changes—

* * * abolished the position of area director and established direct communication between the national director and the center directors and chairmen of chapter blood donor committees. Area representatives of the Blood Donor Service were appointed by area managers to expedite all matters that concerned chapters as such, as distinct from blood donor center operations.

The reorganization effected at this time preserved the advisory and controlling relations between the Blood Donor Service, the Army and the Navy Medical Departments, and the Subcommittee on Blood Substitutes, NRC, as set forth in the May 1941 agreement between the American Red Cross and the Division of Medical Sciences, NRC. The changes increased the measure of control exerted by the national director of the Blood Donor Service over local activities, but there were still points of inefficiency and friction. Some observers believed that truly satisfactory functioning could not be achieved until all paid chapter personnel in charge of recruitment of donors, publicity, and other activities were placed on the national payroll, under the national director of the Blood Donor Service (11).

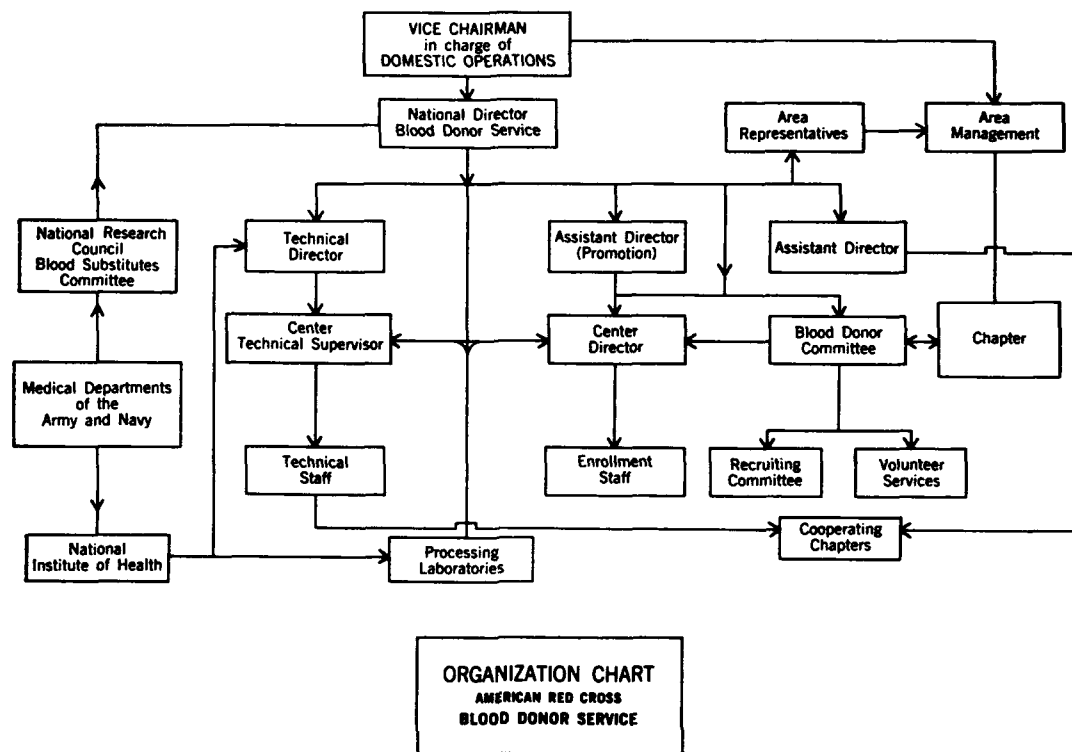
CHART 3.—*Organization chart, American Red Cross Blood Donor Service, November 1942*

Local Organization

Technical supervisor.—It was stipulated in the original agreement that each chapter employ a full-time director to administer its blood donor center, to be responsible for all nontechnical activities, for the direction of nontechnical personnel, and for the maintenance of equipment and supplies. The chapter director served as the normal channel of communication between the center and the National Director, Blood Donor Service, to whom he made weekly reports of blood procurement and monthly statistical and financial reports. He had paid secretarial and other assistance as required for the enrollment of donors and his other administrative functions.

The technical supervisor of each chapter was a local physician, preferably an expert in the field of blood transfusion, who served without recompense, at the appointment of the Subcommittee on Blood Substitutes, NRC, under the direction of the National Technical Director of the Blood Donor Service. The local technical supervisor brought to the attention of the National Technical Director all problems related to the technical procedures employed and to relations with processing laboratories. He was responsible for the selection of physicians, nurses, medical secretaries, blood custodians, and other personnel engaged in the bleeding of donors and the handling and shipping of blood. He organized and directed the technical staffs of the centers and was responsible for

technical operations and procedures according to the techniques specified by the Subcommittee on Blood Substitutes, NRC.

It was essential that the technical supervisor and the center director in each chapter work closely together. They were the only members of the local organization who received instructions concerning details of operation of the center directly from National Headquarters. Each time the director and the technical supervisor of a newly created blood donor center were appointed, they visited, and studied at firsthand, some center already in operation, preferably the pilot center in New York or the center at National Headquarters in Washington, D.C.

Professional personnel.—Personnel shortages, as might have been expected, plagued the Red Cross blood donor program during the entire war. Because enough civilian physicians could not be found to man the centers, nurses were trained in bleeding techniques, and Army and Navy medical officers were later assigned to the centers. After some 6 million pints of blood had been collected, it was estimated that an average of 800 to 850 bleedings per week was the best that could be expected from a physician, while each registered nurse could be expected to produce about 120.

At the meeting of the Subcommittee on Blood Procurement, 18 August 1941 (5), it had been decided that there was nothing in the regulations drawn up by the National Institute of Health that would prohibit the collection of blood by nurses, though a physician must be present and available for consultation at all times. This was an important decision: Nurses were in short supply, but they were easier to secure than physicians. In addition, physicians working in the blood donor centers had little time to collect blood; they were kept busy carrying out physical examinations on donors. Policies concerning the use of nurses varied from chapter to chapter. In some chapters, nurses performed the entire procedure. In others, physicians made the original venipuncture and nurses completed the collection of the blood.

At the Conference on Blood Procurement on 14 February 1942 (12), Dr. Robinson stated that the whole blood procurement program was being jeopardized because civilian physicians were leaving the centers to enter the Army or for other reasons. He wondered whether it might be possible to have a number of Army officers, perhaps 15, assigned to the Red Cross Blood Donor Service. Brig. Gen. Charles C. Hillman thought it unlikely.

Dr. Robinson introduced the matter again at the meeting of the Subcommittee on Blood Substitutes on 23 June 1942 (13). The centers were still losing physicians. An attempt to secure women physicians had failed numerically. If the blood procurement program were to succeed, the Armed Forces must make some provision for the assignment of competent physicians to it. For the 1.4 million bleedings so far requested for the year beginning 1 July 1942, 56 bleeding teams would be needed, each to procure 500 bleedings per week. This number would provide only for the plasma program then contemplated and the pilot order of 51,000 units of albumin, not for any expansion which might occur in the latter program. Dr. Robinson hoped that the Army and

the Navy would each assign 19 officers to the centers, to bring the professional staffs up to the 56 physicians just specified.

The subcommittee recommended to the Surgeons General of the Army and the Navy that they give favorable consideration to the assignment of a small number of medical officers to temporary duty in the Red Cross bleeding centers, on the ground that shortages of personnel were already jeopardizing the entire program. A point made in the recommendation was that losses occurred when blood was collected by untrained and incompetent personnel. A report from the Pittsburgh Blood Donor Center, in which the rate of clotting had previously been very low, showed that it had suddenly become very high, apparently as the result of the employment of four inexperienced phlebotomists.

By November 1943, when 35 centers were in operation (14), it was estimated that 135 physicians were the bare minimum with which they could be conducted, without any allowance for illness or other unforeseen emergencies. At this time, these centers were being operated by 34 civilian physicians, 40 Naval medical officers, and 60 Army medical officers, who were under the operational control of the Transfusion Branch, Office of The Surgeon General.

An attempt to utilize officers separated from service for physical disabilities did not succeed. They often proved unable to tolerate duty in the centers and entirely unable to withstand the hardships of work in mobile units. Many had to be relieved because of reactivation of their physical disabilities. With no replacements available for them, appointments had to be canceled, and, in view of the urgent appeals made for blood donations, this was bad public relations.

From the standpoint of public relations, it was probably unwise to have accepted some of the medical personnel in both the civilian and the military groups. At the Conference on Blood Preservation on 19 January 1945 (15), many of the volunteer physicians serving as local technical supervisors expressed the opinion that a number of Army medical officers of substandard quality had been assigned to the bleeding centers and that their handling of donors had sometimes created serious breaches in public relations. These difficulties had been infrequent with Naval officers. The conference was assured that the Army Medical Department would take steps to correct the situation at once.

Essential as was the work of these blood donor centers, assignment to them was neither interesting nor desirable. Attempts to rotate the officers assigned to them were not particularly successful, and many remained in them, without chance for promotion, for 2 years or more.

As centers were closed during the last months of the war, personnel in them were released, and by 17 August 1945, 3 days after the Japanese surrender, the Transfusion Branch, Office of The Surgeon General, requested the retention of only seven officers, three in centers on the west coast, which would continue to supply blood for the Pacific; one at the center in the Pentagon, which would supply blood for Walter Reed General Hospital, Washington, D.C.; and three at the center in New York, to complete a research study on O blood (p. 259).

Enlisted personnel.—The enlisted personnel assigned to the blood donor centers played an extremely important part in their successful operation. They performed work of a highly technical nature, including blood typing, agglutinin titrating, Rh tests, and Kahn tests. Reports on the blood moved overseas from the whole blood centers at New York, Boston, and Los Angeles indicated the satisfactory nature of their work. The staff sergeants at these centers were doing work usually handled in Army laboratories by commissioned medical officers or members of the Sanitary Corps, and it was with considerable difficulty that ratings of technical sergeant were finally secured for them.

Volunteers.—By the most conservative estimate, at least 100,000 volunteer workers contributed full- or part-time service to the Blood Donor Service during the 4½ years of its operation. Their work was usually organized by the chapter blood donor committee, in cooperation with the chairman for Volunteer Special Services. They served as staff assistants, canteen workers, Gray Ladies, nurses' aides, and drivers in the Motor Corps. Lay and professional workers also contributed to the managerial, public relations, and recruiting aspects of the Blood Donor Service.

The exact distribution of the volunteer work is not known, but returns from a questionnaire sent out to the blood donor centers at the end of the war indicated that of 52,700 volunteers who replied, 13,300 had worked in canteens; 9,700 in the Staff Assistance Corps; 5,200 as nurses' aides; 4,600 in the Motor Corps; 4,100 in the Hospital and Recreation Corps; and 15,800 in other services.

BLOOD DONOR CENTERS

Establishment.—The first Red Cross blood donor center in the Blood Plasma Program of World War II opened in New York on 4 February 1941 (fig. 19, table 1). The 35th opened in Fort Worth on 10 January 1944. Eleven centers were opened in 1941, 19 in 1942, and 5 in 1943 or early in January 1944. The nine centers opened between 1 December 1941 and 1 February 1942 had all been planned or were in process of establishment before Pearl Harbor.

Centers were closed as special requirements for the Army and the Navy were completed. Four centers were closed when the Navy contracts for albumin were terminated in October 1944. Nineteen were closed after the German surrender in May 1945. By 15 September 1945, the only center still in operation was in Denver; it was kept open at the request of the Army to supply small amounts of whole blood to the nearby Fitzsimons General Hospital, Denver, Colo.

Facilities.—Five centers occupied the property of local Red Cross chapters during all, or almost all, of their period of operation. Seven occupied donated space and two others space donated for all but a portion of the time. The remainder operated in rented space in stores or office buildings, usually in downtown areas or shopping districts, with public transportation, parking space, and space for trucking facilities (fig. 19).

TABLE 1.—American Red Cross blood donor centers in order of their establishment

Center	Date of opening	Date of closing
1. New York	4 Feb. 1941	15 Aug. 1945
2. Philadelphia	1 May 1941	15 Aug. 1945
3. Baltimore	19 May 1941	19 May 1945
4. Washington	1 June 1941	15 Aug. 1945
5. Buffalo	1 July 1941	19 May 1945
6. Rochester	21 July 1941	19 May 1945
7. Indianapolis	27 Sept. 1941	19 May 1945
8. Boston	1 Dec. 1941	15 Aug. 1945
9. Detroit	1 Dec. 1941	19 May 1945
10. Pittsburgh	1 Dec. 1941	19 May 1945
11. St. Louis	10 Dec. 1941	19 May 1945
12. San Francisco	2 Jan. 1942	15 Sept. 1945
13. Cleveland	8 Jan. 1942	19 May 1945
14. Los Angeles	20 Jan. 1942	15 Sept. 1945
15. Milwaukee	20 Jan. 1942	19 May 1945
16. Chicago	1 Feb. 1942	15 Aug. 1945
17. Cincinnati	1 Mar. 1942	19 May 1945
18. Brooklyn	9 Mar. 1942	15 Aug. 1945
19. Atlanta	11 May 1942	19 May 1945
20. San Antonio	1 June 1942	15 Oct. 1944
21. Portland	17 Aug. 1942	15 Sept. 1945
22. Denver ²	14 Sept. 1942	1 Dec. 1945
23. Hartford	15 Oct. 1942	19 May 1945
24. New Orleans	26 Oct. 1942	15 Oct. 1944
25. Harrisburg	9 Nov. 1942	19 May 1945
26. Schenectady	23 Nov. 1942	19 May 1945
27. Columbus	1 Dec. 1942	19 May 1945
28. Minneapolis	1 Dec. 1942	19 May 1945
29. Kansas City	7 Dec. 1942	19 May 1945
30. St. Paul	7 Dec. 1942	19 May 1945
31. Oakland	15 Feb. 1943	15 Sept. 1945
32. Louisville	31 May 1943	19 May 1945
33. San Diego	15 Aug. 1943	15 Sept. 1945
34. Dallas	3 Jan. 1944	15 Oct. 1944
35. Fort Worth	10 Jan. 1944	15 Oct. 1944

¹ Inception of Army and Navy project. Previous bleedings procured from Walter Reed General Hospital and Naval hospitals.

² Continued operation after closing of other centers, at request of Army, to provide blood for Fitzsimons General Hospital, Denver, Colo.

All the facilities occupied required some remodeling for the special needs of the Blood Donor Service. Most of it could be accomplished by temporary partitions. As new centers were planned, they were altered and reconstructed in the light of earlier experience. Air conditioning was necessary in some centers in the South.



FIGURE 19. American Red Cross blood donor centers. A. New York, N.Y. A mobile team is about to depart. B. St. Paul, Minn. C. Louisville, Ky.

The size of the facilities varied with the weekly quotas of the centers, which ranged from 1,500 to 10,500 bloods. All but 5 of the 22 centers in operation before October 1942 later had to move into larger quarters.

The following rooms were required:

Offices for the center director, the physician or medical officer in charge, the special assistant, and the recruiting and publicity staffs. In the larger centers office space was also provided for the chairman of the Blood donor committee and for the committee (fig. 20).

Rooms for the reception, testing, examination, and bleeding of donors, which are described in connection with the technique of collecting the blood (p. 148).

A special telephone room for appointments and for reception of the innumerable inquiries which came into each center.

A room for files for registration cards and other donor records and for material used in recruiting and in obtaining redonations.

Workrooms for preparing, cleaning, and sterilizing equipment and supplies; handling bleeding equipment, and storage of supplies and equipment.

Rooms for the refrigeration of blood collected at the center, for reception of blood from mobile units, and for packing of blood in refrigerated chests for shipment to processing laboratories. These rooms were preferably at the rear of the center, out of the way of donors, and with ready access to trucks.

Canteens, restrooms, and locker space for nurses, volunteers, and other members of the staff.

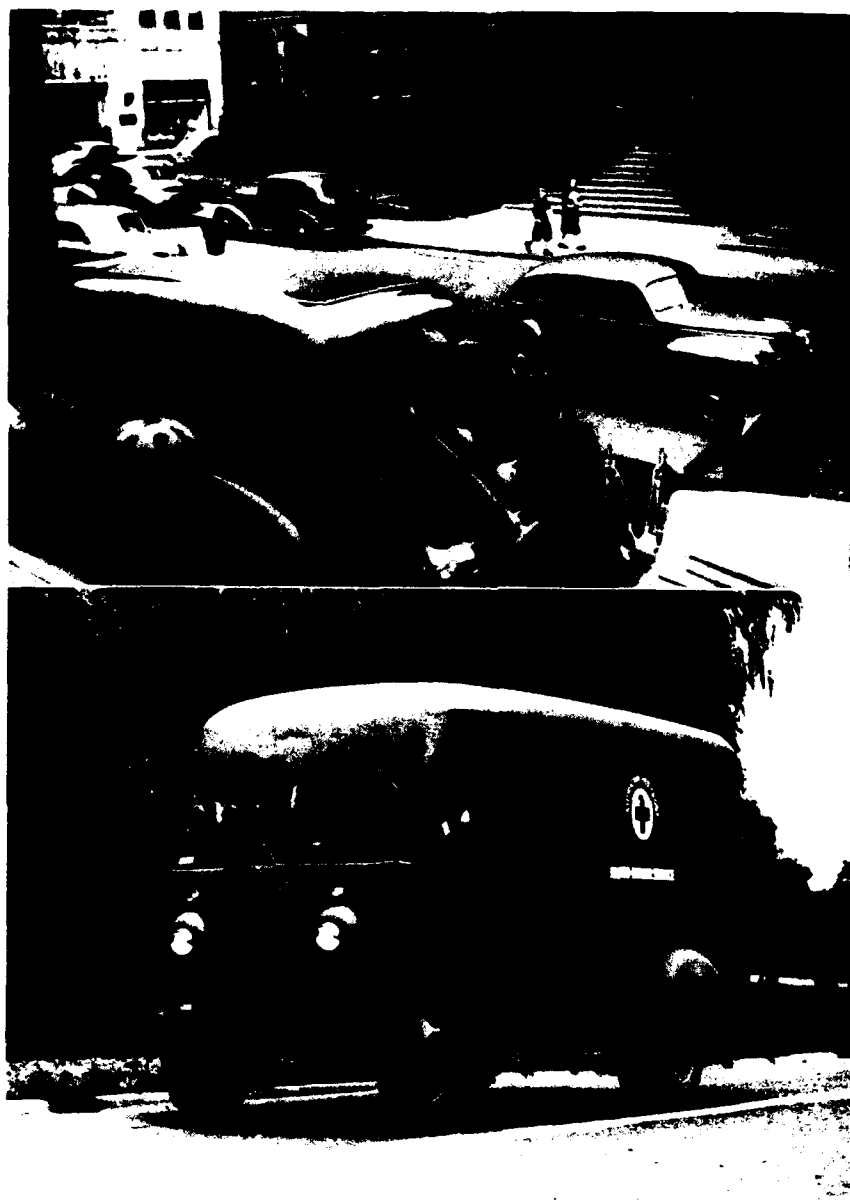

FIGURE 20. —Committee room, American Red Cross Blood Donor Center, Fort Worth, Tex. Dr. G. Canby Robinson, Director, Blood Procurement Project, ARC, is at the head of the table, fifth from left.

MOBILE UNITS

Mobile units (fig. 21) were operated out of all blood donor centers, the numbers ranging from one to four. At the height of the program, 63 were in operation, and, in all, 47 percent of the blood donations were made through them. These units operated within a radius of 75 miles of the 35 centers, and it was estimated that their use brought 60 percent of the population of the country within range of the Blood Donor Service.

Mobile units had a number of advantages. They gave flexibility to the donor centers in filling their quotas. They materially expanded the territory and population from which donors could be drawn. They also allowed hundreds of Red Cross chapters and their thousands of members to participate in the Blood Donor Service, a participation which, for geographic reasons, would not have been possible otherwise.



American Red Cross photographs

FIGURE 21.—Mobile units, American Red Cross Blood Donor Service.

Equipment.—The physical equipment of a mobile unit usually consisted of a 1½-ton truck, although some centers continued to use the 1-ton panel truck, which was originally provided, till the end of the war. Many of the trucks were given by civic and other organizations.

Each unit was equipped with folding tables; 10 or 12 specially designed folding cots; four or more portable refrigerators, each with a capacity of 40 bottles of blood; and 9 or 10 boxes that contained all the supplies needed for collecting blood. On the cover of each box was a list of its contents. The



American Red Cross photographs

FIGURE 22.— Setup of mobile units, American Red Cross Blood Donor Service. A. Los Angeles, Calif. B. Trenton, N.J.

truck was so packed that a temporary blood center could be set up almost as soon as the destination was reached (fig. 22). A variety of buildings was used—schoolhouses, assembly halls, parish houses, or available space in an industrial or military establishment.

Staff.—The technical staff of the mobile unit consisted of the physician in charge; five or six nurses; a technical secretary; and a blood custodian, who



FIGURE 22.—Continued. C. Baton Rouge, La., where the blood was collected in the Capitol, under a statue of Bienville, Louisiana's first Governor. D. An unidentified location.

frequently served as chauffeur. Occasionally, a few well-trained volunteers from the parent center went along, but more often the cooperating chapter supplied the volunteers. The technical staff was transported in station wagons, many of which were also special gifts.

Policies and procedures.—The cooperating chapters made all arrangements for the visits of the mobile units, the preparations usually requiring several weeks of intensive work and publicity. It was necessary to recruit and enroll specified numbers of donors for each day of the operation; to secure the most suitable rent-free building available for the operation; to organize the necessary volunteer services; and to supplement the equipment from the center with locally provided tables, lights, couches, and canteen equipment.

The activities of the cooperating chapters generally corresponded with those of fixed centers except that recruitment took the form of intensive drives rather than day-after-day publicity. Since many of the towns visited were relatively small, it was often necessary to comb several counties to meet the quotas set. The wide appeal, and the relatively greater efficiency, of periodic drives as compared to routine recruitment was evidenced by the fact that only 15 percent of the donors enrolled in mobile units canceled their appointments or failed to keep them as compared to 25 percent in the fixed centers. Relations with the cooperating chapters were always cordial, and their arrangements were always efficient.

Activities.—Mobile units visited not only cooperating chapters but also branches of chapters, industrial plants within the jurisdiction of the blood donor centers, military establishments, and Federal and state penal institutions. Many times, churches, under the stimulation of their clergy, recruited donors as well as contributed blood themselves.

By the end of the war, it was estimated that mobile units had operated in 3,260 different places, including 1,100 cooperating Red Cross chapters, 1,130 branches of chapters, 590 industrial plants, 260 military establishments, and 180 other places. Many other chapters made repeated efforts to be included in the program, although they were so remote from the centers that it would have been impractical to include them.

CONFERENCES

A number of conferences on the blood donor program were held during the war. They included:

1. A conference on technical operations at Atlantic City, N.J., on 7 June 1942. It was attended by the technical supervisors of the centers then in operation and representatives of the National Headquarters, American Red Cross, the National Research Council, the National Institute of Health, the Army and the Navy.

2. A conference on general problems in Indianapolis on 19–20 January 1943, attended by the chairmen of blood donor committees; directors of all

centers then in operation; and representatives of the National Headquarters, ARC, and the Army and the Navy.

3. A conference in New York on 15-16 December 1943 and a similar conference in Chicago on 18-19 January 1944, attended by regional technical supervisors, the directors of the centers, and the chairmen of the center blood donor committees.

The special items discussed at the meetings are described under appropriate headings.

CAMPAIGNS FOR BLOOD DONORS

General Considerations

The American Red Cross Blood Donor Service began with the enormous emotional advantage that donations of blood could save the lives of wounded men. Thousands of persons who could make no other contribution to the war effort gladly gave their blood, and many of them repeated their donations as often as they were permitted. It is ironic, therefore, that from the beginning to the end of the program, the major problem was to obtain an adequate number of donors to meet the requirements. Spontaneous, unsolicited donations were the exception rather than the rule except in special circumstances. Only unceasing efforts enabled the centers to meet their quotas, particularly during lulls in fighting.

The requirements for blood in the 10-month period between the institution of the Blood Donor Service and Pearl Harbor were negligible compared to later demands. Only 28,974 pints of blood were procured during this period, an average of 724 pints per week for the 10 centers then in operation. Only two of these centers had been active during the entire 10 months, and the average amount procured by them was 145 pints per week. Even the largest center, at peak operation during the prewar period, obtained only 441 pints per week.

Donations increased notably immediately after Pearl Harbor, and increased similarly after other severe fighting. After the Normandy invasion, donors poured in from the streets and swamped the telephone lines. During that week, 123,284 pints of blood were collected, and thousands of future appointments were made.

On the other hand, the flow of information concerning the war provided by the free press of the United States sometimes had the effect of a two-edged sword. Immediately after the Normandy landings, for instance, the happy news was received that casualties had been fewer than anticipated. Donations promptly declined sharply and did not again approach the invasion peak until the spectacular race across France began several weeks later.

The pre-Pearl Harbor period had made one thing quite clear, that general publicity must be supplemented by specific recruiting techniques. With spontaneous response apparently depending largely upon the ebb and flow of

battle, the greatest single problem was how to maintain an adequate number of donors when the war news was not spectacular.

A second difficulty inherent in the program and not generally clear to the public, in spite of efforts to clarify it, was the necessity for operating each center and each mobile unit on a strict system of weekly quotas. No surpluses could be built up. Planning had to envisage a regular number of donors every day. It was a serious matter when the quotas were not met and also a serious matter when collections exceeded capacity, as they did, for instance, in September 1943.

A part of this same consideration was that blood procurement facilities were necessarily located near processing laboratories. As a result, publicity which would have been gladly provided throughout the country in motion picture theaters, over radio networks, and in similar media had to be used with great care. Only a few experiences were needed to show that national appeals for donors caused confusion and frustration in communities in which facilities for processing blood donations were not available. The closing of collection centers at the height of the fighting also made for difficulties in public relations, perhaps because the reasons—that special programs, such as the serum albumin program, had been successfully concluded—were not made as clear as they should have been.

External circumstances also interfered with donations. Plasma deliveries in December 1943 were 40 percent short of the quota because of an epidemic of influenza. On 9 February 1945, a blizzard in the East almost wiped out the donations scheduled for that day and the next several days.

Cancellations of appointments and failures to appear for scheduled appointments were serious losses in themselves, and they also wasted the time of physicians, nurses, and technicians, for they kept other volunteers from using the time scheduled. Some centers found it profitable to send out reminders several days in advance of appointments. About 10 percent of donors who appeared for their appointments had to be rejected for physical reasons.

For these and other reasons, it was necessary to secure an enrollment of about 150 donors to obtain each hundred pints of blood. This meant that the 13,326,242 pints of blood collected during the war by the Red Cross required the enrollment of nearly 19 million persons.

Multiple donors.—A major source of blood came from multiple donors. Most centers had a special desk at which, before they left, donors were invited to make future appointments. Some donors voluntarily phoned for second appointments. It was estimated that the average donor made two donations. About 1½ million gave three donations, 150,000 gave a gallon each, and about 3,000 gave 2 gallons or more. In some centers, multiple donations ran as high as 60 percent of the blood collected. Multiple donations and the publicity which attended them did much to dispel the fear in some minds that giving blood was harmful.

Development of Recruiting Program

Since the United States was not at war when the Red Cross Blood Donor program was begun, publicity was naturally less urgent than it became later. Promotional material was devoted chiefly to an explanation of the project and its potential value if war should come. The pamphlet issued in November 1941, entitled "Teamwork From Publicity to Plasma," was intended to stimulate general interest in the blood program; to provide information as to its origin, purpose, and objectives for those who were to cooperate in its organization and operation; and to insure accuracy and consistency of effort.

In January 1942, the importance of publicity and promotion in a country at war was recognized by the appointment of an Assistant National Director of the Red Cross, whose function was to coordinate all promotional matters and assist the blood donor centers in publicity and recruiting. This official was in direct contact with the directors of the centers, the chairmen of the local blood donor committees, and the chapter personnel in charge of local recruiting and publicity. All activities connected with promotion and public relations were thus closely coordinated with the administrative and technical aspects of the Blood Donor Service on both the national and the local levels. The office of the Assistant National Director (including his assistant, two special representatives who served as volunteers, and the secretarial staff) also acted as liaison between the Blood Donor Service, the information departments of the Army and the Navy, the Office of War Information, the War Activities Committee of the Motion Picture Industry, the Writers' War Board, and similar organizations.

This office of the Blood Donor Service prepared and distributed to the donor centers a large variety of promotional material, including posters (fig. 23), leaflets, car cards, pamphlets (fig. 24), motion pictures, photographs, radio transcriptions and announcements, recruiting plans, and publicity kits. Commercial firms generously contributed outdoor advertising space (fig. 25).

In May 1942, a revised publicity kit prepared by the Public Information Service, National Red Cross Headquarters (7), was furnished to the chapters operating blood donor centers. This kit contained information on the origin of the program; the initial activities; the increased requests for blood; the location of the 18 blood donor centers then in operation and of the laboratories processing plasma; the explanation of why the collecting centers were restricted to these special localities; the restricted use of plasma (that is, its reservation for military use only); suggestions for publicity for the individual chapters; material for promotional activities, including newspaper releases and fillers, posters, displays, folders, and leaflets; and spot radio announcements. The kit also contained information about the processing and use of plasma, including its preparation as dried plasma. Finally, it contained a talk to be used while personal appeals were made for donations from special groups in person or on the radio.



FIGURE 23.—Posters used by American Red Cross for recruiting blood donors.

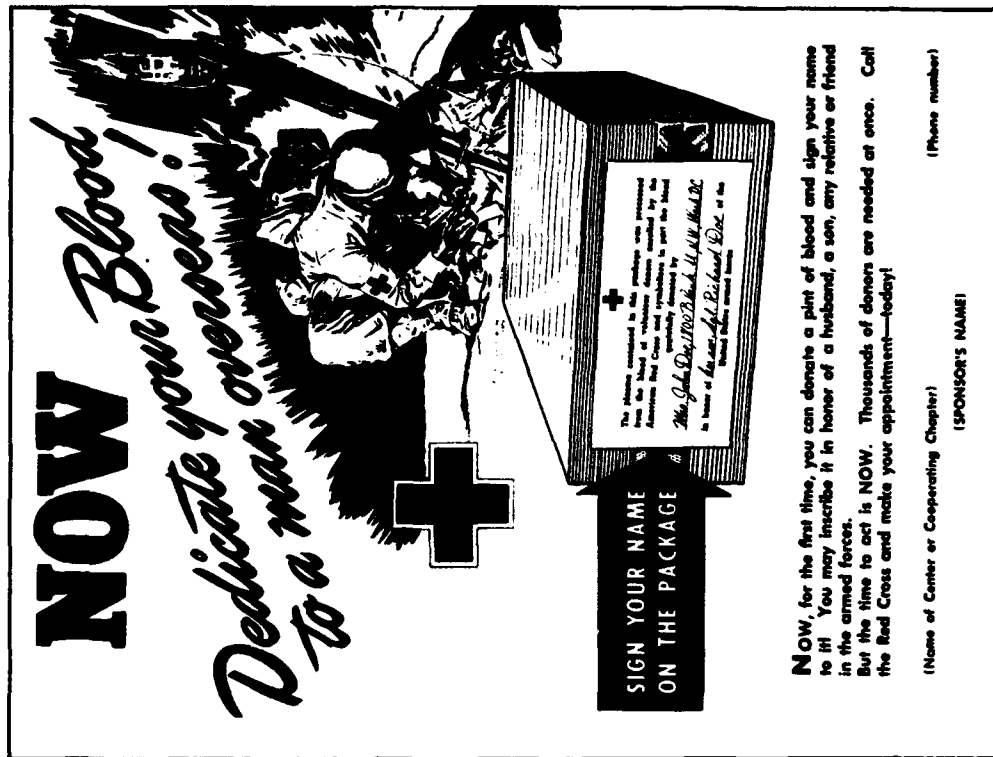

FIGURE 24.—Covers of pamphlets used by American Red Cross for recruiting blood donors.



B
FIGURE 25.—Outdoor posters, contributed by commercial firms, advertising blood donor centers. A. San Diego, Calif. B. San Francisco, Calif.

Special Methods

In spite of the use of all possible advertising media and methods, enough donors were not attracted by these means to meet the steadily increasing demands for blood, and special plans for the recruitment of donors had to be put into effect. They included:

1. House-to-house canvasses by Red Cross volunteers, members of the Junior Red Cross, Boy Scouts, and other organizations.
2. Organized drives in schools, to persuade students to persuade their parents to give blood.
3. Recruiting booths in department stores and office buildings.
4. Personal appeals, by well-trained, tactful Red Cross personnel, in motion picture theaters.
5. Distribution of application blanks in business firms, industrial plants, and at meetings of civic, labor, religious, and fraternal groups.

These methods all produced direct results, in addition to the general publicity they provided, but all of them had the same defect: They brought large numbers of appointments, but the percentage of so-called no-shows was much larger than when donors voluntarily telephoned for appointments. More precise methods of recruitment were obviously necessary.

Participation of labor unions.—At the conference of blood donor service officials in January 1943, just after the Army and the Navy had sharply increased their requests for blood, a plan was presented for the participation of labor unions. It had been worked out, at the request of the unions, between National Headquarters, ARC, the American Federation of Labor, the Congress of Industrial Organizations, and the Railway Brotherhoods. The basis of the plan was that locals throughout the country, with the endorsement of their national organizations and in cooperation with local blood donor officials, should seek to stimulate blood donations from their members. A booklet was prepared explaining the plan in detail, and other informational and recruiting material was made available for local use.

The contacts and activities resulting from this plan led to a high degree of cooperation between the unions and the Blood Donor Service centers, which was fostered by meetings at local levels. When the group recruiting plan, to be described next, was put into effect, the groundwork for it had already been laid by the plan already in effect in labor unions.

Group recruiting.—The group recruiting plan was a precise method of obtaining donors which had been introduced and perfected by some centers in the first year of the program. It was given added impetus when it was endorsed by a national conference of Blood Donor Service officials in December 1943 and in January 1944. Thereafter, it was used by all the centers and did much to maintain the necessary blood quotas, especially during the periods in the spring and late summer of 1945, when rumors of impending enemy capitulation began to lessen the effectiveness of appeals for donors.

The group recruiting plan was carried out as follows:

1. A card index in each center showed the larger local business firms and organizations, the name of the head of each firm, and the number of employees or members.

2. Each such organization was asked to provide a regular number of weekly donors, the number depending upon the total number employed and usually averaging 5 percent of the personnel.

3. To implement the plan, special recruiting committees were formed in each center, composed of civic and community leaders who had had experience in such drives. Each member was provided with promotional material suitable for the organization to which he was assigned. The organizations themselves assumed the responsibility for securing the pledged number of donors and for furnishing alternates if those originally scheduled could not or would not keep their appointments. The members of the recruiting committee pointed out to the officials of the organization the importance of appointing really representative labor-management committees to sign up donors. It was also recommended that the employees be allowed to donate on paid time.

This method provided a regular schedule of donors for each center each week. If a center could schedule 50 concerns or organizations which would supply an average of 10 donors each per week, it could be assured of 500 donors per week and could make up the rest of its quota from repeated donations, publicity, and other methods. Moreover, by controlling the supply of donors, the flow through the centers could be regulated and the most efficient use possible made of personnel and facilities. It was found that donors recruited by their own firms and organizations generally kept their appointments (fig. 26), because interdepartmental competition and pride of achievement were called into play. From the standpoint of the firms, the donations did not interfere seriously with their production, and they, like their employees, profited from pride of achievement. Many of the firms adopted the slogan, "A Pint of Blood for Every Star in Our Service Flag."

While precise figures are not available, it is believed that at least 20,000 business and industrial organizations participated in this phase of the blood donor program. With the possible exception of the overall publicity techniques and the repeat donors signed up in the centers, this plan produced more donors than any other used. In one city, under the leadership of an extremely able chairman, Federal agencies alone provided between 60 and 70 percent of all donors after the plan began to operate. The secret of success in every instance lay in careful internal organization and the amount of hard work devoted to personal contacts.

To complete the story of efforts to procure blood donors, two other items should be mentioned. The first is the presentation on the "Army Hour," a regular wartime radio program, on 24 October 1943, of a dramatization of blood plasma, its collection, and its uses. The second is the film entitled "Life



FIGURE 26—U.S. Army cadets from Marquette University ready to give blood at the Milwaukee, Wis., donor center.

Line," which was presented to the Blood Donor Service officials and others in attendance on the conferences in December 1943 and January 1944. Most of the officials present asked to borrow it for local showing.

Recognition of Donations

There were a number of proposals to offer inducements to blood donors, with the hope of increasing the number of donations. The plan was tried out in the spring of 1943, in Brooklyn, with the offer of tickets to baseball games for each donation, but the public reaction was instant and adverse. The plan was discontinued on the third day, and nothing like it was ever proposed again.

E awards. By the end of June 1942, the Red Cross had collected 461,493 pints of blood. To express their formal appreciation to the Blood Donor Service, the Surgeons General of the Army and the Navy, on 15 September 1942, presented the Army E flag and the Navy E award emblem to the Chairman of the American Red Cross, at ceremonies at the National Headquarters in Washington. All the chapters which had participated in the program up to April 1942 were represented by chapter officials and personnel of the blood donor centers.

The same production awards were later made at local ceremonies to the 18 chapters which had participated in the program up to this time and were subsequently made to chapters which entered the program later. The ceremonies at which these awards were made were arranged with great care, and the effect on recruitment of donors was usually evident.

In 1943 and 1944, the Army-Navy Award Board added stars to the pennants of the original recipients for sustained excellent performance.

The Gallon Club.—It is an interesting fact that the American Red Cross itself apparently had no realization, when the Blood Donor Service was instituted, of the magnitude the program was finally to assume. Each donor received a bronze emblem on his first donation and a silver emblem on his third. No further recognition was provided for, on the assumption, then widely held, that the project, even if expanded, would not require more than three donations from any one donor. Later, it was realized that multiple donors should receive greater recognition. Gallon Clubs were formed in several cities, and red, white, and blue ribbons were attached to the silver emblems to indicate 1-, 2-, and 3-gallon donors. In retrospect, it is unfortunate that more conspicuous recognition was not given to multiple donors.

Labeling of plasma.—In December 1944, in response to numerous suggestions and as an added incentive to donations, the Red Cross label on the official Army-Navy package of dried plasma was altered to read (fig. 24):

The plasma contained in this package was processed from the blood of volunteer donors enrolled by the American Red Cross and symbolizes in part the blood gratefully donated by ——— in honor of ——— of the United States Armed Forces.

This plan was purely symbolic, since it was technically impossible to identify the plasma processed from any particular blood. Nonetheless, it gave donors a sense of active participation in the war effort, and about a third of them inscribed their names on the labels after the plan was put into effect.

OTHER ASPECTS OF THE PROGRAM

Local conflicts.—As pointed out elsewhere (p. 91), a number of communities attempted to collect blood for local use, and their efforts interfered with the national program to obtain blood for the Armed Forces. As late as December 1943, a large New York City hospital began an intensive campaign to recruit donors for its own blood bank, and it took the combined efforts of the Red Cross, the Office of Civilian Defense, and the Superintendent of Hospitals of the City of New York to straighten out the situation.

Offers and suggestions.—During the war, the Red Cross, the Army and the Navy, and other governmental agencies received many questions and suggestions connected with the blood program. Some extremely detailed questions concerned the production and uses of plasma. Whenever there was a lull in the fighting or word of the approaching end of hostilities, there were numerous inquiries as to whether blood was still needed. One correspondent had guinea pigs whose blood she wished to sell for conversion into plasma.

Many soldiers wrote to suggest that blood banks be established on their military posts, and many lay persons wrote to propose the establishment of blood banks and processing plants for plasma in their communities. Some of them had already raised money and purchased equipment, including some

mobile units, for these purposes. Some hospitals wrote offering plasma which they had prepared locally.

A great many of these well-meant but misdirected efforts arose from the situation already discussed, the difficulty of controlling publicity for the procurement of blood without making it clear that, for practical reasons, it could be collected and processed only in certain localities. The reply to these inquiries and offers was always the same: That the Red Cross was the sole authorized procurement agent for blood for the Armed Forces and that plasma had to be prepared under such strict specifications that it could be processed by, and procured from, only certain laboratories. Organizations and individuals who wrote offering to supply blood were told that they might give it through the Red Cross. Those who wrote proposing that the military be bled were told that voluntary donations from the Armed Forces were permitted and encouraged but that the blood program was primarily a civilian effort. Similarly, although some of the suggestions came from higher authority, the plan was not adopted of taking blood from inductees at the time of their induction. Signs were placed in all induction centers giving the location of the nearest blood donor center and suggesting that men who had been deferred or were disqualified for service might wish to take advantage of this opportunity.

Rumors and sabotage.—During the entire war, rumors continued to spread that could have seriously hurt the blood program if they had not been tracked down and refuted immediately. Questions concerning the deaths of soldiers from lack of plasma were always promptly denied; they were simply not true.

One of the most persistent rumors was that the Red Cross was selling plasma. In October 1943, this particular rumor created special difficulties and great embarrassment for the mobile unit which went to the Glenn L. Martin and other plants to collect blood. When police checked the rumor, they found it to be far more widespread than it had seemed at first. As late as May 1945, it was necessary for the Office of The Surgeon General to deny the sale of plasma by the Red Cross, the correspondent who had made the inquiry being told that any person circulating such a rumor should be reported to the Federal Bureau of Investigation.

The explanation of this canard seemed, in some instances, to arise from the care of military personnel in civilian hospitals after they had been in accidents. When they were treated with plasma in these hospitals, in cities in proximity to Army Liquid Plasma centers, the plasma which had been used from hospital supplies was replaced in kind from military supplies. Otherwise, the Army would have had to pay civilian prices for the plasma which had been used. One rumor which arose in such a situation created a particularly serious situation at a hospital in Atlanta, which, so the story ran, was buying plasma from Lawson General Hospital, Atlanta, Ga.

Since the country was at war, and since blood and plasma could easily have been tampered with, special precautions against sabotage were in effect throughout the blood donor program (p. 295). No known instance of sabotage ever occurred.

THE TOTAL PROGRAM

During the operation of the Blood Donor Service of the American Red Cross, from 4 February 1941 to 15 September 1945, a total of 13,326,242 blood donations were collected by 35 chapters (tables 2-5). The number rose from 48,504 in 1941 to 5,371,664 in 1944 and 2,302,227 in 1945, during which year the war in Europe ended on 8 May and the war in the Pacific on 14 August.

TABLE 2.—Number of blood donations, length of operation, and highest weekly procurement of each American Red Cross blood donor center

Center	Total number of donations	Length of operation		Highest weekly procurement
		Years	Months	
New York.....	1, 272, 931	4	6½	10, 733
Los Angeles.....	1, 094, 718	3	8	10, 460
Boston.....	800, 640	3	8½	8, 157
Philadelphia.....	702, 488	4	3½	6, 704
Detroit.....	667, 561	3	5½	6, 152
Chicago.....	642, 393	3	6½	6, 729
San Francisco.....	592, 198	3	8½	6, 146
Pittsburgh.....	570, 541	3	5½	5, 478
Washington.....	527, 400	4	2½	4, 907
Cleveland.....	492, 049	3	4½	4, 899
Brooklyn.....	483, 086	3	5	4, 710
St. Louis.....	424, 276	3	5	4, 426
Baltimore.....	349, 039	4		3, 874
Milwaukee.....	336, 589	3	4	3, 674
Cincinnati.....	335, 403	3	2½	3, 051
Buffalo.....	328, 412	3	10½	3, 275
Portland.....	307, 084	3	1	3, 864
Rochester.....	303, 397	3	10	3, 108
Indianapolis.....	292, 572	3	7½	2, 692
Hartford.....	279, 357	2	7	3, 468
Kansas City.....	261, 621	2	5½	3, 065
Columbus.....	258, 402	2	5½	3, 357
Minneapolis.....	229, 410	2	5½	2, 482
Oakland.....	214, 122	2	7	2, 996
Louisville.....	190, 850	2		2, 818
Schenectady.....	190, 232	2	6	2, 220
St. Paul.....	177, 320	2	5½	2, 020
Harrisburg.....	173, 873	2	6½	2, 084
San Diego.....	173, 573	2	1	2, 998
Atlanta.....	157, 956	3		2, 022
Denver ¹	150, 880	3		2, 342
New Orleans.....	119, 739	2		2, 694
San Antonio.....	90, 925	2	4½	2, 332
Dallas.....	77, 682		9½	2, 704
Fort Worth.....	57, 523		9	2, 034
Total.....	13, 326, 242	-----		144, 675

¹ Continued operation after closing of other centers, at request of Army, to provide blood for Fitzsimons General Hospital. Procurement after 15 Sept. 1945 is not included in this report.

TABLE 3.—Production report of American Red Cross blood donor centers, February 1941-31 August 1945

Center	February 1941- December 1944	1 Jan.- 28 July 1945	30 July- 4 Aug. 1945	6-11 Aug. 1945	13-18 Aug. 1945	20-25 Aug. 1945	27 Aug.- 1 Sept. 1945	Total August 1945	Total to date	Maximum weekly production
Boston	648, 985	145, 998	2, 389	2, 510	758			5, 657	800, 640	3, 500
Brooklyn	376, 194	101, 977	2, 110	2, 316	489			4, 915	483, 086	2, 750
Chicago	563, 996	74, 436	1, 868	1, 600	493			3, 961	642, 393	2, 500
Denver	140, 578	8, 773	241	301	186	236	188	1, 152	150, 503	300
Los Angeles	839, 878	241, 294	4, 849	5, 323	1, 546	574	376	12, 668	1, 093, 840	7, 500
New York	992, 629	267, 432	5, 783	5, 456	1, 631			12, 870	1, 272, 931	8, 000
Oakland	136, 283	71, 452	2, 404	2, 144	835	357	246	5, 986	213, 721	2, 500
Philadelphia	588, 938	108, 259	2, 360	2, 268	663			5, 291	702, 488	2, 750
Portland	219, 281	82, 640	1, 962	1, 625	392	288	288	4, 555	306, 476	1, 750
San Diego	115, 718	53, 660	1, 229	1, 423	509	336	272	3, 769	173, 147	2, 000
San Francisco	434, 327	146, 819	3, 790	4, 013	1, 076	675	563	10, 117	591, 263	4, 500
Washington	403, 284	117, 031	3, 135	3, 076	874			7, 085	527, 400	2, 500
(23) Closed centers	5, 563, 924	800, 805							6, 364, 729	
Total bleedings	11, 024, 015	2, 220, 576	32, 120	32, 055	9, 452	2, 466	1, 933	78, 026	13, 322, 617	40, 550
Whole blood ¹	378, 874	300, 790	3, 359	3, 805	2, 745	2, 466	1, 933	14, 308	693, 972	
Dried plasma and serum albumin	10, 645, 141	1, 919, 786	28, 761	28, 250	6, 707			63, 718	12, 628, 645	

¹ Including whole blood sent to hospitals in Zone of Interior

TABLE 4.—Production report of American Red Cross blood donor centers, February 1941-31 March 1943

Center	February 1941- December 1942	January- February 1943	1-6 Mar. 1943	8-13 Mar. 1943	15-20 Mar. 1943	22-27 Mar. 1943	28 Mar.- 3 Apr. 1943	Total to date
Atlanta.....	15,772	2,328	1,105	425	715	979	767	2,886
Baltimore.....	54,484	12,530	1,882	1,195	1,112	2,164	2,007	18,512
Boston.....	96,197	27,336	4,191	2,161	2,128	4,940	4,535	77,356
Brooklyn.....	48,023	15,985	2,413	4,598	4,690	3,057	2,993	146,487
Buffalo.....	62,788	18,354	2,572	2,948	3,076	2,407	2,259	78,495
Chicago.....	77,350	28,679	4,941	2,514	2,358	5,251	5,646	93,252
Cincinnati.....	52,603	15,875	2,182	4,931	5,180	2,589	2,564	131,978
Cleveland.....	56,919	19,473	2,441	2,516	2,801	2,871	2,716	81,130
Columbus.....	2,776	11,343	1,725	2,709	2,765	1,631	1,751	89,894
Denver.....	14,220	14,103	1,657	1,735	1,708	1,772	1,726	22,669
Detroit.....	103,869	28,872	4,265	1,747	1,770	4,747	4,476	111,995
Harrisburg.....	2,371	6,705	1,076	5,220	4,812	1,195	1,260	15,049
Hartford.....	8,044	11,442	1,799	1,222	1,220	2,144	1,640	28,658
Indianapolis.....	56,920	14,784	2,235	1,928	1,661	1,866	1,710	81,587
Kansas City.....	1,867	12,232	1,604	2,123	1,949	1,918	2,014	23,679
Los Angeles.....	95,502	32,298	5,072	4,878	6,253	6,233	6,532	156,768
Milwaukee.....	47,026	16,397	2,201	2,227	2,537	2,281	2,222	74,891

Minneapolis.....	2, 396	9, 836	1, 429	1, 893	1, 660	1, 833	1, 831	20, 878
New Orleans.....	1 1, 655	1 3, 014	1 423	1 515	1 559	1 504	1 515	1 7, 185
New York.....	154, 419	43, 230	7, 258	7, 408	7, 486	7, 236	6, 909	233, 946
Philadelphia.....	91, 529	20, 926	3, 531	3, 971	4, 282	4, 122	4, 003	132, 364
Pittsburgh.....	65, 682	23, 174	2, 866	3, 067	3, 313	3, 283	3, 317	104, 702
Portland.....	1 5, 434	1 2, 668	495	581	1, 089	1, 253	1, 275	4, 693
Rochester.....	66, 778	14, 419	1, 888	2, 253	2, 177	2, 430	2, 262	1 8, 102
San Antonio.....	1 7, 471	1 1, 864	1 311	1 326	1 314	1 311	1 331	1 10, 928
San Francisco.....	73, 201	21, 276	2, 128	2, 681	2, 915	3, 096	2, 781	108, 078
Oakland.....		1, 777	981	1, 039	1, 120	1, 018	1, 197	7, 132
Schenectady.....	1, 971	5, 802	1, 219	1, 062	1, 366	1, 350	1, 370	14, 140
St. Louis.....	75, 809	21, 041	2, 559	2, 761	3, 093	3, 125	3, 038	111, 426
St. Paul.....	1, 319	6, 047	895	905	1, 279	1, 024	1, 488	12, 957
Washington.....	13, 547	12, 642	1, 936	2, 303	2, 392	2, 221	2, 386	37, 427
	1 32, 221	1 3, 172	1 274	1 244	1 253	1 458	1 328	1 36, 950
Total bleedings.....	1, 370, 163	469, 624	69, 554	76, 076	80, 087	80, 309	78, 849	2, 221, 662
Liquid plasma.....	56, 773	17, 149	1, 770	2, 027	2, 008	2, 045	1, 900	83, 672
Dried plasma and serum albumin.....	1, 313, 390	452, 475	67, 784	74, 049	78, 079	78, 264	76, 949	2, 140, 990

1 Liquid plasma. At this time, several centers had shifted their collections from liquid to dried plasma and a few were still providing blood for both forms.

TABLE 5.—Production report of American Red Cross blood donor centers, February 1941-30 June 1944

Center	February 1941- December 1943	1 Jan.-27 May 1944	29 May-3 June 1944	5-10 June 1944	12-17 June 1944	19-24 June 1944	26 June-1 July 1944	Total for June 1944	Total to date	Maximum weekly production
Atlanta	55, 780	34, 372	1, 638	1, 822	2, 022	1, 528	1, 713	8, 723	98, 875	1, 750
Baltimore	18, 512	64, 796	2, 743	3, 679	3, 821	3, 289	2, 706	16, 238	18, 512	2, 500
Boston	362, 984	123, 310	4, 239	6, 124	6, 106	5, 430	4, 728	26, 627	246, 087	5, 500
Brooklyn	182, 182	76, 843	3, 388	4, 710	4, 692	4, 332	3, 835	20, 957	512, 921	4, 000
Buffalo	189, 160	53, 578	1, 426	2, 597	2, 388	2, 394	2, 132	10, 937	279, 982	2, 500
Chicago	325, 523	114, 204	4, 348	5, 645	5, 406	5, 539	5, 227	26, 165	253, 675	5, 000
Cincinnati	172, 530	50, 940	1, 678	2, 717	2, 456	2, 327	2, 198	11, 376	465, 892	2, 500
Cleveland	223, 037	83, 197	3, 583	4, 391	3, 892	3, 834	3, 655	19, 355	234, 846	4, 000
Columbus	110, 148	55, 762	2, 403	3, 357	2, 805	2, 436	2, 457	13, 458	325, 589	4, 000
Dallas		39, 819	1, 893	2, 035	2, 166	2, 078	1, 760	9, 932	179, 368	2, 750
Denver	63, 489	34, 987	1, 487	1, 613	1, 781	1, 640	1, 673	8, 194	49, 751	2, 000
Detroit	329, 389	108, 603	3, 363	5, 667	5, 340	4, 824	4, 766	23, 960	106, 670	1, 750
Fort Worth		24, 334	1, 890	1, 851	1, 911	1, 846	1, 777	9, 275	461, 952	5, 000
Harrisburg	72, 450	34, 659	1, 375	1, 542	1, 753	1, 720	1, 599	7, 989	33, 609	1, 500
Hartford	124, 835	52, 276	2, 206	3, 105	2, 711	2, 248	2, 040	12, 310	115, 098	1, 500
Indianapolis	162, 180	47, 605	1, 464	2, 219	2, 145	2, 002	2, 025	9, 855	189, 421	2, 500
Kansas City	101, 195	53, 349	2, 147	3, 065	2, 383	2, 631	2, 592	12, 818	219, 640	2, 000
Los Angeles	403, 638	181, 422	8, 395	9, 852	9, 612	9, 460	8, 465	45, 784	167, 362	2, 750
Louisville	51, 335	40, 263	1, 881	1, 747	2, 210	1, 817	1, 861	9, 516	630, 844	9, 000
Milwaukee	163, 193	58, 611	2, 682	3, 543	3, 674	3, 029	2, 671	15, 599	101, 114	2, 000
Minneapolis	84, 731	44, 882	2, 151	2, 380	2, 196	2, 152	2, 088	10, 967	237, 403	3, 000
									140, 580	2, 250

New Orleans.....	8, 622	45, 332	2, 260	2, 694	2, 433	2, 205	2, 188	11, 780	65, 734	2, 000
	1 27, 551								1 27, 551	
New York.....	517, 727	191, 888	8, 410	9, 822	9, 530	9, 306	9, 111	46, 179	755, 794	9, 000
Philadelphia.....	325, 651	118, 017	4, 797	6, 053	6, 048	5, 912	5, 523	28, 333	472, 001	5, 500
Pittsburgh.....	268, 104	90, 908	3, 353	4, 965	4, 932	4, 030	4, 330	21, 610	380, 622	4, 000
Portland.....	88, 932	50, 176	2, 101	2, 590	2, 514	2, 506	2, 325	12, 036	151, 144	2, 500
	1 7, 293								1 7, 293	
Rochester.....	178, 465	46, 186	1, 028	1, 756	1, 799	1, 714	1, 442	7, 739	232, 390	1, 500
San Antonio.....	1, 223	31, 640	1, 817	2, 120	1, 871	2, 209	1, 926	9, 943	42, 806	1, 500
	1 22, 879								1 22, 879	
San Diego.....	24, 325	38, 537	1, 236	1, 364	1, 403	1, 756	1, 698	7, 457	70, 319	2, 000
San Francisco.....	226, 453	81, 206	3, 638	4, 222	4, 550	4, 123	3, 615	20, 148	327, 807	4, 250
Oakland.....	54, 371	30, 743	1, 431	1, 364	1, 867	2, 041	2, 165	8, 868	93, 982	1, 750
Schenectady.....	70, 150	36, 886	1, 560	2, 220	2, 101	1, 886	1, 538	9, 305	116, 341	1, 500
St. Louis.....	219, 054	67, 061	2, 747	3, 742	4, 426	3, 785	3, 424	18, 124	304, 239	3, 500
St. Paul.....	61, 539	35, 182	1, 637	1, 939	1, 939	1, 927	1, 859	9, 301	106, 022	1, 750
Washington.....	148, 838	71, 598	3, 007	4, 006	3, 750	3, 466	3, 173	17, 402	237, 838	3, 500
	1 49, 830	1 9, 163	1 473	1 766	1 751	1 730	1 682	1 3, 402	1 62, 395	1 500
Total bleedings.....	5, 652, 351	2, 322, 335	95, 875	123, 284	121, 384	114, 152	106, 967	561, 662	8, 536, 348	110, 500
Liquid plasma.....	179, 554	44, 150	1, 960	2, 379	2, 532	2, 370	2, 355	11, 596	235, 300	2, 250
Dried plasma and serum albumin.....	5, 472, 797	2, 278, 185	93, 915	120, 905	118, 852	111, 782	104, 612	550, 066	8, 301, 048	108, 250

1 Liquid plasma

The first request for blood for plasma by the Army and the Navy, in February 1941, was for 15,000 pints. In May 1941, when the completion of the first quota had convinced all concerned of the feasibility of the project, an additional 209,000 pints were requested. In December 1941, after Pearl Harbor, another 165,000 pints were requested for the current fiscal year. On 1 January 1943, the request for that calendar year was set at 4 million pints, and the request for the calendar year of 1944 was set at 5 million pints.

The impact of the attack on Pearl Harbor and of the declaration of war against Japan on the emotions and reactions of the U.S. public was reflected in the Blood Donor Service. In November 1941, blood donations had been about 1,200 per week. In December, the weekly donations rose to 4,600. By the end of April, they exceeded 50,000. By September 1943, they had reached 100,000 and they were maintained at or above this weekly level during most of 1944. The largest weekly procurement, 123,284, was for the week ending on 10 June 1945, the amount collected, as already mentioned, being the reflection of the D-day landings on the Normandy beaches. After 21 October 1944, the weekly averages progressively declined, as centers that were no longer needed were closed, and only about 2,000 donations per week were being collected when the project was concluded on 15 September 1945. At the peak of the program, the 6-month period between January and July 1944, total donations averaged 110,923 pints a week. Based on the 48-hour working week then generally in effect, this was approximately 1 pint every 2 seconds.

Distribution.—Of the more than 13 million pints of blood collected by the Red Cross during World War II, 10,299,470 pints were processed into dried plasma. More than 3 million 250-cc. packages were put up, and more than 2.3 million 500-cc. packages. About 310,135 pints of blood were used in military hospitals in the Zone of Interior, as either liquid plasma or whole blood.

The largest amount of O blood, 14,928 pints, procured in any single week for shipment overseas was collected between 19 and 24 March, during the battle on Iwo Jima. This amount, a daily average of 2,497 pints, was over and above the amounts collected for plasma and serum albumin. In all, 387,462 pints of group O blood were flown overseas, 205,907 to Europe by the Army Air Transport Command, and 181,555 to the Pacific by the Naval Air Transport Service.

Costs.—The total cost of the Blood Donor Service to the American Red Cross was approximately \$15,870,000, about \$1.19 per pint of blood collected. Of this amount, about 19 cents was paid from local chapter funds and the remainder by the National Headquarters.

In the original program, the total cost of the operation was borne by the Red Cross. When the project expanded, the costs rose so sharply that, as of 1 September 1942, the Army and the Navy assumed the costs of servicing the collecting equipment, which were added to the expense of processing the blood. As of 1 August 1943, the cost of transporting the blood to the processing laboratories was also assumed by the Government. The cost of servicing the equipment averaged about 60 cents per set, and the cost of transporting each

bottle of blood in a refrigerated container was about 15 cents. When blood typing was discontinued on 1 November 1942 (p. 241), for reasons other than expense, the cost fell about 7 cents per donation, for a total of about a half million dollars.

All funds expended by the Red Cross were contributed by the American people. They were carefully supervised and profitably expended, and it is not possible to estimate what they purchased in terms of human lives saved.

THE END RESULT

The Red Cross Blood Donor Service was translated, almost overnight, from a limited peacetime activity to a major national contribution to the military effort. It was enormously successful because of the fine organization of the program; the hard work of those who operated it; the hundreds of thousands of hours contributed by volunteer workers; and, most of all, the voluntary donation of millions of pints of blood by hundreds of thousands of patriotic American citizens, whose gift of themselves saved untold thousands of lives of wounded American troops.

References

1. Robinson, G. C.: American Red Cross Blood Donor Service During World War II. Its Organization and Operation. Washington: The American Red Cross, 1 July 1946.
2. Phalen, J. A.: The Blood Plasma Program. Division of Medical Sciences, National Research Council. Washington: Office of Medical Information, 1944.
3. Minutes, meeting of Committee on Transfusions, Division of Medical Sciences, NRC, 31 May 1940.
4. Minutes, meeting of Subcommittee on Blood Substitutes, Division of Medical Sciences, NRC, 30 Nov. 1940.
5. Minutes, meeting of Subcommittee on Blood Procurement, Division of Medical Sciences, NRC, 18 Aug. 1941.
6. Methods and Technique of Blood Procurement as Prescribed by the National Research Council for Use in the Red Cross Blood Procurement Centers (ARC 784). Washington: American Red Cross, September 1941.
7. Methods and Technique Used in Red Cross Blood Donor Centers (ARC 784, rev.). Washington: American Red Cross, January 1943.
8. Minutes, meeting of Subcommittee on Blood Substitutes, Division of Medical Sciences, NRC, 12 May 1942.
9. Robinson, G. C.: Blood Donor Service. 18 Dec. 1942.
10. The Organization and Operation of the American Red Cross Blood Donor Service (ARC 1217, rev.). Washington: The American Red Cross, December 1942.
11. Voorhees, Col. T. S., JAGD: Proposed Program as Evolved in Discussion Between Dr. Taylor of the American Red Cross and Captain Schwartz and Colonel Voorhees on 12 Jan. 1943, to Make Possible Increase to Approximately 80,000 per Week in Blood Donations, 15 Jan. 1943.
12. Minutes, Blood Procurement Conference, Division of Medical Sciences, NRC, 14 Feb. 1942.
13. Minutes, meeting of Subcommittee on Blood Substitutes, Division of Medical Sciences, NRC, 23 June 1942.
14. Minutes, meeting of Subcommittee on Blood Substitutes, Division of Medical Sciences, NRC, 17 Nov. 1943.
15. Minutes, Conference on Blood Preservation, Division of Medical Sciences, NRC, 19 Jan. 1945.

CHAPTER VI

Blood Donors and the Technique of Collection of Blood¹

REQUIREMENTS FOR BLOOD DONORS

When the Red Cross Blood Donor Service was inaugurated in 1941, there were two problems concerning donors to be considered. The first was their recruitment (p. 119). The second was their selection. The second problem had two parts, (1) the collection of useful and usable blood, and (2) the protection of the donors from any mischances and sequelae of their donations. In general, the rules which were adopted by the Subcommittee on Blood Procurement, NRC (National Research Council), at the 18 August 1941 (2) meeting remained the basic rules throughout the program, though certain variants were introduced as experience was accumulated.

Initial Specifications

Initial requirements for blood donors were as follows:

1. Donors should be between 21 and 60 years of age.
2. Donations should be accepted from both males and females and from members of all races.
3. No donor should be accepted from whom a donation of 500 cc. could not be expected.
4. The temperature by mouth should not exceed 99.5° F. (39.5° C.).
5. The blood pressure should not exceed 180/100 mm. Hg.
6. The hemoglobin should be 80 percent or more.
7. The pulse should be recorded and note made of bradycardia and any irregularity. In practice, donors with any irregularities were rejected except that no attention was paid to an occasional dropped beat.
8. Women who were pregnant or who had delivered or miscarried within the preceding 9 months were not accepted.

Diabetics were accepted only on the written permission of their personal physicians.

Donors were also asked when they had last given blood and were questioned concerning possible diseases, which are discussed under a separate heading (p. 141).

¹ Unless otherwise indicated, all data in this chapter are from Dr. G. Canby Robinson's final report of the Red Cross Blood Donor Service in July 1946 (1).

Later Specifications

As time passed, the following alterations were made in the original specifications for donors:

1. The age was lowered to 18, with the proviso that donors in this age group must present signed permission from their parents or guardians.
2. Donors whose temperature was above 98.4° F. (37° C.) were not accepted.
3. Donors with blood pressures up to 200/100 mm. Hg were accepted.
4. A hemoglobin level of 12.3 gm. percent was required, the determination to be made by a really precise method (p. 160).
5. Both male and female donors must weigh at least 110 pounds.
6. Donors were instructed not to eat within 4 hours before the donation, and in the interim to drink no milk. Originally, the requirement was that no fatty foods must be eaten within a 4-hour period, since at the end of this time, the fat concentration in the blood would be reaching its highest level.
7. The following groups of donors were also not accepted:
 - a. Those who had had tooth extractions within 24 hours.
 - b. Those who must return to work with heavy machinery within 8 hours.
 - c. Those who had been treated for rabies within the previous 5 years.
 - d. Those who were extremely sensitive to horse serum and similar substances, for fear of passive transfer of sensitivity to the recipient, which would later prevent the effective use of sera for tetanus, gas gangrene, and other conditions. Many observers thought that this risk could be ignored because of the large pools of plasma being used.
 - e. Military and commercial fliers, including crews as well as pilots.

The understanding was that donors who had been receiving sulfonamides should be evaluated individually. This regulation was honored more in the breach than in the observance. At the 2 June 1944 meeting of the Subcommittee on Blood Substitutes (3), an instance was reported of transfer of sulfathiazole sensitivity from a donor to a recipient who was receiving the drug. Although it was thought that such instances might become more frequent, there were no other reports of the kind.

Even after all the prescribed regulations and restrictions for donors had been met, there were still some questionable cases. In these, the decision for acceptance or rejection was made on an individual basis, by the physician in charge of the center. It was the rule, if any doubt existed after the evaluation, to reject the donor.

Release

Every donor was required to sign a release (fig. 27) stating that he or she was voluntarily furnishing blood through the American Red Cross to the Army and the Navy, and that he or she agreed that neither the Red Cross nor anyone connected with the Blood Donor Service would be held responsible for any event that might follow the donation.

The number of registered donors whose donations were rejected was reported each month by each center to the Technical Director of the program. Of 14,695,836 persons registered, 1,514,085 (10.3 percent) were rejected,

chiefly for low hemoglobin levels (p. 158) or high blood pressure. The breakdown was as follows:

- 5,026 of 932,927 first-time male donors (0.5 percent).
- 13,859 of 1,781,481 male re-donors (0.75 percent).
- 105,432 of 1,043,833 first-time female donors (10 percent).
- 241,694 of 1,849,860 female re-donors (13 percent).

RELEASE

I am voluntarily furnishing blood through the American Red Cross to be used by the Army and Navy of the United States or for civilian protection and for that purpose I am at my own risk submitting to the tests, examinations, and procedures customary in connection with donations of blood. I agree that neither The American National Red Cross nor any surgeons, physicians, technicians, nurses, agents or officers connected with any of them, or who may be participating otherwise in this work, shall be in any way responsible for any consequences to me resulting from the giving of such blood or from any of the tests, examinations or procedures incident thereto, and I hereby release and discharge each and all of them from all claims and demands whatsoever which I, my heirs, executors, administrators or assigns have or may have against them or any of them by reason of any matter relative or incident to such donation of blood, and I agree that the above-mentioned organization may use in any way that they may deem advisable any balance or residue of the blood, and any by-products therefrom.

IN WITNESS WHEREOF I have hereunto set my hand and seal this

day of 194

In the presence of (L. S.)

.....

FIGURE 27.—Release signed by donors before they gave blood at American Red Cross blood donor centers.

DONORS WITH SPECIAL DISEASES

History-Taking

The problem of disease in volunteer blood donors had two aspects, (1) the protection of the donor and (2) the protection of the recipient from transmissible diseases or diseases thought to be transmissible. At the outbreak of the war and the beginning of the blood program, very little specific information was available as to the transmissibility of diseases if blood were drawn during an illness or shortly thereafter. As a precaution, however, donors were not accepted if they had had, or were recently convalescent from, any infectious disease or any other disease of known or unknown etiology.

Regulations provided that blood donors should be questioned by the registered nurse or the physician in charge of the center concerning their previous history of disease and any current symptoms. On the whole, these regulations were honored, though it must be admitted that their observance depended not only upon the care (or carelessness) of center personnel but also upon the workload. On D-day, for instance, when the centers were crowded with unscheduled as well as scheduled donors, questioning must have been superficial if it was carried out at all.

The regulations, however, provided for questioning the would-be donor on the following matters (4):

1. Any illness within the past month. Particular note was taken of the presence, or expected development, of upper respiratory infections. The physician in charge was asked to rule in questionable cases.

2. Sinusitis and hay fever. Donors were acceptable if they were not having acute attacks and were otherwise in good health.

3. Septic sore throat within the past 3 months. The physician in charge made the decision.

4. Undulant fever or clinical tuberculosis within the past 5 years. Either disqualified the donor. If he had had extrapulmonary tuberculosis, the physician in charge made the decision.

5. Cardiovascular disease, as evidenced by shortness of breath, swelling of the feet, a persistent cough, or pain in the chest. A history of cardiovascular disease, or the existence of any of these symptoms and signs, disqualified the donor.

6. Jaundice within the past 6 months. Donors with such a history were immediately disqualified. If there was a family history of jaundice, the physician in charge made the decision on the basis of the closeness of contact and the nature of the jaundice. It should be remembered that serum hepatitis did not become a problem until the last year of the blood program (p. 674).

7. Fainting spells and convulsions. The physician in charge made the decision. Such donors were practically always rejected.

8. Rabies. Volunteers who had had treatment for this condition within the past 5 years were rejected.

9. Virus infections such as dengue, yellow fever, atypical pneumonia, and virus exanthemata. These volunteers, who were usually evaluated individually, were not accepted until 6 months had elapsed.

On the basis of a review of the literature, which contained reports of several cases in which leukemic blood had been transfused, it was decided that this disease was not transmissible by this route (5). On the contrary, there were some reports of the treatment of agranulocytosis by leukemic blood. There was also some evidence that sodium citrate was somewhat toxic for the cells of mice with leukemia.

The risk of serum hepatitis from transfused plasma, unsuspected until late in the war, proved the greatest risk of all (p. 674). Early in the war, the chief concern was with syphilis and malaria.

Syphilis

The "Minimum Requirements for Unfiltered Normal Human Plasma," issued by the National Institute of Health on 20 February 1941 (p. 279), specified that an acceptable serologic test for syphilis must be made in a qualified laboratory on a specimen of blood taken at the time of bleeding and that the blood should not be used for the production of normal human plasma unless the result of the test was negative.

At the meeting of the Subcommittee on Blood Substitutes on 13 July 1944, the subject was discussed extensively, and it was agreed that the evidence

showed that the chance of transmitting syphilis by transfusion was very remote. The life of the spirochete had been demonstrated in laboratory studies with infected testicular tissue to be less than 92 hours in stored blood, and its survival would probably be shorter in organisms occurring naturally in the bloodstream.

The following recommendations were therefore adopted:

1. A serologic test for syphilis should be required on each blood intended for processing into plasma, the test to be performed by a method approved by the Venereal Disease Division of the U.S. Public Health Service.

2. In addition, the Kline exclusion test or the Kahn presumptive test should be performed on bloods to be used in suspensions of red blood cells.

3. Resuspended red blood cells would be acceptable for use only if they were derived from serologically negative blood.

4. Blood cells to be used for resuspension and transfusion should be held for 72 hours at 79° F. (4° C.) before reinfusion, in conformity with existing Red Cross regulations.

Malaria

Malarious donors in the Zone of Interior never furnished the problem that they did in certain oversea theaters (pp. 423 and 597), but they could not be ignored, one reason being that there were then no criteria for the complete cure of malaria (5). It was known that the parasites did not survive either freezing or drying, and that frozen or dried plasma processed from the blood of malarious donors therefore would not transmit the disease.

The matter first came up at the meeting of the Subcommittee on Blood Substitutes on 10 March 1942 (6). A number of lines of investigation were suggested, and the Army and the Navy were advised, for the present, to use caution in processing liquid plasma in malarious districts.

At the 12 May 1942 meeting of the subcommittee (7), the opinion was expressed that the fear of transmission of malaria through plasma had perhaps been overemphasized. Studies on fowl malaria at the Naval Medical School had indicated that this variety of *Plasmodium* does not survive in dried plasma. Recent observations in Puerto Rico had included a patient who received 10 cc. of unfiltered plasma obtained from a malarious donor and who had clinical signs of malaria and positive smears 25 days after inoculation. Subjects who received the same inocula passed through a Seitz filter did not develop the disease. The plasma used in these experiments was aspirated from citrated blood that had been refrigerated for 48 hours.

A letter from Dr. Lowell R. Coggeshall read at the 23 June 1942 meeting of the Subcommittee on Blood Substitutes (8) expressed his own opinion that lyophilized plasma infected with malarial parasites was not dangerous and that there would probably be no infections from the transfusion of liquid plasma over 10 days old if all the red blood cells had been removed. Conclusive laboratory proof of these opinions would be long in forthcoming, but it had already been established that plasma infected with *Plasmodium knowlesi* was not infective for Rhesus monkeys, even when fresh, if all the red cells

had been removed. A report from the Malaria Conference stated its official opinion that there was a real hazard from the transfusion of infected plasma, though it was probably safe to use it if all the red cells had been removed by centrifugation.

At the subcommittee meeting on 20 October 1942 (9, 10), Cdr. Lloyd R. Newhouser, MC, USN, reported experiments carried out with Lt. Cdr. Eugene L. Lozner, MC, USN, on 18 patients, none of whom developed malaria after transfusions of 500 cc. of dried plasma infected with different species, with parasite counts of 150,000 per cc. A preliminary report from Dr. Mark C. Boyd, of the Rockefeller Foundation, concerned the intravenous injection of 35 cc. of reliquefied lyophilized plasma prepared from blood with a high density of parasites secured from patients with *Falciparum* malaria. None of the subjects in a completed experiment had developed malaria, and a second experiment was sufficiently far advanced to indicate that the results would be similar.

The question of the transmission of malaria by transfusion came up again at the 13 July 1944 meeting of the Subcommittee on Blood Substitutes (5), in connection with the blood donor regulations of the New York City Department of Health, already discussed in connection with the possible transmission of syphilis by red blood cell suspensions. It was generally doubted that a physical examination, with reliance upon an enlarged spleen, would identify malarious donors; the Army experience had showed the absence of this finding in many hundreds of men with malaria. The Board for the Coordination of Malarial Studies considered the search for a palpable spleen "a futile gesture."

At this meeting, Commander Lozner reported studies that showed that when only 5-10 cc. of infected blood had been injected after 8 days' storage, infection had followed. If it could be calculated that the parasites died at a rate plotted on a logarithmic curve, then they would probably survive in larger quantities of blood for 2-3 weeks. Transmission of malaria had been reported from donors who had been clinically cured for 15 years.

Dr. Robinson pointed out that the regulation that a donor should be rejected who had had clinical manifestations of malaria within the past 15 years had been made for the protection of the donor from activation of the infection rather than for the protection of the recipient.²

At the end of this discussion, it was recommended that a particularly accurate history on possible malarial infection be obtained from all donors whose blood was intended for preparation of red blood cell suspensions. Any donor with a history even remotely suggesting the possibility of malarial infection, however far in the past, should not be accepted. Donors should be asked not only whether they had had malaria but whether they had been in areas in which the disease was known to be endemic.

² At Grady Hospital, Atlanta, Ga., it was not uncommon for patients who had incurred trauma, sustained hemorrhage, or been given inhalation anesthesia to have temperature charts suggestive of tertian or quartan malaria. Blood smears were done routinely on these patients and frequently revealed the plasmodial parasite.

ROUTINE OF DONATION

In a program of such magnitude as the Red Cross Blood Donor Service, an assembly line type of production had to be developed (11). This was necessary not only because of the large quantities of blood handled but also because, when as fragile a biologic product as blood was being dealt with, standardization of the operation was essential. It was also necessary for the protection of the vast army of donors that all equipment and all technical details of collections be standardized.

Bleeding was carried out by teams, each of which consisted of a physician, four nurses, a secretary, and one or two shipping clerks. The basis of operation was a unit consisting of two beds and a worktable under the supervision of one nurse. A trained team could easily handle 100 donors in 4-5 hours. The fewer the people who did the bleeding, the less the chances of contamination.

No single person was a more essential part of the team than the secretary. The handling of records had been planned to require as little transcription as possible, but all subsequent handling of the blood depended upon the accuracy of the serial numbering of the medical record, bleeding bottle, and serologic tube. The medicolegal importance of accuracy in this respect needs no elaboration.

The routine of a donation was as follows:

1. The prospective individual donor phoned for an appointment, or, less often, came directly to the donor center. If time and space were available, he was taken at once; otherwise, he was given the earliest possible appointment.

2. Entry to the center was through a reception room, with an adjoining cloakroom. The donor then passed on to a second room, in which his appointment was checked, and his name and address were entered on a daily booking sheet (fig. 28). A standard, serially numbered registration card (fig. 29) was prepared for him. It contained the questions each donor was asked, space for the replies and for entering other data, and the release which he was later asked to sign (fig. 27).

3. In the succeeding room, the blood pressure, temperature, and pulse were taken and recorded. A hemoglobin determination was made (fig. 30). The registered nurse who had carried out these procedures also asked the necessary questions and recorded the replies. These proceedings were conducted at separate tables, so that complete privacy was assured. When they were completed, the donor signed the release. Later, all data connected with the donation (and subsequent donations) were filed under the donor's name (fig. 31).

4. Bleeding was originally conducted in separate cubicles in the belief that the sight of other donors would be harmful. It was soon found that a common bleeding room (fig. 32), where the donors were in full view of each other, was good psychology and also efficient, in that the physician in charge could keep close check on all donors while bleeding was in progress. As many as 36 bleeding tables or cots were set up in a single room, with a small work stand between each pair.

5. When the original regulations were drawn up (2), it was specified that the donor lie recumbent for at least 10 minutes after the blood was drawn. If there was any sort of reaction, the period of recumbency was prolonged or he was moved to a separate room, in which he was under the supervision of the physician in charge, a nurse, or a nurse's aide, as his condition indicated.



FIGURE 28. Reception and registration rooms at American Red Cross blood donor centers. A. Louisville, Ky. B. San Antonio, Tex. C. San Francisco, Calif.



FIGURE 28.—Continued. D. St. Louis, Mo. E. Fort Worth, Tex. F. Unidentified center (photograph, courtesy American Red Cross).

AMERICAN RED CROSS Blood Donor Registration Card				7-104 Rev. Feb. 1944
Mr. Miss Name Mrs.	Serial No.	Date		
Street	Full Name	Date		
Address	Street	City	State	
Telephone No.	Date of Birth	Number of donations		
When did you last donate blood?	Temperature		Pulse	Hemoglobin
				% Blood pressure
Any chronic or serious illness?	Any form of heart trouble?		Refused	
Illness in the last month?	Shortness of breath?		Unsuccessful bleeding	
Malaria?	Swelling of the feet?		Serology only	
Clinical pulmonary tuberculosis?	Undulant fever within 5 years?		Reaction	
A persistent cough?	Fainting spells?			
Pain in the chest?	Convulsions?			
Diabetes?	Jaundice within 6 months?			
Remarks	Pregnant or postpartum 5 months?			
Nurse	Doctor			

(Date)	(Serial No.)
HUMAN CITRATE BLEEDING AMERICAN RED CROSS	
DONOR CENTER	
(Donor's Name)	
(Date)	(Serial No.)
HUMAN BLEEDING REPORT AMERICAN RED CROSS	
DONOR CENTER	
(Donor's Name)	
(Method)	(Date)
(Results)	
I certify that the above named donor appears to be free of disease transmissible by blood and immune for the date which is also the day of receiving the blood from said donor.	
(Emergency Physician)	

FIGURE 29.—Card used by American Red Cross for registration and history of blood donors.

6. After the rest period, the donor was taken to the canteen, operated by the Red Cross Canteen Corps, and, seated at a small table, was given milk, a soft drink, crackers, or other light refreshment (figs. 33 and 34). Whisky was not given.

7. When the donor was ready to leave the center, he was presented with a certificate and emblem (p. 128) attesting the donation, and was also given the opportunity to make an appointment for another donation at the end of 8 weeks.

The reception and treatment of donors at the centers were an important part of the Blood Donor Service. All personnel recognized the importance of treating them courteously in every phase of the procedure. They were welcomed cordially but not effusively. If a volunteer had to be rejected, the reason for the rejection was made clear by careful explanation by the physician or nurse, and, if it seemed practical, the suggestion was made that he reapply at a later date.

The spirit of comradeship among the donors in the centers was notable, although they represented every social, economic, and educational background. The sights and sounds in the canteen after donations suggested groups of old friends rather than persons who shortly before had been complete strangers to each other. The donation of blood without doubt raised the spirits of the donor who had made it, and the donors themselves repeatedly expressed this feeling.

TECHNIQUE OF COLLECTION OF BLOOD

General Considerations

The basic requirement that blood be collected under conditions of absolute asepsis was met by the use of a closed system (4, 12). Standard equipment was used (p. 151). It was decided that gloves, gowns, masks, and caps need



FIGURE 30 —Determination of donor's hemoglobin and blood pressure, American Red Cross Blood Donor Center, San Antonio, Tex.

not be used, and that sheets and towels need not be sterilized (2). Everything used in the bleeding set, however, was sterilized in an autoclave at 250° F. (121° C.) for 30 minutes. In addition to the equipment prepared daily at each center for the next day's quota, a constant supply of equipment had to be sent to the centers from the processing laboratories, where needles were sharpened, rubber tubing was cleaned, and other procedures were carried out.

The greatest care was exercised in all details of the procedure. A sterile needle was used for each donor, dispensed from an individual test tube or other container from which it could be removed without risk of contamination from air or from the hands of the operator. The Novocain (procaine hydrochloride) for each day's use was dispensed at the beginning of the day, by one nurse, under as nearly aseptic conditions as possible. Diaphragm-stoppered bottles, which permitted multiple withdrawals, were not used.

Details of Technique

Bleeding was usually carried out by a graduate nurse, under supervision of the physician or medical officer in charge. Any problems which arose during the procedure were referred by the nurse to him.



FIGURE 31.--Fileroom, American Red Cross Blood Donor Center, San Antonio, Tex.

The following technique was employed (fig. 35):

1. With the donor recumbent on a padded table or bed, the arm was bared, and the most suitable site for venipuncture selected. Usually, this was the anterior aspect of the upper forearm.

2. A blood pressure cuff, folded to half its width, was applied to the arm, to serve as a tourniquet. Except during the flow of blood into the bottle, the tourniquet was not released unless a clamp was applied to seal off the inlet tubing completely. Before the vein was entered, the pressure in the cuff was raised to 40-60 mm. Hg.

3. The selected site was scrubbed mechanically over an area 4 by 4 inches with 50-percent solution of green soap followed by the application of alcohol (70 percent by weight). Iodine (2-percent aqueous solution U.S.P.) was applied, allowed to dry, and then removed with a sponge wet with alcohol. If, for any reason, bleeding had to be delayed, the field was covered with a gauze square soaked in alcohol.

4. Venipuncture was performed without touching the prepared area of the forearm. If introduction of the needle was difficult, it was permissible to palpate the site above and below the puncture after the needle was in situ. If the needle had to be withdrawn after it had penetrated the skin, a fresh bleeding set was used for the second attempt. Not more than two attempts to enter a vein were permitted.



FIGURE 32.— Collection of blood at various American Red Cross blood donor centers. A. San Diego, Calif. B. Fort Worth, Tex. (showing the last blood donation before the center was closed on 13 October 1944). C. Unidentified center (photograph, courtesy American Red Cross).

5. The actual bleeding occupied about 5 minutes. Every effort was made to collect 500 cc., and no bleeding was counted as such unless the bottle was filled to the 300-cc. level. If suction was necessary, as it occasionally was, a hand pump was used. The bottle was not rotated during the collection of the blood.

6. After the needle was withdrawn, the arm was either kept extended or was elevated; it was never flexed. Pressure was maintained over the venipuncture with a gauze square held in place by the nurse or, more often, by the donor himself. Then a small piece of gauze, held in place by adhesive, was placed over the puncture.

7. While the bleeding was in progress, the bleeding bottle was tagged, as was the serologic tube, with the donor's name and serial number, and the name on each receptacle was checked with the donor. A double card was used for the bleeding bottle.

8. The serology sample was taken at the end of the bleeding. The tube was kept below the level of the bottle, to prevent blood from running back into the bottle, while it was collected.

9. A spring clamp was placed on both steel inserts and both tubes in the stopper of the bleeding bottle (fig. 36), so bent as to constrict the rubber tubes at the bases of the inserts. An eighth of an inch of tubing extended above the edges of the steel inserts, so that there was no danger of their cutting through it. Both inlet tube and airway tube were cut flush with the edge of the stopper.

10. A careful check was made, to be certain that there were no air leaks about the hub of the needle or at the point at which the tubing was connected with the steel tubes. If any leaks were found, or if there was any break in technique in the course of the bleeding, the bleeding tag was marked "P.C.," to indicate potential contamination.



FIGURE 33.—Canteens, American Red Cross blood donor centers. A. Los Angeles, Calif. B. Clifton, Tex. (mobile setup). C and D. Fort Worth, Tex. E. San Francisco, Calif. F. St. Paul, Minn.

Postbleeding Disposition of Blood

The bottles of blood were moved at frequent intervals from the bleeding room to large refrigerators, the temperature of which was strictly controlled. At the end of the day, all the donations were packed in refrigerator chests (p. 204) by trained blood custodians (fig. 37) and dispatched, by railway express or truck, to a processing laboratory. A daily shipping list, including each donor's name and serial number, was made in triplicate and accompanied each ship-



FIGURE 34.—Kitchen attached to canteen, American Red Cross Blood Donor Center, Fort Worth, Tex.

ment. Processing, beginning with serologic testing, started the following morning. The blood was moved on prearranged express schedules, so that each lot reached the laboratory within 24 hours after it was collected.

REACTIONS TO DONATIONS

The efficiency of the selection of donors by the regulations outlined is evidenced in the very few fatalities, and the few really serious accidents, which occurred in the course of the program. The accident rate in donor centers, in fact, was far below the accepted accident rate for the population as a whole (11). It was concluded at the end of the war, taking into consideration the millions of people involved, that the donation of a pint of blood was harmless and that among the same group of people, engaged in such presumably innocuous occupations as taking baths, using electrical appliances, or going up or down stairs, the percentage of accidents over the same period was probably much greater.

In April 1943, a member company inquired of the Medical Committee of the Industrial Hygiene Foundation whether the giving of blood affected production and caused absenteeism. It was the unanimous opinion of the committee that there were no undesirable effects at all (13).



FIGURE 35.—Steps in collection of blood at American Red Cross blood donor centers. A. Application of blood pressure cuff as tourniquet. The donor giving blood (at El Toro, Calif.) is twice-wounded Marine Air Corps Ace, Capt. Don Aldrich, who shot down 20 Japanese planes in the Pacific. B, C. Venipuncture. D. Application of gauze to site of puncture and elevation of arm after blood has been collected. (Photographs A and B, courtesy American Red Cross.)

A sample experience was cited to prove the statement: One company, after an intensive drive among office and shop employees had produced 3,348 donations during the visit of a mobile bleeding unit, did not find a single absence from illness immediately afterward that could be attributed to the donation. One reason, of course, was that the careful predonation check had eliminated the donors likely to be adversely affected. The blood was always drawn after the worker went on the shift, never before. Office workers generally returned to work directly, but shop workers waited for 2 hours.

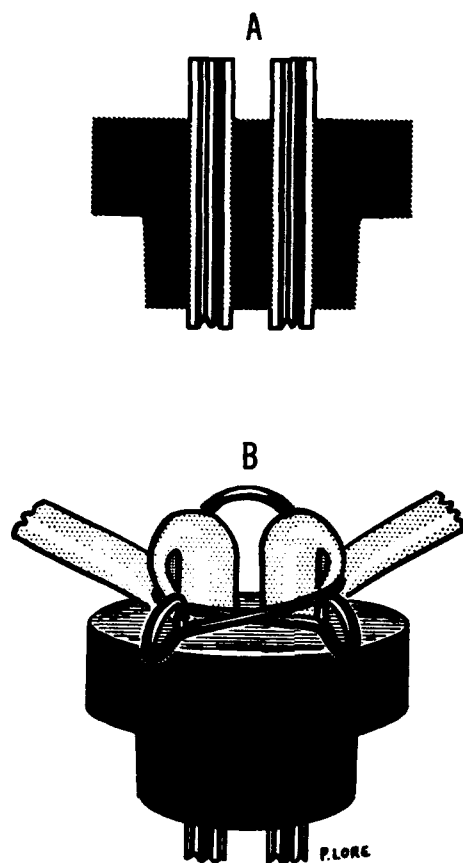

FIGURE 36.—Application of clamp to Red Cross donor bottle when collection of blood is complete. A. Airway and bleeding tube. B. Bottle tubes clamped off.

Other companies also reported that they found no absences attributable to the donations, no increased incidence of colds or other upper respiratory infections, and no increase in fatigue. Many reported, on the contrary, that the donation seemed to have provided a stimulus to greater effort and improved morale.

Incidence of Reactions

In order to obtain information directly from the donors concerning the effects of donation, 10,000 postcards were distributed to consecutive donors at each of four centers, with the request that they be filled in and returned within the week. Replies were received from 27,021 donors (68.2 percent), the number probably including most, though not all, of those who had experienced any effects.

Of the 27,021 donors who replied, 81.6 percent had no complaints. Those with complaints usually had more than one. In all, 8.9 percent reported some general ill effects and 10.1 percent had some trouble in the arm from which the



FIGURE 37. Shipping room at unidentified American Red Cross blood donor center.

blood was withdrawn, but only 4.1 percent reported limitation of activity within the week after the donation (the figures are overlapping). The percentage of upper respiratory infections, less than 1 percent, was lower than the general incidence of such infections during the period covered by the survey. A good proportion of those who complained of some lassitude and weakness in the 48 hours after the donation were sedentary indoor workers or housewives. The Blood Donor Service was unaware of specific instances of absenteeism, but there is no doubt that occasional persons took advantage of their donations to remain away from work.

Types of Reactions

Accidents and reactions among donors were analyzed by Dr. (late Major, MC) Earl S. Taylor (*11*) in a presentation to the American Medical Association at its annual meeting in June 1942, by which time 286,197 bleedings had been carried out, with 10,348 reactions (3.5 percent). Later, with Dr. Mary Heiss Boynton, Major Taylor (*12*) analyzed the reactions which had occurred in the more than 7 million donors who had given blood up to 1 April 1944. The significant data of both analyses were as follows:

Fatalities. Several fatal illnesses had their inception immediately after donations, the most important being in the group of donors with cardiac or

other circulatory conditions. In all, there were 10 fatal cardiovascular accidents within 3 to 48 hours after the donors had left the centers, in addition to 1 fatality in a center, caused by a sudden coronary arterial occlusion. The giving of blood was thought to have had little or nothing to do with these deaths.

There were also eight instances of angina pectoris, coronary thrombosis, or cerebral hemorrhage during, or within 2 hours after, the donations; all were followed by recovery.

Fainting.—In both the 1941 and 1944 surveys, the most disturbing reaction was impending faintness, actual faintness, or occasionally, a deeper loss of consciousness. Compilation of reports from all bleeding centers at the end of the war gave the number of donors who "fainted or stayed longer than usual" after the donation as 490,000 out of more than 13 million donors (3.7 percent). About half of this group showed definite syncope, though the loss of consciousness was only momentary. A small number presented not only loss of consciousness but generalized convulsions, incontinence, cyanosis, and, occasionally, very striking tetany with carpopedal spasm. All responded rapidly to symptomatic treatment.

All centers were equipped to treat such conditions, and all mobile units carried with them equipment for intravenous administration of saline solution, as well as sedative and other drugs.

The most likely subject for syncope was a young adult weighing between 100 and 110 pounds (later, 110 pounds was the lower limit for a donor). If he was also hypotensive, he was almost certain to have some reaction. Another candidate for syncope was the donor who had worked a long shift at a factory, particularly in warm weather; in such cases, dehydration was also a factor.

Emotional and psychic influences played a major role in fainting. Some donors fainted before bleeding was begun or soon after it was started. In a few instances, the wife or the husband fainted while the spouse was being bled.

Weakness.—Few opportunities arose to pass judgment on donors who complained of limitation of activities because of weakness or lassitude for 7–10 days after the donation. When examinations could be made, no basis was found for the complaints, which seemed to be chiefly of emotional or psychogenic origin.

Lacerations and contusions.—A few lacerations, contusions, and fractures occurred in association with fainting, most often in subjects who had refused to rest after the donation.

Local reactions.—The most frequent local complication was extravasation of blood into the tissues at the point of venipuncture. The area was discolored, and was sometimes swollen and uncomfortable, for several days. There were a few instances of dermatitis about the venipuncture, but no record of iodine or other burns. There were also about 30 reported instances of local infection. It was reported that one donor had developed a staphylococcal septicemia after the donation, but since he recovered in 5 days, the diagnosis was considered highly unlikely.

Other complications.—Other complications than those just discussed were minor and infrequent. All rumored reports of profound anemia and prostration were traced to the sources and all were found to be groundless.

REGENERATION OF HEMOGLOBIN

Initial Studies

In June 1941, Dr. Taylor (15) reported an analysis he had received, in a personal communication from E. M. Katzen, of a carefully controlled study of 100 professional male donors of the Blood Transfusion Association, New York City. These 100 men had given 3,617 transfusions, averaging 525 cc. each, over periods ranging from 4 to 14 years and averaging 7 years. They had given from 16 to 101 times during the period of observation, an average of 36 times per donor. They were required to rest 1 week between transfusions for each 100 cc. of blood donated. They had hemoglobin determinations every month they gave blood and a routine checkup every 3 months if they had not donated in the interval.

None of these donors showed any significant failure to regenerate hemoglobin when they were studied at the end of their rest period, and over the years there had been little variation from their original hemoglobin values. This long-term study was taken to indicate that repeated blood donations at stated intervals had no deleterious effects on healthy donors.

At a meeting of the Subcommittee on Blood Substitutes on 23 June 1942 (8), Dr. Taylor pointed out that the immense number of donors recruited by the Red Cross Blood Donor Service offered opportunities for investigation, particularly studies of hemoglobin regeneration, which should not be neglected. At the meeting of the subcommittee on 17 November 1943 (16), he reported the studies of Dr. Charles Doan, Ohio State University College of Medicine, on over 4,000 donors who had given blood from one to five times at the Red Cross donor center at Columbus, Ohio. When blood was given every 8 weeks, about 80 percent of the women donors showed prompt return to their original hemoglobin values. The remaining 20 percent did not, nor did their values return to the original levels even when the interval between donations was as long as 4 months. In view of these facts, it seemed to Dr. Taylor that a certain number of donors would either have to be rejected (and the Tallqvist technique, unfortunately, was difficult to read at the 80-percent level, then the critical level for rejection of donors) or would have to be given iron.

Dr. Doan's data confirmed the observations made by Fowler and Barer (17) at the State University of Iowa College of Medicine on 200 donors, who gave blood for 636 transfusions.

The idea of administering iron to donors was not well received by some of the committee members, who thought it a dangerous policy for Red Cross donor centers to practice medicine. Dr. A. M. Fisher, who was present as a representative of the Canadian National Research Council, said that donations in

Canada were now limited to five a year. Some Canadian donor centers prescribed iron but others thought it a poor policy to suggest to donors that they might not regenerate blood promptly.

The problem of posttransfusion anemia in women donors was discussed at a subsequent meeting of the Subcommittee on Blood Substitutes (18) and at the Blood Donor Conferences held in December 1943 and January 1944 (p 119). Captain Taylor reported at these meetings that several studies carried out by the Red Cross had showed that a certain percentage of female donors developed some anemia after blood donations, but he did not consider it justified to say that "medical authorities were becoming worried about possible resultant anemias." At the January 1944 conference, there was general agreement that the incidence of posttransfusion anemia was about 15 percent, but there was opposition to the administration of iron by physicians at the blood donor centers.

Recommendations of Ad Hoc Committee

An ad hoc committee (Dr. Elmer L. DeGowin, Chairman, Captain Taylor, Col. Douglas B. Kendrick, MC, Captain Newhouser, Dr. Max M. Strumia) appointed at the 5 January 1944 meeting of the Subcommittee on Blood Substitutes met on 19 January 1944, with Dr. Doan; Dr. Willis M. Fowler; Dr. Carl V. Moore, Washington University School of Medicine; and Dr. William Thalhimier. It was agreed:

1. That the Tallqvist test for hemoglobin was highly inaccurate and had not been effective in the selection of donors without anemia.
2. That many female donors who should not have given blood had been accepted on the basis of this test.
3. That the Red Cross, to prevent posttransfusion anemia, must devise other standards for the selection of donors. Changes in the technique of selection had been impractical up to this time, particularly in mobile bleeding units, because there had been no quick, accurate, and simple technique available to determine the hemoglobin level.

The ad hoc committee recommended:

1. That the recently devised Thalhimier modification of the copper sulfate technique of Phillips, Van Slyke et al. (p. 257) be used to determine the critical level of hemoglobin for the selection or rejection of donors. This test had the additional advantage of indicating hypoproteinemia; Dr. Doan's data suggested that some women tend to regenerate plasma proteins after transfusion even more slowly than they regenerate hemoglobin.
2. That over the next 6 weeks, Dr. Doan compare the accuracy of the prescribed method with that of the Evelyn colorimeter in the blood donor center at Columbus, Ohio. Final acceptance of the copper sulfate method should await his final report.
3. That arrangements be made to procure the solutions used in the copper sulfate test and to procure photoelectric colorimeters to use for occasional quantitative determinations of hemoglobin in multiple donors and for checking the accuracy of the copper sulfate technique.
4. That the minimum level of hemoglobin for acceptable donors of both sexes be tentatively placed at 11.5 gm. percent. By this criterion, if Dr. Doan's data were correct, about 25 percent of all females and about 20 percent of all males living in conditions similar to those in Ohio would be rejected. Final action on this point would be taken after receipt of further studies by Dr. Doan on multiple donors.

5. That Drs. Doan and Moore be permitted to prescribe iron at their discretion in the blood donor centers at Columbus and St. Louis. Dr. Doan wished to give iron only to re-donors who regenerated hemoglobin slowly. Dr. Moore wished to test its effect on the incidence of rejections of re-donors. Both physicians were asked to observe the effect of its prescription on relations of the centers with the local medical profession.

No action would be taken, until additional data were available, on the volume of blood to be collected from female donors; on the incidence of rejection of female donors in the age group 18-21 years; and on an increase of intervals between donations in women. At the urgent request of Captain Taylor, who thought it highly undesirable to question women on this point, no recommendations were made concerning donations during menstruation.

In further discussion of iron therapy, it was concluded that since medical practice varied in different localities, the local technical supervisor was in the best position to judge the repercussions of any given policy on the local medical profession and on the procurement of donors. There was general agreement that repeated bleedings undoubtedly produced iron-deficiency anemia in some women and that the Red Cross, because of its publicity concerning the safety of blood donations, was morally if not legally responsible for it.

Followup Actions

By 21 April 1944 (19), all blood donor centers had been supplied with materials for the Thalheimer-Phillips-Van Slyke copper sulfate test. The solutions were adjusted to a hemoglobin concentration of 12.3 gm. for all donors, since it had been found in over a thousand males tested that only 5 had hemoglobin levels below 13.5 gm. percent. With a minimum standard of 12.4 gm. percent, about 10 percent of prospective female donors had been rejected, the incidence being slightly higher at the Columbus Blood Donor Center than at others. The correlation between the Evelyn and the copper sulfate techniques was reported as good. The solutions were regularly checked for accuracy.

In view of these data, it was recommended that a single standard of hemoglobin, 12.3 gm. percent, be used as a minimum for donors of both sexes.

Statistics averaged for several centers for May 1944, covering a total of 12,545 prospective women donors, showed a rejection rate of 17 percent (3). The rate was 10 percent for 6,000 first-time donors, which was the expected figure arrived at on the basis of a large series of determinations by the photoelectric cell colorimeter. On their initial appearance, only 0.3 percent of male donors were found to have hemoglobin values below the minimum of 12.3 gm. percent. The male rejection rate on re-donation varied from 0.2 to 8 percent. The rejection rate in female donors ranged from 12 to 55 percent.

No further changes were made in the minimum hemoglobin level during the remainder of the war.

References

1. Robinson, G. C.: American Red Cross Blood Donor Service During World War II. Its Organization and Operation. Washington: The American Red Cross, 1 July 1946.
2. Minutes, meeting of Subcommittee on Blood Procurement, Division of Medical Sciences, NRC, 18 Aug. 1941.
3. Minutes, meeting of Subcommittee on Blood Substitutes, Division of Medical Sciences, NRC, 2 June 1944.
4. Phalen, J. A.: The Blood Plasma Program. Division of Medical Sciences, NRC. Washington: Office of Medical Information, 1944.
5. Minutes, meeting of Subcommittee on Blood Substitutes, Division of Medical Sciences, NRC, 13 July 1944.
6. Minutes, meeting of Subcommittee on Blood Substitutes, Division of Medical Sciences, NRC, 10 Mar. 1942.
7. Minutes, meeting of Subcommittee on Blood Substitutes, Division of Medical Sciences, NRC, 12 May 1942.
8. Minutes, meeting of Subcommittee on Blood Substitutes, Division of Medical Sciences, NRC, 23 June 1942.
9. Minutes, meeting of Subcommittee on Blood Substitutes, Division of Medical Sciences, NRC, 20 Oct. 1942.
10. Lozner, E. L., and Newhouser, L. R.: Studies on the Transmissibility of Malaria by Plasma Transfusions. *Am. J. M. Sc.* 206: 141-146, August 1943.
11. Taylor, E. S.: Procurement of Blood for the Armed Forces. *J.A.M.A.* 120: 119-123, 12 Sept. 1942.
12. Minutes, meeting of Subcommittee on Blood Substitutes, Division of Medical Sciences, NRC, 18 July 1941.
13. What About Blood Donations by War Workers? A Discussion by the Medical Committee of Industrial Hygiene Foundation and Other Medical Specialists. Pittsburgh: Industrial Hygiene Foundation, April 1943.
14. Boynton, M. H., and Taylor, E. S.: Complications Arising in Donors in a Mass Blood Procurement Project. *Am. J. M. Sc.* 209: 421-436, April 1945.
15. Taylor, E. S.: Blood Procurement for the Army and Navy. Preliminary Report. *J.A.M.A.* 117: 2123-2129, 20 Dec. 1941.
16. Minutes, meeting of Subcommittee on Blood Substitutes, Division of Medical Sciences, NRC, 17 Nov. 1943.
17. Fowler, W. M., and Barer, A. P.: Rate of Hemoglobin Regeneration in Blood Donors. *J.A.M.A.* 118: 421-427, 7 Feb. 1942.
18. Minutes, meeting of Subcommittee on Blood Substitutes, Division of Medical Sciences, NRC, 5 Jan. 1944.
19. Minutes, meeting of Subcommittee on Blood Substitutes, Division of Medical Sciences, NRC, 21 Apr. 1944.

CHAPTER VII

Plasma Equipment and Packaging, and Transfusion Equipment

Part I. Plasma Equipment and Packaging

Most of the dried plasma used in World War II was put up in a standard packaged devised jointly by representatives of the Army (Capt. Douglas B. Kendrick, MC) and the Navy (Cdr. Lloyd B. Newhouser, MC, USN) and modified from a package devised by Dr. Max M. Strumia (p. 165). These officers were members of a Subcommittee on the Standardization of Dispensing Equipment appointed at the 19 April 1941 meeting of the Subcommittee on Blood Substitutes (1). At the 8 May meeting of the latter subcommittee (2), they were appointed a continuing committee to test blood substitutes and to test equipment for their administration.

There was considerable experimentation before acceptable equipment and packaging were devised and put into production, and occasional suggestions were made for their modification after they had been put into general use.

ORIGINAL PACKAGES

The first 15,000 packages of dried plasma delivered by the plasma program were processed by Sharp & Dohme, a firm which had had considerable experience in this field before the emergency arose. The components of the unit, consisting of a flame-sealed glass vial of dried plasma, a glass bottle of distilled water, an intravenous needle, and rubber tubing, were rather loosely packaged in a cardboard box. The unit, which was accepted as a matter of expediency, proved unsatisfactory in several respects. Although the flame-sealed ampule (figs. 38A and B) represented the best possible storage technique, it had certain disadvantages: Its shape required a package undesirably large for field use. The neck of the bottle was very fragile, and breakage frequently occurred at the point at which the stopper was inserted. Also, the rubber stopper could very easily be pushed down into the ampule when the dispensing needle was inserted as well as when water was added to reconstitute the plasma. Since these accidents were estimated as likely to occur in about 10 percent of packages of this type, consideration was given to other models. A later proposal that the components of the Sharp & Dohme unit be put up in cellophane bags was not considered practical and was not explored further.

First consideration was given to the container (Vipule) developed at the Reichel Laboratories (fig. 38C). The components of the set were put up in tin

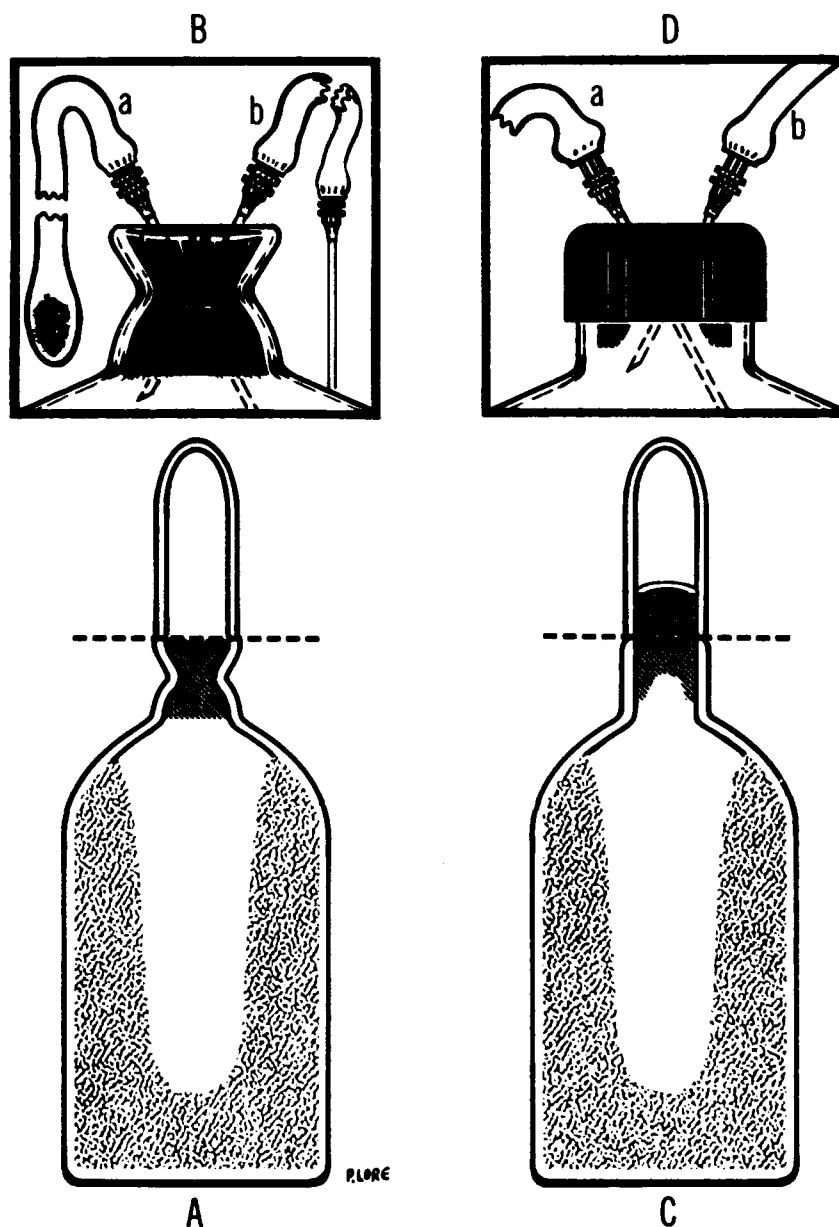

FIGURE 38.—Types of containers used early in World War II for dried plasma. A. Sharp & Dohme combination vial and ampule. B. Same, after flame-scaled tube has been broken off and removed, leaving rubber stopper in situ: airway (a), giving needle and tubing (b). C. Reichel container (Vipule) for dried plasma, with stopper of sleeve type. D. Same after glass sealing tube was broken and removed and sleeve turned back over broken edges of tube, so that container was converted into a rubber-stoppered vial. Airway (a) and giving needle (b) were then inserted into vial through stopper, as in other apparatus.

cans, but the packaging was so loose that breakage was considered inevitable, especially with a container of this shape and size. The flame-sealed ampule contained 110 cc. of normal human plasma, and the amount could be doubled by double-processing. If plasma were processed twice, however, it lost some of its stability and flocculation of globulin and fibrin occurred when it was re-dissolved. As a matter of expediency, an order was given for 25,000 units, but, as was expected, the equipment did not hold up under use (3, 4).

At a meeting of the Subcommittee on Blood Substitutes on 19 April 1941 (1), a plasma package devised by Dr. Strumia, and suitable for storage of both frozen and dried plasma, was demonstrated and evaluated. This package occupied slightly less space than the Reichel package. It consisted of:

1. A 400-cc. bottle of distilled water, of hard, noncorrosive glass, with square shoulders.
2. A similar bottle containing 250 cc. of dried plasma, with residual moisture of less than 1 percent.
3. A gum-rubber vaccine type of stopper, about three-fourths of an inch in diameter, containing a glass airway. After a vacuum had been drawn on the plasma bottle, the stopper was covered with a heavy gel cap.
4. An intravenous set for administration of the reconstituted plasma.

These items were put up in a tin can filled with nitrogen and sealed under vacuum. It was thought that with certain modifications this unit would prove acceptable for field use.

There were further discussions on equipment at the 23 May meeting of the Subcommittee on Blood Substitutes (5), including a discussion of the gage of the needle to be included in the set. Tests showed that when a 22-gage needle was used, it took 4 minutes to transfer the distilled water to the bottle containing dried plasma, against 30 seconds when a 16-gage needle was used. Another minute was required for complete solution of the plasma. With an 18-gage needle, the rate of flow was 10-15 cc. per minute. Under pressure achieved by blowing through the cotton-filtered tubes, the entire amount of plasma (250 cc.) could be administered in 5 minutes. It was finally decided that the rate of flow would not be materially increased if a needle larger than 16 gage were used and that it might be difficult to insert a larger needle into the vein.

At this same meeting, it was formally recommended that the recommendations of the Subcommittee for the Standardization of Dispensing Equipment be adopted by the Armed Forces. At the next meeting on 18 July 1941 (6), it was further recommended that deviations from standard equipment be permitted only with the approval of the Field Director, American Red Cross, if they were minor, and only with the approval of the National Institute of Health and the Subcommittee on Blood Substitutes, NRC (National Research Council), if they were major.

DEVELOPMENT OF STANDARD PACKAGE

At the 18 July 1941 meeting of the subcommittee (6), the equipment and package (fig. 39) devised by Commander Newhouser and Captain Kendrick,

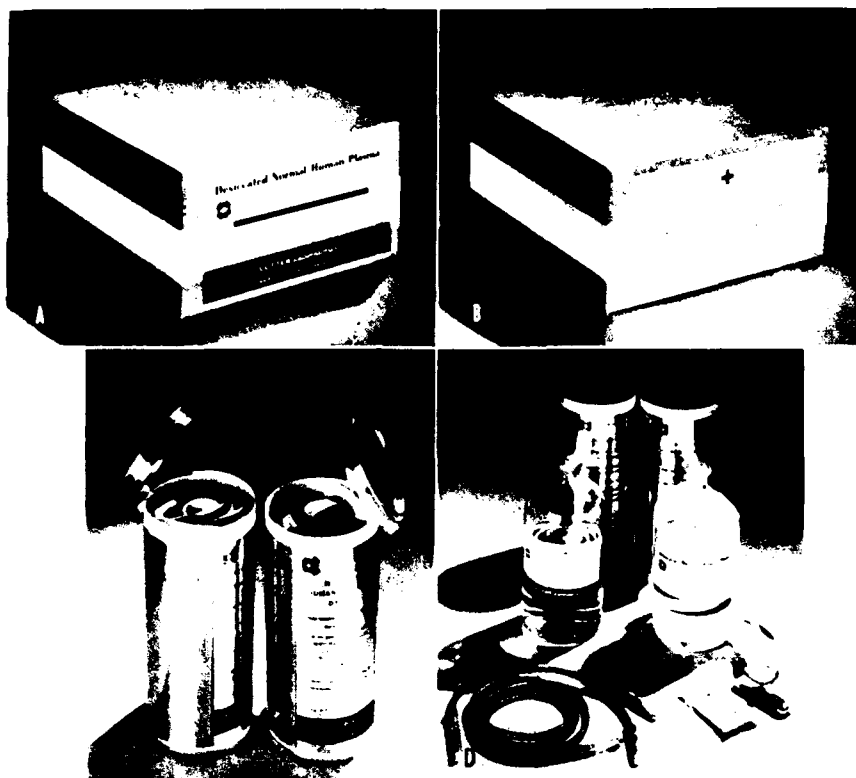

FIGURE 39. Standard Army-Navy 250 cc.-plasma package and contents. A. Front of box. B. Back of box. C. Tops removed from cans of distilled water and plasma, with contents showing and ready for removal. D. Contents removed from cans.

which were modified from the Strumia model, were recommended for adoption by the Armed Forces, and, with only minor modifications in the original model, were used throughout the war. In the development of this package, as in many other efforts, Dr. Strumia, Commander Newhouser, and Captain Kendrick worked very closely together (7).

The completed standard package of dried human plasma (Catalog Item Plasma, Normal, Human, Dried, No. 16088) (8) consisted of:

1. A 400-cc. bottle containing the dried solids obtained from 300 cc. of citrated plasma, evacuated and sealed under 29 inches (73.6 cm.) of vacuum. The solid content contained between 17.5 and 18 gm. of plasma protein. An earlier proposal (7) that the labels on plasma containers should specify the amount of the original plasma from which the dried plasma had been prepared would have required individual determinations of total protein and was rejected as completely impractical.

The bottle was stoppered with a hood-type rubber stopper (fig. 40) and was equipped with a cloth tape for suspending it in the inverted position while the plasma was being administered.

2. A 100-cc. bottle, with a similar stopper but sealed without a vacuum, containing 300 cc. of sterile, pyrogen-free distilled water.

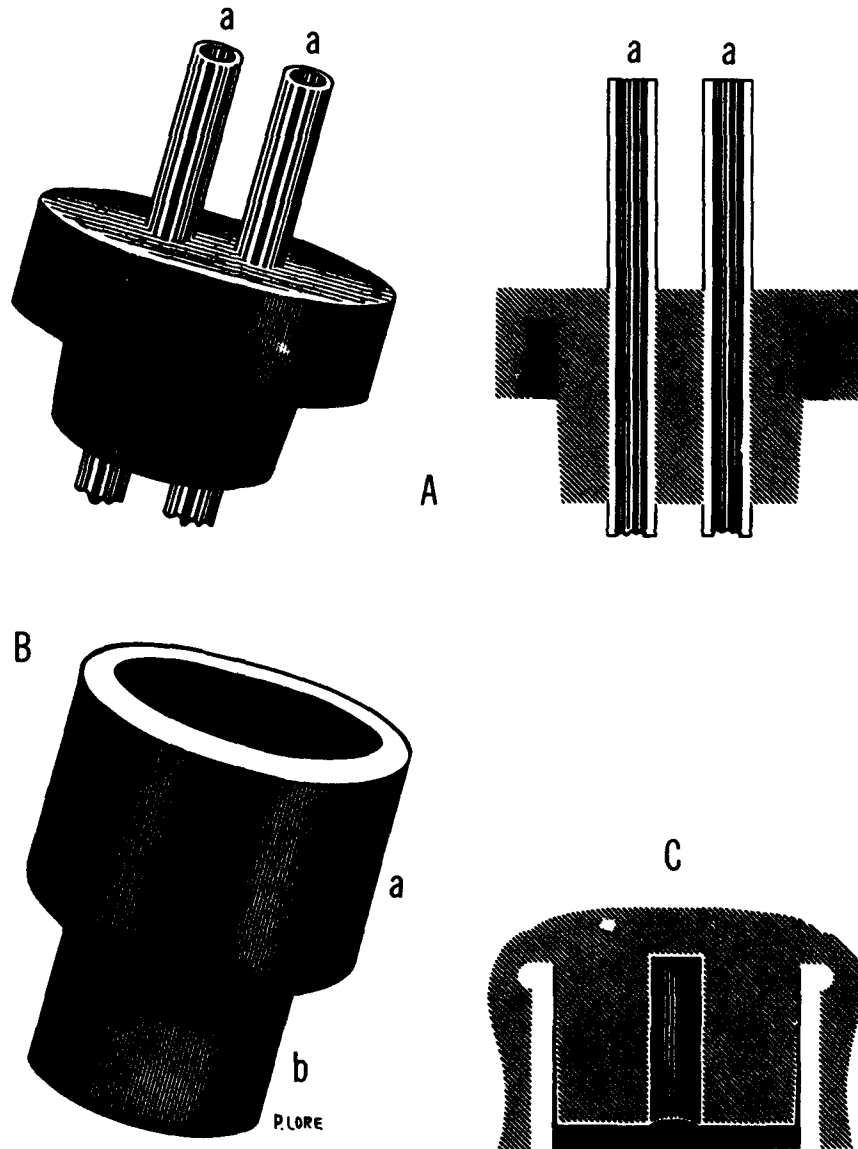

FIGURE 40.—Stoppers used in blood and plasma program. A. Flange-type stopper used in American Red Cross bleeding bottle: protruding steel tubes (a), to which were attached rubber tubes used to collect blood and as airway. B. Rubber stopper used for plasma and water containers in standard Army-Navy plasma package: sleeve (a), plug (b). C. Stopper used for plasma bottle in situ, with sleeve turned down.

3. Equipment for intravenous administration, consisting of:

a. An airway assembly, consisting of 9 inches of rubber tubing, with a needle on one end for insertion into the stopper and a cotton filter on the other end.

b. An intravenous injection set, consisting of 48 inches of rubber tubing with a glass cloth filter for use during the administration of the plasma. At one end of the tubing was a glass adapter fitted to an 18-gage intravenous needle. At the other end was a short 15-gage needle to be used to connect the intravenous set to the plasma bottle.

The bottle containing the dried plasma, the double-ended needle for adding distilled water to the plasma, and a clamp were placed in a tin can which was evacuated to 25 inches (63.5 cm.) of vacuum and sealed. The bottle containing the distilled water, the intravenous injection set, and the air filter were sealed in another can filled with dry nitrogen. The cans were opened with keys spotwelded to their bottoms. It was not considered necessary to supply alcohol and cotton for skin preparation, since they were standard items of supply.

Both cans were packaged in a tape-sealed, waterproof fiberboard box. It was specified that the tape must be pressure-sensitive; waterproof; 1½ inches wide; with no rubber content, either crude or reclaimed; not white, and incapable of reflecting light; and capable of withstanding severe climatic changes without appreciable deterioration. Paper tape was not satisfactory. Since the cans fitted snugly into the box, a string was placed around them to facilitate their removal.

Instructions for the reconstitution and use of plasma were lithographed on the can containing the plasma. A label on one end of the finished package indicated that the blood from which the contained plasma had been made was furnished by volunteer donors through the American Red Cross. A questionnaire for recording data on the use of the plasma was enclosed in each package. All packages put up after January 1943 bore the warning that the plasma must be used within 3 hours after it was reconstituted.

The metal can used in the Army-Navy plasma package was a standard Navy item, used for the priming charge of explosives. There was therefore no delay in its procurement. Later, in order to conserve tin, the Navy directed the American Can Co. to electroplate the can. The ends were made of bonderized steel.

Testing of Package

The standard plasma package was first used under combat conditions at Pearl Harbor. Meantime, it had undergone extensive testing (7, 9):

1. Six packages were placed in a refrigerator variously, right side up, upside down, and on their sides at -4° F. (-20° C.) for 18 hours. When the packages were removed from the refrigerator, all could be opened easily. The water was solidly frozen, but thawed satisfactorily at room temperature, in hot tap water, and in a water bath at 98.6° F. (37° C.), without breakage.

2. Eight packages were placed in a Dry-Ice refrigerator car at -148° F. (-100° C.) for 18 hours, four on end and four on their sides. When they were removed, the tape bindings were frozen, but the boxes were easily opened at the end of an hour. Thawing of the distilled water was accomplished by the methods just described, with equal ease and no breakage.

3. Packages forwarded to the Fleet Surgeon, U.S. Pacific Fleet, were sent out with landing parties and placed under 5-inch (12.7-cm.) and 12-inch (30.5-cm.) guns during firing practice and during dive bombing in the months of May and August 1941. The cans were somewhat battered, but they had retained full vacuum and there was no breakage.

The few complaints received about standard Army-Navy plasma packages were individual and concerned single units. Complaints about the plasma itself, which were also few, are discussed under separate headings.

COMPONENTS OF THE PLASMA PACKAGE

Certain of the components of the standard plasma package require special comment, for one reason or another.

Labels

By the spring of 1944, reports began to be received from the Pacific Ocean Areas indicating that the white labels used on the plasma packages and the contained bottles, as well as the gold-colored cans, were serving as excellent targets for enemy fire when plasma was used in the field during combat. Visibility was reduced by using an olive-drab box; painting the cans olive-drab; and changing the labels, suspension tape, and string used to withdraw the cans from the box from white to olive-drab.

Stoppers

The difficulties that arose with stoppers were due chiefly to the increasing use of synthetics in their manufacture. Lots from one manufacturer became vulcanized into certain shapes when they were sterilized and, unless they were reused with bottles of precisely that size, they were too loose and had to be discarded. In some lots, the needles seemed to act as plugs. These and other difficulties were eventually eliminated, and several types of stoppers were found satisfactory (fig. 40).

Some manufacturers placed transparent gelatin (gel) caps over the rubber stoppers used on the water bottles, to prevent deterioration of the rubber. The rubber stopper used on the plasma bottle did not need such protection as the can containing it was filled with nitrogen and then vacuum-sealed.

Filters

Whatever equipment was used in the administration of plasma, the "Minimum Requirements for Filtered Normal Human Plasma or Serum" drawn up by the National Institute of Health on 25 February 1941 (p. 279) required that filtration be an integral part of the process. The specification had been accepted by the Subcommittee on Blood Substitutes at an earlier meeting (1). It took some time, however, for a satisfactory filter to be devised (fig. 41).

Cloth filters had a number of defects (10). Unless they were constructed so that the cloth did not adhere to the sidewalls of the glass housing, the filtering surface was considerably decreased and the tip of the filter did not act, as intended, as a flow meter. An entirely efficient cloth filter would have been



FIGURE 41.—Evolution of plasma filters from glass cloth filter (lower right) to stainless steel mesh filter (top).

undesirably large and would have required the use of a cumbersome and readily breakable glass housing.

Glass cloth filters were also not entirely satisfactory (11), one reason being that in mass production they were sometimes so tightly packed that they acted as baffles instead of filters. Complaints from Attu (12), on the difficulty of placing dried plasma into solution at the temperatures encountered in the Aleutian Islands, were attributed to the filters rather than to the cold; dried plasma could easily be placed in solution at a temperature of 10° F. (—12° C.).

The question of satisfactory filters was discussed in detail at the Conference on Transfusion Equipment and Procedure on 25 August 1942 (13). Some of those present believed that the same filter could be used for plasma and preserved blood. Others doubted it, even if the filter had an adequate surface. The problem was solved when the changeover to the larger plasma package was made (p. 172) and the glass cloth filter previously used was replaced by a small 200-mesh stainless steel filter. The shortage of stainless steel of the desired mesh created some difficulties initially, and until it could be obtained, 100-mesh stainless steel was used and found so satisfactory that it continued

to be employed. With the introduction of this type of filter, most filtration difficulties ended, though a few were reported on the Normandy beachhead (p. 553) and in the Pacific (p. 598).

Tubing

Probably the most serious material shortages in the plasma program concerned the tubing used in the recipient sets (14). Part of the same problem was the deterioration that occurred in rubber during long periods of storage, which was inevitable in the stockpiling of plasma. The matter came to a head at the Conference on Transfusion Equipment on 25 August 1942 (13), with the appointment of a Committee on Transfusion Equipment (Dr. Elmer L. DeGowin, Chairman, Dr. Strumia, Commander Newhouser, Colonel Kendrick, and Dr. John B. Alsever, Office of Civilian Defense, ex officio). A member of the War Production Board was also appointed to sit with this committee.

A variety of possible substitutes were considered:

1. The Division of Surgical Physiology, Army Medical School, had begun to experiment with cellophane tubing in 1941 and had found that it had many desirable features. When properly prepared, it was nontoxic. It could be used efficiently by experienced technicians. It was useful for the injection of crystalloid solutions. On the other hand, it was not suitable for general use throughout the Army, and since it could be used only once, no saving would be effected in substituting it for rubber.

2. Expendable cellophane tubing prepared by the Baxter Laboratories had been used by the Blood Research Division, Walter Reed General Hospital, Washington, D.C., and it was agreed that it could be utilized if rubber became unavailable.

3. Commander Newhouser had instituted studies with vinyl acetate tubing but had not found it suitable (15). Dr. Strumia and his group, however, believed that this tubing could be utilized if certain precautions were taken.

4. The original work with cellulose tubing was done by Hartman (16), at the Henry Ford Hospital in Detroit in 1940. Tests in the laboratory of the Army Medical School and by a testing board representing both the Army and the Navy resulted in the decision that it would not withstand the rigors of the tropical and arctic regions in which U.S. troops were then stationed. Since dried plasma was not used in military hospitals in the United States, it was not thought practical to substitute cellulose tubing for the equipment then in use.

5. It was generally agreed that latex was the most desirable material for tubing. While it was collapsible, its walls did not adhere to each other, and tubing with a caliber of three-eighths of an inch did not retain air bubbles in the column of blood; the air always rose to the top of the column (1). Latex, however, was a new product, and it was in short supply all through 1942, because of the necessity of testing samples before orders could be placed or shipments accepted. Additional delays were caused by failures of processors to follow the specified routine for securing priorities in equipment and materials.

In October 1943, a change in specifications resulted in saving some 50 percent of the latex formerly required for tubing: It was found entirely satisfactory to reduce the inside diameter of the tubing from three-sixteenths of an inch to one-eighth of an inch and the thickness of the wall from one-eighth to one thirty-second of an inch.

Tin Cans

In April 1942, the request of Eli Lilly and Co. for additional tinplate to use in cans for the plasma package was refused. On 4 May, at the request of the Army-Navy Munitions Board, a meeting was called, attended by representatives of all processors of dried plasma and presided over by the Navy representative on the Munitions Board (17). Brig. Gen. Charles C. Hillman made the following points:

1. Packages of plasma were subjected to various climatic conditions, ranging from tropical to arctic.

2. Up to this time, no substitute for tin containers for plasma packages had been found. Neither lacquered steel nor plastic was able to retain the nitrogen used in forming the vacuum, which was essential. The present package represented much experimentation by practical engineers. Until an acceptable substitute was found, the use of tin was essential.

3. Contracts about to be let for dried plasma for fiscal year 1943 were for 900,000 units of plasma, which would require 1.8 million tin cans. The tin requirement for the 1943 program would therefore be about 18,000 pounds. These packages contained highly critical material. The dried blood plasma was processed from blood donations given by patriotic American citizens for wounded American soldiers, and the tin requirement was very small indeed compared to the value of the contents of the cans.

It was the consensus of the meeting that The Surgeon General should make representations to NRC for further assistance in procuring the tin requested; that an appeal be made through proper channels to the War Production Board for at least a 6-month supply for present requirements; and that the present packaging be continued while further research was conducted.

At this same meeting, the question of stainless steel in the recipient needle of the intravenous set was also discussed. Difficulties in procurement had arisen about it. It was considered essential to use stainless steel because rubber acted adversely upon steel except in a nitrogen atmosphere. If carbon steel were substituted, it must be expected that a considerable number of plasma packages would be rendered useless by rust, since it was practically impossible to keep moisture entirely out of the cannula of the needle. This would probably make no difference if the plasma were used within a month. If, however, it were not used for 3-4 years, it might make a considerable difference: When plasma was needed, it should be ready for immediate use.

Eventually the tin, as well as most of the other materials needed in the plasma and whole blood programs, was secured, though it required continuous and extended correspondence about even such apparently minor matters as the supply of paper cups (p. 295).

THE LARGER PLASMA PACKAGE

As early as May 1941, the desirability of a larger plasma package was already being considered (2, 5). By this time, it was agreed that if a casualty needed plasma, 250 cc. was not a sufficient dose. It was thought, however, that larger containers might be difficult to carry forward, and there was no doubt

that a smaller amount, given early and far forward, might be more beneficial than a larger amount given later in a clearing station. To avoid procurement delays, the Subcommittee on Blood Substitutes decided to proceed with the production of the smaller package but to make the development of a larger package a subcommittee objective, with Colonel Kendrick responsible for its production.

By November 1942, requests for larger quantities of plasma had led to intensive work on the preparation of new containers. The small size of the unit was almost the only serious criticism of the present plasma package. At the 15 December 1942 meeting of the Subcommittee on Blood Substitutes (15), it was pointed out that the amount of plasma in the present package could be increased in three ways without altering the volume of the package:

1. After 250 cc. of plasma had been dried in the container, another 250 cc. could be introduced and the whole amount redried. This plan was not desirable: The volume of the flask would allow for reconstitution to only twice the isotonic concentration, and the subcommittee had already recorded its opposition to the use of concentrated plasma (p. 275).

2. The 250 cc. of plasma dried separately in two bottles could be poured into a single bottle. The National Institute of Health was opposed to this method because no satisfactory means had yet been devised of making the transfer under aseptic conditions.

3. The amount of plasma dried in the original container could be increased from 250 cc. to 400 cc., which would require lengthening the drying time to 48 hours, an increase of about 50 percent. For the present, this seemed the most practical plan, though it was hoped that in the near future a bottle could be designed which would contain 500 cc. of plasma but would still fit the metal can in use.

Experimental work had shown that by the use of a 750-cc. bottle, 600 cc. of plasma could be dried to a residual moisture of less than 1 percent. By the use of a 9½-inch can instead of the 7-inch can presently in use, 500 cc. of plasma could be packaged in a box only 2 inches longer than the box presently in use. Eighteen large packages would occupy the same space as 24 small packages but would represent the same quantity of plasma as 36 small packages.

To make the change from the smaller to the larger package introduced difficulties in the supply of critical materials (18, 19). All but two of the firms presently processing plasma required material that was critical. Cutter Laboratories listed 14 essential changes, plus 6 others that would be necessary if the amounts of plasma then being pooled were changed. Parke, Davis and Co., which had just achieved production of the smaller packages in excess of 3,000 units per week, was dismayed by the changeover. Its dryers were of the manifold type and it was doubtful that the proposed 600-cc. bottles would fit on them without changes.

The requirements of a single laboratory, Eli Lilly and Co., indicated how serious it was to change specifications for any product during the war. This firm estimated that it would require approximately 5,420 pounds of copper, for which it would ultimately release 3,000 pounds of scrap copper; 50 pounds of brass; 2,500 pounds of iron; 375 pounds of stainless steel; new equipment for measuring temperatures by means of thermocouples; and various accessories, as well as noncritical materials. The highest priority possible would be re-

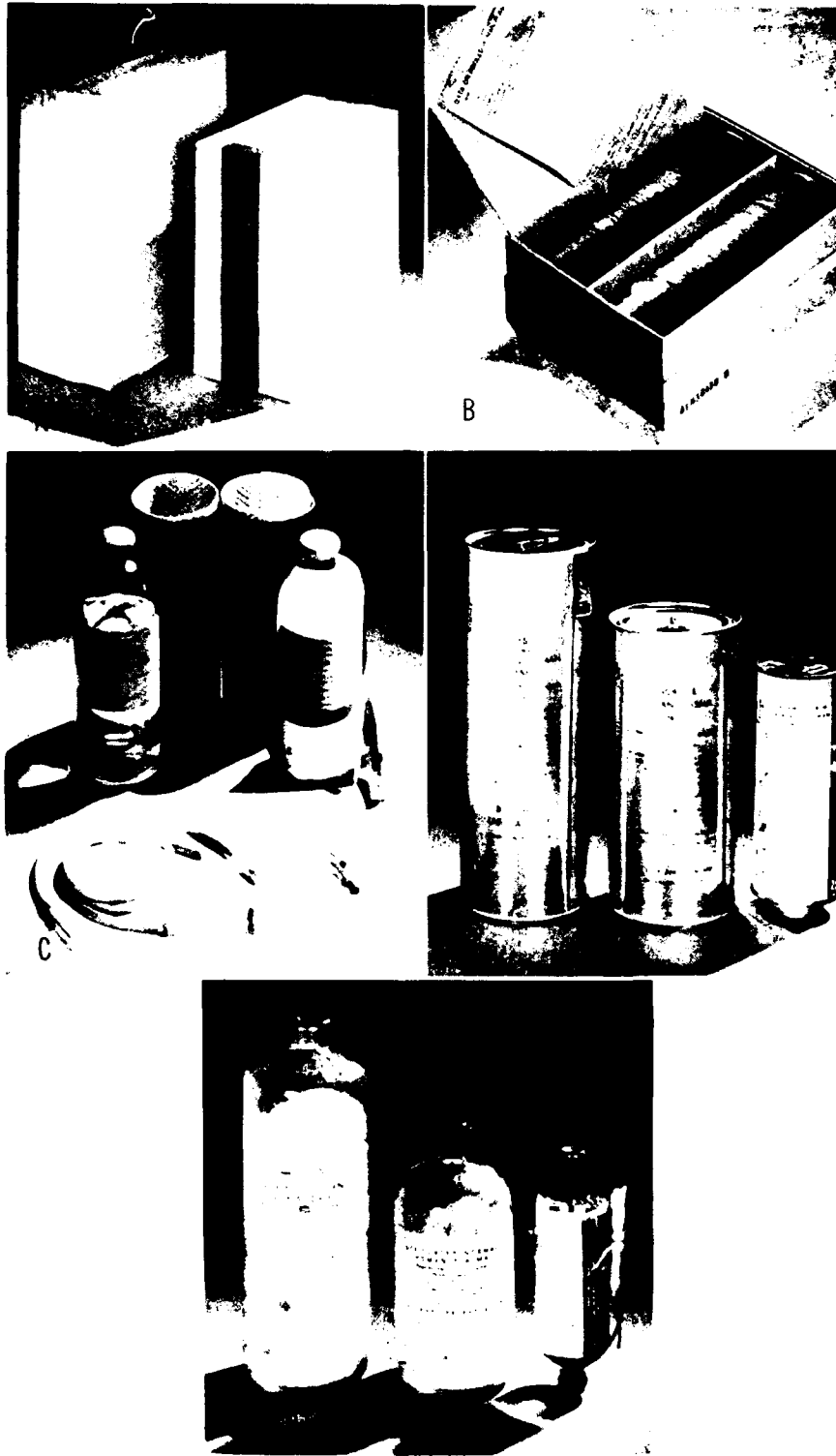

FIGURE 12. See opposite page for legend.

quired, including priority for larger bottles and cans, if production were not to be delayed. As matters worked out, this company was ready to begin production before any of the other laboratories, and it was given a contract for 2,000 large units as a trial run.

When all estimates had been received from the various processing laboratories, Col. Charles F. Shook, MC, made a blanket priority request for the necessary critical materials from the War Production Board, which was granted on 6 March 1943.

Production of the larger package (fig. 42) did not begin until 1 July 1943. There were numerous reasons for the delay. The company which manufactured the cans had to make a number of changes in its equipment and, for a time, was doubtful that the new can would be as strong as the smaller can. Breakage of the distilled water bottles took time to overcome. Finally, since the speed of drying, for physical reasons, was partly a function of the plasma shell, it was found difficult to dry 500 cc. of plasma in a bottle not much larger than a bottle designed to contain half that amount. These various problems were eventually solved, first in the laboratory and then in commercial production. In spite of the preliminary difficulties, the changeover was made with remarkably little trouble, as Colonel Kendrick and Commander Newhouser found on trips to various laboratories in July and August. Parke, Davis and Co. and Ben Venue Laboratories continued to make the smaller package until the end of the war.

From the beginning, the emphasis in the plasma program had been on the importance of conserving critical materials necessary for processing, particularly rubber and metal. The change to the larger package saved about half of the rubber tubing previously used, which amounted to many hundreds of thousands of feet; stainless steel for needles; and other critical material. The larger package also provided twice the amount of plasma in about a third of the space previously occupied by the smaller package, another important consideration in view of the shortage of shipping space.

By the time the larger packages of plasma went into production, medical officers were fully cognizant of the need for larger quantities of plasma for resuscitation—at least 500 cc. was now regarded as the minimum—and they were delighted to have it provided so conveniently.

PACKAGING OF DRIED PLASMA FOR ZONE OF INTERIOR USE

While dried plasma was not generally used in Zone of Interior hospitals, it was occasionally needed in both general and station hospitals when emer-

FIGURE 42.—Large plasma package introduced in 1943. A. Large and small packages of dried plasma. B. Box opened to show contents and questionnaire. C. Contents removed from cans. D. Large and small cans of dried plasma, and can of serum albumin, to show comparative sizes. E. Large and small bottles of dried plasma and vial of serum albumin. Note texture of plasma after shell freezing and drying.



FIGURE 43. Package devised at Army Medical School for dried plasma supplied to Zone of Interior hospitals. Note that cans were not used. A. Exterior of package. B. Box opened to show contents. C. Contents removed. D. Intravenous set.

gencies arose. It was also distributed to installations not ordinarily supplied with liquid plasma, such as Air Force bases and a variety of smaller installations in which plasma was not used sufficiently often, or in large enough quantities, to make a supply of liquid plasma practical. Finally, crash ambulances at emergency landing fields were supplied with dried plasma.

During fiscal year 1944, a package for dried plasma to be used in these installations in the Zone of Interior was developed in the Division of Surgical Physiology, Army Medical School (fig. 43). About 20,000 were produced.

One of the indirect advantages of this package was that it permitted the instruction of Medical Department personnel in the use of dried plasma, even though the packaging differed from that of the oversea supply.

PROPOSED CHANGES

Until almost the end of the war, numerous proposals were made by medical officers and others concerning equipment for plasma and blood, most of the suggestions probably being inspired by the lack of provision in oversea theaters, until late in the war, of equipment for transfusing whole blood. Some of the suggestions were made by physicians of great competence in their special fields, but they could not be considered when materials were in critical supply and procured with difficulty and when machines were tooled for bottles, containers, and other equipment in standard sizes. Letters of explanation and appreciation were written to all who made suggestions.

Part II. Transfusion Equipment for the Oversea Program

GENERAL CONSIDERATIONS

U.S. Army medical installations went into North Africa in November 1942 with only the most elementary equipment for transfusion (p. 432). Similarly, U.S. Army units in the European theater had no standard equipment, and the items developed before D-day were chiefly improvised.

The selection and procurement of satisfactory transfusion equipment for hospitals in the Zone of Interior was not a problem. Commercially prepared vacuum-type bleeding bottles and donor and recipient sets, which were reusable, became amply available early in the war. On the other hand, equipment used for transfusion in civilian hospitals was far too complicated for use in the field (1).

Long before the reports of the British and United States experience in North Africa began to be received in the Office of The Surgeon General, personnel of the Division of Surgical Physiology, Army Medical School, had been investigating the development of transfusion equipment, including equipment for field use (fig. 44). They based their endeavors upon the following hard facts:

1. Wounded men who had lost large quantities of blood in combat were poor surgical risks, even after they had received plasma in large quantities. They must also receive whole blood in large quantities before they could become safe risks for anesthesia and surgery.

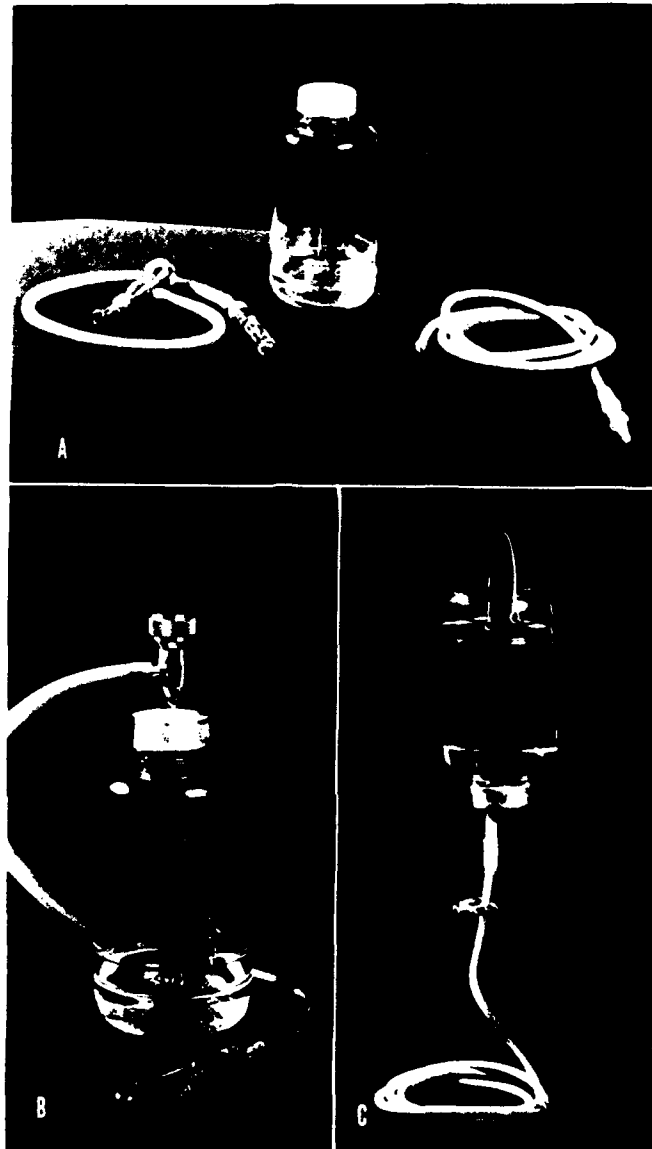

FIGURE 11. Collecting and giving set devised at Army Medical School. A. Components of bleeding set. B. Bleeding set assembled. C. Giving set with filter.

2. A blood program to supply whole blood in the necessary amounts would become practical only when an acceptable type of transfusion equipment had been developed, together with satisfactory containers for its transportation. The following criteria must be met:

a. A sterile closed system must be utilized for the collection and storage of blood.

b. A preservative solution must be devised in which blood could be safely stored for 14 to 21 days.

c. A transfusion set must be devised so inexpensive that it could be discarded after a single using. In civilian life, the chief cause of transfusion reactions was the presence of pyrogens in the recipient sets, usually as the result of improper cleansing. Under field conditions, the difficulties of cleaning and preparing collecting and recipient sets would make the use of equipment that was not expendable both impractical and unsafe. The transfusion set must also be so simple that it could be used by enlisted men with a minimum of instruction, the sine qua non, of course, being the skill necessary to insert a needle in the recipient's vein. Dr. (later Lt. Col., MC) Robert C. Hardin had shown that this skill could be readily attained (p. 85).

British Proposal

On 20 January 1941, Col. (later Maj. Gen.) Paul R. Hawley, MC, then in the United Kingdom as an observer, sent The Surgeon General, at the request of the Director General, British Army Medical Services, a model of the apparatus used for blood transfusion in the British Army (20). A description of the apparatus, with instructions for its use, was contained in the training pamphlet on resuscitation. The Director General requested that some consideration be given to the advisability of standardizing this equipment in the U.S. Army. The plan seemed to him to have several advantages:

1. Simplicity and economy of procurement, including the saving of rubber by the use of tubing of a single size.
2. Facility of supply of all troops in the same theaters.
3. Similar training of all Allied medical personnel in the use of the same type of equipment, so that, if necessary, reinforcing technical personnel might be exchanged.

The Director General claimed no superiority for this particular equipment except that all British medical units, including Emergency Medical Service hospitals, were equipped with it, and all personnel had been trained in its use for some time. He would, however, be willing to consider standardizing some other type of equipment.

It is not clear why this approach was not followed up by The Surgeon General, U.S. Army, except that by this time the investigations at the Army Medical School had made considerable progress. A vacuum bottle had been developed, holding 700 cc., against 400 cc. for the British bottle, and needles and transparent latex tubing had also been developed. The British tubing was opaque. More important, the British bleeding set was not completely closed. In spite of these differences, however, the British transfusion set would probably have been accepted for U.S. use if only it had arrived some months earlier.

DEVELOPMENT OF EQUIPMENT

Improvised Technique

At the meeting of the Subcommittee on Blood Substitutes on 9 April 1943 (21), Colonel Kendrick pointed out that, at that time, the only equipment with which blood for transfusions could be collected in medical installations overseas was a beaker. The risk of contamination was present even when the blood was transfused immediately, and this method was totally inappropriate for the storage of blood, though it was quite evident, from the large numbers of casualties expected, that stored blood in large quantities would be necessary to care for them. The present plan was to employ plasma exclusively forward of evacuation hospitals (when the Mediterranean Blood Bank went into operation 10 months later, whole blood was employed in field hospitals), but at that, 50,000 transfusions might be necessary for each 100,000 casualties.¹ The bottles necessary for this amount of blood would occupy, it was estimated, 6,100 cu. ft. of shipping space.

To make up for the lack of standardized equipment and the shortage of shipping space, the following proposals were made:

1. In evacuation hospitals, all transfusions should be given with fresh blood, one reason being the lack of refrigeration for storage of blood; the single refrigerator provided was usually filled with biologicals.

2. At general and station hospitals, at which level donors could be more easily procured, blood should be collected and shipped forward as necessary. It would be collected in the 1,000-cc. Baxter flasks used for intravenous fluids, in 50 cc. of sodium citrate solution. The flasks would be washed in physiologic salt solution as soon as they were used and would be autoclaved with the rubber tubing and rubber stopper still in situ. A vacuum would be induced with a pump; three such pumps were available in each general hospital. There would be ample refrigeration, for tables of equipment allowed for three kerosene-burning 8-cu. ft. refrigerators for each hospital.

These proposals were, in general, incorporated in Circular Letter No. 108, Office of The Surgeon General, U.S. Army, 27 May 1943 (22). Instructions were given in it for the transfusion of fresh whole blood in general hospitals in oversea theaters within 4 hours after it had been collected and for the transfusion of stored blood, to be collected by a closed system and used within 7 hours after it had been collected (fig. 45). Colonel Kendrick's concurrence in this circular letter was most reluctant but, under the circumstances, there seemed to be no other choice.

¹ This was a remarkably accurate estimate, which still holds (1962); 0.5 pint per casualty is the accepted allowance for whole blood in present planning.



FIGURE 45.—Collection of blood in overseas theaters by use of empty sterile plasma bottle contained in large standard Army-Navy plasma package and usually discarded. A. Distilled water being transferred from bottle in standard package to plasma bottle. B. Glass beads and sodium citrate solution in rubber-stoppered vial requisitioned from United States. Beads act as filter. C. Stopper of plasma bottle removed, so that beads and citrate solution can be poured into it. D. Beads and solution being poured into plasma bottle.



FIGURE 15. Continued. E. Plasma bottle ready for collection of blood. F. Bleeding by gravity, with stopper of plasma bottle removed. G. Insertion of needle into donor's vein. H. Donation nearing completion.

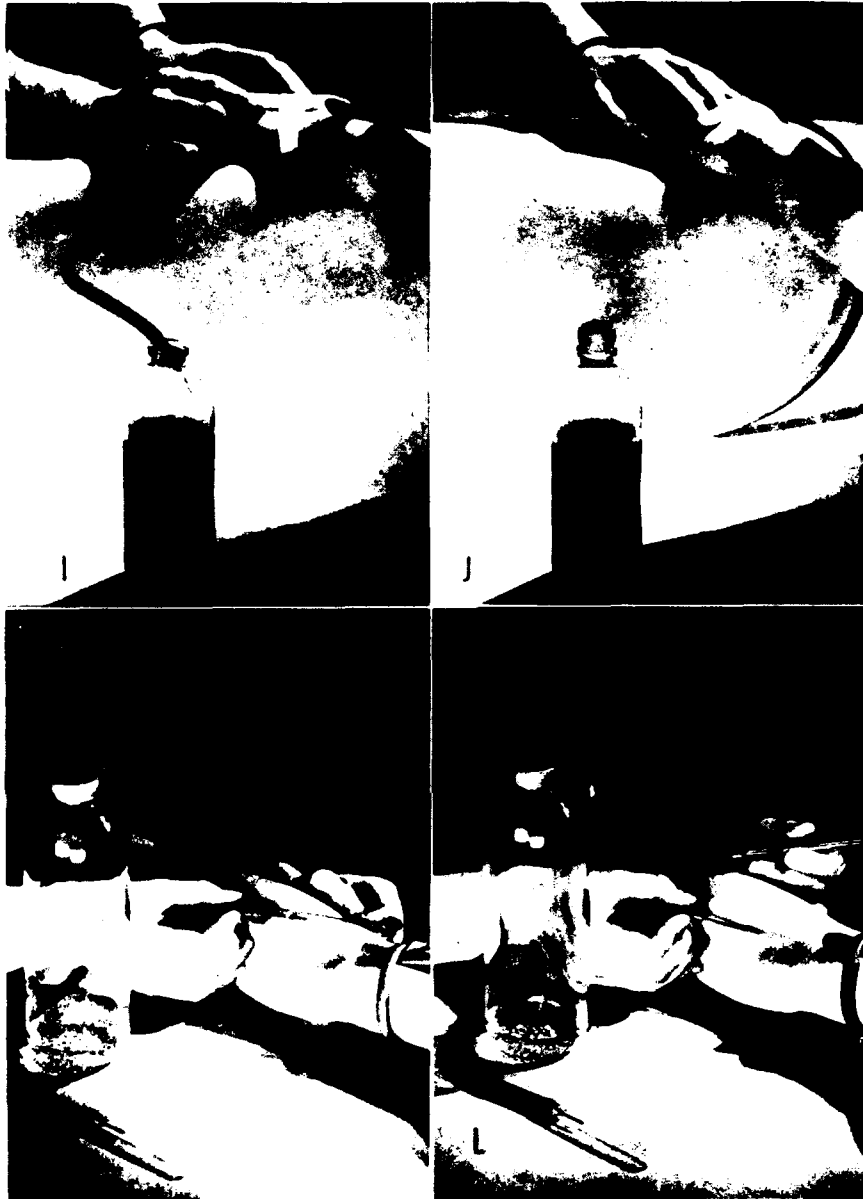

FIGURE 45.—Continued. I. Detachment of needle from vein. J. Replacement of sterile stopper on bottle. K. Alternative technique of bleeding under closed system, accomplished by pulling vacuum on plasma bottle. L. Insertion of needle in donor's vein.

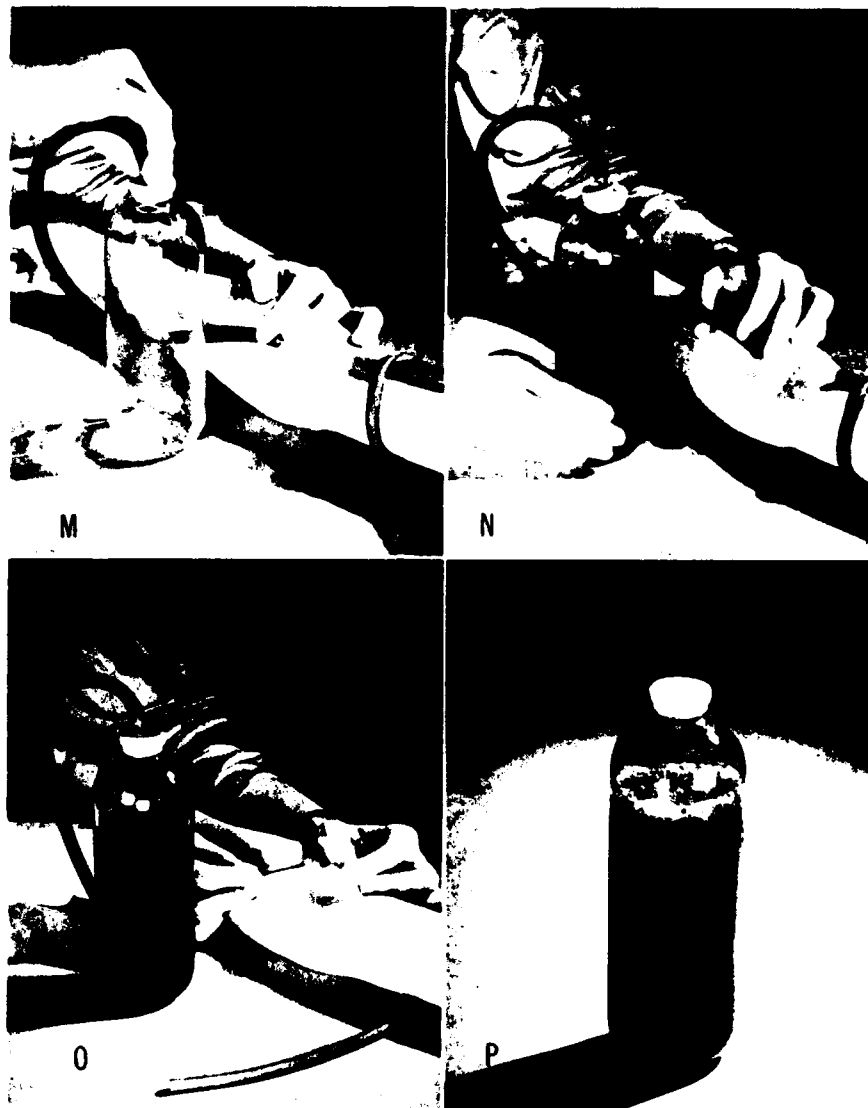

FIGURE 15. Continued. M. Other end of donor set connected to plasma bottle by insertion of needle through stopper. N. Completion of donation. O. Detachment of needle from vein. P. Blood ready for transfusion. Bottle contains blood, sodium citrate, and glass beads.

Recommendations

The ad hoc Committee on Transfusion Equipment appointed at the 9 April 1943 meeting of the Subcommittee on Blood Substitutes (21) made the following recommendations at the 13 May meeting of the subcommittee (23):

1. That the expendable Army-Navy package for dried plasma (p. 165) be used for whole blood transfusions in medical installations in theaters of

operations. When the dried plasma had been reconstituted, the empty distilled water bottle would provide a closed receptacle which would be sterile and free from foreign material. The intravenous and airway assemblies used for plasma infusion could be salvaged for the administration of blood by cleaning them immediately.

2. That the anticoagulant solution with glass beads used for filtration be packaged in individual vials, ready for immediate use.

3. That facilities for preparing and sterilizing equipment for transfusion and storage of whole blood be made available for general hospitals overseas.

These recommendations, it was emphasized, implied supervision of the entire process by personnel experienced in the techniques used in the preservation and transfusion of whole blood.

This plan was frankly an expedient, and an unnecessary one at that. At this time (May 1943), vacuum bottles were available, and a completely satisfactory closed system could have been used for the collection of blood (fig. 44). The equipment was just as good as any used later for the oversea airlift. The shipment of these containers overseas, however, was not permitted, and make-shift arrangements therefore had to be resorted to.

The ad hoc committee pointed out that the plan proposed, while an expedient, did have a number of advantages:

1. Under the plan in effect for the distribution of plasma, the equipment necessary for transfusion would be available in large quantities in all oversea medical installations.

2. This equipment lent itself to either open or closed transfusion.

3. It was interchangeable with the equipment currently employed in the administration of crystalloid solutions.

4. The cleaning of containers would be reduced to a minimum.

5. Shipping space would be conserved, since the necessary equipment was already overseas and considered expendable, its original purpose having been fulfilled. It could therefore be considered expendable after being used for transfusion.

DESIGN OF FIELD TRANSFUSION UNIT IN EUROPEAN THEATER

Development of Model

Statement of the problems.—Early in 1943, when it became evident that there were no official plans and no standardized equipment for the use of whole blood in the European theater farther forward than the communications zone, Maj. (later Lt. Col.) Charles P. Emerson, MC (fig. 46A), at the 5th General Hospital, and Maj. (later Lt. Col.) Richard V. Ebert, MC (fig. 46B), turned their attention to a number of problems which obviously



FIGURE 16. A. Maj. (later Lt. Col.) Charles P. Emerson, MC. B. Maj. (later Lt. Col.) Richard V. Ebert, MC.

required solution before the use of whole blood in forward installations would become practical (25):

1. Designing a transfusion set that would be simple, sturdy, and easily operated; that would offer a minimum of technical difficulties and complications; and that could be used repeatedly, so that an excessive number would not be required.
2. Devising a method of cleaning and sterilizing transfusion equipment that would be rapid, efficient, and safe; that would require no source of heat; and that would involve the use of only those materials provided with the set.
3. Restricting the materials used in the construction of sets and assembly of kits exclusively to those available in the theater of operations.
4. Incorporating the transfusion equipment, with all necessary appurtenances, into compact units or kits that could be packed readily and transported easily.
5. Providing a method of selecting blood donors that would reduce to a minimum the risk of transfusion reactions due to group incompatibility.

First model. The basic unit of the set designed by Major Ebert and Major Emerson was the Baxter Vacoliter flask (fig. 47A). It was available in quantity and was calibrated, and its glass and rubber components were excellent.

This model was constructed with a long glass tube extending to the bottom of the flask. To this long tube was connected an 18-inch piece of rubber tubing, fitted with a glass adapter for a Luer needle. The blood was collected through this tubing. A short piece of glass tubing inserted through the stopper of the bottle served as an airway. Suction was applied to the airway to expedite the collection of the blood. At the end of the donation, sodium citrate solution was introduced through the long tubing.

When the blood was used, air was introduced into the airway by means of a blood pressure bulb, to force the blood out of the flask and into the recipient's vein.

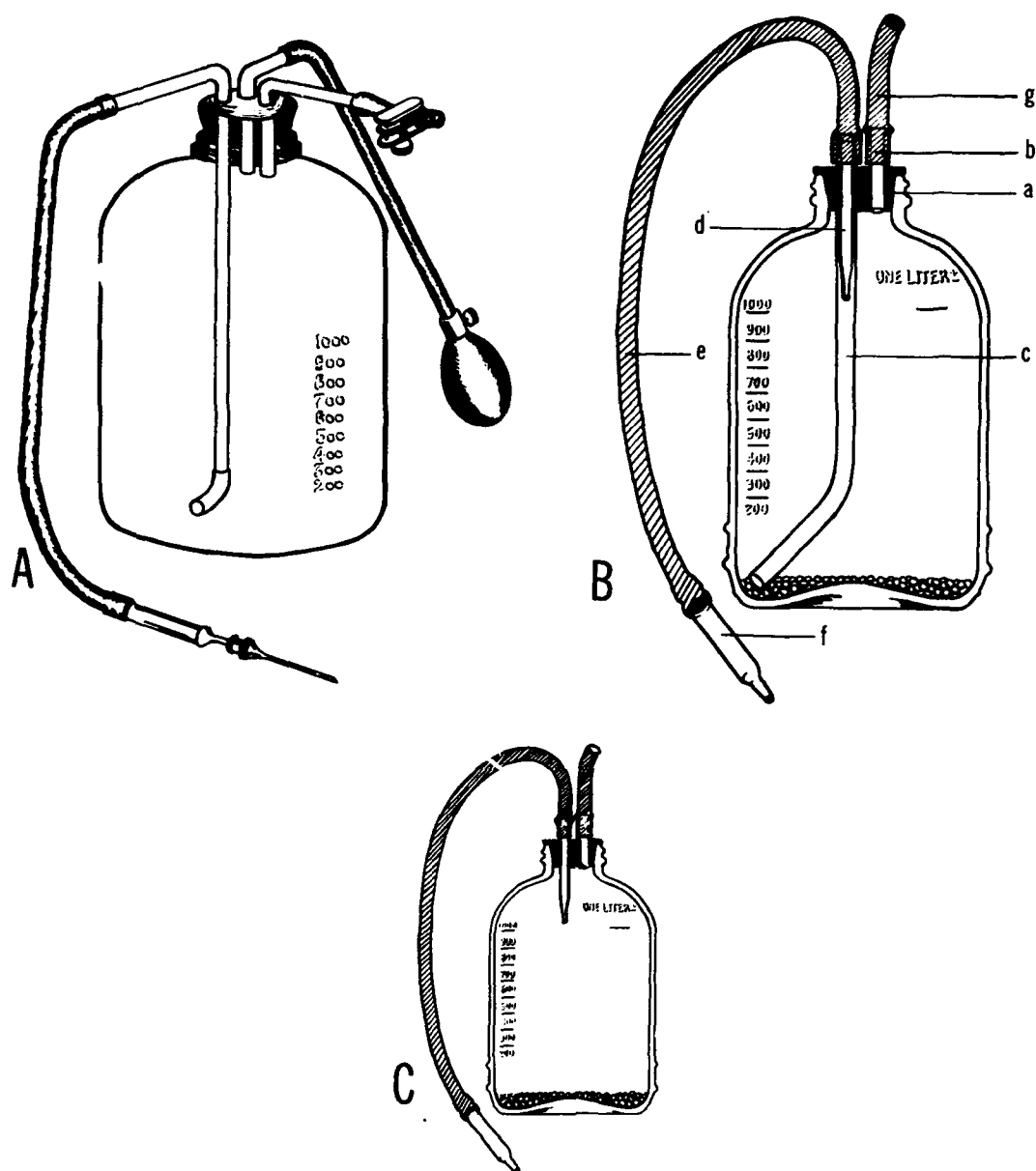

FIGURE 47.—Evolution of donor bottle in Ebert-Emerson transfusion set. A. First model. B. Second model: Rubber stopper with two holes (a); medicine dropper, cut to $1\frac{1}{8}$ inches (b); glass tube, 10-mm. diameter, $8\frac{1}{4}$ inches long (c); medicine dropper (d); gum rubber tube, 14 inches long (e); adapter for Luer needle (f); gum rubber tube, 3 inches long (g). C. Final model, with long glass tube eliminated.

Second model.—The original model, even when modified, proved somewhat cumbersome to use, and it was soon abandoned for a set constructed with a larger caliber (10-mm.) glass tube, into which a medicine dropper was inserted (fig. 47B). With this model, which utilized a single tube connection for both collection and transfusion, the blood flow during the donation could be observed.



FIGURE 48. Collection and administration of blood by Ebert-Emerson technique, with improvised equipment. A. Collection. B. Gravity administration.

Third model.—A third model (fig. 47C) was constructed when it was found that the long rubber tubing which was issued with each package of dried plasma, and which incorporated both a filter and an adapter, could be connected to the short glass tube and replace the airway. When the flask was inverted and suspended by its bale, blood could be injected by gravity, the venesection tube serving as an airway (fig. 48). This was a convenient arrangement, since plasma was used in sufficient amounts to supply all the

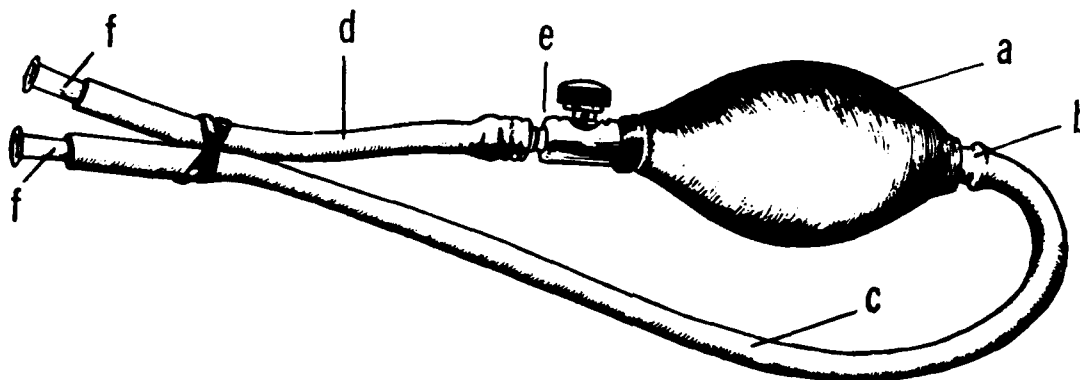

FIGURE 49.—Higginson enema syringe adapted for suction in Ebert-Emerson technique of blood collection: sphygmomanometer bulb (a); inlet valve (b); rubber tube, 12 inches long (c); rubber tube, 3 inches long (d); outlet valve (e); and medicine droppers (f).

rubber tubing necessary. The tubing required no preparation before use and could be discarded after the transfusion.

This model proved so satisfactory that the pressure technique, which had been devised chiefly to eliminate the cleaning and sterilization of long lengths of rubber tubing, was abandoned. In the final model, the long glass tube, which was fragile and difficult to construct, was also abandoned.

Several other changes were also made. The modified blood pressure bulb originally used to expedite the donation and the introduction of the sodium citrate solution had not proved particularly satisfactory; it was replaced by a Higginson enema syringe (fig. 49). Glass beads were added to the flask when it was found that small clots were sometimes clogging the needle. When the flask was inverted, clots and fibrin particles were removed as the blood filtered through the beads.

Anticoagulant.—When the Ebert-Emerson set was first worked on, early in 1943, no sterile sodium citrate solution was available in U.S. supply depots, and British sources were used for it. Later, it was found that sodium citrate was present in sufficient excess in U.S. dried plasma to provide the amount of anticoagulant required in the field transfusion set. After numerous tests of potency, it was found that one part of reconstituted dried plasma prevented the clotting of two to three parts of blood; if one unit (300 cc.) of reconstituted plasma was aspirated into the collecting bottle before 500 cc. of blood was collected, the blood would not clot. The anticoagulant problem was thus



FIGURE 50. Technique of cleansing Ebert-Emerson transfusion set.

solved provided that (1) only group O donors were used in the field and (2) the recommendation was followed that plasma be given routinely with whole blood.

Cleaning and sterilization. Cleaning transfusion equipment in the field presented special difficulties, because running water would not be available and water alone was not sufficient for cleaning the set. Experiments showed that the Ebert-Emerson equipment could be cleaned rapidly and thoroughly if some alkaline detergent, such as a compound used for dishwashing, were used in aqueous solution and pumped into the set and through the tubing with a Higginson enema syringe. The alkaline detergent solution completely dissolved the lipoid and protein components of the blood insoluble in neutral solutions. Water from any available supply was used for rinsing, followed by a final rinsing with the sterile, pyrogen-free water provided for reconstituting plasma; a small amount of it was reserved for this purpose (fig. 50).

Sterilization was originally a major problem. Autoclaving takes a considerable time, and facilities for it were often lacking in the field. Sterilization by boiling was unsatisfactory for two reasons, (1) that smaller sterilizers could not accommodate the set and larger sterilizers were difficult to heat from available sources, and (2) that the large amounts of organic and inorganic matter in the water contaminated the sets.



FIGURE 51.—Ebert-Emerson transfusion set, packed in ammunition box and ready for use. Each box contained three transfusion bottles and accessory equipment.

The sterilization problem was settled by introducing an ounce of 80-percent alcohol into the set immediately after it was cleaned and leaving it in situ until the set was used again. Insertion of the adapter into the airway created a closed system, and inverting the bottle distributed the alcohol to all parts of the set. There were no reactions when this method was used, and experimental studies showed that sterilization could be accomplished by it in less than 20 minutes.

Transfusion kit.—The field medical chest, which was originally used as a container for the field transfusion kit, proved too bulky and heavy to be practical. The small wooden box next constructed for this purpose introduced problems of manpower and supply and proved not sturdy enough for field use. Eventually, the ammunition box used for 265 rounds of .50-caliber machinegun cartridges was adapted for this purpose (fig. 51). It was painted green, with a caduceus on the side, and was transported by the handle on the top. Each box contained three transfusion bottles, 20 ampules of 2.5 percent sodium citrate solution, needles for collecting and giving blood, Novocain (procaine hydrochloride), typing sera, two Higginson enema syringes, alcohol, a cleaning compound, pus basins for washing the sets, and a small Luer syringe.

A hand centrifuge was also provided for field use; this was an essential item, because the errors known to exist on identification tags required group testing before the blood was used, even though only group O blood was employed. Crossmatching was considered unnecessary.

Controversy Over Acceptance of Field Transfusion Unit

Before commenting on the controversy which arose concerning the use of the Ebert-Emerson field transfusion units, several points should be made clear:

1. There had been no previous provision in the European theater for transfusion in Army medical installations. The confusion in the theater was evidenced in December 1943, when a general hospital was informed, in response to its inquiry, that it would have to improvise both giving and receiving sets. It was also suggested that some of the hospital blood bank personnel visit the 5th General Hospital and study the field transfusion unit devised by Major Ebert and Major Emerson.

2. On 27 March 1943, Col. (later Brig. Gen.) Elliott C. Cutler, MC (25), wrote to General Hawley, theater Chief Surgeon, that standardization of a portable transfusion unit for combat areas must be undertaken in view of the reports from North Africa and Italy of the large amounts of whole blood being used in the routine of resuscitation. He had been informed by Brigadier Lionel E. H. Whitby, RAMC, in charge of the British Army blood program, that in British medical installations, the use of wet plasma had been practically abandoned in favor of whole blood.

On 22 September 1943, Colonel Cutler (25) again wrote General Hawley of the urgent need for field transfusion sets. He described the Ebert-Emerson set, listing its advantages and pointing out that it had been approved by Brigadier Whitby; by Captain Hardin, who had been working with the British Central Blood Bank at Bristol for the past 9 months (p. 470); and by members of the Professional Services Division, Office of the Theater Chief Surgeon. He recommended that this set be put in production at once for transfusion teams to use for the transfusion of severely wounded casualties with blood secured from lightly wounded casualties. He also recommended that the description of the set be sent to the Office of The Surgeon General.

3. Communications between the Office of The Surgeon General and the European theater were not always rapid, and the circular letter (No. 108, 27 May 1943, (22)) in which instructions were given for improvised equipment for blood transfusion did not reach the United Kingdom until the Ebert-Emerson set had been devised, modified, and put into its final form. On 26 August 1943, General Hawley pointed this out to The Surgeon General (26), also making it clear that local theater action had been necessary in view of the lack of any formal plan or standardized equipment for transfusions of whole blood.

4. The safety of the equipment devised had been tested by numerous transfusions on volunteers, the first transfusion with each modification of the model being given to Major Ebert and Major Emerson.

Criticism and Countercriticism

On 15 September 1943 (27), and again on 17 September (28), the Transfusion Branch, Office of The Surgeon General, declined to accept the Ebert-

Emerson field transfusion unit on the ground that it was in conflict with policies of the Office as set forth in Circular Letter No. 108. The technique described in this letter had been developed with the idea of utilizing equipment already on hand, which would require only minimum sterilization (intravenous tubing, needles, and filter). Moreover, the plans at this time did not envisage the use of whole blood forward of hospitals in which adequate autoclaving facilities would be available for sterilization of the sets.

Two specific criticisms of the Ebert-Emerson technique were made:

1. The method of sterilization was open to question. It was doubtful that rinsing with 80-percent alcohol would insure a sterile, pyrogen-free container.
2. Experience had shown that it was much safer to have a filter in the intravenous line during transfusion, to prevent the introduction of small blood clots into the recipient's bloodstream, with the risk of embolism. When blood was collected or administered by pressure bulb, it was also desirable to have an air filter in the line, to reduce the possibility of airborne contamination.

On 23 September 1943, Major Ebert and Major Emerson sent Lt. Col. Robert M. Zollinger, MC, Senior Consultant in General Surgery, European Theater of Operations, U.S. Army (29), a memorandum in which they reiterated that with the techniques which they had employed, they had never had a pyrogenic reaction. They had also had no difficulty with clots when they did not use filters, and they doubted that a clot which could pass through an 18-gage needle could produce any detectable embolic phenomena.

The following points were also stated in their memorandum:

1. It had been decided that it might be desirable to use the British Army transfusion bottle instead of the Baxter bottle in the field transfusion unit. The British bottle was already in use in the theater for stored whole blood, and it might be desirable to standardize all theater transfusion methods. More important, Baxter bottles were in increasingly short supply, and their total unavailability later might constitute an insoluble problem.
2. The transfusion techniques outlined in Circular Letter No. 108 provided for transfusions only in fixed hospitals. The Ebert-Emerson unit had been designed, at the expense it was granted, of certain traditional refinements, to meet the need for blood in more forward installations, a need repeatedly stressed in information from the Mediterranean theater.

Major Ebert and Major Emerson objected to the policies and procedures set forth in Circular Letter No. 108 for the following reasons:

1. Many of the materials specified for use were not always available, especially in forward installations. The 500-cc. plasma unit was not available in the European theater. Collection of blood in the 300-cc. distilled water flask was not practical. After 50 cc. of sodium citrate solution had been introduced into it, the amount of blood that could be collected would scarcely be worth the effort. The intravenous fluid flask used in the Ebert-Emerson set had a capacity of over a liter. Other items lacking included 50-cc. vials of sodium citrate solution with glass beads (Item No. 14306); stainless steel mesh filters in glass housings (Item No. 36099); and 15-gage needles of the 2-inch hose connector type (Item No. 33578) (fig. 52). Neither glass beads nor mesh filters (considered unnecessary refinements) were required with the proposed field unit.
2. The open technique recommended in the circular letter was likely to introduce appreciable amounts of foreign matter into the blood, especially when transfusion was necessary in dusty or sandy atmospheres. The Ebert-Emerson technique was a closed system, in which there was no risk of contamination in the receiving flask.

3. The crossmatching recommended in the circular letter was not feasible with the equipment provided for the field. The safest plan was to use O donors exclusively, rechecking their blood group by the high-titer, dried rabbit sera provided by the Army. Donors with weak A₂-agglutinogens were more likely to be identified by this technique than by crossmatching with the blood of recipients with anti-A agglutinins in low titer.

4. The airway recommended in the circular letter would cause the air pressure in the bottle to be below atmospheric pressure. This situation, plus the fact that the blood must pass through a layer of glass beads, a filter, and two needles, would materially limit the rate of administration. The flow would be further impeded by the venous constriction often present in casualties in shock, whose response to transfusion often depended upon the volume and speed of transfusion. The proposed field unit had been designed for the administration of blood under pressure, and the model finally evolved did not require suspension of the bottle.



FIGURE 52.—Hose hub type of needle designed to connect with rubber tubing.

On 27 September 1943, Colonel Cutler (30) transmitted this information through channels to the Office of The Surgeon General, expressing himself as in complete sympathy with it. He also emphasized the importance of using whole blood in forward installations, as shown by the data being received from the North African theater, and the urgency of constructing some sort of transfusion apparatus in the European theater with the materials available there.

Conference of 6 December 1943

Major Ebert was sent to the Zone of Interior on temporary duty in the late fall of 1943 (31) and attended the conference on blood transfusion equipment held on 6 December 1943 (32), in the Office of The Surgeon General. The frank discussion possible clarified many of the issues which had arisen in connection with the proposed field transfusion unit.

Major Ebert emphasized and clarified the following points:

1. The use of only proved O blood.
2. The use of the British transfusion bottle and recipient set.
3. The packing of all the components of the transfusion unit in a single unit in a single compact package, for their efficient use. Six units were packaged in each ammunition box used for this purpose.

Major Ebert pointed out that until 500-cc. plasma units were supplied to the theater, it was impossible to carry out the recommendations in the 27 May 1943 circular letter. He was told to request the theater medical supply officer to requisition a sufficient number of the larger plasma packages for all units, so that the distilled water bottle could be used for transfusion.

Since the transfusion equipment then in development in the Zone of Interior would probably not be ready for shipment until about 1 February

1944 (it was not received in the European theater until April 1944), it was agreed that the field transfusion unit devised by Major Ebert and Major Emerson should be put into production and used until expendable bottles and recipient sets could be supplied. It was suggested that he ask the theater supply officer to requisition the new equipment promptly, so that it could be shipped as soon as it became available. Major Ebert requested, and was given, samples to take back with him, so that preliminary training with the new equipment could be begun.

EXPENDABLE TRANSFUSION EQUIPMENT

The expendable equipment eventually provided for oversea theaters consisted of a donor set and a giving set, each put up in sealed aluminum foil containers (33).

Bleeding Bottles

Up to late 1944, the blood bank at the 152d Station Hospital in the United Kingdom used the dumbbell-shaped British bleeding bottles (p. 193), into which blood was drawn by gravity or with the aid of mild suction applied to the airway by a hand pump. When bottles were finally sent to the European theater from the Zone of Interior, the commercially available vacuum bleeding bottles (fig. 44, p. 178) were selected for several reasons:

1. They had been found extremely satisfactory over the previous 4 years at the Army Medical School, in the processing of liquid plasma for Zone of Interior hospitals. Blood banks in general hospitals had also used them with equal satisfaction.

2. Their use provided assurance of sterile, pyrogen-free blood and other solutions.

3. They were economical as well as safe. They were so inexpensive, in fact, that it would not be economical to return them by cargo ship or plane to the Zone of Interior for reuse. This was an important consideration. The return of needles, tubing and filters from the Continent after D-day was so slow and incomplete that it was the chief limiting factor in sending whole blood to the Continent (p. 551). By the end of June, 7,000 sets were still missing in First U.S. Army scheduled returns. These difficulties continued until blood began to be received from the Zone of Interior the last week in August.

4. Since the bleeding bottles would be used only once and would replace locally prepared equipment, they would conserve the personnel used in each installation to clean bottles and prepare solutions. When Capt. John Elliott, SnC, reported on his visit to the blood bank at Salisbury in January 1945, one of his comments was that 25 to 35 percent of bank personnel were engaged in the preparation of nonexpendable equipment (34). The change to the vacuum type of disposable bottles was therefore even more important than it might seem superficially.

Donor Set

The disposable donor set consisted of:

- One needle, 16-gage.
- One needle, 17-gage.
- One clamp, Hoffman type.
- 18 inches of rubber tubing, three-sixteenths by three thirty-seconds inch.

When the set was used, the clamp was placed on the rubber tubing near the 16-gage needle and tightened sufficiently to close the lumen. The needle was inserted through the thickest portion of the rubber stopper of the vacuum bottle. The 17-gage needle was inserted into the donor vein. The clamp was then loosened and was adjusted as necessary to control the rate of flow.

Although the donor set was considered expendable, it could be used five or six times if facilities and personnel permitted proper cleansing and sterilization.

Recipient (Giving) Set

The giving set consisted of (fig. 53):

- A filter housing and connector, glass.
- A filter, Monel metal, 100-mesh, single-layer.
- A perforated rubber stopper
- A glass connecting tube.
- An intravenous needle, hose rubber, 18-gage.
- An airway tube, metal, 18-gage.
- 36 inches of rubber tubing, one-eighth by one thirty-second inch.

The connector at one end of the glass filter housing was used to engage the bleeding bottle at the free hole. The other end was closed by the perforated rubber stopper.

The glass connecting tube was passed through the hole of the stopper and attached to the rubber hose. The 18-gage intravenous needle was attached to the other end of the hose. The Monel metal filter in the glass housing was inserted and held in place by the rubber stopper at the lower end of the housing. The filter was inverted, so that blood ran into it, thus increasing its filtration surface by about a third. The metal airway tube, after insertion, provided an outlet for the glass airway tube.

When this set was used, the glass housing was completely filled, so that there was no break in continuity of the bloodstream between the housing and the bottle. An adequate head of pressure, extending from the top level of the blood in the bottle to the lowest level of the tubing, was thus assured. This precaution was essential to provide a steady flow of blood into the vein.

Critique

It was obviously impossible to supply equipment for the European theater that would be at the same time inexpensive, complete with all refinements, and acceptable to everyone. The expendable set finally selected had an adequate



FIGURE 53.—Disposable blood transfusion (giving) set standardized for Army-Navy use, contained in aluminum tube, and complete with stainless steel filter and 17-gauge intravenous needle. A. Components of set. B. Set in use in shock ward in European theater. The blood being used has been preserved in Alsever's solution.

filtering mechanism and was so constructed that it was capable of use without difficulty not only by medical officers, many of them without special experience in this field, but also by the nurses and enlisted men who would have to administer most of the blood. It did not provide either a drip indicator or a Luer-tip glass connector for the needles. Both were regarded as unnecessary refinements. The lack of the indicator was compensated for by maintenance of a steady head of pressure. The rate of flow was automatically controlled by the gage of the needles used, which did not permit blood to be introduced into the vein rapidly enough to overload the circulation. A simple means of determining that blood was running into the vein was to place a drop of water or alcohol on the airway outlet. If it was sucked up into the glass airway tube, it was evident that suction existed and that blood was flowing out of the bottle.

Part III. Albumin Packaging

The package devised by Commander Newhouser and Colonel Kendrick was demonstrated at the Conference on the Preparation of Normal Human Serum Albumin on 5-6 June 1942 (35), and again at the Conference on Albumin Testing on 19 October 1942 (36). The corrugated fiberboard package (37) was small and compact, and had the added advantage, for Navy use, that it floated (fig. 54). Each package contained the material and equipment for three injections. Instructions for use of the albumin were lithographed on the cans.

The components of the package were:

100 cc. of 25-percent normal human serum albumin prepared from human plasma.

One double-ended glass vial, with a rubber stopper at each end.

One bale (suspension tape) for use with the ampule.

One air filter assembly consisting of a three-fourths inch, 16-gage hose hub needle; 1 inch of rubber tubing to fit the hose hub needle; and cotton to be placed in the rubber tubing to serve as an air filter.

One injection assembly, consisting of 40 inches of rubber tubing; one three-fourths inch, 16-gage hose hub needle; one plastic test tube and stopper to protect the needle; one glass observation tube with ground glass Luer-type tip, 2.5 cm. in length and 2-3 mm. in diameter; one three-fourths inch, 20-gage intravenous needle, with plastic test tube for its protection.

One metal can (three to package) for each unit of albumin. The key to open the can was spotwelded to the bottom of the can, as in the plasma package.

The metal can used in the Army-Navy serum albumin package was a standard Navy item, used for the priming charge of explosives. There was therefore no delay in its procurement. Later, in order to conserve tin, the can was electroplated. The ends were made of bonderized steel.

Note.—As a matter of convenience, special aspects of equipment are further discussed under theaters of operations and elsewhere.

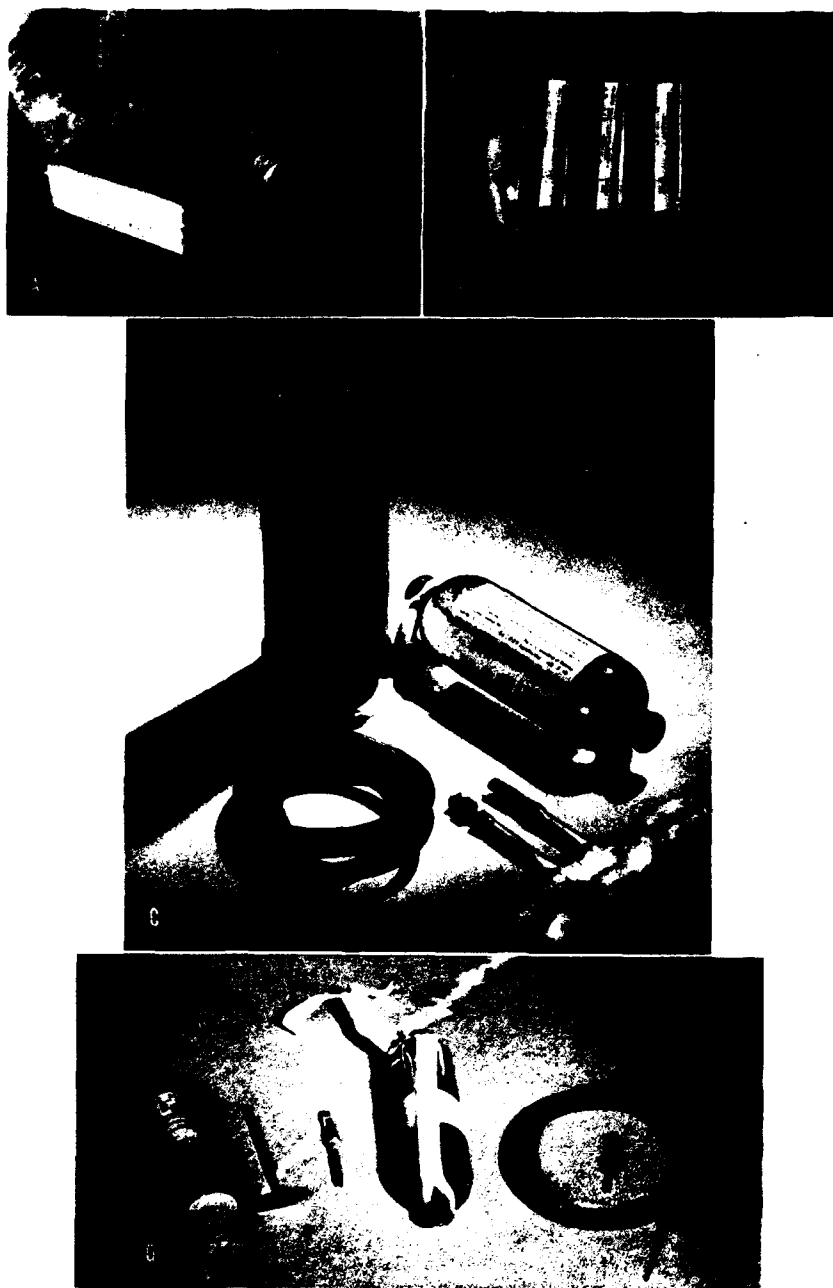

FIGURE 54.—Standard Army-Navy serum albumin package. A. Exterior of box. B. Box with cover removed to show 3 cans it contains. Each can contains 100 cc. of human serum albumin (25 percent) with equipment for its administration. Contents of each can equal a 500-cc. shock unit of plasma. C. Contents removed from can. Decal on can is instructions for administration of serum albumin by equipment shown. D. Serum albumin equipment on left, which was adopted, in contrast to equipment on right, which was originally devised (for noncombat use) but which would have been hard to package and keep sterile. Had this equipment been adopted, administration would have had to be quickly by hand, whereas equipment adopted permitted administration by gravity.

References

1. Minutes, meeting of the Subcommittee on Blood Substitutes, Division of Medical Sciences, NRC, 19 Apr. 1941.
2. Report, Subcommittee for the Standardization of Dispensing Equipment, Committee (sic) on Blood Substitutes, Division of Medical Sciences, NRC, 8 May 1941.
3. Memorandum, Col. J. H. McNinch, MC, for The Surgeon General, U.S. Army, 2 Feb. 1944, subject: Report of Deficiencies in Packaging of Human Plasma.
4. Memorandum, Lt. Col. Douglas B. Kendrick, MC, to the Chief Surgeon, European Theater of Operations, U.S. Army, 10 Mar. 1944, subject: Report of Deficiencies in Packaging of Human Plasma.
5. Minutes, meeting of Subcommittee on Blood Substitutes, Division of Medical Sciences, NRC, 23 May 1941.
6. Minutes, meeting of Subcommittee on Blood Substitutes, Division of Medical Sciences, NRC, 18 July 1941.
7. Strumia, M., Newhouser, L. R., Kendrick, D. B., and McGraw, J. J.: Development of Equipment for Administration of Dried Plasma in the Armed Forces. *War Med.* 2: 102-113, January 1942.
8. Specifications for Normal Human Plasma, Dried, No. 1546 D, 15 Apr. 1942.
9. Memorandum Report, Lt. Col. Douglas B. Kendrick, MC, to Lt. Col. Burr N. Carter [sic], 14 Dec. 1942, subject: Effect of Low Temperatures on Standard Army-Navy Dried Plasma Package.
10. Memorandum, Lt. Col. Douglas B. Kendrick, MC, for Maj. Michael E. DeBakey, MC, 1 Oct. 1943, subject: Filters.
11. Minutes, meeting of Subcommittee on Blood Substitutes, Division of Medical Sciences, NRC, 21 Apr. 1944.
12. Memorandum, Lt. Col. B. N. Carter, MC, for Chief of Inspection Branch, Plans Division, Office of The Surgeon General, 15 Oct. 1943, subject: Report of Operations on Attu.
13. Minutes, Conference on Transfusion Equipment and Procedure, Division of Medical Sciences, NRC, 25 Aug. 1942.
14. Memorandums and correspondence concerning tubing for plasma sets, 11 Sept. 1942-6 Apr. 1944. [On file, Historical Unit, U.S. Army Medical Service, Walter Reed Army Medical Center, Washington, D.C.]
15. Minutes, meeting of Subcommittee on Blood Substitutes, Division of Medical Sciences, NRC, 15 Dec. 1942.
16. Hartman, F. W.: Use of Cellophane Cylinders for Desiccating Blood Plasma. *J.A.M.A.* 115: 1989-1990, 7 Dec. 1940.
17. Minutes, meeting of Manufacturers of Dried Blood Plasma, 4 May 1942.
18. Memorandum, Col. C. F. Shook, MC, for Maj. Gen. James C. Magee, 2 Mar. 1943, subject: Specification Meeting.
19. Minutes, Blood Plasma Conference, Division of Medical Sciences, NRC, 24 Mar. 1943.
20. Letter, Col. Paul R. Hawley, MC, to The Surgeon General, 20 Jan. 1941, subject: *British Apparatus for Blood Transfusion.*
21. Minutes, meeting of Subcommittee on Blood Substitutes, Division of Medical Sciences, NRC, 9 Apr. 1943.
22. Circular Letter No. 108, Office of The Surgeon General, U.S. Army, 27 May 1943, subject: Transfusion of Whole Blood in the Theaters of Operations.
23. Minutes, meeting of Subcommittee on Blood Substitutes, Division of Medical Sciences, NRC, 13 May 1943.
24. The Development of a Field Transfusion Unit, Maj. Richard V. Ebert, MC, and Maj. Charles P. Emerson, MC, 5th General Hospital.

25. Official Diary, Col. Elliott C. Cutler, MC, Senior Consultant in Surgery, European Theater of Operations, U.S. Army.
26. 1st Wrapper Indorsement [sic], Brig. Gen. Paul R. Hawley to The Surgeon General, 26 Aug. 1943, subject: Circular Letter No. 108, OSG.
27. Memorandum, Maj. Michael DeBakey, MC, to Col. Elliott C. Cutler, MC, 15 Sept. 1943, subject: Blood Transfusion Unit.
28. Memorandum, Lt. Col. Douglas B. Kendrick, MC, to Brig. Gen. Paul R. Hawley, 17 Sept. 1943, subject: Blood Transfusion Unit.
29. Memorandum, Maj. Richard V. Ebert, MC, and Maj. Charles P. Emerson, MC, to Lt. Col. Robert M. Zollinger, MC, 23 Sept. 1943, subject: Criticism of Method of Whole Blood Transfusion in Circular Letter No. 108.
30. Memorandum, Col. Elliott C. Cutler, MC, to the Office of The Surgeon General, 27 Sept. 1943, subject: Blood Transfusion Unit.
31. Memorandum, Brig. Gen. Paul R. Hawley to The Surgeon General, 12 Nov. 1943, subject: Transfusion of Whole Blood.
32. Report, Maj. Richard V. Ebert, MC, to the Chief Surgeon, Services of Supply, European Theater of Operations, U.S. Army, for attention of Col. Elliott C. Cutler, MC, 6 Jan. 1944, subject: Conference on Whole Blood Transfusion Held in The Surgeon General's Office, 6 December 1943.
33. Kendrick, D. B., Elliott, J., Reichel, J., Jr., and Vaubel, E. K.: Supply of Preserved Blood to European Theater of Operations. Bull. U.S. Army M. Dept. No. 84, pp. 66-73, January 1945.
34. Memorandum, Capt. John Elliott, SnC, to Chief, Surgical Consultants Division, Office of The Surgeon General, through Director, Army Medical School, 1 Feb. 1945, subject: Transportation of Blood from the U.S. to the ETO Blood Bank in Paris.
35. Minutes, Conference on the Preparation of Normal Human Serum Albumin, Division of Medical Sciences, NRC, 5-6 June 1942.
36. Minutes, Conference on Albumin Testing, Division of Medical Sciences, NRC, 19 Oct. 1942.
37. Specification for Normal Serum Albumin (Human) Concentrated. 51-N-015a (INT), 8 Feb. 1943.

CHAPTER VIII

Transportation and Refrigeration

PRELIMINARY SPECIFICATIONS

The question of how blood should be transported and refrigerated came up early in the blood-plasma program. At a meeting of the Subcommittee on Blood Procurement on 18 August 1941 (1), it was formally recommended that the bottles of blood be precooled with Dry Ice before they were shipped and should be shipped under thermostatically controlled temperatures, well below 50° F. (10° C.). Rous and Turner (2) had shown in 1916 that the rate of hemolysis was much greater when blood was stored at 68° F. (20° C.) rather than at 41° F. (5° C.). The lower temperature was, of course, as important as the upper. Later, when metabolic processes were more clearly understood, it was realized that the metabolism of the red blood cells was reduced at a lower temperature and that they therefore needed less nourishment, which meant that the nutrition supplied by the dextrose in preservative solutions was more fully utilized.

In a discussion of refrigeration for the transportation of blood at the December 1943 meeting of the American Society of Refrigerating Engineers (3)—when movement of blood by air had begun to be considered—the following points were made:

1. Whole blood, to be useful and safe, must be maintained at a constant temperature of about 39° to 43° F. (4° to 6° C.).

2. This is not a problem in most hospital units since, when they are operational, electric current is available for refrigeration. The problem arises when blood must be transported.

3. One of the requirements, therefore, in a refrigerator used for blood for military purposes is a compressor capable of maintaining the temperatures just specified when the refrigerator is in transportation as well as when it is plugged into regular power outlets. This requirement means that any refrigerator which is used must be capable of operation from a small generator which can develop one-third to one-half kilowatt of power and can also provide 110-volt, 60-cycle alternating current.

4. The refrigerator selected must be sturdy and well insulated, so that the temperature in it will remain at the desired level when it is used in climates in which the ambient temperature may rise to 130° F. (54° C.). The cabinet must be about 3.5 to 4 cu. ft., to accommodate 40–50 bottles of blood. Because of the weight limitation on cargo for planes, even of the largest type, it is desirable that the box should not weigh over 80 pounds.

A refrigerator which met these specifications for the air transport of blood was not developed by the Army during World War II (p. 208). The program for providing whole blood for oversea theaters did not become a complete reality, however, until, in addition to the development of equipment for collecting and administering blood, means of refrigeration had been developed for its storage and preservation during the airlift (p. 214).

TRANSPORTATION IN THE ZONE OF INTERIOR

Railway Shipments

The original arrangements were that blood should be shipped from Red Cross donor centers in various cities to the processing laboratories by the Railway Express Agency, Inc., in Church containers (4). These refrigerated containers (fig. 55) had been devised by Maj. Elihu Church, president of the Church Co., for food. From the standpoint of safe transportation and refrigeration, they proved admirably adapted for the rail transportation of blood in the Zone of Interior. They had certain disadvantages, however, including their cost, their excessive weight, and their limited number.

By March 1943 (4), shortages of Church containers had become critical. Schedules of shipment of the containers between laboratories and centers were not being maintained, especially on the east and west coasts, even though more than 300 of the 450 Church containers then in use had been assigned to the blood-plasma program. The Red Cross considered it essential that a pool sufficient for at least one day's supply of blood be maintained at each donor center.

Action was taken to improve the situation at a meeting in the main (New York City) office of the Railway Express Agency on 5 March 1943, attended by the chief of the eastern division of the agency; Major Church; Dr. (later Major, MC) Earl S. Taylor, representing the American Red Cross; and Col. Charles F. Shook, MC, representing The Surgeon General. All district managers of the agency were informed of the urgency of the situation and were instructed to give first priority to blood shipments and to expedite the return of empty containers. Arrangements were also made to expedite the repair of damaged containers.

At this time, 100 additional containers were in process of manufacture. Later, the shortage of containers was called to the attention of a representative of the War Production Board, with special emphasis on the urgent necessity of refrigeration of the blood, particularly during long hauls.

By the end of 1943, all but 37 of all the Church containers in the country were being used by the American Red Cross. By the middle of 1944, enough were available to transport all the bloods being procured each week. Adequate reserves were maintained at strategic points, and repair parts were also in adequate supply.



FIGURE 55.— Shipping room of American Red Cross Blood Donor Center, Louisville, Ky., showing Church container used to transport blood from centers to processing laboratories.

An article published in the *General Electric News* was intended to stimulate the interest of the workmen making the Church containers by explaining their own vital role in the blood-plasma program. Major Church had reprints of the article made for distribution to all employees of the Railway Express Agency who had any connection with the shipments of blood from the centers to the processing laboratories.

Truck Shipments

In June 1944, Dr. Milton V. Veldee complained to Maj. Frederic N. Schwartz, MAC, in the Office of The Surgeon General, and to Dr. G. Canby Robinson and Major Taylor of the American Red Cross that blood was being shipped from certain donor centers to the processing laboratories by truck

instead of by Railway Express and sometimes had to be iced two and three times along the way (5). The laboratories had complained of the arrangement and Dr. Veldee objected to it on several grounds:

1. A great deal of experimentation had gone into the development of the Church container, which had proved, on the whole, very acceptable for both summer and winter shipments. Before any new arrangements could be accepted, it would be necessary to study the physical condition of the blood shipped under them in all weather conditions, which would require at least a year. Meantime, the National Institute of Health specifications, which had been somewhat liberalized since the start of the program, must be observed.

2. The Red Cross should not lend itself to scrapping a well organized and smoothly functioning service in favor of a new and untried method, which involved factors with such high war priorities and critical shortages as gasoline, trucking equipment, and manpower.

3. While there was probably no legal, contractual reason why the Red Cross should not cancel its agreement with the American Railway Express Agency, Inc. and the Church Co., both had given splendid cooperation.

As a result of Dr. Veldee's protest, all blood donor centers reverted to the original arrangements for transportation and refrigeration, and they remained in effect until the end of the war.

Refrigeration in the Zone of Interior of blood designed for the oversea airlift is discussed under that heading.

STATUS OF REFRIGERATION, 1943-AUGUST 1944

Airlift Requirements

After attending a conference in the Aero-Medical Laboratory at Wright Field, Dayton, Ohio, on 25 October 1943, Maj. (later Col.) Douglas B. Kendrick, MC, recommended (6) that a refrigerator developed by the Airtemp Division, Chrysler Corp., Dayton, Ohio, for the transportation of frozen biologicals in airplanes be modified for the similar transportation of blood (fig. 56). The Chrysler representatives did not think it would be possible to make the refrigerator specified by the Medical Department (1 cu. ft., 80 lb.), and an attempt at development would take 4-6 months. The Chrysler box was already in production. No action had been taken on Colonel Kendrick's recommendation when the airlift to Europe began in August 1944.

Field Requirements

Standard refrigeration was satisfactory for the storage of blood in hospitals and was part of authorized equipment. A refrigerator for use in the field, however, had to be operated by a gasoline generator as well as by the usual power outlets, to provide for the time it was being transported in trucks. The Division of Surgical Physiology, Army Medical School, working in conjunction with Mills Industries, Inc., Chicago, developed an electric refrigerator of 4-cu. ft. capacity, which held 50 bottles of blood. It operated on 110-volt,



FIGURE 56.—Lightweight aluminum refrigerator (Chrysler) developed by the Army Air Forces. A. Refrigerator open. B. Refrigerator closed. C. Compressor.

60-cycle A.C. current supplied by the usual power outlets or by a 750-watt (1 hp.) generator.

On 23 November 1943, Mills Industries was given a letter of intent for the purchase of this whole blood cabinet, to be delivered within 4 weeks (7). On 25 May 1944, in response to a letter from the Director, Technical Division, Office of The Surgeon General, Colonel Kendrick (8) recommended that this refrigerator (with other transfusion equipment) be standardized. The recommendation was approved, but at this time, less than 2 weeks before D-day, only a prototype existed. This box was later produced in quantity and is still (1962) in use.

THE AIRLIFT TO THE EUROPEAN THEATER

The Decision to Fly Blood Unrefrigerated in Flight

When the airlift of blood to the European theater ceased to be academic in August 1944 and became a matter of extreme urgency, two matters had to be settled immediately. The first was the preservative solution to be used (p. 224). The second was the possible risk of flying blood, even if refrigerated again immediately before enplanement and refrigerated immediately after deplanement, without refrigeration in transit. One problem was intimately related to the other.

At this time, no action had been taken on the Chrysler refrigerator recommended in November 1943 for use in transportation of blood in planes (6). The Division of Surgical Physiology, Army Medical School, had been working with Engineers' Development Laboratory, Armed Services Medical Procurement Agency, Fort Totten, N.Y., on a fiberboard container for this purpose, but it was not ready for use. It is hard to explain why, long after an efficient insulated box was in use in the Mediterranean theater (p. 417), and long after blood was being flown to the Pacific Ocean Areas by the Navy in an efficient insulated box (p. 213), the Army was flying blood to Europe without refrigeration. Furthermore, the Navy was using ACD (acid-citrate-dextrose) solution as a preservative, which materially reduced the space occupied by each bottle, while the Army was still using Alsever's solution, which was not so effective a preservative and which required considerably more space for each bottle.

When the question of flying blood to Europe came up in August 1944 (about 8 months after the proposal had previously been rejected (p. 465)), those responsible for the blood program in the Zone of Interior were faced with an extremely difficult decision: Would the urgent need for whole blood in the European theater be more adequately met by sending 450 pints of blood daily under refrigeration, or by sending 900 pints daily without refrigeration during the flight period of transportation? Military necessity often forces undesirable compromises, and here there was never any question that the wiser decision was to send the larger amounts.

It is easy to say, long after the end of the war, that the decision should never have had to be made. That is entirely true. On the other hand, the plan was not adopted either recklessly or hastily. There was ample evidence to support the belief that while lack of refrigeration in flight was an undesirable alternative, it was a perfectly safe plan (p. 211). If 600-cc. bottles had been available and if ACD solution had been approved then, the plan employed would not have been adopted. At the time, however, it was the only reasonable solution, and it was safe within the framework of the methods employed.

There was no question in the minds of those who had to make the decisions that (1) fresh blood was best for wounded casualties and (2) that blood kept under refrigeration at every stage until it was used was more desirable than blood not constantly under refrigeration. A condition, however, not a theory, was confronting those responsible for getting the blood to Europe, and their decision was:

1. That if blood were put in Alsever's solution and were kept refrigerated until it was placed aboard the plane, it could safely be flown across the ocean unrefrigerated during the 16-24 hours, or sometimes longer, taken for the flight.

2. That if the blood were then replaced under refrigeration, it could be safely used for 21 days from the date of collection. Later, after the program had become so efficient that the blood became available in Europe within 4-6 days after it had been collected, or even earlier, this interval was reduced to 18 days.

Objections to the Plan

At a conference held in the Office of The Surgeon General on 15 August (9) and attended by Col. (later Brig. Gen.) Elliott C. Cutler, MC, Col. William F. MacFee, MC, 2d Evacuation Hospital, and Maj. Robert C. Hardin, MC, these officers stated that they considered sending blood overseas without refrigeration an unsafe practice, which they were unwilling to accept. They were given the following explanation of, and justification for, the plan:

1. The blood would be delivered in 1,000-cc. bottles containing 500 cc. of blood and 500 cc. of Alsever's solution. The bottles would be refrigerated before and immediately after the blood was collected and would remain under refrigeration until they were placed on board the plane. They would be refrigerated at Prestwick, shipped by air to the Continent in refrigerated cans, refrigerated again at the blood depot, and then delivered to forward areas in refrigerated cans. Thus, the only time the blood would not be under refrigeration would be during the Atlantic crossing.

2. Blood collected in Alsever's solution had been shipped without refrigeration from the Army Medical School to Prestwick and back to the school; there, tests showed that the supernatant plasma contained no more than 28 mg. of hemoglobin per 100 cc. Blood in the same solution had been shipped unrefrigerated to Bermuda, Los Angeles, and Hawaii and had been off refrigeration for as long as 5 days. At the end of this period, the supernatant plasma

contained no more than 25 mg. of hemoglobin per 100 cc. No reactions of any kind had followed transfusions with this blood on three separate patients.

3. When blood collected in Alsever's solution and kept off refrigeration for periods ranging up to 72 hours was tested for hemolytic change, it was found that it could be stored safely for up to 8 days, against safe periods of 21 days with refrigeration.¹

4. For the past year, liquid plasma prepared at the Blood Research Division, Army Medical School, had been obtained from unrefrigerated blood, kept at room temperatures, 70° to 90° F. (21° to 32° C.). When the unrefrigerated red blood cells, which were resuspended in isotonic sodium chloride solution, were used after 5 days' storage, the reaction rate was comparable to, or lower than, the rate after transfusion with refrigerated red blood cells. The increase in the recipient's red blood cell count and hemoglobin level was also comparable to the increase observed after the use of refrigerated red blood cells.

5. Although it was granted that proof of safety would be obtained only after actual experience with large amounts of blood, the proposal to fly blood unrefrigerated to Europe during flight was considered safe because the only difference between using unrefrigerated blood and red cells in the Zone of Interior and using them abroad would seem to be the conditions to which the blood would be subjected during flight.

Other Studies on Refrigeration

Numerous studies made before the war, particularly at the State University of Iowa (p. 220), on the effects of refrigeration on blood have been mentioned in other connections. One or two other studies might be cited:

Bushby and his associates (10) studied storage of blood at various temperature levels. They showed that rapid cooling of the blood immediately after collection was not harmful but that undue delay in refrigeration (up to 24 hours) had deleterious effects; that cooling to 32° F. (0° C.) for 2 days before storage at 39° F. (4° C.) did no harm, nor did warming to room temperature after 4 days' storage at this level; and that it was apparently safe to remove a bottle of blood from the refrigerator, let it warm, and then store it again.

At the Conference on Blood Preservation on 19 January 1945 (11), when blood was already being flown to Europe without refrigeration en route, Dr. J. G. Gibson, 2d, reported observations on 10 blood specimens shipped by air under refrigeration. The amount of free hemoglobin in the plasma was 8-13 mg. percent, and survival of the red cells after transfusion was excellent. In contrast, blood shipped by plane to Paris and return, without refrigeration either way, was found greatly deteriorated; it had been 11 days in transit.

¹ It should be emphasized that these tests were made simply to determine the theoretic safety of keeping blood unrefrigerated for certain periods of time if logistic restrictions proved overriding and it became necessary to use this method. It was clearly understood, by all concerned with the program, that blood should be kept at a constant temperature.

At this same conference, Lt. Cdr. Eugene L. Lozner, MC, USN, reported observations on transfusions carried out with blood collected in ACD solution in Washington and on the west coast, shipped to Guam in Navy refrigerated boxes, and then shipped back to the Naval Medical School in Washington. Filtration through the recipient apparatus was good. Blood in which less than 2 percent of the red cells were hemolyzed produced no untoward reactions. Recipients who were given blood more than 28 days old showed bilirubinemia but no hemoglobinemia.

STUDIES ON UNREFRIGERATED BLOOD FLOWN TO THE EUROPEAN THEATER

Numerous studies were made on blood flown unrefrigerated across the Atlantic, beginning with samples from the first shipments (12). Tests at the blood bank at Salisbury showed that the fragility of the red blood cells and the amount of free hemoglobin released compared very favorably with the same tests on blood collected in the European theater.

Temperatures on the transocean flight.—A formal test on the temperatures of blood in transit without refrigeration was made in January 1945 by Capt. John Elliott, SnC, Assistant in the Division of Surgical Physiology, Army Medical School. He reported to Brig. Gen. Fred W. Rankin, through the Director of the School, on 1 February 1945, as follows (13):

A shipment of blood collected in Washington and Baltimore on 12 January 1945 was accompanied to Paris and observed along the way. The total time in transit was 6 days and 12 hours. The scheduled flight time from the United States to Paris was 28 hours, but all crews questioned agreed that it was not unusual during the winter for planes to be delayed en route for 1 to 5 days.

The first crew turned on the heat in the plane immediately after it took off from Washington. This crew, like the second, which took over at the Azores, stated that their instructions were to maintain a temperature above freezing but that they had had no information about a safe upper limit. The blood was transported during the entire trip at a temperature below 54° F. (12° C.), with the lower limit 46° F. (8° C.), except for a single period of 6 hours, during which the range was 61° to 81° F. (16° to 27° C.). During the first 4 hours of the flight, the temperature range was 46° to 54° F. (8° to 12° C.) except for 2 hours on the ground at Bermuda, when it rose to 81° F. (27° C.). At Saint Mawgan, England, where the plane was delayed for almost 5 days, the outside temperature was between 32° and 46° F. (0° and 8° C.) and the blood was kept aboard.

During the stop at Saint Mawgan, Captain Elliott was able to discuss the transportation of whole blood with several crews from Army planes and from Transworld and American Airlines planes. Army pilots had instructions to maintain temperatures between 37° and 48° F. (3° and 9° C.); one of them had the instructions posted in the cabin. Commercial pilots had no written instructions but had been told verbally to maintain temperatures above

freezing. These data were confirmed by crews questioned on the return trip.

According to Captain Elliott's information, only one shipment of blood had been delayed at Bermuda during the operation of the program to date. During December and January, 12 shipments had been delayed at the Azores, and during December, 19 had been held over at Saint Mawgan. No information could be secured concerning delays at Stephenville, Newfoundland, or Prestwick, Scotland.

The commanding officers at the hospital in Bermuda and the dispensary in the Azores and the flight medical officer at Saint Mawgan had all been told to offload blood and store it under refrigeration if a plane was to be held more than 2 hours. There was ample refrigerating capacity at all of these stations, and the excellent cooperation of priorities, traffic, and medical officers insured the proper handling of the blood while the planes were on the ground.

Refrigeration in the European theater.—The 400 to 500 bottles of blood collected daily by the blood bank at the 152d Station Hospital at Salisbury were flown to Paris in iced marmite cans (fig. 120, p. 534). Refrigeration facilities there, at the continental section of the blood bank, were practically unlimited. The 300 to 400 bottles of blood collected locally and the blood received from the Zone of Interior were sent forward in refrigerators mounted on trucks. The blood from Salisbury was shipped in the marmite cans in which it was received; these cans held sufficient wet ice to maintain desired temperatures for 24 hours or more.

Though the Paris operation was a very large one—up to 31 December 1944, the bank had received 28,974 bottles of blood from the Zone of Interior, and, for the first 25 days of January, it had received 21,677 bottles—there had been no losses from lack of refrigeration.

Recommendations

In the report of this tour of inspection, Captain Elliott made the following recommendations, based on his observations:

1. All shipments of blood from the United States should be accompanied by a numbered manifest stating the time and place the blood was collected, the storage temperature at the airport, the time of departure from the United States, temperature readings at 2- or 3-hour intervals during the crossing, storage temperatures during delays on the ground, and any other pertinent information containing temperature and storage conditions.

With these data, the Paris Blood Bank would have a record of the temperatures at which the blood had been maintained from collection to delivery and, depending upon the length of time optimum temperatures had been maintained, could determine whether the present 16-day dating period could be safely extended to 21 days. Major Hardin hoped that this system would be instituted as soon as possible.

2. All plane crews should be given uniform instructions concerning the proper temperatures to be maintained in planes flying blood.

3. Refrigeration during transportation should be provided as soon as possible.²

² Captain Elliott recommended an immediate 5-percent increase in the daily airlift to Paris and also recommended, in view of an imminent request to increase shipments by 20 percent, that plans be set in train at once to implement this increase.

On 1 February 1945, Maj. John J. McGraw, Jr., MC, Acting Chief Division of Surgical Physiology, Army Medical School, made the following comments on this report, through the Director, Army Medical School, to the Chief, Overseas Branch, Issue Section, Supply Division, Office of The Surgeon General, and to General Rankin (14):

On the basis of this report, there was no doubt that the Air Transport Command was carrying out a most efficient operation in the airlift of blood to Europe. To increase the efficiency and safety of the operation, it was recommended:

1. That Captain Elliott's recommendations concerning the maintenance of a temperature chart for the airlifted blood be instituted at once and that the chart originate with the center collecting the blood.

2. That the responsibility for handling blood be fixed at all stages en route and that those responsible be instructed to keep the temperatures of the blood as far as possible between 39° and 50° F (4° and 10° C.).

These recommendations were put into effect on 17 February 1945.

EXPENDABLE REFRIGERATION CONTAINERS FOR THE OVERSEA AIRLIFTS

One highly favorable circumstance in the program of blood for Europe was that shipments began in late August and most of the bloods flown across the Atlantic without refrigeration were moved during the coldest part of the year, when overheating of the blood was unlikely. During this interim, active work continued on an expendable iced container, which was ready in the spring, when warmer weather began. Also during this period, the Navy accumulated sufficient experience flying blood to the Pacific in ACD solution to produce statistical evidence of its safety. The use of this solution permitted a reduction of 400 cc. in the size of the bottle, which largely compensated for the additional space occupied by the iced containers.

Containers

Navy container.—The Navy expendable refrigerated box was put into use as soon as the Navy airlift of blood to the Pacific began in November 1944. Trial runs began in September. When the insulated chests were demonstrated by Capt. Lloyd R. Newhouser, MC, USN, at the Conference on Blood Preservation on 19 January 1945 (11), about 19,000 bloods had been shipped in them by plane from San Francisco to Pearl Harbor, re-iced there, and then flown on to Guam, and thence to more forward points. The overall rate of discard had been 1.7 percent, and the reaction rate in about 6,000 transfusions had been 2.7 percent.

The Navy chest (fig. 140, p. 612) was made of plywood insulated with 3 inches of Fiberglass. It weighed 87 pounds packed and occupied 5.9 cubic feet. Inside, a galvanized iron receptacle contained a central canister filled

with 15 pounds of ice and had space for sixteen 600-cc. flasks of blood in ACD solution.

Testing had been rigorous and had included parachute drops, without damage. The observations of Lt. (later Lt. Cdr.) Henry S. Blake, MC, USN, on a test shipment had shown that temperatures within the chest were maintained at 45.5° to 48° F. (7.5° to 9° C.).

Army container.—The Army container (fig. 182, p. 762), as finally developed, was made of reinforced (double) cardboard, insulated with aluminum foil and cotton batting. It was both flameproof and moistureproof. Like the Navy box, it occupied 5.9 cubic feet. It was fitted with wire racks which held 24 recipient sets and twenty-four 600-cc. bottles of blood in ACD solution. The compartment for ice held 19 pounds, and both icing and re-icing were simple. The empty box weighed 35 pounds and, with its contents, about 105 pounds. The shipping weight per bottle was thus only 4 pounds, against 5½ pounds per bottle for the Navy container.

The date and hour of packing were recorded on the instruction sheet on the lid of the box. Also recorded were the date and hour (about 48 hours later) when re-icing would be necessary if the box had not arrived at its destination.

Ice was supplied to the bleeding centers at Boston, New York, and Washington in the amount of about 1,000 pounds each per day. The blood was refrigerated as soon as it was collected, and the containers were re-iced as necessary before they were placed on the oversea planes and again after they were removed. Re-icing en route was cared for, by arrangement, by the Air Transport Command and the Naval Air Transport Service.

Specific instructions were given to all bleeding centers for the correct handling of the insulated boxes and the new solution bottles.

These containers proved entirely satisfactory throughout the remainder of the airlift. They also proved useful to oversea organizations, such as clearing stations, which had no refrigeration, as well as to installations in which refrigerating space was limited. The only real objection to them concerned their original color, a light, glossy tan. On occasion, stacks of empties in the field attracted enemy planes on strafing missions, particularly on moonlight nights. Advanced blood banks in the European theater quickly learned that these boxes must be camouflaged or destroyed. The same complaint was made about Navy boxes in the Pacific. Later, all containers were painted olive-drab.

Changeover to Refrigerated Containers and ACD Solution

The Reynolds Metal Co., without waiting for a formal order, provided six insulated sample containers, and they were shipped to Paris, two a day, on 26, 27, and 28 February. Each contained 24 bottles of blood. Observations en route and at the Paris Blood Bank indicated an entirely satisfactory per-

formance (15). The temperature was at all times within the required range (39° to 50° F., 4° to 10° C.), and refrigeration lasted longer than the period set forth in the specifications for the containers. At the end of the longest run, 64½ hours, the box still contained 10–12 pounds of ice, and all the bloods in it were in excellent condition.

Meantime, arrangements were made in the Zone of Interior for requisitioning the necessary containers and also for the changeover from Alsever's to ACD solution. All changes had to be carefully integrated with each other: The blood had to be flown to Europe daily; it could not be held over. Most centers did not have storage facilities for more than a 3-day supply of containers. Orders for the larger bottles of blood, containing Alsever's solution, had to be canceled, but only just in time for the bottles containing ACD solution to be read in correlation with the delivery of the containers.

On 24 March 1945, Maj. Gen. Paul R. Hawley made the urgent request of The Surgeon General that, beginning at once, all blood shipped to the European theater be refrigerated and be put up in ACD solution (16). Alsever's solution, he said, had been satisfactory in respect to cell survival in the recipient within the age limits used, but the pressing need for refrigeration made it advisable to change to ACD solution, to reduce the volume of shipments but permit shipment of the same amount of blood. The theater experience with ACD solution had been too small for valid comparison with Alsever's solution, but he was willing to accept the NRC (National Research Council) pronouncement that it was at least as satisfactory.

When General Hawley made this request, practically everything in the Zone of Interior was ready for the changeover to ACD solution and the use of expendable insulated containers. In fact, a radiogram had already been sent to him on 19 February 1945, from the Office of The Surgeon General, informing him that the 1,200 bloods delivered daily to Paris unrefrigerated and in 1,000-cc. bottles in Alsever's solution would shortly be replaced by the same number in 600-cc. bottles in ACD solution and in insulated, expendable containers. The total weight requirement of each shipment would be 5,000 pounds and the total space requirement 320 cu. ft.

The new plans were put into effect on 1 April 1945, and the first blood was flown from the east coast to Europe under these arrangements on 9 April 1945.

Flying chilled blood to Europe on planes without refrigeration was a highly successful expedient. That it succeeded does not make the plan either wise or desirable. All future programs for the use of whole blood should include provisions for constant, reliable refrigeration.

On the other hand, this unrefrigerated blood saved an untold number of lives that would have been lost if, because refrigeration was lacking, no blood at all had been flown to Europe.

References

1. Minutes, meeting of Subcommittee on Blood Procurement, Division of Medical Sciences, NRC, 18 Aug. 1941.
2. Rous, P., and Turner, J. R.: The Preservation of Living Red Blood Cells in Vitro. I. Methods of Preservation. *J. Exper. Med.* 23: 219-237, February 1916.
3. Kendrick, D. B.: Refrigeration Applications for Blood Plasma and Biologicals. *Refrigerating Engineering* 47: 33-39, January 1944.
4. Memorandums and correspondence on transportation of blood in Church containers, 5 Mar. 1943-15 Dec. 1943. [On file, Historical Unit, U.S. Army Medical Service, Walter Reed Army Medical Center, Washington, D.C.]
5. Memorandums and correspondence on shipment of blood by trucks, 9 June 1944-8 Aug. 1944. [On file, Historical Unit, U.S. Army Medical Service, Walter Reed Army Medical Center, Washington, D.C.]
6. Memorandum, Lt. Col. Douglas B. Kendrick, MC, to Chairman, Medical Department, Technical Committee, Office of The Surgeon General, 15 Nov. 1943, subject: Military Characteristics of Refrigerator for Frozen Biologicals.
7. Letter of Intent, Lt. Col. Douglas B. Kendrick, MC, to Mills Industries, 23 Nov. 1943, subject: Purchase of "Whole Blood Cabinet."
8. Memorandum, Lt. Col. Douglas B. Kendrick, MC, for Director, Technical Division, Surgeon General's Office, 24 May 1944, subject: Blood Transfusion Equipment, Field.
9. Memorandum, Lt. Col. D. B. Kendrick, MC, for Brig. Gen. Fred W. Rankin, 23 Aug. 1944, subject: Conference on Supply of Whole Blood for the ETO.
10. Bushby, S. R. M., Kekwick, A., Marriott, H. L., and Whitby, L. E. H.: Survival of Stored Red Cells After Transfusion. *Lancet* 2: 414-417, 5 Oct. 1940.
11. Minutes, Conference on Blood Preservation, Division of Medical Sciences, NRC, 19 Jan. 1945.
12. Kendrick, D. B., Elliott, J., Reichel, J., Jr., and Vaubel, E. K.: Supply of Preserved Blood to European Theater of Operations. *Bull. U.S. Army M. Dept.* No. 84, pp. 66-73, January 1945.
13. Memorandum, Capt. John Elliott, SnC, to Chief, Surgical Consultants Division, Office of The Surgeon General, through Director, Army Medical School, 1 Feb. 1945, subject: Transportation of Blood from the U.S. to the ETO Blood Bank in Paris.
14. Memorandum, Maj. John J. McGraw, Jr., MC, for Chief, Overseas Branch of Issue Division, Supply Section, Office of The Surgeon General, 1 Feb. 1945, subject: Report of Trip to ETO Blood Bank.
15. Memorandum, Capt. Leslie H. Tisdall, MC, for Chief, Development Branch, Office of The Surgeon General, 8 Mar. 1945, subject: Test Shipment of Refrigerated Blood.
16. Memorandum, Maj. Gen. Paul R. Hawley to The Surgeon General, 24 Mar. 1945, subject: Refrigeration of Blood for Trans-Atlantic Shipment.

CHAPTER IX

Preservative Solutions

DEFINITIONS AND CRITERIA

As pointed out elsewhere, there is a distinction between stored blood and preserved blood that is not always observed but that always should be. Muether and Andrews (1), whose extensive studies in this field will be mentioned later, were among the first to point it out. Stored blood is citrated blood which has been kept for hours or days, at temperatures between 36° and 46° F. (2° and 8° C.), and to which nothing has been added to inhibit deterioration of the erythrocytes; sodium citrate is an anticoagulant, not a preservative. Preserved blood is blood to which some additional substance has been added to check disintegration of the erythrocytes. It was the solution of the problem of halting this disintegration that made possible the use in oversea theaters of whole blood flown from the United States.

While varying criteria have been advanced for safe and effective preservation of blood, the following met essential military requirements:

1. The blood must be collected in a closed system and handled as little as possible at every step of processing to avoid contamination.
2. It must be kept at a low, constant temperature from collection to administration.
3. The technique of preservation must be simple and inexpensive.
4. The preserved blood must maintain to a high degree the properties of fresh blood if it is to serve its therapeutic purpose. This purpose can be accomplished only if the blood shows a low rate of hemolysis and a high rate of red blood cell survival.
5. The ultimate fate of transfused red blood cells determines the effect of the transfusion upon the recipient.

Red blood cell survival has been studied in detail by a number of observers, beginning in 1919 with Ashby (2), whose differentiation agglutination technique is still regarded by many observers as more efficient than the modern radioactive cell-tagging technique (p. 221) because the Ashby technique permits the observer to follow the red cells through their lifespan.

HISTORICAL NOTE

First Studies on Hemolysis

When Rous and Turner (3, 4), in 1916, published their work on the preservation of living red cells in vitro, they had been able to find only a single

report on this or any other related study except the demonstration, in 1914, by Abel, Rowntree, and Turner (5), that only formed elements of the blood need to be replaced in healthy animals depleted by hemorrhage.

The results of the Rous-Turner studies were as follows:

1. The rapidity of hemolysis was generally increased when only electrolytes were added to the blood. When sodium citrate was used, human red blood cells tended to break down rather rapidly; disintegration occurred relatively early even when the smallest quantity that would prevent clotting was used.
2. Hemolysis was greatly diminished when saccharose or dextrose was added to the citrated blood. Human red blood cells remained intact for about 4 weeks when a solution was used consisting of two volumes of 3.8-percent sodium citrate solution and five volumes of 5.4-percent dextrose solution for every three volumes of blood.
3. The most effective preservative solutions were approximately isotonic with blood serum.

Robertson (6), in 1917, applied the technique of Rous and Turner in what amounted to the operation of the world's first blood bank, in casualty clearing stations of the British Army (p. 5).

Introduction of Sodium Citrate

The first step on the road to the therapeutic use of blood in World War II battle casualties was the successful use of citrated blood in 1914 at Mount Sinai Hospital, New York City (7-9).

In a retrospective view of his experiences, published in 1958, the late Dr. Richard Lewisohn (10), who is generally credited with the introduction of the method, pointed out that the famous British obstetrician, Braxton Hicks, used sodium citrate as an anticoagulant in 1869 but that a number of fatalities forced him to abandon it.

Later experiments by other observers with hirudin, sodium oxalate, and peptone showed all of these agents to be too toxic for clinical use. Sodium citrate, usually in 1-percent concentration, had long been used as an anticoagulant in blood collected for laboratory purposes, but this concentration, which was assumed to be necessary to prevent coagulation, was also assumed to be too toxic for human administration. By a careful series of animal experiments, Lewisohn showed that a concentration of 0.2-percent sodium citrate was sufficient to prevent coagulation of blood in vitro for 2 or 3 days. His clinical studies showed that up to 5 gm. of sodium citrate could be safely introduced into adults intravenously, though, paradoxically, its introduction caused a temporary shortening of the recipient's own coagulation time. It was thus possible to transfuse as much as 2,500 cc. of blood at a time—and that, added Lewisohn, quite unprophetically, "is more than anybody ever wants * * * to introduce into the recipient" (10).

In his 1958 communication (10), as well as in his original report in January 1915 (7), Lewisohn pointed out that results identical to his own had been published by Agote in Buenos Aires in the same month his report was published.

In his 1915 communication, he also acknowledged the work of two other observers: In March 1914, Hustin, in Brussels, had treated a patient with blood mixed with glucose and sodium citrate. In January 1915, Weil (11) published the report of an earlier report before the New York Academy of Medicine dealing with the use of citrated blood at General Memorial Hospital. He used a 10-percent citrate solution, in the proportion of 1 cc. of solution to 10 cc. of blood, and gave transfusions of as much as 350 cc. from 3 to 5 days after the blood had been collected.

Over forty years later (10), Lewisohn's philosophic reaction to these various reports about the same time as his own was that when an idea is ripe, it occurs to a number of persons at the same time.

For a time, it seemed that reactions to the use of citrated blood might destroy the usefulness of the method. It was evident, however, that citrate played no part in the chills when Lewisohn and Rosenthal (12), also at Mount Sinai Hospital, demonstrated that reactions were not caused by sodium citrate but by pyrogens present in carelessly cleaned transfusion equipment. When a special department was created to handle the equipment, the incidence of posttransfusion chills fell from 12 percent to 1 percent. Many years later, when the Mount Sinai technique was introduced in a hospital in Novgorod, by Satunov, the incidence of reactions there fell from 53 percent to 2 percent.

Preservatives Between the World Wars

The Rous-Turner solution was widely used in the United States between the World Wars, but it was difficult to prepare; the bulk of the final solution was undesirably large; and the concentration of plasma was so dangerously high that the plasma had to be discarded (13, 14). The solutions introduced by Perry (15), at the Moscow Institute of Hematology (M.I.H. solution) (16), and by Gnoinski of Warsaw all had very undesirable features.

DeGowin, Harris, Plass, and their associates used a modification of the Rous-Turner solution, consisting of 3.2-percent trisodium citrate in 100 cc. of water; 5.4-percent anhydrous dextrose in 650 cc. of water; and 500 cc. of blood. This gave a total volume of 1,250 cc., and a blood-diluent ratio of 1.5:1. The solution preserved red cells *in vitro* quite as well as the Rous-Turner solution; produced satisfactory clinical results; and had the advantage of conserving the plasma, which had to be discarded when the Rous-Turner solution was used.

From their reviews of the literature and their own experience, DeGowin and his associates drew the following conclusions (13, 14, 17):

1. Progressive hemolysis occurred in human blood in all the preservatives studied and was much greater when the blood was stored at 68° F. (20° C.) rather than at 41° F. (5° C.).
2. The addition of large quantities of isotonic dextrose solution slowed the rate of hemolysis considerably as compared with the rate in blood stored with little or no added dextrose.

3. Hemolysis was much less in blood stored in sealed flasks from which air was completely excluded.

4. Erythrocytes stored in the DeGowin et al. solution resisted destruction by shaking better than those stored in citrate alone or in saline. These observers used blood stored in their own solution up to 38 days with no reactions.

TRANSPORTABILITY OF WHOLE BLOOD

At the first meeting of the Committee on Transfusions, NRC (National Research Council) on 31 May 1940 (18), and the first meeting of the Subcommittee on Blood Substitutes on 30 November 1940 (19), much of the discussion concerned improvement of methods of preserving whole blood, both to increase the safe period of its use and to make it safely transportable. As was pointed out at a later conference (20), the decision to use preserved blood in wartime would make a great deal of difference in its availability at many points at which the wounded would be treated; the question was not one of advisability but of feasibility.

In 1940, there was very little authoritative information on the transportability of whole blood, though as Lewisohn pointed out in 1958 (10), in 1916 Brem had collected blood in citrate solution in his office and taken it by plane to a patient in another city. Blood had also been transported by the British Medical Service in World War I (p. 6).

At both of the meetings just mentioned, work carried out at the State University of Iowa, by Drs. Everett D. Plass, Elmer L. DeGowin, Robert C. Hardin, and their group, was summarized; it was reported in the literature the following year (14). Between 1 September 1938 and 17 November 1940, 2,123 transfusions had been given with blood preserved in the DeGowin modification of the Rous-Turner solution, with 4.1 percent of reactions and with highly satisfactory clinical results. Optimum inhibition of hemolysis during storage required a dextrose concentration of at least 3 percent, though, as British workers had shown, concentrations of as low as 0.3 percent permitted longer red blood cell survival in the recipient's blood than was achieved with citrate alone.

The prevailing belief that red blood cells would not withstand transportation and would rupture with slight trauma did not seem reasonable to the Iowa group, in view of the trauma such cells ordinarily withstand as they are forced through the capillary circulation. Rigid tests of transportability were therefore undertaken on blood put up in Baxter bottles in citrate-glucose (3 percent) solution after it had been kept in a refrigerator up to 18 days. To avoid shaking, the contents of each bottle had been brought up to 1,250 cc. The bottles were transported in ordinary milk cans, covered with quilts and re-iced at least once every 24 hours. Twenty bloods were shipped by plane to San Francisco and back, and 20 other samples were taken by ambulance to outlying districts of Iowa City, to test the effect of rough roads.

There was no appreciable increase in hemoglobin levels in the centrifuged plasma either before or immediately after transportation in 20 bloods. In

the remainder, the increases were insignificant, the largest being from 8.4 to 18.3 mg. percent.

All these bloods were then used for transfusion, on appropriate indications, from 3 to 45 days after they had been collected. The only transfusion reaction, which was limited to chills and fever, occurred in a patient who had undergone thoracoplasty.

Blood was also carried by car for 30 hours, including stopovers, for a distance of 720 miles. It was then flown from Iowa City to Oakland and back, a distance of 3,539 miles and 24 hours of flying time (46 hours including stopovers). When the flasks were examined 30 minutes after the plane had landed, the erythrocytes in many of them had almost completely sedimented during the trip.

DEVELOPMENT OF PRESERVATIVE SOLUTIONS

No action was taken on preservative solutions until the Conference on Transfusion Equipment and Procedure on 25 August 1942 (20), at which the chairman, Dr. Robert F. Loeb, requested Dr. DeGowin to draw up a statement of the problem and propose a plan to be submitted for consideration to the Surgeons General of the Army and the Navy. At the meeting of the Subcommittee on Blood Substitutes on 20 October 1942 (21), the proposal was made to recommend to the Armed Forces the use of preserved blood whenever this was feasible and fresh blood could not be used. There was no discussion of the preservative, and action on the recommendation was deferred.

At the meeting of the subcommittee on 13 May 1943 (22), a letter was read from Dr. P. L. Mollison, suggesting the use of what he termed a "slough preservative," incorporating citrate, citric acid, and dextrose, the constituents used in the preservative solution later adopted for blood flown overseas. Dr. DeGowin was authorized to prepare a summary statement, incorporating all experimental and clinical data available on preservative solutions and physical equipment for whole blood preservation and shipment.

The Conference on Preserved Blood recommended by the subcommittee convened on 25 May 1943 and heard a number of reports, as follows (23):

1. Dr. O. F. Denstedt, of McGill University, reported on survival experiments with the Ashby technique, on transfused preserved red cells, and Dr. Joseph F. Ross, Evans Memorial Hospital, Boston, reported, with Dr. Milan A. Chapin, on studies on the hemoglobin molecule made with radioactive isotopes of iron.

It was brought out in the discussion that the value of a preservative must be judged by its effectiveness in prolonging the *in vivo* survival of transfused erythrocytes as well as by its ability to prevent *in vitro* hemolysis, changes in osmotic fragility and cellular potassium content, and changes in other components. The radioactive tagged cell technique reported by Drs. Ross and Chapin was so sensitive that 0.005 cc. of transfused cells could be detected in 1.0 cc. of the recipient's blood with an accuracy of ± 10 percent, and the total volume of labeled cells which had to be injected into the recipient was so small that it produced no hemodynamic or hematopoietic disturbance. The results of this study also indicated that the breakdown products of hemoglobin were rapidly reutilized for the synthesis of new hemoglobin. It was therefore impossible to trace the survival of the injected cells for more than

24-48 hours, but this made little difference, since it is in the period immediately after transfusion that survival is of the greatest importance. It could be concluded from these observations that even though transfused cells were destroyed rapidly, they were of distinct, if temporary, value in promoting blood formation.

2. Dr. Denstedt discussed the modifications of the DeGowin modification of the Rous-Turner solution which he and his associates had devised at McGill University (and which he later requested be called the McGill solution (24)). The first of these solutions consisted of 400 cc. of blood, 80 cc. of 3.2-percent sodium citrate, and 120 cc. of 5.4-percent dextrose. These quantities constituted 600 cc. of solution, with a blood-diluent ratio of 2:1. With this dilution, most bloods could be stored up to 6-8 weeks at 39° F. (4° C.), with less than 1-percent loss by hemolysis.

The second solution consisted of 400 cc. of blood, 80 cc. of 3.2-percent sodium citrate, 80 cc. of 5.4-percent dextrose, and 40 cc. of an isotonic buffer solution. The resulting solution consisted of 1,000 cc. of 0.3 molar (4.14 percent) monobasic sodium phosphate ($\text{NaH}_2\text{PO}_4 \cdot \text{H}_2\text{O}$), 925 cc. of 0.3 molar (1:2 percent) sodium hydroxide (NaOH), and 480 cc. of water. These quantities also produced 600 cc. of solution with a blood-diluent ratio of 2:1. The second solution was recommended on the ground that it maintained the citrate concentration above 0.34 percent and also maintained an effective level of dextrose. The buffered solution retarded cell swelling during storage, retarded changes in organic phosphates, and reduced cohesion of cells on sedimentation. When buffered bloods were stored at 50° F. (10° C.), the changes were no greater than when they were stored at 39° F. (4° C.). With unbuffered bloods, the changes at the higher temperature were more rapid.

At the 10 August 1943 meeting of the subcommittee (25), the discussion of preservatives was continued. Dr. Edwin J. Cohn introduced a recommendation that glucose be added whenever blood was stored at low temperatures. Dr. Max M. Strumia objected to the additive; his own work with urobilin levels in blood had not shown any superior red blood cell survival in vivo when it was used; in fact, cellular fragility seemed to be increased. He also saw no advantage to preserving blood for more than 5 days, the average time for which blood was then banked. Dr. DeGowin pointed out that military demands were irregular and that the attempt to operate a bank with blood that could be stored only 5 days would result in excessive losses of blood, which could be used if longer periods of storage were possible. In view of the differences of opinion, Dr. Cohn withdrew his recommendation.

Meantime, Dr. John B. Alsever, then in the U.S. Public Health Service, had devised a solution composed of 0.42-percent sodium chloride, 0.8-percent sodium citrate, and 2.05-percent dextrose; 500 cc. of this mixture had to be used with each 500 cc. of blood (fig. 57).

Alsever's solution had proved satisfactory with the usual criteria for studying red blood cell preservation; that is, rate of spontaneous hemolysis, fragility tests, hemoglobin levels, and incidence of reactions. At the 24 September 1943 meeting of the Subcommittee on Blood Substitutes (26), it was recommended to the Armed Forces that, if blood was to be stored for more than 5 days, refrigeration and the addition of glucose was essential. In the light of present knowledge, Alsever's, DeGowin's and Denstedt's solutions would be equally effective.

With the recommendation at the subcommittee meeting on 17 November 1943 (27), that The Surgeon General of the Army give consideration to the

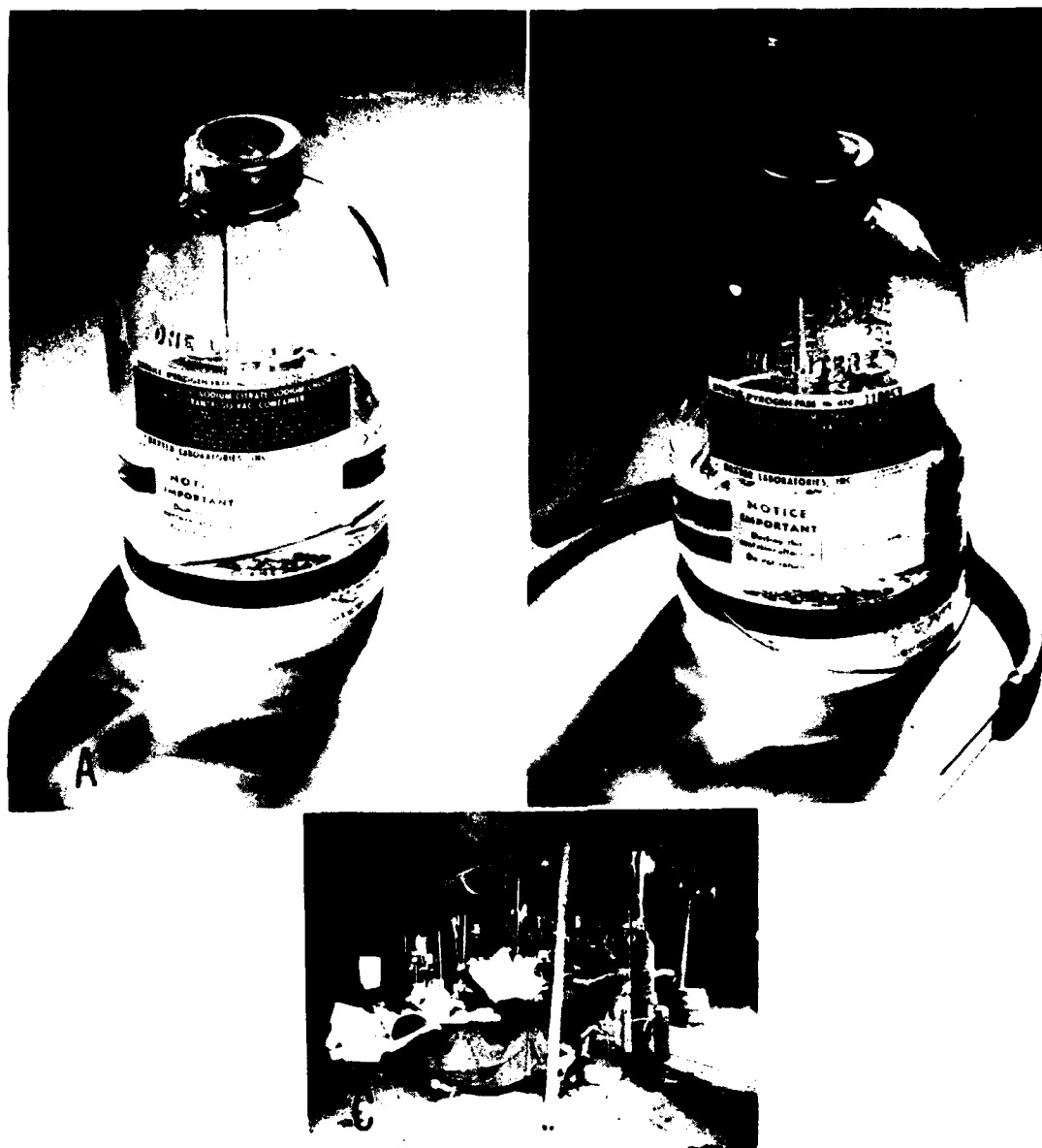

FIGURE 57. Preservation of blood with Alsever's solution. A. One-liter bottle containing 500 cc. of Alsever's solution. B. Bottle ready for collection of blood. C. Blood put up in Alsever's solution in use in postoperative ward, 10th Field Hospital, Granovillers, France, November 1944. Note suspension of bottles from cord over beds.

transportation of whole blood by airlift to certain theaters of operations (p. 465), the question of preservatives became more urgent, though it was not discussed further at this time. Maj. Gen. Norman T. Kirk's acknowledgment of the recommendation about the airlift of blood was read at the 5 January 1944 meeting (27). In the meantime, he had rejected it.

Dr. DeGowin reported at the Second Conference on Blood Storage on 2 March 1944 (28) that the modified Rous-Turner solution had been used in

more than 13,000 transfusions given over the past 5 years at the State University of Iowa College of Medicine. The upper storage limit was 30 days, and the incidence of reactions was low and no greater with aging blood than with blood used earlier. No definitive action was taken in regard to preservatives at this conference or at the meeting of the subcommittee on 3 March 1944 (29), at which the Loutit-Mollison solution (30) was first mentioned.

Selection of Alsever's Solution for Oversea Airlift

When the Third Conference on Blood Storage was convened on 30 August 1944 (31), blood put up in Alsever's solution and flown from the United States was already being administered in field hospitals in France. When the decision concerning a preservative had to be made without delay, because of the critical situation in Europe, Alsever's solution, in the absence of a definitive recommendation from the Subcommittee on Blood Substitutes, seemed to be the wisest choice for a number of reasons. They were stated (32) at the conference held in the Office of The Surgeon General on 15 August 1944 (p. 209). In substance, they were as follows:

1. The Subcommittee on Blood Substitutes, NRC, had agreed on 24 September 1943 (26) that Alsever's solution was at least as good as DeGowin's and Denstedt's solutions; up to that time, the experience with Denstedt's solution had been limited.

2. Tests with these solutions had been carried out at the Army Medical School since 1939. In 1943, a blood transfusion and intravenous fluid service had been set up at Walter Reed General Hospital, Washington, D.C., and operated by the Blood Research Division of the school.

3. When the McGill solution was tested, the precipitation of fibrin, particularly when blood that had been stored for more than 7 days was used, was so great that the steel filters in the giving sets had frequently become completely blocked.

4. The more dilute Alsever's solution, which had the disadvantage of requiring 500 cc. of solution to each 500 cc. of blood, had been used in more than 2,000 transfusions. The added crystalloid content minimized fibrinogen precipitation, and blood stored in this solution was much easier to administer through standard Army filters.

Alsever's solution had been submitted to rigorous testing. Only proved O blood had been used, up to 30 days old. It had been shipped by plane to the west coast without refrigeration and returned to the Army Medical School in good condition. With continuous refrigeration, the blood could be used from 25 to 30 days after it was collected; the free hemoglobin was no more than 25 mg. percent. When refrigeration was interrupted for 24 hours, the dating period was reduced to 18-21 days. When the blood was taken from the refrigerator and left at room temperature for 48-72 hours, spontaneous hemolysis reduced the dating period to 14-16 days.

Blood put up in Alsever's solution was also tested in other ways. During 28 days of storage, it was shaken every day. It was transported in trucks for 8- to 24-hour periods two or three times a week, in temperatures ranging from just above freezing to 50° to 60° F. (10° to 15° C.). The method of testing was therefore extremely severe, and the fact that the blood stood up well under the conditions—most of them far more severe than blood handled under controlled conditions would be subjected to—made it evident that it would be practical to supply preserved blood to oversea theaters.

The reaction rate with blood preserved in Alsever's solution was about 1 percent. No jaundice had followed any transfusion. Even though blood preserved in this solution had been given in quantities up to 3,000 and 4,000 cc. over a 12-hour period, none of the patients who had received these quantities had developed pulmonary edema. Kilduffe and DeBakey's (33) review of the literature did not support the contention that if 4,000 to 5,000 cc. of blood were given over a 24-hour period, pulmonary edema would necessarily occur. DeBakey had personally given as much as 9,000 cc. in 12 hours without its development. It was understood, of course, that these generalizations did not apply to casualties with blast injuries or to patients with organic heart disease and myocardial insufficiency.

5. A final and very practical reason for selecting Alsever's solution rather than ACD (acid-citrate-dextrose) solution as the preservative for blood to be airlifted to Europe was that the containers for it were already in production in August 1944 when General Kirk reversed his decision not to supply blood to the European theater, as many working in this field had always believed that it inevitably would be reversed. As it was, their procurement of these containers in the necessary quantities was a crash operation. With wartime shortages and priorities, it would have taken at least 3 to 4 months to provide the necessary containers for the Loutit-Mollison acid-citrate-dextrose solution.

Substitution of ACD Solution for Alsever's Solution

Many years after the war, it is perhaps difficult for readers who were not participants in the events to understand why ACD solution was not used when the airlift of blood to Europe began in August 1944, or at least why it was not substituted for Alsever's solution in the winter of 1944-45, when the Navy had already proved its safety and efficiency in the airlift of blood to the Pacific. There are a number of explanations, though perhaps no real excuses. One was the late development of the Loutit-Mollison solution; it was first described in December 1943 (30). Another was Major Hardin's unwillingness to accept the changeover in the European theater before the new solution had been adequately tested. The third was procurement of the smaller bottles necessary when a smaller amount of preservative solution was used.

Testing of ACD solution.—The Loutit-Mollison solution was first mentioned in a meeting of the Subcommittee on Blood Substitutes on 3 March

1944 (29), when Dr. G. M. Guest, who was representing the Canadian Committee on Medical Research, recommended that it be investigated, on the ground that the British were rapidly coming to use it since its description in December 1943 (30).

On the basis of Dr. Guest's suggestion, a number of comparative investigations were undertaken, including clinical testing at the Army Medical School. Preliminary reports were made at the 2 June 1944 meeting of the Subcommittee on Blood Substitutes (34), 4 days before D-day, and at the Third Conference on Blood Storage on 30 August 1944 (31), after the airlift to Europe had already begun. They showed that ACD solution preserved blood satisfactorily for at least 21 days. An investigation at the Children's Hospital in Cincinnati showed that, after 38 days' storage in it, the red blood cells were in the same state of preservation as after 10 days' storage in simple citrate solution and after 22 days' storage in neutral citrate-glucose solution.

In addition to the reduced bulk (the initial blood-diluent ratio of 4:1 was later reduced to 6:1, 70 cc. of solution to 450 cc. of blood), ACD solution was considered to have the following advantages:

1. With an enriched solution of dextrose, nutrition was provided for the red blood cells that they did not receive from other solutions containing only sodium citrate and physiologic salt solution.
2. The addition of citric acid to the solution lowered the pH sufficiently (to about 5) to eliminate the tendency to fibrin-clot formation evident in blood kept longer than 14 days in other solutions.
3. When blood was preserved in the natural environment of this solution, under constant refrigeration, tests showed that the red blood cells were less fragile, and tolerated handling and transportation much better, than when they were preserved in other solutions.

At the conference on 30 August 1944 (31), too late for implementation in the airlift already underway, it was passed, Dr. DeGowin dissenting, that ACD solution be recommended as the best available solution for the preservation of whole blood; the optimum dilution factor was considered to be 20 percent solution to 80 percent blood. Dr. DeGowin did not consider that sufficient evidence had been presented to date for evaluation of Alsever's solution, nor did he consider that ACD solution had been tested sufficiently clinically to permit an opinion concerning fibrin precipitation with it.

It was further recommended at this conference that the Armed Forces transport whole blood at temperatures between 39° and 50° F. (4° and 10° C.) from the time of collection to the point of final delivery. There was no discussion of how this recommendation should be implemented.

Further studies on ACD solution were reported at the Conferences on Blood Preservation on 19 January 1945 (35) and on 8 February 1945 (36), as well as in Weekly Newsletter No. 136, Division of Medical Sciences, National Research Council, 7 October 1944. Among the data reported were the following:

1. ACD solution was much simpler to prepare and autoclave than Alsever's solution.
2. Fibrin formation was minimal. There had been no difficulties of this kind in 200

transfusions of blood stored in this solution and used in routine blood bank operations at the Massachusetts Memorial Hospital.

3. When the survival of transfused cells tagged with radioactive isotopes in the recipient circulation was used as a criterion, there was little difference between ACD and Alsever's solutions during the first 15 days of storage; 70 percent of the cells survived during the first 48 hours after transfusion. Later, there was a considerable difference, survival being 20 days in Alsever's solution and 30 days in ACD solution. This was a discrepancy of practical military importance.

4. A report by Dr. Strumia, whose conclusions were of value because of his association with the blood-plasma project from its inception in 1940, indicated that ACD was the most effective preservative solution tested to date.

All reports emphasized that the data were obtained under constant refrigeration. Deterioration of the red blood cells began during short periods of storage at room temperature and was not halted by subsequent refrigeration.

Procurement of new bottles.—The substitution of 600-cc. bottles for collection of the blood in ACD solution for the 1,000-cc. bottles used to collect it in Alsever's solution required changes of orders to contractors, who had to continue to produce the larger bottles to meet current needs while preparing for the changeover to the smaller bottles. By careful planning, the changeover to the smaller bottles was made without delay and without undue wastage of the larger bottles.

Acceptance of ACD solution in the European theater.—When Capt. John Elliott, SnC, returned from the European theater after his January 1945 visit (37), he brought word that Major Hardin was unwilling to have ACD solution substituted for Alsever's solution until there was overwhelming evidence of its superiority. He wished comparative tests of the two solutions to be conducted in the theater, on the reasonable ground that it was not wise to discard an agent that had proved satisfactory for one that he did not consider had been adequately tested.

The necessary tests were carried out by flying successive shipments of blood in ACD solution to the European theater, as described elsewhere (p. 215). The results proved entirely satisfactory clinically, though perhaps less impressive numerically. Major Hardin was informed, however, of the satisfactory results obtained with ACD solution in the massive airlift of blood to the Pacific, as well as of the fact that the use of smaller bottles would permit refrigeration of the blood during the airlift across the Atlantic. He was also told of an improvement in the bottles; the stoppers were now hollowed out inside, so that the tip of the filter housing projected a short distance into the bottle and any clots that might form fell around, rather than into, its adapter.

When ACD solution began to be used on 1 April 1945, the 50 cc. of 4-percent sodium citrate solution formerly placed in a 750-cc. bottle was replaced by 100 cc. (later 70 cc.) of a solution consisting of 2.0 gm. of citric acid, 8.0 gm. of sodium citrate, 27.0 gm. of dextrose (all U.S.P.), with water to make 1,000 cc. After 100 cc. of this solution was placed in a 600-cc. bottle, the vacuum in the bottle was checked and corrected with a vacuum pump to 720

mm. Hg. The pH of the ensuing mixture was 5-5.6. When 500 cc. of blood was added, the pH of the contents was 6.8-7; and the final concentration of sodium citrate was 0.46 percent, of dextrose 0.45 percent, and of citric acid 0.03 percent.

Critique of Preservatives

There was, of course, never any argument about the superiority of fresh whole blood over the most efficiently preserved whole blood. But fresh whole blood was not practical from any standpoint for frontline use. It was impractical to collect it locally, and its life was too short to fulfill requirements imposed by shipping it from the Zone of Interior to the European theater. Some preservative therefore had to be used.

Since preserved blood had to be used in forward areas, the important point was that when the decision not to airlift blood to Europe, recommended in November 1943, was necessarily reversed in August 1944, no decision had been reached by the Subcommittee on Blood Substitutes as to the best preservative to use (26, 38).

When the airlift to Europe was authorized, the decision as to the preservative to use therefore had to be made in the Blood Research Division, Army Medical School, and made without delay. Alsever's solution was selected for a number of reasons: It contained a satisfactory concentration of electrolytes and dextrose. Its dilution was less than the 750-cc. dilution of the DeGowin solution, though its 500-cc. bulk was undesirably large. Its pH was desirable. Fibrin formation was minimal. Finally, with the Alsever solution, preservation of the blood for 21 days was possible.

It is regrettable that ACD solution had not been tested adequately when the selection of a preservative for oversea use became necessary in August 1944. It is also regrettable that the changeover from Alsever's to ACD solution was not made as soon as the Navy experience in the Pacific proved the safety and efficiency of the latter solution. On the other hand, as has been pointed out in connection with flying blood to Europe without refrigeration during the period of the flight, there were many thousands of lives saved because blood was provided in Alsever's solution. Many of these lives would have been lost if the airlift had been deferred until a more efficient preservative had been tested.

In his report on his Pacific tour to Col. George R. Callender, MC, in December 1944 (39) (p. 590), Lt. Col. Douglas B. Kendrick, MC, repeated his earlier recommendation that the 1,000-cc. bottle containing Alsever's solution in the field transfusion set should be replaced by the 600-cc. bottle containing ACD solution as soon as the next contracts became effective and should thereafter be used for blood sent to the European theater. He considered the recommendation justified because, by 12 October 1944, Capt. Lloyd R. Newhouser, MC, USN, had received reports on trial runs to the Pacific that indicated that both bottle and solution were entirely satisfactory.

TESTS OF EFFICIENCY OF PRESERVATIVE SOLUTIONS

It was brought out at the Conference on Preserved Blood on 25 May 1943 (23) that the basic criterion of the value of a preservative was the in vivo survival of transfused erythrocytes (p. 217). At the Third Conference on Blood Storage on 30 August 1944 (31), it was formally agreed that the conference favored, as an optimal criterion of whole blood preservation, the survival of 90 percent of the transfused red blood cells for 48 hours and, as a satisfactory criterion, the survival of 70 percent for 48 hours. Any specimen of blood should be rejected which contained in excess of 50 mg. percent of free hemoglobin.

At this same conference, it was agreed that tests for determining the in vivo preservation of red blood cells should include agglutination techniques, the radioactive isotope method, studies on blood bilirubin, and determination of the total urobilinogen output. In vitro testing should include spontaneous hemolysis, osmotic resistance of the red cells, escape of potassium and other components from the cells, glycolysis, fibrin formation, and enzyme systems. The osmotic fragility test was not considered a satisfactory determination of in vivo survival.

Bushby and his group (40), studying various blood preservatives, showed, from the bilirubinemia associated with the transfusion of stored blood, that the older the blood, the more rapidly were its corpuscles destroyed in the recipient bloodstream. The iron pigment thus set free, however, was phagocytosed by the reticuloendothelial system and assisted in blood regeneration during recovery from hemorrhage. These observers believed that if the blood was not so old that a dangerous quantity of pigment would be suddenly liberated, the administration of even quite old blood to an exsanguinated patient had much to recommend it. Their theory seemed to be proved by the successful use of blood well beyond its dating period during the fighting in France in May 1940 (p. 20).

To complete the record, a final study on posttransfusion survival of erythrocytes might be mentioned, which was reported at the Conference on Blood Preservation and Red Cell Resuspension on 6 December 1945 by Capt. John B. Ross, MC (41). It was based on a study made with ACD solution in the original volume (120 cc. per 480 cc. of blood) and in a reduced volume (50 cc. per 450 cc. of blood). The solution, which had a pH of 5.0, contained 2.5 gm. of disodium citrate and 3.0 gm. of dextrose. The results, which were determined by the radioactive isotope technique, showed the in vivo survival of erythrocytes to be the same in both solutions. To exclude possible variations in the donor blood, the bloods stored in each solution were obtained from the same donors.

SPECIAL STUDIES

It has not been possible, in the compass of this chapter, to describe all of the various studies on blood preservatives made by workers under contracts set up by the Committee on Medical Research, National Research Council,

nor has it been possible to describe any of them in detail. The reports are available in the minutes and conferences of the Subcommittee on Blood Substitutes and other committees and subcommittees.

It is not the function of this history to review the literature on the subject, though much of it was pertinent to, and useful in, the work of the Subcommittee on Blood Substitutes in the fulfillment of its functions. Attention is called particularly, in addition to the studies mentioned in the text, to the studies of the following workers:

1. Scudder and his associates in 1939 (42).
2. Mollison and Young in 1940 and 1941 (43, 44).
3. Maizels and Paterson in 1940 (45).
4. Mainwaring, Aylward, and Wilkinson in 1940 (46).
5. Muether and Andrews in 1940 and 1941 (1, 47-50). The series of studies by these observers on "stored" blood were particularly useful. They endeavored to meet the objection that, as they put it, much of the literature on changes in stored blood was lacking in controls and colored by preconceived ideas on the subject.
6. Ross, Finch, Peacock and Sammons, which were concluded in 1947 (51). Their extensive studies on in vitro preservation and posttransfusion survival of stored blood, made at the Massachusetts Memorial Hospital and the Massachusetts Institute of Technology, included 16 solutions. Their chief conclusion was that, from a practical standpoint, blood stored in ACD solution, or one of its modifications, for 7 to 10 days is as satisfactory for transfusion as fresh blood. Blood stored for 3 weeks and providing cells of 70-percent viability is satisfactory for emergency transfusions but is not so good as whole blood or blood stored for shorter periods of time.

References

1. Muether, R. O., and Andrews, K. R.: Studies and Uses of Stored Blood and Plasma. *South. M. J.* 34: 453-462, May 1941.
2. Ashby, W.: The Determination of the Length of Life of Transfused Blood Corpuscles in Man. *J. Exper. Med.* 29: 267-281, 1 Mar. 1919.
3. Rous, P., and Turner, J. R.: The Preservation of Living Red Blood Cells in Vitro. I. Methods of Preservation. *J. Exper. Med.* 23: 219-237, February 1916.
4. Rous, P., and Turner, J. R.: The Preservation of Living Red Blood Cells in Vitro. II. The Transfusion of Kept Cells. *J. Exper. Med.* 23: 239-248, February 1916.
5. Abel, J. J., Rowntree, L. G., and Turner, B. B.: On the Removal of Diffusible Substances From the Circulating Blood of Living Animals by Dialysis. *J. Pharmacol. & Exper. Therap.* 5: 275-316, January 1914.
6. Robertson, O. H.: Transfusion With Preserved Red Blood Cells. *Brit. M. J.* 1: 691-695, 22 June 1918.
7. Lewisohn, R.: A New and Greatly Simplified Method of Blood Transfusion. A Preliminary Report. *M. Rec.* 87: 141-142, 23 Jan. 1915.
8. Lewisohn, R.: The Development of the Technique of Blood Transfusion Since 1907: With Special Reference to Contributions by Members of the Staff of the Mount Sinai Hospital. *J. Mt. Sinai Hosp.* 10: 605-622, January-February 1944.
9. Lewisohn, R.: Blood Transfusion: 50 Years Ago and Today. *Surg. Gynec. & Obst.* 101: 362-368, September 1955.
10. Lewisohn, R.: The Citrate Method of Blood Transfusion in Retrospect. *Surgery* 43: 325-327, February 1958.
11. Weil, R.: Sodium Citrate in the Transfusion of Blood. *J.A.M.A.* 64: 425-426, 30 Jan. 1915.
12. Lewisohn, R., and Rosenthal, N.: Prevention of Chills Following Transfusion of Citrated Blood. *J.A.M.A.* 100: 466-469, 18 Feb. 1933.

13. DeGowin, E. L., Harris, J. E., and Plass, E. D.: Studies on Preserved Human Blood. I. Various Factors Influencing Hemolysis. *J.A.M.A.* 114: 850-855, 9 Mar. 1940.
14. DeGowin, E. L., and Hardin, R.: A Plan for Collection, Transportation and Administration of Whole Blood and of Plasma in Warfare. *War Med.* 1: 326-341, May 1941.
15. Perry, M. C.: Preservation of Blood for Transfusion. *Wisconsin M.J.* 25: 123-127, March 1926.
16. Elliott, G. A., MacFarlane, R. G., and Vaughan, J. M.: The Use of Stored Blood for Transfusion. *Lancet* 1: 384-387, 18 Feb. 1939.
17. DeGowin, E. L., Hardin, R. C., and Alsever, J. B.: *Blood Transfusion*. Philadelphia and London: W. B. Saunders Co., 1949.
18. Minutes, meeting of Committee on Transfusions, Division of Medical Sciences, NRC, 31 May 1940.
19. Minutes, meeting of Subcommittee on Blood Substitutes, Division of Medical Sciences, NRC, 30 Nov. 1940.
20. Minutes, Conference on Transfusion Equipment and Procedure, Division of Medical Sciences, NRC, 25 Aug. 1942.
21. Minutes, meeting of Subcommittee on Blood Substitutes, Division of Medical Sciences, NRC, 20 Oct. 1942.
22. Minutes, meeting of Subcommittee on Blood Substitutes, Division of Medical Sciences, NRC, 13 May 1943.
23. Minutes, Conference on Preserved Blood, Division of Medical Sciences, NRC, 25 May 1943.
24. Minutes, meeting of Subcommittee on Blood Substitutes, Division of Medical Sciences, NRC, 5 Jan. 1944.
25. Minutes, meeting of Subcommittee on Blood Substitutes, Division of Medical Sciences, NRC, 10 Aug. 1943.
26. Minutes, meeting of Subcommittee on Blood Substitutes, Division of Medical Sciences, NRC, 24 Sept. 1943.
27. Minutes, meeting of Subcommittee on Blood Substitutes, Division of Medical Sciences, NRC, 17 Nov. 1943.
28. Minutes, Second Conference on Blood Storage, Division of Medical Sciences, NRC, 2 Mar. 1944.
29. Minutes, meeting of Subcommittee on Blood Substitutes, Division of Medical Sciences, NRC, 3 Mar. 1944.
30. Loutit, J. F., and Mollison, P. L.: Advantages of a Disodium-Citrate-Glucose Mixture as a Blood Preservative. *Brit. M. J.* 2: 744-745, 11 Dec. 1943.
31. Minutes, Third Conference on Blood Storage, Division of Medical Sciences, NRC, 30 Aug. 1944.
32. Memorandum, Lt. Col. D. B. Kendrick, MC, for Brig. Gen. Fred W. Rankin, 23 Aug. 1944, subject: Conference on Supply of Whole Blood for the ETO.
33. Kilduffe, Robert A., and DeBakey, Michael: *The Blood Bank and the Technique and Therapeutics of Transfusions*. St. Louis: C. V. Mosby Co., 1942.
34. Minutes, meeting of the Subcommittee on Blood Substitutes, Division of Medical Sciences, NRC, 2 June 1944.
35. Minutes, Conference on Blood Preservation, Division of Medical Sciences, NRC, 19 Jan. 1945.
36. Minutes, Conference on Blood Preservation, Division of Medical Sciences, NRC, 8 Feb. 1945.
37. Memorandum, Capt. John Elliott, SnC, to Chief, Surgical Consultants Division, Office of The Surgeon General, through Director, Army Medical School, 1 Feb. 1945, subject: Transportation of Blood From the U.S. to the ETO Blood Bank in Paris.
38. Minutes, meeting of ad hoc Committee on Transfusion and Equipment, Division of Medical Sciences, NRC, 12 May 1943.

39. Letter, Lt. Col. D. B. Kendrick, MC, to Col. George R. Callender, MC, 28 Dec. 1944, subject: Blood Supply to Pacific.
40. Bushby, S. R. M., Kekwick, A., Marriott, H. L., and Whitby, L. E. H.: Survival of Stored Red Cells After Transfusion. *Lancet* 2: 414-417, 5 Oct. 1940.
41. Minutes, Conference on Blood Preservation and Red Cell Resuspension, Division of Medical Sciences, NRC, 6 Dec. 1945.
42. Scudder, J., Drew, C. R., Corcoran, D. R., and Bull, D. C.: Studies in Blood Preservation. *J.A.M.A.* 112: 2263-2271, 3 June 1939.
43. Mollison, P. L., and Young, I. M.: Survival of the Transfused Erythrocytes of Stored Blood. *Lancet* 2: 420-421, 5 Oct. 1940.
44. Mollison, P. L., and Young, I. M.: Failure of in Vitro Tests as a Guide to the Value of Stored Blood. *Brit. M. J.* 2: 797-800, 6 Dec. 1941.
45. Maizels, M., and Paterson, J. H.: Survival of Stored Blood after Transfusion. *Lancet* 2: 417-420, 5 Oct. 1940.
46. Mainwaring, B. R. S., Aylward F. X., and Wilkinson, J. F.: Potassium and Phosphate Content of Plasma From Stored Blood. *Lancet* 2: 385-387, 28 Sept. 1940.
47. Muether, R. O., and Andrews, K. R.: Use of Stored Blood: A Practical Application. *Hosp. Progress* 21: 246-250, July 1940.
48. Muether, R. O., and Andrews, K. R.: Studies on "Stored Blood." I. Technic for Storage of Blood. *Am. J. Clin. Path.* 11: 307-313, April 1941.
49. Muether, R. O., and Andrews, K. R.: Studies on "Stored Blood." II. Effect of Storage on Human Blood. *Am. J. Clin. Path.* 11: 314-320, April 1941.
50. Muether, R. O., and Andrews, K. R.: Studies on "Stored Blood." III. Effects of Stored Blood on the Recipient. *Am. J. Clin. Path.* 11: 321-328, April 1941.
51. Ross, J. F., Finch, C. A., Peacock, W. C., and Sammons, M. E.: The *in Vitro* Preservation and Post-Transfusion Survival of Stored Blood. *J. Clin. Invest.* 26: 687-703, July 1947.

CHAPTER X

Laboratory Techniques and Special Laboratory Studies

BLOOD TYPING OF MILITARY PERSONNEL

Implementation of Policy

After considerable discussion of the wisdom of, and necessity for, the blood typing of military personnel, instructions were issued for this action in War Department Circular No. 123, 24 June 1941 (1), by the addition of changes in AR (Army Regulations) 40-1715, 15 August 1932, and AR 600-40, 22 June 1931, as follows:

1. **AR 40-1715.**—Paragraph 7 is added as follows:

Determination and recording of blood types of all military personnel.—A. The blood group of each individual on active duty in the military service will be determined, using the International (or Landsteiner) classification. The proper performance of the tests in each organization will be a responsibility of the surgeon. The results will be recorded, using the symbols "A", "B", "AB", or "O", as indicated.

b. The surgeon will be responsible for the proper recording of the blood group on the identification tag of each individual tested. An additional record will be made in the case of enlisted personnel on W.D., A.G.O. Form No. 24 (Service Record) and in the case of officers or other personnel, on W.D., M.D. Form No. 81 (Immunization Register).

In conformity with this War Department circular, Circular Letter No. 70, Office of The Surgeon General, War Department, was issued on 14 July 1941, with the subject: The determination and recording of the blood groups of all individuals in the military service (2). It dealt with the following points:

1. Materials for blood typing with methods of their procurement. The reagents required consisted of mixtures of sucrose and dried sera from rabbits that had been immunized, with human erythrocytes of groups A and B, respectively. Medical Department specifications required that the potency of the sera be such that when they were used as directed specific macroscopic agglutination of A, B, and AB human red blood cells, respectively, would occur within a period not to exceed 60 seconds.

2. Interpretation of results.

3. Recording of results. The blood type was to be recorded on the man's identification tag only after it had been checked by a medical officer against the individual's completed blood grouping test.

4. Performance of the test (a) in small posts or isolated detachments by a surgeon with a few enlisted assistants and (b) its performance in larger organizations, on an assembly line basis, with the help of one or more teams of Medical Department personnel. Details were given for each step of the procedure.

The letter pointed out that an error in the technique of the test or in the recording of the result could be extremely serious and might even result in a fatality.

Supplemental Instructions

4 September 1941.—Only a brief experience with the typing of military personnel brought to light difficulties and errors. Circular Letter No. 88, Office of The Surgeon General, War Department, was issued on 4 September 1941, with the subject: Supplemental information concerning determination of blood type in accordance with SGO (Surgeon General's Office) Circular Letter No. 70 (3). It covered the following points:

1. Variations in temperature and concentration of the red cell suspension in tests run in the field necessitated some latitude in the time allowed for agglutination (specified in the original directions as not to exceed 1 minute). This variation was to be determined by the medical officer in charge of the team.

2. All normal saline solution used in typing must be prepared from sodium chloride, A.C.S. (Item No. 14290, Medical Department supply catalog), thoroughly desiccated and accurately weighted. Tablets intended for the preparation of normal saline solution (Item No. 13020), apparently due to some inhibiting substance in their content, had been found to delay or inhibit the test.

3. The precise amount of serum indicated was to be used; an excess delayed agglutination.

4. If dried sera became so tightly packed in the original containers that difficulty was experienced in measuring out the small amounts required for individual tests, it could all be put into solution and a specified amount of the solution used.

26 November 1941.—Circular Letter No. 112, Office of The Surgeon General, War Department, issued on 26 November 1941, subject: Supplemental information, concerning determination of blood type in accordance with SGO Circular Letters Nos. 70 and 88 (4), reflected additional experience. In this letter, the objective of blood typing of military personnel was defined—it had apparently not been clearly understood before—as making possible the calling of voluntary donors of a specific blood type and securing them on very short notice. The following points were also covered:

1. The possibility of error in mass blood grouping was recognized, but it was postulated that crossmatching would be done before transfusion, and errors would thus be recognized. This precaution, however, was no reason for relaxing efforts to be absolutely accurate in testing and recording.

2. Insufficient time was sometimes being allowed for proper agglutination. As a result, blood types other than O, particularly the AB group, were being recorded as O. Such errors could be prevented if all tests in which agglutination did not occur promptly were held for observation for 20 minutes or longer.

3. Any validated evidence of apparently unsatisfactory sera should be reported to the Army Medical School, so that it could be determined whether the sera were really unsatisfactory or technical errors were responsible for the poor results.

2 December 1942.—Still further clarification was attempted in Circular Letter No. 170, Office of The Surgeon General, War Department, Services of Supply, 2 December 1942, subject: The purpose of blood grouping Army personnel (5). In this letter, it was pointed out that the policy of blood grouping of military personnel and its purpose seemed to have been misunderstood by some medical officers. Some reports of alleged errors suggested that

the writers believed the errors would inevitably lead to serious reactions if the persons whose blood was wrongly classified should be used as either donors or recipients. The assumption that the first typing test would be the only one performed was based on a false premise. To correct the misconception, it was pointed out again that the purpose of the program was to simplify assembling donors whose blood would probably crossmatch with that of intended recipients. It was never intended, when the mass grouping program was set up, that crossmatching should be omitted.¹

Errors would be reduced, the letter continued, by care in all steps of the grouping process and in recording of results. Some stations were preparing their own grouping sera from tested human donors with high titer serum, but this was not recommended, at least as a routine.²

The following precautions were also emphasized:

Slides should be observed long enough for slower reactions to develop, though no arbitrary period of observation could be specified because of variations in temperature, serum titer, degree of mixing of serum and cells, and the relative agglutinating ability of the cells. Various expedients to provide a rough check had been tried: The test could be done on groups of 20 to 25 men at a time and no results recorded until half of the slides showed agglutination with anti-A serum. Or no results except in the AB group should be recorded until the slides had been under observation for 20 minutes, even though most agglutinations were evident within a minute or two. Observations up to 30 minutes were desirable if excessive drying could be avoided.

Some blood grouping teams observed all slides microscopically unless macroscopic agglutination was evident. Other teams repeated the tests on all blood that gave no agglutination with anti-A serum; that is, they repeated the tests on all persons originally grouped as B or O. This was regarded officially as an unnecessary precaution, not worth the effort if the original tests had been carefully performed.

Mass Methods of Typing

Necessary as it was, the blood grouping program was one more thing to interfere with the training of troops. Many installations therefore devised their own methods of expediting the procedure. In some, unfortunately, the haste led to confusion, and the confusion led to errors, a certain proportion of which could unquestionably be explained in this way. In other installations, the short cuts were really efficient.

¹ In spite of errors in the laboratory, the blood grouping program was highly practical. If 100 group O donors were desired, only men whose identification tags were so marked would report. The chances were that, after retyping, 85 to 90 would prove to be group O. Without the preliminary screening, it would have been necessary to call at least 200 prospective donors to find approximately 100 group O donors.

² For some reason, the responsibility for the original typing program was assumed by the Preventive Medicine Division, Office of The Surgeon General, and was retained by it throughout the war. It would obviously have been more efficient for the personnel directly in charge of the blood program to have supervised this part of it.

National Research Council

The matter of typing military personnel was brought up at the meeting of the Subcommittee on Blood Substitutes on 23 May 1941 (6), when the policy was still under consideration. The experience of the Blood Transfusion Association in New York (p. 13) had indicated that the rabbit sera presently in use were not so potent as they should be, but it was expected that more avid material would shortly be available.

When the subcommittee met on 18 July 1941 (7), typing of all military personnel on active service had been authorized (p. 233), and substantial contracts for rabbit serum had been let with the only firm then processing it. In view of the circumstances, the subcommittee considered that any action in the matter was outside of its jurisdiction. A year and a half later, in January 1943 (8), it completely reversed this attitude and interested itself in the development of new and more avid sera.

DEVELOPMENT OF TYPING SERA

Types of Sera

Rabbit sera.—The anti-A and anti-B rabbit sera available at the beginning of the war were, as just indicated, not so avid as they should have been. Tests by the DeGowin technique (9) showed that A titer agglutinated cells in dilutions up to 1,000 but not in dilutions up to 2,000. The B titer was strong; agglutination could be obtained in dilutions up to 1:4,000 though not up to 1:8,000. These sera had two advantages, that they did not need refrigeration and that the titer was so high that expert skill was not necessary to use them. They also had a serious disadvantage, that they were hygroscopic and, when exposed to air, took up moisture.

In the beginning, when material could be secured only from a single laboratory, there was not very much that could be done. As time passed, the rabbit sera improved, and, even when globulin fractions were available to prepare more avid sera, rabbit sera were still considered satisfactory and the Army continued to use them throughout the war. Each lot purchased was tested at the Army Medical School, which was a relatively simple matter: Techniques for preparation of sera produced relatively large lots, all units of which could reasonably be expected to be identical. Tests on a single unit therefore gave information which could be applied to all units in the lot. As a practical matter, it was recommended that samples of each pool be submitted for examination before the material was packaged, so that, if they did not meet specifications, they could be fortified with more active material and submitted again for appraisal. The production of satisfactory sera depended upon rigid adherence to all details of processing, including temperature controls, protein concentration, and salt content.

Work at the Army Medical School showed that an increase in the salt component of the serum-cell suspension mixture resulted in more rapid agglutination. After many tests, it was found that a 1.4-percent concentration of sodium chloride in the final mixture was optimum, and the original directions packed with dried rabbit sera were altered to include this information.

Human sera.—One of the early activities of the Division of Surgical Physiology, Army Medical School, was an attempt to improve the avidity of the grouping sera then in use. Its personnel, working with the Chemistry Division of the school, demonstrated that very avid and very high titer grouping material could be prepared from plasma by separation and concentration of the globulin fraction containing the isoagglutinins. Anti-A and anti-B globulins were produced as byproducts of the fractionation process and were available in large quantities because of the contracts for albumin let by the Navy.

The original work on plasma fractionation had been done in Dr. Edwin J. Cohn's laboratory at the Harvard Medical School, and, in December 1942, at the request of Col. George R. Callender, MC, and Lt. Col. Douglas B. Kendrick, MC, Capt. John Elliott, SnC, and Lt. Louis Pillemer, SnC, were placed on temporary duty there, to develop a new technique for preparing typing sera from human plasma. The method developed called for preparation of albumin and its byproducts from pools of plasma made up exclusively of A bloods or B bloods, it having been found that the appropriate globulin fractions from such pools ordinarily contained highly potent blood grouping substances.

At the meeting of the Albumin and By-Products Group on 22 January 1943 (8), Dr. Cohn reported on Lieutenant Pillemer's work. The technique he had developed was closely related to the fractionation process devised at Harvard, but it employed methyl alcohol, since the low temperatures required with ethanol were not required with this precipitant. The demonstration that isoagglutinins could be prepared from both type A and type B bloods showed that they could be prepared as byproducts of the large-scale industrial preparation of albumin. They were concentrated in fraction II+III, and if the euglobins were separated from the pseudoglobulins, the isoagglutinins would be found in the euglobin fraction. With this technique, sufficient typing solution to carry out an enormous number of typing tests could be prepared from a relatively small amount of plasma.

The separated, concentrated material prepared by the Pillemer technique lent itself well to blood grouping purposes. While it was not so viscous as whole serum, it possessed sufficient surface tension to form well-rounded droplets on a glass slide. The addition of Merthiolate to a final concentration of 1:1,000 did not interfere with the interactions of isoagglutinins and red cells and eliminated the necessity for filtering out bacteria. The isoagglutinating activity of the separated globulins stored as a liquid at room temperature (77° F., 25° C.) remained unimpaired for 4 weeks.

When the macroscopic slide technique was used, the concentration of this serum could be so adjusted that agglutination with incompatible erythrocytes occurred visibly in 5 seconds and was complete at 60 seconds.

DeGowin Technique

At the 23 March 1943 Conference on Blood Grouping (9), Dr. Elmer L. DeGowin recommended the following technique, which he had employed satisfactorily on more than 4,000 bloods:

The slides used were made of double-thickness window glass, with the edges ground smooth by a suitable stone. Areas 1 by 3 inches were marked out on the slides with a glass cutter or wax pencil, or by spraying lacquer over mask paper. Each of the 20 such areas on each slide was marked with the number of the blood specimen to be examined.

Three medicine droppers of similar bore were used, two for the typing sera and the third for cell suspensions. The third dropper was washed in physiologic salt solution after each use. Typing sera could be either rabbit or human but must have a titer of at least 1:128.

Drops of sera were placed in the proper areas on each plate and the cell suspensions added. The time of the test was recorded on the plate which was set aside to be read in 30 minutes. In the interim, the plate was tilted a few times, to disturb the sedimented films, and it was also checked for Tyndall's phenomenon.

Two independent tests were made of the same bloods and the results of the two series were compared. Additional tests were made on the bloods in which discrepancies were found.

By this technique, which was generally the technique followed in the Army, one worker, with a minimum amount of laboratory equipment, could set up and read over 100 tests an hour.

Establishment of Criteria

At the Conference on Transfusion Equipment and Procedure on 25 August 1942 (10), it had been unanimously recommended to the American Red Cross and to the Surgeons General of the Army and the Navy that when large numbers of bloods were to be tested, the following precautions be taken:

1. Two independent series of typings should be performed on the same bloods. If discrepancies were discovered when results were compared, the affected subjects should be reexamined.
2. Only typing sera of high titer should be used.
3. Only freshly prepared red cell suspensions should be used.
4. The utmost care should be exercised in the recording of results.
5. The slide method, with reading in 30 minutes at room temperature, was faster than the centrifuge method for mass typing and was quite as accurate if sera were potent.

These recommendations were accepted and put into practice.

At the Conference on Blood Grouping on 23 March 1943 (9), Lieutenant Pillemer reported continuing increases in the potency of the sera prepared by his technique; a number of other observers confirmed his statement.

The following standards for typing sera, both human and rabbit, were suggested, but no formal action was taken on them:

1. Sera should have a macroscopic titer of at least 1:100.
2. Clumping should begin within 20 seconds, and agglutination should be complete within 60 seconds.
3. Anti-A sera should be sensitive for A₁ and A₂B cells and should react definitely with other rare subgroups of A.
4. Negative reactions should be clear cut.
5. Keeping qualities of the sera, which preferably should be dried, should be defined.
6. If possible, a central authority should pass upon the quality of sera intended for distribution.

At this conference, special emphasis was placed upon the importance of accepting rabbit antisera for typing only if it met the same standards as those laid down for human serum. A good deal of rabbit sera that had been examined had not been satisfactory. In some lots, the anti-B serum had not exceeded the titer of average human serum and absorption had been inadequate. One lot had been too weak to produce any agglutination at all. Another lot, evidently because of unsatisfactory absorption, had shown cross reactions with group A cells. Dr. Philip Levine, Beth Israel Hospital, Newark, N.J., thought that if rabbit sera were used, a stipulation must be made that they must be absorbed with group A or group B cells rather than group O cells. Dr. Ernest Witebsky, who had been able to immunize rabbits with saliva containing A or B specific substances, pointed out that this technique had the advantage of not producing the species-specific agglutinins which require subsequent absorption.

In 750 bloods examined by the technique described by the manufacturers of rabbit sera, there had been an error of 10 percent, but there were no errors at all when the same sera were used by the DeGowin technique. It was concluded that a considerable number of errors could be explained by the fact that the manufacturer's directions were simply not specific enough.

Universal Donors

It was tentatively proposed at the 23 March 1943 Conference on Blood Grouping (9) that universal donors be employed for the Armed Forces, with the following specifications:

1. Group O blood should be used only when titration indicated that the agglutinins in the plasma were weak.
2. Crossmatching must never be omitted, because some agglutinins act on O cells.
3. A biologic test should be employed; that is, 50 to 100 cc. of donor blood should be injected into the recipient, and his plasma before the transfusion should be compared with his plasma 1½ hours afterward for evidence of

hemolysis. (This specification was quickly discarded when it was pointed out by the chairman of the conference that biologic tests would be entirely impractical in frontline hospitals.)

The vigorous discussion that followed the proposal to recommend group O blood for the Armed Forces covered the following points:

1. The determination of blood groups by identification of the agglutinogens with known sera must be further checked by matching unknown sera against known cells.

2. The proposed checks on cells and plasma should be made with venous blood. This proposal was considered unnecessary, since enough blood for testing could be secured from the lobe of the ear.

3. There was a wide difference of opinion as to the most common typing errors and which bloods they concerned. After several proposals to avoid these errors had been made, Dr. DeGowin pointed out that the most expeditious procedure would be to make two independent determinations of the bloods. This plan, he believed, would have the further advantage of making it unnecessary to deal with agglutinins of weak titer in unknown sera.

4. It was agreed that the centrifuge technique was preferable when only a few bloods were to be examined but that it was impractical with large numbers, when it would impose too great a burden in respect to both time and equipment. It was granted that rouleaux formation was sometimes confusing when the slide technique was used.

5. Captain Elliott had observed that a period of more than 20 minutes, with constant agitation (which was practical only mechanically) was necessary to secure agglutination in some rare bloods. Dr. William Thalheimer used plate glass slides, which were agitated constantly, and read at the end of 30 minutes. Dr. DeGowin had found 30 minutes without agitation sufficient if the sera employed had a titer of at least 1:128. Others agreed that the time required depended upon the avidity of the sera used.

6. There was no agreement as to the advantages of macroscopic versus microscopic observation. Some workers considered both were necessary. Others considered microscopic observations necessary only when personnel were relatively untrained. Still others thought that, in training laboratory technicians, more errors were committed with the microscope than without it.

7. Dr. Alexander S. Wiener reported composite observations to the effect that transfusions with incompatible blood resulted in an increase in the titer of the natural agglutinins of the recipient. Blood stroma (cells and fibrinogen) had proved nonantigenic on injection. After transfusion of 250 cc. of pooled plasma (Sharp & Dohme), the increase in the recipient's agglutinin titer had been from 5- to 10-fold. To obtain the maximum titer, the serum must be withdrawn no sooner than 10 to 14 days after the transfusion; otherwise, potency was lost rather quickly.

Testing and Acceptance

At a meeting of the Albumin and By-Products Committee on 10 May 1943 (11), Dr. Cohn pointed out that continuous improvements had been made in the concentration of isohemagglutinins, and presumably more could be made, but the question, for practical purposes, was how much more improvement was necessary. He suggested that Dr. DeGowin and Colonel Kendrick act as a committee to examine the various products and report on their relative values.

At the meeting of the Subcommittee on Blood Substitutes on 13 May 1943 (12), Dr. DeGowin reported results of titration of various globulin preparations to be at wide variance. He thought it plain that all cooperating workers must adopt uniform techniques and suggested that mimeographed

instructions be prepared and sent to all workers, specifying methods to be used and criteria to be employed in evaluating agglutination tests. This was done.

At the 10 August 1943 meeting of the subcommittee (13), Dr. DeGowin announced that the various workers who had been evaluating Lieutenant Pillemer's serum had agreed on criteria of potency. New preparations had been sent to them for evaluation by these criteria. It had also been agreed by these workers that a large amount of the isoagglutinin preparation should be processed and, if accepted as satisfactory, should be dried, packaged, and used as "reference" serum. Other sera could be compared with it directly, thus eliminating many of the variables of sensitivity of test erythrocytes and differences in titration techniques.

At the meeting of the subcommittee on 24 September 1943 (14), Dr. Cohn reported that reference sera had been prepared in quantity and were being held in bulk awaiting the report of the evaluating workers, as well as instructions concerning packaging. Six lots had already been accepted as approximately equal in potency.

When the subcommittee met on 17 November 1943 (15), Colonel Kendrick reported that all necessary steps in the development of the new sera had been carried out. Both the Lederle Laboratories and Eli Lilly and Co. were producing them; Lieutenant Pillemer had been sent to the Lederle Laboratories and Captain Elliott to both firms to instruct their personnel in the new technique. Initial difficulties had been eliminated. Dr. Cohn pointed out that, while the present method of preparation was not entirely satisfactory, it was the best available, and that uniformity of a product was seldom attained in the first few runs. Captain Elliott emphasized the value of testing the material at each step in the process, so that, if any change in avidity occurred, it could be detected at once.

Dr. Cohn had emphasized, at an earlier meeting (14), that commercial firms must be as rigidly supervised in the production of sera as of other by-products of plasma fractionation. At still another meeting (16), he had emphasized the practical importance of making sure that the method currently used in the preparation of isoagglutinins would give a reproducible product. He would consider the responsibility of his own laboratory ended in regard to typing sera when satisfactory reference material had been prepared.

The Army Medical School and the Navy used these sera throughout the remainder of the war. The Army did not utilize them until after the war had ended.

TYPING ERRORS

The Red Cross Experience

The original plan to type donors at the processing firms, at the expense of the American Red Cross, had been adopted with the full realization that it would be costly (17). It was discontinued as of 1 November 1942, because

the great expansion of the program made it impossible to secure the technical help necessary to carry out the tests accurately (18).

Shortly after the institution of the typing program, errors began to be discovered, and at the meeting of the Subcommittee on Blood Substitutes on 12 May 1942 (19), Dr. G. Canby Robinson asked for guidance on the course to be followed at the blood donor centers. It was recommended that a statement be added to the cards given to the donors after each donation to indicate that the blood should be regrouped and crossmatched before all transfusions. This recommendation was put into effect.

Controlled Studies

At the next meeting of the subcommittee on 23 June 1942 (20), too few data had been collected concerning techniques at the various processing laboratories (as had been recommended at the previous meeting) to be useful. Dr. DeGowin, however, outlined a very promising experiment, undertaken shortly before, whereby the blood groups of cadets at the U.S. Naval Preflight School at Iowa City were being checked by two workers independently, in lots of 40 to 93 specimens. In his opinion, the personal equation was such that no technician was likely to perform large numbers of tests without making occasional errors. A pharmacist's mate, well trained in laboratory work, was making one series of tests and Dr. DeGowin was making the other. His technique (p. 238) was used in both series.

The final report on this study, which concerned 3,876 bloods, was made at the Conference on Blood Grouping on 23 March 1943 (9) (table 6). The errors in 24 tests were unassigned because there was no opportunity to check the bloods involved. In the remaining tests, one worker made 40 errors (1.0 percent) and the other, 110 (2.8 percent). "None of the errors," said the final report, "could have been detected except by comparison of the results of two independent tests on the same blood."

At this conference and at previous meetings (9, 20), at which preliminary reports of this study had been made, the sources of these errors were discussed. Both workers made more errors (double the number) when larger numbers of bloods were examined. Many errors were made when the two workers used the same typing sera; they could be attributed to minor variations in technique; transposition of specimens; errors in transcription; confusion in reading results, such as failure to detect agglutination or reporting false agglutination; the use of too thin cell suspensions; or the addition of insufficient serum to the suspension.

An analysis of the errors threw considerable light upon the reasons some of them had been made. All of the transpositions were made by one worker, who had apparently developed habits that facilitated the selection of the wrong tube from the rack or who had neglected opportunities for checking the labels. The same worker made most of the mistakes in the identification of A and B blood. Most of the false agglutinations were reported by the worker who used

TABLE 6.—Errors in blood grouping determinations made by two independent workers on identical blood specimens

Date 1942-43	Number of bloods	Author (DeGowin)				Navy					Unassigned errors	
		Missed agglutination	False positive	Transposition	Clerical	Total	Missed agglutination	False positive	Transposition	Clerical		Total
6/9	¹ 40	1				1	2				2	
6/10	¹ 35				2	2						
6/11	¹ 35											
6/12	¹ 192											3
6/26	¹ 286		7			7	1	1	7		9	1
6/29	¹ 39											
6/30	¹ 37											
7/3	¹ 38								2		2	
7/7	¹ 43											
7/8	¹ 29											
7/10	¹ 164	4	1			5						
7/24	¹ 163						2	4	1		7	
8/9	² 185											8
8/22	² 186	12				12	1				1	
9/5	² 184	1				1	5				5	
9/19	² 202						1		2		3	
10/3	² 198						3				3	3
10/17	² 432		1			1	12				12	9
1/11	¹ 335	1				1	2	1			3	
1/23	¹ 300			1	7	8	2	1			3	
1/31	¹ 30						1		1		2	
2/12	¹ 212						3				3	
2/18	¹ 146			1		1	8				8	
3/2	¹ 365		1			1	27	18	2		47	
Total	3, 876	19	10	2	9	40 (1. 0%)	70	25	13	2	110 (2. 8%)	24

¹ Same typing sera employed by both workers.

² Rabbit sera employed by author, human sera by Navy.

KEY: Missed agglutination—errors due to failure to note or to demonstrate agglutination with either anti-A or anti-B sera, or both. False positive—errors due to reporting of agglutination that could not be demonstrated on recheck. Transposition—errors due to reporting of group A for group B or vice versa, usually as the result of confusing the right and left sides of the slide. Clerical—errors committed in transcription of results. Unassigned—errors apparent as discrepancies in reports of the two series but not rechecked because second blood specimens could not be obtained. Bloods reported in all assigned errors were rechecked by potent typing sera from at least two human sources and frequently by rabbit sera as well.

sedimented cell suspensions. The use of 3-percent physiologic salt solution, as recommended by Hans Sachs, tended to produce pseudoagglutination in sedimented cells, particularly when microscopic readings were attempted.

The slide and centrifuge techniques proved equally accurate, but the centrifuge technique, while faster for single examinations, consumed more time

than could be spent in mass typing. It took more time to manipulate the tubes and centrifuge, required more glassware, and required time to clean the glassware. With strong sera, it was useful to use the slide method at room temperature, reading the results at the end of 30 minutes with a minimum of agitation.

This type of study did not reveal errors due to defective or weak sera; errors in labeling of the original cell suspensions; or errors in transcribing results from laboratory reports to notification cards, formal reports, and identification tags.

The errors detected were also, of course, entirely unrelated to later errors made in releasing incorrect bottles of group-specific blood from the storage refrigerators and administering the wrong bottles of blood to recipients. These administrative errors seldom occurred in blood banks operated under the control of physicians and other workers well trained in laboratory techniques and interested in blood banking as a medical specialty.

The Subcommittee on Blood Substitutes found Dr. DeGowin's report extremely significant. Probably both workers made fewer errors than they would have made ordinarily since the planned comparison of results served as a constant stimulus to careful work, a factor which would be absent if there was no parallel grouping. Dr. DeGowin was eminently skilled in this work. The well-trained pharmacist's mate was undoubtedly supercareful during the period in question.

In view of the errors made in this controlled study by a skilled physician and an extremely skilled worker, the members of the subcommittee found it alarming to consider the percentage of errors that probably had been made in the mass typing performed on Army and Navy personnel. By this time (March 1943), there must have been, by conservative estimate, at least 100,000 men in the Army alone who were erroneously typed. The situation was not dangerous if all medical officers who gave transfusions clearly understood that the blood type stamped on the identification tag was simply tentative. In the pressure of an emergency, it was feared that some might omit crossmatching.

The Armed Forces Experience

Reports from various military organizations could be cited to indicate the percentage of error in recorded blood groups of military personnel and also, fortunately, the realization of those in authority that such errors existed.

On 4 March 1943, for instance, Maj. Gen. Paul R. Hawley was informed of grouping errors (6 percent) that had been discovered in the 10th Station Hospital, then in Northern Ireland (21). If the margin of error was as high in other units, the commanding officer wrote General Hawley, the matter required attention because of the risk of placing undue reliance on the information on the casualty's identification tag if emergency transfusion should be required.

General Hawley immediately ordered sample checks of other installations.

As a result, checks were made of practically all the patients then in four general hospitals, four station hospitals, and one evacuation hospital, the numbers ranging from 810 at a general hospital to 83 at a station hospital. It was found that 154 of the 2,340 bloods examined had been incorrectly typed. In addition, 179 patients had no identification tags, and there was no record of the blood group on 33 tags. The investigation thus revealed 366 unsatisfactory records, 14.34 percent. The largest observed error was in group B, but the total error was not related to any separate blood group.

Lt. Col. (later Col.) John E. Gordon, MC, Chief, Preventive Medicine Division, Office of the Theater Chief Surgeon, who had conducted the investigation, recommended to General Hawley that the Office of The Surgeon General be advised of the error that had been discovered, that all medical officers in the command be advised of it and be warned that direct crossmatching must be carried out before every transfusion, that command action be taken to assure the completion of required data on identification tags, and that measures be instituted to insure the constant wearing of tags by all members of the command. All of these recommendations were implemented.

The experience just described was typical of that of other hospitals in the theater and in other theaters, but, once the error was realized and bloods were regrouped routinely before transfusion, it did no real harm.

The 5- to 10-percent error in blood grouping was unfortunate and undesirable, but it might have been expected for a number of reasons: the lack of avidity of the typing serum, the utilization of antibody from rabbit serum that was not always as good as it might have been, and the inexperience of the personnel who did the typing. One source of errors has already been intimated, the fact that in many camps and posts during the war, personnel responsible for mass typing, through a mistaken sense of values, placed high on their priority list the speed with which the typing was done. Speed led to confusion, and confusion produced errors, which were compounded by the lack of experience of those doing the typing.

THE RH FACTOR

Historical Note

It is an interesting commentary, on what was known of blood at the beginning of World War II, that the book on blood banks and transfusions by Kilduffe and DeBakey (22), which was published in 1942 and was as authoritative as such a text could be in changing times, contains no entry in the index for the Rh factor.

It was not until 1940 that the cause was found for the occasional hemolytic reactions that occurred when blood was properly classified and crossmatched. In that year, Landsteiner and Wiener (23) demonstrated that incompatibility could occur within the same blood group in which compatibility had been

proved. By injecting rabbits or guinea pigs with red blood cells obtained from the *Macaca rhesus* monkey, they obtained a serum which would agglutinate 100 percent of rhesus monkey cells and with which they demonstrated what they named, for obvious reasons, the Rh factor.

Further studies showed that a large proportion of all human beings, regardless of their basic A, B, AB or O blood groups, have Rh agglutinin in their red blood cells. It is inherited as a mendelian dominant in about 87 percent of white persons, 95 percent of Negroes, and 100 percent of Chinese. Those who do not have it naturally occasionally become isoimmunized with it if they are transfused with Rh-positive blood. It was soon realized that the important aspect of this new discovery was not the group which had the Rh factor in their red cells but the smaller group who did not, and who might become immunized when it was introduced into the bloodstream.

Two other discoveries were also made. The first was that when an Rh-negative woman becomes pregnant with a fetus whose cells are Rh-positive, she will probably become immunized against the positive cells. The second discovery was that when Rh-negative recipients received multiple transfusions of Rh-positive blood, even though it was group-compatible, hemolytic reactions of increasing severity might occur.

Military Significance

The second discovery concerning the Rh factor was of great military importance, since, as time passed, it became more and more the practice to give multiple transfusions to combat casualties after injuries and to patients with chronic sepsis. The prospects were that this practice would increase. From the military standpoint, the chief significance of the formation of anti-Rh agglutinins by an Rh-negative individual was that subsequent transfusions of Rh-positive bloods might lead to increasingly severe, and eventually fatal, reactions.

By 1943, enough such instances of Rh immunization had occurred at the Walter Reed General Hospital, Washington, D.C., where the patients could be observed directly by the transfusion personnel at the Army Medical School, to make the potential seriousness of this threat very clear. By the end of 1944, certain conclusions were possible (24):

1. Minor reactions usually preceded serious reactions and were likely to be mistaken for ordinary pyrogenic reactions because they were characterized only by chills and fever. They might occur before very much blood had been given and thus serve as an indication for stopping the transfusion. In military practice, this necessity was extremely unfortunate because transfusions were so often lifesaving.

2. The *in vivo* survival of transfused Rh incompatible cells was poor.

3. Reactions to Rh incompatibility did not occur in nonimmunized patients. Therefore, the first transfusion, or even a series of closely spaced

transfusions, could often be given without untoward results. After the initial transfusion of incompatible Rh blood, antibodies which had formed in the recipient's circulation in small amounts might react immediately with the specific Rh (or Hr) antigen in the transfused cells and become so neutralized that none remained in the circulation. For this reason, although the recipient of the incompatible blood had become immunized, reactions in later transfusions would not occur until there had been a sufficient interval between transfusions to permit the removal of the antigen (that is, the transfused cells) and the accumulation of sufficient antibody to cause incompatibility.

4. The severity of the reaction would depend upon the amount of antibody in the recipient's blood. There might not be enough to cause even a mild reaction but there also might be enough present, or enough might develop later, to cause a fatal reaction, because of lysis of the transfused cells over a period of a few days to a few weeks. While little lasting benefit would be attained by the transfusion, the major important result would be the fatal hemolytic reaction that might occur in an Rh-negative individual because anti-Rh agglutinins were present in his bloodstream.

When Captain Elliott visited the Continental Blood Bank in Paris in January 1945, he was particularly impressed with the low rate of reported transfusion reactions (25). Maj. Robert C. Hardin, MC, he reported, did not agree with those who feared reactions on the basis of the Rh factor. From reports available to him, Major Hardin thought that the incidence in multiple transfusions was not more than 0.6 per thousand. In his opinion, it was far better to continue to put the emphasis on indications for transfusion and to attack the problem of pyrogenic reactions and hemolytic reactions resulting from the A and B agglutinin system, which were at least three times more common. He did not mean that the Rh factor should be ignored, merely that it should be kept in the proper perspective, which it would not be if emphasis on it were permitted to obscure the primary transfusion problems in the European theater.

In his report on this trip, Captain Elliott discussed the Rh factor in military medicine as follows:

The natural incidence of Rh agglutinogen in the general white population meant that one out of every eight white recipients of Rh-positive blood might become isoimmunized. Since, however, donors were selected at random, it could be assumed that 13 percent would be Rh-negative, which would make the proportion of Rh-incompatible donors 1:10 instead of 1:8. Since approximately 7 out of every 8 random recipients of random bloods would be Rh positive and 1 out of every 8 random donors would be Rh negative, approximately 1 of every 10 positive recipients would be isoimmunized by transfusion of blood from Rh-negative donors.

In the event that Rh-negative recipients and donors were not identified and specific Rh blood was transfused, it was entirely possible, Captain Elliott continued, that some 10 percent of Rh-positive recipients and an equal propor-

tion of Rh-negative recipients would become isoimmunized. This did not mean, however, as on first glance it might seem to mean, that 20 percent of recipients would have reactions caused by Rh incompatibility. What it did mean was that, at some time interval after the first transfusion or after a closely spaced series of transfusions, subsequent transfusions might cause numerous mild reactions, some serious reactions, and a few fatal reactions. Moreover, because of the rapid destruction of transfused Rh-incompatible red cells after the formation of Rh or Hr antibody, such recipients might require many more transfusions than if Rh-compatible blood had been used. The warning of trouble would be reactions of progressively more serious nature with every subsequent transfusion.

Provision of Rh Testing Serum

Multiple spaced transfusions were usually given in rear hospitals and in hospitals in the Zone of Interior. It would be necessary, therefore, to provide every such hospital with enough potent Rh testing serum to prevent such reactions by the use of Rh-negative blood for Rh-negative recipients, this being the only sure way of avoiding them. Rh testing was also essential in military hospitals that operated an obstetric service, since all women who gave birth to erythroblastotic children were liable to fatal transfusion reactions if they were transfused with Rh-positive blood. The use of such serum would also help to prevent or modify erythroblastosis in infants and permit its correct treatment when it occurred.

When the military significance of the Rh factor began to be appreciated in 1943, there was not enough Rh testing serum available to supply even a small proportion of the Army hospitals that should have it. Attention was therefore directed toward making supplies of it available, and toward determining when it should be used.

Indications for Rh testing.—The Rh factor was first discussed by NRC (National Research Council) personnel at the Conference on Blood Grouping on 23 March 1943 (9). The matter arose in connection with the technical manual then in preparation and how much concerning the Rh factor should be included in it. The scarcity of potent serum at this time made the recommendation that testing should be carried out routinely little more than academic, except, perhaps, in base hospitals. The meeting concluded without taking formal action.

The matter came up again at a conference held on 24 June 1943 (26) to revise the Army manual on blood grouping, which was not, however, issued until 1946. It was pointed out that, at this time (1943), so much confusion existed concerning the military importance of the Rh factor that a definitive statement by the conference would serve to throw the problem into proper perspective. Except for Dr. Louis K. Diamond, of the Children's Hospital, Boston, who

presented a minority report,³ the following statement was agreed to by all present:

The problem of isoimmunization with the Rh factor is predominantly encountered in Rh-negative women who have become immunized as a result of one or more pregnancies with Rh-positive children. It is possible to immunize some of the 15% of males and females who are Rh-negative by repeated transfusions with Rh-positive blood. To effect this, multiple transfusions carried out over a period of weeks, or even months, are necessary to induce a sufficient degree of immunity [titer of antibodies] so that subsequent transfusions with Rh-positive blood may cause reactions. It is common experience that reactions in individuals so sensitized by transfusion begin with mild reactions which progress in severity with subsequent transfusions with Rh-positive blood. Accordingly, there is usually adequate warning before a dangerous or fatal reaction develops.

Since only a small percentage of Rh-negative individuals can be sensitized with the Rh factor, *this group feels that there is no indication to embark on a large scale routine Rh testing of the personnel of the armed forces.* It would also seem more practical to this group to recommend that anemias in members of the armed forces who have apparently become immunized should be treated by means other than blood transfusions.

In view of the occasional sensitized patient in continental military establishments in whom further blood transfusions seem essential, and in view of the much greater importance of Rh sensitization in obstetrical and gynecological practice, *it is recommended to the Subcommittee on Blood Substitutes that all means be furthered for the collection and proper distribution of potent anti-Rh serum for both the armed forces and for the civilian population.*

In view of the current low supply of potent human anti-Rh serum, *it is recommended that it be employed only by experienced and skilled workers and only then when specific indications arise.*

On the basis of these recommendations, the conference saw no reason for including a section on Rh testing in the Army Laboratory Manual (TM 8-227) at this time. This recommendation was reversed at the 10 August 1943 meeting of the Subcommittee on Blood Substitutes (13), when it was recommended that the section covering the Rh factor drawn up by the Conference on Blood Grouping held 23 March 1943 (9) should be included in the manual.

Testing difficulties continued throughout the war. In his memorandum of 11 December 1944 to Col. B. Noland Carter, MC, Captain Elliott mentioned the scarcity of testing serum and the unsuitability of the test then in use in front-line installations (24). This test took an hour to run and required the use of an 81° F. (-27° C.-) waterbath, a centrifuge, and a microscope. Later, when the wounded casualties were moved back to rear installations, where additional transfusions might be necessary and where their Rh group could be determined, there might already be so many transfused red cells in the circulation that Rh-negative recipients might be erroneously grouped as Rh positive and given

³ At the Conference on Blood Grouping on 23 March 1943 (9), Dr. Diamond reported a study he was directing in over 8,000 transfusions, 90 percent of the reactions in which he thought were on the basis of Rh incompatibility. These reactions were characterized by chills, jaundice, anuria, transitory bilirubinemia, or failure of the recipient's red blood cells to increase to the expected amount after transfusion. Dr. Diamond also called attention to the multiple transfusions which had been necessary in the victims of the Coconut Grove disaster.

At the Conference on Blood Preservation and Red Cell Suspension on 6 December 1945, he reported that he had examined 30 servicemen who had received transfusions in which the Rh type was unknown. He had found that 30 of these were Rh negative and that about a quarter of the 30 had anti-Rh agglutinins in their blood.

transfusions of Rh-positive blood, possibly with fatal consequences. Captain Elliott saw only one way to eliminate this risk; namely, to determine the Rh group before the first transfusion. If this was not possible, it was still desirable to make the test later, so that subsequent transfusions would be Rh compatible.

Procurement of serum.—Late in 1943, Captain Elliott demonstrated that naturally immunized individuals could be stimulated to produce high-titer, anti-Rh serum by the injection of very small amounts of Rh-positive blood. These persons could be safely bled at frequent intervals if the blood withdrawn was replaced by transfusions of Rh-negative blood. Unfortunately, this promising plan to enlist cooperative persons with Rh-negative blood in a program for the production of Rh testing serum was not carried out.

Until the middle of 1945, which means practically until the end of the war, most of the Rh testing serum used in Army hospitals was prepared at the Army Medical School or purchased from Dr. Diamond.

Late in 1944, Lederle Laboratories developed a very potent anti-Rh serum, prepared from animals, which could be used by a slide technique at room temperature, with macroscopic reading of the result (24). The test could be completed within 10 minutes and required no equipment other than glass microslides. The reaction was clear, and the technique so simple that laboratory technicians could easily learn it.

The test seemed admirably adapted for use in frontline installations in which primary transfusions were given. If the transfusion had to be given before Rh grouping could be done, a suspension of the recipient's cells could be prepared before the blood was given and his Rh group determined later. Determination of the blood group and the transfusion of Rh-compatible blood later would prevent isoimmunization and assure longer in vivo survival of transfused red cells.

If this test were put into use, it would permit the identification and maintenance of a panel of Rh-positive donors. Blood collected in donor centers in the Zone of Interior for shipment overseas could be properly grouped and the Rh factor marked on the bottle.

At this time (December 1944), the Lederle Laboratories had on hand for immediate shipment material for about 1.5 million tests and would have more within the next 3 months. The total supply would be more than enough for distribution for all Army installations in which it could be used.

Captain Elliott recommended that the Lederle serum be procured and distributed, that laboratory officers and technicians be taught the technique, and that the importance of transfusing Rh-compatible blood whenever it was possible be called to the attention of all concerned.

Promising as the outlook seemed, it was found, on further investigation, that the Lederle serum produced false positive results if the tests were not very carefully performed and were not read within a definite time after they were set up. The allowable margin of error was so small that it was reluctantly concluded that the serum could not safely be used routinely in Army laboratories.

At a meeting of an ad hoc committee of the Subcommittee on Blood Substitutes on 2 June 1944 (28), it was announced that Dr. Wiener had been able to produce a high-titer anti-Rh agglutinin in women with erythroblastotic fetuses, whose blood originally showed a low titer. This was accomplished by the intravenous injection into them of 50 cc. of Rh-positive blood. A proposal for a contract was being submitted, but no action was taken on it during the war.

Early in 1945, Dr. Joseph M. Hill, Baylor University, began to produce large quantities of Rh testing serum by stimulating naturally immunized individuals. The serum was dried from the frozen state, vacuum sealed in ampules, and offered for sale to the Army with the assurance that all Army needs could thus be met. The serum was thoroughly tested and was found to be both potent and stable. Specifications were therefore written, and it was recommended that the serum be included in the medical supply catalog as a standard item. This was done.

Shipments of Rh-negative blood to Europe began on 12 February 1945, in the amount of 240 pints; 625 pints were shipped in March and 576 pints in June, after hostilities had ended in that theater.

Technique.—The test for Rh compatibility used at the Division of Surgical Physiology, Army Medical School, was carried out as follows (29):

1. A drop of Rh antiserum was placed in a test tube, and 1 drop of fresh 2-percent blood suspension in saline solution was added.
2. The tube was shaken, then placed in a water bath at 37° C. or in an air incubator for an hour.
3. After incubation, the sedimented cells were very gently resuspended and inspected for macroscopic agglutination. If agglutination was not observed, the tubes were centrifuged at 750–1,000 r.p.m. for 1 minute. The packed cells were then gently resuspended and observed for macroscopic agglutination.
4. If macroscopic agglutination was not evident, the slide was examined microscopically.
5. Absence of agglutination denoted that the blood was Rh negative (fig. 58). Any degree of agglutination indicated that it was Rh positive.

SCREENING TEST FOR O BLOOD

When the airlift of group O blood was planned, there was immediate need for a rapid screening test to select group O donors. Captain Elliott devised a simple, effective method:

Avid, proved high-titer group O serum was dried, in single test doses, in small glass shell vials. Individual grouping sets were made up, consisting of a vial of serum and a vial of salt solution. One drop of the donor's blood was added to the salt solution and two drops of the suspension were transferred to the dried serum. The serum agglutinated cells of groups A, B, and AB, but did not agglutinate group O cells.

This technique effectively identified about 98 percent of group O donors. A second check, to reduce the possibility of error to a minimum, was carried out at the donor centers by checking the blood of each apparent group O donor with red blood cells of known A and B groups before the blood was shipped.

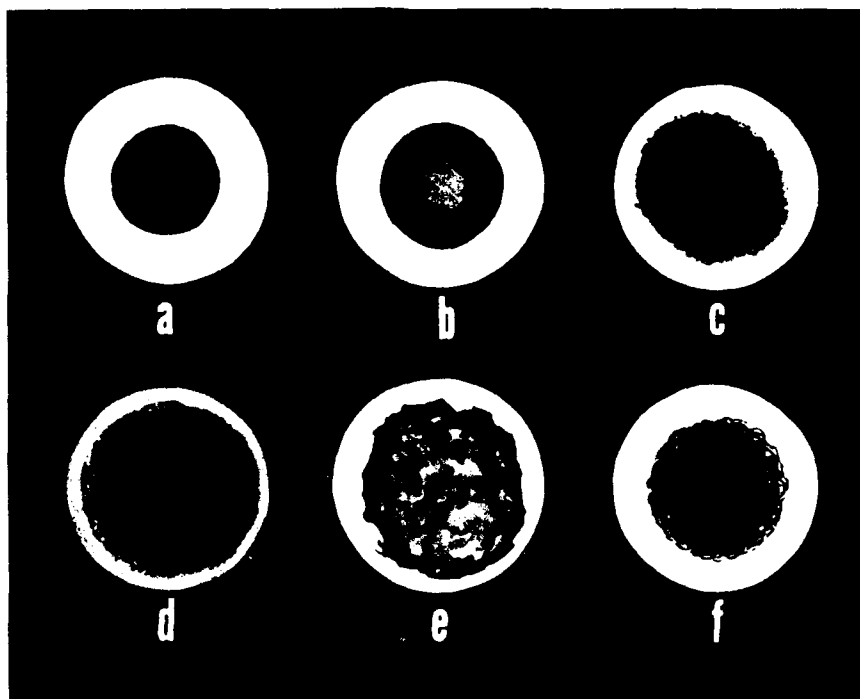

FIGURE 58. Sedimentive technique of testing for Rh factor (57). This illustration shows the red cell sediment (magnification 1:2) in agglutination tubes examined from below with hand lens; negative reactions (a and b); the inner light disk in fig. b is explained by a slight convexity in the bottom of the tube; faintly positive reaction (c); weakly positive reaction (d); and typical positive reactions (e and f).

The screening sets were quickly put into production by the Reichel Division of Wyeth Laboratories and later by Cutter Laboratories. They were used in all the Red Cross centers in which blood was collected for shipment overseas, the donors thus identified being bled into the special bottles provided for oversea shipment.

HEMATOCRIT DETERMINATIONS

Copper Sulfate Falling Drop Test

A most important consideration in the management of shock was its early recognition. The degree of reduction in the blood volume was usually the initial, and often the only, determining factor. With this information available, therapy could be precise, and, if the supply of blood or plasma were limited, these agents could be most usefully distributed among the casualties.

No means of making this determination existed when the United States entered the war, nor was any developed until almost 2 years had passed. At the Conference for the Revision of the Army Manual on Blood Grouping on 24 June 1943 (26), part of the discussion concerned the pressing need for some

method for the rapid measurement of blood concentration under field conditions. Certain specifications had to be met: The method must require little blood, little time, and apparatus that would not be disturbed by temperature ranges from Guadalcanal to Alaska. The method must be applicable on shipboard, on the unstable base of a rolling vessel, and must be simple enough to be mastered readily by an enlisted man. The problem of devising such a method was assigned to the group working on shock at the Rockefeller Institute for Medical Research.

At the meeting of the Subcommittee on Shock on 1 December 1943 (27), Dr. Donald D. Van Slyke, of the institute, described the technique jointly devised by himself; Lt. Robert A. Phillips, Lt. Vincent P. Dole, and Lt. Kendall Emerson, Jr., all MC, USN; Dr. Paul B. Hamilton, and Dr. Reginald M. Archibald (30). Specific gravity measurements, Dr. Van Slyke stated, were the only ones that would meet the specifications. The Barbour falling drop technique was excellently adapted to civilian needs, but it required special apparatus, a stable base, and organic liquids with a high temperature coefficient. His group therefore decided to initiate its search for a suitable test for field use on the old principle of dropping blood into standard solutions of known gravity. They further decided that, in order to avoid the temperature coefficients of organic liquids, which expand about five times as much as aqueous solutions, aqueous solutions must be used as the standard.

When salt and glycerol solutions were used for this purpose, the drop of blood or plasma being tested dissolved so rapidly that results were only approximate. To prevent this phenomenon, a protein precipitant in the form of a mixture of salt and picric acid was added to the solution, to form a film about the drop of blood or plasma and hold it together.

This test had been in use only a single day when Lieutenant Phillips walked into the laboratory with a copper sulfate solution which, in itself, met all the requirements. It was easily prepared by dilution of a copper sulfate solution made up by shaking a pound of copper sulfate crystals in a pint of water for 5 minutes. The temperature coefficient of the standard solution was the same as that of blood, which made a temperature control unnecessary.

When a drop of blood or plasma was dropped into this solution (fig. 59), a layer of copper proteinate formed about it and held it together in a sac that did not change its gravity for about 20 seconds, which was long enough to determine whether the drop rose or fell in the solution. At the end of this time, the drop absorbed the copper and fell to the bottom. Another test could be run at once and about a hundred tests could be run with the same solution. A convenient portable kit (fig. 60) contained everything necessary for the test.

Accuracy was surprisingly high; it was possible to obtain blood and plasma gravities precise to 1 in the fourth decimal place, which was several times as accurate as was needed (27). With accuracy so easily obtained, the method could be used not only to estimate plasma proteins but also to estimate hemoglobin, by determining the difference between the gravities of whole blood and plasma. In 20 bloods tested by this method, hemoglobin

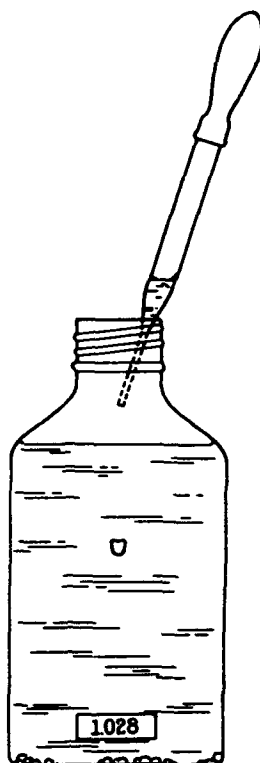

FIGURE 59.—Demonstration of copper sulfate (falling drop) method of measuring specific gravities of whole blood and plasma (30).

estimates had varied only 0.7 percent from the results of determinations by a particularly precise form of the oxygen capacity method. Hematocrit values could also be determined from the blood and plasma gravities; they agreed, within an average of 2 percent, with determinations by the standard centrifuge method.

The test had been employed under a variety of circumstances. A medical officer on a hospital ship in the Pacific had seen a preliminary description of it in *BUMED* and had made a test study of it on medical personnel. The results had not been affected by the motion of the ship or by temperature changes within the range of 60° to 106° F. (15° to 41° C.). Later, the same officer had used the test on some 800 sick and wounded brought aboard in 2 hours. Under the circumstances, he wrote Dr. Van Slyke and his associates, there was not much time for anything but a laboratory test as simple as this.

The line charts (charts 4 and 5) devised by Lieutenant Dole for calculations of plasma proteins, hematocrit, and hemoglobin greatly simplified the test. When a straight edge was laid across a set of scales, all of these values could be obtained, and the entire test completed, within 2 minutes. The possible variations of hemorrhage, seepage of plasma, and dehydration were so numerous that any quick means of making the diagnosis and furnishing

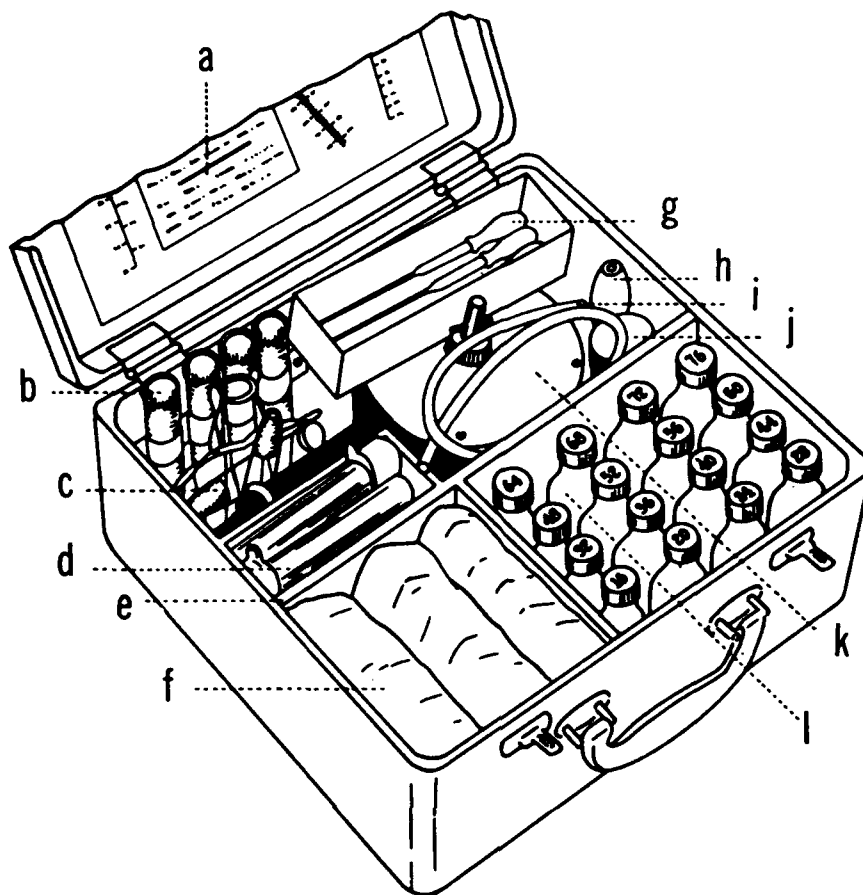
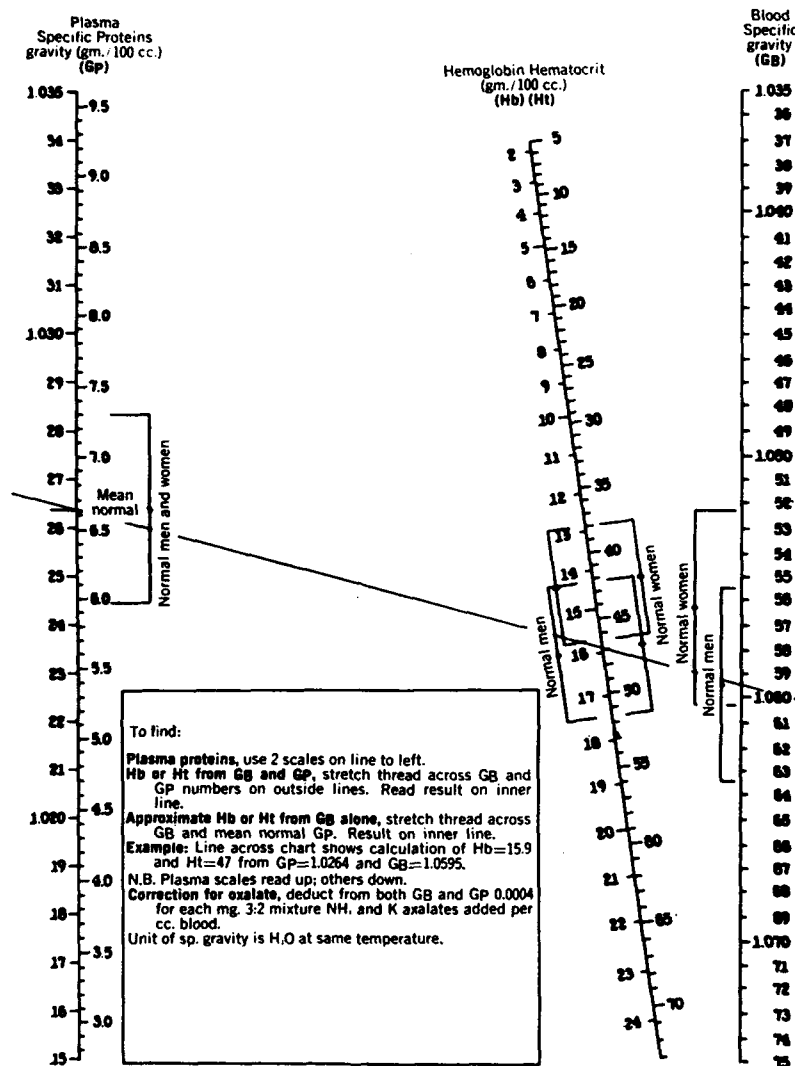

FIGURE 60.—Portable kit in portable typewriter case 13 inches by 12 inches by 6 inches for copper sulfate (falling drop) method of measuring specific gravities of whole blood and plasma (30). Line chart for calculating plasma gravities proteins and hemoglobin (a), metal centrifuge cups (b), removable centrifuge head (c), 12 oxalated tubes with rubber caps (d), $\frac{1}{2}$ inch plywood partitions (e), twelve 10-cc. syringes and needles in sterile packs (f), medicine droppers (g), handle for centrifuge (h), tourniquet (i), 2-oz. bottle with alcohol sponges (j), portable hand centrifuge (k), and 2-oz. bottles containing copper sulfate solution (l).

a guide to treatment was useful, for the fluid needs of the casualty in shock depended upon the category into which he fell. Hematocrits of 25 to 30 indicated a blood loss of 2,000 cc. or more, which was common in casualties with multiple or extensive wounds.

The copper sulfate (falling drop) test does not indicate the total circulating blood volume, as it is sometimes stated that it does. It does provide a method of determining the relative quantity of circulating red blood cells plus information concerning the hematocrit, hemoglobin, and plasma protein levels. It not only indicates the need for whole blood and the approximate

CHART 4.—Line chart for calculating plasma proteins, hemoglobin and hematocrit from specific gravities of plasma and blood



Source: Phillips, R. A., Van Slyke, D. D., Dole, V. P., Emerson, K., Jr., Hamilton, P. B., and Archibald, R. M.: Copper Sulfate Method of Measuring Specific Gravities of Whole Blood and Plasma with Line Charts for Calculating Plasma Proteins, Hemoglobin and Hematocrit from Plasma and Whole Blood Gravities. From the U.S. Navy Research Unit at the Hospital of the Rockefeller Institute for Medical Research, n.d.

amounts needed (about 500 cc. for each three points of desired increase in the hematocrit), but also indicates the absence of indications for blood transfusion and thus prevents the waste of this valuable and scarce substance.

This test was used with great satisfaction in all theaters of operations, one reason being that it required neither elaborate equipment nor trained personnel. When the tubes for the test were kept on the ward, with (dry) syringes, the test could be made on the spot and the information needed could be acted upon without delay.

CHART 5.—Line chart for calculating percentages of normal plasma proteins and hemoglobin from specific gravities of plasma and blood

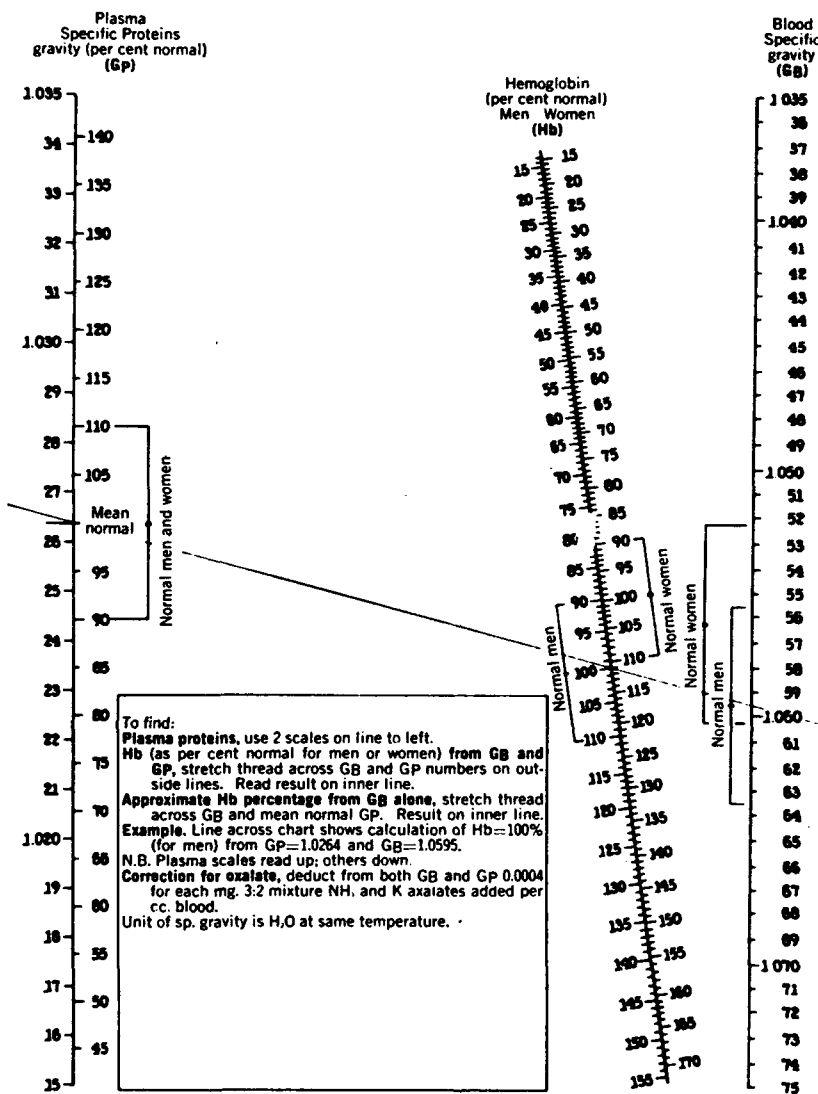

Source: Phillips, R. A., Van Slyke, D. D., Dole, V. P., Emerson, K., Jr., Hamilton, P. B., and Archibald, R. M.: Copper Sulfate Method of Measuring Specific Gravities of Whole Blood and Plasma with Line Charts for Calculating Plasma Proteins, Hemoglobin and Hematocrit from Plasma and Whole Blood Gravities. From the U.S. Navy Research Unit at the Hospital of the Rockefeller Institute for Medical Research, n.d.

Thalhimer modification of the Van Slyke et al. test.—Shortly after the test devised by Van Slyke and his group was described, the Thalhimer modification of the test, which had the approval of the workers at the Rockefeller Institute, was officially adopted for use in American Red Cross blood donor centers (31). This modification was the use of a single solution of copper sulfate, of appropriate specific gravity, to register the critical level of hemoglobin agreed on for the selection or rejection of donors. A drop of blood

was collected from a needle or knife prick in an expendable glass capillary tube, from which it was expelled into the solution by pressure on a rubber bulb of the type used in vaccination. The level of acceptance of donors was 12.5 gm. percent, and the specific gravity of the solution was set for that level. If the drop of blood floated, the donor was rejected.

DYE MEASUREMENT OF BLOOD VOLUME

Dr. Magnus I. Gregersen, Columbia University College of Physicians and Surgeons, at the Conference on Shock on 1 December 1943 (27), described a dye technique for the determination of the total plasma. Technical difficulties hampered the production of the materials in quantity and it was not possible to develop the method further during the war.

TITRATION OF BLOOD

Shortly after the blood bank was established in the Mediterranean theater, certain difficulties arose (p. 424) that led to the practice of titering all O blood and reserving blood with an anti-A or anti-B agglutinin titer of 1:250 or higher for group O recipients.

Titration was not practiced at the beginning of the airlift of blood to Europe, and, though it was directed by The Surgeon General in early October that it should be carried out, it was not begun until February 1945, because of the delay in collecting the necessary equipment and securing and training personnel (32). Except for the first few shipments, all blood flown to the Pacific areas was titrated. The practice in both airlifts was to designate blood with high titer as suitable for group O recipients only.

Special Investigations

Naval Medical Research Institute.—Several special studies on the titer of blood and plasma were made in the course of the war.

Two studies of the titer of pooled plasma at the Naval Medical Research Institute, National Naval Medical Center, gave essentially the same results (33). The first study covered 300 titrations and the second 1,000, with 100 monovalent controls. The investigations produced no evidence of any harmful effects as a result of the titer of isohemagglutinins present in pooled plasma and no justification for preliminary crossmatching of plasma before it was administered. The data also tended to discredit reports that undue reactions after the infusion of pooled plasma were caused by agglutinins in it.

American Red Cross Blood Donor Service.—Dr. Thalhimer, Associate Technical Director of the Red Cross Blood Donor Service, and Maj. Earl S. Taylor, MC, Technical Director (34), reported on the anti-A and anti-B agglutinin titers in 1,354 pools of human plasma, in which the number of individual plasmas in the pools varied from 6 to 60. The pools were either random

samples or were secured from every 5th or every 10th specimen encountered in routine processing. In 99.7 percent of the pools, macroscopic agglutinin titers were less than 1:40, and in 97 percent they were less than 1:20. In 355 small pools, made up of 6 to 10 individual plasmas, the percentage of relatively low titers (1:20 to 1:40) was somewhat higher than in larger pools, but the proportion of titers of 1:40 or higher was no greater than in the larger pools, which indicated the safety of the smaller pools.

A special study was made of pools of type O plasma with titers up to 1:256. Clinical administration of these plasmas caused no reactions, nor were there any signs or symptoms of intravascular agglutination.

These observers concluded that pooled plasma prepared in small pools at hospital blood banks or in larger pools at processing laboratories, in which the plasmas entered the pools by chance and without selection, could be safely administered to all individuals, regardless of their blood type.

Whole Blood Procurement Service.—The Army Whole Blood Procurement Program processed some 1,500 bloods daily, which made it practical to obtain enough high titer bloods for a comprehensive study of the effects of transfusion of such blood to incompatible recipients. The study was undertaken by Maj. Leslie H. Tisdall, MC, Coordinator, Army Whole Blood Procurement Service, and his associates, with the cooperation of volunteers at the Colorado State Penitentiary (35).

The study covered the titration of 1,650 group O bloods, 376 of which (22.7 percent) were found to have anti-A or anti-B agglutinins, or both, of 1:640 or higher. Infusions in the amount of .50 cc. of high-titer group O plasma were given to 39 volunteers representing other than O blood groups. Plasma was used instead of blood to make sure that any subsequent hemolytic reactions would be the result of hemolysis of recipient, not donor, cells. The investigators considered the criterion of a hemolytic reaction to be the demonstration of hemolysis of the recipient's red blood cells while the donor cells remained intact. Posttransfusion observation lasted for a minimum of 8 hours and was personal and careful.

The isoagglutinin titer of the 39 incompatible transfusions ranged from 1:400 to 1:4,000. Two volunteers, given plasma with a titer of 1:500, had no reactions. Three, given plasma with titers of 1:1,000 to 1:3,000, had chills and fever but no evidence of hemolysis. The remaining 34 volunteers, given plasma with titers from 1:400 up to 1:4,000, all had hemolytic reactions; full recovery ensued in all cases in from several hours to 4 days.

Major Tisdall and his associates concluded that O blood was safe to use for universal donations when the antibody titer was no higher than 1:1-200 by the centrifuge technique which they had devised. They believed that a standardized technique of this kind should be adopted and that Rh-negative, low-titer O blood should be kept available in every hospital blood bank.

The experience with high-titer group O blood in the Mediterranean theater was substantiated by the studies made at Walter Reed General Hospital in 1945 by Maj. John J. McGraw, Jr., MC. They showed a subclinical increase in

bilirubin after the use of high-titer blood and pointed to the desirability of using low-titer group O blood whenever possible in combat casualties. Major McGraw's studies also showed the importance of Rh testing to reduce the risk of severe and fatal transfusion reactions in Rh-negative recipients.

STUDIES ON A AND B SUBSTANCES

A number of studies were made before and during the war on the use of the A and B substances developed by Witebsky to neutralize the agglutinins in group O blood and condition it, so to speak, for universal donation. These substances were procurable commercially. Witebsky developed them originally from human gastric juice and later from saliva, and he questioned the safety of the products produced by commercial firms from hog (A substance) and horse (B substance) stomachs.

A conference on Group-Specific Substances A and B was held on 19 March 1945, with an extensive agenda (36). It was the sense of the meeting that these preparations were now sufficiently safe to be recommended for addition to human blood employed for transfusion in the Armed Forces; that a subcommittee under the chairmanship of Dr. Witebsky be appointed to assume responsibility for their standardization, control, safety, and manufacturing improvement; and that fundamental research be undertaken in the field.

At the Conference on Resuspended Blood Cells, combined with a meeting of the Subcommittee on Blood Substitutes, on 18 May 1945 (37), the ad hoc committee appointed at the 19 March meeting made its report on standardization of A and B substances and on directions for their use. Studies were then in progress to determine techniques of sterilization, incorporation in ACD (acid-citrate-dextrose) solution, storage without loss of antibody-neutralizing power, and other details. When the data listed were at hand, the subcommittee would be asked to vote on recommending that these substances be used to neutralize anti-A and anti-B agglutinins in group O whole blood distributed to the Armed Forces.

The war ended before these studies were concluded, and A and B substances were not used in the Korean War.

STUDIES OF CELL SURVIVAL AFTER TRANSFUSION

Ashby, in 1919, was the first to publish studies on differential cellular agglutination as a method of estimating cell survival rates after transfusion (38). During World War II, his method was considered more reliable than even the ingenious technique described by Ross and Chapin (39) in 1943 of radioactive iron tagging of red blood cells because the Ashby technique, unlike the Ross and Chapin technique, permitted the investigator to follow the transfused red cells throughout their entire lifespan.

Gibson's studies (39) by the Ashby technique indicated that the type of preservative used and the conditions under which the blood was stored had

much to do with the lifespan of the red cells. Human erythrocytes transfused shortly after their collection in sodium citrate remained intact after transfusion and disintegrated at the rate of about 1 percent per day. Cells that were nonviable at transfusion disappeared from the bloodstream within 24 hours. Viable cells completed the normal 120-day life cycle.

SEROLOGIC TESTING FOR SYPHILIS

The original Red Cross donor regulations prohibited the use of serologically positive blood (p. 142), and this restriction continued throughout the war though all the evidence was to the effect that this was an unnecessary precaution when the blood was not used for immediate transfusion (40).

Details of losses from this cause are stated elsewhere (p. 568). By the end of August 1942, the eight commercial laboratories processing blood for plasma had received a total of 559,767 units of which 32,812 (5.8 percent) had been lost for various reasons, including 3,094 units (0.55 percent) discarded as serologically positive (41). This proportion remained essentially the same whether blood was collected at the donor centers or overseas.

The matter of serologically positive blood was discussed in detail at the meeting of the Subcommittee on Blood Substitutes on 15 December 1942 (42), in connection with the work being done by Dr. Cohn on plasma fractionation. Dr. Cohn made the following points:

1. The minimum requirements for plasma and albumin laid down by the National Institute of Health did not prohibit the use of serologically positive blood.
2. A search of the literature by Drs. William C. Boyd, John F. Enders, and Charles A. Janeway revealed no evidence that spirochetes survive outside of the body for as long as 48 hours.
3. To fortify the evidence, these observers conducted studies that showed that *Spirochaeta pallidum* was rendered noninfectious, if not killed, by the lyophilizing process used in the processing of plasma. The studies included inoculation, transfer, and adequate controls.

In Dr. Cohn's opinion, there was no question that these reports and studies proved the inability of lyophilized plasma to transmit syphilis. Since the processing of serum albumin involved both freezing and drying, he saw no reason to exclude serologically positive blood from use as long as the processing included these two phases. A letter from Dr. Milton V. Veldee, read at this meeting, stated that he was "unable to get very much disturbed over the chance introduction of 1 serologically positive bleeding into a pool intended for processing to serum albumin." He considered that this random happening had "absolutely no significance from the standpoint of transmission of syphilis * * * or from the aesthetic point either, whatever the latter is." Dr. Veldee did object, however, to the proposal that all serologically positive bloods be concentrated and used for albumin, and this was not done.

Blood collected at the Red Cross blood donor centers for plasma and albumin was tested serologically at the processing plants. When the airlift to Europe began in August 1944, equipment and personnel were supplied to

permit each donor center to perform its own serologic tests. It was thus possible for each center to ship out each day's collection at the end of the day and for all the bloods collected to be sent overseas without further delay for processing. The same plan was used with the Pacific airlift.

Syphilitic Donors

At the 15 December 1942 meeting of the Subcommittee on Blood Substitutes (42), it was agreed that nothing could be done to exclude the blood of syphilitic donors who applied to the centers in the very early stages of the disease, before serologic tests were positive. Blood was never taken from persons with a history of genital sores or discharges within the last 6 months, and, in deference to public opinion (probably the "aesthetic point" mentioned in Dr. Veldee's letter just quoted), donors who were known to have syphilis or to have had syphilis were not permitted to give blood. A Kahn or Kolmer test was always performed on bloods to be used for transfusion.

In oversea military hospitals, if no nonsyphilitic donor was available in an emergency, it was the practice to use a donor with a history of syphilis if he had no clinical evidence of the disease, if he had been adequately treated in accordance with current directives, and if serologic tests had been negative for not less than a year.

As time passed, large numbers of soldiers on leave or stationed near blood donor centers began to give blood, and an occasional positive serologic reaction was turned up among them. The problem of reporting these donors was complicated by the fact that many of them were on furlough, or were moved, or soon to be moved, from the posts to which they were then attached. On 21 September 1943, Dr. Robinson wrote to The Surgeon General for instructions in these cases (43). Although it might add somewhat to the responsibilities of the donor centers, Dr. Robinson thought it would be practical to obtain the serial number of each donor from the Armed Forces.

The reply from The Surgeon General (44) asked that the name, Army serial number, and station of each donor from the Armed Forces be obtained at the time of the donation. If the blood proved serologically positive, the information should be sent at once to the commanding general (attention: chief, medical branch) of the army service area in which the donor center was located, with the request that the information be relayed to the surgeon of the Army installation in which the soldier was stationed. This procedure would insure that the information reached the responsible medical officer in the most expeditious manner possible and would simplify tracing the soldier in the event that he had changed stations.

On 16 March 1944 (45), these instructions were further modified in the light of information recently obtained to the effect that, after repeated blood donations, a certain proportion of donors would show false positive tests.⁴ It was

⁴ It was also discovered that false positive tests might occur shortly after the smallpox vaccination required of all military personnel.

therefore requested that positive serologic tests on soldiers who had made two or more donations should not be reported as directed unless it were possible to recheck the tests and they were still positive 2 months later, without blood having been given in the interim.

References

1. War Department Circular No. 123, 24 June 1941, paragraph I, Determination and Recording of Blood Types—Changes in AR 40-1715 and 600-40.
2. Circular Letter No. 70, Office of The Surgeon General, War Department, 14 July 1941, subject: The Determination and Recording of the Blood Groups of All Individuals in the Military Service.
3. Circular Letter No. 88, Office of The Surgeon General, War Department, 4 Sept. 1941, subject: Supplemental Information Concerning Determination of Blood Type in Accordance with SGO Circular Letter No. 70.
4. Circular Letter No. 112, Office of The Surgeon General, War Department, 26 Nov. 1941, subject: Supplemental Information Concerning Determination of Blood Type in Accordance with SGO Circular Letters No. 70 and No. 88.
5. Circular Letter No. 170, Office of The Surgeon General, Services of Supply, War Department, 2 Dec. 1942, subject: The Purpose of Blood Grouping Army Personnel.
6. Minutes, meeting of Subcommittee on Blood Substitutes, Division of Medical Sciences, NRC, 23 May 1941.
7. Minutes, meeting of Subcommittee on Blood Substitutes, Division of Medical Sciences, NRC, 18 July 1941.
8. Minutes, meeting of Subcommittee on Albumin and By-Products, Division of Medical Sciences, NRC, 22 Jan. 1943.
9. Minutes, Conference on Blood Grouping, Division of Medical Sciences, NRC, 23 Mar. 1943.
10. Minutes, Conference on Transfusion Equipment and Procedure, Division of Medical Sciences, NRC, 25 Aug. 1942.
11. Minutes, meeting of the Albumin and By-Products Group, Division of Medical Sciences, NRC, 10 May 1943.
12. Minutes, meeting of Subcommittee on Blood Substitutes, Division of Medical Sciences, NRC, 13 May 1943.
13. Minutes, meeting of Subcommittee on Blood Substitutes, Division of Medical Sciences, NRC, 10 Aug. 1943.
14. Minutes, meeting of Subcommittee on Blood Substitutes, Division of Medical Sciences, NRC, 24 Sept. 1943.
15. Minutes, Conference of Albumin and By-Products Group, Division of Medical Sciences, NRC, 17 Nov. 1943.
16. Minutes, Conference of Albumin and By-Products Group, Division of Medical Sciences, NRC, 28 July 1943.
17. Minutes, meeting of Subcommittee on Blood Procurement, Division of Medical Sciences, NRC, 18 Aug. 1941.
18. Minutes, meeting of Subcommittee on Blood Substitutes, Division of Medical Sciences, NRC, 10 Nov. 1942.
19. Minutes, meeting of Subcommittee on Blood Substitutes, Division of Medical Sciences, NRC, 12 May 1942.
20. Minutes, meeting of Subcommittee on Blood Substitutes, Division of Medical Sciences, NRC, 23 June 1942.
21. Letter, Lt. Col. Thomas E. Lanman, MC, to Chief Surgeon, European Theater of Operations, U.S. Army, 4 Mar. 1943, subject: Incorrect Recording of Blood Type on Identification Tags.
22. Kilduffe, Robert A., and DeBakey, Michael: *The Blood Bank and the Technique and Therapeutics of Transfusions*. St. Louis: C. V. Mosby, 1942.

23. Landsteiner, K., and Wiener, A. S.: Studies on an Agglutinin (Rh) in Human Blood Reacting with Anti-Rhesus Sera and Human Isoantibodies. *J. Exper. Med.* 74: 309-320, 1 Oct. 1941.

24. Memorandum, Capt. John Elliott, SnC, for Division of Surgery, Office of The Surgeon General (attention: Col. B. N. Carter, MC), through Director, Army Medical School, 11 Dec. 1944, subject: Rh Blood Grouping.

25. Memorandum, Capt. John Elliott, SnC, to Chief, Surgical Consultants Division, Office of The Surgeon General, through Director, Army Medical School, 1 Feb. 1945, subject: Transportation of Blood from the U.S. to the ETO Blood Bank in Paris.

26. Minutes, Conference for the Revision of the Army Manual on Blood Grouping, Division of Medical Sciences, NRC, 24 June 1943.

27. Minutes, Conference on Shock, Subcommittee on Shock, Division of Medical Sciences, NRC, 1 Dec. 1943.

28. Minutes, Meeting of the Group Appointed by the Subcommittee on Blood Substitutes to Consider Methods of Using Normal Human Serum Albumin in the Army Air Forces, Division of Medical Sciences, NRC, 2 June 1944.

29. Clinical Significance of the Rh Factor. *Bull. U.S. Army M. Dept.* No. 78, July 1944, pp. 50-52.

30. Phillips, R. A., Van Slyke, D. D., Dole, V. P., Emerson, K., Jr., Hamilton, P. B., and Archibald, R. M.: Copper Sulfate Method of Measuring Specific Gravities of Whole Blood and Plasma with Line Charts for Calculating Plasma Proteins, Hemoglobin and Hematocrit from Plasma and Whole Blood Gravities. From the U.S. Navy Research Unit at the Hospital of the Rockefeller Institute for Medical Research, n.d.

31. Minutes, meeting of Subcommittee on Blood Substitutes, Division of Medical Sciences, NRC, 2 Mar. 1944.

32. Memorandum, Maj. F. N. Schwartz, MAC, to Chief, Personnel Service, Office of The Surgeon General, 11 Oct. 1944, subject: Allotment of Six Additional Enlisted Technicians.

33. Lozner, Lt. Eugene L., MC, USN: Studies on Agglutinin Titers of Pooled Plasma. Research Project X-104, Report No. 2. Naval Medical Research Institute, National Naval Medical Center, Bethesda, Md., 19 Aug. 1943.

34. Thalhimer, W., and Taylor, E. S.: The Low Agglutinin Titer of Both Small and Large Pools of Plasma. *J.A.M.A.* 128: 277-279, 26 May 1945.

35. Tisdall, L. H., Garland, D. M., Szanto, P. B., Hand, A. M., and Barnett, J. C.: The Effects of the Transfusion of Group O Blood of High Iso-Titer into Recipients of Other Blood Groups. *Am. J. Clin. Path.* 16: 193-206, March 1946.

36. Minutes, Conference on Blood Group Specific Substances A & B, Division of Medical Sciences, NRC, 19 Mar. 1945.

37. Minutes, Conference on Resuspended Blood Cells and meeting of Subcommittee on Blood Substitutes, Division of Medical Sciences, NRC, 18 May 1945.

38. Ashby, W.: The Determination of the Length of Life of Transfused Blood Corpuscles in Man. *J. Exper. Med.* 29: 267-281, 1 Mar. 1919.

39. Minutes, Conference on Preserved Blood, Division of Medical Sciences, NRC, 25 May 1943.

40. Taylor, E. S.: Procurement of Blood for the Armed Forces. *J.A.M.A.* 120: 119-123, 12 Sept. 1942.

41. Report on Loss of Blood due to Syphilis From Eight Processing Laboratories, n.d.

42. Minutes, meeting of Subcommittee on Blood Substitutes, Division of Medical Sciences, NRC, 15 Dec. 1942.

43. Letter, Dr. G. Canby Robinson to Maj. Gen. Norman T. Kirk, attention V. D. Control Division, 21 Sept. 1943.

44. Letter, Lt. Col. Thomas B. Turner, MC, (for The Surgeon General) to Dr. G. Canby Robinson, 24 Sept. 1943.

45. Letter, Lt. Col. Douglas B. Kendrick, MC, to Maj. Earl S. Taylor, MC, 16 Mar. 1944.

CHAPTER XI

The Plasma Program

HISTORICAL NOTE

World War I

This whole chapter on the plasma program should be read with the recollection that for all practical purposes, the clinical use of plasma for shock and hemorrhage was a development of World War II, just as the concept of hemorrhagic shock was a development of that war.

Reviews of the literature indicate (1) that the clinical use of blood plasma and serum was first suggested by Bowditch in 1871 and Luciana in 1872. Ehrlich was the first to point out that the most stable method of preserving the total solids of plasma or serum was removal of the water component. The basis of the enormous plasma and serum albumin programs, as well as of the clinical use of these agents in World War II, is inherent in these two suggestions.

The military use of blood plasma as a substitute for whole blood in combat casualties was proposed in March 1918, in the *correspondence columns* of the *British Medical Journal*, by Gordon R. Ward (2), as a way of eliminating the risk, in transfusions given at casualty clearing stations, that the donor red blood cells might be hemolyzed in the recipient bloodstream (p. 7). Citrated plasma would be easy to store and administer, and its use was rational: Wounded men did not die from lack of hemoglobin but from loss of fluid, with resulting devitalization and low blood pressure. Ward's suggestion of a controlled study of plasma, whole blood, and gum acacia was apparently not followed up, nor was his idea put to clinical use in combat casualties in World War I.

Also in 1918, Rous and Wilson (3) concluded from experimental studies on dogs that loss of blood volume, not loss of red blood cells, was the important consideration in hemorrhage. Even after gross hemorrhage, these workers were able to restore the blood pressure to normal, and maintain it at the normal level, by replacing the blood they had removed with an equal quantity of plasma. Plasma, they pointed out, had only half the viscosity of blood, and it seemed to them, in order that the diminished number of red cells might carry on the work of the body, that a brisker circulation, secured by a less viscid fluid, would be desirable.

Mann (4), also in 1918, reported that parenteral injections of homologous serum were fully as effective in experimental surgical shock as any other method (p. 335). Serum might therefore be a valuable agent in the treatment of shock if whole blood were not available.

The Interval Between the Wars

In 1927, Strumia and his group (5) at the Bryn Mawr Hospital began to use plasma in the treatment of severe infections because it was simpler to prepare, and had a larger yield, than homologous serum, and also because serum frequently caused severe reactions, which even heterologous plasma, given intravenously, did not. As early as 1900, Brodie (6) had called attention to the differences in the behavior of serum and plasma. He thought, though the hypothesis is still unproved, that the untoward reactions from serum were caused by the fibrin precipitation which occurred when serum was separated from clotting blood.

By 1931, the Bryn Mawr group were using plasma routinely in the treatment of certain hemorrhagic diseases as well as infectious diseases. Their policy of using it within 24 hours after the blood was drawn deprived them of one of its chief advantages; namely, its safe storage.

The first use of plasma as a hemostatic agent was apparently by Filatov and Kartasevskij (7) in 1935. In the same year, Heinatz and Sokolow (8) used it in the treatment of hemolytic shock.

The following year, Elliott (9) proposed that both plasma and serum be used in the treatment of surgical, obstetric, or traumatic shock whenever transfusion was indicated. His reasoning, like Ward's, was that the replacement of lost blood volume was more important than the replacement of red blood cells, because the maintenance of osmotic pressure is a function of the plasma proteins. Elliott also advanced two other ideas: (1) that liquid plasma could be stored for long periods without deterioration, and (2) that if plasma was pooled (he used up to eight donors), neither typing nor crossmatching would be necessary because the antibody titer would be neutralized.

Elliott's observations were quickly confirmed by a number of other observers. Then, in 1939, he, Tatum, and Nasset (10) recommended stored plasma as "an ideal substitute for whole blood in the emergency treatment of shock and hemorrhage for war wounds." Elliott's earlier recommendation that plasma could be safely used without typing or crossmatching was now supported by their experience in 191 transfusions. The technique of collecting the blood in "a sealed vacuum transfusion set" was described, with the separation of the plasma from the blood in a completely closed system that prevented contamination.

In 1940—the year before the United States entered World War II—Strumia and his associates (11) recommended the use of citrated blood plasma, without crossmatching, in the treatment of burns and shock, their results paralleling those of Mahoney (12), Elkinton (13), and McClure (14). Best and Solandt (15) reported encouraging results with plasma and serum in the prevention of experimental shock. In 1941, Kekwick and his associates (16) reported the treatment of shock and hemorrhage in air raid casualties and concluded that plasma was as effective as whole blood in restoring blood volume

in injuries of this type.¹ By this time, Strumia and McGraw (5) were using plasma in large amounts, up to 950 cc. in a single injection. One of their burned patients received 7,300 cc. of plasma over an 11-day period.

All of these early experimental and clinical studies were made with liquid plasma, prepared in small amounts in hospital laboratories.

The experience with plasma in the Blood for Britain project is described elsewhere under that heading (p. 13).

GENERAL CONSIDERATIONS

The procurement of plasma on the major scale required by the Armed Forces in World War II was possible only because of the cooperation of many persons and agencies, including:

1. Volunteer donors; that is, the general public. The alternative to their donations would have been the outright purchase of blood, which would have been very expensive, probably not practical in the amounts required, and undesirable from other aspects.

2. The Army Medical School, whose activities and functions have already been described (p. 61).

3. The Army and the Navy, whose cooperation, which is described under appropriate headings, eliminated duplications, cut through bottlenecks, and added greatly to the efficiency and success of the project. By agreement, the Army handled all contracts for plasma and the Navy, all contracts for serum albumin and the other plasma fractions.

4. The American Red Cross, with its national scope, hundreds of well-organized chapters, and thousands of volunteer workers.

5. The NRC (National Research Council), acting chiefly through the Subcommittee on Blood Substitutes of the Committee on Blood Transfusions.

6. The Army Medical Procurement Agency, which, to avoid confusion and the writing of multiple contracts, acted as purchasing agent for all plasma, albumin, and byproducts supplied commercially to the Army and the Navy.

7. Commercial biologic firms, selected according to their geographic location in respect to blood donor centers and their actual and potential facilities for processing blood.

8. The manufacturing firms which developed and supplied the equipment necessary for the collection and processing of blood.

Definitions

Plasma is the supernatant fluid that separates from the cellular elements when an anticoagulant is added to blood. Serum is the liquid portion that separates during the process of clotting. Plasma contains fibrinogen. Serum

¹ These observations support the concept that if gross hemorrhage is not a factor, plasma is adequate in the management of shock. Victims of air raids had been struck by flying debris or had been crushed or buried; they did not have the multiple wounds caused by high-velocity missiles and associated with hemorrhage which require whole blood.

does not. The distinction in nomenclature should be carefully observed, for the plasma and serum albumin programs in World War II were separate projects, though the serum program was a development of the plasma program. The "technical paradox" by which dried blood plasma was listed as serum in the Army supply catalog was not corrected until well into 1944 (17).

FORMS OF PLASMA

Background of Selection of Plasma for the Armed Forces

An earlier chapter in this volume, dealing with the evolution of the whole blood program contains an extended discussion of the reasons that led up to the selection of plasma for use of the Armed Forces by the Subcommittee on Blood Substitutes on 19 April 1941 (18) (p. 51). Briefly, they were as follows:

By the time World War II broke out in Europe, which was more than 2 years before the United States entered the war, experimental studies and clinical testing had advanced sufficiently far to make it clear that either serum or plasma would be the most desirable agent for the management of shock in battlefield casualties and in forward hospitals. There was practically no difference in their clinical effect. The only biochemical difference between them was that serum contained no fibrinogen, its removal having occurred during the clotting process. Reactions with both agents were insignificant. Liquid plasma, if properly handled, could be safely stored for months. Frozen plasma could also be kept for indefinite periods. A dried form of plasma could be produced, though methods of drying were not yet entirely satisfactory. The chief advantage of plasma was that the yield was 15-20 percent greater per pint of blood than the yield of serum.

When the subcommittee recommended that either frozen or dried plasma be employed in lieu of blood in the treatment of shock, there were a number of reasons why the Armed Forces had little choice but to accept the decision:

1. Supplying whole blood to the Armed Forces in the now imminent war, in the quantities likely to be needed, together with its safe storage and transportation, presented logistic problems of enormous proportions that simply could not be solved in the light of either the knowledge possessed or the facilities available in 1940-41. Preservative solutions that would permit long storage periods of blood were just being developed (p. 221). Investigations on thoroughly dependable, avid grouping sera were in their very early stages (p. 236). The development of suitable equipment for the collection, storage, and dispensing of whole blood was in its infancy (p. 163). Refrigeration equipment for use in the field under varying conditions of heat, cold, and humidity had not yet been manufactured (p. 206). Finally, an airlift capable of delivering blood to the far reaches of the battlefield was still almost 3 years away.

2. Frozen plasma was obviously unsuitable for use under battlefield conditions. While liquid plasma could have been used, dried plasma had greater

advantages. It could be dried from the frozen state to less than 1-percent moisture content. In this state, it could be packaged under vacuum and preserved for years without refrigeration and without being affected by extremes of heat and cold. From the standpoint of logistics, the equipment necessary for its reconstitution and intravenous administration could be incorporated in a small kit, which could be made available under almost any conditions of war.

3. No matter in what form it was used, plasma could be administered without typing or crossmatching.

4. The administration of plasma was attended with a negligible incidence of reactions.

5. Most important of all, in the light of immediate needs, dried plasma could be easily, safely, and quickly produced commercially in the large quantities likely to be needed.

The inherent organic and other characteristics of plasma, particularly the ease with which it could be manufactured, stored, and transported, clearly made it a practical and desirable agent. The reasons for its selection in 1941, while they do not fully explain lack of attempts to supply whole blood to field units at this time, did take cognizance of obstacles that went far toward discouraging even the most ardent advocates of whole blood as a feasible replacement fluid in Zone of Interior hospitals. These reasons were even more valid in the recommendation at this time of plasma as a feasible and practical agent in oversea hospitals.

The 1941 decision of the subcommittee was, of course, colored by the position of the Office of The Surgeon General almost a year earlier, to the effect that when blood could not be collected locally, plasma, "either plain or dried," would have to be used (19). At this meeting (Committee on Transfusions, 31 May 1940), arrangements were also made for Dr. Max M. Strumia to be provided with blood, collected by the southwestern Pennsylvania Chapter of the American Red Cross, for the production of dried plasma to be tested by the Army and the Navy Medical Schools and by members of the Subcommittee on Blood Substitutes.

The several hundred lots of plasma prepared and distributed by Dr. Strumia from the blood secured by the Red Cross, as arranged at the 31 May 1940 meeting of the Committee on Transfusions, were reported on at the 18 July 1941 meeting of the Subcommittee on Blood Substitutes (20,21). Each lot contained from 17.5 to 18 gm. of plasma dried by sublimation from the frozen state by a technique employing water vapor condensation by low temperature in flame-sealed ampules (vacuoles). The containers were large enough to permit reconstitution with water and were suitable for direct administration of the solution. The difficulties, all minor, which were reported by the workers who used the plasma, chiefly Army and Navy medical officers, were assumed to be those that would be experienced on the average hospital service. The only reactions were urticarial, and they were few and mild.

The following conclusions were drawn from this experience:

1. Although plasma concentrated four times can be given without untoward reactions, normal reconstituted plasma is usually superior to the concentrated variety.
2. Without additional supplemental electrolytes, serum albumin cannot be depended upon to restore circulating blood volume in acute peripheral circulatory failure, especially in dehydrated patients.
3. The investigation was regarded as entirely successful from the standpoint of practical production of dried plasma which was safe for human administration.

Dating Period

The dating periods for all varieties of plasma, which eventually proved surprisingly long, were originally little more than guesswork, because of lack of previous experience.

When liquid plasma was first prepared, NIH (National Institute of Health) set the dating period at a year. Studies by Dr. F. H. L. Taylor, with Capt. Lloyd R. Newhouser, MC, USN, and Lt. Cdr. Eugene L. Lozner, MC, USN, to determine whether this limit was justified, showed that it could safely be extended. Clinical administration of 2-year-old plasma to burned patients, with normal controls, showed it to be an excellent agent to combat shock. It is true that this plasma was devoid of most active globulin components, complement, fibrinogen, and prothrombin, and had no power of coagulation on recalcification. Nonetheless, the administration of 2,000 cc. did not increase the coagulation time of the recipient's blood nor did it decrease its concentration of prothrombin.

The U.S. Public Health Service first set 2 years as the dating period for dried plasma (with the specification that the cutoff date should appear on the container). Later, the date was extended to 36 months, and, finally, all limitations were removed.

FROZEN PLASMA

Development of Use

30 November 1940.—At the 30 November 1940 meeting of the Subcommittee on Blood Substitutes (22), Dr. Strumia reported on the technique of drying plasma from the frozen state and recommended the standardization of apparatus and technique, the location of Red Cross centers for collecting and drying plasma, and the establishment of a distribution chain. It was at this meeting that the Red Cross was asked to assume the responsibility of collecting blood for the plasma program (p. 102).

Also at this meeting, in a report of the Blood for Britain project, it was pointed out that liquid plasma was frequently contaminated, but that there was apparently no multiplication of bacteria in dried plasma.

19 April 1941.—At the 19 April 1941 meeting of the Subcommittee (18), Dr. Strumia reversed his previous position and stated that he now thought

that in many ways frozen plasma was superior to both liquid and dried plasma. The method developed in his laboratory for the preservation of frozen plasma was "very simple, very economical and * * * likely to apply to the needs of both civil and military nature in the greatest majority of cases."

The only disadvantages Dr. Strumia could see to his proposals were that it would be more difficult to transport frozen plasma under adverse conditions and that this form could not be reconstituted into concentrated plasma if it were needed in that form.

All of Dr. Strumia's remarks were predicated on the correct processing of the plasma; that is, it must be collected under aseptic precaution; in a closed system; and with as brief a timelag as possible between the collection of the blood, its centrifugation, and the fixation of the plasma by freezing (fig. 61). Care also had to be taken that thawing did not occur accidentally, from frequent opening of the storage cabinet, or from transient failure of current. In these circumstances, labile constituents could deteriorate.

In view of the advantages he had listed, Dr. Strumia considered the frozen variety of plasma to be the product of choice for those communities in which the exact time or the exact need could not be predetermined, but in which unexpected needs might be extremely heavy, as in large industrial areas or communitywide catastrophes. Processing should be done with the technical advice, and under the supervision, of some such authority as NRC. The bulk of the plasma processed from the blood procured by the Red Cross should be processed and distributed in this form.

These views were not generally accepted. Dr. Milton V. Veldee stated that only in grave emergencies would he favor the freezing of plasma or serum by hospitals, though he agreed with Capt. (later Col.) Douglas B. Kendrick's point, in which Dr. Edwin J. Cohn concurred, that plasma might be preserved, as a matter of expediency, in the frozen state while the capacity of commercial plants for desiccation was being increased.

18 July 1941.—At the 18 July meeting of the subcommittee (20), certain facts were frankly faced. The Navy had impelling needs and would require most of the 200,000 units of dried plasma now on order. This would leave no blood substitutes on hand for emergencies likely to occur in the training maneuvers underway and to continue during the summer. Base hospitals had no blood banks, since The Surgeon General had refused to permit the storage of either blood or plasma. In addition, medical officers had to be trained in the handling of plasma and in an understanding of its potentialities and limitations.

Captain Kendrick therefore proposed, with Commander Newhouser concurring, that a limited number of bleeding units be set up to supply frozen plasma for the Armed Forces in the Zone of Interior and that personnel in charge of these units be trained in Washington or at some other suitable center. For the past year, the Naval Medical School in Washington had been supplying adjacent naval hospitals with limited amounts of frozen plasma.



FIGURE 61. Preparation of liquid plasma at 8th Service Command Laboratory, Fort Sam Houston, Tex., September 1942. A. Centrifugation of blood to separate plasma from red blood cells. B. Pooling of plasma after centrifugation of blood in 2,000-cc. bottle containing 200 cc. of glucose solution. C. Display showing bleeding bottles, pooled liquid plasma, liquid plasma in 600-cc. bottles ready for dispensing, frozen plasma, and cultures to check sterility of plasma. D. Pooled liquid plasma held in storage until cultures are reported negative; then, it will be frozen. E. Freezer loaded with frozen plasma, which will be kept in this state until it is removed and thawed for shipment. Toward end of war it was found that this technique, adopted to preserve plasma proteins, also preserved virus of serum hepatitis.

This recommendation was conveyed to the Surgeons General of the Army and the Navy and was put into effect, with certain modifications.

Conclusions Concerning Frozen Plasma

At the annual meeting of the American Society of Refrigerating Engineers on 7 December 1943, Colonel Kendrick summarized the experience of the Medical Department with frozen plasma as follows (23):

1. Plasma, properly prepared in a closed system which excludes contamination, can be preserved at room temperature and safely administered after 24 months' storage.
2. Plasma can be safely prepared from blood kept at room temperature. This method yields a very clear product.
3. If plasma is stored as a liquid, it should be maintained at room temperature rather than 39° F. (4° C.) because at lower temperatures fibrin precipitates readily, and the result is an undesirable product from an esthetic standpoint.
4. Liquid plasma stored at room temperature loses its labile components (complement and prothrombin), which are useful in wound healing, but retains intact its albumin and globulins, which are essential in the treatment of shock and burns.
5. If plasma is stored in the frozen state, there are almost no changes in its constituents.
6. While plasma can be either shell frozen (p. 281) or frozen without rotation, there is no advantage to the former technique if it is merely to be stored frozen.
7. Commercially available ice cream cabinets are well suited for both freezing and storing plasma. The position of the bottle during the freezing process is of little importance.
8. The time required for freezing should not exceed 6 hours, but the complete process can be accomplished routinely in 3-4 hours. When the 6-hour limit is exceeded, the plasma tends to look turbid when it is thawed. Its efficacy is not affected, but the clinician is likely to regard it as contaminated.
9. Frozen plasma should be kept at a constant temperature, preferably between 14° to -4° F. (-10° to -20° C.). If the temperature is allowed to rise slowly, up to 32° F. (0° C.), the minute thawing which occurs may result in the precipitation of fibrin.
10. If plasma is thawed rapidly in a water bath at 98.6° F. (37° C.), fibrin will not be precipitated. Plasma thawed by this method can be refrozen, rethawed, and refrozen again, and the cycle can be repeated many times, without any apparent changes in its properties. These facts carry an important practical implication: If power failure occurs, it is better to remove the plasma from the icebox, thaw it, and refreeze it when power has been restored.

These various observations made it possible to draw up the following rules for the preparation and storage of frozen plasma in hospitals:

1. Blood must be collected in a completely closed system.
2. The blood can be kept at room temperature or at 39° F. (4° C.), but the supernatant plasma must be recovered within 72 hours after the blood is collected.
3. The plasma should be stored in a well insulated, low temperature cabinet, maintained at 14° to -4° F. (-10° to -20° C.), capable of freezing the plasma within 4 hours.
4. When plasma is required for use, it can be thawed in a water bath at 98.6° F. (37° C.) in 20-25 minutes. It is good practice to keep three or four bottles of plasma thawed out and available for immediate use in the operating room or emergency room.
5. Pools of 1,800 cc. of plasma should be aspirated into receptacles containing 200 cc. of glucose, which gives a final solution of 5-percent glucose in each 500 cc. of plasma. With this dilution, fibrin precipitation does not occur when plasma is stored at room temperature after thawing.

LIQUID PLASMA

Refrigeration

Refrigeration was at first considered necessary for the preservation of liquid plasma simply because it was the universal custom to refrigerate the blood from which it was prepared. When it was refrigerated at 43° to 46° F. (6° to 8° C.) by Strumia and McGraw (5), there was progressive flocculation of the more unstable proteins, and bacterial contamination was also a risk. Control series at the Army and the Navy Medical Schools later showed that liquid plasma stored without refrigeration was just as satisfactory as refrigerated plasma from the standpoint of sterility, hemoglobin content, and plasma protein content, and was far more satisfactory from the standpoint of clarity.

Supply of Liquid Plasma for Zone of Interior Hospitals

When liquid plasma was first introduced, it was thought best to use it in the hospital in which it was prepared, or in hospitals in the community. The results of the mass collection of liquid plasma in the Blood for Britain project, with its high rate of contamination (p. 14), had been discouraging. The explanation of the difficulties in the British program was simple: If the mass processing of plasma was to prove safe and practical, collection and processing must be carried out by a completely closed, completely aseptic technique.

While the Blood for Britain project was underway, the Blood Research Division in the Army Medical School was investigating the possibility of supplying liquid plasma to hospitals in the Zone of Interior. Names of possible donors were provided in groups of 10 by the American Red Cross, and from the 10, a daily average of 6 donors was secured, who were bled at a small center set up in the school. The first plasma processed for this purpose was distributed in December 1940. At the same time, by a similar project, the Naval Medical School, U.S. Naval Medical Center, made liquid plasma available to all naval hospitals in the continental United States. The plasma was kept in the frozen state until just before shipment; then it was thawed at 98.6° F. (37° C.) and shipped in the liquid state.

In June 1941, the Army and the Navy Medical Schools combined their efforts, and a collection center was opened in Washington, D.C., as a joint Army-Navy project. The Red Cross procured the donors by public solicitation, and helped in the operation of the center. The technical help was furnished by the Army and the Navy Medical Schools. The blood thus secured was divided between the Army and the Navy, and the Army share was processed into liquid plasma at the Army Medical School.

From these small beginnings came the project by which liquid plasma was supplied to military hospitals in the Zone of Interior as an easy, quick, and economical way of supplying them with plasma (p. 95). The Division of Surgical Physiology at the Army Medical School supplied liquid plasma for

the hospitals in the First, Second, Third, and Fourth Service Commands. It also trained personnel who operated the plasma processing laboratories in the other service commands (fig. 61), and supervised the installation and operation of these laboratories. After 22 March 1944, all liquid plasma for Zone of Interior hospitals, whether for emergency use or routine replacement, was obtained from the Army Medical School.

CONCENTRATED PLASMA

Concentrated plasma was discussed at several of the meetings of the Subcommittee on Blood Substitutes in 1941 (20, 24, 25), and several tests were made with it. The basic of the proposal was twofold: (1) that any casualty who really required plasma would need at least two units, and (2) that the adoption of the plan would reduce the container volume by half, with a corresponding saving in supplies and shipping space. It was concluded that concentrated plasma was not so safe an agent as isotonic plasma (26).

DRIED PLASMA

General Considerations

In the spring of 1943, at the request of The Surgeon General, E. G. Pickels (27), from the International Health Division of the Rockefeller Foundation, visited the nine biologic firms then processing dried plasma for the Armed Forces. He was accompanied by representatives of a firm of engineering consultants engaged by the Government to conduct a survey in connection with the renegotiation of contracts. On his return, Dr. Pickels felt justified in quoting from a publication by Franz Oppenheimer in the *New York State Journal of Medicine* dealing with techniques of drying plasma:

It is a truly remarkable achievement that the American biologic industry has taken a laboratory process, which is complicated and meticulous, and has rapidly developed production methods so efficient that they were now supplying several million units of plasma per year to the armed forces.

It was a well-deserved tribute, which was repeated many times, in one form or another, in the course of the war.

The processing of whole blood into dried plasma for the Armed Forces became a function of the large commercial biologic and pharmaceutical laboratories. When the need arose, in 1940, no individual and no private or commercial organization had had any extensive experience with the production of dried plasma. The Sharp & Dobme experience, while considerable, had been on a small scale. Some consideration was given to the formation of a large, nonprofit plasma processing plant in cooperation with some large hospital, but the idea promptly gave way to the more realistic decision that commercial laboratories would be better suited for the task. Their performance, as just indicated, was remarkably satisfactory.

After the blood for plasma had been collected at the Red Cross blood donor centers, it was refrigerated and shipped to the commercial firms which would process it and which had been selected for the work for two reasons: their nearness to the bleeding centers and their facilities.

Plasma was processed in the following steps:

1. When the blood reached the processing firms, the required serologic studies were performed on each donation.
2. Then the plasma was separated from the cellular elements in centrifuges, after which varying numbers of bloods were pooled and bacteriologic and toxicity tests were performed.
3. The plasma was shell frozen in individual bottles by rotating them in a properly cooled medium. It was important that the freezing process be carried out in as short a time as possible.
4. When necessary—when, for instance, the supply of blood exceeded the processing facilities—the plasma could be stored indefinitely in the frozen state. Otherwise, it was desiccated from the frozen state under high vacuum, after which the bottles of dried plasma were evacuated, stoppered, and placed in evacuated metal containers.

The description just given makes the process of drying plasma sound reasonably simple. The manual published in November 1942 by the Office of Civilian Defense (28) pointed out that, contrary to the prevailing opinion among the uninformed, the preparation of dried plasma of U.S.P. quality or better was an exacting task, requiring expensive equipment and trained personnel. A small, inexpensive drying machine, suitable for use in individual hospitals or small communities, and meeting the specifications for processing dried plasma, did not exist. The preparation of dried plasma was an undertaking for a large laboratory, with financial resources and an adequate staff, and, even then, it was practical only if the distribution area extended over a very large territory.

Historical Note

Historically, the development of desiccated plasma falls into three distinct periods (28):

1. Desiccation was used on a very small scale, for a limited amount of research and teaching.
2. Research and teaching were expanded, and desiccation was applied to the preservation of convalescent serum in a few large medical centers.
3. The growing appreciation of the value and necessity of supporting blood protein levels and the administration of concentrated plasma for its hypertonic effects foreshadowed the mass preservation and use of desiccated plasma in various concentrations.

Development of special techniques.—Ehrlich, as already pointed out, was the first to observe that the most stable method of preserving the total solids of plasma or serum was to remove the water. The process was carried out successfully in serum by Rosenau in 1895, Martin in 1896, and Noguchi in 1907. It was not until 1909, however, that any practical application was made of these observations. In that year, Shackell (29) described the basic principle

of vacuum desiccation from the frozen state, a process essential to the production of a highly soluble product which would retain its original properties.²

Shackell also solved another basic problem, how to deal with the huge volume of water vapor released from only a few cubic centimeters of frozen plasma under the high vacuum conditions required for the drying process. The volume was far too great for any pump then available to handle. By the use of the principle of chemical adsorption, Shackell provided a lead which many subsequent investigators followed, though his choice of sulfuric acid for a desiccant, as well as his design of the machine, limited the usefulness of his method. In addition to his use of a chemical adsorbent, which prevented saturation of the exposed surface, the type of pump Shackell used produced an extreme vacuum very rapidly. Moreover, freezing the material before desiccation eliminated possible concentration of substances and, to a lesser degree, prevented shrinkage and hardening (30).

In 1935, Elser, Thomas, and Steffen (31) improved the design of the original drying machine by the use of a manifold system with attached glass containers and a cold trap for collecting the moisture. They found themselves severely restricted, however, by the characteristics of the chemicals used. Greaves and Adair (32) had the same experience the following year. These difficulties, including insufficient speed of adsorption, dilution, scum formation, and other changes which retarded the pickup of water vapor as the process proceeded, increased as the size of the apparatus was increased. Qualitatively, a highly successful product could be obtained, but the difficulties mentioned, together with the expense of using a new desiccant for each lot of plasma, limited the use of the method devised by Elser and his associates.

Later, this group (33) used carbon dioxide snow, which produced a temperature of -94° F. (-70° C.), and still later they used mechanical refrigeration, which produced a temperature of -29° F. (-34° C.).

Within a closed system of manifolds and tanks hooked up to a vacuum pump, water vapor escapes from the plasma by sublimation. Between the plasma bottle and the pump, there is a cold chamber, refrigerated externally mechanically or by carbon dioxide and alcohol, to provide temperatures of -58° to -101° F. (-50° to -74° C.). The water vapor is thus condensed and frozen on the inner wall of the chamber, and the remaining water is thus removed from the line and the vacuum is, in turn, adequately maintained.

Elser must be credited with the first processing of large quantities of biologicals in their original containers. He also accomplished vacuum sealing directly from the machine.

In 1934 and 1935, Mudd, Flosdorf, and their associates (34, 35) continued the work done by Elser and his group and placed the large-scale desiccation of frozen sera on a practical basis, by attaching ampules of prefrozen material

² E. G. Pickels (27), in his comprehensive report on the desiccation of plasma from the frozen state, noted that Shackell was apparently not familiar with the desiccation experiments of Altmann, reported in 1890. Although Altmann was interested only in fixing and preserving the structure of tissue, he was the first to dry biologic material kept in a frozen state. Pickels' report has an excellent, usefully annotated list of references, many of which themselves contain comprehensive lists of references.

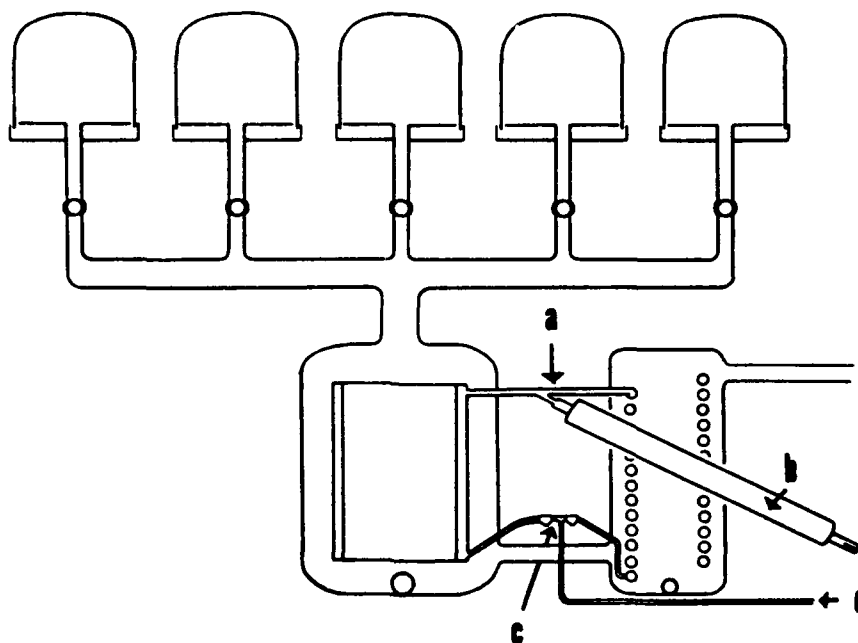

FIGURE 62.—Equipment for cold-trap condensing method of drying plasma: Suction lines to compressor (a), heat interchanger (b), thermostatic expansion valves (c), and liquid line from compressor (d).

to a manifold in the open air and employing solid CO_2 to refrigerate the cold trap (fig. 62). They also used alcohol and Methyl Cellosolve for the freezing mixture.

In 1939, Flosdorf and Mudd (36) introduced what they termed the Cryochem process, using a specially prepared anhydrous calcium sulfate (Drierite), which had the property of regeneration. It was an ingenious idea, but it did not prove practical for large-scale production.

In 1939, Greaves and Adair (33) reported a technique which utilized a cold-trap condenser. They placed the serum in a desiccating chamber provided with electrical heaters and arranged for the moisture to be collected on mechanically refrigerated coils. Their report included a comprehensive discussion of the temperature relations to be considered in drying large volumes of sera.

In 1940, Hill and Pfeiffer (37) reported the Adtevac technique, which used cooled silica gel as an adsorbent for the water vapor. The gel could be regenerated by heating and the adhered moisture drained off. This technique, the report noted, was entirely satisfactory for use in connection with a hospital blood bank but was not suitable for large-scale production.

A variety of other techniques and modifications of older techniques were introduced during 1940 (1, 36, 38-40).

At a meeting of the Blood Plasma Producers Association on 27 October 1942 (41), Dr. Sidney O. Levinson and Dr. Franz Oppenheimer of the Michael Reese Hospital described a technique for shortening the desiccation process by

the use of a sort of cage of copper and aluminum sheeting around each bottle, with an individual gold reflector which provided infrared heat. A new type of compressor was also used. The technique was not accepted for a number of reasons, including the expense (\$15,000 per unit) and the requirement for critical materials in the construction of the apparatus. If the requirements for blood plasma were increased and expansion of the present program became necessary, it was the sense of the meeting that the installation of the Levinson-Oppenheimer method might then be considered.

Although, for practical reasons, the Levinson-Oppenheimer technique could not be adopted at this time (1942), it was an important contribution, for it permitted complete control of the amount of heat imparted to all areas of the shell-frozen plasma, in keeping with the variations in the vacuum gage readings. Dr. Levinson's additional suggestion, that drying could be facilitated by the techniques then in use if a widemouthed bottle were substituted for the constricted-neck bottle employed, was protested by Dr. Veldee because of the danger of contamination. The action of the conference, based, as it was, on wartime conditions, was entirely justified. Nonetheless, this was superb, highly efficient equipment because of its correct application and control of heat exchange. It was installed later at Hyland Laboratories and was put to good use during the Korean War.

Conclusions.—In concluding his historical review of techniques for the desiccation of plasma, which was prepared after commercial production had been on a practical basis for almost 3 years, Pickels made the following points:

1. When a cold surface of sufficiently low temperature is employed for collecting water vapor, the maximum possible rate of sublimation from frozen material in a given container will be obtained if the conduits from the container to the trap are sufficiently wide and short.
2. This important theoretical condition was taken advantage of by Oppenheimer and Levinson in their experiments with combined drying and condensing chambers which depended on mechanical refrigeration. The same condition was also taken advantage of by Wyckoff in the design of his multiteated, CO₂-cooled "pigs" (p. 280).
3. These methods began to approach the optimum solution from the standpoint of theoretically desirable features and practical performance, especially when speed of drying was a prime consideration.
4. The steam ejector technique offered a decided advantage only for very large-scale production, and even then only when circumstances were peculiarly favorable.

Criteria of Acceptable Dried Plasma

At the meeting of the Subcommittee on Blood Substitutes on 8 May 1941 (24), the following criteria of acceptable commercially dried plasma were stated:

1. The moisture content of the final product must be less than 1 percent.
2. The hemoglobin content must not exceed 25 mg. percent.
3. The sterility standards must be equivalent to those required by the National Institute of Health (42).
4. The product must be soluble within 10 minutes when reconstituted to its original volume.

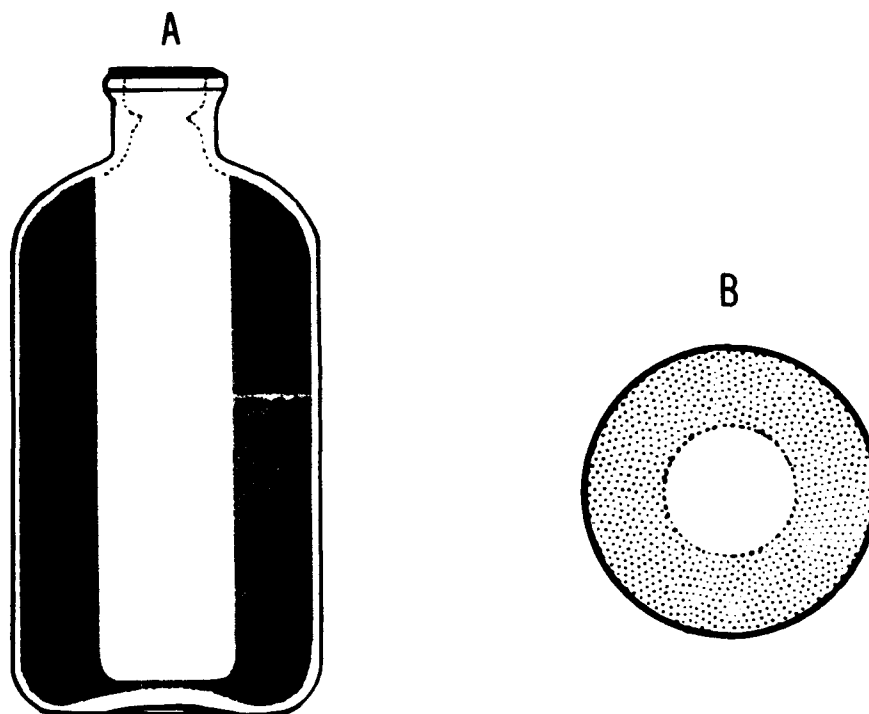

FIGURE 63.—Shell-frozen plasma. A. Sagittal section of container. B. Cross section. Note that volume of plasma does not exceed 75 per cent of volume of container.

5. The reconstituted material must be no more turbid than the product from which it was made.

At this time (May 1941), the equipment devised by Dr. Strumia was proving highly efficient for hospital and laboratory preparation of dried plasma, though it was not suitable for commercial production. The Sharp & Dohme method and the Reichel modification of this method had been approved by the National Institute of Health. The Hill and Pfeiffer Adtevac method had not yet been approved, but it was thought that the changes being made in it would make it acceptable. The Wyckoff-Lagsden "pig" method was under development at Lederle Laboratories, and it was thought that it would eventually be capable of handling large quantities of plasma. When it had been fully developed, it proved a most efficient technique.

COMMERCIAL PROCESSING OF DRIED PLASMA

By December 1943, nine commercial laboratories were engaged in the production of dried plasma. As they entered the program separately, with little liaison with one another in the initial phases, they used widely different types of equipment, though the principles of desiccation which each employed were practically identical.

Shell Freezing Technique

There was general agreement that shell freezing of liquid plasma was necessary to obtain the best dried product. By this process, the plasma was frozen to the inner aspect of the bottle in a shell or layer of uniform thickness, with an empty cone or circular channel in the long axis of the bottle extending from the bottom to the neck (fig. 63). Since the volume of plasma frozen did not ordinarily exceed three-quarters of the volume of the container, the diameter of the circular channel was equal to, or greater than, the thickness of the shell.

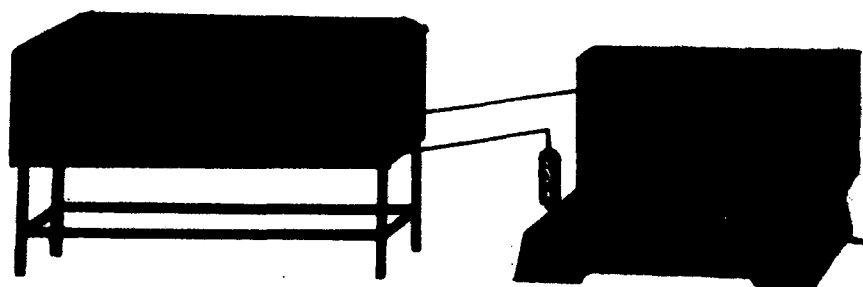

FIGURE 64.—Shell-freezing machine for use with carbon dioxide ice or mechanical refrigeration with coils.

Shell freezing (fig. 64) was essential before the plasma was dried, to provide for proper evaporation of the moisture from it. When the shell was formed, the surface area from which evaporation could take place was increased. The dried plasma had a flaky appearance and the interstices present increased the speed of reconstitution when distilled water was introduced into the container. A shell of uniform thickness was essential; otherwise, the rate of evaporation might be irregular, and melting and fusion of the plasma would result.

Methods.—Shell freezing and drying were accomplished in a variety of ways (figs. 65–71). Most often, the stoppered bottles containing the liquid plasma (300 cc. of plasma in 400-cc. bottles) were rotated horizontally at 2–8 r.p.m. in a cold bath ranging in temperature from -58° to -101° F. (-50° to -74° C.). It was essential that the bottles make contact with the bath for depths of no more than one-eighth to one-fourth of an inch, to prevent freezing of plasma in the neck of the bottle. When plasma froze in this location, the diameter of the orifice was reduced and drying time was increased, since the escape of water vapor from the bottle was partly a function of the diameter of the outlet. It was found that horizontal rotation produced a better shell than rotation at a 45° - or 60° -angle. When the bottles were rotated at an angle, plasma froze in the bottom of the container and formed a button which was thicker than the remainder of the shell and which frequently melted slightly during the drying process. The result was fusion or gumming of the plasma,

and the further result was that the plasma became denatured and would not go into solution normally.

Ethyl alcohol and Methyl Cellosolve were usually used to secure the desired temperatures. The alcohol bath was considered better because the fumes from the latter agent, particularly when the shelling was carried out in a closed room, might produce symptoms of methyl alcohol poisoning in the workers.

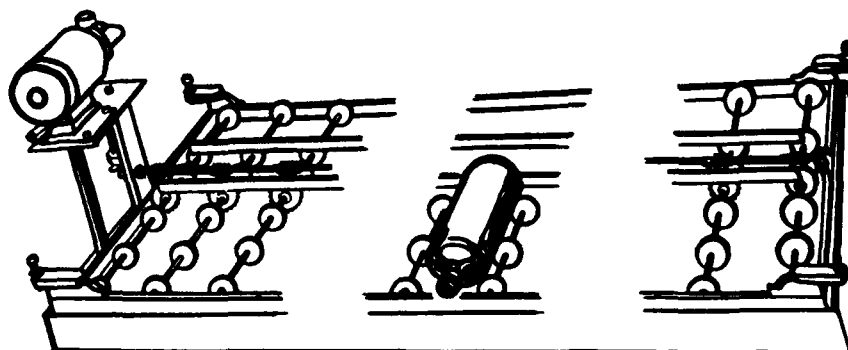

FIGURE 65.—Equipment for freezing plasma, consisting of mechanical rotator, carbon dioxide ice, and shell freezer.

The original idea that biologics must be shell frozen at -101° F. (-74° C.) arose from the practice of using Dry Ice in alcohol, which produced temperatures at that level. Long after mechanical refrigeration, which permitted graded temperature levels, was available, the idea persisted that for the best results, shell freezing was necessary at the level mentioned. The extensive experimental work on freezing plasma by Strumia and his group (5), which was published in 1941, disproved this contention and established the feasibility of shell freezing within the temperature range of -58° to -76° F. (-50° to -60° C.).

Refrigeration machines first developed for maintaining shell freezing units at -101° F. (-74° C.) consisted of two high-stage compressors with propane on the low side and ethane on the high side; each compressor operated with a 2-hp. motor. This equipment did not prove satisfactory: The refrigeration capacity was insufficient. The ethane compressor frequently became fouled with oil. The expansion valve on the high side frequently became clogged with ice from water in the ethane gas.

The possibility of using higher temperature ranges for shell freezing greatly simplified the use of mechanical refrigeration for this purpose. In several commercial laboratories, shell freezing was accomplished routinely at -58° to -76° F. (-50° to -60° C.). The machines were operated by one-stage compressors which used F-22 gas or two-stage compressors which used F-12 gas. At such ranges, plasma could be shell frozen in 15-25 minutes.

Equipment for Shell Freezing and Drying Plasma

Space does not permit the detailed description of the equipment used for shell freezing of plasma (fig. 72) and for drying it, but the whole process is described in an article published in 1944 (23).

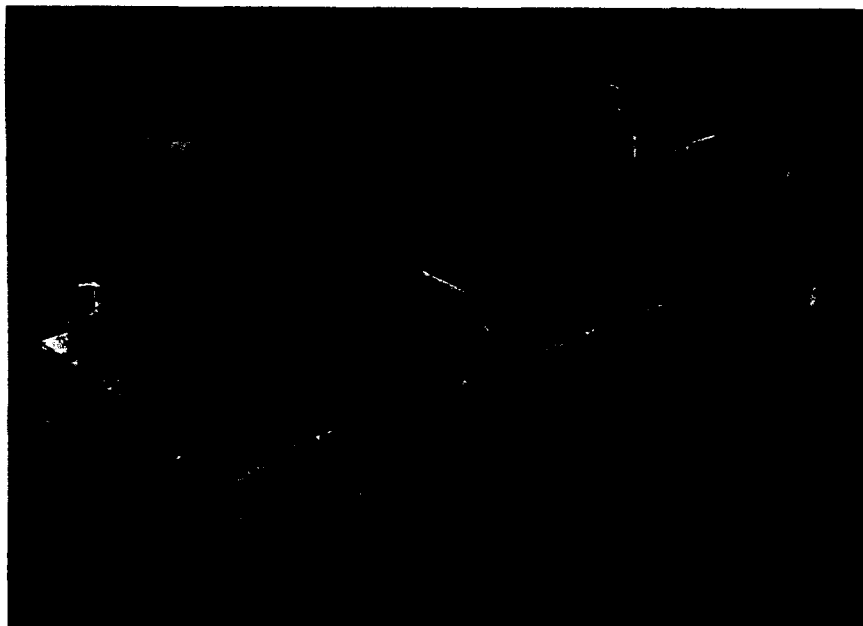

FIGURE 66.—Typical shell-freezing tray with small electric motor to power rotating wheels. Wheels are normally submerged under solution of carbon dioxide and alcohol.

ADDITIVES

Preservatives.—The National Institute of Health minimum requirements for normal human plasma, issued on 20 February 1941, provided that after the sample of pooled plasma had been withdrawn for the sterility test, a sufficient amount of a "suitable preservative" should be added, "except that phenol or a similar compound" should not be regarded as suitable.

The Subcommittee on Blood Substitutes discussed this matter on several occasions. It was brought out, at the first discussion (22), that the Blood Transfusion Association of New York had found Merthiolate unsatisfactory and Zephiran too toxic for use. Some of the subcommittee membership thought that plasma was best stored without any preservative at all (25). A recommendation to this effect was waived when it was found that commercial firms were not inclined to process plasma without one (43).

Merthiolate (1:10,000) was originally employed for this purpose. At the 19 September 1941 meeting of the subcommittee (43), the question was raised whether, when massive doses of plasma were necessary, there was danger that the patient might receive too much of the mercurial preservative and might incur renal damage. A motion setting a limit to the amount of plasma containing a mercurial preservative which might be given was lost after it was pointed out that the amount of mercury administered with plasma did not

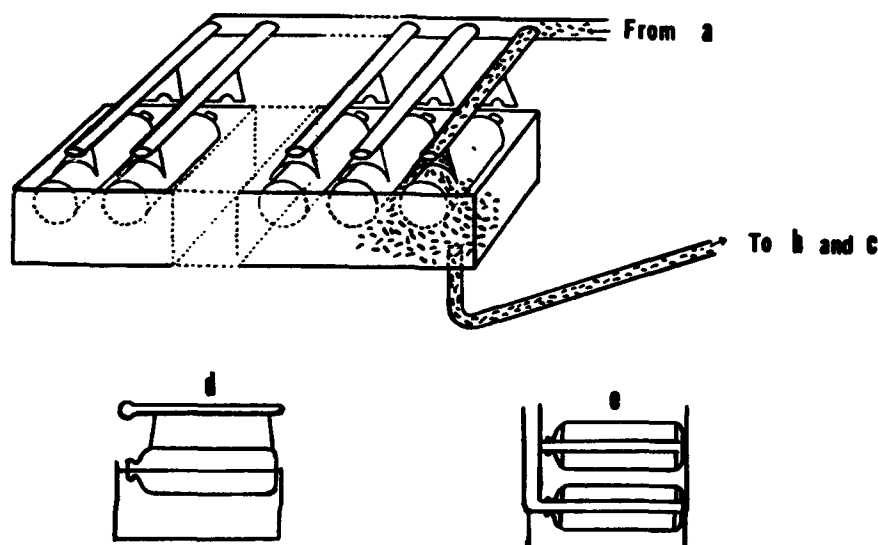

FIGURE 67.—Equipment (Cutter Laboratories) for Emery technique of shell-freezing plasma: cold alcohol (a), low temperature compressor (b), circulating pump (c), end view of apparatus (d), and top view (e).

compare with that used in antisyphilitic treatment or given in the form of mercurial diuretics.

It was agreed that a preservative was an added protection during the time which elapsed between the opening of the container of plasma and its infusion, but no action was taken, though some members of the subcommittee thought—and action was later taken to that effect—that the lapsed time should not be more than 3 hours. The NIH minimum requirements simply stated that plasma “should be used promptly after restoration.”

At the 3 November 1941 meeting of the subcommittee (44), Dr. Veldee reported for himself and Dr. Soma Weiss on the review of the literature which they had been appointed to make at the previous meeting: Merthiolate apparently had some bacteriostatic value, and possibly some bactericidal value. The presently employed concentration of phenylmercuric nitrate in plasma (1:50,000) was not considered toxic. Dr. Weiss, however, was willing to accept Merthiolate as a preservative only if a definite limitation were set on

the dosage of plasma and if the symptoms of mercurial poisoning were published on the label of the can. Other members suggested a limit of 3–6 liters of plasma in 24 hours. Dr. Strumia suggested putting the preservative in the distilled water, the amount of which could be regulated as desired. It was finally passed that phenylmercuric nitrate, 1:50,000, or Merthiolate, 1:35,000, be used in plasma, with the maximal dose to be 4 liters in 24 hours. This recommendation was later adopted. On 10 April 1942, Dr. Veldee authorized the change, with the concurrence of others concerned, from phenylmercuric

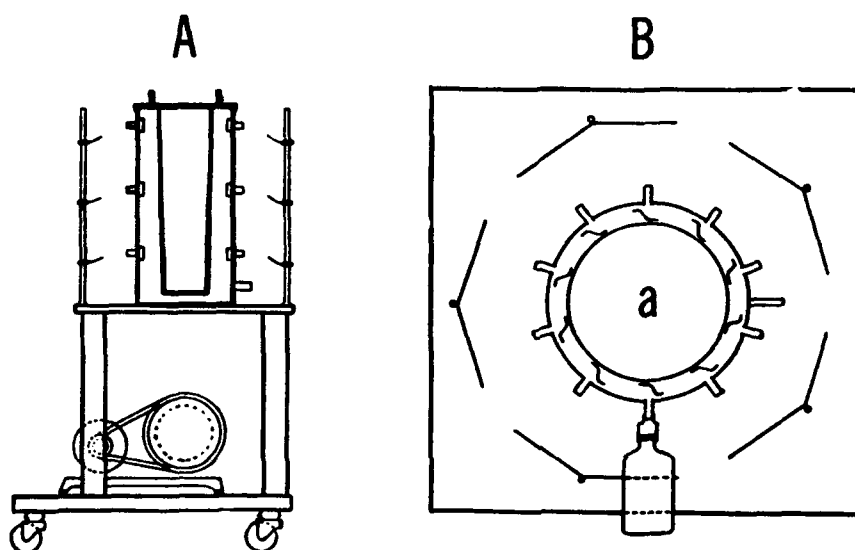

FIGURE 68.—Wyckoff-Lagsden cans (Lederle pigs) for cold surface condensation technique of drying plasma. A. Lateral view. B. Top view: container for Dry Ice and alcohol (a).

nitrate to phenylmercuric borate, the proportions (1:50,000) to remain the same.

On two occasions, the subcommittee decided that sulfonamide derivatives should not be used in plasma (43, 45). Dr. Veldee's studies confirmed the observations of others, including the British, that they produced no significant bacteriostatic effects.

Sodium citrate.—An attempt on the part of one of the processing firms to substitute 25 cc. of sodium citrate for the usual 50 cc. of 4-percent solution, in order to reduce the amount of fluid in the large plasma bottle, began hopefully, as did the control series conducted at the Army Medical School. The high percentage of clotting, however, forced a return to the original practice.

Sodium chloride.—The question of omitting sodium chloride from the citrate solution used as a preservative came up when Dr. Cohn reported that processing of serum albumin was simpler when it was not used (45). When



FIGURE 69. Wyckoff-Lagsden pigs used to dry plasma at Blood Research Division, Army Medical School.

its omission was studied from the standpoint of plasma yield, the difference was found to be only about 1 percent (76). The plasma yield in 1,500 liters of blood processed without salt by Eli Lilly and Co., averaged 55.3 percent after centrifugation (77).

Dextrose. In June 1942, Commander Newhouser reported that he had begun to make pools of plasma diluted in the proportion of 2,000 cc. of plasma to 200 cc. of 50-percent dextrose, by the sedimentation technique, with results that were so far very satisfactory. Two opinions were expressed, that the addition of glucose would have no effect on flocculation and that there was more flocculation without glucose than with it. At the Naval Medical School, dilute plasma had been kept in the plasma bank for 24 months without precipitation, and there had been no flocculation over a 14-month period in plasma to which dextrose had been added.

Citric acid. Studies by Dr. Strumia (75) on the reconstitution of dried plasma with 0.1-percent citric acid solution instead of distilled water showed that the pH of 7.4-7.6 thus secured preserved much of the complement and prothrombin, labile elements which were lost in considerable amounts on storage. It was also found that a citric acid solution with a pH of 2.8 kept much better in glass than did distilled water. These observations were confirmed by Commander Newhouser, Colonel Kendrick, Dr. F. H. L. Taylor,

and others, and it was therefore recommended on 15 December 1942 that 0.1 percent citric acid solution be substituted for 1.0 percent sodium chloride in the reconstitution of dried plasma (48). This recommendation was later put into practice.

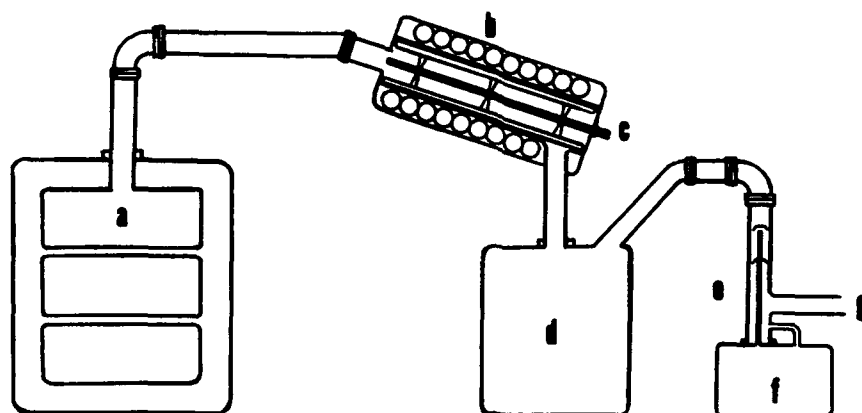

FIGURE 70.—Vacuum diffusion process for drying plasma: Drying chamber (a), rotary condenser (b), motor (c), receiver (d), oil diffusion pump (e), burner (f), and mechanical vacuum pump (g).

FILTERS

National Institutes of Health requirements specified that each package of dried plasma contain a warning as to the danger of injecting plasma intravenously without the use of a filter in the tube leading from the plasma reservoir to the recipient.

The amount of plasma which could be filtered through the ordinary Seitz filter before the filter became clogged and closed was so small that this method was not practical until the pads were saturated with sodium citrate or some other solution. Five-inch pads permitted the filtration of 18,000 cc. of plasma at 98.6° F. (37° C.) in less than 3 hours.

In February 1942, Dr. Strumia reported a series of experiments intended to determine the effects on citrated plasma of filtration through a Seitz sterilizing filter (49). Filtration through pads saturated, respectively, with 0.85-percent saline solution and 4-percent sodium citrate-saline solution apparently caused a loss of some or all of the fibrinogen. When the material was left standing at 39° F. (4° C.), both lots developed a heavy precipitate, resembling fibrin, and containing, respectively, 0.11 gm. and 0.13 gm. of fibrinogen.

A second experiment indicated that filtration through a Whatman filter No. 1 under the conditions of the experiment caused an appreciable loss of fibrinogen, a sharp increase in pH, an apparent loss of prothrombin, but no appreciable loss of other proteins and no changes in the complement titration.

When the material was kept in a liquid state, flocculation was extremely annoying.

Dr. Strumia did not consider filtration of properly prepared plasma necessary for purposes of sterilization, since bacterial contamination in it was extremely small. In 105 pools made from 885 individual bloods, cultures made by the National Institute of Health technique had shown only two pools to be contaminated.

Occasional complaints were received that some bottles of dried plasma contained an excess of fibrin or fibrinogen particles, which interfered with

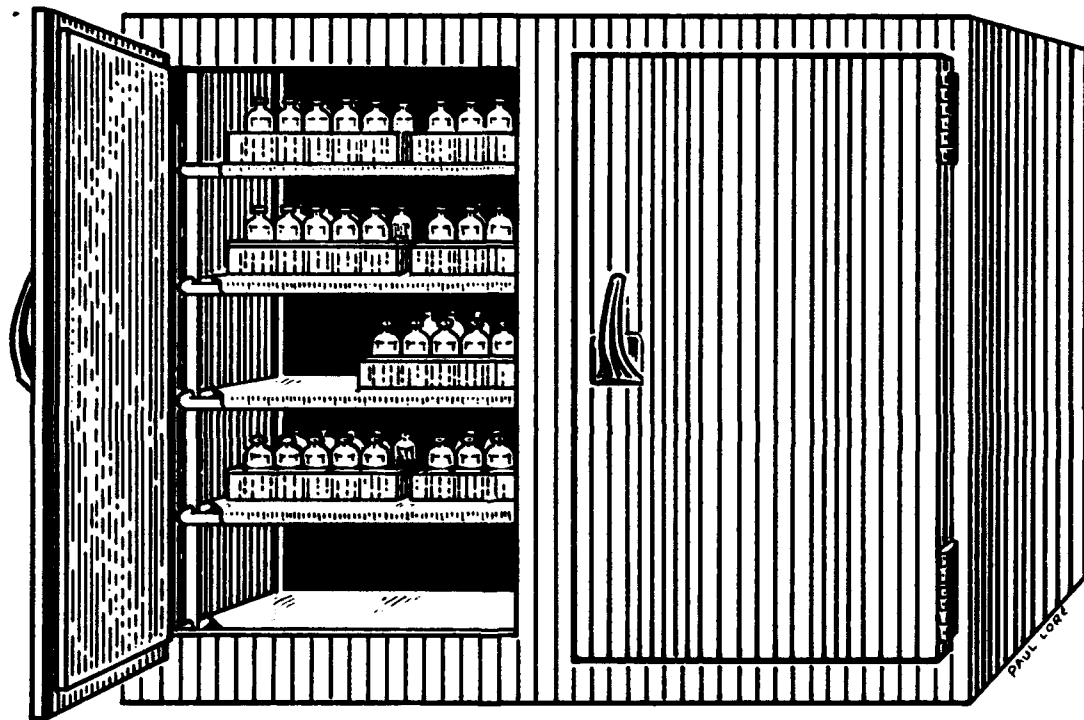

FIGURE 71.—Diagrammatic sketch of drying chamber for plasma, with circulating water, heated to desired thermostatically controlled temperature, within shelves.

the infusion. The complainants were always informed that there was no risk from the use of such plasma if it were filtered during administration, as all plasma should be.

Dr. Leo Rane, at the Lederle Laboratories, conducted studies with special clarifying and bacteria-absorbing filter pads almost free of calcium. They were not yet available commercially when this plant was inspected in January 1945, but Dr. Rane sent a few to the Army Medical School, to be tested for sterility, postfiltration precipitation, fibrinogen, and other things. The war ended before the study could be implemented.

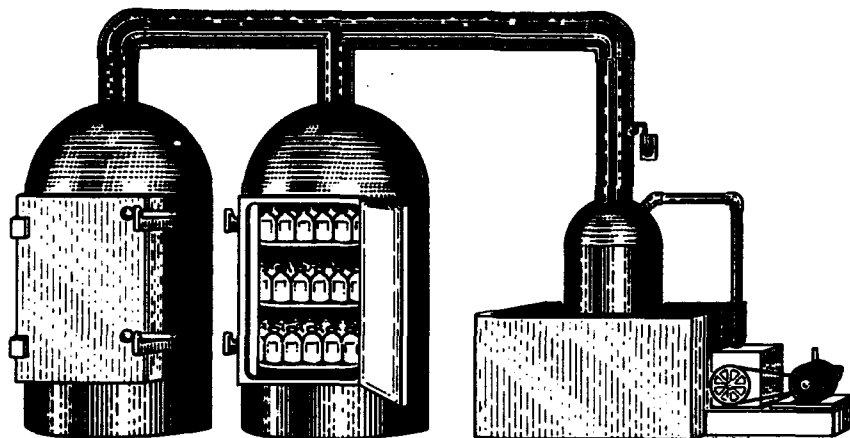

FIGURE 72.—Schematic drawing of blood plasma freeze drying equipment.

MASS PRODUCTION OF DRIED PLASMA

Establishment of Program

The first contract for dried plasma, for 15,000 packages, in February 1941, was made with Sharp & Dohme because of their previous experience in this field (19). By April (18), this firm had processed 1,140 units of 250 cc. each, with a loss of 126 units, 76 by breakage and the remainder for other reasons. By July (20), it had received 5,902 bloods, processed 5,496, and released 2,976 for distribution.

Before the declaration of war on 8 December 1941, three other contracts had been made. A small amount of plasma (750 packages) was available at Pearl Harbor, but the Navy, whose immediate needs were greater than those of other services, had received most of the other production.

Eventually, eight commercial firms were processing plasma, as follows (50):
Sharp & Dohme, beginning on 4 February 1941.

Eli Lilly and Co., beginning on 1 October 1941.

Lederle Laboratories (Division of American Cyanamid Co.), beginning on 14 October 1941.

Reichel Laboratories, Inc. (later Reichel Division of Wyeth, Inc.), beginning on 18 November 1941.

Ben Venue Laboratories, beginning on 10 January 1942.

Cutter Laboratories, beginning on 12 January 1942.

Hyland Laboratories, beginning on 13 May 1942.

Parke, Davis and Co., beginning on 29 June 1942.

In the opinion of some members of the Subcommittee on Blood Substitutes, the multiplicity of contractors introduced elements of danger. Others thought it safer to spread out the contracts, in case of unforeseen emergencies. The

original contracts were difficult to write because the time factor was unknown and because the performance of the companies would be dependent upon the supply of blood from the Red Cross. All through the war, it was a major problem to establish a satisfactory correlation between the full utilization of the processing capacities of the laboratories and the procurement of blood by the Red Cross blood donor centers.

Other laboratories that came into the blood program later processed only serum albumin. Although the Subcommittee on Blood Substitutes had ruled that plasma or serum, frozen or dried, would be acceptable for use in wounded casualties, it was Dr. Veldee's opinion that the same laboratory should not produce both serum and plasma (24).

The subcommittee, at the April 1941 meeting (18), had accepted the "Minimum Requirements for Filtered Normal Human Plasma or Serum," issued by the National Institute of Health on 25 February 1941 (p. 279). It also recommended that the Armed Forces purchase dried plasma from any processing firm that employed methods acceptable to the U.S. Public Health Service.

There was never any objection to holding plasma in a shell-frozen state until drying apparatus was installed and ready for use. The purpose of this plan was threefold: (1) to provide a reserve against future augmented demands for plasma; (2) to enable the Red Cross donor centers to step up blood deliveries as rapidly as possible, without regard to present limitations in commercial drying capacity; and (3) to stockpile plasma for use when the albumin program would make additional demands on blood supplies.

The story of the processing of dried plasma throughout the war was one of continued increases in the requirements of the Armed Forces, continued expansion of the processing laboratories to meet these demands, and ingenious solution of the various problems that arose, including the shortages of trained personnel and of equipment needed for production. There would be little profit in going into details of these matters, but a few special points might be mentioned, beginning with the fact, already stated, that to avoid confusion and the writing of multiple contracts, arrangements were made for the Army Medical Procurement Agency, in Brooklyn, to act as purchasing agent for all plasma prepared commercially for the Army and the Navy.³

An early investigation showed that contracts entered into by any firm with the Army and the Navy precluded the taking out of an injunction against that firm because of infringement of patent rights (24).

EXPANSION OF REQUIREMENTS

The first contract for dried plasma, 15,000 packages from Sharp & Dohme in February 1941, was deliberately small, partly because the resources of the firm were then quite limited, partly because this was frankly a trial contract (19).

³ Unless otherwise specified, the data in the remainder of this chapter are derived from Dr. G. Canby Robinson's final report of the Red Cross Blood Donor Program (50).

At the 23 May 1941 meeting of the subcommittee (25), Col. (later Brig. Gen.) Charles C. Hillman, MC, reported that letters had been sent to a number of processing laboratories asking each for bids on 25,000-lots of dried plasma. The requirements for fiscal year 1941-42 had been set at 100,000 units (18). By the 18 July meeting (20), 6 months before the United States entered the war, they had risen to 200,000 units. In July 1942, 6 months after the United States entered the war, the estimates for fiscal year 1942-43 were for 1,640,000 units of dried plasma, and the processing firms were being requested to bid on production up to 350,000 units each. These estimates were all for the small (250-cc.) package of plasma.

In March 1945, when it was estimated that the war in Europe might end in August, the estimated requirements for the Army and the Navy for the remainder of 1945 (March-December) were for 1,010,000 large packages of plasma which would require 2,222,000 bloods. This would have made the total Army-Navy requirements for 1945, counting what they had already received, 1,020,000 large packages or 2,244,000 bloods.

By the end of the war, of the more than 13 million pints of blood collected by the American Red Cross, 10,299,470 pints had been processed into dried plasma, put up in 3,147,744 250-cc. packages and 3,049,636 500-cc. packages.

Throughout the war, the increase in requirements of the Armed Forces, the capacity of the blood donor centers, and the capacity of plasma processing laboratories had to be kept in balance. The proper distribution of donations from the centers to the processing laboratories involved the geographic grouping of the centers in relation to single laboratories, the provision of transportation facilities, and the rapid readjustment of shipping occasionally necessary to move bloods to another laboratory because the laboratory to which they were usually allotted could not handle them.

Weekly reports of the distribution of blood donations were carefully studied by the Red Cross, by personnel in the Office of The Surgeon General, and by other interested parties. If donations were in excess, blood was likely to be wasted. If they did not come up to the capacity of the processing laboratory, equipment was wasted, and, even more important, so was personnel. The distribution of blood donations from Red Cross collection centers for the week ending 22 July 1944 to commercial laboratories was as follows:

Lederle:		Lilly:	
Capacity.....	18, 500	Capacity.....	17, 000
Donations:		Donations:	
New York.....	9, 204	St. Louis.....	3, 855
Brooklyn.....	3, 639	Indianapolis.....	2, 026
Rochester.....	1, 319	Cincinnati.....	2, 777
Schenectady.....	1, 616	Atlanta.....	1, 381
Buffalo.....	2, 175	Louisville.....	1, 907
		Columbus.....	2, 675
		Milwaukee.....	3, 068
Total.....	17, 953	Total.....	17, 689

Sharp & Dohme:		Hyland:	
Capacity.....	12, 500	Capacity.....	5, 000
Donations:		Donations:	
Boston.....	4, 853	Los Angeles.....	3, 933
Philadelphia.....	5, 300	San Diego.....	1, 570
Harrisburg.....	1, 604		
		Total.....	5, 503
Total.....	11, 757	Abbott:	
Reichel:		Capacity.....	6, 750
Capacity.....	7, 500	Donations:	
Donations:		Kansas City.....	2, 468
Pittsburgh.....	4, 400	Minneapolis.....	2, 198
Washington.....	3, 550	St. Paul.....	1, 814
Total.....	7, 950	Total.....	6, 480
Squibb:		Upjohn:	
Capacity.....	5, 000	Capacity.....	5, 000
Donations:		Donations:	
Baltimore.....	2, 632	Chicago.....	4, 551
Hartford.....	1, 997		
		Armour:	
Total.....	4, 629	Capacity.....	7, 000
Ben Venue:		Donations:	
Capacity.....	4, 000	New Orleans.....	1, 898
Donations:		Dallas.....	1, 890
Cleveland.....	3, 800	San Antonio.....	1, 450
		Fort Worth.....	1, 681
		Total.....	6, 919
		Army, Navy Laboratories:	
Parke, Davis:		Capacity.....	2, 250
Capacity.....	5, 000	Donations:	
Donations:		Denver.....	1, 587
Detroit.....	4, 584	Washington.....	372
		Total.....	1, 959
Cutter:		Whole Blood (for U.S. Military	
Capacity.....	13, 500	Hospitals):	
Donations:		Donations:	
Los Angeles.....	4, 819	Chicago.....	10
San Francisco.....	4, 067	Total bleedings.....	106, 891
Oakland.....	1, 763	Maximum capacity of labora-	
Portland.....	2, 458	tories.....	109, 000
Total.....	13, 107		

The essential factor in meeting these conditions was the assignment of correct weekly quotas to each of the bleeding centers. The quotas were set, and changes were made in them, only by the National Director, American Red Cross, after he had taken into consideration (1) the total requirements of the Army and the Navy; (2) the distribution of these requirements among the contracting laboratories; and (3) the number of bloods necessary to enable each laboratory to fulfill its Army or Navy contract by the date specified in the contract. In deciding upon possible increases in quotas, it was also necessary to consider the professional staff of the center and the possibility of

expanding it, the facilities of the center, the size of its physical plant, the number of mobile units which it could operate, and the facilities of the processing plant which the center supplied.

EQUIPMENT FOR THE PLASMA PROGRAM

Commercial Production

When the plasma program was set up, the chief bottleneck was the shortage of equipment for commercial processing (18). The laboratories were unwilling to provide equipment, or to expand what they already possessed, without formal contracts. The most essential item in the program, centrifuges, was the item in shortest supply, since those which would take the large American Red Cross horse bottles were then made by only one firm in the country, the International Equipment Co., Boston.

A number of suggestions were made to overcome these difficulties:

1. That the Army and the Navy should purchase the necessary equipment, and rent it or lease it to the processing firms.
2. That the equipment be developed under the auspices of the National Research Council and be popularized under its name and auspices. The Medical Research Council of Great Britain had established this precedent.
3. That sedimentation techniques be considered as a substitute for centrifugation.
4. That centrifuges of different sizes be used. Thus, 450-cc. bottles could be spun with No. 1 centrifuges, which were in ample supply. If No. 3 centrifuges, which were in short supply, could be used, each of them could handle 32 bottles every 9 hours. The yield, which would be greater than with any other centrifuge, would shortly compensate for their additional cost.
5. That representatives of the Army and the Navy be authorized to visit firms making equipment for the program, in an endeavor to expedite production. This recommendation was carried out.

Confusion continued to mark the procurement of equipment for the plasma processing program for the first year of its existence. On 16 September 1942, a meeting of all concerned with the program was held in the Office of The Surgeon General (51), and the following plan of organization was decided on:

1. By the express desire of The Surgeon General, the responsibility for the whole plasma program would remain entirely within the Armed Forces. Manufacturers would obtain extensions of preference ratings for materials and supplies, except for expansion projects, through the Supply Division, Office of The Surgeon General.
2. All expansion projects and all requests for preference ratings for replacement equipment would be cleared through the War Production Board. The Army-Navy Munitions Board would pass on all such requests by the customary procedure requiring concurrence of this Board, which would keep in close contact with the requirements of the Medical Department in acting upon the applications. Also, in view of the fact that supplies of blood represented the essential raw material in the plasma and albumin program, the Board would keep informed on the bleeding program.
3. The Army-Navy Munitions Board would maintain a compilation of requirements of all manufacturers of materials other than blood needed in the preparation of plasma.

This listing would be based on estimated production for periods of approximately 4 months. Calculations would be on the basis of anticipated blood deliveries and plant capacities. These data would be submitted to the Office of The Surgeon General for guidance in scheduling production and delivery of equipment to individual processing laboratories. The performance of each processing firm would be evaluated through review of periodic reports to be submitted at the request of the Legal Division, Office of The Surgeon General.

4. To avoid confusion, it was suggested (a) that the Office of The Surgeon General instruct processing laboratories regarding the procedures they should follow in procurement of equipment; and (b) that, except on expansion projects or replacement of equipment, contacts with the processing laboratories be limited to representatives of the Armed Forces, the National Institute of Health, and the Red Cross.

When these arrangements were put into effect, the procurement and replacement of equipment in the plasma program were both greatly simplified, and the changeover to the larger package, which was effected in July 1943 (p. 172), was carried out with remarkable smoothness. Problems continued to arise, of course, but very often it was found that they had been caused by failure of the processing laboratory to follow the directions laid down.

The part of the plasma program concerned with supplies was stabilized during fiscal year 1943-44. By this time, most of the material required by the processing laboratories had been standardized, and the various concerns which supplied the equipment had scheduled their production to conform with the needs of the program. Centrifuges, mobile refrigerating chests, and other items whose lack had seriously curtailed the plasma program for an extended period were no longer limiting factors. The War Production Board made spare parts available for centrifuges, so that repairs could be effected with a minimum of delay.

Equipment for Red Cross Blood Donor Centers

Shortages of equipment and supplies and delays in their procurement plagued the Red Cross blood donor centers during the entire war. The opening of new centers was frequently delayed for this reason. The lack of such small items as gauze, adhesive, needles, syringes, and thermometers could delay the operation of a center until they were supplied. Many times, since the quantities were not excessive, manufacturers and jobbers supplied enough material to permit continued operation, and repeated requests were made of the proper agencies of the War Production Board.

On 3 March 1943, a meeting to determine the best method of securing supplies and equipment for the bleeding centers was attended by Dr. G. Canby Robinson, National Director of the Blood Donor Service, American Red Cross; Dr. (later Major) Earl S. Taylor, Technical Director of the Service; Col. Charles F. Shook, MC, Special Representative of The Surgeon General for the Blood-Plasma Program; and representatives of the Procurement Division, American Red Cross, and the Priorities Division, War Production Board. A special expediter was to be appointed from the War Production Board for requests from the Red Cross, and all requests for priority ratings would be

expedited. It was expected that, for the usual items, clearance would not require over 48 hours. The centers were requested to anticipate their requirements for 4 months in advance so that contracts could be placed accordingly.

In general, the plan decided on at this meeting worked out very well, but there were still many delays. The procurement of paper cups is an illustration, which could be multiplied many times over, of the difficulty of securing essential items during the war. A steady supply of paper cups was necessary at all blood centers, to provide fluids for the donors, as there were no facilities for washing and sterilizing nonexpendable cups. About 35,000 cups of three sizes were needed each month. When they could not be secured through regular channels, a special endeavor was made to expedite them, but it took 3 weeks and a dozen letters and memorandums, as well as multiple phone calls, to set in motion the action that finally led to their procurement. Meantime, some chapters were securing their cups by daily purchases of small numbers wherever they could be bought.

OTHER PRODUCTION DIFFICULTIES

In spite of the amicable relations that existed between the processing laboratories and those concerned with the plasma program in the Army, the Navy, and the American Red Cross, there were numerous arguments and misunderstandings of various kinds. This was inevitable. The drying of plasma was a new process, not yet reduced to strict formulas, for which equipment was being devised as the program developed.

There were mechanical difficulties of various kinds to be ironed out, particularly after production was stopped for any reason. An extended shutdown was usually followed by trouble on the first run afterward, and it was found to be economical to keep all desiccation units running at a fairly steady rate.

In March 1943 and again in May 1944, labor troubles led to impending strike threats. In each instance, The Surgeon General wrote the employees of the processing laboratories of the vital importance of the plasma program and the imperative necessity of avoiding any work stoppage. In both instances, the difficulties were settled without any loss of time, but in both, arrangements had been made to transfer the involved firm's quotas of blood to the nearest unaffected firm if the threatened strikes had actually occurred.

Sabotage, as already intimated, was a theoretical possibility during the entire war in the whole program—whole blood, plasma, albumin, byproducts, and intravenous fluids. Fortunately, it never was anything but theoretical. The usual precautions against it were practiced throughout the war, including fencing of all plants, 24-hour-a-day guards, and screening of employees as far as was practical. Empty bleeding bottles were kept under lock and key. Blood was transported from the blood centers to the processing plants by pre-arranged express schedules, and all containers used were sealed in transportation.

TESTING

Army Medical School

The first extensive testing in the plasma program was conducted by Dr. Strumia (p. 269). This was a clinical study of plasma prepared in his laboratory from blood provided by the American Red Cross. He was assisted in it by Captain Kendrick, Commander Newhouser, and members of the Subcommittee on Blood Substitutes.

When the first supplies of plasma became available commercially, the practice was adopted of testing each lot chemically and clinically in the Blood Research Division, Army Medical School, before it was released for use from the medical depots. Originally, one package in each thousand was tested (table 7). In March 1943, in order to reduce the heavy workload, the number of samples was reduced to 1 in each 5,000. Since individual lots of plasma were made up of only 15-25 bottles, it was neither practical nor economical to test one package per lot. When it was proposed by a hospital commander in January 1944 that this be done, it was pointed out that his plan would mean that 5 percent of all plasma produced would be tested, which would be a waste of valuable material as well as an unnecessary precaution: During the last 5 months, only two packages had been rejected out of 350 examined, this number representing a production of approximately 1¼ million packages. A little later, testing was limited to one package per month selected at random from each laboratory.

When the samples were received at the Army Medical School, the package was first studied for possible external defects. The plasma was examined in the Chemistry Division to determine moisture content, hemoglobin content,

TABLE 7.—Results of testing of 1,008 lots of commercially produced plasma in Army Medical School

Producer	Lots			
	Tested	Retested	Accepted	Rejected
A.....	177	5	170	7
B.....	100	0	99	1
C.....	83	0	83	0
D.....	131	0	131	0
E.....	43	3	43	0
F.....	159	3	158	¹ 1
G.....	88	1	84	4
H.....	154	4	154	0
I.....	73	0	73	0
Total.....	1,008	16	995	13

¹ Partial.

and plasma protein content. It was then tested for solubility, with a note of the time required for complete solution. Finally, the plasma was administered to patients who were carefully observed for any adverse reactions, particularly chills and fever.

Processing Laboratories

Each laboratory was required to maintain complete records on each lot of plasma processed, the reports showing serologic tests; cultures; toxicity tests and bulk sterility tests on each pool; time required for processing; time required for drying and the temperature levels during the process; and final sterility and residual moisture determination on the dried product. Monthly reports were also required.

In view of the completeness of these records and their availability for inspection, it was decided, in the spring of 1944, to discontinue testing at the Army Medical School. The change was considered entirely safe since by this time all the laboratories under contract had had extensive experience and were turning out satisfactory products.

Analysis of Questionnaires

Materials and methods.—An analysis of 1,407 of the questionnaires included in the packages of dried plasma and returned after material had been used was carried out at the Naval Medical Research Institute in December 1943 (52, 53). The 1,407 infusions of dried plasma were compared with a previous study of 1,751 infusions of liquid plasma.

Of the 1,407 infusions analyzed, 300 had been given at the National Naval Medical Center and 119 were given between midnight and 8 a.m., the time of administration suggesting that they were given for emergency reasons. The 1,407 infusions had been given to 734 patients, 457 of whom had received 1 injection each, 2 of whom had received 22 injections each, and 34 of whom had received 9 injections each. Eighty percent of the material injected was produced by three laboratories; there was no essential difference in clinical results or incidence of reactions.

The distribution of clinical indications and therapeutic results was essentially the same for both dried and liquid plasma. Hypoproteinemia, including jaundice and infection, was the chief indication, followed by shock and hemorrhage. The peak month of administration, July 1942, coincided with the peak month of the postvaccination hepatitis epidemic. In 22 of the 25 fatal cases in the dried plasma series, the indications for the infusion included shock, with or without hemorrhage, and burns. Although hypoproteinemia and jaundice accounted for more than 40 percent of the indications in the total series, only 2 of the 25 deaths were associated with these conditions. In the remaining death, the indications for plasma administration were not stated.

The average amount of dried plasma given to each patient was 526 cc. and of liquid plasma, 711 cc. The fact that the reported average for all patients exceeded 500 cc. clearly justified the recent adoption of 500-cc. packages.

Results.—The response to plasma was considered favorable in 96 percent of the patients in each series. There were no hemolytic reactions in either series, and the reaction rate in both was essentially the same, about 5 percent. Patients in shock had fewer reactions than those not in shock. Only one patient had more than 2 reactions; this man had 4 reactions in 18 infusions, 2 of which occurred on the same day, after consecutive infusions. Of the eight other patients with multiple reactions, five sustained both on the same day after consecutive infusions.

Of the 74 reactions in the dried plasma series, 25 were urticarial, a larger proportion than in the liquid plasma series. Two explanations were advanced:

1. The lability of the allergen, a theory for which no proof could be demonstrated.

2. Something in the diet of the donors. All of the liquid plasma used in the series was prepared at the Naval Medical School, from blood drawn at a single, closely supervised center, whose donors had eaten little in the 6 hours before the donation. It was conceivable that at centers at which blood was procured for dried plasma this regulation was not strictly enforced.

The reaction rate for liquid plasma stored for less than 4 months was 5.1 percent, and for plasma stored beyond this limit, 3.0 percent. These rates further suggested that some mildly toxic labile constituent of fresh plasma might be stored in the dry state.

Studies on blood pressure and pulse rates.—As a part of this general study, the effect of plasma administration on blood pressure was investigated in 392 infusions given to 378 patients, and on the pulse rate in 513 infusions given to 442 patients. The data were as follows:

1. The average increase in systolic blood pressure produced by the administration of plasma, over a period not exceeding 24 hours, to patients with initial systolic pressures under 100 mm. Hg was 28 mm. Hg in those in shock and 14 mm. Hg in those with hypoproteinemia.

2. The average decrease in pulse rate in patients with initial rates over 100 per minute was 13 per minute in those in shock and 6 per minute in those with hypoproteinemia.

3. In general, the increase in systolic blood pressure was much greater than the decrease in pulse rate. In patients in shock, the coefficient of correlation between the two responses was extremely low and not statistically significant.

4. There were no statistically significant differences between the results of dried and liquid plasma.

INSPECTION OF PROCESSING LABORATORIES

After all laboratories were in production, periodic inspections were made, in compliance with a directive from the Office of The Surgeon General on 9 July 1942. Reports were sent to his office, to the Army Medical Purchasing Officer, and to others concerned in the program (54-58).

The original purpose of these inspections was to make certain that the best possible production techniques were being employed, and that all possible precautions were being taken to provide a safe and effective product. Variations from standard techniques were detected and corrected. Any improvement in procedure observed at one laboratory was promptly made known to other processing firms.

These frequent contacts made it possible to reduce contamination rates and losses from other causes. One of their most useful functions was the correction of the rumors, false impressions, and misunderstandings that invariably rose in a project of such magnitude. The relations between the Division of Surgical Physiology, Army Medical School, and the commercial laboratories had been excellent before large-scale production of plasma began, and this liaison, which also existed with the Navy, was maintained by these visits, which were usually made by Colonel Kendrick and Captain Newhouser.

YIELDS OF PLASMA FROM BLOOD

One of the subjects discussed at the Blood Plasma Conference in Chicago on 24 March 1943 was the volume of plasma recovered from each bleeding bottle (59). The monthly reports indicated wide variations. In January, the yield for the processing laboratories ranged from 275 to 309 cc., with yields for individual firms varying from 260 to 314 cc.

A number of reasons might account for these discrepancies:

1. The volume of the anticoagulant solution in the bleeding bottle varied, though the intent was that it should be 50 cc., less whatever amount was lost by evaporation during, and subsequent to, sterilization. Measurements made in 12 bleeding centers showed the maximum range from 47 to 70 cc., the minimum from 16 to 50 cc., and the average from 44 to 58 cc. It was urgent that each laboratory overhaul its technique so that the employee charged with introducing the anticoagulant could not vary it from bottle to bottle. Dr. Taylor, who had directed this investigation, considered it probable that sterilization techniques should also be checked.

2. The volume of blood collected varied. To study this discrepancy, 2,475 bleeding bottles were selected at random from the Church containers as they were received at one laboratory. The volume of blood was determined by measurements on a marked bottle, in 50-cc. graduations from 550 to 250 cc. Percentage variations ranged from 50.0 and 29.5 to 0.9 and 0.2. These variations had been called to the attention of all bleeding centers.

3. Wide differences were found in revolutions per minute and the time factor with various models of centrifuges. When a No. 13 model was used, the revolutions per minute varied from 1,300 to 2,300 and the time interval of four motor speeds from 20 to 60 minutes. When a No. 3 model was used, the corresponding figures were 2,000-2,500 r.p.m. and 25-45 minutes. Unless it were assumed that the lowest number of revolutions per minute, or the shortest interval, was optimum, it had to be assumed that centrifugation at some laboratories was not adequate. One laboratory reported a yield of plasma of 285.5 cc. when a No. 13 centrifuge was used at 1,800 r.p.m. for 50 minutes and of 297 cc. when the time was extended to 65 minutes. It was planned to supply each processing laboratory with a table showing the relation of revolutions per minute to the time factor necessary to secure a full plasma yield.

4. A study of two processing laboratories that received blood from the same bleeding centers showed, over a 5-month period, that the yield of plasma was the same in both on one occasion but that there was a maximum variation of 45 cc. and an average variation of 12 cc.

5. Variations were also found in the amount of plasma drawn off after centrifugation. The closed technique, investigation showed, had been well standardized in all processing laboratories. Any variation, therefore, was evidently the fault of the individual who performed the operation. Variations were least when supervision was most careful.

6. The temperature of the blood at the time the plasma was drawn off apparently influenced the yield. Commander Newhouser reported that the Upjohn Co. had found that, if the blood was chilled after centrifugation, it was possible to draw off all but 4 cc. of plasma without distributing the red blood cell layer. The high hemoglobin content of the last bit of plasma drawn off did not interfere with the manufacture of albumin, which this firm was making.

One laboratory made a check of 25 bloods received from five centers, spinning them for 50 minutes at 1,800 r.p.m. After carefully removing all the plasma possible without drawing off red blood cells, the maximum blood-tinged residual plasma recovered varied from 1 to 20 cc. and the average from 4.0 to 8.5 cc. for the individual centers. Based on the total bleedings in all centers for January 1943, the residual yield of plasma would have ranged from 747,000 to 1,589,000 cc., very considerable amounts. If the residual could not be used in dried plasma, it was thought that methods could be devised for salvaging it for use for serum albumin.

The analysis clearly indicated that if optimum conditions were ever approached, the yield of plasma could be materially increased, perhaps by as much as 100,000 bottles per year.

At a conference of the Albumin Testing Group on 22 March 1943 (60), Dr. Veldee again called attention to the very considerable amount of plasma then going to waste because of breakage and because of the amount left in the layer over the packed red cells. An average of 8.5 cc. could be recovered in this layer in every bottle, and the total amount would be about a million cubic centimeters every month. This residual could not be used for plasma because of its red cell content, but it should be processed in some stable form, so that it could be held without loss. These losses were never fully corrected.

ACCOUNTING PRACTICES

Original Plans

Since donated blood immediately became the property of the U.S. Government, it was essential that a precise record be kept of its disposition and of losses of it from all causes. Legally, this was required by Army regulations. Because of the usual source of the raw product, such an accounting was also morally obligatory, and the responsibility for it was keenly felt by all connected in any way with the program.

At an early meeting of the Subcommittee on Blood Substitutes, it was agreed that if contamination, breakage, insufficient samples for serologic

testing, and any other losses and errors were found at the processing laboratories, the information should be telegraphed immediately to the bleeding center responsible and a copy of the wire sent to Dr. Robinson. Gross errors would therefore be investigated and corrected as soon as they occurred.

Accounting practices were fully discussed at a meeting on revision of plasma contracts held at the Purchasing and Contracting Office of the New York Medical Depot on 28 July 1942 and attended by representatives of that office and of two processing laboratories (61). The following agreements were reached: All contracts would contain a provision for complete accounting to the Army of all blood received from the Red Cross and of all its byproducts. The report would start with an inventory of the blood, frozen plasma, and dried plasma on hand when the new contract commenced; would add to the inventory the blood received during the month; would deduct from it losses due to contamination, ordinary breakage, and other causes; would make the proper conversion from amounts of blood to comparable quantities of plasma; and would convert frozen plasma to appropriate quantities of dried plasma, with due regard to shrinkage due to further breakage, possible contamination, and other causes. Credit would be taken for deliveries of dried plasma during the month, and an inventory of blood, frozen plasma, and dried plasma on hand at the end of each month would be shown.

The Army also wished each laboratory to prepare a certified statement accounting for all the blood received from the beginning of the project up to the first report by the new accounting system.

The laboratories were quite willing to prepare the desired accounting. It was thought, however, that the standard Red Cross form was not adequate for this purpose, while the very elaborate statistical report which the Army-Navy Munitions Board had recently requested was rather cumbersome. A single form was later developed which served the Army-Navy Munitions Board requirements and a copy of which was sent to the Red Cross for information.

The laboratories also requested at this meeting that the Red Cross be instructed each month by the Army and the Navy as to the quantity of total blood to be used for plasma and for albumin. If shortages in either program should develop, the laboratories would be in an awkward position if they had made the allocations, and they would probably be criticized by both services.

Criticisms of Original Practices

On 14 September 1943, the Renegotiation Division, Office of The Surgeon General, called to the attention of the Director, Procurement Division, a number of errors in the accounts submitted by the processing laboratories, emphasizing that there was no implication whatsoever of any bad faith on the part of any firms concerned with the program (62). The reports in question were designed to afford protection to the laboratories as well as to the Government and the personnel concerned with letting the contracts. If there were errors in them,

this protection was not being afforded. Moreover, the maintenance of adequate records was related to the renegotiation program in the sense that the relative operating efficiency of the company was always taken into consideration in determining the amount of excess profits to be recaptured. Any figures compiled on the basis of the reports in question would also be in error and subject to criticism by the companies concerned when settlement agreements were entered into.

The chief errors were listed as follows:

1. The form used was not adequate to account for contaminated material that could not be used for plasma but was suitable for albumin.
2. There was no uniformity in the reports of the various laboratories, particularly in respect to contaminated plasma. Some companies wrote it off. Others carried it in their inventory. Still others dropped it and picked it up again, from time to time, to effect so-called recalcification. Some companies reported quantities converted to albumin as if they had been lost in freezing or for other reasons. Some reported high hemoglobin losses as miscellaneous. One company reported large miscellaneous losses as the difference between actual and estimated plasma volume.
3. The present forms did not definitely segregate losses subject to the penalty clause from those not subject to it, though whether this was important would depend upon whether a penalty was to be imposed for negligence, deviation from expected or average performance, or other causes.
4. Some errors originated on the companies' reports. Some were errors in transcription and columnization from the companies' reports to the stock movement record. Other discrepancies might exist which could be disclosed only by a complete audit of records.

To correct these errors the following suggestions were made:

1. Some revision in the form in use was necessary, to allow for contaminated material, which should be recorded uniformly by all companies.
2. The mathematical accuracy of each monthly report should be established on its receipt.
3. Amounts listed as miscellaneous should be analyzed to show causes of loss before the figures were recorded on the stock account.
4. A formal monthly columnarized stock record should be maintained in binder form and balanced and reconciled each month, as was apparently required by paragraph 10 of Army Regulations No. 38-6520. The record should account for the disposition of the blood from the time it was delivered by the American Red Cross until it was received and accepted by an Army depot or other Army installation. The record should be supported by shipping tickets for quantities delivered to the processing companies, receiving reports for quantities delivered to Army depots, monthly reports from each company to show the movement of the blood, and forms to cover quantities charged out. The report should also summarize losses by causes and according to whether or not liability was attached to them.

Justification of Original Reports

As Captain Taylor pointed out to Capt. Frederic N. Schwartz, MAC, in a memorandum commenting on this letter from the Renegotiation Division (63), a number of points had to be taken into consideration in analyzing current accounting practices:

1. The processing firms had never before handled so large a volume of human biologic material. In the initial stages of the operation, many innovations and improvisations were

necessary, and the resulting delays and losses were reflected in conflicting and inaccurate inventory reports.

Some of the early records were quite complex. One firm, for instance, made restitution, of its own accord, for material lost in processing and adjusted its subsequent reports in conformity with the replacement. Another laboratory also made restitution for blood lost through a truck accident on its property.

2. The program was underestimated in its potential size by all concerned with it. Rapid expansion took place before facilities were available, and makeshift arrangements were often necessary to handle the enormous increases in blood delivered to the laboratories.

3. As a result of these various factors, initial losses were excessive in the light of present operations, and errors in bookkeeping occurred that could not be adjusted until there was time for a less hurried appraisal of stocks on hand and other matters.

4. In the first year of the program, contaminated and fused (denatured) material was looked upon as highly dangerous. Some companies charged it off as a complete loss, but others kept it on their shelves, hoping that some use might be developed for it in the future. Some plasma was discarded on the ground that it had lost its original properties. A good deal was used experimentally, in attempts to devise methods of salvaging it, such as recalcification and chloroform extraction. Between October 1942 and February 1943, many large batches of contaminated plasma were used in trial runs at plants preparing to process albumin, so that good material would not be wasted getting the initial difficulties of production ironed out. It was not until July 1943 that the Harvard pilot plant considered it safe to use contaminated plasma in the serum program. Any diversion of such plasma to this use before that date was entirely experimental, and the material used was of no value according to the criteria in the National Institute of Health regulations and those implied in the plasma contracts.

For these various reasons, the forms then in use provided no method of accounting for plasma that, for contamination and other reasons, was charged off on the report but was physically retained by the laboratory for possible conversion to other uses. The conversion of contaminated plasma was a development of the past few months. It was not provided for on the report forms previously in use because this development did not then exist.

National Institute of Health rulings permitted the processing of liquid plasma into dry plasma if contamination was limited to 200 organisms per cubic centimeter. The rationale was twofold, the dilution accomplished by pooling the bloods, and the freezing and drying processes, which killed organisms in this number.

5. In dealing with biologic substances of this nature, and in such volume, it was not practical to interrupt the process to secure measurements exact to the cubic centimeter at various stages of production. Originally filling and sample losses were simply estimated (so-called stick measurements). At Dr. Veldee's request, in October 1942, uniform measurements were made in all laboratories, though it was still impractical to account accurately for every 10 cc., or even every 100 cc.

6. The blood donor centers had the same difficulties as the laboratories. At the beginning of the program, donations probably averaged 20-30 cc. less than present donations. Even at the time of this report, however, the amount of potentially available plasma was no better than an estimated average determined by comparing the amount in individual bottles as they arrived with the average yield of plasma per bleeding as determined by the laboratory. Each bleeding ideally yielded 300+cc. of plasma, the equivalent of one finished standard package. This ideal 1:1 ratio was based on the assumption that each bottle of blood was completely filled (which, for the reasons already stated, it was not). It also made no allowance for breakage, positive serology, filling losses, or contamination.

Standards of performance and checks of efficiency of operation of the processing laboratories by the American Red Cross took into consideration the realistic factors just listed. In planning for deliveries of blood to the processing

laboratories to meet Army contracts, the Red Cross, the National Institute of Health, and the Office of The Surgeon General decided that a ratio of 1:1.2 finished packages of plasma to bleedings would represent excellent performance. As of 31 August 1943, the ratio was 1:1.079.

A further check on laboratory performance, and indirectly on the overall accuracy of the laboratory records, was the breakdown sheet for mechanical and contamination losses prepared each month by Dr. Veldee. Over the last 2 months, these losses, exclusive of serology losses of 0.30 percent, amounted to 2.47 percent. Thus, without taking into consideration filling and sample losses, there was a known and recorded loss of 2.77 percent. In terms of the ratio of bleedings to finished packages, this was 1.03 percent, which compared favorably with the 1:1.079 ratio obtained by the other method of checking.

There were, therefore, five bleedings per hundred, or 1,500 cc. of plasma per hundred bloods, not accounted for statistically. Sterility samples and similar amounts required by National Institute of Health regulations amounted to about 160 cc. per hundred bloods. A fair estimate of the variation of the ideal 550 cc. of citrated blood per donation would account for 2,000 cc. per each hundred bloods or 1,000 cc. of plasma. This left 340 cc. of plasma, or something over one bleeding per hundred, to cover filling and other incidental production losses that could not be measured.

It was Captain Taylor's opinion that those examining the reports submitted to date did not completely understand the background of the plasma production program and the early difficulties it encountered. Also they did not possess the necessary medical knowledge to assess phases of operation and production which did not lend themselves to mathematical calculations. For these reasons, Captain Taylor questioned the justification for the somewhat sweeping condemnation of the present system of recording. By far the largest numbers of errors were clerical, and simple auditing of the monthly reports would easily correct that situation.⁴

Changes in Reporting Practices

At a meeting of representatives of the various components of the plasma program on 1 October 1943, reporting practices were discussed in detail (64). It was not believed that the correction of the errors complained of by the Renegotiation Division would present great difficulties or require basic changes in present policies.

Colonel Kendrick and Captain Taylor pointed out that, at the present time, there was no known method of salvaging contaminated blood, and dropping it from accountability represented no problem at all; it would never

⁴ Captain Taylor also pointed out in this memorandum that the penalty clause in the contracts, particularly its invocation, should be clarified. The legal mechanism for imposition of penalties was not within the competence of interested medical officers. On the other hand, if negligence or deviation from expected or average performance were to be the basis for its invocation, the opinion of those who had intimate knowledge of plasma processing—that is, representatives of the National Institute of Health, the Blood Research Division, Army Medical School, and other agencies—should be sought before action was taken.

be dropped on one report and picked up on another. They also emphasized the difficulties that would face laboratories if they tried to take precise inventories of material which they had retained on their own initiative, in the hope that it might eventually be useful, and which was frequently stored in containers of various shapes and sizes. They thought that an approximate report in liters should be permitted. Also, to take cognizance of the storage problem faced by some processing laboratories, these officers proposed, with Dr. Veldee's concurrence, that contaminated material on hand before 1 August 1943 should be destroyed.

Auditing arrangements for the correction of mathematical errors were suggested, and it was also proposed that the same auditor who performed this task, and who thus became familiar with the form and content of the reports and the problems involved, should make a monthly audit of all reports in the future.

On 6 November 1943, in accordance with suggestions made at the 1 October 1943 meeting, a preliminary letter was sent to the processing laboratories from the Army Medical Purchasing Office in New York incorporating the following information:

1. Recent developments indicated the possibility that blood or plasma hitherto regarded as unsuitable for use because of contamination or for other reasons could be salvaged for certain purposes.

2. At the request of the Army, several laboratories had been retaining this material and had sometimes overloaded their storage facilities with it. Permission to discard all such material on hand before 1 August 1943 was therefore granted all laboratories.

3. Hereafter, no such material would be discarded without first obtaining, through the contracting officer, Army Medical Purchasing Office, permission of the chief, Laboratory of Biologics Control, National Institute of Health.

4. Hereafter, a supplement should be filed with each monthly report indicating the material charged off in all stages of processing, the volume to be reported in liters. If exact quantities were not readily obtainable, as nearly accurate estimates as possible should be used.

Detailed instructions for the reports to be required in the future were sent to all processing laboratories from the Army Medical Purchasing Office on 17 May 1944 (65).

LOSSES

Total Losses

In the *Journal of the American Medical Association* for 12 September 1942, Dr. Taylor summarized the losses which had occurred in 320,442 bloods collected up to 1 May 1942 as follows (66):

Breakage, 0.345 percent, including 126 bottles broken in transit and 842 cracked during centrifugation.

Hemolysis, 0.569 percent. All but 406 of the 1,591 units lost in this category had to be discarded because the blood froze when inadequate shipping arrangements allowed it to be exposed for considerable periods to subzero weather. Some early losses occurred because of failure to remove the Dry Ice used for precooling shipping containers.

Contamination, 2.26 percent. The loss of 6,260 bloods from this cause was considered small in view of the 16 bleeding centers and 4 processing laboratories which had entered the project without any previous experience in this field.

Miscellaneous, 0.284 percent. In all, 794 units in this category had to be discarded. Railroad breakdowns resulting from weather conditions caused some bloods to be held beyond the time permitted by National Institute of Health specifications. One pool of 36 bloods had to be discarded because it contained blood from a donor who developed typhus fever.

Most blood that was discarded was made into typing sera or was used in pilot bottles to test moisture content.

The final report of the American Red Cross (50) shows a loss of 204,848 bloods (1.6 percent) of a total of 12,589,034 delivered to the processing laboratories (table 8). It will be noted that, as in the earlier report, bacterial contamination was the major cause of losses but the percentage had been materially reduced, as had that of all the other causes listed in the first report in 1942.

Losses From Contamination

The risk of contamination was first discussed at the meeting of the Subcommittee on Blood Substitutes on 23 May 1941 (25), when it was learned that a pool of 40 bloods being processed in a commercial laboratory had been found to be contaminated. It was recommended, to prevent wastage from this cause, that pools should consist of not more than 12 bloods. Later, when it was found possible to process contaminated plasma into albumin, the limits were successively lifted to 25 bloods, and then to 50 and more (67).

Two special experiences with losses of liquid plasma from contamination are sufficiently instructive to be reported in some detail.

TABLE 8.—Percentage distribution of causes of 204,848 losses in 12,589,034 bloods delivered to plasma processing laboratories in World War II

Causes of losses	Number of bottles	Percentage of total collections
Bacterial contamination.....	125,748	0.99
Positive serology.....	28,364	.22
Breakage in centrifuge.....	17,048	.13
Breakage in transit.....	1,660	.01
Hemolysis.....	7,567	.06
Clotting.....	3,727	.02
Miscellaneous.....	20,734	.16
Total	204,848	1.6

First experience.—When the liquid plasma center was inspected on 30 July 1943, the chief problem was the gradual increase in contaminated plasma which had occurred over the last 4 months, always with *Staphylococcus albus*. Contamination was occurring in the pools retained in the center as well as in those shipped for testing to the Army Medical School. The circumstances were always the same: the primary culture was negative. Cloudiness began to appear in the pools on the 7th or 8th day, and culture of the pilot bottle on the 10th day revealed the contaminant. It was concluded that contamination probably occurred either when the primary culture was taken or when Merthiolate was added.

Investigation of the technique employed at the center made clear the prime cause of contamination, that the bottles were being entered at the free hole (p. 386), where the stoppers were only 1½ to 1 mm. thick, instead of at the X-mark, where the diaphragm was 7 mm. thick and sealed itself when it had been penetrated, as the thinner diaphragm did not. The result of this technique was that the closed system, essential to the preservation of sterility, ceased to exist.

It was directed that this practice be stopped immediately. It was also directed that individual syringes and needles be used to introduce Merthiolate into the pools; that the practice of covering the plunger of the syringe with glycerin be discontinued; and that as few technicians as possible be assigned to aspirate and dispense the plasma, so that responsibility could be specified if contamination continued to occur.

The contamination rate at this center promptly fell to an acceptable level (less than 1 percent) and continued at this level until the middle of December 1943. Then, it again rose sharply. When the liquid plasma center and the blood donor center which supplied it were visited on 16–17 January 1944, the cause was immediately evident, that the combined bleedings of the fixed donor center and the mobile unit were amounting to 500–580 per day, considerably in excess of the processing capacities of the liquid plasma center. All past experience, in both hospital and commercial laboratories, had shown that the contamination rate always increased in direct proportion to the amount of blood processed beyond the capacities of the laboratories to handle it. The current policies had been instituted by the director of the bleeding center, a civilian, against the wishes of the physician in charge of the center and the chief of the laboratory service at the Army liquid plasma center. Unlike most donor centers, this center was operating as an Army, rather than as a Red Cross, donor center.

Arrangements were made to operate the center in the future as all other bleeding centers were operated, with the technical representative of the Red Cross responsible for personnel, blood quotas, technical procedures, and other policies. Daily bleedings were to be reduced to 300 per day. With these changes enforced, the contamination rate again dropped to an acceptable level.

Second experience.—When the liquid plasma center was inspected on 12 August 1943, another problem in contamination, chiefly from *Staphylococcus aureus*, was encountered. Several explanations for the 3-percent rate were promptly found.

1. Responsibility could not be individualized because of the number of technicians aspirating, dispensing, and culturing the plasma.

It was recommended that the actual preparation of the plasma be limited to two technicians, and that no new technicians be trained in these special procedures until the contamination rate had fallen to an acceptable minimum.

2. Similarly, it was impossible to place the responsibility for autoclaving bleeding and aspirating sets. Untrained technicians were being permitted to operate the autoclave, and undesirable techniques were employed.

It was recommended that a trained technician be made responsible for the sterilization of all sets; that the autoclave be operated at 15 pounds' pressure for 45 minutes; and that a vacuum be pulled for at least 20 minutes, to insure dry sets.

3. Plasma was aspirated under a hood in a cubicle that, because of the heat, could not be closed tightly. Windows in the room also had to be kept partly open.

Nothing could be done at the time to improve these physical conditions except to urge all possible care to counteract them.

4. Inspection of presumably sterile sets showed that the muslin wrappers were completely saturated with glycerin; the humidity was high, and the sets therefore remained continuously wet. When they were opened, excessive amounts of glycerin were found on the aspirating needles, and the valves, the Penrose drains, and other parts of the set were all bathed in it.

It was recommended that the use of glycerin on aspirating needles be discontinued at once.

5. The Penrose drains used in the sets were so short that they did not completely cover the aspirating needles. Also, the glass funnel tips supposed to protect the tips of the needles during aspiration were frequently broken, so that the rubber on the end of the drain came into contact with the needle each time a plasma bottle was penetrated.

It was recommended that all aspirating sets be completely reworked; that new muslin wrappers be used; that the Penrose drains used be long enough to cover the needles; and that new, intact glass tips be supplied.

The prompt fall in the contamination rate at this liquid plasma center proved once again the extreme importance of strict attention to all details of the procedure if a safe and effective product were to be secured.

Processing laboratories.—The rate of contamination at processing laboratories was generally very low. When it rose above accepted levels, the explanation was usually evident. In October 1944, for instance, the high rate at one firm was explained by a break in technique; namely, permitting rubber tubing to lie around for 3 or 4 days before it was sterilized. Directions were given that this period must be reduced to 3 hours. It was arranged that before further release of material from this laboratory, at least 100 packages must be tested, half at the Army and half at the Navy Medical Schools.

At another processing firm, a high rate of contamination was explained by crowded conditions compounded by construction work immediately adjacent to the laboratory. The physical setup continued to be undesirable but the rate fell when special precautions were instituted, and it reached an acceptably low level when the construction work was finished.

Losses From Clotting

Losses from clotting were small in the total plasma program, but the possibility was the occasion for a number of heated discussions and several special investigations in 1942. The question first arose (45) in a letter circulated by Dr. Strumia to the Subcommittee on Blood Substitutes on 8 April 1942, in which he incorporated material from a letter he had written on the subject to the *Journal of the American Medical Association*. In these communications, he stated:

1. That the technique employed by the American Red Cross in collecting blood for the Armed Forces was unsafe.
2. That clotting occurred as the result of this technique in from 12 to 30 percent of all bleedings and that the clots varied in weight from a few grams to 150 gm.
3. That if the larger (850-cc.) bottles used by Sharp & Dohme were employed, instead of the 750-cc. bottles then used by the Red Cross, and if the bottles were agitated during the collection, the rate of clotting would be 12 percent.

In his reply, Dr. Taylor pointed out that agitation of the bottle during bleeding had never been a part of Red Cross technique. In his opinion, Dr. Strumia's statement gave rise to three questions:

1. Did clotting occur in Red Cross donations and if so, did it occur to the extent stated?
2. If clotting did occur, could it be overcome by any special technique, such as agitation of the bottle during the withdrawal of blood?
3. If a minimal degree of clotting occurred, was there any evidence, experimental or clinical, to prove that it was of clinical significance?

A number of investigations were undertaken in the seven processing plants then engaged in the production of dried plasma to settle these questions:

1. Statistical analysis of approximately 200,000 bloods processed up to 1 April 1942 showed that only 97 had been discarded because of gross clotting. The explanation was usually small, unnoticed cracks in the bottom of the bottles, which had permitted the citrate to leak out slowly and resulted in the collection of blood without any citrate solution or with an ineffective amount.

2. A total of 9,164 bloods were strained through coarse- and fine-mesh screens and the solid material thus secured was carefully examined, in many instances by Dr. Taylor, Major Kendrick, or Commander Newhouser. Results varied from firm to firm but were difficult to state comparatively because of the different techniques of reporting. Except in a single laboratory, the rate of clotting was always low, and, with very few exceptions, all of the clots were small. The explanation of the high rate of clotting at the single laboratory just mentioned was that the investigation coincided with the employment of five part-time women physicians, who had had no previous experience in the field, at the blood center supplying much of the blood.

3. To compare the collection of blood with and without agitation, 100 bloods were carefully agitated during collection at the Red Cross Donor Center in New York. No clots were found. On the same day, with the same personnel, another 100 bloods were collected without agitation. One clot, 1½ inches in diameter, was found.

4. In 100 bottles picked at random from collections at the blood donor centers feeding Sharp & Dohme, four clots were found, the largest three-fourths of an inch in diameter. At the Sharp & Dohme laboratory, 100 bottles of blood were collected in the 850-cc. bottle in which it had been stated clotting would be minimal, with and without agitation. In all, seven clots were found, four, 1 inch in diameter and three, 2 inches in diameter. A second

hundred bloods, collected from the same source and in the same manner the following day, revealed six clots, ranging from 1½ to 2½ inches in length and three-fourths of an inch in diameter.

It was concluded from these various investigations that the degree of clotting at the donor centers across the country was of no real significance; that a certain amount would occur, no matter what system, within reason, was employed to collect the blood; and that considerably more conclusive evidence must be produced before the Red Cross technique of collecting blood for conversion to plasma could be considered unsafe. No such proof was ever forthcoming.

DISPOSITION OF SURPLUS PLASMA

The accepted potential of plasma in the management of shock, hemorrhage, burns, and special diseases is evident in the thesis written by a student at the George Washington University School of Business Administration on 11 January 1944, entitled "Potential Post-War Market for Dried Blood Plasma" (68). At that time, there was no indication of the risks of serum hepatitis introduced by its use, a risk which was to complicate the disposition of surplus stocks and lead to the replacement of plasma in the Korean War by serum albumin (p. 782).

Among the earliest plans for the disposition of surplus stocks of plasma at the end of the war was Colonel Kendrick's recommendation *after his visit* to the Mediterranean theater in October 1944. At that time, the ratio of blood to plasma in forward areas was about 1:1, and it was thought that it might approach 2:1. Since whole blood was then available in adequate quantities, Colonel Kendrick thought that consideration should be given to reducing plasma contracts by two plans:

1. All smaller Red Cross bleeding centers should be closed and the larger centers (New York, Washington, Philadelphia, Detroit, Chicago, San Francisco, and Los Angeles) should be operated at full capacity.

2. All surplus stocks of plasma in oversea theaters should be returned to the United States at once, preferably on hospital ships, to avoid the postwar difficulties of returning surplus material. The plasma thus returned could be used for years to come (again, it must be emphasized that the danger of infectious hepatitis from the use of pooled plasma had not yet been realized). When this recommendation was made, recent correspondence had shown that the European theater had an excess of plasma on hand and would need no more for at least 6 months. Inquiries to other theaters also revealed large stocks.

As a matter of fact, by this time, tentative plans had already been made to cut back production of plasma so that contracts could be terminated promptly when the war ended. All producers were asked to limit their purchases of equipment, and contracts were made for the minimum practical level.

Long before the war ended, requests began to be received from various civilian agencies and institutions for unused stores of plasma and its byproducts,

for use therapeutically, prophylactically, and experimentally. The first official steps in the disposition of surplus plasma were not taken, however, until after the war with Japan ended.

On 25 September 1945, Mr. DeWitt Smith, Vice Chairman of the American Red Cross (69), inquired of The Surgeon General whether there would be a surplus of plasma produced from blood obtained by the American Red Cross over and above the amount the Army could use before it became outdated. His interest in the matter arose from the responsibility of the Red Cross to the people who had contributed the blood and who had the right to insist that it be utilized to the best advantage and not wasted by deterioration. If there were a surplus, Mr. Smith wished to know whether the Army would release it without charge for appropriate civilian use, also without charge.

On 1 October 1945, Maj. Gen. Norman T. Kirk (70) replied that, while stock from the Pacific had not yet been reported, there were already available overseas, in excess of Medical Department demands for the next 14 months, 387,385 large packages of plasma and 258,560 small packages. Available in the Zone of Interior were 515,749 large packages and 346,670 small packages. All of the small packages and all but 75,000 of the large packages could be transferred to the American Red Cross.

On 5 November 1945, General Kirk (71) notified Mr. Smith that the excess stocks of plasma and other byproducts described in his 1 October letter were now available for transfer to the Red Cross. The Army would be glad to store the material in its depots until the Red Cross could assume ownership. As to material overseas, the Army, on request, would bring designated amounts to the Zone of Interior or deliver them to Red Cross depots in the various theaters. The actual ownership of the material was to remain with the Government until the supplies were delivered to the Red Cross at the designated depots, to which they would be shipped at Government expense.

In this letter, which was to constitute the terms of the final transfer of excess plasma and byproducts by the Army to the Red Cross, it was emphasized that these materials would be used on a nonprofit basis for public and other appropriate use, "consistent with the terms and spirit of the donations," with the distribution left "to the wise discretion and judgment of the Red Cross." It was also noted:

1. That the Red Cross would be given information concerning the reactions observed in certain groups of products.
2. That the dating on each individual package made it quite clear as to the period in which the plasma could safely be used.
3. That it was assumed that all safeguards would be employed in the distribution of this material.

General Kirk's letter was formally acknowledged on 21 November 1945 by Mr. Smith (72). All proposals in it were accepted. It was requested that all oversea supplies be transferred to the American Red Cross in the Zone of Interior on shipping instructions to follow later.

The remainder of the story of the disposal of surplus plasma is best told in connection with the story of hepatitis (p. 674).

OFFERS AND PROPOSALS

As soon as it became public knowledge that plasma was being processed for use in the Armed Forces, proposals to manufacture it were received from individual physicians and scientists, university and other research laboratories, and commercial laboratories not already engaged in the program.

It was the policy, so far as practical, to inspect the facilities in which it was proposed that the plasma should be processed. In no instance did they prove adequate for large-scale production. The majority of smaller commercial firms, once they learned how delicate and complicated a process large-scale production of plasma (and albumin) was, wanted nothing to do with it.

The reply to proposals to alter methods of production was also usually the same: No matter how excellent the proposed change might be, changes in an established process were simply not practical in wartime because of the difficulty of procuring materials and also because a change in any step of the process meant changes all along the line, which meant delays that could not be permitted in what amounted to a crash operation. Most clinical proposals were completely impractical in the circumstances in which plasma was used.

RED BLOOD CELL RESIDUA

Historical Note

When Oswald H. Robertson (73), in 1917, performed the first transfusion with banked blood (p. 5), he was really using a suspension of red blood cells and not whole blood. Two years earlier, Rous and Turner (74) had reported the successful experimental use of the same method. It is surprising, in view of the good experimental and clinical results, that, except for work by Castellanos and his group (75, 76), this method was not used again until World War II. In 1940, McQuaide and Mollison (77) reported its use in 61 cases of anemia, with 8-percent dextrose in isotonic salt solution as the suspension fluid. The reaction rate was 6.5 percent.

The first use of red blood cells in the United States was during the Blood for Britain project (p. 13). When the plasma, which was sent to England, was separated, a large supply of red blood cells was left, and Scudder and his group (78), at the Presbyterian Hospital in New York, used them for transfusion in 227 cases. As a rule, 500 cc. of the cell residual was used in 500 cc. of physiologic salt solution. The transfusions were type-specific, and the reaction rate was comparable to that at the hospital for transfusions of whole blood. Other civilian hospitals also took up the method, but it did not come into general military use immediately because of the primary necessity for concentrating all efforts on plasma production.

As the red blood cell program finally developed, it was an outgrowth of the preparation of peptone by Parke, Davis and Co., from the blood sludge previously discarded.

Organization of Red Cross Program

The distribution of red blood cells to hospitals began on 1 January 1943 at the Red Cross Blood Donor Center in Detroit (79), but it was not until November of that year that the formal program was set up, with the following arrangements (80):

1. The service was conducted by the technical staff of the American Red Cross Blood Donor Service, under the supervision of the Division of Medical Sciences, NRC, through the Subcommittee on Blood Substitutes. Locally, the service was operated through the donor centers and under the control of the technical supervisors of the centers.

2. The cellular residue was released by the Army and the Navy, which had title to it, to the Red Cross Blood Donor Service, for distribution for therapeutic purposes.

3. Since the cells had to be used within 5 days after the blood was collected, the method was available only to the eight or nine hospitals immediately adjacent to processing laboratories. This restriction was based on the practical consideration that the blood had to be transported to a processing laboratory from the bleeding center; transported back to the center after red cells and plasma had been separated; and, finally, transported to the hospital at which the cells were to be used.

4. The service was designed primarily for military hospitals but it was extended, as was practical, to hospitals organized and equipped for such a service. At the meeting of the Subcommittee on Blood Substitutes on 16 March 1945 (81), when Dr. Robinson requested permission to extend the service beyond the teaching hospitals, to which it had been chiefly limited up to this time, it was recommended that the selection of additional hospitals be left to the discretion of the Red Cross Blood Donor Service.

5. All procedures in each hospital from the time the blood was obtained until it was dispensed were under the control of a single responsible physician. Both physicians and hospitals had to agree in writing to carry out the prescribed methods and techniques for the use of suspended red blood cells and had to assume final responsibility for their administration.

6. The service was to be conducted without cost to those served and without financial profit to any person or institution connected with it. All expenses were borne by the National Red Cross Blood Donor Service, by the mechanisms already in operation.

Technique of Collection, Distribution, and Administration

The following technique was specified for the use of red blood cells, the procedure up through the withdrawal of the plasma being the standard procedure for plasma processing:

1. After centrifugation of the blood and withdrawal of the plasma, a sterile solid rubber stopper is placed in the bottle containing the cells. Only type O cells are used for this purpose. The original white tag is left on the bottle.

2. The cells are resuspended in a dustproof room, with a filling burette, in a pyrogen-free physiologic salt solution (or other solution approved by NRC). The diluent is added as soon as possible after centrifugation. Another sterile solid rubber stopper is inserted.

3. The resuspended cells are returned in refrigerated containers to the blood donor center, where the tags on the bottles are checked with the original list. Pilot tubes are not returned.

4. The resuspended cells are stored in the icebox, at temperatures between 39° and 50° F. (4° and 10° C.). Before they are distributed, the cells are inspected for hemolysis and possible color changes.

5. The dispensing laboratory or blood donor center must ascertain the sterility of all cell suspensions. Fifty negative cultures, by the technique required, must be obtained before any cell suspension is distributed. Thereafter, every fifth bottle must be tested until 300 negative cultures are obtained. Then one bottle is tested by random selection every day of operation.

6. If any contamination is detected, all red blood cell activities must be stopped until an adequate explanation is obtained by investigation of all possible causative factors. Sterility tests must be reinstated by the required techniques before cell suspensions are again released for distribution.

7. After distribution, the cell suspensions must be stored at the temperatures specified. If there is any possibility that the temperature has fallen below the freezing point, the suspensions must be discarded.

8. The bottles are observed at intervals for hemolysis or for color changes in the supernatant fluid. If a violaceous or blackish-red coloration is apparent, or there is any question as to the condition of the suspension, or any unusual odor is detected, the cells must be discarded.

9. The cells must be used within 5 days of the date of bleeding.

10. The suspension must not be dispensed from the original container but must not be removed from it until just before it is to be used. As it is emptied into the dispensing flask, it is carefully observed, so that gross clotting, unusual odors, or other changes will be detected. Retyping and crossmatching are done immediately before the cells are used. The suspension must be given within 5 hours of the time the bottle is opened.

11. The suspension is filtered through four layers of a 44 by 40 bandage roll or through the 100-mesh stainless steel filter in the blood transfusion set. It is not warmed. If the entire contents of a bottle are not used, the unused portion is discarded.

12. Bottles in which cells were delivered must be returned to the blood donor center whence they were dispensed, each bottle accompanied by a properly executed report of the transfusion.

These reports became the property of the Red Cross Blood Donor Service, and its approval before publication of any data or other material concerning the experience was one of the conditions under which cell suspensions were furnished to hospitals and physicians.

The handling of the red blood cells by three separate groups of persons offered chances for breaks in technique because of the divided responsibility, as well as for errors in transcription and for other reasons. It was therefore imperative that the regulations laid down be followed without any deviations.

Hospitals were cautioned not to use red blood cell suspensions for pregnant women or women in the postpartum period without an investigation of the Rh factor. In cases of doubt, only Rh-negative cells were used. The same precautions were observed when repeated transfusions were given with red cell suspensions.

The Detroit Experience

The Detroit Red Cross Blood Donor Center had the first experience with red blood cell transfusions as well as the most extensive; before the war ended, Dr. Warren B. Cooksey, the technical supervisor, had supervised almost 18,000 transfusions with resuspended red cells in 14 local hospitals.

The first report by Dr. Cooksey and Lt. William H. Horwitz, MC, published in the *Journal of the American Medical Association* on 1 April 1944,

covered 4,050 of the 7,864 cell suspensions delivered to the Detroit hospitals to date (82).

Materials and methods.—As a rule, 500 cc. of saline-suspended red cells was given. When large amounts of blood were required, two or three transfusions a day were given, though on a few occasions two to three bottles of diluted and undiluted cells were given as a single transfusion.

The cells were prepared by the immediate resuspension technique, which made it possible to administer them by the gravity method through a standard 18-gage needle. Earlier investigators had shown the difficulty of administering undiluted (packed) red cells and the undesirable pressure needed to accomplish it. Moreover, resuspension at the end of 5 days' storage was accompanied by greater hemolysis and more fragility than when resuspension was carried out as soon as the plasma was withdrawn.

Extensive studies carried out before the formal program was instituted showed no contamination in any sample, and later studies also showed none. When suspensions were deliberately contaminated for experimental purposes, it was found that occasionally within 24 hours, and almost invariably after 48 hours, the affected cells turned dark red and the supernatant fluid showed a purplish-red discoloration that at once distinguished these bottles from the others. The center employed a method of distribution which made it impossible for any hospital to receive the suspensions earlier than 48 hours after the blood was drawn, and this macroscopic observation was therefore employed in lieu of culture of each bottle, which would have been an impossible task. All bottles which showed any discoloration, as well as all bottles not used by the fifth day after bleeding, were discarded.

Before large-scale distribution of these cell suspensions was permitted, the effects of transfusion were studied in 200 patients, with recollection of the demonstration by Denstedt and his associates (83) and by Mollison and Young (84) that the fate of stored blood *in vitro* does not parallel its fate after transfusion.

Hemoglobin determinations were made by the Haden-Hauser technique (16 gm. hemoglobin=102 percent). All determinations were made 2 hours before the transfusion and were repeated serially 24 hours after it. Urinalysis was carried out before the transfusion and for several days afterward, to investigate the presence of hemoglobin or any of its end products. The icteric index was also determined before the transfusion and for several days afterward. The single abnormality in the series, an increase in the icteric index and hemoglobinuria, was found in a woman with Rh-positive blood and a grave anemia of pregnancy. She had the same reaction after transfusions of stored whole blood.

Suspension media.—At first, resuspension was accomplished in salt solution (0.85 percent) adjusted to a pH of 7.2. It was then found that, unless diluents other than physiologic salt solution were used, cells returned to the center after high speed centrifugation showed considerable hemolysis or alterations in the fragility index. Five-percent glucose solution in distilled

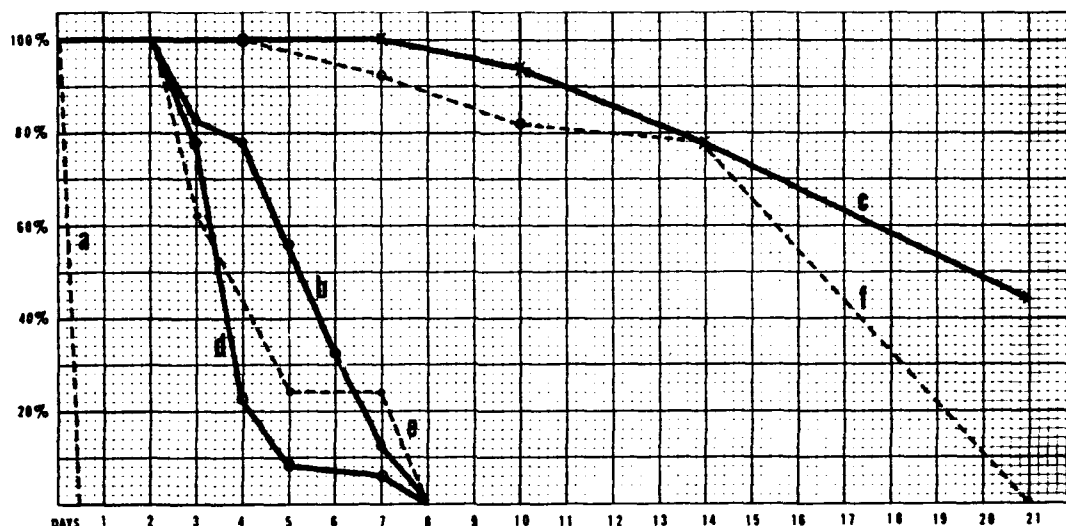
CHART 6.—Hemolytic effect of various diluting solutions^{1, 2}

¹ Number of bottles with clear supernatant fluid or fluid that showed only a trace of hemolysis are shown in percentages by days from day of bleeding.

² Each point on the graph represents observations on at least 12 bottles: Dextrose in distilled water (a), isotonic solution of NaCl (b), Alsever's solution (c), undiluted cells (hemolysis tested by dilution with physiologic salt solution on day of testing only) (d), dextrose in saline solution (e), and Denstedt's solution (f).

water produced complete hemolysis within a short time (chart 6), and 5-percent glucose in physiologic salt solution, 2-percent glucose, and 2- and 5-percent sucrose often had the same effect. Alsever's solution and Denstedt's solution preserved the red cells for much longer periods of time. The fragility index was initially higher with both, but it remained at a more constant level after the fifth day than did the index of saline-diluted cells. Hemolysis and fragility index were not significantly altered when the amount of diluent added to the packed cells was so varied that its volume was a quarter of, a half of, or equal to, the volume of the cells.

Results.—Typical results of red blood cell transfusions were the hemoglobin elevations in 629 transfusions at three hospitals, which ranged, per 500 cc. of suspension administered, from 0.46 gm. in malignant disease to 1.3 gm. in obstetric cases. The red blood cell increase in the same series ranged from 123,157 per cubic centimeter in malignancy to 497,000 in obstetric cases.

In another series of 67 transfusions given to 25 patients, the average hemoglobin elevation per 500 cc. of cellular suspension was 0.56 gm. and the average red blood cell increase 206,700 per cubic centimeter.

Statistics in this study bore out the observations of others that the percentage of reactions was less with resuspended red cells than with stored blood. In one series of 413 red blood cell transfusions in 139 patients, there were nine reactions, 2.1 percent. The definition of a reaction was a chill followed by a temperature elevation. When 342 whole blood transfusions were given to the same group of patients, there were 12 reactions, 3.5 percent. There was 3 percent of reactions in the 629 transfusions just mentioned.

The New York Experience

The New York experience was reported in 1945 by Dr. William Thalhimer, Associate Technical Director, American Red Cross Blood Donor Service, and Major Taylor, Technical Director (85).

Materials and methods.—This experience was based on 761 transfusions of centrifuged type O cells resuspended and stored in 10-percent corn syrup for periods up to 60 days. (By the time the report was published, 3,000 such transfusions had been given.) The transfusions were given to 437 patients, many of whom received repeated injections, sometimes daily, sometimes several times weekly. They suffered from a variety of chronic diseases, such as arthritis; Hodgkin's disease; leukemia of several types; nephritis; anemias; pulmonary tuberculosis; inoperable malignancies; a few acute conditions; and, in one instance, massive hemorrhage from a gastric ulcer.

At the beginning of this investigation, type-specific cells were used, but as time passed, transfusions were limited to type O cells. There was thus much less wastage of resuspended cells, and the possibility of transcription errors was reduced.

At first, only small amounts of cells resuspended in corn syrup were given. Later, as no harmful effects were evident, the amounts were gradually increased from 50 to 75 cc., and then to 500 cc., per transfusion. Still later, a number of patients were given 1,000 cc. in single injections, and several received 1,000 cc. per day over a 3-day period. The patient with a bleeding gastric ulcer received 3,500 cc. in 7 days.

Experimental studies.—Before cells suspended in corn syrup were used clinically, a long series of *in vitro* and animal studies were carried out. The suspension used was 250 cc. of prechilled (41° F., 5° C.) of 10-percent corn syrup (Corn Products Refining Co.) in sterile, pyrogen-free distilled water. The composition of the syrup before dilution was 17.7-percent dextrose; 16.8-percent dextrin (pro-sugars); and 19.7-percent moisture.

It was consistently demonstrated that cells thus resuspended were more stable and less fragile at the end of 21 days' storage at 41° F. (5° C.) than were cells suspended in physiologic salt solution, Alsever's solution, or Denstedt's solution at the end of 5 days. The amount of hemoglobin in the supernatant fluid averaged from 30 to 40 mg. percent at the end of 21 days in corn syrup against 100 mg. percent at the end of 5 days in saline solution.

No deleterious effects were evident in rabbits which received repeated injections of large amounts of 10-percent corn syrup, sometimes as many as 20 injections in 40 days. There was also no evident deleterious effect on rabbit cells preserved in corn syrup for 7 to 28 days. Finally, histologic examinations of animal tissues showed no pathologic changes and no deposits of iron pigment.

The freezing point of the corn syrup was the same as that of 0.85-percent sodium chloride solution. In behavior, the syrup appeared to be isotonic, or very slightly hypertonic, for blood cells. It was speculated that the dextrans

in it, because of their molecular size, might function somewhat as the original plasma in maintaining the stability of the stored, resuspended cells.

The length of survival of transfused cells was studied by the Ashby technique (p. 260), which was followed closely, since it was found that deviations from it gave inconsistent and inaccurate results. Counts were always made in duplicate, and unless the two counts were reasonably close, the whole procedure was repeated. In the 253 consecutive nonagglutinable cell counts done in duplicate on patients of A and B groups who had been transfused with group O cells, the average difference between the counts was 14,000 nonagglutinable cells per cubic centimeter. The unavoidable error—which is present in all red cell counting by even the most competent technicians—did not exceed 10 percent.

Results.—Clinical results in patients treated with red blood cells resuspended in corn syrup were what might have been expected from the administration of the same amounts of whole blood of the same age. There were no evident deleterious effects, and there was a complete absence of hemoglobinuria, hemoglobinemia, and jaundice. A number of patients showed prolonged beneficial effects under truly adverse conditions. Some cases suggested that adequate amounts of blood given over short periods of time had a more generally beneficial effect, and a more sparing effect on the bone marrow, than the same total amount given over a period of several weeks, a plan often necessary because of the difficulty of securing donors.

The greatest field of usefulness of resuspended red blood cells was in chronic secondary anemias of various origins. The cells were available in enormous quantities, and experience soon showed that large amounts could be injected within relatively short periods. Whole blood, because of its greater viscosity, more effective osmotic pressure, high cost, and relative scarcity, was seldom used in this type of anemia. Another advantage of the cell resuspension technique was the reduction in the volume of fluid injected, which was of considerable benefit in such conditions as cardiac failure.

The New York experience furnished significant information about the safety of injecting older blood. Some of the 382 transfusions given to 125 patients at Montefiore Hospital were given with red blood cells only 3 days old, but in many instances the cells were 7, 14, 22, and 24 days old. In two instances, they were 31 days old, and in two other cases they were 38 and 41 days old, respectively. One patient received transfusions with cells that were 50 and 60 days old, respectively.

The survival of transfused cells dropped off sharply after storage periods of more than 24 days. The survival of cells stored for 30, 40, 50, and 60 days was essentially the same as the survival of transfused whole blood stored for the same intervals. Although from 20 to 40 percent of these cells survived in the recipient circulation from 2 to 10 days, it was concluded that it would not be advisable to transfuse cells stored for these periods unless an emergency existed or fresher cells were not available. The results with cells stored in corn syrup for 21 days were just as satisfactory as those obtained with blood

stored in ACD (acid-citrate-dextrose) solution for the same interval, but, after the desired studies had been made, a 14-day expiration period was established.

The experience at Mount Sinai Hospital, 192 transfusions in 150 patients, paralleled that just described for the Montefiore Hospital. On the strength of these results, cells resuspended in 10-percent corn syrup came to be preferred, because of their longer life, to those resuspended in physiologic salt solution. When only red blood cells were needed, clinical results indicated that a transfusion of centrifuged cells resuspended in 10-percent corn syrup gave as satisfactory results as a transfusion of whole blood.

Extension of Service

Experiences at other civilian and military hospitals paralleled those just described at Detroit and New York. The first red blood cell service set up at a military hospital was established at Walter Reed General Hospital, Washington, D.C., in 1942. By the spring of 1944, the use of red blood cell transfusions was standard at all Army general hospitals in the Zone of Interior near enough to processing laboratories for the material to be delivered to them by automobile. This policy resulted in a great saving in the use of whole blood.

Proposals

Among the suggestions made by medical officers not directly connected with the blood program was one for the use of red blood cells in pooled plasma in forward hospitals and on the battlefield. The pooled plasma, this particular officer's argument ran, was already available in these areas, and the red blood cells could be sent overseas, by plane, preserved in glucose for 14 days. It was his opinion that the morale of wounded men would be raised if they knew they would receive whole blood and not plasma. He also recommended the method for Zone of Interior hospitals.

The Transfusion Branch, Surgical Consultants Division, Office of The Surgeon General, explained to the writer that his plan was not necessary in the Zone of Interior, where a modification of it was already employed, and was not feasible in forward areas overseas, where present plans did not provide for typing in the field, since blood grouping was done before whole blood was released. It was also pointed out that the mechanical mixing of blood cells and plasma would require equipment not then supplied. It would be hazardous from the standpoint of possible contamination even in a well-controlled laboratory, and extremely dangerous in forward areas and under field conditions. Not included in the letter to the writer was the fact that at the time of the correspondence (March and April 1944), it was entirely feasible to fly whole blood overseas—as was done 5 months later—but that The Surgeon General had rejected the suggestion when it was made to him in November 1943 (p. 465).

References

1. Harper, S. B.: The Preparation and Experimental Use of Dried Blood Plasma. Proc. Staff Meet. Mayo Clin. 15: 689-694, 30 Oct. 1940.
2. Ward, G. R.: Transfusion of Plasma. Brit. M.J. 1: 301, 9 Mar. 1918 (Correspondence).
3. Rous, P., and Wilson, G. W.: Fluid Substitutes for Transfusion After Hemorrhage. First Communication. J.A.M.A. 70: 219-222, 26 Jan. 1918.
4. Mann, F. C.: Further Experimental Study of Surgical Shock. J.A.M.A. 71: 1184-1188, 12 Oct. 1918.
5. Strumia, M. M., and McGraw, J. J.: The Development of Plasma Preparations for Transfusions. Ann. Int. Med. 80: 80-88, July 1941.
6. Brodie, T. G.: The Immediate Action of an Intravenous Injection of Blood-Serum. J. Physiol. 26: 48-71, 31 Dec. 1900.
7. Filatov, A., and Kartasevskij, N. G.: Die Transfusion von menschlichem Blutplasma als blutstillendes Mittel. Zentralbl. Chir. 62: 441-445, 23 Feb. 1935.
8. Heinatz, S. W., and Sokolow, N. I.: Plasmatransfusion als Methode der Wahl in der Behandlung des Hämolytischen Schocks. Zentralbl. Chir. 62: 1753-1755, 27 July 1935.
9. Elliott, J.: A Preliminary Report of a New Method of Blood Transfusion. South. Med. & Surg. 98: 643-645, December 1936.
10. Tatum, W. L., Elliott, J., and Nessel, N.: A Technique for the Preparation of a Substitute for Whole Blood Adaptable for Use During War Conditions. Mil. Surgeon 85: 481-489, December 1939.
11. Strumia, M. M., Wagner, J. A., and Monaghan, J. F.: The Intravenous Use of Serum and Plasma, Fresh and Preserved. Ann. Surg. 111: 623-629, April 1940.
12. Mahoney, E. B.: A Study of Experimental and Clinical Shock With Special Reference to Its Treatment by the Intravenous Injection of Preserved Plasma. Ann. Surg. 108: 178-193, August 1938.
13. Elkinton, J. R.: The Systemic Disturbances in Severe Burns and Their Treatment. Bull. Ayer Clin. Lab., Pennsylvania Hosp. 3: 279-291, December 1939.
14. McClure, R. D.: The Treatment of the Patient With Severe Burns. J.A.M.A. 113: 1808-1812, 11 Nov. 1939.
15. Best, C. H., and Solandt, D. Y.: Concentrated Serum in Treatment of Traumatic and Histamine Shock in Experimental Animals. Brit. M.J. 1: 799-802, 18 May 1940.
16. Kekwick, A., Marriott, H. L., Maycock, W. d'A., and Whitby, L. E. H.: Diagnosis and Treatment of Secondary Shock. A Study of 24 Cases. Lancet 1: 99-103, 25 Jan. 1941.
17. Memorandum, Maj. Karl Bambach, SnC, to Catalog and Equipment List Branch, Supply Planning Division, 1 Feb. 1944, subject: Items 16088 and 16089, Serum, Normal Human Plasma, Dried.
18. Minutes, meeting of Subcommittee on Blood Substitutes, Division of Medical Sciences, NRC, 19 Apr. 1941.
19. Minutes, meeting of Committee on Transfusions, Division of Medical Sciences, NRC, 31 May 1940.
20. Minutes, meeting of Subcommittee on Blood Substitutes, Division of Medical Sciences, NRC, 18 July 1941.
21. Strumia, M. M.: Disposition Made of Blood Obtained Through the American Red Cross From September 9, 1940 to April 7, 1941. Bull. Blood Substitutes, Division of Medical Sciences, NRC, pp. 189-204.
22. Minutes, meeting of Subcommittee on Blood Substitutes, Division of Medical Sciences, NRC, 30 Nov. 1940.
23. Kendrick, D. B., Jr.: Refrigeration Applications for Blood Plasma and Biologicals. Refrigerating Engineering 47: 33-39, January 1944.
24. Report, Subcommittee for the Standardization of Dispensing Equipment, Committee on Blood Substitutes, Division of Medical Sciences, NRC, 8 May 1941.

25. Minutes, meeting of Subcommittee on Blood Substitutes, Division of Medical Sciences, NRC, 23 May 1941.
26. Minutes, Conference on Albumin, Division of Medical Sciences, NRC, 5 Jan. 1942.
27. Pickels, E. G.: *The Desiccation of Plasma From the Frozen State*. New York: The International Health Division of The Rockefeller Foundation, 1943.
28. *A Technical Manual on Citrated Human Blood Plasma Detailing Its Procurement, Processing, and Use*. Washington: U.S. Office of Civilian Defense, November 1942.
29. Shackell, L. D.: An Improved Method of Desiccation, With Some Applications to Biological Problems. *Am. J. Physiol.* 24: 325-340, 1 June 1909.
30. Stokes, J. S., McGuinness, A., and Mudd, S.: Clinical Applications of the Lyophile Process. *Am. J. Dis. Child.* 50: 535-536, August 1935.
31. Elser, W. J., Thomas, R. A., and Steffen, G. I.: The Desiccation of Sera and Other Biological Products (Including Microorganisms) in the Frozen State With the Preservation of the Original Qualities of Products So Treated. *J. Immunol.* 28: 433-473, June 1935.
32. Greaves, R. I. N., and Adair, M. E.: A Simple Method for the Preservation of Sera by Desiccation in the Frozen State Without the Use of Refrigerants. *J. Hyg.* 36: 507-513, October 1936.
33. Greaves, R. I. N., and Adair, M. E.: High-Vacuum Condensation Drying of Proteins From the Frozen State. *J. Hyg.* 39: 413-445, July 1939.
34. Mudd, S., Reichel, J., Flosdorf, E. W., and Eagle, H.: The Preparation, Properties and Applications of Lyophile Serum Proteins and Complement. *J. Immunol.* 26: 341-342, April 1934.
35. Flosdorf, E. W., and Mudd, S.: Procedure and Apparatus for Preservation in "Lyophile" Form of Serum and Other Biological Substances. *J. Immunol.* 29: 389-425, November 1935.
36. Flosdorf, E. W., Stokes, F. J., and Mudd, S.: The Desivac Process for Drying From the Frozen State. *J.A.M.A.* 115: 1095-1097, 28 Sept. 1940.
37. Hill, J. M., and Pfeiffer, D. C.: A New and Economical Desiccating Process Particularly Suitable for the Preparation of Concentrated Plasma or Serum for Intravenous Use: The ADTEVAC Process. *Ann. Int. Med.* 14: 201-214, August 1940.
38. Hartman, F. W.: Use of Cellophane Cylinders for Desiccating Blood Plasma. *J.A.M.A.* 115: 1989-1990, 7 Dec. 1940.
39. Edwards, F. R., Kay, J., and Davie, T. B.: The Preparation and Use of Dried Plasma for Transfusion. *Brit. M.J.* 1: 377-381, 9 Mar. 1940.
40. Aylward, F. X., Mainwaring, B. R. S., and Wilkinson, J. F.: The Concentration and Drying of Plasma. *Brit. M.J.* 2: 583-586, 2 Nov. 1940.
41. Memorandum, Maj. Howard Hogan, MC, for Col. Charles F. Shook, MC, 2 Nov. 1942, subject: Meeting Blood Plasma Producers, St. Louis, Mo., 10-27-42.
42. Minimum Requirements for Unfiltered Normal Human Plasma, National Institute of Health, 20 Feb. 1941.
43. Minutes, meeting of Subcommittee on Blood Substitutes, Division of Medical Sciences, NRC, 19 Sept. 1941.
44. Minutes, meeting of Subcommittee on Blood Substitutes, Division of Medical Sciences, NRC, 3 Nov. 1941.
45. Minutes, meeting of Subcommittee on Blood Substitutes, Division of Medical Sciences, NRC, 12 May 1942.
46. Minutes, Conference on the Preparation of Normal Human Serum Albumin, Division of Medical Sciences, NRC, 5-6 June 1942.
47. Minutes, meeting of Subcommittee on Blood Substitutes, Division of Medical Sciences, NRC, 23 June 1942.
48. Minutes, meeting of Subcommittee on Blood Substitutes, Division of Medical Sciences, NRC, 15 Dec. 1942.
49. Strumia, M. M.: Effect of filtration on plasma. Report 9 Feb. 1942, prepared for Bull. Blood Substitutes.

50. Robinson, G. C.: American Red Cross Blood Donor Service During World War II. Its Organization and Operation. Washington: The American Red Cross, 1 July 1946.
51. Memorandum, Capt. John A. Purinton, Jr., SnC, to Col. Clifford V. Morgan, MC, 16 Sept. 1942, subject: Human Blood Plasma, Dried.
52. Lozner, Lt. Eugene L., MC, USN: An Investigation and Report of 1,407 Administrations of Dried Plasma in the Standard Package. Research Project X-1279. Naval Medical Research Institute, National Naval Medical Center, Bethesda, Md., 14 Dec. 1943.
53. Dochterman, Ens. Elsie, W-V(S) (H), USNR, and Lozner, Lt. Eugene L., MC-V(S), USNR. Research Project X-179. Final Report. Naval Medical Research Institute, National Naval Medical Center, Bethesda, Md., 23 Feb. 1944.
54. Memorandum, Lt. Col. Douglas B. Kendrick, MC, for Brig. Gen. Fred W. Rankin, n.d., subject: Reports of Visits to Parke Davis and Company, Abbott Laboratories, and Ben Venue Laboratories, 23-26 August 1943.
55. Memorandum, Maj. F. N. Schwartz, MAC, for Brig. Gen. Fred W. Rankin, 4 Aug. 1944, subject: Inspection Trip of American Red Cross Blood Donor Centers.
56. Memorandum, Lt. Col. Douglas B. Kendrick, MC, for Brig. Gen. Fred W. Rankin, n.d., subject: Report of Visit to the Miller Rubber Division of the B. F. Goodrich Company, Akron, Ohio—23 August 1943.
57. Memorandum, Lt. Col. Douglas B. Kendrick, MC, for The Surgeon General, 13 Aug. 1943, subject: Report of Inspections of Army Liquid Plasma Processing Centers.
58. Memorandum, Lt. Col. Douglas B. Kendrick, MC, for The Surgeon General, 29 Jan. 1944, subject: Report of Visit to Denver, Colorado, 16 and 17 January 1944.
59. Minutes, Blood Plasma Conference, Division of Medical Sciences, NRC, 24 Mar. 1943.
60. Minutes, Conference of the Albumin Testing Group, Division of Medical Sciences, NRC, 22 Mar. 1943.
61. Memorandum, Col. Tracy S. Voorhees, JAGD, 28 July 1942, subject: Meeting at the Purchasing and Contracting Office of the New York Medical Depot on July 28th Concerning Revision of Plasma Contracts.
62. Memorandum, Capt. W. G. Patten, SnC, for Lt. Col. Lee I. Park, JAGD, 14 Sept. 1943, subject: Accounting for Donated Blood and Processing Losses in Relation to the Renegotiation Program.
63. Memorandum, Capt. Earl S. Taylor, MC, to Capt. Frederic N. Schwartz, MAC, n.d., subject: Memorandum on Accounting for Donated Blood and Processing Losses in Relation to the Renegotiation Program.
64. Memorandum, Capt. F. N. Schwartz, MAC, for Director, Procurement Division, 2 Oct. 1943, subject: Plasma Accounting.
65. Letters, Lt. Col. H. T. Marshall, MC, to all laboratories processing plasma, 17 May 1944, subject: Instructions for Preparation of Monthly Blood Plasma Report.
66. Taylor, E. S.: Procurement of Blood for the Armed Forces. J.A.M.A. 120: 119-123, 12 Sept. 1942.
67. Minutes, meeting of Subcommittee on Blood Substitutes, Division of Medical Sciences, NRC, 9 Apr. 1943.
68. Sweezy, E. E.: Potential Post-War Market for Dried Blood Plasma. Thesis submitted to George Washington University, Business Administration 151, Marketing, 11 Jan. 1944.
69. Letter, DeWitt Smith, Vice Chairman, American Red Cross, to Maj. Gen. Norman T. Kirk, 25 Sept. 1945.
70. Letter, Maj. Gen. Norman T. Kirk to Mr. DeWitt Smith, 1 Oct. 1945.
71. Letter, Maj. Gen. Norman T. Kirk to Chairman, American Red Cross, 5 Nov. 1945.
72. Letter, DeWitt Smith, Vice Chairman, American Red Cross, to Maj. Gen. Norman T. Kirk, 21 Nov. 1945.
73. Robertson, O. H.: Transfusion With Preserved Red Blood Cells. Brit. M. J. 1: 691-695, 22 June 1918.

74. Rous, P., and Turner, J. R.: The Preservation of Living Red Blood Cells in Vitro. II. The Transfusion of Kept Cells. *J. Exper. Med.* 23: 239-248, February 1916.
75. Castellanos, A., and Riera, R.: Sobre la transfusión de glóbulos y la transfusión de plasma; sus tecnicas e indicaciones. *Bol. Soc. cubana de pediat.* 9: 234-270, June 1937.
76. Castellanos, A.: La transfusión de glóbulos. *Arch. med. inf.* 6: 319-333, July-September 1937.
77. McQuaide, D. H. G., and Mollison, P. L.: Treatment of Anaemia by Transfusion of Concentrated Suspensions of Red Cells. *Brit. M. J.* 2: 555-556, 26 Oct. 1940.
78. Scudder, J., Drew, C. R., Corcoran, D. R., and Bull, D. C.: Studies in Blood Preservation. *J.A.M.A.* 112: 2263-2271, 3 June 1939.
79. Minutes, meeting of Subcommittee on Blood Substitutes, Division of Medical Sciences, NRC, 13 May 1943.
80. Letter, Capt. Earl S. Taylor, MC, to Col. Tracy S. Voorhees, JAGD, 22 Nov. 1943, subject: The Red Blood Cell Transfusion Service of the American Red Cross Blood Donor Service.
81. Minutes, meeting of Subcommittee on Blood Substitutes, Division of Medical Sciences, NRC, 16 Mar. 1945.
82. Cooksey, W. B., and Horwitz, W. H.: Use of Salvaged Red Cells. *J.A.M.A.* 124: 961-964, 1 Apr. 1944.
83. Denstedt, O. F., Osborne, D. E., Stansfield, H., and Rochlin, I.: The Survival of Preserved Erythrocytes After Transfusion. *Canad. M.A.J.* 48: 477-486, June 1943.
84. Mollison, P. L., and Young, I. M.: Failure of In Vitro Tests as a Guide to the Value of Stored Blood. *Brit. M. J.* 2: 797-800, 6 Dec. 1941.
85. Thalhimer, W., and Taylor, E. S.: The Transfusion of Centrifuged Human Type O Cells Resuspended and Stored in 10% Corn Syrup. *J.A.M.A.* 127: 1096-1101, 28 Apr. 1945.

CHAPTER XII

The Bovine and Human Albumin Programs

Part I. Bovine Albumin

In the spring of 1940, when medical resources first began to be mobilized with the realization that the United States would eventually enter World War II, the use of blood serum for shock and other conditions was limited to a few pioneer workers in a few medical centers. Serum albumin, which was to prove the mainstay of the Navy, had not yet been developed. Work with bovine albumin was limited to a few pilot studies, chiefly by Wangensteen at the University of Minnesota (1).

The bovine albumin program in World War II began in late 1940 and progressed in a series of highly encouraging developments until July 1942, when the first real setback was encountered, in the form of a fatal case of apparent serum sickness. Because the potentialities of this form of therapy were believed to outweigh the risks, the program was continued cautiously. A number of serious reactions, however, occurred in volunteers used for testing purposes, and, when a second fatal case of serum sickness of an unusual type was encountered in February 1943, further work with bovine albumin was regarded as unjustified, and the program was officially discontinued the following month. It was a truly discouraging end to a highly promising project.

DEVELOPMENT OF PROGRAM

One of the questions raised at the first meeting of the Committee on Transfusions, Division of Medical Sciences, 31 May 1940 (2), was the possible development of a substitute, preferably synthetic, for human plasma. At this same meeting, "in the interest of clear thinking," it was proposed that protein chemists be brought into the work, and the assistance of Dr. Edwin J. Cohn (fig. 73), Department of Physical Chemistry, Harvard Medical School, was obtained (p. 336). A synthetic substitute was not developed during World War II, but, as just indicated, a great deal of time and effort went into the development of a bovine substitute for human serum albumin.

The first step in the program was a report, at the first meeting of the Subcommittee on Blood Substitutes on 30 November 1940 (3), of previous work with bovine and human plasma by Dr. Owen H. Wangensteen, Department of Surgery, University of Minnesota Medical School. His presentation, like his first publication on the subject (1), made it clear that the intravenous clinical administration of bovine plasma had not yet been established as a safe routine hospital procedure. His work, however, had indicated that this agent could be



FIGURE 73.—Edwin J. Cohn, Ph. D.

given by this route to some patients in fairly large quantities. It was Dr. Wangensteen's opinion that, when the possibilities and limitations of this method became clear, it was likely that it would become a practical hospital procedure "useful in civil as well as in war surgery for various purposes having to do with contracted blood volumes and protein stores."

The first decision in the bovine albumin program concerned the agent to be used; namely, serum, plasma, or a purified fraction of one or the other. As the experiments in the Harvard laboratory progressed (4), it became clear that the albumin fraction had many desirable physiologic and chemical properties and that it was more stable, less viscous, and less antigenic than whole plasma. It also had a larger relative osmotic effect. Chemically, Dr. Cohn reported, there appeared to be no difference between human and bovine albumin. They were the same as to solubility, isoelectric point, electrical charge, mobility, electrophoretic pattern, sedimentation constant, and shape. The difference between them could be detected only by precipitin tests.

Preparation.—Bovine serum albumin was first prepared by a large-scale ethanol-water fractionation method, with purification by isoelectric precipitation. The chief advantage of this technique, which had been developed in the Harvard laboratory, was that at the end of the process, the material could be passed through a Seitz filter. The globulin content was undesirably high, 1 percent, and the single commercial firm (Armour Laboratories Division of Armour & Co.) attempting to produce bovine albumin was having a great deal

of difficulty in reducing it. This firm, incidentally, clearly understood that if an acceptable product was finally accomplished, it would have no monopoly on the process.

Beginning with the meeting of the Subcommittee on Blood Substitutes on 19 April 1941 (4), successive reports were made on the clinical testing of bovine albumin. It was Dr. Cohn's opinion then, and continued to be his opinion until almost the end of the project, that reactions observed were more probably the result of globulin, which might be present in such small amounts as not to be demonstrable by present techniques than the result of albumin per se.

Dr. Cohn listed as immediate objectives in clinical tests:

1. Further proof that beef albumin would replace blood lost in acute hemorrhage.
2. Proof that it would replace plasma in shock. At this time, Dr. Cohn could not recommend it for this purpose.
3. Statistical studies on such matters as the incidence of serum disease and the safety of multiple injections.

It was the opinion of the group at Harvard, based on their immunologic studies, that beef albumin was remarkably inert in the circulation, in which it remained detectable for long periods of time, and was apparently a fairly poor antigen in the human bloodstream.

PROGRESS OF PROGRAM

Since bovine albumin does not appear in human urine, animal experiments were necessary to determine its ultimate fate in the body. Studies conducted by Dr. Orville T. Bailey, Harvard Medical School, on rabbits indicated that such tissue changes as occurred were apparently reversible and were of biologic rather than clinical interest. Nothing resembling amyloid was observed (5, 6).

By July 1941, the crystallized bovine albumin originally produced had been greatly improved in purity. The coloration always present in all albumin preparations disappeared upon recrystallization, a phenomenon which suggested that, in both human and bovine products, the coloration was chiefly dependent upon concentrations of globulins, especially beta globulin, in them.

By April 1942, progress had been so satisfactory in all respects that a detailed report on the crystallization of bovine albumin was made to NRC (National Research Council), acting for the Committee on Medical Research, Office of Scientific Research and Development (7). This report included instructions for the preparation of crystallized bovine albumin, a tabulation of its physical constants in solution, a complete report of its molecular properties in comparison with those of human serum albumin, a report on the experimental histologic effects of the crystalline preparation, and the course and progress of commercial preparation of the material at the Armour Laboratories. A progress report on the clinical experience to date was also included.

When no detectable globulin was found in the available preparations by chemical tests, Dr. Charles A. Janeway undertook a study of bovine albumin

by immunologic methods. His results led him to conclude, for two reasons, that he was measuring a residual impurity:

1. The impurity diminished with each successive recrystallization. This was strikingly illustrated in one preparation, which was recrystallized four times, each time with a decrease in the precipitable substance.

2. The same results were always obtained, no matter what preparation of crystallized bovine albumin was used in adsorbing the antiserum.

The practical application of these results, in Dr. Janeway's opinion, involved the solution of two problems:

1. The development of a more potent antiserum to provide for more readily detectable precipitation. It was thought that an alum-precipitated antigen might be useful.

2. The development of a more accurate method of quantitating the amount of precipitation. It was thought that nephelometry would be simpler than the Kjeldahl nitrogen technique then in use.

Plans were made for further testing by immunologic methods.

At the conference on 16 July 1942 (8), plans were made to study a number of points concerning bovine albumin, but it was agreed that, important as were these matters, none of them should be permitted to divert attention from securing answers to two questions of primary importance to the Armed Forces, (1) the safety of repeated large clinical doses of bovine albumin and (2) its effectiveness in shock.

At this conference, the first instance of serious serum sickness was reported (p. 330), following the use of material that had been recrystallized four times. In discussing the case, Dr. Cohn said that when bovine albumin of satisfactory stability had been obtained, the globulin component had been reduced to less than 2 percent, but preliminary work had shown that no such amount of globulin could be permitted. Crystallization was therefore undertaken, and clinical tests were begun with the new product in November 1941.

Since serum sickness had not been eliminated by the use of even recrystallized bovine albumin, material was being sent to a number of investigators who thought that they could despeciate the molecule, and similar studies were being conducted in Dr. Cohn's laboratory.¹

Three months later (in October 1942), Armour Laboratories was producing bovine albumin with 0.01 percent globulin, and the Harvard laboratory was making a product with 0.001 percent (9).

CLINICAL TESTING

April 1941-June 1942

The development of the bovine albumin program in respect to clinical testing was reported at various meetings of the Subcommittee on Blood Substitutes and at various conferences, and is most conveniently discussed chrono-

¹ The clinicians testing bovine albumin reported to Dr. Janeway, who summarized their data and passed it on to Dr. Cohn for further evaluation.

logically. Dr. Wangensteen, who was continuing his personal studies with this agent (10), also reported at each meeting.

Encouraging reports were made at the meetings on 19 April 1941 (table 9) (4); 8 May 1941 (11); 10 March 1942 (12); 12 May 1942 (13); and 23 June 1942 (14). At the May 1942 meeting, the results seemed so promising that it was agreed to expand the testing program, heretofore confined to Peter Bent Brigham Hospital and Dr. Wangensteen's clinic, to certain other selected hospitals as supplies permitted.²

TABLE 9.—Results of clinical testing with bovine albumin to 19 April 1941

Preparation	Persons injected	Amount	Solution	Reactions
	Number	Grams	Percent	
Armstrong No. 3.....	4	0.4	4	None.
Armour's IV W 15% ethanol.....	4	0.4	4	None.
Armour's IV W 40% ethanol.....	1	8	4	None.
Armour's VII 40% ethanol.....	1	4	20	??Slight, 2 hr. later.
Armour's VII 40% ethanol.....	2	6	4	None.
Armour's VII 40% ethanol.....	1	12	4	Serum sickness after 10 days.
Armour's VII 40% ethanol.....	1	16	4	??Slight, immediate, when injection too rapid.
Armour's VII W rework brown oil:				
(1) 40% ethanol.....	1	5	10	None.
(2) 10% ethanol.....	1	22.5	5	None.

July 1942

7 July.—At a special meeting of the Committee on Medical Research on 7 July 1942 (15), there was a full discussion of the criteria to be employed in the recommendation of bovine albumin for military use. Capt. C. S. Stephenson, MC, USN, thought that 50–60 persons should first be injected with doses of shock size, repeated within 1 or 2 weeks, and followed by reinjections of 25 to 50 gm. after the blood was free of circulating antigen. Dr. Robert F. Loeb deplored the selection of any special number of test subjects. Dr. Wangensteen thought it would be safe to recommend bovine albumin after it had been used successfully in all conditions for which plasma was used. The meeting was

² Through error, this promising news was released to the press, and it had an immediately adverse effect on Red Cross solicitation of blood donors.

reminded by the representative of The Surgeon General that no blood substitute would be practical under combat conditions if a skin test was necessary before it was used. No action was taken.

16 July.—At the Conference on Bovine Albumin on 16 July 1942 (8), the outlook, with one exception, seemed very encouraging. Only four reactions had been encountered in 86 injections of crystalline bovine albumin, in amounts ranging from 10 to 50 gm., against the same number in 35 injections of amorphous albumin. Three of the four reactions with the crystalline substance were pyrogenic, all from the same preparation and to be explained by allowing the solution to stand too long at room temperature between solution and sterilization.

The fourth reaction introduced a disturbing note, for it was a case of possible serum sickness. The summarized case history follows:

Case 1.—A 62-year-old Italian, casually selected for testing during an uneventful convalescence from herniorrhaphy and orchietomy (and with an overlooked previous history of a 20-pound weight loss and mild epigastric pain during the preceding 6 months), was given 12.5 gm. of crystallized bovine albumin twice, at a 6-day interval. The first injection was with a preparation suspected, because of results of the thermal rabbit test, of being pyrogenic. On the 10th day after this injection (the 4th day after the second injection), he developed fever, anemia, arthralgia, edema, purpura due to capillary fragility, urticaria, hypoproteinemia, and nitrogen retention. The fact that bovine albumin disappeared more rapidly than usual from his bloodstream, and that he had a strongly positive skin test as soon as it disappeared, favored the diagnosis of serum sickness. On the other hand, three of seven blood cultures were positive for *Bacillus pyocyaneus*. Contamination was suspected, and it is impossible to avoid the suspicion that this patient had a primary bloodstream infection.

In the discussion that followed the presentation of this case report, the Navy representative stated that he was not too much disturbed by a single instance of serum sickness, especially in a patient with so many other complications. In Dr. Loeb's opinion, in which he was joined by others, unless testing was proceeded with more rapidly, and with the use of larger doses, the problem of bovine albumin, from the military point of view, would become academic.

There was a considerable discussion at this conference of the risks run by subjects and investigators in this kind of work. Dr. Wangenstein thought that the administration of bovine albumin was a justifiable therapeutic procedure, which carried no greater risks than transfusion. Others took the position that reinjections into healthy subjects carried definite risks and must usually be on a voluntary basis. It was the opinion of the meeting that signed releases were not binding and simply emphasized the risks. Dr. Alfred Blalock thought that medical students should no longer be used as subjects.

The conference ended, the minutes relate, "on an optimistic note." All present believed that any risks involved in clinical testing were justified by the encouraging results obtained to date and by the urgency of the needs of the Armed Forces.

At this conference, Dr. Wangenstein reported that 40 to 60 percent of 120 of his patients injected with whole bovine albumin developed serum sickness,

usually about 4 days after the injection had been concluded. He believed the case reported at this meeting to be an instance of serum sickness, though modified by some other factor. He had had no reactions in about 60 patients treated with the amorphous and crystalline preparations of serum albumin prepared by Dr. Cohn and his group, which had been injected in amounts of 25 to 50 gm. in 200 cc. of physiologic salt solution. Six of these patients had previously reacted to injections of bovine plasma.

October 1942

When a Conference on Albumin Testing was convened on 19 October 1942 (16), part of the picture was extremely encouraging. There had been only one immediate anaphylactoid reaction in 170 first injections, and none in over 100 reinjections. Of 36 injections made with a purified, globulin-free, well-tested bovine albumin, 25, in which no reactions had been experienced, were second, third, or fourth injections.

The rest of the picture, Dr. Janeway reported, was highly discouraging. The patient with serum sickness reported on at the 7 July meeting still had severe renal damage. There had been a high incidence of serum disease in the volunteers being studied at Welfare Island, the Norfolk Prison Colony, and the Massachusetts Department of Correction. Although the testing group had been directed to proceed with all possible speed and to inject as many persons as possible three times each over a 3-month period, Dr. Janeway considered that the risks had become too great, and, on 18 September, he had telegraphed the investigators to discontinue all clinical testing until further notice.

Dr. Wangenstein expressed himself as having been surprised and disappointed when he had been asked to discontinue testing. He regarded his results with the new preparation as most encouraging. He had given 126 injections to 80 patients with eight immediate reactions (one anaphylactoid) and four delayed reactions. One of the latter occurred 21 days after the injection and was an instance of severe serum sickness; the situation was confused by the fact that the patient had also had tetanus antitoxin and that her skin test, which was positive to horse serum, was negative to bovine albumin during the latter part of her illness.

Two other reports were made:

1. Dr. Blalock, Johns Hopkins Hospital, reported the treatment of four patients in traumatic shock, with good clinical responses to 25-50 gm. of bovine albumin. One patient, with multiple fractures, had died of fat embolism. At the end of a month, the other three had negative skin tests, but two showed leukopenia.

2. Dr. James T. Heyl reported on his work in Boston. Up to this time, there had been no significant reactions in 25 patients and medical students in whom the emphasis had been on reinjections. When 200 prisoner volunteers were obtained, the risk of serum sickness was one case in 180 injections and

reinjections. There were, however, 21 delayed reactions in 66 injections in this group, 1 of which was fatal and 20 of which were severe enough to require hospitalization.³ A followup revealed three additional delayed reactions.

Case 2.—In the case which ended fatally, the presenting symptom, which was also the most prominent symptom, was acute arthralgia, which appeared in the hip 19 days after the injection. Fever, myalgia, and malaise were moderate. Chills and visceral pain were not present. The patient died in his sleep suddenly and unpredictably on the eighth day after symptoms appeared, 2 hours after he had waked spontaneously for 20 minutes. When his bed was changed at this time, he seemed perfectly normal.

Autopsy, performed by Dr. Bailey, revealed significant findings only in the heart and lungs. The heart, which weighed 400 gm., was flabby, and the myocardium was soft. Histologic examination showed extensive interstitial edema of the myocardium, with infiltration by mononuclear and polymorphonuclear leukocytes. In focal areas, especially in the interventricular septum, coagulation necrosis of myocardial fibers was present, in association with more extensive cellular infiltration.

The right lung weighed 790 gm. and the left, 730 gm. There was extensive pulmonary edema.

The combined changes in the heart and lung were considered to be the cause of death, but the pathologist stated that, if he had performed the autopsy in ignorance of the situation, he could not have determined that a foreign protein had been injected.

The kind of delayed reaction observed in these recent cases resembled the syndrome in the case of serum sickness that had occurred earlier (p. 330). It occurred, on the average, about 14 days after the injection, which most often was the first. It did not resemble the type of reaction previously observed after injections of *amorphous bovine albumin*.

A vigorous attempt to determine the component of the albumin preparations responsible for the recent reactions was already underway. Dr. Cohn was sure that stable crystallized bovine albumin could be prepared by careful control of the conditions of laboratory testing. It was essential to have tests that could pick up alterations in the product. Until some satisfactory animal test was developed, nephelometry could be used to detect the lack of heat stability characteristic of preparations containing denatured albumin.

In spite of the discouraging data presented at this meeting, it was the consensus that the military situation justified the continuation of both experimental studies and clinical testing. Dr. Cohn and the group working with him were authorized to take all the time necessary to develop tests to distinguish between good and bad preparations of bovine albumin. When they considered it safe, clinical testing could be cautiously resumed.

When the Subcommittee on Blood Substitutes met the day after the Conference on Albumin Testing (9), it accepted this recommendation, and the proposed specifications for further testing were outlined in an addendum to the minutes. It is significant and prophetic, however, that Lt. Col. (later Col.) Douglas B. Kendrick, MC, wrote in the margin of his copy of the conference minutes, "Bovine albumin is now dead as a dodo."

³ Dr. Heyl and others connected with the project paid tribute to the courage and unselfishness of the volunteers from the Commonwealth of Massachusetts Department of Correction and the Norfolk State Prison Colony. They clearly understood the risk involved before they volunteered, and their cooperation continued in spite of the high incidence of reactions and the fatality that followed one of them.

December 1942

At a meeting of the Subcommittee on Blood Substitutes on 15 December 1942 (17), Dr. Cohn reported a marked improvement (10 to 20 times) in the stability of bovine albumin preparations. Immunologic studies, however, had still failed to develop satisfactory tests to distinguish lots of albumin that had produced clinical reactions from those that had not. Dr. Wangenstein was extremely desirous of resuming clinical testing, on the basis of his previous good results, and its cautious resumption was authorized, on the ground that further criteria of safety could be developed only by such observations.

TERMINATION OF THE PROGRAM

The official bovine albumin program ended at the meeting of the Albumin Testing Group on 22 March 1943 (18), with the report of a serious reaction in the first patient who had been injected with the new preparation of bovine albumin. The stability of this product was 20 times that of the preparations which had caused the previous serious reactions. The globulin content was estimated at 0.008 percent.

Case 3.—The patient, a 55-year-old white hemiplegic, had had a practically stationary course for the last 3–4 years. He was aphasic, and his spinal fluid Wassermann reaction was positive. He was injected with 25 gm. of the new bovine serum albumin on 20 February 1943. Fifteen days later, without previous symptoms, he suddenly developed a purpuric rash on both legs. He had a chill 3 days later followed by 11 days of fever, during which there were two other chills. He had migratory pains in the limbs, chest, precordium; urticarial as well as purpuric lesions over the legs and lower trunk; and general malaise. For the 10 days before the 22 March meeting, he had felt well.

Laboratory tests showed an increased sedimentation rate; decreased red blood cell counts; decreased hemoglobin values; signs of impaired liver function; a sharp decrease in serum albumin, with no change in the serum globulin; a significant decrease in excretion by the phenolsulfonphthalein test; and no change in the nonprotein nitrogen of the blood.

It was generally agreed that this reaction, whatever its cause, was entirely similar to those previously observed. As soon as Dr. Cohn had heard of it, he had written to Dr. Alfred N. Richards, chairman of the Committee on Medical Research, NRC, informing him of the reaction to a preparation which, like another prepared at the same time, he described as "beautiful." Dr. Wangenstein and Dr. Blalock had used the same preparation without any reaction, immediate or delayed, and a patient on whom Dr. Heyl had used it was asymptomatic at the end of 3 weeks.

In view of the reaction which had occurred with such a greatly improved product, Dr. Cohn had no choice but to consider that his earlier working hypothesis, that the first reactions with bovine albumin were due to the instability of the product, was no longer tenable. He also believed that he had no choice but to recommend that all further chemical and clinical efforts to develop bovine albumin as a project by the Committee on Medical Research

should be discontinued. The Albumin Testing Group approved his action and recommendation, although Dr. Wangensteen continued to be puzzled by the difference between his own results and those of others. To date, he had injected 90 patients with crystalline bovine albumin with only one mild immediate anaphylactoid reaction and only eight delayed reactions, seven of which were mild.

Dr. Cohn regretted that the early promise of bovine albumin had not been borne out. Regardless of the success or failure of future attempts to develop it, he pointed out that if Dr. Walter B. Cannon had not suggested the original plan of developing a blood substitute from animal sources (p. 76), the present method of plasma fractionation, which was yielding human serum albumin, antibody globulins, fibrinogen, and thrombin, might not have been devised.

The action of the Albumin Testing Group was approved at the 23 March 1943 meeting of the Committee on Medical Research, Office of Scientific Research and Development (19), and steps were taken to dissolve the contracts in existence with the various testing groups.

Dr. Cohn emphasized that 177 patients had received injections of crystalline bovine albumin before a severe reaction was encountered. This fact was a challenge which called for an explanation, but solution would be a long term project. Although the hope was expressed that independent efforts would be made to continue testing of bovine albumin, it was realized that this would not be practical without the official sanction of the Committee on Medical Research, because of the risks to patients.

LATER DEVELOPMENTS

Although all intensive work on bovine albumin ended in March 1943, certain other developments might be mentioned to complete the record.

Antimicrobial agents.—All the reactions caused by bovine albumin had followed injections of preparations containing Merthiolate (thimerosal), and Dr. Cohn thought that its presence might play some part in them (20). Clinical results were not conclusive, and animal experiments were undertaken to determine the possible influence of Merthiolate upon antigenicity, especially upon the Arthus phenomenon. Early experiments were suggestive, and it was decided for the future to release bovine albumin without Merthiolate for all clinical testing.

Despeciation.—All work on the despeciation of bovine albumin had been extremely disappointing. In some instances, it had not been accomplished at all, and, in others, extremely toxic substances had been produced.⁴

Clinical testing.—The final report of Dr. Wangensteen's contract with the Office of Scientific Research and Development, dated 10 September 1943 (22),

⁴ Nine months after the U.S. program had been abandoned, a group of English workers reported the successful injection of despeciated bovine albumin (21).

covered 139 patients and included a series of 25 subjects injected with the same preparation from the Harvard laboratory with no reactions. His experience indicated to him that bovine albumin would be a satisfactory blood substitute.

At the 2 June 1944 meeting of the Subcommittee on Blood Substitutes (23), Dr. Wangensteen reported on 15 patients who had been injected with the latest preparation of bovine albumin prepared in the Harvard laboratory and all of whom had received injections from previous lots. Two patients who had had severe reactions on their initial injections had mild purpuric reactions after the second injections. There were no other reactions in this series.

In April 1944, Dr. Wangensteen (7) reported the injection of 83 additional patients with solutions of bovine albumin, with three pyrogenic reactions, all susceptible of explanation by technical errors in preparation of the equipment. There were eight delayed reactions, with incubation periods ranging from 14 to 24 days, all of the type seen in mild serum sickness. The Rumpel-Leede test was positive, but there was no purpura. The incidence of serum disease in his experience thus remained at about 10 percent, as in his original report.

A comparative study on human and bovine albumin by Heyl, Gibson, and Janeway (24), published in November 1943, showed no essential difference in the ability of these agents to draw fluid into the circulation after acute blood loss. No significant immediate or delayed harmful effects were observed during the 3-month period the subjects of the test were followed, but the investigators would not commit themselves, without more extensive clinical tests, as to the safety of using a protein of animal origin in man.

Offers and suggestions.—During the war, occasional letters were received from lay persons suggesting that the blood of beef cattle be used in the treatment of wounded men. It was pointed out in the replies that an extensive experience had revealed no way of making animal blood safe for human use.

On occasion, suggestions of the same kind were made from foreign countries, some purporting to have solved all the problems connected with the use of bovine plasma. These suggestions were similarly answered.

No serious attempt was made to revive bovine albumin as a substitute for human serum albumin after the Office of Scientific Research and Development abandoned the idea in 1943.

Part II. Human Serum Albumin

HISTORICAL NOTE

The first significant work on blood serum was done in 1918 by Mann (25), who observed that the parenteral injection of homologous serum in surgical shock, particularly when large doses were used, produced results as good as, or better than, were obtained by any other method. He therefore suggested that this agent might be of value in conditions in which it could be stored and whole blood could not be obtained.

When Dr. Max M. Strumia and his group at the Bryn Mawr Hospital (26) began to use fresh and preserved serum in the treatment of severe infections, they also encountered frequent severe reactions, even when the serum was homologous and caused no agglutination of the recipient erythrocytes. In 1936, Elliott (27) proposed that untyped serum and plasma be used in obstetric shock (p. 266), his reasoning being that the maintenance of osmotic pressure is a function of the plasma proteins and that the need for replacing lost blood volume is more important than the need for replacing red blood cells. Meantime, Stokes, Mudd, Flosdorf, and their associates at the University of Pennsylvania (28-30) were using lyophilized human serum⁵ prophylactically and therapeutically in various infectious diseases.

In 1937, Fantus (31) advocated serum in burns and in shock without hemorrhage, because of its therapeutic and natural immunizing properties and also because these conditions were usually associated with an excess of red blood cells. In 1940, Strumia, Wagner and Monaghan (26) reported their results with fresh and preserved plasma in a variety of diseases, but found themselves handicapped by frequent, severe reactions, which they attributed to the changes induced in the serum by the lyophile process. In 1938, after a considerable experimental experience, Bond and Wright (32) suggested the use of regenerated lyophilized serum in hemorrhage and traumatic shock. Mahoney (33) reported similar experimental results the same year.

It is typical of the status of human serum albumin at the beginning of U.S. participation in World War II that, at the organization meeting of the Committee on Transfusions on 31 May 1940 (2), only whole blood and dried and liquid plasma were discussed. Serum albumin was not mentioned at all, though the hope was expressed that possible substitutes for human plasma would be found, especially a substitute that could be prepared by synthesis.

LABORATORY DEVELOPMENT

The development of serum albumin in the treatment of shock really began at the first meeting of the Subcommittee on Blood Substitutes on 30 November 1940 (3), with the suggestion, already mentioned, of the chairman, Dr. Cannon, that "it would be in the interest of clear thinking" if protein chemists were brought into the picture (p. 325). In response to the suggestion, Dr. Cohn, whose work on plasma fractionation was already outstanding, undertook his work on serum albumin. Albumin was selected rather than any other component of plasma for several reasons: that it constitutes 65 percent of the proteins of plasma, that it exerts 85 percent of the osmotic pressure of

⁵ Reichel was the first to apply the term "lyophilization" (copyrighted by Sharp & Dohme) to the process by which serum was dehydrated (30). The root word, which means solvent-loving, was convenient and well chosen because it emphasized the noteworthy characteristic of the product, its remarkable solubility, which is a result of both the unaltered lyophilic properties of the serum proteins and the physical structure of the porous solid. The antibodies and complement of the serum suffered no detectable loss in processing, and the rate of subsequent deterioration was reduced to a small fraction of the losses in the liquid state.

plasma, and that it was hoped that it could be packaged in small kits and used in preference to plasma whenever space limitations indicated.

At the 19 April 1941 meeting of the subcommittee (4), after a discussion of the best methods of collecting and dispensing both plasma and serum, the following recommendation was adopted: "* * * the consensus of the committee is that either serum or plasma reduced to either a frozen or a dried state is acceptable and that production should proceed at once with the understanding that in time other recommendations may be made."

The Red Cross had already begun to supply Dr. Cohn with 15 bloods per week, and, at this meeting, he presented three exhibits of albumin prepared by plasma fractionation. The first was a tube containing 10 gm. of serum albumin in 11 cc. of water. The solution appeared slightly discolored because it contained traces of globulin, but it was described as a very stable liquid. It had a high viscosity, like that of heavy machine oil. The second tube contained albumin in a 25-percent solution; this was a clear monogenous fluid. The third tube contained 10 gm. of crystalline albumin. Dr. Milton V. Veldee preferred the 25-percent solution but Dr. Cohn thought the crystalline preparation would be more satisfactory for shipment or for storage in bulk.

CLINICAL TESTING

At the meeting of the Subcommittee for the Standardization of Dispensing Equipment (11), a number of experimental studies were reported, and Captain Kendrick reported the first clinical use of human albumin in traumatic shock:

Case 4.—A 20-year-old man was admitted to Walter Reed General Hospital, Washington, D.C., in May 1941, 16 hours after he had sustained bilateral compound comminuted fractures of the tibia and fibula, fractures of five ribs; and associated pleural damage, pneumothorax, and subcutaneous emphysema. He was confused and irrational, with a blood pressure of 76/30 mm. Hg. After he had been given two units of albumin (each approximately 25 gm.), over a 30-minute period, the pressure rose to 106/70 mm. Hg, and two hours later, after insertion of a Kirschner wire, reduction of one of the fractures, and application of a cast, it was 130/80 mm. Hg. Over the next 12 hours, the patient received 1,250 cc. of fluid by mouth and 1,000 cc. of physiologic salt solution subcutaneously. The systolic pressure remained above 130 mm. Hg during this period, with occasional elevations to 150 mm. Hg. There was no evidence of circulatory failure at any time after the administration of the albumin.

The red blood cell count on admission was 4.1 million per cu. mm., the hemoglobin 14.5 gm. percent, and the hematocrit 44. Twelve hours after the administration of albumin, the red cell count was 3,690,000. Forty-eight hours later, it was 3,780,000 per cu. mm., and the hematocrit was 35 percent. The hemoglobin level was between 12 and 12.5 gm. percent. There were no urinary abnormalities at any time.

At the meeting of the Committee on Blood Transfusions and the Subcommittee on Blood Substitutes on 23 May 1941 (5), it was recommended that the albumin produced in Dr. Cohn's laboratory be tested as rapidly and as extensively as possible. If the clinical tests proved satisfactory, Col. (later Brig. Gen.) Charles C. Hillman, MC, for the Army and Captain Stephenson for the Navy stated that serum albumin would be accepted by the services.

Production of serum albumin in the Harvard laboratory rose to 500–800 gm. per week in July (6). At the 19 September 1941 meeting of the subcommittee (34), Dr. Cohn announced that 3,407 gm. had been prepared or was in preparation; that 447 grams had been used clinically on 11 patients, one of whom had been reinjected after 13 days and another after 2 months; that the dosages had ranged from 7.6 gm. to 61.2 gm.; and that there had been no reactions of any kind.

Further reports were equally good. Up to 31 October 1941 (35), 50 patients had been injected with 788.4 gm. of albumin with no reactions. By 11 February 1942 (36), 125 patients had been injected with 4,247 gm., with only four mild reactions and one moderately severe reaction. The latter followed the use of albumin prepared from dried plasma secured from broken containers. When it was used, it was noted that it was of darker than usual coloration. This reaction occurred after 60 gm. of the albumin had been given to a patient who had lost 1,080 cc. of blood.

The Pearl Harbor experience.—At the Conference on Albumin on 5 January 1942 (37), Dr. (later Brig. Gen.) Isidor S. Ravdin, who had just returned from Hawaii, reported the administration of albumin to seven very severely burned patients injured 10 days earlier at Pearl Harbor. All were edematous and all were losing plasma at the site of their burns. Some of them were so edematous, in fact, that albumin had to be injected into the femoral vein because other veins could not be located. The Naval Hospital had had only 40 units of dried plasma for all its casualties, and some of these patients, in the emergency, had received too much salt solution.

All seven patients were given albumin, and all showed prompt clinical improvement, including one whose state was so critical that the administration of albumin to him was debatable. There was no question as to his response: He was unconscious in the morning when he was given 250 gm. of albumin. In the afternoon, he was talking but was disoriented. The following morning, he was given the same amount of albumin. Twenty-four hours later, the edema had disappeared and he was taking food by mouth.

Most of these patients had hypoproteinemia and had very low hemoglobin readings and red blood cell counts when they were first seen. Some had as little as 8 gm. percent of hemoglobin, 3.5 mg. percent of protein, and 2½ million red blood cells per cc. After the second injection of albumin, all showed hemodilution. Urinary outputs were not recorded, since most of the patients were incontinent, but the rapid disappearance of edema in all cases suggested the excretion of large quantities of urine.

The single reaction occurred in a patient who had had reactions after each earlier injection of plasma. He had a chill after the first injection of albumin but no reaction after the second.

The injections had been accomplished with some difficulty because of the poor quality of the gum-rubber tubing and the small diameter of the rubber latex tubing which had been sent to Hawaii with the albumin because of the emergency.

From his experience at Pearl Harbor, Dr. Ravdin concluded:

1. Albumin accomplished osmotically everything that normal human plasma could accomplish.
2. It produced hemodilution.
3. Laboratory studies showed that it caused a rise in the albumin fraction of the blood and often in the globulin fraction as well. The fibrinogen component was not investigated.
4. Albumin was a very satisfactory agent in patients who needed protein and who had not had too great a red blood cell loss.

The formal testing program continued into early 1943. By the end of February of that year (38), the total number of injections had reached 550, of which 72 were for hemorrhage and for surgical or posttraumatic shock and 48 for burns. Reactions continued insignificant and mild.

Testing Procedures

The following criteria were established after clinical testing had been in progress long enough to indicate what direction they should take (35):

1. Serum albumin should be given to patients in shock, who, if possible, should receive only albumin. Normal subjects should be tested for possible reactions. In all cases, attention should be paid to whether or not fluids were withdrawn from the tissues.
2. The initial dose should usually be 100 cc. of 25-percent solution (1 unit), which is roughly the equivalent of 500 cc. of citrated plasma (39). Administration should take about 20 minutes. The original injection should be repeated in 15 to 30 minutes if the desired response is not obtained. Not more than 10 units (250 gm.) of serum albumin should be given to any patient in 48 hours.
3. Vital signs should be recorded at specified intervals: In experimental subjects, at 30-minute intervals for 2 hours and then at 4-hour intervals for 24 hours; in shocked subjects, at 30-minute intervals as long as shock persists, then at 4-hour intervals for another 24 hours. Hematocrit determinations should also be made before the albumin is administered and at regular intervals thereafter in relation to the patient's progress.
4. Concealed hemorrhage is a possibility to be borne in mind, for it may occur or recur as the blood pressure returns to normal. This risk was evident in a patient at Grady Hospital, with a stab wound of the chest, who responded well to albumin but collapsed suddenly when the blood pressure had reached normal, from hemorrhage from a severed mammary artery undetected until albumin had become effective.
5. In extremely dehydrated patients, additional fluid and electrolytes must be given, since albumin draws fluid into the blood at the expense of other body tissues.
6. Serum albumin is not a satisfactory agent in severe anemia, since it simply increases the circulating blood volume without adding red blood cells.

RECOMMENDATION OF SERUM ALBUMIN TO THE ARMED FORCES

The first formal action on the use of serum albumin in the Armed Forces was taken at the Conference on Albumin on 5 January 1942 (37), when it was recommended to the Surgeons General of the Army and the Navy that, in

addition to continuation of the plasma program, serum albumin be immediately adopted for clinical use for the following reasons:

1. Albumin can be packaged and stored in less than a tenth of the space required for the standard Army-Navy package of dried plasma.
2. It is ready for immediate emergency use, without regeneration.
3. It is stable in solution in temperatures as high as 113° F. (45° C.) for protracted periods.
4. Its adoption will accelerate and supplement the procurement of satisfactory blood substitutes for military use.

It was further recommended at this conference:

1. That the Surgeons General request the Red Cross to secure voluntary blood donors for serum albumin, as part of the total national program.
2. That Dr. Cohn be asked to assume general supervisory direction of the processing of albumin in commercial laboratories.

The Navy, which was primarily interested in serum albumin rather than in plasma, took the necessary steps to implement this recommendation (40).

Further recommendations were made at the Conference on Albumin on 11 February 1942 (36), as follows:

1. That the specifications for the preparation and packaging of human serum albumin prepared by Major Kendrick and Cdr. (later Capt.) Lloyd R. Newhouser, MC, USN, be accepted with certain modifications, and that future modifications be made at the discretion of these officers and Dr. Veldee.
2. That after specifications for the preparation of serum albumin were complete, Major Kendrick and Commander Newhouser meet with representatives of supply and equipment firms to determine the availability of equipment and the time required to supply the component parts for the Standard Package of Human Serum Albumin.

It was unanimously agreed, at the meeting of the Subcommittee on Blood Substitutes on 12 May 1942 (13), that the members reaffirm their earlier recommendation that serum albumin be considered as an established blood substitute of great importance and with many practical advantages. It was further recommended that clinical testing be discontinued and that the approximately 1,000 units of serum albumin in Dr. Cohn's laboratory be turned over to the Navy for clinical use.

At the third Conference on Albumin and By-Products on 26 May 1942 (40), the chairman thought it necessary, in the interests of clearness, that the membership reaffirm its recommendations and limitations by signing the following statements (which were duly agreed to and signed):⁶

Human serum albumin in 25% solution has been recommended to the Army and the Navy to fulfill their specific requirements for a blood substitute which can be transported and administered in small volumes with great facility and with safety. It is clearly understood, as has been etched on the containers and as is indicated in the directive to the Navy,

⁶ This second action was taken at Dr. Cohn's insistence, because of the reluctance of some medical officers in high places to accept serum albumin.

that this concentrated solution should *not* be administered in severe dehydration without the simultaneous administration of fluids of such types as to maintain normal salt and water equilibria. The fluids should be given intravenously, orally *if tolerated* or by any other available route. The above statements apply only to the use of hypertonic albumin solution.

Human serum albumin has been established as being a blood substitute of proven value in that it causes hemodilution and raises blood pressure in a manner similar to blood plasma or serum. On the basis of clinical tests human albumin produces no more reactions than does plasma.

The stability of the human albumin solution as packaged has been established over a period of one year at room temperature in temperate climates. Such material has been carried at sea in the sick bay of a cruiser for three months at a temperature reported to average 37° C. (98° F.) without deteriorations as demonstrated by inspection and human injection. Stability has also been established by inspection at 45° C. (113° F.) for a period of 3 months and at 50° C. (122° F.) for a period of two weeks in the laboratory.

Training

It was decided early in the albumin program that no special indoctrination of medical officers concerning serum albumin would be necessary (16). They had had no experience in its use, but numerous articles had been published on it, and the directions and warnings etched on the can were considered adequate. Informal teaching emphasized the fact that serum albumin must not be used in severe dehydration unless other fluids could be supplied to maintain the normal salt and water equilibrium. Later, a somewhat more intensive educational program was undertaken, to encourage the use of serum albumin in the Navy (7), and the Army made a filmstrip on the subject.

COMMERCIAL PRODUCTION

Although it was not legally possible to enter into contracts for the commercial production of albumin until it had become an accepted product, discussions concerning this phase of the program were recorded at various meetings of the Subcommittee on Blood Substitutes and at albumin and other conferences. Dr. Veldee took the position that the same licensed laboratories should not prepare both human plasma and albumin, but this policy was not adopted. Dr. Cohn believed it would be unfortunate to process albumin in a number of small plants and similarly unfortunate to have manufacturers build their plants on the basis of the amounts specified in the first contracts, since the Navy had promptly indicated its plans for larger amounts.

At the 18 July 1941 meeting of the Subcommittee on Blood Substitutes (6), Dr. Veldee thought that serum albumin had been proved to be of sufficient worth to be licensed as a biologic product. Dr. Cohn said that, while further improvements were to be expected, there were at this time no serious difficulties concerning the stability and sterility of serum albumin or its handling, and he foresaw no obstacles to its commercial production. Although it was against the laws of the Commonwealth of Massachusetts to prepare biologicals directly for use outside the state, the State Attorney General had ruled that

the first 4 kilos of human albumin could be thus distributed, and a bill was being prepared for liberalization of the existing law.

At this same meeting, the subcommittee recommended that all phases of commercial production be under Dr. Cohn's direct supervision. Dr. Cohn believed that the present operation at Harvard should be continued, to avert the lag which might occur when commercial houses without previous experience began to make albumin and also because the many byproducts obtained by fractionation of plasma should be developed.

All possible preliminary steps were taken as soon as the Conference on Albumin on 5 January 1942 (37) recommended serum albumin to the Armed Forces, and, at the next meeting of the Subcommittee on Blood Substitutes (12), it was reported that six commercial firms had indicated their willingness, in response to the letters of intent they had received, to process 8,500 packages of albumin each before 1 October 1942. This would mean that 180,000 additional bleedings must be absorbed by the bleeding centers. The Navy's intention to contract for 250,000 additional packages of serum albumin in the next fiscal year⁷ would require 750,000 additional bleedings, in addition to the 900,000 bleedings necessary for the plasma already contracted for.

Nothing came of the recommendation made at the second Conference on Albumin and By-Products on 15 April 1942 (41) that a pilot plant be established by the Army or the Navy for the processing of human and biologic products for research purposes and clinical use.

In January 1942 (37), Dr. Cohn's laboratory, Armour Laboratories, and Lederle Laboratories were considered capable of producing 1,300 units of serum albumin (25 gm. each) per week. Dr. Cohn stated that any commercial firm could participate in the program if it had large coldrooms and Sharples centrifuges and would send personnel to be trained in his laboratory for at least a month.

A number of important steps were taken after this meeting (40). Specifications for commercial production were drawn up (42). Letters of intent to purchase were sent to the various processing laboratories. Dr. Cohn received official Navy authorization to receive personnel from these firms for instruction in the preparation of serum albumin, and representatives from six producers were thus trained.

There were two chief problems connected with the program. One was the steady increase in the Armed Forces requirements for serum albumin; the requirements for fiscal year 1942-43 were set at 110,000 units for the Army and 250,000 units for the Navy. Each unit of processed albumin required 3.5 units of blood. The second problem was the delay in obtaining Sharples centrifuges. The processing of albumin, while complex, offered no particular difficulties, but the procurement of equipment to process it threatened to delay the program for many months. Dr. Cohn doubted that the amount

⁷ Contrary to the plasma procurement policy, by which all supplies were purchased by the Army Medical Procurement Agency, Brooklyn, all serum albumin was purchased on contracts made by the Navy with processing firms. The smaller amounts of serum albumin which the Army used were purchased from the Navy.

desired could be produced within the specified time and warned that undue haste might be dangerous.

When the Conference on the Preparation of Normal Human Plasma was held at the Plasma Fractionation Laboratory, Department of Physical Chemistry, Harvard Medical School (43), the agenda included discussions and demonstrations of the size of a single batch of plasma, its electrophoretic analysis, bacteriologic filtration, preservatives, temperature stability test, coloration, hemolysis, sterility, separation of red cells, pyrogens, contamination, and plasma fractionation and processing of fractions. Clinical testing of serum albumin was no longer considered necessary. Present problems concerned quantity production and distribution. To date, there had been 41 runs at the Plasma Fractionation Laboratory, 18 at Armour Laboratories, and 6 at Lederle Laboratories.

A number of obstacles to the rapid implementation of the program were discussed, including the joint problems of securing the additional bloods (1½ million) required by the program; their cost (about \$3 million per million bloods); the shortages of equipment, particularly rubber tubing; the futility of priority ratings; the possible substitution of cup centrifuges for Sharples centrifuges, which continued to be in very short supply; and the critical materials in the completed serum albumin package, which was demonstrated at the conference. It was a very different matter, Dr. Veldee remarked, to make diphtheria antitoxin from horses in the backyard and to process serum albumin from blood secured from millions of donors scattered all over the country. Dr. Cohn would not recommend that the Red Cross turn over any bloods to any processing firms until sample and practice runs could be completed with the use of hemolyzed blood or contaminated plasma, which most of these firms had on hand.

At the 23 June 1942 meeting of the Subcommittee on Blood Substitutes (14), the directive prepared by Commander Newhouser for the complete package of serum albumin was approved with the deletion of the footnote dealing with femoral injection (p. 338). At his suggestion, the label was changed to read "Standard Army and Navy Package of Normal Serum Albumin (Human, Concentrated)," the designation "serum albumin" being retained because it was customary in the chemical literature and by general usage.

A special Conference on Albumin on 9 July 1942 (44) dealt with various production matters, including procurement of materials; economy of production; length of processing; deferment of trained personnel; the risk of too great haste; and yields with various types of centrifuges, all of which were still in short supply. It was decided that the question of costs was beyond the competence of the committee, though it was brought out that they would be contingent on the rate at which the initial expenses of equipment could be written off.

At the Conference on Albumin Testing on 19 October 1942 (16), while the quantity production of concentrated human serum albumin still seemed far in the future, prospects were considerably more encouraging. The War

Production Board had expedited the procurement of necessary equipment. Practice runs with contaminated plasma had been carried out at four of the six firms to which contracts had been granted. In every instance, the chemical purity of albumin had been acceptable, less than 2 percent of globulin being present. Three firms had begun to process serum albumin from blood supplied by the Red Cross, and, after some initial difficulties from contamination, they were producing satisfactory material, which would be released after clinical testing. Personnel from Dr. Cohn's laboratory had worked in several commercial laboratories, to aid in the beginning of production. Production at the Harvard laboratory was continuing.

Up to this time (October 1942), there had been:

- 78 first injections of crystalline albumin with no reactions of any kind in 61.
- 76 second injections, with no reactions in 69.
- 28 third injections, with no reactions in 26.
- 3 fourth injections, with no reactions.

At this conference, Dr. Cohn outlined the testing of commercial serum albumin as follows:

Navy specifications called for a 25-percent solution, to save space, and for stability at 122° F. (50° C.) to avoid spoilage in tropical temperatures. As soon as a lot of albumin was filtered, six bottles were forwarded to the Harvard laboratory. To date, no reaction had occurred in patients who had received human albumin that had passed the rabbit thermal test then in use.

After Captain Stephenson and Colonel Kendrick had expressed themselves as more anxious about rubber tubing than about albumin, it was formally recommended that testing thereafter be conducted on the final package. Also, in deference to those present who thought three tests insufficient, it was recommended that clinical testing thereafter include five tests, carried out in Boston and at the Army and the Navy Medical Schools. Since a standard batch of albumin would not usually exceed 380 bottles (38,000 cc.), the revised tests would require 8 bottles, just over 2 percent, of each lot.

Progress thereafter was much faster. By the middle of December (17), four laboratories were using Red Cross blood in production, and two other firms were making practice runs. Difficulties with pyrogens had been overcome; they had been traced to filter pads and distilled water. Dr. Cohn suggested that trouble would be avoided, and valuable plasma conserved, if, from time to time, testing were carried out on distilled water, new lots of supplies, and equipment, including the intravenous equipment placed in the final Army-Navy containers.

Accelerated tests were being used, with assays carried out by electrophoretic analysis. Studies indicated that in all samples of albumin tested to date there was less globulin than the amount permitted in the specifications. Progress with all the first lots, however, was cautious, it being considered more advisable to establish correct standards than to make haste.

Requests from the Armed Forces for serum albumin continued to increase. In March 1943 (18), the Navy, which had already contracted for 360,000 units

(100,000 for the Army), asked for an additional 350,000 units, to be delivered by July 1944. Since this goal was obviously impossible with present facilities, the problem was solved by opening a new processing plant (Armour Laboratories) at Fort Worth on 1 November 1943; Fort Worth, Dallas, and Houston were the last untapped blood donor centers in the country.

At the Conference on Albumin on 22 March 1943 (18), Dr. Cohn discussed various aspects of the quantity production of serum albumin:

1. Achievement of chemical purity presented little difficulty. In all, 100 of 113 preparations examined to date had been found more than 99 percent pure, and only 1 had contained more than 1.5 percent of globulin. In view of these observations, Dr. Cohn intended to discontinue routine electrophoretic analysis of every lot.

2. Studies by Dr. George Scatchard indicated that the instability of some serum albumin preparations was caused less by the albumin than by the impurities in it. Studies on bovine albumin had contributed greatly to the stabilization of human albumin. The flocculation and haziness in certain preparations after heating remained a problem to be solved.

3. Most preparations had passed the rabbit thermal test without difficulty. After a discussion of the number of clinical tests that should be required—some observers thought as many as 12 should be used—it was agreed that the same criteria should be applied to human albumin rendered pyrogen-free by heating as would be applied to standard albumin preparations. Dr. Veldee had one reservation: Heating itself might do damage, and, for this reason, he thought that the use of heated preparations should be restricted.

4. Albumin made from contaminated plasma was apparently safe and satisfactory for use, but more caution should be used in accepting it, and more careful clinical testing carried out with it, than were employed in albumin made from uncontaminated plasma. Similar precautions should be employed in serum albumin made from plasma in broken bottles.

5. The production figures with the use of the DeLaval centrifuge were attractive, but the introduction of new methods at this stage would probably delay the program. If the program was to be expanded, and if it were certain that these centrifuges could be obtained, then it might be well to consider their use.

6. Dr. Cohn was now ready to perform only stability tests on the bulk product, and to perform all other tests in the final containers. This would save both time and material. Of the 328 clinical pyrogen tests performed between 10 June 1941 and 19 March 1943, only one preparation that had successfully passed NIH (National Institute of Health) rabbit thermal test had given any febrile reaction in man.

7. One of the commercial laboratories had been informed that a donor had developed mumps 48 hours after his donation. There was no known instance of transmission of mumps by transfusion, and it was agreed that it would not be practical to follow donors after they had given blood.

At the 9 April 1943 meeting of the Subcommittee on Blood Substitutes (45), Dr. Cohn reported that the program was proceeding satisfactorily quantitatively and so well qualitatively that a revision of the test schedule might be considered; in particular, the number of heated specimens tested could be reduced, which would save 10 days. The subcommittee authorized Dr. Cohn to establish the number and type of tests to be employed.

At the 13 May 1943 meeting (20), it was reported that 700 bottles of contaminated plasma processed into albumin by the Cutter Laboratories had been found satisfactory chemically. One of two lots tested for pyrogens had caused no reactions. The other lot had given three reactions. The present policy was to request three additional containers for examination if a reaction occurred

in any of the five routine clinical tests. If any of the three additional clinical tests was positive, the entire lot was discarded.

Delivery of serum albumin was at first disappointingly slow (table 10). Only 26,119 packages had been delivered by the end of July 1943, against an expected 150,000 (46). Then, the situation improved. Within the next 2 weeks, the number rose to 45,000 (the figures are cumulative), by the first of October (47) to more than 80,000, and by the middle of November (48) to almost 125,000. As of 2 June 1944 (23), 325,838 units of human serum albumin had been authorized for shipment to the U.S. Naval Medical Supply Depot; of this amount, 36,699 units had been produced during May. Quality continued to improve. All the albumin made at the Harvard pilot plant over the past several months had been held in the dry state, in anticipation of experimental needs.

TABLE 10.—Accepted production of units of normal human serum albumin, June 1942–November 1943¹

Year and month	Production laboratory							Total
	Cutter	Harvard	Lederle	Lilly	Sharp & Dohme	Squibb	Upjohn	
<i>1942</i>								
June.....		83						83
July.....		241						241
August.....		370						370
December.....		611		88		71		770
<i>1943</i>								
January.....	31	220	168					419
February.....	380			2,042		272		2,694
March.....			87	506				593
April.....		400	522	2,330	575	45		3,872
May.....	1,671	408	914	2,233	1,245	179	2,066	8,716
June.....	2,146		1,106	4,503	1,437	1,869		11,061
July.....	3,652	126	607	3,033	228	4,473		12,119
August.....	3,629		1,820	2,619	1,409	5,325	792	15,594
September.....	4,505		4,371	3,981	2,635	7,441	2,957	25,890
October.....	4,841		4,264	6,113	964	9,235	2,513	27,930
November.....	2,168		678	3,471		7,051	546	13,914
Total.....	23,023	2,459	14,537	30,919	8,493	35,961	8,874	124,266

¹ The production of the Harvard laboratory was shipped to the Bethesda Naval Hospital; that of the commercial laboratories went to the U.S. Naval Medical Supply Depot.

There had been a striking decrease in the amount of material requiring reworking because of failure to meet specifications of either sterility or stability. The yield of albumin from plasma had also increased. With modifications in

processing methods, it rose from 27.5 gm. per liter to 29.3 gm., and then to 30.2 gm. per liter. Allowing for losses, the final yield was about 25.4 gm. per liter.

After extensive testing and the ironing out of certain initial difficulties, albumin made from contaminated plasma had proved safe and effective, and sizable amounts were secured from this source. In addition, firms not making albumin were turning their contaminated stocks over to firms that did, and great savings were thus being effected.

In April 1944 (7), the Canadian National Research Council offered to the United States about 10,000 liters of contaminated serum, all of which it proposed to destroy if U.S. authorities could not reclaim it as albumin. It would be given to the Army and the Navy with no financial or other obligations. Eli Lilly and Co. were able to work the contaminated serum into acceptable, pyrogen-free serum albumin, and the Canadian offer was gladly accepted.

Some anxiety was originally felt that the development of byproducts other than albumin might slow up the albumin program. This fear was discounted. In fact, when the Navy made contracts for byproducts with firms holding contracts for serum albumin, Dr. Cohn approved the plan, on the ground that plasma fractionation was an integrated process (40).

The report of the American Red Cross Blood Donor Service to 1 September 1945 (table 11) showed that the seven commercial firms eventually involved in the albumin program had processed 2,329,175 donations into 569,014 packages, all of which had been delivered to the Navy except for 1,704 packages which one firm was holding, awaiting shipping instructions (49).

ARMY REQUISITIONS FOR SERUM ALBUMIN

When serum albumin was in process of development, the small size of the package made it seem of great potential usefulness during landing operations and for airborne troops and such ground forces as pack-drawn mountain troops. The Army requisition for fiscal year 1942-43 was 110,000 units, but, up to 1 January 1944, because of production delays, only 36,000 units had been received. In November 1943, the requirements for calendar year 1944 were tentatively set at 150,000 units, including the 74,000 units undelivered in 1943. This requisition was later reduced to 60,000 units (50).

The reason for the reduction in the requisition for serum albumin was a revision of the premises on which the original requirements had been made (50). The small size of the package lost some of its attractiveness to the Army in the face of the necessity for making intravenous fluids available along with the albumin; unless fluids were available, albumin could not be used in dehydrated casualties. Also, experience had shown that there were almost no circumstances, including combined landing operations, in which plasma could not be supplied in adequate quantities. Albumin, of course, continued to be used according to indications in head injuries and in burns.

TABLE 11.—*Summarized report of albumin production to 1 September 1945*

Production laboratory	Bloods received	Packages delivered to U.S. Naval Medical Supply Depot
Lederle.....	285, 809	91, 022
Lilly ¹	413, 588	101, 916
Squibb.....	551, 143	116, 395
Cutter.....	321, 464	79, 719
Sharp & Dohme.....	136, 906	26, 675
Upjohn.....	324, 766	78, 913
Armour.....	295, 499	74, 374
Total.....	2, 329, 175	569, 014

¹ This firm had on hand 1,704 completed packages being held for shipping instructions.

TECHNIQUES OF PLASMA FRACTIONATION

In February 1942, when Dr. Cohn was requested to prepare specifications for the commercial production of serum albumin, he described four methods for the fractionation of plasma (40). The first technique was impractical for industry. The third, in which the supernatant of fraction IV was concentrated in a still, had to be given up because of the high incidence of pyrogens and the time required to dialyze away the accumulated salts. The fourth method, crystallization, occupied too much time. The second technique, with some modifications, was used by the processing firms. The technique is too complex to be described in detail here, but its essential steps were as follows:

1. Separation of fraction I, separation of fractions II and III, and precipitation of fraction IV.
2. Sedimentation of fraction IV.
3. Clarification of the supernatant from fraction IV, precipitation of fraction V, and reprecipitation of fraction V

More than one step could be accomplished at a time, and each could be completed within 48 hours. The complete processing of one batch would thus require a total time of 6 days. The method was the same as that employed in Dr. Cohn's laboratory; expansion of production involved no changes in the basic principles but merely changes in the mechanical equipment for handling the various steps, as well as changes in certain details, of the process. Thus, the recovery of tax-free alcohol used in the small-scale operations at the Harvard laboratory did not pay. It became an immediate problem in commercial production, and care had to be taken to provide against the distillation of volatile contaminants. There was some delay when one commercial firm was permitted to change from dialysis to capillary methods of adding alcohol. All the first material thus treated had to be reworked, but there were no difficulties in succeeding runs.

REFRIGERATION

It was originally thought that albumin would require refrigeration (37). Then, it was found that it could be stored at room temperature without deterioration.⁸ Since, however, it was intended for use of the Armed Forces in all parts of the world, samples were tested for stability at 113° F. (45° C.) for 1 month and at 98.6° F. (37° C.) for 2 months. It was found that albumin would not remain stable at these temperatures if more than a very small amount of globulin was present. Later (34), in view of military requirements, it was decided to extend the temperature range from -58° F. to +122° F. (-50° C. to +50° C.).

ADDITIVES

Sodium Chloride

One of the first observations made about serum albumin in the Subcommittee on Blood Substitutes (34) was that it was more stable when it was made up with sodium chloride; without it, early preparations became cloudy at room temperature. The matter was to come up in other meetings of the subcommittee and at various conferences on albumin.

An ad hoc committee (Dr. Veldee, Dr. Earl S. Taylor, and Lt. William G. Workman, MC) was appointed to study the problem in May 1942 (13), after Dr. Cohn stated that the addition of sodium chloride to the blood intended for plasma fractionation greatly complicated the processing of serum albumin. The higher the salt content, the larger was the amount of globulin passing into fraction V, and the larger the amount in fraction VI. The ad hoc committee found the plasma yield to vary by less than 1 percent with and without salt. These observations paralleled those made by Eli Lilly and Co. It was also found that the total osmotic pressure of 25-percent albumin could be considerably increased by adding more sodium chloride and considerably decreased by reducing the amount used if either change were desired (16).

In January 1943, at a meeting of the Subcommittee on Albumin and By-Products (51), it was pointed out that the clinician's preference for isotonic solutions of serum albumin might be on unsound grounds from the standpoint of physical chemistry; a hypertonic solution would increase the stability of the product. It was proposed that the sodium chloride content of serum albumin be increased to 2 percent. The amount of solution injected was so small that there could be no valid objection to this increase. Potassium salts, however, should not be added, because some of the clinical conditions encountered would be complicated by hyperpotassemia.

⁸ At this time (1962), albumin is stored at 4° to 6° C., and the dating period has been correspondingly increased.

In March 1943, the salt content of serum albumin was altered from 0.15 to 0.3 molar. The change at least doubled the stability of the product at 135° F. (57° C.) and also increased its stability at 122° F. (50° C.), though less strikingly (48). Samples from each of the processing firms kept for 100 days at 122° F. (50° C.) looked clear enough at the end of the period to be used clinically (table 12). Dr. Cohn would have expected a twofold improvement in the stability of the product with the doubling of the salt component, not the sixfold increase that had occurred and that might reflect increased skill on the part of the producers.

When 0.3 molar sodium chloride was first used, authorization was given for making as much as 0.09 of this component sodium acetate. Later (52), Dr. J. Murray Luck and his associates at Stanford University demonstrated that a further increase in the length of the paraffin chain of the anion would increase for this purpose the stability of the serum albumin. Sodium butyrate was tested and discarded because of the undesirable odor. Albumin was then prepared with 0.05 molar sodium phenylacetate plus 0.25 molar sodium chloride. Still later, sodium mandelate was substituted for phenylacetate because of its therapeutic properties. Tests showed that whichever of these agents was used would make possible the heating of albumin for hours at temperatures close to 168° F. (70° C.), a step which would also reduce the dangers of bacterial or virus contamination (tables 12 and 13).

TABLE 12.—Effect of storage at various temperatures on stability at 57° C. of crystalline human albumin (lot HA-64)

Conditions of experiment		Hours required for increase of 50 Mueller units				Hours required for 5% increase in viscosity			
NaCl		0.15	0.15	0.30	0.30	0.15	0.15	0.30	0.30
pH		6.8	7.0	6.8	7.0	6.8	7.0	6.8	7.0
Storage days	Storage temperature								
	Degrees C.								
0	—	93	79	244	148	51	44	104	84
100	0	105	81	183	167	58	40	117	93
200	0	98	83	182	184	55	45	117	94
100	25	63	55	153	117	39	28	94	68
200	25	39	45	103	117	24	27	71	60
100	37	63	47	110	124	33	23	85	87
200	37	30	32	81	108	18	30	65	61

TABLE 13.—*Effect of storage at various temperatures on viscosity of crystalline human albumin (lot HA-64)*

Conditions of experiment		Ratio of viscosity after storage to initial viscosity			
NaCl		0. 15	0. 15	0. 30	0. 30
pH		6. 8	7. 0	6. 8	7. 0
Storage days	Storage temperature				
	<i>Degrees C.</i>				
0	—	1. 00	1. 00	1. 00	1. 00
100	0	0. 99	1. 01	1. 01	0. 99
200	0	0. 99	1. 00	1. 01	1. 00
100	25	0. 99	1. 01	1. 01	0. 99
200	25	1. 00	1. 01	1. 01	1. 00
100	37	1. 00	1. 02	1. 03	1. 01
200	37	1. 02	1. 03	1. 03	1. 02

In a supplementary report, Dr. Luck and his associates (53) recommended that a large-scale clinical experiment be conducted with 25-percent human serum albumin solution, of pH 6.6 to 7.0, containing 0.04 molar sodium mandelate and 0.26 molar sodium chloride. Such solutions would probably be of great stability and, if clinical trials revealed no adverse effects, should be employed in place of the present serum albumin solution. Dr. Hans Clarke had suggested acetyl phenylalanine, and it was thought that it might be possible to replace mercurials with it in both albumin and dried plasma. Studies based on these proposals were limited to trial runs.

Meantime, thermal stability was generally improving, and by the spring of 1944 (52), it was unusual to find more than an occasional sample with stability of less than 50 hours at 135° F. (57° C.). Mueller nephelometers had been distributed to the processing houses, and comparative studies of their results and those of the Harvard laboratory showed satisfactory agreement. Electrophoretic and ultracentrifugal controls had long since been discontinued.

In October 1944, Captain Newhouser directed all laboratories fractionating plasma under Navy contracts to prepare serum albumin of low salt content "if such a change is commercially feasible, will supply a product with satisfactory stability and does not increase the contract cost of the serum albumin."

Isoelectric albumin could be prepared practically free of sodium ions, but it was stable only in the dry state and could not be dispensed in solution. If there were sufficient advantage in preparing completely salt-free albumin, it could be dispensed in the dry state, with glucose in the diluent bottle, but this

would require new contract specifications and a new package. No clinical evidence existed, however, of the value of reducing the sodium ion concentration below a certain level.

A preliminary report of this investigation was made on 16 January 1945 (54), and a summary report was made to the Subcommittee on Blood Substitutes on 16 March 1945, by Dr. Cohn (55), as follows:

1. Accumulated evidence to date indicates no significant behavioral differences between the new salt-poor albumin and the standard salt-containing preparation in shocked or in normal individuals. In shock, injection of 25-percent albumin, whether salt-poor or salt-containing, always increases the blood volume. In dehydration, the injection of additional fluids is still recommended.

2. Preliminary evidence indicates that salt-poor albumin is an effective diuretic agent in the nephrotic syndrome and in hepatic cirrhosis associated with severe edema.

3. In a small group of surgical patients with hypoproteinemia and edema, concentrated albumin has been found to mobilize water from the interstitial spaces into the plasma. Used in a few patients after trauma, it produced a significant rise in plasma protein concentration.

4. Salt-poor albumin, stabilized with 0.04 molar acetyl tryptophan or 0.04 molar mandelic acid, retains its stability better than standard serum albumin preparations when heated at 140° F. (60° C.) for 10 hours. This procedure, or some comparable heating procedure, would destroy most bacteria in vegetative forms as well as such viruses as that of infectious hepatitis. It has been recommended that studies be undertaken as soon as possible of the time required to destroy the agent of hepatitis at a given temperature.⁹

5. The original opinion of serum albumin as to its convenience, rapidity and ease of administration, and effectiveness in increasing plasma volume in injury and shock has been fully confirmed by this investigation.

As a result of the evidence secured in this investigation, it was recommended that salt-poor albumin be substituted for the current preparation, which contained 0.3 molar sodium chloride. It should be prepared without a mercurial preservative (p. 354); should be stabilized with 0.04 molar acetyl tryptophan, a derivative of a natural amino acid; and should be heated for such periods and at such temperatures as might be necessary for the destruction of viruses.

At this meeting it was also recommended that products of plasma fractionation, including human serum albumin, be included in the "United States Pharmacopeia." This recommendation was not made effective until November 1950, with the 14th edition. Plasma had first appeared in the 1942 edition.

Antibacterial Agents

At the January 1942 Conference on Albumin (37), Dr. Cohn reported that the experience gained at one of the processing companies had indicated that it was highly dangerous to add Merthiolate to albumin. Experimental studies were to the same effect. The production of albumin was delayed at least 6 weeks by the necessary investigations. A proposal that preservatives be eliminated entirely was made at the 19 July 1943 conference (56), but if this was

⁹ The menace of hepatitis was just beginning to be appreciated (p. 647).

done, it was pointed out in the discussion, at least a third of the total product would have to be tested. This plan would be workable as far as individual bulk containers were concerned but totally impractical in the final containers.

The problem, as Dr. Cohn pointed out at this conference, fell into two parts, (1) filtration to achieve a sterile product and (2) the use of preservatives. With a 30-percent solution, the viscosity was too great for convenience. Later (16), Dr. Cohn reported an observation not previously made, that 25-percent normal human serum albumin is essentially isoviscous with respect to blood.

Serial studies by Col. Elliott S. Robinson, MC, showed that the more rapidly the albumin was filtered, the better the results from the standpoint of sterility. Using Seitz filters, he found that contamination was not a particularly troublesome problem. He attributed the good results partly to good luck and partly to attempts to expedite the procedure. Filtration became easier as the globulin content of preparations was reduced.

Studies reported by Dr. Janeway at the 19 July 1943 meeting (56) had been undertaken on the assumption that alcohol was a good bacteriostatic agent. In four complete runs, and an almost completed fifth run, he had taken bacterial counts at every fractionation and found contamination low; the average, figured in terms of the original plasma to take care of dilution, was 30 colonies per cc. Although the counts were very low, sterility was not achieved at any point until fraction V, which carried down bacteria, was taken off. The supernatant was free from bacteria, but the precipitate was not; it usually contained a smaller number of bacteria than might have been anticipated, but the counts might run up to about 100 colonies per cc. of redissolved fraction V. Samples were taken in quadruplicate. The results were the same whether they were frozen or left at ice box temperatures, but there was occasionally a considerable difference between cultures made at room temperature and at 98.6° F. (37° C.).

It was concluded that alcohol did not act as a sterilizing agent, at least at the temperatures at which these studies were conducted. It was also concluded that bacteria were collected at most of the steps in the process, from the operators, filters, and other sources, but that the number was probably not great enough to have any influence on pyrogens, though if the organisms were of the gram-negative variety, a few would be sufficient to cause trouble.

Dr. Veldee agreed that, assuming dried serum albumin to be relatively sterile, the important points would be the speed of getting the material into solution, the temperature of the solution, and the speed with which it went through the filter. Colonel Robinson's experience had been limited to relatively small lots. The NIH experience had included 75-liter lots. Colonel Robinson had used a very simple type of Seitz filter, which could be cleaned and inspected for leaks. Dr. Veldee doubted that such filters would be used in the larger commercial houses and thought that in certain circumstances the technique of filtration might well be a source of contamination. If there was a small defect in the filter, there was more chance of its showing up with 75- than with 25-liter lots.

As to preservatives, Merthiolate in 1:15,000 concentration had always been acceptable to NIH, but if 1:10,000 had been proposed when the minimum requirements for human plasma were being drawn up, it would have been equally acceptable. The problem was this: In all other biologics except human plasma and serum, the dosage was small, usually 1 or 2 cc., or under 10 cc., and the effective bactericidal dose per patient was equally small. Therefore, any one of a number of preservatives could be used to kill any living organism. With albumin, plasma, or serum, however, such large doses had to be given that preservatives could not be used in the same concentration as in smaller dosages because of the risk of toxicity.

FURTHER CLINICAL STUDIES

At the Conference of the Albumin and By-Products Group on 14 December 1943 (67), Dr. Cohn pointed out that the development of serum albumin had undergone two phases. In the first, all the material produced was devoted to an appraisal of its efficiency in shock. In the second, all the material was delivered to the Armed Forces for use overseas. At this time, with full commercial production underway, the output of the pilot plant at the Harvard Medical School constituted less than 1 percent of the total production, and he believed that a third phase might be considered, in which the output at this plant could profitably be devoted to the study of diseases and conditions other than shock. He agreed with those who pointed out that, while the amount of serum albumin thus used would be small in comparison with the total amount, great quantities would be required in the treatment of nephrotic states, cirrhosis, and nutritional edema, and the needs of the Armed Forces must not be jeopardized in any way by the proposed research program.

In December 1944, the Committee on Medical Research, NRC, was requested by the Navy to provide additional clinical data on serum albumin, with special reference to the increase in plasma volume accomplished by its use with and without the additional administration of crystalloid solution. An additional purpose of the investigation was the testing of the new salt-poor albumin preparation just developed. The conditions studied included trauma of various kinds, with and without shock and with and without active fluid loss at the time of the investigation; postoperative states, with and without shock; and medical conditions. Normal subjects were also studied.

Considerable scattering was found in the increase in plasma volume per gram of albumin injected, which was to be expected, even in normal subjects, as the result of differences in tissue hydration, circulatory state, renal activity, and other variants. Injured subjects, especially those with hemorrhage, burns, or peritonitis, who were losing fluid actively, sometimes held little or none of the injected albumin and fluid and showed only insignificant increases in plasma volume.

The following conclusions were considered warranted:

1. As an overall average, the injection of concentrated human serum albumin was associated with a rapid, and sometimes immediate, increase in plasma volume of 12-14 cc. per gram of injected albumin. The same average held per gram of albumin retained.
2. Administration of a fixed amount of saline solution intravenously with the serum albumin (800 cc. with 200 cc. of 25-percent albumin) resulted in an appreciable increase in plasma volume as compared with the increase that followed the administration of albumin alone. Experimental studies on dogs, in which dehydration was produced by withholding fluids or by inducing diuresis with glucose, had shown that the administration of albumin alone did not restore the circulating blood volume and blood pressure to normal and that the survival rate was low.
3. Patients in severe shock, presumably with continuing losses of blood or plasma, showed much smaller increases in plasma volume per gram of albumin given (an average of 8 cc. in shock against 14 cc. without shock). Thus, in severe shock, the administration of 25 gm. of serum albumin without additional fluid would correspond to a plasma infusion of 200 cc. Maj. (later Lt. Col.) Henry K. Beecher, MC, reached approximately the same conclusion in his study of battle casualties in Italy, although the only criterion of improvement available to him was arterial blood pressure (p. 40).
4. In several instances, the administration of additional intravenous salt solution after the administration of albumin produced further increases in plasma volume.
5. No differences were noted in the results of salt-poor and salt-containing solutions.

TERMINATION OF PROGRAM

The production of serum albumin consumed an increasing number of blood donations until February 1944, when about 30,000 bloods a week were being supplied for this program. Then, with the needs of the Navy and the far smaller needs of the Army well provided for and supply simply a maintenance matter, production was gradually reduced until 15 October 1944, when it was cut sharply. The Armour Laboratories plant in Fort Worth was closed and the blood donor centers which had supplied it, in Fort Worth, Dallas, and New Orleans, were also closed. Four other laboratories ceased receiving blood for serum albumin at this time, but other processing laboratories continued to operate, on a curtailed scale, until the end of the war.

References

1. Wangenstein, O. H., Hall, H., Kremen, A., and Stevens, B.: Intravenous Administration of Bovine and Human Plasma to Man: Proof of Utilization. *Proc. Soc. Exper. Biol. & Med.* 43: 616-621, April 1940.
2. Minutes, meeting of Committee on Transfusions, Division of Medical Sciences, NRC, 31 May 1940.
3. Minutes, meeting of Subcommittee on Blood Substitutes, Division of Medical Sciences, NRC, 30 Nov. 1940.
4. Minutes, meeting of Subcommittee on Blood Substitutes, Division of Medical Sciences, NRC, 19 Apr. 1941.
5. Minutes, meeting of Subcommittee on Blood Substitutes, Division of Medical Sciences, NRC, 23 May 1941.
6. Minutes, meeting of Subcommittee on Blood Substitutes, Division of Medical Sciences, NRC, 18 July 1941.
7. Minutes, meeting of Subcommittee on Blood Substitutes, Division of Medical Sciences, NRC, 21 Apr. 1944.

8. Minutes, Conference on Bovine Albumin, Division of Medical Sciences, NRC, 16 July 1942.
9. Minutes, meeting of Subcommittee on Blood Substitutes, Division of Medical Sciences, NRC, 20 Oct. 1942.
10. Kremen, A. J., Hall, H., Koschnitzke, H. K., Stevens, B., and Wangensteen, O. H.: Studies on the Intravenous Administration of Whole Bovine Plasma and Serum to Man. *Surgery* 11: 333-355, March 1942.
11. Report, Subcommittee for the Standardization of Dispensing Equipment, Committee on Blood Substitutes, Division of Medical Sciences, NRC, 8 May 1941.
12. Minutes, meeting of Subcommittee on Blood Substitutes, Division of Medical Sciences, NRC, 10 Mar. 1942.
13. Minutes, meeting of Subcommittee on Blood Substitutes, Division of Medical Sciences, NRC, 12 May 1942.
14. Minutes, meeting of Subcommittee on Blood Substitutes, Division of Medical Sciences, NRC, 23 June 1942.
15. Minutes, meeting of Committee on Medical Research, Division of Medical Sciences, NRC, Office of Scientific Research and Development, 7 July 1942.
16. Minutes, Conference on Albumin Testing, Division of Medical Sciences, NRC, 19 Oct. 1942.
17. Minutes, meeting of Subcommittee on Blood Substitutes, Division of Medical Sciences, NRC, 15 Dec. 1942.
18. Minutes, Conference on Albumin, Division of Medical Sciences, NRC, 22 Mar. 1943.
19. Minutes, meeting of Subcommittee on Blood Substitutes, Division of Medical Sciences, NRC, 23 Mar. 1943.
20. Minutes, meeting of Subcommittee on Blood Substitutes, Division of Medical Sciences, NRC, 13 May 1943.
21. Edwards, F. R.: Despeciated Bovine Serum (D.B.S.): A Substitute for Human Plasma. *Brit. M. J.* 1: 73-76, 15 Jan. 1944.
22. Wangensteen, O. H., Kremen, A. J., and State, D.: The Experience of the Surgical Clinic of the University of Minnesota Medical School in the Use of Bovine Albumin as a Blood Substitute. Committee on Medical Research, Office of Scientific Research and Development, 10 Sept. 1943.
23. Minutes, meeting of Subcommittee on Blood Substitutes, Division of Medical Sciences, NRC, 2 June 1944.
24. Heyl, J. T., Gibson, J. G., 2d, and Janeway, C. A.: Studies on the Plasma Proteins. V. The Effect of Concentrated Solutions of Human and Bovine Serum Albumin on Blood Volume After Acute Blood Loss in Man. *J. Clin. Invest.* 22: 763-773, November 1943.
25. Mann, F. C.: Further Experimental Study of Surgical Shock. *J.A.M.A.* 71: 1184-1188, 12 Oct. 1918.
26. Strumia, M. M., Wagner, J. A., and Monaghan, J. F.: The Intravenous Use of Serum and Plasma, Fresh and Preserved. *Ann. Surg.* 111: 623-629, April 1940.
27. Elliott, J.: Preliminary Report of a New Method of Blood Transfusion. *South. Med. & Surg.* 98: 643-645, December 1936.
28. Stokes, J., Jr., Mudd, S., Roddy, R. L., Eagle, H., Flosdorf, E. W., and Lucchesi, P.: The Use of Lyophile Human Serums for Prevention and Treatment of Infectious Diseases. *Am. J. Dis. Child.* 48: 1428-1429, December 1934.
29. Flosdorf, E. W., and Mudd, S.: Procedure and Apparatus for Preservation in "Lyophile" Form of Serum and Other Biological Substances. *J. Immunol.* 29: 389-425, November 1935.
30. Flosdorf, E. W., and Mudd, S.: An Improved Procedure and Apparatus for Preservation of Sera, Microorganisms and Other Substances—the Cryochem-Process. *J. Immunol.* 34: 469-490, June 1938.
31. Fantus, B.: The Therapy of the Cook County Hospital. *Blood Preservation.* *J.A.M.A.* 109: 128-131, 10 July 1937.

32. Bond, D. B., and Wright, D. G.: Treatment of Hemorrhage and Traumatic Shock by the Intravenous Use of Lyophile Serum. *Ann. Surg.* 107: 500-510, April 1938.
33. Mahoney, E. B.: A Study of Experimental and Clinical Shock With Special Reference to Its Treatment by the Intravenous Injection of Preserved Plasma. *Ann. Surg.* 108: 178-193, August 1938.
34. Minutes, meeting of Subcommittee on Blood Substitutes, Division of Medical Sciences, NRC, 19 Sept. 1941.
35. Minutes, meeting of Subcommittee on Blood Substitutes, Division of Medical Sciences, NRC, 3 Nov. 1941.
36. Minutes, Conference on Albumin, Division of Medical Sciences, NRC, 11 Feb. 1942.
37. Minutes, Conference on Albumin, Division of Medical Sciences, NRC, 5 Jan. 1942.
38. Minutes, meeting of Subcommittee on Blood Substitutes, Division of Medical Sciences, NRC, 24 Feb. 1943.
39. Minutes, Conference on Albumin, Division of Medical Sciences, NRC, 11 May 1942.
40. Minutes, Conference on Albumin and By-Products, Division of Medical Sciences, NRC, 26 May 1942.
41. Minutes, Conference on Albumin and By-Products, Division of Medical Sciences, NRC, 15 Apr. 1942.
42. Specifications for a Complete Package of Serum Albumin (Human) Concentrated for the Army and Navy, n. d.
43. Minutes, Conference on the Preparation of Normal Human Serum Albumin, Division of Medical Sciences, NRC, 5-6 June 1942.
44. Minutes, Special Conference on Albumin, Division of Medical Sciences, NRC, 9 July 1942.
45. Minutes, meeting of Subcommittee on Blood Substitutes, Division of Medical Sciences, NRC, 9 Apr. 1943.
46. Minutes, Conference of Albumin and By-Products Group, Division of Medical Sciences, NRC, 28 July 1943.
47. Minutes, meeting of Subcommittee on Blood Substitutes with Subcommittee on Neurosurgery; Conference of Albumin and By-Products Group, Division of Medical Sciences, NRC, 5 Oct. 1943.
48. Minutes, Conference of Albumin and By-Products Group, Division of Medical Sciences, NRC, 17 Nov. 1943.
49. Final report, Albumin Production, American National Red Cross Blood Donor Service to 9/1/45.
50. Memorandum, Lt. Col. Douglas B. Kendrick, MC, for Brig. Gen. Fred W. Rankin, 2 Feb. 1944, subject: Requirement for Human Serum Albumin.
51. Minutes, Conference on Production of Normal Human Serum Albumin and Its By-Products, Division of Medical Sciences, NRC, 22 Jan. 1943.
52. Minutes, meeting of Subcommittee on Blood Substitutes, Division of Medical Sciences, NRC, 2 Mar. 1944.
53. Luck, J. M., Ballou, G. A., Bassett, D., Boyer, P. D., Lum, F. G., and Rice, R.: The Stabilization of Standard Human Serum Albumin With Sodium Mandelate and Sodium Phenylacetate. Blood Substitutes Report No. 15, Subcommittee on Blood Substitutes, Division of Medical Sciences, NRC, 15 Mar. 1944.
54. Salt-Poor Albumin. Interim Report, under Contract OEMcmr-139, Department of Physical Chemistry, Harvard Medical School, 16 Jan. 1945.
55. Minutes, meeting of Subcommittee on Blood Substitutes, Division of Medical Sciences, NRC, 16 Mar. 1945.
56. Minutes, Conference on the Production of Normal Human Serum Albumin and Its By-Products, Division of Medical Sciences, NRC, 19 July 1943.
57. Minutes, Conference of the Albumin and By-Products Group, Division of Medical Sciences, NRC, 14 Dec. 1943.

CHAPTER XIII

Byproducts of Plasma Fractionation

GENERAL CONSIDERATIONS

One of the truly important achievements of the plasma-blood program in World War II—and, indeed, one of the important scientific contributions of the century—was the development by Dr. Edwin J. Cohn and his group at the Department of Physical Chemistry, Harvard Medical School, of a practical physicochemical technique by which plasma could be separated into clinically usable fractions. The wartime work was an extension of previous work done in this laboratory on plasma fractionation, and was directly stimulated by the endeavor to find a purified preparation of bovine albumin. The fractions separated, particularly albumin, proved of great value during the war and have since affected many areas of medicine. The work that Dr. Cohn began is continuing and expanding under the auspices of the Protein Foundation, which was established in 1953.

By the Cohn technique, each plasma fraction is precipitated in ethyl alcohol, under specific conditions of temperature, pH, ionic strength, and protein concentration, in a coldroom, at a temperature of 23° F. (−5° C.). Since the processing is carried out below the freezing point of water, denaturation of the plasma proteins by alcohol does not occur. Bacterial growth is also inhibited. The dried fractions can be stored for an indefinite period before they are used.

The six major fractions of plasma were described in 1947 by Dr. Cohn as follows (1):

Fraction I contains most of the fibrinogen and the antihemophilic globulin.

Fraction II, obtained by subfractionation of II+III, contains the gamma-globulin antibodies of proven value in the prophylaxis of measles and probably also of infectious hepatitis.

Fraction III-1 contains other antibodies, including those to typhoid 0. The isoagglutinins, including the anti-Rh antibodies of value in blood typing, are also concentrated in this fraction.¹

Fraction III-2 contains prothrombin and one of the components of complement. Prothrombin converted by thromboplastin to thrombin has proved of value in conjunction with fibrin foam or some other pledget as a hemostatic agent and, in conjunction with fibrinogen, in the formation of clots, films as dural substitutes, and tubes for other surgical uses.

Fraction III-3 contains plasminogen, the precursor of plasmin, which has sometimes been called the fibrinolytic enzyme.

Fraction III-0 is rich in lipoprotein, including the so-called X-protein of McFarlane, which interacts in the plasma in such a way as to suggest that the molecular weight varies with concentration. * * *

¹ Isoagglutinins and the Rh factor are discussed in the chapter on laboratory tests.

CHART 7.—Fractional distribution of various components of plasma, proportion separated in each fraction, and uses for each to 1947

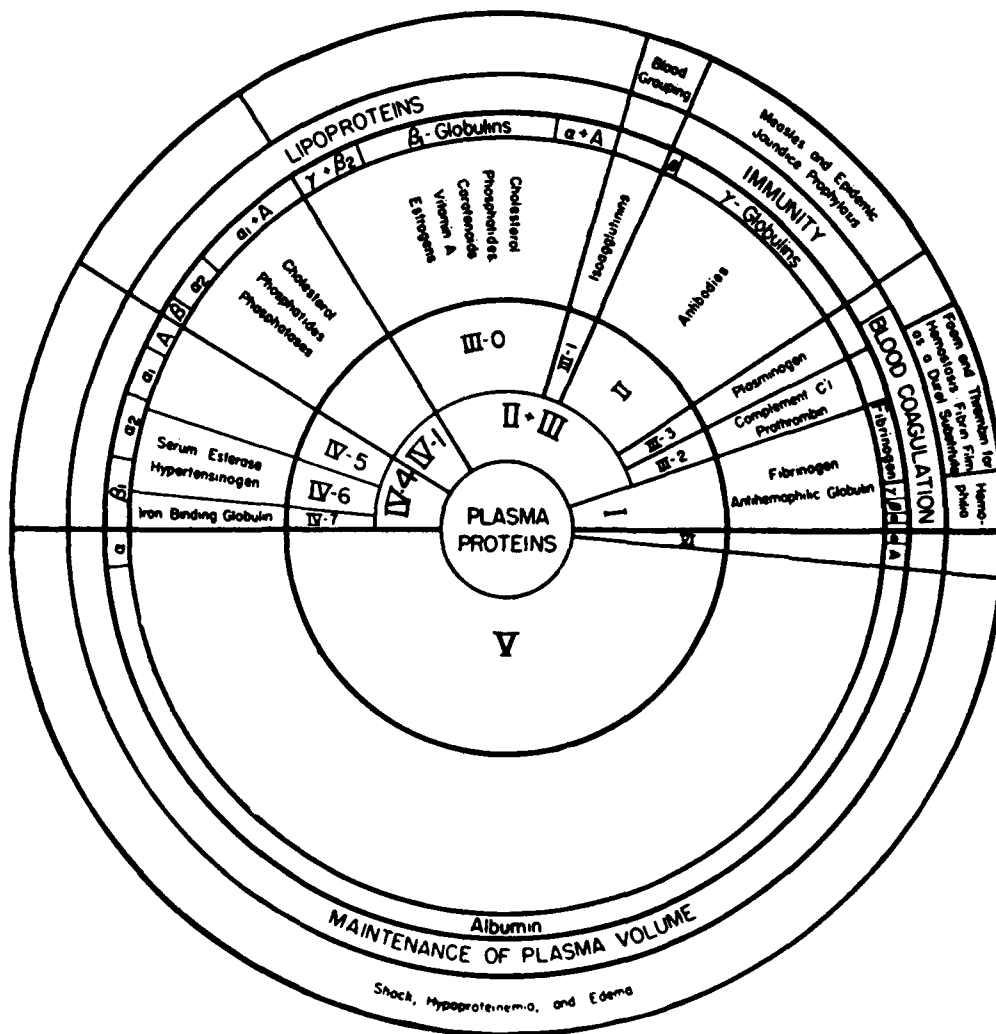

Source: Cohn, E. J.: The Separation of Blood into Fractions of Therapeutic Value. *Ann. Int. Med.* 26: 341-352, March 1947.

Fraction IV-1 is lipoprotein in nature. * * *

Fraction V contains the human serum albumin that has been made available in such large amounts to the Armed Forces for use in the treatment of shock, hypoproteinemia and edema. As at present released for distribution under conditions that have been specified by George Scatchard, Laurence E. Strong and Walter L. Hughes, Jr., it is poor in salt and is so stable in the presence of nonpolar anions, developed for this purpose largely by J. Murray Luck, that it is heated in the final container for 10 hours at 60° C. That these conditions suffice for the destruction of the virus of infectious hepatitis has been demonstrated by Joseph Stokes, Jr.

Fraction VI consists of the large amount of salts, especially citrates, and the small amount of protein left in the mother liquors following the removal of these various precipitates. * * * Fraction VI deserves further exploration, as do fractions of proved therapeutic value.

The distribution of the various components of plasma into fractions was indicated graphically in this same presentation (chart 7).

Aside from the specific value of the various plasma fractions, the plasma fractionation program had three general advantages:

1. Whole blood was conserved, since only the special component required in the special case was used.
2. Great economic savings were effected in the blood program.
3. Since plasma fractions were of human derivation, they possessed all the advantages of homologous substances. There was therefore no fear of sensitivity reactions.

The size of the plasma fractionation program is an indication of its importance. Up to May 1945, 1,218,531 units of plasma fractions had been produced, the largest production of a single fraction being 576,996 units of human serum albumin (2).

The Conference on Plasma Fractionation on 14 March 1945 (3) summarized the previous experience with plasma fractionation and indicated future trends. Reference to the minutes of this conference and to the minutes and appended reports of various meetings of the Subcommittee on Blood Substitutes is recommended for readers who desire more detailed information concerning this program than limitations of space permit here.

HEMOGLOBIN

Several research projects on hemoglobin solutions in replacement therapy were undertaken during the war, under the auspices of the Subcommittee on Blood Substitutes (4, 5), but their use was never seriously considered. Some studies were encouraging, but the careful work of Lamson and his associates (6) showed that such solutions would support life in shocked animals for only a few hours and that, to be effective at all, they must be given before severe shock developed. There were also other objections: The rise in blood pressure which they produced was extremely high in relation to the volume of fluid replacement. The metabolic rate rose more than 100 percent, an extremely undesirable reaction in patients in shock. The increase in pulse pressure was also considerable. Clinically, moderately severe reactions resulted even when only small testing amounts were injected. All of these phenomena were related to the established facts concerning the toxicity of hemoglobin.

GLOBIN

Although extensive studies were carried out with globin (3, 7, 8), the protein component that makes up about 96 percent of hemoglobin, nothing of practical value came of them during the war.

The first publication on globin, by Schulz in 1898 (9), which concerned its preparation and properties, was later invalidated when it was found that he was dealing with a denatured protein. Most subsequent investigations were

concerned with modifications of his method in an attempt to obtain so-called native globin. The attempt was successful, but the material obtained was either toxic or antigenic.

Dr. Max M. Strumia's work with globin, which was begun in the spring of 1941, was first brought up in the Subcommittee on Blood Substitutes at the meeting of 13 May 1943 (8). The project he proposed—the derivation of globin from the hemoglobin of discarded erythrocytes and its use as a blood substitute—was recommended to the Committee on Medical Research, with the stipulation that Dr. Strumia use the facilities and advice of Dr. Cohn and Dr. Linus Pauling.

Reports on the progress of this project were made at various meetings of the Subcommittee on Blood Substitutes (2, 10-13), and at a special conference on globin on 21 April 1944 (14).

Globin production proved highly practical (15), for 700 gm. could be prepared with relative ease from about 3,000 cc. of packed red cells; this was the equivalent of 13,000 cc. of plasma or 53 blood donations. Globin, however, was never put to military use.

IMMUNE SERUM GLOBULIN

A conference on immune globulins was held on 8 February 1943 (16) to discuss possible uses for the globulin fractions containing immune bodies prepared by Dr. Cohn's group at Harvard, to evaluate the immunologic data already obtained on various preparations, and to consider criteria for further assay. At an earlier meeting (of the Albumin and By-Products Group), Dr. Cohn had emphasized the desirability of so fractionating human plasma that the greatest possible use might be made of its byproducts (7).

The data presented to, and the significant conclusions of, the conference may be summarized as follows:

1. Fraction II+III, obtained as a byproduct of processing human plasma and containing most of the beta and gamma globulins, was shown to contain antibodies that reacted with a variety of infectious agents and with the isoantibodies of the human blood groups.
2. Fraction II, obtained by further fractionation of fraction II+III, and thus freed of prothrombin, thrombin, and much of the undesirable isoantibody, was shown to contain certain antibodies that were protective against the viruses of mumps and influenza A, as well as an antibody that inhibited the agglutination of chicken red cells by influenza A virus and another antibody that reacted with the H antigen of *Eberthella typhosa*.
3. The antibody content of fraction II represented a concentration of at least 14 to 16 times that of plasma, though not all the antibody of the plasma had yet been recovered.
4. Further investigations would include: (1) tests of the intravenous use of fraction II, to be run by Drs. Charles A. Janeway and Stokes; (2) tests to determine the cause of the immediate, painful reactions occasionally encountered, after modification of the final product in respect to salt concentration; and (3) further experiments on the effect of time and temperature on the activity of suitably resistant viruses or bacteriophage in the presence of albumin and globulin fractions, to determine whether inactivation by mild heating was practicable.
5. Preliminary clinical trials of the prophylactic and modifying effect of fraction II + III and of fraction II strongly suggested that both would be of value in the prevention or

modification of measles, and further trials with fraction II among military personnel were considered warranted, especially for the protection of troops about to be sent overseas. The risk of inoculating soldiers with an unknown virus and producing infectious jaundice was recognized, but it was considered justified in order to achieve mass protection against measles.

For this purpose, 10,000 vials containing 5 cc. each of fraction II, prepared according to specifications already decided upon, would be produced as soon as possible and kept ready for immediate use by the Army and the Navy. On the authorization of the Acting Surgeon General, Navy, certain commercial firms were already proceeding with the preparation of fraction II from stocks of fraction II+III then available on their shelves. These preparations would be tested at the Harvard laboratory and would not be released for clinical use until physicochemical tests and tests for immune bodies had been satisfactory. The stocks of fraction II+III at the Harvard laboratory would also be converted to fraction II.

6. The possible value of fraction II against mumps, scarlatina, influenza, poliomyelitis and other diseases was discussed but definite conclusions were considered justified only in respect to measles.

The commercial production of immune globulin steadily improved. Some preparations, Dr. Cohn reported on 21 April 1944 (13), contained over 99 percent of gamma globulin, against 85 percent in some of the earlier preparations. Because of the improvement, the protein concentration was decreased from 20 to 16.5 percent in preparations containing over 96 percent gamma globulin, thus standardizing it at a concentration 25 times that of pooled plasma. After clinical tests proved satisfactory, 0.3 molar solution of glycine was employed as a diluent.

At the end of the war, gamma globulin was considered effective in preventing measles or in decreasing its severity (17-20). There had been enough experience with it in infectious hepatitis to warrant its consideration as a therapeutic agent (p. 679), but its preventive effect in this condition and in homologous serum jaundice had not been established. It was not successful as a preventive or therapeutic agent in mumps, scarlet fever, or other communicable diseases with the possible exception of anterior poliomyelitis.

FIBRIN FOAM AND FIBRIN FILM

The development of fibrin foam and fibrin film represented an extremely important neurosurgical advance, for these materials helped to solve two major problems outstanding in the field at the beginning of World War II, one connected with hemostasis and the other with the prevention of meningo-cerebral adhesions.

Prothrombin, which was obtained in the fractionation of plasma as a byproduct of fraction II, rapidly loses its activity. When it was converted into thrombin, the only form in which its potent coagulating properties could be exerted, it could be filtered and stored in the frozen state until facilities were available for preparing it in dry form (21, 22). When contracts were let for the preparation of immune globulin, a provision to this effect was included and thrombin was thus available in ample quantities.

Preliminary studies by Dr. Orville T. Bailey, to determine the effect of thrombin on bleeding from the cut surface of the liver in guinea pigs, showed that oozing was reduced by 50 percent (7). The material was then tested as a hemostatic spray at Peter Bent Brigham Hospital, the Boston Children's Hospital, the Hospital of the University of Pennsylvania, and several other institutions, in neurosurgery, surgery of the spleen and gallbladder, tonsillectomy, and other operations. All reports (23) indicated that thrombin was a most effective agent in controlling oozing that could not be controlled by sutures. The experience of Lt. Col. (later Col.) R. Glen Spurling, MC, at Walter Reed General Hospital, Washington, D.C., was, however, generally confirmed, that neither human nor bovine thrombin gave more than temporary hemostatic results unless it was supported on some sort of matrix (17, 24).

At the 22 January 1943 meeting of the Albumin and By-Products Group (7), it was agreed that thrombin was now ready for extensive clinical testing. It was also proposed, on the basis of experimental evidence, that films of fibrinogen and thrombin might prove useful in the management of burns in the field because of the simplicity and speed of the technique and the small bulk of the material.

It was a great disappointment to find, shortly after the war, that thrombin harbored the virus of hepatitis and that the promising use of fibrin foam therefore had to be discontinued.

Fibrin Foam

At the 13 May 1943 meeting of the Subcommittee on Blood Substitutes (8), it was reported that soluble cellulose manufactured by the Eastman Kodak Co. had been saturated with thrombin, by the method developed by Dr. Tracy Putnam, and had proved satisfactory in a small number of clinical cases.

When thrombin first became available, Lt. Edgar A. Bering, Jr., MC, USN (25), and Dr. Bailey had applied it in solution to bleeding points in several cranial and spinal operations. It did no harm, even when it reached the lateral ventricle, but its effect was entirely transient. Lieutenant Bering then conceived the idea of using fibrinogen, converted into fibrin foam, as a matrix. The dry foam was a light, porous, slightly brittle material, in which the air spaces could easily be seen with the naked eye. When it was wet with thrombin solution, it became soft, pliable, and somewhat resilient.

In vitro testing of pledgets of fibrin foam and of soluble cellulose soaked in thrombin solution showed, on the basis of clotting of fibrinogen solution, that the foam was a much more effective matrix than cellulose. Solutions of only 10 thrombic units per cc. were necessary with it, against solutions of at least 40 thrombic units with cellulose.

Using monkeys (*Macaca mulatta*), these observers placed fibrin foam saturated with thrombin on traumatized and untraumatized areas of the cortex and into the cortical substance. Sulfadiazine and penicillin were used locally

in some of the animals. Soluble cellulose was used in one control series and muscle in another, smaller series. The animals were sacrificed at intervals of 24 hours to 3 months.

The local reaction of the tissues to soluble cellulose and to fibrin film was insignificant. Most of the foam had disappeared at the end of a week, and no fragments of it could be identified at the end of 3 weeks. The speed of absorption and the nature of the tissue reaction were not influenced by the presence of antimicrobial agents. The reaction of the tissues to muscle was considerably greater.

The first applications of fibrin foam were made in cases in which bleeding was difficult to control and the application of muscle was not feasible. The hemostatic effect was evident even when large venous channels were opened. The technique was next extended to simple oozing from the cerebral surface or the outer surface of the dura. Finally, the foam was left in place. No traces of it were found on histologic examination or autopsy from 9 to 81 days after it was used.

At a conference of the Albumin and By-Products Group on 17 November 1943 (24), it was reported that fibrin foam had been used successfully on 60 neurosurgical patients at Walter Reed General Hospital and on the same number at Peter Bent Brigham Hospital, as well as in several smaller series. It was agreed that the material was of extraordinary value as a hemostatic agent in neurosurgery.

By the end of 1943, it had been used in well over 500 neurosurgical cases. It had also been used experimentally to control bleeding from the kidney, liver, spleen, lung, and heart, and in a few clinical cases. It had proved of great value in hemophiliacs, in controlling bleeding from traumatic lacerations, and in maintaining hemostasis during minor surgical procedures such as tooth extractions.

The demand for thrombin foam was not exceeding the supply in Dr. Cohn's laboratory, and the conference agreed that the next important step was to produce it on a scale sufficient to permit its widespread use. These arrangements were duly made (5). The first contracts, for appraisal purposes, were let by the Committee on Medical Research. The subsequent contracts were made by the Navy.

Demands for fibrin foam increased throughout the remainder of the war. When Lederle Laboratories reported that it had been successful in filtering contaminated plasma and expected, as a result, to reduce plasma losses from contamination, some anxiety was expressed that there would not be enough substandard plasma available for the production of fibrin foam and thrombin, which were being made from it. The war ended before any such shortages developed.

In February 1945, it was recommended that fibrin foam and thrombin, presently in use as nonstandard items, should be standardized. The length of the dating period had not been determined, but it was evident that no deterioration would occur as long as sterility was maintained.

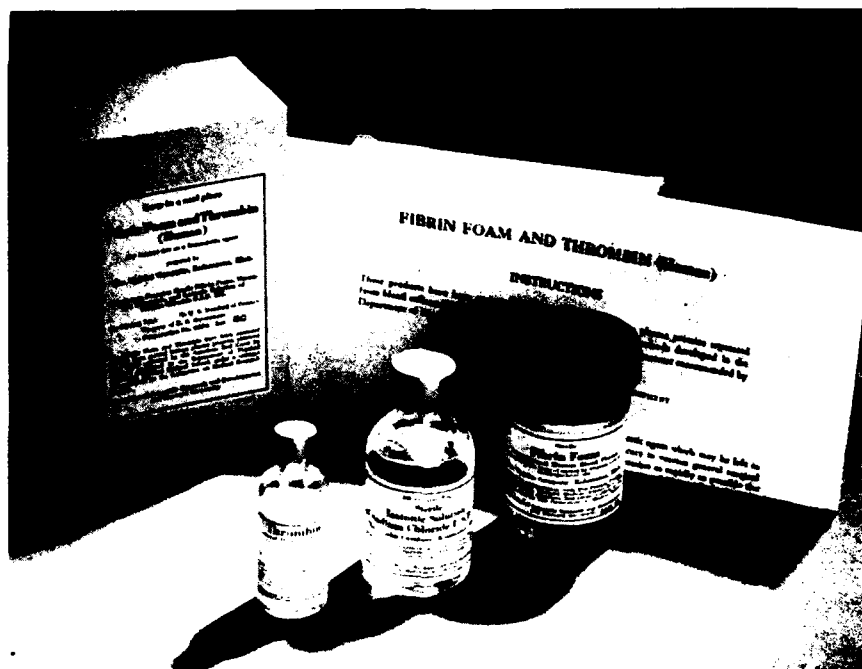

FIGURE 74.—Commercially prepared fibrin foam, thrombin, and sterile isotonic sodium chloride solution.

Fibrin foam was packaged with a small vial containing dried human thrombin, which, at the operating table, was dissolved in 50 cc. of physiologic salt solution (fig. 74). The solution was complete in less than a minute if the mixture was vigorously stirred. Portions of fibrin foam, cut in the desired shapes and sizes, were placed in it. As the foam became saturated with thrombin, a moderate amount of spontaneous shrinkage occurred. The porosity of the fibrin matrix permitted swift penetration of the thrombin solution into all parts of the mass.

The following case history is an illustration of the prompt and effective hemostasis accomplished by fibrin foam.

Case 1.—This patient was received at the 45th General Hospital after exploration for a thoracoabdominal wound. Several days later, when the large gauze pack in the liver was removed, a hemorrhage occurred. After several episodes of bleeding, the abdomen was reopened and a number of clots were removed, along with a necrotic portion of the liver. The wound, which was on the superior surface of the right hepatic lobe, had to be repacked to check bleeding.

Several additional episodes of bleeding occurred over the next several days, the blood losses ranging from 200 to 800 cc. each time. The longest period without bleeding was the 10 days immediately after the first laparotomy.

The patient gradually lost ground in spite of 38 blood transfusions. Attempts to pack the bleeding tract with dried blood plasma were not successful. Then, after some fibrin foam had been obtained, a third laparotomy was done. After clots and additional necrotic tissue had been removed, the wound in the liver was packed with the fibrin foam.

The gauze pack over the foam was removed without incident on the fourth postoperative day. The single hemorrhage after this operation, on the 10th day, was so slight that there

was no change in pulse or blood pressure. With this exception, recovery was smooth. The patient was given 4 additional transfusions, making 42 in all, with a total of 21,000 cc. of blood.

Fibrin Film

Techniques developed at the Harvard laboratory made it possible to process fibrin clots into films of any desired size, shape, and thickness (26). These films were translucent, flexible, and elastic, and possessed of considerable tensile strength. Changes in preparation made it possible to vary the time required for absorption in situ from a few days to several months. The films were made in various weights and were of the following types:

P, plain fibrin film.

F, a fibrin film with a fabric backing.

W and WF, types P or F with a waterproof backing.

The fibrin film used in both clinical and experimental studies was prepared in flat sheets of various sizes and thickness. The films were sufficiently strong to be sutured without tearing. They could be trimmed to fit the defect and were so elastic that they could easily be fitted over rounded or irregular surfaces, whose contours they assumed. They were composed of two parts. The protein part, which made up 20 to 60 percent of the films by weight, was at least 90 percent fibrin. When the films were prepared, the remainder was composed of glycerol, but when they were immersed in water or physiologic salt solution, the glycerol was removed and the water taken up was regarded as the final plasticizer under these conditions.

The process of dipping fibrin film in hot glycerol required special handling by operators skilled in sterile techniques. In November 1944 (27), an alternative technique was worked out in the Harvard laboratory, by which the material was packaged in a flame-sealed glass tube and sterilized by steam. The final moisture content was not more than 10 percent. This method was suitable for large-scale production and yielded a product which could be given a much longer dating period.

Before fibrin film was used clinically as a cerebral covering for dural defects caused by either accident or surgery, Drs. F. D. Ingraham and Bailey (27) studied its use in monkeys (*M. mulatta*), applying it to replace the dura mater over both traumatized and untraumatized cerebral cortex, under bone flaps; after removal of the bone; and with and without the local application of sulfadiazine and penicillin. The animals were sacrificed at intervals ranging from 1 day to 6 months. There was no physiologic evidence of cortical irritation during any of these periods. Detailed histologic studies revealed no essential tissue changes and no adhesions. As time passed, the film was first surrounded by a small amount of fibrous tissue, from which it could easily be separated, and was then replaced by a layer of fibrous tissue about the thickness of the original film. Neither healing nor tissue reaction was influenced by the use of sulfadiazine or penicillin.

Fibrin film was first used as a clinical dural substitute in a patient with lead encephalitis, who required two operations. The original film was replaced at the second operation. Nine months afterward, the patient was in excellent condition.

The original policy was to use fibrin film only in such cases as the one just described, in which multiple surgery was likely to be necessary, and in relatively hopeless conditions, such as brain tumors (26-28). Later, it was used in any condition in which dura had to be removed or the cortex was left unprotected because of the retraction of normal dura, as in decompression operations. The film was cut slightly larger than the defect, and the edges were passed underneath the cut dural margin.

By the end of 1943, Drs. Ingraham and Bailey had used fibrin film in 44 cases, including 25 intracranial and intraspinal tumors; 8 congenital anomalies; 6 lead encephalopathies; 3 cases of Jacksonian epilepsy; and 2 compound fractures. They had recovered the film for examination 18 times, at secondary surgery or autopsy, at intervals of 14 hours to 81 days after implantation. In no instance was the slightest evidence of an inflammatory reaction seen grossly, and there was a striking absence of adhesions. In 10 of these cases, the films were examined histologically. The tissue reactions, both in extent and character, were similar to those already described for experimental animals.

In 1945, Dr. Ingraham and his associates (28) reported a total of 94 cases in which fibrin film was used; glycerol-treated material was used in 59 cases, and steam-sterilized material in the remainder. No abnormalities of any kind were evident in the 33 patients followed 6 months or more, nor were there any instances of tissue reactions, adhesions, or retarded healing in 19 specimens recovered at a second operation or at autopsy.

Fibrin film was also used successfully in the treatment of a small number of second and third degree burns. Healing was rapid as in control areas covered with petrolatum-impregnated gauze.

Fibrin film was occasionally used in peripheral nerve suture but gave rise to foreign body reactions in practically every instance.

References

1. Cohn, E. J.: The Separation of Blood into Fractions of Therapeutic Value. *Ann. Int. Med.* 26: 341-352, March 1947.
2. Minutes, Conference on Resuspended Blood Cells, and meeting of Subcommittee on Blood Substitutes, Division of Medical Sciences, NRC, 18 May 1945.
3. Minutes, Conference on Plasma Fractionation, Division of Medical Sciences, NRC, 14 Mar. 1945.
4. Minutes, Conference on Albumin and By-Products, Division of Medical Sciences, NRC, 24 June 1942.
5. Minutes, meeting of Subcommittee on Blood Substitutes, Division of Medical Sciences, NRC, 2 June 1944.
6. Lamson, P. D., Robbins, B. H., and Greig, M. E.: Studies on Shock Induced by Hemorrhage. X. Hemoglobin Solutions as Blood Substitutes. *J. Pharmacol. & Exper. Therap.* 83: 225-234, March 1945.

7. Minutes, meeting of Subcommittee on Albumin and By-Products, Division of Medical Sciences, NRC, 22 Jan. 1943.
8. Minutes, meeting of Subcommittee on Blood Substitutes, Division of Medical Sciences, NRC, 13 May 1943.
9. Minutes, meeting of Subcommittee on Blood Substitutes, Division of Medical Sciences, NRC, 5 Jan. 1944.
10. Minutes, meeting of Subcommittee on Blood Substitutes, Division of Medical Sciences, NRC, 16 Mar. 1945.
11. Minutes, meeting of Subcommittee on Blood Substitutes, Division of Medical Sciences, NRC, 3 Mar. 1944.
12. Minutes, meeting of Subcommittee on Blood Substitutes, Division of Medical Sciences, NRC, 17 Nov. 1943.
13. Minutes, meeting of Subcommittee on Blood Substitutes, Division of Medical Sciences, NRC, 21 Apr. 1944.
14. Minutes, Conference on Globin, Division of Medical Sciences, NRC, 21 Apr. 1944.
15. DeGowin, E. L., Hardin, R. C., and Alsever, J. B.: Blood Transfusion. Philadelphia and London: W. B. Saunders Co., 1949.
16. Minutes, Conference on Immune Globulins, Division of Medical Sciences, NRC, 8 Feb. 1943.
17. Minutes, Conference of Albumin and By-Products Group; meeting of Subcommittee on Blood Substitutes with Subcommittee on Neurosurgery, Division of Medical Sciences, NRC, 5 Oct. 1943.
18. Minutes, Conference on Production of Normal Human Serum Albumin and Its By-Products, Division of Medical Sciences, NRC, 19 July 1943.
19. Janeway, C. A.: Clinical Use of Products of Human Plasma Fractionation. I. Albumin in Shock and Hypoproteinemia. II. Gamma-Globulin in Measles. *J.A.M.A.* 126: 674-680, 11 Nov. 1944.
20. Blood Substitutes Report No. 18, Committee on Medical Research, Office of Scientific Research and Development, subject: Testing of Immune Serum Globulin (Human) in the Prophylaxis of Measles, 21 Apr. 1944.
21. Minutes, Conference of Albumin and By-Products Group, Division of Medical Sciences, NRC, 28 July 1943.
22. Minutes, meeting of Subcommittee on Blood Substitutes, Division of Medical Sciences, NRC, 24 Sept. 1943.
23. Minutes, Conference on Albumin and By-Products, Division of Medical Sciences, NRC, 15 Apr. 1942.
24. Minutes, Conference of Albumin and By-Products Group, Division of Medical Sciences, NRC, 17 Nov. 1943.
25. Bering, E. A., Jr.: Clinical Uses of Products Made From Human Fibrinogen and Human Thrombin. Work carried out between Office of Scientific Research and Development and Harvard University on products developed in the Department of Physical Chemistry, Harvard Medical School, from blood collected by the American Red Cross. 1943.
26. Ingraham, F. D., and Bailey, O. T.: The Use of Products Prepared From Human Fibrinogen and Human Thrombin in Neurosurgery. Fibrin Foams as Hemostatic Agents; Fibrin Films in Repair of Dural Defects and in Prevention of Meningocerebral Adhesions. *J. Neurosurg.* 1: 23-44, January 1944.
27. Ingraham, F. D., and Bailey, O. T.: Clinical Use of Products of Human Fractionation. III. The Use of Products of Fibrinogen and Thrombin in Surgery. *J.A.M.A.* 126: 680-685, 11 Nov. 1944.
28. Ingraham, F. D., Bailey, O. T., and Cobb, C. A.: The Use of Fibrin Film as a Dural Substitute. Further Studies and Clinical Results. *J.A.M.A.* 128: 1088-1091. 11 Aug. 1945.

CHAPTER XIV

Blood Substitutes and Other Intravenous Fluids

Part I. Blood Substitutes

GENERAL CONSIDERATIONS

Historical Note

A considerable amount of basic research was carried out on so-called blood substitutes¹ in World War I, during which the use of blood was an occasional rather than a general procedure. The Committee on Surgical Shock and Allied Conditions, established by the Medical Research Committee of Great Britain, made comprehensive studies on suitable crystalloid and colloid solutions to correct the physiologic alterations that occur in shock, and similar studies were made in the United States (1). By the end of the war, two important, if negative, facts had been established:

1. Experimental studies on crystalloid solutions showed that they were too readily diffusible to be useful in elevating a decreased blood volume and maintaining it at an adequate level. Clinica^l experience confirmed the experimental data.

2. There was an obvious need for a macromolecular substance that could be used in solution to provide an intravascular osmotic effect sufficient to maintain an adequate plasma volume. Gum acacia, which was studied extensively for this purpose (p. 384), proved to have two serious defects, that it caused toxic reactions and that it was stored in the tissues.

Policies of National Research Council

Gum acacia continued to be used in replacement therapy by a number of observers, particularly Dr. John S. Lundy at the Mayo Clinic, after World War I, but its use had been generally abandoned long before World War II broke out. It was logical, therefore, that at the first meeting of the Committee on Transfusions, on 31 May 1940 (2), one of the committee functions should be listed as the development of possible substitutes for human plasma or the possible synthesis of plasma.

¹ Although the term, "blood substitutes," was dignified during World War II by being used in the designation of one of the most active and most useful groups of the National Research Council (the Subcommittee on Blood Substitutes, Committee on Transfusions), it was little more than an example of wishful thinking. No blood substitutes existed when the nomenclature was first employed, and no thinking person really expected that any would be devised. A more correct term, "plasma expanders," came into use after World War II, and, in official documents, the still more accurate—though very cumbersome—term, "plasma substitutes not derived from human blood," was employed. As a convenience, however, the term "blood substitutes" has persisted, and, for this reason, it is frequently used in this volume.

The search continued throughout the war, for the fundamental reason that, in spite of the success of the plasma program, the requirements for replacement fluids were likely to prove considerably in excess of the amount of blood contributed. The search for effective, nontoxic blood substitutes, nonhuman in origin, therefore had to be expedited. At the meeting of the Subcommittee on Blood Substitutes on 13 May 1943 (3), at which these views were expressed, it was reported that Dr. Alfred N. Richards, Chairman, Committee on Medical Research, NRC (National Research Council), had indicated the agreement of his committee with this point of view. Projects related to the search for blood substitutes would be considered urgent; it was fully understood that they would be long term and more or less speculative. It was agreed that, as far as was practical, these studies should be integrated with the studies of the groups working on experimental and clinical shock.

A really urgent need for blood substitutes never arose in World War II because of the generous donations of whole blood; rapid advances in the processing of blood into plasma; and similar advances in the fractionation of plasma and the development of some of its derivatives, particularly serum albumin. Extensive research was continued, however, and considerable experience was gathered, particularly in the use of gelatin, which proved the safest and most effective of the agents investigated.

The results of the various studies are summarized briefly in the following pages. Readers who wish further details are referred to the minutes of the Subcommittee on Blood Substitutes, its ad hoc committees, and the various conferences on special subjects.

Criteria

In one respect, the investigation into gelatin as a blood substitute was duplicated in investigations into most other substances: At the 20 October 1942 meeting of the Subcommittee on Blood Substitutes (4), Dr. Robert F. Loeb reported that most applications for research studies revealed incomplete knowledge of the problems involved and were notably lacking in tests for toxicity as well as in reports of clinical testing. Such tests as had been carried out were fragmentary.

At the First Conference on Gelatin on 10 November 1942 (5), Dr. Loeb pointed out to the participants that the experience of the Subcommittee on Blood Substitutes to date had been such that "certain criteria had come to be recognized as the sine qua non for any substance to be seriously considered for the treatment of shock in human beings." These criteria were:

1. The colloidal osmotic pressure of the substance in question must be equivalent to that of normal blood plasma.
2. The substance must be capable of production with a constant and reproducible composition.
3. The mode of preparation must be such as to exclude or eliminate pyrogens.

4. The viscosity of the substance must be such as to permit easy intravenous administration.

5. Its stability must be such that it could withstand the wide ranges of temperature encountered in a global war. Also, it must remain stable for long periods of time.

6. It must be easily sterilized.

7. It must not be toxic. It must not cause leukocytosis, hemolysis, or an increase in the sedimentation rate. It must be either utilized in the body or readily eliminated from it. It must not be stored in the liver, adrenal glands, spleen, brain, or any other organ.

8. Its repeated injection into human beings must not provoke sensitivity.

In addition to these criteria, Dr. Loeb mentioned two other considerations which would affect the decision to develop and use a blood substitute:

1. During the war, ease of production and accessibility of source materials were obviously of great importance.

2. The ability to manufacture or process any substance under aseptic conditions might conceivably have considerable bearing on the decision to develop it, since the introduction of bacteria might lead to the production of toxins or antigens.

GELATIN

Initial Suggestions

Gelatin was first mentioned as a possible blood substitute at the meeting of the Subcommittee on Blood Substitutes on 10 March 1942 (6). The principal reason for the suggestion was that a 6-percent solution had been found to have the viscosity of whole blood at room temperature and an oncotic (osmotic) pressure of 65 mm. H₂O. Also, allergists had used gelatin for years as an injection vehicle and there was ample proof that it was not antigenic.

At the 20 October 1942 meeting of the subcommittee (4), Dr. Loeb proposed a meeting of all groups interested in research on gelatin, so that research workers could present their studies to members of the subcommittee and could be made aware of the problems that must be solved before gelatin could be recommended as a blood substitute. He also stated that he had interviewed a manufacturer of gelatin, who viewed with alarm the proposal to inject this substance into human beings, chiefly because it was impossible to manufacture a product of entirely uniform quality.

November 1942

At the First Conference on Gelatin on 10 November 1942 (5), the following data were brought out in reports by various investigators:

1. In general, no toxic effects were observed from injections of gelatin. The temperature elevations occasionally noted in both clinical and experimental studies were believed to be caused by pyrogens or by the specific dynamic action of a readily available protein.

2. Studies at the University of Louisville School of Medicine showed that gelatin satisfactorily restored the blood pressure of animals in shock, and that they withstood second hemorrhages as well as dogs resuscitated with whole blood. Studies at the Bowman-Gray School of Medicine, however, showed that the blood pressure was frequently not restored completely, and that most of the animals died when shock was produced by the Blalock clamp. Some observers found gelatin lifesaving in slow hemorrhage.

3. There was no evidence of storage of gelatin in the tissues in animals studied at autopsy, sometimes as long as 103 days after injection.

4. Excretion of gelatin via the urine was not attended with oliguria.

5. Reinjection experiments confirmed the prevailing opinion that gelatin was not antigenic.

6. Hemodilution was usually evident after injection.

7. A controlled study of burn shock in dogs showed gelatin solutions effective in compensating for the loss of plasma and maintaining survival beyond the period death might be expected from that cause.

8. In vitro, gelatin produced marked conglutination and acceleration of sedimentation of erythrocytes, though neither phenomenon was observed in experimental animals.

At this conference, it was reported that various gelatin preparations had retained their stability for several months at 37° F. (3° C.). Dr. Samuel E. Sheppard, of the Eastman Kodak Co., reported perfection of a process of fractionation of gelatin that eliminated the products of lower molecular weight and resulted in gelatins of higher and more uniform molecular sizes. The studies were made by a precision viscometric control device.

Also at this conference, Mr. Joseph H. Cohen, president of the Edible Gelatin Manufacturers' Research Society of America, discussed the production of gelatin for medical purposes. As it was often produced commercially in 1-ton lots, it was a heterogeneous substance, and no factory controls existed to insure a uniform product for intravenous injection. If a special gelatin, of a specified uniform quality, were required for military purposes, it would be advisable to set up a pilot plant in which the entire manufacturing process could be subjected to biologic and other laboratory controls.

At the meeting of the Subcommittee on Blood Substitutes immediately after this conference (7), there was a full discussion of the need for a gelatin of uniform quality with which all experiments could be conducted. Dr. Loeb appointed Dr. Edwin J. Cohn and Dr. Sheppard to draw up specifications for such a preparation.

These specifications were presented at the meeting of the subcommittee on 15 December 1942 (8). They concerned the source of the material, methods of processing it, molecular homogeneity (size and shape), hydrolytic control, viscosity, colloid osmotic pressure, and pH.

February 1943

At the Second Conference on Gelatin on 23 February 1943 (9), much of the discussion still concerned the production of a uniform product, pyrogen-free,

stable, and without the property of causing clumping of erythrocytes. It was noted that the presence of pyrogens might be due not to the product but to the use of water that was not pyrogen-free, a point laboratory workers were remarkably prone to overlook (p. 651).

At the conclusion of this conference, Dr. Loeb asked for a show of hands to determine who, at this time, would be willing to recommend to the Subcommittee on Blood Substitutes that it recommend to the Armed Forces that gelatin be used as a blood substitute. No hands were raised.

September 1943

At the Third Conference on Gelatin (10), it was again necessary to point out that the reports made were not directly comparable because the preparations of gelatin used were in various stages of degradation and because the variables introduced modified the results. Some progress, however, had been made. It was now evident that gelatin could be prepared in solutions that were not pyrogenic for man, that were not toxic, and that were physiologically active. The most urgent requirement at this time was considered to be a clinical comparison of the gelatins made by the Knox Gelatin Co. and the Upjohn Laboratories. Dr. Cohn believed that the largest molecule consistent with stability should be used.

The following resolutions were passed:

1. That the Subcommittee on Blood Substitutes recommend to the Committee on Medical Research that comparative studies of gelatin solutions with different physicochemical characteristics be made in various types of injury by physiologic and clinical groups.
2. That solutions degraded as little as possible be compared with those degraded to the point at which their loss from the bloodstream was relatively rapid, with special attention to deposition and excretion of the gelatin and sedimentation of red blood cells as well as to the therapeutic effects achieved. It was admitted that the accomplishment of fluidity and stability compatible with military conditions would probably be difficult.
3. That the subcommittee recommend to the Chairman, Division of Medical Sciences, NRC, that the Pure Food and Drug Administration be informed of the conferences held on gelatin (and pectin) as replacement agents.

November 1943

At the subcommittee meeting on 17 November 1943 (11), it was reported that tests with the Upjohn Co. product had been carried out on Welfare Island volunteers. No toxic reactions had followed the injection of 5-percent solution in amounts up to 1,000 cc. Fifty percent of the amount injected was eliminated in the urine within 24 hours. Dr. Owen H. Wangensteen had injected 10 patients with the same preparation, with one reaction. All products used had caused conglutination, but when the gelatin was made up in solutions without electrolytes, pseudoagglutination had not occurred.

December 1943

At the 1 December 1943 meeting of the Subcommittee on Shock (12), Dr. John S. Lockwood, University of Pennsylvania School of Medicine, made a comprehensive report on the use of gelatin in shock:

1. The effectiveness of physiologic salt solution in shock is definitely enhanced by the addition of 4- to 6-percent of nonantigenic, nonpyrogenic gelatin. The resulting solution seems entirely adequate to restore circulating blood volume and maintain colloid osmotic pressure, even when hemorrhage has been massive and repeated. When gelatin is used, the volume of blood which can be withdrawn is limited in repeated hemorrhages only by the need for red blood cells.

2. Experimental studies with a carefully determined tolerated blood loss (blood pressure below 20 mm. Hg) and immediate replacement with plasma, gelatin, or saline solution were repeated an hour later, with survival of all the animals. After the third hemorrhage, another hour later, the amount of red blood cell depletion was so great that death occurred within an hour unless red blood cells were administered with the fluid replacement. All the animals survived when their red cells were replaced after the third hemorrhage. After gelatin infusion, the volume of blood that could be withdrawn on the second and third hemorrhages was twice as great as with saline solution and half as great again as with plasma.

3. Since the 4-percent gelatin solution developed a colloid osmotic pressure 50 percent greater than that of plasma, it produced hemodilution more rapidly. Because of the rapid hemodilution, the tolerated bleeding volume of the gelatin-treated animal was greater on the second and third hemorrhages than that of the plasma-treated animal. Blood pressure was as well maintained after gelatin infusion as after plasma replacement.

When a critical level of hypotension was prolonged, as in graduated blood withdrawal, factors other than simple maintenance of colloid osmotic pressure entered the picture, and gelatin was apparently less effective than plasma in achieving permanent survival.

Clinical tests at the Hospital of the University of Pennsylvania covered 103 infusions of 100 liters of gelatin solution to 62 patients. There were no toxic reactions. Three patients in the group who were in shock received only gelatin infusions; they recovered without incident.

April 1944

Continued favorable reports on the use of gelatin in shock at succeeding meetings (13-15) led to the adoption of the following resolution at the 21 April 1944 meeting of the Subcommittee on Blood Substitutes (16):

That the Subcommittee on Blood Substitutes has agreed on the publication of a statement on its evaluation of studies on gelatin preparations for intravenous use. It does this to make available its conclusions regarding the proper use and the limitations of gelatin and at the same time to make it clear that the preparation and use of gelatin in no way decreases the need for the procurement of blood by the American Red Cross and the preparation from it of blood substitutes for the Armed Forces. The above statements are limited to gelatin solutions specifically prepared for intravenous use. Such solutions should be prepared only in specially constructed plants under the most rigid physicochemical and biological control.

The statement in question covered:

1. The chemical composition of gelatin and its degradation.

2. Its physiologic and clinical properties. At this time, the solution considered of optimal value in the treatment of hemorrhage and shock was a 6-percent solution, in physiologic salt solution, with the general physicochemical characteristics of what was known as the Knox P-20 type.

3. The limitations of gelatin as a replacement agent and the unanswered questions concerning it, which included the following:

a. Solutions of gelatin gel at about 68° F. (20° C.) and therefore cannot be used in the field in cool or temperate climates.

b. The optimal solution of gelatin presently available shows slow but definite and continued degradation at temperatures encountered in certain theaters of operation.

c. The viscosity of the optimal solution of gelatin is greater than that of whole blood.

d. The proper typing of blood after the administration of gelatin solutions requires further study. It may be well to issue the warning that a sample for typing must be withdrawn before gelatin is administered.

e. It is not known whether the optimal solution will impair the return of normal function to kidneys in sustained ischemia, severe burns, or the crush syndrome.

f. Gelatin solutions probably do not contribute significantly to nutrition. Their only place in medical therapy would be to restore circulating blood volume depleted in various types of acute injury.

g. The influence of gelatin upon the equilibrium in the distribution of plasma proteins between the circulating blood and the tissues requires further investigation.

End of Investigation

The only other significant investigation of gelatin during World War II concerned the abolition of rouleaux formation by the addition of glycine (0.28 molar) to the cell suspension. This observation, originally reported by Dr. Johannes Vogelaar (17), New York City Cancer Institute, Welfare Island, N.Y., was confirmed by studies at the University of Pennsylvania School of Medicine and at the Harvard laboratory (13).

The ample supplies of blood, plasma, and albumin available during the last year of World War II made it unnecessary to carry out further studies with gelatin. The investigation was revived when the Korean War broke out (p. 786).

PECTIN

At the Conference on Pectin on 24 February 1943 (18), it was noted in one of the reports that the intravenous use of pectin sols was first discussed by Feissly in 1925 and that, to date, 22 articles on the subject, covering some 500 clinical cases, had appeared in the literature. Much of this work had been done by Hartman and his associates at the Henry Ford Hospital. No thrombosis or other ill effects had been reported.

Experimental Studies

It was also pointed out at this conference that pectin was defined in the seventh edition of the *National Formulary* as "a purified carbohydrate product obtained from dilute acid extract of the inner portion of the rind of citrus fruits

or from apple pomace. It consists chiefly of partially methoxylated polygalacturonic acids."

The proposal that pectin be studied as a possible blood substitute was made to Dr. Loeb on 6 October 1941, in a letter from Dr. Richard M. Johnson, Medical Director, Frederick Stearns & Co. At the meeting of the Subcommittee on Blood Substitutes on 3 November 1941 (19), Dr. Loeb stated, as the result of his survey to date, that he considered all studies on pectin up to this time to be unsatisfactory in respect to the toxicity factor. Dr. Cohn found no evidence in the material submitted to him for examination to indicate that pectin was not antigenic. It was emphasized that all reports must state the method of preparation and the approximate composition of the pectin used.

At this conference, representatives of the Research Department, California Fruit Growers Exchange, stated that for the previous 4 years the possible medical use of pectin had been studied under their auspices in a total of 776 experimental animals, as follows:

1. From 30 to 50 percent of the pectin injected was recovered from the urine within the first 24 hours after injection and from 45 to 60 percent within 6 days.
2. From 80 to 85 percent of the injected pectin was found in the blood 20 minutes after the injection, about 19 percent in 24 hours, and about 10 percent in 48 hours.
3. No significant changes were noted in the coagulation time after the injection.
4. After massive injections, no deposits of pectin were found in the liver, kidneys, and spleen on chemical examination, and the weights of these organs were comparatively normal.
5. Animals given injections every other day for 6 weeks maintained their normal weight and appetite.

These investigators pointed out that pectin occurs along with cellulose in the white inner portion of the rind of citrus fruit (albedo). The blood from a million donors would produce plasma equivalent in volume to 2.0 percent pectin sols made from only about 11,000 pounds of purified pectin, an amount that could be made in a few weeks. In view of this prospect, and because of the emergency, further studies with pectin were considered justified.

A number of reports on pectin were made at the February 1943 conference, but they were extremely disorganized. The criteria for blood substitutes developed by the subcommittee (p. 372) were presented to the investigators, and they were told that some investigations, notably that on gelatin, had made great progress because these criteria had been observed. It was emphasized that the first problem in the investigation of pectin was to secure samples for physicochemical analysis; measurement of osmotic pressure in an osmometer did not give a satisfactory idea of the size of molecules or molecular aggregates. When the Subcommittee on Blood Substitutes met on 17 November 1943 (11), Dr. Loeb reported that, although testing facilities for physicochemical studies of pectin had first been offered in February 1942, no samples had yet been submitted by any workers. Cutter Laboratories, however, had discontinued the distribution of its pectin until the lots produced had been evaluated at the Massachusetts Institute of Technology.

Solutions of pectin made up by the Hartman technique and by the technique used at the Cutter Laboratories were studied under the direction of Dr. Loeb. In the course of the investigation, he expressed himself as skeptical of the value of this agent except, possibly, as a capillary cement; on the basis of present evidence, he doubted that it had any place in medicine. When the final report was made in April 1942, it was Dr. Loeb's conclusion that the osmotic pressure of pectin solutions was inadequate and that they were no more effectual than salt solution (14).

Clinical Studies

Investigators at the University of Illinois College of Medicine and at the Henry Ford Hospital were convinced, from clinical experience, of the value of pectin, though not many of the patients they had tested were in shock (18). A similar study at Cook County Hospital was not impressive. A later report from the same hospital, by Dr. Hans Popper, made it clear that it would not be safe to recommend pectin as a blood substitute to the Armed Forces (20).

OTHER BLOOD SUBSTITUTES

Little or no progress was made on other blood substitutes during World War II.

Isinglass.—Isinglass (fish gelatin) was studied both clinically and experimentally under the auspices of the Canadian National Research Council. It was discussed at numerous meetings of the Subcommittee on Blood Substitutes, but no formal studies with it were made beyond an investigation of its physicochemical properties in the Harvard laboratory (3, 5, 6, 10, 11, 16, 21, 22).

Glutamyl polypeptide.—Glutamyl polypeptide (d (—)-glutamic acid polypeptide) was prepared by Dr. Maxwell Bovarnick, at the Albany Hospital, who found that it could be isolated in large quantities from cultures of *Bacillus subtilis* and obtained in pure form by copper precipitation (23). When it was discussed for the first time by the Subcommittee on Blood Substitutes on 20 October 1942 (4), Dr. Cohn stated that it was the most promising blood substitute suggested in some time. Further investigation, unfortunately, did not bear out its early promise (24, 25).

Aldobionic acid.—Aldobionic acid was discussed as a blood substitute at the meeting of the Subcommittee on Blood Substitutes on 10 November 1942 (7). It was prepared by treating cotton with nitrogen peroxide. It had a highly effective osmotic pressure. Injection into rabbits produced hemodilution; afterward, a certain amount of the substance appeared in the urine as sugar.

In the discussion, Dr. Alphonse R. Dochez pointed out that bacterial polysaccharides such as aldobionic acid were not in themselves antigenic, but,

when they became congested in the body, they might serve as antigens. Dr. Cohn did not think this new agent should be rejected without further investigation, since a whole series of chainlike polymers could probably be broken down to molecules of a size that would produce effective osmotic pressures.

No further study was made of this agent.

Oxidized cotton.—Experiments at the College of Physicians and Surgeons, Columbia University, indicated that when cotton was oxidized with nitrogen tetroxide, it became soluble in bicarbonate solutions and exerted a high osmotic pressure (8). Some hemodilution apparently occurred after injections of solutions of relatively high osmotic pressure. Studies on six rabbits had shown it to be nonanaphylactogenic but moderately pyrogenic. Large amounts were tolerated when they were given in repeated small injections. The single animal that died had had 50 cc. of 4-percent solution; no pathologic changes were found to explain the death. When the other five animals were sacrificed, the only significant findings were swelling and vacuolization of the convoluted tubules of the kidneys.

Oxidized cotton appeared unchanged in the urine within 3 hours after injection. Within 24 hours, 80 percent or more had left the bloodstream. In vitro studies showed no changes in the hemoglobin, the red blood cell and platelet counts, the sedimentation rate, and blood agglutination. There was a moderate drop in the hematocrit and a slight increase in the venous clotting time.

It was thought that it might be possible to prepare oxidized cotton with a lower carboxyl content and, presumably, a higher molecular weight, that would pass through the kidneys less rapidly and be effective in the bloodstream for a longer time. No further action, however, was taken.

Alginic acid.—The Subcommittee on Blood Substitutes did not follow up a suggestion that alginic acid prepared from kelp might be a satisfactory blood substitute (7).

Amino acids.—The suggestion that nitrogen lost in shock be replaced by intravenous injections of solutions of pure amino acids was based on the observation that urinary nitrogen is increased in shock (7). In the discussion, however, it was brought out that the loss is no greater than occurs in an upper respiratory infection with fever, when no such therapy would be contemplated (25). It was the consensus of the Subcommittee on Blood Substitutes both times the proposal was brought up that the method might be applicable in prolonged protein starvation but had no place in the management of shock.

Sodium glycerol polysuccinate.—Studies on dogs and mice at the College of Physicians and Surgeons, Columbia University, with sodium glycerol polysuccinate showed no toxic reactions in the animals tested and no pathologic changes at autopsy but also held no promise for its use in shock (26).

Periston.—Periston (polyvinylpyrrolidone), the proprietary preparation used by the Germans in World War II, was first mentioned at the 13 May

1943 meeting of the Subcommittee on Blood Substitutes (3), in a letter from England calling attention to its description in a German medical journal. The previous experience in the United States with vinyl derivatives suggested that this one would not be particularly helpful.

At the 28 July 1943 Conference of the Albumin and By-Products Group (27), a bottle of Periston (Blutflüssigkeitersatz) that had been captured in Tunisia, with other German medical material, was exhibited, and arrangements were made for various studies to be conducted on it. These studies were reported at the 24 September 1943 meeting of the Subcommittee on Blood Substitutes, as follows (28):

Dr. Orville T. Bailey's anaphylaxis studies were entirely negative, both in vivo and at autopsy. His toxicity experiments revealed gross pathologic changes in the spleen (splenomegaly) and, on microscopic examination, very active hematopoiesis throughout the splenic sinusoids. These changes were described as the type to be expected in severe bone marrow damage, though sections from several bones showed no changes in the marrow. Autopsy also revealed changes in the liver that were apparently progressive, even after treatment had been discontinued. The pathogenesis and significance of the hepatic and splenic changes were difficult to evaluate.

At this same meeting of the subcommittee, Dr. George Scatchard and his associates at the Massachusetts Institute of Technology described the physical properties of Periston as follows:

1. The material is a colorless solution with a pH of 7.2, containing about 2.45 gm. per 100 cc. of solids other than sodium chloride. It remains completely liquid even when stored at 32° F. (0° C.).
2. The average molecular weight calculated from studies of osmotic pressure measurements is about 37,000.
3. The viscosity is somewhat greater than that of normal plasma or serum but considerably less than that of blood.
4. Studies with the ultracentrifuge show behavior of the type exhibited by most linear polymers.

No other samples of Periston became available for study during the war. Further investigations were conducted by U.S. observers before the Korean War (p. 788).

Dextran.—The only mention of dextran at the meetings and conferences of the National Research Council during the war was at the 16 March 1945 meeting of the Subcommittee on Blood Substitutes (29), at which Dr. Scatchard called attention to reports in the lay press of studies on it at the University of Upsala. The material to be made available for study to The Surgeon General was late in arriving because of manufacturing difficulties, and all investigations on it were conducted after the war (p. 790).

Part II. Other Intravenous Fluids

Provision of Intravenous Fluids

The unsuccessful attempt of the Subcommittee on Blood Substitutes to provide for a special service in the Medical Department to handle all intravenous fluid therapy, together with the arguments for the proposal, is described elsewhere (p. 76). It was fortunate that the additional recommendation that salt and glucose solutions and other intravenous fluids be procured commercially was accepted.

From the beginning of the war, there were numerous discussions at various levels as to how distilled water and physiologic salt solution and glucose solution should be provided for field use. The matter was fully discussed at the meeting of the Subcommittee on Blood Substitutes on 9 April 1943 (30). Maj. A. L. Chute, RCAMC, remarked that the British were distributing their fluids from Cairo, where they were prepared by officers and laboratory assistants especially trained for the work (p. 16). Col. (later Brig. Gen.) George R. Callender, MC, said that similar arrangements were being planned in the U.S. Army. It was agreed that the many difficulties in the preparation of intravenous fluids and the operation of autoclaves and stills that must be overcome, even when repair parts and skilled technical assistance were readily available, would be multiplied overseas in a combat zone.

The tonnage of shipping required for a given amount of commercially prepared solutions would be about 20 percent more (2,200 tons, 120,000 cu. ft.) than for equipment and materials to prepare them in the zone of combat (1,693 tons, 100,000 cu. ft.). In spite of the added space they would require, it was the sense of the meeting that it was sound policy to have intravenous fluids prepared in the Zone of Interior and shipped overseas rather than prepared overseas.

One reason for the recommendation was that the most efficient still would yield acceptable distilled water only if the raw water had a low content of solids and was not heavily contaminated with pyrogens. A still could not take originally dirty water, as much water overseas would be, and convert it into distilled water which could safely be injected intravenously. It would also be necessary to autoclave bottles, sterilize equipment, and train personnel to prepare the solutions. All of these requirements would be difficult to provide overseas.

The impracticability of preparing intravenous fluids in the field is well illustrated in a report of the 77th Evacuation Hospital on 18 April 1943:

The hospital was provided with a water still (Market Forge Co., Everett, Mass.) designed to burn kerosene. But in North Africa, at that time, kerosene was practically impossible to obtain and so was unleaded gasoline. Leaded gasoline was therefore used. It burned with such an intense flame that it was necessary to use only one of the two burners, but the small orifice through which

the gasoline was sprayed before combustion promptly became clogged, and the frequent cleaning necessary took time and was a great nuisance.

When the hospital had to depend upon a distant water supply, as it usually did, a Lister bag was utilized as a container for the water to be distilled. It was suspended on three 9-ft. tent poles, 4 ft. off the ground, this height being necessary to secure the head of pressure required to circulate the water through the condenser jacket. A rubber tube connected the bag with the condenser. The output water from the still was collected in an enamel pail and emptied back into the Lister bag every 10 minutes. The distilled water was collected in a separate container.

Under these conditions, it was possible to distill 1 gallon of water every 2 hours. One person had to be in constant attendance while the still was in use.

This was obviously not an efficient operation, and its duplication, in one form or another, in the multiple field and other Army hospitals resulted in an enormous waste of manpower and in the production of fluids limited in amount and not always safe. It was a relief to all concerned when intravenous fluids began to be supplied from the Zone of Interior in late 1943.

SALT SOLUTION

Historical note.—When the United States entered World War I, there was almost general agreement that the use of physiologic salt solution, as well as of Ringer's solution, in shock and hemorrhage had only temporary effects at best (1). Saline solution, because it is a crystalloid solution, promptly passes from the capillaries into the tissue spaces and, as it passes out of the circulation, probably carries some protein molecules with it. As a result, the blood pressure, when saline solution was used, was shortly as low as it was before, or even lower. It was generally agreed that the decrease of osmotic pressure in the vascular system was detrimental.

Subcutaneous injections of salt solution were equally ineffective; the solution simply spread into the fascia in the area of injection. The suggestion that hypertonic salt solution be used to withdraw fluids from the tissues, in an attempt to increase the blood volume by a sort of "internal transfusion," was as ineffective as it was irrational (31).

Rous and Wilson (32), who analyzed all the available blood substitutes in 1918, considered all of them preferable to salt solution.

World War II experience.—Both salt and glucose solutions were occasionally used early in World War II, partly through ignorance, more often because nothing else was available. Within a short time, these solutions were used only as they would be used in civilian practice; that is, for the correction of dehydration and impairment of the electrolyte balance. Their use for these purposes was infrequent immediately after wounding and quite frequent, as in civilian practice, after operation.

GUM ACACIA

Historical note.—Experimental studies in World War I (1) indicated that gum acacia had a number of properties which might make it useful in replacement therapy. These studies showed that a solution of 6–7 percent in 0.9-percent sodium chloride had the same viscosity as whole blood and the same osmotic pressure as plasma. It was chemically inert. It did not cause thrombosis or promote clotting. It could be sterilized without chemical or physical alteration, and did not induce anaphylactic reactions when it was used repeatedly.

There was considerably less agreement about the clinical value of gum acacia. In October 1918, Maj. Oswald H. Robertson, MC, visited forward hospitals and systematically collected observations on its use from a large number of resuscitation teams (33). Some opinions were laudatory, some indifferent, and some decidedly condemnatory. The poorest results were reported in shock that had been untreated for 15–20 hours, in patients who were treated without first being warmed, in very severe hemorrhage, and in gas bacillus infection. Major Robertson's observations coincided with those of Maj. W. Richard Ohler, MC (34), who had had an extensive experience as a resuscitation officer.²

World War II experience.—The use of gum acacia was never considered by the Subcommittee on Blood Substitutes in World War II. After World War I, however, it was used in a number of civilian institutions, including the Mayo Clinic. It is interesting to note that Baer's bibliography (p. 785) contains references to its experimental use as late as 1950 and to its clinical use as late as 1948.

SODIUM BICARBONATE

Historical note.—In World War I, a number of observers, including Lt. Col. Walter B. Cannon, MC, Chairman of the Subcommittee on Shock, NRC, in World War II, suggested the use of soda bicarbonate solution in shock characterized by acidosis and air hunger, the objective being to increase the low alkali reserve (1). Later, it was realized, that this low reserve was the consequence of hypotension and was the effect, not the cause, of shock. When acidosis occurred, sensitive structures had already been gravely injured by oxygen deficiency.

World War II experience.—The use of sodium bicarbonate solution was never seriously discussed in World War II, in the light of the newer knowledge of shock (35).

COMPLAINTS

Intravenous Solutions

Intravenous solutions were prepared under strict specifications, including a rigid pyrogen test, and the commercial products were excellent. The Office

² It should be noted again that resuscitation was a term developed in World War I, in spite of the general belief that it was originated in World War II.

of The Surgeon General did not test the material before it was distributed, but the policy was that sample bottles from lots which had given rise to reactions would be sent to the Division of Surgical Physiology, Army Medical School, for investigation. There were only three really serious complaints.

Southwest Pacific.—At the meeting of the Subcommittee on Blood Substitutes on 13 May 1943 (3), it was stated that private reports from New Caledonia were to the effect that the distilled water in some packages of plasma had a foul odor and that reactions had been noted of a degree proportionate to the intensity of the odor. In the circumstances, these criticisms could not be evaluated, but it was pointed out that report forms existed for making complaints through channels. No such reports were received. At this meeting, Dr. Max M. Strumia exhibited rubber stoppers which had suffered no apparent deterioration after being in use on bottles of distilled water for 30 months at temperatures of 98.6° to 104° F. (37° to 40° C.).

China-Burma-India theater.—On 12 July 1943, Lt. Col. (later Brig. Gen.) Isidor S. Ravdin, MC, Chief, Surgical Service, 20th General Hospital, reported through channels (36) that difficulties had arisen with solutions "supposedly prepared for intravenous use" because of:

1. Erosion of the aluminum caps due to leakage and resultant chemical action.
2. Fungus growth in the bottles.
3. Pyrogenic substances in a large percentage of the flasks.

These solutions had been prepared more than a year ago. Since they were put up in a cheap type of soft glass, Colonel Ravdin thought that substances from the glass might have got into the solution, though, in flasks from one processing laboratory, the presence of fungus growths raised a serious question as to the original sterility of the solutions or their ability to maintain sterility after preparation and bottling. Solutions from another firm had given rise to 10 percent reactions in one lot, and to 7 percent reactions in another. The high incidence at the 20th General Hospital was in sharp contrast to the 1 to 1.5 percent of reactions in the Zone of Interior with solutions of greater age, but Colonel Ravdin was unwilling to entertain the suggestion of Col. Douglas B. Kendrick, MC, that some local error in the preparation of the intravenous sets might be responsible for the reactions.

In the considerable correspondence which followed the original complaints, the following information was received, chiefly in reply to direct questions:

1. The aluminum caps showed signs of erosion in 40 of 400 bottles. These stoppers were sometimes cracked, and they looked "tacky."
2. Nearly all the bottles with eroded caps had lost vacuum.
3. About 25 bottles showed signs of fungus contamination.
4. The bottles with eroded caps showed fungus formation but no evidence of precipitates or increased turbidity.
5. The rubber diaphragms of the stoppers were intact and all stoppers were tightly fitted to the bottles.
6. The bottles with eroded tops often arrived in damaged cardboard containers. Those in secure wooden crates were generally in good condition.
7. The fungus growth seemed to parallel the increase in environmental temperature

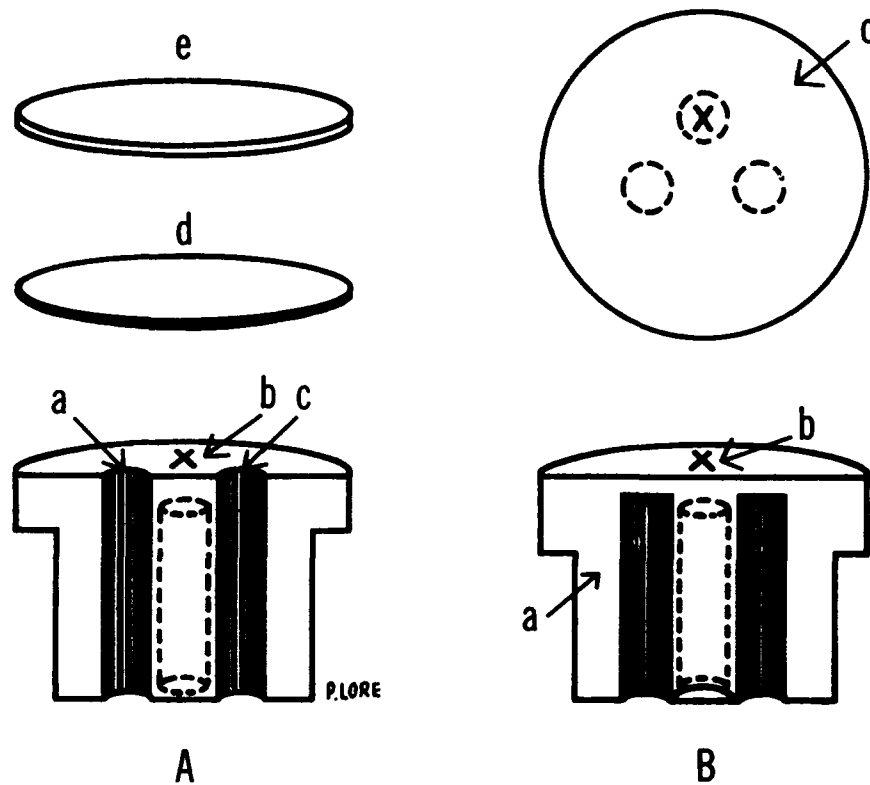

FIGURE 75.—Closures for bleeding, plasma, and intravenous solution bottles (Baxter). A. Early type of closure: Airway (a), point (X) of insertion of needle at time of bleeding (b), outlet (c), thin rubber disk which occludes two openings when vacuum is pulled on bottle (d), and aluminum cap (e). This stopper depends on diaphragms to provide integrity. B. Lateral view of modified, integrally molded stopper (still in use in 1962) which provides completely closed system for collection of blood and storage of plasma and other fluids, as the early model did not: Diaphragms, approximately 2 mm. thick—one provides an airway when it is penetrated by the needle, the other provides an entrance into the bottle for the giving set (a); diaphragm (X) 6-8 mm. in thickness, through which bleeding needle is inserted; when needle is removed after donation, stopper seals itself and the closed system is thus maintained (b); top of modified stopper (c).

during the monsoon. It sometimes appeared while the bottles were in storage on shelves in the central dressingroom, which was always excessively hot during the day because the sterilizer was in it.

8. The bottles with eroded tops invariably had either a reduced vacuum or none, probably from absence of a diaphragm. Otherwise, there was no relation between (1) the presence of erosion and the status of the vacuum and (2) the number of reactions and the fungus growth.

This experience illustrated the absolute necessity of utilizing a completely closed, continuous piece of rubber in the bottling of solutions for intravenous use (fig. 75). The presence of fungus growth was to be expected in solutions

stored for long periods of time in improperly closed containers. When closure was by a single piece of rubber, the vacuum within the container was maintained and contaminants could not enter. Solutions thus packaged had been observed for 3-year periods without deterioration of either the rubber stopper or the solution. The bottles in which fungus growth had developed were closed by a thin rubber diaphragm disk that covered the two holes in the stopper. Maintenance of the vacuum depended upon the disks' remaining in contact with the openings. If the containers were handled roughly, this contact could be lost and contamination could occur.

Because of this experience, Capt. Lloyd R. Newhouser, MC, USN, and Colonel Kendrick, with the aid of industry, devised specifications to provide for an integrally molded stopper which completely sealed the opening of the bottle and maintained a vacuum of 27–29 inches (Hg) without leakage. The closure was further strengthened by the use of an aluminum cap and seal. Thereafter, all bottles for intravenous fluids and for blood were provided with this type of closure.

Since the experience, unfortunate as it was, was limited to a single hospital and steps had already been taken to correct the difficulties, Colonel Kendrick did not concur with the proposal that this hospital prepare its own solutions and also prepare them for other hospitals in the vicinity.

European theater.—Inquiries made in the European theater after the experience in the China-Burma-India theater produced the information that, in general, the intravenous fluids supplied were extremely satisfactory and that no known reactions had followed their use. It had been necessary to discard about 2 percent of the flasks supplied by each of two firms because of the presence of a visible precipitate in the solution. There was no loss of vacuum in these flasks. Cultures showed no growth, and efforts to identify the precipitate as a mold had been unsuccessful.

It was decided that these solutions, like the ones that had been unsatisfactory in the China-Burma-India theater, had been prepared when commercial production was just beginning, before the new specifications for closure of the flasks were written.

Distilled Water

In the summer of 1943, a number of complaints were received in the Supply Division, Office of The Surgeon General, (1) that the equipment provided did not produce distilled water of the quality required for the production of intravenous fluids, and (2) that the production of distilled water never equaled the capacity stated by the manufacturers. Inspection of installations in and near Washington and New York revealed that the stills currently supplied were entirely satisfactory for medical needs when they were properly cared for and operated. The principal factors required for their efficient operation were maintenance of thermal pressure, a steady flow of water, and cleansing of the apparatus at regular intervals. Neglect of any of these factors caused unsatis-

factory qualitative and quantitative production. The intervals at which cleansing was necessary varied; the chemical composition of the water used might make it necessary every 24 hours. The efficiency of personnel was the determinate factor in every operation.

The installation at one hospital was an ideal demonstration of faulty operation and maintenance. A battery of three 10-gal. capacity precision-type stills, set up to produce 10 gal. of triple-distilled water each hour, was actually producing 1 gal. per hour because of leaks in the steam and waterlines and lack of cleansing. The operating personnel could not recall ever having cleaned the apparatus.

These visits of inspection furnished assurance that the equipment provided to Zone of Interior hospitals was adequate for the purposes for which it was intended. In his report, Colonel Kendrick described a new still, manufactured by the American Sterilizer Co., whose main advantage was its simple design. It could be operated with any standard heating element and cleaned with an ordinary scrubbing brush. He recommended that due consideration be given to this item in the preparation of future equipment specifications.

Colonel Kendrick also recommended that a circular letter be issued, announcing the policy of The Surgeon General that hereafter commercially produced intravenous solutions would be furnished and that distilling apparatus would not be required to produce distilled water of the quality essential for intravenous use. This letter was issued on 27 July 1943.

References

1. Cannon, Walter B.: Wound Shock. *In* The Medical Department of the United States Army in the World War. Washington: Government Printing Office, 1927, vol. XI, pt. 1, pp. 185-213.
2. Minutes, meeting of Committee on Transfusions, Division of Medical Sciences, NRC, 31 May 1940.
3. Minutes, meeting of Subcommittee on Blood Substitutes, Division of Medical Sciences, NRC, 13 May 1943.
4. Minutes, meeting of Subcommittee on Blood Substitutes, Division of Medical Sciences, NRC, 20 Oct. 1942.
5. Minutes, First Conference on Gelatin, Division of Medical Sciences, NRC, 10 Nov. 1942.
6. Minutes, meeting of Subcommittee on Blood Substitutes, Division of Medical Sciences, NRC, 10 Mar. 1942.
7. Minutes, meeting of Subcommittee on Blood Substitutes, Division of Medical Sciences, NRC, 10 Nov. 1942.
8. Minutes, meeting of Subcommittee on Blood Substitutes, Division of Medical Sciences, NRC, 15 Dec. 1942.
9. Minutes, Second Conference on Gelatin, Division of Medical Sciences, NRC, 23 Feb. 1943.
10. Minutes, Third Conference on Gelatin, Division of Medical Sciences, NRC, 4 Sept. 1943.
11. Minutes, meeting of Subcommittee on Blood Substitutes, Division of Medical Sciences, NRC, 17 Nov. 1943.

12. Minutes, Conference on Shock, Subcommittee on Shock, Division of Medical Sciences, NRC, 1 Dec. 1943.
13. Minutes, Conference of the Albumin and By-Products Group, Division of Medical Sciences, NRC, 14 Dec. 1943.
14. Minutes, meeting of Subcommittee on Blood Substitutes, Division of Medical Sciences, NRC, 5 Jan. 1944.
15. Minutes, meeting of Subcommittee on Blood Substitutes, Division of Medical Sciences, NRC, 3 Mar. 1944.
16. Minutes, meeting of Subcommittee on Blood Substitutes, Division of Medical Sciences, NRC, 21 Apr. 1944.
17. Vogelaar, J.: The Suitability of Gelatin as a Component of a Blood Plasma Substitute. Factors Affecting the Conglutination of Human Erythrocytes by Gelatin. Blood Substitutes Report No. 23, Division of Medical Sciences, NRC, 7 Dec. 1943.
18. Minutes, Conference on Pectin, Division of Medical Sciences, NRC, 24 Feb. 1943.
19. Minutes, meeting of Subcommittee on Blood Substitutes, Division of Medical Sciences, NRC, 3 Nov. 1941.
20. Popper, H.: Deposition of Material in the Tissues After Injections of 1.5% Pectin Solution. Blood Substitutes Report No. 17, Division of Medical Sciences, NRC, 10 Apr. 1944.
21. Minutes, meeting of Subcommittee on Blood Substitutes, Division of Medical Sciences, NRC, 19 Sept. 1941.
22. Minutes, meeting of Subcommittee on Blood Substitutes, Division of Medical Sciences, NRC, 23 Mar. 1943.
23. Bovarnick, M.: The Formation of Extracellular *d* (—)-Glutamic Acid Polypeptide by *Bacillus Subtilis*. *J. Biol. Chem.* 145: 415–424, October 1942.
24. Minutes, meeting of Subcommittee on Blood Substitutes, Division of Medical Sciences, NRC, 24 Feb. 1943.
25. Minutes, meeting of Subcommittee on Blood Substitutes, Division of Medical Sciences, NRC, 10 Aug. 1943.
26. Seegal, D.: Studies on Glycerol Polysuccinate. Blood Substitutes Report No. 9, Division of Medical Sciences, NRC, December 1945.
27. Minutes, Conference of Albumin and By-Products Group, Division of Medical Sciences, NRC, 28 July 1943.
28. Minutes, meeting of Subcommittee on Blood Substitutes, Division of Medical Sciences, NRC, 24 Sept. 1943.
29. Minutes, meeting of Subcommittee on Blood Substitutes, Division of Medical Sciences, NRC, 16 Mar. 1945.
30. Minutes, meeting of Subcommittee on Blood Substitutes, Division of Medical Sciences, NRC, 9 Apr. 1943.
31. Kendrick, D. B., and Wakim, K. G.: Intra-Arterial Hypertonic Saline Solution in Experimental Shock. *Proc. Soc. Exper. Biol. & Med.* 40: 114–116, January 1939.
32. Rous, P., and Wilson, G. W.: Fluid Substitutes for Transfusion After Hemorrhage. First Communication. *J.A.M.A.* 70: 219–222, 26 Jan. 1918.
33. Robertson, O. H.: Transfusion With Preserved Red Blood Cells. *Brit. M. J.* 1: 691–695, 22 June 1918.
34. Ohler, W. R.: Treatment of Surgical Shock in the Zone of the Advance. *Am. J. M. Sc.* 159: 843–853, June 1920.
35. Minutes, meeting of Subcommittee on Shock, Division of Medical Sciences, NRC, 29 Jan. 1944.
36. Correspondence, Lt. Col. I. S. Ravdin, MC, and Office of The Surgeon General, 12 July–23 Oct. 1943, subject: Deficiencies in Intravenous Fluids, China Burma India Theater of Operations.

CHAPTER XV

The Mediterranean (Formerly North African) Theater of Operations

Part I. Fifth U.S. Army

EVOLUTION OF POLICIES

The use of whole blood overseas in the management of wounded casualties developed in MTOUSA (Mediterranean (formerly North African) Theater of Operations, U.S. Army) (1). While its development was a local affair, it influenced the policies and practices in both ETOUSA (European Theater of Operations, U.S. Army) and the Pacific areas. The experience occurred in two chief phases:

1. The British experience blazed the trail (2). On the outbreak of war, in September 1939, the British immediately put into action the plans previously set up for the provision of whole blood to troops in the field (p. 15). In the Western Desert, 18 bottles of blood, 19 bottles of plasma or serum, and 20 bottles of physiologic salt solution were used for each hundred of the 17,572 troops wounded between 10 April and 28 November 1942. The use of blood was more liberal than these figures suggest, since the total casualties include the missing, in some of the actions.

The entire British experience proved that while plasma was extremely valuable in the provision of temporary circulatory support for casualties with multiple wounds, accompanied by massive hemorrhage, from mortars, high explosives, and landmines, it was not enough. Whole blood, which had the oxygen-carrying properties lacking in plasma, was essential for the support of casualties for anesthesia and initial wound surgery. The British experience also proved that it was completely practical to transport whole blood for long distances; when the fighting moved to Italy, British hospitals continued to receive blood from the bank in Cairo until the transfusion unit moved to Bari, Italy.

2. Information concerning the British experience was made constantly available to Col. Douglas B. Kendrick, MC, in the formative days of the blood-plasma program in the Zone of Interior by Col. Frank S. Gillespie, RAMC, British Medical Liaison Officer (p. 54). Col. Edward D. Churchill, MC, Consultant in Surgery to the Surgeon, Fifth U.S. Army (fig. 76), was fully informed of it when he assumed his duties in North Africa in March 1943. Before he left the Office of The Surgeon General for North Africa, he had been

requested to undertake a study of the entire problem, with the twofold objective of determining (1) whether, with plasma readily available, whole blood were really needed, and (2), if it were, how best it could be provided.



FIGURE 76.—Col. Edward D. Churchill, MC, Consultant in Surgery, Fifth U.S. Army.

EARLY EXPERIENCES

In spite of the British experience, U.S. Army hospitals that landed in North Africa in November 1942 and those that landed later had practically no equipment for whole blood transfusion (p. 393). It was the prevailing opinion then that plasma would be so effective that only a very small proportion of wounded would require whole blood early in their treatment. A few officers in the Army Medical Department and a few members of the Subcommittee on Blood Substitutes had expressed concern over the lack of preparation for whole blood transfusion, but no strong, direct, constructive, formal recommendation had been made, and there was, therefore, no provision at the time for supplying whole blood to Army hospitals overseas.

The treatment of shock with plasma produced gratifying results in Tunisia and throughout the war (figs. 77-80). It was provided in ample quantities. It was often given in 1,000-cc. amounts. It was often continued during evacuation to the rear, or it was given prophylactically, in advance of evacuation, particularly in patients with fractures of the femur or with abdominal wounds (who later in the war would be operated on in field hospitals). It did not require much experience, however, to learn as the British had long since learned, that when blood had been lost, the only effective replacement was whole blood.

There is no doubt that lives were lost in North Africa and that morbidity was increased because blood was not used soon enough (until evacuation hos-



FIGURE 77.--Administration of blood plasma in battalion aid station, about half mile behind frontlines, S. Agata, Sicily, 9 August 1943. The same first aid station is shown in the frontispiece of this volume.

pitals, or sometimes general hospitals, had been reached) or in sufficient quantities. There were three explanations:

1. Facilities for transfusion had not been provided.
2. Transfusion with improvised equipment was extremely inconvenient and often impractical under field conditions.
3. The importance of whole blood had been overlooked while the potentialities of plasma had been overstressed.

In his report of 3 April 1943 to the Surgeon, II Corps, Maj. (later Col.) Howard E. Snyder, MC (3), included among his recommendations the need for a more convenient method of blood transfusion and for a source of donors other than clearing station personnel (p. 395). The need for whole blood in combat casualties and the extreme inadequacy of the equipment for obtaining it and administering it had already been reported to the Surgeon, II Corps, by the chief of surgery, 77th Evacuation Hospital, through channels, in December 1942. The report of the 77th Evacuation Hospital on 18 April 1943 stated, "As the need for whole blood transfusion grew critical, we found that nothing had been provided for this purpose" (4).

At that time, this hospital had no citrate, no distilled water, and no facilities to make it. The only equipment was what Capt. Joseph J. Lalich, MC, who headed a shock team, had been able to obtain from the British blood bank while the hospital was stationed in England. Sodium citrate was obtained from a French pharmacy. A still was borrowed from the French.



FIGURE 78. Administration of blood plasma to wounded German soldier at battalion aid station by corpsmen of 1st Battalion, 85th Mountain Infantry, 10th Mountain Division, Fifth U.S. Army, Villafranca, Italy, April 1945.

Blood was obtained from the hospital detachment. Shock teams were organized to collect and administer blood, administer plasma and other intravenous therapy, make distilled water for the entire hospital, sterilize equipment for transfusion and other intravenous therapy, and perform crossmatching. With these makeshift arrangements, the casualties in this hospital received more blood than plasma, and the report is an illustration of both the difficulties attending an improvised operation and the ingenuity of the hospital personnel.

In a report to The Surgeon General on 1 June 1943, Surgeon, II Corps, Col. Richard T. Arnest, MC, pointed out that if sterile tubing, filters, and needles were provided, with facilities for crossmatching, whole blood transfusions could be given almost as conveniently as plasma transfusions. The difficulty at this time was lack of equipment.

Meantime, almost as soon as he had arrived in North Africa, Colonel Churchill concluded, from his personal observations and from studies that he instigated, that large quantities of whole blood were needed in combat areas to treat casualties with severe wounds (2). Toward the end of the North African campaign, he detailed Maj. (later Lt. Col.) Eugene R. Sullivan, MC, Chief, Laboratory Service, 16th General Hospital, to investigate transfusion requirements and facilities in forward hospitals. On 13 July 1943, Major Sullivan reported that facilities for whole blood transfusion were entirely inadequate. He recommended that there be provided, ready for immediate



FIGURE 79.—Administration of blood plasma to wounded soldier in Italy after house had been hit by bombs, November 1943.

use, vacuum bottles for bleeding, appropriate apparatus for the administration of whole blood, equipment for Kahn serologic tests, and electric refrigerators for the storage of blood in all field hospital platoons and all evacuation hospitals. With this equipment, Major Sullivan believed that forward hospitals could operate their own blood banks.

Reports of his own and Major Sullivan's observations were forwarded by Colonel Churchill, through channels, to the Office of The Surgeon General and to those in that office concerned with the blood-plasma program. He emphasized that his first task had been the identification of the problem (5). The campaign in North Africa had ended before corrective measures could be taken, but the necessary information was now available for future action. The single fact that stood out most prominently in the care of battle casualties in North Africa was the indispensability of whole blood before, during, and after initial wound surgery. Unless casualties were properly resuscitated—and their resuscitation included whole blood, often in large quantities, to replace what they had lost—surgery would be attended with an excessive mortality rate. Plasma could not replace whole blood.

Sicily

As a result of the North African experience and the subsequent studies by Colonel Churchill, Major Snyder, and others, a system of blood banks was set up in the Sicilian invasion in evacuation and general hospitals, sometimes



FIGURE 80.—Fifth U.S. Army corpsmen administering blood plasma in open field to wounded comrade. In background is a war-ravaged town. Date is unknown, but the picture was taken before the introduction of large plasma bottles.

only 3 or 4 miles behind the combat zone (6). The blood was collected from volunteer donors among the combat troops, with the approval of their commanding officers, and from convalescent and slightly wounded casualties. Chaplains were of great help in obtaining donors, and the field directors of the American Red Cross maintained the records and otherwise assisted in the program. Plasma, of course, continued to be used in quantity.

FIRST PLANNING FOR A THEATER BLOOD BANK

Alternate Proposals

When the organization of a theater blood bank was first discussed in the Mediterranean theater, in June 1943, it was thought that blood would be necessary for about 18 of every 100 casualties, and that 1 unit of blood would be required for every 3 units of plasma. The ratio of transfusions to casualties, however, rose steadily as surgeons gained experience in combat surgery.

Two methods of providing the necessary blood were discussed at this time, (1) the distributing system employed by the Royal Army Medical Corps, and

(2) a unit system, set up in individual hospitals, which would eliminate the necessity for a distributing system.

British system.—The basis of the British system, as described elsewhere (p. 15), was the collection of blood in hospitals in the communications zone and its distribution to hospitals in the forward area. A forward distributing unit received blood from the base collecting unit, stored it, and distributed it as necessary to forward field transfusion units, which were located at the points at which initial wound surgery was performed.

Unit hospital system.—The unit system first proposed for U.S. Army hospitals was advocated because of the following advantages:

1. It would eliminate the elaborate distributing system used by the British, which required additional personnel and mobile refrigeration.
2. It would reduce the time lost by donors, who would be secured from Army personnel.
3. It would permit the utilization of type A donors, who, with type O donors, account for about 82 percent of all bloods. In the British system, only type O donors were used.
4. It would permit personal supervision of all technical details by personnel of the hospital in which the transfusion was given. Any technical errors could thus be identified and corrected at once.
5. Hospitals using blood would be responsible for reducing excessive use and wastage, estimated at 10-15 percent in the British system.
6. There would be no losses by freezing during the winter, and losses by road accidents and transportation would be minimal.
7. The unit system would be more effective in overwater or assault operations, in which distribution from a base, or even from a forward center, must await the establishment of air transport.
8. The unit system could be started in the Mediterranean theater as soon as transfusion sets were acquired. If necessary, a distribution system could be set up later.

The disadvantages of a unit system were also recognized:

1. It would continue to place the burden of procuring blood upon busy forward hospitals, which had, however, shown themselves capable of assuming it. It would also mean that saline and glucose solutions and distilled water must continue to be prepared and distributed by hospitals; by the British system, these duties were assumed by the base installation.
2. Since troops in the combat zone would be used as donors, instead of base troops, the risk of transfer of malaria might be increased; it was relatively safe, from this standpoint, to bleed troops as soon as they had arrived in the theater.
3. When a hospital moved, except a field hospital platoon, which had mobile refrigeration, refrigeration would be interrupted and whatever blood was on hand would be wasted.
4. Both expendable and nonexpendable equipment would be required. Mobile hospitals, particularly those that would use blood in the largest amounts, should not be weighted down with the equipment necessary to wash, sterilize, and store bleeding bottles. Moreover, hospitals often worked without adequate supplies of pure water and with limited quantities of distilled water, and these lacks would make the cleansing process difficult and unsatisfactory.
5. Additional refrigeration would be required in evacuation hospitals, or a modification of the refrigerators now in use. To keep field hospitals completely mobile, it would be necessary for each platoon to be supplied with a refrigerator truck. Insulated boxes would also be needed for emergency shipment of blood from evacuation to field hospitals.

Recommendation for Unit System

In a report of this discussion from the Consultant in Surgery to the Surgeon, NATOUSA (North African Theater of Operations, U.S. Army), of 2 July 1943, the following recommendations were made (2):

1. That a unit system to supply whole blood be immediately authorized in the theater.
2. That training personnel be detached as necessary from present assignments to put it into operation.
3. That the transfusion sets necessary be requisitioned by cable.
4. That the principle of using corps troops as donors be cleared through command channels, since command could at any time block the supply; this had happened in certain organizations in Tunisia. It was estimated that for an operation resulting in 20,000 casualties, 3,600 donors would be required from corps troops or from lightly wounded divisional troops during their evacuation to the rear.

It was pointed out that the basic difference between the unit system described and the British system was the placement of the donor reservoir, which would be in the forward and not the base area.

It was also recommended in this report that a central laboratory be established in the theater, to provide whole blood, plasma, intravenous solutions, and distilled water for the Fifth U.S. Army, on the ground that the British Base Transfusion Unit had demonstrated the feasibility of supplying large amounts of whole blood to combat troops.

Blood Supply, September 1943–February 1944

By the time U.S. troops had landed at Salerno on 9 September 1943, it was apparent that even with the availability of vacuum bottles, which had now reached the theater, for the collection of blood, it would be impossible for forward hospitals to collect sufficient blood to treat their casualties adequately (7). Shortly after these landings, therefore, Col. (later Brig. Gen.) Joseph I. Martin, MC, Surgeon, Fifth U.S. Army, urged the theater Surgeon, then Brig. Gen. Frederick A. Blesse, to authorize the establishment of a transfusion unit to support Fifth U.S. Army field and evacuation hospitals. The Anzio-Nettuno landings were then in the planning stage, and, when no action was taken on General Martin's request, it was necessary for him to request British assistance in providing blood for them. In all, U.S. hospitals on the Anzio beachhead received about 4,000 pints of blood from this source; a large part of it was donated by Army Air Forces personnel in the area, but collecting and processing were done by the British blood transfusion unit at Foggia with British equipment. The first blood from the Fifth U.S. Army blood bank in Naples was not received on the beachhead until 23 February 1944.

During this period, as well as later, British blood was used for U.S. troops elsewhere in Italy (fig. 81). The use of serum was limited to British troops (fig. 82).



FIGURE 81.—Transfusion given with British equipment and British-supplied blood to British victim of S-mine, Garigliano River area, Italy, 18 January 1944. Fifth U.S. Army blood bank in Naples had not yet been established. Casualty's face is black as the result of concussion.

In ETMD (Essential Technical Medical Data), NATOUSA, 1943 (8), the advantages of a collecting unit in a base section, to supply a portion of the blood used in forward hospitals, were outlined:

1. Service troops in the base could be used as donors, thus eliminating any interruption in the work of forward troops.
2. A collecting unit in the base could conduct a more rigorous examination of donors to eliminate those with jaundice and malaria. It could also control the quality of the blood by holding it long enough to perform Kahn tests and to search for malarial parasites.
3. The holding of small reserves of blood in the base area, subject to constant turnover by distribution to forward areas, would provide a bank adjacent to base units that could be used in the event of a devastating air raid or other catastrophe.
4. The current tactical situation, with a relatively stable front close to a large base area, was ideal for the distribution of blood under such a system.

Two disadvantages were listed:

1. It was undesirable to allow forward hospitals to become entirely dependent on the base section for blood; in overwater assaults and other conceivable tactical situations, it was essential that they be able to be self-sustaining in respect to blood for long periods of time.
2. The plan proposed would reduce whole blood to the status of a supply item, and it was not desirable to shift the responsibility for providing a lifesaving agent to an impersonal organization. No matter how carefully the system was organized, it would fail, through no fault of its own, under critical circumstances. A base section collecting and distributing unit should be regarded simply as an accessory to a vigorous and sustained effort by individual hospitals to maintain their own blood banks, not as a means of release from this responsibility.



FIGURE 82. Wounded Sikh, receiving infusion of blood serum (British) at temporary first aid station, Crespino, Italy. Fifth U.S. Army area. 22 September 1944.

ESTABLISHMENT OF BLOOD BANK AT 15TH MEDICAL GENERAL LABORATORY

In February 1944, the whole blood situation was reviewed in all its aspects by General Martin; Colonel Arnest; Major Sullivan, representing General Blesse, and Col. Virgil H. Cornell, MC, Commanding Officer, 15th Medical General Laboratory (fig. 83) (9). Major Sullivan had just returned from an inspection trip in Fifth U.S. Army field and evacuation hospitals, in which he



FIGURE 83.—Col. Virgil H. Cornell, MC,
Commanding Officer, 15th Medical General
Laboratory

had surveyed their blood transfusion problems.¹ The outcome of the meeting was the recommendation that a transfusion unit be organized to supply 100 bottles of blood daily to meet Fifth U.S. Army and Peninsular Base Section requirements. A letter containing this recommendation was sent to Maj. Gen. Morrison C. Stayer, Surgeon, MTOUSA, by Colonel Cornell, through channels, on 5 February 1944. Before action could be taken on it, the Army had raised the calculated needs to 200 bottles per day.

The 15th Medical General Laboratory, which arrived at Naples on 20 November 1943, was the parent organization of the Fifth U.S. Army blood bank. It was the second laboratory of the kind to be organized in World War II and, in general, was set up on the pattern of the central laboratory at Dijon in World War I (10).

Soon after its arrival in Naples, the laboratory was asked by the Surgeon, Peninsular Base Section, to operate a small (20-bottle) blood bank, to supply the Naples area and the medical center there, to provide against emergencies. During the period required for Headquarters, NATOUSA, to draw up tables of organization and equipment for the proposed transfusion unit to be established in the theater, the laboratory undertook to supply blood for Fifth U.S.

¹ Until almost the end of the war, Major Sullivan continued to be attached to the Office of the Surgeon, NATOUSA. It was essential that some officer in this office have the responsibility for the coordination of the transfusion program with other theater activities. Major Sullivan acted as consultant on transfusions and in this role played a very important part in the theater blood program.



FIGURE 84.—Maj. John J. McGraw, Jr., MC, Chief, Blood Bank, drawing blood from nurse donor at 15th Medical General Laboratory near Naples, September 1944.

Army hospitals. One officer (Capt. (later Maj.) John J. McGraw, Jr., MC) (fig. 84), and two enlisted men were assigned to a blood bank section and later served as a cadre for the transfusion unit.

Colonel Cornell took a great interest in the transfusion unit, and devoted much time and effort to helping Major Sullivan develop it. The availability of a medical officer of Colonel Cornell's experience, with his rank, was a distinct advantage. On numerous occasions he took direct responsibility and was able to obtain far prompter cooperation from other units and services than could the commanding officer of the unit, who, for the major period of its operation, had the rank of captain.



FIGURE 85. GI blood donors in line before receiving building, 2d Medical Laboratory, Fifth U.S. Army, Carinola area, Italy, May 1944.

Collections. The first blood collected at the laboratory on 23 February 1944, from group O donors, was sent to the Anzio beachhead, where it was distributed by the British field transfusion unit stationed there. Between this date and 1 May 1944, the laboratory collected 4,134 bloods. The one officer and two enlisted men assigned to the blood bank section were able to collect and process enough blood to meet the demands of the hospitals on the beachhead until the special transfusion unit was authorized on 9 May 1944.

During May, 6,363 bloods were collected, an achievement that would have been impossible without the help of personnel from the 1st Medical Laboratory, Fifth U.S. Army, which was attached to the 15th Medical General Laboratory on 27 April 1944. These officers and men, in addition to providing help in the collection and processing of blood, had an excellent opportunity to learn the conduct of a blood bank during a period of maximum activity. Using 12 beds, the combined personnel of the two laboratories drew a total of 4,685 bloods between 14 and 31 May, a daily average of 260. During the same period, after air contact had been made with forward units of the Fifth U.S. Army, personnel of the 2d Medical Laboratory (figs. 85 and 86) collected an additional 410 bloods.

Most of the blood collected in the February-May period went to the Anzio beachhead. The remainder was used in nearby general and station hospitals.



FIGURE 86. Technicians taking blood for typing, 2d Medical Laboratory, Fifth U.S. Army, Carinola area, Italy, May 1944.

THE 6713TH BLOOD TRANSFUSION UNIT (OVHD.)

Organization

The 6713th Blood Transfusion Unit (Ovhd.) was activated on 9 May 1944, by General Orders No. 85, Headquarters, Peninsular Base Section, 8 May 1944 (11). It was assigned to Headquarters, NATOUSA, and attached to the 15th Medical General Laboratory for administration, quarters, and messing facilities. Although it was officially a separate organization, the transfusion unit, for all practical purposes, was a department of the laboratory. This was a fortunate arrangement, for it permitted the use of many laboratory facilities and services. Kahn tests, for instance, were performed by the serology section of the laboratory. It was thus possible for the transfusion unit to conserve space, equipment, time, and personnel.

As the transfusion unit was set up, it operated in two sections (chart 8), a base section which collected and processed blood in the base and shipped it to the other section, which functioned as a smaller distributing section in the Fifth U.S. Army area. This organization was far closer to the British system than to the unit system originally recommended, by which individual hospitals were largely responsible for their own supply. The explanation for the changed plan appears in a memorandum addressed to The Surgeon General on 27 May 1944 by Col. Earl Standlee, MC (12). In this memorandum, Colonel Standlee

CHART 8.—Diagram of blood transfusion service for field army, North African theater, 27 May 1944

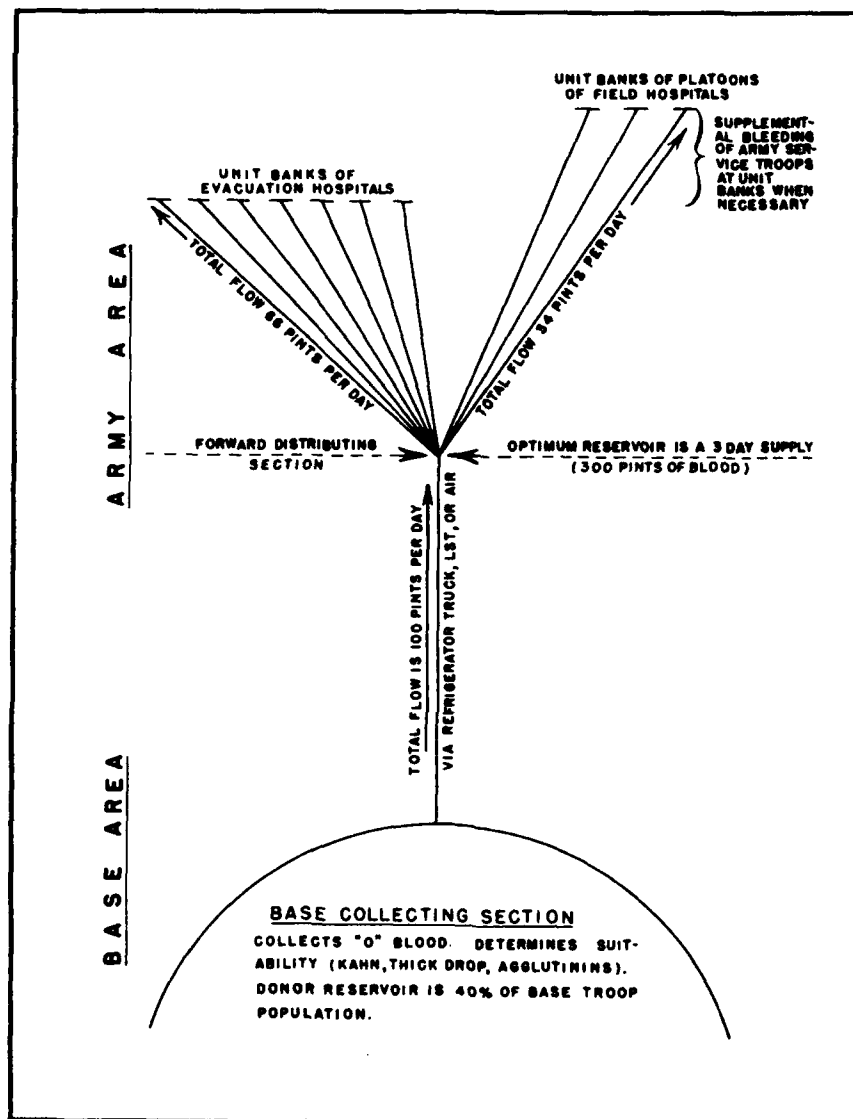

Source: Memorandum, Col. Earl Standlee, MC, to The Surgeon General, 27 May 1944, subject: Blood Banks in Theater of Operations.

pointed out that the great need for blood was in the forward, not the base, area. In the Fifth U.S. Army hospitals, between the invasion at Salerno and the end of the Cassino campaign, 4,600 transfusions were given in the Army area against 300 in the base. The emphasis should therefore be on supplying blood to Army rather than to base installations. When the base was close to the battle-line and evacuation was relatively rapid, the amount of blood used in base hospitals increased accordingly.



FIGURE 87. Transfusion in postoperative ward, 33d Field Hospital, Fifth U.S. Army, September 1944.

Transfusions were ordinarily given only in field (fig. 87) and evacuation hospitals in the forward Army area, these being the first installations staffed and equipped for their administration. They were not ordinarily given in battalion aid stations or in collecting and clearing stations, though occasionally, as during the rapid advance after the breakout at Anzio, these installations were so far ahead of field hospitals that blood was sent to them. There was no point to providing blood for clearing stations that were abreast of field hospitals.

As the plan worked out, field hospitals were supplied with all the blood they requested; they were never expected to provide their own. Evacuation hospitals operated their own blood banks when their casualty load was light. When it was heavy, they were supplied with additional amounts of blood from the base.

Bleeding Center

In addition to serving as the Unit headquarters throughout the war, the 15th Medical General Laboratory at the Fair Grounds in Naples served as the base bleeding section until the middle of April 1945, 3 weeks before the war in Italy ended. Another center was set up at the Red Cross enlisted men's service club in Naples. As the fighting moved north, bleeding centers were set up in Rome, Florence, and Pisa. Centers were sometimes set up temporarily in Army laboratories in replacement depots too far distant for convenient

transportation of donors to the main center. The need for multiple centers increased as the Army advanced and base section troops were less concentrated.

Individuals came to the centers by whatever transportation they could secure. Organizations usually provided transportation for groups, or blood bank trucks were sent for them. In actual practice, the most efficient way to secure donors was to make contact with unit commanders a few days in advance of the need and ask them to provide groups of volunteers, who could be picked up at specified hours by organization or blood bank trucks.

Mobile bleeding units were sometimes sent out to bleed donors who could not report to the donor centers. Prisoners in disciplinary stockades, for instance, had to be handled in this manner. This was not a practical method, however, until the last month of the war, because of lack of expendable donor sets. Cleaning and sterilization of donor sets provided the biggest obstacle to the efficient operation of mobile bleeding units in Italy.

Distributing Center

The first blood collected at the 15th Medical General Laboratory was distributed by the British field transfusion unit operating in the Anzio area and by the 2d Medical Laboratory operating in the Carinola area. On 22 June 1944, the 6713th Blood Transfusion Unit began to operate its own forward distributing center, with 1st Lt. (later Capt.) John T. Kroulick, MAC, in charge. The center was always located near an airfield and was usually attached to an evacuation hospital for quarters and rations. If, however, an Army laboratory were situated in the area, it was sometimes attached to it. The center moved from its first location at Anzio to Rome, and then, as the fighting moved up the peninsula, to Grosseto, Florence, Bologna, and Verona, where it was located, at the 8th Evacuation Hospital, when the war in Italy ended. By the middle of June, all personnel had returned to the Naples base.

Personnel

When the 6713th Blood Transfusion Unit (Ovhd.) was planned, the estimated requirements for blood for Fifth U.S. Army field and evacuation hospitals, based on the amounts used to date, were set at 100 pints per day. Original personnel for the procurement and distribution of this amount consisted of 3 officers and 16 enlisted men. Before the unit was organized, the need for blood in Fifth U.S. Army hospitals, which were then receiving casualties from one armored and six infantry divisions, had increased to 200 pints per day, and the personnel allotment was increased to 5 officers and 20 enlisted men. Later, the allotment of enlisted men was increased to 38.

Personnel and equipment of the unit were sufficient to process 200 bloods a day with relative ease and to handle 300 pints daily for short periods without too much difficulty. When fighting was heavy, however, and 300 or more bloods were required daily for long periods, more help was needed. At the

beginning of the Po Valley offensive, between 11 and 21 April 1945, 6,450 pints of blood were collected and processed, including 871 pints on one day.

Skilled personnel from the 15th Medical General Laboratory assisted during periods of stress. Even so, during major offensives, such as the Garigliano offensive, the assault on the Gothic Line, and the campaign in the Po Valley, it was necessary to attach additional personnel to the unit, usually from a hospital ship platoon, an adjacent general hospital, an army medical laboratory, a medical battalion, or replacement depots. When a replacement center located about 25 miles from the 15th Medical General Laboratory served as an independent bleeding section, some of the keymen from the original unit were trained intensively for about a month and assigned to it. They were slowly withdrawn as the replacement center section became able to function without help.

If Air Forces personnel, informal assistants, and hired civilians are included in the count, the total strength of the blood transfusion unit once rose to 90 persons, about 15 of whom were engaged in the distribution of blood, clerical work, supply, liaison, and other accessory tasks.

When 300 donors were bled daily, the 5 officers and 38 enlisted men attached to the unit had the following duties (figs. 88-92):

1. Contacts with donors, one officer and one enlisted man.
2. Registration of donors, three enlisted men.
3. Grouping bloods and preparing malaria smears, three enlisted men.
4. Bleeding donors, two officers and six enlisted men.
5. Labeling, capping, and packing bottles for shipment, three enlisted men.
6. Staining and reading malaria smears, two enlisted men.
7. Performing Kahn tests, one officer and two enlisted men.
8. Titration and check of blood grouping, two enlisted men.
9. Washing and sterilizing equipment, four enlisted men. When local civilian personnel were employed for this purpose, they were carefully supervised by an enlisted technician. An experienced technician always operated the autoclave.
10. Correspondence, preparation of pay vouchers, two enlisted men.
11. Forward distribution, one officer and four enlisted men.
12. Driving, four enlisted men.

When 300 donors a day were bled, officers and enlisted men worked the entire day. When larger numbers were bled, nightwork was necessary, and it was also necessary when, for one reason or another, donors could present themselves only at night. The frequent necessity for keeping personnel on duty all night, to maintain a 24-hour blood service, made for constant shortages of trained workers. Only the skill and devotion of the personnel of the blood transfusion unit made it possible to supply the large amounts of blood needed in the Fifth U.S. Army area in 1944 and 1945.

Personnel difficulties were compounded when it was necessary to operate several bleeding sections at long distances from each other. Theoretically, the most economical and efficient way to operate a blood transfusion unit is in one location, but circumstances in the Mediterranean theater frequently did not permit such an arrangement. In his October 1945 memorandum to The

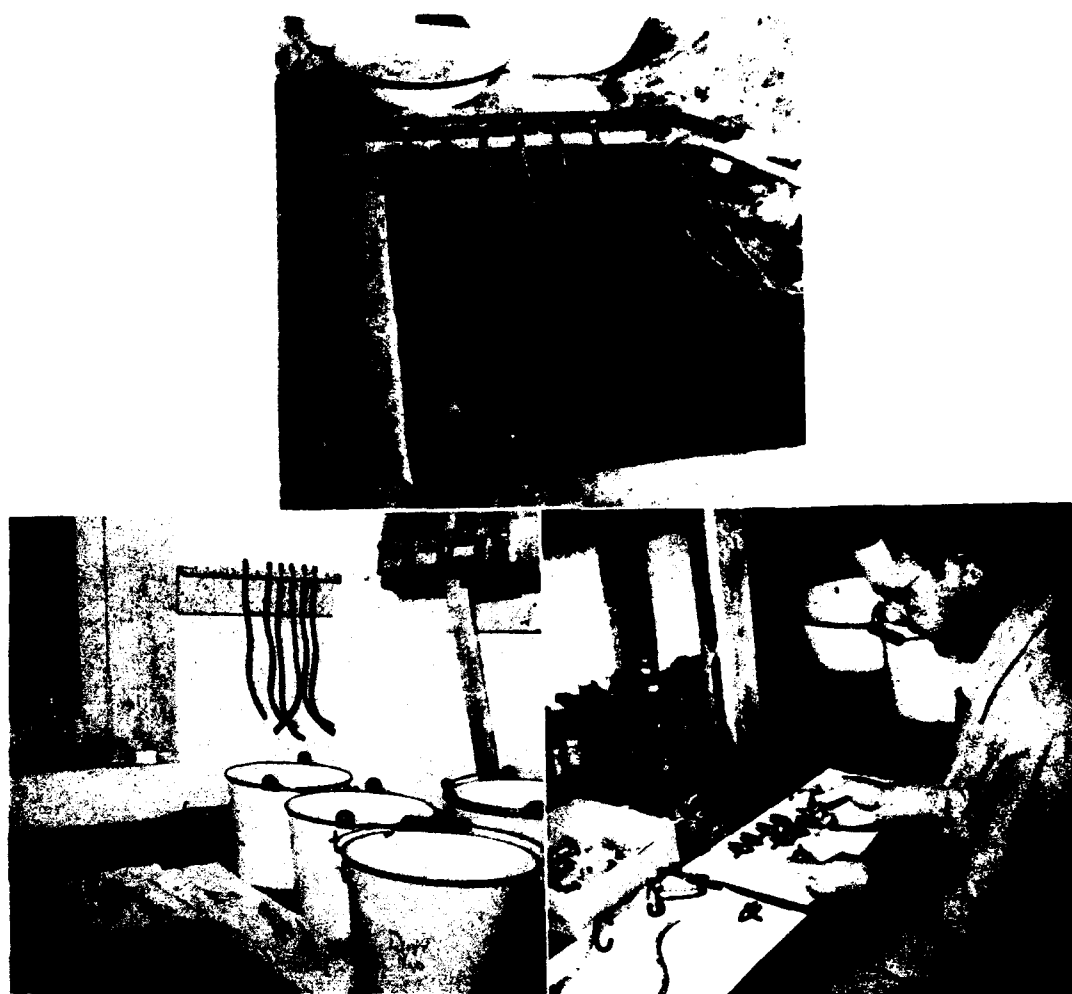

FIGURE 88.—Preparation of donor sets, 15th Medical General Laboratory, Naples, March 1944. Cleaning of giving and receiving sets after use was done by a very demanding technique. The objective was to complete the whole procedure, including reassembly, testing, and autoclaving, within 2 hours of the time the equipment had been used. A. Cleansing of tubing and valves in cold running water, introduced under pressure, after which distilled water will be used. B. Donor sets drying by gravity before sterilization. C. Technician cleaning and oiling blood collecting valves and tube assembly.

Surgeon General, Colonel Standlee recommended that in the future two transfusion units be established instead of one. Administration would then be more flexible, bleeding in isolated areas would be simplified, and the additional personnel would provide an additional margin of safety in case of disability from sickness and during rapid movement.

The forward distributing section was always in charge of a medical officer, who could assure proper handling and equitable distribution of the available blood, and who could also aid in the solution of transfusion problems that might arise in forward hospitals.

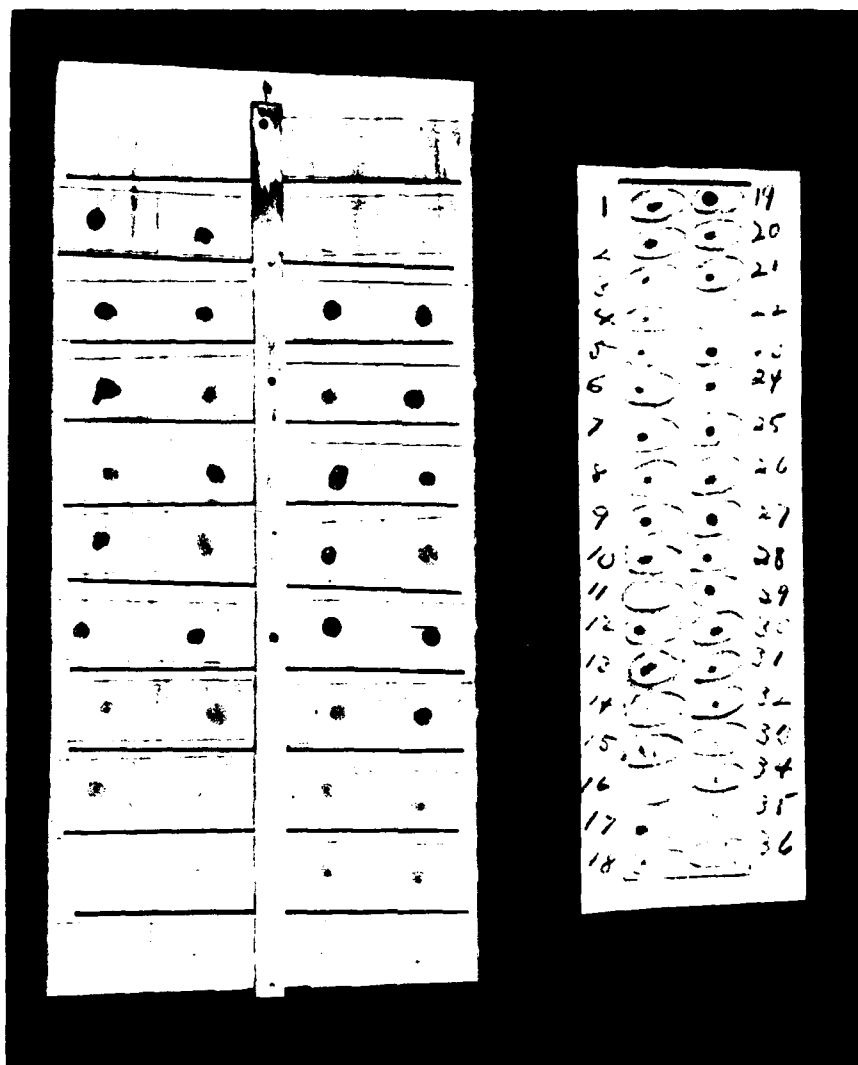

FIGURE 89.-Laboratory examinations at 15th Medical General Laboratory blood bank. A. Unstained thick films, to exclude malaria. B. O donors' cells matched against group O serum. Circles 15 and 22 show presumptive gross agglutination, which indicates that blood type on identification tags was erroneous.

Officially, the personnel of the forward section, since they operated in the Army area, were on detached service with the Surgeon, Fifth U.S. Army. Their operational and administrative control, however, remained with the base transfusion unit. They carried their own tents, blankets, and other equipment, and, for housekeeping purposes, they were attached to the most convenient evacuation hospital or army laboratory in the area.

When several scattered bleeding sections were in operation, administrative details, accounting for supplies and property, liaison, donor procurement, and

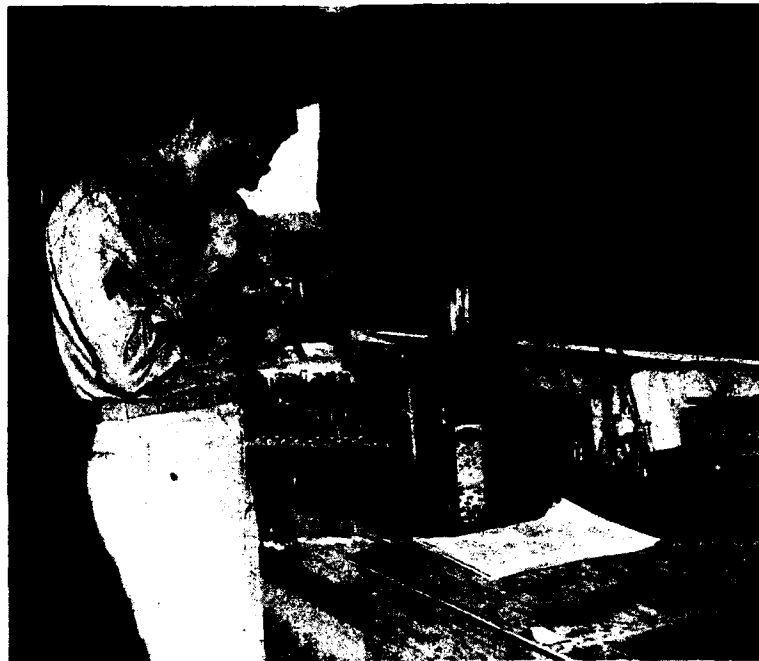

FIGURE 90.—Technician typing blood (third check), 15th Medical General Laboratory, Naples, August 1944.

maintenance of records proved to be a considerable task. All the officers of the unit participated in the work, with the channels of administration leading back to the base unit.

The desirability of including a medical administrative officer in the table of organization of blood transfusion units was debated in the theater before the 6713th Blood Transfusion Unit (Ovhd.) was established. On the surface, it seemed that it might be wise to concentrate all the responsibilities just listed in the hands of an administrative officer who would have no professional responsibilities and who could replace either a Medical Corps officer or a Sanitary Corps officer in the table of organization. It was decided, however, not to make the substitution, and the decision was wise, since the attachment of the unit to the 15th Medical General Laboratory eliminated many administrative problems.

In his August 1945 memorandum to The Surgeon General (13), Colonel Standlee strongly recommended against the appointment of a medical administrative officer; the entire blood bank operation, he pointed out, required a background of scientific training, and the Medical Corps or Sanitary Corps officer who would be lost by the substitution would have numerous professional duties. If, however, it was not practical, for any reason, to attach a transfusion unit to a large laboratory or other large organization, then the addition—not substitution—of an administrative officer would be necessary rather than desirable.



FIGURE 91. Blood typing at 15th Medical General Laboratory blood bank, Naples, September 1944.

TRAINING

It was necessary that the personnel of the base collection section be skilled in all aspects of the blood program, including fundamental principles, knowledge of blood types and typing, bleeding techniques, cleaning of apparatus, asepsis and sterilization, distillation of water, crossmatching, Kahn serologic testing, examination of smears for plasmodia, recognition of contaminated or overage blood, and fundamentals of refrigeration.

The noncommissioned officer in charge of a bleeding section, the enlisted men who cleaned, prepared, and sterilized the bleeding sets, and the technicians responsible for blood grouping and other laboratory procedures required at least a month's training in excess of their basic technical laboratory training. The usual laboratory technician, even though he was trained in venipuncture, did not attain a satisfactory degree of efficiency in bleeding donors until he had had additional training and practice. Some of the additional training was formal and didactic, but it was soon found that there was no substitute for breaking in a technician by assigning him directly to a bleeding unit in active operation.



FIGURE 92.—Reading Kahn tests on dono. bloods, 15th Medical General Laboratory blood bank.

A certain amount of rotation was practiced from one section of the laboratory blood bank to another, but, in general, the tendency was toward specialization, so as to develop keymen in the blood bank as in other sections of the hospital.

All medical officers and nurses in the Mediterranean theater, as well as selected noncommissioned officers, received thorough training in the technique of reconstitution (fig. 93) and administration of plasma. The training was essential. When casualties were pouring in, there was no time to study instructions or labels on containers. Demonstration sets were used to advantage during the training, and so was Film Strip 8-51 when it was available.

In April 1944, a program was set up by which medical officers from each Army hospital and technicians from each hospital laboratory were sent to the blood bank at Naples for 3 days of intensive instruction. The handling of banked blood was greatly improved at the various hospitals as a result.

In September 1944, a complete series of motion and still pictures were made of blood bank activities from the time the donor arrived at the bleeding center until the blood was used in a frontline hospital. The script was prepared by Colonel Cornell. Film Strip 8-51, a black-and-white 35-mm. production, of 8,400 feet, was sent to the Signal Corps Photographic Center on Long Island on 22 December 1944.



FIGURE 93. Medical aidman preparing dried blood plasma for use, Fifth U.S. Army, M. Grande area, 20 February 1945.

TRANSPORTATION AND REFRIGERATION

Trucks. Transportation obtained from theater stocks consisted of two 2½-ton trucks, two 1½-ton trucks, two weapons carriers, and one ¼-ton jeep. The jeep was used for general utility purposes and to make contact with adjacent units from which donors could be secured.

One 2½-ton truck was mounted with a large refrigerator powered with generators (3 kw.). It had a capacity of 450 pints of blood and was used for storage purposes at the forward distributing section. The other 2½-ton truck, together with one of the 1½-ton trucks, was used at the base section to transport donors and supplies and for similar purposes. The other 1½-ton truck carried a moderately sized refrigerator with the necessary generators, and was used to deliver blood from the bleeding section to the forward distributing section of the bank (fig. 94). The two weapons carriers were mounted with smaller refrigerators, powered by the necessary generators, and were used to distribute blood from the forward distributing section to field and evacuation hospitals.

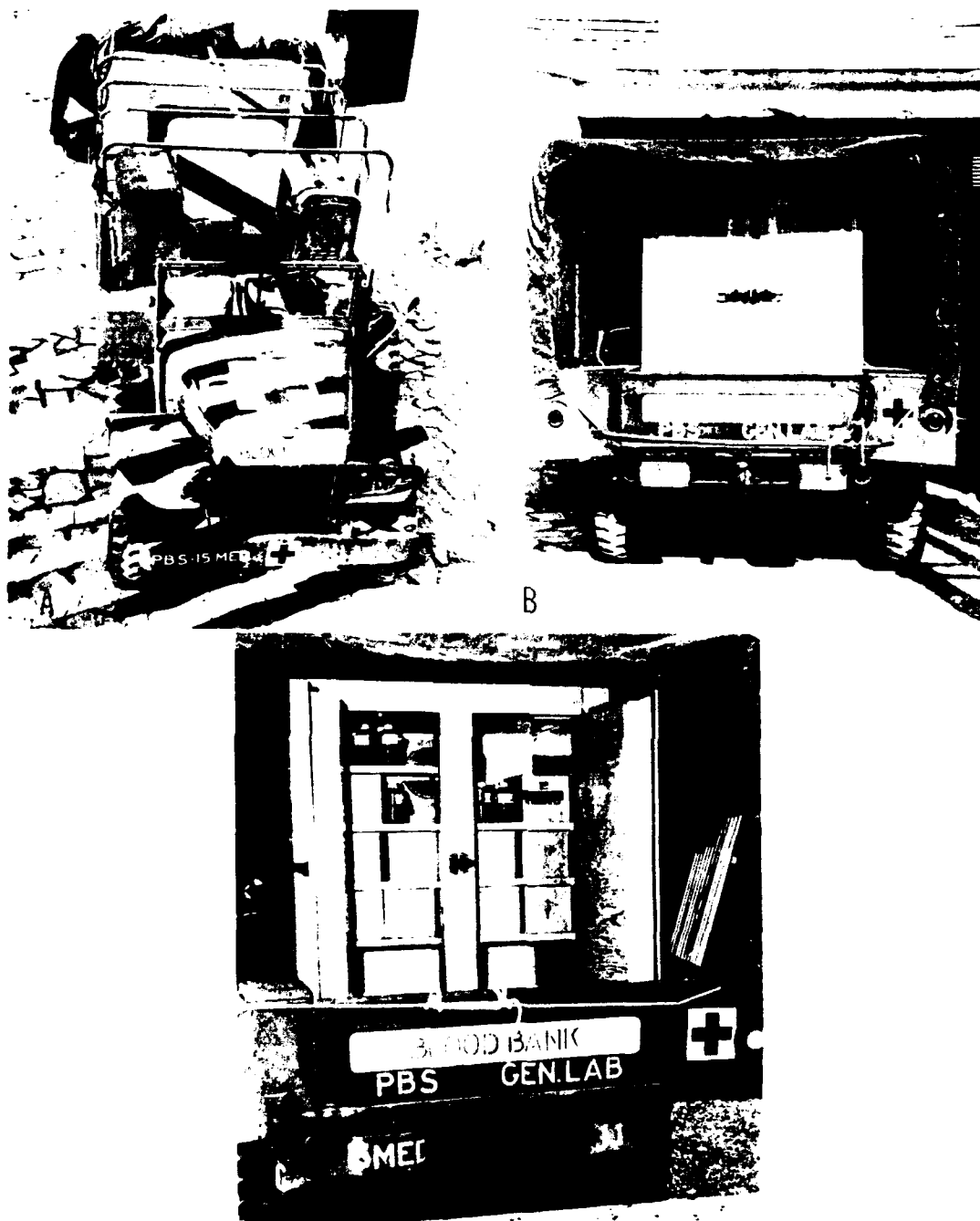

FIGURE 94.—Truck with refrigerator used for delivery of blood, 15th Medical General Laboratory, Naples, March 1944. A. Refrigerator with compressor and two generators, one of which could take over if the other broke down. B. Rear view of truck, showing front of refrigerator, which is a company mess type, reinsulated and altered to fit 1½-ton personnel carrier in which blood is transported. C. Refrigerator opened to show method of storing blood in it.



FIGURE 95.—Insulated box for shipment of blood constructed at 15th Medical General Laboratory, Naples, of U.S. plywood, door hinges, and salvaged blankets; Sardinian cork; German pitch and trunk clamps; and Italian handles. A. Box, open and empty. B. Open boxes (showing top layer of bottles), ready for dispatch to Anzio beachhead, March 1944. C. Closed container, with the 36 bottles of blood that could be shipped in it.

The vehicles were not in the best of condition when they were allotted, and not infrequently one or more had to be put up for repairs.

The delivery of all refrigerators was delayed; the first shipment was lost at sea, and the second did not arrive until some months after the invasion of Italy. Eventually, however, electric refrigerators were available for all medical installations in the theater, up to and including field hospitals. They had sufficient space for about 40 bottles of blood each. When kerosene refrigerators were used, the chief problem was the procurement of white gasoline for their operation. The necessity for good mechanical refrigeration, both in fixed hospitals and on trucks, carried the implication that the services of competent refrigerator mechanics be constantly available.

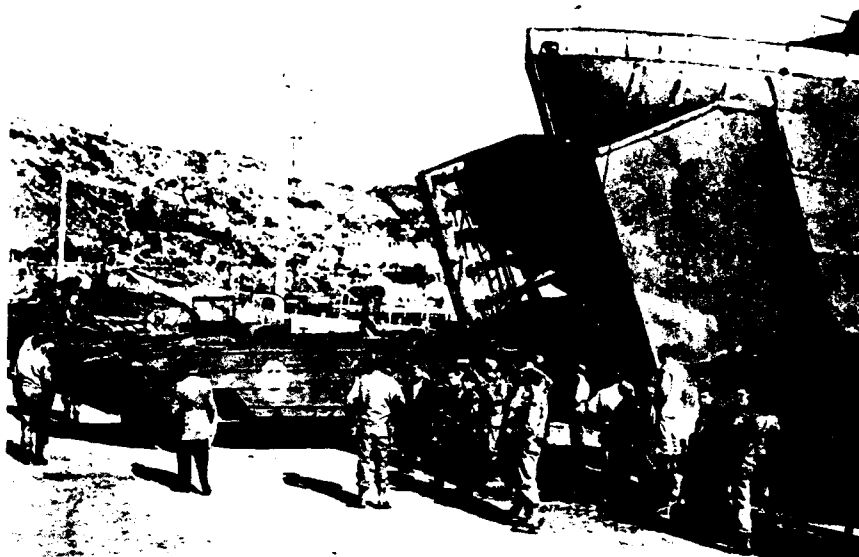

FIGURE 96.—Blood being loaded (as it was daily) at Bagnoli, Italy, on LST for shipment to Anzio beachhead.

The large refrigerators in the 2½- and 1½-ton trucks did not receive unduly rough treatment and stood up very well. The household-sized refrigerators mounted in the weapons carriers did not stand up well, as might have been expected, since they traveled more than 150 miles each day, over very rough roads. They were soon discarded and deliveries were accomplished in insulated boxes (fig. 95).

These boxes, which were constructed in the Utilities Section, 15th Medical General Laboratory, were made of plywood and were insulated with 2 inches of cork. The insulation was sufficient to limit the temperature elevation to no more than 54° F. (12° C.), even when the box was exposed to the sun for 12 hours. A good deal of ingenuity was shown in their construction, which often included Italian hinges, German clamps, and gaskets from salvaged GI blankets. Each container held 4-6 cardboard cartons, each of which contained six bottles of blood.

These boxes were definitely not expendable. Their number had to be limited to the absolute minimum necessary for the operation because of the scarcity of material, particularly plywood and cork. They were later used for the airlift of blood from Italy to southern France (p. 448).

AIR TRANSPORTATION

The first blood delivered to the Anzio beachhead, which was also the first blood distributed from the blood bank at the 15th Medical General Laboratory, was sent by LST's (landing ships, tank) (fig. 96). At this time, the beachhead was still isolated, and most of the blood collected was sent to

the hospitals on the Cassino front. When the fighting was intensified at Anzio, a request was made that blood be flown in. The necessary arrangements were made within 6 hours, and blood was delivered by plane to Anzio and elsewhere regularly thereafter, the largest shipment on a single day being 450 bloods.

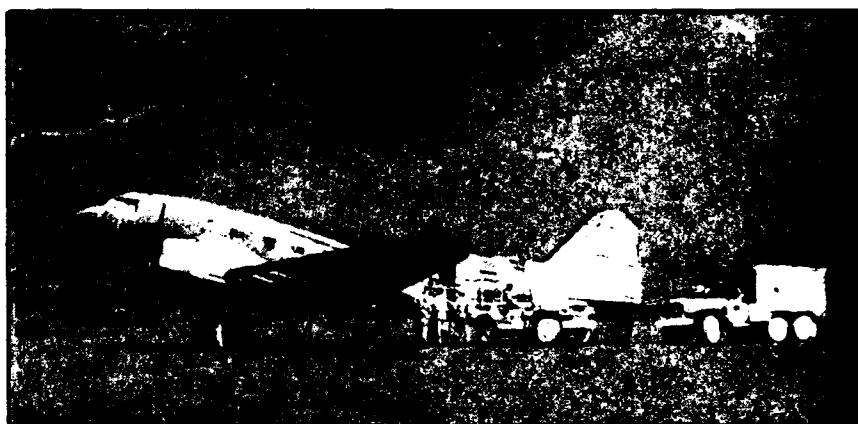

FIGURE 97.—Unloading C-47 blood plane on Cecina Airfield, Italy, August 1944. This plane carried blood in Italy, and later from Italy to southern France.

C-47 plane.—At the request of Colonel Cornell, a C-47 aircraft (fig. 97) was attached to the 15th Medical General Laboratory, to be used as a carrier for the delivery of blood to units of the Fifth U.S. Army, originally to the Anzio beachhead and later, as the fighting moved up the peninsula, to other parts of Italy (map 1).²

At first, the blood plane was operated by the Air Transport Command. Then the task was taken over by the Troop Carrier Command. The pilots lived in the officers' quarters at the 15th Medical General Laboratory, along with the officers of the blood transfusion unit. They took a genuine and personal interest in their work and often flew the blood forward in very bad weather. The most forward airfield capable of taking a C-47 plane was invariably used. Although such fields were often reserved for fighter planes, an exception was always made for the plane carrying blood. The availability of this service made it possible to collect blood from such widely separated points as Naples, Rome, Pisa, and later Florence (map 1), for delivery to hospitals in the Army area.

The blood plane was usually airborne within 90 minutes after the blood was taken out of the refrigerator. The flight from Naples to Anzio took 30 minutes, and from Naples to Leghorn 2 hours.

² The assignment of this plane was a historical first and has not since been duplicated.

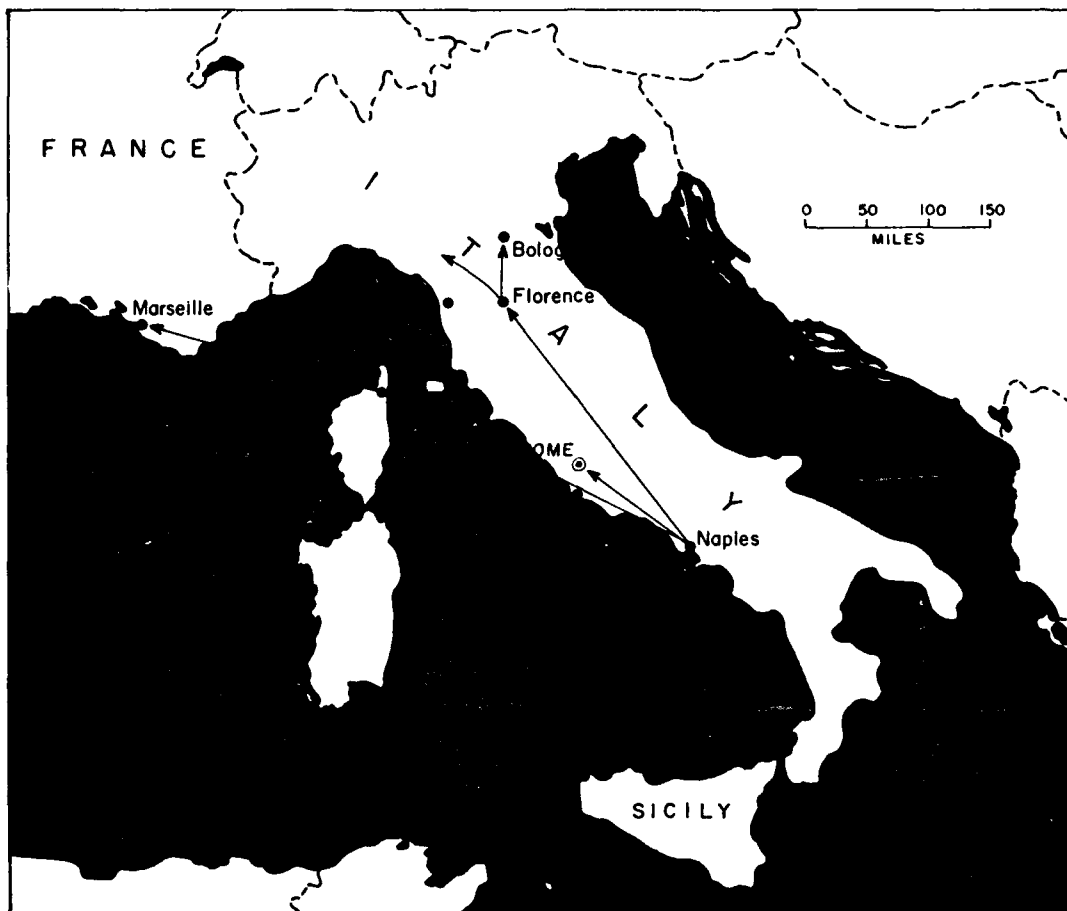

MAP 1.—Map, showing movement of whole blood from Naples up the peninsula, and from Naples to Marseille for Seventh U.S. Army supply.

The blood plane carried penicillin regularly and, occasionally, emergency shipments of dressings, anesthetics, plasma, and other medical items. When the load permitted, it also carried medical personnel. On the return trip, it carried empty insulated boxes, sometimes laboratory specimens, and sometimes medical personnel.

Blood sent forward by air was turned over at the landing field to personnel from the forward distributing center. An important feature of air transport was that the blood was always accompanied by a courier whenever there was any reason to fear that the plane might not be able to make direct contact with the personnel from the forward center. When, as often happened, the field at which the blood plane was to land was inaccessible because of bad weather or for tactical reasons, the pilot landed blood and courier at the nearest available field. It was then the courier's duty to secure transportation for the blood to the forward distributing center, or to make contact with the center and wait with the blood until someone came for it. Even better, when personnel per-

mitted, was the practice of sending two couriers with blood when trouble was suspected. Then, one would wait with the blood at the airport until transportation was available to the forward distributing center, while the other returned on the plane with the requirements for the next day's supply of blood.

The courier system insured that the blood was always under the personal care of personnel trained to handle it properly. Without courier escort, the blood would many times simply have been left on an airfield for hours, without protection from either heat or cold, and would have become useless or dangerous.

L-5 planes.—In the spring of 1945, when L-5 aircraft became available, they were used to shuttle fresh whole blood from the blood bank in Florence to field hospitals in the mountains in the forward area. Later, these planes flew blood into the Po Valley. This service was one of the timesaving and lifesaving improvisations of the Italian campaign. It was used not only during the bitter mountain fighting but also when the Army Medical Service was spread over hundreds of miles after the breakout into the Po Valley.

DISTRIBUTION

The transfusion officer of each evacuation hospital and each platoon of each field hospital coordinated the daily needs of his hospital with the officer in charge of the forward distributing center, who reported the daily needs of the whole forward area to the base bank.

In general, there was a fortunate relation between the distribution of hospitals in Italy and the state of the terrain and roads (11). Both north of Rome and in the Po Valley, the roads were good and the weather was favorable, which permitted rapid movement and pursuit. When the tactical situation bogged down and bad weather was accompanied by deep mud, there was a strain on all theater transportation. On two occasions, once in the vicinity of Rome and later in the Po Valley, hospital units were scattered over such great distances that, if weather or road conditions had existed such as prevailed in lower Tuscany or along the Gothic Line, regular deliveries of blood would have been impossible with the vehicles on hand. With a front of 60-70 miles to be supported, the blood plane leapfrogged the forward distributing unit and delivered blood to the most advanced airfield from which forward hospitals could be serviced.

It was suggested in the final report of the blood transfusion unit (11), that the addition of the half-size blood transfusion detachment, team NA (T/O&E 8-500) would increase transportation by four additional vehicles, as well as increase personnel. With these additions, it would be possible to establish two forward distributing points on a wider extended front and also facilitate intercommunication between dispersed bleeding sections.

During the war and afterward, the suggestion came up at intervals that, whenever it was difficult or impossible to carry blood directly to field or evacuation hospitals by forward distributing units, regular medical supply channels

be used temporarily. To this suggestion, Major Sullivan, Colonel Kendrick, and others responsible for the whole blood program took violent exception for the following reasons (11):

1. Whole blood is highly perishable. A single mistake in its handling, a single lapse in refrigeration, can result (and has resulted) in fatalities.

2. The supply depot has many and various duties, and its organization is not such as to allow it to assume the highly specialized function of handling whole blood.

3. Whole blood is a substance which becomes useless and dangerous with age. To place the responsibility for its handling in normal supply channels would encourage the practice, useful with other items, but highly undesirable with blood, of placing bottles of blood on shelves of various echelons of supply depots, where the dating period would be exhausted before the blood was used or the oldest blood would be used first, to prevent outdating.³

4. A transfusion service operates best when the distribution of blood is in the hands of trained personnel under professional guidance and not under the supervision of supply officers. The only exception to this rule in the Mediterranean theater was the occasional practice, to relieve pressure on transportation, of permitting forward hospitals to pick up their own blood in insulated boxes at the airfield.

5. Professional handling of blood from procurement to use has the following advantages:

a. Receiving hospitals can be assured of fresh supplies of blood at all times because their day-by-day requirements will be filled by trained delivery teams.

b. Daily delivery service makes it possible for the transfusion service to know the whereabouts of each medical facility. This proved to be a very practical point. When an Army was advancing, it was often difficult to find hospitals, particularly when transportation was over country roads already crowded with military vehicles, in clouds of dust, or through deep ruts filled with mud.

c. Professional personnel of delivery teams can provide guidance concerning various aspects of blood transfusion and can, in turn, obtain criticisms from hospitals as to the equipment provided and the service in general.

d. Proper refrigeration during transportation and storage will be assured.

DONORS

Since no provision had been made for blood donors for the landings in North Africa, securing donors was a constant problem until the blood bank was established. Hospitals developed their own methods, but most of them used service troops, keeping them at the hospital until they were needed. At some

³ This situation did come to pass in Korea, where the Supply Service was in charge of the distribution of blood, which frequently was close to the expiration of the dating period when it was issued.

hospitals, they were brought in by truck every morning, 25 at a time. If all were used before night, another group was trucked in. This was a highly inefficient system, and very wasteful of manpower in terms of time. When, however, hospitals had no facilities for the storage of blood, it was the only system possible.

Members of the medical detachment and medical officers attached to hospitals gave generously, but it was soon evident that not enough blood could be supplied from this source.

The use of lightly wounded patients as donors was authorized by the Surgeon, II Corps, on 7 August 1943 (14), but there were few volunteers from this source. These men considered themselves to be patients, and they feared that if complications followed their wounds, they might be so weakened by their donations that they would be in serious trouble. At the 77th Evacuation Hospital (4), it was reported that the stimulus of "I might need it when it happens to me" was completely lacking. In the opinion of even lightly wounded men, "it" had already happened to them. Prisoners of war were sometimes used for donors, but only if they volunteered.

When iceboxes finally became available to evacuation hospitals, many of them drew blood in advance and kept from 4 to 6 pints on hand at all times. The safety and efficiency of this method led to the acceptance of the concept that, if equipment and personnel were provided, it would be entirely possible to draw blood from troops in the base who would not be in combat soon; check the blood there for syphilis and malaria; and then distribute it to all forward hospital installations. This was precisely the system finally put into effect.

When the blood bank was eventually established at the 15th Medical General Laboratory, the great majority of donors were U.S. Army personnel assigned to noncombatant duties or attached to units which would not be in combat for at least a month. Service troops provided many thousands of donors. The best sources were nearby replacement depots and staging areas. A few thousand British soldiers, several hundred U.S. sailors, and a sprinkling of Allied Armed Forces and U.S. civilians gave the remainder of the donations. Many men who had been wounded and had received transfusions reported to the blood bank to pay their debt to it.

Attempts to form donor lists were not successful; the rapid turnover of personnel in replacement depots and staging areas made the lists almost useless, even in service units, in which the population was more stable.

Specifications

Circular Letter No. 3, Office of the Surgeon, Headquarters, II Corps, 7 August 1943, addressed to all unit surgeons and dealing with the care of the wounded in Sicily, listed the following specifications for blood donors (14):

1. Donors must have a negative history and physical examination, and a Kahn test must be performed when possible.

2. A donor with a history of malaria is not acceptable unless he has been symptom-free for 2 years. A donor with a history of infectious hepatitis is not acceptable.
3. Crossmatching must be done before each transfusion.

The following additional specifications were made concerning malaria:

1. All personnel of the U.S. Army in Sicily are on suppressive Atabrine (quinacrine hydrochloride) therapy, and it is recommended that no additional antimalarial therapy be given either to recipient or donor in an emergency transfusion. If the transfusion is elective, a booster dose of Atabrine (0.2 gm.) is given to the donor the night before the blood is drawn, or quinine (10 gr.) is given to him 6 hours before the transfusion.
2. All donors are questioned concerning chills and fever in addition to specific questioning about a history of malaria.
3. The abdomen is palpated. If the spleen is enlarged, the donor is rejected.
4. If laboratory facilities are available, thick and thin smears of the donor's blood are examined for malarial parasites.

A malaria smear was examined for 1 minute about 30 minutes after it had been fixed and stained. Of the first 54,383 donations examined in 1944 (15), only six slides were found positive for malaria, an incidence of less than 1:10,000. By this time, it was the policy to reject donors with a history of malaria, no matter how long they had been symptom-free. In the January-March 1945 period, no positive slides were found in 11,191 bloods. Since laboratory personnel were limited, it was decided, in view of these findings, to abandon malaria smears. An increased incidence of malaria was not observed in battle casualties receiving transfusions after testing was abandoned.

The policy about jaundice varied, but, after November 1944, each donor was required to leave a urine specimen, which was examined by the methylene blue test for increased bilirubin content. A small number of bloods from donors with possible latent jaundice were discarded on the basis of this test (15).

Donors with a history of syphilis were accepted only if standard Army treatment, which had resulted in negative serologic tests, had been completed at least a year before the donation.

Payment of Donors

Circular Letter No. 27, Office of the Surgeon, Headquarters, NATOUSA, 20 August 1943 (16), called attention to Public Law 196, 77th Congress, 30 July 1941, which provided for the payment of blood donors. The law in question permitted payments up to \$50 per donation, but the circular letter stated that, since donations had now become so commonplace, donors would be paid at the rate of \$10 per donation, and higher payments would be permitted only for rare bloods such as those containing antibodies against certain diseases. Payments were facilitated by the appointment of all officers in the transfusion unit as class B finance officers. Funds at their disposition were usually about \$5,000, but, in peak periods, were raised to as much as \$25,000. As a matter of convenience, the Finance Officer, Peninsular Base Section, approved a special form which permitted the payment of 22 donors on a single voucher (WDFD

Form No. 25, Modified) instead of the use of a single form for each individual donor.

Payment of donors, which continued until 31 December 1944, was an important factor in securing blood donors in the Mediterranean theater. Some men refused the money, or asked that it be given to the Red Cross, but the majority accepted it. The practice of giving each donor a drink of whisky after the donation was discussed several times but never put into practice.

SELECTION OF TYPE O BLOOD

Blood sent from the Naples blood bank to the Anzio beachhead and other Army hospitals was all type O. A few patients had mild attacks of shivering or slight chills, but there were no serious reactions at first.

Until April 1944, no attempt was made to screen out O bloods with high anti-A or anti-B titer or to limit the use of high-titer blood to O recipients (7). Differentiation of these bloods had been discussed in planning for the bank, but no action was taken, though the policy of using O blood for all recipients was adopted with some misgivings by a number of medical officers.

In April 1944, two fully investigated cases provided the stimulus to titrate O bloods and to reserve those with high-agglutinin content for O recipients only:

Case 1.—The first patient, seen at the 9th Evacuation Hospital, was an Arab with a severe abdominal wound. His blood type was A. After 75 cc. of group O blood collected at the hospital from another Arab had been given to him, he had a severe chill, his temperature rose to 105° F., and his condition was very poor. The transfusion was stopped at once. An hour later, there was a marked elevation of the blood bilirubin, and a more pronounced elevation 4 hours later, though the serum used for crossmatching before the transfusion had had a normal bilirubin content. Next morning, the sclerae were yellow. The first urine specimen after the reaction had been discarded, but all others were normal, and there was no oliguria at any time. Recovery was uncomplicated.

When the blood in the donor bottle was reinvestigated, it was found to be group O and Rh-positive. The plasma agglutinated the recipient cells in a dilution of 1:8,000, indicating very high titer.

Case 2.—The second patient, at the 94th Evacuation Hospital, had multiple severe wounds and was given six transfusions of O blood, none with an extremely high titer, within 12 hours. Although there was never evidence of hemolysis, he became markedly oliguric, and he died of uremia on the fifth day.

It was considered highly unlikely that this second patient's oliguria was caused by the O blood he had received and much more likely that it was the result of his initial and prolonged shock. Nonetheless, Major Snyder at once initiated discussions with Maj. (later Lt. Col.) Henry K. Beecher, MC, Capt. (later Maj.) Charles H. Burnett, MC, Captain Lalich, and others who had made special studies of shock and transfusion. The reactions were also discussed with medical officers at the 15th Medical General Laboratory.

Captain Lalich reported observing urinary difficulties in a number of other cases of shock which he had investigated. The difficulties were by no means universal, but some had occurred, and some had been serious. He did

not think, however, that sufficient evidence had yet been accumulated to inculcate group O blood or to request that the blood bank furnish type-specific blood. While others thought that the request should be made immediately, it was agreed that low-titer O blood should be given a further trial before any change in present policies was instituted. As a precaution, all blood with an anti-B titer over 1:64 was to be marked for group O recipients only.

On 1 May 1944, when Major Snyder visited the 33d Field Hospital on the Anzio beachhead, he was told of two deaths in group A patients who had received group O blood. Most medical officers were now convinced that the use of group O blood in group A recipients was unsafe and should be discontinued. After further discussions with officers of the blood bank in Naples, it was agreed that sufficient evidence was now at hand to warrant a change in policy and to supply group A and group B blood for group A and group B recipients, respectively. A circular letter would be prepared to accompany the shipments of type-specific blood.

Before these arrangements could be completed, the decision was reversed by higher authority, and the Surgeon, Fifth U.S. Army, was informed on 13 May 1944 by the Commanding General, North African theater, for action by the Commanding Officer, 15th Medical General Laboratory, that the Base Collecting Section of the 6713th Blood Transfusion Unit (Ovhd.) would furnish Fifth U.S. Army installations with only a single type of blood, group O, with an agglutinin below 1:64.

There were two reasons for this decision: One was the fear that more deaths might be caused by errors in crossmatching if both group A and group B blood were supplied than would result if group O blood titered for anti-A and anti-B agglutinogens continued to be used. The second reason was the possibility that group A or B blood might be administered through tubing through which plasma was running, with resulting serious reactions.

In a return radiogram, the Commanding Officer, 15th Medical General Laboratory, pointed out the following facts:

1. Rigid compliance with the order received might necessitate discarding half the O blood drawn. In the past, O blood with an anti-A titer of 1:250 or over had been marked for group O recipients only. This blood comprised only about 15 percent of all bloods drawn. The radiogram just received precluded the use of O blood with a titer of over 1:64 for anyone. Immediate authority was requested for the use of group O blood for O recipients, regardless of titer.

2. Four histologically proved cases of fatal hemoglobinuric nephropathy were known to have followed the use of group O blood for A recipients.⁴ In two of these fatalities, only low-titer blood had been used. Major Beecher had information of other clinical cases in which the circumstances were similar, and he had ceased to use group O blood for A recipients.

3. An immediate investigation by Colonel Churchill was requested, with authority to modify or revoke the order of 13 May from theater headquarters.

⁴ Although fatal hemoglobinuric nephropathy occurred in these four patients, all of whom had received low-titer group O blood, it must not be inferred that the transfusion of the O blood was responsible and that the sequence was causative. Low-titer group O blood was given to many thousands of casualties in the Mediterranean and European theaters and in the Pacific areas without any reactions. The more reasonable explanation of the sequence is that, in these cases, the blood administered contained B isoagglutinins and therefore was incompatible.

The matter was finally resolved by continuing, as in the past, to use group O blood of any titer for O recipients and to mark all blood with a titer of 1:250 or more to be used for group O recipients only.

When the Board for the Study of the Severely Wounded made its report in 1945 (6), it exonerated transfusion as the cause of lower nephron nephrosis in most badly wounded men and put the responsibility on shock (p. 666).

TECHNIQUE OF COLLECTION OF BLOOD

The technique by which blood was collected at the blood bank at the 15th Medical General Laboratory and other bleeding centers was substantially the same as that used in Red Cross bleeding centers in the United States (figs. 98-101).

There was usually an airspace of 20-30 cc. (fig. 102) left in each bottle after the donation. While the various tests were being run, each bottle was reevacuated through a blood donor valve attached to an electric vacuum pump (fig. 103), and the empty space was filled with a 5-percent solution of dextrose in 0.85-percent sodium chloride (fig. 104). The dextrose solution was added from a 1,000-cc. bottle of solution, by means of a valve attached to an appropriate length of rubber tubing. It was used for two reasons, its preservative effect and to fill the bottle completely, so that the red cells would not be traumatized by shaking of the blood during transportation over rough roads. If the bleeding bottle originally contained glucose and citrate, as some did, the topping was accomplished with physiologic salt solution.

When the necessary tests had been carried out and duly recorded, the work-sheet (fig. 101) was handed to a second technician, and each batch of blood was given a final check. Bloods which were not group O were segregated and appropriately labeled. Bloods from donors with positive or doubtful Kahn tests, positive malaria smears, or (later) positive methylene blue urinary tests, were discarded, as were all bottles that showed an excessive amount of hemoglobin in the supernatant plasma.

The remaining bloods, proved to be group O and suitable for transfusion (fig. 105), were labeled *Group O. Kahn negative. Drawn*
Use within 7 days. (date)

Bloods which showed a high anti-A or anti-B agglutinin titer, or both, were further identified by a large shipping tag tied around the neck of the bottle (fig. 105) and reading *For group O recipients only. Carefully group patient before using this blood.*

After the criterion for titration was changed from 1:128 to 1:64, about 35 percent of all group O bloods were labeled as high titer.

After processing was completed, the bloods were refrigerated at 39° F. (4° C.) overnight or longer, depending upon the requirements of forward hospitals. Ordinarily, processing on each batch of bloods was completed well



FIGURE 98. Scenes from bleeding room, 15th Medical General Laboratory, Naples, September 1911.



FIGURE 99.—Completion of individual donation, 15th Medical General Laboratory, Naples, March 1944.

within 24 hours of their collection, so that the freshest possible blood could be sent forward, in view of the 7-day dating period. On some occasions, blood collected at the blood bank in the morning could be flown forward in the early afternoon.

LABORATORY TESTS

Titration

When the possible risk of high-titer blood for non-O recipients was recognized at the Naples blood bank (p. 424), it became the custom to perform a single tube titration against known A and B cells with serum from each O blood (1:32 dilution, 1:64 final dilution). After 14 May 1944, all titrations at the bank were made with a 1:64 dilution of serum, and all bloods whose sera showed agglutination of A or B cells in this dilution were plainly marked for O recipients only. Of the 4,398 bloods titrated by this technique between this date and 31 May 1944, 1,649 (37.5 percent) showed a titer of 1:64 and were labeled accordingly. It was considered more practical to perform titration tests than to employ Witebsky's A and B group-specific substances for specific neutralization of normal isoagglutinin in group O blood (p. 260).

The 6th General Hospital used the following technique in order to employ high-titer O blood in acute emergencies in which an appropriate donor could not be found and in which there was no time to wait for crossmatching (17):

1. All plasma in a flask of high-titer blood was withdrawn and discarded.
2. The plasma withdrawn was replaced with an equal amount of pooled plasma supplied in the standard package.



FIGURE 100.—Technician preparing blood sample for typing, titration, and serologic testing, 15th Medical General Laboratory, Naples.

This hospital gave more than a dozen of these so-called cocktail transfusions with only one reaction, and that pyrogenic.

Typing

In the MTOUSA blood bank, as already described, the blood type was determined by two independent laboratory examinations. Blood from the donor's finger was first matched against known anti-A and anti-B serum with a minimum titer of 1:64. Microscopic readings were done at the end of 30 minutes. The second test was with blood from the tubing used to fill the small bottle; separated serum was matched against a 2-percent saline suspension of known A and B cells.

When blood had to be given in emergencies in forward hospitals and tests for direct compatibility were impractical, the blood group of the recipient had to be accepted on the basis of his identification tag, in which the known error was from 5 to 25 percent.

DAILY WORK SHEET Date _____

Number	Name	Cells	Plus	Serum	Plus	Serum I 64		Kahn			Remarks	
		Anti-A Serum	Anti-B Serum			A Cells	B Cells	A Cells	B Cells	0125		025

FIGURE 101.—Daily worksheet, used to record results of various tests, 15th Medical General Laboratory, Naples.

Other Tests

Kahn tests were performed routinely in the blood bank and in hospitals that operated their own blood banks. In the early days of the North African theater, serologic testing was not always possible; there were no facilities for it ahead of large evacuation hospitals.

After December 1944, the methylene blue test was used on urine specimens collected at the blood bank, to detect excess bilirubin. About 1.09 percent of the examinations were positive or doubtful. This was a pilot survey, and its full significance was not assessed.

The Phillips-Van Slyke copper sulfate method of estimating the hematocrit, hemoglobin, and plasma protein concentration (p. 253) became standard laboratory procedure in the theater as soon as the test was introduced in 1943.

Studies of red blood cell survival in blood collected and processed by the technique used at the Naples blood bank were performed at Harvard in early 1945 by the radioactive iron technique. They showed 80 percent survival at 24 hours in blood used after 14 days' storage.



FIGURE 102.—Blood donations secured at 15th Medical General Laboratory, Naples. Note froth at top of bottle on left, and completely filled bottle on right. Glucose solution will be added to the bottle on left, to fill up space now occupied by froth, partly for preservative effect of solution on red blood cells, and partly to prevent sloshing of blood during transportation.

FACILITIES

In his final report to The Surgeon General in 1945, Colonel Standlee (13) made several points about facilities for a blood bank:

1. The base collection section should be attached to a theater or army laboratory or to a base general hospital close to a large concentration of base troops.
2. Because of the urgent need for sterility, the base unit should be set up in a permanent building or prefabricated hut, with room for beds for bleeding donors and for donors to rest after their donations; office space; laboratory space; space for sterilization, washing, and preparation of equipment; space for storage of blood; and refrigeration facilities. If prefabricated huts were used, three would be required.
3. Quarters for personnel and parking space for vehicles should also be provided.
4. Engineering help would be required for the installation of new facilities. Floors were preferably of concrete. Doors and windows must be screened. Four sinks were necessary. Hot water was desirable; running water, essential. Partitions, laboratory tables, and stools could be of wood. There must be a continuous and dependable supply of 110-volt electric current; refrigeration must not be interrupted.

While these facilities were highly desirable, numerous experiences proved that it was quite possible to bleed efficiently and safely in far less propitious surroundings. Thus, the bleeding center at the Fair Grounds in Naples was a temporary structure of roughhewn boards and beams, with partitions of burlap and cheesecloth. One bleeding center was in a whitewashed cowbarn,



FIGURE 103.—Technician using vacuum pump to create slight negative pressure in bottle of blood, which is not entirely filled. Then, glucose-saline solution (bottle in background) will be introduced into blood bottle through sterile tubing and needle until level of liquid reaches top of bottle. 15th Medical General Laboratory (6713th Blood Transfusion Unit (Ovhd.)), Naples, August 1944.

with two beds to a stall. At the 12th General Hospital, the blood bank was located in two small rooms on the third floor of the building in which the operating rooms were housed. Since the hospital laboratory was some distance away, the bank functioned as a branch laboratory, its function being limited to special tests pertaining to surgery, such as hematocrit determinations and white blood cell counts. The two beds in the smaller of the two rooms that the bank occupied were used for donors during the day and as quarters for bank personnel on duty at night.

EQUIPMENT

Early Improvisations

When evacuation hospitals landed in North Africa in November 1942, equipment for blood transfusion was in extremely short supply (p. 3935). It consisted of small numbers of flasks, burettes, rubber tubing, and intravenous needles. With these meager supplies, it was possible to clean, assemble, and sterilize a few units for the administration of whole blood, which had to be given within 3 or 4 hours after it was collected. Facilities for Kahn tests were

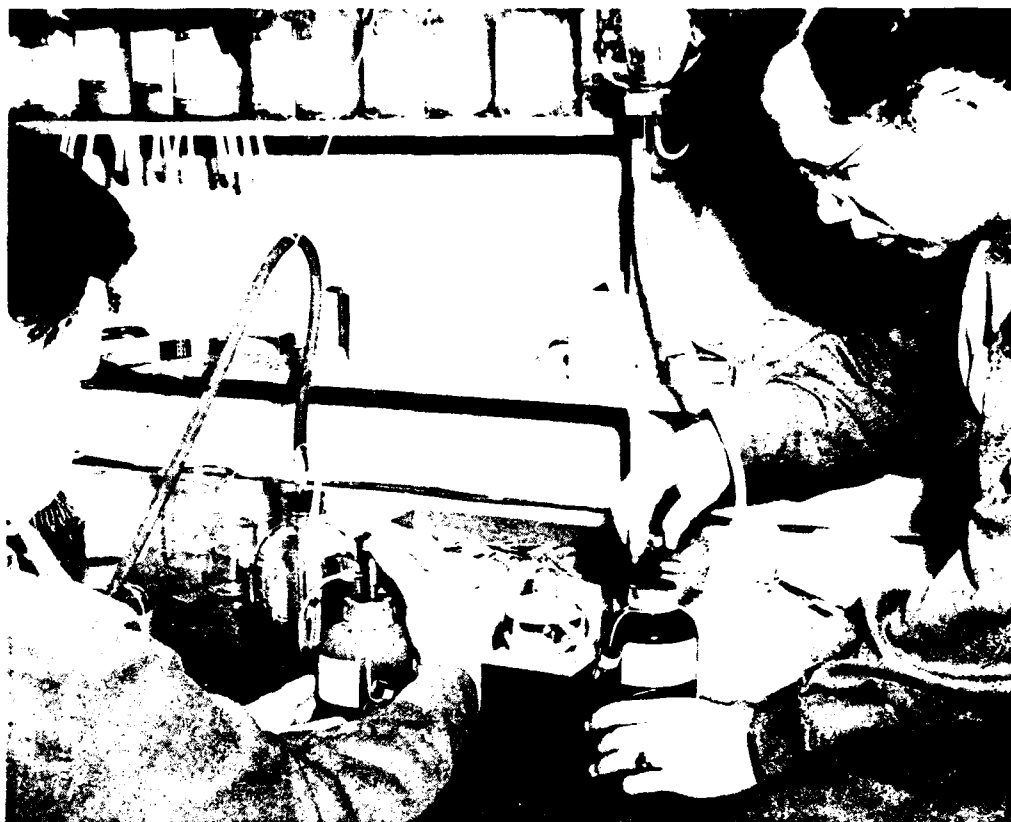

FIGURE 104.—Technicians filling bottles of blood with glucose-saline solution, 15th Medical General Laboratory, Naples, March 1944. Note frothy top content of bottle on left.

not available farther forward than Army medical laboratories attached to evacuation hospitals, and facilities for crossmatching were often lacking.

Improvisations were necessary in all hospitals. The 77th Evacuation Hospital in the beginning used Baxter bottles and tubing from the plasma sets. Then it secured 15 British bleeding bottles, which proved to be more convenient and more easily sterilized because of their metal screw tops. Certain modifications were made in them, including the transfer of the wire mesh from the giving to the taking set to simplify cleaning. The tubing and bottles were first cleansed in cold water, as advised by the British Transfusion Service, and then were rinsed in freshly distilled water (distilled with difficulty (p. 382)), which was never older than 2 hours. After 50 cc. of freshly prepared 6-percent sodium citrate had been placed in each bottle, the metal cap was partly screwed on, and muslin gauze was tied over it. Once bottles and tubing were prepared, they were autoclaved within an hour or less at 15 pounds' pressure for 30 minutes. The metal caps were screwed on tightly before the bottles had a chance to cool off.

Other evacuation hospitals also attempted to operate blood banks by utilizing used saline and saline-glucose bottles for bleeding bottles. The plan

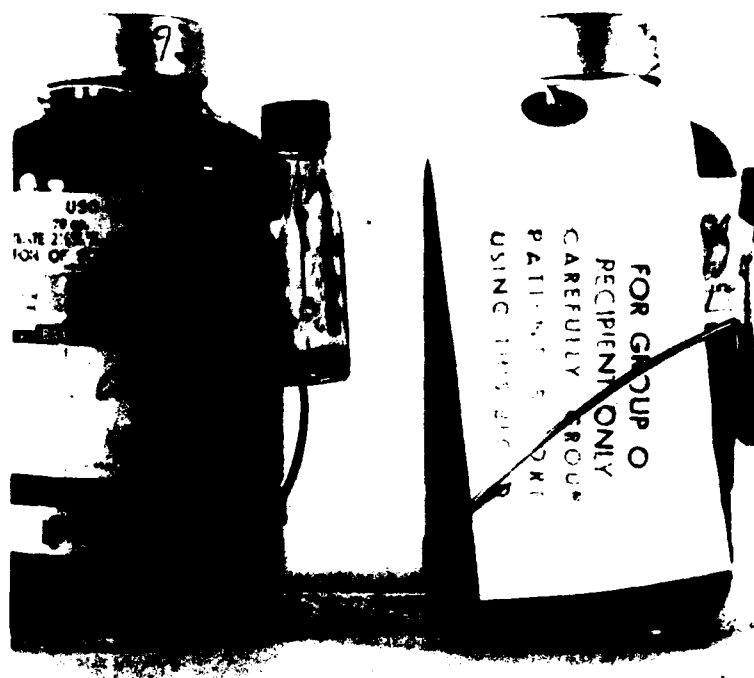

FIGURE 105.—Bottled whole fresh blood collected at 15th Medical General Laboratory, Naples, August 1944. Bottle on left, which is low titer, may be used for recipients in any blood group. Bottle on right, which is high titer, is conspicuously tagged to be used for group O recipients only.

permitted the use of blood but it had many undesirable features. Preparation of the apparatus required a great deal of time and, with the collection and processing of blood, placed too heavy a burden upon already overworked laboratory and surgical personnel. Also, the number of available donors in the Army area was limited, and blood collected in combat circumstances frequently caused reactions.

In spite of the efforts and ingenuity that went into the improvisations used to collect and administer blood in the Mediterranean theater, the fact remains that none of the donor and recipient sets improvised from the bottles and tubing supplied with plasma and intravenous solutions constituted really satisfactory apparatus. Nor did the equipment made from glass and aluminum tubing salvaged from wrecked planes. The distilled water used for cleaning and preparing the improvised equipment and preparing citrate solutions was in short supply and sometimes contaminated. Numerous reactions could be explained by the use of old tubing that was improperly cleaned because of lack of material to clean it adequately.

Many hospitals duplicated the experience of the 38th Evacuation Hospital, in which, until February 1944, when Baxter Transfusovac bottles became available, all the material used for collecting blood was improvised.

Capt. (later Maj.) William T. Thompson, Jr., MC, while in charge of the blood bank at the 45th General Hospital, devised a satisfactory technique of drawing blood in quantity when enough valves could not be obtained for the donor sets. He placed large intravenous needles on the ends of short pieces of heavy tubing which were clamped off until the needles were placed, respectively, in the donor's vein and in the bleeding bottle. Later, a similar piece of equipment was developed by the Army Medical Department. This improvisation was also employed in the continental United States in 1943.

Standardized Equipment

The arrival of blood transfusion apparatus in the Mediterranean theater was long delayed. The first radio request for it to the Office of The Surgeon General, in May 1943, was disapproved because existing regulations did not permit its shipment outside of the Zone of Interior (18).

Requests for bleeding bottles had been frequent since the beginning of the North African campaign, and this equipment, procured through Supply Service channels, began to arrive just as the Italian campaign got underway. Expendable recipient sets were not received in quantity in the theater until early in 1945. This meant that the responsibility for the preparation of recipient sets rested with individual hospitals during most of the war. It was a considerable task for busy forward hospitals, but they did it remarkably well, realizing that an appreciation of the importance of whole blood replacement whenever blood loss had occurred carried with it the obligation of having sufficient recipient sets and tubing ready at all times.

Donor set.—The 6713th Blood Transfusion Unit (Ovhd.) report for June 1944 (11), after some experience with the Army expendable blood donor apparatus (Medical Supply Item No. 9351510), contained the following comments on it:

1. The use of this donor set is limited by a number of considerations, beginning with the fact that a preliminary period of trial and error is necessary before a technician, no matter how skilled he may be with other types of donor sets, can master this one.

2. The set is not well adapted for donors whose veins are small or whose blood flow is sluggish. Unless donors in these categories are bled in 4 to 4½ minutes, clotting will occur in one or both needles.

3. The greatest usefulness of this set is in outfitting bleeding teams to collect blood at multiple or isolated points, and also in eliminating some of the work during periods of stress, when as many as 800 donors sometimes must be bled in a day.

4. The valves are eminently satisfactory when they are properly cared for, assembled, and used. With them, one man can bleed two donors simultaneously with relative ease, and the total personnel required for bleeding is fewer. Bleeding personnel, however, preferred the old type stainless steel mechanical valve (a component of item No. 3609300) to the new stainless steel valve containing a rubber inset, which they often found difficult to operate.

5. If the thick-walled taking tube were 18 inches in length instead of 12 inches, it would

be more flexible, and the hose could later be used for local bleeding, or could be issued to fixed hospitals which drew their own blood.

The donor needle on this set was not intended to be salvaged, but personnel of the unit commented that it could have been made useful for subsequent venipunctures to secure blood specimens or for use on nonexpendable donor sets if a slight change had been made in the structure of the hub. With this change, a syringe or adapter could be fitted onto the needle, and it could be washed thoroughly before sterilization.

Expendable recipient set.—The blood transfusion unit personnel had no experience, of course, with the disposable recipient set (item No. 9351520), but secured the following comments on it from officers and technicians who used it in forward hospitals. The experience with it in June 1944 was limited, but some of the comments were repeated in the ETMD for May 1945 (19), after it had been used in more than 10,000 transfusions in field and evacuation hospitals:

1. This set has the great advantage of being expendable. Until it was received in sufficient numbers, shortly before the war ended, the cleaning and sterilization of donor sets constituted the chief problem in the operation of a transfusion service.

2. The absence of any visible drip mechanism makes it impossible, or at least very difficult, to determine whether blood is flowing satisfactorily into the recipient or if the apparatus has become plugged. Since one person frequently must observe multiple transfusions, and at the same time perform other duties, it is important to be able to determine the speed and efficiency of the blood flow.

3. The use of an unhubbed needle to tap the vent tube of the bleeding bottle does not permit the creation of a pressure chamber inside the bottle to start or accelerate the blood flow.

4. If a short bevel were substituted for the long bevel on the giving needle, the hazard of transfixing veins in shocked casualties with collapsed veins would be greatly reduced.

5. Piercing of the rubber bung of the bleeding bottle at the correct point is frequently difficult because of the small grasping surface presented by the hub of the puncture needle. When this difficulty has arisen, the intense squeezing effect of the fingers has frequently caused the rubber hose to spread laterally over the puncture needle, with a resulting air leak in the vacuum in the bottle, which it is possible to overcome by tying a few turns of black silk over the portion of the rubber hose encasing the hub.

6. The giving needle is the hose-connector type. A glass adapter fitting the standard hubbed needle would be highly desirable for several reasons: In casualties with low blood pressure and collapsed veins, it is difficult, without such an adapter, to know when the needle is in the vein. In burned or wounded casualties, it is often necessary to use the same vein for numerous purposes, such as withdrawing blood for examination with a syringe and giving various therapeutic fluids. In the most severely shocked patients, in whom a cannula is tied into the vein, an adapter could be readily removed from the needle and inserted into the cannula.

7. Since the blood flow is dependent upon gravity, and since resistance in the line may greatly impede the flow, it would be better if the thin rubber giving line were made 48 inches rather than the present 42 inches.

8. In badly bled-out casualties, emergencies often arise in which it is desirable to give blood under pressure. This is not possible with the present airway-piercing cannula, which is sawed off and hubless. An airway-piercing needle with a hub and with an attached short length of rubber tubing would remedy this defect.

9. The structure of the apparatus is not suitable for administering multiple transfusions through a single needle or the successive administration of blood, plasma, and electrolyte and glucose solutions through a single needle. As a result, multiple successive venipunctures are necessary, which is a serious drawback in seriously wounded casualties.

These and similar comments were, of course, justified. On the other hand, it was fully realized, when the recipient set was devised, that it was not so complete as the commercial set used in fixed hospitals in the Zone of Interior. But some of the refinements had to be sacrificed because of shortages of critical materials and in the interest of reducing the size of the oversea package. In spite of the lack of a drip flowmeter, the recipient set worked well because, in the treatment of casualties in shock, speed of injection of the blood was so desirable that there was no real need to meter the blood flow.

PRESERVATIVES

If preservative solutions that permitted storage of blood for 14 to 21 days had been available in the Mediterranean theater when the blood bank was established, a good deal of waste would have been avoided. At that time (February 1944), the bleeding bottles contained only sodium citrate solution, which is an anticoagulant, not a preservative. Even when dextrose was added to the blood, the dating period did not exceed 7 days.

Bottles containing 600 cc. of Denstedt's solution were available in the Zone of Interior, but could be shipped only in small numbers. Later, bottles with Alsever's solution could have been requisitioned from the Zone of Interior, but most surgeons in the theater, like others in other theaters, considered the volume of this preservative solution undesirable. It would also have introduced the risk of pulmonary edema in patients who required many transfusions in a short period of time. ACD solution was never used in the Mediterranean theater. It was not standardized by the Medical Department until early in 1945, and, by the time bottles containing it had reached Italy, the war was over.

STATISTICAL DATA

Requirements for, and Utilization of, Whole Blood

When the blood bank was established in Naples in February 1944, it was estimated that the amount of blood needed per casualty would be from 0.6 to 0.7 pint. In the last 4 months of 1944, this estimate was reasonably well sustained.

In their study of combat casualties in Fifth U.S. Army hospitals, Colonel Snyder and Capt. (later Maj.) James W. Culbertson, MC, compiled the following data (7):

1. Of all the casualties treated in field hospitals, about 70 percent required blood and received an average of 3 pints each. About 63 percent required plasma and received an average of 2½ units each.

2. Of all the casualties treated in evacuation hospitals, about 20 percent required blood and received an average of 2 pints each. About 15 percent required plasma and received an average of 2½ units each.

3. While the average administration of blood late in 1944 was 0.6 pint per casualty, this was true only in hospitals in which blood was used in adequate amounts. The rates for all Army hospitals were far below this.

4. The effect of the location of the hospital on the need for blood is evident in the figures for the Salerno-Cassino fighting, in which 4,600 transfusions were given in the Army area, against 300 at the base. When, however, the base was close to the battleline and evacuation was rapid, its needs rose accordingly.

The changing concept of blood and plasma is also evident in comparative figures (2):

During the Tunisian campaign in February 1943, in a series of 200 surgical patients, half of whom required emergency operation, 6 blood transfusions were given, against 350 plasma infusions. At this time, the surgeons had little choice; they had ample amounts of plasma but no facilities for transfusion and no donors except detachment personnel, who could not be checked for either malaria or syphilis.

Of 431 seriously wounded patients admitted to one II Corps hospital between 21 January and 28 February 1943, 101 received plasma and 31 whole blood. In March 1943, of 561 patients who underwent 741 surgical procedures at the 48th Surgical Hospital, 97 received whole blood. A few more lives might have been saved, Major Snyder noted, if a more convenient method of blood transfusion had been available, as well as better sources of blood.

When this same hospital moved forward in May 1943, to support the final Bizerte offensive, at one time it was within 12 miles of the fighting front. Between 4 and 11 May, it admitted 403 casualties, of whom 292 underwent major surgical procedures, which were often multiple. Between 5 and 8 May, it averaged 60 admissions per day. On 7 May, 82 operations were performed. During this period, 84 transfusions and 291 plasma infusions were given (1:3.4).

Losses

The registration and bleeding of a donor at the bleeding center did not necessarily insure that his blood would be used for a wounded casualty (table 14). For a number of reasons, there was a loss of approximately 10 percent between registration and distribution, and a further loss of about 5 percent between distribution and use. Among these reasons were losses from breakage, clotting of the blood in bottles, clogging of the blood in recipient sets, and expiration of the dating period. Some of these factors could be partly controlled, but not all of them could be eliminated.

A certain amount of hemolysis occurred at the time of bleeding, apparently being influenced by the operator's technique. Each time new groups of technicians were trained, the incidence of hemolyzed blood rose. While a certain amount of hemolysis (estimated at 25 mg. per 100 cc.) was considered compatible with safety, no one could say with certainty where the dividing line was, and the practice was to err on the side of caution.

TABLE 14.—*Production of 6713th Blood Transfusion Unit (Ovhd.), February 1944–June 1945*

Year and month	Donors		Bloods		
	Registered	Rejected	Collected	Discarded	Distributed
<i>1944</i>					
February	258	9	249	2	247
March	2, 074	69	2, 005	25	1, 980
April	1, 793	104	1, 689	130	1, 559
May	6, 958	564	¹ 6, 644	273	6, 371
June	5, 017	375	² 5, 092	72	5, 020
July	6, 724	510	6, 214	281	5, 933
August	8, 509	696	7, 813	617	7, 196
September	11, 708	866	10, 842	454	10, 388
October	10, 615	724	9, 891	207	9, 684
November	4, 010	265	3, 745	200	3, 545
December	4, 029	273	3, 756	156	3, 600
<i>1945</i>					
January	3, 293	192	3, 101	256	2, 845
February	4, 033	125	3, 908	221	3, 687
March	4, 444	262	4, 182	225	3, 957
April	11, 521	814	10, 707	427	10, 280
May	2, 261	130	2, 131	85	2, 046
Total	87, 247	5, 978	81, 969	3, 631	78, 338

¹ Includes 250 bottles collected by the 2d Medical Laboratory (Army).

² Includes 450 bottles collected by the 2d Medical Laboratory (Army).

A satisfactory explanation was never advanced for the hemolysis invariably present to some degree when the vacuum technique was used. Some medical officers with extensive experience explained it as due to an excess of glycerin in the valves. Others, with equal experience, thought the explanation was too rapid bleeding, with collapse of the tube during the procedure. Still others thought the high vacuum in the bleeding bottle might cause disruption of a certain proportion of red blood cells.

Every attempt was made to adjust supply to demand, but with a storage period limited to 7 days, this was extremely difficult. Not infrequently, stocks had to be built up in expectation of a large-scale offensive that was later postponed. The end of heavy fighting was even more unpredictable than the beginning of an offensive, so again, when fighting suddenly ceased, the bank would be left with large stocks on hand. Some wastage of blood would have been avoided, as well as wastage of vacuum bottles always in short supply, if the blood transfusion unit had been given more precise advance information about probable casualties in forthcoming engagements.

The base section ordinarily had a 24-hour supply of blood on hand and the forward distributing section, an additional 24-hour supply. Blood thus reached forward hospitals on the third day, leaving it with 4 more days of useful life.

Very little blood was used in Italy after the 7-day dating period because of daily deliveries from the base to the forward section and from the forward section to Army hospitals. The schedule was difficult to maintain because large reserves could not be built up without risking wastage from aging. It was practical only because the lines of communication were short.

Whenever possible, blood not used in forward hospitals was distributed to base hospitals, being shipped back to them as it neared its 7-day limit. There were times, however, when this was not practical. The various field and evacuation hospitals were sometimes so widely separated that regular contact with them was impossible and their aging blood could not be secured for salvage. This happened at the fall of Rome, when the distributing unit went forward with Army hospitals and for a time was completely out of touch with hospitals in Rome.

The total blood transfusion unit loss of 10 to 15 percent from bled donor to transfused recipient was probably as close to the absolute minimum as possible when dealing with blood that had a 7-day expiration date.

Overall Statistics

The 200 pints of blood brought into Anzio on 22 January 1944, the day of the landings, were used up by 27 January. Thereafter, an average of 100 pints per day was brought in, usually by LST's, less often by small planes, which could land on the airstrip without drawing German fire. Two enlisted men, who checked all incoming supplies, had the special responsibility of watching for the blood and dispatching it immediately by truck to the medical dump. It was held there by the British transfusion unit, which stored it and distributed it. This was a highly efficient operation.

Something over 4,000 pints of blood were brought in between 22 January and 25 February, inclusive. Between 26 February, when the blood bank at Naples took charge of the operation, and 25 May 1944, 5,128 pints of blood were supplied to the hospitals on the Anzio beachhead.

Before the breakout at Anzio at the end of May 1944, it had become evident that the blood bank could not supply as much blood as would be needed for that offensive. With General Martin's approval, Major Snyder arranged with Lt. Col. (later Col.) Kenneth F. Ernst, MC, Commanding Officer, 2d Medical Laboratory, which was attached to the Fifth U.S. Army, for an additional 100 pints daily (?). The first delivery was made on 26 May. With more recipient sets, the laboratory could have supplied more blood. With the limited number available, it was necessary to stop collections at noon every day to clean and resterilize the equipment.

Tables 14 and 15 show the production and distribution figures for the blood collected in Italy from the first collection at the 15th Medical General Laboratory in February 1944 to the end of the fighting in that theater in May 1945. The figures include the blood collected by the laboratory before

the 6713th Blood Transfusion Unit (Ovhd.) was activated; the blood collected by the 6703d while it remained in Italy (p. 455); and the blood collected by the 2d Medical Laboratory (Army) while it was attached to the Fifth U.S. Army. It does not include figures for blood collected by individual hospital blood banks.

Report of 6713th Blood Transfusion Unit (Ovhd.)

The tabulated report of the 6713th Blood Transfusion Unit (Ovhd.) for January–May 1945 was as follows (11):

Of 25,689 donors registered, 1,659 had to be rejected, 1,251 because they were not group O (group A 854, group B 309, group AB 88). The other 408 were rejected because of disease, recent donations, and a variety of other reasons.

Of the 24,030 donors bled, 23,862 were group O (group A 127, group B 36, group AB 5).

Of the bloods drawn, 1,199 were discarded at the bleeding center (5 percent), because of hemolysis and outdating (682); incomplete filling of bottles (189); positive serology (114); and positive or doubtful bilirubinuria by the methylene blue test (214).

TABLE 15.—*Distribution of 78,329 bloods collected by 6713th Blood Transfusion Unit (Ovhd.), February 1944–June 1945*

Year and month	Hospital distribution			Total
	Fifth U.S. Army	Seventh U.S. Army	General and station	
<i>1944</i>				
February.....	229		18	247
March.....	1,822		158	1,980
April.....	1,536		23	1,559
May.....	5,223		513	5,736
June.....	3,630		1,820	5,450
July.....	4,126		1,644	5,770
August.....	1,092	3,539	2,285	6,916
September.....	4,198	4,380	1,498	10,076
October.....	5,998	3,144	1,087	10,229
November.....	3,121	168	433	3,722
December.....	3,314		325	3,639
<i>1945</i>				
January.....	2,688		192	2,880
February.....	3,493		114	3,607
March.....	3,796		166	3,962
April.....	9,624		315	9,939
May.....	2,038		482	2,520
June.....	94		3	97
Total.....	56,022	11,231	11,076	78,329

In addition to the 682 bottles of blood discarded at the bleeding center because of hemolysis and outdating (2.8 percent), 120 were discarded at the distributing center for the same reasons plus assumed contamination (0.5 percent).

Of the total of 24,030 donors bled, 1,319 bloods were discarded for all reasons (5.4 percent). From the 25,689 donors registered, 22,831 bottles of blood were secured for distribution. There was thus a net loss of donors, blood, or both between registration of donors and distribution of blood of 2,858 (11.1 percent).

Of the 22,831 useful bottles of blood, 19,779 were distributed to Fifth U.S. Army hospitals; 675 to base hospitals in Naples; and 2,301 to base hospitals in Florence, Leghorn, Pisa, Verona, and Bologna. Fifty-four bottles were used for media and typing sera, and 22 bottles were on hand at the end of the fighting.

Of the 23,683 group O bloods whose agglutinin titers were determined, 7,113 were found to have anti-A, anti-B, or both anti-A and anti-B titers of 1:64 or over (30 percent). These bloods were labeled *For group O recipients only. Group patient carefully.*

The following laboratory tests were made on the blood collected:

74,914 blood groupings, including 25,440 screening tests, 24,440 cell groupings, 24,030 serum groupings, and 5 Rh groupings.

24,030 slide agglutinin titrations.

25,486 hemoglobin determinations.

24,030 Kahn tests.

209 Kolmer tests.

9,565 malaria smears.

24,118 tests for urinary bilirubin.

HOSPITAL EXPERIENCES

The experience of individual hospitals brought out many practical points in the use of whole blood. Thus the 9th Evacuation Hospital, which functioned as a general hospital in Italy and as an evacuation hospital in southern France, found it extremely important to identify bleeding bottles and tubes very carefully by number because of the large number of Arab patients with the same names, or almost similar names. It also found it important to do minor as well as major crossmatching.

The 45th General Hospital established its own blood bank in March 1944 after observing the value of whole blood in delayed primary wound closure; it recorded only four unsatisfactory results in 265 such wound closures. Bank personnel emphasized that a great deal of waste could have been avoided had the hospital received some advance notice, as it usually did not, about the probable number and general type of casualties it would receive after an offensive.

At the 21st General Hospital (20), the training program in anesthesia included instruction in resuscitation, oxygen therapy, transfusion, and other intravenous therapy. This section administered all blood. The two enlisted men attached to it were trained in transfusion and oxygen therapy and served as assistants to the chief anesthesiologist.

At this hospital, detachment personnel interested their friends in nearby units in the blood bank and had a stirring response. Needs were met and then surpassed; it was not uncommon to turn away more donors than were bled.

The number of transfusions rose progressively from 22 in January to 827 in November and 1,761 in December. Those who watched the results of the blood program as it unfolded remarked many times that they were watching medical history in the making. Anesthesiologists declared that they no longer had to contend with shock on the operating table, no matter how formidable the surgery. Surgeons undertook operations on patients whom they once would have considered hopeless risks, without fear of irreversible pathophysiology. The universal opinion in this hospital was that blood accomplished what plasma simply could not accomplish.

When the 21st General Hospital arrived in southern France, maintenance of its blood supply was difficult because of the small number of troops in the immediate vicinity. This problem was solved by organizing a laboratory team which went to accessible units and bled the donors there. The whole experience of this hospital is an interesting illustration of what could be accomplished, in the face of difficulties, once personnel were convinced of the need for, and the value of, whole blood in the management of wounded casualties.

SURVEY OF BLOOD PROGRAM

Most of the material in the report to The Surgeon General by Colonel Kendrick on his visit to the Mediterranean theater in October 1944 (21) is presented elsewhere in this volume, under the headings of shock, resuscitation, complications of blood transfusion, especially anuria, and other headings, but certain general comments should be repeated here:

1. The interest and enthusiasm displayed by the medical officers and other personnel in the theater over the potentialities of whole blood were impressive. Equally impressive was their recognition of the possible dangers associated with its use.

Colonel Churchill had himself supervised the development of the program from his arrival in North Africa in March 1943. His first recommendations were the result of his personal verification of the need for whole blood by his own examination of wounded casualties in clearing stations and forward hospitals. Highly competent medical officers had then been assigned to work on the problem from various aspects: Major Sullivan and Captain McGraw, from the standpoint of the supply and preservation of whole blood; Major Beecher, from the angle of resuscitation in field and evacuation hospitals; and Maj. Champ Lyons, MC, and Maj. (later Lt. Col.) Oscar P. Hampton, Jr., MC, who studied the indications for whole blood in base hospitals in connection with their work on penicillin.

As might have been expected, there were some divergences of opinion, even in this small group, but by this time certain principles had been established as basic and should be used to guide future blood bank operations. The experience of these officers by this time was so large that their conclusions could be accepted as entirely valid.

2. The officers in the theater worked on the premise, established in the Zone of Interior, that fresh blood is necessary in the treatment of battle casualties and that any departure from its use is simply to meet contingencies imposed by the military situation.

3. The error in identification tags was about 10 percent, which corresponded to the error found in the European theater (p. 244).

4. The possible relation of anuria to the use of group O blood was recognized (p. 424), but remained to be proved. It was suggested, however, that it might be safer to use low-titered O blood (1:128) until a definite conclusion was arrived at, even though the policy would require another testing procedure in the bleeding center.

5. A tendency was sometimes observed to give too much blood before surgery in field and evacuation hospitals. Experience showed that casualties who failed to demonstrate clinical improvement after receiving 3-4 pints of blood were either continuing to bleed or had some fulminating infection. In either event, surgery was necessary. Transfusion should be continued during the operation.

6. Practically all instances of shock observed by Colonel Kendrick were the result of hemorrhage. Most casualties in shock had hematocrits ranging from 25 to 30, as the result of hemorrhage followed by hemodilution. Even when these patients had received adequate amounts of blood in forward hospitals, they entered base hospitals with hematocrits from 30 to 35. It was the general impression that such patients withstood surgery better when their hematocrits had been restored to approximately normal values (40-45). A pint of blood raised the hematocrit by an average of 3 percent and the hemoglobin by an average of 0.9 gm. percent. Studies of several series of compound fractures of the femur by Major Lyons and Major Hampton showed that an average of 2,600 cc. of blood was required over a 3-4 day period to carry the patients safely through surgery. No proof had been found that multiple transfusions modified infection or increased the speed of healing, but there was no doubt that these patients withstood surgery better when their blood values were approximately normal.

7. Alkalinization was considered indicated when multiple transfusions were necessary. At this time, 150 cc. of 4-percent sodium citrate was being used for this purpose. Since sodium-r-lactate (6/M.) was already available in 500-cc. vacoliter bottles (Baxter), Colonel Kendrick recommended that it be standardized and used instead. His recommendation was accepted.

8. Expendable collecting and giving sets were not yet available in the Mediterranean theater. Preparation and sterilization of these sets in busy evacuation and field hospitals were difficult to accomplish properly, as some reactions proved very clearly. Colonel Kendrick recommended that transfusion teams be provided with flexible equipment; namely, 1,000-cc. collecting bottles containing Alsever's solution and 600-cc. bottles containing Denstedt's solution. This recommendation was not implemented.

COMMENT

On 29 October 1944, in his letter of transmittal to the Surgeon, NATOUSA (9), Colonel Cornell noted that the accompanying quarterly history of the 6713th Blood Transfusion Unit (Ovhd.) was "probably the first of its kind." His (first) indorsement continued:

Captain McGraw has briefly told the essential facts of the activities of that unit and its cooperative partner, the 6703 Blood Transfusion Unit (Ovhd.). Their successful accomplishments of their mission have been in great part due to Captain McGraw's training, industry, and application to duty. Under his leadership they have successfully met demands for three and four times the quantity of blood originally considered. The men at the base section have worked steadily for long hours to continually supply the needs of at first one, and then two, armies. The forward distributing sections have driven all the rough roads at the front day and night and have accomplished an excellent job. The pilots of the blood planes have flown through foul weather when other ships were grounded and landed on "closed" fields to get the blood through. Blood bank couriers have ridden many miles in open trucks to deliver the blood forward when our advanced fields could not be used. The entire group are to be highly commended for a new and difficult task, not done, for they will carry on, but carried thus far in the best traditions of the Medical Department.

Anyone familiar with the work of the oversea blood banks in all theaters knows that this tribute is applicable to them all.

Part II. Seventh U.S. Army

ORGANIZATION

When the Seventh U.S. Army invaded southern France in August 1944, the supply of whole blood for it furnished few problems because it utilized the experience of the blood bank at the 15th Medical General Laboratory in Naples and of the 6713th Blood Transfusion Unit (Ovhd.) which operated out of it (22-24). The field and evacuation hospitals of this Army were thus relieved of the heavy task that had been the original lot of forward hospitals of the Fifth U.S. Army, procurement and storage of their own blood as well as its administration. The Seventh U.S. Army also escaped the always undesirable necessity of bleeding line and service troops in forward areas.

The 6703d Blood Transfusion Unit (Prov.)⁵ which supported the invasion of southern France was made up of personnel withdrawn from three sources between February and April 1944: (1) an inactivated station hospital; (2) the 1st Medical Laboratory; and (3) the 6713th Blood Transfusion Unit (Ovhd.). It was attached to the 15th Medical General Laboratory for instruction and

⁵ The 6703d Blood Transfusion Unit (Prov.) was set up at Bagnoli, Italy, on 22 June 1944, by General Orders No. 124, Peninsular Base Section, NATOUSA, on 21 June 1944. On 31 October 1944, the unit was relieved of its attachment to the Peninsular Base Section and assigned to Continental Advance Section at Dijon. On the same date, all officers and enlisted men were relieved of their assignment to the unit and assigned to the Office of the Surgeon, Headquarters, NATOUSA, whence they were transferred to the European theater.

On 17 February 1945, by Organization Order No. 122, Headquarters, Communication Zone, ETOUSA, the unit was redesignated the 6825th Blood Transfusion Company (Non-T/O).

training. By the time personnel were assigned to it on 1 July 1944, almost all of its equipment was available.

The organization and operation of the 6703d Blood Transfusion Unit were facilitated by a number of facts: The 1st Medical Laboratory, from which part of its personnel was secured, had been staging with the 15th Medical General Laboratory since 1 May 1944. Personnel assigned from the 6713th had gained considerable practical experience during the advance on Rome in June 1944 and were now well versed in blood bank operations. After the 6703d was activated, the two units worked together until the forward distributing section went to France on 15 August 1944. After that date, the bleeding and processing section of the 6703d continued to work with the blood bank in Naples until it also moved to southern France in November.

As the result of these circumstances, the careful training by Colonel Cornell, and the warm interest and cooperation of Colonel Arnest, Surgeon, Peninsular Base Section, NATOUSA, the 6703d Blood Transfusion Unit (Ovhd.) was a well-trained and smoothly functioning unit when it began to operate independently. It was divided into a base bleeding section and forward distributing section and, in general, it followed the techniques and policies of the 6713th Blood Transfusion Unit.

PERSONNEL

The authorized personnel of the 6703d Blood Transfusion Unit consisted of a major, MC; two captains, MC; two captains, SnC; and 28 enlisted men, including 1 technical sergeant and 3 staff sergeants. A full complement of officers was never attained, but the roster of enlisted men and noncommissioned officers was usually complete.

In his final report, the historian of the unit noted that the personnel originally assigned to the base bleeding section could handle 100 pints of blood a day. The unit consistently shipped close to 200 pints, which required borrowing personnel from other organizations. It was recommended that additional personnel should be provided in any future table of organization, particularly two additional drivers and two additional laboratory technicians. This recommendation was carried out.

Although the unit was supposed to be attached to an Army laboratory for administration as well as for rations and quarters, it soon became evident that many administrative duties would have to be handled by unit personnel, in addition to their regular duties. It was recommended that in the future the table of organization for a blood transfusion unit provide for a master sergeant and a clerk-typist. This recommendation was carried out.

OPERATIONS

The base bleeding section of the 6703d Blood Transfusion Unit began operations in July 1944, assisting the 6713th to supply blood to the Fifth U.S.

Army. Both units were attached to the 15th Medical General Laboratory, and personnel and equipment were pooled. Different sections of the 6703d were sent to France in August and in October, but the combined activities of the two units continued until the last section of the 6703d went to France on 27 October 1944.

Invasion of Southern France

The forward distribution section of the 6703d Blood Transfusion Unit was assigned to the 1st Medical Laboratory for the invasion of southern France on 15 August 1944. The personnel who landed with the assault troops on D-day were attached to platoons of field hospitals, and each group was supplied with refrigerators mounted on trucks. The assignments were as follows:

1. An officer and an enlisted man attached to a platoon of the 11th Field Hospital, which supported the 44th Division, had 188 bottles of blood in seven insulated boxes. This group had the main refrigerator unit.
2. Two enlisted men attached to a platoon of the 10th Field Hospital, which supported the 3d Division, had 144 bottles of blood in four insulated boxes.
3. Two enlisted men attached to another platoon of the 11th Field Hospital, which supported the 36th Division, had 168 bottles of blood in seven insulated boxes.
4. The First Special Service Force (a mixed Canadian and U.S. group, which, like rangers and commandos, had a special combat mission) had 100 bottles of blood in insulated containers. Some of the hospital ships in the invasion armada also carried small amounts of blood, sometimes in vegetable refrigerators.

Personnel of the forward distributing section embarked at Naples a week before the invasion. The blood was placed aboard the transports just before the ships departed. This plan assured a supply not over 7 or 8 days old for immediate invasion needs. The soundest principles of combat loading were observed; that is, the blood was loaded late, so that it could be taken off early, and it was distributed among several ships. Corps and division surgeons and line officers required considerable persuasion before these results were accomplished.

On D-day, each group, with its refrigeration, was landed on a separate beach. On D+1, the three groups made contact with each other, and thereafter they operated as a single distributing unit for all the hospitals on the beachhead.

Battle casualties for the first 3 days of the landings had been estimated at 1,881, and, on the basis of previous experience, about 0.6 pint of whole blood was supplied for each (1,129 pints). The 1,400 bottles provided, aside from the additional small amounts carried on hospital ships, included an excess of 271 bottles, which were regarded as essential insurance against possible loss. Actually, battle casualties numbered only 989, and nonbattle casualties, whose requirements for whole blood were generally less than those of battle casualties, numbered 205.

AIR TRANSPORT

Through the cooperation of the Navy and the Army Air Forces, arrangements had been made to deliver whole blood to the target area, beginning on D+1 and continuing until an airstrip could be established. The plan (map 1) involved flying the blood collected in Naples to Corsica, whence it was carried to the landing beaches by patrol vessels and motor torpedo boats.

The schedule was carefully worked out. The special blood plane, with the courier who was to fly with the blood, waited on the airfield in Naples for the arrival of the truck that brought the blood from the blood bank immediately before the plane took off. The insulated boxes (fig. 95) containing the blood were loaded and lashed in place, together with the French blood drawn in North Africa and flown to the base the previous day. When the plane landed on the northern tip of Corsica, a truck carried it to the patrol torpedo boat, where the Navy assumed responsibility for it. The courier who had brought in the blood the previous day exchanged information with the courier accompanying the fresh blood, and the empty boxes and bottles were loaded on the plane returning to Italy.

When the patrol boat arrived off the French beaches, it identified itself, and an officer or enlisted man from the forward distributing center, who was expecting it, came alongside in a DUKW (amphibious truck, 2½-ton cargo) with a truckdriver (fig. 106). The blood was trucked a mile or two inland, where it was loaded into the refrigerator truck awaiting it. If the roads were too bad for the 2½-ton truck, the insulated boxes were loaded on weapons carriers for distribution. The trucks sometimes traveled as much as 35 miles to meet the blood plane, their progress being expedited by the military police. At each hospital, a 6-cu. ft. refrigerator was reserved in the laboratory tent for the storage of blood.

In the initial planning for D-day, Col. Frank B. Berry, MC, Consultant in Surgery, Seventh U.S. Army, received invaluable help from Colonel Cornell, who personally arranged for all the contacts in the transportation of the blood. As a result, there were no delays, and more blood than was needed was always available during the landings, as well as later in the campaign.

After airfields became available in southern France on D+8, blood was flown directly to them from Naples in 2 to 2½ hours.

The use of a courier was even more important in southern France than in Italy. The Italian front never covered a great deal of ground, and it was therefore relatively easy to make contact with the forward distributing section as each load of blood arrived from the base. In France, the distances were much greater, and the plane was sometimes forced to land more than a hundred miles from its designated field. When this happened, the courier assumed responsibility for the blood, and, since he was armed with proper authority from base and theater commanders, he was able to secure motor transport to truck the blood forward to the distributing center.

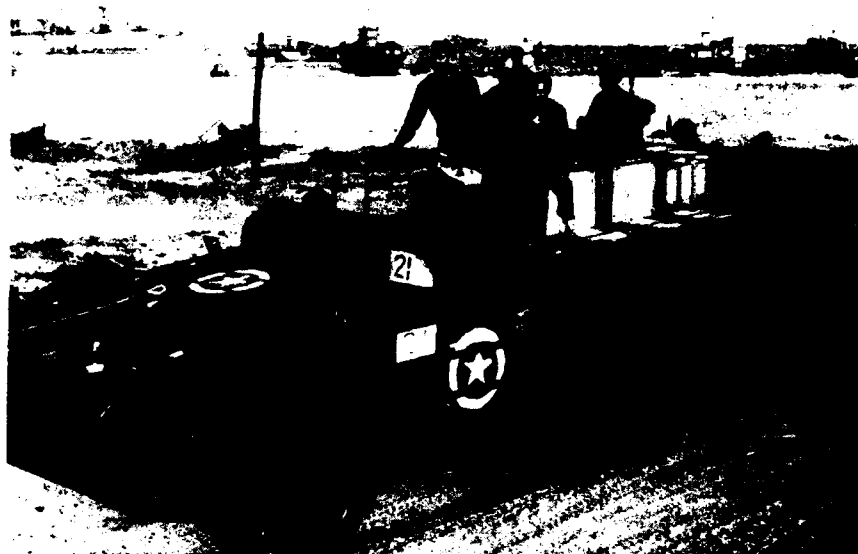

FIGURE 106.- DUKW arriving on beach in southern France loaded with French and American blood and penicillin. The blood, donated by service troops and others in replacement depots in Naples sector, has been flown from 15th Medical General Laboratory, Naples, and is destined for field hospitals in Seventh U.S. Army. When some of these insulated boxes were left in the sun for 8 hours, the increase in temperature was only 3° F. (5° C.).

Contact with the collecting unit in Naples was maintained by daily cables and through the couriers who accompanied the daily blood shipments. The daily report included the amount of blood delivered to each hospital, the amount on hand, and the amount requested in the next shipment. If the blood plane did not make contact with the forward distributing center and the courier had to supervise the delivery of blood, the officer in charge of the transfusion section in each hospital notified the base by any available means of the amount required.

Blood was delivered to the forward distributing center by plane until 2 November 1944, when flying conditions in southern France became too bad for this mode of delivery to be continued.

FORWARD DISTRIBUTING SECTION

Between 24 August and 17 December 1944, the command post of the forward distributing section of the 6703d Blood Transfusion Unit (Ovhd.) moved 11 times. At times, the advance of the Seventh U.S. Army was so rapid that it was necessary to set up a forward substation, in addition to the

command post located near a forward airfield. This substation, which serviced forward field hospital platoons, was sometimes 50-70 miles ahead of the command post.

Immediately after the landings in southern France, the forward distributing section began to make daily deliveries of blood to field and evacuation hospitals in its two weapons carriers. The forward section was usually located at a point midway between the two flanks of the line, and one vehicle went east and one west. As a rule, the round trips could be made in less than 8 hours, during which time the blood could be kept cold in the insulated boxes in which it had traveled from Italy. If the trip was likely to require more time, the 1½-ton truck, which usually met the blood plane, was used. The large refrigerator was a storage box and was moved only when the command post of the distributing section moved.

It was soon evident that the transportation on hand was inadequate to the needs of the blood distributing section, and arrangements were made with the Surgeon, Seventh U.S. Army, for two additional weapons carriers and drivers. Later, these vehicles and personnel were replaced by vehicles and drivers from the 58th Medical Battalion. This arrangement continued until the end of the war.

The forward distributing section encountered logistic difficulties from the time of the landings until March 1945. The distances were always long. The roads were poor, and, through the mountains, were often snowbound and icebound. In December 1944 and January 1945, during the fighting in the Colmar Pocket, the front was divided into two rugged sectors. In addition to the run of 130 miles to the rear, to pick up the blood from the bleeding center at Dijon (p. 452), it was necessary to make runs of 100 miles to each of these sectors. Communications with the base were always difficult and uncertain and were sometimes impossible. After air service had been abandoned, it often took from 2 to 4 days for the two sections of the blood bank to communicate with each other or to communicate with Paris through SOLOC (Southern Line of Communications). As a result, a wasteful supply of blood had to be maintained in forward hospitals.

During this period, the Seventh U.S. Army grew in size and the territory covered by it increased. It is remarkable that it was kept supplied with blood by a forward section that never had more than six drivers and that operated entirely with its own three trucks and two borrowed weapons carriers.

About 18 December 1944, conditions became so bad that deliveries to individual field hospitals had to be suspended. Instead, deliveries were made to headquarters platoons, which got the blood through to the other platoons. Some field and evacuation hospitals at considerable distances from the command post of the distributing center assisted in the distribution of the blood by sending their own transportation part of the way to meet the blood bank truck.

BASE BLEEDING SECTION

The 1st Medical Laboratory, which had been attached to the 15th Medical General Laboratory, left Italy on 4 September 1944, to set up in France and to prepare a location for the 6703d Blood Transfusion Unit (Ovhd.). It took with it all the equipment and transportation of the base bleeding section. Lt. (later Capt.) William S. Proudfit, SnC, who was assigned to the unit, was put on temporary duty with the Seventh U.S. Army, to aid the 1st Medical Laboratory in setting up a blood bank section. Eight enlisted men from the 21st General Hospital were placed on temporary duty with the Seventh U.S. Army for the same purpose.

The choice of a location for the bleeding center was difficult because the Army was moving so rapidly that concentrations of troops were few and temporary. Finally, Épinal was selected as the best site because of the large concentration of service troops there at the time. The bleeding section began to function on 11 October and operated at this site until 29 October, when facilities for a permanent installation were found in the medical school at Marseille. During the 3 weeks the collecting section functioned at Épinal, it drew and processed more than 2,400 bottles of blood. In order to use donors more efficiently, group A as well as group O blood was supplied to hospitals in the area. The 375 bottles of A blood were plainly labeled and there were no untoward incidents.

At Marseille, the bleeding section was attached to the 4th Medical Laboratory (Army) for administration, rations, and quarters. Essential equipment was obtained from the Surgeon, Dijon Base Section, and the section was ready to draw blood on 1 November 1944. The remainder of the bleeding section arrived from Italy in the middle of November. The Marseille center operated until 11 May 1945. It was because the Seventh U.S. Army landed in friendly territory in southern France that it was possible to bring the collecting section from Naples into Marseille, in the rear of the Army area, so promptly.

Personnel from nearby staging areas and a replacement depot supplied the first donors at the Marseille bleeding center. It soon became apparent, however, that because of the fluctuations in personnel strength, these sources could not supply the 175-200 pints of blood necessary each day. An additional bleeding center was therefore opened early in December on a prominent street in downtown Marseille.

In January 1945, a mobile bleeding unit was organized from bleeding section personnel to care for donations at distant military installations. All blood collected in Marseille was processed at the medical school.

The success of the Marseille operation was in large part due to publicity in civilian newspapers and in the *Stars and Stripes*; activities of the American Red Cross; assistance of civil affairs-military government officials; and the maintenance of donor rolls by individual units, in accordance with Letter

AG 742, Op MC, Headquarters, Communications Zone, ETOUSA, 14 March 1945 (24).

Delivery of blood.—When the bleeding section of the blood transfusion unit moved to Marseille, blood drawn there was shipped by rail to Dijon and then trucked to Épinal for distribution. When the command post of the forward distributing section moved to Lunéville, and later to Sarrebourg, the shipments were relayed from Épinal by transportation furnished by the 23d General Hospital. On 9 March, the routing was changed, and blood from Marseille, as well as from the European blood bank in Paris, both arrived at Lunéville by rail. On 12 March, blood from Marseille was sent to Nancy by rail, and blood from Paris by plane.

At this time, the distribution of blood was greatly simplified because the services of two distributing sections were obtained from the 127th Station Hospital, to supplement the unit distributing section. These sections were attached to CONAD (Continental Air Defense Command), and by CONAD to an air holding unit, where they acted as a rear blood station. This station received all blood from the bank in Paris, with which effective daily communication had now been established, stored it, and shipped the containers back to Paris. It was able to provide for all the needs of the blood transfusion unit distributing center until the end of hostilities.

During the last weeks of the war, the unit command post made five moves, one from France to Germany and the remainder in Germany. The forward distributing section continued to supply small amounts of blood after the end of hostilities until it rejoined the parent unit in Marseille on 8 June 1945.

TRANSFER TO ETOUSA

A supplementary blood supply for Seventh U.S. Army hospitals was necessary while the bleeding section of the 6703d Blood Transfusion Unit was moving from Épinal to Marseille. Arrangements for this purpose were made with the European blood bank, and deliveries to Épinal began on 28 October 1944. They were to be discontinued after the transfer to Marseille had been made, but the demand for blood was so great that they were continued until the Seventh U.S. Army passed into the logistic control of the European theater on 20 November 1944. The first shipments consisted of blood drawn and processed in the theater. Later, Seventh U.S. Army hospitals were supplied with blood collected in the Zone of Interior and flown to Paris.

DONORS

The procurement of donors was a constant problem throughout the operation of the 6703d Blood Transfusion Unit (Ovhd.). In Italy, donors were first procured from U.S. troops in the Naples area. Contacts and arrangements

were made with the various units by telephone, and transportation was furnished by the blood bank.

When the 6703d Blood Transfusion Unit opened an independent bleeding center at the 24th Replacement Depot at Caserta, procurement of donations was fairly simple. Arrangements were made with the post surgeon, and troops were marched to the bleeding station, so that transportation did not have to be furnished.

Up to 1 September 1944, enough donors were available from these sources to meet the need for blood for Seventh U.S. Army hospitals without too much difficulty. Then, as more and more troops were sent to France, the situation became more critical.

All the blood drawn at Épinal came from U.S. troops. Units were reached by telephone, and donors were transported to the blood bank, which was then attached to the 59th Evacuation Hospital. By the time the bleeding unit had moved to Marseille, most Seventh U.S. Army service troops in the Épinal area had been bled once.

Bleeding of civilian donors began at the Marseille subcenter on 8 December 1944. The response was at first slow. Then it increased, only to fall off during the holidays. It finally increased again and remained stable. In December 1944, 20.52 percent of the 6,042 donors were civilians. In March 1945, civilians made up 61.86 percent of the donors and in April, 53.72 percent. By this time, casual military donors had practically disappeared, one reason being that payment to them had been discontinued on 31 December 1944. Flight rations, provided by the Surgeon, Dijon Base Section, made donations attractive for civilian donors of whom 12,772 were bled.

In February 1945, at the request of the Surgeon, Seventh U.S. Army, A blood as well as O blood was collected, the donor reservoir being considerably increased by the 30-percent component thus secured. Most of the A blood was obtained from civilians. It was checked and handled with great care, and there were no known instances of trouble.

Malaria smears were discontinued at Marseille on 1 February 1945, as they had been in Italy (p. 453).

EQUIPMENT

The equipment used by the base bleeding unit was generally satisfactory except that the tube racks were insufficient, the drying oven was too small, facilities for distilling water were inadequate, and there was no cyclotherm. A special still was constructed at the 15th Medical General Laboratory when it was found that the issue still was entirely incapable of putting out the large amounts of distilled water required in the operation of the blood bank. Other deficiencies were corrected by improvisations by unit personnel, assisted by engineers at the base.

REFRIGERATION AND TRANSPORTATION

The mechanical refrigeration and transportation originally provided for the 6703d Blood Transfusion Unit consisted of:

1. A 45-cu. ft. refrigerator mounted on a 2½-ton truck with 3-kw. generators to furnish 24-hour electric current. The fly of the truck shaded the generators during the summer months and generally protected them from the weather. This refrigerator was the main storage unit and moved only when the section advanced.

2. Two 6-cu. ft. refrigerators mounted on weapons carriers, with 1½-kw. electric generators. These refrigerators were used for delivery of the blood.

3. Insulated cork-lined plywood boxes for use in transporting the blood (p. 417). The first supply was inadequate, and 60 additional boxes were constructed by the utilities section of the 15th Medical General Laboratory. Ten were somewhat larger than the others and were constructed to hold Dry Ice, which proved necessary for the preservation of the blood over the longer routes in France. The Dry Ice was obtained in Pompeii and flown to France with each shipment of blood, in specially constructed insulated boxes, longer and narrower than those used for blood. A satisfactory temperature could be maintained for 24 hours with the use of about 1,000 gm. of Dry Ice provided from Pompeii.

4. Storage refrigerators for hospitals. The 8-cu. ft. mechanical refrigerator (item No. 7375585) powered by kerosene did not prove satisfactory under field conditions, since it weighed 800 pounds and had to be kept level. Kerosene was often difficult to obtain, and the temperature was not always as low as the required 39° F. (4° C.).

The 7-cu. ft. household type of electric refrigerator was satisfactory for the storage of blood in evacuation hospitals. The lightweight ice cream type of refrigerator brought to NATOUSA late in 1942 and issued on the basis of one per evacuation hospital, and one per platoon of a field hospital attached to an army, also proved satisfactory for the storage of blood collected locally or delivered from the base. It held 40 bottles of blood.

Recommendations

The original refrigerator-truck equipment had to be supplemented at once, as already noted. At the conclusion of the war, the unit history specified that the following equipment was minimum for a distributing center operating in an army area:

1. Two 2½-ton trucks with refrigerator space for 1,000 bottles of blood each.
2. Six ¾-ton weapons carriers with refrigerators.

Essential personnel were specified as six drivers, six assistant drivers, one refrigerator mechanic, and one motor (automobile) mechanic. It was emphasized that a forward unit could not perform properly without motor and refrigeration mechanics.

STATISTICAL DATA

The base bleeding section of the 6825th Blood Transfusion Company sent 42,713 pints of blood to the forward distributing section between August 1944 and May 1945 (table 16). In addition, it sent 369 pints to hospitals in the Dijon Base Section and to other communications zone installations. During July, August, and September 1944, it provided 2,467 pints of blood for Fifth U.S. Army hospitals and hospitals in Naples. This is a total of 45,549 pints.

The forward section of the 6825th Blood Transfusion Company, from supplies of blood received from the base bleeding section and from the European theater blood bank, distributed 57,964 pints to Seventh U.S. Army hospitals and 7,707 pints to hospitals in the communications zone, a total of 65,671 pints.

The numerous discrepancies in the statistics of the blood program in the Seventh U.S. Army were explained by Colonel Berry in two ways:

1. Records were, understandably, sometimes very poor. In particular, blood used in field hospitals on casualties who were resuscitated and sent on to evacuation hospitals for surgery was frequently not recorded.

2. A considerable amount of blood was hoarded, especially during the winter months, and was later discarded without record. A certain amount was also frozen during the winter, because of long exposure en route.

TABLE 16.—Shipments of blood by bleeding section, 6825th Blood Transfusion Company (Non-T/O), August 1944–May 1945

Year and month	To forward distributing section	To hospitals in Dijon Base Section (Communications Zone)
<i>1944</i>		
August.....	<i>Pints</i> 3, 539	<i>Pints</i> -----
September.....	4, 380	-----
October.....	4, 801	-----
November.....	4, 205	3
December.....	5, 728	22
<i>1945</i>		
January.....	4, 706	50
February.....	3, 432	38
March.....	4, 698	68
April.....	5, 904	16
May.....	1, 320	172
Total.....	42, 713	369

The real reason for the discrepancies in oversea statistics, as compared with the precision of Zone of Interior statistics, is that the circumstances in which blood and plasma were used did not lend themselves to careful bookkeeping.



FIGURE 107. Blood plasma being given to infantryman, wounded on patrol, as he is put into ambulance for evacuation to rear after receiving first aid at battalion aid station, 103d Division, Seventh U.S. Army, southern France, February 1945.

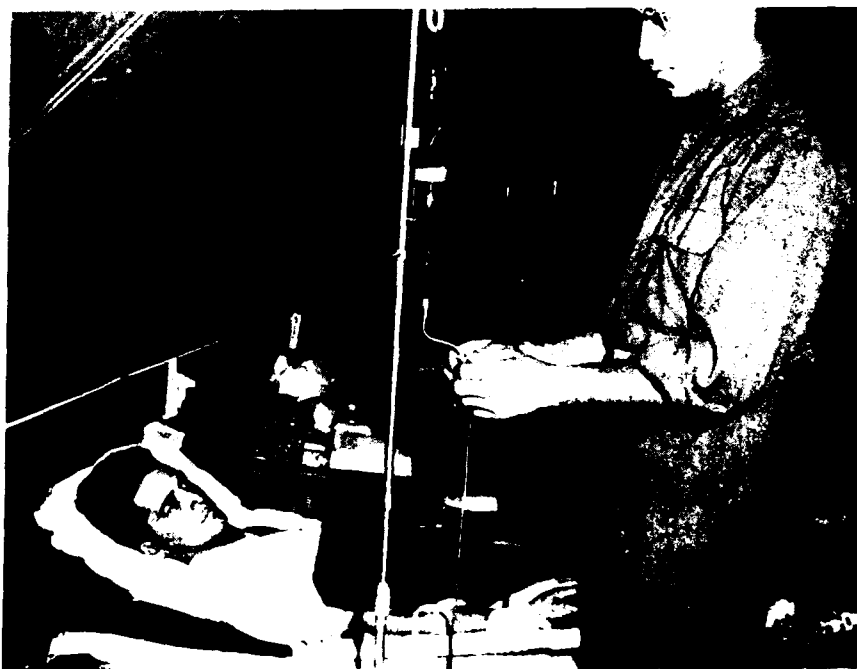

FIGURE 108.- Blood transfusion in forward hospital in Seventh U.S. Army, Besançon area, France, September 1944.



FIGURE 109. Administration of albumin by U.S. corpsmen to wounded French woman in temporary first aid station in shadow of amphibious Sherman tank. She and the other casualties (German soldiers) were wounded in the Saint-Raphael area of southern France, in the 36th Infantry Division Area, Seventh U.S. Army, August 1944.

CLINICAL CONSIDERATIONS

Plasma (fig. 107) and blood (fig. 108) were used in Seventh U.S. Army hospitals on the usual indications. Albumin was used only occasionally and in special circumstances (fig. 109).

References

1. Kendrick, D. B.: History of Blood and Plasma Program, United States Army During World War II, 1 Aug. 1952.
2. Report of Consultant in Surgery to the Surgeon, NATOUSA, 2 July 1943.
3. Report, Maj. Howard E. Snyder, MC, to Surgeon, II Corps, 3 Apr. 1943, subject: Care of the Wounded.
4. Report to the Surgeon, II Corps, through Commanding Officer, 77th Evacuation Hospital, 18 Apr. 1943, subject: Functions of a Transfusion Team in an Evacuation Hospital.
5. Report, Col. Richard T. Arnest, MC, Headquarters, II Corps, Office of the Surgeon, to The Surgeon General, 1 June 1943, subject: Care of the Wounded.
6. Medical Department, United States Army. Surgery in World War II. The Physiologic Effects of Wounds. Washington: U.S. Government Printing Office, 1952.
7. Snyder, Howard E.: Fifth U.S. Army. In Medical Department, United States Army. Surgery in World War II. Activities of Surgical Consultants. Volume I. Washington: U.S. Government Printing Office, 1962.
8. ETMD, NATOUSA, for December 1943.
9. Cornell, Col. V. H., MC: History of the 15th Medical General Laboratory, 20 December 1942-31 May 1944, 31 Oct. 1944.
10. The Medical Department of the United States Army in the World War. Washington: U.S. Government Printing Office, 1927, vol. II, pp. 157-165.

11. Reports of 6713th Blood Transfusion Unit (Ovhd.), 6 June 1944; 24 July 1944; 25 Oct. 1944; 3 July 1945.
12. Memorandum, Col. Earl Standlee, MC, to The Surgeon General, 27 May 1944, subject: Blood Banks in Theater of Operations.
13. Memorandum, Col. Earl Standlee, MC, to The Surgeon General, 28 Aug. 1945, subject: Blood Banks in Theater of Operations.
14. Circular Letter No. 3, Office of the Surgeon, Headquarters, II Corps, 7 Aug. 1943, subject: Care of the Wounded in Sicily.
15. ETMD, MTOUSA, for March 1945.
16. Circular Letter No. 27, Office of the Surgeon, Headquarters, NATOUSA, 20 Aug. 1943, subject: Donation of Blood for Transfusion and Other Purposes. Act, 30 July 1941 (Public Law 196, 77th Cong.).
17. History, 6th General Hospital, MTOUSA, 1942-44.
18. Minutes, Conference on Preserved Blood, Division of Medical Sciences, National Research Council, 25 May 1943.
19. ETMD, MTOUSA, for May 1945.
20. Annual Medical History of Laboratory Section, 21st General Hospital, 3 Jan. 1944.
21. Report, Lt. Col. Douglas B. Kendrick, MC, to The Surgeon General, 15 Jan. 1945, subject: Trip to the North African Theater of Operations.
22. Berry, Col. Frank B., MC: Surgery in the Seventh Army, 15 August 1944 to 30 April 1945, n.d.
23. Rogers, Capt. Albert M., MC: Organizational History, 1944, 6703 Blood Transfusion Unit (Ovhd.).
24. Rogers, Maj. Albert M., MC: History of 6825th Blood Transfusion Company, n.d.

CHAPTER XVI

The European Theater of Operations

Part I. General Considerations

SPECIAL CIRCUMSTANCES IN THE EUROPEAN THEATER

In any chronicle of the blood program in ETOUSA (European Theater of Operations, U.S. Army), it is important to remember that the military situation in this theater was entirely different from that in MTOUSA (Mediterranean Theater of Operations, U.S. Army) and that the medical situation differed accordingly. In the Mediterranean theater, a single army operated on a single land mass, within a relatively limited area. Serious transportation problems often existed, but blood did not have to be flown across water, as from England to the Continent, and as it was flown later from the Zone of Interior to Europe. Bad weather was therefore seldom a complete hindrance to the delivery of blood in Italy. It was an extremely serious problem in the European theater, for the always limited supply of blood never permitted storage in any significant amounts.

There were also other differentiating circumstances. In Italy, medical control could be uniform; there was a single army, and there was a single army surgeon. In the European theater, there were five U.S. field armies. Just as each army commander had his own concepts of how to fight, so each army surgeon had his own concepts of how to care for casualties and of the need for whole blood for them.

Theater facilities could not possibly supply all the blood needed for casualties on the Continent, but the blood bank in operation at the 152d Station Hospital when Lt. Col. (later Col.) Douglas B. Kendrick, MC, Special Representative on Blood and Plasma Transfusions to The Surgeon General, arrived in the United Kingdom in August 1944 showed how excellent such a service could be, even when it had no support from the Zone of Interior, if it was under the control of a competent, dedicated medical officer, who used all the resources available to him (1).

EDUCATION AND INDOCTRINATION

Information on developments in the use of whole blood had been sent to the Chief Surgeon, ETOUSA, in various ways throughout the war. The

Special Representative on Blood and Plasma Transfusions, OTSG (Office of The Surgeon General), had kept him informed of developments in the NRC (National Research Council) committees on blood and blood substitutes and on shock. The Chief Surgeon had received the monthly ETMD (Essential Technical Medical Data) reports from MTOUSA, and some of his staff had visited the theater. Col. Eugene R. Sullivan, MC, and Capt. (later Maj.) John J. McGraw, Jr., MC, who were in large part responsible for the establishment and operation of the Mediterranean Theater Blood Bank, had visited the European theater before D-day and had reported their Mediterranean theater experiences. They had much to contribute, for the Mediterranean had been an active theater of operations for 2½ years before D-day in Europe.

All of these channels of information, however, were not enough. The use of whole blood was only one of many therapeutic methods in which medical personnel inexperienced in combat injuries required indoctrination, instruction, and experience.

The First and Third U.S. Armies, in the weeks immediately after the invasion, had had only limited amounts of whole blood. They had to use them sparingly. Within a short time thereafter, blood began to be flown to them in liberal quantities. There had been no chance in either Army—the Third U.S. Army had been operational for only 3 weeks when the airlift from the Zone of Interior began—to set up research teams, and equally little time for hard-pressed operating surgeons to grasp the urgent need of seriously wounded casualties for whole blood in liberal amounts.

The chief lesson that had to be learned in the European theater after the airlift from the Zone of Interior began was not the value of whole blood for severely wounded men but the desirability of using it in liberal quantities and its present availability for such use. Surgeons were used to a mere trickle of blood, which had to be reserved for the casualties who needed it most because their condition was poorest. Naturally, with such experiences behind them, medical officers had to be convinced that they could now be assured of all the blood they needed, and that they could use it prophylactically as well as for casualties in dire state. It was a hard task to persuade forward surgeons that now all they needed to do to secure blood in any needed quantity was simply to ask for it in that quantity.

Another lesson that had to be learned in the European theater was that group O blood in a closed system could be used with almost absolute safety. This was not the situation in the Zone of Interior when many—perhaps most—medical officers had gone overseas, and they had reason to be skeptical at first.

That these lessons were well learned is evident in the fact, pointed out elsewhere, that in the last months of the war in the European theater, as in the Mediterranean theater, the ratio of units of blood to wounded men was close to 1:1.

Part II. Initial Activities in the Zone of Interior for an Oversea Transfusion Service

BACKGROUND OF PROJECT

By the middle of 1943, as the result of the joint activities of the Division of Surgical Physiology, Army Medical School (p. 61), and the Subcommittee on Blood Substitutes, Division of Medical Sciences, NRC (p. 74), all the items had been developed which would permit the use of whole blood in oversea theaters. These were:

1. Satisfactory grouping sera (p. 236).
2. An expendable transfusion set (p. 195).
3. A satisfactory preservative solution (p. 221).
4. A refrigerator which would make possible the storage of blood up to 21 days (p. 206).

The safety and efficiency of all of these items had been so thoroughly tested by the agencies involved that it now seemed logical to propose that the necessary equipment be sent overseas and that the theaters be authorized to train their own personnel to collect and distribute blood to all fixed and forward hospitals. On the most exacting analysis, this proposal seemed entirely reasonable. In particular, the provision of expendable transfusion sets disposed of the chief cause of anxiety in transfusions, the risk of reactions from the reuse of equipment. This practice, even in trained hands in civilian hospitals, would inevitably increase the incidence of pyrogenic reactions and, under circumstances of warfare, would further increase the incidence of reactions.

FIRST PROPOSAL, OCTOBER 1943

The background thus being prepared, Colonel Kendrick addressed a memorandum on the use of whole blood in theaters of operations to Lt. Col. (later Col.) B. Noland Carter, MC, Director, Surgery Division, OTSG, who was then in charge of the blood program in this office. This memorandum, which was dated 5 October 1943, covered the following points (2):

1. The British experience in the Mediterranean theater, the similar American experience there, and reports from medical officers in the European theater had made it clear that whole blood was essential in oversea theaters of operations. The need was greatest in forward hospitals in which major surgery was performed. In these installations, casualties were often seen with red blood cell counts as low as 1½ million to 2 million per cu. mm.

2. Plasma did not solve the problem. It was an admirable and effective agent, but it had definite limitations. It could raise the blood pressure after hemorrhage, but it could not prepare a casualty for major surgery. The British Eighth Army at El Alamein had used bottles of blood, plasma, and physiologic salt solution in the ratio of 18:19:20 per hundred casualties. When plasma was used intelligently, it was an effective preliminary

replacement fluid, but in abdominal wounds, hemorrhage, sepsis, burns, and similar pathologic conditions, whole blood was necessary, probably in a ratio to plasma of 1:2 or even 2:2.

Plasma could correct losses in blood volume if it was given early, in adequate quantities, and if hemorrhage was controlled at the same time. When a casualty was treated late, or if hemorrhage was not controlled, then whole blood was essential.

3. The disadvantages of whole blood as compared with plasma were frankly admitted. Blood had to be collected locally in theaters of operations. Donors would be limited to military service personnel, personnel in rest camps, lightly wounded casualties, and, occasionally, the local civilian population. Malarial and syphilitic donors could not be employed. Blood was cumbersome to handle. It had to be grouped before administration. It had to be distributed with numerous precautions. The chances of contamination of blood were greater than the chances of contamination of liquid or dried plasma made from blood collected and processed in a closed system.

A number of tests had to be carried out before blood could be used, and the necessity for them limited the extent of its use. Serologic tests were necessary, but equipment to perform them was not available farther forward than evacuation hospitals. Microscopic examination of thick and thin smears was necessary to rule out malaria, but microscopic equipment was not available forward of evacuation hospitals, and trained personnel who were in short supply, were needed to read the slides.

Equipment (autoclaves and stills) was not available overseas in sufficient quantity to prepare transfusion sets for repeated use, nor were personnel available for collecting and preparing them. If the necessary equipment and personnel could not be provided, it would be necessary to ship overseas commercially prepared transfusion sets which could be discarded after a single use.

Finally, because blood was highly perishable, it had to be stored under refrigeration, which was not available forward of evacuation hospitals.

4. Fresh blood collected in an open system could be used for transfusions, but could not be kept for more than a few hours. Transfusions with blood collected in this fashion had been given in U.S. Army hospitals during the North African campaign, but the number had been limited because of the lack of blood. Furthermore, the use of blood in small quantities had limited its effectiveness.

Recommendations

In the light of the facts just set forth, Colonel Kendrick made the following recommendations in his 5 October 1943 memorandum to Colonel Carter:

1. Stored blood, collected in a closed system, should be supplied to medical installations as far forward as field hospitals.

2. Blood should be collected in the area of a general hospital from military personnel or, if circumstances permitted, from civilians near the base. It should be collected by a base collection unit and supplied in refrigerated chests (storage containers) to advanced units.

3. To reduce the necessity for blood grouping in forward hospitals, only proved type O blood should be stored.

4. The quantities of blood provided should be based on the estimate that 20 percent of all combat casualties would require resuscitation, and 20 percent of these would require blood as well as plasma. According to Brigadier Lionel E. H. Whitby, RAMC, Director of the British Army Transfusion Service, 30 pints of protein fluid were necessary for every hundred wounded, in the proportion of 3 pints of plasma to 1 pint of blood. According to Col. Edward D.

Churchill, MC, Consultant in Surgery to the Surgeon, MTOUSA, 18 pints of blood were required for every hundred wounded, in the proportion of one unit of blood for every two units of plasma.

Proposed Implementation of Recommendations

In Colonel Kendrick's memorandum of 5 October 1943, it was pointed out that Circular Letter No. 108, issued by OTSG on 27 May 1943 (3), provided for the transfusion of fresh whole blood in general hospitals overseas up to 4 hours after it had been collected, and also provided for the transfusion of stored blood, to be collected by a closed system, up to 7 hours after it had been drawn. The evidence at hand now indicated that whole blood transfusions must be made readily available in every medical installation in which major surgery was to be done. This would be possible only by the use of preserved blood stored at designated depots, preferably general hospitals.

This policy would require implementation as follows:

1. Necessary equipment would include:
 - a. Sterile vacuum bottles containing 200 cc. of Denstedt's solution (glucose and citrate), in which blood collected in a closed system could be kept for 21 days.
 - b. Expendable recipient sets with cellophane tubing and cloth filters.
 - c. Donor sets consisting of a metal flow valve to be inserted in the stopper of the vacuum bottle and connected to a collecting needle by 18 inches of heavy rubber tubing. A roller-type valve, capable of completely compressing the rubber tubing, could be used in place of the metal valve to control the flow of blood.
 - d. Two refrigerators, of 16-cu. ft. capacity, for each general hospital, for the storage of blood. They should be kept in the laboratory, where serologic and malaria tests would be made and donor and recipient sets cleaned.
 - e. Insulated containers, each to hold from 10 to 20 flasks of blood. It would be necessary to work out the arrangements for a supply of ice with the Quartermaster and Corps of Engineers overseas.
2. Transportation to forward areas would be by trucks, ambulances, or airplanes. Since blood would frequently be collected outside of general hospitals and would require transportation to them, it would be more practical to have transportation assigned to collecting teams and distributing units, with the transfusion office in each general hospital responsible for providing it.
3. Personnel would include:
 - a. Transfusion officers and assistants at general hospitals in the communications zone. Their function would be to procure donors, collect and store blood, and dispense it to their own installations and to installations farther forward.
 - b. Shock teams, consisting of resuscitation officers and enlisted men, properly trained in the use of plasma and albumin. These teams would be assigned as necessary to field and evacuation hospitals and to mobile surgical units.
 - c. A chief transfusion officer on the staff of each theater surgeon in each theater of operations. His function would be to train personnel assigned to the blood transfusion service and to exercise general supervision over the handling and transportation of transfusion equipment and blood. He should be present at all staff conferences, so that he could work out arrangements for a supply of blood in each operation. Medical officers, especially those in landing parties, would require individual training in the tactical employment of transfusion units.

d. A chief of the blood transfusion service in the Zone of Interior. This officer's functions would include design and testing of equipment for intravenous therapy, supervision of the procurement of equipment, supervision of the processing of plasma and serum albumin, and liaison with the American National Red Cross Blood Donor Service and the National Research Council.

This memorandum, it should be noted, was prepared on the fundamental assumption that replacement therapy, including intravenous therapy as well as blood replacement, constitutes a specialized branch of medicine and that to collect blood, group it correctly, and store and distribute it are processes that require the services of specially trained personnel. These functions cannot be safely delegated to untrained personnel because any slip, however trivial, in the collection and use of whole blood, in addition to causing unnecessary and sometimes excessive losses of a scarce and valuable substance, may result in severe and even fatal reactions.

ACTIONS ON PROPOSAL

Presentation of Proposal to Chief Consultant in Surgery, OTSG

On 3 November 1943, Colonel Kendrick followed his 5 October memorandum by a second memorandum to Brig. Gen. Fred W. Rankin, Chief Consultant in Surgery, OTSG, containing a summary of his earlier memorandum to Colonel Carter (4). On 6 November, General Rankin prepared a similar memorandum for The Surgeon General (5). In it, he stressed the need for stored blood in theaters of operations and described the equipment necessary to provide it. He also described expendable commercial equipment for both giving and receiving sets.

Presentation of Proposal to Subcommittee on Blood Substitutes, NRC

The plan outlined in Colonel Kendrick's memorandum of 5 October 1943 was presented by him to the Subcommittee on Blood Substitutes, NRC, at the meeting held on 17 November 1943 (6). He stressed the following points:

1. Reports from the field indicated that wounded casualties required whole blood as well as plasma.

2. At present, whole blood transfusions were being carried out overseas with empty plasma bottles. A recommendation had been approved by OTSG to provide refrigerating equipment for field hospitals, evacuation hospitals, and general hospitals. Collecting bottles containing Denstedt's solution would also be provided, as well as microscopes and equipment for typing and cross-matching of blood, so that blood banks might be operated at these points.

3. A satisfactory airlift was now available, as it had not been earlier, when this subcommittee (p. 53) and the Conference on Blood Grouping (p. 53) had recommended that whole blood be provided for combat casualties.

4. The recommendation that collecting units be organized in general hospitals overseas, with teams to administer transfusions as far forward as possible, had been made to OTSG but had not been accepted.

After Colonel Kendrick's memorandum had been discussed in detail, the following resolution was moved and passed:

Resolved: That the Subcommittee on Blood substitutes recommend through channels that The Surgeon General of the Army give consideration to the transportation of whole blood by airplane to certain theaters of operations.

Rejection of Proposal by The Surgeon General

On 13 November 1943, a summary of General Rankin's memorandum of 6 November 1943 was hand-carried by Colonel Carter and Colonel Kendrick to The Surgeon General (7), who rejected the proposal at once, on the following grounds (8):

1. His observations in oversea theaters had convinced him that plasma was adequate for the resuscitation of wounded men.

2. From a logistic standpoint, it was impractical to make locally collected blood available farther forward than general hospitals in the communications zone.

3. Shipping space was too scarce to warrant its use for sending disposable transfusion equipment overseas.

On the basis of these facts, Maj. Gen. Norman T. Kirk, The Surgeon General, directed that the provision and use of blood in oversea theaters should be limited by the instructions set forth in Circular Letter No. 108, 27 May 1943 (p. 463).

General Kirk's position was equally adamant in a second conference with Colonel Carter on 16 December 1943 (8).

Although personnel in charge of the blood program were not in agreement with The Surgeon General's decision—and although the plan rejected out of hand was essentially the same as the plan by which blood was sent overseas only 10 months later—they had no choice but to accept it.

There were several probable reasons for General Kirk's refusal to consider the proposed program, perhaps the most important being that he shared the still rather general opinion that plasma was a satisfactory agent of resuscitation and that the use of whole blood in large quantities was not necessary for battle casualties. Undoubtedly, too, he had been directed by higher authority, because of limited shipping space, to limit the tonnage of medical supplies shipped overseas. Since he considered plasma adequate for resuscitation, he did not believe that flying transfusion equipment overseas, let alone flying whole blood, was sufficiently important to substitute the equipment (and blood) for other supplies and, thus keep within the allowable tonnage. It also did not seem important to him to point out to the Commanding General, Army Service Forces, under whom his office operated, the urgency of increasing the allowable tonnage to supply whole blood for wounded men, as was done less than 10

months later. As a matter of fact, except for the lack of an airlift, transfusion services could have been activated in all theaters in the spring of 1943, for the basic work on the preservation, transportation, and safe usage of whole blood had all been done by that time, and the equipment necessary for such a service had also been developed.

It was learned in 1960 that the decision not to send blood to Europe from the Zone of Interior had been made long before the interview with The Surgeon General in December 1943. As is pointed out elsewhere (p. 475), Maj. Gen. Paul R. Hawley, Chief Surgeon, ETOUSA, had already been informed by The Surgeon General that he would not approve of this plan.

REVIVAL OF PROPOSAL, APRIL 1944

Presentation to The Surgeon General

No further action was taken in the Zone of Interior in regard to supplying blood for combat casualties until 17 April 1944. Then, with D-day in Europe obviously imminent, Colonel Kendrick addressed another memorandum to The Surgeon General on the subject of whole blood in theaters of operations (9). As in his earlier memorandums, he pointed out the success of the plasma program, the method of supplying fresh whole blood in fixed hospitals in the communications zone, as set forth in Circular Letter No. 108, OTSG, and the need for stored whole blood in forward as well as in base hospitals. He also pointed out that the quantity of fresh blood which could be made available by bleeding donors (so-called on-the-hoof bleeding) would be limited during peak operations by the inevitable confusion attending the operations and by the necessity of performing time-consuming laboratory tests.

By this time (April 1944), theaters of operations had made their own plans for supplies of whole blood, but techniques for their implementation, as well as the equipment, varied considerably in scope. Colonel Kendrick therefore proposed to The Surgeon General:

1. That a complete study be initiated to determine the needs for whole blood, requirements as to equipment and personnel and standardization of techniques to supply whole blood to medical installations in the field. The study would include a trip of inspection to one or more active theaters to observe their techniques and equipment before final recommendations were made.

2. That the Office of The Surgeon General develop techniques and standardize equipment to provide for the use of stored whole blood in theaters of operations. The following plan was suggested:

- a. Only group O blood would be sent to forward hospitals.
- b. Blood would be collected at bases from service personnel or the civilian population by a collecting team consisting of a medical officer, a nurse, and seven enlisted technicians, two of whom would also act as drivers.
- c. Laboratory procedures, including serology, malaria testing, and blood grouping would be done by the collecting teams.

d. Blood would be sent as far forward as field hospitals, upon request, in refrigerators mounted on trucks. It would be handled by a distributing or delivery team of two enlisted men.

e. A transfusion officer in each unit would be responsible for maintaining an adequate supply of blood and for its administration. The remainder of the transfusion team in each unit would consist of a nurse and three enlisted technicians. It was essential that all transfusion officers and other personnel be well trained for this special work.

f. A transfusion officer attached to the staff of the theater surgeon would be responsible for supervision of the collecting team and for all other activities concerned with blood within the theater.

3. Transportation for the collecting team would consist of a truck or ambulance to transport personnel and a ½-ton truck for equipment and refrigerators. Transportation for the delivery team would consist of a similar truck for refrigerators.

4. Other equipment would consist of:

a. An electric refrigerator to operate on 110 volts, or on usual power outlets, or on a 750-watt generator. The refrigerator should be large enough to hold from 36 to 50 bottles of stored blood and should maintain a temperature range of 46.4° to 50.0° F. (8° to 10° C.).

b. One-liter vacuum bottles containing 500 cc. of Alsever's solution.¹

c. Collecting sets consisting of a 20-inch length of ¼- or ⅜-inch rubber tubing, with two 17-gage needles.

d. Dispensing sets consisting of expendable glass housing with metal filter and rubber tubing.

In a memorandum addressed to The Surgeon General on 21 April 1944, General Rankin repeated the information in Colonel Kendrick's memorandum of 17 April concerning the relative limitations of plasma and the absolute necessity for stored blood for combat casualties (10). He also stressed the need for standardizing methods and equipment for the collection and storage of blood in all theaters, in keeping with military requirements.

REQUEST FOR OVERSEA MISSION

In the memorandum just mentioned, General Rankin requested that Colonel Kendrick be ordered to the Southwest Pacific, to carry out the study proposed in the latter's memorandum of 17 April, to study blood and plasma requirements, and to investigate the use of albumin and other byproducts of the plasma-blood program. General Rankin recommended that when this mission had been completed, techniques and equipment be standardized in the Office of The Surgeon General for the use of replacement fluids in all theaters of operations.

¹ By this time, Alsever's solution was being used in the Zone of Interior in place of Denstedt's or other solutions. Its use had been approved by the Subcommittee on Blood Substitutes in September 1943 (p. 467), but its replacement by ACD (acid-citrate-dextrose) solution was not recommended until November 1944, 3 months after the airlift to the European theater had become operational (p. 226).

The justification for the mission and for the selection of the area in which it was to be carried out was that no one in the Southwest Pacific had had the training and experience necessary to train the personnel required for a blood program, supervise equipment, and organize an efficient transfusion service. Colonel Kendrick, General Rankin's memorandum continued, had been responsible for the blood and plasma program in the Zone of Interior from its onset. If plans could be made to make blood available in the Southwest Pacific, over long distances, in the face of difficult terrain, a high incidence of malaria, and extreme temperatures, then methods of providing blood in other theaters would be greatly simplified. Such a study would make it possible to combine laboratory experiences with field requirements and eventually to standardize equipment and methods of transfusion for the entire Army.^{2,3}

In the official request for temporary duty for Colonel Kendrick for the mission just described, which was made on 4 May 1944, it was stated that the trip would be made with Capt. Lloyd R. Newhouser, MC, USN, in order to coordinate methods and equipment for the use of blood and blood substitutes in the Army and the Navy and thus simplify therapy when combined operations were undertaken.

The readiness date requested for this mission was 5 June 1944—which was the day before D-day in Europe. In retrospect, it seems that it might have been wiser if the trip had been made to the European theater. On the other hand, no precise information was then available about the date of D-day, and the need for guidance in the Pacific was obviously very great.

RECOMMENDATIONS BY SURGERY DIVISION, OTSG

In the annual report of the Transfusion Branch, Surgery Division, OTSG, made on 1 July 1944 for fiscal year 1944 (14), the section dealing with blood began with the statement that, although plasma had been supplied to the Army in adequate quantities since 1941, the need for blood had never been lost sight of. The report reviewed the work of the Division of Surgical Physiology, Army Medical School, in the development of a closed system for bleeding; the development of a preservative solution in which blood could be stored safely for 2 to 3 weeks; the development of disposable transfusion sets; and the development of refrigerating equipment. Although all of this equipment was available by D-day in Europe, 6 June 1944, and stored whole blood could then have

² Had time permitted, it would have been profitable to study the successful transfusion service and blood bank in operation in the Mediterranean theater (p. 400) before the trip to the Southwest Pacific. It did not, and, as events proved, there was urgent need for guidance and help in the Pacific areas. On the other hand, the fact that Colonel Kendrick was ordered to the Pacific instead of to Europe at this particular time is an indication of the secrecy surrounding the date set for D-day. Apparently, as late as May 1944, The Surgeon General did not have this information.

³ It is interesting to recollect that as early as 31 May 1940 (11), the Committee on Transfusions, NRC, recognized the need for field studies in the blood program. At the meeting on 9 April 1943 (12), the subcommittee recommended the appointment of a qualified fact-finding group to make field studies, on the ground that its own work had reached the point that it could no longer function effectively without "more precise information concerning field problems and conditions imposed by the military requirements in this war" (p. 79). On 24 September 1943, the subcommittee again raised the question (13). No such civilian investigation was ever undertaken, probably because The Surgeon General was reluctant to ask for the necessary clearances.

been provided for field use, as of 30 June 1944, no plan had been approved by The Surgeon General for collecting and supplying blood to the theaters, each of which had therefore developed its own plans.

In the fall of 1943, the report continued, the Surgery Division, OTSG, had proposed to The Surgeon General a plan that utilized tested and approved equipment and that provided for the collection and delivery of blood in oversea theaters. The plan was predicated on the concept that blood transfusion and the use of other replacement fluids constituted a specialized branch of medicine. Well-trained technicians were necessary to collect blood, group it correctly, and store it safely. These functions could not be delegated to untrained personnel, for errors could result in severe and even fatal reactions.

The plan had been rejected as unessential and impractical in November 1943. In June 1944, the report concluded, the need for a transfusion service in active theaters of operations was even more apparent than it had been in 1943. It was therefore urgently recommended that additional thought be given to preparing and adopting a simple plan to make blood available in every theater, using:

1. The 4-cu. ft. refrigerator developed during the past year.
2. The expendable recipient set now available.
3. Asever's solution now available as a preservative.
4. The collection of blood by a closed system.
5. O donors exclusively.

Part III. Initial Activities in the European Theater

INITIAL PROVISION OF BLOOD AND PLASMA

The first U.S. troops which arrived in England, in January 1942, had no provision for blood transfusion, and for some time their supplies of plasma were entirely inadequate. The deficiencies were easily explained: Troops were being deployed, or arrangements were being made for their deployment, all over the world, and supply ships were being sunk.

Arrangements were promptly made to supply blood and plasma (at first in the wet form) from British sources. As might have been expected, certain difficulties arose, some of which continued into 1943 (15). The first U.S. requests for plasma were extravagantly large. Some individual units requested plasma and blood at irregular intervals directly from British blood centers instead of procuring them, as they were instructed to, through U.S. Army medical depots. Also, small amounts of blood were procured from civilian sources. If these practices had not been stopped at once, the U.S. Army would have been placed in the position of being a factor, albeit a passive and unwitting factor, in the disruption of the well-organized British Army Transfusion Service. Fortunately, relations between Brigadier Whitby, in charge of the British Transfusion Service, and Col. (later Brig. Gen.) Elliott

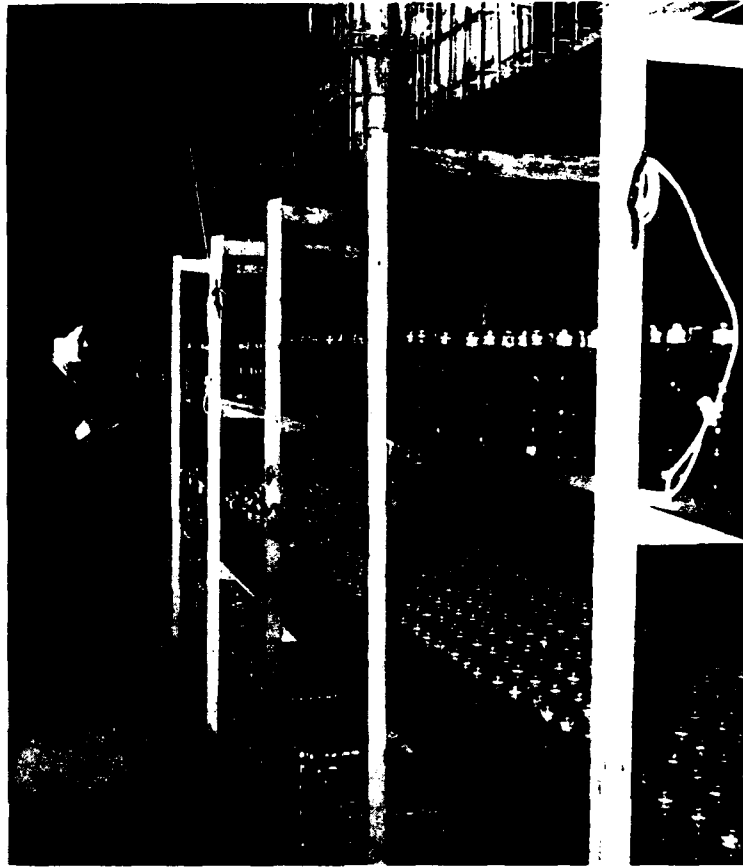

FIGURE 110.- Inventory of liquid plasma in wet plasma storehouse, British Army Blood Supply Depot, West House, Chilton Polden, Bridgewater, Somerset, England, 1943.

C. Cutler, MC, Consultant in Surgery to the Chief Surgeon, ETOUSA, were so intimate and cordial that misunderstandings could be settled as they arose.⁴

In June 1943, there was a gradual changeover from British wet plasma (fig. 110) to British dried plasma; the issue also included distilled water and giving sets (16). In December 1943, U.S. hospitals in the United Kingdom began to receive dried plasma from the Zone of Interior (17).

TRAINING IN BRITISH BLOOD SUPPLY DEPOT

In August 1942, Capt. (later Lt. Col.) Robert C. Hardin, MC (fig. 111), who had had a wide experience in blood procurement and replacement therapy

⁴One of the first items of official correspondence directed to Colonel Cutler for action was a report on the British Army Blood Supply Depot submitted by Capt. (later Lt. Col.) Robert C. Hardin, MC, who was then serving as U.S. liaison officer at the depot (p. 478). The theater Chief Surgeon, in turning over the report to Colonel Cutler, signified that the Chief Consultant in Surgery would be responsible for the technical aspects of providing blood, blood substitutes, crystalloids, and related substances to the U.S. Army medical units in the theater.



FIGURE 111.—Left to right: Col. Elliott C. Cutler, MC, Lt. Col. Ralph S. Muckenfuss, MC, and Maj. Robert C. Hardin, MC, summer 1944.

at the State University of Iowa, Iowa City, Iowa, with Dr. Elmer L. DeGowin and Dr. Everett D. Plass (p. 220), was placed on temporary duty at the British Army Blood Supply Depot, Southmead Hospital, Bristol. His functions were to serve as liaison supply officer and to gather as much information as he could about the British system of procurement and handling of blood and blood products, including the technical details of collection, processing, storage, and distribution. Captain Hardin also collected data concerning British methods of treating shock, the amounts of blood and plasma required in the management of battle casualties, and the management of casualties in the Battle of Britain as well as the Battle of France. Personal contacts with the officers who had had these experiences proved most helpful.

Captain Hardin also studied methods of training officers and enlisted men in the procurement and distribution of blood and in shock and resuscitation. Special courses were conducted for this purpose. When Col. James C. Kimbrough, MC, Chief, Professional Services, Office of the Chief Surgeon, ETOUSA,

investigated the possibility of a few U.S. medical officers with special interest in the subject attending these courses, Brigadier Whitby replied that he would be delighted to have three officers attend each course. He thought they would provide a new source of postlecture argument, which would be both instructive and stimulating. He also agreed to give a limited number of courses to non-commissioned officers and enlisted technicians. The courses of instruction continued into May 1944 and were attended by more than 200 U.S. officers. The policy paid off in friendship and cooperation as well as in dissemination of knowledge.

APPOINTMENT OF CONSULTANT ON TRANSFUSION AND SHOCK

A consultant on transfusion and shock was even more necessary in the European than in the Mediterranean theater, since several armies operated in it, with several widely separated blood bank units attached to them.

The question first came up on 2 January 1944, when Colonel Kimbrough was informed by Colonel Cutler of the provisions for the whole blood service. It was pointed out to him that the highly specialized nature of this service made it essential that a competent officer be placed in charge of it. On 5 January, General Hawley instructed Col. James B. Mason, MC, to appoint an officer to direct the whole blood service in the theater (18). It was highly desirable that he be appointed promptly, for basic decisions had already been taken about the service; a large quantity of equipment was already available; and personnel would soon be assigned. This was therefore the time for a director to take hold of the service and weld the separate parts into a whole. The officer nominated, General Hawley specified, must be a forceful executive, with a good knowledge of Army organization and operations, and must be qualified, from a professional standpoint, to advise on the use of whole blood.

Colonel Mason at once nominated Captain Hardin for the position, on the ground that he was better acquainted with all the details of the acquisition and processing of blood than any other officer in the theater. Brigadier Whitby had written Colonel Cutler on several occasions of the assistance he (Captain Hardin) had been to him. In addition to handling the administrative details of U.S. participation in the courses of instruction at Southmead Hospital, he had shared in the work of the depot; delivered lectures on transfusion reactions, changes in stored blood, and the use of blood substitutes; and had otherwise carried part of the teaching load during the year he worked at the blood bank. In his return letter to Brigadier Whitby, Colonel Cutler had said he expected to make great use of Captain Hardin in the future, as an assistant in the Consultant Service, in the organization of shock teams, and in the establishment of hospital blood banks.

Captain Hardin was appointed theater transfusion officer on 7 February 1944.

HOSPITAL BLOOD BANKS

Authorization

The establishment of blood banks in U.S. hospitals in the United Kingdom first arose in October 1942 and was the subject of a number of discussions thereafter until they were authorized by Circular Letter No. 51, Office of the Chief Surgeon, ETOUSA, 5 April 1943 (19). They were set up only in general hospitals. Station hospitals employed fresh blood as the need arose, and one or two had arrangements to secure it from British sources, but they were not authorized to store blood.

The following instructions were given in Circular Letter No. 51:

1. Only U.S. Army personnel should be used as donors in the area controlled by the British Army Transfusion Service (the counties of which were listed).
2. In other areas, general hospitals should set up blood banks in consultation with local civilian medical authorities, using civilian donor panels.
3. Neither civilian nor military donors would be remunerated.
4. Under no circumstances were British Army Transfusion sets to be used with civilian sets. They were entirely separate, and no hospital should use both.

Progress Report, June 1943

On 9 June 1943, Captain Hardin reported to Colonel Cutler on the progress made in setting up blood banks in general hospitals in the United Kingdom as follows (20):

1. The 2d General Hospital had facilities for the storage of whole blood and had operated a small bank for several months. The civilian donor panel allotted to it by the British Army Transfusion Service contained the names of about 800 persons living near the hospital and was augmented by hospital personnel. Bleedings were carried out once weekly, the number of donors bled being determined by the weekly requirements. This hospital was supplying a local British Emergency Medical Service hospital with blood.
2. The 5th General Hospital was setting up its bank. It had been supplied with British military equipment and had a local civilian panel of 800 persons, augmented by hospital personnel. Because of the proximity of this hospital to the Royal Infirmary in Salisbury, which used the same panel, bleeding would be carried out there, by teams from both hospitals, on the scale necessary to provide the blood needed for both institutions. The addition of U.S. personnel would be the only departure from the previous bleeding practice in this location. Adequate refrigeration was available at the 5th General Hospital for blood storage.
3. The 30th General Hospital, which was located in the British Emergency Medical Service area, had made satisfactory arrangements with local transfusion authorities in Nottingham, from which it received 20 pints of blood every 2 weeks. Emergency supplies beyond this amount were obtained from either the Mansfield General Hospital or the EMS (Emergency Medical Service) Laboratory in Nottingham. The 30th General Hospital staff reciprocated this assistance by furnishing a medical officer to carry out bleedings for the EMS laboratory every week or two. To date, the hospital needs had averaged only 5 pints per week, but outdated, unused blood was returned to the EMS laboratory for processing into plasma, so there was no waste. The hospital had adequate refrigeration facilities.

4. The 52d General Hospital, which was also located in the EMS area, had made arrangements similar to those of the 30th General Hospital with local civilian laboratories in Birmingham and Worcester. It received 4 pints of blood per week, which covered present needs, and returned outdated blood for processing into plasma. The greatest present need of this hospital was for an electric refrigerator to maintain a constant temperature for blood storage.

5. The 67th General Hospital had arranged for a blood bank with a civilian panel allotted from the British Army Transfusion Service. The bank would cooperate with local civilian hospitals by arrangements similar to those made by the 2d and 4th General Hospitals.

6. The 298th General Hospital could now supply its needs directly from a British Army blood supply depot because of its location only 5 miles away. At present, it was keeping four bottles of type O blood constantly on hand for emergencies and could procure more if it were needed. Outdated blood was returned for salvage. This arrangement was more satisfactory to the British Army Transfusion Service than the allotment of a civilian panel to the hospital. At present, the demand for blood was not sufficient to make storage in the hospital economical, but the basic organization for a blood bank had been built up and equipment for it provided. The sets for taking and giving blood had been manufactured in the hospital from salvaged glassware.

Operation

The details of operation of a hospital blood bank were set forth in Medical Bulletin No. 14, Office of the Chief Surgeon, Headquarters, ETOUSA, for 1 January 1944 (21). The description covered organization, equipment, its cleansing and sterilization, technique of bleeding, blood grouping, and technique of administration.

Hospitals which maintained their own blood banks in the United Kingdom developed special practices. After the invasion, for instance, the 182d General Hospital found the blood donor panel maintained from its own personnel adequate for ordinary circumstances but not sufficient when convoys arrived and large amounts of blood were needed. An arrangement was therefore worked out with personnel of the nearby G-18 depot to supply the blood needed at these times. The men on this panel were already typed, serologic tests had been run on them, and their medical histories had been reviewed. When the blood was needed, therefore, it could be drawn and administered at once. This hospital did not store blood between convoys.

INCREASING AWARENESS IN THE EUROPEAN THEATER OF THE NEED FOR WHOLE BLOOD

The blood program in the European theater developed along two lines. One was the increasing realization of the necessity for blood rather than plasma in the management of wounded men (though the complete realization did not come until after D-day). The other was the increasing realization that local supplies of blood could not possibly meet the needs of the theater and that blood must be flown to the theater from the Zone of Interior (though again it was not until after D-day that the full realization came).

During 1942, as just indicated, there was no blood program, as such, in the European theater. The growing appreciation of the need for whole blood began to take expression early in 1943 and is best described chronologically.⁵

1943

January–April.—On 29 January 1943, in a memorandum to Dr. P. L. Mollison, British Blood Transfusion Service, Lt. Col. (later Col.) William S. Middleton, MC, Senior Consultant in Medicine, ETOUSA, thought there might develop “a swing toward whole blood transfusions” (22). “Actually,” he continued, “we sense a movement in that direction at the present time.” The British, as pointed out elsewhere (p. 54), had appreciated this necessity almost immediately after the outbreak of the war more than 3 years ago.

When the Chief Surgeon, ETOUSA, first directed that provision be made to supply whole blood for combat casualties, in July 1943, he did not mention the possibility of securing blood from the United States. The omission is explained in a letter written to Col. John Boyd Coates, Jr., MC, Editor in Chief of the history of the U.S. Army Medical Department in World War II, which is appended to the official diary of Colonel Cutler, Senior Consultant in Surgery, European theater, in the second of the volumes devoted to the surgical consultant system in this historical series (23). There is a strong implication, General Hawley wrote, in some sections of this diary, that his own disapproval of certain recommendations made by the consultants was purely arbitrary and capricious. The explanation is that throughout the war he frequently had top secret information that he could not share with even his deputy. Many of his adverse decisions were based upon such information. An example was his reluctance in 1943 and in 1944, before D-day, to attempt to obtain whole blood from the Zone of Interior. For this, there were two reasons. The first was that the transatlantic airlift in 1943 was so limited and so restricted by priorities that it could not take on any additional load. The second reason was that The Surgeon General had told him flatly that he would not approve of flying blood overseas.

The Surgeon General's opposition to the plan was made official on 8 April 1943, when a radiogram was received from The Adjutant General, War Department, stating that no whole blood could be expected in the theater from the Zone of Interior.

When General Hawley first directed that steps be taken to procure whole blood for hospitals in the United Kingdom, there was probably no really serious consideration, or at least no general consideration, of securing blood from the Zone of Interior on the part of those whose task it was to implement his orders. All the planning was based on securing the required blood from troops in the

⁵ The organization of the ETOUSA Blood Bank at the 152d Station Hospital was proceeding at the same time that the events related in this section were occurring. For reasons of continuity of narration, however, the history of the blood bank is told in a separate section (p. 498).

theater, with perhaps some donations from civilian sources. At intervals, however, the possibility of procurement of blood from the United States was brought up, sometimes tentatively, sometimes with real conviction, as the following facts show:

Early in 1943, it was pointed out by the Professional Services Division, Office of the Chief Surgeon, ETOUSA, that medical officers in the Mediterranean theater were reluctant to use plasma in forward areas, even though it was difficult to obtain whole blood for transfusion. The chief purpose of blood was to increase the oxygen-carrying capacity of the casualty for a period long enough to support him through surgery, and plans must therefore be made to use blood "up the line." It was recommended that a supply of blood be made available in the United Kingdom and also from sources in the United States.

May.—On 10 May 1943, in a memorandum to General Hawley, Colonel Cutler discussed information he had secured in recent conferences with Brigadier Whitby. He mentioned three possible sources of blood for the treatment of shock (24):

1. Lightly wounded casualties could be bled in the frontlines. The transfusion laboratory teams of mobile surgical units were provided with equipment for drawing and administering blood. Possibly, if the blood were used judiciously, these teams might be able to collect all that would be needed, but in the light of the British experience, this source must not be regarded as entirely sufficient, and plans must be made for a supplementary supply.

2. Blood secured from base and service troops in rear areas could be transported to the front by an organization similar to, and perhaps patterned after, the British Blood Transfusion Service (p. 15).

Blood collected in this manner had to be processed; that is, it had to be retyped and tested serologically, and glucose had to be added to it. When it was properly refrigerated, it was useful for a minimum of 14, and a maximum of 21, days. Equipment was necessary for typing and serologic tests, and refrigeration was required for the laboratory in which the processing was done.

Blood thus secured could be delivered to frontline units by air or surface transport, but precautions must be taken to keep it at temperatures below 42.8° F. (6° C.) at all times and also above freezing. A supply dump would be necessary behind frontline forces to handle blood and distribute it to the transfusion teams in the forward area. Such a unit might well be patterned after the British base transfusion unit, which was also equipped to manufacture glucose and physiologic salt solutions and to recondition and sterilize all apparatus.

3. Blood procured from the Zone of Interior represented the largest pool available. Supplies from this source could enter the transfusion service overseas either at the laboratory where blood drawn from troops was processed or at the forward dump. Refrigeration presented special problems, for the blood must at all times be kept within the temperature range just stated. Nonethe-

less, it was perfectly feasible to fly blood over the distance involved. As a matter of fact, transportation of blood by plane was possibly less harmful than transportation by road.

June.—On 5 June 1943, Captain Hardin sent a memorandum to Colonel Cutler discussing blood procurement as follows (25):

1. Blood could be obtained in the United Kingdom from base and SOS (Services of Supply) troops, but these troops, scattered as they were over a wide area, would furnish a somewhat problematical source of supply. Moreover, because blood would be most needed then, they would have to be bled during periods of combat activity, when they would be least available. If a constant stream of donors was made available, it was estimated that a single team could bleed up to 150 men a day.

2. Blood might also be collected from British civilians, who would probably furnish a more reliable source, but this plan had numerous complications.

3. If blood were collected in the Zone of Interior, it must be delivered to the theater by airlift. Its collection, processing, and initial delivery to a depot in the United Kingdom would be the function of any appointed agency in the Zone of Interior. Its reception, interval storage, and distribution to laboratory transfusion teams, base units, or both would be the responsibility of the United Kingdom blood depot but would differ in no way from the organization for the distribution of blood collected in the United Kingdom. The receiving depot would necessarily be located near an airport, and adequate refrigeration must be provided for the blood from the time it was offloaded from the plane until it was used.

At a conference with his consultants on 23 June 1943, General Hawley told them that blood used in the theater must be collected locally; it could not be procured from the United States.⁶ They were to consult with the British concerning its preservation and storage.

August.—In a memorandum for the record dated 29 August 1943 and entitled "Project," Colonel Cutler dealt at length with the procurement, storage, and supply of whole blood for combat troops in the theater (26). There was an overwhelming necessity for the blood, he stated, and a central blood bank was essential. Blood secured from lightly wounded soldiers would not be sufficient for the needs of forward areas. Blood from the Zone of Interior was not mentioned.

An attached appendix, prepared by Lt. Col. (later Col.) Ralph S. Muckenfuss, MC, Commanding Officer, 1st Medical Laboratory, dealt with technical considerations of procurement, storage, equipment, records, and issue. SOS troops in the United Kingdom, it was stated, would provide a sufficient source of supply for the O blood required.

⁶ Here and elsewhere, this statement is repeated as a matter of record. In the light of the information General Hawley had had from the Office of The Surgeon General through The Adjutant General (p. 475), there would have been no point to his encouraging the possibility of securing blood from the Zone of Interior.

In an undated ⁷ memorandum, apparently also prepared in the summer of 1943, Colonel Cutler discussed the blood program in the theater in the light of the British experience and practices and on the basis of Captain Hardin's experience as U.S. liaison supply officer at the British Blood Supply Depot. The plan was as follows:

1. The source of the blood was to be "suitable [meaning type O] volunteer donors from SOS units."

2. Base section commanders would cause unit commanders under their jurisdiction to obtain lists of men with type O blood. They would also designate hospitals to be used as bleeding centers.

3. On call from the commanding general, SOS base section commanders would assemble the required number of donors at specified centers, where bleeding teams dispatched from the medical blood depot would withdraw 400 cc. of blood from each donor.

In an undated memorandum for the record apparently prepared about this time, Colonel Cutler set forth additional aspects of the blood program for the theater. It seemed desirable to have for casualties in the field additional supplies of refrigerated fresh whole blood originating either in the United States or from SOS troops in the United Kingdom. If this plan were adopted, it would require:

1. The setting up of bleeding centers either in the United Kingdom or the Zone of Interior.

2. The transportation of blood in refrigerated airplanes to the Continent.

3. The use of refrigerated trucks to take the blood up the line to medical installations, which must have facilities to provide refrigerated storage for it.

In essence the plan outlined in this memorandum, presumably written in early August 1943, was the plan by which, a year later, blood began to be provided for the European theater.

Later in the same memorandum, Colonel Cutler pointed out that unless and until air supremacy was established, so that blood could be flown to the Continent from the United Kingdom, whatever blood was needed would have to be obtained on the hoof, from SOS troops or walking wounded.

Colonel Cutler did not again mention the possibility of securing blood from the United States in a number of additional memorandums on transfusion during the remainder of the year, nor was this possibility mentioned in other memorandums or at meetings dealing with blood supply and the blood bank.

November.—On 13 November 1943, in a memorandum for the record, Colonel Cutler (27) took the position that all general hospitals in the United Kingdom should either set up their own blood banks or "join in" with local British banks from which they could secure blood. The chief point, he said, was to have blood available. His final remark, that the chief point was to have

⁷ Dr. Cutler's death shortly after the war has made it impossible to supply missing dates or settle certain other questions which have arisen in the preparation of this section. His official diary has proved a very useful source of information, but some entries, as might be expected, would benefit by clarification that cannot now be obtained.

blood available, was an indication of the growing realization of the importance of this substance.

On this same date, Colonel Cutler also wrote Colonel Mason, Chief, Operations Division, Office of the Chief Surgeon, that he was concerned over what might happen if a major attack should begin and great numbers of casualties be brought to England in need of blood (28). On 18 November, Colonel Mason replied that plans for the distribution of whole blood provided for emergency supplies to station and general hospitals in the United Kingdom (29). Under normal circumstances, each hospital could provide enough blood from donors available in and about hospitals.

On 26 November 1943, General Hawley prepared a memorandum for the Commanding General, SOS, ETOUSA, in which he stated the need for whole blood for combat troops and for the establishment of a blood bank to be maintained with blood collected from SOS troops (30). He thought that blood should be provided as far forward as division clearing stations.

December.—On 3 December 1943, Colonel Mason informed General Hawley that the blood bank which he desired to have established was now so completely planned that the service would be ready to function on D-day. Base section commands would be requested to set up panels of donors. Blood from the Zone of Interior was not mentioned.

On 18 December 1943, General Hawley again informed the Commanding General, SOS, ETOUSA, of the necessity for the provision of whole blood for combat troops in the theater (31). He emphasized that an unfailing source of whole blood would be necessary, but, in his recommendations for the transfusion service, he mentioned only voluntary donations from SOS troops. The possibility of supplying blood by plane from the Zone of Interior again was not mentioned.

1944

January.—On 2 January 1944, the Commanding General, 1st Army Group, was informed by Headquarters, ETOUSA, that the provision of whole blood for combat casualties had been approved for all echelons down to and including division clearing stations (32). Whole blood would be considered an item of medical supply; it would be distributed through medical supply channels, and would be given the highest priority in transportation. Provision was made for equipment and personnel for a transfusion service for each army without requisition (p. 543).⁸

Upon the receipt of this communication, Colonel Kimbrough recommended that the chief consultants in medicine and surgery and the commanding officer of the 1st Medical Laboratory present to the Chief Surgeon a concrete plan for the operation of the stipulated transfusion service.

⁸ With the conversion of the 152d Station Hospital to the theater blood bank, this provision was promptly abrogated. Also, although approval was given for the use of blood in clearing stations, it was seldom if ever provided in them because it was immediately available in platoons of field hospitals, and its use was more practical and more efficient in the hospitals.

On 2 January 1944, Maj. (later Lt. Col.) Richard V. Ebert, MC, submitted to the Chief Surgeon, ETOUSA, for the attention of Colonel Cutler, the agenda of a meeting he had attended on 6 December 1943 in the Office of The Surgeon General in Washington (p. 194). It was shortly before this meeting that The Surgeon General had declined to consider the collection of blood in the United States for the European theater and its transportation thereto by air (p. 465).

It was The Surgeon General's opinion, reported Major Ebert, that shocked patients could be suitably treated with plasma and that whole blood was therefore not necessary in most forward areas, certainly not forward of evacuation or field hospitals. It was the sense of this meeting that transfusion services should be established in each hospital and that these services should be responsible for everything connected with transfusions, including the formation of a donor panel.

March.—As D-day drew nearer, unsettling thoughts about the adequacy of the arrangements for supplying blood for wounded casualties apparently began to cross the minds of those responsible for their care.

On 31 March 1944, Colonel Cutler wrote to Colonel Kimbrough that he had discussed with Colonel Muckenfuss and Major Hardin the possible extension of blood production. He believed that present capacities were fairly satisfactory, but he was having a memorandum prepared showing what would be needed in the way of personnel and equipment if they had to be expanded (33). The trial distribution of blood to hospitals in East Anglia, mentioned in this memorandum as to be held shortly, never took place.

April.—On 1 April 1944, at a meeting at the blood bank at Salisbury (34), the question of the capacity of the bank to furnish sufficient quantities of blood for operations on the Continent was discussed in great detail by the committee responsible for the blood program.⁹

When planning began in the summer of 1943, it was difficult to estimate the probable requirements for the invasion of the Continent because there were no experience tables to furnish guidance. Figures from North Africa were not yet available. The only definitive figures, in fact, were those reported by the British Blood Transfusion Service, which had operated with the Middle East command. They indicated that a ratio of 1 pint of blood for each 10 casualties would be adequate, and planning was begun on this basis.

For D+90, the period on which all planning for Operation OVERLORD was based, casualties on the Continent were expected to average 1,875 per day, which would mean, allowing 500 cc. of blood for each casualty in shock (estimated at 20 percent of the total number), that 200 pints of blood per day would be required.

Bank personnel believed that it would be possible to collect 200 pints of blood a day for 90 days, a total of 18,000 pints, and to collect a maximum of

⁹ Unless otherwise identified, material in the following pages is derived from the official diary of the ETOUSA Blood Bank (34).

600 pints per day for shorter periods. Storage space for 3,000 pints of blood was available, and the blood could be stored for a maximum period of 14 days before use.

The original plan was to provide 1,000 pints of blood between D-day and D+5. On D+6, 600 pints would be provided, and on the following day, from 200 to 600 pints. These quantities were considered in excess of the amounts likely to be required, and it would therefore not be necessary for the collecting teams to work at full capacity during this period. Each team could collect 120 pints of blood daily if a constant stream of donors were made available.

A single citation of statistics will make clear how far the actualities of combat were from the original planning (35). By 20 July 1944, 46,918 casualties had been admitted to medical installations of the First U.S. Army on the far shore, and 15,250 pints of blood had been delivered, a ratio of 1 pint to 3.06 wounded. Of the total number of wounded up to this date, 22,768 were seriously wounded, which changes the ratio of pints of whole blood to wounded to 1:1.48. Later, the ratio was to be 1:1.

The plans called for the bleeding of base troops (SOS and Air Forces). In late summer of 1943, a study of the SOS troop basis indicated that by D-day, which it was then thought would be in May 1944, there would be approximately 350,000 officers and enlisted men in the theater. It was estimated that in this group there would be a minimum of 80,000 men with type O blood, of whom some 60,000 would be available as donors. Each of them would donate four times. On the basis of these estimates, the capacity of the panel was set at 240,000 pints annually.

At the 1 April 1944 conference at Salisbury, new figures were quoted that had been secured by General Hawley in a teleprinter conversation with the Office of the Adjutant General, on 7 March 1944. They cast serious doubts upon these estimates. In view of the alarming reduction in the capacity of the blood donor panel which had been indicated by General Hawley's information as to troop strengths and troop movements, it was recommended that steps be taken immediately to plan for the acquisition of whole blood, type O, from the United States. The committee did not consider that even the establishment of a panel of donors from the Eighth Air Force would solve the problem. It also recommended that the blood bank at once increase its normal daily processing capacity to a minimum of 500 pints.

At another conference on blood supply on 5 April 1944, Colonel Kimbrough again called attention to the plans previously described for flying blood from the United States to the European theater. In a report to General Hawley, Colonel Kimbrough repeated this recommendation and recommended its implementation, for a number of reasons (36): The donor response from SOS units had been extremely disappointing; not more than 20 percent of the troops had volunteered. As the invasion would proceed and more and more troops would be sent to the Continent, the pool of donors in the United Kingdom would become progressively smaller, though it would increase in forward

areas, where blood procured on the hoof might perhaps be taken into consideration. Finally, the capacity of the blood bank was then only 200 pints daily, against an estimated total daily requirement after D-day of 500 pints. In view of reports from the Mediterranean theater of the increasing use of whole blood, it was highly probable that this estimate was too low. On the whole, however, it was thought that a ratio of three units of plasma to one of blood, or even five units of plasma to one of blood, would be adequate.¹⁰

When discussions of the blood program began in the European theater, the prewar ideas of the total value of plasma were simply carried over into the planning, just as they had been in the North African theater in 1942 and early 1943. In the Fifth U.S. Army, however, the experience had not borne out the concept that plasma could be substituted for whole blood (37, 38). At the present time, large quantities of blood, sometimes as much as 4,000 cc., were being used, the objective being to bring the red blood cell count up to 4 million per cu. mm. within 12 to 24 hours after wounding.

The experience of the North African theater gradually became known in the European theater, but its full impact was not realized until Col. Thomas J. Hartford, MC, Executive Officer, Office of the Surgeon, 1st Army Group, returned from a trip to Italy in March 1944 (39). He brought the disquieting news for those planning the blood supply for the invasion of the Continent that 1 pint of whole blood was now considered necessary for each 2.2 wounded (table 17) rather than the 1:8 or 1:10 originally estimated. This seemed to Colonel Kimbrough an excessive estimate which required reconsideration, though he was not in a position to criticize data obtained from battlefield experience.

In his 6 April report to General Hawley, Colonel Kimbrough analyzed present plans for the blood supply for the invasion as follows: On D-day, from previous collections, 4,200 pints would be available. For the next 7 days, the bank would collect 500 pints daily. After this time, it was anticipated that the daily blood supply from the bank could not exceed 200 pints.

The amounts of blood required by the new estimates, Colonel Kimbrough concluded, could not possibly be met with the present facilities of the ETOUSA Blood Bank or the limited pool of donors available. A stronger directive was being prepared in the hope of obtaining a larger panel of donors. It might be necessary to offer to pay the troops for their donations, or to give them whisky as an incentive. It might also be necessary to build a laboratory on the far shore, to care for the increased needs. In Colonel Muckenfuss' opinion, this could not be done in less than 90 days. The solution of the problem, however, seemed to be the procurement of blood from the Zone of Interior.

At another conference on 7 April 1944, a somewhat more optimistic spirit prevailed. It was hoped that a second letter to base section commanders from Headquarters, SOS, would inspire more donors to contribute. With an improved donor response, and with the period immediately after D-day provided

¹⁰ Additional details of the 5 April 1944 conference are discussed with the ETOUSA Blood Bank, in the section concerned with planning for Operation OVERLORD.

TABLE 17.—Use of blood by U.S. troops in Italy, 1 September 1943–25 February 1944¹

Unit and period of time	Casualties	Transfusions	Ratio
Evacuation hospitals.....	13, 763	3, 060	1: 4.5
Field hospitals.....	1, 044	1, 571	1.5: 1
Total.....	14, 807	4, 631	1: 3.2
94th Evacuation Hospital:			
23 September–9 October.....	411	56	1: 8
13 October–6 November.....	499	150	1: 3.3
7 November–12 January.....	1, 863	840	1: 2.2
Anzio beachhead, 22 January–25 February:			
British.....	3, 527	² 1, 262	1: 2.79
United States.....	4, 523	² 2, 456	1: 1.85

¹ Plasma usually used: 3.54 units plasma to 1 pint blood.

² Bottles of blood used.

NOTE.—The ratio is actually blood to total casualties. While I was there, they were sending 100 bottles of blood a day to Anzio. The amount used, especially early, does not represent the amount required or desired but in many instances the amount available. Another fact that is significant is that high explosives accounted for 827 of the battle casualties admitted to any of the hospitals during the period September-January in this theater.—T. J. H.

Source: Official Diary, 152d Station Hospital Blood Bank, 1944–45.

for, it was thought that enough blood could be collected daily to satisfy the estimated demand until D+60. Then, additional teams and donors would have to be added.

An extended discussion of equipment brought out another difficulty: The normal 200-pints-per-day capacity of the blood bank could be increased to 500 to 600 pints for a few days, but by the 10th day, at the latest, the output would have to be reduced because the limited supply of giving sets could not be rotated fast enough.

Colonel Kimbrough was also concerned about the longevity of whole blood with the preservatives then in use. The average useful life was not more than 10 days, and he had been informed that, even under optimum conditions, blood could not be delivered to the front in less than 10 days after it had been drawn.

General Hawley, who was kept informed of these various developments, expressed himself as much concerned over them. In view of the limited useful life of whole blood and the impossibility of its reaching the front in less than that lifespan (10 days), he did not think the average usable life of blood at the front could be more than 6 days, and it would be safer to estimate it as 5 days. From the practical standpoint, this meant that the blood bank must be able to replace the total demands at the front every 8 days. In spite of Colonel Kimbrough's opinion that this could be done, General Hawley doubted it.

Table 18 contains the estimates prepared in response to a request from the Planning Branch, Operations Division, Office of the Chief Surgeon, on 6 April 1944 for "firm figures" for the blood requirements from D-day to D+90 (39).

TABLE 18.—*Estimated demands for whole blood, 29 April 1944*¹

Period of time	Casualties	Estimated demands	
		Total	Daily
	<i>Number</i>	<i>Pints</i>	<i>Pints</i>
D-day to D+3.....	16, 879	3, 376	844
D+4 to D+10.....	4, 770	954	136
Total.....	21, 649	4, 330	394
D+11 to D+20.....	9, 907	1, 981	198
D+21 to D+30.....	14, 637	2, 927	293
Total.....	24, 544	4, 908	245
D+31 to D+45.....	20, 895	4, 179	279
D+46 to D+60.....	23, 280	4, 656	310
Total.....	44, 175	8, 835	295
D+61 to D+75.....	20, 513	4, 103	273
D+76 to D+90.....	22, 048	4, 410	294
Total.....	42, 561	8, 513	284
D-day to D+90.....	132, 929	26, 586	292. 1
D+4 to D+90.....	116, 050	23, 210	266. 7

¹ One pint of whole blood estimated for each five casualties.

On 12 April 1944, in a memorandum to General Hawley, Colonel Cutler recommended that donors be paid \$10 each, as had been done in Italy. If this plan to increase donations were not adopted, he thought that supplemental supplies of blood must be flown to the European theater from the Zone of Interior.

D-DAY AND AFTER

Blood was sent from the United Kingdom to the Continent on D-day and during the first days of the invasion through the ETOUSA Blood Bank according to the plans prepared in January 1944. It was in reasonably adequate supply, at least in the light of the standards of usage of blood which then prevailed.

24 June 1944

On 24 June, the situation changed. Up to this time, in accordance with the original planning (40), the bank had supplied 250 pints of blood a day to the First U.S. Army. As of this date, an additional 250 pints per day was

"imperatively" requested for this Army. The Supply Division had also been informed that a meeting of responsible medical officers would shortly be held on the far shore to determine a new pattern of requests for whole blood. It was thought that at least 500 pints per day would be requested.

Colonel Cutler was very much pleased with the early operations of the blood bank. Late in June, he wrote in his official diary (23):

The tremendous demand for blood completely justifies the establishment of the blood bank and from reports and observations it is clear we must have saved life by the establishment of an E.T.O. blood bank. * * * Lieutenant Reardon of the blood bank is now on the far-shore. He has a large Navy-type refrigerator buried in the ground and (8) trucks (each taking 80 pints) are working well with the First Army delivering blood at this time. Almost all LST's and hospital carriers either gave up their blood to people on the far-shore or used it up on casualties on the trip back. Little was actually wasted. The major difficulty about blood has been the return of kits and sets and marmite jars.

On 17 September 1958, General Hawley annotated this entry in Colonel Cutler's diary with the statement that each outbound LST (landing ship, tank) carried twice the amount of blood estimated that it would need on its return trip (23). The excess was unloaded on the far beach.

2 July 1944

Although the Third U.S. Army was not to become operational until 1 August, some medical units later assigned to it were serving in France with the First U.S. Army, and on 2 July 1944, a communication concerning planned needs for blood for this (the Third U.S.) Army was sent from its headquarters to the Commanding General, ETOUSA, for General Hawley's attention. In this communication, it was stated that the original allocations of blood were now considered inadequate for anticipated demands in forthcoming operations, especially in the light of the amounts presently being consumed by the First U.S. Army. These amounts were not considered excessive. The planned Third U.S. Army allocation was 150 pints daily from D+29 to D+32, 200 pints daily until D+39, and 350 pints daily until D+90. It was urgently requested that these allotments be increased to 300, 400, and 550 pints daily, respectively, for the periods specified.

There was still no universal agreement, however, that blood was needed in such quantities. On 2 July 1944, Colonel Cutler wrote Colonel Kimbrough that from his observations on the far shore and his studies of battle casualty rates, he thought that, if blood were used carefully, it would not be needed in these amounts for two reasons (41):

1. In November 1943, Colonel Churchill had estimated that 20 percent of battle casualties would need resuscitation. In the European theater, casualties in invasion troops through 25 June had numbered 24,939, less than a thousand a day. Of every thousand casualties, not more than 10 percent, 100 men, would require blood. If each of them needed 2 pints, that would make the requirement 200 pints per day for each thousand casualties. Some patients might need additional transfusions because of secondary hemorrhage

or for other reasons, but an extra 200 pints of blood per day should be ample for this group. Thus, with a casualty list of 1,000 per day, 400 pints daily should meet the requirements of the First U.S. Army.

2. Colonel Cutler had observed while on the far shore that very little plasma was being used, though, theoretically, a casualty's protein requirements could be met by it.

Colonel Cutler had discussed these matters with Col. Joseph A. Crisler, Jr., MC, Consultant in Surgery, First U.S. Army, and had reminded him that under conditions of unusual stress, blood could be secured from walking wounded; special donor sets had been provided for this purpose.¹¹

12 July 1944

On 12 July 1944, Colonel Kimbrough wrote General Hawley that the ETOUSA Blood Bank was supplying 500 pints of whole blood daily to the Continent and was utilizing its panel of donors to full capacity (42). It was also planning to secure donors from the Air Forces, though the number from this source would not be large, since only ground troops could be used. Reports from the Continent indicated that blood was being used economically. The most optimistic estimates of the ultimate capacity of the ETOUSA panel of donors was 700 pints of blood daily. With increased operations on the Continent, this amount would not meet the demand.

Colonel Kimbrough therefore recommended:

1. That plans be laid on to obtain whole blood for transfusion from the Zone of Interior.

2. That facilities of the ETOUSA Blood Bank be used to distribute blood received from the Zone of Interior and delivered from that point to the Armies. The bank already had a well-organized distribution system, and its utilization would avoid duplication of facilities.

24 July-1 August 1944

As the scarcity of blood became increasingly serious, a system of allocations was set up:

1. After the breakthrough at Saint-Lô, on 24 July 1944, daily allocations of available blood were made to medical units of the First U.S. Army.

2. This plan was continued until 1 August 1944. Then, until 25 August, when supplies from the Zone of Interior began to arrive, Colonel Mason conferred daily with Col. Alvin L. Gorby, MC, Surgeon, 12th Army Group, to be sure that the dwindling supplies of blood were delivered to the areas in which the largest numbers of casualties were anticipated.

In other words, by the end of July, the demand for blood had far outpaced the supply. Its increased use for combat casualties and the stepped-up

¹¹ Early in 1942, it had been concluded in the Zone of Interior that bleeding of walking wounded was completely unrealistic. It also was considered especially objectionable in view of the large numbers of 4-F's in the United States who could act as donors. It proved impractical in combat zones in all theaters.

operations on the Continent had combined to produce exactly the shortages in the supply that the planners of the program had feared might occur and that many of them had thought could be avoided only if blood were procured from the Zone of Interior.

On 28 July 1944, Lt. Col. (later Col.) Robert M. Zollinger, MC, Surgical Consultant, ETOUSA, wrote the Surgeon, Forward Echelon, Headquarters, Communications Zone, concerning the amounts of blood necessary for combat casualties (43). Recommendations had been made in the "Manual of Therapy, European Theater of Operations," as well as elsewhere, that blood be given in the ratio of one part blood to two parts plasma. Current requirements, however, were more nearly 1:1. After visiting field and evacuation hospitals, he was convinced that this latter ratio might be correct, especially in field hospital platoons, near the frontlines. Large amounts of blood were unquestionably needed. If the requirements sometimes seemed excessive, a partial explanation was the backlog of patients often awaiting operation. They had been prepared for operation by shock teams, but because of the press of more urgent casualties, their timelag was lengthened, and it was often necessary to continue the administration of blood and plasma or to repeat it. This contingency had probably not been taken into consideration in pre-D-day estimates of the blood that would be needed.

On 31 July 1944, the day before the Third U.S. Army was committed, Colonel Kimbrough again notified General Hawley of shortages of blood on the Continent (44). Current demands were for approximately 1,000 pints per day. The capacity of the SOS panel of donors in the United Kingdom was now about 400 pints daily. A supplemental panel from certain elements of the Air Forces contributed about 250 pints daily. The daily deficit—more than 300 pints—could not possibly be met by donations on the Continent, and the demand for blood would increase as operations became intensified.

Colonel Kimbrough therefore recommended to General Hawley that plans be made to obtain a thousand pints of whole blood daily from the Zone of Interior by air transport.

IMPLEMENTATION OF THE WHOLE BLOOD PROPOSAL

July–August 1944

31 July.—General Hawley had not waited for Colonel Kimbrough's second communication to take action. On 31 July 1944, his executive officer requested the Personnel Division, Office of the Chief Surgeon, to arrange air transportation to the Zone of Interior for Colonel Cutler, Major Hardin, and Col. William F. MacFee, MC, Commanding Officer, 2d Evacuation Hospital, for stays of 10 days, 6 weeks, and 21 days respectively (45). The trip was essential, the request read, to initiate and implement a supply of a thousand pints of whole blood daily from the United States to the United Kingdom.

When the question was raised whether it was necessary for all three officers to make the trip, General Hawley's reply was immediate and unequivocal (46). It was. Colonel Cutler, as Chief Surgical Consultant in the theater, must be present at the formulation of the program. Colonel MacFee, an experienced surgeon, was in command of an active evacuation hospital supporting the First U.S. Army. He had been in France since D-day and could give The Surgeon General a firsthand account of blood requirements on the Continent. Major Hardin was in charge of the blood bank, which had about reached the limit of its capacity; armies in the field were requesting more blood than could possibly be supplied by it. The matter could not be handled by phone or radiogram. Highly technical details had to be arranged, including adaptation of the transfusion set used in the Zone of Interior to use in the European theater. The matter was regarded as "of the greatest urgency" and "all three officers" must be returned to the United States.

2 August.—On 2 August 1944, a radiogram was sent through channels from General Hawley to The Surgeon General, U.S. Army, as follows (47):

Burden is being imposed that the ETO Blood Bank cannot meet in the demand for whole blood for the forces fighting in France. That blood is necessary and is saving lives, all are convinced. It is believed necessary that daily air shipment of 1000 pints be sent. To coordinate this matter, returning to the United States are Colonel Cutler, Colonel William MacFee, and Major Hardin.

5 August.—On 5 August, General Hawley followed up this radiogram with an explanatory letter to General Kirk (48). The economy of the use of blood, he wrote, had been thoroughly investigated. Blood was not being used extravagantly. The fact was inescapable that its use was hastening recovery and saving lives.

The capacity of the ETOUSA Blood Bank, General Hawley continued, was set at 300 pints daily, but from D-day to D+50, it had delivered an average of 480 pints daily. Its capacity was being built up to 500 pints daily, but this would not be enough as troop strength increased.

The Air Transport Command was prepared to put on one or two planes daily, as necessary, to fly the blood from the United States. The Troop Carrier Command would deliver it by plane direct from Prestwick, Scotland, where it would be landed, to the Continent, and it would thus be in France within 48 hours after it had left the United States.

General Hawley hoped that a small amount of the blood collected for plasma could be diverted to the European theater as whole blood without endangering the plasma program. No publicity need attend the diversion, though perhaps it might stimulate donations if the donors knew that the blood they gave might be in the veins of a soldier in France within 3 days after it was collected.

When the question of supplying blood to Europe from the Zone of Interior was first raised, as Colonel Cutler noted in his official diary (23), General Hawley was concerned about the length of time it would take to get the blood to England. He thought that there would be a minimum of 72 hours after it

was collected before it could leave the Zone of Interior. The whole project would be futile if the blood did not have sufficient life after its arrival in the United Kingdom. There was an extended discussion of this point in a meeting of his consultants on 28 July 1944, but he was finally convinced, when the procedures to be employed in the Zone of Interior were explained to him, including an airlift to the United Kingdom, that the program was feasible. "The Surgeon General," he said, "is definitely opposed to it, but I am willing to put it up to him." At this time, he was already planning to send Colonel Cutler, Colonel MacFee, and Major Hardin to the United States to discuss the plan.

11 August.—General Kirk replied to General Hawley's letter of 5 August on 11 August 1944 (49). Immediately after receiving it the previous day, he had had a conference with Maj. Gen. George F. Lull, Brig. Gen. Raymond W. Bliss, and General Rankin.

All three of these officers believed that within 10 days it would be possible to begin shipping 500 pints of blood daily to the European theater. It would be sent in Alsever's solution, which would bring the volume to 1 quart. The blood would be good for 30 days¹² and would be shipped without refrigeration.¹³ The safety of this method had been tested by flying blood to Prestwick and to San Francisco without harm to it (p. 209).

13 August.—On 13 August, General Kirk sent General Hawley the following radiogram through channels (50):

Whole blood is subject. This office prepared to ship 258 pints daily for first week commencing 21 August. This amount will increase to 500 as blood becomes available. Shipments will be made without refrigeration. Is sufficient refrigeration available in theater to accommodate shipments? Estimated weight first shipment 1200 pounds and 387 cubic feet. Request air priority and shipping instructions furnished this office. Request immediate reply.

COMMENT

The reversal of General Kirk's previous refusal to consider plans for shipping blood overseas followed his visit to the Mediterranean theater the first week of July 1944. He was influenced, one may speculate, by his observations there. When he visited the theater blood bank at the 15th Medical General Laboratory, he was given a brief statement of its organization and activities: Between 23 February 1944, when the first shipment was made to the Anzio beachhead, and 6 July 1944, a total of 16,574 units had been supplied to the Fifth U.S. Army. This amount, the report stated, represented over 9 tons of fresh human blood, the cells of which had been kept potent by careful handling and refrigeration. The report also included details of the selection

¹² This should be 21 days.

¹³ Here and elsewhere, the term "without refrigeration" is somewhat misleading. It was only during the actual flight time that blood sent overseas to Europe was not under refrigeration. It was placed under refrigeration as soon as it was drawn, was kept under refrigeration until it was placed on the plane, was placed in a refrigerator if the plane was on the ground for more than a brief period en route, and was again placed under refrigeration as soon as it was taken off the plane. As a matter of fact, the temperature of the blood changed no more than 6° F. during the period it was without refrigeration on the plane (p. 211).

of donors, the processing of blood, and the reservation of high-titer group O blood for O type casualties. The memorandum ended with the statement that an abundant supply of whole blood had enabled surgeons in forward hospitals to save the lives of desperately wounded soldiers by operations previously considered too dangerous to be undertaken.

The chronicle of the oversea blood program now moves to its implementation in the Zone of Interior.

Part IV. Definitive Actions in the Zone of Interior for an Oversea Transfusion Service

REVIVAL OF PROPOSAL FOR AIRLIFT OF BLOOD TO EUROPE

As reports from Europe began to indicate an increasing need for whole blood for combat casualties, numerous discussions were held in the Surgery Division, Office of The Surgeon General, to initiate action in anticipation of the airlift which now seemed inevitable in spite of the earlier rejection of the plan by General Kirk.

On 3 August 1944, General Rankin sent a memorandum to The Surgeon General stressing the urgent need for blood in the European theater and outlining two plans by which it might be procured from the Zone of Interior (51):

1. Whole blood could be secured from Red Cross donor centers.
2. Red blood cells could be provided from plasma processing centers.

The use of red blood cell suspensions for transfusion had been well established, but there were certain practical difficulties in the way of utilizing this source of blood for the immediate needs of the European theater. The chief difficulty concerned the bleeding bottle then in use.

Since it was quite certain that these difficulties could be overcome, it might ultimately be desirable to institute this second plan, which would provide red blood cell suspensions without interference with the blood program now in operation. In view of the urgency of the situation, however, it seemed wisest to institute the first plan. It could be put into operation, and delivery of blood could be begun, within 7 to 10 days after the airlift was authorized.

Only type O blood would be used. It would be obtained, after typing of donors, at the Washington and New York blood donor centers. The blood would be packed in cardboard containers and shipped in unrefrigerated planes to the European theater. Blood prepared with available equipment by the procedure to be outlined could be safely used for as long as 30 days after it was collected. It was thought that the combined output of the Washington and New York centers would provide an airlift of 500 pints of blood daily.

The plan proposed would be implemented as follows:

1. Personnel. Three technicians would be provided at each bleeding center by the Blood Research Division, Army Medical School, and the Navy. They would perform the typing, grouping, and serologic tests. Five or six untrained workers would be provided at

each center, either by the Red Cross or the Army, to clean and prepare the collecting sets.

2. Equipment. This could consist of:

a. Bottles of 1,000-cc. capacity, each containing 500 cc. of Alsever's solution. Each center would be provided with 500 bottles per day. At the present time, 3,500 bottles could be obtained. Another 5,000 could be obtained within a week, and thereafter the supply would be unlimited.¹⁴

b. Donor bleeding sets. Each center would need an initial supply of approximately 1,000 sets, which could be obtained immediately from Army depots. Since the sets could be cleaned and reused, the initial supply would be adequate.

c. Typing sera and equipment for serologic testing. Adequate supplies of both items would be furnished by the Blood Research Division, Army Medical School.

d. Shipping containers. The cardboard containers in which the bottles of blood left the Red Cross blood donor centers could be used for packing the blood, six bottles to a container, and transporting it by plane. The packaging would be done at the blood donor centers. Refrigeration during the flight was desirable but in the emergency not considered absolutely essential (p. 209). An effort would be made to develop a suitable insulated container for shipping purposes.

e. Equipment for administering the blood. Since this was standard equipment, it would be presumed that it would be available in the oversea theater.

3. Procedure. This would be as follows:

a. Each donor would be tentatively typed at the hemoglobin stations of the Red Cross blood donor centers.

b. As the donor entered the bleeding room, the typing would be read.

c. Each type O donor would be bled into the special prechilled bottles containing Alsever's solution. All other donors would be bled into the usual Red Cross collection bottles which contained citrate solution and were used in the procurement of blood for the plasma and albumin programs.

d. Grouping would be confirmed from the clotted blood sent to the laboratory of the donor center.

e. Bottles of confirmed type O blood would be placed in cardboard containers and stored immediately in the refrigerator at the Red Cross center until a sufficient quantity had been accumulated for shipment. Additional refrigerators were available and could be supplied as needed.

f. A schedule would be developed with the Air Transport Command for delivery of the blood from the centers to the planes by the Red Cross Transport Service.

This plan, with minor modifications, was the same plan proposed and rejected in December 1943 (p. 462). It was also, with modifications, particularly the change to ACD solution and refrigeration in April 1945, the plan by which blood was shipped to Europe during the rest of the war.

At this time—the first week of August 1944—the first definite request was received from the European theater for shipments of whole blood, and the lines of development in that theater and in the Zone of Interior began to merge.

PREPARATIONS FOR AIRLIFT

Activities were intensified in the Surgery Division, Office of The Surgeon General, as soon as the request from ETOUSA was received and the decision

¹⁴ Bottles large enough to hold the necessary amounts of Alsever's solution were not in production when the request to fly blood to the European theater was received in the Office of The Surgeon General. The manufacturers, however, sensing the urgency of the situation, provided them in a crash operation typical of the part American industry played in the entire blood-plasma program.

was made to ship blood to the European theater. Supplies of various kinds had to be procured, and additional personnel were necessary for the collecting centers. Action was taken at a series of conferences.

10 August 1944

The conference held on 10 August 1944 (52), to which General Kirk had referred in his letter of 11 August to General Hawley, was attended by General Rankin; Colonel Carter; Captain Newhouser; Colonel Kendrick; Maj. Earl S. Taylor, MC, Technical Consultant, Volunteer Donor Service, American Red Cross; and Lt. (later Lt. Cdr.) Henry Blake, MC, USN, Assistant Technical Consultant; Maj. (later Lt. Col.) Oscar B. Griggs, MC, Supply Service, OTSG, and Lt. Col. John J. Pelosi, MC, Supply Service, OTSG; and Maj. (later Lt. Col.) Frederic N. Schwartz, MAC, Operations Officer, Blood Plasma Branch, Surgery Division, OTSG.

The business of this conference was to make the plans for the shipment of whole blood from the Zone of Interior to the European theater. In general, the plan used was the one outlined by General Rankin in his memorandum to The Surgeon General on 3 August 1944. As the plan was finally adopted, the details were as follows:

1. The American Red Cross Blood Donor Service would be responsible for procuring blood in Washington, New York, or other centers which might be required to provide blood in the quantities needed by the oversea theaters. Initially, 180 to 390 bleedings would be obtained daily in New York, and 78 to 180 in Washington. If more blood was needed, other centers would be brought into the program.

2. Equipment required for the airlift overseas would include:

- a. Sterile, 1,000-cc. vacuum bottles each containing 500 cc. of Alsever's solution.
- b. Sterile, expendable donor sets put up in aluminum tubes.
- c. Sterile, expendable dispensing sets, similarly prepared.
- d. Typing sera.
- e. Supplies for the Kahn test, including a centrifuge.
- f. Stencils for classifying and numbering bloods for shipment.
- g. Packaging supplies, including brown paper, paper tape, and shipping tags.

3. Personnel for each donor center would consist of a medical officer qualified to operate a blood bank and three technicians, two for typing blood and one for shipping it. The personnel to operate the whole blood service would be provided by the Personnel Branch, Office of The Surgeon General. Personnel from the Army Medical School would establish the whole blood station in New York and serve there temporarily. Colonel Kendrick, Special Representative on Blood and Plasma Transfusion, Office of The Surgeon General, would be responsible for the whole blood operation.

4. Blood would be transported from the donor center to the airport by the American Red Cross or under some other arrangement agreed upon by the Army and the Red Cross. The blood would be refrigerated from collection to emplanement. The Red Cross was installing large refrigerators in the centers selected to supply the blood, so that this requirement could be met.

5. The request to the Army Transport Command for the shipment of blood to the European theater must originate from that theater. (This request had been made on 1 August by General Hawley's office and had been granted at once.)

6. The care, refrigeration, and transshipment of blood after it arrived overseas was the responsibility of the European theater. The theater had been asked to notify the Office of

The Surgeon General when refrigeration would be available there and when the initial shipment of blood could be received. The whole blood procurement station in New York would be ready to begin shipments on 21 August 1944.

7. The European theater was also requested to ask that a medical officer accompany a shipment of blood from the collecting center in the Zone of Interior to the installation in the European theater in which the blood was to be used, in order to investigate all the problems concerned with the shipping of whole blood overseas and also to study the operation of blood banks in the European theater. (Colonel Kendrick was given this assignment (p. 495).

The request for blood from the European theater had been for 1,000 pints per day. It was agreed that every effort would be made to supply this quantity, but it was recognized that it might not be feasible at first to send more than 750 pints daily, because of the limited capacities of bleeding centers on the east coast. If the quota could not be met, perhaps the deficit could be made up with resuspended red cells (p. 490).

It was agreed at this meeting that, beginning on 21 August 1944, 250 pints of blood would be shipped daily for a week. No definite commitments were made for the next week, but it was hoped that the quantity could be stepped up to 500 pints daily on 28 August, to 750 pints on 4 September, and to 1,000 pints daily after 11 September.

At the conclusion of this conference, The Surgeon General stated that if operating surgeons in the European theater desired whole blood, they should certainly have it, and every effort would be made to provide what they had requested.

15 August 1944

Another conference held on 15 August 1944 in the Surgery Division, Office of The Surgeon General (53), was attended by General Rankin, Colonel Carter, Colonel Kendrick, Major Schwartz, and others from this office and from the American Red Cross concerned with supply and procurement. The meeting was also attended by Colonel Cutler, Colonel MacFee, and Major Hardin, who had just arrived in the United States. Since consent to the shipment of blood to the European theater had already been secured from The Surgeon General when these officers arrived, the discussion chiefly concerned the details of the arrangements for shipping blood. Colonel Cutler was particularly concerned with two points, (1) the lack of refrigeration on the transatlantic flight; and (2) the use of Alsever's solution. This was no time, he said, to experiment on the American soldier.

The discussion on refrigeration at this meeting is included under the general heading of refrigeration (p. 209). The discussion on the use of Alsever's solution as a preservative, to which Colonel Cutler also took exception, is similarly discussed under the heading of preservatives (p. 229).

At this conference, Colonel Cutler was told that, somewhat later, the European theater would be supplied with resuspended red blood cells from type O blood. They were available in abundance, as a byproduct of the plasma program, and it was thought that they could be used to advantage. They would be put up in 600-cc. Baxter bottles and would be flown to Prestwick,

being treated en route and after receipt exactly as whole blood was treated. It was planned to send the first shipment with Major Hardin on his return to Europe, so that he could distribute the material to hospitals whose personnel were suitably trained in the use of blood in this form. Several trial runs would be necessary before regular shipments were begun.¹⁵

It was agreed at this meeting that the Army would establish three or four collecting centers for the procurement of blood for the European theater, beginning with the American Red Cross blood donor centers in Boston, New York, and Washington. Lieutenant Blake thought as much as 750 pints daily could be obtained from these three centers. To increase the amount to 1,000 pints per day, it would be necessary to establish another collecting center in one of the Red Cross donor centers in the Midwest. It would be impossible to meet the commitments for whole blood, plasma, and albumin from the quotas presently available on the east coast.

The blood sent to the European theater would be tested serologically and grouped. Every effort would be made to send only group O blood, but retesting before using was advisable. Since this would entail entering the bottle and drawing out a small sample, it was suggested that the tests be made within 3 hours of the time the blood was to be used, to reduce the possibility of contamination.

FIRST SHIPMENTS

These various plans were carried out, and substantially as contemplated. The first shipment of blood, 258 bottles, was flown from the Zone of Interior to Prestwick (map 2), on 21 August. It was transshipped by refrigerated truck to Salisbury, the base of the European Theater Blood Bank; and thence was flown to France, where it arrived on 27 August 1944. The shipment from the Zone of Interior on 24 August consisted of 180 bottles, and the shipment on 25 August, of 336 bottles.

Refrigeration facilities at Prestwick could care for 222 cartons of blood, each containing 6 bottles. The plan was to keep the blood there under refrigeration at least 4 hours and to use it for periods up to 10 days.

When Colonel Cutler arrived from the United States at Prestwick on 25 August, 350 pints of blood in Alsever's solution were on the plane with him, and the blood was still cool at the end of the flight (23). Giving sets, however, were not included.

The following day, Col. S. B. Hays, MC, Chief, Supply Division, Office of the Chief Surgeon, sent a radiogram to PEMBARK (port of embarkation) New York, stating that the first shipments of whole blood had arrived in good condition but that they had not included recipient sets (filter, tubing, needle), as

¹⁵ In spite of the abundance of red blood cells as a byproduct of the plasma program and the proved usefulness of blood in this form (p. 312), this plan proved impractical. The cells could not be used safely for more than 5 days, which was an insufficient time to deliver them to using hospitals in the European theater. Thalheimer's method of using corn syrup as the diluent was developed too late to be useful, which is unfortunate, for it extended the longevity of packed red blood cells to 18 days.

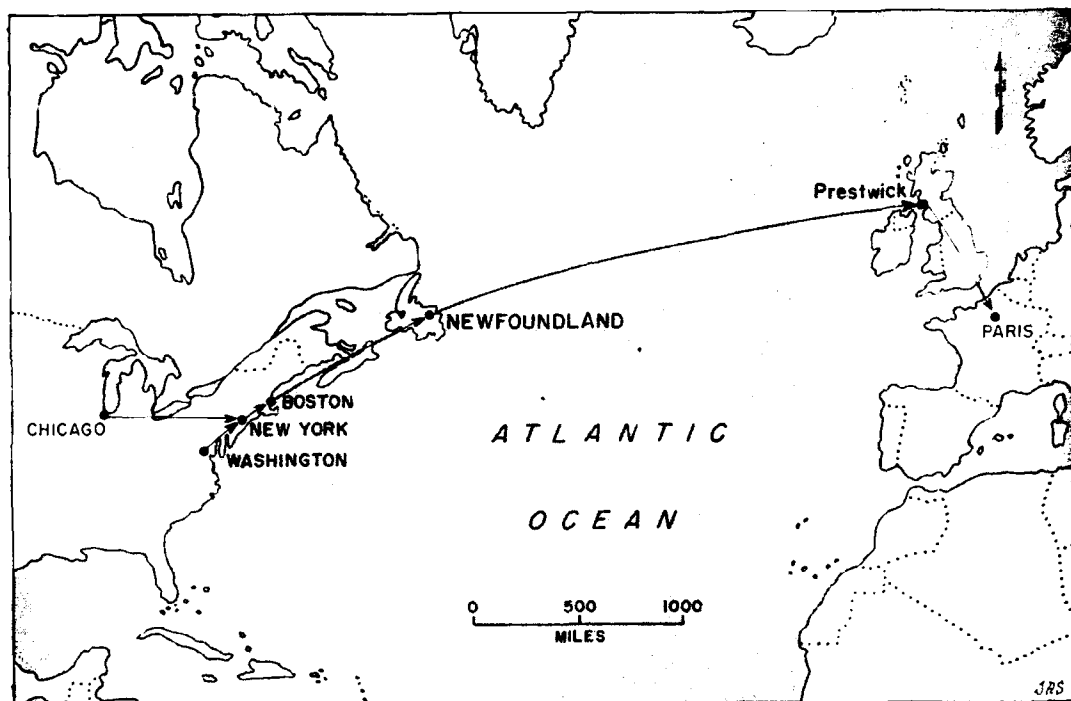

MAP 2.—Flight plan of airlift of blood to Prestwick, Scotland, and thence to the European Continent.

the plans had called for. The Surgeon General, on 31 August, replied that recipient sets were not presently available for the shipments but that they would be received within the next few days, as they were.

On 26 August, PEMBARK notified Supreme Headquarters, Allied Expeditionary Force, that air priority had been set up, effective on 1 September, for the daily shipment of whole blood to Europe in the amount of 2,250 pounds (class 1, medical).

On 28 August, according to orders requested on 20 August, Colonel Kendrick left the Zone of Interior with a large shipment of blood. The justification for the requested orders had been that it was simply not possible to put a system, however good it might be, on paper and expect it to work of itself. When the substance to be transported was as valuable as blood, it was essential to follow it up, make sure that it was properly handled at every point along the way, and also see that it was properly used. The account of Colonel Kendrick's trip appears under appropriate headings elsewhere.

On 24 September 1944, the Continental Section, ETOUSA Blood Bank, 152d Station Hospital, assumed the responsibility for the distribution of all blood on the Continent and continued to exercise this function until the end of the war (p. 515).

Shortly after the Continental Section had assumed this responsibility, steps were taken to have the blood flown directly from the United States to the

Continent. Difficulties in storage and shipping facilities delayed the operation of the plan, and it was not until 15 October that the Air Transport Command began to fly blood directly to Orly Field, Paris.

Part V. The European Theater Blood Bank ¹⁶

Section I. Establishment

PRELIMINARY PLANNING

After the Chief Surgeon, ETOUSA, General Hawley, directed, in July 1943, that plans be made to supply blood to forward hospitals in the combat zone, the task of implementing his instructions was assigned to the Operations Division of his office, of which Colonel Mason was chief. Colonel Mason served as chairman of the Whole Blood Service Committee, which also included Colonel Kimbrough, Colonel Cutler, Colonel Middleton, Col. Walter L. Perry, MC, Chief, Finance and Supply Division, and Captain Hardin, liaison officer with the British blood depot and later senior consultant in shock and transfusion.

This committee was promptly convened after receipt of General Hawley's instructions. After several preliminary conferences it requested, and received from him, approval of the following decisions, which were essential for future planning:

1. Whole blood, except in emergencies, would be reserved for medical units in the combat zone.
2. Whole blood would be made available as far forward in the combat zone as platoons of field hospitals attached to clearing stations of divisions.
3. The blood would be obtained from volunteer donors from Services of Supply units, who would be organized into a theater blood panel.
4. The blood used would be type O only. It would be preserved by the glucose-citrate solution devised by the Medical Research Council of Great Britain, would be kept under constant refrigeration, and would have an expiration period of 21 days from the date of collecting.
5. Whole blood would have the highest priority in transportation. This priority had been obtained from the Commanding General, Services of Supply, and had been confirmed by the theater commander.
6. The blood service would be operated by a theater unit, with sub-elements to be attached, as required, to major commands for operations.

ORGANIZATION AND FUNCTION

On 19 August 1943, after the decisions just listed had been approved by General Hawley, detailed planning for the blood bank began, with agreement

¹⁶ Unless otherwise indicated, the material in this section is derived from the official histories of the 152d Station Hospital Blood Bank (54, 55); the official history of the 127th Station Hospital Blood Bank (56); Major Hardin's annual report on transfusion and shock to the Chief Consultant in Surgery, ETOUSA, dated January 1944 (57); and the published reports by Colonel Mason, on the planning and operation of the European Theater Blood Bank (58, 59).

CHART 9.—Operations chart, Whole Blood Service, ETOUSA, Operations Division, Office of Chief Surgeon, 1943

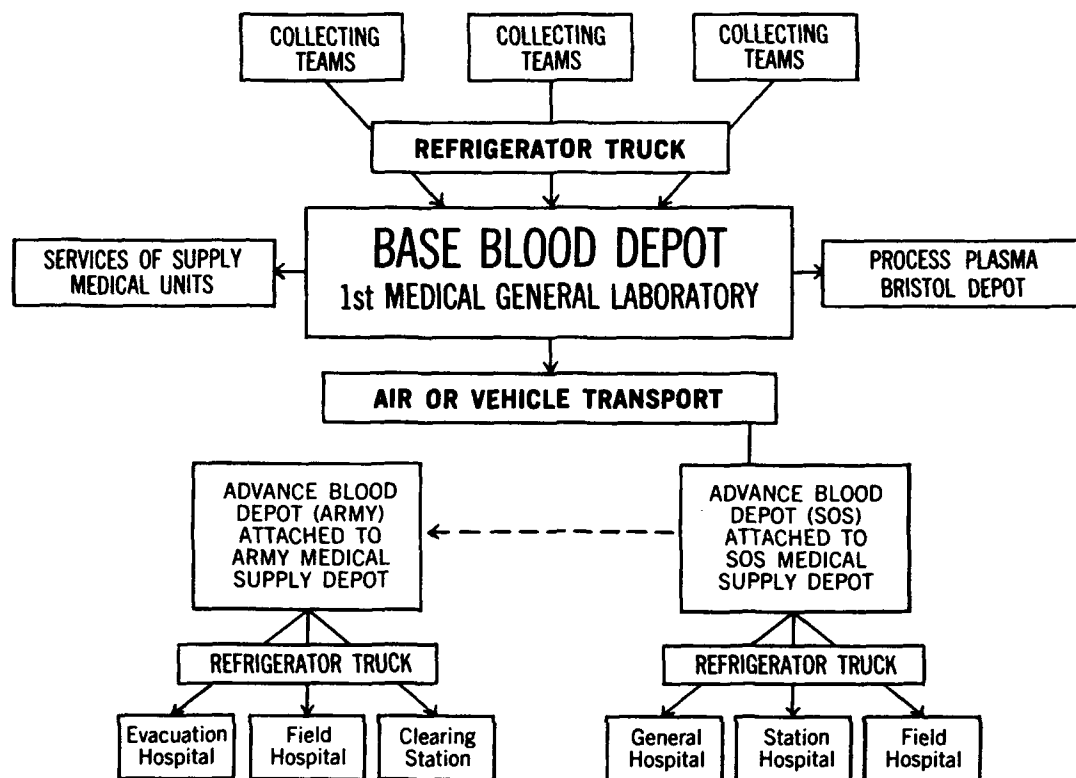

first of all upon an operations chart (chart 9). The functions of the whole blood service were to be the procurement, processing, storage, and issue of whole blood. The organization responsible for these functions had to be tailored to fit the military requirements. The operations chart reflected this necessity by providing (1) a fixed depot for processing and storage of the blood and (2) advance mobile depots for its temporary storage and delivery.

Representatives of the Professional Services Division and their assistants developed the clinical policies for the use of blood. Captain Hardin, Colonel Muckenfuss, Commanding Officer, 1st Medical Laboratory, and their associates developed the technical procedures for the operation of the blood bank and for the training of bank personnel. They also prepared the lists of special equipment required. Colonel Perry and his associates worked with Colonel Mason in the development of the PROCO (projects for continental operations) mechanism by which equipment, vehicles, and other supplies were secured for these new and unusual operations, which were over and beyond T/E (table of equipment) provisions. The T/O (table of organization) for the new unit, the tactical operating procedure, and related instructions were prepared in the Operations Division, Office of the Chief Surgeon, ETOUSA. Colonel Mason, as chairman of the ad hoc committee, had the responsibility for coordination of

the various phases of the plan, its consolidation into a single whole, and supervision of its initial implementation.

Organization of Proposed Unit

Since there was no unit in the Medical Department tables of organization which could meet, or be revised to meet, the needs of the proposed whole blood service, an entirely new organization was planned,¹⁷ as follows:

1. Headquarters.
2. Base depot section, which included personnel and equipment for bleeding teams.
3. Advance depots, Army type (two).
4. Advance depots, SOS type (two).

The 11 officers and 143 enlisted men in this organization would be attached for rations to nearby organizations, thus effecting a considerable saving in mess and housekeeping personnel and equipment.

The organization postulated was considered capable of operating a whole blood service for a theater force of two field armies, the communications zone, and the Air Forces on the Continent. Later, when a third field army would become operational in the 12th Army Group, additional personnel would be required for the base depot, and additional advance depots of both the Army and SOS type would also be required.

Section II. 152d Station Hospital Blood Bank, United Kingdom Section

CONVERSION OF 152D STATION HOSPITAL TO BLOOD BANK PURPOSES

When the request for additional personnel to form the organization just described was denied in the War Department, General Hawley acted with characteristic vigor to compensate for the adverse decision. He directed an assessment of all the 250-bed station hospitals then in the United Kingdom, and, as soon as the report was received, he requested, and obtained, the permission of the theater commander to utilize the 152d Station Hospital, then at Bath, England, as the ETOUSA Blood Bank.

Construction

Planning for the necessary construction for the blood bank at the 152d Station Hospital was begun late in October 1943. On 12 November, an official request was sent from the Hospitalization Division, Office of the Chief

¹⁷ Provision is now made in T/O & E 8-500 for blood bank detachments, which were added in 1950. This provision goes far, though not all the way, to insure that, if blood banks are again needed by the Armed Forces, there will be an adequate allocation of enlisted grades and ratings.

Surgeon, ETOUSA, to the Operations Division, for alterations and construction work on a general medical laboratory at Salisbury, in order to establish a blood bank in the United Kingdom to collect, process, and store blood. The facilities were requested as promptly as possible.

The work was carried out by Engineer personnel of the Southern Base Section, ETOUSA, and, by 1 April 1944, the building was completed and all equipment was in place.

Transfer of Location

On 22 January 1944, the 152d Station Hospital was transferred from its original location at Bath to Salisbury, to the site of the 1st Medical Laboratory, commanded by Colonel Muckenfuss (fig. 111), who also became commanding officer of the 152d Station Hospital. Major Hardin, who was assigned to duty with the 298th General Hospital, and had been detached to the 1st Medical Laboratory for the purpose of organizing the ETOUSA Blood Bank, was transferred to the 152d Station Hospital, where he assumed the duties of executive officer of the blood bank section. Unit administration of both the laboratory and the station hospital was carried out jointly in Colonel Muckenfuss' office.

PERSONNEL

Original Personnel

The use of the 152d Station Hospital for a blood bank solved what at first seemed an insoluble problem, but it was not an ideal solution. There were decided drawbacks to the use of a station hospital for such a highly technical unit. Multiple transfers from other sources were necessary to provide personnel qualified in laboratory and blood bank operations; there was a qualitative and a quantitative paucity of such specialists among both officers and enlisted men on T/O for the hospital. The limitations of the T/O also made the technical ratings of both noncommissioned officers and enlisted men particularly inadequate. This was unfortunate, for it meant that many who were highly qualified were denied the promotions which they richly deserved.

One type of technician extremely difficult to secure was the refrigerator mechanic, who is an essential person in the operation of a blood bank. Enough of them were eventually found, by combing the theater, and it is a tribute to their capabilities and their devoted work that not a single major refrigerating breakdown occurred during the entire period of operation of the ETOUSA Blood Bank. This was a truly remarkable record.

By the first week of February 1944, the personnel of the 152d Station Hospital had been reconstituted to meet the needs of the blood bank. All of the medical officers, with one exception, and all of the nurses, with one

exception, had been transferred out of the unit and replaced with specialists, and enlisted men had been similarly transferred and replaced.

On 25 March 1944, a special emergency treatment group, consisting of 19 officers, 23 nurses, and 151 enlisted men were transferred into the unit.¹⁸ This group was subdivided into two other groups, the larger of which was trained to function as blood bank personnel and the smaller of which operated a 50-bed hospital for research purposes.

Training

Training for the blood bank operation began at Salisbury the first week in February. It was carried out partly by didactic lectures, partly by demonstrations, but chiefly by the repeated performance, under supervision, of individual duties by the personnel whose responsibility they were.

In all, up to D-day, 24 surgical technicians were trained to bleed donors, and 16 enlisted men were trained to clean, assemble, and sterilize equipment used to collect and administer blood. In addition, 60 truck drivers were trained to transport refrigerated blood.

Colonel Mason's suggestion to General Hawley that Captain Hardin be sent to the Mediterranean theater, to study operations of the blood bank at the 15th Medical General Laboratory in Naples, was unfortunately not implemented.

Proposed Augmentation of Personnel

On 17 April 1944, Major Hardin informed the Operations Division, Office of the Chief Surgeon, that the present personnel, in his judgment, could operate the blood bank through D+60. Additional personnel would be needed for the next 30 days, to meet the estimated daily requirement of 300 pints of blood. After D+90, still further augmentation would be required, since a depot would be established in the forward communications zone and increased demands for blood were anticipated. To furnish the additional manpower needed after D+60, training of additional personnel should begin by D+30.

If a base depot in the communications zone were to operate independently, additional personnel would be required for serologic testing, blood typing, mess management, and unit administration and supply. All of these functions were now handled by the 1st Medical Laboratory. Major Hardin believed that 61 additional enlisted men would be necessary, in addition to 2 Medical Corps officers, company grade, and 1 Sanitary Corps or Medical Administrative Corps officer. The later designation of the 127th Station Hospital as a second blood bank (p. 513) solved this problem.

¹⁸ The medical officers and nurses in this group had been members of the Harvard-American Red Cross Hospital which was stationed in Salisbury before the United States entered the war. They joined the U.S. Army in Salisbury. When the 152d Station Hospital came to Salisbury, the two units were amalgamated under the designation of "special treatment group." Later, most of this group was transferred back to the 152d Station Hospital. These transfers were really only paper manipulations, but a great deal of time and effort went into them.

Difficulties of Retaining Trained Personnel

Throughout the war, it was a constant struggle to keep the trained personnel of the various sections of the blood bank from being given other assignments. On 3 April 1944, for instance, Major Hardin felt obliged to point out that all personnel serving as drivers should be kept with the base depot blood section. If they were placed with advance blood depots, he feared that the ground replacement group might ask for them.

In December 1944, when replacements for ground troops were sorely needed in the field armies, the question arose of transferring trained men in the blood bank to such duties. Colonel Cutler pointed out that it would jeopardize the supply of safe whole blood if these personnel were removed.

In April 1944, Col. David E. Liston, MC, had suggested that if additional personnel were needed to operate the blood bank, nurses of the 152d Station Hospital could be trained for this purpose. The matter did not come up again until 1 January 1945. Then, in a memorandum for the record, arguments for and against the use of nurses in a blood bank were outlined as follows:

Commanders of hospital blood banks considered nurses much better than enlisted men for their purposes. Several months ago, when the tables of organization of the general hospitals had reduced the number of nurses allotted to them, consideration was given to withdrawing nurses from the hospital blood banks, but it was decided not to; their value in the blood banks was considered greater than their value in hospitals, however much they might be needed in them.

At this time, however (January 1945), 19 general hospitals were being shipped to the theater without their full complement of nurses. In view of the critical situation in these hospitals, it now seemed that the need for nurses in blood banks must be subordinated to present necessities. After much discussion, the nurses assigned to blood banks were retained in them.

On 15 January 1945, General Cutler suggested to Major Hardin that WAC (Women's Auxiliary Corps) personnel might be used in place of nurses. If so, his idea was that enlisted men be moved in to replace nurses and that they then be relieved with WAC personnel. This plan was never adopted.

OPERATIONAL STRUCTURE

Base Bank

The 152d Station Hospital blood bank was divided into four sections, and the personnel assigned to them were trained for specific, specialized duties in the base and in advance banks. These sections were:

1. A record section, which maintained records of prospective donors as submitted on monthly reports sent in by SOS units, arranged bleeding schedules, maintained records of bleedings, correlated laboratory reports, and reported positive serologic tests and errors in typing on identification tags to the unit commanders concerned.

2. A collecting section, which was composed of four mobile bleeding teams, each made up of seven enlisted men and one medical officer. The enlisted men included a driver, a



FIGURE 112.—Solutions room, European Theater Blood Bank. Technicians are adding 3.2-percent sodium citrate solution as anticoagulant to British-type bleeding bottles.

clerk, an orderly, and four surgical technicians. They were supplied with appropriate equipment and were dispatched from the base bank to camps at which donors were bled according to prearranged schedules. Each team could bleed an average of 20 men in an hour. All donors were unpaid volunteers, and only type O blood was collected.

The blood was collected by a closed system in sterile 600-cc. bottles containing 100 cc. of 3.2-percent sodium citrate U.S.P. (figs. 112 and 113). At the end of the bleeding, a sample of blood for typing and serologic testing was collected from the tubing of the donor set into a sterile Wassermann tube. The collecting bottle and the tube were immediately placed under refrigeration. At the end of each day, all blood drawn was taken to the base bank by truck or plane (fig. 114).

3. A manufacturing and processing section, which had two functions. One was the cleaning, assembling, and sterilizing of all equipment (fig. 115). For each pint of blood

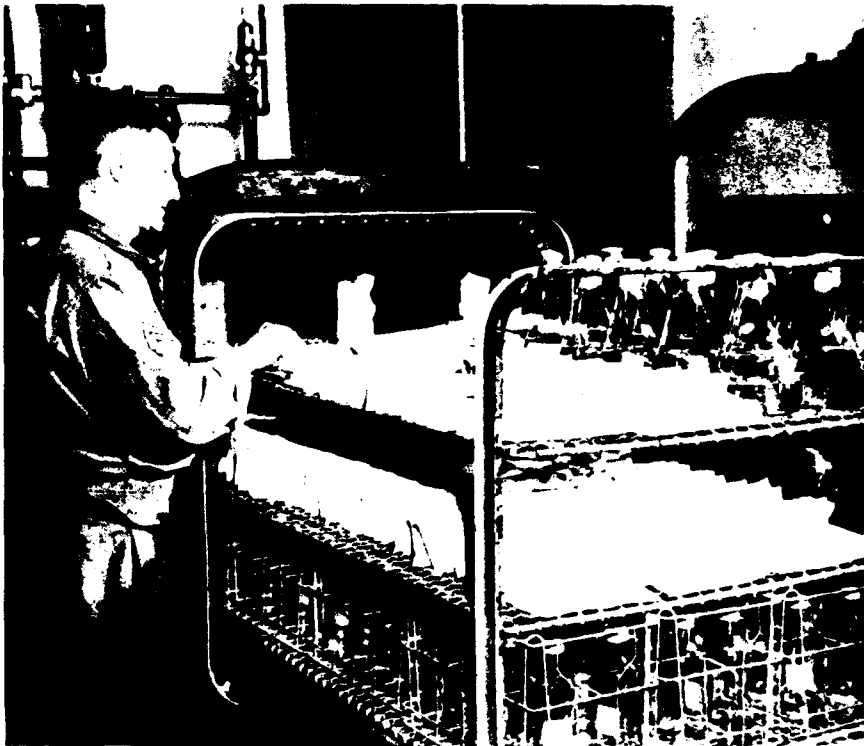

Figure 113. Autoclave being loaded with bottled solutions and equipment for collection of blood, European Theater Blood Bank, 1944.

collected, there was needed a collecting bottle, a donor set, and a recipient set. The second function was processing of the blood, which consisted of two operations:

a. Typing and serologic testing, which was carried out by the 1st Medical Laboratory. Blood showing positive or doubtful Kahn tests was discarded, and the individual's name and Army serial number were reported to his unit commander by the records section.

Off types of blood (that is, blood other than group O) were labeled according to type (fig. 116) and the notation *Must Be Crossmatched Before Use* was affixed to the bottle. These bloods were issued to fixed hospitals, but only after personal conferences with the medical officers who would be responsible for their use.

b. The addition of a preservative (fig. 117). Enough dextrose in 5.4-percent solution was added to the blood to fill the bottle completely. The amount required ranged from 40 to 50 cc. and averaged 45 cc.⁴

4. A storage and shipping section, which was responsible for the refrigeration of the blood while it remained in the blood bank; its packing for shipment; and its delivery by

⁴ Dextrose was not added to the blood collected in the Zone of Interior blood program. The necessity for opening and recapping the bottle to add it made a break in the closed system of handling. This procedure had been tested by the British before it was adopted at the 1724 Station Hospital blood bank. Although it was carried out under a bacteriologic hood, with strict operating room asepsis, it was a potentially hazardous procedure. So far as is known, however, no instance of contamination resulted from it.



FIGURE 111. Transfer of bottles of blood from refrigerated storage to delivery trucks, also refrigerated, for shipment to waiting plane, United Kingdom, August 1941.

refrigerated truck to ports, airfields, or hospitals in the United Kingdom. The blood was stored and transported at temperatures ranging from 35.6° to 42.8° F. (2° to 6° C.). When it was moved by air, it was packed in Quartermaster food containers (marmite cans), one pan of which was filled with ice (fig. 118). This improvisation maintained a temperature of 37° F. (3° C.) for between 37 and 72 hours, depending upon the outside temperature.

Record System

The following system of records was used in the blood bank:

1. A perforated, doubly numbered label on the collecting bottle had space for the name of the donor, the date, and the number of the collecting team. The team clerk printed the donor's name on the label, using his identification disk and a printing machine. This was the field record.
2. The perforated lower portion of this label, marked with the same number as the upper portion, was torn off and used as a label for the Wassermann tube.
3. The field record turned in by the bleeding team was completed by entry on the label of the blood type and the serology when these tests had been completed in the laboratory.
4. A ledger kept in the blood bank indicated the final disposition of each bottle of blood; that is, when it left the laboratory or whether it was discarded for positive serology or for other reasons.
5. Another ledger was used to record the date each unit of blood was received, the total amount received, the amount discarded, the amount shipped, with the date, and the daily balance.
6. Advance depots were required to keep the same kind of ledger.



FIGURE 115. - Preparation of transfusion equipment for reuse, European Theater Blood Bank, August 1944. A. Cleaning equipment after its return from Continent. Note marmite can, in which blood was shipped under refrigeration. B. Preparation of giving sets, base blood bank depot, Paris, November 1944.

Advance Banks

The advance banks or depots of the 152d Station Hospital blood bank had the sole responsibility for the handling and delivery of blood. They were of two types, SOS banks and Army banks (chart 9), and each type operated with two detachments. The detachments of the SOS and Army blood banks were made up of personnel specially trained in the storage and delivery of blood. They operated independently, but were attached to the nearest organization for rations.

1. The communications zone or SOS advance bank operated behind each army, on or near airfields in the advanced section of the communications zone.

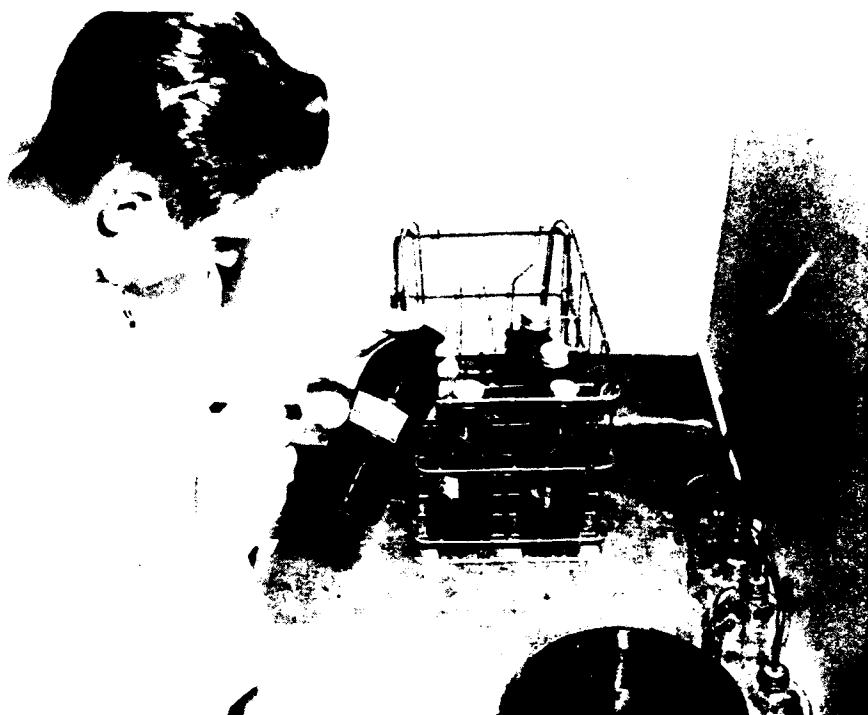

FIGURE 116.—Labeling of filled bottles of blood, European Theater Blood Bank, April 1944.

The personnel received shipments of blood from the base bank and delivered it to army banks and to hospitals in the communications zone. Its personnel consisted of an officer and 16 enlisted men, one of whom was a refrigeration mechanic.

The equipment consisted of one $\frac{1}{4}$ -ton truck; two motorcycles, solo; and four $2\frac{1}{2}$ -ton 6 by 6 cargo trucks with refrigerators (each with a built-in, motor-driven gasoline refrigerating unit). The 6 by 6 trucks were divided as follows:

Two trucks with 60- to 80-pint capacity, used for delivery of blood.

One truck with 500-pint capacity for bulk delivery of blood to Army depots.

One truck with 1,000-pint capacity, for storage.

2. Army type banks were attached to medical depots of the army they served. They delivered blood to all field and evacuation hospitals of that army, moving, as necessary, when the army moved. These banks were always located far forward in the territory of the command or in the field army service area, depending upon the location of the airstrips by which they were supplied. If the airfield was immediately behind the army rear boundary, the Army could pick up its own blood. Otherwise, its blood supply was secured from the depot in the communications zone.

One of the most practical modifications of the original plan for the delivery of blood to hospitals of the field armies was the daily reversal of the routes.



FIGURE 117.—Processing of blood donations, European Theater Blood Bank, April 1944. A. Sterilizing top of bottle of blood before it is filled to top with glucose solution. B. Introduction of glucose solution. C. Capping bottle of blood.



FIGURE 118. Shipment of blood, collected from rear echelon troops, in marmite cans from Continental Section, European Theater Blood Bank, December 1944. Truck is being loaded at 152d General Hospital.

PROGRESS REPORT

On 15 April 1944, Major Hardin made the following report to the Senior Consultant in Surgery, Office of the Chief Surgeon, on the current status of the blood bank:

1. The physical plant was complete.
2. All officer personnel were present except for the officer to be in charge of the laboratory, who would report within the week. Enlisted personnel were sufficient for the present operation: 129 were permanently assigned, and 12 others were attached.
3. Training of all personnel had reached a level at which full operation of the bank was possible.
4. Supplies were complete except for a few critical items, which were essential for the operation of the bank. These included 2,300 long piercing needles; 2,000 short piercing needles; 24 refrigerators ABSD (Army Blood Supply Depot-British) type C; and 22 2½-ton 6 by 6 trucks. Measures were being taken through channels to expedite the delivery of these items.
5. Shortages in some critical items procured from British sources might make it necessary to make some changes in the giving apparatus. The amounts and times of delivery had not been met on these items in the past, and there was every reason to fear that if requirements for blood were doubled, as now seemed likely, there would be further difficulties with procurement. Experiments with new types of giving apparatus had therefore been carried out, and satisfactory substitutes for the British items had been found.

6. Amounts of blood necessary to meet the newly calculated demands (on the 1:1.5 basis, (p. 482) were being computed, and expansion of personnel for this reason, as well as for later operations, was being considered. Expansion of the bank operations to meet the demands for blood to D+90 would present no particularly difficult problem,²⁰ but expansion for demands likely after that time would require doubling the present personnel. It would also require duplication of the present equipment, and provision of additional heavy equipment such as generators, centrifuges, and autoclaves.

Shortly after this report, the blood bank had an unusual opportunity to test its capacities before D-day: During the course of Operation TIGER (a practice loading and sailing project), three fully loaded L. T's were attacked and sunk off Portland, Dorset, by German E-boats. The numerous casualties were hospitalized in adjacent U.S. Army hospitals, and the bank was called upon to supply the large amounts of blood needed. It functioned well, but in Major Hardin's opinion it should have functioned better.

FURTHER PLANNING FOR OPERATION OVERLORD

A conference on the blood program in the European theater was held on 5 April 1944, at the 1st Medical Laboratory (p. 481) (60). It was attended by Colonel Muckenfuss, who acted as chairman, and Major Hardin, from the 1st Medical Laboratory; Colonel Kimbrough and Colonel Zollinger; Col. Keith W. Woodhouse, MC, from the Southern Base Section; Colonel Mason, from the Advance Base Section; Colonel Crisler; Lt. Col. Nathan Weil, Jr., MC, Consultant in Medicine, Third U.S. Army; and Lt. Col. George S. Richardson, MC, Ninth Air Force, Air Transport Command.

The following points were brought out:

1. The physical facilities of the blood bank were well planned, and blood was already being obtained. It was expected that the bank would function smoothly when mass production began.

2. If, as seemed likely, daily requirements of blood would amount to 500 to 700 pints instead of the 400 pints then estimated, it would be necessary to add two more bleeding teams and increase the personnel by 33 percent. Two additional 2½-ton trucks would also be necessary. It was believed that if the facilities of the bank were thus augmented, its production could meet the need for whole blood for Operation OVERLORD.

3. There was considerable discussion about the marking of the large refrigerators, trucks, and marmite cans to be used in the blood operation. The cans were labeled "ETOUSA Blood Bank," but unless it was also indicated that they were the property of the Medical Department, they might be converted to other purposes by the units to which they were delivered. If they were lost, they could easily be traced if they were properly marked (as they were). Special arrangements would be necessary to hold the cans firmly in place during transportation.

4. Advance blood depots on the far shore would be utilized to store blood to be provided by the LST's to be used in operations on the far shore in the early stages of the invasion.

5. The First U.S. Army would determine the phase at which the refrigerator for its advance blood bank could be taken ashore. Meantime, blood would be delivered in marmite cans, by means of the daily Red Ball Freight.²¹ Medical officers of this Army thought that

²⁰ It was to present a major problem (p. 484).

²¹ Blood was seldom delivered by this means. The idea did not prove practical because the Red Ball Freight was not under medical control.

the need for blood would be great enough for it to use all that became available, without wastage, within the specified time limits. It would be responsible for collecting and distributing its own blood.

6. It was pointed out that in the early stages on the far shore, trucks could probably not be used to transport blood because their motors would be water sealed. Marmite cans therefore seemed the only practical way of conveying the blood ashore. It was suggested, however, that all medical units be assigned given amounts of blood and that they carry it ashore as part of their equipment. Other units could be similarly helpful; the engineer companies, for instance, could carry three cans each, and field hospitals could bring in their own blood. It would be necessary to know the exact phasing of these medical units, so that the blood bank could be kept aware of time, place, and amount of blood needed. These suggestions were not implemented.

The recommendations by this conference on the assignment of advance blood banks are more conveniently discussed elsewhere (p. 518).

MAJOR ELEMENTS OF THE FINAL PLAN

The procedure planned for the blood bank for the invasion and thereafter was as follows (31):

1. Blood would be collected from the donor panel by bleeding teams from the United Kingdom bank and would be returned to the bank in refrigerated trucks.

2. It would be processed at the depot and stored until requisitioned for delivery.

3. Every day, the blood required on the Continent would be transported under refrigeration, by air, to the advance blood depots in ADSEC (Advance Section, Communications Zone), where it would again be stored under refrigeration.

4. The amount of blood delivered would be determined by daily forecasts of requirements by the commanding officers of the advance Army blood bank detachments. The forecasts, which would cover the succeeding 4 days, would be given to the ADSEC bank, which would consolidate the requirements before delivering them to the Supply Division, Office of the Chief Surgeon, for transmission to the base bank.

5. The bulk delivery truck of the advance blood depot would transport the blood to the advance depot in the Army area which it was supporting.

6. From the depot, trucks would operate a milk route delivery to the evacuation and field hospitals in the particular Army area. In practice, each vehicle would be assigned a certain number of these hospitals to service.

7. The blood depot in ADSEC, in addition to serving mobile hospitals of the Advance Section, would also be expected to respond to calls from the Army Surgeon to deliver blood to Army hospitals as special needs arose in them. (This frequently happened after D-day, and the successful accomplishment of this particular mission was another illustration of the workability and flexibility of the planned blood program.)

8. The same system of collection and delivery would be followed when the blood bank moved to the Continent. (This system was employed when blood

began to be flown from the United States directly to the bank in Paris and delivery of blood to forward areas was initiated from that point.)

It was anticipated, and events proved the expectation correct, that the central control of the blood which had been planned would have a number of operational advantages and would also effect economies in its distribution and use. At no time was blood left in forward hospitals in excess of the 4-day period for which forecasts had been received. Also, after the blood bank moved to Paris, all blood within 3 days of the expiration date was picked up and returned to the bank (61).

Supply of blood for LST's.—In the initial discussions of blood to be supplied by the blood bank for use by the Navy on LST's on D-day, 10 pints had been requested for each boat. These estimates, however, were not made official until 27 April 1944 (40). Then 2,000 pints were requested, to be placed aboard the hundred LST's which would be used for the invasion. It was mentioned in this communication (from the Commander of U.S. Naval Forces in Europe to the Chief Surgeon, SOS, ETOUSA) that representatives of the Chief Surgeon's office had agreed that a stock of 1,000 pints of blood would be maintained at loading points to replace the blood used on shipboard.

It was requested that delivery of the initial stock of 2,000 pints of blood be made by refrigerated trucks to landing points of the LST's shortly before departure time. The amounts required for specific ships at specific loading points would be indicated in future correspondence after these matters had been worked out. The crossing would take 24 hours or less.

These arrangements were duly concluded. It was further arranged that the loading of the initial supply of blood would be the responsibility of the ETOUSA Blood Bank, beginning on D-5. Maintenance of supply would be from the hards, where the exchange of blood for empty bottles, used equipment, and outdated blood would take place. It had been proposed that a courier accompany the blood, but this request had been refused. It was hoped that the request would still be granted (it never was), as this was the best way to insure the return of empty bottles and used sets.

Standing Operating Procedure No. 21

On 21 March 1944, Colonel Muckenfuss, Commanding Officer, 1st Medical Laboratory, to which the European Theater Blood Bank was attached, was instructed to prepare for the Plans and Operations Division, Office of the Chief Surgeon, an SOP (standing operating procedure) covering in detail the proposed operating procedure for the whole blood service in the European theater (62). On 27 March, Colonel Muckenfuss was informed that it would not be necessary to publish the entire SOP for the blood service in the general SOP for the theater but only that portion of the operation contingent on the services of, or assistance required from, any other organization.

The SOP was duly prepared and was forwarded on 14 April 1944 (63). The description in it covered the collection of blood in the United Kingdom, its

delivery to the medical section of G-45, its packaging, its loading on planes, and its receipt on the far shore. This SOP also defined the responsibilities for the various commands and agencies for the air shipment of critical medical supplies.

THE INVASION

On 23 May 1944, the blood bank at the 152d Station Hospital went into full operation, using for this stage of the invasion mission the advance blood depots planned for use on the Continent. The operation was conducted in two phases.

Phase I

Detachment A, as planned, was attached to the 1st Medical Depot Company of the First U.S. Army for movement to the Continent. Detachments B, C, and D were moved to port areas, together with a temporary detachment of base bank personnel, equipped with refrigerator trucks from the regular advance bank.

Loading of the LST's began on 1 June and was completed on 3 June. In all, 109 craft were loaded, in seven ports, with 10 pints of blood each. In addition, three hospital carriers, at widely separated ports in England, Scotland, and Wales, were each supplied with 20 pints of blood, which were delivered to them by special couriers from the bank. For various reasons, these carriers all had to turn back.

Phase II

The temporary detachment from the base bank was recalled to it as soon as the loading of the LST's was completed. The other three detachments remained in place to carry out their part of the second phase of the blood bank mission, which at this time was twofold:

1. The supply of blood to returning LST's and hospital carriers for use on the far shore. For a long time, the blood bank detachments also handled the supplies of biologicals and penicillin for these craft.

2. The supply of blood to transit and holding hospitals which were receiving casualties in the United Kingdom. For a time, it was also a blood bank responsibility to supply these hospitals with biologicals and penicillin.

The blood bank kept in storage a reserve of whole blood, which was used to supply field hospitals in the vicinity and to resupply hospital carriers and LST's which had brought casualties from the far shore and were returning to it. This blood was distributed daily in small refrigerator trucks. A small amount was supplied to LST's in hand-carry ice containers.

The southern part of England was divided into four geographic areas, and the hospitals in the three coastal areas were supplied by the blood bank detachments. The fourth area, which was inland, was supplied directly from the base blood bank at Salisbury.

When air evacuation began from the Continent, on D+7, a fifth area was set up, with the 217th General Hospital at Swindon, because of its central location, serving as a supply center. Deliveries of blood were made to this hospital, and holding hospitals at airstrips nearby obtained the small amounts which they needed from it. Blood was also delivered to the 347th Station Hospital.

As a matter of convenience, the activities of the detachments of the blood bank are described under a separate heading (p. 518).

Section III. 127th Station Hospital Blood Bank, United Kingdom Section

AUTHORIZATION

On 14 April 1944, as a result of the discussions and recommendations at the meeting on blood supply on 5 April 1944 (p. 481), Colonel Liston, Deputy Theater Surgeon, approved the initiation of a request for duplication of PROCO (p. 541) equipment necessary for a base blood depot on the Continent (34). The request included two additional Army depots, and two additional communications zone, advance blood depots. In this memorandum, Colonel Liston stated that the next 250-bed station hospital that arrived in the United Kingdom would be earmarked for the operation of the second blood bank on the Continent and that the equipment necessary to operate it as such would be requisitioned at once.

CONVERSION OF FACILITIES AND PERSONNEL

When the 250-bed 127th Station Hospital arrived in Salisbury on 9 July 1944, it learned for the first time that its future major mission would be to function as a second blood bank in the European theater. It would also continue to operate certain facilities for the 1st Medical Laboratory, unit personnel, British civilian and military personnel, and personnel in need of treatment because of local emergencies.

When the conversion had been accomplished, all facilities on the post were shared by the 1st Medical Laboratory and the 127th Station Hospital blood bank. By prorating personnel, the shared facilities were efficiently manned and maintained. The hospital and laboratory maintained separate headquarters, but a few administrative offices were conducted jointly. Medical officers, nurses, and enlisted men were rotated between duties in the hospital and in the blood bank.

On 7 August 1944, as the first step in the transition from station hospital to blood bank, Colonel Muckenfuss assumed command of the hospital, vice Lt. Col. Julius Chasnoff, MC.

TRAINING

Training of hospital personnel in the operation of the blood bank was successfully effected by assigning them to work side by side with the experienced personnel of the 152d Station Hospital, which had been in operation as a blood bank since early in the year. The training, though massive, was not difficult. The personnel of the 127th Station Hospital had trained together since the hospital was activated at Fort Hancock, N.J., in December 1942, and their long association as a unit made them both disciplined and adaptable.

The training of men in assignments foreign to station hospital personnel, such as blood research officers and refrigerator mechanics, presented the greatest difficulty. Only 11 licensed motor vehicle drivers were with the hospital when it arrived in the United Kingdom, but others were quickly trained according to the new demands, and the transportation section eventually had 81 qualified and licensed drivers.

During the training period, there was a loss by transfer of 28 general service enlisted men, who were replaced by a like number of limited service men from combat units in France. These men were so carefully fitted into positions suited to their individual abilities that they were employed to the best advantage and the efficiency of the blood bank was not impaired.

OPERATION

On 26 August 1944, the 127th Station Hospital formally assumed full operation of the blood bank at Salisbury, plus its equitable share of the duties necessary to maintain the post in conjunction with the 1st Medical Laboratory, and the 152d Station Hospital prepared to depart for France. All technical operations of the bank were under the direction of Capt. (later Maj.) Forest H. Coulson, MC.

After the takeover, the transportation section of the new blood bank became increasingly active. Many service troops had left the United Kingdom, and the bleeding teams had to travel for increasingly greater distances to collect the blood. They ranged from the borders of Scotland to the Channel ports, and from the London area to the Welsh mountains. During September 1944, the unit vehicles traveled 20,511 miles. During October, the mileage reached 36,980; during November, 35,087; and during December, 47,611. This was a total of 140,189 miles, an average of 1,149.1 miles per day.

On 17 May 1945, the last blood was drawn by the teams, and no further bleedings were scheduled. During the peak of their operation, they averaged 450 bleedings per day.

As a matter of convenience, the activities of the detachments of the 127th Station Hospital blood bank are discussed under a separate heading.

Section IV. 152d Station Hospital Blood Bank, Continental Section

MOVEMENT TO THE CONTINENT

When the 152d Station Hospital blood bank was ordered to the Continent late in August 1944, the equipment for a complete blood bank was requisitioned and assembled at the medical section of Depot G-45 in the United Kingdom. Here, it was crated for shipment, so that it could be picked up without delay when the unit began to move. In addition to the transportation regularly allotted to the hospital, ten 4-ton dump trucks were borrowed from Ordnance, with the agreement that they would be delivered to the Chief of Ordnance on the Continent.²² This mutual aid agreement enabled the bank to carry all of its equipment with it directly to Paris and thus to escape the delays which would probably have ensued if the equipment had been shipped separately.

When movement orders were received on 15 September, the 152d Station Hospital blood bank was divided into two units, a vehicle party commanded by Major Hardin, then the Executive Officer, who was to become commanding officer of the blood bank on the Continent, and a marching party. Both parties moved to the marshaling area the following day. On 17 September, the vehicle party moved to Southampton, embarked on LST 696, and reached Omaha beach on 19 September.

The marching party of the blood bank left the marshaling area on 18 September and embarked the same day on H.M.S. *City of Canterbury*. It landed on Omaha beach the following afternoon.

The entire unit left the staging area on 20 September, equipped with K-type rations, and reached the 203d General Hospital at Garches the following day.

On 25 September 1945, the storage and shipping section of the 152d Station Hospital blood bank undertook the receipt, storage, and initial distribution of all blood received on the Continent. Temporary storage facilities were obtained through the Office of the Chief Surgeon. A pyramidal tent erected at Le Bourget Field served as a joint office for the shipping section and for depot M407, which handled air shipments.

²² This arrangement was possible because of a chance observation by Lt. Col. (later Col.) Bryan Fenton, MC, and Maj. (later Col.) R. L. Parker, MAC, while they were on their way to the south of England on another mission. Seeing mile after mile of empty vehicles scheduled for shipment to the Continent, they were struck by the unused potential transportation capacity. At their suggestion, these vehicles were loaded with medical supplies and provided with drivers from replacement depots who were also scheduled for service on the Continent. A triple purpose was thus served: The movement of the vehicles was expedited. The receipt of medical supplies was expedited. Replacements reached the Continent rapidly.

The operation was originally very successful. Then the Assistant Chief of Staff, G-4 (logistics), SOS, ETOUSA, found that medical tonnage allocations were being exceeded and that many truck drivers were not reporting, as ordered, at the Replacement Depot on the Continent. At this point, G-4 took over the operation. In the meantime, however, the equipment of the 152d Station Hospital blood bank, along with tons of other medical supplies, had been moved to the Continent quickly and expeditiously.

PERMANENT LOCATION

On 10 October, a site for a base blood bank was found at Vitry-sur-Seine, and officers and enlisted men moved to it from the 203d General Hospital. The nurses were left at the hospital. Two wings on the ground floor of the building selected were used for the bank operations, together with a temporary wooden structure placed between the wings by the former German occupants. The building had been considerably damaged, but repairs on it were begun immediately by French contractors, working under U.S. Army Engineers. The installation of the blood bank equipment and the necessary wiring and plumbing were done by personnel of the 152d Station Hospital.

On 20 October, the 1st General Hospital occupied the remainder of the buildings on the site at Vitry-sur-Seine and took over the administration of the post. As soon as possible, a joint officers' mess, an enlisted men's mess, and living quarters for nurses, officers, and enlisted men of the 152d Station Hospital blood bank were established in cooperation with the 1st General Hospital.

OPERATIONS

After 3 November 1944, the blood bank in Paris occupied the key position in supplying blood to the hospitals on the Continent. All blood from the Zone of Interior and from the United Kingdom section of the European Theater Blood Bank at Salisbury was funneled through it, as was all blood drawn locally.

Blood collected locally was secured from volunteer SOS troops with type O blood. Not very much was needed from this source.

On 28 October 1944, shipments were begun to the 6703d Blood Transfusion Unit, to supplement the supply of blood to the Seventh U.S. Army. As will be recalled, this unit landed in southern France with that Army. By the end of the year, 354 pints per day were being shipped to this unit.

The Continental Blood Bank remained in Paris until the end of the war. Equipment and transportation were adequate at all times. Technical operations were always essentially the same as originally planned.

Personnel problems, however, frequently arose. The bank consistently operated at some 30 persons under strength, chiefly because of reassignment and transfer of medical officers, nurses, and enlisted men, with insufficient replacements for them. At all times, also, several officers and enlisted men were on detached duty. The shortages were partly compensated for by the employment of 13 French civilians, 5 for the care of buildings and grounds and 8 for the cleaning and assembly of donor sets. The net decrease in total personnel did not result in any lowering of technical standards because, late in 1944, the use of expendable recipient sets and expendable bottles for the collection of blood reduced the time and work necessary in the preparation of equipment by about half.

The four detachments operating in the forward areas when the blood bank arrived in Paris continued to operate as before. Delivery of blood to the

armies was simplified when two detachments of the 127th Station Hospital arrived in October 1944 to operate with the Seventh U.S. Army.

Except for a single brief interval, during the envelopment of the Ruhr Basin, distribution of blood from the Paris bank followed the SOP of shipment to ADSEC Detachments B and D from the base bank and forward from these detachments to Detachments A and C (chart 10). During this interval, Detachment B delivered blood to units of the Fifteenth U.S. Army in addition to delivering blood to Detachment A. The added duty presented no great

CHART 10.—Chart showing procurement and distribution of whole blood, ETOUSA, 1944-45

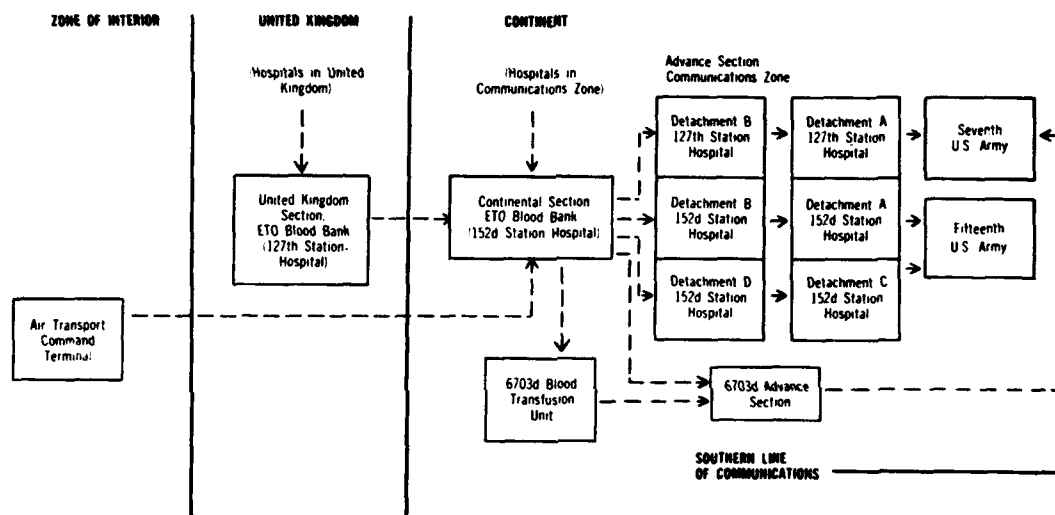

difficulty, since only a small amount of blood was used by the Fifteenth U.S. Army on the west bank of the Rhine.

After the blood bank was set up in Paris, communications between it and its advance detachments were generally excellent until the final days of the war. Then, when the blood depots moved with the airstrips, to keep the appropriate Army depots supplied, their whereabouts was sometimes unknown in Paris for as long as 36 hours.

On the cessation of fighting in Europe on 8 May 1945, the four detachments operating in the Army areas and in ADSEC were brought back to the base bank in Paris, the last arriving on 24 May. These detachments were then disbanded and their personnel were absorbed into the structure of the parent unit.

The base bank continued to operate as such until 15 June 1945; the last shipment of blood was made on 14 June. The last shipments from the bank in the United Kingdom had been received on 11 May and the last shipment from the United States on 15 May. After that date, all blood distributed on the Continent was collected and processed by the Continental Blood Bank.

*Section V. Activities of the European Theater Blood Bank
Detachments*

152D STATION HOSPITAL BLOOD BANK

Assignments

At the conference on blood supply held at the 1st Medical Laboratory on 5 April 1944, it was recommended that the assignment of advance banks be as follows:

First U.S. Army: Detachment A in the Army zone, supported by Detachment B in the communications zone.

Third U.S. Army: Detachment C in the Army zone, supported by Detachment D in the communications zone.

This was essentially the plan employed on the Continent (map 3). When the Ninth U.S. Army became operational and the 127th Station Hospital had been added to the blood bank at the 152d Station Hospital, the same plan was employed: Detachment A of that hospital operated in the Army zone, supported by Detachment B in the communications zone.

Movement to the Continent

On D+1, two refrigerator trucks from Detachment A, which had been loaded with predetermined amounts of blood by Detachment C at Southampton, were landed on Omaha beach. Their drivers were responsible for the delivery of this blood to medical units in the area.

Two other refrigerator trucks, one of which was preloaded with blood, also from Detachment A, were landed on Utah beach on D+3. Their drivers had the same duties as the drivers of the trucks landed on Omaha beach. Both groups also took off unused and unneeded blood from LST's going back to the United Kingdom with few casualties or with casualties who did not need blood.

By D+6, the remainder of Detachment A had arrived in France and was stationed at Martha Dump (Medical Supply Depot, First U.S. Army). The trucks of this detachment could readily distribute all the whole blood available to the field and evacuation hospitals which required it because in the early days of the invasion, the lodgment area on the Cotentin Peninsula was very limited.

All whole blood brought into France during the first days of the invasion was brought in by surface craft. On D+7, it began to arrive by air, on the airstrip in the rear of Omaha beach. Thereafter, C-47 planes brought in practically all blood from the United Kingdom.

The third phase of the blood bank operation called for the movement of Detachments B, C, and D to the Continent. There had been no need for them there earlier.

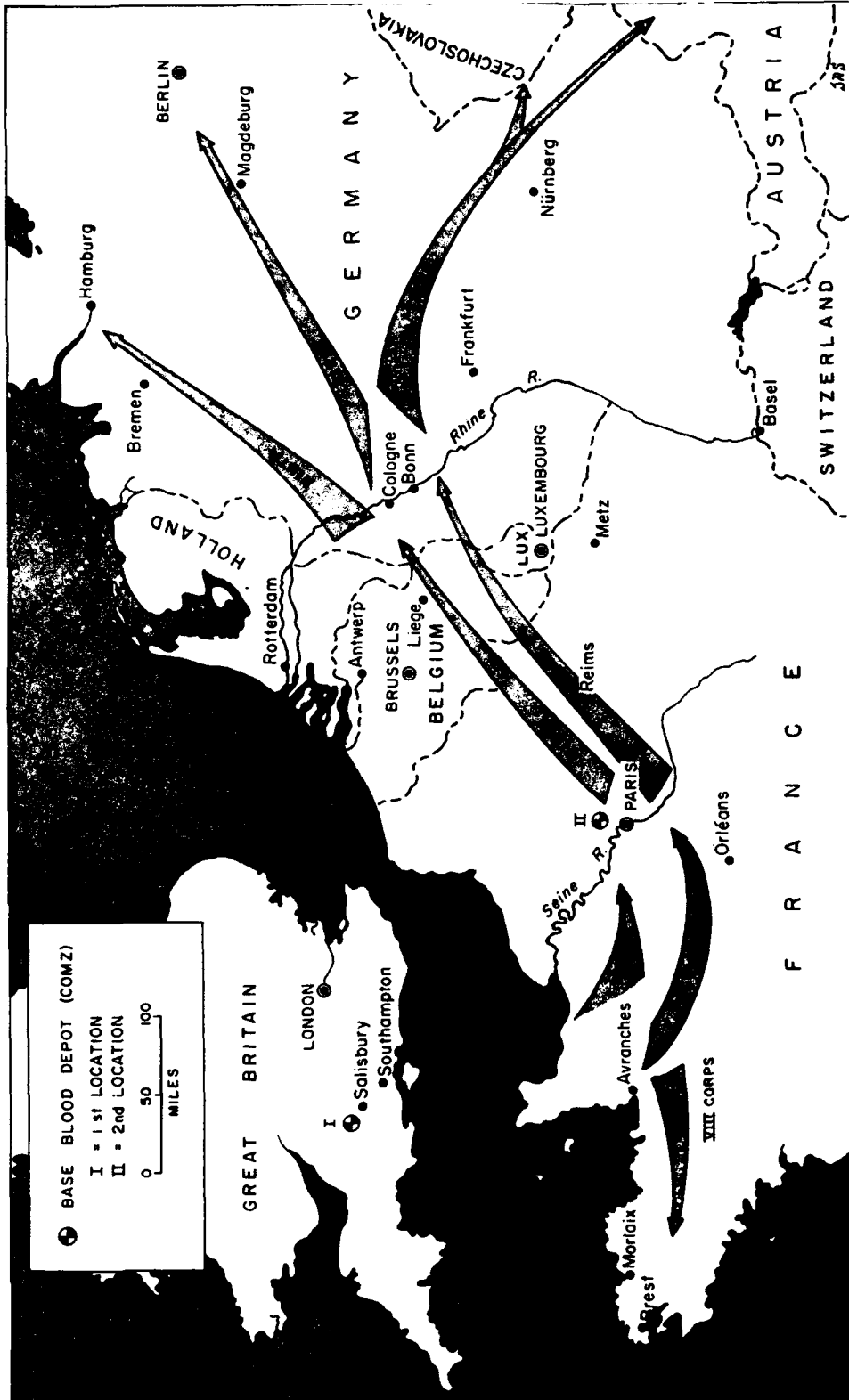

MAP 3.—Operations map showing movements of ADSEC mobile blood depots on the European Continent, 1944-45, in support of the field armies (59).

Detachment C arrived in France on 10 July and began to serve the hospitals supporting the VII Corps of the First U.S. Army, which was operating toward the south on the Normandy Peninsula. On 4 August, Detachment C also took over delivery of blood to hospitals of the Third U.S. Army, which had become operational on 1 August.

Detachments B and D arrived on the Continent on 18 July, attached to the Advance Section, Communications Zone. On 23 July, for Operation COBRA (the breakthrough at Saint-Lô), Detachment B was placed at Trévières, with the 31st Medical Depot Company, to support Detachment A. Detachment D was initially located on the airstrip at Binniville, but a few days later it took station at the 30th Medical Depot Company at Chef du Pont.

Departures from SOP

The SOP for delivery of blood to the Continent (40) called for trucking of blood from the base bank to the field; separate air shipment of blood to each ADSEC detachment; and delivery forward, by truck, to the respective armies served by the particular detachments. On occasion, departure from this procedure was necessary:

1. The major test of the flexibility of the plan devised for the supply of whole blood first came in August, when the bank was called upon to support, at the same time, the VIII Corps of the Third U.S. Army operating in the Brittany Peninsula and the eastward drives of the First and Third U.S. Armies. To handle this situation, Colonel Mason directed a regrouping of personnel and equipment of the ADSEC detachments as follows:

Detachment B was placed in support of the First and Third U.S. Armies, at first from the airstrip at Courtil, in Brittany. It was given the 1,000-pint refrigerator truck and the 500-pint bulk delivery truck from Detachment D. Between 13 September and 2 October, Detachment B gave full support to both armies, even when this mission required splitting itself in half because of the diverging fronts.

Detachment D was placed in direct support of the field and evacuation hospitals operating with the reinforced VIII Corps. It operated initially from the airstrip at Courtil and later from the strip at Morlaix in Brittany. It was given temporarily the two 80-pint delivery refrigerator trucks belonging to Detachment B, which, with its own trucks, gave it four delivery vehicles. This enabled Detachment D, from mid-August to early October, to operate a shuttle service between the airstrip and the field and evacuation hospitals. The detachment then reverted to its original mission of backing up the Third U.S. Army.

2. In October 1944, the Surgeon, Third U.S. Army, requested that supplies of blood be sent directly to mobile hospitals supporting the divisions engaged before Metz.

3. On 24 October 1944, Detachment B took over delivery of blood to hospitals of the Ninth U.S. Army, continuing this function until 1 November,

when Detachments A and B of the 127th Station Hospital arrived and took over the mission of supplying the hospitals of this Army and the communications zone hospitals behind it.

4. Also in October, Detachment B became responsible for the delivery of blood to the mobile hospitals supporting the 82d and 101st Airborne Divisions of the XVIII Corps in the Eindhoven-Nijmegen Area. One delivery truck from this detachment transported blood daily from the airstrip near Saint-Trond, Belgium, to the combat area over "Hell's Highway." On at least one occasion, the vehicle carrying the blood had to be escorted by tanks, to protect it against interference by roving German patrols. Although it was constantly subjected to small arms fire, it was never hit. The drivers and assistant drivers of the two trucks engaged in this operation were awarded the Croix de Guerre by the French Government.

While it was stationed in the vicinity of Saint-Trond, Detachment B received all its blood by air. It was entirely mobile and could move immediately to the vicinity of any airfield near the front to which a supply of blood could be flown. After 10 November, when it went on to Liège, it received its blood by both plane and truck. The first night the detachment was at Saint-Trond, a German V-1 bomb blew out several of the windows in the chateau in which it was billeted. While it was in Liège, it was subjected to constant V-1 bombing.

This detachment had some minor refrigerating problems. Its storage refrigerators kept the blood at the correct temperature only when the environmental temperature was above the required limit. When it dropped below that level, the temperature in the icebox had to be raised by the use of a 200-watt bulb and cans of hot water, and hourly checks were made.

Evaluation of Performance

This was probably the most trying period for any of these detachments. The work could not have been handled by units not thoroughly trained and seasoned.

One reason for the successful flexibility of the ADSEC operation was that the Commanding General, Brig. Gen. (later Maj. Gen.) Ewart G. Plank, had given his Surgeon, Col. Charles H. Beasley, MC, direct command over all medical units assigned or attached to ADSEC. Colonel Mason, who was Colonel Beasley's executive officer, was directed to exercise personal supervision over the blood bank operations in ADSEC and to coordinate all matters of blood supply with the army surgeons, the Surgeon, 12th Army Group, and the Chief Surgeon.

The work of the detachments of the 152d Station Hospital blood bank was faithful and consistent. Great resourcefulness and initiative were shown by the commanding officers, 1st Lt. Herbert H. Reardon, MAC; 2d Lt. (later 1st Lt.) Eugene E. Stein, MAC; 2d Lt. (later 1st Lt.) Philip Shaulson, MAC; and 2d Lt. (later 1st Lt.) Joseph A. Plantier, MAC. With the men of their

units, they showed consistent courage and devotion to duty. Deliveries were often made under difficult conditions, in unknown, dangerous terrain, but the drivers took pride in getting the blood through, even though it had to be transported through artillery and small arms fire. When bridges were destroyed, the drivers forded streams. They were often annoyed by snipers, and they sometimes found that the installations to which they were taking blood had been wrecked by enemy action. The successful operation of the ETOUSA Blood Bank was in large measure due to the efforts of the officers and men of the advance detachments.

127TH STATION HOSPITAL BLOOD BANK

Movement to the Continent

On 2 October 1944, two advance detachments (A and B) activated from personnel of the 127th Station Hospital blood bank departed for France, fully trained and equipped for their new missions. Almost as soon as these detachments had left, two additional detachments (C and D) were activated and began training. Personnel, trucks, and supplies were kept ready for another call from the Continent. The loss of manpower because of the detachments already sent to France was felt, as was the alert maintained until Detachments C and D went to France in March 1945, but increased efforts of the remaining personnel compensated, and the internal mechanism of the blood bank was in no way slowed down.

Detachment A (Provisional)

Detachment A of the 127th Station Hospital, commanded by Capt. A. C. Shainmark, MAC, landed on Utah beach in October 1944 (64), just as the battle for Aachen was terminating and plans were in hand for the Ninth U.S. Army to cross the Roer River and push on to the Rhine. After a 2-day stay in Paris, to obtain additional supplies, the detachment pushed on to Namur, Belgium, and then to Maastricht, Holland, which it reached on 27 October. After personnel of the 28th Medical Depot Company arrived there several days later, the detachment moved to its location.

The first shipment of blood was received on 30 October 1944, from the ADSEC supporting unit (Detachment B), which was located near an airfield in the vicinity of Liège and which served as the link between Detachment A and the blood bank in Paris. Thereafter, the trucks of Detachment A moved along with the army, maintaining continuous contact with forward medical units and delivering blood to them daily.

Captain Shainmark was kept fully informed of the movements and locations of field and evacuation hospitals as the Ninth U.S. Army swept forward across Germany to Helmstedt, where it was operating on V-E Day. Several times, the blood bank truck appeared on the scene while hospitals were still rolling to their new locations. At the height of the Battle of the Roer, when

several field hospitals crossed the swollen river almost side by side with the infantry, the trucks of Detachment A often delivered more than 500 pints of blood to them daily. Similarly, when the Ninth U.S. Army crossed the Rhine, the hospitals on the East Bank received the blood they needed as soon as they were set up.

In all, Detachment A (Provisional) distributed about 35,000 pints of whole blood.

Detachment B (Provisional)

Detachment B of the 127th Station Hospital arrived on Utah beach on 22 October 1944 and reported to the 152d Station Hospital blood bank in Paris. Here, it received orders to proceed to Namur, Belgium, where it arrived on 26 October and where it received further orders to proceed to Saint-Trond, Belgium. Here, it began to work with Detachment B, 152d Station Hospital blood bank, and gradually took over from it the servicing of the forward hospitals supporting the Ninth U.S. Army.

Detachments C and D (Provisional)

When Detachments C and D (Provisional) of the 127th Station Hospital went to the Continent, they were attached to the Seventh U.S. Army (instead of the Ninth, as had originally been planned) because the advance section of the 6825th Blood Transfusion Company had been found too small to care for total Army needs. Until late in March, all blood collected by this company was shipped directly to the Seventh U.S. Army. Thereafter, the blood was routed through Paris, which permitted much more effective control and distribution, as well as augmentation of the inadequate supply.

Part VI. Blood Donors in the European Theater ²³

FIRST PROVISIONS FOR BLOOD DONORS

Before blood donor panels were formally established in the United Kingdom late in 1943, occasional suggestions were made to the effect that noncombatant troops follow the example of U.S. civilians and provide blood for casualties. These suggestions were all answered in the same manner:

1. At the time (1942), the demand for blood in the European theater was not very great.

2. The location of the blood banks in the United Kingdom, particularly the British blood bank at Bristol, limited donors to troops in the immediate vicinity of the banks.

²³ Unless otherwise identified, the material in this section is from the official diary of the ETOUSA Blood Bank (34) and from the official diary of General Cutler (25).

3. As soon as blood collecting teams began to operate in the vicinity of particular organizations, members of these commands might voluntarily submit themselves as donors. It was expected that detachment commanders of units stationed in the vicinity of hospital blood banks would shortly set up panels of names of men who would be willing to donate blood upon call.

During this period, the emergency need for transfusions was met from the nearest available personnel, preferably from the recipient's own unit. The literal interpretation of the latter clause led to some difficulties, which were eliminated when instructions were given early in January 1943 that blood required for emergency transfusions must be secured from the nearest available personnel and not from members of the recipient's own unit if it did not fall into the category of availability.

FORMAL PLANNING FOR THE BLOOD SUPPLY

Formal plans for securing blood donations for combat casualties from U.S. Army personnel in the United Kingdom began in October 1943, with an inquiry by the Theater Chief Surgeon of the Professional Services Division of his office as to the effects of withdrawal of 500 cc. of blood. He had already notified Captain Hardin that it would be his policy not to use donations from combat personnel. On 31 October, Colonel Cutler notified General Hawley that in his opinion, in which Colonel Middleton concurred, the resistance of the individual who gave blood in this amount would not be affected adversely in any circumstances of weather or environment (65).

In November 1943, General Hawley wrote the Commanding General, Services of Supply, ETOUSA, as follows (66):

1. The lifesaving value of large-scale transfusions of whole blood during military operations has been repeatedly confirmed by the experience of the United States and of our Allies in other theaters of war.

2. It will be necessary to establish in the United Kingdom a reservoir of type O blood donors, under military control, in order to secure an adequate amount of stored whole blood for operations on the Continent.

3. Potential donors are present in large numbers in SOS military personnel in the United Kingdom. It is thought that a simple statement of the need for whole blood, contained in a call for volunteers addressed to soldiers with type O blood in SOS units, will have a highly satisfactory response.

4. The Blood Panel, ETOUSA, will consist of a consolidated nominal list of volunteers, to be maintained by the Chief Surgeon.

5. The collection of blood will not be required until approximately D+7. Subsequent listings may be required at 90-day intervals.

6. It is recommended that an initial call be made for donors for such a blood panel.

In accordance with General Hawley's suggestion, a letter dated 15 December 1943 and containing the following instructions was sent by Lt. Gen. John Clifford Hodges Lee, Commanding General, SOS, ETOUSA, to the commanders of Channel Base Section, Eastern Base Section, Western Base Section, and

Southern Base Section. The Northern Ireland Base Section was not included because its geographic situation would not permit ready transportation of blood collected there to processing and storage depots. General Lee directed that his letter be published to all units of the command and that the appended message from him be read at the first formation after its receipt. The letter contained the following information (67):

1. The establishment of a blood panel for ETOUSA, containing the names of type O donors from SOS units, is required to insure an adequate supply of whole blood for the treatment of the wounded. The establishment of this panel has been approved by the Theater Commander.

2. It is therefore desired:

a. That a nominal list of type O volunteer donors be prepared in each unit and retained in unit headquarters.

b. That a record of the number of type O volunteers be maintained by units in the base section headquarters.

c. That the records just specified be corrected as of the 15th of each month and that, immediately following each correction, a report of the number of type O donors in each unit of the SOS troops in each base section be sent to the Commanding Officer, ETOUSA Blood Bank, 1st Medical Laboratory.

d. That upon call by the Commanding Officer of the ETOUSA Blood Bank, the volunteer type O donors of the unit specified be assembled at a designated bleeding station (ordinarily the unit dispensary) at an hour to be determined by each commander, which will not interfere seriously with the normal duties of the unit and which will be reasonably convenient for the bleeding team.

e. That only light duty be required of donors from the time of bleeding until reveille the following morning.

3. As a rule, four-fifths of a pint of blood will be taken at each bleeding,²⁴ and no donor will be bled oftener than once in 3 months. The withdrawal of this amount of blood will have no ill effect upon the donor and will not reduce his physical capacity for work or predispose him to illness.

4. Active interest in maintaining as many volunteers as possible is enjoined.

The message from General Lee, to be read at the first formation after the receipt of the letter just abstracted, was, in summary, as follows (68):

1. Defeat of the enemy cannot be accomplished without the loss of life and wounding of United States soldiers.

2. Large quantities of blood, which medical considerations limit to type O blood, would be required for transfusion for their comrades in the field forces.

3. Volunteers whose identification tags showed type O blood were being asked to donate blood when called upon. Instructions would be issued as to when and where these donations might be made.

General Lee's message concluded: "You, who are eligible, may well be proud of this opportunity to place your name on this Roll of Honor—the Blood Panel, ETOUSA."

²⁴ The practice in the United States during and for several years after the war was to withdraw 500 cc. of blood at each donation. The smaller amount was used at this time because British bleeding bottles, after the anticoagulant was added, would hold only 400 cc. It is now (1962) United States practice to withdraw only 450 cc. of blood from each donor, it having been found that when the smaller amount is taken, the incidence of fainting is materially reduced.

INITIAL RESULTS

It had been estimated that to maintain adequate supplies of whole blood for battle casualties in the European theater, at least 90 percent of all blood type O individuals in the Southern Base Section must volunteer as donors. The results reported on 10 March for the first solicitation (table 19) were not encouraging, and the second report, on 21 April (table 19), showed no great improvement.

TABLE 19.—*Response to request for type O blood donors in the United Kingdom, spring 1944*

Base section	Number of units	Number of donors	Percentage of troop strengths
10 March 1944			
Eastern.....	116	4, 589	58. 80
Western.....	130	10, 075	34. 48
Southern.....	267	9, 207	27. 98
Total.....	513	23, 871	40. 35
21 April 1944			
Eastern.....	135	5, 316	62. 48
Western.....	356	19, 020	72. 06
Southern.....	309	10, 350	30. 30
Total.....	800	34, 686	55. 55

On 6 April 1944, the Office of the Adjutant General, Headquarters, SOS, notified the base section commanders, SOS, and other headquarters commandants that the response to the request for blood donors had fallen far short of expectations (69). All were therefore directed to note the importance of this project and to consider methods of increasing the number of volunteer donors.

At a conference on blood supply in the United Kingdom on 7 April 1944, as well as several times later, it was tentatively suggested that if the response of blood donors continued to be unsatisfactory, consideration be given to paying them under Army Regulations No. 40-1715. This plan was never adopted.

POSTINVASION DONATIONS

Shortly after D-day, when it became evident that blood was in short supply, considerable publicity, chiefly informal, was given to the need for donors, and there were numerous volunteers from various sections of the theater chief surgeon's office, the Adjutant General's Office, and other offices. The reply to

these offers was always the same, that the volunteers would be bled whenever a sufficient number of O donors could be brought together, and that the entire process would then be streamlined, so that there would be a minimum of delay and absence from duty. Numerous donations were secured from these sources.

Even the arrangement to fly blood from the Zone of Interior to the European theater did not end the need for local donations. Thus, on 24 September 1944, a little over a month after the airlift was instituted, the Operations Section, Office of the Chief Surgeon, noted that supplies at Prestwick were low and that a regular schedule of bleedings in the United Kingdom must be maintained if 1,000 pints of blood were to reach the Continent every day.

On 31 December 1944, Colonel Cutler wrote the deputy theater surgeon that the panel of blood donors in the United Kingdom had become very small. Two weeks earlier, General Hawley had approved the bleeding of combat troops in the United Kingdom if it were certain that they would remain there for 2 or 3 weeks after the blood had been taken. There had been no formal notification of this policy, and Colonel Cutler suggested that dissemination of the information be expedited.

On 15 January 1945, General Hawley notified the Surgeon, United Kingdom Base, that he had investigated the possibility of bleeding combat troops and had been assured by competent medical authorities that this would not be injurious to them. Blood from this source would add materially to the blood donor panel. General Hawley had also been assured that there was no physiologic or medical contraindication to using these troops as donors if they would not enter combat within 2 weeks after they had been bled. The theater commander had approved the bleeding of combat units staging in the United Kingdom. Now that he had done so, General Hawley wished this additional source of whole blood to be properly exploited through technical channels.

On 8 March 1945, a memorandum was sent out from Headquarters, Communications Zone, ETOUSA, to the chiefs of general and special staff sections of that Headquarters stating that the Commanding Officer, 152d Station Hospital blood bank, had reported a critical shortage of type O blood and had requested that "all personnel" be canvassed in an effort to secure voluntary donations. In this memorandum, the chiefs of general and special staff sections were instructed to submit to the Headquarters Commandant not later than 14 March 1945, a nominal list of personnel who possessed type O blood and were willing to donate it. The order was widely circulated and a considerable number of volunteers were thus secured.

The airlift of blood from the United States ended the problem of blood shortages except for occasional periods when blood was in temporarily short supply. Until the airlift was instituted, the effective organization of the local donor panel proved the key to the success of the ETOUSA Blood Bank. Plans for the panel were most efficiently implemented by Col. Robert E. Peyton, MC, and Col. Angvald Vickoren, MC, both of the Operations Division, Office of the Chief Surgeon, ETOUSA. Unit medical officers also were very helpful.

BLOOD AND PLASMA DONATIONS TO BRITISH

The propriety of donations of blood by U.S. troops to British blood banks came up as early as 9 October 1942. On that date, Captain Hardin, then Liaison Officer at the blood bank in Bristol, wrote to Colonel Cutler that in certain areas, British hospitals were being furnished with small amounts of blood by U.S. Army units. This was a practice, he said, fully in keeping with general practices of reciprocity between the Royal Army Medical Corps and the U.S. Army Medical Corps.

One difficulty, however, had arisen: When blood was collected in U.S. Army hospitals and used in British military hospitals, some U.S. soldiers expected to be paid \$10 per pint. Brigadier Whitby thought that if this were done, British civilians might also expect to be paid for donations, which would be against a longstanding British policy in both civilian and military practice.

Colonel Cutler ruled that U.S. personnel, whether civilian or military, would not be paid for the donation of blood.

On 17 June 1943, in response to an earlier query, The Adjutant General, War Department, informed Headquarters, SOS, ETOUSA, that the transfer of dried plasma from U.S. sources to Allied commands could not be approved. The plasma had been secured entirely through donations by patriotic Americans of blood to the American Red Cross, and it was intended only for U.S. fighting forces. Its production, moreover, was geared to estimated requirements, and there was none to spare. This ruling did not, of course, apply to the treatment of Allied personnel in U.S. Army medical installations or to the emergency use of plasma in Allied hospitals when there was no other plasma available.

Later, Colonel Cutler further ruled that U.S. troops would not be permitted to act as donors for British blood supplies. There would be unfortunate repercussions in the United States, he thought, if, with all the plasma generously donated by civilians, U.S. troops were required to give blood as well as to fight.

The question of U.S. Army donations to British blood supplies came up again late in 1943. On 20 October, Captain Hardin wrote to Colonel Cutler that, during a recent drive for donations, teams from the British Army Transfusion Service had met with considerable enthusiasm from U.S. troops, and, in at least one instance, the commanding officer of such a unit had offered to produce large numbers of donors. In fact, tentative arrangements had already been made for bleeding them. Brigadier Whitby was naturally pleased with the response but did not wish to proceed without definite approval of the Office of the Chief Surgeon. He desired to avoid possible unpleasant future comments by making it clear that the response was entirely voluntary on the part of U.S. troops and was not the result of any direct appeal to them.

This particular organization (the 29th Division), Major Hardin pointed out, because of its location would not be asked to volunteer in the U.S. bleeding program. If it were bled by the British, the donations would be completed by 1 January 1944. His own opinion was that no combat unit should be bled later than 60 days before it was expected to go into action.

Colonel Cutler replied on 24 October 1943 (65) that the bleeding of U.S. troops for British use represented a very important principle. It had been decided by the U.S. Army that blood would not be requested from any of its own combat organizations. If this particular combat division were bled, other troops might wish to volunteer, and, once the principle were violated, there would be difficulty in stopping the practice. He therefore recommended that the donation of blood by U.S. soldiers for British supplies be forbidden unless the staff at Headquarters, ETOUSA, could so guarantee combat dates that it would be certain that no troops would be bled later than 60 days before they went into action.

On 1 February 1944, Col. Howard W. Doan, MC, Executive Officer, Office of the Chief Surgeon, wrote Sir Francis R. Fraser, Director-General, British Emergency Medical Service, that while there would be no objection to individual U.S. soldiers' serving as volunteer donors for the British, the U.S. Army blood program was expected to get underway shortly (70). When it did, it would utilize all available sources for the procurement of whole blood and thus reduce the number of volunteers to the British supply.

In May 1944, the question came up again, this time in connection with the Air Forces (71). The Surgeon, Eighth Air Force, received a memorandum from the Surgeon, Headquarters, 1st Bombardment Division, to the effect that representatives of the British Red Cross had requested permission for their transfusion vans to visit Air Forces camps. The British arrangement would apparently not interfere with U.S. Army plans for collecting blood, since only SOS units and Ground Forces would serve as donors. Brig. Gen. Malcolm C. Grow, Surgeon, Eighth Air Force, referred the matter to the Chief Surgeon, ETOUSA, for decision, with the comment that in his own opinion, the request should be favorably considered if it would not interfere with the U.S. Army blood procurement program. It was understood that no flying personnel would act as donors and that all donations would be voluntary, with no pressure brought on Air Forces personnel to provide them.

At about the same time, a similar suggestion from another source was referred to the Professional Services Division, Office of the Chief Surgeon, by the Operations Division of that office, with the statement that the attached correspondence suggested that the Eighth Air Force had not been approached for blood donations. If so, it was the writer's opinion that a potential pool of donors had certainly been missed and the omission should be investigated by the Professional Services Division.

The reply to the first letter (from General Grow) by the Deputy Surgeon, ETOUSA, Colonel Liston, and to the second letter by the Director of the Professional Services Division, Colonel Kimbrough, were to the same effect: When the ETOUSA donor panel for the blood bank was established on 6 January 1944, Air Forces personnel were the only U.S. troops engaged in active combat. East Anglia, where the Eighth Air Force was stationed, was not readily accessible to the British blood bank in the Southern Base Section of England. Finally, it was the intention to use Air Forces personnel as local donors for U.S. hospitals in East Anglia when the need for blood for them arose. Also, when the ETOUSA panel of donors was decreased by movement of SOS troops to the Continent, it might become necessary (as happened) to enlarge the panel by the addition of donors from the Air Forces. For these various reasons, Air Forces personnel could not be permitted to donate blood to the British.

PRISONER-OF-WAR DONORS

In August 1944, when German prisoners were being taken in great numbers, the suggestion originated with some of them that they be used as donors (72). On 6 September 1944, Colonel Kimbrough notified the Surgeon, United Kingdom Base, that the Chief Surgeon, ETOUSA, had no objection to this practice if the donors were volunteers.

PAYMENT OF DONORS

Although payment of blood donors was permitted by law and was practiced in the Mediterranean theater during most of the war (p. 423), General Hawley ruled that neither military nor civilian donors should be paid in the European theater. This ruling was duly incorporated in Circular Letter No. 51 (19).

It was tentatively suggested on several occasions, as already mentioned, in connection with planning for the invasion of the Continent, that it might be necessary to pay donors, but no action was ever taken on the matter. When the question was occasionally raised by hospital commanders, because of special circumstances, permission was always refused.

COMPENSATION FOR ACCIDENTS

When arrangements were being discussed for the maintenance of blood banks to be supplied from British civilian donor panels, Colonel Cutler took the position that claims for monetary compensation for accidents suffered by civilian donors who were being bled by U.S. Army medical officers should be the responsibility of the U.S. Government and not the British War Office. In the experience of the British Army Transfusion Service, according to Captain Hardin, claims had been small in both numbers and amounts. The American experience in this respect was also negligible.

Part VII. Practical Considerations of the Blood Program in ETOUSA

PRELIMINARY PLANNING FOR THE AIRLIFT TO THE CONTINENT

Although whole blood was not an item of medical supply during World War II, the Overseas Branch, Supply Division, Office of The Surgeon General, had the responsibility for shipping it to the United Kingdom and thence to the Continent (73). That function entailed arrangements for air priorities and also required the coordination of shipments with the Air Transport Command for allotment of space based on the daily estimated needs of the theater.

October 1943

Early in October 1943, General Hawley took up with the Commanding General, SOS, ETOUSA, the logistics of the delivery of whole blood to the Continent as follows:

1. Whole blood must be transported rapidly to the locus of use and must be properly chilled during transport. Otherwise, it could not be used to render effective aid to the wounded. Failure of either delivery of the blood or refrigeration would spell failure of the blood program.
2. Shipment by air was the method of choice. If enemy action, weather, or other conditions prevented this mode of transport, then shipment by special refrigerated trucks, on high priority, would be necessary to insure safe delivery of properly chilled blood in adequate amounts.
3. It was recommended that the Commanding General, Army Air Forces, be called upon to assume primary responsibility for delivery of blood to the Continent and that necessary planning and policies to implement the service be prepared jointly by representatives of the Air Forces and SOS.
4. It was also recommended that the chief of transportation be notified that refrigerator vehicles carrying blood must have the highest priority for water transportation when air delivery is not possible.

November 1943

On 4 November 1943, Colonel Mason wrote to the Chief Surgeon, in reference to the communication just summarized, that while it might not be necessary to mention to the Chief, Transportation Corps, that blood shipped by refrigerated truck must be given the highest priority, approval of this specific arrangement by General Lee might prove very useful (74).

December 1943

In a conference held on 22 December 1943, Col. Edward J. Kendricks, MC, Surgeon, Ninth Air Force, informed Colonel Mason that Troop Carrier Command planes would deliver blood from the vicinity of the blood base depot

to fields on the Continent in the vicinity of Army medical supply depots (75). The Troop Carrier Command of the Ninth Air Force had transported blood for the British Eighth Army in the North African campaign and was therefore familiar with the necessities.

Colonel Kendricks requested that a study be prepared concerning the maximum weight and space required for a single shipment of blood. The British had been allotted 2,240 pounds of cargo space daily for air transport.

April 1944

On 7 April 1944, in order that the logistic requirements of the blood program be placed in command channels, the Chief Surgeon requested that the air transport of whole blood to the Continent begin on D+14 and provided the following information (34):

1. The requirement of this operation is 500 pints per day.
2. This blood can be delivered by truck from the ETOUSA Blood Bank at the 1st Medical Laboratory to the nearest forward takeoff point in the United Kingdom for transport to designated fields or landing strips on the Continent.
3. The blood will be packed in cylindrical insulated iced containers, 18 inches high by 16 inches in diameter. The 50 containers required for 500 pints of blood can be stacked in a space 17.66 feet long, 2.66 feet wide, and 3 feet high. The total weight is 3,350 pounds. The average space occupied by 1 container is 2.8 cu. ft. Its empty weight is 32 pounds and its loaded weight, 67 pounds.

On 10 April 1944, the Commanding General, Ninth Air Force, upon request, sent the Office of the Chief of Staff, ETOUSA, the following information to implement the previous request for an allocation of daily cargo space to cover the combined air tonnage requirements of blood and medical supplies for the Army, the Army Air Forces, and the Communications Zone on the Continent (76):

1. Designation of an airfield in the immediate vicinity of Salisbury, where the main storage point and personnel to handle the blood were located, would be most desirable. As a second choice, a field in the immediate vicinity of Thatcham, Berkshire, Greenham Common, or Aldermaston would be satisfactory. If an airfield near Thatcham were designated, blood would be delivered daily to the medical section in Depot G-45 at this location and held there in refrigerators until called forward by the Air Force. Then it would be placed in iced, insulated containers and delivered in trucks to airfield personnel at the time specified.
2. Whole blood prepared for air shipment would be packed in U.S. Quartermaster insulated food containers, each holding 10 bottles of blood and 10 recipient sets. Refrigeration would be maintained by cracked ice (10 pounds to the can) in an insert placed on top of the bottles. This arrangement would maintain optimum refrigeration for approximately 40 hours in an air environmental temperature between 65° and 85° F. (18° and 28° C.). Packing of the containers and their delivery by truck to the designated airfield would be the responsibility of the blood bank.
3. The Air Force would load the containers on the plane and transport them to the far shore within the limit of the lifts authorized and subject to military situations and flying conditions. Here it would unload the containers and turn them over to the medical representative of the Army Advance Section, Communications Zone, or Forward Echelon, Communications Zone, whichever was located at the receiving field on the far shore. Distribu-



FIGURE 119. Loading blood in refrigerated marmite cans for shipment to European Theater Blood Bank by a mobile unit, March 1944. Blood was collected at Shoot End Camp, Alderbury, England.

tion of the blood after its receipt would be made by the advance blood depot attached to the Army Advance Section, Communications Zone, or Forward Echelon, Communications Zone.

4. Empty shipping containers and used blood recipient sets would be collected by advance blood depots and delivered to airfields designated by the Ninth Air Force, whence they would be returned to the Greenham Common Airfield. Here they would be turned over to the Medical Section of Depot G-15 located there.

Over General Dwight D. Eisenhower's name, the information in this letter was sent to the Commanding Generals of the 1st Army Group, the U.S. Strategic Air Force, the First and Third U.S. Armies, and the Ninth Air Force.

Generally speaking, this was the plan by which blood was transported to the Continent during the fighting in Europe (figs. 119-126).

Before D-day, the plans for air supply from the United Kingdom to the Continent included a CATOR (Combined Air Transport Operations Room) to assign priorities, allocate aircraft and tonnage, and coordinate air movements (27). Lt. Robert E. Pryor, MAC, was appointed to coordinate the movement of medical supply by air and to be the representative in CATOR. Direct communication was authorized between the commanding officers of the blood bank and the Troop Carrier Command, which was to fly the blood in C-47 planes. Basic policies and procedures for decentralizing the operation were therefore worked out satisfactorily. In addition, the liaison officer of the Ninth Air



FIGURE 120. Marmite can, opened to show whole blood packed in ice for shipment to 120th Evacuation Hospital, June 1944.

Force visited the blood bank on 2 May 1944, to become acquainted with the staff and to learn their special problems.

Greenham Common, the airfield selected for the takeoff of planes carrying blood, was excellently located for this purpose. It was only 3 miles from Depot G 45, to which blood was to be delivered, and only 38 miles from the ETOUSA Blood Bank at Salisbury.

By D-day, arrangements had been concluded with the 21 Army Group (British) for a daily 4,000-pound airlift to the Continent for blood, penicillin, and biologicals, with additional standby provision for emergency shipments.

AIRLIFT TO THE CONTINENT AFTER D-DAY

From the beginning, the planned airlift worked excellently (59). As early as D + 1, ether and penicillin were being dropped by parachute to medical units on the beaches. By D + 7, emergency landing strips were available on the far shore, and, weather permitting, daily shipments of blood went forward from that date. By the end of June, the daily tonnage exceeded the original allocation, and a second plane was added to the airlift, so that 5 tons of blood and medical supplies per day could be transported to the far shore. The two



FIGURE 121.—Interior of C-47 loaded with whole blood in refrigerated marmite cans for shipment to ADSEC Blood Depot in France, summer 1944.

C-47's flew so regularly that their flights were described in official documents as the milk run. Additional planes were supplied for special emergencies.

The whole system worked smoothly. When blood was delivered to the planes in the United Kingdom in marmite cans, with a block of ice or cracked ice in the top insert, it reached the Continent in good condition, with temperatures of 39° to 40° F. (4° to 4.5° C.), even when outside temperatures were as high as 85° F. (28° C.), the maximum expected.

In September, after the fall of Paris, the Supply Division established a receiving point, with office and storage space, at Le Bourget Airfield. This was the terminus of the milk run from the United Kingdom.

Getting supplies forward to the armies was another matter. This problem was solved by Lieutenant Pryor's discovery near Paris of a squadron of 20 small C-64 planes which were not being used; they were too large and too slow for observation and liaison work and too small for routine cargo work. Their personnel, because of their enforced idleness, were unhappy and frustrated. Arrangements were made with this squadron to fly blood and medical supplies forward and bring back wounded, usually five per plane (three litter patients



FIGURE 122.—Blood in refrigerated marmite cans being unloaded from C-47 on grass landing strip by soldiers of ADSEC Blood Depot, France, summer 1944.

and two sitting patients). The movements of the planes were controlled from General Hawley's office.

This was an admirably successful arrangement. In 3 months, these planes transported 30,000 pints of whole blood, in addition to 463 tons of other medical supplies. On the return trips, they evacuated 1,168 patients.

On 1 September 1944, the Chief Surgeon requested G-4 to arrange for permanent diversion of the two transport planes which had been assigned for the daily airlift of blood from the United Kingdom to the Continent from the airstrip originally used to a strip farther forward (78). The requirements for whole blood had moved forward with the armies, and it was no longer satisfactory to haul the blood forward by shuttle plane or transport it by road. Blood from the United Kingdom was now augmented by blood from the Zone of Interior, and it was imperative that all supplies arrive at their final designation as rapidly as possible.

On 22 September, Colonel Hays requested G 4, ETOUSA, to notify PEMBARK that hereafter, all shipments of blood from the Zone of Interior should be flown to Paris and that shipments to Prestwick, Scotland, should be permanently discontinued (79). This change was effected.

Air transport to forward areas was continued as long as flying conditions permitted. During December, however, the weather was so unfavorable that truck and train shipments became standard procedure. When truck transport was used, deliveries were most satisfactory when there was a prearranged



FIGURE 123. -C-47 plane arriving at airfield in United Kingdom with wounded from Continent, July 1944. It will carry blood from the United Kingdom Blood Bank on its return to the Continent.

rendezvous between vehicles of base and advanced depots. When good flying weather returned in the spring, the tedious, time-consuming delivery of blood by road was discontinued.

In early December, the only contact the blood bank had with the Seventh U.S. Army was by air. Later, blood was shipped to it by regular passenger train also; during the first week of February, this was the only means by which blood reached this Army.

In January 1945, 45 of the 60 C-64 planes were replaced with 7 C-47's, which gave a daily airlift of $17\frac{1}{2}$ tons for blood and other medical supplies. These planes were frequently used to pick up supplies in the United Kingdom and deliver them directly to the armies. After the Rhine had been crossed, the armies were so far ahead of established depots and were operating in territory in which rail transportation had been so completely disrupted that the medical service was fortunate in having an adequate airlift.

OTHER MEANS OF TRANSPORTATION

The Red Ball Coaster Freight Service, set up before D-day, amounted to rapid delivery service by speed boats from ports in southern England to the far shore (34). Because it was not under medical control, it was employed only during the early days of the invasion, at which time it was very useful. When blood was carried by this service, it was top-loaded; that is, it was last on and first off. The Army had personnel on the beaches in Normandy to search for and receive emergency cargo arriving by these boats.

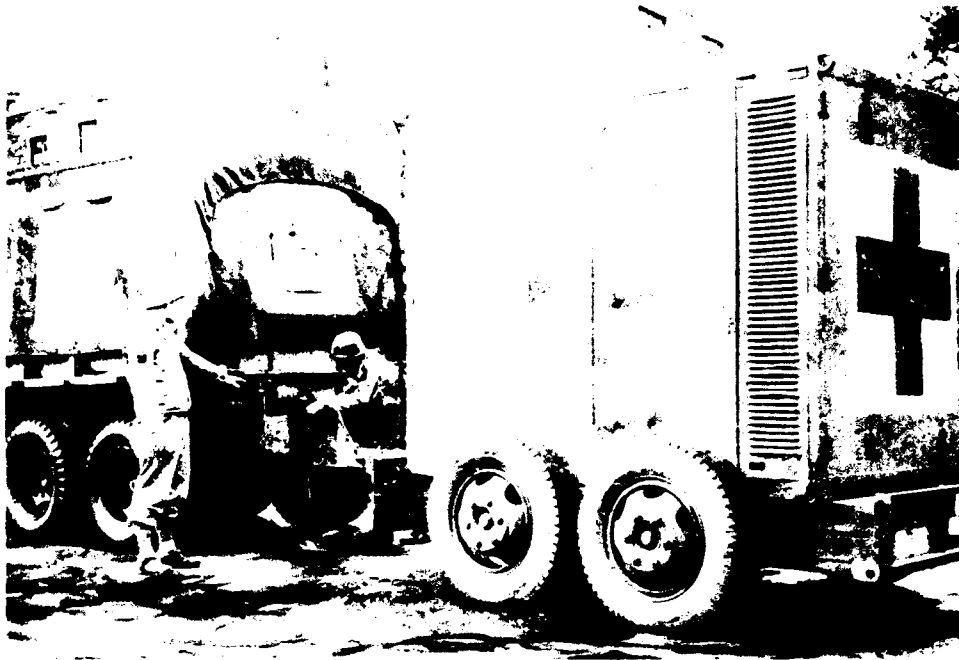

FIGURE 121. Delivery vehicle with 80-pint refrigerator in truck body. Behind this vehicle is 1,000-pint mobile refrigeration truck of Detachment A, 152d Station Hospital, First U.S. Army, Belgium, October 1944.

Another plan for the immediate delivery of blood in the early days of the invasion was, as already mentioned, less successful than other methods. In the discussions before D-day, the daily shipment of blood on hospital carriers, with couriers to meet the boats and take the blood off, seemed to many participants the simplest, and therefore the most foolproof, method of getting blood across to the far shore. The plan was put into effect on D-day, but all but one of the assigned hospital carriers had to put back to port for various reasons. Very little blood was therefore delivered by this route.

Dropping of blood by parachute was discussed in the planning in the Zone of Interior for blood in the European theater, but the Surgery Division, Office of The Surgeon General, did not recommend it because it did not seem necessary and the idea was dropped. If it had been used, appropriate containers would have been required.

AIRLIFT FROM THE ZONE OF INTERIOR

The initial request for an airlift from the Zone of Interior to the European theater was made by Colonel Hays to the theater G 4 on 1 August 1944. After pointing out the inability of the blood bank in the theater, even operating at maximum capacity, to supply the needs of the army fighting in France, he specified the requirements for a daily airlift of blood alone of 1,000 pounds,



FIGURE 125. Refrigerator truck being loaded with blood by enlisted men of Continental Section, European Theater Blood Bank, November 1944. This blood was collected in England. Note British bleeding bottles.

which, with the necessary refrigeration, would amount to 6,700 pounds (500 cu. ft.). The blood would be carried to Europe in iced marmite cans (standard Quartermaster 4-gallon, insulated food containers). The returning airlift would require only 4,500 pounds but would require the same space, since an empty can, although it weighs less, takes up as much space as a full can. If the refrigeration units for planes under development at Wright Field, Dayton, Ohio, should become available, the requirements would be less, since marmite cans and ice would no longer be necessary.²⁵

On 12 August 1944, G 4 Headquarters, ETOUSA, was requested by the theater Chief Surgeon to advise The Adjutant General, War Department, that the theater was prepared to accept 258 pints of blood daily, and had the refrigeration to care for it. A daily airlift of 300 pints had been assigned. Each container, with 10 pints of blood and the requisite amount of ice, would weigh 67 pounds and would occupy 5 cu. ft. of space. The total allotment required was 2,010 pounds and 150 cu. ft. of shipping space. The return

²⁵ Colonel Hays' reference was to the work then underway at Wright Field, in collaboration with the Division of Surgical Physiology, Army Medical School, to develop a refrigerator for blood which would operate in planes on 24-volt batteries. This work was not completed until late in 1944, and only the prototype was available when the airlift to the European theater was instituted (p. 208).

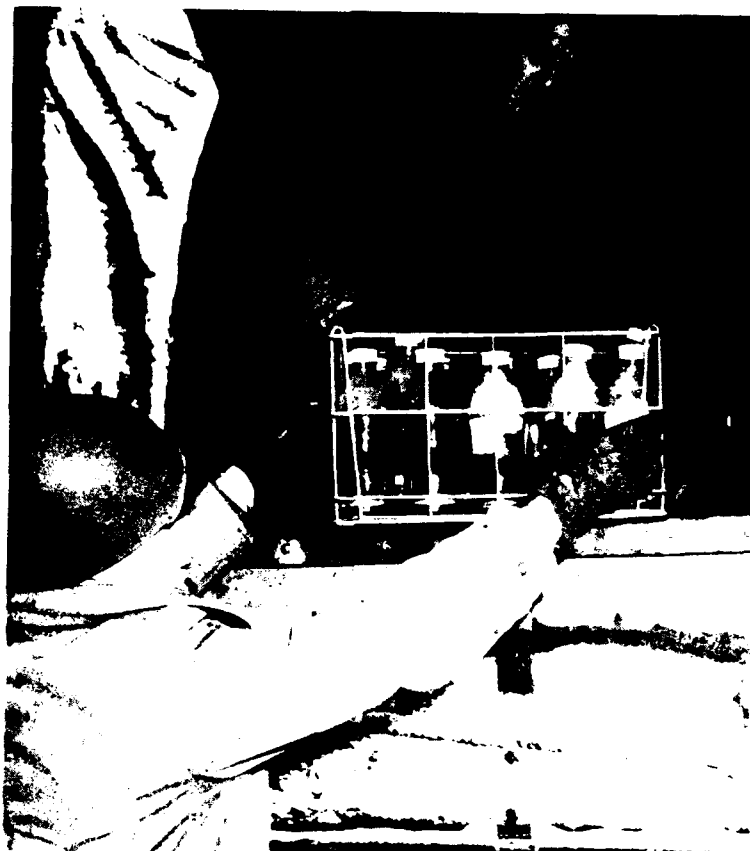

FIGURE 126. Whole blood being unloaded from 2½-ton refrigeration truck at 16th Field Hospital, Boulaide, Belgium, December 1944.

airlift would weigh only 1,350 pounds. Shipping requirements would be increased as Zone of Interior production increased.

On 18 August, General Hawley was notified by General Kirk that the blood shipped from the Zone of Interior would not be refrigerated in transit on the plane and that the containers need not be returned. The request for transportation to G 4, ETOUSA, was altered accordingly. Since the blood would be placed in marmite cans when it was unloaded at Prestwick and would be refrigerated during transit to the far shore, an airlift of only 4.5 pounds would be necessary for every pint of blood delivered to France.

On 20 August 1944, Headquarters, ETOUSA, was informed that the first 300 pints of blood would leave PEMBARK the following day; that shipments would increase to 500 pints daily as soon as sufficient blood could be procured; and that the blood received at Prestwick must be flown to the far shore as soon as possible.

Arrangements were made with the Air Transport Command, ETOUSA (CATOR), to fly the blood daily from Prestwick to the far shore, landing, until

further notice, at the Courtil Airstrip. Colonel Hays, on 27 August, issued the following instructions for handling the blood:

1. The blood received from the Zone of Interior was to be placed at once, in its original carton, under refrigeration. All cartons would be marked with the date of receipt and the oldest blood would be shipped out first.

2. Blood would be shipped to the Continent in the cartons in which it was received, not in the marmite cans originally proposed. Daily telephonic reports would be made to CATOR at Air Headquarters, Norfolk House, London, stating the number of cartons on hand to be transported and their weight.

3. Unless the atmospheric temperature was between 30° and 50° F. (-1° and 10° C.), blood would be kept in the refrigerator at Prestwick until word was received that the plane was ready to receive it for transportation to the Continent. Pilots were to be cautioned that blood must not be allowed to freeze en route and that the cabin temperature was to be kept as close as possible to the temperature range just specified.

REPORTS AND ESTIMATES

The original plan for a weekly report of blood movements at Prestwick was changed on 6 September 1944 for a daily report, to include the number of bottles of blood on hand from the previous day, the number received from the Zone of Interior, the number shipped to the Continent, the number otherwise disposed of, and the balance on hand at the end of the day. Similar totals were also requested for each week, with any comments desired. One copy of each daily report, addressed to the Office of the Surgeon, Headquarters, Communications Zone Forward, for the attention of Colonel Hays, was to accompany the blood being transported. A second copy was to go to the same office by air courier, and a third was to go to the Office of the Surgeon, United Kingdom Base, attention the Supply Division.

Daily airlift requirements, as just noted, were to go to CATOR in London.

REFRIGERATION AND TRANSPORTATION

Transportation of blood in the European theater from base banks to using hospitals in forward areas involved questions of refrigeration as well as transportation.

Pre-D-day Planning and Procurement

Transportation.—In October 1943, Colonel Perry, then Chief, Finance and Supply Division, Office of the Chief Surgeon, wrote The Adjutant General, War Department, through channels, concerning the requirements of the whole blood service, pointing out that special provision must be made for it (PROCO) because it was operating without a T/O or a T/E (80). All items necessary could be obtained locally except cargo trucks, 30 (later 34) of which were requested. Twelve should be delivered by 1 November 1943, twelve by 1 February 1944, and the remainder by 1 April 1944, so that the necessary minor alterations could be made on them, to convert them to their new purpose, and

to mount refrigerators on them. This would take a minimum of 8 hours for each truck.

These trucks had not been received by 17 March 1944, and twelve 6 by 6 cargo trucks were requested as an advance issue of the total requisition so that conversion could be begun. In this same memorandum, Captain Hardin described the various trucks he had examined and explained why he had selected the 2½-ton, 6 by 6 cargo truck as most suitable for transportation of 400-pint refrigerators.

By 18 April, 12 of the 34 trucks requisitioned had been received and were already in use by the blood bank. It was urgently requested that delivery of the remainder be expedited. It would take 3 weeks to convert them, and they must be ready before the start of operations on the Continent, for the ETOUSA Blood Bank could not function without the necessary vehicular equipment.

By the middle of May 1944, all necessary vehicles for the First U.S. Army had been received and were in use or ready for issue. The vehicles for the Third U.S. Army had also been received and would be ready for issue as soon as refrigerators were mounted on them. Earlier, the blood bank had been instructed to classify these trucks as surgical trucks; mark them permanently with Red Cross markings; mark the cab visors "ETO Blood Bank"; and use them only for the supply, packing, and transportation of whole blood.

Refrigeration.—Although PROCO was not approved until 27 October 1943, the refrigerators requisitioned for the blood bank arrived well in advance of the need for them. Because of shortages in the United States, however, it had been feared that they might not arrive on time, and steps were therefore taken to procure them in the United Kingdom. Through the efforts of Colonel Perry, Brigadier Whitby, and Lt. Col. (later Brigadier) John P. Douglas, RAMC,²⁶ the British furnished:

7 walk-in refrigerators, each of 1,000-pint capacity, which took care of the initial requirements for fixed storage at the base and the requirements of mobile units. Each refrigerator had an attached motor-driven unit, which the British also furnished.

2 bulk-delivery 500-pint capacity refrigerators, suitable for use in communications zone depots.

30 smaller refrigerators, of 60- to 80-pint capacity, for the blood bank.

All of these items were available by 1 April 1944, which made it possible to plan for D-day as follows:

6 refrigerators for the base depot, each with a capacity of 600 pints of blood.

4 refrigerators, of 80-pint capacity, mounted on 2½-ton trucks on the hards, where there would be two advance section line of communications blood depots.

2 storage refrigerators, of 600-pint capacity, with the advanced blood depots.

4 refrigerators, of 540-pint capacity, mounted on 2½-ton trucks.

8 refrigerators, of 80-pint capacity, on 2½-ton trucks for the Third U.S. Army advance depot.

²⁶ Brigadier Whitby and Colonel Douglas furnished invaluable help in all the planning and organization of the U.S. Army Blood Bank, including the provision of bottles, tubing, needles, and a few other items which had to be obtained from British supplies. Their extensive experience was also helpful in the solution of many problems of logistics.

The overall capacity of the refrigeration described was 8,240 pints of blood.

Post-D-day Transportation

On 23 June 1944, 2½ weeks after D-day, a message was sent to the War Department from ETOUSA, requesting additional vehicles for the blood bank, the capacity of which was not sufficient to meet the requirements of the present situation. Since the troop basis would shortly be supplemented by two additional armies, a request was made for 30 additional 2½-ton 6 by 6 trucks; 4 days later, the request was increased to 34. If this type of truck was not available, 1½-ton trucks would be acceptable. The basis of the request was that requirements for blood had proved far larger than originally estimated, that the blood bank in the United Kingdom could not further increase its capacity, that it was not possible to build up reserves of a perishable substance such as blood, that a blood bank must therefore be established on the Continent with the assurance that it could provide adequate supplies of blood as they were requested.

On 12 July 1944, the 152d Station Hospital informed the theater Chief Surgeon that its requisition for 30 additional trucks for the expansion of PROCO III had been disapproved by the War Department and, without increased transportation facilities, increased demands for blood could not be met.

Although the original request for additional trucks was refused, the refusal was later countermanded and the trucks, of the type specified, were duly delivered, thanks in large part to the firm stand in the matter taken by Colonel Hays.

FIELD TRANSFUSION UNITS

Authorized Personnel and Equipment

On 2 January 1944, in a memorandum dealing with whole blood, Headquarters, ETOUSA, informed the Commanding General, First U.S. Army, that the following personnel and equipment would be furnished each field army without requisition and would be regarded as over and above T/O and T/E provisions (32):

1. Personnel: 1 officer and 22 enlisted men.
2. Transportation: Nine 2½-ton trucks; one ¼-ton truck; two motorcycles solo.
3. Other necessary transfusion equipment, including about nine refrigerators to be transported on unit transport.

Preparation of Equipment

After the Ebert-Emerson transfusion set had been approved in 1943 by the Medical Supply Board, Office of the Chief Surgeon (p. 185), the first problem

was to find an appropriate place for assembling and packing the sets. With some minor alterations, appropriate facilities were found at Thatcham, and General Hawley ordered that, as supplies for the sets became available, they be transferred there and frozen for use in field units. The assembly and packaging of the units was accomplished under the supervision of Maj. (later Lt. Col.) Charles P. Emerson, MC, who was sent to Thatcham on temporary duty.

Shortages.—The assembly of the sets was not a simple matter because of shortages and substitutions (81). Although Baxter bottles had been requisitioned, British bottles were received, and, to avoid further delays, they were used. Only 3,000 vials of sodium citrate solution with beads were received, instead of the 10,000 necessary for the 350 (reusable) transfusion sets to be supplied to each field army. The British vials, which were substituted, were the same size as the U.S. vials but had to be repacked because the British packing was undesirably bulky. The instructions to be included in each set did not arrive at Thatcham until 14 February, several weeks after the assembly of the sets had begun. In April 1944, the prospects were that it would take 10 months for British firms to fill the order for 70,000 Welsbach gas mantles to be used as filters. The 15-gage needles to be substituted for the 17-gage needles originally used were requested from the Zone of Interior on air priority, but they were still not available by the end of August. Special requests had to be placed in April and May for such items as 3,800 adapters to be used to attach the Luer needle to the rubber tubing in the units.

Shortages of blood donor needles, filters, and rubber tubing continued even after D-day until they were corrected by shipments of whole blood from the Zone of Interior.

Allowances and Distribution

There was considerable discussion on the matter before the distribution of transfusion sets was settled in the European theater. The original plan was to supply 2 sets to each clearing company, evacuation hospital (400-bed, 750-bed), and field hospital, and 10 sets to each auxiliary surgical group (82). Later, the distribution was modified to provide 6 for each field hospital and 20 for each auxiliary surgical group. It was estimated that 350 field transfusion sets would be needed for each of the two field armies then contemplated (83).

In January 1944, these estimates were expanded. On the basis that 2 casualties out of each 10 would require transfusion, it was estimated that about 20,000 sets would be needed for each 100,000 expected casualties, which meant that 4,000 sets should be ordered at once (84). It was then expected that sterile expendable transfusion sets would be ready for distribution in February and could be supplied to hospitals and used as replacements for the field transfusion sets then packaged in ammunition cases.

The suggestion that station and general hospitals be provided with field transfusion units was not accepted, since whole blood transfusions could be accomplished in them by modified British sets, which would be requisitioned

through channels from the British Army Transfusion Service (p. 179). These hospitals were so equipped, furthermore, that they could clean and sterilize their own equipment.

By 13 March 1944, all field transfusion units had been completely assembled at Thatcham (85). They differed from the units originally planned in two respects: That the amount of typing serum was sufficient for only 25 donors, not for 50, and that, because of shortages, citrate had been secured from British and not U.S. sources, which decreased the number of transfusions possible with each set from 18 to 10 or 11. Individual organizations, however, could requisition additional citrate and typing sera as needed.

The 175 transfusion sets requisitioned by the First U.S. Army were delivered to it about the time expendable transfusion sets were first received from the Zone of Interior. The latter were in very short supply—by 11 May, only 1,815 of the 4,000 sets requisitioned on 20 January had been received in the theater—and, for this and other reasons, it was not considered advisable to replace the Ebert-Emerson sets already delivered to the First U.S. Army. The Third U.S. Army, however, which had requisitioned 250 of the field transfusion units, was supplied with the expendable sets, on the basis of two of the disposable sets for each of the field transfusion sets requisitioned. When the First U.S. Army required replacements, it, too, would be provided with the disposable sets.

All problems of this kind were eliminated when blood began to be flown from the United States to the European theater, since disposable giving sets were included with each unit of blood.

ROLE OF THE SUPPLY DIVISION IN THE WHOLE BLOOD PROGRAM

Initial Planning

While the whole blood program in the European theater could not have been operated without the aid of the Supply Division, Office of the Chief Surgeon, ETOUSA, this division had no responsibility at all for the collection, processing, storage, or distribution of blood (73). That was the responsibility of the ETOUSA Blood Bank, at the 152d Station Hospital, with the later support of the 127th Station Hospital. The function of the Supply Division was threefold:

1. To call up blood from the Zone of Interior and the blood bank at Salisbury according to the demands for it from the field.
2. To provide the necessary supplies for the operation of the bank.
3. To aid logistically in securing transportation for the blood.

The relation of the Supply Division to the blood program first appeared in a memorandum from Headquarters, ETOUSA, to the Commanding General, First U.S. Army, dated 2 January 1944 and dealing with the provision of whole blood from the Medical Service (32, 86). In this memorandum, it was stated

that whole blood would be an item of medical supply which would be distributed through medical supply channels and given the highest priority in transportation.

On 17 March 1944, in a conference between Colonel Muckenfuss and Major Hardin, it was agreed that all requests for supplies of whole blood should proceed through the same channels as requests for medical supplies. On 12 April, this understanding was expanded to indicate that "through normal channels" meant that requisitions would proceed from the Continent to Headquarters, G-4, SOS, where they would be extracted, sent to the theater chief surgeon's office, and then relayed to the base blood depot. This procedure, it was estimated, would consume 48 hours.

Early in March 1944, the Supply Division began to plan for the delivery of blood from the blood bank at Salisbury to the Continent via Depot G-45 at Thatcham (73). It would be the responsibility of the blood bank to get the blood to this depot and the responsibility of supply personnel at Thatcham to see that it was loaded on the plane and that provisions were made for icing the blood from this point until it reached the Continent. When blood was shipped from the bank at Salisbury, and later, when it was shipped from the Zone of Interior, it was the responsibility of the Supply Division to see that it was properly iced along the way. If any shipment of blood was improperly iced or was mishandled for any other reason, it was the responsibility of the Supply Division to investigate the circumstances and correct them if the division was responsible; if not, the blood bank was informed.

Implementation of Plans

The assignment of planes in which blood was transported to the Continent cleared through the office of Colonel Hays, not only because of the priority for blood but also because of the priority of other supplies, particularly penicillin, which were sent to the Continent on an emergency basis. Personnel of the Supply Division soon learned that, when planes were difficult to procure, blood and penicillin were both magic words.

No difficulties arose in the relation of the blood program to supply channels as long as the blood bank remained at Salisbury. In September, when the 152d Station Hospital blood bank moved to the Continent, some misunderstandings developed.

On 23 September 1944, Colonel Kimbrough wrote the Executive Officer, Office of the Chief Surgeon, suggesting that a circular letter be published, stating that:

1. The 152d Station Hospital would operate the Continental Section of the ETOUSA Blood Bank.
2. Major Hardin, commanding officer of the hospital, would serve as director of the bank, in addition to his other duties.
3. Technical supervision of the bank functions (that is, procurement, processing, storage, and distribution of blood) would be the responsibility of the Professional Services Division, Office of the Chief Surgeon, ETOUSA.

Colonel Hays objected to this proposal, on the ground that the division of responsibility within the Office of the Chief Surgeon was not a matter for a circular letter. In his opinion, the outside world should consider this office as an entity, and the division of responsibility and authority in it should be handled by an office memorandum. He called attention to Office Memorandum No. 10, 17 September 1944, over the signature of Colonel Doan, Executive Officer, Chief Surgeon's Office, which stated that the Supply Division of this office was responsible for the requisitioning of blood in adequate quantities to meet requirements on the Continent and for its proper and timely distribution. These responsibilities would require intimate coordination with other divisions of the Office of the Chief Surgeon, especially by the Professional Services Division and the Plans and Operations Division. Associated divisions were reminded to keep the Chief of the Supply Division constantly acquainted with the situation as it applied to their particular activities. Any irregularities or suggested improvements in procedure which came to the attention of any one division should be transmitted to the responsible division.

As a result of the discussion, in which others participated, Office Memorandum No. 10 was rescinded and Office Memorandum No. 19, dated 30 October 1944, was issued in its place. In substance, it was as follows:

1. Whole blood for transfusion purposes is obtained from bleeding on the hoof (local bleeding), from the United Kingdom Blood Bank at Salisbury, or from the United States by air.
2. In the near future, blood will be furnished by a blood bank on the Continent. (As a matter of fact, by the time this memorandum was issued, the Continental Blood Bank had already been set up and was distributing blood.)
3. The provision of whole blood for transfusion is a complicated procedure, involving the establishment of technical standards, with technical supervision of collection; preparation; storage; transportation; issuance; and, finally, administration of the blood to the recipient. The division of responsibility and authority²⁷ in this procedure is as follows:
 - a. The Professional Services Division is responsible for the establishment of standards and for technical supervision of the collection, processing, and administration of whole blood.
 - b. The Supply Division is responsible for the supervision of transportation, storage, and distribution of the blood.
4. Since blood is chiefly transported by air, and since the same planes are used for the transportation of other medical supplies, the transportation and distribution of blood and other medical supplies moved by air are very closely related.
5. In carrying out the duties assigned to him, the Senior Consultant in Blood Transfusion and Shock, Major Hardin, who is also commanding officer of the Continental Blood Bank, will operate under the supervision of the Professional Services Division and the Supply Division as just outlined.
6. All divisions of this office (that is, the Office of the Chief Surgeon, ETOUSA), will keep the Chief of the Professional Services Division and the Chief of the Supply Division acquainted with any matter pertaining to the supply of whole blood within the division of responsibility as just outlined. Information to higher echelons and instructions to lower echelons, including requests for information, will be routed through these channels.

²⁷ This division of responsibility proved to be as unnecessary as it was undesirable. It worked in this instance because Major Hardin made it work; an officer of lesser stature might readily have failed. The present (1962) policy is to place the entire responsibility for the transfusion service in professional hands.

Occasional difficulties continued to arise, but, on the whole, the relation of the whole blood program to supply channels was cooperative, and personnel of the blood program freely admitted their obligation to the Supply Division for its successful operation.

SECURITY MEASURES

Unusual activity in the blood bank would, of course, have been a clear indication that the date of the invasion was approaching. On 1 May 1944, General Hawley wrote to the Commanding Officer, 1st Medical Laboratory (87), that the pony edition of *Time* for 24 April 1944 had carried an item to the effect that a recent dry run in the bank had been just for practice but that 3 weeks before the invasion, "the dry run will become wet." Obviously, General Hawley wrote, after such an announcement, no better indication could be given to the enemy of the date of the impending invasion than the inauguration of a stepped-up collection of blood. He found it necessary, therefore, to direct that blood be collected on the maximum possible scale from this date until the invasion; otherwise, it would not be possible to resume collection until after the invasion. He requested all details concerning the origin of this statement and concerning the clearance of the particular correspondent responsible for it.

In reply, Colonel Muckenfuss stated that no correspondent for this publication had ever visited the 1st Medical Laboratory; the term "dry run" had not been used in the laboratory for at least 3 months; small-scale bleedings had been made at frequent intervals; and blood could not be kept longer than 3 weeks, which made the statement about beginning to collect blood "in earnest" 3 weeks before the invasion obviously incorrect. He could therefore throw no light on the source of the statement. He added that he had discussed the problem of security several times with Major Hardin, to decide on methods of minimizing evidences of unusual activity in the blood bank.

Immediately after General Hawley's complaint was received, all bleeding teams were sent out from the bank every day, to work all day and collect blood in places in which there were only a few donors, who were bled behind ostentatiously locked doors. At the end of each long day, the few donations thus procured were rushed in clearly marked 500-pint refrigerators to the blood bank.

Actual blood collection for the invasion began 20 days before D-day, but, by Colonel Muckenfuss' own desire, he was not informed of Major Hardin's time schedule, and, as the latter expressed it in 1961, "I was the only person who ever knew when the blood bank was actually turned on."²³

²³ Queried as to the correctness of this statement, Dr. Hardin wrote as follows on 18 February 1963:

"The statement that I made that I was the only person who 'knew when the blood bank in the ETO was actually turned on' is literally correct. The circumstances under which this arose now have somewhat unreal characteristics, but went something like this.

"Several months before D-day the headquarters of the ETO blood bank was visited by a public relations officer who had in tow a *Time* reporter. Among the many questions asked of me was the one of how long blood could be kept. At

HOUSEKEEPING ARRANGEMENTS

As already mentioned (p. 499), the 152d Station Hospital, which served as the ETOUSA Blood Bank, was attached for housekeeping and general administrative purposes as long as it was in England, to the 1st Medical Laboratory. A similar arrangement was in effect for the 127th Station Hospital when it took over the blood bank functions of the 152d Station Hospital and the latter moved to the Continent.

Different arrangements were necessary when the 152d Station Hospital moved to the Continent, in September 1944. The parent bank in Paris was then attached for housekeeping and administrative purposes to the 1st General Hospital (p. 516).

The detachments of the two blood banks which operated in the field were attached for these purposes to any convenient medical supply depot, the commanding officers of which provided rations, quarters, space for blood storage, and other needs. These arrangements were highly satisfactory. The medical supply depots to which the detachments were attached rendered great assistance to them. The mobility of the Army medical supply depots made the setup particularly satisfactory, for the Army detachments of the blood banks also followed the armies which they served. Locations of station and evacuation hospitals were secured from the depots to which the detachments were attached, and some confusion sometimes arose.

The revised directives for ADSEC detachments (54, 57) provided for attaching them for rations and administrative purposes to the units which

that time the proper answer was 21 days and in due course there appeared an article in *Time* magazine which said the ETO blood bank would begin collecting blood 20 days before D-day. This was an assumption made by the reporter, but happened to be uncomfortably correct. As you can imagine, General Hawley was reasonably upset and he ordered me to undertake such activity as would make it impossible for people to know by observation when the ETO blood bank was actually 'turned on.' For that reason, we began somewhat hectic activity designed to produce confusion among all observers and among my own personnel. Bleeding teams were sent hither and yon, but always to units where there were too few donors to be of significance when we really started collecting blood. The blood was brought back to the central laboratory and processed and was distributed to hospitals so that there was no evidence at the central unit of how little blood was actually being collected.

"The units of the ETO blood bank which were to go across the Channel were put into positions of embarkation along with other troops behind the barbed wire along the southern coast of England some time in advance of the invasion. They were sent there without instructions as to what their mission was or where they were going. Later I was given a pass which let me go behind the wire and brief my units and, as a matter of fact, take blood to them for transport across the Channel. As you know, we landed our first depot unit in Normandy on D-plus one. In addition, we loaded blood on 104 ships, most of which were LST's converted to bring troop wounded back from France. No one in the unit knew where these ships were to dock and be loaded, nor the day nor time, except myself and I kept this after receiving it at the British Naval Headquarters in Southampton entirely in my memory, never writing it down. I personally supervised the loading of refrigerator trucks in Salisbury and these and their drivers went behind the wire where they were met by some of my officers already in that locality. After accomplishing their mission these trucks and drivers were kept behind the wire until the invasion of Normandy was a fact.

"My memory fails me as to the exact time but early in the spring it became necessary for me to know when D-day would occur. One morning at General Hawley's headquarters in London, I was taken to the middle of a large room by Colonel Liston and others and the date of D-day was whispered in my ear. I was told that this date was a planning date and that the actual invasion would occur within a 48-hour span of this date. Thus I knew when to begin the bleeding in the blood bank in earnest, when to put blood behind the barbed wire along the southern coast, and when to begin all of the operation in earnest. I was forbidden to disclose this date to anyone else, of course, and although several of the people in the unit must have realized that D-Day was imminent, I am certain that no one was actually aware of the real day until it happened.

"I hope this clears up my statement and I hope that none of us will ever go through that kind of an experience again."

operated Army Air resupply strips. This plan was quickly put into effect by an agreement between the Commanding General, Ninth Air Force, and the Commanding General, ADSEC, and it continued to be standing operating procedure for the rest of the war. It had many advantages. The blood detachment could quickly unload the C-47's which transported their daily supply of whole blood. The distance between this location and the banks in the Army area was short. Communications with Headquarters, ADSEC, and the base depot of the ETOUSA Blood Bank were almost immediately available.

In order that commanding officers of these mobile blood units be unhampered by tight control, they were given relative freedom of action in planning their forward movements. The Surgeon, ADSEC, however, insisted upon prior clearance for moves when the situation permitted, for station list and order purposes, and, in an occasional instance, tactical requirements demanded other dispositions than those planned.

EARLY OPERATIONAL DIFFICULTIES

As might have been expected, a number of problems arose in connection with the whole blood service in the first weeks of its operation. On 19 July 1944, a number of them were called to the attention of Col. (later Brig. Gen.) John A. Rogers, MC, Surgeon, First U.S. Army, by General Hawley's office (88):

1. Trucks designated for blood were being required to carry out many diversified tasks, such as hauling tools, medical supplies, repair parts, and even personnel. This left insufficient time for the proper maintenance of these trucks and of the refrigerators mounted on them. If this unwise practice were continued, it could lead to serious interruptions in the blood program, for no trucks were available as replacements for these special trucks; they were essential for the delivery of blood.

2. The motorcycles and jeeps designated for the blood bank had been moved from its control and had thus lost their value for their designated purpose, which was to make contact with using units.

3. The blood bank was not kept posted on the movement of forward hospitals, and they were sometimes difficult to locate.

4. It would help materially in the use of blood if the blood service were notified when a hospital was closing and moving. The blood in its control could then be picked up and re-distributed, and the hospital could be restocked when it was again in operation. Blood was too precious a commodity for any of it to be wasted through preventable deterioration.

It was evident, General Hawley concluded, that as more and more troops were committed, greater economy must be practiced in the use of blood. The limit of supply was fixed not by the organization which collected and processed it but by the availability of suitable donors. That limit had almost been reached, and it was therefore requested that necessary action be taken toward improving the efficiency of the blood service on the far shore.

The memorandum from General Hawley's office bore out complaints from members of the blood detachments. In June 1944, the commanding officer of one such detachment wrote to Major Hardin that his two motorcyclists had

been placed on detached service and that he had just lost a sergeant. He wished no replacement for the latter, but if he had to have one, he wanted a private.

He still had no jeep. His trucks were working well, but were getting unnecessarily hard wear. He wrote:

In addition to hauling blood, we are ordered to pick up laboratory specimens. We have to carry the depot refrigerator mechanic and the depot sterilizer mechanic out to their jobs at one of the hospitals. We also carry parts and tools. We carry the men back to the depot or to a different hospital. We still haul some freight from the depot to advance sections or vice versa. We carry biologicals from the airstrip to the depot and optical repairs from the depot to the airstrip. We haul X-ray machines for repair and back.

It was increasingly difficult, the writer continued, to keep refrigerators in good condition because of damage caused to them by hauling freight. The trucks were kept on the road so much that their maintenance was as unsatisfactory as the maintenance of the refrigerators.

It was also difficult to keep up with the increasing number of hospitals in the area, the writer went on, now that the blood detachment was on the same post as the base platoon of the medical depot and information as to hospitals was no longer secured from First U.S. Army Headquarters. Changes in location were often received late and were often incorrect. On a recent trip, one of the detachment trucks had spent the entire night searching for the hospital to which its blood was consigned and did not find it until the next day, when correct information about its location was secured.

The writer found the failure of the Supply Division (headquarters not stated) to discuss proposed changes with blood personnel very discouraging: A recent ruling, for instance, that marmite cans be sent to field hospitals to increase the amount of blood to be kept on hand in them was put into effect without previous notice. The result would be an increased lag in the return of these cans and an imbalance in both cans and recipient sets.

This extremely pessimistic memorandum ended on a brighter note, that using hospitals seemed to be entirely satisfied with the blood service. The misuse of the trucks, however, of which the writer complained and which duplicated the experience of other detachments of the blood bank, further substantiated the importance of completely dissociating blood from medical supply.

INQUIRY INTO EFFICIENCY OF AIRLIFT TO EUROPEAN THEATER

On 8 January 1945, at the suggestion of Colonel Carter, who believed that the desired information would be expedited by personal communication, Major McGraw, who was now in the Office of The Surgeon General, wrote to Major

Hardin asking for details of the operation of the oversea blood program (89). Up to that time, very little information had been received in the Office of The Surgeon General regarding blood sent to the European theater. Indeed, not much was known about what happened to it after it was put on the oversea plane. Improvements in handling were desirable and would be facilitated by information on the following points:

1. How long did it take blood to reach the ETOUSA Blood Bank? Presumably, it should reach it in about 24 hours after it was put on the plane, but there must be many occasions when bad weather delayed shipments en route. If so, steps should be taken to prevent both warming and freezing.

2. Were all shipments received? There was no assurance at the present time that blood might not often be landed at an alternative field and left unattended or even forgotten.

3. Was it desirable to send a courier with each shipment? Personnel of the North African Theater Blood Bank, with which Major McGraw had previously worked, considered it absolutely essential that a responsible person accompany each shipment of blood to northern Italy as well as to southern France. It was the courier's responsibility to see that the blood was properly handled at any emergency landing field en route and to secure land transportation to within a reasonable distance of its destination if the plane could not put in at the regular airfield.

4. In what condition did the blood reach the theater? There was concern that some of it might be frozen or hemolyzed, or that some containers might be broken.

5. Was enough blood being received? The Red Cross had heard unofficially that there was some resentment in the European theater because less blood was shipped than had been requested. The director of the Red Cross blood bank had reported this story to The Surgeon General, who could only reply that the last request from ETOUSA had been for 1,000 bottles a day and that 1,000 bottles a day were being sent. The shipments could be increased beyond this amount if the request was made.

6. Were the hospitals satisfied with the blood? Were there hemolytic or pyrogenic reactions from it? Were there any errors in blood grouping?

In this same letter, information was requested concerning titration practices. In Italy, a technique was employed by which it was possible to pick out about 30 percent of the highest titered O bloods. These bloods were marked for the use of O recipients only. The practice had been adopted because of a severe hemolytic reaction in a patient with group A blood, who had received group O blood with a very high anti-A titer (p. 424).

Most of these questions were answered by Capt. John Elliott, SnC, from his observations in the European theater on his visit there later in January (90). They are discussed under appropriate headings. In general, his report was highly favorable. So far as he could determine, no blood from the United States had been contaminated on receipt, nor had there been any errors in typing. About 18 bloods of each thousand had to be discarded because of hemoglobin in the supernatant plasma. Since it had been discovered in December 1944 that a small number of bottles of blood hemolyzed rapidly, for no reason that could be discovered, the plan had been adopted of allowing all blood to sediment for 24 hours before it was shipped out of the Paris Blood Bank (91). Each bottle was then examined visually before it left the bank.

CLINICAL PROBLEMS

Difficulties With Equipment

On 27 June 1944, General Hawley requested G-4 to provide space on a plane the following day for Major Hardin to fly to the Continent. On his own visit, he had observed certain difficulties in the administration of blood, particularly maintenance of the proper rate of flow, which was a most important element in the procedure. He wished Major Hardin to investigate the trouble immediately.

Major Hardin arrived on the far shore the following day, and, in fulfillment of General Hawley's mission, visited the Office of the Surgeon, First U.S. Army; the 1st Medical Depot Company; the Advance Blood Bank (Detachment A) of the 152d Station Hospital; and the 45th, 67th, and 128th Evacuation Hospitals (92).

In discussions with Colonel Crisler, Consultant in Surgery, First U.S. Army, Major Hardin learned that the difficulties in the blood program were chiefly in the administration of the blood, during which the rate of flow was frequently inadequate. Most observers considered the filter at fault, but Colonel Crisler, as well as Col. William G. Amspacher, MC, Chief of Plans and Operations, Office of the Surgeon, First U.S. Army, believed that the filter was adequate and that the rate of flow was hampered by the size of the needle and the adapter. Some officers complained that they had lost patients because the blood clotted. While the complaints were most prevalent on the beaches, there were also difficulties in hospitals and they continued for some time, even after the Continental Blood Bank had been established.

Some officers overcame the poor performance of the filter by using gauze for filtration. Others transferred the blood to salvarsan tubes for administration. Still others, who were in the majority, applied positive pressure by means of a Higginson syringe obtained from the field transfusion set or a sphygmomanometer bulb. Results with all methods were about the same, but the use of positive pressure was not desirable because the tubing and adapters provided were not of a quality to withstand the pressure. When this expedient was employed, it was a common experience for the system to spring leaks, with the result that the transfusion had to be stopped and the blood being used had to be discarded. The solution would have been the use of 15-gauge needles, but they were not available until much later.

Major Hardin considered all of these complaints justified. Transfusion should be a continuous and efficient procedure. In the period immediately after D-day, it was too often improvised and interrupted. It became continuous and efficient when expendable transfusion sets were supplied, with adequate filters and needles of larger bore.

Colonel Cutler believed that bank blood which clotted did not contain a sufficient quantity of citrate solution. It is true that when blood began to be

received from the Zone of Interior in Alsever's solution, complaints of clotting ceased. Many observers, however, continued to believe that it was not desirable to give blood diluted 50 percent by the preservative solution.

When the expendable set was introduced, with the giving needle attached directly to the rubber tubing, there was seldom any difficulty in transfusing a casualty who had good veins. When the veins were collapsed, the situation was different. Since the needle was attached directly to the rubber tubing, without a connecting observation tube, it was not easy to detach the needle and hook it up to a syringe, to facilitate location of the vein. Some modification of the set was necessary in such circumstances. This was accomplished at some hospitals by cutting off the needle attached to the rubber tubing and replacing it with the needle and observation tube from the plasma set. After the needle had been connected to the syringe and the vein located, the needle was attached to the Luer tip of the observation tube before the transfusion was started.

Aging of Blood

On his visit to the European theater in September 1944 (1), Colonel Kendrick was informed of two transfusion reactions, accompanied by chills and fever, which had occurred in the 1st Platoon of the 60th Field Hospital, and of eight similar reactions in 50 transfusions in the 12th Evacuation Hospital. In discussions with the chiefs of the surgical and laboratory services in the hospitals involved, he learned that, in each instance, the blood was within a few days of the expiration date, or beyond it. Most of the patients for whom it had been used had lost a great deal of blood, and they were transfused with the aging blood because of their extreme need.

Further investigation revealed other special circumstances. Immediately after the service to Prestwick from the Zone of Interior had been inaugurated, there was a sharp reduction in the number of casualties and a corresponding decrease in the requirements for whole blood. As a result, there was a lag in shipments from the United Kingdom to France, and some blood was stored for 8 or 9 days before it was sent to the far shore. At one time, even though the collection of blood in the United Kingdom was halted altogether, there was a backlog of 6,000 pints of blood in the United Kingdom.

Major Hardin and Colonel Kendrick recommended that, beginning at once (26 September 1944), blood from the Zone of Interior be sent immediately from Prestwick to France, the oldest blood on hand being shipped first, to be sure that it was used before the dating period expired. They further recommended that blood which could not reach hospitals in France before the expiration date be used in general hospitals in the United Kingdom, or, if necessary, discarded entirely. It was expected that, as the number of casualties again increased, the lag would be overcome. This did not happen immediately, however, and for a time, blood continued to be sent to the far shore which had aged a week or more before it reached the using hospitals.

An additional difficulty in this connection was that, because of bad flying weather and the consequent delays, some blood had already aged for several days in the Zone of Interior before it was flown to the United Kingdom.

The safety of using blood that was from 14 to 18 days old for exsanguinated casualties could not be readily determined from existing evidence. The impression prevailed that those casualties with depleted blood volume were more likely than others to have reactions after intravenous therapy.

On a priori evidence, this reasoning seemed sound. As blood ages, the amount of free hemoglobin in it increases, as does the amount of plasma potassium. Although the normal human kidney will tolerate rather large quantities (up to 5 gm.) of hemoglobin without significant pathologic changes, the exsanguinated casualty probably has a much lower threshold for this substance. When anoxia is added to lowered blood pressure and decreased circulating blood volume in a casualty who has suffered severe hemorrhage, it is logical to assume that renal function will be impaired. Then, if blood with 50 to 100 mg. of free hemoglobin per 100 cc. is injected, there is a real increase of free hemoglobin in grams per volume, and kidney function is further impaired. As a result, reactions might be expected.

While this reasoning was recognized as purely conjectural,²⁹ it did suggest the need for providing greatly exsanguinated casualties with as fresh blood as possible. It also suggested the need for alkalinizing casualties who had sustained severe hemorrhage and had to be given 3-4 pints of blood over a short period.

After his tour of First and Ninth U.S. Army installations in September 1944, Colonel Cutler expressed the opinion that field hospitals should be given whole blood, that is, ETOUSA blood, while evacuation hospitals, in which the need for blood was generally less acute, should be given preserved Zone of Interior blood, in which there were fewer corpuscles. No action was taken.

The whole subject of reactions is discussed in detail under that heading (p. 649).

Use of Chilled Blood

Another subject brought up to Colonel Kendrick on his visit to the European theater in September 1944 was the use of chilled blood in exsanguinated patients. Clinical usage had demonstrated the safety of injecting blood at 39° to 43° F. (4° to 6° C.), and the practice was now routine in many civilian hospitals.

The injection of chilled blood into patients in shock from exsanguination, who were in an unstable state and exposed to cold surroundings, had not yet been investigated. It seemed safe to conclude that this practice would produce no biologic reactions, but the experience in field hospitals had shown that it caused chilly sensations, and both patients and surgeons objected to it. Colonel

²⁹ The present (1962) belief is that hemoglobin plus ghost cells originating in nonviable red blood cells are responsible for the reactions described.

Kendrick therefore recommended that, whenever time permitted, blood to be used in exsanguinated casualties be removed from the refrigerator an hour before the transfusion. This practice had its own elements of danger: Blood could be used safely after it had stood at room temperature for 2 or 3 hours, but in the rush of caring for many casualties at once, it might be overlooked and left out of the icebox until it was no longer safe to use.

Part VIII. Statistical Data

QUANTITATIVE USE OF BLOOD

Initial Observations

When it became evident, soon after the invasion of the Continent, that much more blood would be required for combat casualties than had been anticipated, the question naturally arose as to how efficiently the blood available was being used. On this point there were several opinions.

When Major Hardin returned from the trip to the Continent which he had begun on 28 June, he reported that he had not seen a single casualty in whom transfusion had not been both helpful and desirable (92). It was being given to exsanguinated casualties to build up the hemoglobin level and restore lost blood volume and was also being used to combat gas gangrene. It did not appear to him that blood was being used to excess.

Statistical data were not readily available, but in the three evacuation hospitals which he had visited, the ratio of blood to casualties was 1:4.7 and the ratio of plasma, 1:3.2. The ratio of blood to plasma was about 1:1.4. Since many casualties had received plasma before admission to the hospital, these ratios could not be accepted as entirely accurate. There was perhaps some justification for the hope that the use of smaller amounts of blood, backed up by plasma, might produce almost as good results as the use of whole blood. Perhaps a ratio of one unit of blood to three units of plasma might be considered by First U.S. Army medical personnel, since the supply of blood would always be limited and the amount administered must be adjusted to the supply.

At about the same time as Major Hardin's survey, Colonel Zollinger conducted an investigation of the relative use of plasma and blood in forward hospitals (43). The shock teams which made the study reported that the ratio in field hospitals was 1.63:1 and in evacuation hospitals 1.34:1. More important than the actual figures was the opinion of the surgeons: A medical officer on one of the 3d Auxiliary Surgical Group teams, who had previously worked in North Africa and Sicily, stated that the greatest single medical blessing in the European theater was the availability of blood from the blood bank, which was making it possible to operate on, and save, casualties who would never have survived on plasma alone.

On 1 July 1944, General Hawley wrote Colonel Rogers, Surgeon, First U.S. Army, that on a recent trip to the Continent, Colonel Cutler had gained the impression, as he had on his own recent trip, that in some units blood was not being used economically. Since there was a limit to the amount that could be supplied, use must be proportionate to the supplies available.

When Colonel Cutler transmitted Major Hardin's report (92) to General Hawley, he noted that the present ratio of blood to plasma indicated that only a little more plasma than blood was being given. He had expected that the amounts of plasma used would be at least double the quantities of blood used. He considered the present usage of blood quite satisfactory, but the Professional Services Division must be constantly alert to be sure that this valuable substance was being utilized correctly.

Essential Technical Medical Data from the European theater for October 1944 (93) also had some criticism of the excessive amounts of blood used in some cases. Investigation had shown that, on the whole, if appreciable benefit were not obtained after 4 pints of blood had been transfused, a consultation should be requested, to determine whether prompt operation would not be the proper procedure.

As time passed, the realization grew that, contrary to the first impression that blood was being used to excess, more was needed than had been given originally. By October 1944, shock teams were beginning to view more critically the necessity for correcting depleted blood volume by the use of whole blood. Canadian shock teams, working with apparatus for determining blood volume, had found that the reduction in severely wounded men averaged 33 percent, which was equivalent to a loss of 2,000 cc. in a man 5 ft. tall and weighing 70 kilograms. On the basis of this observation, the demand for blood by Army surgeons was not considered excessive.

Adjustment of Supply and Demand

One of the problems of the blood program was to supply blood in proportion to the need for it, since it is not a substance which can be stocked indefinitely. On 14 September 1944, General Hawley wrote General Kirk that, as soon as the supply of whole blood had been increased by the institution of the airlift from the United States on 21 August, the demand for it had decreased by about 75 percent, because of the slackening in combat (94). This had been a temporary situation. Now that the First U.S. Army was up against the Siegfried Line, it was expected that the need for blood would promptly increase again.

Even during slack periods in combat, when supply exceeded demand, care was taken to waste no blood. In December 1944, Colonel Kimbrough proposed, in a memorandum to Colonel Hays, that during such periods, general hospitals, which were required to supply their own blood, be provided with blood from the Paris bank. He had observed that whole blood was accumulat-

ing for field use while at the same time general hospitals were having difficulty setting up blood panels. Colonel Liston, acting for General Hawley, concurred in this recommendation, and it was put into effect. Shortly afterward, the Battle of the Bulge resulted in renewed demands for very large amounts of blood.

Special and unexpected requirements for blood also sometimes arose. Thus, in the spring of 1945, the 182d General Hospital reported an unusual demand for blood, chiefly because of the malnourished condition of many liberated U.S. Army POW's (prisoners of war).

The real need for whole blood for wounded casualties is attested to by the experiences of individual forward hospitals. The 84th Field Hospital is an illustration. It landed on Omaha beach on 14 July 1944, operated for a short time with the First U.S. Army, and then was assigned to the Third U.S. Army. During August, it moved 13 times in support of the 79th Division Clearing Station. After 6 November 1944, it was assigned to the Seventh U.S. Army, in which it operated in support of division troops.

No matter where it was serving, the personnel of this hospital found, month after month, that from 60 to 90 percent of the casualties it received were either in shock or had been in shock within the previous 6 hours. Most of them had received plasma in forward installations, but almost without exception, they also needed large amounts of blood before they could be pronounced ready for operation.

CRITIQUE ON THE USE OF BLOOD ON THE CONTINENT

July-September 1944

In his tour of Army installations on the far shore in September 1944, as the Special Representative on Blood and Plasma Transfusions to The Surgeon General, Colonel Kendrick made the following observations (1):

1. The quantity of protein fluid that can be injected into a casualty over a period of time without undue reactions varies because of individual tolerances. As much as 9 pints of blood and 2-6 pints of plasma can be safely given over a 24-hour period, depending upon the circumstances.
2. A casualty with an organically normal cardiovascular system, who has suddenly become exsanguinated, can presumably tolerate the introduction of 3-4 liters of blood and plasma over a 24-hour period.
3. If casualties who have suffered severe hemorrhage do not respond to the amount of blood and plasma just mentioned, surgical consultation is necessary. Failure to respond may be due to continued hemorrhage or to the results of severe tissue damage, and prompt surgical intervention may be necessary.
4. Observations in field and evacuation hospitals in the First and Third U.S. Armies showed that excessive amounts of blood had sometimes been used. The most important single factor in the picture was the timelag between wounding and the beginning of treat-

ment. Casualties seen fairly early, that is, within 3 hours after wounding, were frequently benefited by blood in relatively large amounts, 8-9 pints given in 2-4 hours. If, however, the casualty was exsanguinated and the timelag had been long, up to 10-12 hours, very little improvement could be expected, even with enormous quantities of blood. Some patients had been given 27 pints in 18-24 hours.

From his observations on the Continent, Colonel Kendrick concluded:

1. From a practical standpoint, it was impossible to set arbitrary standards as to the relative quantities of plasma and blood an individual casualty should receive. The decision must be based upon individual evaluation of the amount of blood loss; the cessation or continuation of hemorrhage; the degree of shock; the blood pressure and pulse rate; the number and severity of the wounds; the timelag; and, most important, the general status of the patient.

2. If surgical consultation was requested when no improvement followed the transfusion of 3-4 pints of blood, tremendous quantities would not be used without adequate justification.

AIRLIFT TO THE EUROPEAN THEATER

The oversea service to ETOUSA from the Zone of Interior began on 21 August 1944 and ended on 10 May 1945. During this period, according to the Army Whole Blood Procurement Service, 201,105 pints of blood were flown across the Atlantic (table 20).

TABLE 20.—Final consolidated report of monthly shipments to ETOUSA, Army Whole Blood Procurement Service, 21 August 1944-10 May 1945

Year and month	New York shipments	Brooklyn shipments	Boston shipments	Washington shipments	Baltimore shipments	Total shipments
<i>1944</i>						
August.....	2,489	-----	-----	1,092	-----	3,581
September.....	8,202	-----	4,561	3,048	-----	15,811
October.....	7,781	828	5,179	3,096	-----	16,884
November.....	9,034	3,548	5,519	4,668	-----	22,769
December.....	9,936	3,734	6,392	4,688	1,540	26,290
<i>1945</i>						
January.....	9,959	4,301	7,219	4,881	2,487	28,847
February.....	9,042	4,241	5,826	3,768	2,388	25,268
March.....	10,994	5,402	6,524	4,999	2,591	30,510
April.....	9,226	4,503	5,282	3,499	1,897	24,407
May.....	2,420	756	1,641	1,237	684	6,738
Total.....	79,083	27,316	48,143	34,976	11,587	201,105

For the week ending 26 August 1944, the first week of the service, 1,627 pints of blood were shipped, a daily average of 271. For the next week, the total shipped was 3,017 pints, a daily average of 503. During the week ending 18 November, 6,150 bottles were shipped, a daily average of 1,025. During 25 days of collections in December, 26,657 pints were shipped, an average of 1,066 bleedings per working day. The highest point in shipments was reached during the week ending 3 March 1945, when 7,230 pints were shipped to the European theater.

By the end of January 1945, the theater was receiving an average of 6,000 pints of blood per week, even though bad flying conditions sometimes forced the Air Transport Command to suspend deliveries for 1 to 3 days at a time. On 24 January 1945, General Hawley wrote General Kirk that the whole blood transfusion setup, from supply to administration to the patient, was "one of the happiest situations" in the theater, and that his (General Kirk's) office had played the dominant role in it.

At this point it is necessary to repeat the statement, made several times previously, that the statistical data in this volume, while as complete and as correct as possible, are not always complete and are sometimes in conflict. In table 20, for instance, which represents the final report of the Army Whole Blood Procurement Service for the entire period of the airlift to Europe, the total number of units of blood shipped is put at 201,105. In the official history of the American Red Cross Blood Donor Service (95), the number is put at 205,907 (p. 101). The explanation of this discrepancy is probably that some of the bloods collected for this purpose were, for one reason or another, not used in the airlift.

In theaters of operations, the circumstances in which blood was given were simply not conducive to accurate recording. The reader, therefore, is cautioned against accepting as numerically accurate all the data presented, though he is entirely safe in accepting as accurate the trends that they represent.

PRODUCTION OF ETOUSA BLOOD BANK

Table 21 is a record of the production of blood by the ETOUSA Blood Bank operated in the United Kingdom first by the 152d Station Hospital and later by the 127th Station Hospital, and operated on the Continent by the 152d Station Hospital (54, 55, 57, 96).

Table 22 is a record of all deliveries of blood to and on the Continent by the ETOUSA Blood Bank and from the Zone of Interior via Prestwick.

TABLE 21.—*Production and distribution of blood, ETOUSA Blood Bank, April 1944–June 1945 (57)*

Year and month	United Kingdom Section ¹ distribution—			Continental Section ² distribution	Total monthly blood bank distribution
	On Continent	In United Kingdom	Total		
<i>1944</i>					
April.....		20	20		20
May.....		1,790	1,790		1,790
June.....	7,650	3,945	11,595		11,595
July.....	11,890	906	12,796		12,796
August.....	13,018	411	13,429		13,429
September.....	5,359	515	5,874		5,874
October.....	8,150	749	8,899		8,899
November.....	7,910	573	8,483	4,178	12,661
December.....	11,550	650	12,200		12,200
<i>1945</i>					
January.....	12,100	709	12,809	3,977	16,786
February.....	9,464	515	9,979	91	10,070
March.....	6,677	1,278	7,955	2,704	10,659
April.....	8,162	1,602	9,764	27	9,791
May.....	1,764	806	2,570	435	3,005
June.....		6	6	1,054	1,060
Total.....	103,694	14,475	118,169	12,466	130,635

¹ Operated by 152d Station Hospital until 1 September 1944, then by 127th Station Hospital.

² Operated by 152d Station Hospital.

USE OF BLOOD IN ARMY INSTALLATIONS

In analyzing the statistical data for the use of blood in the individual armies (tables 23–26) and the combined armies (table 27) on the Continent during the period of combat, a number of points should be borne in mind (96):

1. During the first 3 months after D-day—that is, until almost the end of August 1944—the supply of blood was limited. Sometimes it was extremely limited. A great deal more should have been used than was used, but it was not available. In June 1944, the ratio of blood to wounded in forward installations was 1:3.9, not because that was a desirable ratio but because that was all the blood there was to use. This ratio gradually changed. For the remainder of the war it averaged out at 1:1.5. In February 1945, it became 1:1, and it remained at this level thereafter.

2. There was no regularity or uniformity in the distribution of blood to using units. This was because the amount delivered was always in direct response to the collective demands of the forward hospitals, which were based, in turn, on estimated casualties. If casualties did not materialize as expected, then the amount of blood asked for was excessive. The blood had to be requisitioned, however, if it was thought that it would be needed. It was utilized elsewhere whenever possible, but losses from this cause had to be accepted; they could not be taken into consideration when the amount of blood to be requisitioned was calculated.

TABLE 22.—Delivery of whole blood to using hospital units, ETOUSA, April 1944–June 1945 (96)

Year and month	Communications Zone				U. S. Army Zone						Total
	United Kingdom	Continent		Subtotal	First	Third	Ninth	Seventh	Fifteenth	Subtotal	
		Forward	Rear								
<i>1944</i>											
April.....	20			20							20
May.....	1,790			1,790	6,209					6,209	1,790
June.....	3,945			3,945	13,669					13,669	10,154
July.....	906	262		1,168	4,846	3,604	1,356			9,806	14,837
August.....	411	554		965	4,845	5,643	4,284			15,997	10,771
September.....	1,366	614	34	2,014	6,627	7,866	6,128			21,367	18,011
October.....	749	580	675	2,004	7,348	8,058	8,521			29,363	23,371
November.....	573	2,446	931	3,950	7,945	8,776	3,909			31,868	33,313
December.....	650	4,214	1,262	6,126							37,994
<i>1945</i>											
January.....	709	3,639	1,736	6,084	6,827	12,139	2,628	11,017		32,611	38,695
February.....	515	2,631	1,532	4,678	4,609	10,257	4,292	7,834		26,992	31,670
March.....	1,278	2,886	1,760	5,924	8,908	11,796	4,782	11,205		36,691	42,615
April.....	1,602	475	4,921	6,998	6,393	7,140	6,799	11,729	383	32,444	39,442
May.....	806	26	3,440	4,272	1,175	2,498	2,082	3,188	278	9,221	13,493
June.....	6		617	623							623
Total.....	15,326	18,327	16,908	50,561	79,401	77,777	31,899	76,500	661	266,238	316,799

TABLE 23.—*Ratios of blood delivered to admissions of wounded to forward hospitals, First U.S. Army, June 1944–May 1945 (96)*

Year and month	Admissions	Pints of blood delivered	Ratio of blood to wounded
<i>1944</i>			
June.....	24, 325	6, 209	1:3. 9
July.....	¹ 41, 034	13, 669	1:3
August.....	17, 667	4, 846	1:3. 6
September.....	8, 819	4, 845	1:1. 8
October.....	8, 553	6, 627	1:1. 2
November.....	13, 197	7, 348	1:1. 8
December.....	15, 017	7, 945	1:1. 9
<i>1945</i>			
January.....	11, 961	6, 827	1:1. 7
February.....	6, 537	4, 609	1:1. 4
March.....	12, 367	8, 908	1:1. 4
April.....	9, 581	6, 393	1:1. 5
May.....	196	1, 175	-----
Total.....	169, 254	79, 401	1:2. 1

¹ Statistics for July include Third U.S. Army admissions also.

TABLE 24.—*Ratios of blood delivered to admissions of wounded to forward hospitals, Third U.S. Army, August 1944–May 1945 (96)¹*

Year and month	Admissions	Pints of blood delivered	Ratio of blood to wounded
<i>1944</i>			
August.....	6, 397	3, 604	1:1. 8
September.....	12, 499	5, 643	1:2. 2
October.....	4, 003	7, 866	1. 9:1
November.....	15, 127	8, 058	1:1. 9
December.....	11, 955	8, 776	1:1. 4
<i>1945</i>			
January.....	17, 378	12, 139	1:1. 4
February.....	10, 855	10, 257	1:1
March.....	11, 430	11, 796	1:1
April.....	5, 671	7, 140	1. 4:1
May.....	716	2, 498	-----
Total.....	96, 031	77, 777	1:1. 2

¹ Statistics for July are included in those of First U.S. Army (table 23).

TABLE 25.—*Ratios of blood delivered to admissions of wounded to forward hospitals, Seventh U.S. Army, November 1944–May 1945*

Year and month	Admissions	Pints of blood delivered	Ratio of blood to wounded
<i>1944</i>			
November.....	5,569	8,521	1.5:1
December.....	8,168	11,238	1.4:1
<i>1945</i>			
January.....	8,206	11,017	1.3:1
February.....	4,983	7,834	1.6:1
March.....	7,913	11,205	1.4:1
April.....	8,810	11,729	1.3:1
May.....	438	3,188	-----
Total.....	44,087	64,732	1.4:1

TABLE 26.—*Ratios of blood delivered to admissions of wounded to forward hospitals, Ninth U.S. Army, September 1944–May 1945 (96)*

Year and month	Admissions	Pints of blood delivered	Ratio of blood to wounded
<i>1944</i>			
September.....	2,653	1,225	1:2.2
October.....	1,614	746	1:2.2
November.....	6,625	5,436	1:1.2
December.....	2,728	3,909	1.4:1
<i>1945</i>			
January.....	1,657	2,628	1.6:1
February.....	4,876	4,292	1:1.1
March.....	5,072	4,782	1:1.1
April.....	5,565	6,799	1.2:1
May.....	189	2,082	-----
Total.....	30,979	31,899	1:1

3. The more forward the hospital, the greater was its need for blood. This held not only for hospitals in the army zone but also for hospitals forward in the communications zone (table 22).

4. All armies increased their use of blood as they gained combat experience. Their increased use of transfusion, however, cannot be entirely explained on the ground that blood was increasingly available. The Seventh U.S. Army, which had come from the Mediterranean theater, where a blood bank was in operation, and which had been served by its own blood bank before it came under ETOUSA operational control, consistently used proportionately larger amounts of blood than the other three armies in the European theater.

TABLE 27.—*Ratios of blood delivered to admissions of wounded to forward hospitals, all U.S. Armies, ETOUSA, June 1944–May 1945 (96)*

Year and month	Admissions	Pints of blood delivered	Ratio of blood to wounded
<i>1944</i>			
June.....	24, 325	6, 209	1:3. 9
July.....	41, 034	13, 669	1:3
August.....	24, 064	9, 806	1:2. 8
September.....	23, 971	15, 997	1:2. 3
October.....	14, 170	21, 367	1:1
November.....	40, 518	29, 363	1:1. 4
December.....	37, 868	31, 868	1:1. 2
<i>1945</i>			
January.....	39, 202	32, 611	1:1. 2
February.....	27, 251	26, 992	1:1
March.....	36, 782	36, 691	1:1
April.....	29, 627	32, 444	1. 1:1
May.....	1, 539	9, 221	-----
Total.....	340, 351	266, 238	1:1. 33

The combined figures for the use of blood in all four armies in the European theater (table 27) are more representative of the total use of blood during the period of combat than the reports for individual armies. The ratio for May 1945 has been omitted for all armies, for two reasons. The first is that the cessation of hostilities was not immediately reflected in the discontinuance of shipments of blood from the *Zone of Interior*. The second is that in May, a great deal of blood was used for nonbattle casualties, particularly malnourished RAMP's (recovered Allied military personnel).

It is believed that the combined ratio of 1:1.33 provides a fairly accurate estimate of the demand for blood in all army areas.

Essential Technical Medical Data for the European theater for September 1944 stated that nothing had given forward medical units greater satisfaction than their ability to administer to casualties the whole blood they needed (97). It was hoped that this information would be publicized in the *Zone of Interior*, for, without the blood from that source, the mortality rate would have been much higher and the morbidity much greater.

The same issue contained an analysis of the use of blood in (1) 213 casualties treated in the 13th, 42d, and 47th Field Hospitals for the period 26 July–18 August 1944 and (2) 221 casualties treated in the 2d, 5th, and 97th Evacuation Hospitals for the period 26 July–14 August 1944. All casualties were non-transportable. Not all data are complete for all items, but the analysis is nonetheless very informative.

All the casualties were in shock. In the field hospitals, 57 were in first degree shock, 34 in second degree shock, 31 in third degree shock, and 8 in fourth degree shock. In the evacuation hospitals, the corresponding figures were 28, 41, 41, and 26.

The timelag from wounding to admission averaged 8 hours in 175 patients in field hospitals and 7 hours in 197 patients in evacuation hospitals. The timelag from admission to the hospital to operation averaged 10 hours in 157 patients in field hospitals and 13 hours in 189 patients in evacuation hospitals.

An average of 1.07 pints of plasma had been given in the clearing station to 138 patients received in field hospitals, and an average of 1.3 pints had been given to 131 received in evacuation hospitals. An average of 1.5 pints was given to 197 patients after they reached the field hospital, and an average of 3.5 pints was given to 198 after they reached evacuation hospitals. The total amount of plasma used in field hospitals was thus 302 pints and in evacuation hospitals 715 pints. The total for both clearing stations and hospitals was 451 pints for field hospitals and 892 pints for evacuation hospitals.

An average of 2.34 pints of blood was given to each of the 213 casualties treated in field hospitals and an average of 2.6 pints to each of the 221 treated in evacuation hospitals. The total amount of blood used in field hospitals was 501 pints and in evacuation hospitals 580 pints.

The ratio of plasma to blood was 1.63:1 in field hospitals and 1.34:1 in evacuation hospitals. When the amount of plasma used in clearing stations is included, the final ratio of plasma to blood was 1:1 in field hospitals and 1.53:1 in evacuation hospitals.

There were two reactions to plasma in field hospitals and the same number in evacuation hospitals. For whole blood, the respective figures are 8 and 5.

There were 92 deaths in the 434 casualties, 41 in the 213 treated in field hospitals and 51 in the 221 treated in evacuation hospitals. In all, 184 patients were operated on in the field hospitals and 198 in the evacuation hospitals. Of the 25 casualties who died without operation, 8 died in field hospitals and 17 in evacuation hospitals. Four deaths occurred during operation, three in the field hospitals and one in an evacuation hospital. Of the 63 deaths which occurred after operation, 30 occurred in field hospitals and 33 in evacuation hospitals.

The extremely high mortality rate in evacuation hospitals, closely comparable to that in the field hospitals, is explained by the fact that the evacuation hospitals in this series, contrary to the usual practice, were receiving nontransportable casualties and in effect serving as field hospitals.

LOSSES OF PRESERVED BLOOD

In an operation of such magnitude as furnishing blood for the European theater, conducted on two continents and across an ocean, a certain amount of wastage and loss was inevitable, but in the ETOUSA experience, it was

surprisingly small. One plane crash on 30 November 1944 destroyed 1,146 bottles of blood, but this was practically the only loss of the kind during the whole procedure.

So far as possible, requests for blood from the Zone of Interior were calculated on the basis of anticipated needs, and the calculations, with the adjustment of supply and demand, were remarkably accurate. In September 1944, for instance, shortly after the program had been instituted, daily shipments from the United States were running well ahead of needs, and the program was slowed accordingly. In late October 1944, Colonel Kendrick, then on temporary duty in the European theater, reported that increased quantities of blood would shortly be needed, and the daily requirements were therefore stepped up. In both the United Kingdom bank and the Continental bank, there was also an endeavor to adjust the daily bleedings to the anticipated demand.

While only group O blood was used in combat zones, blood collected that was of other than O type was distributed to selected hospitals, especially those in the United Kingdom. As pointed out elsewhere, whenever this was done, a representative of the blood bank visited the hospital to warn personnel that the blood must be crossmatched before it was used. During the last 6 months of the operation of the blood bank, not a single pint of non-O blood was discarded in the United Kingdom. The demand for odd types of blood never reached significant proportions on the Continent.

In all, about 4,000 pints of outdated blood were used for plasma. About 3,000 pints were discarded because of hemolysis or because the blood was serologically positive. Some blood was also lost because of breakage, and some because of failure of refrigeration.

The total loss of blood in the 316,799 pints which were collected in, or passed through, the ETOUSA Blood Bank was probably in the neighborhood of 15 percent. Because of the short storage period of blood, it is doubtful that any better results could have been expected.

ODD BLOODS

Of the 130,635 pints of blood collected by the United Kingdom Section of the blood bank, 110,878 pints were collected before 1 April 1945 (96). Up to this time, blood was collected only from donors whose identification tags were stamped as type O. In this amount of blood there were 6,607 pints of so-called odd blood; that is, though it was drawn from donors whose identification tags were stamped group O, the blood was of other types. This figure represents an error of 5.96 percent in the original typing of the blood. The error in the blood collected by the Continental Section of the blood bank was substantially the same.

All odd bloods were distributed to local hospitals.

SEROLOGICALLY POSITIVE BLOOD

Serologic tests were positive in 574 pints (0.47 percent) of the blood collected by the United Kingdom Section of the blood bank and in 95 (0.62 percent) of that collected by the Continental Section. Another 57 pints (0.37 percent) were classified as serologically doubtful. All serologically positive blood was discarded.

SUMMARIZED STATISTICAL EXPERIENCES

The experience in the European theater was considered in 1946 to justify the following conclusions in respect to the provision of whole blood in warfare (96):

1. For planning purposes, in the kind of warfare encountered in this theater, the only safe calculation of requirements is the provision of 1 pint of blood for each casualty.

2. This means that a field army in action will require about 500 pints of blood daily.

3. This heavy demand seldom exists for longer than 8 consecutive days. About 400 pints will be needed during the first 24 hours of an operation, about 800 pints between the third and sixth days, and the same amount for the next 2 or 3 days. Then the need will decrease rapidly.

4. In the event of a breakthrough, particularly an armored breakthrough, the demand falls off sharply, to 300 pints a day or less.

5. When infantry attack prepared positions, particularly when they must cross minefields, a large proportion of the wounded, probably about 20 percent, will require transfusion.

6. Whole blood requirements can be supplied only by careful calculations of daily needs. The short storage period of blood precludes the forward movement of large amounts until it is known that they will be needed. To stock all advance blood banks at all times with the maximum amounts likely to be needed could not be tolerated. It would result in tremendous losses, by aging, of a scarce and precious commodity.

Part IX. Special Experiences ³⁰

There were no hospitals in the field, evacuation, or general categories that did not profit from the supply of whole blood for their casualties. This generalization is so valid that when one comes to select unit experiences to use as illustrations, it is extremely difficult to make the choice. For any of the histories related in the following pages, a dozen others could have been selected and would have carried quite as much conviction.

³⁰ The material in this part of the chapter is derived from the 1944-45 reports of the hospitals concerned. All are on file in The Historical Unit, U.S. Army Medical Service, Washington, D.C.

FIELD HOSPITALS

11th Field Hospital

At the 11th Field Hospital, during 1944, 2,532 nontransportable casualties received 8,591,300 cc. of blood in 8,025 transfusions. Almost all of it was furnished by the faithful and consistent operation of mobile blood units. For many casualties, the availability of whole blood made the difference between life and death.

A 24-hour supply of blood was delivered daily, usually between 36 to 48 bottles, with an occasional expansion of the requisition, during periods of stress, to 60 bottles. If the supply of bank blood ran low, fresh blood was drawn from hospital personnel and members of the clearing company. Whenever time permitted, blood was also drawn from these personnel for use in casualties with type A blood.

An intensive study of blood compatibility was made in this hospital, with an investigation of the many variables entering into the production of transfusion kidney and other transfusion reactions. Lower nephron nephrosis appeared in casualties with type A blood more often than in casualties with other types of blood, especially when large quantities of O blood had been given. The reactions occurred in spite of the apparent complete compatibility of the blood used, as shown by microscopic crossmatching.

The age of the blood was not a positive index of the likelihood of transfusion incompatibility. It was generally true that the more recent the blood, the less was the likelihood of a transfusion reaction. At times, however, blood that had been drawn very recently produced highly undesirable effects. On the whole, the degree of hemolysis proved an extremely reliable index and pointed to the way to avoid reactions.

The small number of reactions observed in so many and such massive transfusions was both surprising and gratifying.

56th Field Hospital

Many remarkable instances of recovery after apparently lethal wounds could be attributed to a combination of whole blood and good surgery. A casualty at the 56th Field Hospital illustrates this point. When he was first seen, he was in deep shock from massive loss of blood. He had multiple large lacerated wounds of the lower extremities; multiple fractures of the pelvis; and multiple perforations of the cecum, ileum, and jejunum. He was rapidly resuscitated to the level of operability by multiple simultaneous transfusions of whole blood, after which laparotomy was performed and the intestinal perforations closed. His precarious condition did not permit any surgical procedure on the extremity wounds at this time, and they were simply cleansed by irrigation. The necessary additional surgery was done several days later.

This man's recovery was entirely uneventful, and he was in excellent condition when he was evacuated to a general hospital. Without the blood that rapidly prepared him for operation, he, and many others like him, would surely have died.

77th Field Hospital

The experience of the 77th Field Hospital is an interesting example of the value of plasma in protein depletion as compared with its limited value in freshly wounded casualties.

This hospital arrived in France on 25 March 1945 and shortly afterward began to receive RAMP's. It was immediately evident that malnutrition of all grades of severity, complicated by many types of infection, was to be the principal therapeutic problem.

Because of the limited facilities of a field hospital laboratory, it was not possible to study the blood protein and blood chloride levels in the first patients received. Most of

them were in serious condition, and many were critically ill. They were severely malnourished, dehydrated, and emaciated, and were suffering from anorexia, nausea, vomiting, and diarrhea. Their low blood pressure, rapid pulse and respiration, and other signs suggested surgical shock.

The assumption was that they were suffering from a depletion of blood protein and chlorides, and they were therefore treated with plasma and with glucose in physiologic salt solution, which, it was soon learned, must be given slowly and in small amounts. Before this was realized, five patients developed pulmonary edema during infusions or immediately after the fluid had been injected. Once the clinical condition had improved, the infusions could be given in larger amounts.

The results of plasma infusions in severe malnutrition were generally excellent. Plasma was also used successfully in a few instances of severe nonbacterial diarrhea and in a few instances of nutritional edema.

In all, 173 RAMP's were treated with plasma at the 77th Field Hospital, in units of 300 cc. The average amount given was 2.15 units. The smallest amount, 200 cc., was given to a patient who went into cardiac failure after receiving this quantity by a very slow infusion. The largest amount, 1,114 units, was given to a severely malnourished patient who had been vomiting for 3 days and who had had nonbacterial diarrhea for 80 days when he was received. There were no deaths among these RAMP's.

GENERAL HOSPITALS

43d General Hospital

When the 43d General Hospital was permanently reorganized in August 1944, as a 1,500-bed hospital, a blood bank was set up in it.

Function and equipment.—The hospital laboratory had complete responsibility for all activity pertaining to blood transfusion except the care and preparation of recipient sets, which was the responsibility of the central supply service, and the actual administration of blood, which was a function of ward medical personnel. The laboratory, however, acted in a supervisory and advisory capacity in respect to both these activities, in an endeavor to control the incidence of pyrogenic reactions.

The bank was housed in a separate room, 7.5 by 18 feet, which was near the laboratory and which was arranged specifically for blood bank functions. There were facilities for bleeding two donors at the same time, for storage of donor sets and other equipment, for refrigeration, and for the handling of records.

There were two built-in bleeding tables, each 13 feet long and wide enough to accommodate regulation operating table pads and still leave free space for the donor's extended arm and the collection bottle. The pads were covered with easily cleaned rubber sheeting. A cot was available in the corridor outside for fainting donors; it was not needed very often.

Two single-compartment kerosene refrigerators were used; one did not prove adequate. They gave reliable service but required a great deal of careful attention. Losses by hemolysis emphasized the importance of constant refrigeration; 56 percent of the loss from this cause at the 43d General Hospital occurred in September 1944, from power failure. At this time, the electric

refrigerator used for storage was powered by French current, which was not reliable.

By 1 January 1945, 70 donor sets were in use. This number was large enough to permit some sets to be out of use for minor repairs, and also to allow for possible failure of sterilization facilities for 24 hours. Standard bottles containing citrate solution were used to collect blood.

Personnel.—Personnel of the blood bank, in addition to medical officer personnel, consisted of a private, first class, and two technicians, fourth grade, who were assigned solely to the bank; another technician, fourth grade, who had other duties in addition to his blood bank duties; specialized assistants from the hematology and serology departments; and a German POW, who assisted in washing glassware and sterilizing equipment. The three men assigned full time to the bank had complete charge of the procurement of donors; the collection and care of blood; maintenance of equipment; and, during their duty hours, the issuance of blood to the wards.

Bank routine.—Blood was drawn each day in anticipation of immediate demands. The estimates were based upon the amount of blood used during the preceding 48 hours and the number of low hematocrits reported by the laboratory for the preceding 24 hours.

Arrangements were made each afternoon for the number of donors required, according to blood groups, for the following day. They were secured from hospital personnel, army personnel in the staging area, and the POW enclosure. Donors from outside the hospital were transported to the laboratory in charge of one of the bank personnel.

Donors were selected according to the blood groups listed on their identification tags, but each blood was retyped. A Kahn test was also run on each unit collected, and a thick smear was examined for malaria. Because of difficulty in anticipating demands for blood groups AB and B, it was occasionally necessary to use O blood for patients in these blood groups. In such cases, in addition to routine crossmatching, recipient cells were crossed with donor serum diluted 1:40, to eliminate the risk of a reaction caused by high-titer group O blood.

All crossmatching and typing, except emergency nightwork, were done by the same technician. All crossmatchings were checked by a medical officer in the laboratory before the results were accepted. The Landsteiner or test tube method was used exclusively for crossmatching. This technique minimizes the occurrence of rouleaux formation and can be read immediately after centrifuging, which gives it an advantage over other techniques, all of which require at least a 30-minute wait. It was also considered more accurate than any other method.

A ledger was kept in which were recorded the accession number of the donation, the donor's name and organization, the date of bleeding, and the results of the laboratory tests. After the blood had been used, entries made opposite the flask number included the name of the recipient; the ward; the date of the transfusion; and, if a reaction had occurred, information about it.

Blood was requisitioned on the ward by duplicate slips. The prospective recipient's blood was crossmatched with the vial of uncitrated blood tied to the flask selected for him. If the bloods were found compatible, the flask number was entered on the patient's requisition. One slip was returned to the ward, and the duplicate slip was placed in the bank file.

When the ward was ready for the blood, the slip which had been sent back to it was brought to the bank and the appropriate flask of blood was issued. The date and hour the blood left the bank were entered on the backs of both the ward slip and the file slip. The slip brought from the ward was returned to the ward and placed on the patient's chart. The duplicate slip was placed in the used file of the blood bank. These ward slips were collected from the wards every morning by bank personnel.

The slips used to requisition the blood also had space to note data concerning reactions. If a reaction occurred, pertinent information regarding its type and severity was noted on the ward slip. This system insured that every reaction was reported and could be analyzed by the laboratory. Hemolytic reactions were differentiated from pyrogenic reactions by examination of the post-reaction urine for hemoglobin and urobilinogen. Recipient and donor bloods were also retyped and recrossmatched, to eliminate any possibility of error in the original reports.

When the type of reaction was definitely determined, the information was placed on the back of the file slip, which was then placed in the permanent file. In cases in which no reactions had occurred, duplicate slips were discarded at the end of a month.

Statistical data.—Of the 2,206 units of blood collected at the 43d General Hospital between 25 September and 31 December 1944, 1,029 came from U.S. personnel and 1,127 from German prisoners. All donations were voluntary, and all requests for donors were filled with complete cooperation on the part of both the donors and the officers in command of the organizations from which the blood was secured. U.S. Army personnel were furnished clean towels and bathing facilities and given hot food at the mess, but no whisky. German prisoners were given an extra meal.

Of the 2,206 units of blood collected during 1944, 1,931 had been used for transfusions by 31 December 1944. During November and December, an average of 3 pints of blood was given to each patient transfused. The largest amount given to any single patient was 15 units.

In all, 193 units (8.7 percent) were discarded. Of these, 97 units were discarded because of overaging, 69 because of hemolysis, and the remainder for various other reasons, chiefly positive serology.

There were 126 reactions in the 1,931 transfusions given, 6.5 percent, 110 pyrogenic and the remainder allergic. Of the 110 pyrogenic reactions, 50 occurred during a single week in November. They were traced to the following faults:

1. Failure of ward personnel to dismantle the giving sets and wash them thoroughly in tap water immediately after transfusions were completed.

2. Failure to prepare new rubber tubing for use by boiling it in sodium bicarbonate and rinsing it until the fluid returned clear.

3. Failure to inspect the sets adequately before they were reassembled for sterilization.

4. Failure to rinse them finally in pyrogen-free distilled water or physiologic salt solution.

When these errors, all of human origin, were corrected, the incidence of reactions at the 43d General Hospital returned to its normal low level.

227th General Hospital

The 227th General Hospital reached the Continent on 30 March 1945. It acted as an intermediate depot for the distribution of blood received from the ETOUSA Blood Bank and intended for use in the hospitals of the 813th Hospital Center. There was a heavy demand for blood at this time, but there were ample supplies to meet it. In all, 1,524 bottles were dispensed between 10 April and 1 June, when the bank closed down. Thereafter, blood was secured from officers and enlisted men in the hospital. Donations were generous, but the ample supply of blood previously available had made procurement seem simple, and local donors were rapidly used up. With the fine cooperation of radio stations at Marseille, Nice, and Cannes, as well as other publicity, a panel of donors was secured which met the hospital needs.

The hospital laboratory insisted upon complete control of the bank blood from the moment it was received from the Paris bank until it was dispensed. Refrigeration was regularly checked, day and night, every 2 hours. Electric refrigeration was more desirable than kerosene refrigeration, which had to be watched with particular care, but it was not always available. French current was not dependable, and two small electric refrigerators were secured and supplied with current from one of the hospital generators. Refrigeration problems became minimal after the Paris bank began to send blood in the expendable insulated boxes in which it was received from the Zone of Interior. A commercial source of ice was then utilized, and the boxes were re-iced daily.

This hospital had one constant difficulty to combat, the production of distilled water. Fluctuations in water pressure, the extreme hardness of the water, the inadequacy of French electrical current, and the vulnerability of the stills taxed the best efforts of electricians, plumbers, maintenance men, and laboratory personnel. Their success, however, is attested by the fact that the 227th General Hospital supplied distilled water for several other hospitals in the vicinity in addition to providing for its own needs.

298th General Hospital

The experience of the 298th General Hospital, in general, paralleled that of most other general hospitals, with one exception: On 22 January 1945, when a bottle of blood from the ETOUSA Blood Bank was being crossmatched for a

patient with a spinal cord injury, the donor flask was found to bear the name of Supreme Allied Commander Dwight D. Eisenhower. The *Stars and Stripes*, which reported the incident, said that the general had hoped, when he made the donation, that the disposition of the patient who might receive his blood would be better than his own. After he had received the 500-cc. transfusion, said the article, the patient was in good condition, and his disposition was excellent.

Part X. Statement of the Theater General Board

CONTENTS

The definitive statement on the whole blood service in the European theater is contained in the report of the General Board, U.S. Forces, European theater,³¹ set up by General Orders No. 128, issued on 17 June 1945, to prepare a factual analysis of the strategy, tactics, and administration employed by the U.S. Armed Forces in this theater. The following points were covered (98):

1. The importance of whole blood in the care of the wounded.
2. The organization of the whole blood service in the theater in the United Kingdom and on the Continent.
3. The operation of blood banks in base sections.
4. The distribution of whole blood on the Continent.
5. The determination of requirements of whole blood for continental operations.

It was the conclusion of the General Board that the provisional organization for the supply of whole blood in the European theater was "eminently successful."

RECOMMENDATIONS

The Board made the following recommendations for future operations:

1. That a T/O&E be authorized for an organization similar to the provisional base blood bank for the purpose of collecting and processing whole blood.
2. That whole blood be handled by medical depots operating in the forward communications zone areas and the Army area, since there is no justification for the distribution of whole blood through other than normal medical supply channels. The type of personnel and equipment employed in the European theater by advance blood banks should be incorporated into the T/O&E of medical depot companies.
3. That a ratio of 1 pint of blood for each anticipated wounded admission be used for planning purposes.

COMMENT

Recommendation No. 2 is difficult for a clinician to accept (this board had no clinicians on it). It seems based on a complete failure to grasp the funda-

³¹ This study was prepared by Col. L. Holmes Ginn, Jr., MC, Chief, Medical Section, Chairman; Maj. Joseph J. Strnad, MAC, Deputy Chairman; and 1st Lt. John F. Ward, MAC. Special consultants were Colonel Hays, Col; Robert H. Barr, MC, Surgeon, VII Corps; Lt. Col. Harry S. Green, MAC, Commanding Officer, 13th Medical Depot and Capt. William M. Hamilton, MAC, Medical Supply Officer, Third U.S. Army.

mental fact that blood is a perishable as well as a precious substance and that for both those reasons it must not be handled in normal medical supply channels. One need refer only to a single experience in the Philippines (p. 605) in which blood was thus handled (that is, in normal medical channels) to realize the unwisdom of this recommendation. Had it been in effect in the European theater, it is highly doubtful that the whole blood program would have been as successful as the General Board concluded that it was. In fact, if there was a single conviction rooted in the minds of those who directed the whole blood program, it was that blood is a substance which requires special handling from the moment it is drawn until the moment it is administered.

In the European theater, Medical Supply provided storage facilities and transportation, but the real responsibility for handling this perishable item, which could be lethal without proper supervision, belonged to the transfusion service, which operated under the overall direction of the theater blood bank. It is unfortunate that the same policy was not employed in the Korean War (p. 752).

References

1. Informal Routing Slip, Lt. Col. D. B. Kendrick, MC, to Chief Surgeon, ETOUSA, 26 Sept. 1944, subject: Report of Trip to First U.S. Army Medical Installations.
2. Memorandum, Lt. Col. D. B. Kendrick, MC, for Col. B. N. Carter, MC, 5 Oct. 1943, subject: Transfusion of Whole Blood in the Theaters of Operations.
3. Circular Letter No. 108, Office of The Surgeon General, U.S. Army, 27 May 1943, subject: Transfusion of Whole Blood in the Theaters of Operations.
4. Memorandum, Lt. Col. D. B. Kendrick, MC, for Brig. Gen. Fred W. Rankin, 3 Nov. 1943, subject: Transfusion of Whole Blood in the Theaters of Operations.
5. Memorandum, Brig. Gen. Fred W. Rankin for The Surgeon General, 6 Nov. 1943, subject: Transfusion of Whole Blood in the Theaters of Operations.
6. Minutes, meeting of Subcommittee on Blood Substitutes, Division of Medical Sciences, NRC, 17 Nov. 1943.
7. Memorandum, Brig. Gen. Fred W. Rankin for The Surgeon General, 13 Nov. 1943, subject: Transfusion of Whole Blood in the Theaters of Operations.
8. Memorandum for the Record, Col. B. N. Carter, MC, 16 Dec. 1943, subject: Meeting With The Surgeon General and With General Lull on the Subject of Whole Blood Transfusions in Theaters of Operations.
9. Memorandum, Lt. Col. D. B. Kendrick, MC, for The Surgeon General, 17 Apr. 1944, subject: Transfusion of Whole Blood in the Theaters of Operations.
10. Memorandum, Brig. Gen. F. W. Rankin, MC, for The Surgeon General, 21 Apr. 1944, subject: Transfusion of Whole Blood in the Theaters of Operations.
11. Minutes, meeting of Committee on Transfusions, Division of Medical Sciences, NRC, 31 May 1940.
12. Minutes, meeting of Subcommittee on Blood Substitutes, Division of Medical Sciences, NRC, 9 Apr. 1943.
13. Minutes, meeting of Subcommittee on Blood Substitutes, Division of Medical Sciences, NRC, 24 Sept. 1943.
14. Annual Report, Activities of the Transfusion Branch, Surgery Division, OTSG, fiscal year 1944.
15. Memorandum, Capt. R. C. Hardin, MC, to Chief Consulting Surgeon, Office of Chief Surgeon, ETOUSA, 26 Mar. 1943, subject: Transfusion Arrangements in U.S. Hospitals.

16. Memorandum, Maj. W. A. H. Jaycott, RAMC, for Assistant Surgeon, Office of Chief Surgeon, ETOUSA, 8 June 1943, subject: Supplies of Plasma.
17. Informal Routing Slip, Col. E. C. Cutler, MC, to Col. J. C. Kimbrough, MC, 30 Dec. 1943, subject: Blood Transfusion Service.
18. Informal Routing Slip, Col. J. B. Mason, MC, for the Chief Surgeon, ETOUSA, 6 Jan. 1944, subject: Director of Whole Blood Service.
19. Circular Letter No. 51, Office of the Chief Surgeon, Headquarters, ETOUSA, 5 Apr. 1943, subject: Arrangements for Blood Banks and Transfusion in U.S. Army Hospitals.
20. Memorandum, Capt. R. C. Hardin, MC, to Col. E. C. Cutler, MC, 9 June 1943, subject: Provision for Procurement of Whole Blood for Transfusion in General Hospitals in the ETO.
21. Emerson, Maj. C. P., MC, and Ebert, Maj. R. V., MC: Operation of a Hospital Blood Bank. M. Bull. No. 14, Office of the Chief Surgeon, Headquarters, ETOUSA, 1 Jan. 1944, pp. 7-15.
22. Letter, Lt. Col. W. S. Middleton, MC, to Dr. P. L. Mollison, 29 Jan. 1943, subject: Conference.
23. Cutler, E. C.: The Chief Consultant in Surgery. *In* Medical Department, United States Army. Surgery in World War II. Activities of Surgical Consultants, Volume II. Washington: U.S. Government Printing Office, 1964.
24. Memorandum, Col. E. C. Cutler, MC, to Brig. Gen. P. R. Hawley, through Col. J. C. Kimbrough, MC, 10 May 1945, subject: The Use and Procurement of Blood and Plasma for the ETO.
25. Memorandum, Capt. R. C. Hardin, MC, to Col. E. C. Cutler, MC, 5 June 1943, subject: A Plan for the Procurement and Delivery of Whole Blood for a Continental Task Force from the USA or UK.
26. Memorandum for the Record, Col. E. C. Cutler, MC, 29 Aug. 1943, subject: Project: Preliminary Studies for the Procurement, Storage and Supply of Whole Blood to an ETO Combat Army.
27. Memorandum for the Record, Col. E. C. Cutler, MC, 13 Nov. 1943, subject: Blood Procurement ETO.
28. Informal Routing Slip, Col. E. C. Cutler, MC, to Chief, Operations Division, Office of Chief Surgeon, ETOUSA, 13 Nov. 1943, subject: Whole Blood.
29. Informal Routing Slip, Col. J. B. Mason, MC, to Professional Services Division, Office of Chief Surgeon, ETOUSA, 18 Nov. 1943, subject: Whole Blood.
30. Informal Routing Slip, Brig. Gen. P. R. Hawley, for Commanding General, SOS, ETOUSA, 26 Nov. 1943, subject: Provision of Whole Blood for Battle Casualties.
31. Administrative and Logistical History of the Medical Service, Communications Zone, European Theater of Operations, vol. 7, appendix 10. [Official record.]
32. Memorandum, Lt. Col. R. P. Fisk, Adjutant General's Department, to Commanding General, 1st Army Group, 2 Jan. 1944, subject: Provision of Whole Blood for the Medical Service.
33. Memorandum, Maj. R. C. Hardin, MC, to Operations Division, Office of Chief Surgeon, ETOUSA, 17 Apr. 1944, subject: Expansion of ETO Blood Bank.
34. Official Diary, ETOUSA Blood Bank, 1944-45.
35. Memorandum for the Record, Col. E. C. Cutler, MC, and Maj. R. C. Hardin, MC, 1 Aug. 1944, subject: Whole Blood from USA.
36. Informal Routing Slip, Col. J. C. Kimbrough, MC, to Chief Surgeon, ETOUSA, 6 Apr. 1944, subject: Whole Blood Transfusion.
37. Fifth U.S. Army Medical Service History, 1944.
38. Fifth U.S. Army Medical Service History, 1945.
39. Memorandum, Maj. Gen. P. R. Hawley for Professional Services Division, Office of Chief Surgeon, ETOUSA, 28 Mar. 1944, subject: Blood Supply, and 2d and 3d indorsements thereto.

40. Operating Procedure, The Whole Blood Service, ETOUSA, Office of the Chief Surgeon, Operations Division, 1944.
41. Informal Routing Slip, Col. E. C. Cutler, MC, to Chief, Professional Services Division, Office of Chief Surgeon, ETOUSA, 2 July 1944, subject: Blood.
42. Informal Routing Slip, Col. J. C. Kimbrough, MC, to Chief Surgeon, ETOUSA, 12 July 1944, subject: Whole Blood for Transfusion from the ZI.
43. Informal Routing Slip, Lt. Col. R. M. Zollinger, MC, to Surgeon, Forward Echelon, Headquarters, Communications Zone, 28 July 1944, subject: Evaluation of the Requirements for Whole Blood in Army Hospitals.
44. Informal Routing Slip, Col. J. C. Kimbrough, MC, to Chief Surgeon, ETOUSA, 31 July 1944, subject: Whole Blood Requirements.
45. Informal Routing Slip, Col. J. H. McNinch, MC, to Personnel Division, Office of Chief Surgeon, ETOUSA, 21 July 1944, subject: Return of Colonel E. C. Cutler, MC, Colonel William F. MacFee, MC, and Major Robert C. Hardin, MC, to States.
46. Informal Routing Slip, Col. H. W. Doan, MC, to G-4, 4 Aug. 1944, subject: Request for Orders.
47. Radiogram, CG, U.S. Army, SOS in the British Isles, London, England, to War Department, C 84252, 2 Aug. 1944, subject: Request for Blood from Zone of Interior.
48. Letter, Maj. Gen. P. R. Hawley to Maj. Gen. N. T. Kirk, 5 Aug. 1944, subject: Request for Whole Blood from Zone of Interior.
49. Letter, Maj. Gen. N. T. Kirk to Maj. Gen. P. R. Hawley, 11 Aug. 1944, subject: Whole Blood from Zone of Interior.
50. Radiogram, from AGWAR, from Kirk, signed Somervell for Hawley to Headquarters, Communications Zone, 79474SOSMC, C 84252, 13 Aug. 1944, subject: Whole Blood from Zone of Interior.
51. Memorandum, Brig. Gen. F. W. Rankin, for The Surgeon General, 3 Aug. 1944, subject: Provisions for Supplying Whole Blood to ETO from U.S.A.
52. Memorandum, Lt. Col. Douglas B. Kendrick, MC, for Brig. Gen. F. W. Rankin, 14 Aug. 1944, subject: Plan for Supplying Blood to ETO.
53. Memorandum, Lt. Col. D. B. Kendrick, MC, for Brig. Gen. F. W. Rankin, 23 Aug. 1944, subject: Conference on Supply of Whole Blood for the ETO.
54. Annual Report, 152d Station Hospital, 1944 (ETO Blood Bank), 30 Jan. 1945.
55. Period Report, 152d Station Hospital (ETO Blood Bank), to The Surgeon General, 1 Jan.-30 June 1945, dated 30 June 1945.
56. Annual Report, 127th Station Hospital (ETO Blood Bank U.K.), 1944, 19 Jan. 1945.
57. Annual Report, Transfusion and Shock, from Maj. R. C. Hardin, MC, to Chief Consultant in Surgery, Office of the Chief Surgeon, ETOUSA, 11 Jan. 1944.
58. Mason, J. B.: Planning for the ETO Blood Bank. Mil. Surgeon 102: 460-467, June 1948.
59. Mason, J. B.: The Role of ADSEC in the Supply of Whole Blood to the Twelfth Army Group. Mil. Surgeon 103: 9-14, July 1948.
60. Report, Conference on the Operations of the Blood Bank held at 1st Medical Laboratory, 5 Apr. 1944.
61. Memorandum, Col. H. W. Doan, MC, to Surgeons, Twelfth Army Group; Third, First, and Ninth U.S. Armies, ADSEC, Com Z; Base Sections (Continent), 30 Oct. 1944, subject: Supply of Whole Blood.
62. Letter, Lt. Col. A. Vickoren, MC, to Commanding Officer, 1st Medical General Laboratory, 21 Mar. 1944, subject: Preparation of SOP for ETOUSA Whole Blood Service.
63. Administrative and Logistical History of the Medical Service, Communications Zone, European Theater of Operations, vol. 7. [Official record.]
64. Shainmark, A. C.: The Supply of Whole Blood to Forward Mobile Medical Field Units of the Ninth U.S. Army. Mil. Surgeon 103: 14-16, July 1948.

65. Informal Routing Slip, Col. E. C. Cutler, MC, to Deputy Chief Surgeon, 24 Oct. 1943; Col. J. C. Kimbrough, MC, to Deputy Chief Surgeon, 25 Oct. 1943; Brig. Gen. P. R. Hawley to Deputy Chief Surgeon, n.d.; and Col. E. C. Cutler, MC, to Chief Surgeon, 31 Oct. 1943, subject: Donations of Blood by U.S. Troops to British Transfusion Service; Harmlessness of Blood Donations.
66. Letter, Brig. Gen. P. R. Hawley, to Commanding General, SOS, ETOUSA, November 1943, subject: The Establishment of the Blood Panel, ETOUSA.
67. Letter, Maj. Gen. J. C. H. Lee, to Commanders, Channel Base Section, Eastern Base Section, Western Base Section, and Southern Base Section, 15 Dec. 1943, subject: Volunteer Donations of Blood.
68. Letter, Maj. Gen. J. C. H. Lee, to SOS, 15 Dec. 1943, subject: Volunteer Donations of Blood.
69. Letter, Brig. Gen. R. B. Lovett, to Base Sections Commanders, SOS, ETOUSA, and Headquarters Commandant, ETOUSA, 6 Apr. 1944, subject: Provision of Whole Blood for the Medical Service.
70. Letter, Col. H. W. Doan, MC, to Sir Francis R. Fraser, 1 Feb. 1944, subject: Donations by U.S. Troops to British Transfusion Service.
71. Memorandum, Lt. Col. Thurman Shuller, MC, to Surgeon, 8th Air Force, 5 May 1944, subject: Blood Donors for the British Red Cross, and 3d indorsement thereto.
72. 2d Indorsement, Col. J. C. Kimbrough, MC, 6 Sept. 1944, to basic letter, 26 Aug. 1944, subject: Use of Prisoners of War as Blood Donors.
73. Medical Department, United States Army. Medical Supply in World War II. [In preparation.]
74. Memorandum, Col. J. B. Mason, MC, to the Chief Surgeon, ETOUSA, 4 Nov. 1943, subject: Delivery of Whole Blood to Continent, ETOUSA.
75. Conference, Whole Blood Service, ETOUSA, 22 Dec. 1943.
76. Memorandum, Lt. Col. C. B. Meador, MC, to Planning Branch, Office of Chief Surgeon, ETOUSA, 10 Apr. 1944, subject: Shipment of Medical Supplies by Air Transport.
77. Administrative and Logistical History of the Medical Service, Communications Zone, European Theater of Operations, vol. 6. [Official record.]
78. Letter, Lt. Col. L. H. Beers, MAC, to G-4, Supply Requirements Division, Headquarters, Com Z (Forward), 1 Sept. 1944, subject: Diversion of Air Planes Carrying Blood.
79. Informal Routing Slip, Col. S. B. Hays, MC, to G-4, Headquarters, ETOUSA, 22 Sept. 1944, subject: Request for Future Shipments of Blood to Paris.
80. Letter, Col. W. L. Perry, MC, to The Adjutant General, Washington, D.C., 25 Sept. 1943, subject: Project: Whole Blood Service for ETOUSA.
81. Informal Routing Slip, Lt. Col. Robert M. Zollinger, MC, to Medical Supply Division, attention: Col. W. L. Perry, MC, 20 Feb. 1944, subject: Medical Supplies for Field Transfusion Kit.
82. Memorandum, Lt. Col. Robert M. Zollinger, MC, to Surgeon, First U.S. Army, 17 Feb. 1944, subject: Concerning Distribution of Field Transfusion Units.
83. Memorandum, Lt. Col. Robert M. Zollinger, MC, to Col. E. C. Cutler, MC, 5 Nov. 1943, subject: Transfusion Units.
84. Memorandum, Lt. Col. Robert M. Zollinger, MC, to Medical Supply Division, 13 Jan. 1944, subject: Blood Transfusion Set (Sterile, Expendable).
85. Informal Routing Slip, Lt. Col. Robert M. Zollinger, MC, to Plans and Training Division, attention: Lt. Col. A. Vickoren, MC, 13 Mar. 1944, subject: Concerning Field Transfusion Units.
86. Administrative and Logistical History of the Medical Service, Communications Zone, European Theater of Operations, vol. 9. [Official record.]
87. Memorandum, Maj. Gen. P. R. Hawley, to Commanding Officer, 1st Medical Laboratory, 1 May 1944, subject: Violation of Security.
88. Letter, Maj. Gen. P. R. Hawley, to Col. J. A. Rogers, MC, 19 July 1944.
89. Letter, Maj. J. J. McGraw, Jr., MC, to Maj. R. C. Hardin, MC, 8 Jan. 1945.

90. Memorandum, Capt. John Elliott, SnC, to Chief, Surgical Consultants Division, Office of The Surgeon General, through Director, Army Medical School, 1 Feb. 1945, subject: Transportation of Blood from the U.S. to the ETO Blood Bank in Paris.

91. ETMD, ETOUSA, for December 1944.

92. ETMD, ETOUSA, for June 1944.

93. ETMD, ETOUSA, for October 1944.

94. Letter, Maj. Gen. P. R. Hawley, to The Surgeon General, 14 Sept. 1944, subject: Whole Blood.

95. Robinson, G. C.: American Red Cross Blood Donor Service During World War II. Its Organization and Operation. Washington: The American Red Cross, 1 July 1946.

96. Kendrick, Col. D. B.: History of Blood and Plasma Program, United States Army, During World War II, 1 Aug. 1952.

97. ETMD, ETOUSA, for September 1944.

98. The General Board, United States Forces, European Theater: Study Number 93, Medical Supply in the European Theater of Operations. Chapter 5, Whole Blood Service.

CHAPTER XVII

The Pacific Areas and the China-Burma-India Theater

THE NEW SOUTH WALES RED CROSS BLOOD TRANSFUSION SERVICE

Organization and Techniques

Since the first—and, for a time, the only—general supply of whole blood for U.S. Forces fighting in the Southwest Pacific came from the Red Cross blood bank in New South Wales, Australia, it is appropriate to begin this chapter on the Pacific areas with a brief note on its organization and techniques (1, 2).

The Australian blood service was instituted after a study of methods of blood storage, which resulted in:

1. The selection of the dihydric sodium citrate-glucose solution recommended by the Medical Research Council of Great Britain.
2. The development of a heavily insulated wooden box suitable for transporting blood by air.

The blood of two donors (430 cc. each) was collected into a single 1,000-cc. Soluvac bottle containing 200 cc. of 3-percent dihydric sodium citrate solution and 40 cc. of 15-percent glucose solution. Only group O donors were used. The technician who drew the blood prepared himself by an extremely rigid aseptic technique and repeated the preparation before the second blood was collected. Processing included grouping, crossmatching, the Kline test, and sterility tests.

As soon as the blood was drawn, it was placed in an electric icebox for 2 hours. It was then moved to the insulated box just mentioned. This box held ten 1,000-cc. flasks, and the 56 pounds of ice which it contained was enough to keep the blood between 40° and 46° F. (4.5° and 8° C.) for 48 hours; if the box was not exposed to the sun, the blood remained chilled for as long as 5 days. The ice was placed in the box at least 4 hours before the blood was to be dispatched, and, just before the blood was packed, it was removed, crushed into fine pieces, and replaced. Each box weighed 210 pounds packed and occupied 4.2 cu. ft. of space.

The expiration date of the blood was arbitrarily set at 10 days from the date of collection. Blood considerably older was used in emergencies, with no report of ill effects, but the practice was not considered desirable; it was fully realized that the older the blood, the more advanced the cellular destruction and the biochemical changes, and the greater the risk of infection. Con-

tamination was never a factor, and no reactions attributable to O blood per se were recorded. In fact, thanks to the detailed preliminary planning, there were very few difficulties of any kind when the transfusion service began active operation. Blood not used for transfusion was converted to serum (1), and the wastage factor was therefore kept very low. Rh-negative blood was supplied for Rh-negative casualties.

Distribution

The first box of blood for use by Australian troops was flown from Australia to New Guinea in December 1942. Thereafter, blood was continuously dispatched to forward battle areas. After August 1943, it was also supplied to civilian hospitals and to private physicians in the Sydney metropolitan area.

When the lines of communication became too long for supplies of blood to be flown directly to the battle areas, a relay station was set up in an advanced base (Finschhafen), where the blood was inspected, repacked, and then shipped forward. This unit was also equipped to bleed service troops in the area.

Up to 1 December 1944, about 7,000 liters of blood had been flown from Sydney and Brisbane to combat operational areas.

PLANNING FOR LOCAL SUPPLIES OF BLOOD

The small supply of plasma available at Pearl Harbor (p. 338) was soon augmented by large quantities, and there were practically no shortages of this item during the course of the war. Its portability, ease of administration, and the apparatus supplied with it made plasma an ideal agent in the circumstances of Pacific fighting (figs. 127-131). Nonetheless, from the beginning of the war, some medical officers in the Pacific recognized that there was no substitute for whole blood. The transfusion service in this area had its inception in this concept. In many instances in which plasma was used, it was employed because whole blood was not immediately available, and time could not be lost finding a compatible donor, making the necessary tests, and drawing the blood.

First Proposals

The first proposal for a supply of whole blood procured locally in the Pacific came on 8 February 1943, when Col. Frederick H. Petters, MC, Surgeon, Base Section No. 3, Brisbane, Australia, asked the commanding officers of the 105th and 42d General Hospitals their opinion of the feasibility of establishing a blood bank with donations from nonmalarious troops in the area (3). Blood would be collected in 500-cc. amounts on a continuous daily basis and shipped by plane to advanced bases. The supply of donors in the base was exhausted. The number of troops who could give blood had been depleted by loss of weight and possible malarial infection, and those available were being bled for a second time. It might be possible to identify a group of



FIGURE 127.—Preparation of plasma for administration to incoming casualties, 43d Division Hospital, Rendova, July 1943.

nonmalarious donors, test them serologically, draw and package their blood, and forward it by plane, by the system the Australians had used so successfully.

Replies from Col. Maurice C. Pincoffs, MC, Commanding Officer, 42d General Hospital (4), and Col. Raymond O. Dart, MC, Commanding Officer, 105th General Hospital (5), stated that it would be perfectly feasible to ship blood to advanced bases by the plan proposed, but both specified that the entire procedure should be made the responsibility of personnel trained in the handling of blood at the base and at advanced bases. Either jointly or singly, Colonel Pincoffs and Colonel Dart also made the following points:

1. Some means of prompt communication should be arranged between the officers in charge of blood at the base and at advanced bases, so that the collection of blood could fluctuate with the needs in the forward area.

2. Only group O and group A blood should be used, and collecting flasks should be provided in the ratio of 60:40. Eighty-five percent of recipients would thus receive homologous blood.



FIGURE 128.—Administration of plasma to wounded infantryman, Leyte, Philippine Islands, October 1944.

3. Australian techniques should be investigated. If blood were collected in discarded 1,000-cc. intravenous flasks, the amounts from two donors could be combined and would provide enough for a single exsanguinated casualty; it was assumed that plasma would remain the intravenous fluid of choice, whole blood being given only in circumstances of extreme urgency. Specifications for marking the blood, maintenance of sterility, and other precautions were emphasized.

4. The blood should be refrigerated from collection to administration; in these circumstances, a dating period of 5 days would be considered safe.

5. Donors should be grouped, tested serologically, and examined physically before the blood was drawn, preferably before breakfast, to avoid foreign protein reactions.

Colonel Pineoffs did not believe that a system of volunteer donors would stand up under heavy demands. He recommended that hospitals draw blood from their own detachments and that service troops, not including medical troops with detachments of active hospitals, should form donor pools. Colonel Dart estimated that, if the cooperation of all enlisted personnel at a hospital could be secured, there would be available daily 10 times 500 cc. of blood. If officers and patients were also used, daily availability would increase to 15 times 500 cc. These figures would be maximum, however, if the need were prolonged.¹

¹ They proved to be overly optimistic.



FIGURE 129.—Administration of plasma to wounded Filipino with severe, almost fatal, wound from saber cut by Japanese officer, Manila, Philippine Islands, February 1945.

On 23 February 1943, Col. Julius M. Blank, MC, Surgeon, Advanced Base, sent the following 1st indorsement to Brig. Gen. Guy B. Denit (6):

1. If whole blood were obtained from Australian sources and shipped to the advanced base (as was done 11 months later), it would be necessary to set up a small subbank in this base, with arrangements for precise refrigeration at 38° F. (3.5° C.). Such facilities did not then exist.

2. Blood stored under these conditions would probably become hemolyzed at a maximum of 10 days after bleeding. If it were used, benefits would be reduced and the chances of reactions increased. At the end of this period, however, it should be possible to remove the red blood cells and use the residue—if the proper facilities were available.

3. The use of blood serum had given satisfactory results in most patients sent to the base, and the use of whole blood could therefore be limited to those patients with a marked reduction in the cellular elements.

4. Authorities had set the level of transfusions below which it was not considered practical to establish a blood bank at 1,000 to 1,200 per annum. At the 10th Evacuation



FIGURE 130.—Administration of plasma to wounded U.S. soldier in courtyard of Walled City, Manila, Philippine Islands, February 1945.

Hospital. 50 transfusions had been given to approximately 1,500 wounded in December 1942, and 44 had been given in January 1943. These figures were interpreted to mean that the present supply of donors was adequate and that, unless there was a sudden influx of casualties, blood from the Australian bank was not needed.²

5. If such an influx occurred, it might be advantageous to have an extra supply of blood on hand. It was therefore suggested that adequate storage facilities be provided at the advanced base for a minimum of 25 liters of blood. If the supply were replenished every 10 days, the transfusion capacity per month would be 75 liters. Arrangements could also be made with the Australian blood bank to provide blood to be flown up as requested by radiogram.

In comments on these proposals on 2 March 1943, Maj. (later Col.) Wm. Barclay Parsons, MC (7), pointed out that the assumption that the donor supply was adequate seemed odd, since the paucity of donors had been the main reason for starting the discussion.

BLOOD SUPPLY FROM AUSTRALIA

On 3 August 1943, the Surgeon, Subbase D (Port Moresby), was informed by Colonel Petters (8) that thereafter blood would be supplied regularly from

² It is curious, as well as typical of the lack of knowledge of the potentialities of blood at this time, that it was not realized that the small number of transfusions could be better explained both by lack of blood and by ignorance of its usefulness.

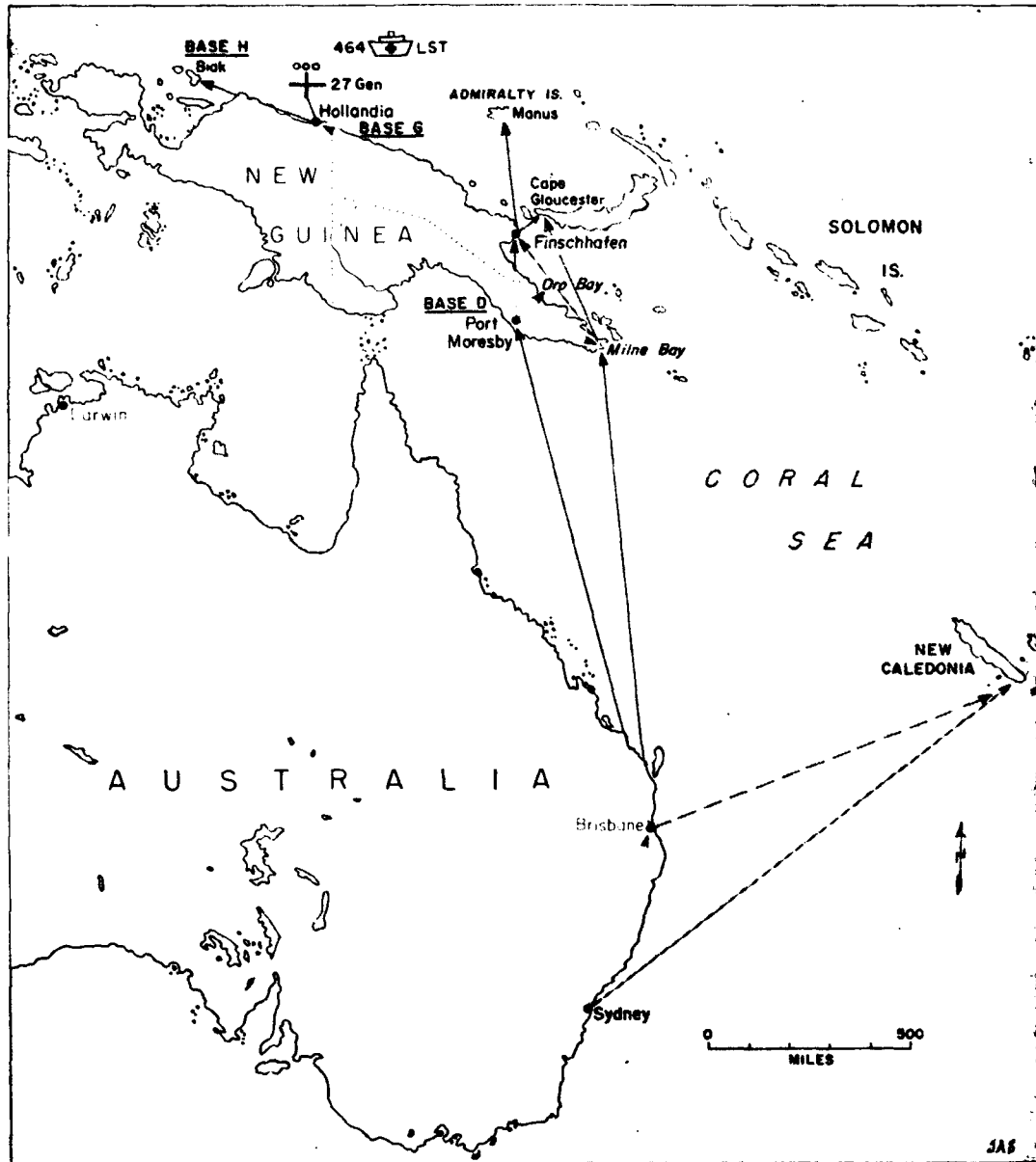

FIGURE 131.—Administration of plasma to wounded U.S. soldier directly behind frontlines near San Nicholas, Luzon, Philippine Islands, March 1945. Filipinos carried the wounded from the front to ambulances in the rear. Note large bottle (500 cc.) of plasma.

the Australian Blood Bank Service, in amounts up to 200 liters per week, within 24 to 36 hours after it had been requested by radiogram. Instructions were given for refrigeration of the blood on arrival; for its shipment forward by air in insulated boxes, which would be supplied; and for a 10-day dating period. It was requested that surgeons in forward areas be informed of the availability of the blood, all of which would be group O. Instructions for the use of the Australian Soluvac giving set were attached. Great emphasis was placed upon the proper cleansing of the equipment immediately after it had been used.

On 22 January 1944, the Australian Blood Distribution Center operating at Port Moresby, New Guinea (map 4), began to supply preserved blood to U.S. troops located at bases within air reach. Delivery to them was by U.S. planes. When this operation began, the useful age of the blood was advanced from 10 to 15 days, it having been found that hemolysis seldom occurred earlier.

By the original plan, 10 liters of blood were flown weekly to Milne Bay, Oro Bay, and Finschhafen in New Guinea. In July 1944, hospital ships



MAP 4.—Distribution of blood from Australian blood bank to Pacific areas and of locally collected blood from Hollandia.

departing from Finschhafen and Hollandia to forward bases at which there had been recent activity were also stocked with blood.

From the initiation of this service until it was discontinued in February 1945, U.S. bases in the Southwest Pacific received 2,310 liters of blood from Australia, about a quarter of their requirements, at a cost to the U.S. Army of \$15 per liter (1).

27TH GENERAL HOSPITAL BLOOD BANK

The plan to use the 19th Medical General Laboratory for a blood bank at Hollandia, to support the Leyte operation, could not be carried out because this unit arrived in the area too late. The laboratory served as a blood bank, however, after the final Japanese surrender and the end of shipments of blood from the Zone of Interior in September 1945 (p. 629).

The bank at the 27th General Hospital (fig. 132) began to function on 9 September 1944, about 5 weeks before the landings on Leyte were scheduled (1). Instructions for its operation were given in the standing operating procedures

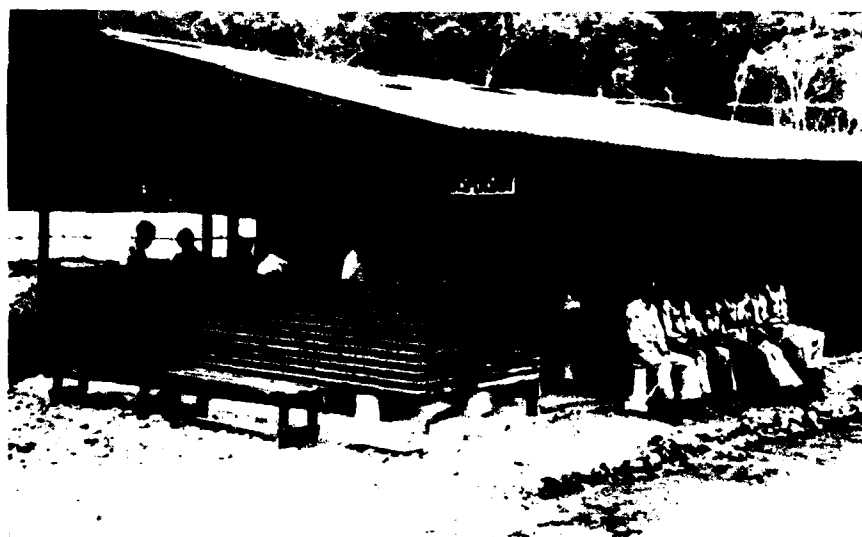

FIGURE 132.—Dispensary housing blood bank at 27th General Hospital, Hollandia, New Guinea, January 1945. Laboratory is in background. Donors are waiting to be called. White containers on ground behind dispensary were used for shipping refrigerated whole blood from the bank.

prepared by Maj. (later Lt. Col.) Mark M. Bracken, MC, who was chief of the laboratory service, and in Technical Memorandum No. 13, Office of the Chief Surgeon, Headquarters, USAFFE (U.S. Army Forces in the Far East), 21 September 1944 (9).

The original plan, to pool the blood of eight donors in 4,000-cc. flasks, had proved technically unworkable. There were no facilities for creating a vacuum powerful enough to permit the collection of satisfactory amounts of blood from each donor into bottles of this size. The substitute plan, to collect individual donations in 600-cc. Transfusovac bottles containing sodium citrate, was more satisfactory from the standpoint of sterility as well as of efficiency. The final content of each flask was 500 cc. of blood; 70 cc. of citrate solution; and 5 cc. of 50-percent glucose solution, which was added before the flask was topped. The original plan of adding sodium sulfathiazole

to the blood was discontinued as unnecessary; the Institute of Tropical Diseases at Sydney had shown that spirochetes and malarial parasites do not survive in blood stored under refrigeration for 5 days.

The dating period of the blood was set at 20 days. Plasma from blood not utilized by this time was to be used locally on burns and on certain types of wounds, though in Major Bracken's experience, plasma thus prepared could be safely used intravenously.

The following modes of transportation were authorized for shipment of blood:

1. By plane, packed in crushed ice in insulated boxes.
2. By boat, similarly packed until it could be placed under refrigeration aboard. The boxes were to be returned to the blood bank.
3. By boat, to which it would be delivered in Thermos jugs. After the blood had been placed in refrigerators aboard, the jugs would be returned to the bank.
4. By boat, in portable reefers (refrigerators), in which it would be delivered to its destination. Blood delivered in this manner kept for 5 days if the boxes were not exposed to direct sunlight.

The bank at Hollandia (map 4) at once began to function actively. During October, 697 liters of whole blood were distributed from it. It proved to be a convenient supply base both for New Guinea bases and for combat areas forward.

On 20 December 1944, a supplementary depot began to operate on Biak Island (Base H), and a bank was projected for Leyte (Base K), as soon as the military situation permitted.

STAFF VISIT TO PACIFIC AREAS BY ARMY AND NAVY CONSULTANTS IN SHOCK AND TRANSFUSION

Objectives and Itinerary

In view of their close association in the plasma program, it was logical that when Capt. Lloyd R. Newhouser, MC, USN, was ordered to the Pacific in June 1944, similar orders should have been requested for Lt. Col. (later Col.) Douglas B. Kendrick, MC, his counterpart in the Army blood and plasma program. Captain Newhouser's orders placed no limit on his activities. Colonel Kendrick's orders directed him to accompany Captain Newhouser at all times.

Their combined survey, which began on 6 June and ended on 8 August, had the following objectives:

1. Investigation of the need for, and availability of, whole blood.
2. Investigation of available equipment and personnel for supplying whole blood and setting up blood banks.
3. Coordination by the Army and the Navy of plans and equipment for supplying whole blood.
4. Investigation of the availability and use of plasma and serum albumin and the need for the products of plasma fractionation.

5. Investigation of the supply and use of penicillin.
6. Collection of other miscellaneous medical information.

As specified in their official orders, Colonel Kendrick and Captain Newhouser went from Washington to Honolulu, and then visited the following locations (map 5) (10):

1. Central Pacific Area: Pearl Harbor, Hawaiian Islands; Kwajalein and Eniwetok, Marshall Islands; Saipan, Mariana Islands; Johnston Island.
2. South Pacific Area: Espiritu Santo, New Hebrides; Nouméa, New Caledonia (twice).
3. Southwest Pacific Area: Brisbane and Sydney, Australia (twice each); Dobodura, Oro Bay, Finschhafen and Hollandia in New Guinea; Biak, Owi, and the Woendi Islands in the Schouten Group; Manus and Los Negros Islands in the Admiralty Group; Cape Gloucester, New Britain; and Milne Bay, New Guinea.

The policy in all of these places was the same: to hold conferences with Army and Navy medical officers with an interest in plasma and transfusion; to visit Army and Navy hospitals, to get a cross section of their activities; and to determine the use of albumin and plasma and the use of, and need for, whole blood. In all areas, Captain Newhouser and Colonel Kendrick found a great need for a transfusion service, particularly in New Guinea, where the distances between the transfusion service in Australia and forward combat areas were becoming too long for efficient transportation of blood. There was agreement in all areas by Army surgeons and Fleet surgeons that there was an increasing need for whole blood, which, up to then, had been available only in limited quantities. Augmentation of the supply had never been possible, nor had it been possible to establish a blood bank, because of lack of trained personnel and equipment.

It was immediately evident to Captain Newhouser and Colonel Kendrick that, for a variety of reasons, it would not be practical to ship blood from Sydney to any area beyond Finschhafen, but they thought it best to delay recommendations for the location of a blood bank until their trip through New Guinea was completed.

Recommendations for Blood Supply in the Southwest Pacific Area

On 19 July 1944, at the request of General Denit (fig. 133) and with the concurrence of Captain Newhouser, Colonel Kendrick submitted to General Denit a plan for a blood transfusion service in the SWPA (Southwest Pacific Area) with special reference to advanced bases, as follows (11):³

1. With high priorities and responsible couriers, it was practical to transport blood from Sydney to Finschhafen. Beyond that point, a transfusion service must be established.

³ The locally supervised programs recommended were all compromises, and none too desirable. It should be remembered, however, that when they were set up, there was no other choice; it was not until August 1944, when the tour of the Pacific areas was practically complete and Colonel Kendrick and Captain Newhouser were on their way back to the United States, that Maj. Gen. Norman T. Kirk reversed his ruling of November 1943 and agreed to the shipment of blood overseas to combat theaters.

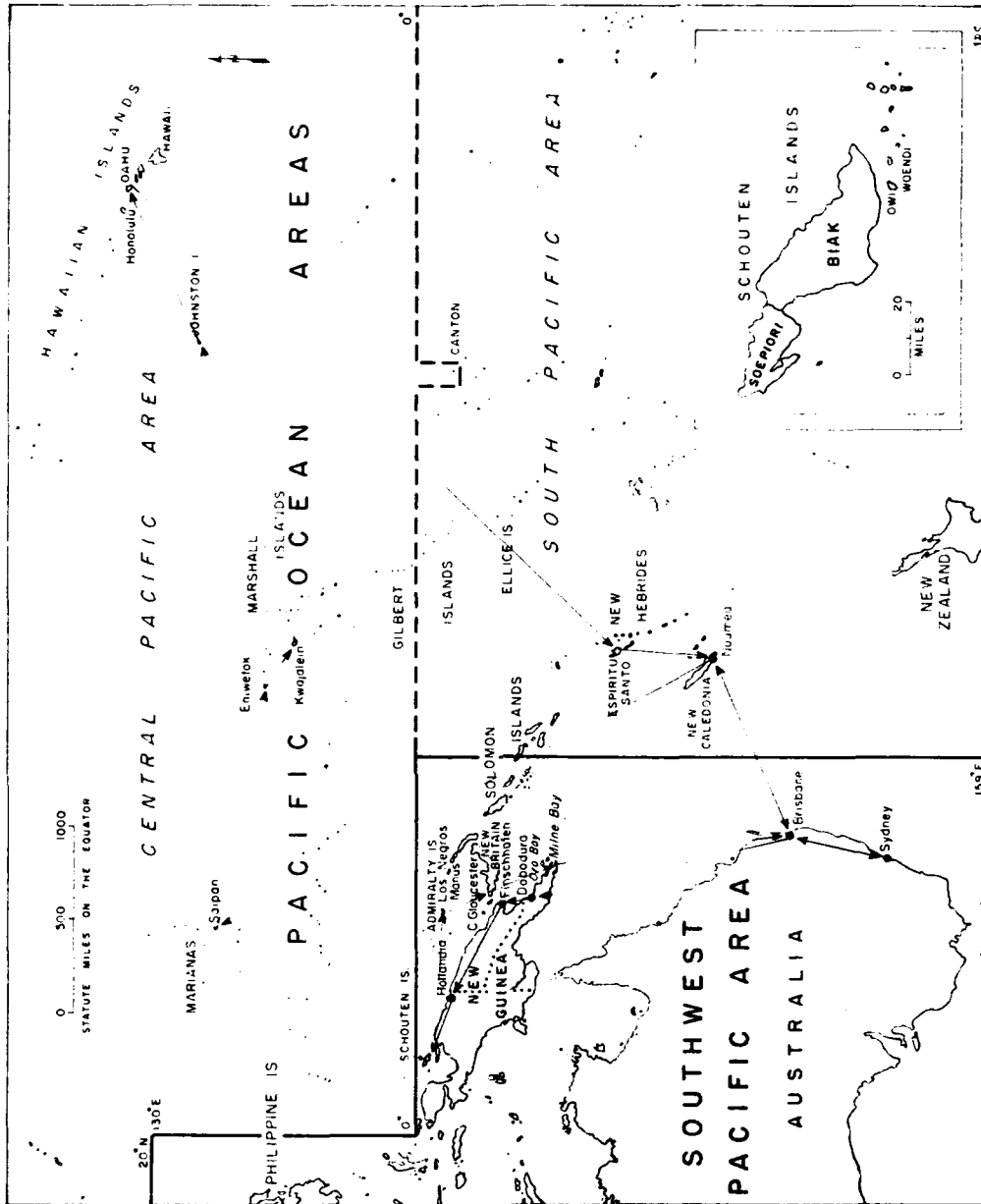

MAP 5.—Itinerary of official representatives of the Surgeons General of the Army and the Navy on blood and plasma during visit to Central, South, and Southwest Pacific Areas, June—August, 1944.

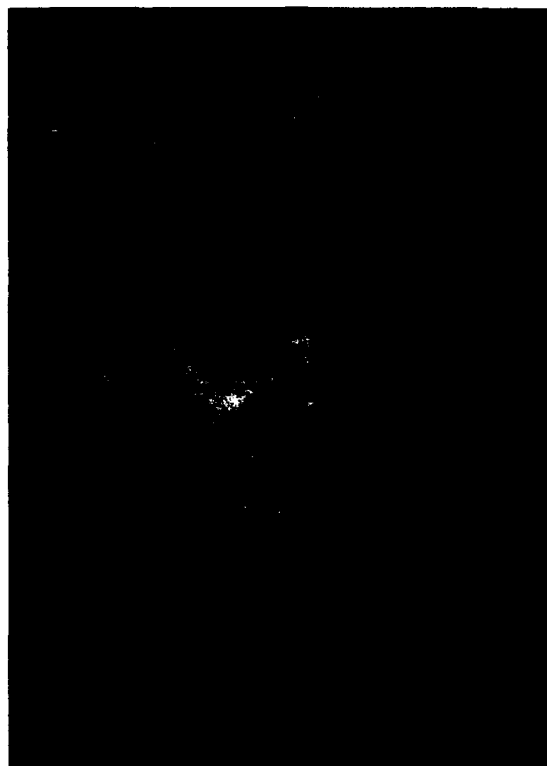

FIGURE 133.—Brig. Gen. Guy B. Denit, Chief Surgeon, USASOS, SWPA, and USAFFE.

2. Two recommendations were made:

a. That a blood bank be set up at Hollandia, because of its proximity to future planned operations; the availability of an adequate service donor population (100 a day); and facilities already available in the area. General Denit had also pointed out another advantage, that an Army laboratory was shortly to be set up there.

b. That a blood bank to service both Army and Navy should be set up initially aboard LST 464 (landing ship, tank), which should remain in Humboldt Bay until the proposed Army laboratory came into operation in this area (11, 12). When the ship eventually moved to a more advanced area, it was anticipated that it could continue to supply Army needs as well as the needs of portable surgical hospital teams aboard all LST's in the area. If the necessary transfusion equipment could be provided (which it was understood the Army had immediately available), this ship had the space, facilities, and trained personnel to institute a transfusion service immediately. Specifications for personnel, refrigeration, equipment, and sources of donors were stated in detail.

At General Denit's request, on 1 July 1944, a requisition had been sent by radio to the Zone of Interior asking for the immediate shipment of 100 "apparatus, blood transfusion, indirect, field assemblies" to produce blood for operations scheduled for the immediate future. A requisition had also been sent through regular supply channels for enough recipient bottles, recipient sets, and refrigerators to supply the need of the SWPA for the next 6 months. General Denit intended to request trained personnel for the bank.

Earlier, a radio request had been made for transfusion equipment for New Caledonia.

There was complete Navy agreement with all of these plans. In all locations, in fact, Captain Newhouser and Colonel Kendrick had been greatly impressed by the way the two services worked together.

Recommendations for Blood Supply in the Central and South Pacific Areas

When Captain Newhouser and Colonel Kendrick reported to Headquarters, SPA (South Pacific Area), on 21 July 1944, they were informed by Capt. (later Rear Adm.) Frederick R. Hook, MC, USN, the Force Medical Officer, that hospital ships evacuating casualties from Saipan were in urgent need of additional blood. It was requested that sufficient equipment be made available to operate a blood bank at Bougainville or Pearl Harbor, where donors could be procured in adequate numbers and whence blood could be flown to the ports into which hospital ships could be ordered. After Captain Newhouser and Colonel Kendrick had returned from a trip to Saipan on the hospital ship *Samaritan*, which was evacuating casualties from the Marianas, the Surgeon, SPA, on 22 July 1944, sent a radio request to the Office of The Surgeon General for 100 field transfusion assemblies for use aboard hospital ships or in a blood bank at Bougainville or any other location that might be decided upon for long storage of blood. Meantime, part of the transfusion equipment which the Army had on hand at Nouméa, New Caledonia, was transferred to the *Samaritan*.

When the visiting officers returned to Pearl Harbor, Capt. Walter M. Anderson, MC, USN, Fleet Surgeon, and Brig. Gen. Edgar King, Surgeon, CPA (Central Pacific Area), requested advice as to the best location for a blood bank to supply blood to advanced locations in the South Pacific Area.

Since the SPA and the CPA had been combined under the POA (Pacific Ocean Areas), it was thought that one bank at an advanced base could care for the emergency needs of the entire Pacific Ocean Areas. Pearl Harbor could provide an adequate donor population but was considered too far removed from the combat zone to supply blood for future operations west of the Marianas. Saipan or Guam, depending upon which had the larger military population, would be a better choice. Blood collected on either island could be transported to the combat zone by hospital ships or LST's until airstrips were secured. Later, Guam was selected as the distributing center for the airlift to the Pacific (p. 614).

LST 464

Just before Colonel Kendrick recommended to General Denit the use of LST 464, acting as hospital ship, as a blood bank for the invasion of Leyte, Lt. Ernest E. Muirhead, MC, USNR, had prepared blood on it and carried it ashore on another LST to supply troops going in at Noemfoor Island. Although

his equipment was extremely limited and he had to use empty intravenous solution bottles, his procedure had proved entirely feasible. Lieutenant Muirhead had had previous experience in the operation of blood banks, and it was recommended that he be put in charge of the bank proposed for LST 464 (11, 12).

Detailed recommendations for operations on this ship covered personnel, equipment, refrigeration, blood grouping, and donors. The closed system of collection, which was essential, would require the use of a sterile, self-sealing, vacuum-type, 1,000-cc. bottle, containing 500 cc. of Alsever's solution. This technique would make it possible to preserve the blood under refrigeration at 43° to 46° F. (6° to 8° C.) for 18 to 21 days. Provision was also made for the use of individually packaged, expendable giving sets, ready for immediate use. Donor sets, consisting of 17-gage needles, latex rubber tubing, and stainless steel valves, would be cleaned and sterilized each time they were used. The tubing must be replaced after 10 to 15 bleedings. The valves could be used several thousand times.

Donors aboard ship would be obtained from Navy personnel. Only type O blood would be used. Serologic tests would be run, but it would be impossible to rule out malaria-positive donors by blood smears. Suppressive treatment with Atabrine (quinacrine hydrochloride), however, which was universal, would prevent the transfer of the infection to the recipient, since most infections were caused by trophozoites. Refrigeration of the blood would also have a lethal effect on the parasite.

These recommendations, including the appointment of Lieutenant Muirhead, were duly implemented on 23 July 1944, by orders from Headquarters, USASOS (U.S. Army, Services of Supply), SWPA. Steps were taken at once to prepare the blood bank on board for the invasion of the Philippines (fig. 134).

DONORS

General Considerations

Hospitals in the Pacific which collected their own blood frequently had difficulty in securing donors. Detachment personnel could not be reused as promptly as in the Zone of Interior because experience had shown that they did not regenerate hemoglobin as rapidly as in more temperate climates. It was always undesirable to bleed troops shortly before they went into battle, and much more undesirable, for the reason just stated, in the Tropics.

When the Sixth U.S. Army was staging in Hollandia for the invasion of Leyte, an attempt was made to maintain a list of 500 donors in the Office of the Base Surgeon, but the project was not successful, partly because of the continued calls for large quantities of blood and partly because of the rapid passage of prospective donors through the base. It was necessary to bleed listed donors promptly if they were to be useful. When necessary, as many as 150 donors could be bled in a day at the 27th General Hospital blood bank.



FIGURE 134.—Transfusion of whole blood at Burauen, Leyte, October 1944. Blood for this campaign was collected on LST 464.

The original plan of requiring two visits of donors (the first for confirmation of the blood group, the Kahn test, and the blood smear, and the second for bleeding if the first examination was satisfactory) proved completely impractical. A great many donors did not return because of transfers, leaves, and for other causes. When the plan was adopted of requiring only a single visit, it proved equally impractical to hold donors until the tests were completed. The routine was therefore adopted of bleeding the donors at once and discarding blood that was serologically positive or that otherwise did not meet specifications.

Calls for volunteers were made by notices in the daily bulletin, at headquarters, and by personal contacts by the officer in charge of the bank with various organizations from which donors might be secured. These were the only practical plans. The postal service was entirely unreliable, and the use of the telephone simply resulted in loss of time. Red Cross workers were very helpful in securing donors from both Army and Navy personnel.

The response to a call for donors was sometimes enthusiastic. The number exceeded 500, for instance, when information, considered reliable, spread



FIGURE 135.—Response of donors to emergency call after air raid, 8th Medical Laboratory, Biak Island, Netherland East Indies, March 1945.

within the 32d Infantry Division, when it was staging at Hollandia, that each donor would receive 2 ounces of whisky and a good meal. The limited facilities of the bank at the 27th General Hospital were all that prevented mass participation. The donations proved well worthwhile: This division was the first to use whole blood on the battlefield, where its usefulness far exceeded the most optimistic hopes for it. It is only fair to add that there was always a prompt response to a real emergency (fig. 135).

The Malaria Problem

The malaria problem first assumed an areawide aspect in June 1944, when preparations for the operation of a transfusion service were first discussed. Upon inquiry, General Denit learned from the Surgeon, Base B (Oro Bay) that New Guinea hospitals were in the habit of using members of their own detachments as donors (13). Even though negative smears for malaria were obtained before bleeding, it was highly probable that a certain percentage of these donors had subclinical suppressive malaria, which would not be apparent on a single smear. Malaria had developed after transfusion in several casualties who had not previously had it and who had received blood from donors who had been in New Guinea for some time. In one instance, the chills and associated fever proved a serious complication of bleeding peptic ulcer. Since

the problem was likely to increase as more troops remained in malarious areas, two procedures were suggested:

1. The supply of pooled blood from Australia, which was now not being used in large quantities, might be increased. Although this blood was supposed to be used within 10 days, it was preserved in glucose and if it were properly refrigerated, the dating period could be extended to 15 days.

2. On the suggestion of 1st Lt. (later Maj.) Frederick B. Bang, MC, of the Malaria Research Group, an intramuscular injection of Atabrine might be given before transfusion. In an emergency, if blood had to be used from a possibly malarious donor, it might be wise to increase the dosage of Atabrine as recommended for patients about to undergo surgery (14).

No positive malaria smears were reported at the bank at the 27th General Hospital in its first 7 weeks of operation (and only one positive serology). One reason was that donors who appeared cachectic and those with a history of malaria, jaundice, or any serious illness within the previous year were not accepted. There were no reports of malaria (or jaundice) after any transfusion. It was realized, however, that since the bank was located in a malarious area, it would be impossible to exclude all malarious donors. It was also considered possible that, in a few instances, viable parasites had been transmitted in the blood and that the transmittal had been masked by the required daily use of Atabrine by all personnel in the area.

Other Tests

Up to the middle of 1945, the Rh factor was not considered of importance in the Pacific. In July 1945, 436 pints of Rh-negative blood were sent from the Zone of Interior in a total shipment of 4,465 pints of blood.

Up to this time, isohemagglutinins had also not been regarded as important. Crossmatching was performed when time permitted but was not considered essential, since the blood had been checked twice in the Zone of Interior. Had the war continued, it would have been necessary for patients who had had numerous transfusions to be crossmatched and have agglutination tests for minor agglutinins.

Errors in the entries on the identification tags averaged about 10 percent.

EQUIPMENT

The story of equipment for blood transfusion in the Pacific areas duplicated that in other theaters; that is, shortages and improvisations until expendable receiving and giving sets became available, the latter when the airlift of blood from the Zone of Interior began in November 1944. Just before that happened, the scarcity of expendable sets was so great that those on hand had to be apportioned among POA and SWPA, according to the intensity of the area need.

Early in the whole blood program in the Pacific, there were some complaints that it was difficult to pass stored blood through the metal-mesh filters

in the giving sets. Up to this time, blood had been stored at 36° to 40° F. (2° to 4.5° C.). The difficulty was almost entirely overcome when the storage temperature was raised to 40° to 45° F. (4.5° to 7° C.) because the gel which formed in the blood at the lower temperature did not form at the higher temperature. One of the most important considerations of storage then became the maintenance of the temperature above 39° and below 45° F. (4° and 7° C.).

In his first report from the Pacific, Colonel Kendrick stated that the Medical Department in that area frequently had to construct its own hospitals and was therefore greatly in need of building tools (10). Without appropriate facilities, blood could not be used. He suggested that hammers, saws, and even sawmills should be issued to hospital units as part of their regular equipment. The suggestion about sawmills was not acted on favorably.

THE AIRLIFT OF BLOOD TO THE PACIFIC

Organization

Since the Army had set up, and was conducting, the airlift of blood to the European theater, under the direction of Colonel Kendrick, it was logical for the Navy to set up and conduct the similar service to the Pacific areas, under the direction of Captain Newhouser. In a conference between Brig. Gen. Fred W. Rankin and Captain Newhouser on 13 October 1944, while Colonel Kendrick was on temporary duty in Europe, it was agreed that the Navy should establish and operate the processing laboratory in San Francisco and should furnish all the bottles, donor sets, and refrigerators for the program. The Army would furnish all the equipment necessary to operate the laboratory. The Surgeon General, Army, agreed to the coordinated program in the Pacific with the understanding that the allocation of blood to the two services would be based entirely upon their requirements. The Navy would fly the blood from the west coast to Guam, process it at the Navy blood laboratory there, and then deliver it to all areas in the Pacific as it was required.

The Army also furnished all personnel for the laboratory at the Los Angeles bleeding center (blood grouping, serologic testing) and for the packaging and shipment of blood to San Francisco. Requests for personnel for these purposes were made by General Rankin in October 1944, and again in February and March 1945, to the Personnel Division, Office of The Surgeon General. Trained technicians were not requested, since the enlisted men required could be trained by the staff of the Los Angeles and other centers supplying blood for the airlift.

American Red Cross Participation

On 26 October 1944, after the feasibility of an airlift of blood to the Pacific had been established, Vice Adm. Ross T McIntire, MC, USN, Surgeon General, U.S. Navy, and Maj. Gen. Norman T. Kirk wrote jointly to Mr. Basil O'Connor, Chairman, American Red Cross, concerning the planned

whole blood program for the Pacific (15). Neither plasma nor serum albumin, it was pointed out, could compensate for the whole blood lost by severe hemorrhage. Up to this time, blood had been obtained in the Pacific from military personnel in combat areas. Since recent developments had shown the feasibility of transporting blood to oversea theaters, the Red Cross was being asked to furnish a minimum of 300 pints of O blood per day for the Pacific from donor centers in San Francisco, Oakland, and Los Angeles, with the understanding that activities might be expanded if larger amounts of blood proved necessary. It was requested that the service begin on or about 15 November 1944 and that the collections be in addition to the blood then being collected for existing programs.

Mr. O'Connor replied on 3 November 1944 that the American Red Cross would be glad to cooperate in the Pacific program and that steps were being taken to procure the blood, as requested, from the centers at San Francisco, Oakland, and Los Angeles (16).

The airlift to the Pacific began with the procurement of blood from the three centers specified (17). As the need for blood increased, the Portland, Oreg., collection center was added to the program on 30 January 1945 and the San Diego, Calif., center on 4 February. The Chicago center began to produce blood for the Pacific on 13 April.

When the need for whole blood ended in Europe with the German surrender on 8 May 1945, the centers on the east coast, which had been collecting whole blood as well as blood for plasma (New York, Philadelphia, Washington, Boston, and Brooklyn) were kept operational for procuring blood to be flown to Oakland. The capacity of these centers, added to that of the centers on the west coast, brought the blood available for shipment to the Pacific to 12,000 pints each week. As of 15 May, all blood collected in the eastern United States was being flown to the west coast, re-iced there, and then flown to Guam (map 6).

By the end of May, arrangements were completed to consolidate the processing of all blood collected in Philadelphia, Boston, Washington, and New York in one large laboratory at the blood donor center in New York. The blood was collected in these cities, taken to New York by refrigerated motor truck, processed there, and then packed in Army expendable insulated boxes for the flight to the west coast. This plan proved both safe and practical. When Maj. Leslie H. Tisdall, MC, inspected the Navy laboratory at Oakland (fig. 136) after these arrangements had been effectuated, he found that shipments arriving from New York needed only a small amount of added ice before being flown to Guam.

Shipments were regulated according to requests from the naval officer in charge of the distribution center on Guam. They varied widely, from no donations at all on a few days to 12,000 pints during one week in May 1945. These irregularities caused some difficulties in the centers, since procurement

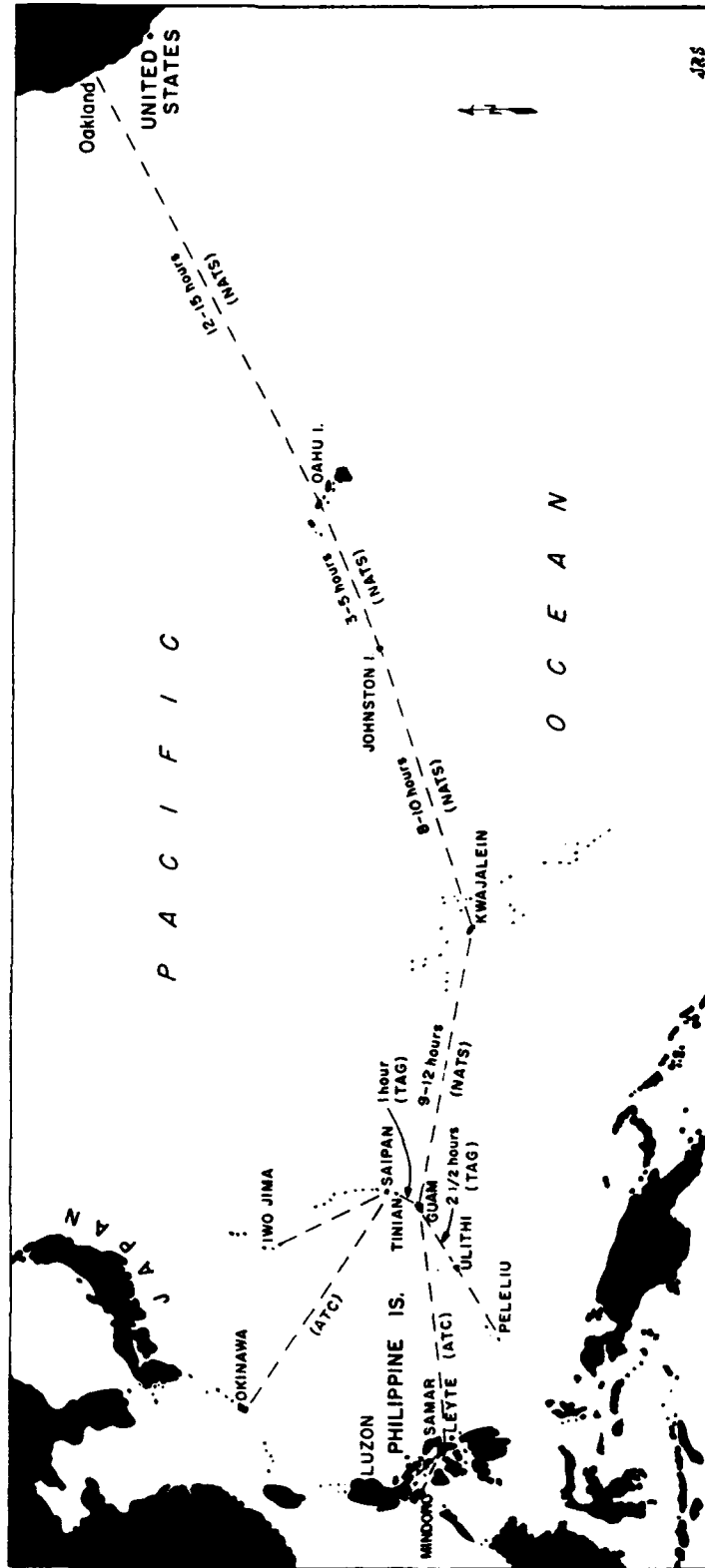

MAP 6.—Flight plan, for distribution of blood to Pacific from U.S. west coast.



FIGURE 136.—Navy processing laboratory for blood for Pacific, Oakland, Calif. Note Church chest in left foreground.

of donations had to be kept at as constant a level as possible. Donations in excess of whole blood requirements were shipped to the laboratories processing plasma.

Initial Difficulties

The inauguration of the airlift of blood to the Pacific terminated, for all practical purposes, the difficulties of replacement therapy in that area. The service evolved into an extremely efficient operation. As Lt. (later Lt. Cdr.) Herbert R. Brown, Jr., MC, USNR, stated in his report on the depot for 6 March 1945, it had not been necessary to make a single major change in the original program and very few minor changes (*18*). The pilot run in September 1944 had gone very smoothly, but there were multiple initial difficulties, both in the Zone of Interior and overseas.

Zone of Interior.—The first shipment of blood left San Francisco for Guam and Leyte (map 6) on schedule on 16 November 1944, in charge of Lt. (later Lt. Cdr.) Henry S. Blake, MC, USN. Brig. Gen. Charles C. Hillman and other Army and Navy personnel were extensively photographed as they assisted in placing the 10 boxes of blood (160 pints) on the plane. A naval medical officer, a naval public relations officer, and a photographer went on the flight, to send back stories and create more interest in the program. The

blood reached Guam on 19 November and Leyte on 22 November without complications.

Numerous complications, however, attended the departure of the first shipment and continued for several days afterward. They were described by Maj. (later Lt. Col.) Frederic N. Schwartz, MAC, who had gone to Los Angeles on 13 November, to establish the Army part of the program, substantially as follows (19):

The laboratory in which the blood was to be processed was not yet ready. All the necessary laboratory supplies had not arrived, including the indispensable centrifuge. Arrangements had not yet been made for air shipments to San Francisco. On the Navy side, there were also shortages, including insulated boxes, and, for a few days, the Oakland laboratory could handle only 40 bloods daily instead of the specified 100 bloods.

The Army was able to meet the original schedules by loans and improvisations. A centrifuge was flown in from Fitzsimons General Hospital, Denver, Colo. Major Schwartz arranged with Hyland Laboratories for the blood to be processed there until the Los Angeles center was ready. This was not a particularly efficient arrangement, for it meant that the blood had to be taken by the Red Cross Motor Corps from the collecting center, where it should have been processed, to Hyland Laboratories for typing and serologic testing. It was fortunate, however, that the arrangement could be made. The blood was taken to San Francisco by the Railway Express Agency, in Church containers.

By 1 December 1944, most of these difficulties had been ironed out and daily shipments to the Pacific amounted to 250 pints, of which 100 were supplied by the Army.

Overseas.—In correspondence with Col. (later Brig. Gen.) George R. Callender, MC (20), and Major Schwartz (21) in December 1944, Colonel Kendrick⁴ stated that planning in the United States for the Pacific airlift had been exceptionally well done but the excellence had been confined to the United States:

1. No command in either the Central or the Southwest Pacific had been advised officially of the whole blood program by either Army or Navy sources. Colonel Kendrick made every effort to assure the surgeons in the various Pacific commands that this was an official program, coordinated by the Army and the Navy, but lack of written authorization sometimes made it difficult to secure cooperation.⁵ He was told at one installation, where con-

⁴ Colonel Kendrick, still serving as Special Representative to The Surgeon General on Blood and Plasma Transfusions, left the United States on 21 November 1944, for temporary duty with the USAFPOA (U. S. Army Forces, Pacific Ocean Areas), of which Brig. Gen. John M. Willis was Surgeon. Colonel Kendrick went to Guam and Leyte almost immediately and did not return to Hawaii until January 1945, after stopping en route for several days of conferences on the blood program with Lieutenant Brown on Guam. By this time, the overall blood program was functioning smoothly in the Zone of Interior, the European theater, and the Pacific; and Colonel Kendrick was relieved of his responsibilities for the program in the Office of The Surgeon General, where he was replaced by Maj. John J. McGraw, Jr., MC (p. 402). Colonel Kendrick was also relieved of his responsibility in the Pacific, where no other consultant was appointed during the remainder of the war.

At this time (January 1945), Colonel Kendrick was placed in command of the 10th Field Hospital, which was designated to land on Okinawa on D+60, but on 14 March, 5 days before the Tenth U. S. Army sailed for that target, the Army Surgeon, Col. Frederic B. Westerfelt, MC, recognizing the peculiar requirements of the management of shock and the handling and use of blood, assigned him to his headquarters as consultant in these special fields. Colonel Kendrick went ashore with the Tenth U. S. Army on Okinawa in early April and served as Consultant in Resuscitation, Whole Blood, and Shock for the next month. He then took command of the 31st Field Hospital.

⁵ This was an unfortunate contretemps. Letters had been written by the Surgeon General, Navy, advising all commanders in the Pacific that blood would be shipped from the United States. The letters were to go airmail, but through some error, they were sent by regular mail. The commanders therefore did not receive them until 2 to 4 weeks after the blood program had been set up in the Pacific.

fusion was rampant, that it was not necessary for a War Department representative to come out and tell them how to run their transfusion service. In an advanced area of the Sixth U.S. Army, his activities were restricted, and he was prohibited from interfering with present policies on the ground that the officers in charge of the program were competent to handle it. By surreptitious methods, Colonel Kendrick provided the surgical consultant, Sixth U.S. Army, with enough information for him to prepare a circular letter on the new service.

2. The blood bank in Honolulu resented being left out of the program, even though its inclusion would have greatly complicated the transportation of blood. The additional supply, in fact, would not have been worth the trouble necessary to secure it.

3. General Denit had not been notified of the program nor had any Army surgeon. Not having received any word on it from the Office of The Surgeon General, Army, they concluded, quite logically, that the program was a Navy responsibility and had sent no information about it to forward hospitals.

4. The arrival of the first shipment of blood in the Southwest Pacific in November 1944 had been reported to the Army surgeon but not to the Fleet surgeon, and Colonel Kendrick, as Consultant on Blood and Transfusion to the Surgeon, POA, found himself in the odd position of selling a Navy program to the Navy.

5. Because of the lack of official notice of the blood program, it was "existing parasitically," by leaning heavily on personnel and equipment from medical supply companies and other organizations, which could ill afford to spare either. It was Colonel Kendrick's opinion that if the program had concerned anything but blood, it could not have operated.

6. Since no blood distribution teams had been set up, the blood was frequently not being handled properly. Sent through ordinary supply channels, it was taking unnecessarily long in delivery. It was sometimes kept without refrigeration, and not even in insulated boxes. It was sometimes distributed without expendable giving sets. Eventually, during the Leyte campaign, Colonel Kendrick was able to have a distribution team set up in the Philippines and to arrange for transportation, a supply of ice, and other essentials.

7. It was regrettable that, because of some confusion in his orders, which kept him in the Central Pacific for 10 days, his planned meeting with Lieutenant Blake did not occur. The exchange of experiences would have been of great value.

In spite of these difficulties, cooperation had been excellent on the part of all concerned. The Naval Air Transport Service and the Transport Air Group, without written authority, gave Colonel Kendrick a No. 1 priority for blood, and asked no questions about it. Since proof existed that the blood service could be operated with sacrifices on the part of other medical units, he saw no reason why, in view of its importance, it should be hamstrung by lack of its own adequately trained personnel, equipment, and transportation. Responsibility to the services and to the donors of the blood warranted the utilization of the best trained personnel and the most efficient equipment possible. If a commodity such as blood were lost, as the result of incompetence on the part of makeshift personnel or inadequate refrigeration at relay points, the armed services would be put in a position of great culpability.

Colonel Kendrick, on the basis of his observations, made the following recommendations (20, 21):

1. A circular letter or directive should be issued by the Army and the Navy, together or separately, authenticating the existence of the transfusion service.

2. The transfusion teams recommended by the Office of The Surgeon General in the T/O & E (Table of Organization and Equipment) sent to Army Service Forces on 15 December 1944 should be immediately approved and activated.

3. Two transfusion teams should be activated, equipped, and ordered to the Pacific, one to USASOS, SWPA, and the other to USASOS, POA.

4. The transfusion service for the entire area should be placed under a single control officer with a combined staff of Army and Navy personnel. The present confusion caused by five or six different officers' being responsible for blood in different installations could no longer be tolerated.

In one way or another, all of these recommendations except No. 4 were implemented by the end of January 1945.

Personnel

When the service to the Pacific was once firmly established, the blood was consistently handled by specialized personnel, by what amounted to a special delivery service, which is the only efficient way to handle such a valuable commodity and, more important, the only safe way. At no stage along the way, from the collecting center in the Zone of Interior to the administration of the blood at the terminal point in the Pacific, was it touched by any but trained, specialized personnel, on permanent assignment. The blood service in the Pacific had its roots in the experiences gained in the Mediterranean and European theaters, as well as in the Zone of Interior.

The initial handling of some of the first blood shipped from Guam to Leyte furnished an excellent example of what could happen to this scarce commodity once it left the care of personnel specially trained to handle it. These shipments had been correctly handled all the way from the Zone of Interior to Leyte. When they reached Leyte, the bottles of blood were taken out of the insulated containers in which they had traveled up to that time, thrown into the backs of trucks, and transported for 4-5 hours over rough roads to the medical installations which had requested them. The temperature, as it frequently was, was 100° F. in the shade, the humidity was extreme, and it was possible to have mud on one's shoes and dust in one's eyes at the same time. These shipments were entirely unusable, and if this sort of handling had not been promptly corrected, the whole carefully worked out program would have been in a fair way to being wrecked and to being highly dangerous besides.

Areas in which the use of whole blood was a new experience, as the area just described, did not immediately comprehend the importance of refrigeration and of other precautions in the handling of blood. The practice was therefore instituted of sending a courier with the blood when the first shipments went to areas new to the program.

Transfusion teams.—On his return from his first trip to the Pacific, in August 1944, Colonel Kendrick recommended to The Surgeon General that a transfusion team be stationed at Saipan to handle blood drawn in the Zone of Interior, as well as to bleed donors if it became necessary to supplement the supply from this source. A second team should be stationed at some other strategic point, to be selected later, to function in the same fashion.

The proposal was accepted, and cadres for the teams were trained at the Army Medical Center and then placed on temporary duty at the Red Cross blood donor centers while they waited assignment to the Pacific. On 17 January 1945, arrangements were made with the Personnel Division, Office of The Surgeon General, to send them to Fort Lewis, Wash., to move them on higher priority than the theater requisition would allow.

Later in February 1945, Brig. Gen. John M. Willis, Surgeon, USAFPOA (U.S. Army Forces, Pacific Ocean Areas), was informed by Col. B. Noland Carter, MC, that such a low priority had been requested for these transfusion teams that there was little chance of dispatching them within the next 6 months. The request to nominate spaces for the officers and technicians of these teams on a theater troop basis had not been acted on by the POA, and it was therefore impossible to activate these units. Their training period had been extended by 30 days, in the hope of straightening out the difficulties. If arrangements for the dispatch of the teams could not be concluded within this period, there would be nothing to do but scrap them. If General Willis agreed that time was a factor, the theater could request that the officers and men who had been trained could be shipped as casuals, to act as cadres for newly formed units to be activated locally, but this, again, would require nomination of spaces on a theater troop basis.

These teams did not reach the Pacific during the war. When, however, the 317th General Hospital reached the POA, General Willis withdrew the blood transfusion personnel and sent them to the Marianas to form two transfusion teams, one for the Marianas and the other for Okinawa, because he did not wish to be entirely dependent on the mainland for the area blood supply.

Operational Factors

While the airlift of whole blood to Europe served as the pilot program, neither distances nor temperatures in that theater presented the handicaps that accompanied the airlift of blood to the Pacific areas (22). The distance from the mainland and the high temperatures in combat areas introduced three operational problems of extreme importance into the Pacific program: (1) transportation; (2) refrigeration; and (3) preservative solutions. All three factors were closely related. A break in any one of them would have made the whole program useless, and, if it had been persisted in, extremely dangerous.

Transportation.—Some 7,400 miles of travel were involved in flying blood from the laboratory at Oakland, Calif., to Leyte in the Philippines (map 6). The actual flying time was about 48 hours, but with stopovers at various points and rechecking at the advanced base on Guam, most blood was 4–5 days old when it reached Leyte.

The itinerary involved moving blood from the bleeding centers at San Francisco, Los Angeles and elsewhere to the naval laboratory at Oakland, where it was prepared for shipment (fig. 136) and whence it was flown to Pearl Harbor, a matter of about 12 hours. At Pearl Harbor, there was a stopover

ranging from 30 minutes to several hours, depending upon circumstances, during which time the blood was re-iced by the Naval Air Transport Service, whose personnel had received special training in its care. The blood was flown from Pearl Harbor to Guam, with brief stopovers at Johnston Island and Kwajalein in the Marshall Islands.

The facility at Guam (figs. 137 and 138) received all shipments of blood from the Zone of Interior. The bloods were placed in the refrigerators there within 15 to 20 minutes after the plane had touched down and were allowed to settle for at least 12 hours, to compensate for the agitation induced by transit and movement. After the bottles had been inspected for hemolysis, clots, and possible contamination, they were placed in the re-iced insulated boxes in which they had traveled from the Zone of Interior, and were shipped by planes of the Transport Air Group, according to requirements and requisitions, to:

1. Ulithi, 2½ hours' transport distance from Guam. The planes landed at Falalop Island, where the shipments were immediately transferred to designated fleet units. The liaison at this base with fleet personnel was excellent, and for this reason, and because a senior medical officer was in charge of shipments, the blood was usually in reefers afloat within 6 to 10 hours after it had left Guam. Two inspections of this base by Lieutenant Brown showed that all concerned with the handling of blood fully appreciated the requirements and the possible dangers of the program.

2. Peleliu, 5 hours' transport distance from Guam. Shipments were made by Transport Air Group planes to U.S. Naval Base Hospital No. 20 at this location as requested.

3. Tinian, 1 hour's flying time from Guam, to U.S. Naval Base Hospital No. 19.

4. Saipan, 1 hour's flying time from Guam. This island was a large Army outlet for hospitals and for further transfer to the Philippine Islands. Col. Eliot G. Colby, MC, Surgeon, Headquarters, Island Command, arranged for Lieutenant Brown to visit all hospitals on the island and to make contact with Navy personnel in order to explain the blood program to them. Also, the better to acquaint Army supply personnel on Saipan with the problems of the transportation of whole blood, Colonel Colby sent a technical sergeant to the base bank on Guam for instruction in the processing of blood for shipment to island bases and fleet units and for its care while it was in storage.

5. The Philippine Islands. From Saipan, blood was carried by Army Transport Command planes to Tacloban Airfield, Leyte, where a medical supply depot received the shipments and saw to their refrigeration and re-icing before distribution. Re-icing was essential, for a trip of 30 to 50 miles to forward area hospitals might require as much as 24 hours because of the rough, difficult terrain to be traversed.

Smaller amounts of blood were shipped to various islands as necessary and were cared for by Navy personnel who understood the requirements for refrigeration and storage.

Whole blood had a routine No. 2 priority in Army shipments and could employ a No. 1 priority when necessary. All shipments by Navy agents were by No. 1 priority. In his 4 July 1945 report from Base K (Leyte), Capt. Henning H. Thorpe, MC, Blood Bank Facilities Officer, recommended that a similar directive memorandum be issued to Army units, to give official recognition to the program of procurement and distribution of whole blood and in keeping with the combined Army-Navy function of the program (23). This suggestion was duly implemented.

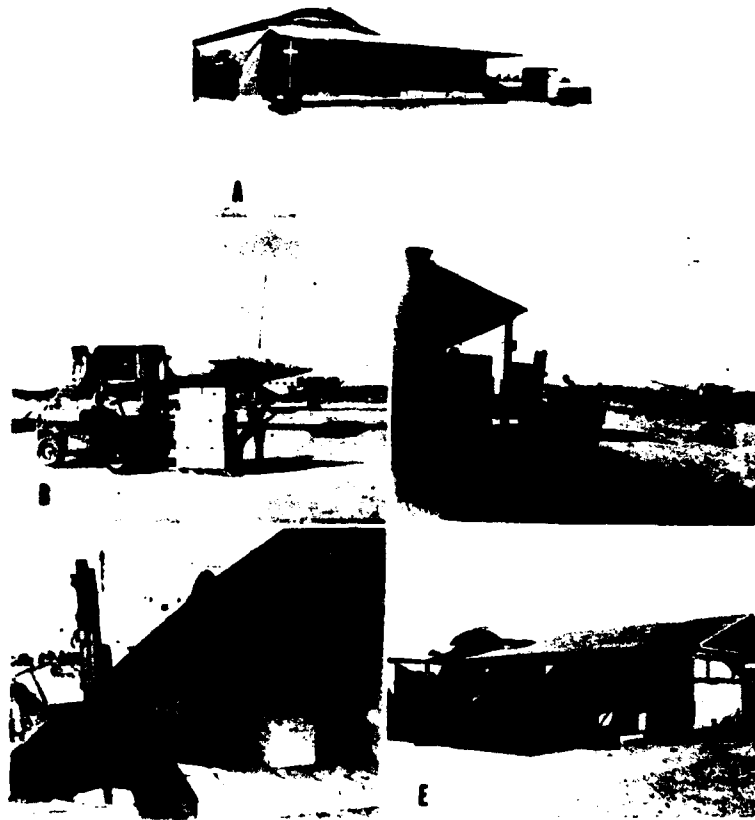

FIGURE 137.— Blood distribution center, Guam. A. Facilities on airstrip. B. Shipping cases of blood being loaded aboard C 54 for distribution to Pacific islands. C. Shipping cases received from mainland being brought to distribution center on Guam. D. Receiving platform. E. Shipping cases on platform.

While it might have been better if whole blood had been given a universal No. 1 priority, no criticism of its handling by transport agencies would be warranted. The cooperation of the Army and the Navy Air Forces was always superb, in all areas. They flew blood to combat units in medium bombers before transport planes could land on airstrips. In emergencies, they set up special flights to transport blood. There was not an instance in which blood was needed that it did not leave on the first aircraft available.

Refrigeration. In spite of the handicap of high environmental temperatures, transportation of blood to, and in, the Pacific was far more a matter of training personnel to observe the proper precautions than of equipment.

The ice chest used by the blood bank in New South Wales (p. 581) was a durable and efficient means of refrigeration. Its chief disadvantage, that it was not expendable and had to be returned to the point of origin, was a real

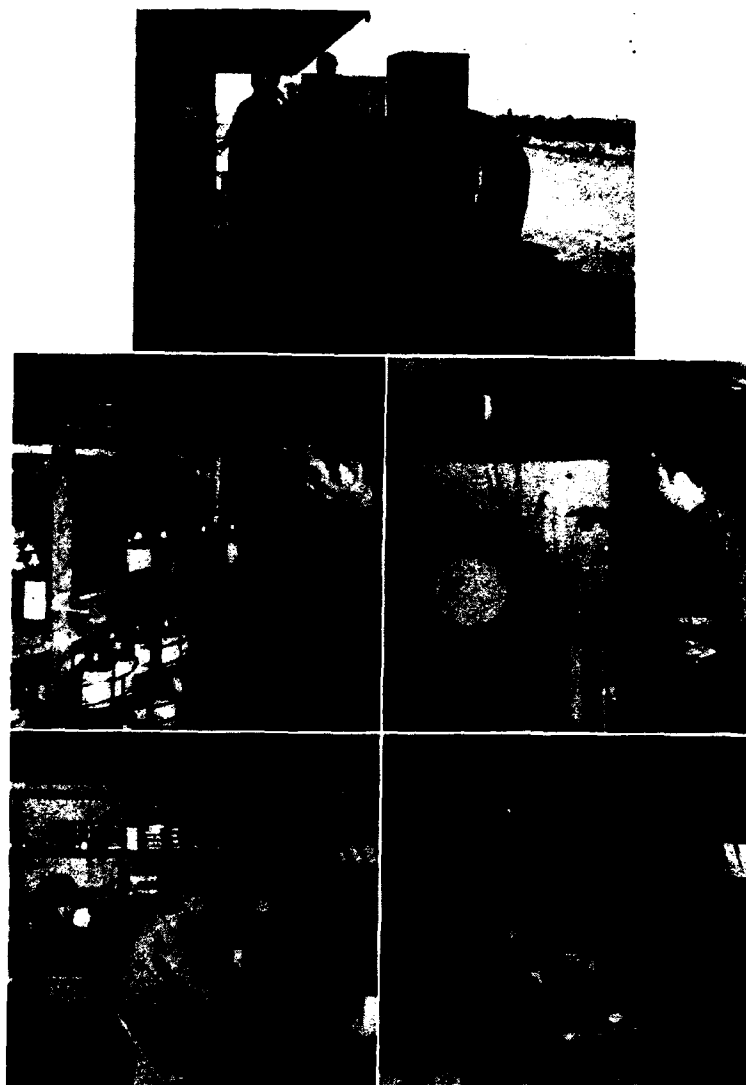

FIGURE 137.—Continued. F. Blood being transferred from shipping cases to walk-in reefer. G. Check of blood in refrigerator. H. Demonstration of equipment for blood distribution. I and J. Processing laboratory on Guam.

disadvantage in an area in which shipping space by land and air was always limited.

The chest developed by the Navy for the airlift of blood to the Pacific (figs. 139 and 140) was lighter than the Australian box and, more important, was expendable.

This chest, which had a hinged cover, measured 21 by 21 by 23 inches. It was made of $\frac{3}{8}$ -inch plywood and was completely lined with 3 inches of Fiberglas. A cardboard box that fitted into the outside box held two metal receptacles, one on top of the other, each 7 inches high and $13\frac{1}{2}$ inches in

diameter, and each fitted with individual metal racks for eight bottles of blood. In the center of the receptacles was a galvanized iron canister $5\frac{1}{2}$ inches in diameter and 14 inches high, with a detachable cover. It held 15 pounds of ice. There was thus no direct contact between ice and bottles of blood. The



FIGURE 138.—Movement of blood at distributing center on Guam. Lt. Herbert R. Brown, MC, USNR, second from left.

box occupied 5.9 cu. ft. of shipping space and, when it was packed with ice and blood, weighed 87 pounds. Testing had been rigorous, but no damage had been sustained by box or contents, even in parachute drops (fig. 141).

Bottles containing ACD (acid-citrate-dextrose) preservative solution were taken directly from the refrigerator to the donor's side. As soon as they were filled, they were placed in a refrigerator cooled to 40° to 45° F. (4.5° to 7° C.) and left there for about 8 hours before they were packed in the portable insulated box just described.

Under average environmental temperatures of 65° to 85° F. (18° to 28° C.), the temperature inside the box could be held to 42° to 45° F. (5.5° to 7° C.) for about 60 hours. When blood shipped from the west coast was re-iced at Pearl Harbor, a half to three-quarters of the ice placed in the box at Oakland was usually still present in the central compartment, and the inside temperature averaged 44° F. (6.5° C.). Lieutenant Blake's observations on a test shipment showed that temperatures within the chest were maintained at 45.5° to 48° F. (7.5° to 9° C.). Boxes not re-iced at Pearl Harbor but flown straight from Oakland to Guam had inside temperatures no higher than 50° F. (10° C.).

When blood was shipped out from Guam, it was replaced in the expendable Navy boxes in which it had been received. The central ice containers were packed with as much ice as possible, and forward installations, without refrigerating facilities, were instructed to re-ice the boxes every 24 hours; the importance of this precaution was emphasized to all units which received blood.



FIGURE 139.—Icing center containers of Navy shipping cases on Guam.

Under combat conditions, refrigerators were frequently not available, but daily re-icing of the expendable boxes proved an entirely satisfactory substitute.

In December 1944, requests were put in—and were filled—for the immediate delivery of three 375-cu. ft. refrigerators to the center on Guam. It was anticipated—as proved true—that current calls for blood would be greatly increased to meet peak loads of combat casualties and that thousands of pints of blood might sometimes have to be handled daily (18).

The standard field refrigerator was used for land transportation of blood.

Preservative solutions. The glucose preservative solutions employed by the Australian blood bank (p. 581) and by the Army bank at Hollandia limited the usable life of blood to 15 days, though permitting its use up to 20 days if refrigeration had been adequate at all times and if marked hemolysis had not occurred (23).

Alsever's solution, as noted elsewhere, was used for the European airlift as a matter of expediency, but its bulk made it undesirable clinically and highly undesirable for an airlift extending over many thousands of miles. The trial runs for the Pacific airlift, begun in September 1944, were made with ACD solution. Their complete success indicated that it would be entirely feasible to ship refrigerated whole blood to the Pacific in this medium. Colonel Kendrick reported on it as follows from his observations in December 1944 (20):



FIGURE 140.—Loading refrigerated Navy shipping containers with blood on Guam.

The ACD solution has stood all field tests in good order. As you know, I viewed the use of this solution with a critical eye because of the lack of clinical experimental work. Hemolysis has been minimal even with severe handling, heat, changes of temperature and terrible roads sometimes requiring 12 hours for delivery to a hospital. With proper refrigeration, ACD protects blood exceedingly well. A well recorded series of transfusions (700) showed a reaction rate of 1.7 percent, none severe, mostly urticarial. We have used a good many bottles after the expiration date, up to 30 days, with good results. Due to the difficulty of controlling supply and demand, some blood passes the expiration date and we hesitate to discard it. We have extended the expiration date to 24 days.

Colonel Kendrick also observed that a number of reactions could be traced to the use of locally prepared sets and did not seem related to the age of the blood.

Hemolysis and Dating Period

When Lieutenant Blake arrived on Guam on 19 November 1944, with 160 pints of blood from the Zone of Interior, it seemed wise to defer examination



FIGURE 141.—Lt. Herbert R. Brown, Jr., MC, USNR, holding blood dropped in test parachute drop on Guam. The insulated box in which the blood was dropped was used by the Navy during the airlift to the Pacific and later during the Korean War.

of the bottles for hemolysis, clots, and other abnormalities until the blood had settled. Behind the blood was a long air trip, and ahead, over roads under construction, was the trip to Naval Base Hospital No. 18. The practice of delaying examination for 12 hours or more after the arrival of the blood immediately became routine.

It was soon evident, however, that bottles of blood that would show hemolysis at all would show it on their arrival on Guam, where they could be detected on screening and could be removed from further shipment. It was not desirable to handle blood any more than necessary, but the World War II experience showed that the red cells, for the most part, tolerated transportation without hemolysis. None appeared even when a full box, containing 16 pints of blood, was dropped by parachute from a height of 800 feet. Another experience was even more significant: Because of the sudden cancellation of a flight while the base bank facility was still located at U.S. Naval Base Hospital No. 18 on Guam, 160 pints of blood intended for an outgoing shipment, which had been

transported 35 miles over poor roads under construction, had to be returned to the reefers. When it was checked 12 hours later, before reshipment, none of the bottles showed any hemolysis and all were considered safe for shipment to Leyte.

The dating period in the Pacific for blood preserved in ACD solution was 21 days after it had been drawn. On numerous occasions, in extreme emergencies, it was used as late as 30 days. Much of it was in excellent condition at this time, and if the war had continued, there seems little doubt that the dating period would have been extended to 28 days, at least for blood that did not have to travel beyond Guam.

ADVANCE BASE BLOOD BANK FACILITY NO. 1

Location

The naval medical officer in charge of the advance base blood bank facility on Guam, Lieutenant Brown, arrived at his post on 17 November 1944. His assistant, Ens. (later Lt. jg) George E. Nicholson, HC, USN, arrived on 21 November 1944 (18, 22, 24).

The day after Lieutenant Brown arrived, the blood bank was set up temporarily at U.S. Naval Base Hospital No. 18, where a 675-cu. ft. refrigerator and an icemaking machine were available. As a temporary arrangement, no fault could be found with this location, but it was evident from the arrival of the first shipment of blood from the Zone of Interior, which Lieutenant Blake brought in 48 hours after Lieutenant Brown had arrived on Guam, that it would not be satisfactory for blood that was to arrive by air and later leave by air over several different military transport systems. The hospital was about 17 miles from Agana Airfield, and transportation would not only be inconvenient but would subject the blood to unnecessary trauma.

The logical location for the blood bank was at the airfield, but the move to it could not be made until 8 December, because the necessary refrigeration was not available. On this date, a 65-cu. ft. refrigerator was secured on loan, and the bank was temporarily located in a large airfreight terminal. The temperature in the refrigerator was maintained at 40° to 45° F. (4.5° to 7° C.) with difficulty because of the heavy demands and the high humidity, and, as a result, the unit had to be defrosted with inconvenient frequency.

When the blood bank finally moved to its permanent facilities at Agana Airfield, the wisdom of the move was immediately apparent. The base communications center was nearby, as were the operational offices of the Military Transport Services. As a result, blood could be delivered with great rapidity. On one occasion, when Lieutenant Brown was on Saipan, visiting the various units afloat and surveying their needs, he sent an operational priority dispatch to Guam for 1,200 pints of blood, with the request that it arrive before dark, as the ships that needed it were sailing that night. The blood depot at Guam received the message through the Port Surgeon's Office at 1300 hours. Planes

with blood aboard left at 1400 and 1500 hours. When the blood arrived at Saipan, at 1600 hours, it was loaded onto an Army reefer truck, taken to the dock area, placed on an LCM (landing craft, mechanized), and by 1900 hours was in the refrigerators of the ships that were leaving at midnight.

As experience increased, the location of the blood bank became even more important. In March 1945, when the possible need for another blood depot came under discussion, Lieutenant Brown stated that, while the location of such a center would depend upon the tactical situation, it could not be emphasized too strongly that the operational efficiency of a blood distribution center depended upon its immediate connection with a large airbase, where emergency requests could be handled immediately. Hospital connections were not necessary.

Notification of Needs

The blood depot on Guam supplied the urgent needs of the latter part of the campaign on Leyte to the limit of transportation and storage facilities. It also supplied other units of the Army and the Navy ashore and afloat within a radius of 1,100 miles. Hospitals in the Marianas depended entirely on Guam for their large demands for blood. A moderate backlog of blood was maintained in all these hospitals, and cooperation concerning notification of needs was excellent.

All hospitals were informed that a notification of at least 10 days was required for any increase in operational demands, and a notification of 4 to 5 days for emergency requests. Requests for blood were made from Guam to the 12th Naval District in San Francisco, whence they were cleared to the blood donor service. It took about 7 days for donor centers on the mainland to step up their collections to meet increased demands in the Pacific. It was therefore necessary for hospital installations to anticipate their needs and notify the distribution center on Guam, through channels, well in advance of the time the blood would be needed. All requests were on the basis of 1 pint of blood per casualty.

The amount of blood handled through Guam greatly increased as operations were extended to Luzon, and then to Iwo Jima and Okinawa. Between 19 November and 24 December 1944, 6,480 pints of whole blood were received and 5,040 pints were distributed. In February 1945, 16,608 pints were received and 16,563 distributed. On several days during the month, 1,000 pints daily were handled, particularly during the final staging for the Iwo Jima operation. In April, 25,760 pints were received and 30,177 pints, including the excess from March, were distributed (24). Early in the month, it was necessary to distribute the accumulated blood and reduce the supply from the Zone of Interior. Later in the month, the requests to the Zone of Interior had to be increased because of increased demands from the Philippines and a considerable increase in the Okinawa requirements.

LEYTE

Planning

It was expected that, as the fighting in the SWPA increased in intensity and advanced from New Guinea to the Philippine group, the Japanese would begin to use field artillery of higher caliber, with greater frequency, and that bombing from the air would be heavier and more constant. Since wounds produced by shell and bomb fragments cause shock, hemorrhage, and extensive tissue destruction, ample amounts of both plasma and blood would be necessary. Supplies of plasma furnished no problem; they were always ample, and they were used intelligently.

The Leyte operation was the first in which combined Army and Navy blood banks were used and in which blood was supplied in the first stages of the operation. In general, the plan employed was that recommended to General Denit by Colonel Kendrick, with Captain Newhouser's concurrence, on 19 July 1944 (p. 591). It involved (map 4):

1. The transportation of blood from Sydney to Finschhafen.
2. The establishment of a blood bank at Hollandia.
3. The establishment of a blood bank aboard LST 464 which had been converted into a hospital ship.

The recommended blood bank was set up aboard LST 464, with Lieutenant Muirhead in charge. Its supplies were supplemented by the 27th General Hospital, which began to function as a blood bank on 9 September 1944. By 9 October 1944, plans for the initial supply of whole blood for the Leyte invasion and its maintenance had been agreed upon by representatives of the Sixth U.S. Army (fig. 142), the Medical Supply Section, USASOS, and the Seventh U.S. Fleet.

The blood supply was planned and reported in ETMD (Essential Technical Medical Data) as follows (25):

1. The task force would take 200 liters of blood ashore with it, for use on the beaches. Between D+5 and D+7, 400 additional units of blood would be shipped from Base G (Hollandia) on the 10 returning LST's, for delivery by the Sixth U.S. Army medical supply depot on shore to Sixth U.S. Army medical units.
2. Thereafter, blood would be shipped automatically by the Base G medical supply depot on LST's at the rate of approximately 200 units every 5 days until D+20. These amounts would be varied only on radio instructions from the Sixth U.S. Army to the medical supply depot on Base G. On such instructions, the blood would be flown to Leyte via Biak, where 100 liters was kept as a pool. The first blood for the pool would be brought by an LST which would leave Base G on D+6.
3. LST 464, converted to a hospital ship, would arrive on the beach on D+4, with 100 liters of blood. This ship was equipped to collect and process blood, and it was expected that enough donors could be secured from troops on the beach to provide ample amounts for LST 464 and other LST's caring for casualties. These LST's were located in the harbor at intervals of 1,000 to 2,000 yards apart.
4. LST's arriving in the harbor on D+2 and D+21 would each bring 100 liters of blood.



FIGURE 142.—Col. (later Brig. Gen.) William A. Hagins, MC, Surgeon, Sixth U.S. Army.

Implementation of Planning

In general, the plans just described were implemented in the Leyte operation, which began on 20 October 1944. Plasma was used extensively, and the supply was adequate at all times. Its value in burns and in shock without hemorrhage was indisputable, but it was proved again that it was a supplement to, and in no sense a substitute for, whole blood in hemorrhage and that its use might, indeed, give rise to a false sense of security.

On D-day, two 200-cu. ft. mobile reefers, each containing a thousand 500-cc. units of blood, were put ashore on the beaches in which combat activity was greatest. The blood was well used, but it was evident in retrospect that even greater quantities should have been supplied. Multiple transfusions, for instance, often could not be given. Moreover, since whole blood had not been available in previous combat except as it was obtained by on-the-spot donations, some organizations apparently remained ignorant of its ready availability in this operation. Steps were taken to avoid this error in future operations.

Casualties brought to LST 464 received excellent shock treatment and preoperative preparation. Blood was taken from each patient for hemoglobin,

hematocrit, and protein estimations, and replacement therapy was based on the findings. This was the first time the combined facilities of Army-Navy blood banks were used in the initial stages of an operation, and cooperation was excellent.

LST 464, in addition to treating casualties, drew blood and acted as a blood bank for the 7th Amphibious Force. The great advantage in the use of this particular LST was that she acted primarily as a hospital ship, not primarily as a cargo ship and only secondarily as a hospital ship, after the cargo was unloaded. She was therefore able to remain on station in the harbor and was available for medical service at all times.

LST 464 also received blood from the depot at Biak via the LST's returning to Leyte after taking casualties to Biak. Each convoy scheduled for Leyte, as already noted, received additional stores of blood to take back.

The landing at Leyte presented a problem in the care of casualties not encountered in any previous operation; namely, the bombing attacks on all ships in the harbor, including hospital ships, by Japanese suicide planes. Large numbers of casualties continued to occur in the harbor for 38 days and provided the strongest possible indications for the liberal use of whole blood. They had to be treated aboard ship. It proved impractical and inefficient to take them ashore for treatment because of poor communications, difficulties in beaching, inadequate facilities, poor roads, and lack of transport. The risk of keeping hospital ships on station in the harbor was too great, in view of the indiscriminate bombing, and the problem would have been insoluble without the presence of LST 464 and other LST's.

Blood From the U.S. Airlift

In all, about 3,000 units of preserved whole blood were used during the first 30 days of the Leyte campaign, including blood from the 27th General Hospital bank at Hollandia, from the relay depot at Biak, and from LST 464. Arrangements had been made to have additional supplies of blood flown from the Australian blood bank at Sydney if it should be necessary to supplement the blood provided for at the beginning of any large operation.

Up to 22 November 1944, all of the blood used in the Leyte operation was provided by the plans worked out by Colonel Kendrick in July 1944. On the twenty-second of this month, Lieutenant Blake, representing the Army, the Navy, and the American Red Cross, arrived on Leyte with 80 pints of whole group O blood which had been flown from San Francisco via Guam. This was the first blood to arrive from America and it represented a turning point in the transfusion service in the Pacific. With greatly increased supplies available, greatly increased use of blood was possible, and plasma assumed its proper role in replacement therapy as a supplement to whole blood, not as a substitute for it.

Between 19 November and 24 December 1944, 4,256 of the 6,480 units of whole blood received on Guam went to Leyte (22).



FIGURE 143.—Lt. Col. Frank Glenn, MC,
Consultant in Surgery, Sixth U.S. Army.

LUZON

Planning

The Leyte operation, as already indicated, was the first combined Army-Navy whole blood project, and in retrospect, for a number of reasons, it seems that it could probably have been handled more efficiently. The operation on Luzon was handled better, for two chief reasons:

1. Information concerning the blood supply was well disseminated. Through the efficient cooperation of Maj. (later Lt. Col.) Frank Glenn, MC, Consultant in Surgery, Sixth U.S. Army (fig. 143), Colonel Kendrick was able to present the blood program in detail to the senior medical officer, Navy; representatives of the Surgeon, Sixth U.S. Army; base and other surgeons; and a number of other medical officers with special interest in the use of blood. At this meeting, he was able to demonstrate to these officers that they could have all the blood they needed from the Zone of Interior and that it would be delivered according to their requests if they merely made the requests.

2. Colonel Kendrick had encountered, during his stay on Leyte, a well-trained pathologist and fine medical officer, Captain Thorpe, who, with totally inadequate resources, had done remarkably good work in supplying the Sixth U.S. Army with blood. When he came into the Zone of Interior program, most operational difficulties were cleared away.

In the month Colonel Kendrick spent with the Sixth U.S. Army, he was able to work out a blood program for the invasion and to arrange for the delivery

of blood from Guam according to estimated needs from D-day onward, as follows (26):

1. A responsible officer, either MC or MAC, would be designated in the Sixth U.S. Army to be in charge of the blood bank. He would be adequately assisted by enlisted men and would have the sole responsibility for the operation of the blood bank.

2. Equipment would consist of four 220-cu. ft. reefers with a capacity of 1,600 to 2,000 bottles of blood; one vehicle to take blood from the beach to the airstrip to the distribution center; and an ice machine.

3. Beginning on 30 December 1944 (D-day on Lingayen Gulf, Luzon, was set for 9 January 1945), 300 to 400 pints of blood would be requisitioned daily from the States. The four reefers to be used could accommodate 700 to 800 pints each, but for the M-1 (Luzon) operation, only 400 to 500 pints would be stored in each. The reefers would be dispersed on LST's, so that they could be put ashore as soon as the military situation permitted. On shore, one reefer would be placed behind each division, but as soon as the tactical situation permitted, all four would be brought together, to serve as a central distribution facility. The officer in charge would be responsible for stocking the reefers at the mounting point of the invasion with blood sufficiently fresh to arrive at the target area within the usable time limit.

4. The requirement of 1,600 pints of blood for the Sixth U.S. Army was based on the number of expected casualties and was in addition to the quantity requested for the Navy. The needs of both services for the first 4 days of the operation were set at 3,500 pints. To meet these requirements:

2,400 pints would be shipped from the States.

500 pints would be shipped from the blood banks at the 27th General Hospital in Hollandia and the 9th General Hospital, which then would be serving as a blood bank on Leyte.

600 pints would be collected locally by LST 464.

5. After the first 5 days of the operation, blood would be supplied from Leyte to the target by LST's or other ships leaving Leyte for Luzon. Blood would be flown in as soon as an airstrip was secured. The blood bank officer would be responsible for developing the line of supply and receiving the blood upon its arrival at the target.

6. If reefer space was limited, the racks containing the blood could be stored without the insulated boxes. The boxes, which contained the giving sets, must be taken aboard the LST's, and the blood must be replaced in them before landing, to keep it cool during its distribution.

A supply of ice to refrigerate the insulated boxes might not be available early in the assault. If this happened, the blood must be delivered directly from the reefer to the using hospital. The ice machine, with a capacity of 800 to 1,000 pounds per day, must be placed ashore and made available to the distribution team at the earliest practical time.

7. On 23 December 1944, the Navy estimated its requirements as 1,200 pints of blood at the mounting area on 3 January 1945; 700 pints on 4 January 1945; and 500 pints on 6, 9, 14, and 20 January. The LST 464 would bring in 1,200 pints for use on D-day and D+1, and would serve as a distribution point for other ships receiving casualties or acting as transports for casualties.

This plan did not include the whole blood supply to convoys departing from Hollandia, Aitape, Noemfoor, and Sansapor, nor did it include the resupply of blood for hospital ships bringing casualties to New Guinea bases. All blood for these purposes would be supplied by the blood bank at Hollandia and the depot at Biak. If the ships departed from Hollandia, the blood would be placed aboard them there. Blood would be flown from Hollandia to Aitape and to Noemfoor for the convoys departing from those points. Blood for

convoys leaving Sansapor would be flown from the depot at Biak. Convoys which left Leyte would carry blood from the Zone of Interior.

Implementation of Planning

The scope of the amphibious landings on Luzon was so vast that it was impossible to set up a central distribution point, and the arrangements just outlined had to be substituted. The blood was placed aboard ship just before the convoys departed. All clearing companies, portable surgical hospitals, field hospitals, evacuation hospitals, hospital ships, and cargo LST's with medical officers aboard had fresh refrigerated whole blood with them when they left for the target.

At the beginning of the Luzon operation, equalization of supply and demand furnished something of a problem, which disappeared when better liaison was established between the mainland and forward areas (27). By the end of January, blood was being received at Leyte that still had 17 days of life. It was therefore possible to forward the blood by ship and have it received on Luzon with several days of life still left in it.

The first blood was flown into Luzon from Leyte 12 days after the invasion, by medium bombers, before transport planes could land (18). The Luzon experience suggested that in future operations it might be wise to plan that ships and LST blood banks supply forces ashore for about 14 days; after that time, air transportation could be relied on.

When the system was finally established smoothly, it was considered ideal (28). Blood shipped from Guam on requisition went to Tacloban, on Leyte, where Captain Thorpe screened each shipment before it was placed under refrigeration. Blood for local distribution was stored in a 350-cu. ft. refrigerator at the 34th Medical Depot. Blood for Luzon was placed in a stationary refrigerator, provided by the Quartermaster Refrigerator Co., whose 4,300-cu. ft. capacity assured a minimum temperature change when the door was opened. The temperature was maintained at 38° to 43° F. (3.5° to 6° C.). Three refrigerating units were used, so that, if one failed, the others could operate while repairs were being made.

Before the blood was placed in the refrigerator, each box was opened, the blood was examined, and the amount of ice in the cylinder was noted. The expiration date of the blood was written on the outside of the box. The blood was refrigerated with the lid of the box propped open, to allow the temperatures inside and outside to equalize and thus to insure a stable temperature while the icebox doors were opened and closed. Each box was re-iced before issue.

Supply was controlled by radiogram to the Island Command, Guam. The bank at Leyte operated on a 24-hour basis for distribution, and arrangements were made with the signal center that all messages concerning blood were reported immediately, by phone, to the bank. Shipments could thus be moved at once. Radio notification of the arrival of the blood, and the use of couriers whenever there might be any delay en route or at the receiving end, insured

the arrival of the blood in good condition because refrigeration had been maintained and the boxes re-iced as necessary during transportation.

When necessary, emergency items were requested by radio or telephone and were dropped over the frontlines, often within a matter of minutes, from artillery liaison planes. Recovery was almost 100 percent satisfactory, and even such delicate items as plasma and blood were received in good condition (29).

Plasma was in ample supply and well used (figs. 127-131). The first direct issue of blood in the Manila area was by the 15th Medical Supply Platoon (Aviation) on 11 March 1945. The initial supplies were obtained from Leyte via Base M (San Fernando, La Union). Later shipments were made directly from Leyte to the Nielson Airfield in Manila.

The average daily issue during March to units in the area was 125 pints (30). During April, the daily issue ranged from 160 to 175 pints, and, for the next 3 months, it averaged 175 pints. When casualties began to drop as heavy fighting on Luzon ceased, any blood not utilized before the expiration date was transferred to the Philippine Island Civil Affairs Unit, for use in civilian hospitals. All blood supplied during this period originated in the Zone of Interior.

IWO JIMA

The Iwo Jima operation, which lasted from 19 February to 16 March 1945, was a Navy-Marine operation (18, 31).

OKINAWA

Planning

When Colonel Kendrick was appointed Consultant in Blood and Shock to Col. Frederic B. Westerfelt, MC, Surgeon, Tenth U.S. Army, on 14 March 1945, it was only 5 days before the Army sailed for the invasion of Okinawa. Little additional planning was possible at this time, but he was able to see that the ships that went to Okinawa from Saipan were loaded with all the blood likely to be needed for the first stage of this operation, which was an Army-Marine responsibility.

The plan for supplying blood for the Okinawa operation, which was incorporated in the III Amphibious Corps Administrative Plan No. 1-45, Annex Easy, was in essence as follows:

1. The Distribution Center at Guam would stock AH's (hospital ships) with suitable quantities of whole blood and would also stock LST 929, which had been designated for medical use by the Commander, Joint Expeditionary Forces.
2. APH's (transports for wounded) and APA's (transports, attack) were scheduled to arrive at the target within the usable limits of the blood carried on the other ships.
3. At the target, LST 929 and AH's would act as a local distribution center for APH's, APA's, PCE(R)'s (patrol craft, escort (rescue)), and LST's used for evacuating casualties. They would also supply blood for the medical units ashore.

4. As soon as practical, a temporary whole blood distribution center would be established ashore and would take over the distributing functions of LST 929 and AH's which had been used for this purpose.

5. The distributing center on Guam would supply the distributing center ashore with adequate quantities of blood by air or by fast surface transportation. When hospitals were established, they would receive their blood by air.

6. Personnel, refrigerators, flake ice machines, and other equipment would be supplied to the temporary distribution center and LST 929 by ComServPac (Commander, Service Force, Pacific). Personnel and equipment would be taken ashore in assault shipping as soon as the landing force commander could arrange their transportation.

Implementation of Planning

The plans worked out perfectly. The Fleet drew its whole blood supply in mid-March; some of it was due to expire late in March and the remainder at various dates in early April. In the event that resupply would have been necessary before regular channels of supply could be opened, 75 bottles of blood were prepared to be dropped by parachute at some one of the Fleet refueling stations. This did not prove necessary, though preliminary tests at Agana Bay had proved that this method of delivery was entirely practical and did not harm the blood dropped.

Blood was brought into the target area by eight AH's, LSV-6 (landing ship, vehicle), and AGC-4 (amphibious force flagship), the U.S.S. *Ancon*. The LST(H) 929 (landing ship, tank (casualty evacuation)), designated as the distribution center afloat, arrived at the target on L-day. Because it was a slow ship, it brought in no blood, but it received blood at once from LSV-6 and the U.S.S. *Solace* (AH). Additional AH's arriving at 2-3 day intervals brought in about 1,700 pints per ship. Any excess over the needs of the casualties on the AH's was transferred to the LST(H) 929, which distributed blood to the seven other LST(H)'s and the numerous APA's which had arrived.

LST 929 continued to act as the distribution center afloat until L+15, when the blood distribution team set up by Colonel Kendrick was able to go ashore and begin to function. Its arrival at the target had been delayed because the ship on which it had been transported was damaged by a suicide dive bomber and could not be unloaded at once. During this period, the XXIV Corps received all the blood it needed from LST(H) 929 which was lying off Beach Orange 2 in close proximity to it. Blood was supplied to the III Amphibious Corps during the same period by transfer of blood from LST(H) 929 to LST(H) 951, which was conveniently located off Beach Yellow 2, near Corps headquarters. When the III Amphibious Corps advanced north on Okinawa, blood reached it from this LST(H), which went up daily to evacuate casualties.

By L+20, about 12,900 pints of blood had reached the target by surface carrier. Approximately 3,200 pints were retained aboard AH's, LST(H)'s, and APA's for their own use.

The first blood, 200 pints, received by air, arrived on Okinawa on L+17. The distributing center ashore (fig. 144) was set up at Yon-tan Airstrip, where

it operated with two 150-cu. ft. refrigerators, equipped with generators. Daily shipments from Guam (200 pints) were received from Guam after L + 18.

The original plans called for the provision of 6,000 pints of whole blood for the target on Love Day and the delivery of another 3,000 pints by hospital ship during the first week of the campaign. The course of events made clear the importance of the control of blood by trained personnel if wastage was to be



FIGURE 144. General view of blood distribution center, U.S. Navy, off Route No. 1, Okinawa, July 1945.

avoided: The casualties in the first days of the Okinawa operation were unexpectedly low. As a result, only 3,000 pints of blood were needed, and the resupplies planned for this period were not needed at all. A small amount of blood was lost, but most of the 3,500 pints involved were saved. Several of the ships to sail with blood from Ulithi were not dispatched because they were not needed. A medical officer sent to Honolulu to investigate local needs found that most of the blood on which the dating limit was due to expire could be utilized there.

The initial slow pace of the campaign made it possible for Colonel Kendrick, accompanied by Col. George G. Finney, MC, Consultant in Surgery, Tenth U.S. Army, Lt. Col. (later Col.) Harold A. Sofield, MC, and Col. Walter B. Martin, MC, to make daily trips ashore for indoctrination purposes. The circumstances were peculiarly propitious: The Japanese had retreated south as the landings were made, and it was a week before real resistance was encountered. During this interval, it was therefore possible for these officers to visit every field and evacuation hospital ashore, whether Army or Navy, and to pass on to the hospital staffs all the available information about the use and handling of whole blood, including the information Colonel Kendrick had secured in the Mediterranean and European theaters about its correct use in battle casualties. The discussions covered careful triage at the field hospital level after adequate resuscitation (figs. 145, 146, and 147), the physical arrange-



FIGURE 145. Administration of plasma to officer wounded by Japanese sniper, Okinawa, April 1945.

ments of a shock ward (p. 707), the employment of shock teams, and the establishment and observance of a routine of surgical management. When the hard fighting started, the medical officers responsible for the care of battle casualties were well trained in resuscitation procedures and in the use of whole blood.

The daily distribution of blood ashore varied from 5 cases originally to 59 cases. As soon as needs began to increase, the center at Guam was requested to ship 1,000 pints immediately, to provide for a backlog in case of bad weather. As the operation progressed, it was necessary to increase the requisitions to 750 pints per day. Between L - 39 and L - 42, 2,336 pints were used.



FIGURE 146.—Administration of plasma to soldier wounded on Okinawa, 7th Division, May 1945.

Shock Teams

Because large numbers of casualties were anticipated in the Iwo Jima and Okinawa operations, shock teams were used in numerous hospitals. The team attached to the 148th General Hospital was organized on 26 February 1945, on Saipan. It consisted of five medical officers, two nurses, and four enlisted men, so assigned that the team was on duty around the clock. Two of the enlisted men were trained to perform venipunctures.

The shock center was located in a small quonset hut. Refrigerated blood was stored conveniently near it, in a large reefer. Equipment was generally sufficient, but motorized transportation would have saved time because of the extent of ground occupied by the hospital.

All casualties were treated by a regular shock routine, which included immediate determinations of hemoglobin and of the hematocrit and plasma protein values by the copper sulfate technique, which was generally used in the Pacific as soon as it became available. These results were entered on a mimeographed form that bore the patient's name, serial number, and ward assignment and that was checked in the shock center before it went to the ward. If the hematocrit level indicated the need for blood, the center notified the ward officer and provided the proper amount. If, however, a casualty seemed clinically in need of blood, the ward officer, without waiting for the laboratory results, phoned the information to the shock center, which provided the transfusion.



FIGURE 117.— Administration of plasma to wounded infantryman on Okinawa, April 1945. A cigarette was often an essential part of resuscitation.

In order to save time and avoid unnecessary repetition of venipunctures, each ward officer gave the shock center each morning a consolidated requisition for the estimated blood and other intravenous fluid needs of all his patients for the next 24 hours.

During the Iwo Jima and Okinawa campaigns, between 24 February and 13 August 1945, the shock team at the 148th General Hospital handled 3,767 patients, who received 4,748 pints of whole blood. The 164 reactions averaged 4.3 per patient and 3.0 per transfusion. Of the 5,412 pints of blood received, 664 had to be discarded because of excessive lipoid content, clotting, overdating, and technical difficulties of administration.

The smooth functioning of this well-organized shock team played an important role in the low mortality rates achieved in both the Iwo Jima and the Okinawa campaigns.

Critique

In his report to General Willis on the blood program for the Okinawa campaign, Colonel Kendrick made the following comments:

1. Overall planning was practical and effective. Shipment of blood by surface carriers provided adequate supplies for the initial phase of the operation. Reefers and an ice-manufacturing machine on LST(H) 929 enabled this ship to act as a distribution center for units afloat and ashore.

2. The LST(H) 929 arrived at the target area without its own supply of blood because its slow speed would have made the blood outdated before its arrival. It had to draw its

supplies from other ships before it could begin to function as a distribution center, and this delay, which made the LST(H) 929 dependent on other ships, was responsible for some delay ashore.

3. APH's and APA's were stocked with varying quantities of blood at the assembly point, and certain other ships were also well stocked. All of these ships could have drawn blood, as they needed it, from LST(H) 929, and it would be advisable to use this plan in future operations.

4. The plan called for AH's as well as LST(H) 929 to act as distributing centers for other ships. The AH's carried sufficient blood for this purpose, but no personnel had been designated to act as distribution teams or to keep adequate records of issues of blood. Local distribution could be accomplished with less confusion if some designated LST acted as the other floating distribution center and was made responsible for issues of blood and records of receipts and distribution. If the shoreline in a future operation should be long, another LST could be designated as a subdistribution ship, to supply half of the beachhead, but not to supply other ships. Because of this possible necessity, two LST's should be provided with reefers and ice machines. At Okinawa, LST 951 supplied the III Amphibious Corps and served as a supplementary distribution center.

5. The blood distribution team was delayed in going ashore because the U.S.S. *Achinar*, on which it traveled, sustained bombing damage. Since the team was not brought in on the LST(H) 929, it provided no support for the distribution activities on that ship. Hereafter, team and equipment should be transported on the LST which is to serve as a distribution center, or on one of the LST's which accompanies it, so that the team can maintain complete control of blood distribution afloat and ashore, part of the team remaining afloat on the LST until the distribution center ashore is functional.

6. Considerable confusion was caused in medical installations ashore by lack of knowledge as to where blood could be obtained. In future operations, instructions should be given by each corps to its medical installations concerning the location of the distribution center afloat. The officer in charge of the blood distribution team should notify each shore part of the location of the floating center and the availability of blood from it.

7. The LST(H) 929 did not have facilities for delivery of blood to the beach when signaled by the shore party.

8. The equipment brought ashore by the distribution team was not completely adequate. The ice machine could not be used because accessory parts were lacking. There was no provision for water for manufacturing ice and for removing latent heat. Water tanks, piping, a water trailer, a water pump, and other supplies could be obtained from Island Command and NCB's (Navy construction battalions) before the center ashore could make its own ice. In the meantime, it had to obtain its ice from LST(H) 929. An ice machine with accessory cooling system should be available for immediate use in future operations.

Another 2½-ton 6-by-6 truck to transport a third 150-cu. ft. reefer and a 250-gallon water trailer should be made part of the equipment of distribution teams.

9. While a distribution team proved entirely capable of functioning as a blood supply point under the supervision of a hospital corps officer, it was considered imperative that a medical officer be responsible for the proper care and use of blood. He could be in charge of the team or attached to the medical section of the Landing Force Commander's headquarters. The second arrangement would be more desirable, for it would give the officer more latitude in advising on the proper use of whole blood.

Colonel Kendrick made recommendations to cover these various points and also recommended:

1. That the personnel of all medical installations assigned to an amphibious task force be instructed before departure in the principles and practices relating to the treatment of shock and the proper use of whole blood.

2. That each field hospital supporting amphibious operations have attached to it four shock teams, each consisting of a medical officer, a nurse, and two enlisted men. It would thus be possible for two teams to be on duty each 12 hours.

TERMINATION OF AIRLIFT

As the campaigns in the Southwest Pacific decreased in intensity and then were concluded, the quantity of whole blood needed and used decreased correspondingly. The blood bank at Hollandia and the depot at Biak were closed at the end of 1944, since planning for the invasion of Japan was predicated on procurement of the major supply of blood from the Zone of Interior (p. 639).

The abrupt end of the Pacific war on 14 August 1945 caused an equally abrupt change in the transfusion service. On 5 September 1945, the commanding generals of all base areas and commands were notified by Colonel Dart, Deputy Chief Surgeon, U.S. Army Forces, Western Pacific, that shipments of whole blood from the Zone of Interior would be discontinued on or about 15 September and that thereafter blood must be obtained from local sources (32). A blood bank had been established at the 19th Medical General Laboratory in Manila to supply blood for hospitals in the Philippine Islands and would begin to function on 15 September.⁶ Instructions were given for the procurement of blood from this source. The dating period for properly refrigerated blood was set at 30 days. If a hospital needed only small amounts of blood, it should collect it from local donors. Attention was called to the technical instructions on the storage and administration of blood contained in Circular Letter No. 38, Office of the Chief Surgeon, USAFPAC (U.S. Army Forces, Pacific), dated 20 August 1945 (33).

The plan worked out very well. After shipments from the Zone of Interior ceased, the blood bank at the 19th Medical General Laboratory in Manila took care of the initial needs of the army of occupation and supplied the needs of all U.S. hospitals in the Philippines as long as they were in operation. The absence of opposition in Japan and adjoining territories soon relieved the blood bank of the necessity of supplying blood for the armies of occupation.

STATISTICAL DATA

An accurate statistical analysis of the whole blood program in the Pacific is almost impossible because of the circumstances under which many, perhaps the majority, of transfusions were given. The figures to be cited should therefore be viewed as representing trends correctly but not accepted as precise data.

Supplies From the Zone of Interior

Final figures from the American Red Cross show the following shipments of whole blood, group O, to the Pacific (17):

⁶ Although the delayed arrival of the 19th Medical General Laboratory made it impossible to use it for blood bank purposes, as had been planned, it served as a blood bank in Manila both before and after the Japanese surrender.

	<i>Amounts in units</i>
<i>1944</i>	
November 16	1,667
December	8,265
<i>1945</i>	
January	10,575
February	20,576
March	29,215
April	24,842
May	41,558
June	22,505
July	8,029
August	11,604
September 15	2,719
Total	181,555

The wide variations in the monthly amounts, which reflect the varying intensity of fighting, made for difficulties in maintaining collection schedules in the Zone of Interior. The remarkable accuracy of the estimates, however, is evident in the April 1945 report of the distributing center on Guam (24): In that month, it was necessary, for the first time, to distribute excess supplies of blood to general and other hospitals in the bases, instead of sending it forward to combat zones.

Oversea Supply and Distribution

The following general data, which are incomplete and inaccurate because of the circumstances (p. 455), are available for the supply and distribution of blood in the Pacific:

4,260 units (2,130 liters) to U.S. Army bases in New Guinea and the Philippine Islands by the Australian Red Cross Blood Transfusion Service between January 1944 and February 1945 (p. 586).

2,597 units to U.S. bases in New Guinea, the surrounding islands, and the Philippine Islands by the whole blood bank at the 27th General Hospital, Hollandia, New Guinea, between September and December 1944.

88,728 units to U.S. bases in the Philippines by the blood distribution center, Leyte, Philippine Islands, between December 1944 and September 1945. All of this blood was received from the Zone of Interior via Guam (23, 34).

2,145 units to U.S. bases in the Philippine Islands by the blood bank at the 19th Medical General Laboratory, Manila, in September and October 1945, when these tabulations were concluded.

As the result of planned indoctrination combined with the availability of preserved whole blood, the use of blood in all forward installations in the Southwest Pacific increased steadily (35). There were few medical officers who did not eventually realize that lost whole blood can be replaced only by whole blood. The value of massive transfusions was also universally appreciated, and it was not uncommon to encounter patients in rear hospitals who had received from 5,000 to 7,000 cc. within a few hours after wounding. The blood supply was originally on the basis of 1 pint of blood per casualty but frequently much more blood was used. In one series of 6,807 casualties treated surgically, 10,242 units of blood were used, and by the end of the war a ratio of 1.5:1 was the rule.

While accurate total figures are not available, certain comparative statistics are significant:

The first report for U.S. Naval Whole Blood Distribution Center No. 1 on Guam, from 19 November to 24 December 1944 (22), showed that 6,480 pints were received from the mainland, of which 5,041 pints had been distributed, 4,256 pints to Leyte, 288 pints to hospital ships and Fleet units, 48 pints to the 3d Marine Division, 128 pints to the 168th General Hospital, 40 pints for civil emergencies on Guam, 191 pints to three naval base hospitals, and 14 pints to the U.S. Naval Air Base Dispensary. In addition, 76 pints had been discarded for causes not connected with outdating.

The April report from the Guam distribution center (24) showed 5,663 pints of whole blood on hand on 1 April and 25,760 pints received during the month from the United States. Of this amount, 12,568 pints were distributed to the Philippine Islands and 15,916 to the Okinawa operation. By 30 April 1945, a total of 18,316 pints of blood had been distributed for the Okinawa operation, of which 5,120 pints had been shipped by air. The remainder of the blood flown to Guam, mostly in small amounts, went to hospitals in the Marianas and on Guam, and to hospital ships and Fleet units. Included in the April distribution was the blood (535 pints) that went to hospitals in the Hawaiian Islands when casualties in the first stage of the Okinawa operation proved fewer than had been anticipated (p. 624).

From L-6 to L+43, approximately 25,444 pints of blood were supplied for the Okinawa operation, 12,900 by surface carrier and the remainder by air (31). During this period, there were 23,681 casualties, including killed in action, wounded in action, missing in action, and nonbattle casualties. The ratio of 1 pint of blood per casualty admitted to field hospitals, which had been established in the Mediterranean and European theaters, was thus exceeded in the Okinawa operation, one reason being the kamikaze suicide bombings.

Between 1 April and 21 June 1945, approximately 40,000 units of blood were received by the various hospitals and other medical installations operating on Okinawa.

Losses

Considering the circumstances in the Pacific, it is remarkable that the losses of blood were so small. They were chiefly due to hemolysis, breakage, failures of refrigeration, and outdating.

Hemolysis.—Early in the operation of the airlift, it was well established that bottles of blood which would become hemolyzed would be in that state on their arrival at Guam, where they could be screened and discarded as necessary (p. 607). It was also found, in the Pacific and elsewhere, that blood could undergo considerable movement without hemolysis.

In the total shipments, excessive hemolysis before the outdating period was reached occurred in less than 5 percent of the flasks. The single serious complaint in respect to this change came from the 2d Field Hospital, which, on one occasion, found 80 percent of its stock hemolyzed. While the precise

cause was never determined, the most plausible explanation was a break in refrigeration technique.

Breakage.—Breakage was remarkably infrequent. Lieutenant Brown reported no instance of breakage in the blood received at Guam between 25 December 1944 and 31 March 1945, and Captain Thorpe made the same statement in his 4 July 1945 report from the Leyte bank.

Failure of refrigeration.—The chief losses from refrigeration failures were in forward hospitals and, for the most part, in hospitals in which the control of blood was not the responsibility of a single medical officer with training in this field. Faulty refrigeration, with temperature fluctuations and storage at too high temperatures, was the chief cause of loss of blood by hemolysis. Base units reported only small losses because of incorrect refrigeration. This would be expected, for they had good refrigerators and experienced mechanics to maintain them.

Outdating.—The blood that combat medical units carried with them to the target always was loaded at the latest possible date, so that the expiration date would not be exceeded before a new supply could be flown in; this was not possible until airstrips were secured. Invasion forces went ashore with supplies of blood adequate for all estimated casualties. Most of the losses—many unrecorded—probably occurred at such times. There was no alternative, however, to the provision of blood on the basis of possible needs. Resupply was on the basis of actual needs; automatic resupply would have occasioned far heavier losses than those that occurred.

The bank at Leyte was at first supplied with blood with only 10 days of life remaining in it, the fresher blood being given to Fleet combat teams. As supply and demand equalized, the bank at Leyte was supplied with fresher blood. It was kept stocked at all times with 3–4 days' supply, to provide for emergency requests and to guard against failure of supplies because of bad flying weather. Not much blood was lost by outdating, and, according to Captain Thorpe, there was never a time during the operation of this bank that blood was not available for issue.

The dating period for all banked blood in the Pacific, including the blood collected locally, was set at 21 days. There was some discussion in the spring of 1945 about extending the shelf life to 28 days, but no formal action was taken.

The report of the center on Guam for June 1945 showed total losses due to aging in 1945 as 3.6 percent, 2.9 percent for the first quarter and 4.3 percent for the second. During this period there were only three occasions when supply and demand were not well balanced; in January, in preparation for the Luzon invasion; in April, in preparation for the Okinawa invasion; and in June, when there was an unexpectedly rapid cutback of requirements in the POA and SWPA. On all of these occasions, more blood was ordered than was needed for the combat forces, but most of it was used in hospitals to the rear.

The total losses from aging were probably somewhat higher than these figures suggest because they take incomplete account of losses in hospitals,

particularly the forward hospitals which required only small amounts of blood at irregular intervals but which had to carry a stock large enough for possible emergencies (36).

The use of blood beyond the 21-day limit set was not recommended, but the dating period was occasionally exceeded when the choice lay between outdated blood or no blood at all. Lives were undoubtedly saved as a result. At one time, when the 7th Portable Surgical Hospital received a heavy influx of casualties, it used a considerable amount of outdated blood with no reactions (37). Two casualties, each of whom received more than 4,000 cc. in a 36-hour period, showed no ill effects, though all of the blood used was outdated from 14 to 20 days (37).

CLINICAL CONSIDERATIONS

Indoctrination

When Colonel Kendrick reached Hawaii on 25 November 1944, he went on to Guam, and then, after discussions there with Lieutenant Brown, he continued on to Leyte, to discuss all aspects of the supply and use of whole blood with medical officers in General Denit's office and with the Surgeon, Sixth U.S. Army. At this time, there were no personnel in the POA who had the overall responsibility of supervising the reception, storage, and distribution of blood or who had the authority to undertake these tasks.

Also, as might have been expected in the circumstances, there was no general recognition of the importance of the liberal use of whole blood in battle casualties. One of Colonel Kendrick's important tasks, and it was not a particularly easy one, was the indoctrination of medical officers concerning this modality. He had to convince officers of the Sixth U.S. Army, which had been functioning effectively for several years without adequate supplies of whole blood, that the new blood program had a great deal to offer them. Many of them frankly told him that they had got along very well without it and him. He also had to convince medical officers in an army that had never had enough of anything that they could have all the blood they needed and wanted simply by asking for it. His observations in the Mediterranean and European theaters stood him in good stead, for he could bear personal testimony to the feasibility and advantages of the plan he was advocating.

The acceptance of the blood program and the liberal use of whole blood that followed (fig. 148) can be attributed chiefly to the vision and support of the Consultant in Surgery, Sixth U.S. Army, Major Glenn. Without his understanding of the problem, and without the high esteem in which he was held by medical personnel in the Sixth U.S. Army, it would have been far more difficult than it was to support this Army with the blood which it required.

As has been pointed out already, the arrival of the first shipment of blood from the United States changed the whole face of the management of shock and hemorrhage in the Pacific. Up to that time, the ratio of pints of blood to casualties had been about 1:10. The ratio changed to 1:1, and later to 1.5:1.



FIGURE 148. Administration of blood to U.S. casualty, wounded when his division command post was shelled, Leyte, Philippine Islands, October 1944.

When whole blood was immediately available as far forward as clearing companies and portable surgical hospitals, it became the practice to use plasma only when blood was not at hand, which was seldom, or to supplement transfusion, but never as a substitute for it. By March of 1945, it was routine for invasion forces to carry blood ashore with them, and it was not uncommon, on reading a casualty's Emergency Medical Tag in a rear hospital, to find that he had received 1 or more pints of bank blood at a clearing company (37). Some casualties received as much as 6 pints in an hour.

Numerous reports from individual surgeons and hospitals testified to the value of whole blood. The Surgeon, Palawan Task Force, said that the buffered whole blood brought in with medical units on D-day in the Luzon operation proved invaluable: "The value of whole blood over plasma for battle casualties is unquestioned." A surgeon at the 27th Portable Surgical Hospital said that the mortality rate from abdominal wounds dropped 20 percent when transfusions, penicillin, and oxygen therapy became available. A report from the 80th General Hospital stated that the superiority of whole blood over plasma was most striking in casualties with shattered pelvises and associated abdominal injuries, who required 3,000 to 4,000 cc. of blood in the first 24 hours after wounding. The surgeons of the 119th Station Hospital found plasma of little value in casualties received for definitive and convalescent care. "Blood is what is needed."

The comments of the Surgeon, Sixth U.S. Army, were particularly enthusiastic. The use of plasma in the restoration of blood volume in hemorrhage and shock needed no comment on its merits, he wrote, but if hemorrhage had occurred, only whole blood could meet the situation. Blood had been used extensively as far forward as battalion aid stations. Given over a 24-hour period, 5,000 cc. could completely change the appearance and outlook of a critically wounded casualty. The use of whole blood in the Luzon campaign had played a very significant part in reducing the mortality from serious wounds and had also proved that massive transfusions early, followed by slower transfusions, were much more efficacious than plasma. Finally, fewer reactions were occurring with banked blood than had occurred with fresh blood collected locally.

Numerous case reports were also cited that showed both the value of whole blood and the success of the indoctrination in its use. One casualty, for instance, with a ruptured arteriovenous aneurysm in the thigh, received 5 pints of blood immediately and another 5 pints over the next 12 hours. By former methods of collecting and administering blood, he could not possibly have been saved. With banked blood immediately available, he was brought out of shock, hemorrhage was controlled, reparative surgery was done, and both life and limb were preserved.

The Luzon Experience

The Luzon experience is typical of all later experiences with whole blood. In this campaign, for the first time, blood was administered to all patients with severe and moderately severe wounds or with evidence of impending shock, regardless of their status on admission. Those with no signs of shock received 2 pints of blood. Those in moderate shock received from 4 to 6 pints, run in rapidly by gravity. Those in shock from severe hemorrhage sometimes received as much as 10 pints in 90 minutes. One patient received 17 pints in 9 hours. In severely shocked patients, blood was often forced through cannulas into several veins at once by multiple syringes or by pressure gravity techniques. After observation of the results of these practices, it required little effort to convince Sixth U.S. Army medical officers at headquarters or in the field of the value of the whole blood program.

Whole blood was used in chest wounds with the usual precautions against overhydration. It was given liberally in wounds of the abdomen and of the extremities. Its postoperative use was found to be an effective way to prevent wound disruption. Casualties coming from forward hospitals often suffered from hypoproteinemia, and the liberal use of blood and plasma, supplemented by early high-protein feedings, helped to prevent this complication.

Blood was also used as necessary on the medical service. Several patients with aplastic anemia received 20 pints or more before evacuation.

Techniques of Administration

Data concerning the practices used in the administration of whole blood in Pacific hospitals were reported in the ETMD for March and April 1945 (35). The container was inverted and agitated gently until the cells had returned to a state of uniform suspension in the plasma. The blood was given either cold as it was taken from the refrigerator or after it had stood at room temperature for a short time; it was never warmed to body temperature. When it was given rapidly, it was preferable that it be at environmental temperature. When it was given over a 30- to 90-minute period, the temperature seemed unimportant.

The time required to administer a unit of blood was widely variable. When pressure was exerted by use of the bulb on a Baumanometer or by some other means, a pint could be given in 5 to 10 minutes. A transfusion could be given rapidly under minimal pressure if a cannula was tied into the long saphenous vein. The intrasternal route was occasionally used. When a casualty was in severe shock, two transfusions could be run into different veins at a rapid rate. As soon as bleeding was controlled and the blood pressure returned to a satisfactory level, the rate of administration was decreased, and the blood was given just rapidly enough to keep the pressure near that level.

Difficulties originally experienced with filtration of the blood soon disappeared with improvements in the filter. There were some complaints because it was not possible, with the sets used, to see the blood dripping through a glass adapter, but the objection was not considered significant when a filter was used which did not clog.

PLASMA

The story of plasma in the Pacific is much the same as its story in other theaters. Before whole blood was available, many casualties who clearly needed whole blood were given plasma; some received as much as 10 to 14 bottles over a period of a few hours. Once whole blood became available and its correct use was comprehended, plasma was used on the proper indications.

In his report to The Surgeon General on his survey of blood requirements and supplies in the Pacific in July 1944, Colonel Kendrick stated that he and Captain Newhouser had found adequate supplies of plasma in all areas (10). Some of the packages were 2½ years old, but plasma, distilled water, and intravenous equipment were still intact and uncontaminated, and there was no apparent deterioration of the rubber tubing or stopper. The few reactions reported after plasma transfusions were apparently urticarial. Medical officers were enthusiastic about the change to the 500-cc. package.

On land, plasma was reconstituted in battalion aid stations, carried forward, and administered as splints were applied before the casualty was moved. In thick jungle country such as on Biak, where it often took 8 hours to move a

casualty 4 miles by litter, the use of plasma before and during evacuation was often lifesaving.

The use of plasma both afloat and ashore was greatly extended by training Army and Navy corpsmen to prepare and administer it. Aboard ship, naval medical officers depended upon these well-trained men to administer most of the plasma given. The ability of enlisted men to master the intravenous technique was sometimes underestimated. They learned readily, and some technicians, who had not been trained, administered plasma for the first time under fire simply by following the instructions on the container.

The following instances illustrate the importance of giving enlisted personnel such training:

A seriously wounded man lay in a depression in the direct line of fire of an active Japanese machinegun. To leave him without treatment would have risked his going into irreversible shock. To move him would have meant certain casualties for the litter squad. A staff sergeant, who was later awarded the Silver Star medal for bravery, crawled out to him, dressed his wounds, splinted a fracture, and then administered three units of plasma to him by lying by his side and elevating the bottle of plasma with one hand (38).

Five men in a command post about an hour's litter carry from a battalion aid station were seriously wounded by a short 81-mm. mortar. An enlisted technician on the spot prepared five units of plasma, suspended the bottles by forked sticks in the ground, and had the last infusion flowing before the first was complete.

Many lives were saved because enlisted technicians with supplies of plasma were assigned to companies carrying out flanking attacks in the jungle and operating apart from the battalion.

OTHER REPLACEMENT AGENTS

Serum albumin was available in the Pacific but Captain Newhouser and Colonel Kendrick found that it was not widely used, either ashore or on ships, for several reasons: Many medical officers had never heard of it; the circumstances did not favor rapid dissemination of information. No extensive educational program had been carried out concerning it, and plasma, which had been the subject of careful indoctrination, was universally available and had proved extremely satisfactory. The necessity for using additional fluid with albumin was a distinct disadvantage, for dehydration was a real entity in troops fighting in the Pacific areas.

Many hours were spent on hospital ships and in other Army and Navy installations instructing medical officers on the availability and use of serum albumin. It was also pointed out that it need not be stored in refrigerators, in which it was being kept in all the storehouses visited.

Almost nothing was known in the Pacific about immune globulin, fibrinogen, thrombin, and fibrin foam.

All intravenous preparations and equipment examined were found in good condition, although some of the tubing had been exposed to temperatures from 85° to 110° F. for 18 months.

CONCLUSIONS

Once the program to supply blood to the Pacific from the mainland had been instituted, there was never a shortage of blood in these areas. At times, when the weather was bad and supplies on hand did not exceed 24-hour requirements, some concern was felt, but, as in the European theater, the blood never failed to arrive when and where it was needed. Had Operation OLYMPIC (p. 639) been carried out and the estimated 500,000 to 600,000 casualties come to pass, there is little doubt that sufficient blood would have been provided for all their needs. In one operation out of four, said the May 1945 report of the distribution center at Guam (36), in reference to the early stages of the Okinawa operation, "we had too much too early but in none, including the other phases of the Okinawa operation, to date did we ever have too little too late." That statement continued true until the end of the war.

The experience of the airlift of blood to the Pacific and the handling and use of blood there proved a number of points:

1. That it is perfectly practical to collect blood in the Zone of Interior and deliver it safely to a theater far removed from the point of origin. It was not unusual for blood to be collected in the United States, sometimes in cities as far inland as Chicago, and to be used in places as remote from the point of collection as Okinawa within 6 days after it had been collected.

2. That a theater transfusion officer, with his staff, attached to the office of a theater surgeon and given the proper authority and resources, can keep a combat force adequately supplied with blood. This is true, however, only if the resources made available to this officer include the staff, personnel, and equipment necessary to collect, process, and deliver whole blood to all medical installations in the theater.

3. That in dealing with a commodity such as blood, which has only a brief life and which is easily contaminated and rendered not only useless but dangerous, handling and distribution must be the responsibility of medical officers and other personnel trained in this particular specialty. For the reasons just stated, blood cannot be handled efficiently or safely through conventional supply channels.

4. That collection of blood from base troops is necessary to insure adequate supplies of fresh whole blood in the event that transportation from the Zone of Interior is impossible because of adverse weather. Local collections are also useful in buffering the wide fluctuations in the amounts required from the Zone of Interior. It was very difficult for the Red Cross to regulate its schedule so as to bleed no donors one day and 2,000 the next, and then to drop from 2,000 to almost none again on very short notice.

5. That the delivery of blood over great distances and its distribution to widely dispersed medical units on separate land masses require coordination and timing of a high degree. The experience on Okinawa proved that in island operations, in which blood must be carried ashore with landing forces, it is essential that a trained medical officer, with experience in the handling of blood be given the responsibility for prior planning, for distribution, and for resupply, and also be given the resources necessary to discharge his duties. All the blood used at Okinawa came, via Guam, from the United States, 8,000 miles away. With the dating period set at 21 days, it required careful timing to guarantee adequate quantities of blood with minimum wastage from outdating. That the project was accomplished so successfully was due to (1) a highly efficient blood supply system extending from the Zone of Interior to Okinawa and (2) to the assignment of a trained transfusion officer who was responsible for planning, supply, and distribution, and for the proper clinical use of the blood once it had reached the target.

As these conclusions indicate, perhaps the most essential factor in the efficient operation of a transfusion service is the assignment to the office of the theater surgeon of a trained transfusion officer, whose responsibility is overall supervision of the transfusion teams and liaison between hospitals, teams, and the source of blood in the Zone of Interior.

OPERATION OLYMPIC

Just before the end of the campaign on Okinawa, at the suggestion of Col. I. Ridgeway Trimble, MC, Consultant in Surgery, SWPA, General Denit invited Colonel Kendrick to Manila to plan the blood program for the invasion of Japan (Operation OLYMPIC). It was interesting that even at this late date, certain medical personnel in the SWPA, while fully recognizing the urgent need for whole blood, doubted that all that was regarded as necessary for the invasion of Japan could possibly be supplied.

The essentials of the plan developed for Operation OLYMPIC were as follows (39):

1. Whole blood would be flown under refrigeration by an Army-Navy airlift from the Zone of Interior to Guam. All requisitions would clear through this center.
2. Accessory distribution units would be set up in Manila and on Leyte and Okinawa, each to be operated by a well-trained and well-equipped distribution team.
3. Initial supplies of blood would be provided by the Manila center. The center at Okinawa would be responsible for resupply by surface carrier, air, or both means.
4. The blood supply at the target would be provided initially by LST(H)'s designated as blood distribution centers afloat. As soon as possible, blood distribution teams would be put ashore at each of the target areas.

Detailed descriptions were given of personnel, equipment, function of the centers, and other matters.

Blood would be provided for Operation OLYMPIC as follows:

1. A consultant or other responsible medical officer would be attached to USAFPAC as officer-in-charge of the transfusion service.
2. The two Army transfusion teams on duty in Saipan would be requested from the Commanding General, POA. One team would be assigned to Manila, to serve as a distribution team and, when necessary, as a blood collecting team. The other would serve in Okinawa as a collecting team and would be prepared to furnish distribution personnel to go forward to the target area on call if one of the teams at that point should be incapacitated.
3. Three Navy distribution teams would be attached to the Sixth U.S. Army, one to go in with each assault force. These teams would be transported to the target on the LST(H)'s designated as blood distribution points afloat and would function on them until they went ashore. The center ashore would be centrally located, to supply both installations ashore and ships afloat.
4. One LST(H) would serve as a blood distribution center at each target. It should be provided with adequate reefer space for the necessary amounts of blood and should also be provided with an ice machine. If the beachhead were wide, each LST(H) might need to be supported by other LST(H)'s serving as subsidiary blood distribution points, but all blood should be obtained from the designated whole blood distribution center afloat.
5. Delivery of blood to individual hospitals would be a unit function. If the LST(H) serving as the distribution center afloat were on the beach, the supply of blood to shore units would be simplified. If it were offshore, transportation of the blood should be by LCV's (landing craft, vehicle, personnel) at the direction of the distribution team aboard the LST(H). Arrangements should be made for flash signals for notification of the need of blood on the beach.

Blood requirements for the invading Army and Marine troops were estimated at 1.5 pints per casualty and on the assumption that 80 percent of all casualties arriving in forward hospitals would require blood. For the first 15 days of the invasion, 7,780 casualties would require 11,670 pints of blood. The respective cumulative figures for the first 30 days would be 18,060 casualties and 27,090 pints; for the first 60 days, 44,725 casualties and 67,087 pints; and for the first 120 days, 99,948 casualties and 149,922 pints.

To insure adequate supplies, enough blood should be carried ashore initially for a 5-day period; this plan would require 6,000 pints of blood, 2,000 pints to be loaded with each assault force. After the first 5 days, resupply would depend upon placing distribution centers as close to the target as possible, the availability of surface and air transportation, and maintenance of an adequate flow of blood from Guam to the distribution centers at the target. Because of the short haul, it would be most desirable to utilize the distribution center at Okinawa for the resupply of blood until airstrips were available. This center should be familiar with the total blood requirements for Operation OLYMPIC, and requests from the target area should be addressed to it.

The officer in charge of the transfusion service should work out a table showing the amount of blood required, the dates it must arrive, and the points at which it should be delivered from Guam. Lieutenant Brown at Guam should have this information at least 12 days before the blood would be needed at the loading points. This interval would allow the centers on the

mainland to step up their program to meet requirements. It would take from 4 to 6 days to accumulate the 6,000 pints of blood needed for the first stage of the operation.

Critique

The plan just outlined was presented to General Denit in sufficient time for it to be approved in his office and sent to the Office of The Surgeon General, so that Maj. John J. McGraw, Jr., MC, then serving as his special representative on blood and plasma transfusions, could comment on it in the light of his experience in the Mediterranean theater.

Major McGraw found the plan excellent and noted that there were 11 centers in the United States capable of supplying whole blood at the rate of 2,300 or more units per day 6 days a week (40). He considered the plan for a consultant at Headquarters, USAFPAC, charged with the overall responsibility for the transfusion service, to be an essential part of the program. He also emphasized again that blood distribution must not be a function of Medical Supply but the responsibility of blood distribution teams which were trained to handle it.

Major McGraw also made the following comments:

1. Blood should not be used after 21 days. At that time, high-titered group O bloods must be considered dangerous for A, B, and AB recipients.

2. The teams assigned to operate the two distribution centers were probably not large enough for the collection, processing, and delivery of significant amounts of blood. It was suggested that they be replaced by the type 2 blood transfusion teams (listed NB under T/O&E 8-500), which consisted of 5 officers (2 MC, 3 SnC) and 26 enlisted men.

3. The Navy distribution teams attached to assault forces should be replaced as soon as possible by Army teams, so that all personnel dealing with blood would be under the control of the consultant on transfusion at Headquarters, USAFPAC.

4. The plan of making each hospital responsible for picking up its own blood, by the ambulances bringing patients to hospitals, was considered a hit-or-miss proposition. It was recommended instead that distribution teams make regular rounds to all hospitals, delivering blood as needed and picking up blood nearing its expiration date for delivery to more active units.

These comments were made on 4 August 1945, just 10 days before the cessation of active fighting, which made unnecessary any further action on the blood program for the invasion of Japan. They were also, Colonel Kendrick noted later, made by an officer whose experience with the supply of whole blood, although very extensive, did not include the ship-to-shore operations required in the Pacific areas. Colonel Kendrick considered having hospital ambulances carry their own blood supply almost the heart of the program in this sort of warfare in its initial stages.

CHINA-BURMA-INDIA THEATER

National Blood Programs

The first blood bank in India was organized in Calcutta, at the School of Tropical Research, in 1925 (41). When the war broke out in 1939, a transfusion service was set up here for the Indian Army, and another center was opened in Lahore. When Japan entered the war and Burma was occupied, the blood program was expanded into most of the major Indian cities, to provide blood for both civilian and military use. All of these centers operated under Government control, but each used techniques to fit the local situation. When they were opened, a Government-sponsored educational program was launched, to overcome the superstitious fears of the polyglot Indian people about giving blood.

Blood was processed into serum in several large cities, and a limited amount of dried plasma was produced in Calcutta. The expansion of the program was hampered by lack of equipment and by long delays in procuring it.

China had no organized blood or plasma program. In 1943, the American Bureau for Medical Aid to China undertook the training of technical personnel in a special donor center in Chinatown in New York. The idea was that this group would be sent to China, as a pilot group to train other technical personnel, who would establish additional centers to bleed donors supplied from military sources. The plan had a limited success.

Blood and Plasma Supplies

When U.S. troops reached India, a basic supply of dried plasma was forwarded to them by air. Maintenance was on the basis of 100 units per month for each 10,000 troop strength. Supplies of plasma were practically always adequate, and it served the same useful purpose that it did in other theaters. Unfortunately, it frequently had to be used when blood would have been more desirable.

The blood bank set up at the 20th General Hospital at Margherita, Assam, in May 1943, also served the 14th and 73d Evacuation Hospitals and all their substations which were accessible by motor transport (42). Wet plasma was also provided, and some serum (figs. 149 and 150). The blood was collected under aseptic precautions by a semiclosed method. It was citrated when it was to be used for whole blood or plasma but not when it was intended for serum. The blood had a shelf life of 10 days. At the end of this time, the plasma was withdrawn and the cells were discarded. No centrifuge was available, so when plasma or serum was to be processed, separation took from 3 to 5 days. The citrated blood, wet plasma, and serum were stored in electric refrigerators of 6-cu. ft. capacity.

When blood first became available, combat injuries were not numerous, and its chief use was for patients with malaria and dysentery, who often were



FIGURE 149.—Stored blood and plasma at 20th General Hospital, Ledo, September 1944. U.S. blood and plasma are on the right, and Chinese blood on the left.

in a serious state of shock, and for civilian-type traumatic injuries. When combat casualties were treated, the indications for transfusion were the same as in other theaters (fig. 151).

Malaria in Donors

The blood of every donor, whether American or Chinese, was examined for malaria, and a Kahn test was also performed. If either reaction were positive, the donation was used for plasma, which was kept in the refrigerator for 14 days before it was used. Information disseminated by the Indian Medical Directorate at New Delhi was to the effect that neither the storage of blood at low temperatures nor the addition of quinine nor Mepacrine (quinacrine hydrochloride) in vitro made malaria-infected blood safe for transfusion (43). If whole blood had to be secured in malarious areas, donors should be selected who had no history of frank attacks, who had had no recent symptoms, whose spleens were not enlarged, and whose thick films were negative.



FIGURE 150. —Processed serum in cold storage at Calcutta Blood Bank, October 1944. Note British bottles, which were used by blood bank of India.

Since potential infection had to be assumed in a malarious area during the malaria season, it was recommended in these instructions that the donor, when time allowed, should be given Mepacrine and that the recipient should also be given it for several days after the transfusion, until his condition had improved sufficiently for a frank attack of malaria to be tolerated.

If the recipient developed malaria, or if it were found that malarious blood had been accidentally given, the diagnosis should be confirmed by examination of thick and thin smears, and the standard course of treatment carried out. After giving blood, donors with latent or suppressed malaria frequently had attacks, especially if they were walking wounded. Standard suppressive treatment should be given in malarial areas; otherwise, no treatment should be given unless an attack of malaria ensued.



FIGURE 151. Lt. Gen. (later Gen.) Joseph W. Stilwell, USA, and Col. (later Brig. Gen.) Isidor S. Ravdin, MC, visiting battle casualties from Myitkyina, Burma front, at Assam Base Hospital, July 1944.

Supplies for Chinese

One of the chief reasons for the establishment of the blood bank at the 20th General Hospital was to provide blood and plasma for Chinese patients. Only small amounts of plasma and serum were available to them from Chinese sources (fig. 152). Arrangements were made with the Director of the All India Institute of Hygiene and Public Health in Calcutta to lyophilize pooled plasma and serum from Chinese donors, with the idea of building up a reserve for use in forward installations. A small blood bank was maintained at the 20th General Hospital, with limited amounts of wet plasma and serum, but the project did not succeed as it had hoped that it would, and the arrangements made in Calcutta were not utilized because Chinese donations barely met the day-by-day local requirements.

At the 20th General Hospital, it was found that blood was needed in about 30 percent of U.S. patients who required replacement therapy and in about 75 percent of the Chinese patients. The chief reason for the discrepancy was the high incidence of hypoproteinemia and severe anemia in the Chinese, as the result of injury superimposed on disease. Serious anemia was frequently secondary to prolonged malnutrition, severe and recurrent dysenteries, and



FIGURE 152. U.S. and Chinese military personnel donating blood at Chinese Services of Supply Headquarters, K'un-ming, China, April 1945.

severe, recurrent malaria. Traumatic rupture of the liver and spleen was also disproportionately frequent in the Chinese soldiers. Enlargement of these organs was frequent in them, and susceptibility to trauma correspondingly great.

References

1. Bracken, Lt. Col. Mark M., MC, n.d., subject: The Use of Whole Blood and Blood Plasma in the Pacific Operational Area During World War II.
2. Report, Maj. R. J. Walsh, Secretary, New South Wales, Red Cross Transfusion Committee, n.d., subject: New South Wales Red Cross Blood Transfusion Service at the Conclusion of the War (1945).
3. Memorandum, Col. F. H. Petters, MC, to Commanding Officers, 105th General Hospital and 12d General Hospital, 8 Feb. 1943, subject: Blood Bank.
4. 1st Indorsement (Memorandum No. 3) from Col. Maurice C. Pineoffs, MC, 12 Feb. 1943.
5. Memorandum, Col. Raymond O. Dart, MC, to the Surgeon, Headquarters, U.S. Army, Services of Supply, Base Section No. 3, 15 Feb. 1943, subject: Shipment of Whole Blood to Advanced Areas.

6. 1st Indorsement (Memorandum No. 3), Col. J. M. Blank, MC, 23 Feb. 1943.
7. Memorandum, Maj. Wm. Barclay Parsons, MC, to Col. F. H. Petters, MC, 2 Mar. 1943, subject: Comments on Letter from Colonel Blank.
8. Memorandum, Col. F. H. Petters, MC, to Surgeon, Subbase D, 3 Aug. 1943, subject: Blood Bank.
9. Technical Memorandum No. 13, Office of the Chief Surgeon, Headquarters, USAFFE, 21 Sept. 1944, subject: Blood Bank.
10. Memorandum, Lt. Col. Douglas B. Kendrick, MC, for The Surgeon General, 30 Oct. 1944, subject: Report of Trip to South Pacific Area, Southwest Pacific Area, Central Pacific Area. Time: June 6th to August 8, 1944.
11. Memorandum, Lt. Col. Douglas B. Kendrick, MC, to Brig. Gen. Guy B. Denit, 19 July 1944, subject: Plan for Blood Transfusion Service in SWPA With Special Reference to Advanced Bases.
12. Memorandum, Lt. Col. Douglas B. Kendrick, MC, to Brig. Gen. Guy B. Denit (attention: Col. A. M. Libasci, MC), 19 July 1944, subject: Supply Problems in the Advanced Bases SWPA.
13. Memorandum, Lt. Col. Bruce P. Webster, MC, to Chief Surgeon, USASOS, 26 June 1944, subject: Informal Report on the Use of Army Personnel as Blood Donors in Malarious Areas.
14. Technical Memorandum No. 6, Office of the Chief Surgeon, Headquarters, USAFFE, 12 May 1944, subject: Treatment of Malaria.
15. Letters, Vice Adm. Ross T McIntire, MC, USN, and Maj. Gen. Norman T. Kirk to Mr. Basil O'Connor, 26 Oct. 1944.
16. Letters, Mr. Basil O'Connor to Maj. Gen. Norman T. Kirk and Vice Adm. Ross T McIntire, 3 Nov. 1944.
17. Robinson, G. C.: American Red Cross Blood Donor Service During World War II. Its Organization and Operation. Washington: The American Red Cross, 1 July 1946.
18. Report, Officer-in-Charge, U.S. Naval Whole Blood Distribution Center No. 1, to Chief of the Bureau of Medicine and Surgery, Navy Department, Washington, D.C., 6 Mar. 1945, subject: Operation of the U.S. Naval Whole Blood Distribution Center No. 1.
19. Letter, Maj. F. N. Schwartz, MAC, to Col. B. N. Carter, MC, 14 Nov. 1944.
20. Letter, Lt. Col. Douglas B. Kendrick, MC, to Col. George R. Callender, MC, 28 Dec. 1944, subject: Blood Supply to Pacific.
21. Memorandum, Lt. Col. Douglas B. Kendrick, MC, to Maj. F. N. Schwartz, MAC, 28 Dec. 1944, subject: Blood Supply to Pacific.
22. Report, Lt. Herbert R. Brown, Jr., MC, USNR, and Ens. George E. Nicholson, HC, USN, subject: Operation of Advance Base Blood Bank Facility No. 1 From the Period of 19 November 1944 Through 24 December 1944.
23. Report, Capt. Henning H. Thorpe, MC, to Chief Surgeon, U.S. Army Forces, Western Pacific, 4 July 1945, subject: Second Quarterly Report for History, Whole Blood Distribution, Office of the Surgeon, Base K.
24. Brown, Lt. Herbert R., Jr., MC, USNR: Operation of U.S. Naval Whole Blood Distribution Center No. 1 for Period of 1 April 1945 to 30 April 1945.
25. ETMD, USAFFE, for November 1944.
26. Kendrick, Lt. Col. Douglas B., MC, n.d., subject: Plan for the Use of Whole Blood in the M-1 Operation.
27. ETMD, POA, for March 1945.
28. ETMD, USAFPAC, for July 1945.
29. History of 32d Infantry Division, SWPA, 1944.
30. ETMD, USAFPAC, for November 1945.
31. Memorandum, Lt. Col. Douglas B. Kendrick, MC, to Surgeon, Tenth U.S. Army, 14 May 1945, subject: Report of Transfusion Services for the Okinawa Operation.

32. Letter, Col. Raymond O. Dart, MC, to Commanding Generals, Philippine Base Section, Luzon Area Command, Bases M, X, K, R and S, 5 Sept 1945, subject: Whole Blood Distribution to Hospitals in the Philippine Islands.

33. Circular Letter No. 38, Office of the Chief Surgeon, General Headquarters, USAFPAC, 20 Aug. 1945, subject: Whole Blood.

34. Report, Capt. Henning H. Thorpe, MC, to Chief Surgeon, Advanced Headquarters, U.S. Army Services of Supply (attention: Central Medical Records Office), 4 Apr. 1945, subject: Initial Quarterly Report for History of Blood Bank Facilities.

35. ETMD, USAFFE, for March-April 1945.

36. Report, Lt. Herbert R. Brown, Jr., MC, USNR, n.d., subject: Operation of U.S. Naval Whole Blood Distribution Center No. 1 for the Period of 1 May to 31 May 1945.

37. Quarterly History, Medical Activities of 7th Portable Surgical Hospital for 1945-1, 1 Apr. 1945.

38. History of 116th Medical Battalion, SWPA, summary 14 Dec. 1942 to 5 Oct. 1943.

39. Memorandum, Lt. Col. Douglas B. Kendrick, MC, to Brig Gen. Guy B. Denit, 21 July 1945, subject: Proposed Plan for the Supply of Whole Blood for the Olympic Operation.

40. Memorandum, Maj. John J. McGraw, Jr., MC, to Col. B. N. Carter, MC (for Col. I. Ridgeway Trimble, MC), 4 Aug. 1945, subject: Comment on Proposed Plan for Supply of Whole Blood for Olympic Operation.

41. Memorandum, Col. Elias E. Cooley, MC, to The Adjutant General, War Department, Washington, D.C. (attention: The Surgeon General, U.S. Army), through Commanding General, U.S. Army Forces, China-Burma-India, 17 Jan. 1944, subject: Essential Technical Medical Data from Overseas Forces.

42. ETMD, Headquarters, U.S. Army Forces, CBI, December 1943.

43. Medical Director's Office, India, Technical Instructions No. 11, General Headquarters, India, 10 Dec. 1943, subject: Precautions to be Observed When Giving Whole Blood Transfusion in a Malarious Area.

CHAPTER XVIII

Reactions to, and Complications of, Blood and Plasma Transfusions

GENERAL CONSIDERATIONS

It is still true (in 1962) that, whenever large numbers of transfusions are given, reactions will occur, though on well-controlled services, they do not exceed 3 percent. It is also still true that some deaths will follow transfusions, though the number is smaller, in fact, than would occur if transfusions were withheld.

At the onset of World War II, reactions after transfusions were sufficiently frequent to alarm even the most enthusiastic proponents of the liberal use of whole blood.¹ They were readily explained: Blood was usually collected by an open system, and principles of sterility and of absolute cleanliness of the apparatus were enforced in only a limited number of hospitals. Many surgeons were therefore wary about using blood at all. When it began to be used in increasing amounts in the management of battle casualties, the pendulum then swung to the other extreme. Reactions were overlooked, and the widespread and highly erroneous clinical impression grew up that transfusion was an innocuous procedure. The relatively easy availability of whole blood and its widespread use brought in its train great benefits but it also brought inevitable misuse.

As more experience was gained and the risks of transfusion began to be appreciated, there was another swing of the pendulum. The impact of severe reactions on persons who had supposed that transfusion was without risk was magnified, and blood was sometimes withheld when it should have been given.

The precise incidence of reactions after transfusions in World War II is not known, for the major reason, already stated several times, that the circumstances in which many, if not most, of them were given did not favor accurate recording. Such statistics as do exist are also of somewhat dubious accuracy, because the differential diagnosis of the reaction was not always correct. Many casualties who were transfused were already running high temperatures and some were having chills. Some diagnoses were therefore made of reactions which did not exist, while some probably went unrecognized.

The incidence of reactions varied from hospital to hospital but invariably was smallest in hospitals which practiced routine investigation of all transfusion reactions as soon as they occurred. A critical appraisal of the findings,

¹ In 1940, Davis (1) collected from the literature 3,273 transfusions of "conserved" blood, with 13.8 percent of reactions. He did not include Onolski's report on the use of 60- to 90-day old blood in six cases, with five reactions. All such compilations, as Davis noted, are open to question because criteria of reactions vary.

with correction of errors, went far toward tightening controls and preventing recurrences.

A listing of the most common causes of transfusion reactions carries in itself the method of preventing them. They include errors in typing, hemolysis due to overaging, physical changes from failure of refrigeration or from storage at lower or higher temperatures than the optimum, contamination, and the presence of pyrogens.

In hospitals which used type-specific blood, transfusion of incompatible blood could be avoided only by the most careful attention to techniques of blood grouping, crossmatching, and typing of donors and recipients; the use of fresh, avid, high-titer typing sera, free from contamination, in adequate quantities; the use of sufficiently heavy cell suspensions; and the performance of the tests by experienced technicians. The plan of having the results of typing and crossmatching checked and the tests repeated by different technicians was well worth the time it took. Indeed, many technicians learned to develop a high index of suspicion when they observed any departure from normal behavior in blood typing.

Another precaution, when it was practical, was to have the person who would give the transfusion collect the blood from the laboratory, start the transfusion, and remain with the patient long enough to be reasonably sure that no reaction would occur or to cut off the flow of blood at once if signs and symptoms did appear. One reason that this was a wise precaution was that the amount of blood given seemed important in hemolytic reactions. Bordley (2), for instance, reported that 5 patients who recovered after such reactions received an average of 314 cc. of blood, while 10 who died received an average of 565 cc. The functional capacity of the kidneys and the general condition of the patients as always, of course, helped to determine the outcome.

The point to be emphasized in any discussion of reactions in World War II is that, while mass transfusions were given, mass reactions did not occur. The number of reactions reported, in fact, was so small that generalizations based on them seem scarcely valid. This important consideration should be borne in mind in reading the following pages and reflecting upon the individual case histories presented.

ALLERGIC REACTIONS

Of the three varieties of transfusion reactions, allergic, pyrogenic, and hemolytic,² allergic reactions were the most frequent and the least serious (3). They followed transfusions of whole blood and plasma and, occasionally, of human serum albumin. They were presumably caused by a response on the part of the recipient to allergens in the blood of the donor. The recipient was sometimes sensitive to what a nonfasting donor had eaten. Passive transfer

² Unless otherwise indicated, the clinical and laboratory material in this chapter is taken from War Department Technical Bulletin (TB MED) 204, 24 Oct. 1945 (3).

of sensitivity was also possible, the recipient showing an allergic response if he came into contact with the specific allergen. For this reason, it was best not to use individuals suffering from major allergies as donors.

Most allergic reactions took the form of urticaria, which readily responded to subcutaneous administration of 0.3-mg. doses of epinephrine. If urticaria appeared, it was best to discontinue the transfusion unless the indications for it were extremely urgent.

Serious allergic reactions took the form of angioneurotic edema or asthma, both of which required immediate discontinuance of the infusion and prompt treatment with epinephrine. Edema of the larynx was occasionally fatal.

It was a common experience in military hospitals to have few reactions in the shock ward as compared with the number in the operating room and the recovery ward, after several transfusions had been given. The interval between the infusions in these cases was too short for the reactions to be explained by the Rh factor, and a more reasonable explanation seemed sensitization of the patients to type O blood or to plasma protein which might have undergone denaturization. The possibility of sensitization of humans to human protein was the last of all explanations to be considered.

PYROGENIC REACTIONS

Historical Note

When sodium citrate was suggested as an anticoagulant in 1914, by several observers at the same time (p. 218), it was at once blamed for the undesirable and often dangerous chills and fever that followed direct transfusion. Practical proof to the contrary was supplied in 1933 by Lewisohn, one of those who had suggested the use of citrate, and Rosenthal (4). Scientific proof went considerably further back. The possible role of distilled water in pyrogenic reactions was demonstrated in 1923 by Seibert (5), who pointed out, in her review of the literature, that its febrile potentialities had been established by Billroth in 1865 and by Bergman in 1869. Hort and Penfold also made observations on contaminated distilled water in 1911.

There were no chills in the first 17 transfusions given at Mount Sinai Hospital in 1915, all by the same physician, who paid careful attention to the preparation of apparatus and solutions (6). When multiple personnel began to give blood, there were numerous reactions, 24 percent in one series of 365 transfusions (7). When transfusions were concentrated in the hands of eight senior members of the house staff, the reaction rate fell to 13 percent.

The high rate of reactions after transfusion continued until Rosenthal advanced the theory that the preparation of the equipment used in its performance was entirely too lax and casual. He was able to demonstrate that posttransfusion chills were caused by foreign proteins introduced as extraneous matter in distilled water or present in the tubing or other apparatus in the form of altered proteins left from previous intravenous injections. Such matter

would always be present unless the instruments were cleansed with the greatest care, immediately after use, by competent technicians, in a central room, with no connection with the operating room or any other part of the hospital.

Such a room was set up, and the detailed technique outlined by Rosenthal, including the use of triple-distilled water, was instituted at Mount Sinai Hospital on 1 October 1931. The results immediately proved his theory. The previous year, there had been 9 percent of chills in 412 transfusions. In the first year of the new setup, although multiple personnel gave the 477 transfusions, there was 1 percent of reactions. In the 6 months before the new department was set up, the incidence of chills after transfusion with citrated blood was 10 percent. In the first 6 months of the operation of the new department, there were no chills in 154 similar transfusions.

Although the use of triple-distilled water was not accepted in some quarters, Lewisohn and Rosenthal's proof, published in 1933 (4), was too conclusive to be ignored. Their experience was always duplicated when their technique was followed, though as time passed, it became clear that the use of triple-distilled water was an unnecessary precaution. At Walter Reed General Hospital, Washington, D.C., when the Research Division of the Army Medical School took over the task of cleansing the equipment, the incidence of reactions fell from 20 percent to 0.5 percent. All rubber tubing was washed within an hour after use, with distilled water, which was forced through it by a 50-cc. syringe or a large Asepto syringe. The tubing was then soaked in 5-percent sodium hydroxide. The temperature of the water and the solution was not important. The equipment was put up in individual sets and autoclaved immediately. The results here and elsewhere left no doubt that the majority of posttransfusion reactions were pyrogenic and were the result of improper cleansing of the transfusion apparatus, particularly the rubber components.

World War II Experience

In World War II, the common errors leading to pyrogenic reactions were as follows:

1. Insufficient cleansing of the rubber tubing, or the glass or metal parts, or the entire equipment.
2. Delay in cleansing used sets, which permitted pyrogens to develop in amounts that could not be removed by ordinary cleaning techniques.
3. Rinsing the equipment with supposedly pyrogen-free water that had become contaminated.
4. Allowing properly cleaned and rinsed sets to stand for 4 hours or more before sterilization.

The elaborate cleaning technique which was possible in civilian hospitals proved completely impractical in combat circumstances. Transfusions could never have been employed as universally as they were if disposable equipment had not been developed and provided along with blood and plasma. The incidence of pyrogenic reactions was invariably increased when hospitals

insisted upon cleaning their own glassware and tubing instead of using the sterilized sets furnished (8).

The severity of the reaction depended upon the amount of pyrogen infused and the susceptibility of the patient. Symptoms and signs might start at any time during or after the infusion, but most often occurred shortly after the infusion had been completed. The reaction varied in severity from a slight to an extreme temperature elevation (which was extremely dangerous if the patient was already running a high fever), with chills, cyanosis, and prostration. The temperature usually returned to normal within 3 or 4 hours and fatalities scarcely ever occurred.

The prophylaxis of pyrogenic reactions was the use of properly cleaned transfusion sets, or, better, the use of disposable equipment. The treatment was immediate termination of the transfusion, for the principal reason that the initial clinical manifestations of serious hemolytic reactions from the transfusion of incompatible blood could not be differentiated from simple pyrogenic reactions. Another reason was, as already pointed out, that the outcome of the reaction depended upon the amount of pyrogenic substances introduced into the bloodstream.

HEMOLYTIC REACTIONS

In 1942, Kilduffe and DeBakey (9) collected from the literature 43,284 transfusions, with 80 hemolytic reactions (0.18 percent) and 45 deaths (0.14 percent). Hemolytic shock was the cause of death in 32 of the 45 fatal cases. The figures leave no doubt that incompatibility reactions are the chief cause of death after transfusion and vindicate the decision to use only O blood in the massive transfusion programs set up in the Mediterranean and the European Theaters of Operations, U.S. Army, and the Pacific areas in World War II.

At the end of the war, as the result of prewar knowledge and wartime experience, the causes of hemolytic reactions could be listed as intravascular hemolysis of incompatible donor cells, whether intergroup (A, B, O) or intragroup (Rh); intravascular hemolysis of recipient cells; intravascular hemolysis of compatible donor cells; and transfusion of hemolyzed blood.

Hemolytic reactions, although relatively infrequent, were always serious, and were always potentially lethal. On the other hand, there is no doubt that many of the deaths classified as caused by transfusions in World War II were the result of the wound itself or of other causes not related to the use of whole blood.

Reactions Due to Incompatibility

Clinical manifestations.—The reaction to transfusion with incompatible blood varied from patient to patient, perhaps depending upon the agglutinin titer of the recipient's plasma. One patient might receive 500 cc. of incompatible blood and have no manifest reaction while another might have a severe

reaction after only 20 to 50 cc. had been given. As a rule, symptoms appeared after 100 to 200 cc. had been given.

There were two clinical components of the reaction, the immediate hemolytic crisis and the later renal complications:

The initial clinical manifestations (hemolytic crisis) usually consisted of a severe chill; pain in the lower back; a sense of substernal oppression; and, sometimes, nausea, vomiting, and involuntary micturition and defecation. After an initial rise of blood pressure, a state of shock might supervene, with extreme hypotension and a weak, fast pulse. After the chill, the temperature might rise to 105° F. Sometimes bleeding occurred from needle puncture wounds or other exposed capillaries.

As a rule, the patient recovered from the initial reaction, though transfusions of plasma or compatible blood might be required, and often, in a few hours, he seemed completely well.

The first urine passed after the reaction was dark brownish-red, was positive for protein, and contained a few red blood cells and a fair number of pigmented casts. The benzidine test was also positive.

The initial reaction was seldom fatal, but after recovery from it, a number of possibilities might come to pass:

1. There might be no further signs or symptoms other than a transient bilirubinemia.
2. There might be transient oliguria, with nitrogen retention, the excretion of large quantities of urine, and then recovery.
3. There might be persistent oliguria, with increasing nitrogen retention, and death in uremia.
4. There might be oliguria leading to complete anuria, or there might be complete anuria from the onset of the reaction. In either event, fatal uremia usually occurred, although a few patients recovered after diuresis. An occasional patient continued to retain nitrogen even after diuresis and died in uremia.

Death from renal failure usually occurred in 4 to 10 days. If the patient had received less than 250 cc. of incompatible blood, the chance for recovery was usually good. If he had received 500 cc. or more, the prognosis was generally poor.

Pathologic process.—The characteristic autopsy findings in a death following the transfusion of incompatible blood were limited to the kidneys. Except for some swelling, there were no pathognomonic gross lesions. The most striking microscopic observation was the presence, within the renal tubules, of pigmented casts consisting of hemoglobin or degradation products of hemoglobin, though mechanical occlusion of the tubules by hemoglobin casts was not believed to be the principal factor in the fatality. Characteristically, the casts occurred only in certain portions of the tubules; namely, the ascending limbs of Henle, the distal convoluted tubules, and the collecting tubules. The distribution of the casts was irregular but not diffuse, and frequently only a small proportion of the tubules were involved.

Less conspicuous than the changes just described, but probably more important, were the degenerative, sometimes necrotic, changes in the tubular epithelium of relatively short segments of the ascending limbs of Henle and the distal tubules. In the neighborhood of the more severely damaged segments, the interstitial tissue often exhibited an inflammatory reaction, with a predominance of small round cells.

The changes in the tubules and their supporting stroma were usually most evident in the zone between the cortex and the medulla. The glomeruli and the proximal tubules; that is, the upper portion of the nephron, were usually normal.

Pathogenesis.—A comprehensive clinical and experimental study of hemoglobinuric nephrosis in traumatic shock by Mallory (10) (formerly Lieutenant Colonel, MC), in 1947, eliminated a number of theories of causation. Fatal renal insufficiency was not produced by the intravenous injection of hemoglobin. Precipitation did not occur in the presence of either acid or alkaline urine. The Van Slyke kidney could not be reproduced experimentally, but when renal ischemia was produced, changes were observed ranging up to necrosis of proximal tubules, though no significant changes occurred in the lower nephron. Experimental pigment-formation could not be produced, and there was no proof of a responsible toxic factor.

In Mallory's study of 60 fatal cases of battle injury, pigment excretion was found in all the casualties, the amount of pigment nephropathy being directly proportional to the severity of the injury. The evidence suggested that, while renal insufficiency preceded all structural changes, it did not progress in the absence of pigment nephropathy. It was the lower nephron, Mallory pointed out, not the upper, in which anatomic changes were present in the presumed posttransfusion kidney. At the end of the war, therefore, and afterward, the posttransfusion kidney remained an unsolved problem.

Diagnosis.—The clinical and pathologic picture just described, while it might be caused by a transfusion of incompatible blood, might also be caused by a variety of other conditions, including shock, crushing injuries, burns, sulfonamide therapy, and possibly various combinations of these conditions. The renal involvement that followed all of them could not usually be differentiated from that resulting from the transfusion of incompatible blood, and no doubt a number of deaths were charged to hemolytic reactions when they were really due to some one of these other causes.

The following test, devised by the serology section of the 15th Medical General Laboratory to differentiate hemolytic from nonhemolytic reactions (11), came into rather wide use: Blood serum, drawn about 15 minutes after the clinical reaction, was compared with the serum taken for crossmatching before the transfusion. The presence or absence of hemolysis in the post-transfusion specimen was compared with the same phenomena in the pre-transfusion specimen.

This simple method proved very useful in indicating whether the reaction was hemolytic and required a complete investigation, or was allergic and re-

quired a recheck of the patient's history, or was pyrogenic and required an investigation of the technique of preparing apparatus and distilled water.

If the posttransfusion sample contained free hemoglobin or bilirubin, additional investigation was required. Another sample was withdrawn about 4 hours after the reaction and tested for bilirubin. If it was present, a search for the cause was made:

1. The blood groups of the recipient and the donor were rechecked.
2. Crossmatching tests were rechecked.
3. The presence or absence of hemolysis was determined by centrifuging a specimen from the donor bottle.
4. The Rh types of the recipient and the donor were checked. A recently transfused Rh-negative patient might show a few Rh-positive cells, and this possibility always had to be taken into account.
5. If the recipient was Rh-negative, the pretransfusion sample of serum was tested for the presence of anti-Rh agglutinins.
6. If the donor was group A, B, or AB and had received group O blood, his serum was titered against the recipient cells.

Treatment.—The immediate treatment of hemolytic crisis was stopping the transfusion at the first sign of any adverse reaction. Plasma was used if shock was present.

The mechanism of renal failure, as just stated, was never clarified during the war, and its treatment therefore remained entirely empirical. It consisted of any single one or a combination of the following methods: alkalization, splanchnic block, decapsulation of the kidney, blood and plasma transfusions, and regulation of the fluid and salt balance. All of these methods were empirical, and none of them was successful in any significant number of cases. Fluid regulation, it should be emphasized, was always an individual matter, for which no general rules could be stated.

Reactions Due to Intravascular Hemolysis of Recipient's Cells

Intravascular hemolysis of the recipient's cells could be caused by the accidental administration of distilled water and by the use of high-titer group O blood for A, B, and AB recipients.

At the Conference on Shock and Transfusion on 25 May 1945 (12), Maj. (later Lt. Col.) Charles P. Emerson, MC, described a type of reaction in which the presence of incompatible isoagglutinins in high-titer blood was manifested by chills, fever, hemoglobinemia, and a rather persistent bilirubinemia. Destruction of red blood cells by group O blood was first demonstrated in a group A patient with severe leptospirosis, who was given a large amount of plasma for 4 or 5 days and then a series of O-blood transfusions for rapid, progressive anemia. When the transfusions were over, every one of his own cells had been replaced by transfused cells, but apparently not to his detriment, for he survived. The observations in this case confirmed Ashby's (13) earlier studies, which showed surprisingly large destruction of recipient cells. Similar observations were made in five patients with severe burns,

one of whom died on the fourth day. All had received large amounts of plasma. An ante mortem Ashby count in the fatal case showed that 96 percent of this patient's red blood cells had been replaced by transfused cells.

Major Emerson's investigation also showed that the increased fragility of recipient cells frequently noted after transfusion was particularly marked after injection of high-titer O blood and after repeated transfusions of O blood or pooled plasma (14). In discussing these observations, Brigadier Lionel E. H. Whitby, RAMC, stated that the fragility curve is always increased after severe burns, because of the external heat applied to the cells as they pass through the burned area. The affected cells continue to be destroyed for many days thereafter. Major Emerson found it hard to believe that, if the patient were to survive, traumatized red cells resulting from a burn could possibly involve an enormously high proportion of his blood.

Since the technique of titration varied from laboratory to laboratory, no specific general rulings were made as to the upper limit of agglutinin titer compatible with safety. It was simply recommended that some technique be selected which would label all group O blood as having a high agglutinin content. It was thought unlikely that such a proportion would be potentially dangerous, but, in view of the fact that many casualties received multiple transfusions, it was also thought that the titer for universal donor blood should be kept as low as possible.

Reactions Due to Intravascular Hemolysis of Compatible Donor Cells

Hemolysis of compatible donor cells could occur promptly after transfusion with blood which had been improperly handled; that is, it was overage or it had been stored at incorrect temperatures. Unless the blood showed definite *in vitro* hemolysis, results were seldom serious and there were often no subjective symptoms, though the transfusion was obviously of little benefit. When the transfused blood was promptly broken down, there would be free hemoglobin in the serum, which would shortly be converted to bilirubin, and clinical jaundice might be evident.

Hemoglobinemia might be expected to have a deleterious effect upon the kidneys of a patient in shock, and fatal anuria was reported after the transfusion of hemolyzed blood.

The proper care of preserved blood and its careful examination before use were all that was necessary to prevent these results.

European Theater

When Maj. (later Lt. Col.) Robert C. Hardin, MC, visited various hospitals in the European theater in the late summer and early fall of 1944, he found a considerable amount of confusion concerning transfusion reactions and a great many untenable theories, which were little more than clinical impressions (15). Furthermore, fatalities were being attributed to transfusions for

no better reason than that the patient had been given blood. It was not realized that a hemolytic transfusion reaction cannot be diagnosed by tissue study, nor was it realized that intravascular hemolysis of incompatible blood is not the only cause of hemoglobinuric nephrosis. In short, the reasoning was entirely of the post hoc, ergo propter hoc variety—the patient had a transfusion; the patient died; therefore, his death was due to the transfusion.

Studies in the European theater corroborated those in the Mediterranean theater and confirmed the highly dubious role of transfusion in the etiology of lower nephron nephrosis (16). In an investigation of a number of reports of autopsies performed at the 91st Evacuation Hospital, Major Emerson found cause to doubt the anatomic diagnoses of hemoglobinuric nephrosis. He thought that the renal changes demonstrated might well be due to prolonged impairment of the renal blood flow, as the result of severe, long continued, hypotension. The renal anoxia was probably further enhanced by the severe anemia induced by massive plasma transfusions; by anoxia resulting from impaired pulmonary ventilation; and, quite possibly, by diffuse intravascular agglutination resulting from the injection of isoagglutinins, although this factor could not be properly evaluated, since the patients' blood groups were seldom noted on their records.

Most of these patients had been treated for oligemic shock. Their hypotension had been prolonged. They had exhibited temporary oliguria and albuminuria; reduction of the urinary pH; and, in an occasional case, excretion of red blood cells and casts. In all but two cases, which ended fatally, these findings were transitory, clearing within 24 to 48 hours after restoration of the arterial pressure.

Case 1.—In the first fatal case, the casualty, in addition to multiple intestinal perforations, had required nephrectomy for a severe lacerating renal wound. He had been in a state of oligemic shock for 8 hours and had received 4,000 cc. of O blood during his first 10 hours of hospitalization. He died on the fifth day.

Case 2.—The second patient had multiple sucking wounds of the chest with severe intrapulmonary hemorrhage. He had been in severe shock, as the result of hemorrhage, anoxia, and marked oligemia, for 30 hours. His blood group was A, and he had received 4,000 cc. of O blood during the first 24 hours of hospitalization. He died on the ninth day.

Clinically, there was no sign of a transfusion reaction in either case, and the Ashby count indicated no unusual degree of hemolysis of recipient cells. The second patient developed severe hypertension on the sixth day. Both patients exhibited oliguria progressing to anuria and uremia.

In the first case, necropsy showed eosinophilic granular casts of the distal portion of the nephrons of the remaining kidney, which was edematous. The diagnosis of hemoglobinuric nephrosis was consistent with the pathologic picture described by Mallory. In the second case, there were also hemoglobin casts in the renal tubules. It was Major Emerson's opinion that these post mortem findings, even though hemoglobinuria was not demonstrated during life, might be explained by diffusion of small amounts of hemoglobin through the glomeruli of ischemic kidneys. Once the hemoglobin had gained entrance

to the tubules, either insufficient reabsorption of water might occur, or the filtration pressure of the urine might be so inadequate that any casts that formed could not be dislodged. The benzidine test, in contrast to its efficacy in other biologic fluids, was not entirely satisfactory for the detection of minute amounts of hemoglobin in the urine, and small amounts might be regularly overlooked. The free hemoglobin from which these casts were derived could be either free hemoglobin in the transfused blood or hemoglobin derived from the patient's own red cells hemolyzed by injected incompatible isoagglutinins. It was assumed that the concentration required to free plasma hemoglobin might be much lower than was ordinarily conceived.

Thus in the European theater, as in the Mediterranean theater, lower nephron nephrosis remained an unsolved problem at the end of the war. From the standpoint of this volume, the important consideration is the multiple causes other than transfusion which could give rise to what was erroneously called by many observers the posttransfusion or the transfusion kidney.

SPECIAL THEATER EXPERIENCES

Mediterranean Theater

There are no accurate reports of the reaction rate in transfusions accomplished with blood from the bank at Naples. An overall rate would be of little significance as an index of the suitability of the blood provided: Each hospital in the theater prepared its own recipient sets, and the bank, while it distributed instructions for their proper cleaning and preparation, had no control over the procedures. The incidence of reactions therefore varied from hospital to hospital and was related to the efficiency with which the sets were cleaned and sterilized (17).

Only once was there any serious question concerning the quality of the bank blood. This was in May 1945, when a shipment of blood, all from one bleeding center, resulted in 18 febrile reactions in three separate hospitals. Four of the patients died, but in only two cases was the transfusion considered the direct cause. Bacterial examination of two bottles from this shipment revealed psychrophilic organisms which had probably gained entrance to the blood because of incorrectly sterilized donor sets. There were no other deaths and no febrile reactions attributable to the blood itself, though 78,329 units had been distributed up to the time of this survey (October 1944) (17).

In 1943, a number of febrile reactions at the 91st Evacuation Hospital were attributable to the extreme difficulty experienced in cleansing the filters of the recipient sets (18). Aside from the risk of reactions, the blood would not run through the filters. Facilities for proper cleansing of transfusion equipment were not available in forward hospitals, and, at this hospital, as at many others, it had to be cleaned and sterilized in the operating room. None of the reactions was serious, and no hemolytic reactions occurred.

British transfusion units in the Mediterranean theater included one set of sterile equipment with each two bottles of blood intended for forward hospitals. Disposable equipment from the Zone of Interior was received in the theater too late to be useful. It would have been highly desirable, and some reactions could have been avoided, if the Naples bank had been able to prepare transfusion equipment to be supplied with the blood, but neither equipment nor personnel were in the theater in sufficient supply to permit such a plan.

European Theater

To clarify the confusion in the minds of many medical officers about transfusion reactions and the so-called transfusion kidney, Administrative Memorandum No. 150 was issued on 27 November 1944, from the Office of the Chief Surgeon, Headquarters, European Theater of Operations, U.S. Army (19). In this memorandum, it was frankly admitted that, because of the enormous number of transfusions being given in the theater, a certain number of reactions were inevitable. Allergic, pyrogenic, and hemolytic reactions were described, and their prevention and treatment were outlined.

In this same memorandum, all hospitals in the theater were instructed to submit weekly reports to the Office of the Chief Surgeon, the data to include the number of transfusions given; the number of reactions and their classification; and, for each reaction, the type of blood, its source, its age, and the source of the giving set (disposable, or prepared locally).

By 30 December 1944, 3,741 transfusions had been reported, with 188 reactions of all types. Major Hardin considered that the incidence of pyrogenic reactions, 3.7 percent, and of hemolytic reactions, 0.48 percent, was too high. The incidence of hemolytic reactions, however, was probably less than stated because deaths were being signed out as hemoglobinuric nephroses when the blood given had nothing to do with the complication or the death. Many of the casualties, in fact, had been anuric before they received any blood.

Special studies of the reports submitted by hospitals in the theater and analyzed by Major Hardin and several of his associates are presented in tables 28-31 (15). Perhaps the most interesting feature of this analysis is contained in table 31, which indicates the responsibility of poor preparation of locally prepared sets in the incidence of pyrogenic reactions.

One is immediately impressed by the discrepancies in the reaction rates reported by hospitals in different echelons of medical care. The first explanation of the higher rate in rear hospitals is multiple transfusions and the development of Rh sensitivity. Patients transfused in forward hospitals on one day were often transfused again 10 to 14 days later, in general hospitals in the rear. The possibility of producing Rh sensitivity by the indiscriminate use of blood whose Rh type was not known was suddenly real, and subsequent transfusion provided the opportunity for the sensitivity to become manifest.

A simpler explanation, however, is available for the low reported incidence of reactions in forward hospitals, that in a field or evacuation hospital, during

TABLE 28.—*Reactions to blood transfusions in field hospitals over 17-week period in the European Theater of Operations, U.S. Army*¹

Weekly periods	Transfusions	Reactions	Reactions	Classification		
				Allergic	Pyrogenic	Hemolytic
	Number	Number	Percent	Number	Number	Number
1.....	253	2	0.79		2	
2.....	742	18	2.42	1	16	1
3.....	579	9	1.55		8	1
4.....	939	5	.53	2	3	
5.....	1,233	26	2.11	7	16	3
6.....	1,307	18	1.38	3	15	
7.....	1,104	15	1.36	3	11	1
8.....	1,304	27	2.01	6	20	1
9.....	907	18	1.98		18	
10.....	1,043	8	.77	1	7	
11.....	929	16	1.72	5	9	2
12.....	1,039	7	.67	2	5	
13.....	1,101	18	1.63	7	9	2
14.....	1,111	14	1.26	3	11	
15.....	1,494	5	.34		4	1
16.....	1,228	15	1.22	10	5	
17.....	803	1	.12	1		
Total.....	17,769	224	1.26	52	160	12

¹ There were six deaths in the 12 hemolytic reactions.

a rush of casualties, mild reactions were often overlooked and only the most severe reactions were noted, let alone recorded. In general and station hospitals, with larger staffs and less pressure, more accurate observation and recording were possible.

The figures in these tables cannot be accepted unequivocally, for the reasons mentioned, but the collection served the purpose for which it was intended, to check upon the operations of blood banks and to build a basis for further investigation. One important thing that was learned was that it was dangerous to accept reports of reactions based on less than 500 transfusions and that a minimum of 1,000 transfusions was necessary for conclusions of any validity.

In his report of his trip to the European theater in January 1945, Capt. John Elliott, SnC, reported Major Hardin's emphatic belief that the reaction rate from blood flown from the United States was considerably lower than that of blood collected locally in the theater (20). Up to that time, 18,460 transfusions had been given with 643 reactions, 3.5 percent. Blood collected locally accounted for 26 percent of the reactions but for only 10 percent of the transfusions. Blood from the Zone of Interior accounted for about 28 percent of the reactions but for about 60 percent of the transfusions. Blood from the

TABLE 29.—*Reactions to blood transfusions in evacuation hospitals over 20-week period in European Theater of Operations, U.S. Army*¹

Weekly periods	Transfusions	Reactions	Reactions	Classification ²		
				Allergic	Pyrogenic	Hemolytic
	<i>Number</i>	<i>Number</i>	<i>Percent</i>	<i>Number</i>	<i>Number</i>	<i>Number</i>
1.....	761	36	4.72	12	17	7
2.....	1,060	40	3.77	5	27	8
3.....	1,372	33	2.40	3	29	1
4.....	1,878	32	1.70	5	24	3
5.....	2,400	47	1.95	9	32	6
6.....	1,545	37	2.43	12	23	2
7.....	1,909	31	1.62	12	15	4
8.....	1,101	27	2.45	10	14	3
9.....	807	17	2.11	3	13	1
10.....	1,210	51	4.21	2	39	9
11.....	817	33	4.04	4	22	5
12.....	1,063	21	1.97	4	16	1
13.....	1,316	33	2.51	4	25	2
14.....	1,338	12	.89	4	5	-----
15.....	1,800	2	.11	-----	2	-----
16.....	1,306	19	1.43	3	16	-----
17.....	1,095	11	1.00	2	9	-----
18.....	778	10	1.28	4	6	-----
19.....	969	7	.72	2	5	-----
20.....	397	1	.25	-----	1	-----
Total.....	24,920	500	2.00	100	340	52

¹ There were 27 deaths in the 52 hemolytic reactions; 6 other deaths in the group were not attributed to the transfusions.

² In the 10th through 14th weeks, there were eight unclassified reactions.

TABLE 30.—*Reactions in 18 general and station hospitals after transfusion with blood obtained from the United Kingdom Section, European Theater Blood Bank*¹

Year and month	Transfusions	Reactions	Reactions	Classification	
				Allergic	Pyrogenic
	<i>Number</i>	<i>Number</i>	<i>Percent</i>	<i>Number</i>	<i>Number</i>
<i>1945</i>					
March.....	1,063	24	2.2	-----	-----
April.....	1,402	30	2.1	10	20
May.....	307	4	1.3	1	3
Total.....	2,772	58	2.1	11	23

¹ There were no hemolytic reactions in this group.

TABLE 31.—*Influence of local preparation of transfusion sets on pyrogenic reactions in various types of hospitals*

Types of hospital	Number of pyrogenic reactions	Number with locally prepared sets	Percent
Field hospitals.....	160	62	38.7
Evacuation hospitals.....	340	136	40.0
General hospitals.....	346	174	50.2
Total.....	846	372	44.0

United States accounted for the largest proportion of allergic reactions but by far the lowest proportion of pyrogenic and hemolytic reactions.

Similarly, striking figures were reported for February 1945. In that month, 32 percent of the transfusions which were followed by reactions occurred with locally prepared sets. The use of locally prepared sets also explained the reactions which occurred in bloods collected by the theater bank (21).

Special studies on the effects of transfusion of incompatible isoagglutinins were carried out at the 5th General Hospital by Major Emerson and Maj. (later Lt. Col.) Richard V. Ebert, MC (22), and were supplemented by additional studies made by Major Emerson on detached service with the 91st Evacuation Hospital (18). They arrived at the following conclusions:

1. The repeated injection of group O blood or pooled plasma, or their injection in massive amounts, into individuals of other than group O produces hemolysis of recipient cells, the degree of which may be significant. The process is occasionally accompanied by a febrile transfusion reaction.

2. The hemolytic process is associated with progressive increase of hypotonic erythrocytic fragility, which is apparently related to the hemolytic phenomena described by Ham and Castle. These observers produced the same processes in experimental animals by the injection of nonspecific agglutinins.

3. Evidences of profound hemolytic disease may appear after massive plasma transfusions given to patients of other than group O. This phenomenon was observed in four patients and was in contrast to the good results in three patients with comparable injuries, who were treated similarly and whose blood group was O.

4. A certain proportion of nonspecific pyrogenic transfusion reactions may be caused by the stroma of hemolyzed red blood cells in the transfused blood. Prevention of these reactions depends not only on proper refrigeration of stored blood but also on the maintenance of red blood cell diffusion in the blood diluent by repeated agitation of the bottle during storage. Results of preliminary studies suggested that the survival of red blood cells during storage is limited by the amount supplied of an exhaustible nutrient factor.

In his separate study, Major Emerson followed 61 patients throughout their course in the 91st Evacuation Hospital, making elaborate clinical and laboratory studies on them during the 5-week period ending 10 May 1945. All had incurred severe wounds and all required intensive replacement therapy, including 265 units of whole blood, 222 of which were flown from the United States.

During the period in question, 520 units of blood were given in the hospital, with eight reactions. The data in one case are incomplete. Three of the reactions followed the use of partly hemolyzed blood, and the remainder occurred in casualties of groups A and B, who received O blood with a high titer of isoagglutinins ranging from 1 to 500 against the patient's cells.

The hemolysis was attributed to three factors: the age of the blood (10 days or more in all instances); failure to agitate the blood frequently during storage, so that the red cells in the bottom of the flask were not kept in contact with the preservative diluent; and failure of refrigeration.

Major Emerson considered that, from the practical point of view, the importance of these and other findings (space does not permit their inclusion here) was as follows:

1. Repeated transfusion of group O blood into other than group O patients may be an ineffectual and uneconomic procedure except in emergency replacement therapy.

2. The transfusion of very large amounts of group O blood, and even of pooled plasma, into recipients of other blood groups may cause serious hemolytic disease.

3. It is conceivable that irreversible organic changes involving the kidneys, liver, central nervous system, and other organs may occur as the result of prolonged, diffuse intracapillary agglutination.

4. The implication is strong that whenever feasible, strictly compatible blood, of the recipient's blood group, should be used. Under conditions that render the exclusive use of group O blood necessary, only blood of low titer should be supplied. There are strong reasons to suspect that even pooled human plasma with a low agglutinin titer, if administered in very large amounts to persons of blood groups other than O, may have undesirable and even dangerous effects, and that the use of fractionated human albumin might be preferable in such cases.³

Occasional hospitals, during the course of the war, indicated their desire to collect their own blood and not use banked blood because of fear of reactions and for other reasons. Major Hardin was willing that hospitals should maintain their own blood banks if they wished to, but he pointed out that if a hospital should ever be either isolated or overwhelmed with casualties, either the system would collapse or the patients would not be adequately transfused (23).

Maj. Gen. Paul R. Hawley's position was unequivocal. He considered that most of the deaths reported as caused by transfusion were due to other causes, including overloading kidneys already damaged from toxins elaborated in the crush syndrome or other injuries. Up to March 1945, the transfusion death rate in the European theater was 0.12 percent, which compared very favorably with the 0.14 percent of transfusion deaths recorded in the literature.

³ Certain of these assumptions are based on the false premise that group O blood instead of type-specific blood was advised for routine use in peacetime as well as in war. This, of course, was not true. It was recommended for use in the circumstances of war, particularly in combat areas, because it was considered far safer as a universal replacement agent than type-specific blood could possibly be. It is believed that the results fully vindicated this decision.

"I shall not," he wrote, "tolerate exuberant enthusiasts casting any doubt upon a technique that has saved the lives of thousands of American soldiers" (24).

REACTIONS FROM CONTAMINATED BLOOD

One of the most serious complications of blood transfusion, but one which fortunately occurred only infrequently, followed the use of grossly contaminated blood. The recipient became violently ill shortly after receiving the blood and death usually occurred in a few hours.

Four such reactions occurred on 23 and 24 January 1945, at the 43d General Hospital, two in German prisoners of war and two in U.S. soldiers (25).

The course in each case was almost identical. Shortly after the transfusion, chills occurred, without pain or respiratory difficulty. Then, the patients quickly passed into a state somewhat, but not altogether, like shock. They were disoriented, but frank coma did not develop. The blood pressure was well within the shock range, but the general appearance was not typical of shock. The pulse rate was extremely rapid, but at first was of good volume and there was no noticeable sweating. Within a short period of time, the temperature rose sharply, in one instance to 106° F. Later, cyanosis appeared. The outstanding feature in each case was the profound circulatory collapse, which predominantly involved the peripheral vascular bed. Three patients died. At post mortem examination, the only findings common to all three cases were heart failure, with the right ventricle primarily involved.

An elaborate investigation followed, hampered by the fact that the Baxter bottles in which the blood had been collected and the donor sets used were no longer available for examination. It was not possible to determine how the contamination had occurred, but the situation was described as the kind that "keeps blood bankers awake at night."

After these fatalities, Major Hardin instituted cultural spot checks of the bloods in the United Kingdom Blood Bank and at the Continental Blood Bank in Paris.

LOWER NEPHRON NEPHROSIS

The lethal sequelae of shock were not appreciated at the beginning of the war, as might have been expected; the peacetime experience with this condition is never on the massive scale on which it occurs in wartime, and such sequelae are therefore numerically less frequent and tend to be less impressive. In World War II, they were very frequent, because of the vast number of shocked casualties, and they became more impressive and more apparent as more patients, with improved methods of resuscitation and surgery, lived long enough to develop them.

These sequelae were due primarily to asphyxia of organs or tissues during the prolonged period of reduced volume flow of blood. Post mortem examinations by knowledgeable pathologists demonstrated, in such delayed deaths, irreparable damage to the brain, the kidney, and the liver. These sequelae

must be mentioned here because of the implication, which proved to be incorrect, of the role of transfusion in the pathogenesis of the condition that came to be known as lower nephron nephrosis.

Mediterranean Theater

Lower nephron nephrosis, manifested clinically by oliguria and anuria, became a prominent feature of the crushing injuries sustained in air raids on London during the first months of the war. Up to October 1944, when Lt. Col. (later Col.) Douglas B. Kendrick, MC, reported on it to the Surgical Consultants Division, Office of The Surgeon General, about 50,000 transfusions had been given in the Mediterranean theater, 114 of which had been followed by anuria, which was usually fatal (17).

Clinical syndrome.—Certain findings were characteristic of the renal complications that occurred after injury and transfusion:

1. All the patients had gone into shock after wounding.
2. All had received blood and plasma before operation, but the quantities had varied, as had the titer of the blood.
3. Although large quantities of blood were given in fixed hospitals, in preparation for reparative surgery, sometimes 1,000 to 1,500 cc. for 2 or 3 days, anuria was almost never observed at this echelon of medical care.
4. Lower nephron nephrosis occurred in group O recipients as well as in recipients of other groups who received group O blood.
5. When anuria was to develop, it appeared early, usually within the first 24 hours after admission to a field or evacuation hospital.
6. The anuria was associated with a progressively increasing nonprotein nitrogen retention, which was unaffected by the injection of whole blood, plasma, crystalloid solutions, or alkalinizing solutions; once anuria developed, alkalization was not effective.
7. Death occurred within 5 to 7 days unless the patient died earlier from other causes.

When it was thought that lower nephron nephrosis was caused by the use of group O blood in nongroup O recipients, an endeavor was made to supply type-specific blood to forward hospitals. The attempt was overruled (p. 425) and, in the light of more correct information, it was realized that it would have been a futile gesture from the standpoint of preventing this renal complication of wounding.

Special investigations.—The principal reason for the creation of the Board for the Study of the Severely Wounded (p. 420) was the investigation of lower nephron nephrosis (16). The observations of the board may be summarized as follows:

1. Studies made after resuscitation, and after operation in surgical cases, indicated that, functionally, all portions of the nephron were almost equally impaired for varying periods of time. The impairment depended upon the severity of the initial insult, and the state of shock on admission also depended upon it. These physiologic observations did not correspond with the histologic findings in fatal cases, in which the lesion observed was always predominantly in the lower nephron.

2. The clinical syndrome of renal insufficiency after shock was remarkable chiefly for the paucity and mildness of its symptoms. The most frequent symptom, drowsiness slowly deepening into stupor, might be absent until death was impending. The only frequent sign was pulmonary or peripheral edema.

3. Blood pressure determinations and laboratory tests were more useful than clinical observations. In the ascending order of diagnostic importance, laboratory findings included proteinuria, persistent urinary acidity, excretion of benzidine-positive material, azotemia, and fixation of specific gravity at a low level. When these findings were associated with hypertension, the diagnosis was established.

Other important findings included nitrogen and phosphorus retention, acidosis, hypochloremia, and an increase in the plasma volume. Practically all of the abnormalities, it should be noted, were those that reflect rapidly diminishing renal function.

4. The case fatality rate was approximately 75 percent. Death usually occurred within 10 days after wounding. Apparently, if the wounded man could survive this critical period, renal function might begin to recover and he had a chance of survival.

5. When recovery ensued, it was characterized by what was termed "the syndrome of recovery diuresis."

6. The best treatment of lower nephron nephrosis was its prevention, by prompt and adequate resuscitation of every casualty in shock. None of the therapeutic methods employed was really effective except the prevention of pulmonary edema by control of the fluid intake. It was a grave error to overload the circulation during the critical 10-day period.

7. Evidence was meager that alkalinization would prevent renal complications in the severely wounded. The original plan, to give alkalis as soon as renal complications became evident, was eventually discarded, and their use, beyond the amount given routinely with citrated whole blood or blood substitutes, was not recommended.

8. The lack of correlation between concentrations of benzidine-reacting pigment in the plasma and the hemoglobin or myoglobin in the urine suggested that the alteration of the threshold was variable. The irregularity with which extensive muscle injury was followed by myoglobinuria indicated that some factor other than necrosis of muscle cells was at work. This factor—which was not shock—apparently had to do with the maintenance of reestablishment of the circulation in the involved muscles. Occasionally, severe myoglobinuria developed in the absence of demonstrable muscle injury. The almost constant presence of moderate or severe shock in such cases suggested the possibility of diffuse ischemic muscle injury not recognizable morphologically. The fact that severe myoglobinuria and severe hemoglobinuria were often observed in the same patient suggested the possibility of a common mechanism.

SOUTHWEST PACIFIC AREA

Statistics for transfusion reactions are more incomplete for the Pacific areas than for other theaters because the circumstances of warfare were less favorable than elsewhere for precise reporting. Reports (which were required, as in the European theater) were received on only 22,000 of the pints of blood distributed from Guam, but the 3.1 percent rate indicated in them can be accepted as accurate (26). A number of severe hemoglobinurias were reported, but most of the reactions were mild, and 41 percent were allergic. As in other theaters, a number of deaths attributed to transfusions were not related to them except in the sense that they occurred after blood had been given.

The reaction rate was higher when the blood was outdated. Up to 21 days, it was between 2 and 4 percent. Between 22 and 30 days, when the specified time limit had passed, it was 5 to 6 percent.

The low reaction rate secured in transfusions with blood flown from the Zone of Interior was chiefly explained by the use of disposable recipient sets. Whenever locally prepared sets were used, the reaction rate was higher. All of the hospitals which received Zone of Interior blood were warned that the recipient sets provided with the blood must be used.

When the plan of flying blood to the Pacific was first announced, many surgeons thought the reaction would be prohibitively high (27). Within a matter of weeks, their skepticism was overcome by the low rate; the convenience of not having to crossmatch the blood; the absence of fatalities; and the beneficial results secured, which permitted major surgery with an enormous reduction in the surgical risk.

It was not surprising that hospitals using large amounts of preserved whole blood invariably reported reaction rates well below those of units using smaller amounts. Efficient refrigeration, elimination of mechanical difficulties, and greater experience were all contributing factors. The rates were notably lower in hospitals in which special shock teams handled all transfusions.

Transfusion reactions were more frequent and more severe in Filipinos than in U.S. personnel (28, 29). They were chiefly allergic and manifested by edema and urticaria, but one station hospital reported two fatal cases of anuria soon after the landings on Leyte, and later reported a third fatal case. Presumably, these reactions were on the same basis as the plasma reactions which occurred in Filipino personnel.

PLASMA TRANSFUSION REACTIONS

Urticarial reactions sometimes followed the infusion of plasma, though they were not very frequent. Almost without exception, reactions classified as hemolytic could be traced to the use of contaminated plasma and thus were incorrectly diagnosed as hemolytic.

Early Experiences

The possibility of reactions to plasma therapy was first brought up in the Subcommittee on Blood Substitutes at the 18 July 1941 meeting (30), when 262 transfusions were reported from cooperating civilian hospitals with 19 reactions, 7.3 percent; the series included transfusions with type-specific plasmas, pooled liquid plasma, and dried plasma. These reactions, it must be remembered, occurred at a period when plasma was first being tested as a so-called blood substitute and when the techniques of collection of blood offered an invitation to infection and to other complications.

At two later meetings of the subcommittee in 1942 (31, 32), the subject came up again, since several articles had appeared in the literature describing reactions to plasma infusions. The experiences reported were contrary to Dr. Max M. Strumia's extensive experience; in 2,200 plasma infusions which he had observed personally, there were only five reactions, all urticarial. He was inclined to attribute the reported reactions to the use of plasma obtained from partly clotted blood, or, less probably, to pyrogenic substances in the plasma. He could find no evidence that they were due to an incompatibility between the recipient's cells and the plasma injected. Pooled plasma occasionally showed a relatively high isoagglutinin titer, but, when the plasma was given at the usual rate (5-10 cc. per minute), the agglutinins were not only diluted in the recipient's bloodstream but were apparently also absorbed or inactivated as rapidly as they were injected into the circulation.

An editorial published in the *Journal of the American Medical Association* on 19 September 1942 (p. 79) contained inaccurate and misleading information concerning the potential toxicity of plasma (33). It was considered important that it be corrected at once because of its possible effect on the blood procurement program. The editorial which corrected the erroneous statements left much to be desired, but the article prepared by Dr. William Thalheimer and published in the *Journal* for 19 December 1942 was a competent and reasoned rebuttal (34).

Production difficulties.—In August 1944, complaints were received from the Office of the Chief Surgeon, European Theater of Operations, U.S. Army, that reactions were occurring after the administration of dried plasma from a certain laboratory. The plasma which had caused the reactions had contained excessive amounts of fibrin particles. The use of plasma from this firm had been forbidden in the theater; its issue had been discontinued; and the New York Port of Embarkation had been requested to delay further shipments. All installations in the First and Third U.S. Armies, Advance Section, and all laboratories in the United Kingdom were requested to report, on a special questionnaire, on any reactions which had occurred after the administration of plasma in the last 2 months.

Clinical testing with the offending lots of plasma at the Army and the Naval Medical Centers was followed by chills and fever in about 7 percent of

the patients, and a number of the bottles used showed moderate amounts of fibrin. When the firm which had produced the offending plasma was visited in October 1944 by Colonel Kendrick, Capt. Lloyd R. Newhouser, MC, USN, and Lt. (later Lt. Cdr.) Henry S. Blake, MC, USN, certain changes in production technique were advised, including chilling of the blood before centrifugation, to eliminate excessive amounts of fibrin in the final product. It was also recommended that all plasma produced by this particular laboratory before these changes were made should be used only in the United States. There were no adverse reports from any of the hospitals to which it was distributed.

Special Investigations in the European Theater

Early in 1945, while a survey of transfusion reactions was being made in the 91st Evacuation Hospital, a number of plasma transfusion reactions were also observed, some quite serious (35). A special study was therefore undertaken of the plasma transfusions given during a recent 25-day offensive, during which 1,022 patients were handled on the surgical service.

In this group, 109 patients, 10.6 percent of the surgical admissions, received 323 units of plasma, an average of 3 units per patient. There were 21 reactions, of which 3 were urticarial; these reactions simply caused discomfort and did not impede the progress of treatment. There were also 14 pyrogenic reactions and 4 modified hemolytic reactions, all sufficiently severe to delay recovery, though none were lethal. Counting only these 18 reactions, the reaction rate was 5.3 percent for the 323 injections and 15.6 percent for the 109 patients.

Pyrogenic reactions.—The pyrogenic reactions were similar to those observed in reactions sometimes observed after the intravenous administration of other fluids. Chills and temperature elevations were the chief manifestations. The temperature, which ranged from 101° to 104° F., returned to normal in 3 or 4 hours. There was no fall in the blood pressure, no urinary suppression, and no abnormalities in the urinalysis.

Many of the patients received additional plasma and blood without further difficulty. The pyrogenic reactions, however, were serious because they often occurred in the shock ward, in patients being prepared for operation, and their progress through X-ray examination to the operating room had to be delayed for a matter of hours until recovery from the reaction took place.

Hemolytic reactions.—The four modified hemolytic reactions were far more serious. Three patients had received no intravenous fluid except plasma. The fourth had received two units of blood, but the onset of the reaction occurred while he was receiving plasma. One patient presented a typical picture of peripheral vascular collapse. The systolic blood pressure fell to 60 and 32 mm. Hg, respectively, in two cases and could not be obtained in the other two. One patient had no elevation of temperature, but the elevations in the three other cases ranged from 102° to 103.4° F.

Two of the patients were anuric for 12 and 24 hours, respectively. All had red blood cells and granular casts in the urine. All had positive orthotoluidine reactions.

Icterus index determinations were made 24 hours after the reaction in two cases and were reported as 9 and 11, respectively; 2 days later, the values were 5 and 6, respectively.

Three of the patients were group A and the fourth, group O. All received large amounts of plasma in relatively short periods. The titer of the plasma to the recipient's cells was 1:8 in two cases and 1:16 and 1:54, respectively, in the other two.⁴

All four patients were treated successfully by the routine used for hemolytic blood reactions. An attempt was made to alkalinize the urine with sodium chloride, with careful regulation of the fluid intake and close observation to detect any signs of pulmonary edema; it would have been easy to drown these patients in the attempt to increase the renal output. Serum albumin was also used and was very effective.

No reasonable explanation was found for these reactions at the time of their occurrence. None of the patients had wounds of the urinary tract. The possibility that the findings were due to massive tissue destruction with hemoglobin could not be excluded, but similar phenomena were not observed in other casualties with injuries of comparable kind and severity. The most reasonable immediate explanation seemed to be that, when several infusions of plasma were given over a relatively short time, an agglutinin titer might be built up which might react with the cells of all blood types except AB. In retrospect, these phenomena seem to an observer who did not witness them personally to be explained by the use of contaminated plasma rather than as true hemolytic reactions.

The Southwest Pacific Experience

There were occasional isolated reports of plasma reactions in the Southwest Pacific, none particularly convincing and most of them readily explained, usually by contamination of the plasma. One experience, however, was extremely serious (36):

On 21 April 1945, the Office of The Surgeon General received a report of eight fatal reactions after the use of U.S. Army plasma for Filipino civilians in the San Lazaro Hospital in Manila, a civilian hospital staffed by civilian Filipino physicians.

The 11 patients among whom these 8 fatalities occurred were all greatly emaciated, debilitated and avitaminotic. All had nonspecific ileocolitis, which it was thought would be improved by the administration of plasma.

The course of events was substantially the same in 10 of the 11 cases, in all of which the plasma was given on the same day, 24 March. About 30 minutes after the intravenous administration of 250 cc. of normal human

⁴ The titer seems quite low to be causing reactions.

plasma, 9 of the 10 patients complained of chilly sensations, which lasted about 30 minutes; none of them had a real chill. All complained of malaise and muscular pains. Their temperatures were not taken but they were obviously febrile. They were wrapped in blankets and each was given 2 cc. of 10-percent camphorated oil intramuscularly.

Of the 10 patients, 7 died between 4 and 16 hours later, 2 in 4 hours, 1 in 5 hours, 2 in 7 hours, 1 in 12 hours, and 1 in 16 hours. Autopsies performed in two cases revealed nothing to explain the fatal outcome.

Two units of the lot of plasma used for these patients were set aside for analysis, and, through a tragic error, one of them was given to a critically ill patient. An hour later, he developed a chill and complained of extreme substernal oppression and dyspnea. When this patient, the only one observed by a U.S. Army medical officer, was first seen, he was unconscious, with shallow, gasping respirations, at the rate of 5 per minute. The pulse was rapid and thready, and the lips and nails were cyanotic.

Artificial respiration was attempted but was unsatisfactory because a chest spica was in situ. Blankets and hot water bottles were applied, and the foot of the bed was elevated. Other treatment consisted of Adrenalin (epinephrine), 1 cc. intramuscularly; an infusion of 5-percent glucose in physiologic salt solution; and a transfusion of 500 cc. of type O blood. During the transfusion, the patient became conscious, asked for food, and clinically seemed much improved. The pulse continued rapid but was of good volume. An hour later, after an episode of extreme dyspnea, he was dead.

A tendency to react to infusions of plasma and to blood transfusions had been noted elsewhere in the Philippine Islands in patients with marked malnutrition, and it was thought that these fatal reactions might be the result of the serious hypoproteinemia then frequent among Filipinos. It was considered imperative, however, to investigate and rule out the presence of special toxic factors in this particular lot of plasma. A variety of steps were taken to achieve this purpose, and to warn all hospitals in the Southwest Pacific Area of the possible risk of plasma infusions as evidenced by these fatalities. They were instructed to use dried human plasma with extreme caution in Filipinos and to substitute whole blood for it whenever possible.

Of the 39 units of plasma in this particular lot, only a single sample was left. When it was tested at the National Institute of Health on 28 April 1945 (37), the appearance of the package and that of its contents were in accordance with specifications. All the tests performed in respect to solubility, moisture, sterility, and safety were in conformity with the minimum requirements. Pyrogen tests on rabbits, however, revealed that the product was definitely pyrogenic.

Investigation of the production of this particular lot of plasma showed that it represented the pooling of 50 separate bleedings. Sterility tests of the blood were all negative at the end of 48 hours' incubation, and the bloods were therefore pooled and processed in the usual manner. At the end of 7 days, one of the bloods was found to be contaminated, but when the plasma was tested for

sterility, it met the minimum standards requirement, and there was no evidence of contamination when it was tested routinely at the National Institute of Health.

It was considered surprising that such a slight contamination as had occurred in this lot of plasma, 1 of 50 bloods, would have caused the finished product to be pyrogenic, particularly since the processing laboratory reported that the contaminating organism was identified as *Staphylococcus albus*, which is ordinarily regarded as only mildly pyrogenic.

On 28 March 1945, the Office of the Surgeon, Headquarters, Luzon Base Section, requested information from all the hospitals in the area on the plasma reactions that had occurred in the past 30 days among U.S. soldiers, Filipino soldiers, and interned civilians. It was directed that plasma from all lots that had produced reactions was not to be used until further notice.

Eleven installations, including clearing companies, medical battalions, and field, evacuation, and general hospitals reported no reactions (38). The remaining seven installations (one clearing station, one portable surgical hospital, two field hospitals, two evacuation hospitals, and one general hospital) reported a total of 54 reactions, the great majority of which occurred in Filipino patients with debilitating diseases. The products of seven different laboratories were involved, but in only the single case just described was it possible to investigate the plasma responsible for the reaction.

Maj. John J. McGraw, Jr., MC, Special Representative on Transfusion in the Office of The Surgeon General, made the following comments on the San Lazaro Hospital experience (39):

1. The type of reaction was very similar to that which occurs when grossly contaminated plasma or blood is transfused.

2. Since the sample tested at the National Institute of Health was sterile, the possibility exists that the plasma became contaminated when it was dissolved. Minor contamination not infrequently occurs as a result of breaks in technique. If the plasma is used promptly, the contamination is usually of little significance. If the solution is allowed to stand for several hours before use, bacteria may eventually be present in very large numbers. Heavily contaminated plasma can produce severe and even fatal reactions. Dried plasma should always be used within 3 hours of the time it is dissolved.

3. The debilitated condition of these special patients undoubtedly made them less able to tolerate adverse reactions.

4. No particular significance was attached to urticarial reactions, which occur in about 2 percent of all blood and plasma transfusions, usually on a background of allergy. The fact that the same lot of plasma that produced urticarial reactions also produced chills and fever in some patients was considered of more significance. Theoretically, plasma should never produce chills and fever. On the other hand, even minor breaks in the technique of the preparation of distilled water or of intravenous tubing can result in the formation of pyrogenic substances. It could not be determined whether the giving sets used at San Lazaro were prepared locally.

5. It was recommended that any lot of plasma suspected of producing chills and fever should be used only in a general hospital, in which its effects could be observed under controlled conditions. If it appeared to be pyrogenic, it should be destroyed. The Surgeon General should be notified if the plasma of any single commercial house seemed excessively pyrogenic. It was neither desirable nor necessary to withdraw a lot of plasma and destroy it because urticaria followed the use of some units in it.

This is a logical, well-reasoned comment on an unfortunate episode which undoubtedly occurred because of a break in technique somewhere along the line of production and administration.

HOMOLOGOUS SERUM JAUNDICE

General Considerations

In the light of the postwar incidence of homologous serum jaundice, it is important to make certain points clear about its wartime occurrence after plasma transfusion:

1. Although pooled plasma was used in enormous quantities in battle casualties all during the war, the causative relation between the plasma itself and the numerous instances of jaundice in military personnel after its use was not realized until late in 1944.

2. In retrospect, what happened is clear: When blood is not pooled, a single transfusion from a donor with serum hepatitis is unlikely to cause the disease in many recipients. When, however, blood is pooled, as it is when plasma is processed, the chances of contracting jaundice are correspondingly increased.⁵

3. Serum hepatitis was never a problem in Zone of Interior hospitals, in which practically all of the plasma used was liquid and pools prepared from more than eight bloods were seldom used. Up to 50 bloods per pool, however, were used in the early stages of the dried plasma program, and later, in 1944-45, even larger pools were frequently used.

4. The relation of these various facts to the development of jaundice and serum hepatitis was finally perfectly evident, but the war was practically over before the causal sequence was widely appreciated.

5. The lack of realization of this relation is apparent in the lack of action in the matter on the part of the Subcommittee on Blood Substitutes, NRC (National Research Council), whose members were remarkably alert to all developments in the field of blood and plasma transfusion. Jaundice was discussed at a number of meetings in 1942 (31, 32), and 1943 (40), in connection with serum albumin, particularly in regard to the development of jaundice after immunization against yellow fever; each immunizing dose contained 0.04 cc. of human serum, and attention was naturally directed to it as a possible

⁵ Since serum hepatitis often appeared without clinical jaundice, a number of observers expressed the opinion that the disease would be more correctly termed "homologous serum hepatitis" rather than "homologous serum jaundice."

vehicle for a wild virus. A number of inquiries were set on foot, but, at this time, no one had observed, or heard of, jaundice after plasma transfusion. As a precaution, however, the Red Cross Blood Donor Service began to reject all donors with a history of jaundice within the previous 6 months.

6. The homologous serum jaundice that followed plasma transfusion was, of course, entirely distinct from the widespread outbreak of hepatitis in the Army in 1942, which, as just mentioned, was caused by an icterogenic agent in certain lots of yellow fever vaccine then in use (41). It was also not related to the hepatitis which occurred among troops in North Africa in 1943 and at other times during the war.

Special Studies

During 1943 and 1944, a number of reports appeared in the American literature concerning the development of hepatitis after the administration of homologous blood products. The realization of the cause-and-effect relation and of the importance of this variety of hepatitis was brought home when concentrations of the disease began to appear in various hospitals overseas (table 32) and in the Zone of Interior, and special investigations were begun on them (42-45).

The conclusions drawn in most of these investigations are, unfortunately, little more than assumptions, and not very convincing ones at that. For a number of reasons, they could hardly be otherwise:

1. The clinical and histologic pictures in both homologous serum jaundice and infectious (epidemic) hepatitis are practically identical.
2. Proof that icterogenic agents existed in the plasma transfusions that had been given was entirely lacking.
3. Very few patients with wounds of any consequence had not received plasma.
4. Further confusion in differential diagnosis was caused by the fact that there was intimate contact between patients with serum hepatitis and those with epidemic hepatitis in hospitals along the line of evacuation, in ships and planes, and in Zone of Interior hospitals.
5. A controlled investigation was impossible, for the various reasons stated, and the premises on which most reports were based were extremely unstable and tenuous.

Survey, 1 June 1945.—As of 1 June 1945, a survey was undertaken in all Army general hospitals in the Zone of Interior to identify all patients with hepatitis, of any degree or associated with any other condition, under the direction of Maj. Philip E. Sartwell, MC (44). The form provided was also to be filled out for each death from hepatitis within the preceding 30 days. The survey form (fig. 153) was made as simple as possible in view of the heavy load then being carried by all general hospitals in the United States.

At this time, about 85 percent of the general hospital population in the country consisted of casualties evacuated from overseas, 85 percent of them because of battle wounds and the remainder because of other injuries and

TABLE 32.—Percentage of patients developing hepatitis while hospitalized for some other condition, European and Mediterranean theaters, 1944

Cause of hospitalization	Number of cases						Percentage developing—			
	Total		Developing infectious hepatitis		Developing other hepatitis ¹		Infectious hepatitis		Other hepatitis ¹	
	ETO	MTO	ETO	MTO	ETO	MTO	ETO	MTO	ETO	MTO
Disease other than hepatitis ²	24,697	14,146	12	28	9	20	0.05	0.20	0.04	0.10
Nonbattle injuries: ³										
Penetrating and perforating wounds.....	1,275	737	3	2		2	.24	.27		.27
Compound fractures.....	1,491	593	3	2		1	.20	.34		.17
All others.....	22,378	12,275	9	29	3	9	.04	.24	.01	.07
Total.....	25,144	13,605	15	33	3	13	0.06	0.24	0.01	0.10
Battle wounds: ³										
Penetrating and perforating wounds.....	9,446	5,301	63	33	13	2	0.67	0.62	0.14	0.04
Compound fractures.....	5,110	1,769	19	20	6	3	.37	1.13	.12	.17
All others.....	9,711	4,873	35	37	2	7	.36	.76	.02	.14
Total.....	24,267	11,943	117	90	21	12	0.48	0.75	0.09	0.10

¹ Includes cases with a diagnosis of hepatitis or jaundice unqualified.

² Based on a 20-percent sample of admissions for psychoneurosis and a 2-percent sample of all other disease admissions exclusive of those admitted with hepatitis.

³ Based on a 20-percent sample of admissions.

Source: Medical Statistics Division, Office of The Surgeon General, Department of the Army.

diseases. Most of them had been hospitalized for a month or more before being returned to the Zone of Interior. The majority of patients admitted to the general hospitals from other hospitals in the United States were suffering from conditions that required specialized types of care not available at station or regional hospitals.

The number of cases of hepatitis reported, 1,762, with 15 fatalities, was much larger than had been anticipated (table 33). All 64 general hospitals reported at least 1 case and the majority reported from 5 to 30 cases. The regional distribution was not significant because so many of the reporting hospitals were special treatment centers. Of the patients, 87 had been prisoners of war. There was, however, a higher incidence in patients from the Mediterranean theater than from the European theater.

For a variety of reasons, the data concerning previous plasma and blood transfusions were not considered reliable. Plasma transfusions were chiefly given in forward areas, in which circumstances did not favor the keeping of precise records. The patient's own recollections could not be accepted. Finally, additional confusion was introduced by the fact that, although the

HEPATITIS SURVEY FORM				
1.	NAME & ASN _____	AGE _____	RACE _____	
2.	DATE OF ADMISSION _____			
3.	THEATER FROM WHICH EVACUATED _____ (If soldier had not been overseas, so state)			
4.	DID PATIENT RECEIVE TRANSFUSION WITHIN 4 MONTHS BEFORE ONSET OF HEPATITIS?			
	YES	NO	UNKNOWN	
5.	BLOOD PRODUCT USED			
	WHOLE BLOOD	PLASMA	UNKNOWN	
6.	DATES OF TRANSFUSIONS _____			
7.	CAUSE FOR ADMISSION TO PRESENT HOSPITAL _____			
	WOUNDED (GIVE DATE OF WOUND) _____			
	NON-BATTLE INJURY (GIVE DATE OF INJURY) _____			
	MEDICAL CONDITION (STATE DIAGNOSIS AND DATE OF ONSET) _____			
8.	DATE OF ONSET OF SYMPTOMS OF HEPATITIS _____			
9.	HAS JAUNDICE BEEN PRESENT?		YES	NO
10.	CLASSIFICATION OF HEPATITIS ATTACK:		ACUTE	RECURRENT
	CHRONIC (SYMPTOMS LASTING MORE THAN SIX MONTHS)			
11.	SEVERITY OF HEPATITIS ATTACK:		MILD	MODERATE
			SEVERE	FATAL

FIGURE 153.—Form used in 1 June 1945 survey of hepatitis in Army general hospitals in Zone of Interior.

question about transfusion was limited to the 4 months preceding the onset of hepatitis, a number of reports, though by no means all, gave information about the use of plasma and blood for longer periods.

The data collected in this survey were considered to warrant the conclusion that a large proportion of patients hospitalized with hepatitis on 1 June 1945 had contracted their disease because of the presence of an icterogenic agent in transfused blood or plasma. The conclusion naturally did not warrant the inference that any of these transfusions were not indicated or that too much blood or plasma was used. Saving the patient's life was obviously more important than protecting him against the remote possibility of his contracting hepatitis.

Other special studies in general bore out the results of this survey. A planned study at McCloskey General Hospital, Temple, Tex. (45), for instance, from 1 February to 30 April 1945, showed 57 cases of hepatitis in 935 battle casualty admissions, 1 in 322 patients who had received no blood or plasma, and 51 in the 528 who had received either or both. There were 5 cases of hepatitis in the remaining 75 patients whose histories were too incomplete to use.

TABLE 33.—Data obtained in survey of hepatitis in Army general hospitals, Zone of Interior, 1 June 1945¹

Information obtained in survey	Total patients		Transfused patients	
	Number	Percent	Number	Percent
Total cases reported (including deaths in preceding 30 days).....	1,762	100	500	100
Initial cause of hospitalization:				
Wounds.....	607	34	434	87
Nonbattle injuries.....	49	3	23	5
Initial hepatitis.....	934	53	-----	-----
Disease other than hepatitis.....	165	9	42	8
Classification of hepatitis:				
Acute.....	1,499	86	469	95
Recurrent.....	127	7	15	3
Chronic (over 6 months' duration).....	120	7	9	2
Areas of service:				
European and Mediterranean theaters.....	1,311	75	373	75
Pacific and Asiatic theaters.....	369	21	117	24
United States.....	62	4	3	0.6
Other areas.....	9	0.5	2	0.4
Cases in liberated American prisoners.....	87	5	3	0.8

¹ The totals in several categories do not add up to 1,762 or 500 respectively because the questionnaires were not always completely filled out. In such cases, the percentages computed are based on the total number of completed reports.

Case History

While general surveys were inconclusive, an occasional case, such as the one reported by Lt. Col. (later Col.) Marion H. Barker, MC (46), from the Mediterranean theater, offers rather strong proof of the possible transfer of the disease to a recipient from a donor in whom it proved fatal. The (greatly abbreviated) history is as follows:

The sergeant who made the donation was a 235-lb., strong, well-muscled member of a general hospital medical detachment, with an entirely negative previous history. On 8 May, he played a vigorous game of baseball and knocked a home run. On the next day, he acted as a donor, and, on 10 May, his blood was given to a 19-year-old rifleman who had sustained a gunshot wound of the right lower abdomen on 25 April 1944.

On the next day, 11 May, the donor reported to sick call, and he died on 14 May, of fulminating infectious hepatitis, confirmed by the clinical course, the laboratory findings, and the necropsy findings. There was no doubt of the diagnosis, nor was there any doubt that this man had been perfectly well up to, and including, the fifth day before his death, when he gave 500 cc. of blood.

As soon as it became known that the donor had hepatitis, the recipient was transferred to a special ward, where he was kept under close observation. He remained perfectly well, and all laboratory tests were negative, until 21 May, when he began to complain of lower abdominal pain and generalized discomfort. The temperature was 99.4° F. On 23 May, a blood smear showed a few of the abnormal toxic lymphocytes ordinarily seen in early infectious hepatitis. Thereafter, the clinical course, as well as the laboratory findings, were entirely typical of infectious hepatitis, except that jaundice did not appear until 1 June.

The patient was critically ill for the next several days, but, after 8 June, his condition gradually improved and he went on to an apparently normal recovery.

In this case, although the incubation period of 11 days is extremely short, and although the events may have been no more than a coincidence, it seems reasonable to assume that they represent a direct human transfer of hepatitis from a donor with fulminating, fatal, infectious hepatitis to a recipient who was apparently recovering normally from a minor battle wound.

Preventive Measures

Since the virus of hepatitis could not be detected by the techniques available in 1945, when its importance began to be realized, the only means of preventing its transmission was a more rigid examination of blood donors than had hitherto been required, including a detailed history; a physical examination, with special reference to the liver; and a battery of laboratory tests. Aside from the fact that such a routine would be completely impractical, if only from the standpoint of expense, it was doubtful that the most elaborate requirements would uncover all cases of incipient jaundice and low-grade or latent hepatitis (43).

There seemed, in short, no practical way of eliminating the asymptomatic blood donor who never developed jaundice. By inoculating human volunteers with icterogenic serum, Neefe and his associates (47) were able to demonstrate that, at least in some cases, a subclinical hepatitis precedes the onset of jaundice by a considerable period. Clinical confirmation of these experimental observations was obtained in two cases in which studies were done a month before the onset of jaundice.

Capt. (later Maj.) Emanuel M. Rappaport, MC, in a special study of asymptomatic donors (42), suggested routine serial studies of liver function 8 weeks after transfusion, to uncover latent hepatitis which would otherwise escape detection. He had observed four such cases. Such a program was, of course, impractical at a time when all available laboratory facilities were taxed to capacity with more immediate problems, and was not very practical at any other time.

Prophylactic and Therapeutic Use of Gamma Globulin

Soon after gamma globulin was introduced by Stokes and Neefe (47), in 1945, as a prophylactic measure in infectious hepatitis, its efficacy in this respect was verified by Havens and Paul (48). Since an intimate relation had been demonstrated between the viruses of infectious and homologous serum hepatitis, it was logical to recommend that gamma globulin be given to all patients who had received either blood or plasma and that it be given immediately after the transfusion, since the incubation period of hepatitis produced by inoculation, while it might extend to 130 days or more, might also be only 30 days or even less.

This recommendation was transmitted to the Surgeon, Mediterranean Theater of Operations, 3 June 1945, by the Office of The Surgeon General. The recommendation was duly complied with (49). The same instructions were given to medical officers in the European theater in Circular Letter No. 53, Office of the Chief Surgeon, 19 June 1945 (50).

At a conference in the office of Brig. Gen. James S. Simmons, Director, Preventive Medicine Division, Office of The Surgeon General, on 25 July 1945 (51), the prophylactic use of gamma globulin was fully discussed. Brig. Gen. Fred W. Rankin was not yet convinced that the relation between transfusion and hepatitis had been incontrovertibly established, nor was he convinced of the preventive value of gamma globulin, but he was not opposed to its prophylactic use. Brig. Gen. Hugh J. Morgan, Consultant in Medicine, Office of The Surgeon General, was sufficiently impressed with the findings of Major Sartwell's survey of hepatitis in Zone of Interior hospitals to believe that gamma globulin should be administered routinely. All present agreed to recommend that all wounded patients who had been transfused and who were received in hospitals in the United States between 21 and 120 days after wounding should routinely receive gamma globulin. The recommended dose was 10 cc.

This was the last official action in regard to posttransfusion hepatitis in World War II. The postwar problem is described elsewhere (p. 776).

References

1. Davis, H.A.: The Transfusion of Conserved Blood. *Am. J. Surg.* 50: 698-702, December 1940.
2. Bordley, J. III: Reactions Following Transfusion of Blood, With Urinary Suppression and Uremia. *Arch. Int. Med.* 47: 288-315, February 1931.
3. War Department Technical Bulletin (TB MED) 204, 24 Oct. 1945, subject: Complications of Blood Transfusion.
4. Lewisohn, R., and Rosenthal, N.: Prevention of Chills Following Transfusion of Citrated Blood. *J.A.M.A.* 100: 466-469, 18 Feb. 1933.
5. Seibert, F. B.: Fever-Producing Substance Found in Some Distilled Waters. *Am. J. Physiol.* 67: 90-104, December 1923.
6. Lewisohn, R.: A New and Greatly Simplified Method of Blood Transfusion. A Preliminary Report. *M. Rec.* 87: 141-142, 23 Jan. 1915.
7. Lewisohn, R.: Blood Transfusion: 50 Years Ago and Today. *Surg. Gynec. & Obst.* 101: 362-368, September 1955.
8. Administrative and Logistical History of the Medical Service, Communications Zone, European Theater of Operations, vol. 13, chapter 14, Professional Aspects of the Medical Service. [Official record.]
9. Kilduffe, Robert A., and DeBakey, Michael: The Blood Bank and the Technique and Therapeutics of Transfusions. St. Louis: C. V. Mosby Co., 1942.
10. Mallory, T. B.: Hemoglobinuric Nephrosis in Traumatic Shock. *Am. J. Clin. Path.* 17: 427-443, June 1947.
11. History, 15th Medical General Laboratory, 20 Dec. 1942-31 May 1944, 31 Oct. 1944.
12. Conference on Shock and Transfusion, afternoon session, 25 May 1945. Office of the Chief Surgeon, Headquarters, European Theater of Operations, U.S. Army.
13. Ashby, W.: The Determination of the Length of Life of Transfused Blood Corpuscles in Man. *J. Exper. Med.* 29: 267-281, 1 Mar. 1919.

14. Report, Maj. Stewart C. Wagoner, MC, to Army Surgeon, Ninth U.S. Army, 12 Feb. 1945, subject: Report of Transfusion Reactions.
15. Hardin, Lt. Col. Robert C., MC, Holt, Maj. Benton B., MC, and Coulson, Maj. Forest H., MC: Reactions to Transfusions, n.d.
16. Medical Department, United States Army. Surgery in World War II. The Physiologic Effects of Wounds. Washington: U.S. Government Printing Office, 1952.
17. Report, Lt. Col. Douglas B. Kendrick, MC, to The Surgeon General, 15 Jan. 1945, subject: Trip to the North African Theater of Operations.
18. Emerson, Maj. Charles P., MC: Investigation of Transfusion Therapy—Ninth U.S. Army, 6 April–10 May 1945.
19. Administrative Memorandum No. 150, Office of the Chief Surgeon, Headquarters, European Theater of Operations, U.S. Army, 22 Nov. 1944, subject: Blood Transfusion.
20. Memorandum, Capt. John Elliott, SnC, to Chief, Surgical Consultants Division, Office of The Surgeon General, through Director, Army Medical School, 1 Feb. 1945, subject: Transportation of Blood from the U.S. to the ETO Blood Bank in Paris.
21. ETMD, European Theater of Operations, U.S. Army, for February 1945.
22. Emerson, C. P., and Ebert, R. V.: A Study of Shock in Battle Casualties. Measurements of the Blood Volume Changes Occurring in Response to Therapy. *Ann. Surg.* 122: 745–772, November 1945.
23. Memorandum, Maj. Robert C. Hardin, MC, to Chief Consultant in Surgery, Professional Services Division, Office of the Chief Surgeon, Headquarters, European Theater of Operations, 21 Mar. 1945, subject: Transfusion Reactions.
24. Letter, Maj. Gen. Paul R. Hawley to Col. William E. Shambora, MC, 24 Mar. 1945.
25. Report, Lt. Col. Francis P. Parker, MC, to the Commanding Officer, 43d General Hospital, 22 Feb. 1945, subject: Investigation of Transfusion Reactions.
26. Minutes, Conference on Blood Preservation and Red Cell Resuspension, Division of Medical Sciences, NRC, 6 Dec. 1945.
27. ETMD, Pacific Ocean Area, for January 1945.
28. Report, 64th Portable Surgical Hospital, 2d quarter, 1945.
29. Clinical abstract, Fatal Transfusion Reaction, 311th General Hospital, 24 Nov. 1945.
30. Minutes, meeting of Subcommittee on Blood Substitutes, Division of Medical Sciences, NRC, 18 July 1941.
31. Minutes, meeting of Subcommittee on Blood Substitutes, Division of Medical Sciences, NRC, 12 May 1942.
32. Minutes, meeting of Subcommittee on Blood Substitutes, Division of Medical Sciences, NRC, 20 Oct. 1942.
33. Toxicity of Human Plasma. *J.A.M.A.* 120: 206–207, 19 Sept. 1942.
34. Thalheimer, W.: Intravenous Injection of Pooled Normal Plasma or Serum. Is it Dangerous? *J.A.M.A.* 120: 1263–1267, 19 Dec. 1942.
35. Letter, Maj. Stewart C. Wagoner, MC, to Army Surgeon, Ninth U.S. Army, 21 Mar. 1945, subject: Plasma Reactions.
36. Letter, Brig. Gen. Guy B. Denit to The Surgeon General, Army Service Forces, 21 Apr. 1945, subject: Reports of Reactions Following Administration of Human Blood Plasma, Item 1608900.
37. Letter, Dr. M. V. Veldee to Maj. J. J. McGraw, Jr., MC, 28 Apr. 1945.
38. Letter, Office of Surgeon, Headquarters, Luzon Base Section, to commanding officers of hospitals in the area, 28 Mar. 1945, subject: Plasma Reactions; Summary of replies, entitled "Plasma Reaction Summary," n.d.
39. Memorandum, Maj. J. J. McGraw, Jr., MC, to Liaison Branch, Purchase Division (attention: Maj. A. O. Glasson), 17 May 1945, subject: Reactions Following Administration of Plasma in Far East.

40. Minutes, meeting of Subcommittee on Blood Substitutes, Division of Medical Sciences, NRC, 24 Feb. 1943.
41. Walker, D. W.: Some Epidemiological Aspects of Infectious Hepatitis in the U.S. Army. *Am. J. Trop. Med* 25: 75-82, March 1945.
42. Rappaport, E. M.: Hepatitis Following Blood or Plasma Transfusions. Observations in Thirty-Three Cases. *J.A.M.A.* 128: 932-939, 28 July 1945.
43. Rappaport, Capt. E. M., MC: Further Observations on Delayed Hepatitis Following Transfusions and the Role of Asymptomatic Donors in this Syndrome, n.d.
44. Sartwell, Maj. P. E., MC: Infectious Hepatitis in Relation to Blood Transfusion. Findings of a Survey Conducted in Army General Hospitals, n.d.
45. Grossman, E. B., and Stokes, J., Jr.: Post-Transfusion Hepatitis in Battle Casualties and a Study of Its Prophylaxis by Means of Human Immune Serum Globulin. *J.A.M.A.* 129: 991-994, 8 Dec. 1945.
46. ETMD, North African Theater of Operations, U.S. Army, for August 1944.
47. Stokes, J., Jr., and Neefe, J. R.: The Prevention and Attenuation of Infectious Hepatitis by Gamma Globulin. *J.A.M.A.* 127: 144-145, 20 Jan. 1945.
48. Havens, W. P., and Paul, J. R.: Prevention of Infectious Hepatitis With Gamma Globulin. *J.A.M.A.* 129: 270-272, 22 Sept. 1945.
49. Memorandum, Col. Earl Standlee, MC, to The Surgeon General, U.S. Army, 22 July 1945, subject: Hepatitis in Transfused Individuals.
50. Circular Letter No. 53, Office of the Chief Surgeon, Headquarters, European Theater of Operations, U.S. Army, 19 June 1945, subject: Homologous Serum Jaundice (sec. II).
51. Memorandum, Maj. P. E. Sartwell, MC, for file, 25 July 1945, subject: Prevention of Post Transfusion Hepatitis.

CHAPTER XIX

General Considerations of Shock Therapy

According to Brig. Gen. Elliott C. Cutler (1), the single feature of professional care that contributed most directly to the improvement in morbidity and mortality in World War II was adequate resuscitation of the wounded man. This factor, in his opinion, transcended in importance any single method of therapy, even the administration of blood and plasma, for it comprised the total evaluation and care of battle casualties before surgery, not attention to a single anatomic region or some particular wound. This concept led to the greatly improved management of shock, chiefly by the liberal use of whole blood.

PRINCIPLES OF RESUSCITATION

Role of Surgery

In a report to the Surgeon, NATOUSA (North African Theater of Operations, U.S. Army), on 2 July 1943, Col. Edward D. Churchill, MC, emphasized what was, for all practical purposes, a new principle in military medicine, the role of surgery itself in resuscitation (2, 3).

The establishment of a shock or resuscitation ward, Colonel Churchill pointed out, to which casualties in actual or impending shock could be sent as they were received, was an efficient arrangement and absolutely essential when casualties were received in overwhelming numbers. When this system was used, however, there was one error to be guarded against: Resuscitation might come to be regarded as a subspecialty of military surgery and, as such, as a goal in itself. Though it might seem too obvious for mention, one central fact had to be repeatedly emphasized, that a wounded man was resuscitated not only to deliver him from his immediate peril but also to prepare him for whatever surgery he needed.

With this concept in mind, a number of principles of resuscitation became clear:

1. Any delay in resuscitation prolongs the crucial interval between the time of wounding and surgery; that is, the timelag.
2. Any delay in the reversal of shock increases the deleterious effects of circulatory failure. Prompt restoration of blood volume stands out as the most important advance in the war to date (July 1943).
3. Resuscitation of every casualty being prepared for operation is an integral part of the surgical management of trauma. Operating surgeons must not fail to follow closely the clinical course of patients in the resuscitation wards. They must not wait for the patients to be "served up" to them. They

must not rely on the judgment of inexperienced medical officers with inadequate training in surgery. To divorce the surgeon from shock is a disquieting outgrowth of war that cannot be too severely condemned.

4. Replacement fluids must be introduced rapidly. The use of a syringe to increase the rate of flow is too infrequent.

5. Delay in the procurement of whole blood must not be interpreted as justification for not using plasma.

6. The resuscitation ward tends to become a routine stopping point to regulate the flow of casualties to the operating room. The delay caused by lack of precision in the selection of casualties for resuscitation is wasteful and intolerable.

Practical Implications

In the months that followed Colonel Churchill's report, a sophisticated and highly efficacious system of resuscitation was developed in the North African theater.¹ Out of this development came the implementation of his concept that surgery was indeed the climax and goal of resuscitation and was in itself the most potent of all acts of resuscitation.

The immediate outgrowth of this new concept was the establishment of field hospitals immediately adjacent to clearing stations (4), with the result that surgeons trained and equipped to perform emergency surgery were brought within a short litter-carry of casualties whose wounds did not permit them to be transported to an evacuation hospital to the rear but who, after resuscitation, could be operated on close to where they were wounded.

Concepts of Shock and Its Management

It was extremely important that all medical officers and others responsible for resuscitation should understand that shock is not a fixed state but is dynamic. Once resuscitation was begun (figs. 154, 155, and 156), the casualty had to be observed frequently and carefully, so that surgery could be performed at the peak of improvement. Once that peak had passed, it was usually difficult, and sometimes impossible, to attain again the same degree of response to the measures employed. Delay during periods of pressure might mean a lost opportunity in the selection of the optimum time for operation. Stabilization of the circulatory mechanism was, however, essential before surgery was undertaken. Clinical observations were important. So were such observations as the level of the blood pressure, the pulse rate, the presence or absence of sweating, and the state of the peripheral circulation. Serial determinations (fig. 157) of the pulse and blood pressure were necessary; single observations might be highly misleading. Pulse volume was often more important than pulse rate. Collapsed veins and fluctuations of the blood pres-

¹ Full details of shock and resuscitation appear in another volume of this historical series, based on observations made in the Mediterranean Theater of Operations, U.S. Army, by Lt. Col. Henry K. Beecher, MC, and others (5).



FIGURE 154.—Administration of plasma and other intravenous therapy in shock ward, 60th Field Hospital, Dieuze, France, November 1944. Note U.S. plasma bottle hanging by white tape, and, next to it, British transfusion bottle, with filter below it, containing blood collected in the European theater.

sure sounds with respiration indicated that restoration of the blood volume had been inadequate.

No reliable criteria were ever developed for recognition of the degree of hemodynamic instability in shocked patients. Blood pressure readings provided only a rough indication. Often when the pulse rate and blood pressure had been restored to almost normal levels, movement of the patient, however slight, might cause a rapid reversion to the original stage of shock. If the significance of this reversion was not realized and if further resuscitation was not carried out before anesthesia and operation, deep and fatal shock might occur. In some cases, compensation might be so complete that, while there were no objective signs of shock, a slight additional blood loss might induce a rapid fall in the blood pressure. Continued or recurrent hemorrhage was one of the most important considerations in resuscitation. The possibility was always to be suspected in casualties who did not respond to adequate resuscitation, including adequate blood replacement.

In general, the degree of shock was proportional to the amount of blood lost, though there was occasionally a surprising lack of correlation. In wounds



FIGURE 155.—Transfusion in progress in typical shock ward, 102d Evacuation Hospital, Huy, Belgium, January 1945.

of the spleen or the mesentery, in which 1,000 to 1,500 cc. of blood could be aspirated from the peritoneal cavity, there was sometimes complete hemodynamic compensation. It was a mistake to be content with that status. The safety of these casualties required that they be transfused before operation and that preparations be made to transfuse them rapidly during operation (fig. 158), to compensate for the blood loss during it. Many medical officers shared Dr. Owen H. Wangenstein's opinion that measured blood loss at operation always proved larger than it seemed (5).

Limitations of Plasma

Since loss of blood externally or into body cavities was the principal cause of shock, its successful management depended upon the restorations of both red blood cells and blood volume. Plasma alone would not suffice (p. 55). In fact, used beyond a certain point, it might do harm by diluting the remaining blood cells at a time that rising blood pressure, caused by the plasma transfusion, could increase hemorrhage. Also, a false sense of security might be induced when elevation of the systolic pressure was accomplished by plasma alone. A pressure elevated by these means might fall precipitately with induction of anesthesia, operative manipulations, or mere movement of the



FIGURE 156.—Transfusion in shock ward in U.S. field hospital in Germany. Note suspension of blood bottle (Alsever type) from overhead wire.

patient. Finally, the plan of giving only plasma before operation, with the idea of making up the preoperative blood deficit on the operating table, was poor practice and dangerous besides.

RESUSCITATION

Diagnostic Routine

The plan of resuscitation which evolved in the Mediterranean theater came into general use elsewhere. It began with first aid measures, which frequently included the administration of plasma (figs. 159-162), on the battlefield. They were followed, as soon as the casualty was hospitalized, by rapid, complete examination, with his clothing removed, to appraise his general condition; estimate his state of shock; and determine the factors



FIGURE 158.—Transfusion in operating room of 111th Evacuation Hospital, Ninth U.S. Army, November 1944.

The diagnostic routine also included roentgenologic examination and the performance of certain laboratory tests. These tests were limited to those absolutely necessary; a medical staff that was too energetic might well contribute to the precipitation or aggravation of traumatic shock in a badly wounded casualty.

On the basis of these examinations, casualties were grouped into two categories:

1. Those with minor or slight wounds, in good condition, who needed no special preoperative preparation. They were operated on as soon as possible, with due regard to the more urgent needs of more seriously wounded casualties.

2. Those with severe wounds, who were in shock, and in whom adequate resuscitation might mean the difference between survival and death. The classification of casualties according to their degree of shock has been described elsewhere (p. 39).

Blood Replacement

Casualties admitted in severe shock, with no perceptible blood pressure, were given low-titer group O blood immediately and rapidly, without waiting for grouping and crossmatching of the first liter. The blood was sometimes run into two, three, or even four veins, depending upon the urgency of the patient's state. Blood was obtained at the first venipuncture for grouping and crossmatching in subsequent transfusions



FIGURE 159.— Administration of plasma on beach, only few feet from surf, to survivor of landing craft sunk off coast in first days of invasion of Normandy, June 1944.

In cases in which there was time for laboratory examinations, a unit of plasma or albumin could be given while preparations were made for transfusion. After 1,000 to 1,500 cc. of non-type-specific blood had been given to a bled-out casualty, a new sample of his blood was obtained for crossmatching, and the same precaution was repeated after the administration of every additional liter.

When the systolic blood pressure had risen to 80 mm. Hg, the rate of transfusion was reduced while an additional 500 cc. of blood was administered over a 30- to 60-minute period. The rationale of this practice was that the blood pressure often reached an almost normal level before the depleted blood volume had reached a safe level. Transfusions for prophylactic purposes; that is, to guard against a possible fall of blood pressure, were also given slowly.

Ideally, blood replacement was always an individual matter, based on the requirements of the casualty. Since the initial blood pressure was sometimes misleadingly high, the necessity for transfusion was best gaged by the extent and severity of the wound or wounds, the probable amount of blood lost, and the general state of the patient. When Maj. (later Col.) Howard E. Snyder, MC, began to visit hospitals as Consultant to the Surgeon, Fifth U.S. Army (7), he could easily tell, simply by looking at patients after operation,



FIGURE 160.—Care of wounded, one of whom is receiving plasma, at advance battalion aid station, Mortain, France, August 1944.

which ones had not had enough blood before operation; they looked white and bled-out. Generally speaking, each 3- or 4-point deficit on the hematocrit scale or each 0.9-gm. percent deficit in hemoglobin required a transfusion of 500 cc. When there was doubt, it was considered better to give blood than to withhold it.

Blood was sometimes given in larger amounts than was necessary (3). Aside from the waste of a scarce and precious substance, results achieved by this method were no better than those achieved with amounts more consonant with the actual needs. The use of excessive amounts of blood could also be dangerous: If there was no response in the pulse or blood pressure to the transfusion of 2 to 4 pints of blood, it had to be assumed that hemorrhage was continuing or that an overwhelming infection was the cause of the failure of resuscitation. In such cases, immediate operation offered the best chance of life.

Blood was given during operation according to the indications and was also given after operation in large numbers of cases. The correction of nutritional depletion was an essential phase of postoperative care. Many of the wounded had been living for weeks under field conditions, with suboptimum consumption of protein, calories, and vitamins. Loss of blood and plasma at wounding increased the protein and hemoglobin deficits. Postoperative dietary restrictions and exudation into inflamed tissues led to further depletion. These conditions, which retarded wound healing and delayed convalescence,



FIGURE 161.—Wounded British soldier receiving plasma under care of U.S. and British corpsmen, British-U.S. sector, Holland, October 1944.

responded well to plasma and blood transfusions, continued until the red blood cell count was above 4 million per cubic millimeter and preferably higher. The correction of these deficits was a postoperative objective.

In his May 1944 report to the Surgeon, NATOUSA, Colonel Churchill pointed out that not until the end of 1943 were supplies available in sufficient quantities to permit the establishment of facilities for adequate resuscitation of wounded in forward areas (*6*). The improvement effected was evident in comparative series: In the first, 200 casualties in Tunisia who were operated on in forward hospitals received 350 plasma infusions and 6 blood transfusions. In the second series, 297 casualties in Italy were admitted to a field hospital, a type of installation which did not exist during the Tunisian campaign. In this series, 285 of the 297 casualties received 1,364 units of plasma and 277 received 511 transfusions. The two series are perhaps not entirely comparable,



FIGURE 162.—U.S. corpsmen administering care to German civilian who stepped on mine, Würselen, Germany, November 1944. Administration of plasma is part of first aid therapy.

since the first included many less seriously wounded than the second. On the other hand, more than half of the casualties in the first series had wounds serious enough to require immediate operation, and, had facilities and blood been available, there is little doubt that as many of them, proportionately, would have been treated by transfusion as in the second series.

TECHNICAL CONSIDERATIONS

A number of technical improvements and short cuts were developed in all theaters as experience increased. Some of them were as follows:

If blood had to be administered rapidly, an 18-gage needle attached to a 50-cc. syringe was inserted into the tube already in situ, which was clamped off just below the needle. After the syringe had been filled with blood, the clamp was placed above the needle and the blood was pumped in.

When a second transfusion was to be given immediately after the first, the original needle was left in situ and the second transfusion set was connected with it.

If the veins were collapsed, one of the superficial veins about the ankle could be exposed and a cannula inserted, which could be left in place for 24 to 48 hours.

Blood could also be forced in rapidly by the use of a bulb from the blood pressure apparatus attached to the air inlet of the blood bottle. This was an effective method in extreme emergencies but not desirable, for, in careless hands, it could—and did—carry the risk of air embolism.

General Surgical Team No. 25, 2d Auxiliary Surgical Group, which once used 20,000 cc. of type O blood in 4 days, developed the practice of crossmatching three to four bottles

of blood at once if the casualty seemed exsanguinated (7). This practice had two added advantages, that there was no delay in the transfusions and that recipient sets, which were frequently in short supply at this time, were conserved by the use of the same set for the total amount of blood.

Intrasternal administration of parenteral fluids was discussed at a number of meetings of the Subcommittee on Blood Substitutes and allied groups (8, 9) but, after a vigorous discussion, it was decided not to recommend it, for two reasons: It required a degree of skill unlikely to exist in medical officers of all degrees of training and experience. Also, some fatalities had been reported after it, from puncture of the inner table of the sternum and puncture of the mediastinum.

There was also a vigorous discussion concerning administration of fluids by the femoral vein (8, 9). This technique had been used successfully at Pearl Harbor in burned patients, but it was concluded that it was too dangerous for general use. One reason was that a hypertonic solution such as concentrated human albumin might cause serious damage if it was extravasated.

As early as 1940, Dr. Elmer L. DeGowin and his associates (10) at the State University of Iowa School of Medicine had demonstrated that preserved blood could safely be given without reheating. This practice, which later became routine Army practice, had a number of advantages. It eliminated the frequently costly apparatus and the manpower expended by medical and nursing personnel in the former endeavor to keep parenteral fluids at body temperature during injection. It also saved the time formerly spent in heating blood, and eliminated the risk of hemolysis from the injudicious application of heat.

USE OF BLOOD IN ZONE OF INTERIOR HOSPITALS

In the spring of 1945, Col. B. Noland Carter, MC, Assistant Chief, Surgical Consultants Division, Office of The Surgeon General, was impressed, on his visits to a number of Zone of Interior hospitals, by an apparent tendency to use too little blood in the preoperative, operative, and postoperative management of battle casualties. Part of the explanation was the paucity of surgical personnel trained in the use of whole blood as well as in its storage and processing. Before the war ended, the amounts being used were increased as medical officers who had used blood overseas returned to the United States. At a few hospitals, blood had always been used in adequate quantities. Walter Reed General Hospital, Washington, D.C., as might have been expected, was outstanding in this respect, for the blood for the 250-300 transfusions given there every month was provided by the Blood Research Section, Division of Surgical Physiology, Army Medical School, which conducted most of the research on whole blood carried out before and during the war.

To be certain that difficulty in obtaining blood was not the explanation of its minimum use, Colonel Carter instituted a survey, in April and May 1945, of the hospitals he had recently visited (11). With the end of the war, no action was taken in the matter, but the replies to his questionnaire are worth putting on the record:

Ashford General Hospital, White Sulphur Springs, W. Va., which gave about 20 transfusions a week, obtained the blood from the hospital detachment and civilian personnel. If the necessary refrigerator could be supplied, it was thought that about 50 pints of blood a week could be secured and the number of transfusions per week increased by 10 or 15.

Thomas M. England General Hospital, Atlantic City, N.J., gave about 20 transfusions a week. It procured the necessary blood from the Philadelphia chapter of the American Red Cross and had adequate facilities for its storage.

Mayo General Hospital, Galesburg, Ill., gave 59 transfusions in January and 60 in March 1945, against an average of 28 in each of the preceding 4 months. The increase was explained by the increase in the number of operations and in their magnitude. Blood was procured from men of the detachment, who were paid \$10 for each donation. An informal arrangement had been made with the civilian hospitals in Galesburg, which paid \$25 per donation, that no men of the detachment would be permitted to donate blood at any of them until they had first donated at Mayo General Hospital. No man was permitted to donate oftener than every 6 weeks, and 3 months was the preferable interval. The hospital staff saw no particular advantage to establishing a blood bank with such a pool of donors at hand and only a limited amount of surgery being done.

Newton D. Baker General Hospital, Martinsburg, W. Va., reported a strong tendency early in its operation to use plasma in preference to blood because of its ready availability and its ease of administration. Over the past several months, an attempt had been made to use more blood, and an average of three transfusions a week had been given between 1 January and 9 April 1945. Group B and group AB bloods were sometimes in short supply but there had been no shortages in donors of other types. Although the number of transfusions given was small, the use of blood was considered adequate. Paraplegics had sometimes presented compatibility difficulties, possibly because they had already received so many transfusions.

Lovell General Hospital, Ayer, Mass., which operated its own blood bank, gave an average of 30 transfusions a week. Blood was obtained without difficulty from the medical and Women's Army Corps detachments and civilian employees and was supplemented by blood from the Worcester Blood Bank and the Boston Red Cross Chapter, which provided as many as 20 bottles a week and could furnish more if necessary.

DeWitt General Hospital, Auburn, Calif., which gave an average of 12 transfusions a week, obtained blood from civilian and military members of the hospital staff. Local Red Cross representatives had informed the commanding officer of the hospital that about 100 Auburn civilians, who periodically gave blood for the plasma program, would be glad to contribute to the hospital if the need should arise.

Halloran General Hospital, Staten Island, N.Y., which operated its own blood bank, gave about 40 transfusions per week. Group O blood was secured from duty personnel, and A, B, and AB blood from the Army Whole Blood Procurement Service, which procured it from the New York chapter of the American Red Cross.

Billings General Hospital, Indianapolis, Ind., which operated its own blood bank, gave 559 transfusions between 27 March and 27 April 1945. The blood was secured from individuals confined in the U.S. Disciplinary Barracks on the post and was collected at regular intervals. The bleeding of prisoners was always on an entirely voluntary basis.

Brooke General Hospital, San Antonio, Tex., which gave about 40 transfusions per week, was not permitted to operate a blood bank because the liquid plasma center operated at the 4th Army Laboratory at Fort Sam Houston could supply all the blood needed. The hospital, however, had set up a transfusion section which prepared and issued all intravenous sets, typed all patients requiring transfusion, crossmatched all bloods, drew all bloods collected in the hospital, and investigated reactions. The transfusion section kept 6 pints of O blood on hand at all times for emergency use, replacing within 24 hours all blood used.

The bulk of the blood collected locally came from the medical detachment. Donors were paid at the usual rate. Civilian donations amounted to about 15 per week.

Walter Reed General Hospital

Late in 1943, the Division of Surgical Physiology, Army Medical School, undertook to supply blood for all routine transfusions at Walter Reed General

Hospital. A strict record was kept of the first 3,000 transfusions given under the new system, and a continuing effort was made to see that recipient sets were properly prepared. With this precaution, the reaction rate, as already noted, was reduced from 22 percent to approximately 0.5 percent.

Only O blood was supplied. At first, the bloods were not tested for agglutinin titer, and no effort was made to avoid giving A, B, or AB recipients transfusions of high-titer blood. During this period, there was only one instance in which it was suspected that an A recipient might have suffered from some hemolysis of her own cells. The reaction was mild, perhaps because the blood had been collected in Alsever's solution and the amount of agglutinin was therefore diluted and was taken into the bloodstream more slowly than if the amount of solution transfused had been 500 or 600 cc.

In January 1945, a number of high-titer bloods were deliberately given to A and B recipients. No clinical reactions were observed until bloods with titers of 1:1024 or higher were administered. Then, the patients had chills, fever, vomiting, and other symptoms, and an increase in the serum bilirubin was observed.

Since these observations suggested that high-titer O bloods might cause reactions in non-group O recipients, all O bloods handled at the hospital in the future were separated on the basis of their agglutinin content. The titration technique which was adopted separated approximately 25 percent of O bloods with the highest titers of anti-A or anti-B agglutinins, or both. High-titer bloods were given only to O recipients, and low-titer bloods were reserved for A, B, and AB recipients.

Maj. Leslie H. Tisdall, MC, Coordinator, Army Whole Blood Procurement Service, with his associates, made a study of the effects of high-titer O blood on incompatible recipients (12) (p. 259), and further studies in the Zone of Interior were being planned when the war ended.

PLASMA THERAPY

Indications

While too much credit was given to plasma early in World War II, it remained until the end of the war an extremely useful emergency agent. This has been indicated in so many discussions earlier in this volume that any repetition is unnecessary here.

There were certain injuries and conditions in which plasma was of greater value than blood or was needed in addition to blood. These included:

1. Head injuries. Limitation of fluids was desirable, and plasma was given only in sufficient quantities to control shock and restore blood volume.
2. Crushing injuries, in which hemoconcentration was frequent. The tremendous swelling which developed in the limbs of these victims after they were removed from beneath the stones and masonry which had crushed them often was associated with very high hematocrit values. The management of these injuries was also complicated by the development of pigment nephropathy and anuria, which might be enhanced by blood transfusions.

3. Fulminating clostridial myositis, particularly of the wet type. Loss of plasma through the wound or into the affected muscles was best combated with large plasma infusions. These same patients, however, tended to present severe anemia, and they required whole blood as well as plasma.

4. Severe wounds associated with hypoproteinemia; abdominal wounds which required prolonged nasogastric suction; and bedsores, particularly in paraplegics. Amino acid solutions for intravenous use were never generally available in World War II and were not available at all until late in the war. Plasma proved to be an excellent substitute.

5. Burns, which furnished perhaps the most clear-cut indication of all for the use of plasma. When Elkinton (13), in 1939, reported four cases treated by this method, he pointed out:

a. That hemoconcentration or diminution of the plasma volume, as measured by serial hematocrit determinations, was evident in all four patients, who also all exhibited a decrease in the plasma protein concentration, a decrease which, because of the hemoconcentration also present, was even more marked than the figures indicated.

b. That plasma infusions, to replace the lost plasma and protein, was the most rational therapy. Whole blood would supply the necessary elements, but to add red cells to a circulation already relatively overloaded with them, was not logical.

The onset of shock in severe burns is remarkably rapid and may occur within an hour after injury. Immediately after injury, however, the need for plasma is not yet reflected in the hematocrit, and larger amounts are needed than its current level indicates.

The tragic experience of the fire at the Cocoman Grove in Boston in November 1942 provided an instructive experience in the management of shock in burns (14). The mass disaster bore a real resemblance to the situation that might be encountered in military experience. An instructive comparison was also furnished between the use of plasma at Massachusetts General Hospital, where all the patients were treated uniformly, under the direction of Dr. Churchill, and its use at the Boston City Hospital, where the patients were treated on five separate services.

In cases of burn shock not complicated by wounds, in which the reduced blood volume was due almost entirely to loss of plasma, the most common error of management in World War II was failure to administer plasma rapidly enough and in large enough amounts. The best results were secured when it was given into two veins, or with positive pressure, until the hematocrit became approximately normal. Then, administration was continued at a rate just sufficient to maintain this level. As much as 4,000 to 6,000 cc. of plasma might be necessary in the first 24 to 36 hours in extensive burns. After this period, secondary anemia tended to develop rapidly, and whole blood replaced plasma in the management of the injury.

The special experience of the 77th Field Hospital in the European theater, commanded by Maj. Henry Metz, MC, with the use of plasma in true protein depletion, in which it was more valuable than whole blood, is described elsewhere (p. 570).

Dosage and Administration

The dosage of plasma, as of blood, was an individual matter. The blood pressure level was the simplest method of determining the need for it and the response to it, but not necessarily the most accurate method.

The degree of hemoconcentration was another method of determining the amount of plasma to be used; 50 cc. was given for every point that the concentration exceeded the normal 100 percent. It was also estimated that 100 cc. of plasma was required for every point that the hematocrit determination exceeded the normal of 45.

When the hematocrit was low, patients treated with plasma sometimes had a rapid pulse for days, even though the blood pressure was well sustained.

It was realized very early in the war that 250 cc. of plasma was never an adequate dose; if plasma was needed at all, at least 500 cc. was necessary, and, many times, a good deal more (15, 16). As time passed, the initial dose tended to become larger, up to 1,000 cc., and some hospitals, such as the 33d Field Hospital in November 1943, reported using as much as 5,000 cc. for resuscitation (6).

The first 500 cc. of plasma was given rapidly, and rapid administration was continued until the blood pressure became approximately normal. If the patient was evacuated to the rear, additional plasma was given before he was put in the ambulance. This method was very useful in the Tunisian campaign, when, field hospitals not yet being in use in their later conventional manner, undesirably long evacuations were often necessary. Plasma was also given during transportation, particularly to patients with abdominal injuries and fractures of the femur. Later, of course, patients with such injuries were resuscitated and operated on in forward hospitals.

Isotonic plasma was recommended by the Subcommittee on Blood Substitutes (15). Its members did not look with favor on the use of concentrated plasma (p. 275).

Other Proposed Uses

The suggestion that dried plasma be used as a menstruum for the local application of penicillin to wounds did not get beyond the experimental stage. The same was true of a study at the University of Chicago on filling the pleural space with plasma after lung resection, to compensate for the protein loss that occurs after such operations.

Attempts to treat decompression sickness with plasma, on the ground that some patients presented decreases in specific gravity, came to no more than the suggestion. A similar fate befell the suggestion that concentrated dried plasma be used in the treatment of acute nephritis.

The proposal that plasma be administered by hypodermoclysis in deeply shocked casualties was discouraged for the reason that if the veins were collapsed and difficult to locate, there was all the more reason for injecting plasma intravenously as promptly as possible to restore an effective circulating blood volume.

Technique of Administration

The standard Army-Navy package of dried plasma contained two sealed cans and a printed questionnaire. Filling out the questionnaire was the final step of administration of plasma and was particularly important in the early days of the program, when the Blood Research Section, Army Medical School, urgently needed the data thus secured to determine further steps in procedure.

The detailed technique of plasma administration is described in figure 163.

SERUM ALBUMIN THERAPY

The Army, in contrast to the Navy, used very little serum albumin because of its satisfaction with plasma and for other reasons (p. 347). Clinically, except for the need for supplying fluids when serum albumin was used in dehydrated patients, there was little to choose between the two agents. At times, however, the compact size of the serum albumin package was a distinct advantage. One medical officer, for instance, related how he and some of his corpsmen, after they had lost all their plasma when their landing boat was sunk off the Normandy beaches, filled their pockets with packages of serum albumin and administered it to many seriously wounded men, most of whom lived to be taken aboard ships on which they could receive definitive care.

As albumin was put up for the Armed Forces, its high concentration made its physiologic effect dependent upon the rapidity with which it mobilized interstitial fluid. In a well-hydrated patient, this was no problem; the circu-



FIGURE 163.—Reconstitution of standard Army-Navy package of normal human dried plasma. A. Unopened waterproof cardboard box sealed with waterproof tape. B. Removal of tape from box. C. Opened box, showing contained cans, which are removed by pulling on the draw cord. D. Cans removed from box. E. View of can showing spot-welded key on top.



FIGURE 163. Continued. E. Opening of can with spot-welded key. G. Removal of contents of cans. The plasma can, packaged under vacuum, contains a double-ended needle, intravenous needle, and bottle of dried plasma. The water can, packaged under nitrogen to protect the rubber tubing, contains an intravenous set, an airway assembly, and a bottle of distilled water. H. Contents of cans assembled for demonstration. I. Insertion of double-ended needle into water bottle, for transfer of water to dried plasma bottle. J. Insertion of other end of double-ended needle into plasma bottle after preliminary inversion of water bottle and painting of stopper of plasma bottle with antiseptic solution. K. Insertion of airway needle into water bottle if vacuum is not sufficient to pull all water into plasma bottle. After the water is transferred, the airway needle is withdrawn from the water bottle and inserted into the plasma bottle.



FIGURE 163. Continued. L. Direct transfer of water to plasma bottle when standard techniques just described (J, K) have failed. Plasma reconstituted by this technique must be used immediately. M. Shaking (or rotation) of plasma bottle while water is being added, to expedite solution, which normally takes 1-2 minutes. N. Airway inserted into stopper of plasma bottle, after it has been painted with antiseptic solution. O. Giving needle inserted into stopper of plasma bottle. The plasma is now ready for administration by the usual intravenous technique. Note the turbidity of the reconstituted plasma, which has no effect on its usefulness. P. Attachment of intravenous needle, still covered by glass tube (and up to this point by a cellophane wrapper), to Luer tip of glass observation tube. Q. Final step in administration of plasma, filling out questionnaire in package, to be returned to the Blood Research Section, Division of Surgical Physiology, Army Medical School.

lating blood volume was promptly increased, and the intravascular discrepancy characteristic of shock was promptly overcome. In the dehydrated casualty, the problem was different. Since the majority of wounded soldiers, under the rigorous conditions of combat, were dehydrated, isotonic fluids usually had to be administered along with the serum albumin. This was no problem for the Navy but made the use of albumin by the Army far less practical and convenient.

At the 2 June 1944 meeting of the Subcommittee on Blood Substitutes (17), the principal discussion concerned the possibility of resuscitation in airplanes. It was decided that if this procedure should be attempted, serum albumin would be the best agent to use. There were numerous problems, including limitation of space, thermal stability, and the effect of turbulence. No further action was taken, chiefly because D-day was 4 days after this meeting and the Army Air Forces were fully occupied with other, more urgent matters.

At the end of the war, the clinical indications and contraindications for the use of serum albumin were quite clear:

1. It could be used in shock and in hypoproteinemic states almost interchangeably with plasma. It had to be borne in mind, however, that albumin is purified protein and contains no complement, prothrombin, or other components of plasma.

2. Serum albumin was of special value in edematous patients, particularly in burned patients, because it could be administered without a significant amount of fluid. On the other hand, if it was given to a dehydrated patient the parenteral administration of fluid was necessary simultaneously or immediately after the serum was injected.

3. Serum albumin was useful in patients with cranial injuries, in which fluids were generally contraindicated.

4. The fact that albumin is hypertonic and remains in the vascular system longer than hypertonic crystalloid solutions made it necessary to use it with great care. It was not useful in older patients if any myocardial weakness was evident; the rapid elevation of the blood pressure could cause pulmonary edema. It was also contraindicated in concealed arterial bleeding and in uncontrolled or recurrent hemorrhage because of the rapid rise in blood pressure which it produced.

Technique of Administration

The standard Army-Navy package for concentrated serum albumin (fig. 164A and B) contained three cans (fig. 164C), each of which contained:

A double-ended glass container, sealed at each end with rubber stoppers, and containing 100 cc. of 25-percent solution of serum albumin (25 gm.).

An airway.

Equipment for intravenous administration.

Tape for suspension of the albumin bottle.

Etched on the metal can were the following instructions for the administration of the serum albumin (fig. 164):

1. Open metal can with attached key.
2. Remove air filter needle, intravenous set, and intravenous needle.
3. Remove container of albumin.
4. Apply alcohol or iodine to both rubber stoppers.
5. Holding container in upright position, insert air filter needle through top of rubber stopper.
6. Insert short needle of intravenous set through rubber stopper at opposite end.
7. Attach intravenous needle to observation tube.
8. Allow tubing to fill with albumin solution.
9. Insert intravenous needle into vein. If venipuncture is difficult, cut down on vein.
10. Suspend container about 3 ft. above patient.
11. Except in severe shock, do not let rate of administration exceed 5 cc. per minute.

MANAGEMENT OF SPECIAL TYPES OF WOUNDS

Wounds of the Extremities

Patients with multiple wounds of the extremities, particularly those produced by landmines, traumatic amputations, and fractures of the femur, required large amounts of blood. A common mistake in the management of femoral fractures in the early experience of the Mediterranean theater was failure to restore the blood volume promptly. Penicillin was brought to the theater by Maj. Champ Lyons, MC, in the late winter of 1943, and he and Maj. (later Lt. Col.) Oscar P. Hampton, Jr., MC, introduced an extremely successful three-point program of blood, penicillin, and surgery (18). In all their instruction, they emphasized that even as potent an agent as penicillin would be less potent without the liberal use of whole blood and that surgery would be much less successful—and sometimes impossible—without it.

Blood was given in preparation for operation, during operation, and post-operatively in the forward hospital, and was also given later, before reparative surgery, in the base hospital.

Secondary anemia, often of a considerable degree, was evident in casualties admitted to base hospitals, even when they had received large amounts of blood in forward hospitals. These anemias would undoubtedly have corrected themselves spontaneously in time if adequate diets had been supplied and had been supplemented by iron therapy. There was, however, an urgent need to get on rapidly with reparative surgery, not only because the military situation required the rapid turnover of hospital beds but, even more impellingly, in the patient's own best interests. Wound closure with low hematocrit levels would have introduced a completely preventable surgical risk (19, 20).

Three series of fractures of the long bones illustrate these points (18):

1. At the 16th Evacuation Hospital, 28 of 100 casualties with fractures of the femur required between 1,500 and 2,000 cc. of blood before and during operation, and only 9 patients in the series required no blood at all. In contrast, only 3 of 100 patients with compound fractures of the radius, ulna, or long bones required blood in such quantities, and



FIGURE 164. Administration of serum albumin. A. Standard box containing three bottles of albumin. B. Removal of sealing tape. C. Opened box with contents. D. Can with spot-welded key.

63 required no blood at all. Casualties with compound fractures of the humerus, tibia, fibula, or both bones of the leg constituted an intermediate group.

2. At the 23d General Hospital, 33 patients with fractures of the long bones had hematocrit values under 30; 80 others had values between 31 and 40; and only 25 (18 percent) had values of 40 or higher, the desirable level for reparative operation. Only 2 of 38 patients with fractures of the femur fell into the latter category.

3. At the 21st General Hospital, the proportions were substantially the same in 166 patients with fractures of the long bones; 37 had hematocrit readings under 30, and only 31 (19 percent) were regarded as safe for operation without further blood replacement.

While no absolute proof can be adduced to show that such intensive blood replacement was necessary for good results, there is a great deal of indirect proof. The program of reparative surgery in compound fractures, the use of penicillin, and liberal whole blood replacement therapy came into existence in the Mediterranean theater at about the same time. It is naturally impossible to attribute the improved results that promptly followed their introduction to any single one of these factors. It was the general impression, however, that the anesthetic risk was far less in patients whose secondary anemia had been corrected, that wound healing was prompter, and that convalescence was less



FIGURE 161. Continued. E. Opening of can with key. F. Bottle, airway, and giving set being removed from can. G. Double-ended albumin bottle, double-ended airway, giving set, and needle. H. Albumin and equipment set up and ready for use. Airway has been inserted in one end of bottle and intravenous needle in other. Set will be suspended by cloth scrap attached to bottle.

complicated. It was also the impression that those who had received liberal transfusions were less likely to present chronic infections.

Abdominal Injuries

Casualties with abdominal injuries required replacement therapy by the usual routine (3). In such injuries, however, it was important to observe the response carefully. If it was not what could be expected with the amount of blood used, prompt surgery was indicated, on the ground that hemorrhage might be continuing or that a fulminating chemical peritonitis might be present.

Plasma was often used liberally in the first few days after closure of a colostomy, to reduce edema of the suture line, and to prevent narrowing of the anastomotic orifice.

Chest Injuries

Both plasma and blood had to be given with great caution in chest injuries (21). Decompensation was always a possibility if edema were per-

mitted to develop. The same precautions concerning the risk of overloading the circulation held in thoracoabdominal wounds. Sometimes the need for correction of cardiorespiratory pathophysiology, which indicated limitation of fluids, had to be balanced against the need for liberal amounts of blood because of hemorrhage from associated injuries. Theoretically, if red blood cells had been available, their use might have solved the problem of the need for blood and the risk of overloading the circulation in chest injuries.

Before blood was available in liberal quantities in the Mediterranean theater, blood aspirated from the chest was sometimes used for transfusion. Surgeons differed as to the periods within which they considered it safe to use such blood; most were conservative, limiting the time to no more than 6 hours. The blood was never used, of course, if there was the smallest suspicion that a thoracoabdominal wound was present.

ADMINISTRATIVE CONSIDERATIONS

Preparation of Manual On Shock

At the first meeting of the NRC (National Research Council) Committee on Transfusions on 31 May 1940 (19), Dr. Alfred Blalock was appointed to prepare a small pamphlet on shock and allied subjects, for distribution to the Army and the Navy. His choice as principal author was wise, for few people had done more than he to develop the concept of hemorrhage as the basic cause of shock.

It is of interest, therefore, and indicative of how completely shock therapy was revolutionized during the war, to find in this pamphlet (22):

1. A full discussion of isotonic salt and glucose solution in the prevention of shock.
2. A statement of the limitations of blood banks in wartime because of the cumbersome cooling unit necessary, and the limited shelf life of blood. It was pointed out, however, that one of the greatest advantages of preserved blood was that larger quantities could be given than were ordinarily used.
3. A discussion of plasma (twice as long as the space devoted to blood), in which the concept was presented that the loss of red blood corpuscles would be tolerated quite well if the lost plasma were replaced. One of the advantages of plasma was said to be that it did not add to the concentration of red blood corpuscles, hemoconcentration being the usual finding in shock. The intravenous injection of adequate quantities of plasma was considered "probably the single most effective and valuable and practical method for the prevention and treatment of shock, with the possible exception of methods of hemostasis."

All of these statements were correct in the light of 1940 knowledge.

Shock Teams

The blood banks in the Mediterranean and European theaters had a single function, to provide blood for wounded casualties. The U.S. Army blood service personnel, unlike the British Army Transfusion Service personnel, had nothing to do with the administration of the blood. British personnel were trained in the processing and care of preserved blood and also in its

administration. U.S. personnel were trained only in its procurement and processing.

As shock was handled in the Mediterranean theater during World War II, it was the shock teams assigned from auxiliary surgical group personnel and not organic personnel of field hospitals who carried the major responsibility for treating casualties and determined the efficiency of their care in these hospitals (3). The supervision of shocked casualties by hospital personnel was the responsibility of the anesthesiologist, whose hands were full with his own duties, supervision of his helpers, and supervision of replacement therapy in the operating room.

This situation was almost inevitable. In contradistinction to other areas of medicine and surgery, there was no pool of civilian medical personnel trained in the mass treatment of shock. Almost any civilian physician could treat single patients adequately in peacetime practice, and that was how shocked patients were usually encountered, as individuals. In warfare, there were few occasions on which it was not necessary to treat several casualties at the same time, and it was often necessary to treat overwhelming numbers of seriously wounded casualties simultaneously. Few medical officers possessed this knowledge and ability when they entered the Army and they had to be trained afterward (p. 87).

Shock Wards

Shock wards were promptly set up in hospitals in combat areas in all theaters. The ward described by Col. Douglas B. Kendrick, MC, in October 1945 (figs. 165 and 166) brings together the best features of all such wards as they evolved with experience (23):

Facilities.—While facilities must conform to available terrain, shock wards, whenever possible, should be located in proximity to the triage tent and as close as possible to the surgical tent. If terrain permits, it is best to have all of these tents, plus the radiology tent, joined. With such an arrangement, service is more efficient, and mud, heavy rains, and blackout regulations are less hampering.

The tentage should be sufficient to accommodate 40 patients at the same time (fig. 165). Two squad tents, attached to each other laterally, with the adjoining sidewalls raised, will provide adequate space for 25, and a third tent, joined to one or the other, can care for an additional 15 casualties. Shock wards should not be divided. When they are, additional personnel and equipment are necessary, and comparative surgical priorities are more difficult to establish.

Equipment.—Good light is essential for examination, venipuncture, and laboratory work. If electrical fixtures are limited, bulbs attached to long drop cords provide adequate lighting.

Also needed are:

1. Wooden horses (80), half 25 and half 29 inches high, so that litters can be placed in either the Fowler or the Trendelenburg position.

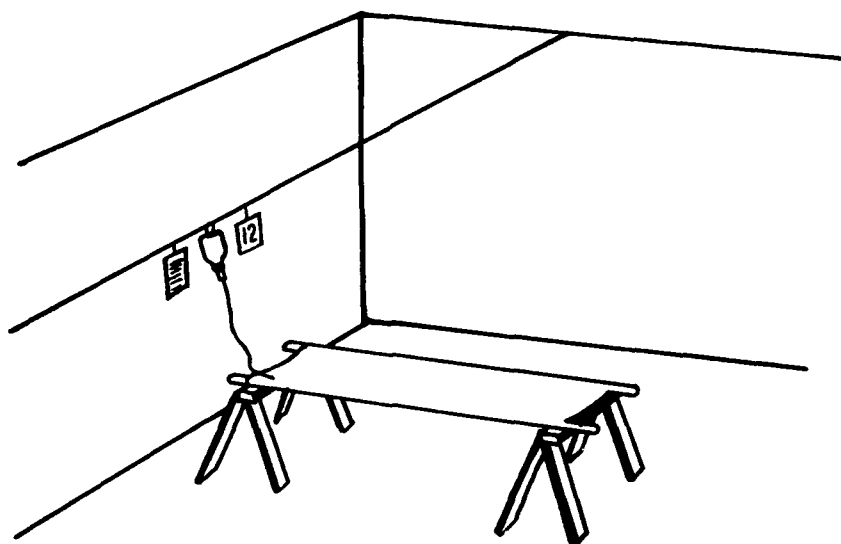

FIGURE 165.—Interior of shock ward, showing litter on sawhorses. Wire, strung above litter, suspends charts, identification cards, and blood, plasma, and other intravenous fluids.

2. Overhanging wires (fig. 165), strung about 7 feet high and so distributed that a wire passes over each litter. These wires are used for intravenous fluids, individual records, and, for rapid identification, cards with each patient's number.
3. Tourniquets.
4. A refrigerator.
5. A large sterilizer or two small sterilizers.
6. Wash basins, kidney basins, sponge cups, and drinking cups.
7. Levin tubes, urinals, bedpans, and enema bags.
8. Oxygen tanks, reducing valves, and oxygen masks.
9. Syringes, 5-, 10-, 30-, and 50-cc., 100 of each.
10. Hypodermic needles, from 25- to 15-gage.
11. Sternal needles.
12. Intravenous cannulas.
13. Clinical thermometers.
14. Bandages, Carlisle dressings, large and small gauze squares, petrolatum gauze (for sucking wounds of chest), and adhesive tape.
15. Blankets.
16. Portable Van Slyke copper sulfate specific gravity sets and a centrifuge for determining hematocrit and plasma protein values.
17. Phlebotomy sets and chest aspirating sets.
18. Morphine solution in 100-cc. bottles, procaine hydrochloride solution, sodium amytal, and aspirin.
19. Penicillin.

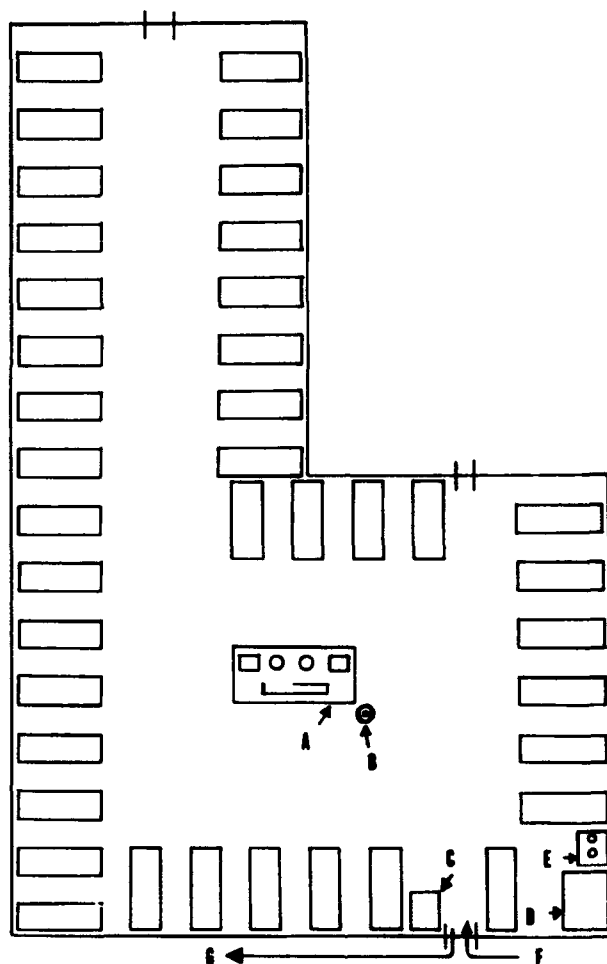

FIGURE 166.—Setup of shock ward. A. Utility table. B. Oxygen tank. C. Sterilizer. D. Refrigerator. E. Wash-bowls. F. Entrance from triage ward. G. Exit to surgery. In retrospect, it would have been more efficient to place the refrigerator in the center of the ward.

20. Whole blood, plasma, isotonic sodium chloride solution, and 5-percent dextrose solution in distilled water.

21. Forms for recording transfusions and other intravenous medication.

22. A bulletin board for posting lists of casualties under treatment for shock, with recommended surgical priorities.

A center table, with multiple shelves, placed in the center of the ward makes all equipment and supplies readily accessible. Glassware is washed and prepared on a small table near the sterilizer.

Staffing.—Shock wards must operate fully staffed 24 hours a day. The minimum personnel to handle 30 patients in shock is two officers and four enlisted men, so assigned as to provide efficient coverage in the circumstances.

Enlisted men should be well trained in aseptic techniques and in the preparation and administration of blood and other intravenous fluids.

Because of the volume of work on a shock ward, it is desirable to utilize personnel from other services. After adequate instruction, dental officers prove very useful, and personnel from the medical services can also help, especially early in a combat operation, when, as a rule, there are few medical admissions.

Assignment of duties.—The duties of medical officers on a shock ward are to make an initial examination; control hemorrhage; close sucking wounds of the chest; aspirate hemothoraces; relieve tension pneumothorax; perform intercostal nerve block; take blood for hematocrit and plasma protein determinations; maintain a check on the blood pressure; order replacement therapy and assist in giving it; outline the therapeutic measures to be employed; supervise the setting up and maintenance of records; record all therapy; follow the results of treatment; correlate them with the shock process; determine transportability; and, in conference with the chief of surgery, establish operative priorities, with due regard to relative possibilities of survival.

The medical officer in charge of the ward also organizes the duty roster of officers and enlisted men on shock teams and assigns them to specific tasks.

The duties of enlisted men are to administer morphine, penicillin, blood, plasma, and other therapy as directed by the medical officers; maintain adequate supplies; attend to the care and operation of the sterilizer; clean glassware; record all procedures carried out on patients; provide ordinary nursing care, such as taking temperatures; removing bloody blankets and clothing; cleanse patients, at least superficially; and supply coffee, water, and other fluids if the patients are able to take them.

Experience proved that the methods just outlined provided a simple and efficient routine for the management of shocked casualties.

References

1. Administrative and Logistical History of the Medical Service, Communications Zone, European Theater of Operations, vol. 13, chapter 14, Professional Aspects of the Medical Service. [Official record.]
2. Report of Consultant Surgeon to the Surgeon, NATOUSA, 2 July 1943.
3. Medical Department, United States Army. Surgery in World War II. General Surgery. Volume II. Washington: U.S. Government Printing Office, 1955.
4. Snyder, Howard E.: Fifth U.S. Army. *In* Medical Department, United States Army. Surgery in World War II. Activities of Surgical Consultants. Volume I. Washington: U.S. Government Printing Office, 1962.
5. Minutes, meeting of Subcommittee on Blood Substitutes, Division of Medical Sciences, NRC, 24 Sept. 1943.
6. Report of Consultant Surgeon to the Surgeon, NATOUSA, 31 May 1944.
7. Hurt, Maj. Lawrence E.: General Surgical Team No. 25, 8 Aug. 1944.
8. Minutes, Conference on Albumin, Division of Medical Sciences, NRC, 5 Jan. 1942.
9. Minutes, meeting of Subcommittee on Blood Substitutes, Division of Medical Sciences, NRC, 23 June 1942.
10. DeGowin, E. L., Hardin, R. C., and Swanson, L. W.: Studies on Preserved Human Blood. IV. Transfusions of Cold Blood Into Man. *J.A.M.A.* 114: 859-861, 9 Mar. 1940.

11. Use of Whole Blood in Zone of Interior Hospitals. Survey, Col. B. N. Carter, MC, April-May 1945
12. Tisdall, L. H., Garland, D. M., Szanto, P. B., Hand, A. M., and Barnett, J. C.: The Effects of the Transfusion of Group O Blood of High Iso-Titer Into Recipients of Other Blood Groups. *Am. J. Clin. Path.* 16: 193-206, March 1946.
13. Elkinton, J. R.: The Systemic Disturbances in Severe Burns and Their Treatment. *Bull. Ayer Clin. Lab., Pennsylvania Hosp.* 3. 279-291, December 1939.
14. Memorandum, Lt. Col. D. B. Kendrick, MC, to Director, Army Medical School, 15 Dec. 1942, subject: A Preliminary Report on the Cocoanut Grove Disaster From the Massachusetts General Hospital, 6 December 1942.
15. Minutes, meeting of Subcommittee on Blood Substitutes, Division of Medical Sciences, NRC, 23 May 1941.
16. Robinson, G. C.: American Red Cross Blood Donor Service During World War II. Its Organization and Operation. Washington: The American Red Cross, 1 July 1946.
17. Minutes, meeting of Subcommittee on Blood Substitutes, Division of Medical Sciences, NRC, 2 June 1944.
18. Medical Department, United States Army. Surgery in World War II. Orthopedic Surgery in the European Theater of Operations. Washington: U.S. Government Printing Office, 1956.
19. Minutes, meeting of Committee on Transfusions, Division of Medical Sciences, NRC, 31 May 1940.
20. Churchill, E. D.: The Surgical Management of the Wounded in the Mediterranean Theater at the Time of the Fall of Rome. *Ann. Surg.* 120: 269-283, September 1944.
21. Medical Department, United States Army. Surgery in World War II. Thoracic Surgery, Volume I. Washington: U.S. Government Printing Office, 1963.
22. Shock, Prevention and Treatment. A manual prepared for the Medical Corps of the Army and Navy, under the direction of the Medical Division of the National Research Council, by Alfred Blalock, Nashville, Tenn.
23. Kendrick, Lt. Col. Douglas B.: Organization of a Shock Service in a Combat Area Hospital. *J. Mil. Med. Pacific* 1: 14-21, October 1945.

CHAPTER XX

The Blood, Plasma, and Related Programs in the Korean War

Part I. Administrative Background

GENERAL CONSIDERATIONS

When the Korean War broke out on 25 June 1950,¹ less than 10 years after the United States had entered World War II and less than 5 years after that war had ended, the situation was improved over the situation in December 1941 in only one respect: No well-organized blood bank system was in operation, but a plan for the supply of whole blood and plasma did exist. The plan had not been implemented, however, because it had been prepared only a short time before the outbreak of hostilities. It is extremely unfortunate that planning had not begun earlier, for the need for whole blood arises whenever combat commences; the Korean War proved again that whole blood cannot be provided promptly and efficiently unless supplies, equipment, trained personnel, and a detailed plan for its collection, processing, transportation, and distribution have already been set up.

When the Korean War broke out, the course of events in respect to the blood program was as follows:

1. Blood collecting teams were immediately utilized in Japan, to meet the first need for blood in the field.
2. These supplies proved inadequate as action became more intense, and requests for whole blood were sent to the Zone of Interior.
3. The American Red Cross was asked, as in World War II, to become the collecting agency for blood for the oversea airlift. Fortunately, this agency already had in operation a blood collecting program to supply blood to civilian hospitals in the United States, and could build upon it.
4. Later, when the initial program proved inadequate, an Armed Forces Blood Program and a National Blood Program were established and remained in operation until the end of active fighting in Korea.
5. A plasma program was also developed which later had to be discontinued because of the risk of serum hepatitis associated with plasma infusions (p. 776). The production of human serum albumin was substituted for the production of plasma and was supplemented by the production of plasma expanders (the so-called blood substitutes of World War II).

¹ That date should be borne in mind. Unless the dates of the various activities to be described are borne in mind and are related to the dates of the Korean War (25 June 1950, when the invasion of South Korea occurred, and 27 July 1953, when the armistice was signed), it will not be realized that, in many instances, the actions were almost too late.

In spite of the expedient nature of the blood program, casualties in Korea never lacked the blood they needed, but the comment is justified concerning this war, as it was concerning World War II, that the efficient way to provide blood for combat casualties is not to wait for the need for it to arise and then to provide it, at least initially, by a series of improvisations.

It is interesting, and somewhat depressing, to note in various reports of conferences concerning the blood and blood-derivatives program in the Korean War how quickly the World War II experience seemed to have been forgotten and how the tendency was again evident to concentrate on agents other than whole blood in the management of combat and other casualties. At a meeting of the Subcommittee on Shock, Committee on Surgery, NRC (National Research Council), on 14 November 1951 (1), Dr. Walter L. Bloom rather impatiently called the attention of the members to the fact that the entire philosophy of plasma expanders was questionable. Military and surgical groups, he said, should define the limitations of these substitutes, and they should be considered as suitable for emergency use only. The first need of combat casualties was for whole blood.

THE INTERIM BETWEEN THE WARS

A knowledge of certain background facts is essential to the story of the blood, plasma, and plasma-expanders program in the Korean War, beginning with one major difference between this program and the similar program in World War II: In the Korean War, the program covered civilian defense as well as military needs. In World War II, the two responsibilities were entirely separate. The development of the program that provided blood and plasma in the Korean War is best described chronologically.²

1945-46

In September 1945, with the end of hostilities in World War II, the whole blood program was discontinued immediately, and the plasma program was terminated as promptly as contracts could be ended. The research that had been a part of both programs also came to an end except for the plasma-fractionation studies, which were continued in Dr. Edwin J. Cohn's laboratory at Harvard.

During the interim between the wars, needs for whole blood in Army hospitals were met within the hospitals. There were no plans, militarily or otherwise, to stockpile reserves of plasma for a national emergency. Indeed, had such a disaster occurred, there would have been no program to put into effect. The whole blood program would have died between the wars except for the stimulus provided by the activities of the American Red Cross.

² Unless otherwise indicated, the data in this section of this chapter are derived from the excellent and well-documented account of the blood, blood derivatives, and plasma-expanders program in the first 2 years of the Korean War prepared by Col. Patrick H. Hoey, MC, USAF, Chairman of the blood and blood derivatives group (2), and the convenient account of the historical development of the Office of Assistant Secretary of Defense (Health and Medical) prepared by Miss Elsie LaMantia (3).

1947

Postwar activities in respect to blood began on 26 July 1947, with the passage of the National Security Act (Public Law No. 253, 80th Congress), which established the Department of Defense (D). This act provided for the establishment of NSRB (National Security Resources Board) to advise President Harry S. Truman on policies relating to industrial and civilian mobilization. It also provided for the policy just mentioned, the integration of civilian and military health resources. Finally, it authorized steps leading toward a more unified control of national medical services.

1948

On 1 January 1948, the then Secretary of Defense, Mr. James V. Forrestal, appointed a Committee on Medical and Hospital Services of the Armed Forces, to study all questions of common interest to the three medical services, with a view to obtaining maximum efficiency and economy in all their operations. Secretary Forrestal's committee consisted of Maj. Gen. Paul R. Hawley (Ret.), chairman (hence, the Hawley Committee); the Surgeons General of the Army, the Navy, and the Air Force; and Rear Adm. Joel T. Boone, MC, USN, who served as executive secretary.

In the meantime, the President had appointed a Commission on Reorganization of the Executive Branch of Government under Ex-President Herbert Hoover (the Hoover Commission), which, by the middle of 1948, had two task forces working on the coordination of health and medical matters in the National Military Establishment:

1. The Task Force on National Security (the Eberstadt Committee).
2. The Task Force on Federal Medical Services (the Voorhees Committee).

The Hawley Committee had recommended that a civilian committee be established, to serve in a consultant and advisory capacity to the Secretary of Defense on medical and health affairs, and both of these task forces made similar recommendations.

On 9 November 1948, still another committee was appointed, the Armed Forces Medical Advisory Committee. Its chairman, Mr. Charles P. Cooper (hence, the Cooper Committee), also served as Deputy to the Secretary of Defense in the fields of medicine and health. The committee consisted of the Surgeons General of the three services, General Hawley, and a number of distinguished civilian physicians.

The recommendations of this committee immediately identified a structural weakness in the Office of the Secretary of Defense: There was no agency or personnel in it to implement committee recommendations after the Secretary had approved them. The Surgeons General, who were members of the committee, were in the untenable position of making recommendations to the Secretary and then receiving these same recommendations from him for comment. This phase of the problem was solved by removing the Surgeons General from membership on the Cooper Committee.

1949

In February 1949, the Joint Chiefs of Staff asked that the Cooper Committee consider the entire question of "unification or coordination" of the Armed Forces medical services, including the possible development of a single medical service. At the end of 2 months of intensive study, the committee recommended against a single Tri-Force medical service. Instead, it recommended that the recommendations of the Eberstadt, Voorhees, and Hawley Committees should be implemented and that an organization be established in the Office of the Secretary of Defense, with authority to act on committee and other recommendations.

In accordance with this recommendation, the Medical Service Division was set up in the Office of the Secretary of Defense in May 1949, with a director who had authority to

establish general policies for the medical services of all three Armed Forces. The Hawley Committee was then dissolved and its subcommittees were transferred to the Medical Service Division. The Cooper Committee continued to function.

On 29 September 1949, the Medical Service Division was renamed the Office of Medical Services. Its current director, Dr. Richard L. Meiling, was named Director of Medical Services and Assistant to the Secretary of Defense for Medical Affairs. Dr. Meiling established a Medical Advisory Council consisting of the three Surgeons General, who met weekly in his office. After the Korean War broke out, the Surgeon General of the U.S. Public Health Service and the Medical Director of the Veterans' Administration were added to the membership of the Council.

1951

The Cooper Committee continued to function throughout 1950, as did the Office of Medical Services. On 2 January 1951, the Cooper Committee and the Office of Medical Services were replaced by an Armed Forces Medical Policy Council, whose director was named Assistant to the Secretary of Defense for Health Affairs. The Council consisted of the three Surgeons General; a dental surgeon; and two other civilians, Dr. Isidor S. Ravdin and Dr. W. Randolph Lovelace III, both of whom had had wide medicomilitary experience. With the establishment of this council, there was now fully carried out, for the first time, the intent of Congress as expressed in the National Security Act of 1947 (p. 715). Also for the first time:

1. There existed in the DOD (Department of Defense) an organization with authority to coordinate medical policy within the department as well as between the department and other governmental agencies and civilian medical and allied health organizations.
2. The three Surgeons General had authority to represent their respective departments in the formulation of medical and health policies at the level of the Department of Defense.

1953

There were no further changes of consequence in the medical structure of the Department of Defense until 1 April 1953, when DOD Directive 5136.4 established the position of Assistant to the Secretary of Defense (Health and Medical) in the Office of the Secretary of Defense. This was a considerable forward step. All medical and health policies, plans, standards, criteria, and other aspects of medical service could now be reviewed in the Office of the Assistant to the Secretary of Defense (Health and Medical), who also maintained liaison, on both a national and an international basis, with all other governmental and civilian health and medical agencies and associations. The advice of the Surgeons General was made available to the Assistant to the Secretary of Defense as necessary.

On 30 June 1953, Congress approved Reorganization Plan No. 6 for the Department of Defense. This plan authorized, among nine Assistant Secretaries of Defense, an Assistant Secretary of Defense (Health and Medical); thus, in effect, regularizing and giving authority to the plan adopted in the Office of the Secretary of Defense in April 1953. On 2 September 1953, the Secretary of Defense, by DOD Directive 5136.4, established a Health and Medical Advisory Council composed of civilians.

Meantime, the NSRB chairman, former Secretary of the Air Force W. Stuart Symington, had set up a Health Resources Office, which reported directly to him and which was responsible for the development of plans and recommendations relative to mobilization and allocation of health resources and for the medical aspects of civilian defense. Dr. Howard A. Rusk was appointed chairman of the special committee to advise Mr. Symington on broad policies relating to health resources. When these last actions were taken, the armistice of 27 July 1953 had already ended the fighting in the Korean War.

Comment

The organizational steps just outlined were all extremely important and are entirely relevant to the blood program in the Korean War. They meant that, for the first time, the Department of Defense would coordinate and integrate all phases of its health program, including the blood program, to conform with broad policies established at the presidential level. It also meant that recommendations of task groups concerning coordination with other agencies would no longer be conflicting, since both military and civilian national health agencies would now act jointly, to meet the overall requirements of national mobilization.

INITIAL STEPS IN THE NATIONAL BLOOD PROCUREMENT PROGRAM

One of the joint problems that came to the attention of the Director of Medical Services, Office of the Secretary of Defense, in 1949, soon after the establishment of his position, concerned military and civilian requirements for whole blood and blood derivatives. An inventory of existing stocks of plasma and other derivatives, early in October of that year, indicated that they were very low (p. 772); that there was no coordinated plan to expand them; and that, if an emergency should arise, there were no facilities for their augmentation. Only four laboratories were producing plasma commercially. Their combined annual production was about 300,000 units, and they had no incentive to expand it, for plasma was a nonprofit item.

This situation was viewed with the seriousness it deserved, and, on 26 October 1949 the Director of Medical Services, acting for the Secretary of Defense, appointed a task group to study the whole problem of providing blood, blood derivatives, and plasma substitutes (expanders) for the Armed Forces in peacetime and in war. The investigation was to cover such related matters as supplies and equipment for transfusion; training of personnel in the technical aspects of procurement, control, storage, transportation, and use of blood and blood derivatives to meet expanded requirements of an emergency program; and the development of a system of logistics capable of meeting requirements on a global scale (4).

The members of this Task Group included Capt. Hilton W. Rose, MC, USN; Capt. Lloyd R. Newhouser, MC, USN; Col. William S. Stone, MC, USA; and Lt. Col. (later Col.) Alonzo A. Towner, Jr., MC, USAF. The comprehensive report which they submitted to the Secretary of Defense on 15 March 1950 (4) had been approved by the Military Medical Advisory Council (the predecessor of the Armed Forces Medical Policy Council) on 14 February 1950. On 5 May 1950, the report was approved by the Secretary of Defense, in a memorandum addressed to the three Service secretaries, and thus became official DOD policy (5).

As of this date, the retrenchment that had characterized all activities relating to blood in the postwar period began to be reversed, but it was almost too late: It was less than 2 months later that the outbreak of hostilities in Korea required the immediate translation of still theoretical concepts of a national emergency into a stern reality, though, fortunately, several additional weeks were to elapse before a request for whole blood came to the Zone of Interior from the combat area.

REPORT OF TASK GROUP

The report by the Task Group to the Director of Medical Services on "A Suggested Program of Whole Blood and Blood Derivatives for the Armed Forces" in March 1950 analyzed the problem; summarized the commercial potential for dried plasma; and outlined the requirements for stockpiling plasma and for the collection, distribution, and use of whole blood. In substance, the report was as follows:

The Problem

Whole human blood, required in modern therapy, cannot be stockpiled because it is extremely labile; it requires constant refrigeration and precise technical control and handling; and, under present procedures, it cannot be stockpiled for more than 30 days.

The Armed Forces can operate blood banks to meet peacetime requirements but cannot supply wartime necessities. It is not desirable to use combat troops as donors. Neither in peacetime nor in war can the Armed Forces provide blood derivatives.

The reserves of blood derivatives left from World War II will largely be outdated by the end of 1950, though some can be reprocessed, at about a third of the cost of new products. The total amount that has been reprocessed, however, will provide only a third to a half of the required war reserve (set at a million units) for the Armed Forces. Reprocessing and handling can be carried out only by specially trained personnel, with considerable technical background.

The present civilian program for blood and blood derivatives is not adequately organized or planned to meet the requirements of the Armed Forces, the civil defense program, and other civilian needs in time of war.

The wartime needs can therefore be met only by a national program, which must be organized in peacetime.

The Present Situation

At this time (March 1950), the blood procurement situation in the United States is as follows:

1. Twenty-one blood banks are in operation in Armed Forces installations. All have standardized equipment and supplies, are centrally controlled, and would be capable of

operating under wartime conditions. Four of these banks are each collecting 300 pints a month. The others are collecting from 50 to 250 pints each.

2. Some two or three thousand nonprofit blood banks are in operation, most of which belong to the American Association of Blood Banks.³ About half of these banks actually draw and process blood. The remainder, whose chief function is to serve their own hospitals and adjacent rural communities, act merely as storage and issue points for blood drawn elsewhere. When the operations of these banks are entirely intrastate, they are under no control, and their equipment, supplies, and procedures are not standardized. If, however, these hospital banks would adopt NIH (National Institutes of Health) standards and could produce significant surpluses above their own needs, they could contribute to the national blood program.

3. Four commercial blood banks are in operation in New York. Others are in operation in Dallas, San Francisco, and Chicago, and there are a few smaller banks in other locations. They lack trained personnel and uniform standards, and it is doubtful that they could expand significantly in time of war.

4. Only three commercial biologic laboratories are now collecting blood for plasma: Cutter Laboratories, 100,000 pints per year; Hyland Laboratories, 40,000 pints per year; and Sharp & Dohme, 150,000 pints per year. All these laboratories produced plasma during World War II, and Sharp & Dohme also produced plasma fractions, which only Cutter Laboratories is now producing.

Equipment can be manufactured by a number of larger firms as well as some smaller firms, on reasonably short notice, with certain exceptions. There would be difficulty, for instance, supplying 15- to 20-gage needles for intravenous and donor sets if they should be required at once, though within 6 months, well over a million could easily be produced.

Recommendations

The Task Group, on the basis of the World War II experience factor, set the replacement requirements for each combat casualty who survived to be hospitalized at one 500-cc. unit of whole blood and the same amount of plasma or other blood-derivative. Only group O blood would be used, preserved in ACD (acid-citrate-dextrose) solution; typed for the Rh factor; and refrigerated at 4° to 10° C. from collection until administration.

The Task Group did not think that the Department of Defense of itself could procure such amounts of blood and blood derivatives and therefore recommended immediate coordination with other interested governmental and non-governmental agencies in the development of a program that would meet the standards and fulfill the requirements of the Department of Defense, as well as civilian requirements, in peacetime and in wartime.

The Task Group also recommended that the Department of Defense assume responsibility for the direction and implementation of the whole blood program and its coordination with other agencies, including the American Red Cross; Armed Forces blood banks; commercial biologic agencies; and nonprofit and commercial blood banks. It was noted that, if these various separate groups were to serve as an integrated national blood group, they must be tightly controlled because of the multiple risks attending the use of blood, including its perishability; incompatibility; possible errors in grouping, typing, and cross-

³ Although this is the figure used by the Task Group, it seems high unless every hospital laboratory storing a few pints of blood is considered a blood bank.

matching; contamination from unsound techniques; unsatisfactory conditions of storage; and possible transmission of such diseases as malaria, syphilis, and hepatitis.

Finally, the Task Group recommended that the Director of Medical Services should be responsible for, and direct, the continued study and implementation of the Department of Defense blood program and all coordination of the activities of the department with those of other agencies.

In addition to these basic recommendations, the Task Group made the following specific recommendations:

1. That transfusion supplies, equipment and procedures as standardized for the Armed Forces be standardized by all participating agencies, with the Director of Medical Services, DOD, taking the necessary steps to accomplish this objective.
2. That biologic standards for blood and blood derivatives be uniform throughout the country, with necessary legislation to assure the adoption of the desired criteria.
3. That all military combat plans include logistic requirements for blood.
4. That all blood donations be voluntary.
5. That a war reserve be established for plasma, plasma substitutes (expanders), and transfusion supplies and equipment, with economical maintenance of estimated requirements, and that a system be devised for replacing deteriorated supplies, so as to maintain a satisfactory and economical reserve.
6. That research on blood preservation and on improvement of transfusion equipment be emphasized by the Department of Defense. It was suggested that the sum of \$100,000 be allocated annually for the next 2 or 3 years to provide for additional research in these fields.

It was essential, the report of the Task Group concluded, that the agency for civilian and military whole blood requirements that was developed in peacetime should be of such a character that it could be expanded in time of war to meet logistic requirements and organization, training, and operating procedures. Such an agency should have ramifications down to the community level, so that, in an emergency, all potential sources of blood could be tapped. Also, the personnel of such an agency should be so organized and trained that, in time of war, its existing operational activities would simply have to be expanded.

Continuing misconception of requirements for whole blood.—Another depressing phase of the development of the blood program after World War II was the position taken by the Director of Military Supply and the Acting Chief, Requirements Coordination, Munitions Board, in April 1950, in connection with the recommendations of the Task Force (6).

Both granted the necessity for a national blood program, the importance of its prompt development, and the wisdom of correlating military and civilian requirements, policies, standards, and procedures. These officers, however, could not agree with the recommendation that the Director of Medical Services, Department of Defense, be responsible for, and direct continued study and implementation of, the DOD blood program and its coordination with other agencies. Nor could they agree that the director should take steps to accomplish standardization of related military and civilian supplies, equipment, and procedures, for the following reasons:

1. Blood and blood derivatives are considered a supply commodity or munition.
2. The Munitions Board is legally responsible for developing coordinated policies relating to military supplies.

3. The blood program is no different from other programs and must be handled in the same manner as other programs.

It would be hard to imagine a more total misconception of the requirements and implications of a whole blood program. The position of these officers, obviously taken in complete ignorance of how whole blood must be procured, handled, and administered, represented everything the Subcommittee on Blood Substitutes, NRC, the Blood Transfusion Branch, Office of The Surgeon General and other agencies and personnel had fought against during World War II. Had these ideas been permitted to prevail, the entire whole blood program for Korea would have foundered and many lives would probably have been lost from the use of incorrectly handled blood. The controversy had no chance to develop, however, for the Secretary of Defense, in August 1950, gave the operational responsibility of the blood program to the Directorate, Armed Services Medical Procurement Agency, and directed the Director of Medical Services, DOD, to prescribe the policies and standards for the implementation of the program (7).

IMPLEMENTATION OF TASK GROUP PROPOSALS

In May 1950, Dr. Meiling assumed the chairmanship of a Blood and Blood Derivatives Committee in the Department of Defense, which had the function of determining the need of the Armed Services for plasma and whole blood. He at once appointed an ad hoc committee on blood and blood derivatives to serve in an advisory capacity to him.

At its meeting on 28 July 1950—a month after the outbreak of the Korean War—the Military Medical Advisory Group, in a full discussion of the Blood and Blood Derivatives Program, decided that the American Red Cross should be the coordinating blood procurement agency for the Department of Defense and that the Armed Services Medical Procurement Agency should be assigned operational responsibility for the program in the Department of Defense.

A week later, when the Secretary of Defense formally assigned operational and technical responsibility for the program to the Directorate of the Armed Services Medical Procurement Agency, the directorate at once requested the chief of this agency to establish a blood and blood derivatives division within the agency. At the same time, the directorate requested that the director of Medical Services, Office of the Secretary of Defense, grant membership in the Task Group studying the Whole Blood and Blood Derivatives Program to the chief of the Procurement Agency and the chief of its Blood and Blood Derivatives Division.

All of these requests were granted. Col. Douglas B. Kendrick, MC, who had been in charge of the Army blood program in World War II from its inception until November 1944, was named chairman of the Blood and Blood Derivatives Group, which position he held for the next 2 years. On 1 May 1952, he was succeeded by Col. Patrick H. Hoey, MC, USAF, who held this position

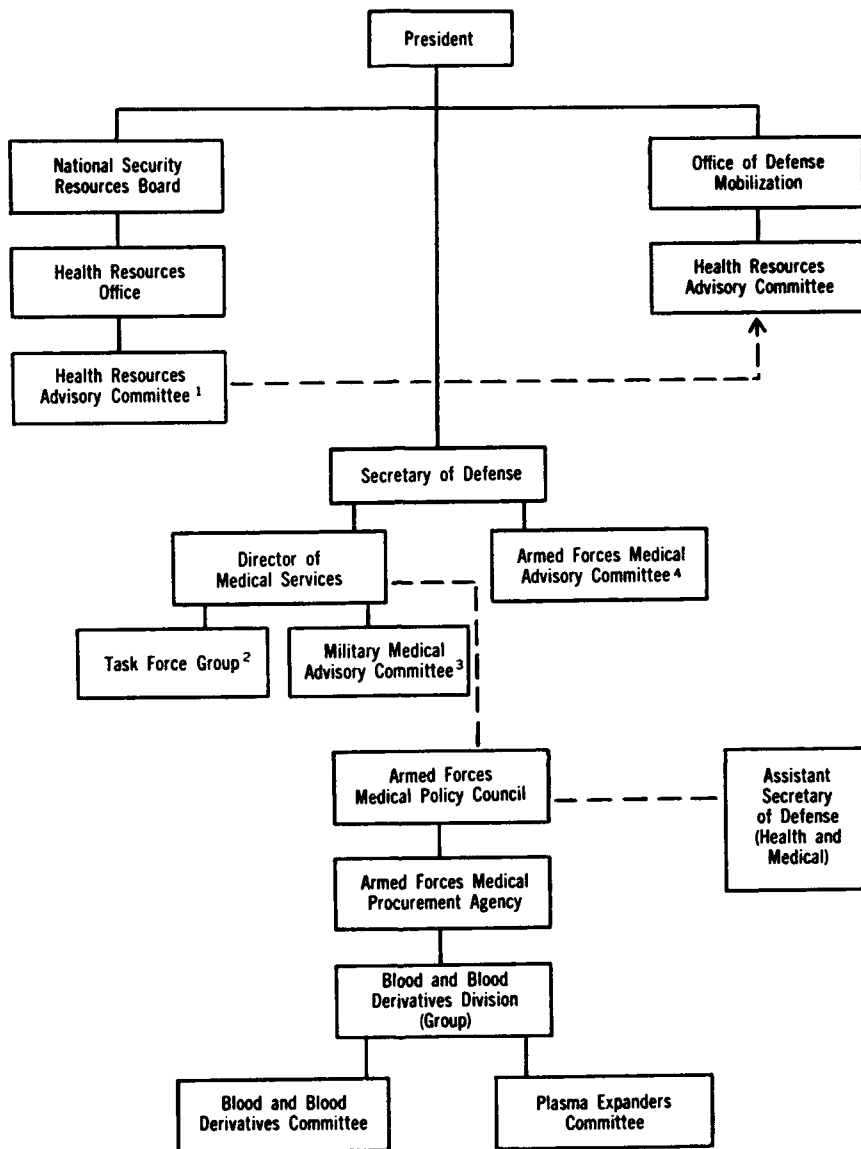
CHART 11.—*Structural organization of blood and blood derivatives program, 1949*

¹ Transferred to Office of Defense Mobilization on 26 Apr. 1951.

² Composed of a medical officer from each of the three Services—Army, Navy, Air Force.

³ Composed of the Surgeons General, Army, Navy, Air Force, and Public Health Service, and the Chief Medical Director, Veterans' Administration.

⁴ Composed of civilian physicians and dentists under the chairmanship of Charles P. Cooper.

until the end of the war. Lt. Col. Arthur J. Carbonnell, MC, was the Army member of the group from 15 February 1951 to 18 February 1952.

On 12 September 1950, the Armed Services Blood and Blood Derivatives Division (which became the Armed Services Blood and Blood Derivatives Group a few days later) was officially established. It consisted of a professional staff and of administrative, field, laboratory, and liaison branches. Its mission was as follows:

1. To provide whole blood for FECOM (Far East Command).

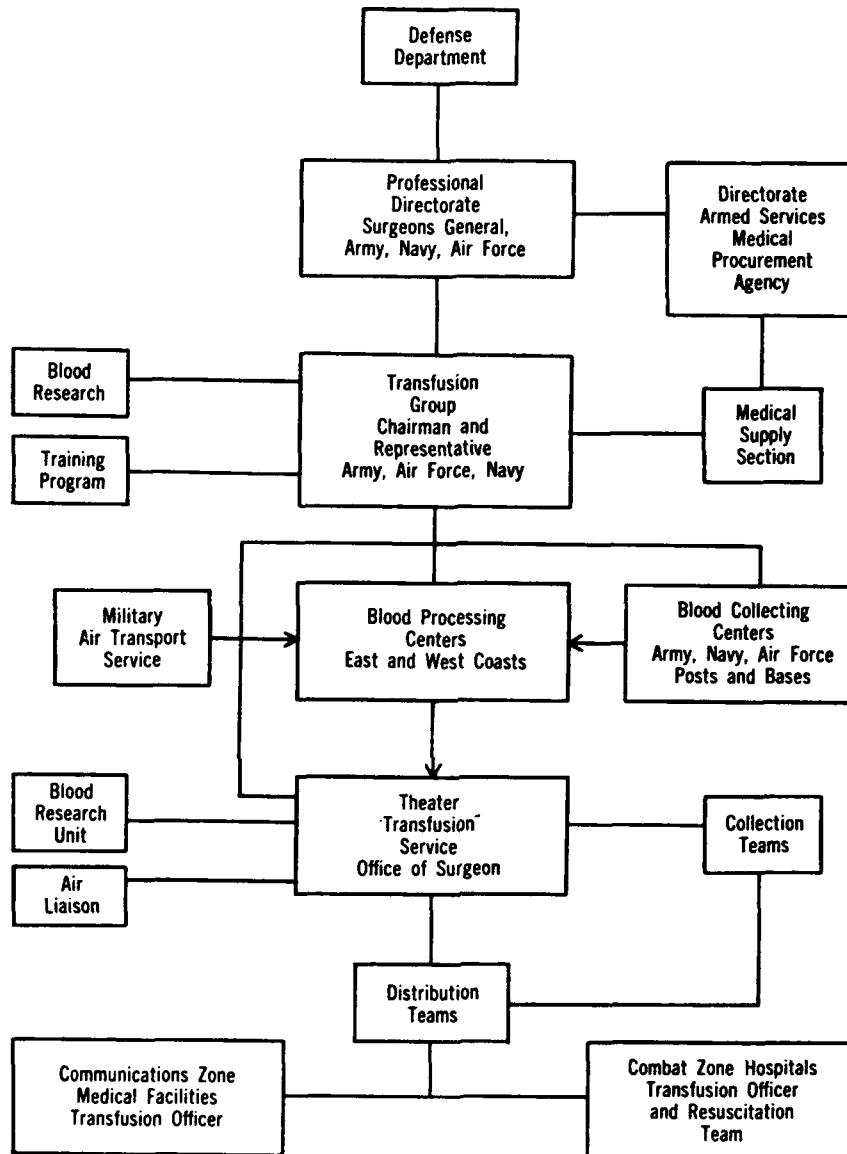
CHART 12.—*Structural organization of blood and blood derivatives program, 1950*

2. To provide whole blood for the production of dried plasma for the DOD War Reserve stockpile.

3. To reprocess outdated stocks of plasma produced in World War II.

4. To investigate developments in the field of plasma-expanders.

The actual division of responsibility for the blood and plasma program was that the Committee on Blood and Blood Derivatives recommended policy and the Blood and Blood Derivatives Group had the operational responsibility for its implementation.

The structural evolution of the blood and blood derivatives program in the Department of Defense between 1949 and 1953 is shown in charts 11, 12, and 13.

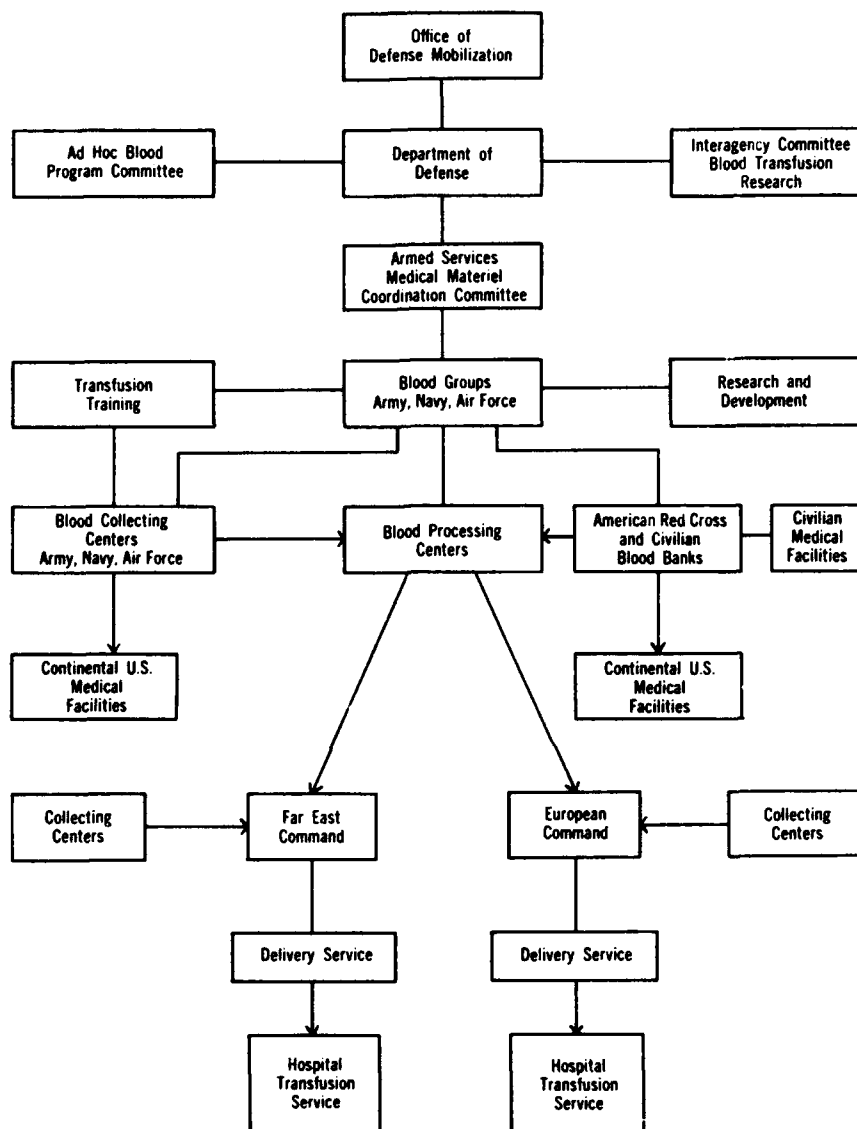
CHART 13.—*Structural organization of blood and blood derivatives program, 1952*

NATIONAL RESEARCH COUNCIL

Organization and Functions

The Subcommittee on Blood Substitutes, Committee on Shock, Division of Medical Sciences, NRC, had done such important work on the collection and distribution of whole blood and its derivatives, and had supervised so much valuable research, in World War II, that it was reactivated in 1948 as the Committee on Blood and Blood Derivatives. The work of the subcommittee had lapsed at the end of World War II, but in the interim before its reconstitution, the American Red Cross, which was entrusted with returning surplus

blood derivatives to the people of the United States who had contributed them, used many of the same physicians who had served on the subcommittee on its own Committee on Blood and Blood Derivatives, thus maintaining their contacts with the blood program. The reason for the reactivation of the World War II subcommittee was the realization that a national emergency would demand huge amounts of blood and blood derivatives for civilian as well as military uses, and the subcommittee was promptly enlarged because of the complexity of the problems to be solved.

As soon as it was activated, the Committee on Blood and Blood Derivatives went actively to work. At its first meetings, the stage of existing knowledge in the special fields of blood and blood derivatives was assessed. Ad hoc responsibilities were delegated to particular members, who were directed to investigate equipment, preservatives, and sterilization of blood and blood derivatives. Contracts for research in the field of blood and blood derivatives were reviewed for the National Military Establishment and the Veterans' Administration.

At the meeting of the Committee on Blood and Blood Derivatives on 3 December 1949, much of the agenda concerned general principles and policies (8). Dr. Charles A. Janeway, chairman of the committee, pointed out that the blood program was an integral part of national defense and that the counterpart of this committee during World War II had sat as an advisory group to all agencies and organizations concerned in any way with blood. Its successor committee would perform the same functions.

Dr. Meiling, Director of Medical Services, Office of the Secretary of Defense, explained the functions of his office. Dr. Cohn spoke of the importance of the cooperation of all agencies concerned in the blood program. During World War II, he noted, no decision regarding blood products was ever made without the approval of the Laboratory of Biologics Control, National Institutes of Health. Many of these matters were within the province of the Food and Drug Administration. The World War II subcommittee had been careful never to recommend any action or procedure on the basis of research alone; the practicability of all recommendations was tested by pilot operations. It was possible that blood might be collected by some agency other than the Red Cross, which was now operating with no obligations to turn over any material to the Armed Forces in an emergency. The important consideration was that there must be a single blood program, cooperative and not competitive. In conclusion, said Dr. Cohn, "Failure to act until an emergency entails accepting the responsibility for being unprepared."

By this time (December 1949), a great many problems had already been referred to the Committee on Blood and Blood Derivatives, NRC, and many more were to be referred to it before and during the Korean War. The recommendations made concerning them are discussed under appropriate headings. The contribution of the committee was incalculable. There were, however, many perfectionists on it, and, at intervals, the more practical-minded members felt constrained to remind them of current needs. If, for

instance, excessive and unnecessary standards of accuracy were required, the volume of production would be impractically small. The point at issue was the quick determination of what agents were safe to put into people's veins from the standpoint of immediate or delayed antigenicity and toxicity.

At the December 1949 meeting, an ad hoc committee was appointed to consider all phases of the blood program, talk with civilian defense planning groups and other agencies, and then make recommendations to the Committee. The membership of this committee included Dr. Janeway, Dr. Cohn, Dr. Ravdin, Dr. Carl V. Moore, and Dr. Charles A. Doan.

At this same meeting, a number of changes were recommended in the 13 May 1943 agreement with the American Red Cross, both to bring the text into agreement with the current organizational situation and to indicate that collections of blood were for civilian needs as well as for needs of the Armed Forces. It was also recommended that a committee be formed to serve in an advisory capacity to the American Red Cross, Department of Defense, National Institutes of Health, Veterans' Administration, Atomic Energy Commission, and whatever agency would be responsible for civilian defense.

Some of the problems referred to the Committee on Blood and Blood Substitutes, NRC, might be mentioned here, to indicate their range and importance:

1. Could not a preservative solution be devised in which blood for transfusion and blood intended for plasma could both be collected?
2. What measures should be adopted to safeguard plasma to be stockpiled while it was being processed?
3. How could transmission of virus infections from plasma infusions be prevented?
4. Could the dating period of blood be extended?
5. How could the incidence of clots in collected blood be reduced?
6. Would siliconing the inside of collecting bottles improve the product?
7. What was the present estimate of the value of gelatin? Oxypolygelatin? Dextran? Periston? Inquiries concerning these and other plasma-expanders were to come up repeatedly.

THE AMERICAN RED CROSS PARTICIPATION

The Committee on Blood and Blood Derivatives, DOD, recommended to the Secretary of Defense on 2 October 1948 and 10 January and 13 February 1949 that the American Red Cross be officially designated as the agency to collect blood for the National Military Establishment. The Subcommittee on Burns, Committee on Surgery, NRC, also recommended, in November 1949, that some large-scale machinery for the collection of blood be set up.

On 20 July 1950, the Secretary of Defense, then Mr. Louis Johnson, recommended to the Chairman of the American Red Cross, then Gen. George C. Marshall, that the relation which had existed during World War II between that organization and the War and Navy Departments be reestablished between it and the Department of Defense to meet the needs of the Armed Forces for blood and blood derivatives (9). On 22 July, General Marshall replied that the Red Cross would at once increase its blood collections and that Adm.

Ross T McIntire, MC, USN (Ret.), who was assigned to the Red Cross National Blood Program, would be assigned to work with Dr. Meiling on the necessary plans (10).

On 30 August 1950, Mr. Symington, as Chairman, NSRB, formally requested, through General Marshall, that the American Red Cross accept the responsibility for coordinating a nationwide civil defense blood program for recruitment of donors and for the collection, storage, processing, and preparation for shipment of blood and blood derivatives collected under the program (11). On 7 September 1950, General Marshall replied that the Red Cross would accept the specified responsibilities, on the assumption that local civil defense units would coordinate their planning with the national program (12).

The Boston Agreement.—Meantime, on 11 and 12 July 1950, the Committee on Blood and Blood Derivatives, American Red Cross, and the Red Cross Medical Advisory Committee on the National Blood Program met in Boston with representatives of the American Medical Association, the American Association of Blood Banks, and the American Hospital Association, to determine their relations with each other. The so-called Boston Agreement provided that these four agencies would cooperate with each other in peacetime and with the National Security Resources Board in time of war (13). In peacetime, there would be a free exchange of blood on a unit-for-unit basis, as would best serve community needs. As a matter of principle, surplus blood would be given to the Red Cross or other designated agencies for conversion into blood derivatives. In time of war, procurement agencies would be set up in communities not already served by Red Cross regional blood centers.

It was recognized at this conference that standardization of equipment for the blood program was desirable in peacetime and imperative in a national emergency. It was also recommended that all blood banks cooperating in the joint program should meet the minimum standards of the National Institutes of Health.

Part II. The Whole Blood Program

Section I. Blood Procurement in Japan

INITIATION OF PROGRAM

The blood program for the Korean War began in Japan. Here, in the interim between the wars, a few Army hospitals, all of which were authorized to provide definitive surgical care, collected blood from donor lists in accordance with Army Regulations No. 40-1715. These hospitals, located mainly in the Tokyo and Osaka areas, operated small banks, sufficient for their own needs.

Within 10 days after the outbreak of the Korean War (then considered only a police action), it became apparent that the Armed Forces in combat would



FIGURE 167.—Blood donors (Flag allowance personnel, Commander, U.S. Naval Forces, Far East) lined up outside 406th Medical General Laboratory blood bank, Tokyo, July 1950, ready to donate blood for fighting forces in Korea.

require blood in large amounts, and plans were at once made for a centrally controlled blood procurement program in Japan (2, 14). Three initial steps were taken:

1. A special blood bank unit was formed from personnel of the 406th Medical General Laboratory to operate a blood bank there. As the bank was first set up, it consisted of a collecting and processing center in Tokyo, a transportation and courier center (later called the Blood Bank Storage Depot and Shipping Section) in Tokyo, and an advance blood bank depot at the 118th Station Hospital in Fukuoka.
2. 8090th Blood Bank Laboratory Detachment was organized as a temporary duty unit in August 1950 and was assigned to the 406th Medical General Laboratory. The detachment consisted of two mobile bleeding units and a laboratory unit. It functioned until 5 November 1951, when it was replaced by the 48th Blood Bank Laboratory Detachment.
3. Blood bank sections were activated in Korea, as organic parts of medical supply depots.

The necessary organizational steps were taken quickly, donors were recruited (fig. 167), and the first shipment of blood from Japan (69 bottles) was sent to the 8054th Evacuation Hospital in Pusan, Korea, on the night of 7 July 1950.

SUBSEQUENT DEVELOPMENTS

For the first 5 weeks, the blood bank operated on an emergency basis, as troop strength built up rapidly and field medical installations were sent to Korea to care for casualties. It then became evident that the combat in which the U.S. troops were engaged would be considerably more than a local engagement, rapidly terminated, and that blood bank operations must be put on a firmer basis.

The first step was to determine a working ratio between anticipated casualties and future needs for whole blood. By the use of figures supplied by the Assistant Chief of Staff, G-1 (personnel), which were available daily and were regarded as accurate, a ratio was developed of 0.82 pint of blood to each casualty wounded in action and surviving to be hospitalized.

At this time, the donor panels in the Tokyo-Yokohama areas could supply, at the most, 100 pints of blood per day. Official approval had not yet been obtained for the use of Japanese donors, and, until the end of 1950, blood was secured only from noncombatant Army, Navy, and Air Force personnel; Allied Forces personnel; civilian employees of the U.S. Armed Forces; foreign nationals other than Japanese; and adult dependents of these groups.

When the needs of anticipated casualties were surveyed realistically, it was at once clear that available local donors could not possibly meet their requirements, and a request for blood was made on 15 August 1950 to the Zone of Interior (15) and promptly acceded to (p. 713). It was hoped, however, that local sources could continue to meet emergency needs and could also supply group-specific and Rh-specific bloods, which, as in World War II, would not be sent from the Zone of Interior.

After 6 months of combat, and after blood from the Zone of Interior had been reaching Korea for over 4 months, it was found that the ratio of blood to casualties had undergone a change. The factor then used, 3.32 pints of blood for each combat casualty who was hospitalized, was based on an experience factor for logistic blood requirements that included not only the blood actually used but the blood wasted in storage and distribution, a wastage that was then considered unavoidable in such a perishable product as blood in such combat circumstances as Korea.

The first bloods collected in Japan were transported from the bank at the 406th Medical General Laboratory to the advance depot at the 118th Station Hospital in Fukuoka in railway baggage cars, three of which had been equipped with reach-in reefers (refrigerators) for this purpose. Later, air transport was used almost exclusively (p. 752).

JAPANESE DONORS

Techniques of collection of blood in Japan generally followed those employed in Red Cross bleeding centers in World War II until donations from Japanese began to be accepted, at the end of 1950. Then, certain changes in

procedure were necessary. For one thing, language difficulties made it necessary to employ a small Japanese staff, as well as to use nurses and volunteers supplied by the Japanese Red Cross (fig. 168). For another, Japanese medical authorities were at first reluctant to depart from their standard practice of limiting donations to 200 cc. Some concessions, naturally, had to be made to the small size of the Japanese, who could not routinely give 500 cc. of blood as did U.S. donors, and tables of maximum collections for bleeding them and others of similar stature were therefore worked out (table 34). When these standards were adhered to, there was never any evidence of immediate or delayed harmful effects from the donations.

TABLE 34.—Authorized collection of blood, from Japanese nationals and other donors of small stature

[Per pound of body weight]

Body weight		Authorized collection		Blood and anticoagulant	
Male	Female	Male	Female	Male	Female
<i>Pounds</i>	<i>Pounds</i>	cc.	cc.	cc.	cc.
100	105	250	230	370	350
105	110	260	240	380	360
110	115	275	250	395	370
115	120	290	260	410	380
120	125	300	275	420	395
125	130	310	285	430	405
130	135	325	295	445	415
135	140	330	310	450	430
Over	145	Maximum	320	Maximum	440
-----	150	-----	330	-----	450
-----	Over	-----	Maximum	-----	Maximum

PUBLICITY

Publicity for the blood program in Japan was provided by the U.S. and the Japanese Red Cross, the Armed Forces radio station in Tokyo, the Pacific edition of the *Stars and Stripes*, and similar sources. Documentary films showing blood bank operations were made by the Army Signal Corps and by Japanese photographers for use locally as well as in the United States. Posters, pictures, and stories were provided for both local and stateside release by General Headquarters and Joint Logistical Command Public Information Offices.

On one occasion, a spectacular air rendezvous was made with the U.S.S. *Boxer*, then in Korean waters; her crew donated 2,407 pints of blood in 4 days. On another occasion, Gen. Douglas MacArthur publicly received a token



FIGURE 168.—Japanese mothers, representing the United Nations Educational, Scientific and Cultural Organization, giving blood for forces in Korea at 406th Medical General Laboratory, Tokyo, February 1952, as their children watch.

shipment of blood from the German employees of a commercial airline. On 4 July 1951, the medical section of the Joint Logistical Command, at a carnival at Meiji Park, staged a complete demonstration of blood bank operations; the processing of the blood was carried out in full view of the spectators. The Gallon Club, instituted in August 1951, had almost 150 members within a few weeks.

STATISTICAL DATA

During fiscal year 1951, a total of 43,479 donors were interviewed at the blood bank in Japan and more than 39,000 pints of blood were collected from them through the efforts of the central bank and its mobile teams. The chief reason for refusing donors was a history of disease, including malaria and infectious hepatitis, and of hypertension. Only 175 positive serologies were encountered, 0.4 percent.

The low incidence of Rh-negative blood (table 35), a Japanese racial characteristic, limited to a considerable degree any extensive use of Japanese donors if Rh-compatible blood was to be given to a recipient population composed chiefly of Americans and Europeans. In the first 2,784 Japanese

bloods collected, there were only 19 Rh-negative bloods, 0.68 percent. The distribution according to type in 39,100 units of Japanese blood collected in 1951 is shown in table 35. Statistics for 1952 and 1953 were of the same order.

In 1951, almost 25 percent of the blood received in Japan by the blood bank was procured in that country (table 36). Something over a third of this amount was collected in Tokyo. The remainder was collected by mobile teams at various stations in the vicinity, including 6,456 pints from the U.S. Naval Hospital in Yokosuka and 3,308 pints from the U.S. Army Hospital in Yokohama.

TABLE 35.—*Type distribution of blood collected in Japan, 1951*

Blood type	Bloods	Blood type
Type O:	<i>Number</i>	<i>Percent</i>
Rh positive, high titer.....	10, 378	56. 2
Rh positive, low titer.....	5, 142	29. 7
Rh negative, high titer.....	1, 848	10. 0
Rh negative, low titer.....	1, 070	5. 9
Total.....	18, 438	47. 1
Type A:		
Rh positive.....	12, 309	84. 5
Rh negative.....	2, 251	15. 5
Total.....	14, 560	37. 2
Type B:		
Rh positive.....	3, 722	85. 9
Rh negative.....	608	14. 1
Total.....	4, 330	11. 0
Type AB:		
Rh positive.....	1, 511	85. 2
Rh negative.....	261	14. 8
Total.....	1, 772	4. 7
All types:		
Rh positive.....	33, 062	84. 5
Rh negative.....	6, 038	15. 5
Grand total.....	39, 100	

TABLE 36.—Receipts of blood, Tokyo Blood Depot, 1951-52

Month	1951			1952		
	Collected in Japan	Received from Zone of Interior	Total	Collected in Japan	Received from Zone of Interior	Total
	<i>Number</i>	<i>Number</i>	<i>Number</i>	<i>Number</i>	<i>Number</i>	<i>Number</i>
January.....	2,614	7,060	9,674	3,274	9,648	12,922
February.....	4,233	9,264	13,497	3,509	8,328	11,837
March.....	2,319	9,224	11,543	2,218	8,472	10,690
April.....	2,952	13,466	16,418	2,163	8,640	10,803
May.....	3,287	15,032	18,319	2,177	8,976	11,153
June.....	3,053	10,528	13,581	2,725	7,920	10,645
July.....	2,454	10,392	12,846	1,986	7,368	9,354
August.....	1,926	9,048	10,974	2,356	7,415	9,771
September.....	2,722	11,496	14,218	2,555	7,558	10,113
October.....	5,769	14,424	20,193	5,882	9,360	15,242
November.....	3,871	10,632	14,503	2,337	8,112	10,449
December.....	3,572	8,639	12,210	3,321	8,760	12,081
Total.....	38,772	129,205	167,977	34,503	100,557	135,060

Section II. The Development of the Whole Blood Program in the Zone of Interior

THE FIRST YEAR

Collections of blood by the American Red Cross for the Department of Defense began in August 1950. By the middle of 1951, those responsible for the blood and plasma program in the Department of Defense were increasingly concerned because procurement was lagging far behind requirements and commitments (2). Whole blood requirements for the Armed Forces were being met, but reserves of plasma were in alarmingly short supply because of lack of blood to process.

On 20 July 1951, the chairman of the Armed Forces Medical Policy Council, Dr. Lovelace, projecting present trends into the future, reported to the Secretary of Defense that the blood procurement program of the Department was in serious need of revision. On the basis of a report made to the Policy Council on 16 July 1951 by an ad hoc committee,⁴ Dr. Lovelace recommended that the program be referred to the newly established Health Resources Advisory Committee of the Office of Defense Mobilization for information and assistance. He also recommended that the American Red Cross Blood Donor

⁴ This committee consisted of Colonel Kendrick, Chairman; Captain Newhouser, Department of Defense; Maj. Gen. David N. W. Grant, USAF (Ret.), and Mr. Richard Swigart, American Red Cross; and Dr. F. Douglas Lawrason NRC.

Program be stimulated with the assistance and cooperation of the Department of Defense, as follows:

1. There should be a continuously active advertising campaign for donors.
2. Additional collection centers should be established.
3. Blood procurement should be stimulated on the local level in every possible way, especially when blood banks were located in heavily populated areas and within reasonable shipping distance of existing plasma plants.
4. The Red Cross should be requested to establish priorities for blood for the Department of Defense.

In addition to these steps, which should be taken jointly with the American Red Cross, Dr. Lovelace recommended that the Department of Defense:

1. Should establish a military blood collection program to reach military personnel and civilian employees on military bases.
2. Should institute a policy of purchasing plasma from civilian commercial laboratories which met NIH specifications.

THE ARMED FORCES BLOOD DONOR PROGRAM

On 2 August 1951, in a DOD directive, the Acting Secretary of Defense, Mr. Robert D. Lovett, announced the establishment of an Armed Forces Blood Donor Program, "to provide a continuous and vigorous campaign, in conjunction with the Red Cross, to persuade the civilian and military population to contribute whole blood to the Armed Forces" (16). The program would be launched on 10 September 1951.

The Director of Information, Office of the Secretary of Defense, would be responsible for directing publicity and information concerning the program. Policy guidance would be provided by the Armed Forces Medical Policy Council, Office of the Secretary of Defense. All programs would be coordinated through the Armed Services Medical Procurement Agency.⁵

The success of the military program was immediate (figs. 169-172). Within a few months there were more donors than facilities to handle them. The attitude of the Air Force was typical of all the Services. On 6 September 1951, the Air Adjutant General directed that "every level of command of the Air Force give its whole-hearted cooperation to insure the success of the program." Effective on 10 September, the date of initiation of the program, or as soon thereafter as possible, Air Force collection centers would be established at Lowry Air Force Base, Denver, Colo., Lackland Air Force Base, San Antonio, Tex., and Sheppard Air Force Base, Wichita Falls, Tex. Tentative sites were also selected for other collection centers, to be activated as necessary later.

⁵The National Advertising Council worked closely with the Director of Information, DOD, and deserves much of the credit for the outstanding success of the program.



FIGURE 169.—Official poster of Armed Forces Blood Donor Program instituted September 1951.

THE NATIONAL BLOOD PROGRAM

One of the major problems of blood procurement was the necessity of providing blood for civil defense as well as for combat needs. It was studied by Dr. Rusk, Chairman, Health Resources Advisory Committee, and his staff; on their recommendation, on 10 December 1951, President Truman issued an Executive order to the effect that the Director of the Office of Defense Mobilization would provide, within his office, "a mechanism for the authoritative coordination of an integrated and effective program to meet the nation's requirements for blood, blood derivatives and related substances" (17). In this order, it was pointed out that a subcommittee on blood had been appointed within the Health Resources Advisory Committee, to develop "a single National Blood Program encompassing all phases of the problem." It was the President's desire that the activities of all departments and agencies in the field be coordinated "through this mechanism."



FIGURE 170.—Shipments of blood for processing centers secured from military installations in Zone of Interior. A. From Fort Bragg, N.C., October 1951, by train. B. From Camp Rucker, Ala., October 1951, by plane. C. From Fort Leonard Wood, Mo., November 1951, by truck.



American Red Cross photograph

FIGURE 171.—Mr. William J. Richards, Red Cross representative, Capt. Ray Jones, and Copilot Wilson Byerhoff inspecting shipment of blood as it arrived via American Air Lines at San Francisco Airport for transshipment to Japan, 26 August 1950.

On 18 February 1952, the Subcommittee on Blood (the Cummings Committee) submitted a statement of basic principles upon which the reorganized program should be based. The substance of this report, which was immediately transmitted to the Secretary of Defense, Mr. Lovett, was as follows (18):

1. The program created to meet the blood needs of the nation in the time of national emergency and to be known as the National Blood Program would represent a coordination of the blood programs already in existence.
2. No agency would duplicate the efforts of another agency unless the task could not otherwise be performed adequately. Before such a duplication occurred, there must be agreement for it among the agencies involved and the Office of Defense Mobilization.
3. The recruitment program for volunteer donors would emphasize the National Blood Program as a whole and not any specific part thereof.
4. The Department of Defense and the Federal Civil Defense Administration would be authorized to establish and maintain separate plasma reserves.
5. The Red Cross would continue to be the blood collecting agency for the National Defense Program except for the facilities (then 34) of the Department of Defense in Armed Forces installations located in areas not covered by the collecting facilities of the National Red Cross. These collecting facilities now included 41 regional programs covering 1,540 local chapters and cooperating blood banks.

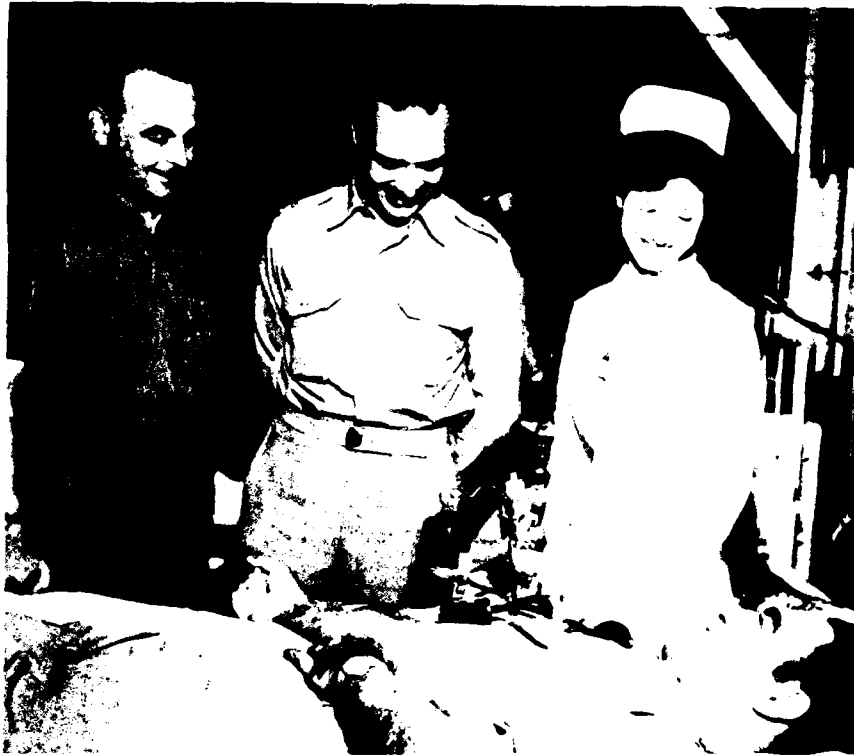

FIGURE 172. -Representatives of Swiss and British Armies watching as nurse takes blood from representative of Iranian Army during visit of mobile blood unit from Louisville Regional Blood Donor Center to Fort Knox, Ky., July 1950. On this visit, 189 donations were secured.

6. Priorities for allocation of blood would be as follows:
 - a. The Armed Services, for whole blood transfusions.
 - b. Civilian needs for whole blood and blood derivatives.
 - c. Allocation of the remaining blood collected for the production of plasma and blood derivatives to meet immediate needs and establish national reserves.
7. In the event of enemy action, the total reserves of plasma, blood derivatives, and plasma expanders would be allocated as necessary by Executive order.
8. The Red Cross would continue to operate, for military use only, 15 centers serving 258 local chapters and would participate in a cooperative program with 35 civilian blood banks which would coordinate supply.
9. Research on blood and related problems would be coordinated through a committee set up by the National Research Council and composed of experts in the field, including liaison representatives from the Department of Defense. Funds would be provided for the research projects by the participating agencies.
10. There would also be a continuing effort to train personnel in the laboratory and clinical phases of blood supply and to foster and provide for research, so that, in the event of another emergency, any blood bank system setup would be operated by well-trained medical officers thoroughly versed in all phases of military blood banking and logistics.

These recommendations were put into effect and the national blood program was successfully operated according to them for the remaining years of the war.

Section III. The Oversea Airlift to Korea

GENERAL CONSIDERATIONS⁶

The Korean War began on 25 June 1950, and active fighting ended on 27 July 1953, with the signing of an armistice. The formal Zone of Interior blood supply program for Korea began on 15 August 1950, with a radio request from the Far East Command for shipments of blood from the Zone of Interior to augment the quantities collected and distributed by the 406th Medical General Laboratory in Tokyo (15). The first blood shipped in response to this message, which had been requested for 30 August, left the temporary laboratory at the U.S. Naval Hospital in Oakland, Calif., for Japan on 26 August 1950. On 8 February 1954, a dispatch from the Far East Command recommended that the service be terminated, and the last blood was flown to Japan on 13 February 1954 from the Armed Services Whole Blood Processing Laboratory, Travis Air Force Base, Calif. Between the dates of the first and last shipments, this laboratory had received and handled 397,711 pints of whole blood, of which 340,427 pints had been shipped to Japan for transshipment to Korea for distribution to the various medical units of the United Nations there. The Travis laboratory was placed on a standby basis on 13 February 1954 and was deactivated a month later. This program was the largest operation of its kind in the history of military medicine in the United States.

The important steps in the development of the administrative background of the airlift of blood in the Korean War have been described in detail elsewhere (p. 713). Many of the most important actions, it will be remembered, were taken after fighting had commenced.

PROCESSING LABORATORY, TRAVIS AIR FORCE BASE

Establishment

In order that the military might have a central processing facility in which to receive blood collected by the American Red Cross, perform necessary laboratory tests on it, package it, and ship it to Japan for transshipment to Korea, a processing laboratory was established at Travis Air Force Base (then Fairfield-Suisun Air Force Base), Calif., where a Military Air Transport Service group of the Pacific Division was located. The building selected had to be renovated and converted for this purpose, and until it was ready, on 25 September 1950, a temporary laboratory was set up and operated in the U.S. Naval Hospital at Oakland, Calif., about 50 miles away.

⁶ Unless otherwise specified, the material concerning the airlift is derived from the history of the Armed Services Whole Blood Processing Laboratory, Travis Air Force Base, Calif., 25 August 1950-15 March 1954 (19).

During the war, a number of attempts were made to establish a blood processing laboratory on the east coast, but no definitive action was ever taken, though supplies and personnel were earmarked for an emergency standby facility at the U.S. Naval Hospital, Chelsea, Mass. This facility was not called upon, but it was expected that, if it had been, it could have begun to ship blood to Japan within 24 hours after activation.

Functions

The Armed Services Whole Blood Processing Laboratory at Travis Air Force Base performed the following functions:

1. It received whole blood from the American Red Cross, performed appropriate laboratory tests on it, and shipped it to the Far East Command for use in Korea.
2. It maintained a record of all bloods received in the laboratory and their disposition.
3. It coordinated whole blood requirements with the Armed Services Blood and Blood Derivatives Group and the appropriate representatives of the American Red Cross.
4. It maintained a close working arrangement with the medical supply section of the Travis Air Force Base in requisitioning and drawing of supplies required in the day-to-day operations of the laboratory.
5. It maintained liaison with other military organizations and civilian agencies as necessary for efficient accomplishment of its mission.
6. It prepared and submitted to the chairman of the Armed Services Blood and Blood Derivatives Group routine reports and such special reports as were requested.

Facilities and Equipment

Structures of the permanent laboratory included a building of 3,400 sq. ft. and two warehouses, respectively 2,786 and 800 square feet. All buildings, office equipment and supplies, housekeeping items, heat, electricity, gas, communication services, and motor vehicle transportation were furnished to the laboratory and maintained by the Travis Air Force Base. Billeting and messing facilities for laboratory personnel were also furnished by Travis Air Force Base. A Navy panel truck, on loan from Oakland Naval Hospital, was assigned to the laboratory for general use.

The building at Travis Air Force Base that was converted into a laboratory was an old hospital messhall. The conversion required the installation of lighting fixtures, water-distilling apparatus, refrigerators, sinks, laboratory counters and workbenches, and natural gas fixtures. The precooling room and warehouses were not completed until about 8 months after the laboratory was occupied. When the converted building was taken over, however, on 25 September 1950, everything else was in such good order that a shipment of blood could be sent to Japan the same day.

Initial medical supplies and equipment were procured directly from the Oakland Naval Medical Supply Depot. Later, by agreement among the three Services, the requirements and stock control section of the Supply

Division, Office of The Surgeon General, U.S. Army, was given the responsibility of furnishing medical supplies and equipment to the laboratory. All requisitions went through the Travis Air Force Base medical supply section to the Alameda Army Medical Supply Depot.

The operational cost of this laboratory was estimated at over \$1 million a year. It cost approximately \$17.83 to procure and process a pint of blood and transport it from the United States to the Far East Command in Japan, this sum including \$6.56 paid to the Red Cross for processing services, \$9.40 for laboratory expenses, and \$1.87 for transportation costs.

Personnel

Four Navy blood bank technicians arrived from the east coast at the laboratory on 23 August 1950. Office, laboratory, and cold storage spaces were made available to them at once, and supplies and equipment were procured from the hospital and from the U.S. Naval Medical Supply Depot in Oakland. As a result, 48 hours after these technicians had arrived, the first whole blood shipment (1,488 pints) was received, processed, and delivered to the Military Air Transport Service at Travis Air Force Base for transshipment to Japan.

Requests for additional laboratory personnel were at first handled very slowly, and, by the middle of September 1950, the staff working in the Oakland laboratory included, in addition to the four original technicians, only one Navy Medical Service Corps officer and three laboratory technicians. Laboratory technicians were borrowed from Oakland and Mare Island Naval Hospitals and from Letterman General Hospital, San Francisco, Calif. Clerical and some general duty helpers were borrowed from Travis Air Force Base and the Oakland Naval Hospital. Additional duty corpsmen and convalescent patients aided on a day-to-day basis. All of these men were returned to their duty stations when additional permanent personnel began to arrive about the middle of October. In spite of its personnel difficulties, the laboratory handled over 7,000 pints of whole blood during the weeks of its operation at the U.S. Naval Hospital in Oakland.

In the approximately 42 months of its operation, an average of 35 persons were regularly attached to the laboratory, including an average of 11 from the Army, 10 from the Navy, and 14 from the Air Force (fig. 173).

Training.—A quick, efficient blood bank technique can be acquired only by experience, and most of the personnel assigned to the Travis laboratory were inexperienced. All therefore worked long hours while they were receiving individual instruction.

A formal training program was set up a few months after the laboratory was activated, and 59 persons completed the course of instruction, including 14 Air Force Medical Service Corps officers, 34 Army enlisted men, and 11 Air Force enlisted men.



FIGURE 173. Personnel of Travis Air Force Base Whole Blood Processing Center. Seated, left to right, M. Sgt. John F. Firmani, USA, NCOIC (Noncommissioned Officer in Charge) of Blood Processing Department and head of Section III; M. Sgt. Marvin C. Lynn, USAF, leader, Laboratory Section III; Lt. James H. Parker, MSC, USN, officer in charge; 1st Lt. William R. Bonnington, MSC, USAF, assistant officer in charge; M. Sgt. Joseph F. Firmani, USA, NCOIC of Supply Section; M. Sgt. Milton L. Burgeson, USAF, administrative assistant to OIC and NCOIC, Records Section. Standing, Sgt. Henry M. Sottnek, USA, leader, Receiving-Storage-Shipping Section II; T. Sgt. Alvis E. Hotchkiss, USAF, leader, laboratory Section II; M. Sgt. Leon C. Bramum, USA, NCOIC of Blood Processing Department and head of Section II; HMI Sherwood J. Syverson, USN, blood bank technician; and S. Sgt. John E. Ahearn, USAF, leader, Receiving-Storage-Shipping Section III.

Work Schedules

Because of its short life, 21 days at best, expeditious as well as expert handling of blood is necessary, and the work schedule at the Travis laboratory was geared to that consideration. Blood from the collection centers was shipped by air, rail, or motor transport, as most convenient. Centers near the laboratory delivered their blood by motor transport. Blood from distant collection centers arrived by air. The shipments were offloaded at airports in San Francisco or Oakland, where they were picked up by the Railway Express Agency and transhipped by train to Fairfield-Suisun, about 7 miles from Travis. Here, they were offloaded and trucked to the laboratory by the agency. Blood from centers nearer the laboratory was sent by train, and delivered to the laboratory by the Railway Express Agency. Because the agency worked on a 5-day workweek schedule, arrangements were made with the motor pool at Travis Air Force Base to meet trains on Saturdays, Sundays, and holidays, pick up the blood and deliver it to the laboratory.

The Red Cross blood donor centers also worked on a 5-day week, usually Monday through Friday. Few collections were made on Saturdays, Sundays, and holidays.

Each Friday, and oftener if requirements changed, the officer in charge of the laboratory at Travis Air Force Base notified the central office of the Red Cross of the quotas of blood desired for the following week. The Red Cross, in turn, designated the donor centers which would collect, process, and ship these quotas. A number of attempts were made, all unsuccessful, to have the weekly quotas collected in equal amounts on each of the 5 days weekly that the centers operated. Few bloods were received from Monday through Wednesday, often not the equivalent of the amounts shipped to Japan. Most bloods were processed from Thursday through Sunday. By Sunday night, the refrigerators were filled, and there was sufficient blood on hand for the Monday-through-Wednesday shipments.

Although bloods arrived in the laboratory at all hours of the day and night, most of them arrived twice daily, at 1000 and 1800 hours. On Sundays and holidays, the bulk of the blood usually arrived at 1800 hours.

Because of these various circumstances, the Travis laboratory had to operate 7 days a week, day and night. After additional personnel arrived at the laboratory in October 1950, separate day- and night-working sections were established to receive, process, and ship blood. The two sections, each composed of equal numbers of clerical, laboratory, and general duty personnel, alternated day- and night-working hours at weekly intervals. A third section, composed of administrative and supply personnel, carried on the administrative and supply duties of the laboratory. This section worked a regular day shift, but its personnel were subject to night call as necessary.

LABORATORY ROUTINE

Collection and Initial Processing

Only proved group-O blood, of low titer and Rh-verified, was sent to Korea. As in World War II, about 45 percent of random donors proved to be group O, and about a quarter of this group had agglutinin titers above 1:64.

The technique of collection was essentially that employed in World War II (p. 145). Donors were screened to make sure that they were group O. Whole blood intended for oversea use was collected in ACD solution (blood intended for plasma was collected in sodium citrate solution). The blood was collected in 500-cc. amounts in sterile, pyrogen-free bottles; samples for serologic testing and crossmatching were collected into pilot tubes. The collection bottles were not entered again until the recipient sets were attached just before the transfusions were to be given. With this precaution, there was no possibility of contamination and there is no record that any occurred.

After the blood had been collected, two technicians performed two separate tests for specificity. With this doublecheck, the percentage of error did not exceed 0.5 percent, and there was not a single report of incompatibility during the course of the war. This was a remarkable record, for the blood that arrived at the processing center at Travis Air Force Base came from donor centers all over the United States.

Serologic tests were also performed, even though by this time there was valid evidence that syphilis could not be transmitted by blood that had been stored longer than 3 days (p. 143).⁷

Later Processing

After the collected blood had been chilled to 39.2° to 42.8° F. (4° to 6° C.), it was shipped by truck, rail, or air to the processing center in insulated Church shipping cases, refrigerated with wet ice (p. 204). Blood usually arrived within 48 hours after it had been collected. At the base, it was taken to the receiving, storage, and shipping section; logged in; placed in a walk-in refrigerator maintained in the temperature range just mentioned; and there unpacked, inventoried, and stored. Two such refrigerators were available, each capable of holding 2,500 pints of blood. The empty insulated blood shipping container was readdressed to the blood donor center whence it had come, and was returned to the center by Railway Express.

The pilot tube containing 6-8 cc. of whole blood was detached from the bottle and taken to the laboratory section, where the sample was regrouped, retyped, and retitered (fig. 174). The repetition of these tests served two purposes: (1) It eliminated units of blood that were not group O. (2) It served, to a degree, as a crossmatch; it was not always possible for medical units in Korea to type and crossmatch their patients before transfusing them.

Each year the Travis laboratory used approximately 9,600 cc. of anti-A and anti-B, and 5,800 cc. of anti-Rh, blood typing sera. During the last month the laboratory operated, the sera were used in dried form. The liquid form, which had been used up to this time, was thought more satisfactory, for several reasons: It contained fewer artifacts. It saved time because it did not have to be reconstituted. It was packaged in smaller units, and less warehouse space was required to maintain an adequate supply. On the other hand, the dried form cost a little less and had a longer useful life, 60 months, against 12 months for the liquid form. There was no significant difference in the number of bloods that could be tested with given amounts of each form.

After testing, a label was securely glued to each bottle, containing the unit blood number, blood group, Rh-factor, point of origin, and original blood donor center number. Although the expiration date did not ordinarily exceed

⁷ At the meeting of the Committee on Blood and Blood Derivatives on 23 September 1953 (after the armistice had been signed), it was proposed by Dr. William G. Workman that serologically positive bloods be used for the preparation of dried plasma, and that bloods intended for these purposes should not be tested serologically (20). These proposals were concurred in by Dr. Thomas B. Turner, Dean, Johns Hopkins University School of Public Health, and were recommended for action by the committee.



FIGURE 174.—Laboratories at blood processing center, Travis Air Force Base. A and B. Typing, titration, and Rh-testing laboratory. C. Typing laboratory. Note slides with wells, a post-World-War-II development.

21 days, an expiration date of 22 days from the date of collection was placed on each bottle because this blood would be shipped across the international date line for use in a later time zone. If the serum agglutinin titer of a unit exceeded 1:256, the label read, *High Titer Group "O" Blood—For Group "O" Recipient Only*. If the titer was less than 1:256, the label simply read *Low Titer*.



FIGURE 175. Containers of whole blood loaded on Military Air Transport Service trailers for delivery to plane that will fly it to Korea. Travis Air Force Base blood processing center, 1952.

Shipment

During the Korean War, the processing laboratory at Travis Air Force Base maintained in store two or three times the estimated daily requirement of blood, so that emergency requests could be met without delay. When such a request was received, the blood was given a No. 1 priority and sent to Japan immediately on a cargo or passenger plane.

If circumstances permitted, the blood was held in the refrigerator for 8 to 12 hours, so that it could be examined grossly for hemolysis, clots, or excessive fat content. Frequently, however, because of the heavy demands, bloods were processed and shipped out on the same day that they were received. They were packed for shipment in the walk-in refrigerators.

Except in emergencies as just noted, all whole blood shipped from the United States to the Far East Command was transported in aircraft of the Military Air Transport Service (figs. 175 and 176). It was flown from Travis Air Force Base to Haneda Air Force Base near Tokyo, with stops at Honolulu and Wake Island (map 7). It was re-iced at these stops if necessary. As soon as the blood arrived in Japan (fig. 177), it was removed from the plane, trucked to the blood storage section of the 406th Medical General Laboratory, and stored there until it was shipped to Tokyo and thence to Korea (fig. 178). All blood moved in Korea was transported by plane or helicopter (fig. 179).



FIGURE 176.- Boxes of blood being loaded on plane for flight from Travis Air Force Base to Tokyo Blood Bank.

STATISTICAL DATA

The largest number of bloods received, tested, and labeled in the Travis laboratory in a single day was 1,881 pints. The overall daily average was 319 pints, based on a 7-day week for the almost 42 months during which the laboratory operated.

The largest number of bloods handled in a single day by the receiving and shipping section was 2,500 pints, this number including both units received and units shipped. The largest shipment placed in a single plane for shipment to Japan was 1,488 pints. The average daily shipment was 273 pints.

The total weight of the blood and recipient sets shipped to Japan was 1,782,434 pounds (891 tons) and the total space required for the shipments, 426,379 cubic feet.

Of the 397,711 pints of whole blood received in the processing laboratory, 340,427 (about 85 percent), were shipped to the Far East Command for use in Korea. The remaining 15 percent included surplus bloods and bloods which for other reasons (hemolysis, clots, breakage, excessive fat content, volume less than 500 cc.) could not be used for transfusions. Most of it (56,809 pints) was sent to the Cutter Laboratories, Berkeley, Calif., for plasma fractionation, but 347 pints were used in local military hospitals. Breakage involved only 128 bottles; 94 were received broken, and 34 were broken during processing.

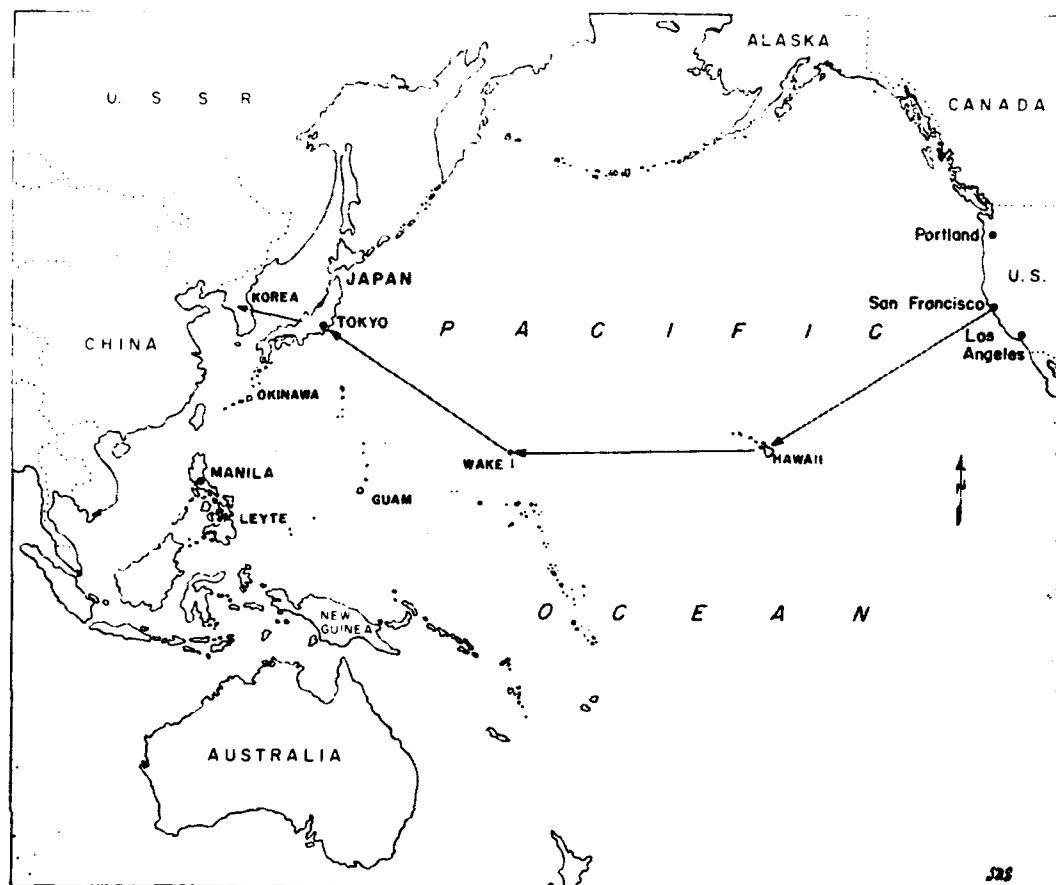

MAP 7.—Flight plan, for airlift of blood from Travis Air Force Base, Oakland, Calif., to Tokyo Blood Bank, and thence to Korea.

Only 144 of the bloods received in the laboratory were not group O; 116 were group A, 24 group B, and 4 group AB. These units had been either mistyped or mislabeled at the original blood donor centers, and the errors were caught when they were retyped in the laboratory. The remarkably low percentage of misgrouped blood indicates the skill and care of the technicians who did the initial grouping and labeling. There was a most responsible task, for, as already mentioned, most group-O blood used in Korea, as in World War II, was not crossmatched before it was used.

About 10 percent of all the blood received had an agglutinin titer of 1:256 or higher. During the first 18 months the laboratory operated, less than 9 percent of the bloods received were Rh-negative. During the last 2 years, because of repeated requests for such bloods, the proportion rose to 12 percent. Rh-negative blood was not sent to Korea but was used in the fixed installations in Japan, since it was in them that Rh-negative casualties might receive repeated transfusions 10 to 14 days after they had received Rh-positive blood in forward hospitals.

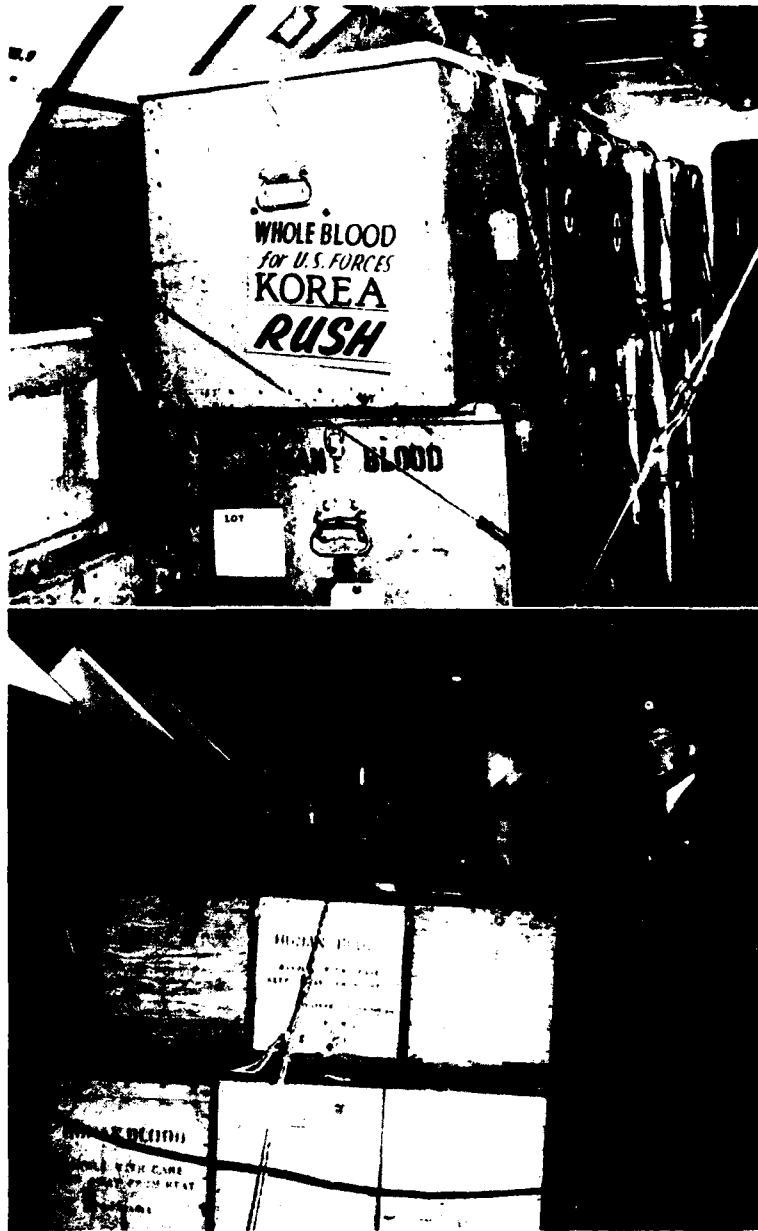

FIGURE 177.—Blood flown from blood processing center, Travis Air Force Base, to Japan. A. One of first shipments of blood from United States, stored in medical depot in Yokohama, August, 1950. B. Boxes of blood just received at Haneda Air Force Base, Tokyo, November 1950.

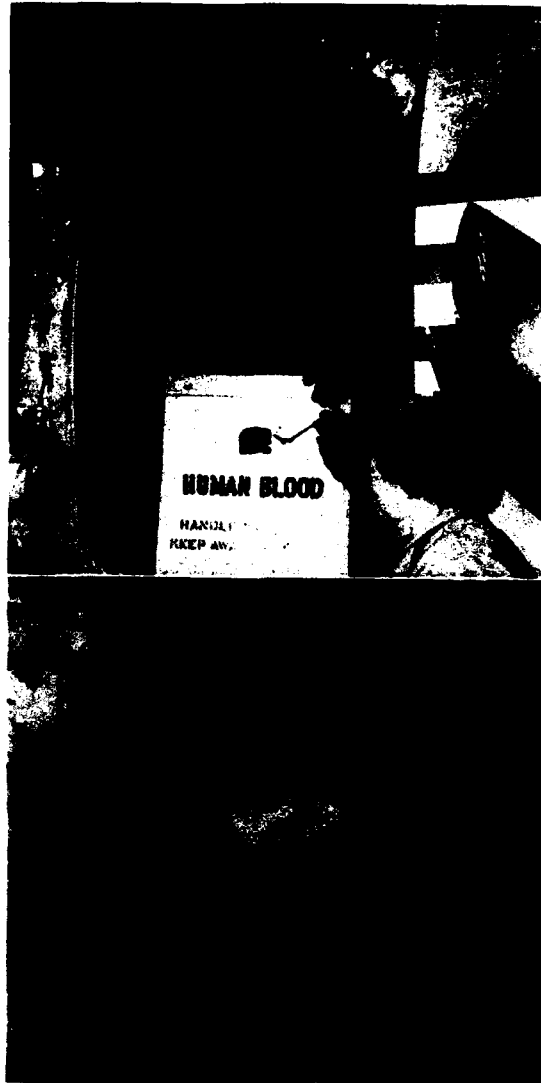

FIGURE 178.—Blood, flown from United States via Tokyo, on arrival in Korea. Blood being unloaded by native labor at Seoul Air Field, Korea, whence it will be transshipped to 11th Evacuation Hospital, February 1952.

Losses.—As has just been indicated, most of the blood rejected for oversea shipment for various reasons was made into albumin and immune serum globulin, so that the overall loss was very slight.

Losses remained at about the same level during most of the war. The heaviest losses occurred in the winter of 1950–51, when, because of inadequate processing facilities in the East, bloods intended for plasma, which had to be shipped to a laboratory on the west coast, froze en route. Otherwise, losses remained at about the same level during most of the war. In March 1952, losses amounted to 4.4 percent (2 percent hemolysis, 2 percent short amounts, 0.004 percent lipemia, and 0.4 percent other causes).

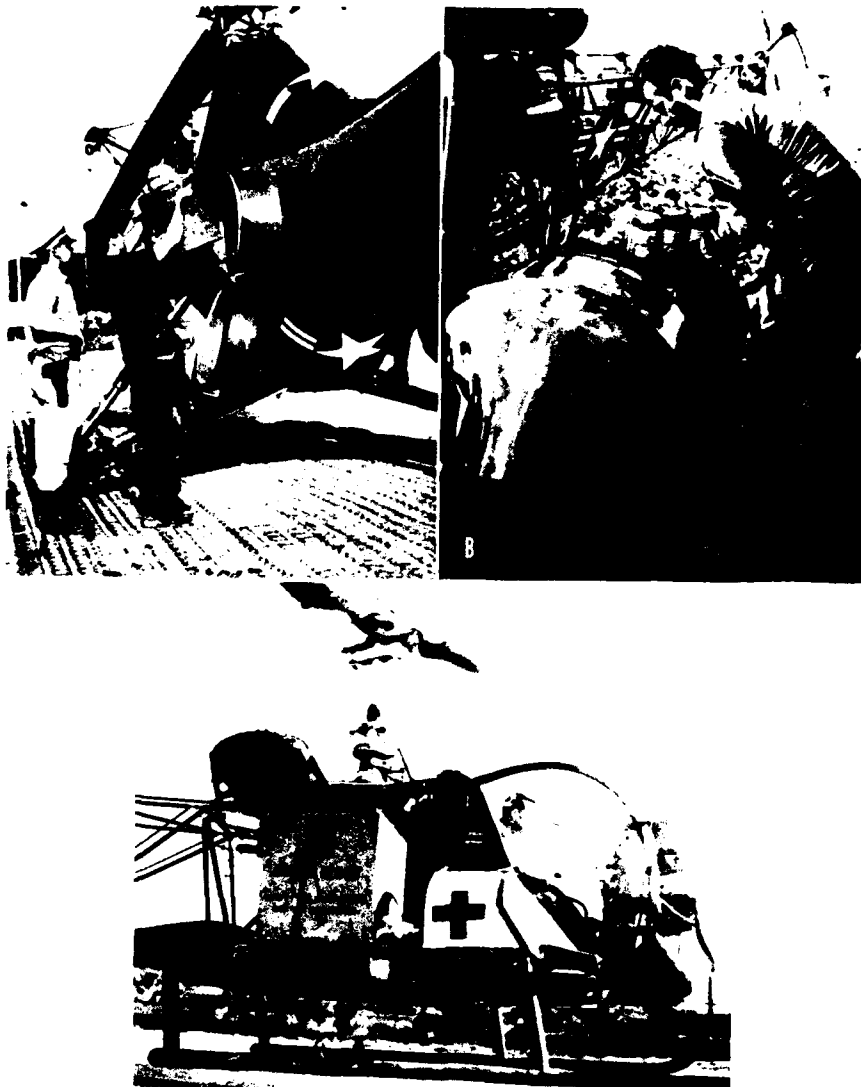

FIGURE 179. Transportation of blood by helicopter, in Korea. A. Blood being loaded for emergency shipment to frontlines. Note that ports of this model of helicopter admit only marmite cans. On return trip, a casualty will be brought back. B. Blood for emergency use in forward mobile army surgical hospital being placed aboard helicopter, Chunchon, Korea, December 1951. C. Helicopter, loaded with whole blood, ready for takeoff, June 1953.

Section IV. The Whole Blood Oversea Experience

ESTIMATE OF NEEDS

Experience in the European theater in World War II showed that an army in action, meeting stiff resistance would require about 500 pints of blood a day, the requirement varying with the type of fighting (p. 557). As would be expected, it was found that the faster an army moved, as in a breakthrough, the less blood would be required. During conventional fighting, in order to keep units supplied with their daily requirements, theater inventories of blood had to be maintained at two to three times normal daily requirements.

These rules of thumb proved quite acceptable for conventional military requirements in Korea (table 37). Estimates for total blood needs were predicated on estimated casualty rates. Requirements usually worked out at $1\frac{1}{2}$ to 2 pints for each hospitalized casualty.

Since delivery of blood from the Zone of Interior could not immediately reflect increased demands from Korea, the policy was to maintain a rather constant demand upon Zone of Interior sources and adjust collections of blood as necessary in Japan.

DISTRIBUTION

At the beginning of the oversea blood program, all blood received in Japan from the Zone of Interior was sent to Korea, while blood collected at the 406th Medical General Laboratory blood bank was used only at fixed hospitals in Japan. Within a short time this policy was changed and all blood was handled at the bank on an integrated basis.

When requisitions from Korea were received, the blood was flown to a distribution point in Korea (chart 14), where a distribution team received it from the courier who had accompanied it. Early in the war, when the fighting was highly fluid, two blood depots were maintained, both in the southern part of the peninsula. Later, as the front stabilized, several subdepots were established farther north. By the end of 1951, three depots were in close support of the front, and two supplied rear areas. Helicopters proved the most efficient way of distributing blood to forward units (fig. 179) as they could evacuate casualties on the return trip.

During 1952, reserve blood depots were maintained in Korea at Pusan and Seoul, and three advanced depots were maintained in Eighth U.S. Army areas. In addition, many hospitals stored reserves of blood to meet possible emergencies.

In Korea, although whole blood was considered a special item, it was handled in medical supply channels. The Supply Service deserves great credit for its cooperation and competence, but personnel intimately connected with the blood program could not accept this concept of handling whole blood. The operation of a blood bank system, including distribution,

TABLE 37.—Ratio of blood issued to wounded in action, 1951-52

Month	1951				1952						
	WIA ¹	Blood sent to Korea ²	Ratio WIA/blood	WIA			Blood sent to Eighth U.S. Army	Ratio WIA/blood			
				U.S. forces	U.N. forces	ROK forces		Total	U.S. forces	U.S.-U.N. forces	Total ³ forces
January.....	2,789	4,989	1.79	727	88	1,208	2,023	7,432	10.22	9.12	3.67
February.....	4,731	9,178	1.94	550	99	570	1,219	7,008	12.74	10.80	5.75
March.....	4,834	9,629	1.99	477	117	367	961	7,440	15.60	12.53	7.74
April.....	4,853	12,108	2.49	726	107	742	1,575	7,200	9.92	8.64	4.57
May.....	4,507	13,366	2.97	882	170	795	1,847	7,056	8.00	6.71	3.82
June.....	3,436	10,366	3.02	1,869	212	1,948	4,029	7,448	3.98	3.58	1.85
July.....	1,628	9,624	5.91	1,594	251	1,694	3,539	6,321	3.97	3.43	1.79
August.....	1,707	8,112	4.75	1,594	241	1,043	2,878	6,209	3.90	3.38	2.16
September.....	6,539	9,864	1.51	1,874	256	2,563	4,693	6,801	3.63	3.19	1.45
October.....	9,968	14,056	1.41	3,767	303	9,583	13,643	9,571	2.55	2.36	0.70
November.....	2,647	12,482	4.72	1,262	383	4,079	5,724	6,720	5.32	4.09	1.17
December.....	1,147	10,036	8.75	607	114	1,511	2,232	7,497	12.35	10.40	3.36
Total.....	48,786	123,810	2.54	15,929	2,341	26,103	44,363	86,703	5.45	4.75	1.95

¹ U.S. and U.N. forces, without ROK forces.

² In 500-cc. units.

³ U.S., U.N., ROK forces.

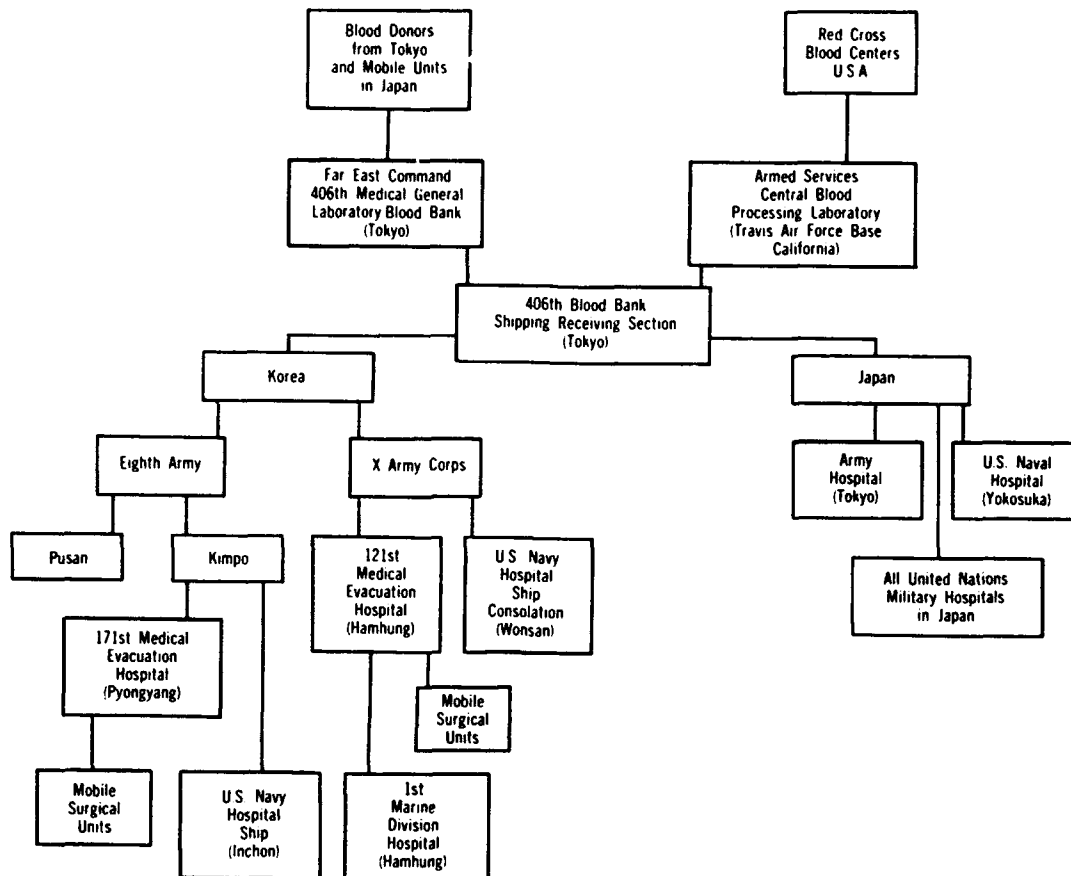
CHART 14.—*Organization for distribution of whole blood for Korea*

these personnel argued, is not a supply problem but a professional logistic project requiring the highest degree of coordination on the part of skilled professional personnel. In their opinion, later concurred in by the investigating officer who made a special survey of the blood program in Korea (p. 755), there should be in every theater a transfusion officer with the responsibility of supplying blood to the armies. By supply standards, the multiple supply points just listed were entirely reasonable. By standards of trained transfusion officers, this policy was inefficient and wasteful because it permitted blood to age in storage.

Aging

It was almost impossible to collect precise data concerning the age of blood received and used in Eighth U.S. Army installations in Korea after it had left the base depot. In 1951, it was estimated that when blood reached the Haneda Air Force Base in Japan from the Zone of Interior, it was 6 days old, which meant that it had an average usable remaining life of 15 days

(table 38). When the blood was received in Korea, the average remaining life was 9.4 usable days. Fragmentary reports from forward hospitals indicated that when it was used, it was from 9 to 20 days old.

TABLE 38.—*Remaining usable days of blood received from Zone of Interior and shipped to Korea, 1951*

Month	Receipts from Zone of Interior	Average number usable days	Shipments to Korea	Average number usable days
January.....	7,064	9.5	4,989	7.1
February.....	9,264	13.6	9,178	12.4
March.....	9,224	13.9	9,629	10.2
April.....	13,466	-----	12,108	10.0
May.....	15,032	12.3	13,366	10.3
June.....	10,528	13.5	10,368	9.3
July.....	10,392	13.5	9,624	7.1
August.....	10,974	12.0	8,112	8.2
September.....	11,496	13.5	9,960	9.5
October.....	14,424	12.6	14,046	9.2
November.....	10,632	13.8	11,676	9.9
December.....	8,639	10.1	9,138	9.3

Medical officers and trained blood bank workers realize the importance of issuing blood that is as fresh as possible, knowing that the older the blood, the faster will red cells break down after transfusion, the less effective is the transfusion, and the more blood must eventually be used. Since supply personnel did not realize this, their policy in Korea in respect to blood was, as with other supplies, to issue the oldest blood first, to get rid of it.

A number of studies by the fragility test were made daily for 10 days on blood that was 8 to 10 days outdated, in the hope that some safe extension of the expiration date could be determined. Although cell fragility was not notably increased over the testing period, no evidence was adduced to encourage the idea that overage blood should be used deliberately.

SURVEY OF WHOLE BLOOD EXPERIENCE, FAR EAST COMMAND

On 11 March 1953, Lt. Col. Arthur Steer, MC, submitted a report to the Chief Surgeon, U.S. Army Forces, Far East, on a 14-day survey made in October 1952 and dealing with the use and supply of whole blood in this command (21). During October, both U.S. and ROK (Republic of Korea) troops sustained higher casualties than at any other time in 1952. The survey was confined to the Eighth U.S. Army area.

Use factor.—Colonel Steer noted that the data he had collected were somewhat difficult to interpret because no policy had been established for the

issuance of blood to ROK units. ROK units were not supposed to be evacuated through Eighth U.S. Army installations, but a significant, though unknown, number, particularly in troops attached to U.S. units, had thus been evacuated and so had been transfused by U.S. Army standards.

During the period of the survey, approximately 20 percent of all U.S. and U.N. (United Nations) casualties, other than ROK wounded, were transfused, at an average rate of 4.4 bottles per casualty or 0.9 bottles per U.S. wounded who reached a medical treatment facility. On the basis of U.S. casualties only, 5.54 bottles were issued per each soldier wounded in action. If all casualties, including ROK casualties, are considered, 1.95 bottles were issued per each soldier wounded in action. The true issue factor thus lay somewhere between 1.95 and 5.54 bottles per U.S. and other U.N. casualties except ROK casualties.

Reserves.—All medical installations and depots surveyed were found to maintain reserves of blood which provided, in toto, an average stock on hand of 7.87 times the average daily amount used and 3.1 times the maximum ever used on any single day. In a sense, this blood was not wasted because aging blood was sent to ROK installations, which were given it at an average age of 16.1 days. The figures, however, "illustrate the compounding effect of reserve levels resulting from the maintenance of multiple depots." Furthermore, the existence of these multiple depots and the maintenance of reserve stocks inevitably resulted in the aging of blood on the shelves. This policy also made the control of reserve levels, as well as flexibility in the use of reserves, extremely difficult. When activity was increased in one portion of the line, for instance, increased needs should have been met by transferring blood to it from a hospital or depot supporting an inactive portion of the front. Instead, they were met by requisitioning more blood from rear areas, where it was supplied without question because there was no single medical officer in charge of the blood supply and with authority to question the requisitions.

Reactions.—During the survey period, there were only 19 reactions (2.5 percent) in the 757 identified patients who received blood. Most of the reactions were mild and of the urticarial type. One hospital, which gave transfusions to 57 patients, reported 11 of the 19 reactions.

Recommendations

Colonel Steer's most important recommendation was that a continuing study be made of the use of whole blood and blood substitutes in Korea, with particular reference to the establishment of a separate medical unit, commanded by a medical officer, whose sole responsibility would be the procurement, storage, and distribution of blood and blood substitutes. For two reasons, such a study should be made by a team sent from the Zone of Interior to the Far East Command by the Department of the Army: (1) Numerically, there were no personnel in the theater who could be detached for the purpose and (2) more important, there were no experienced blood bank operators in the

command. Colonel Steer also considered it important that the group which made the study should have had no previous experience with the control of blood in supply channels and thus would be entirely free from bias.

Another recommendation in Colonel Steer's March 1953 report was that general hospitals outside the Tokyo-Yokohama area in Japan establish small blood banks, subject to frequent supervisory inspections. In the event of emergency, these banks would be provided with blood from the Tokyo bank.

In a later communication to Colonel Kendrick on 15 December 1953, Colonel Steer again emphasized the need for a medical officer in a theater of combat, under the theater surgeon, able to travel in all zones, and to be totally responsible for this blood program (22). This would involve the setting up of minimum standards for local blood collection practices and for shipping and storage procedures, control of the flow and distribution of blood, establishment of minimum bank levels, advice to the surgeon on policies and publicity concerning blood, and constant inspection of all agencies involved in the handling or using of blood. When this recommendation was made, the armistice had been signed, and, within another 2 months, the oversea airlift would be discontinued.

STATISTICAL DATA

The distribution of blood by the Tokyo Blood Depot to hospitals in Japan and in Korea for 1951-52 is contained in table 39.

TABLE 39.—*Distribution of blood by Tokyo Blood Depot, 1951-52*

Month	Distribution, 1951—			Distribution, 1952—			
	To hospitals in Japan	To depots in Korea	Total	To hospitals in Japan	To Communications Zone, Korea	To Eighth U.S. Army, Korea	Total
January.....	2, 295	4, 989	7, 284	2, 026	3, 504	7, 432	12, 962
February.....	2, 546	9, 178	11, 724	1, 776	2, 221	7, 008	11, 005
March.....	2, 588	9, 629	12, 217	1, 380	3, 010	7, 440	11, 830
April.....	2, 132	12, 108	14, 240	1, 611	2, 319	7, 200	11, 130
May.....	2, 540	13, 366	15, 906	1, 029	3, 424	7, 056	11, 509
June.....	2, 466	10, 368	12, 834	1, 473	2, 292	7, 448	11, 213
July.....	2, 037	9, 624	11, 661	1, 420	1, 615	6, 321	9, 356
August.....	1, 664	8, 112	9, 776	1, 478	1, 312	6, 209	8, 999
September.....	2, 574	9, 864	12, 438	1, 591	1, 392	6, 801	9, 784
October.....	6, 150	14, 056	20, 206	2, 484	2, 568	9, 571	14, 623
November.....	2, 517	12, 482	14, 999	1, 951	2, 724	6, 720	11, 395
December.....	2, 299	10, 036	12, 335	1, 488	2, 712	7, 497	11, 697
Total.....	31, 808	123, 812	155, 620	19, 707	29, 093	86, 703	135, 503

Section V. Equipment and Refrigeration for Airlift

PLASTIC CONTAINERS

Development of Criteria

Plastic equipment came under discussion at the Symposium on Blood Preservation held under the auspices of the Committee on Blood and Blood Derivatives, NRC, on 2 December 1949 (23). Dr. Carl W. Walter, who had been working on its development for some time for the American Red Cross, laid down the criteria for it as follows:

1. Simple, one-piece equipment that would permit hermetic sealing during processing, storage, and transportation of the blood and that could be employed with a bacteriologically safe technique.
2. A slow rate of collection, causing minimal physiologic disturbance to the donor.
3. The elimination of air vents, both during collection (by venous pressure and gravity) and during administration.
4. Transparency.
5. Nonwettability.
6. Compressibility, to permit positive pressure infusion.
7. Stability to sterilizing temperatures (121° C. for 30 minutes).
8. Low vapor transmission.
9. Good tissue tolerance.

It was additionally specified, in view of the logistic difficulties which the use of blood presents in times of war and disaster, that plastic equipment recommended must be lightweight, nonbreakable, collapsible, and sized to accommodate the volume of liquid it was intended to contain. Also, it must be inexpensive enough to warrant discarding after a single using but, at the same time, it must be so designed that, in emergencies, it could be cleaned and reused without risk of pyrogenic reactions.

First Model

Dr. Walter's studies had been carried out with equipment fabricated from elastic thermoplastic vinylite resin that incorporated an ion-exchange column (p. 770) of sulfonated polystyrene copolymer. It was sealed by dielectrically induced heat and was sufficiently elastic to yield a hermetic seal if a single throw knot in it were stretched tightly and then released. It was tough and flexible and provoked minimal tissue reaction. The tubing for both donor and recipient sets was extruded with a lumen 3 mm. in diameter and a wall 0.5 mm. thick.

The bag was available in any desired capacity and could be so compartmentalized that a single donation of blood could be subdivided into multiple isolated amounts, each with its own delivery tube for use in multiple small transfusions.

The bag, together with the filled exchange column, fitted with a needle and cannula, was sterilized at 250° F. (121° C.) for 30 minutes. Compressed air was then admitted to the sterilizing chamber to maintain a pressure of 1.4 kg. per square centimeter until the bag had cooled to 194° F. (90° C.). The assembly was ready for use as soon as the pressure had vented.

The cost of the equipment described by Dr. Walter was then \$1.48 per unit, but, when the bags were in mass production, it was expected that the unit cost would be reduced to 45 to 50 cents.

Operation.—Blood was collected in this apparatus essentially as in regular collecting bottles. After the bag had been filled by gravity, the tourniquet was released and a spring clip was placed across the tube distal to the exchange column. Samples for testing were collected in pilot tubes before the needle was removed from the vein. The tube was sealed or knotted close to the bag, and the bag of blood, after being hermetically sealed, was refrigerated.

The transfusion could be given by suspending the bag from a gravity pole by the grommet provided, or the blood could be squeezed into the recipient's vein by placing the bag under his shoulder or buttock. If rapid transfusion was desired, the intra-arterial technique was used, or the operator could stand on the bag.

Comment.—The bag described by Dr. Walter had obvious advantages. Although it took slightly longer to collect the blood than when collecting bottles were used, the quality and yield of blood collected was equal, if not superior, to the quality and yield of blood collected in bottles. Moreover, blood collected in plastic bags practically never had to be discarded because of hemolysis. The bags did not require refrigeration before the blood was collected. A plastic bag containing 500 cc. of blood occupied in the refrigerator only half the space of a bottle holding the same amount. Finally, the insulated containers developed toward the end of the war for the transportation of blood held 48 bags instead of 24 bottles.

Testing and Adoption

By March 1950, the Walter apparatus was in commercial production, by the Fenwal Co., and comparable equipment had been developed by the Abbott Laboratories.

When the ad hoc committee on plastic bag collecting equipment reported on 8 October 1951, plastic equipment had received sufficiently extensive testing in various military and civilian hospitals to establish its desirability and efficiency (24). Further testing was planned for civilian hospitals and Red Cross blood donor centers, and field trials were planned for the Army under what was termed extreme conditions.

Figures 180 and 181 illustrate the final type of plastic equipment developed in the Korean War and demonstrate its use. These bags were never formally used in the blood program in Korea because of objections raised to them by

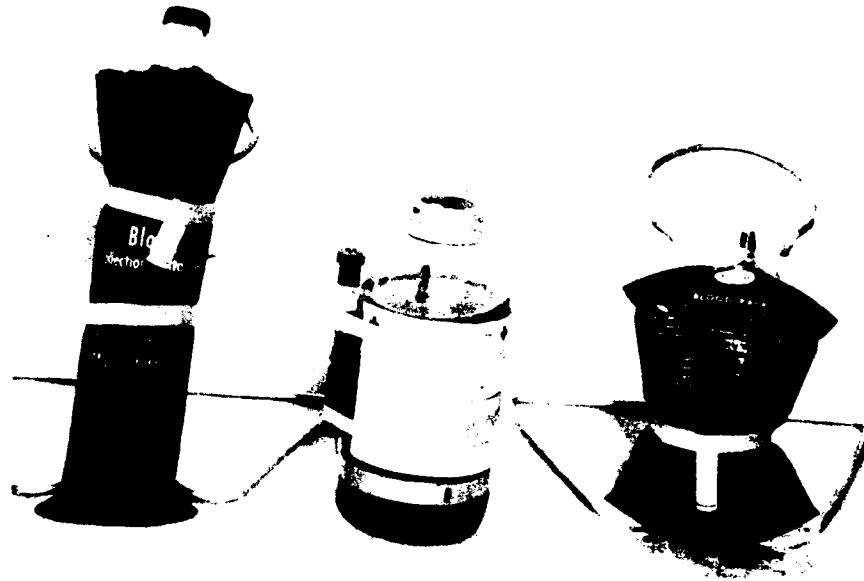

FIGURE 180.—Plastic equipment, standardized as replacement for glass bottles during Korean War. In center is collecting bottle formerly used.

the American Red Cross. They came into general use in military hospitals, though only after some indoctrination. Medical officers at first did not like the plastic equipment, particularly the resin column, and there was some resistance to the use of the bags, even when the blood was collected in ACD solution. At Walter Reed General Hospital, Washington, D.C., where a large-scale test was conducted, it was found worthwhile to have an experienced nurse indoctrinate all personnel in their use.

REFRIGERATED SHIPPING CONTAINERS

Up to the spring of 1951, blood was shipped from the Whole Blood Processing Laboratory at Travis Air Force Base in the Navy (fig. 139, p. 611) and the Army (fig. 182, p. 762) insulated containers developed for use in World War II. The Army boxes did not hold up too well (fig. 183), and when the supply was exhausted, other models were tested (19).

Bailey container.—The first shipping container procured from the Bailey Co. was designed on the principle of the Army box. It had an outside measurement of 8 cu. ft., held 24 pints of blood, and weighed 115 pounds when fully packed and iced.

The outer shell of the Bailey box was made of fiberboard or V-board, which was supposed to be water-resistant. The insulating mechanism moisture-vapor barrier, lid, and ice cans were similar to those used in the Army container.



FIGURE 181.—Demonstration of use of plastic equipment. A. Collection of blood, Fort Sam Houston, April 1952. B. Demonstration of transfusion by gravity by personnel of Walter Reed General Hospital in field tests, June 1952. C. Accelerating rate of blood flow during transfusion by placing bag, which is break-resistant, beneath patient's body.

Sufficient space was allotted for recipient sets, but, in the first model, the wire racks were so close together that the larger type of blood bottle did not fit between the separators.

When the box was closed, it was secured by wingnuts on each side, and handles of sashcord were attached on the same sides. This arrangement made it impossible for personnel to lift the container by the cord handles without scraping their hands on the nuts. As long as the first Bailey container was used, shipping and receiving personnel at the Travis laboratory could be identified by their bruised hands.



FIGURE 182.—Army insulated box, developed late in World War II and used in early airlift to Korea. Boxes are being moved into air-conditioned receiving and shipping room, Travis Air Force Base processing laboratory.

In spite of its defects, this container maintained the proper temperature for blood during its transportation to Japan, and about 2,000 were used. In the meantime, a new model was devised, with a number of improvements, including the attachment of the cord handles and the nuts on different sides. This model, 1,200 of which were delivered, had, like the first model, an outside measurement of 8 cu. ft., held 24 pints of blood, and, when packed, weighed 132 pounds.

The wire racks were so designed that the larger bottles could easily be inserted. This container was, like the first Bailey model, too bulky for one man to handle, and, like the first, it did not withstand adverse weather conditions.

Hollinger container. Containers made by the Hollinger Corp. were put into use in October 1951, after the supply of Bailey containers was exhausted. This container (fig. 184) was built like a trunk. Its outside measurement was 6.4 cu. ft. and it weighed 115 pounds when fully packed. The exterior shell was of plywood covered with laminated fiber to make it waterproof. Insulation was provided by 2-inch slabs of Styrofoam, which were snugly fitted and attached to the inside of the plywood shell by cement. Each of the two wire racks held twelve 500-cc. bottles of blood, and the tin container in the center held about 20 pounds of wet ice. Between the insulation and the wire racks was a moisture-vapor barrier of corrugated paper.

The insulated lid of the Hollinger container was attached by hinges, and the box could be closed and latched like a trunk or footlocker. A strip of rubber around the rim of the box increased its insulating properties. Metal handles



FIGURE 183. Whole blood shipments arriving in Korea in insulated cardboard Army box originally used for airlift. Note that boxes are beginning to show signs of deterioration after transportation and exposure. A. Arrival of blood at 6th Medical Depot, Taegu. B. Arrival of blood at 4th Field Hospital, Taegu.

attached to the sides facilitated handling. Although it could not be handled by one man, this box was easier to move than the containers previously used.

The original Hollinger model was very sturdy, withstood rough handling and bad weather conditions, and maintained the correct temperature en route. Approximately 600 were employed, and each made an average of 10 to 12 round trips from the Travis laboratory to Japan.

While the original Hollinger container was still in use, another container was obtained from this manufacturer. It was also a trunk type, but larger (8.1 cu. ft.), heavier (133 pounds), and better insulated than the first model. The insulating layer, which consisted of 3 inches of Styrofoam instead of the 2 inches used in the smaller container, was supplemented by an aluminum moisture-vapor barrier instead of the corrugated paper barrier used in the original model. The strip of rubber around the rim of the box was wider.

The improvement in insulation, which amounted to less than 0.5° F. over 36 to 40 hours, was not considered enough to compensate for the increased size and weight of this second model. Nonetheless, about 900 were used, each making an average of four round trips from the Travis laboratory to Japan.

Evaluation

Of all the insulated shipping containers used at the Travis processing laboratory, the Navy plywood container and the 6.4-cu. ft. Hollinger trunk-type container were considered the most practical, though the Navy container

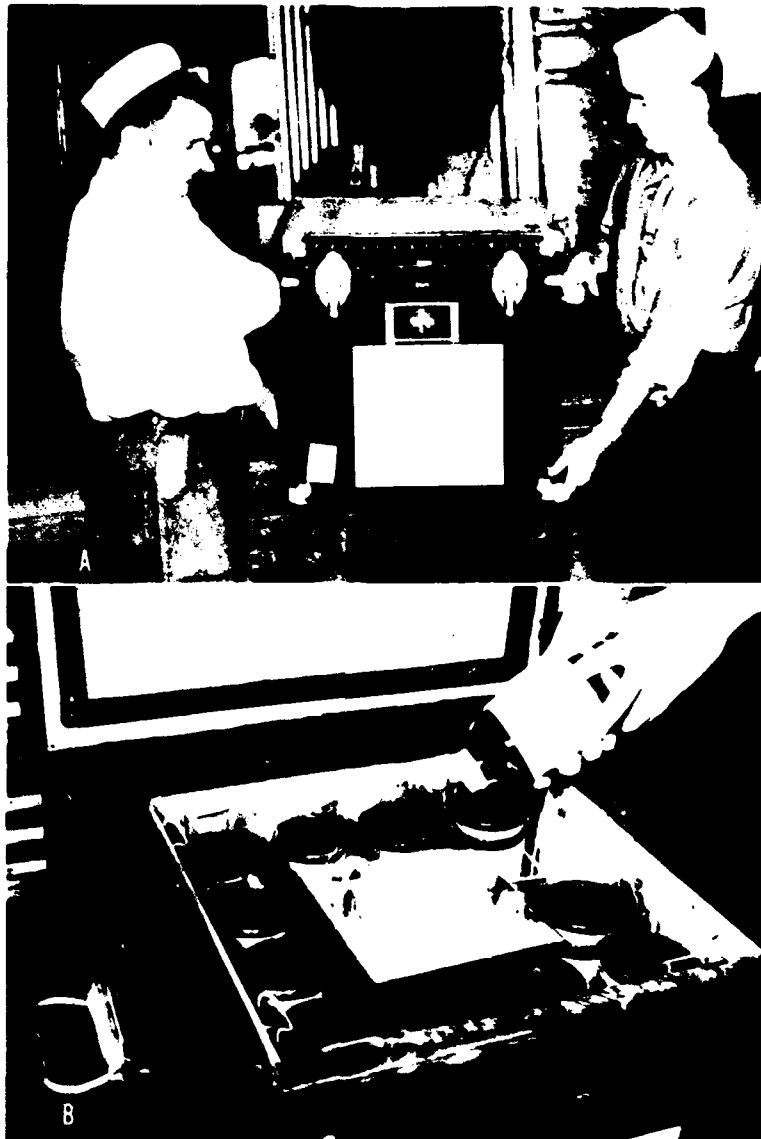

FIGURE 181. Trunk type of insulated container developed for Army by Hollinger Corp. during Korean War. A. Closed. B. Open, loaded with ice and blood and ready for shipment. Note that bottles are upside-down, so that blood cells will settle in the top.

could be used for only two or three round trips against the 12 or more trips the Hollinger container could make.

Fiberboard or V-board containers did not prove practical for field use. They did not lend themselves to long-distance shipping, rough handling, and adverse weather conditions, and they were good for only a single trip. They made difficulties in FECOM, and personnel were understandably reluctant to ship blood to forward areas in them because they sometimes fell apart. The



FIGURE 185.—Refrigerated container, developed at Fort Totten after Korean War and still in use (1962). Note ice in plastic container in cover.

blood distribution center of the 406th Medical General Laboratory in Tokyo had the Navy plywood container (16-pint capacity) duplicated; most of the whole blood shipped from Japan to Korea during the last 2 years of the war went in these boxes.

In all, about 15,000 containers were shipped from Travis Air Force Base to Japan during the course of the war. Of the reusable Hollinger trunk type, 1,500 were the only ones used between October 1951 and February 1954. Though some of them made as many as 12 round trips, they were still in good condition when the program was terminated.

One disadvantage of the Hollinger containers was that they had no space for recipient sets. During the time they were in use, therefore, the sets had to be packed in separate crates, which were shipped with the containers. In all, over 350,000 recipient sets were shipped to the Far East.

The price of insulated shipping containers ranged from \$25–\$30 for the Navy plywood type to \$40–\$50 for the Hollinger container.

Shortly after the war in Korea ended, another refrigerated container, which is still in use (1962), was developed at Fort Totten. This box (fig. 185) has



FIGURE 186. Refrigerator units for storage of blood at medical depot, Chunchon, Korea, December 1951.

space for 24 bottles of blood, weighs only 20 pounds loaded, and costs only \$4.80. The ice is in the plastic bag in the cover, and the arrangement provides better insulation: In the refrigerated container originally developed at Fort Totten, as the ice in the center melted, the tops of the bottles of blood were left unrefrigerated.

REFRIGERATION FACILITIES IN THE FAR EAST

Refrigeration facilities in Japan and Korea (figs. 186, 187, and 188) were generally satisfactory.

Section VI. Techniques of Preservation

PRESERVATIVE SOLUTIONS

Whole blood. The first blood sent to the Far East from the Zone of Interior during the Korean War was collected in the ACD formula used during World War II, 25 cc. of which was used for each 100 cc. of blood (p. 227). At the 23 September 1950 meeting of the Committee on Blood and Blood Derivatives (25), on the advice of Dr. William G. Workman, Chief, Laboratory of Biologies Control, National Institutes of Health, the amount of solution used was left unchanged but the formula was altered to 2.45 gm. of dextrose; 137 gm. of U.S.P. sodium citrate, and 5 gm. of U.S.P. citric acid per 100 cc.

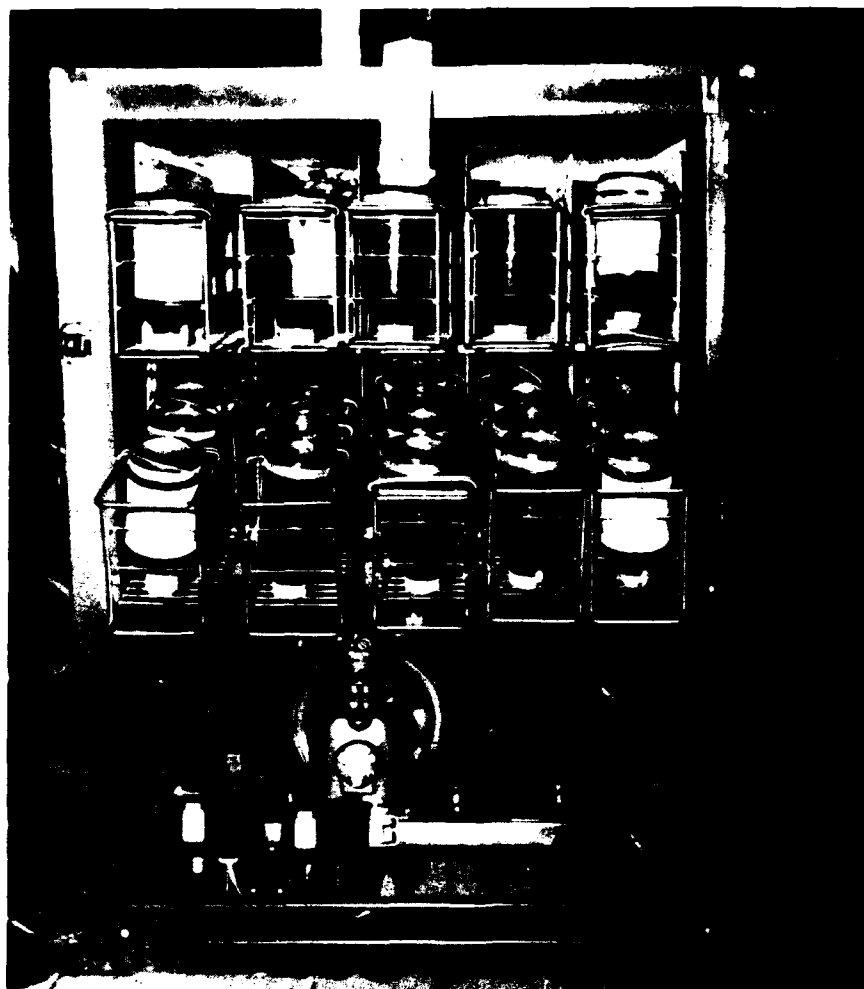

FIGURE 187.-Refrigeration facilities for blood at Eighth U.S. Army Medical Depot, Yonhdung-Po, Korea, June 1953.

of solution. The recommended change was accepted because it was expected that temperature controls would be less precise during the airlift of the blood than during its storage.

Plasma. Blood intended for plasma was usually collected in a 4-percent trisodium citrate solution during the Korean War. When it was collected in ACD solution, the plasma was difficult to dry, and the quality of the product varied from lot to lot.

The question of using a single solution for the collection of blood, no matter for what purpose it was intended, came up a number of times in the Committee on Blood and Blood Derivatives. On 26 August 1952, the Blood Group, Department of Defense, in cooperation with the National Research Council, American Red Cross, and National Institutes of Health, agreed to enter upon a formal investigation of the use of ACD solution in the prepara-

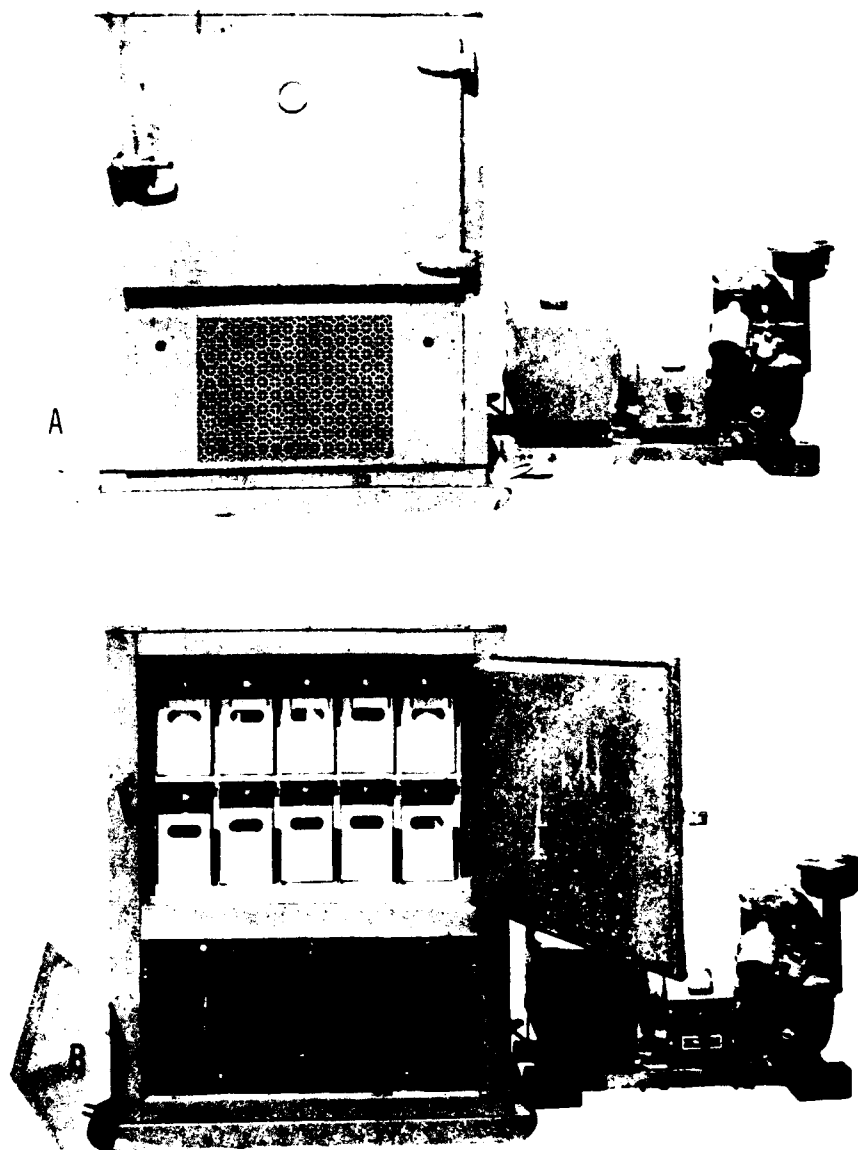

FIGURE 188.—Refrigerator, used in field hospitals in Korea. The prototype of this box was available in World War II but was never put into production. A. Closed. B. Open, showing storage arrangement and mechanism.

tion of plasma. By the plan adopted, 240 units of blood collected in the NIH ACD formula would be shipped to each of two processing laboratories, and samples of the dried plasma produced would be sent to NIH for routine testing. The National Research Council would conduct the clinical investigations.

The investigation, which was not finished during the war, gave only inconclusive results.

RED BLOOD CELL PRESERVATION

It was the consensus of the Committee on Blood and Blood Derivatives that the crux of the problem of blood preservation was the vitality of red blood cells. On 2 December 1949, Dr. Cohn, reporting to the Committee for the Formed Elements Group, stated that all the evidence indicated that intact erythrocytes were necessary if blood was to fulfill its respiratory function (23). He thought it possible that optimum preservation might be achieved only after separation of the red blood cells from all destructive enzymes for which each element served as a substrate.

As time passed, the Committee on Blood and Blood Derivatives, NRC, became more and more convinced that no very great advances could be expected in red blood cell preservation until more basic knowledge concerning these cells was available. The committee (now known as the Committee on Blood and Related Problems) therefore sponsored two symposia on the subject. The first, a Conference on the Differential Agglutination of Erythrocytes, was held on 17 September 1952 (26), and the second, a Symposium on the Structure and Cellular Dynamics of the Red Blood Cell, was held on 11-12 June 1953 (27).

In spite of all the work done on red blood cell preservation before and during the Korean War, the statement made at the 4 March 1953 meeting of the Committee on Blood and Related Problems (28) remained true until the end of the war, that the last great advance in blood preservation was the addition of glucose to the preserving medium (p. 217). This addition marked the first time that the energy of red blood cells had been taken into consideration in attempts to preserve them. On the other hand, while the addition of glucose was an improvement, it did not prevent cellular energy from deteriorating during storage.

Space does not permit the account of several related conferences held during the Korean War under the auspices of various committees and subcommittees of the Division of Medical Sciences, National Research Council. They included, among others, several conferences on blood coagulation and a conference on fibrinolysis.

EXCHANGE RESINS

At the Symposium on Blood Preservation held on 2 December 1949 (23), Dr. John G. Gibson II, Harvard University Medical School, and Dr. Edward

S. Buckley, Jr., Peter Bent Brigham Hospital, reported their work on exchange resins in the preservation of blood as follows:

Reduction of the calcium content of the blood below the critical level will prevent blood clotting by preventing the formation of thrombin by prothrombin, a reaction for which calcium is apparently essential. When citrate is added to blood, a soluble calcium-citrate complex results which does not dissociate sufficiently to provide enough calcium for the reaction just described to occur. Presumably, other divalent ions are also "complexed" by the citrate ion. The same principle is involved in the use of an ion-exchange resin except that the calcium-resin complex is insoluble, as are also the other ion complexes formed. The degree of reduction in effective concentration may therefore be quantitated.

Collecting blood directly into a flask containing the resin did not prove feasible. Best results were obtained when the blood was allowed to flow through a column of resin into the collecting vessel.

Blood collected by this technique did not clot. It showed no significant changes in pH, freezing point, or sodium concentration. The calcium concentration was reduced to less than 1 percent and the potassium to about 1 milliequivalent per liter. Zinc was not removed from either cellular or plasma components. Two *in vivo* canine experiments showed a posttransfusion red blood cell survival of approximately 90 percent.

At the conclusion of this report, Dr. Cohn commented that the most remarkable recent advance in the preservation of blood was the introduction of an ion-exchange resin, which apparently removed not only the calcium involved in coagulation of the blood but also some of the metals utilized in enzyme activity. The collection of blood over an exchange resin into a vessel without a wetting surface, which did not contain an anticoagulant, would, however, make necessary the determination of a new baseline regarding the optimal environment for its formed elements. Except for a few small-scale experiments, blood had never been studied in the absence of citrate concentrations, which were usually quite high.

Among other reports at this same symposium was one by Dr. Charles P. Emerson, Jr., Boston University School of Medicine, which showed that the immediate decalcification of fresh blood by passing it through a resin column had no immediate discernible effect on the osmotic fragility of red blood cells. When, however, the blood thus collected was stored, there was, as in blood stored in ACD solution, a progressive increase in their fragility. Moreover, the magnitude of the changes observed was considerably greater, particularly after the 10th day, than in ACD solution. Resin-collected blood stored less than 10 days without removal of plasma but with the addition of a saline-dextrose diluent seemed comparable in stability to ACD-collected blood stored without modification for a similar length of time. Resin-collected blood stored without further modification was essentially nonviable when transfused on the 20th day; 80 percent was eliminated from the recipient's circulating

blood within 10 minutes and the remainder within 48 hours. The period of survival was essentially the same whether the pH was 7.2 or 6.8.

It was considered possibly significant that poor survival of stored citrate-free, calcium-free blood was invariably associated with the finding of a dextrose concentration below 100 mg. percent.

At a meeting of the Panel on Preservation of Whole Blood and Red Cells on 28 March 1951 (29), it was agreed that none of the studies carried out with ion-exchange resins or anything else had produced sufficient effects on red blood cell survival to warrant changes in the preservative solution in use. It was urged that testing techniques used in the various laboratories be standardized, to facilitate comparison of results and thus aid in the evaluation of the solutions used. Particular emphasis was placed upon the temperature of collection and storage of the blood and upon the rapidity of cooling.

FREEZING

The preservation of whole blood at subzero temperatures, although it had been discussed before the Korean War, was not seriously considered during it.

At the 2 December 1949 Symposium on Blood Preservation (23), Dr. Max M. Strumia reported on the extensive experiments he had conducted with this technique. From them, he concluded that optimal preservation of whole blood for up to 2 months could be accomplished if it were stored at 26.6° F. (-3° C.). The temperature range, however, was relatively narrow. With a variation of more than 1.5° C., even though the physical status of the blood remained unchanged (that is, whether it were liquid or solid), the status of the red blood cells showed considerable deterioration. In all of his experiments, therefore, Dr. Strumia used the temperature of -3° C. as optimal and kept variations within plus or minus 0.2° C. If preliminary shrinkage of the red blood cells, which he considered essential, was carried out by the correct technique before the blood was frozen, the period of preservation was materially lengthened. Cells thus shrunken returned to normal size when they were immersed in plasma but not when they were immersed in physiologic salt or other isotonic solutions. When the cells were used for transfusion, they resumed their normal shape and size within an hour of the transfusion.

The concentration of glucose in the preserving fluid when the cells were frozen at -3° C. was found to be critical. If the level was below 40 mg. percent, preservation was bad. If it was greater, it was fair. If the level was below 20 mg. percent, preservation was "terrible."

At this same meeting, Dr. Walter stated that he had been able to reproduce Dr. Strumia's work; that his laboratory had repeated the work on vitrification done 10 years earlier, with the same results; namely, that approximately 50 percent of morphologically intact erythrocytes were present after thawing. He thought that the problem was one of thawing and that it might be a blind alley.

Part III. The Plasma Program

PLASMA SUPPLIES BETWEEN THE WARS

The details of the disposition of surplus plasma at the end of World War II are related elsewhere (p. 310). In substance, all the surplus, exclusive of certain amounts retained for Army use, was transferred to the American Red Cross, for use by the public which had provided it originally. The stocks transferred amounted to 960,183 250-cc. packages and 1,386,726 500-cc. packages. When the Korean War broke out, a large part of this plasma had been utilized by hospitals, clinics, private physicians, and research workers. What was left had become outdated and required reprocessing, which had been accomplished in only a small number of units.

At the end of World War II, the production facilities for plasma, which had been established by the Federal Government through the Defense Plants' Corp., were dismantled. Equipment was declared surplus. A small portion was purchased by individual laboratories, and the remainder was disposed of by public sale.

STOCKPILES AND FUTURE REQUIREMENTS

Current Stockpiles

Army and Navy inventories as of September and November, 1949, respectively, were as follows:

1. No blood was on hand except for day-by-day requirements.
2. The Army had on hand 16,695 250-cc. packages of plasma and 92,865 500-cc. packages.
3. The Navy had on hand 722,171 500-cc. packages of plasma.
4. The Army had on hand 17,869 standard packages, and 2,679 salt-poor packages, of albumin.
5. The Navy had on hand 242,194 standard packages, and 5,967 salt-poor packages, of albumin.

An Army contract with Cutter Laboratories to reprocess 40,000 packages of outdated dried plasma had gone unexpectedly well. The percentage of loss, which was only 0.3 percent, was chiefly caused by subjecting the material to intense heat and by failure of proteins to go into solution when the plasma was reconstituted. The cost of reprocessing was about a third of the cost of processing fresh plasma obtained from voluntary donors. The National Institutes of Health was willing to approve reprocessed plasma for 5 years. The manufacturers thought a longer dating period was justified.

Stocks of plasma, albumin and gamma globulin on hand were considered temporarily adequate for peacetime requirements. Most of the plasma, however, would become outdated during 1950, and none of it had been irradiated

against the hepatitis virus (p. 778). Also, some plasma would not be satisfactory for reprocessing because of its fat content and because of original inadequate drying. A considerable amount of albumin and other fractions could probably be recovered from the plasma unsuitable for reprocessing, but the remaining stocks might not meet even peacetime needs, and replacements must be procured from agencies participating in the national blood program.

Although there was no substitute for whole blood, as the Task Group emphasized, it could not be stockpiled, and blood derivatives and plasma-expanders must be stockpiled for emergencies. Research must be pressed for better agents for replacement therapy than were presently available.

Wartime Estimates

The March 1950 report of the Task Group (4) estimated that in the event of war, requirements for the Zone of Interior from M-day to M+12 (months) would be 290,000 units of blood and 510,000 500-cc. units of plasma. Oversea estimates were based on two units of blood and two units of plasma for each thousand troops exposed to combat, with 10 percent added for losses due to breakage and outdating. Allowances were also made for shipping losses in the first month, and for the needs of U.S. civilian casualties in the combat zone.

The Task Group estimated that for wartime, at least 120,000 units of blood would be required for shipment overseas during the first year of combat, with increasing amounts thereafter. Transportation of blood in wartime would require the highest priority. The capabilities of various types of aircraft for this purpose were estimated.

The Task Group also recommended:

1. That at least a million 500-cc. packages of plasma should be stockpiled by 1 June 1951, with additional increments procured in yearly installments over the next 4 years. Provision should also be made for rotation of stock by withdrawals to meet current military and civilian needs.

2. That equipment should be stockpiled for the collection and administration of blood and should be replaced by rotation. It was thought that there should be no difficulty in meeting this requirement if manufacturers were provided with the proper priorities.

PROCUREMENT OF PLASMA

Initial Planning

Since at this time there was neither a civilian nor a military blood program in existence of sufficient scope to meet the needs of national defense, the Task Group recommended that, as a first step in procurement of the desired amount of plasma, existing stores of plasma and blood derivatives be reprocessed as they became outdated while additional plasma was being procured to bring the war reserve for the Armed Forces up to the desired level. Along with the re-

sponsibility of whole blood procurement for Korea, the American Red Cross accepted the responsibility of coordinating the collection of blood for plasma.

In August 1950, after a complete survey of commercial laboratories by the Industrial Mobilization Board, DOD, a tentative production schedule was established to meet the target of a million units of plasma by June 1951, a target that had become both more urgent and more difficult because of the outbreak of the war in Korea on 25 June 1950.

Government-owned plasma-processing facilities were set up at once at Sharp & Dohme, the Upjohn Co., and Eli Lilly and Co. Later contracts were made with Hyland Laboratories; Courtland Laboratories; Cutter Laboratories; Armour Laboratories; and E. R. Squibb and Sons. These firms, which were variously located on the west and east coasts and in the midportion of the country, were selected on the principle of locating commercial processing laboratories as near to donor collecting centers as possible, since plasma and red cells must be separated from each other within 24 to 30 hours after the blood is collected.

In October 1950, before planning had proceeded very far, it became necessary to rephrase the stockpiling program because of unexpectedly heavy demands for blood from the Far East Command, as well as because of processing delays. The original goal of a million units by June 1951 was halved, but even this objective could not be met, and, by the end of the fiscal year, only 87,279 units of plasma had been delivered. At this time, seven of the eight plants listed were in operation. Their joint monthly capacity was 58,600 units, and their final capacity as of April 1952 was set at 148,000 units per month.

Procurement Difficulties

For the first 6 months of the new plasma operation, the largest available drying capacity was in the three laboratories on the west coast. By February 1951, the east coast laboratories had a capacity of 10,000 packages per month, but it was not until August 1951 that the laboratories in the middle of the country had completed the installation of their drying equipment. On the east coast, the opening of bleeding centers had been set far ahead of scheduled production, while on the west coast, the reverse was true. As a result, blood had to be shipped to the west coast production laboratories from the east coast bleeding centers. Shipping of blood in ACD solution long distances by air was not desirable technically or economically when the blood was to be used for plasma, and some of it froze during the bitter winter weather, but this plan had to be employed as a matter of expediency.

In January 1951, representatives of the Department of Defense and the American Red Cross were assigned to the processing laboratories to iron out difficulties as they arose and to take corrective action at once. Production at one laboratory, for instance, was held up until administrative and personnel problems were corrected by the appointment of a new laboratory director.

Another laboratory was inoperative for 2 weeks because of trouble with its shell-freezing technique.

Early in January 1952, the Department of Defense learned that the Bureau of the Budget had allocated the funds for its 1953 plasma reserve to Federal Civil Defense, for inclusion in its estimates for stockpiling (2). The situation was considered at a meeting on 18 January 1952, in the Office of the Directorate, Armed Services Medical Procurement Agency, which was attended by both military and civilian personnel. It was agreed that the Blood Donor Program must continue to operate at its present level (300,000 bleedings per month) and that plasma processing facilities be used without interruption. Two general plans were considered:

1. That a single stockpile of plasma be set up for national defense, with both the Armed Services and Federal Civil Defense drawing from it.

2. That Federal Civil Defense take over all control of the Blood Donor Program when existing contracts held by the Armed Services ran out.

Neither of these plans was desirable, but the second was considered the more undesirable of the two: It would require revision of the current program; initiation of new contracts with the American Red Cross and the plasma processing laboratories; hiring of additional personnel; and training them in procurement, testing, inspection, and other procedures. It would also require deemphasizing the program for blood for Korea, which had been generally successful, and stressing the requirements for stockpiling for national defense, with little assurance that the new program would be completely successful or have the same general appeal.

While these plans were being debated, a new factor entered the picture, which could not be ignored by the Department of Defense. This was the "alarming" percentage of hepatitis in persons who had received plasma infusions, especially when the plasma had been prepared from large pools (p. 674). The reprocessing of World War II stocks of plasma had run into this problem, and the Department of Defense wanted no reserves of that kind.

At meetings of the Armed Forces Medical Policy Council on 17 March and 28 April 1952 (2), it was agreed that, after some satisfactory method of sterilization against the virus of hepatitis had been found, the plasma program would be divided into two phases. In the first, priority would be given to military and pipeline requirements for plasma. In the second, stockpile reserves would be accumulated. The Department of Defense wished to continue its priority until such time as the first increment of its reserves had been built up with plasma free from infection, after which stocks would be divided equally between civilian and military agencies. At a joint meeting on 16 May 1952 of the Armed Forces Medical Policy Council and the (Cummings) Subcommittee on Blood, Health Resources Advisory Board, the subcommittee agreed to accept the dual stockpile plan but not the proposal that the Department of Defense build up an increment of infection-free plasma before Federal Civil Defense secured any plasma at all. The Department of Defense, on the

other hand, was entirely unwilling to use currently available plasma, from which a comparatively large proportion of recipients might be expected to develop infectious hepatitis. The Armed Forces could not tolerate long periods of incapacity among its personnel, their corresponding delay in return to duty, and a reduction in the effective military strength of the country. All of these losses could be better tolerated by civilian personnel than by combat troops.

When the disagreement continued, with the Secretary of Defense supporting the position of his Policy Council, it was agreed, on 2 June 1952, that the decision would have to be made by the President. The allocation of plasma reserves was still undecided by the end of the year, but had become largely academic, since no satisfactory method of sterilization of plasma had been devised. A lack of funds also made it impossible to meet the desired goals.

By the end of fiscal year 1952, the Federal Civil Defense Administration had contracted for 750,000 units of plasma, none of which had been delivered. In addition, it had not received any of the 300,000 units of dextran and the 1.2 million units of polyvinylpyrrolidone that had also been ordered.

SERUM HEPATITIS

The potential problem of serum hepatitis, as mentioned elsewhere (p. 776), began to be appreciated only shortly before World War II ended. With the end of the war, the massive use of plasma ceased, and, in the absence of a central reporting agency, such cases of serum hepatitis as occurred after plasma infusion did not have the impact which they would have had in time of war and which they were to have when the outbreak of the war in Korea required a resumption of en masse plasma infusions.

Shortly before World War II ended, Dr. John W. Oliphant and his associates at the National Institute of Health (30, 31) began their work on the ultraviolet sterilization of plasma as part of its processing (fig. 189). The first results were most encouraging, a particularly desirable feature of the method being that the plasma proteins were apparently unaffected by the amount of ultraviolet energy used. Unfortunately, the belief that the problem had been solved was to prove fallacious.

There was scarcely a meeting of the Committee on Blood and Blood Derivatives (the reconstituted Subcommittee on Blood Substitutes), NRC, at which serum hepatitis and attempts at sterilization of infected plasma did not come up for discussion. Space does not permit an extended account of these matters, and the reader is referred to an excellent summary by Dr. Roderick Murray, Laboratory of Biologics Control, National Institutes of Health, who took over the work on Dr. Oliphant's death. The report, which contains a comprehensive list of references, was presented at a Conference on Derivatives of Plasma Fractionation, on 28 October 1953 (32).



FIGURE 189. Technique of plasma production during Korean War. A. Insertion of bottles of blood into large centrifuge to separate plasma from red blood cells. B. Pooling of plasma from bleeding bottles after centrifugation. C. Transfer of plasma from pool into individual dispensing bottles. D. Shell freezing of plasma in large bottles. E. Storage of shell-frozen plasma. F. Ultraviolet light sterilization of plasma. This additional step was introduced into the processing of plasma when serum hepatitis became a serious threat.

Special Studies

The experience of the Armed Forces in Korea showed that, while 0.5 percent of recipients of whole blood developed hepatitis, 12 percent or more developed it after infusions of pooled plasma. In 1951, it was therefore decided to use human volunteers for testing the infectivity of plasma and plasma derivatives and evaluating the efficacy of various methods proposed for its sterilization (table 40).

TABLE 40.—Results of inoculation of volunteers with serum from six suspected donors

Volunteers inoculated	Interval since incriminated donation	Hepatitis cases—			Incubation period for—	
		With jaundice	Without jaundice	Total	Volunteers ¹	Original recipient
<i>Number</i>	<i>Days</i>	<i>Number</i>	<i>Number</i>	<i>Number</i>	<i>Days</i>	<i>Days</i>
10.....	203	0	0	0		65
10.....	385	4	² 2	6	(18), 30, 45, 46, (46), 56	48
5.....		0	1	1	(43)	
10.....	356	1	² 0	1	48	40
10.....	149	1	² 0	1	84	70
10.....	135	4	0	4	35, 50, 56, 72	
5.....		5		5	43, 49, 56, 57, 63	44
10.....	43	2	³ 1	3	(50), 57, 67	32

¹ Incubation periods in parentheses refer to cases of hepatitis without jaundice.

² One additional subject presented equivocal or abnormal tests suggestive of hepatitis without jaundice.

³ Three additional subjects presented equivocal or abnormal tests suggestive of hepatitis without jaundice.

By the time these studies were undertaken, numerous disquieting reports had been received indicating that hepatitis was occurring after the use of irradiated plasma, which presumably had been rendered safe. One such report (33) showed an incidence of 11.9 percent in patients who had been followed for at least 6 months and most of whom had received more than one unit of plasma.

Sterilization Techniques

Ultraviolet irradiation.—Irradiation of plasma with ultraviolet light was usually carried out by exposing a thin film of plasma to radiation from a high intensity source (32). Various types of equipment were used. In some, the plasma was passed through a narrow-bore, usually flat, quartz tube resembling a hollow ribbon. In others, the film was formed on the inside wall of a hollow cylinder or cone which rotated at high speed and in the cavity of which the ultraviolet lamps were located. In some of these lamps, quartz envelopes transmitted most of the ultraviolet light. In others, Vycor envelopes transmitted radiation only in the 2735 Å. band or higher. Apparatus of the latter type was most widely used in the plasma-processing laboratories because of

its ability to handle relatively large amounts of plasma, by the formation of films on the inner surfaces of cylinders or cones.

The NIH studies on the effect of ultraviolet light on plasma were carried out with three different machines of the type just described (table 41). An attempt was made to simulate actual processing conditions. Special attention was paid to the measurement of the ultraviolet output of the lamp used, to continuous monitoring of each irradiation run, and to accurate measurement of the rate of flow of plasma through the apparatus. Each run was also checked by the *Aerobacter aerogenes* test.

The results of this study eliminated the hope originally raised that failure of sterilization might be due to some defect in the apparatus or to inadequate exposure to ultraviolet irradiation. As this experience (table 41) showed, the margin of safety between the sterilizing dose and the dose producing unacceptable denaturation of plasma was not sufficiently great to justify placing much reliance on this technique. Moreover, considerable changes in plasma proteins were apparent after sterilizing dosages that might actually produce inadequate exposure.

TABLE 41.—Results of ultraviolet irradiation of infected pooled plasma

Apparatus and conditions of irradiation	Volunteers	Volume of dose	Hepatitis cases—			Additional subjects with suggestive laboratory findings
			With jaundice	Without jaundice	Total	
	Number	ml.	Number	Number	Number	Number
Dill apparatus:						
515 ml./min.....	10	1.0	3	1	4	0
249 ml./min.....	10	2.0	2	1	3	1
73 ml./min.....	10	4.0	6	3	9	0
Control.....	10	1.0	4	2	6	1
Habel-Sockrider apparatus:						
1 passage.....	10	1.0	4	1	5	1
5 passages.....	10	2.0	0	0	0	0
10 passages.....	10	4.0	0	0	0	0
Control.....	10	1.0	6	0	6	1
Oppenheimer-Levinson apparatus:						
10" bowl, standard lamp.....	8	1.0	3	1	4	0
15" bowl, high-powered lamp.....	8	1.0	2	1	3	0
Control.....	5	1.0	2	0	2	0

Controlled heating.—Samples of infected pooled plasma were subjected to controlled heating by complete immersion in constantly agitated water at 59.2° and 60.4° C. for 2 hours and 4 hours, respectively. Two bottles were tested for each time period, and a fifth bottle was kept at room temperature during the heating process. All bottles were then immediately shell frozen

by means of Dry Ice and alcohol and stored at -20°C . until they were administered to volunteers. Some of the Dry Ice in which the material was transported to the using hospitals was still present when the flasks were opened for the inoculations.

Two groups of 10 volunteers each, who had been carefully screened by liver function tests, were inoculated with the heated material, and 5 others were inoculated with the control plasma. Cases of hepatitis developed in each group (table 42).

Storage at room temperature.—Room storage temperature, which had been developed by Dr. J. Garrott Allen and his associates at the University of Chicago with extremely promising results (32, 34), was evaluated in three groups of volunteers. There were three instances of hepatitis in a group of five subjects inoculated with plasma stored at an almost constant temperature of 70°F . for 3 months against only one instance in 20 subjects inoculated with plasma stored at a similar temperature but for 6 months. The single case of hepatitis in these patients occurred at the end of 196 days, the longest incubation period on record, and was mild.

TABLE 42.—Results of heating infected pooled plasma at 60°C .

Duration of heating	Volunteers	Hepatitis cases—			Incubation period
		With jaundice	Without jaundice	Total	
<i>Hours</i>	<i>Number</i>	<i>Number</i>	<i>Number</i>	<i>Number</i>	<i>Days</i>
2-----	10	3	¹ 1	4	70, ¹ 70, 126, 147.
4-----	10	3	² 2	5	² 84, 87, 88, ² 91, 97.
Not heated-----	5	1	1	2	77, ¹ 77.

¹ Clinical signs and symptoms, no jaundice.

² Only abnormal laboratory findings.

Dr. Allen presented his own figures on plasma stored in the liquid stage for 6 months before use: There was no instance of hepatitis in 1,546 plasma transfusions, with a careful 6-month followup, while over the same period there were 49 cases of hepatitis, 0.4 percent, in 37,026 whole blood transfusions.

At this same meeting, it was reported that beta-propiolactone had failed in experiments involving the administration of transfusion-sized (600 cc.) doses of known infected plasma treated with 3,000 mg. per liter of this agent. Cathode-ray irradiation had proved lethal for the laboratory virus of hepatitis, but it had been given a relatively low priority in experiments on human volunteers because the outlook with beta-propiolactone had then been considered more promising.

Termination of the Plasma Program

There would be little point to citing other clinical and experimental studies with treated plasma. A great many of them were extremely hopeful

up to a point. In September 1950, a distinguished clinician was so impressed with the results apparently being obtained from ultraviolet irradiation that he declared that "the key to the control of homologous serum jaundice is now at hand." The blunt fact is that hepatitis continued to follow the use of plasma, no matter how it was treated. Complete sterilization was never achieved. All methods failed in the end.

The crux of the matter was that the Armed Forces needed some agent to use for resuscitation until the casualty could reach an installation where whole blood was available. They therefore had no choice but to take the calculated risk of using plasma, even though it might cause hepatitis. The risk was considerable. Late in 1951, the incidence of hepatitis after plasma transfusion reached 21 percent, in sharp contrast to the reported World War II incidence of 7.5 percent. Part of the explanation was that much of the plasma used in Korea in the first months of the war had not been treated at all. Moreover, different diagnostic criteria were used in the two wars. In World War II, the diagnosis was chiefly clinical. In the Korean War, any elevation of the serum bilirubin was considered an indication of hepatitis.

In January 1952, the National Institutes of Health agreed that pools of plasma should be reduced from the approximately 400 bloods then being used to not more than 50. The change could not be made immediately because the smaller pools required changes in equipment and techniques.

Hepatitis continued to occur, and at the 8 October 1952 meeting of the Subcommittee on Sterilization of Blood and Plasma, Committee on Blood and Related Problems, it was recommended that, because of the risk of hepatitis, plasma should be used only in emergencies and when no plasma-expander was available (35). Otherwise, serum albumin, which had proved to be extremely effective, or dextran, which had been tested extensively, should be used. The reduced yield from blood, as compared with the plasma yield (p. 342), would be compensated for by the other desirable byproducts secured by fractionation of plasma, and it was recommended that, as far as was practical, the present plasma program be converted to large-scale production of human serum albumin. Meantime, the search for techniques of sterilizing plasma should be continued. It was brought out, however, that when such a method was found, the sterilized plasma would be a new item, and an extensive program of testing and clinical evaluation would be required before it could be recommended and standardized. Some doubt was expressed that the blood procurement program could be sufficiently increased to provide the extra blood needed for the production of serum albumin.

At the 4 February 1953 meeting of the Subcommittee on Sterilization of Blood and Plasma, the third death from hepatitis in a volunteer was reported, and the testing program was suspended by action of the Armed Forces Epidemiological Board (36).⁸ It was recommended at this meeting that

⁸ In his report at the Conference on Derivatives of Plasma Fractionation on 28 October 1953 (32), Dr. Murray gratefully acknowledged the service of the volunteers in these studies, who were secured through the cooperation of the Bureau of Prisons, U.S. Department of Justice, and the staffs of the U.S. Penitentiaries at Lewisburg, Pa., and McNeil Island, Wash., and the Federal Correctional Institution, Ashland, Ky.

packages of plasma prepared for clinical use carry a conspicuous warning to physicians that serum hepatitis could be transmitted by plasma, in spite of ultraviolet irradiation, and also advising careful selection of blood donors.

On 20 August 1953, Circular No. 73, Department of the Army, directed that, because of the risk of serum hepatitis, the higher cost, and the need to use it for the production of specific globulins, plasma would not be used "to support blood volume" unless dextran was not available (37).

Part IV. The Plasma Fractionation Program

SERUM ALBUMIN

When the Korean War broke out, the same reasoning that made the Army choose plasma in preference to serum albumin as their agent of resuscitation in World War II led them to choose it again; that is, it took 4.2 bleedings to provide 25 gm. of serum albumin, against only 1.2 bleedings to provide 250 cc. of plasma. Also, it was usually necessary to supply water when serum albumin was used, whereas the distilled water used in the reconstitution of plasma was provided with it. Finally, the finished price of a unit of albumin was about \$20, against about \$4 for a unit of plasma.

When the military reverses suffered by the U.S. Army in Korea in the winter of 1951 increased the need for replacement substances, 50,000 units of outdated serum albumin were obtained from the Navy and transferred to the San Francisco medical depot for shipment to FECOM. Technically outdated serum albumin proved perfectly satisfactory. One of its advantages was that the small size of the units made it possible for corpsmen to load their pockets with it. Also, serum albumin did not freeze in the bitter winter weather encountered, as reconstituted plasma did.

When the incidence of serum hepatitis made it necessary to discontinue the use of plasma in Korea, serum albumin was the logical substitute. Extensive tests had shown that, when it was heated for 10 hours at 60° C., it carried no risk of hepatitis (28, 38). Also, it could be made from contaminated plasma, which meant that a large quantity could be obtained from the plasma on hand and no longer considered fit for use because of the risk of transmission of hepatitis; it was, of course, essential to use a therapeutic replacement agent that did not cause a second pathologic condition.

Serum albumin was readily administered in forward areas.

GLOBIN

At the meeting of the Subcommittee on Shock, Committee on Surgery, NRC, on 11 December 1950, it was brought out that, though globin is of great nutritive value as a protein, it was lost in 18 percent of the total protein of the blood then being discarded in the form of red blood cells (39). It was

also brought out that problems connected with its clinical use, chiefly hematuria and renal complications, had not yet been overcome.

At the 5 April 1951 meeting of the Committee on Blood and Blood Derivatives (40), it was reported that a modified form of globin, prepared by Sharp & Dohme, from discarded red blood cells, had been used by some 12 investigators to date as (1) a protein supplement and (2) as a plasma-expander. In about a hundred trials, there had been 10 to 15 percent of rather serious reactions, but the processing procedure had recently been altered, and there had been no reactions in the last 60 clinical trials.

Globin was used in 8-percent solution, in doses of about 16 gm. daily, for patients with hypoproteinemia caused by cirrhosis, nephrosis, and other conditions in which there was a negative nitrogen balance. It had been tested on only four patients in shock, and no evidence existed that it possessed sufficient osmotic activity to become a satisfactory plasma-expander. The trials had not been entirely adequate because many investigators had failed to analyze the globin per se in the bloodstream.

GAMMA GLOBULIN

A Conference on the Uses of Gamma Globulin was held on 5 August 1952, under the chairmanship of Dr. Milton C. Winternitz (41). Earlier in the war, there had been numerous meetings concerning this product at the Office of Defense Mobilization, to discuss the amount available and the anticipated needs if testing should indicate that it was effective in preventing paralytic poliomyelitis. If it was proved effective, the nationwide demand for it expected during the summer of 1953 would have a tremendous impact on the blood program, affecting every phase of it from the donation to the final product.

An ad hoc committee which had been convened by the Committee on Blood and Related Problems to assess the situation agreed in principle with proposals developed by the U.S. Public Health Service. It was recommended that the National Research Council investigate current stockpiles of gamma globulin and present production capacities; consider production for the Armed Forces and the civilian population and the equitable distribution of gamma globulin between them; assess the need for, and means of, increasing production; solicit the cooperation of both public and private groups working on this problem; conduct, or arrange for, epidemiologic studies bearing on allocation; adopt such measures of allocation as might be necessary and set up priorities if it was thought that gamma globulin would be in short supply. It was also recommended that the U.S. Public Health Service and the American Medical Association arrange for publicity on the production and use of gamma globulin.

Up to this time (August 1942), three field studies had been conducted, in Provo, Utah; Houston, Tex.; and Sioux City, Iowa. It was thought that a fourth might be necessary. Followup studies were still incomplete, and both the potency and the dosage of gamma globulin remained to be established.

Whether the ad hoc committee assumed that gamma globulin would be only partially successful, or successful in only some cases, it had to postulate some measure of success to make plans for the future. It was most important to be ready to expand production capacity to the limit as soon as possible after all field tests were completed, by 15 October 1952.

In a second report of the ad hoc committee on the uses of gamma globulin on 30 September 1952 (42), it was noted that the first knowledge the National Research Council had of the possible magnitude of the problem was at a meeting held in June 1952, with the Subcommittee on Blood of the President's Health Resources Advisory Committee. The Subcommittee on Blood fully recognized its responsibility because of the possible effect a demonstration of the preventive effect of gamma globulin in poliomyelitis might have on the future of blood collections in the National Blood Program (p. 735) and on the allocation of blood and its derivatives between civilian and military claimants. The present supply of gamma globulin was inadequate. The Office of Defense Mobilization had turned to the National Research Council for help, and the council had noted that its role was to advise, not to implement advice. The Office of Defense Mobilization was investigating the legal implications connected with the situation. The provision of gamma globulin for military dependents was, of course, an Armed Forces responsibility.

At this time (September 1952), the American Red Cross which had received the bulk of the surplus gamma globulin at the end of World War II, was distributing between 700,000 and 800,000 2-cc. doses per year for the prophylaxis of poliomyelitis and was recovering 200,000. It was then producing 70 percent of the current output and commercial firms, 30 percent. The Red Cross was also distributing gamma globulin for the prophylaxis of measles and of infectious hepatitis. The Army was holding 12,000 10-cc. units and had 1,013,450 gm. in the dried state. The Federal Civil Defense Administration had no reserves at all. On an assumed loss of 5 percent of current blood collections of 3,360,000 pints per year, 191,680 gm. of gamma globulin could be recovered.

The problem was discussed at several other meetings in 1952 and 1953 (43, 44), including a conference on Epidemiology of Poliomyelitis (45). The end of active combat in June 1953 eliminated the need for further action on the part of the National Research Council and the Armed Forces.

When final action was taken by the Office of Defense Mobilization in June 1953 to terminate dried plasma contracts, in accordance with NRC recommendations, because of the proved danger of serum hepatitis (32), it was agreed by the Department of Defense and the Federal Civil Defense Administration that the program for the current fiscal year should include only fractionation of plasma, with the production of serum albumin and gamma globulin. All gamma globulin produced would be made available to the American Red Cross and the National Foundation for Infantile Paralysis at the cost of processing.

RED BLOOD CELLS

During the Korean War, as in World War II (p. 313), packed red blood cells were used extensively in the treatment of chronic and secondary anemias and in the preparation of anemic patients for surgery. One of the chief advantages of this technique was that large quantities could be injected within short periods without risk of overloading the circulation. No *in vitro* tests were developed during the Korean War to determine the viability of these cells, and no gross or microscopic characteristics proved useful for this purpose. The only valid criterion of their viability continued to be a study of their survival in normal human subjects, a test that was both difficult and cumbersome. Without a simple method for continuous quality control, rigid standards of collecting, processing, and storage were essential precautions.

CADAVERIC BLOOD

At the fourth meeting of the Committee on Blood and Related Problems on 10 December 1952 (46), an inquiry was received from the Army Research and Development Board concerning the possibility of using cadaveric blood. The American Red Cross had also received numerous letters on the same subject.

In response to these inquiries, Dr. Strumia reported work he had done in this field in 1937-38. He considered only 12 of the 125 cadavers he had examined usable. He obtained much less blood than he expected, an average of 1,500 cc. per body. It was difficult to secure a free flow of blood, even shortly after death; the best flow was from patients who had died of coronary occlusion. He found it impossible to secure a satisfactory flow from the femoral vein, as the Russians had reported, and had to enter the right auricle with a ½-inch trocar. *In vitro* tests were normal in all respects, but the incidence of contamination was very high unless the blood was drawn within 6 hours of death.

Dr. Strumia had not used cadaveric blood clinically, and it was the consensus of the committee that there would be strong esthetic objections to it by both physicians and patients in the United States. It was also pointed out that there was no need for the use of this method for the Armed Forces at this time, since the country was still far from exhausting its donor supply.

Part V. The Plasma-Expanders Program

BIBLIOGRAPHY

It is not the function of this history to go beyond the important historical facts in the study of plasma expanders (the so-called blood substitutes of World War II). Attention should be called, however, to the excellent bibliog-

raphy on plasma expanders (except those derived from human blood) prepared in the reference division of the Army Medical Library (now the National Library of Medicine) in December 1951 (47). This is a most useful list. The references under each major item are grouped according to subheadings; the number of references in each article is stated; and the substance of the article is summarized in one or more succinct sentences.

The need for such a reference list was pointed out in the preface: The treatment of shock was then (1951) the most pressing single medicomilitary emergency. It was urgent both militarily and in the event of a thermonuclear war in which civilians would be involved. Since the prolonged storage of whole blood is not feasible, realism required that two facts be faced, (1) that it would be completely impractical to secure blood from donors in the event of a thermonuclear attack, and (2) that potential donors might well themselves be victims of the attack and therefore candidates for blood. The solution of the military and civilian problem was the development of plasma volume expanders and their stockpiling. This collective bibliography was a useful first step in such a task.

GELATIN AND OXYPOLYGELATIN

The extensive studies made on gelatin during World War II under the auspices of the National Research Council (p. 373) were resumed early in the Korean War. Then, as in World War II, the major objection to gelatin from the military standpoint was that it gelled at about room temperature. It therefore could not be used in the field, and even in hospitals, its use furnished some problems, which would be intensified if bombing or some other catastrophe interrupted electricity and heat.

Some observers believed, in view of the nature of the emergency, that gelatin manufacturers should be encouraged to begin production at once, even if the material might not be precisely what was wanted (39). The proposal that 30 gm. of urea be added to each 500 cc. of gelatin to keep it liquid was considered ingenious, but unsafe unless there could first be assurance that the recipient's urea clearance was normal (48). Such a specification was clearly impractical. Moreover, renal function was often sharply reduced in combat casualties, and if they were given gelatin infusions in the amount of 1,000 to 1,500 cc. in the course of a few hours, they would also receive 60-90 gm. of urea, which was obviously undesirable.

At the 14 October 1950 meeting of the Committee on Shock (49), Dr. Ravdin reported on an oxypolygelatin of superior quality which had been prepared in his laboratory. It did not gel at ordinary temperatures, but it gave rise to toxic reactions closely resembling certain reactions to oxalic acid, and he was not prepared to recommend it at this time. A year later, it was still impossible to obtain production of oxypolygelatins of uniform quality. Moreover, the amounts and rates of excretion varied from laboratory to laboratory, one probable reason being the variety of analytic methods in use.

In February 1953, the outlook was even more discouraging (50). Oxypolygelatin had proved to be antigenic. Its retention in the bloodstream in normotensive patients as well as in bled patients was poorer than that of dextran or Periston (polyvinylpyrrolidone). If its melting point were lowered by further degradation, its molecular weight would also be so lowered that it would not remain in the circulation long enough to have any effect at all. Moreover, the high initial elevation of the plasma volume achieved by gelatin preparations, followed by the rapid loss of the osmotically active material, might throw a patient in shock into a very dangerous state. In fact, if hemorrhage were also present, he would be in real jeopardy unless he were given blood or a more effective plasma-expander than gelatin.

It had been brought out, at one of the earlier meetings of the Committee on Blood and Related Problems (49), that gelatin, like other blood substitutes proposed up to that time, lacked the capacity, essential in the management of shock, to transport oxygen. It was also brought out at this meeting that the Armed Forces must not assume that funds were unlimited for studies in all areas. On the contrary, the field must be narrowed to agents of reasonable cost, suitable for stockpiling, whose production could be expedited. In view of these criteria, it seemed to many members of the committee that further investigation of gelatin was not warranted.

In March 1953, it was reported to the Subcommittee on Shock that fluid gelatin had been sent to Korea for a field trial, and it was believed that reports on it would be favorable, since it had been shown to restore blood volume for brief periods (51). On the other hand, the committee noted that, if not more than 35 percent of the blood volume had been lost and if hemorrhage did not continue, the normal homeostatic mechanisms of the body would tend to maintain the restoration, in which gelatin would play no part.

It was decided at this meeting that the investigation of gelatin and oxypolygelatin should be discontinued until a product could be supplied that could be characterized physicochemically; with evidence of reproducibility and stability; and of higher molecular size, so that it would not be excreted at an excessive rate, as were the products then in use. Data on tolerance and toxicity in animals were also desired.

No further reports on gelatin and gelatin products were made to NRC committees during the Korean War.

POLYVINYLPIRROLIDONE (PERISTON, PVP)

Historical Note

Knowledge of polyvinylpyrrolidone, the plasma-expander more commonly known as Periston or PVP, reached the United States during 1943. The Subcommittee on Blood Substitutes conducted a brief investigation on it (p. 380), but it was not used in the U.S. Army during World War II.

This agent was developed in Germany in 1940, when the need was recognized for a colloidal solution for the emergency treatment of shock (52). It was selected from some 30 compounds studied at I. G. Farben Laboratories. When the choice fell upon polyvinyl esters, polyvinyl alcohol polymers were first tested but were discarded when it was found that bone-marrow depression occurred after their repeated injection. When polyvinylpyrrolidone was synthesized from acetylene and ammonia, the polymers formed had molecular weights as high as 150,000 to 200,000.

According to the Germans, whose investigative methods were not considered entirely satisfactory, about 20 percent of Periston was excreted in the urine in the first 3 days. The remaining 80 percent was thought to be phagocytosed after 24 hours, stored in the reticuloendothelial system, and then probably slowly excreted, perhaps in the bile. Qualitative tests indicated that some Periston remained in the tissues for several weeks after injection.

Development in the United States

Periston was first considered in the Subcommittee on Shock on 14 October 1950 (49). Although it had been widely used in Germany during World War II and about half a million cases had since been followed up, not much was known about its use in recent years. Apparently, it caused no lasting damage to the tissues, but no definitive data were available on its course in the body and on the amount that could be tolerated without deposition in the tissues. Some members of the committee considered it worthless. Others took the position that if it had any deleterious effects, they would have been evident, even in the absence of expert observation, because of the large number of cases in which it had been used.

At the 11 December 1950 meeting of the Subcommittee on Shock (39), it was learned that the Schenley Corp. could then import 5,000 to 10,000 bottles of Periston per month from Germany and by July 1951 expected to import an intermediate form that could be processed further in the United States. Other manufacturers were also able to produce Periston.

The Subcommittee on Shock met with the manufacturers and potential manufacturers of Periston on 4 January 1951 (53). A research project had been approved in principle, but, up to this time, no funds had been assigned for it (54). Some companies were making Periston that very closely resembled the German product, but they stated that their progress would be faster if the Army would reach a decision concerning its use. The Food and Drug Administration was prepared to clear Periston as soon as the National Research Council furnished precise data about it and recommended it. The point was again made that the hundreds of thousands of cases in which it had been used in Germany, plus a favorable report made on it by Dr. J. A. Walker, University of Pennsylvania, furnished sufficient basis for recommending it without much further investigation. The Department of Defense, of course, was not in-

terested in putting money into material coming from a source in which resupply was not certain.

At a meeting of the Subcommittee on Shock on 26 September 1951 (55), another study that had been made in Germany was reported. It had showed no deleterious effects, but it was not adequate by United States standards: Pathologic practices were different. Records were not precisely kept. Sections were not studied carefully, and were not preserved.

Late in 1952, the Subcommittee on Shock recommended that Periston produced according to certain specifications should be stockpiled by the Federal Civil Defense Administration but should be used only in emergencies (56). Other recommendations were withheld until the long-term followup studies then in progress had been completed and a more closely fractionated product of suitable molecular weight had become available and been tested. The effectiveness of Periston had been clearly established, but it was stored in the body for undesirably long periods. Followup studies on German children showed no effect on hepatic and renal function, and post mortem studies made up to 14 months after its injection revealed no abnormalities, but the sense of the committee was that the burden of proof still rested on those who claimed that Periston was perfectly safe.

At the February 1953 meeting of the Panel on Plasma Volume Expanders (50), data were reported on 48 German children which brought the total studied to 68. All had been treated with Periston between 1944 and 1948, and none of them showed any abnormalities.

Special Studies

At the meeting just mentioned, Dr. Robert M. Zollinger reported a number of special studies on Periston made in his clinic. All tests were within normal range except that bone abnormalities were observed in 2 (of 18) examinations made on 14 patients. He and his associates were unwilling at this time to attribute these abnormalities to Periston.

Radioactive studies showed that from 95 to 100 percent of injected Periston was excreted via the urine within 72 hours; 40 percent was excreted within 20 minutes. Within 6 hours, virtually all circulating PVP had disappeared from the plasma. Excretion was thus too rapid for Periston to be of value, and it was recommended that general approval of it should be withheld, though again it was given limited approval for stockpiling for use in emergencies if serum albumin and dextran were not available.

On 3 March 1953, a panel discussion at a meeting of the Subcommittee on Shock brought out the following points (51):

1. Material found in many tissues, after study by various stains, was considered to be Periston or a reaction induced by it.
2. Similar deposits were present in Kupffer and liver cells 14 months after injection.
3. The bone marrow changes just referred to were again present.
4. Abnormal mitoses were observed in embryonic cells grown in tissue cultures in media containing PVP.

5. The anatomic and functional changes noted were mild, but it was thought that their investigation must be pursued over longer periods of time. It was therefore not possible to approve Periston for any but limited stockpiling. It could not be approved for general use.

At a meeting of the Committee on Blood and Related Problems, also in March 1953 (28), radioautographs were reported on patients who had been given K-30 Periston for 1 or 2 weeks before death. After a year's exposure, the tissues showed no concentration greater than twice what would be expected from uniform distribution in any tissues; the accuracy of this technique did not go beyond this level. Other studies showed that the goals of complete elimination of PVP from the body and adequate plasma volume expansion by its use were not mutually compatible.

At the meeting of the Subcommittee on Shock on 20 May 1953 (57), it was reported that large amounts of Periston had been stockpiled by the Government, but further studies were still considered necessary before it could be recommended for any but emergency use. The Korean War ended before further action was taken on it.

DEXTRAN

Dextran came to the attention of the Subcommittee on Blood Substitutes, NRC, shortly before World War II ended (p. 381), but no action was taken on it at that time. Some experimental work was done on it in Army hospital laboratories after the war, but it had not been used clinically in the United States when a request for information about it was received from the Food and Drug Administration at the meeting of the Committee on Blood and Blood Derivatives on 3 December 1949 (8), in connection with an application for its import from a Swedish company (Pharmacia).

Composition and Properties

Dextran was developed in Sweden during the early part of World War II and refined to the point at which it found wide clinical acceptance in Scandinavian countries (58). It was made up of a variety of polysaccharides of varying molecular sizes (59). Its production was quite simple. The only materials needed were sucrose and an organic solvent. Fermentation required only a day, and fractionation was not complicated. The chief bottleneck in production was the elimination of pyrogens and testing for sterility.

Smaller molecules of dextran were rapidly lost from the bloodstream, a matter of importance in military medicine, in which a considerable time might elapse between infusions. About half of each dose was accounted for by excretion through the kidneys or the intestinal tract. The fate of the remainder was unknown when the Committee on Blood and Blood Derivatives began to investigate dextran, but it was thought that the larger molecules were probably

deposited in the reticuloendothelial system and that they might be nephrotoxic or hepatotoxic.

The committee, remembering that periods of 5 to 15 years had elapsed before it was found that gum acacia could lead to amyloid degeneration, understandably took the position that great caution should be exercised in recommending dextran: Macromolecular substances of this type were known to cause rapid sedimentation of red blood cells as well as a tendency to sludging. It was necessary to consider whether dextran might give rise to breakdown products of hemoglobin, which might be nephrotoxic or hepatotoxic. Finally, it was necessary to investigate the maximum safe dosage and over what period this dosage could safely be administered.

Because of the commercial situation in Sweden, it was difficult to obtain pertinent chemical data on dextran (49), and the British, who were also manufacturing it, did not have the desired information. The only data on molecular size were based on viscosity measurement. Moreover, the clinical studies conducted in Europe had not been carried out with the precision used in such studies in the United States.

Another reason for caution on the part of the Committee was pointed out by Col. (later Brig. Gen.) John R. Wood, MC, at the October 1950 meeting of the Subcommittee on Shock (49): The implications of the decision to use dextran for combat and other casualties would, he pointed out, be far reaching. The adoption of any new technique would commit thousands of medical officers to it, and the recommendation of the Committee would probably be followed also by the civil defense organizations.

Experimental and Clinical Studies

Up to September 1950, the British experience with dextran covered 10,000 540-ml. bottles (25). No untoward effects had been observed, but the rate of excretion via the kidneys had varied widely, from 10 to 50 percent. At the end of 9 months, no dextran had been found in the bodies of rabbits except for slight traces in the lymph nodes and bone marrow. There was no histologic evidence of tissue damage. It was believed that the chief production problem was ridding the dextran of the small molecule, to reduce the rate of excretion.

Up to December 1950, the Swedish experience with dextran had covered 200,000 cases (39). In the 10 years of its use, there had been no post mortem evidence of tissue damage, and reactions were fewer than with the use of either blood or plasma. A compilation of articles from the literature by Pharmacia showed an impressive use of dextran by reliable investigators in Denmark, Finland, and Holland as well as in Sweden.

Between 24 and 69 percent of Swedish-produced dextran was excreted within 24 hours. Its molecular weight ranged from 120,000 to 200,000, against 80,000 to 100,000 for the British product. Swedish dextran was now fairly uniform.

Clinical testing in the United States during 1950 produced the following data:

1. Dextran expands plasma volume in the normovolemic individual, and return to the normal level takes a surprisingly long time.

2. In shocked patients, many factors operate to expedite the return of circulatory dynamics to normal. Once normal balance is restored, the body helps to maintain it.

3. A fairly sharp discrimination is exercised by the kidneys, based on molecular size, but the exact size at which excretion occurs varies from person to person. In clinical use, there is no diuresis (as there is experimentally when the smaller molecules are removed), and the excretion of dextran is comparable to the amount of the injection.

At a meeting of the Subcommittee on Shock on 30 January 1951 (52), it was reported that another review of the literature had shown no clinically undesirable renal, hepatic, hematologic, or circulatory changes after the use of dextran. Hemodilution was maintained for at least 6 hours after injection. Between 30 and 50 percent of the injected material was excreted in the urine, but the fate of the remainder was still unknown.

At this meeting a number of clinical reports were made, all to the effect that dextran was of great temporary value. Dr. John S. Lundy, who had had some anaphylactoid reactions with dextran when the material was imported from Sweden and bottled in the United States, had had no difficulty with the total Swedish product.

The single adverse report at this meeting, and at several subsequent meetings, came from Lt. Col. Edwin J. Pulaski, MC, and his group at Brooke General Hospital, San Antonio, Tex., who reported 26 reactions in 105 patients (48, 52, 60), all after the use of Swedish and British dextran. Some of the reactions had been quite severe. A breakdown of the cases showed that four reactions had occurred in 45 anesthetized patients. Seven different lots of Swedish dextran had been used. There were no reactions in patients treated with U.S.-produced dextran, which was now available.

Thirteen ambulatory patients, chiefly Korean veterans, hospitalized at the Forest Glen Section of Walter Reed General Hospital, were given 500-cc. injections of Swedish dextran (Macrodex). All but three had reactions, three of which were moderately severe. The experiment was not considered conclusive. There were no controls, and the patients, who were all in the same ward, were watched over by too many observers amid too much commotion.

Later in the year, 10 volunteers at Brooke General Hospital were studied with fractionated material from a lot of Swedish dextran (55). The observations suggested that the reactions which occurred must be explained by factors other than high molecular weights or aggregates of molecules.

At a Conference on Radioactive Dextran held on 29 August 1951 (61), under the chairmanship of Dr. Ravdin, it was reported that the most precise chemical analyses of excreted dextran had accounted for only 50 percent of the amount injected; all excretion was via the urine. Dextran tagged with

radioactive carbon, prepared by Commercial Solvents Corp., in cooperation with the Argonne National Laboratory, had been distributed to a number of investigators, whose results suggested that 95 percent of the injected material would be either excreted or metabolized. Although the combined studies were limited both in number (three dogs, six rats, four mice) and time (10 days), it was decided to test radioactive dextran clinically without further delay.

At the 13 February 1952 meeting of the Subcommittee on Shock (62), an ad hoc committee, appointed in December 1951, reported that there was no doubt that dextran was antigenic in man and could produce precipitins and skin sensitivity, with the degree of sensitivity apparently unrelated to the occurrence of systemic reactions. All the reactions had occurred in first injections; none had been observed in a limited number of second injections. Immunization apparently played a negative role. Preparations of higher molecular weight seemed to cause more systemic reactions than those of lower weight and also precipitated more antibodies in sensitive subjects (63).

While the studies reported were still incomplete, it seemed to the conferees to be desirable, to minimize reactions, to avoid highly branched dextrans and preparations of high molecular weight. No doubt was felt that reactions to dextran could be extremely dangerous if they occurred in battalion aid stations, where medical supervision might be inadequate. Later, it was recommended that a warning be placed on bottles of dextran that if an anaphylactoid reaction developed, the infusion must be stopped at once and active treatment instituted (64).

At the 1 October 1952 meeting of the Subcommittee on Shock, it was reported that 125 units of dextran had been used in Korea, with good clinical results and no significant reactions (56). A 6-month study had been started in Air Force installations in the United States.

At an ad hoc meeting on dextran fractions on 8 December 1952 (58), it was reported that a fairly large proportion of normal, healthy adults had experienced allergic-type reactions after the use of both British and Swedish dextrans but that the rate with the United States products was very low. It was now possible to define the best possible dextran for mass production. Determination of molecular weight was now quite accurate, and refined analytic methods made it possible to detect even small quantities of dextran in plasma or urine.

Studies on dextran were conducted in Korea in July and August 1952, by members of the surgical research team, on the ground that it was not possible to duplicate total combat situations in the wards and operating rooms of civilian hospitals, or even military hospitals, in the Zone of Interior (65).

During this investigation, 200 500-cc. units of 6 percent dextran were used on 60 patients, 3 suffering from burns and the others from trauma of varying degrees. The total clinical response was excellent. The blood pressure response was most satisfactory. The hematocrit showed a decrease, which was maintained. There were no allergic reactions. One patient received 2,500 cc. of dextran solution in a single day with no ill effects. No

abnormalities were observed at autopsy in the three patients who died. The best tribute to dextran was that the medical officers who used it were uniformly eager for more.

Dextran was used in increasing amounts until the end of the Korean War. To complete the record, one postwar matter should be mentioned: In September 1953, a hitherto undescribed consequence of dextran injections was reported, a prolongation of the bleeding time (66, 67). It had occurred in 2 normal subjects at Walter Reed General Hospital, and in 11 other normal subjects observed elsewhere; the product of four manufacturers was involved. These observations were confirmed by a study of 121 normal subjects at Bolling Air Force Base.

The change in the bleeding time occurred within 3 to 9 hours after the dextran had been given. There was usually a return to normal level within 24 hours. The amount of dextran that had produced the alteration ranged from 500 cc. in a single dose to 6,500 cc. over a 5-day period. There was no correlation between the maximum prolongation of bleeding time and the maximum expansion of plasma volume.

Recommendation and Production

At one of the first meetings after the outbreak of the Korean War at which dextran was discussed (25), Dr. Ravdin emphasized that in the emergency that existed, this product must be investigated promptly as well as thoroughly. He also stated that the Armed Forces must not rely on commercial firms to provide specifications and standardization.

The first contract for the production of dextran was set up with the Commercial Solvents Corp. (54). In December 1950, this firm reported that it was negotiating with Pharmacia to manufacture dextran under its patents (39). The Schenley Corp., which was also producing dextran, had a similar agreement with a British company. Meantime, Pharmacia had already licensed Refined Syrups and Sugars Corp., whose product would probably be bottled by the Abbott and Cutter Laboratories. The American Sugar Refining Co. was working on a new fractionation method which did not require alcohol and which might prove of great value if alcohol should become in short supply. At the meeting at which these details were reported (Subcommittee on Shock, 11 December 1950), it was recommended that the Department of Defense begin to procure dextran that would meet British and Swedish specifications (39).

Encouraging reports on present and anticipated production were made at a conference on 19 December 1950, under the auspices of the Subcommittee on Shock, which was attended by manufacturers of dextran, including a representative of Pharmacia, drug firms, and other interested parties (68). At this meeting the subcommittee recommended that all dextran produced be labeled *For Stocking for Emergency Use*.

During the following month, arrangements were made to purchase 50,000 units of Swedish dextran for the Armed Forces, to bridge the gap while U.S. manufacturers were getting into mass production (69).

By the end of 1951, the National Research Council approved the stockpiling of U.S.-produced dextran and the Department of Defense entered into a contract for its production with Commercial Solvents Corp., Terre Haute, Ind. (2). Delivery was delayed because of the necessity of developing large-scale production facilities.

In April 1952, the Medical Policy Council directed that commitments for the procurement of Periston be canceled and the funds allocated to it be diverted to the procurement of additional quantities of dextran (2). By this time, the risk of hepatitis in the use of plasma was fully appreciated.

By the end of September 1952, Commercial Solvents Corp. had delivered 28,588 of the 810,000 units of dextran contracted for. The other three companies with which contracts had been made later had not yet produced anything, but their facilities were about completed and their potential was 3,060,000 units.

Early in 1953, dextran was approved by the Food and Drug Administration, and a larger proportion of the stockpile was set up with it, though the proportion between synthetic and natural plasma-expanders was deliberately kept in balance. Later in the year, the manufacturers made it clear that they were losing interest in the production of dextran, in the absence of definite commitments for its use by military and civilian agencies (67). The concern of the Subcommittee on Shock at this development was duly transmitted to the Office of Defense Mobilization and the Assistant Secretary of Defense for Medical Affairs.

Plastic equipment.—The first attempt to put dextran up in plastic bags was a failure (51). Vapor transfer through the plastic was so great that the dextran crystallized out in the recipient tube. A later attempt was successful (57). The bags, which were tested in Korea and in certain U.S. hospitals, could withstand sterilization temperatures, and long-term storage was apparently possible; they were tested at 60° C., considered equivalent to 2½ years' storage at room temperature. The vapor transfer problem was settled by the use of an aluminum foil barrier.

FAT EMULSIONS

Two ad hoc Conferences on Fat Emulsions for Intravenous Administration were held during the Korean War, on 24 May 1951 (70) and 19 March 1953 (71). By the time the war broke out, these emulsions had been used extensively enough to establish their clinical value, and it was believed that there was a real need for them to maintain caloric intake in seriously ill and wounded patients. It was true that less than 5 percent of these patients would need

parenteral fat. On the other hand, their needs might be urgent. In Korea, the most imperative nutritional problems were encountered in seriously wounded patients with renal dysfunction and oliguria, in whom it was necessary to limit fluids to 500 cc. per day for about 10 days. During this period, these casualties often lost as much as 45 gm. of nitrogen per day, which was the equivalent of a total 25-pound loss of muscle weight. Wound healing was slow, edema was frequent, and the incidence of wound dehiscence was abnormally high. The desideratum, not yet achieved, was for the development of a pyrogen-free emulsion which would provide from 2,000 to 4,000 calories per day by parenteral administration, in as small a fluid volume as possible.

At the second of these ad hoc conferences, as at the first, there were two chief problems (1) the pyrogenicity of the preparations then available, and (2) their instability. Commercial preparation of consistently safe and satisfactory emulsions could not be expected until a solution was found for these problems. Some of the participants in the discussion thought that if only a fraction of the funds expended in the development of plasma extenders were allotted to this project, results would be prompt and beneficial, but no such allocation was made during the war.

Part VI. Clinical Considerations

THERAPEUTIC PRINCIPLES AND PRACTICES

General Considerations

The principles and practices governing the use of plasma (fig. 190) and albumin (fig. 191) were essentially the same in the Korean War as in World War II. The administration of whole blood also followed the same pattern (figs. 192, 193, 194, and 195) except that intra-arterial transfusion was given a trial.

Intra-Arterial Transfusion

Historical note.—According to Lewisohn (72), the first recommendation for intra-arterial transfusion, by Huerter in 1871, contained the report of eight cases in which defibrinated blood was injected by this route. Not much more work was done on the subject until 1937, when Davis (73) showed, in a study of experimental shock, that the intra-arterial injection of sodium chloride solution elevated the blood pressure but that a similar solution, given intravenously, lowered it. Kendrick and Wakim (74) confirmed these observations in dogs in 1939. They also demonstrated that the intra-arterial administration of physiologic salt solution is not a desirable emergency treatment for secondary shock. In spite of the immediate vasopressor response and the maintenance of the elevated blood pressure for a certain period of time, the end result was always severe injury to the recipient.



FIGURE 190.—Administration of plasma in Korea. A. Company aidmen bringing in casualty from combat area forward of machinegun emplacements. Plasma has not yet been started. B. Plasma transfusion during jeep transportation of casualty to hospital, September 1950. C. Continuing administration of plasma to casualty as he is put aboard plane at Taejon Air Base, en route to Itazuke, Japan, July 1950. This particular plane was one of the last to leave the airstrip. D. Continuation of plasma transfusion as seriously wounded U.S. soldier is unloaded from observation plane (L-5), converted to use as one-casualty air ambulance, and moved to conventional ambulance, 2d Infantry Division Airstrip, Korea, August 1950.



FIGURE 191. Administration of albumin in Korea.
A. Preparation of albumin for treatment of casualty, 15th U.S. Infantry Division, near Chorwon, June 1952.
B. Administration of albumin to casualty, Model Aid Station, 7th U.S. Infantry Division, preparatory to further evacuation by helicopter, Kunwha, July 1952.



FIGURE 192.—Withdrawal of blood from storage for use at 8076th Army Surgical Hospital, Kuna-ri, Korea, November 1950.

Field studies.— During the Korean War, Maj. Curtis P. Artz, MC, Capt. Yoshio Sako, MC, and Capt. Alvin W. Bronwell, MC, treated eight casualties by the intra-arterial route, the largest amount given being 4,500 cc. of blood (75). The surgeon held the needle in the artery during the transfusion, which was discontinued as soon as the systolic pressure reached 100 mm. Hg.

One of the eight casualties died on the operating table, and three others died within 3½ hours of operation. Although the other four recovered, it was the impression of these observers that casualties given blood by this route showed no appreciably improved response as compared with patients who received blood at a comparable rate under pressure or in multiple veins (fig. 195). One of their patients, for instance, who was almost moribund, recovered after being given 5,500 cc. of blood into two veins through 15-gage needles in 30 minutes; 3,500 cc. of blood was pumped into one vein in 21 minutes.

Experimental studies by Major Artz and his group also failed to indicate any superiority of the intra-arterial over the intravenous route. Since the experimental data coincided with clinical impressions derived from the small groups of cases just described, this method of administration was discontinued in favor of rapid intravenous injection of blood through multiple large-gage needles or intravenous cannulas.

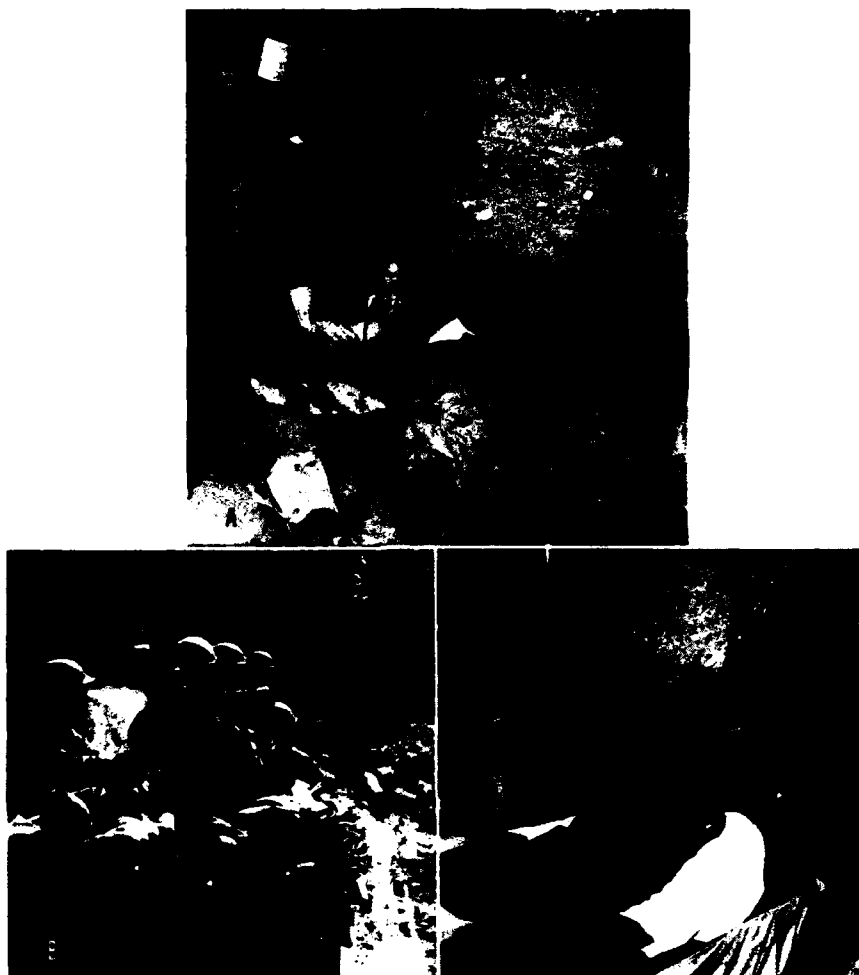

FIGURE 193.—Administration of blood in Korea. A. Near Uijong, April 1951. B. Before evacuation to battalion aid station behind front-lines. C. On pod of helicopter during evacuation from 44th General Hospital, October 1953.

Conclusions.—Intra-arterial transfusion was discussed in detail at a conference at Walter Reed Army Medical Center on 11 June 1953 (76). It was found, in extensive experimental studies, that there was no significant difference in survival rates in experimental and control series, and no significant difference in the effectiveness of intra-arterial and intravenous administration of blood. All studies pointed to the conclusion that it was the rate of transfusion, not the route, that was the important factor.

In the general discussion that followed this presentation, Brig. Gen. Sam F. Seeley, then Chief of Surgery, Walter Reed General Hospital, stated that, provided that an adequate amount of blood was given rapidly, the technique of transfusion probably made little difference as long as cardiac action was still present. In deep shock, it was often mechanically difficult to introduce blood



FIGURE 194.—Transfusion during surgery in Korea.
A. In course of amputation at 8063d Mobile Army
Surgical Hospital supporting I Corps, November 1950.
B. During another operation, same time and place.

into a vein, but always quite easy to make a femoral arterial puncture. He also pointed out that a certain number of casualties could be expected to die from the severity of their injuries, even if they received preferential intra-arterial transfusion.

Other participants in the discussion took the position that intra-arterial transfusion is an extremely dangerous technique; cases were cited in which complete gangrene of the hand, requiring amputation, had followed its use (72). Others, however, in spite of the risk of ischemia, believed that in strictly qualified circumstances intra-arterial transfusion might be justified.



FIGURE 195. Rapid administration of blood to seriously wounded casualty at forward aid station after evacuation from Old Baldy, August 1952.

INVESTIGATIONS

Surgical Research Team

The request of the World War II Subcommittee on Blood Substitutes, Division of Medical Sciences, NRC, to send a team of observers to overseas theaters was never granted (p. 79). The question of sending such a team to Korea was brought up at the second meeting of the Subcommittee on Shock, Committee on Surgery, on 2 November 1950 (57), and several times thereafter until such a team was sent to the Far East in December 1951 (65). The

9 December 1952 meeting of the subcommittee was devoted chiefly to progress reports from the team (64).

The Surgical Research Team was organized by the Army Medical Service Graduate School and the Army Medical Research and Development Board, which appointed personnel, set policies, established techniques, provided consultants, and furnished nonstandard supplies.

In Japan, the team was attached to the Far East Research Unit (406th Medical General Laboratory) in Tokyo for administrative purposes. Here, additional personnel, including consultants, were provided, and supplies available on the Japanese market were obtained. In Korea, the team was attached to the 11th Evacuation Hospital and the 8209th MASH (Mobile Army Surgical Hospital) for standard supplies, day-by-day assistance, and the provision of clinical opportunities.

The principal problems related to blood which were encountered by the team were as follows:

1. During resuscitation, problems associated with the blood bank, the utilization of plasma, and the resulting high rate of homologous serum jaundice.
2. During operation, abdominal hemorrhage and vascular injuries.
3. Sequelae of trauma, including secondary hypotension, posttraumatic anuria, and infections.

The special studies on blood were made by Lt. Col. William H. Crosby, MC; Capt. John M. Howard, MC; and Lt. Col. Joseph H. Akeroyd, MSC (77-79).

Essential Data

General considerations.—When the Surgical Research Team reached the Far East in December 1951, it found blood plentiful in U.S. Army hospitals, as it had been all during the past year. The only blood available in ROK Army hospitals was the amounts occasionally provided by U.S. units (p. 803). The O blood used was now available between 12 and 14 days after collection, instead of 21 to 28 days as originally. Massive and repeated transfusions were given with few reactions, and there were no records of deaths attributable to the use of blood.

A special investigation showed that transportation of blood over the thousands of miles between the United States and Korea had only minor effects on it. Generally, it arrived at forward hospitals in an excellent state of preservation. In 300 pints examined at random, it was found that less than a quarter of 1 percent of the red blood cells had been lost, and, when the blood was transfused, few red cells were found nonviable. The plasma hemoglobin rose from about 50 mg. percent on the 10th day after collection to 100 mg. percent on the 28th day. Harmful amounts of hemoglobin were not released into the recipient's plasma from the transfused blood. Abnormally high plasma potassium was not encountered during or after massive transfusions unless renal failure was also present. The plasma potassium level of bottled blood was apparently a straight line function of time, the concentration increasing at the

rate of approximately 1 milliequivalent per day. The osmotic fragility of the red cells showed few changes during the first 2 weeks after collection. Then it rose sharply, suggesting the desirability, whenever practical, of using blood within the first 14 days after it had been drawn. All the evidence indicated that the use of properly stored blood had only beneficial effects; few if any deleterious effects were observed even when as much as 20 to 30 pints were given in less than 6 hours.

Continuous refrigeration, at temperatures of 0° to 10° C., was absolutely essential to the safe preservation of blood. If refrigeration were omitted, even for brief periods, irreversible changes occurred in the red cells. They might not hemolyze spontaneously in the bottle, but they did not survive after transfusion.

Reactions and sequelae.—Reactions were remarkably infrequent. In 1,620 transfusions observed at the 46th Army Surgical Hospital (8209th MASH), there were only four urticarial reactions and no reactions due to incompatibility. Several hemoclastic reactions were considered as caused by gross contamination of the bloodstream from the sites of wounds or from the peritoneal cavity.

The practice of using O blood for massive transfusions of non-O recipients did not seem harmful provided that so-called dangerous universal donors were avoided. These donors, who are extremely uncommon, have plasma that contains a high titer of anti-A antibodies, which can produce an unmistakable hemolytic transfusion reaction, with all the signs associated with major incompatibility. Some of the recipient's own red blood cells might be eliminated by antibodies in plasma from these donors, though there is no clinical evidence of this phenomenon.

Casualties who received multiple transfusions over long periods of time tended to develop greater sensitivity to pyrogens. This observation, first recorded in 1951 (79), was never explained.⁹

These same casualties were also prone to develop hemosiderosis because of the excess iron deposited after increased erythrocytic destruction. It was suggested, with the fear of hemochromatosis in mind, that if these patients developed resistant chronic anemias, whole blood and red blood cells should be used as sparingly as the circumstances justified.

Patients who received more than 15 pints of blood often showed a tendency to ooze from cut surfaces. The condition regressed quickly, without treatment.

A patient in shock, who had been given a transfusion in excess of the normal capacity of his circulatory system, sometimes developed polycythemia. In such cases, the excess blood was apparently carried in the dilated vessels of the skeletal muscles, liver, and lungs. So-called overtransfusion, which was sometimes employed in severe shock, was surprisingly well tolerated.

⁹ In the light of present (1962) knowledge, this statement about sensitivity to pyrogens may be erroneous. The patients under discussion become sensitized to known or unknown blood factors, and the sensitization tends to cause reactions characterized by chills and fever during or after subsequent transfusions.

Hematologic response.—A battery of hematologic studies was carried out on 37 of the casualties received at the 46th Army Surgical Hospital, located several miles behind the infantry division that it supported, between October 1952 and January 1953. Between 2 and 42 transfusions were used in each case. The plasma hemoglobin was determined in 300 of the units used. Particular attention was paid to the results of storage of blood (high plasma hemoglobin and potassium, low labile factor activity, nonviable platelets and leukocytes). As already mentioned, changes in stored blood were slight and innocuous.

The important observations made in this study were as follows:

1. At the time of resuscitation and shortly thereafter, there was a remarkable loss of circulating red blood cell mass in casualties with wounds associated with considerable tissue destruction. The loss was thought to be caused by hemolysis, though the exact mechanism was not determined. The loss of red cells was sometimes so rapid that a casualty with bilateral traumatic amputation of both legs, even if hemostasis was adequate, might become severely anemic if there was any hesitation in using massive, rapid transfusions. Shock associated with wounds which involved less tissue destruction, such as lacerations of the colon, did not destroy red cells in this fashion. After moderate transfusions, these patients often became polycythemic, and transfusions had to be carried out "rather gingerly," because of the tendency for signs of congestion to appear.

2. During the early period of recuperation from severe wounds, casualties tended to become anemic, apparently as the result of hemolytic processes plus a relative inhibition of red cell formation.

3. A particularly striking observation was that in patients not in group O, massive transfusions of O blood resulted in the virtual replacement of the recipient's cells by cells of the O group. His plasma sometimes contained antibodies against red cells of his own hereditary blood group. Gradual hemolysis of native red cells by transfused antibodies was observed, but the hemolytic process was not evident clinically and did not appear to harm the patient. The presence of foreign antibodies, however, sometimes made it impossible to crossmatch the patient with blood of his hereditary group, and it was believed that transfusions with the hereditary type of blood might be dangerous. Severe reactions, in fact, sometimes occurred when type-specific blood was given after large transfusions of O blood. In the light of this new observation, it was recommended that, after transfusions of universal donor blood had been given, no change should be made to blood of another group until at least 2 weeks had elapsed.

Immuno-hematologic response.—Another special study by Colonel Crosby and his associates was an investigation of 25 casualties from the standpoint of the immuno-hematologic results of large transfusions of group O blood in recipients of other blood groups. These patients were all received by ambulance or helicopter between 1 and 3 hours after wounding. Transfusions

of plasma or whole blood had often been begun at battalion aid stations and they were continued during evacuation, and, as needed, through resuscitation and operation. Some patients received as much as 37 pints of blood within 12 hours. One or two received 20 pints within an hour. Most of the blood transfused was used before the 15th day, and none was used after the 21st day, of shelf life. All the blood was group O, all was Rh-positive, and all was used without crossmatching. It was tested for the high titer isoagglutinins active against group A and group B red blood cells.

The important observations made in this study were as follows:

1. After large transfusions of low titer group O blood into patients of groups A, B, and AB, it was not possible to demonstrate foreign isohemolysins or incomplete antibodies in the recipient serum. Cold isoagglutinins were frequently evident immediately after the transfusion, but they usually disappeared rapidly. In several patients, the titer of foreign anti-A isoagglutinins was quite high, and the antibody persisted in the circulation for several days. A possible explanation was the relatively small amount of A substance in the recipient's blood; when the transfused isoagglutinins were found persistent, the patients usually proved to be weak secretors of A substance in the saliva, or complete nonsecretors.

2. In most of these patients there was evidence of selective destruction of recipient red blood cells after the transfusion of O blood, probably as the result of activity of transfused isoantibodies in the plasma of the transfused blood. The hemolytic activity was observed in cases in which it was not possible to demonstrate the presence of foreign isoantibodies. It was postulated that forms of antibodies might exist that could not be demonstrated by available methods and that manifested themselves only by causing destruction of red blood cells.

3. Clinically, as already mentioned, the hemolytic process originating from such transfused isoantibodies, while it caused destruction of native red cells, did not threaten the lives or impede the recovery of these patients. No reactions, in fact, were encountered or heard of in Korea that might have been ascribed to so-called dangerous universal donors. In practice, the division of group O blood into high and low titer, on the basis of dilution of 1:200 to 1:256, proved perfectly safe.

References

1. Minutes, meeting of Subcommittee on Shock, Committee on Surgery, Division of Medical Sciences, NRC, 14 Nov. 1951.
2. Hoey, Col. Patrick H., MC, USAF: History of the Armed Services Blood, Blood Derivatives and Plasma Expanders Program, August 1950-June 1952, n.d.
3. LaMantia, E.: Historical Development of the Office of Assistant Secretary of Defense (Health and Medical), 1 Nov. 1953.
4. Report, Task Group to Director of Medical Services, 15 Mar. 1950, subject: Suggested Program of Whole Blood and Blood Derivatives for the Armed Forces.
5. Memorandum, Secretary of Defense for the Three Secretaries, 5 May 1950, subject: Policy and Guidance in the Whole Blood and Blood Derivatives Program for the Department of Defense.

6. Memorandum, Rear Adm. M. L. Ring, SC, USN, for Director for Military Programs, Munitions Board (attention: Chief, Office of Programs Coordination), 7 Apr. 1950, subject: Proposed Program of Whole Blood and Blood Derivatives for the Armed Forces.
7. Memorandum, Louis Johnson, Secretary of Defense, for Chairman, Joint Chiefs of Staff; Assistant Secretary of Defense (Comptroller); Secretary of the Army; Secretary of the Navy; Secretary of the Air Force; Chairman, Munitions Board; Director of Medical Services, 5 Aug. 1950, subject: Implementation of the Whole Blood and Blood Derivatives Program for the Department of Defense.
8. Minutes, meeting of Committee on Blood and Blood Derivatives, Division of Medical Sciences, NRC, 3 Dec. 1949.
9. Letter, Louis Johnson, Secretary of Defense, to Gen. George C. Marshall, 20 July 1950.
10. Letter, Gen. George C. Marshall to Secretary of Defense Louis Johnson, 22 July 1950.
11. Letter, W. Stuart Symington, Chairman, NSRB, to Gen. George C. Marshall, Chairman, American National Red Cross, 30 Aug. 1950.
12. Letter, Gen. George C. Marshall to W. Stuart Symington, 7 Sept. 1950.
13. The "Boston Agreement," in Report M-38 of the Committee on Blood Banks, American Medical Association, 15 Sept. 1950.
14. Annual Reports, 406th Medical General Laboratory, 1950-54.
15. Radio message, CINCFE, Tokyo, Japan, to DEPTAR. Washington, D.C., for Surgeon General, NRCX 60076, 15 Aug. 1950.
16. DOD Directive 750.10-1, 2 Aug. 1951, "Medical and Health; Whole Blood, Derivatives, and Substitutes."
17. Executive Order, The President, to Heads of Executive Departments and Agencies, 10 Dec. 1951.
18. Letter, Charles E. Wilson, Director, Office of Defense Mobilization, to Hon. Robert D. Lovett, Secretary of Defense, 21 Feb. 1952, with Inclosure, "National Blood Program," 18 Feb. 1952.
19. History of the Armed Services Whole Blood Processing Laboratory, Travis Air Force Base, Calif. (25 August 1950-15 March 1954), n.d.
20. Minutes, meeting of Committee on Blood and Blood Derivatives, Division of Medical Sciences, NRC, 23 Sept. 1953.
21. Steer, Lt. Col. Arthur, MC: A Fourteen Day Survey of Blood Supply Distribution and Use in Korea, 11 Mar. 1953.
22. Letter, Lt. Col. Arthur Steer, MC, to Col. Douglas B. Kendrick, MC, 15 Dec. 1953.
23. Minutes, Symposium on Blood Preservation, under auspices of Committee on Blood and Blood Derivatives, Division of Medical Sciences, NRC, 2 Dec. 1949.
24. Minutes, ad hoc Committee on Plastic Blood Collecting Equipment, Committee on Blood and Blood Derivatives, Division of Medical Sciences, NRC, 8 Oct. 1951.
25. Minutes, meeting of Committee on Blood and Blood Derivatives, Division of Medical Sciences, NRC, 23 Sept. 1950.
26. Minutes, Conference on Differential Agglutination of Erythrocytes, Committee on Blood and Related Problems, Division of Medical Sciences, NRC, 17 Sept. 1952.
27. Minutes, Symposium on the Structure and Cellular Dynamics of the Red Blood Cell, Committee on Blood and Related Problems, Division of Medical Sciences, NRC, 11-12 June 1953.
28. Minutes, meeting of Committee on Blood and Related Problems, Division of Medical Sciences, NRC, 4 Mar. 1953.
29. Minutes, Panel on Preservation of Whole Blood and Red Cells, Committee on Blood and Blood Substitutes, Division of Medical Sciences, NRC, 28 Mar. 1951.
30. Oliphant, J. W., Gilliam, A. G., and Larson, C. L.: Jaundice Following Administration of Human Serum. Pub. Health Rep. 58: 1233-1242, 13 Aug. 1943.

31. Oliphant, J. W., and Hollander, A.: Homologous Serum Jaundice. Experimental Irradiation of Etiologic Agent in Serum by Ultraviolet Irradiation. Pub. Health Rep. 61: 398-602, 26 Apr. 1946.
32. Minutes, Conference on Derivatives of Plasma Fractionation, Division of Medical Sciences, NRC, 28 Oct. 1953.
33. Murphy, W. P., Jr., and Workman, W. G.: Serum Hepatitis from Pooled Irradiated Dried Plasma. J.A.M.A. 152: 1421-1423, 8 Aug. 1953.
34. Allen, J. G., Enerson, D. M., Barron, E. S. G., and Sykes, C.: Pooled Plasma With Little or No Risk of Homologous Serum Jaundice. J.A.M.A. 154: 103-107, 9 Jan. 1954.
35. Minutes, meeting of Subcommittee on Sterilization of Blood and Plasma, Committee on Blood and Related Problems, Division of Medical Sciences, NRC, 8 Oct. 1952.
36. Minutes, meeting of Subcommittee on Sterilization of Blood and Plasma, Committee on Blood and Related Problems, Division of Medical Sciences, NRC, 4 Feb. 1953.
37. Circular No. 73, Department of the Army, 20 Aug. 1953, subject: Dextran in Lieu of Plasma (paragraph I).
38. Minutes, meeting of Committee on Blood and Related Problems, Division of Medical Sciences, NRC, 19 Oct. 1952.
39. Minutes, meeting of Subcommittee on Shock, Committee on Surgery, Division of Medical Sciences, NRC, 11 Dec. 1950.
40. Minutes, meeting of Committee on Blood and Blood Derivatives, Division of Medical Sciences, NRC, 5 Apr. 1951.
41. Minutes, Conference on Uses of Gamma Globulin, Division of Medical Sciences, NRC, 5 Aug. 1952.
42. Minutes, meeting of ad hoc Committee on Uses of Gamma Globulin, Division of Medical Sciences, NRC, 30 Sept. 1952.
43. Minutes, meeting of ad hoc Committee on Uses of Gamma Globulin, Division of Medical Sciences, NRC, 17 Oct. 1952.
44. Minutes, Panel on Allocation of Gamma Globulin, Division of Medical Sciences, NRC, 20 Jan. 1953.
45. Minutes, Conference on Epidemiology of Poliomyelitis, Division of Medical Sciences, NRC, 14 Feb. 1953.
46. Minutes, meeting of Committee on Blood and Related Problems, Division of Medical Sciences, NRC, 10 Dec. 1952.
47. Baer, K. A.: Plasma Substitutes Except Those Derived From Human Blood, 1940-1951. An Annotated Bibliography. Washington: Army Medical Library, December 1951.
48. Minutes, meeting of Subcommittee on Shock, Committee on Surgery, Division of Medical Sciences, NRC, 21 Mar. 1951.
49. Minutes, meeting of Subcommittee on Shock, Committee on Surgery, Division of Medical Sciences, NRC, 14 Oct. 1950.
50. Minutes, Panel on Plasma Volume Expanders, Subcommittee on Shock, Committee on Blood and Related Problems and Committee on Surgery, Division of Medical Sciences, NRC, 25 Feb. 1953.
51. Minutes, meeting of Subcommittee on Shock, Committee on Blood and Related Problems and Committee on Surgery, Division of Medical Sciences, NRC, 3 Mar. 1953.
52. Minutes, Conference on Dextran and Polyvinylpyrrolidone under the auspices of the Subcommittee on Shock, Division of Medical Sciences, NRC, 30 Jan. 1951.
53. Minutes, meeting of Manufacturers of Periston, under auspices of Subcommittee on Shock, Committee on Surgery, Division of Medical Sciences, NRC, 4 Jan. 1951.
54. Minutes, meeting of Subcommittee on Shock, Committee on Surgery, Division of Medical Sciences, NRC, 2 Nov. 1950.

55. Minutes, meeting of Subcommittee on Shock, Committee on Surgery, Division of Medical Sciences, NRC, 26 Sept. 1951.
56. Minutes, meeting of Subcommittee on Shock, Committee on Blood and Related Problems, and Committee on Surgery, Division of Medical Sciences, NRC, 30 Sept.-1 Oct. 1952.
57. Minutes, meeting of Subcommittee on Shock, Committee on Blood and Related Problems, and Committee on Surgery, Division of Medical Sciences, NRC, 20 May 1953.
58. Minutes, ad hoc Meeting on Dextran Fractions, Subcommittee on Shock, Committee on Blood and Related Problems, Division of Medical Sciences, NRC, 8 Dec. 1952.
59. Minutes, meeting of Committee on Blood and Related Problems, Division of Medical Sciences, NRC, 14 May 1952.
60. Minutes, meeting of Subcommittee on Shock, Committee on Surgery, Division of Medical Sciences, NRC, 19 Apr. 1951.
61. Minutes, Conference on Radioactive Dextran, Division of Medical Sciences, NRC, 29 Aug. 1951.
62. Minutes, Subcommittee on Shock, Committee on Surgery, Division of Medical Sciences, NRC, 13 Feb. 1952.
63. Minutes, meeting of Subcommittee on Shock, Committee on Surgery, Division of Medical Sciences, NRC, 8 May 1952.
64. Minutes, Subcommittee on Shock, Committee on Blood and Related Problems and Committee on Surgery, Division of Medical Sciences, NRC, 9 Dec. 1952.
65. Report of Blood Study Team Activities in the Far East (19 June-30 July 1953), 17 Feb. 1954.
66. Minutes, meeting of Subcommittee on Shock, Committee on Medicine and Surgery, Division of Medical Sciences, NRC, 30 Sept. 1953.
67. Minutes, Panel on Plasma, Subcommittee on Shock, Subcommittee on Blood and Related Problems, Committee on Medicine and Surgery, Division of Medical Sciences, NRC, 29 Sept. 1953.
68. Minutes, Conference of Dextran Manufacturers, under auspices of Subcommittee on Shock, Division of Medical Sciences, NRC, 19 Dec. 1950.
69. Minutes, meeting of Subcommittee on Shock, Committee on Surgery, Division of Medical Sciences, NRC, 5 Jan. 1951.
70. Minutes, ad hoc Conference on Fat Emulsions for Intravenous Administration, Division of Medical Sciences, NRC, 24 May 1951.
71. Minutes, ad hoc Conference on Fat Emulsions for Intravenous Administration, Division of Medical Sciences, NRC, 19 Mar. 1953.
72. Lewisohn, R.: Blood Transfusion: 50 Years Ago and Today. *Surg. Gynec. & Obst.* 101: 362-368, Sept. 1955.
73. Davis, H. A.: The Transfusion of Conserved Blood. *Am. J. Surg.* 50: 698-702, Dec. 1940.
74. Kendrick, D. B., Jr., and Wakim, K. G.: Intra-Arterial Hypertonic Saline Solution in Experimental Shock. *Proc. Soc. Exper. Biol. & Med.* 40: 114-116, Jan. 1939.
75. Artz, Maj. Curtis P., MC, Sako, Capt. Yoshio, MC, and Bronwell, Capt. Alvin, MC: Experiences with Intra-Arterial and Rapid Intravenous Transfusions in a Forward Surgical Hospital.
76. Conference on Response of the Heart to Intra-Arterial and Intravenous Transfusions in the Treatment of Experimental Hemorrhagic Hypotension, Army Medical Service Graduate School, Walter Reed Army Medical Center, 11 June 1953.
77. Crosby, Lt. Col. William H., MC: A Study of Blood Transfusion as Used in the Treatment of Battle Casualties in Korea. A Preliminary Report from the Surgical Research Team, n.d.

78. Crosby, Lt. Col. William H., MC, and Howard, Capt. John M., MC: The Hematologic Response to Wounding and to Resuscitation Accomplished by Large Transfusions of Stored Blood. A Study of Battle Casualties in Korea, n.d.

79. Crosby, Lt. Col. William H., MC, and Akeroyd, Lt. Col. Joseph H., MSC: Some Immunohematologic Results of Large Transfusions of Group O Blood in Recipients of Other Blood Groups. A Study of Battle Casualties in Korea. From U.S. Army's Surgical Research Team in Korea, and Department of Hematology, Army Medical Service Graduate School, Walter Reed Army Medical Center, n.d.

APPENDIX A

Circular Letters, Mediterranean Theater

Instructions and other information on blood transfusion and allied subjects appeared in the following circular letters from the Office of the Surgeon, Headquarters, NATOUSA (North African (later Mediterranean) Theater of Operations, U.S. Army):

5 April 1943.—Letter No. 8, on the treatment of burns, outlined the treatment of shock and provided for plasma therapy and for the later use of blood to combat secondary anemia (1).

15 May 1943.—Letter No. 13, on forward surgery (2), provided the information on blood donors which later appeared in Letter No. 3, Office of the Surgeon, Headquarters, II Corps, 7 August 1943 (3) (p. 422).

20 August 1943.—Letter No. 27, on the donation of blood for transfusion and other purposes, provided for payment of donors (4) (p. 423).

12 May 1944.—Letter No. 30, on blood transfusions (5), dealt with the establishment of blood banks at field, evacuation, general, and station hospitals, with a transfusion officer responsible for the administration of each bank; the provision of blood from a theater bank; the administration of blood: the indications for transfusion; requirements for donors; dating of blood; reactions; and payment of donors. In this letter, it was stated that the Rh factor had no practical importance in forward areas.

10 March 1945.—Letter No. 8, on the care of battle casualties (6), was concerned with initial wound surgery and mentioned resuscitation, with plasma and blood transfusions, only in passing.

The following medical circulars and circular letter were issued from the Office of the Surgeon, Headquarters, Fifth U.S. Army, NATOUSA:

22 April 1944.—Medical Circular No. 7, stated that group O blood would be provided for all the needs of field hospitals at all times (7). Blood would also be provided for evacuation hospitals in periods of great activity; otherwise, these hospitals must procure and process their own blood. Directions were given for collecting and administering the blood, and criteria for donors were outlined.

6 May 1944.—Medical Circular No. 10 (8) was prepared but not issued. It dealt with the hemoglobinuria nephroses which had followed the use of group O blood in group A recipients and the decision in the future to supply group A blood for group A recipients. The urgent necessity for grouping and crossmatching these bloods was emphasized. Since this decision was overruled, this circular was not issued.

Circular Letter No. 3, issued on 7 August 1943 (3), has already been mentioned. It dealt with the care of the wounded in Sicily. Section III, on shock, stated that plasma was "unquestionably the most effective weapon in combating shock," but directed that, when hemorrhage was the major factor, whole blood was to be used, in adequate quantities, as soon as crossmatching would be completed.

References

1. Circular Letter No. 8, Office of the Surgeon, Headquarters, NATOUSA, 5 Apr. 1943, subject: The Treatment of Burns.
2. Circular Letter No. 13, Office of the Surgeon, Headquarters, NATOUSA, 15 May 1943, subject: Memoranda on Forward Surgery.
3. Circular Letter No. 3, Office of the Surgeon, Headquarters, II Corps, 7 Aug. 1943, subject: Care of the Wounded in Sicily.
4. Circular Letter No. 27, Office of the Surgeon, Headquarters, NATOUSA, 20 Aug. 1943, subject: Donation of Blood for Transfusion and Other Purposes. Act, 30 July 1941 (Public Law 196, 77th Cong.).

5. Circular Letter No. 30, Office of the Surgeon, Headquarters, NATOUSA, 12 May 1944, subject: Blood Transfusions.

6. Circular Letter No. 8, Office of the Surgeon, Headquarters, Mediterranean Theater of Operations, U.S. Army, 10 May 1945, subject: Notes on the Care of Battle Casualties.

7. Medical Circular No. 7, Office of the Surgeon, Headquarters, Fifth U.S. Army, 22 Apr. 1944, subject: Blood Transfusions (paragraph II).

8. Medical Circular No. 10, Office of the Surgeon, Headquarters, Fifth U.S. Army, 6 May 1944, subject: Blood Transfusions.

APPENDIX B

Circular Letters, European Theater

The following circular letters, all from the Office of the Chief Surgeon, Services of Supply, Headquarters, European Theater of Operations, U.S. Army, dealt with blood and plasma in the theater.

1942

Letter No. 52, 22 October, subject: Continuation of Blood Banks in American Army Hospitals. This letter authorized the establishment or continuation of hospital blood banks in active cooperation with local medical authorities. Instructions were given for the organization of panels of donors, for the use of British equipment, and for assistance by U.S. Army officers at the weekly bleedings in British Emergency Medical Service centers. When U.S. Army hospitals wanted blood, it would be available to them from Emergency Medical Service sources. This letter was rescinded with the publication of Circular Letter No. 51, 5 April 1943.

Letter No. 58 (Supply No. 11), 27 October, subject: Blood Plasma. This letter contained instructions for the requisitioning of blood plasma in accordance with Circular Letter No. 47 (Supply No. 8), 19 October 1942. Wet plasma could be secured only at Medical Section Depot G-35. Except in "extenuating circumstances," neither type of plasma was to be requisitioned from British sources. This letter was rescinded with the publication of Circular Letter No. 54, paragraph 2, 9 April 1943.

1943

Letter No. 51, 5 April, subject: Arrangements for Blood Banks and Transfusion in U.S. Army Hospitals. This letter has been abstracted in connection with hospital blood banks (p. 473). It was specified in it that, to set up a blood bank, a hospital must have suitable refrigeration.

Letter No. 84, 19 May, subject: Recording of Transfusions with Dried Serum and Prepared Blood Plasma. This letter provided for the details of these procedures to be entered on the field medical card or any other report used in place of the official records. It was rescinded by Circular Letter No. 80, 10 June 1944.

Letter No. 124, 18 August, subject: Allowance of Item No. 16089, Serum, Normal Human Plasma, Dried-Unit Package.

Letter No. 174, 28 November, subject: Schools and Courses of Instruction for Medical Department Personnel in ETO. The general purpose of this letter was to set forth the purpose and scope of American and British schools providing courses of instruction available to Medical Department personnel in the theater. It also established and clarified the procedures to be followed in utilizing these facilities.

Paragraph 4d described the 7-day courses of instruction offered at the British Army Blood Supply Depot School for medical officers at the Southmead Hospital, Bristol, Gloucester. The courses included the principles and technique of bleeding, processing, storage, refrigeration, and shipping of whole blood, together with the clinical aspects of shock and of whole blood transfusions. Opening dates and allotments for the courses were announced periodically to the major commands and base sections by Headquarters, Services of Supply.

1944

Letter No. 71, 15 May, subject: Principles of Surgical Management in the Care of Battle Casualties. Paragraph 3 of this letter dealt with the ratio of blood to plasma, procurement of blood within the unit, procurement of blood from the European theater blood bank, and its handling and storage after procurement.

Letter No. 80, 10 June, subject: Policies and Procedures Governing Care of Patients in ETO. Paragraph 1 of Section III, "Administrative Directives Pertaining to Professional Care," dealt with blood transfusion in general and station hospitals. The subjects covered included facilities, donors, equipment, storage of blood, technique of collecting and administering blood, laboratory controls, cleaning of sets, records, and filters. This circular letter also dealt with plasma therapy.

Letter No. 131, 8 November, subject: Care of Battle Casualties. Paragraph 6 of this circular letter dealt with whole blood transfusions and covered the sources of blood (from the Zone of Interior and the European theater blood bank), indications for transfusion, ratio of plasma and blood, and a warning that vasoconstriction might explain an initially normal blood pressure reading in a patient who was in need of blood.

Administrative Memorandum No. 150, Office of the Chief Surgeon, European Theater of Operations, U.S. Army, 27 November. This memorandum dealt with transfusion reactions and their management. Instructions were also given in it for weekly reports on the total blood used in each hospital, the total number of reactions, and the details of each reaction. These details were to include the source and age of the blood; the source of the set; the type of reaction; the amount of blood given before the reaction occurred; and the management of the reaction, with the results of therapy.

1945

Letter No. 23, 17 March, subject: Care of Battle Casualties. Paragraph 1 of this circular letter described the technique of a test for differentiating between pyrogenic and hemolytic transfusion reactions. It also described alkalization in lower nephron nephrosis and deaths after transfusion.

APPENDIX C

Circular Letters, Pacific Areas

The following official statements on transfusion and blood banks were issued during the course of the war in the Pacific:

Circular Letter No. 9, Office of the Surgeon, Headquarters, U.S. Army Forces in Australia, 4 June 1942, subject: Blood for Transfusion. This letter, which concerned the payment of donors, was rescinded on 16 June 1942 by Circular Letter No. 21, from the same headquarters, subject: Donation of Blood for Transfusion and Other Purposes. This letter also provided for the payment of donors.

Technical Memorandum No. 13, Office of the Chief Surgeon, Headquarters, U.S. Army Forces in the Far East, 21 September 1944, subject: Blood Bank. This letter concerned the establishment of the blood bank at the 27th General Hospital (p. 389).

Technical Memorandum No. 1, Office of the Chief Surgeon, Headquarters, U.S. Army Forces in the Far East, 7 January 1945, subject: Preservation and Administration of Citrated Whole Blood. This memorandum concerned the general use of whole blood, supply, transportation and storage, criteria for use (age, hemolysis), selection of patients for transfusion, appropriate dosages, determination of compatibility, technical points of administration, and reactions.

Circular Letter No. 35, Office of the Chief Surgeon, General Headquarters, U.S. Army Forces, Pacific, 13 August 1945, subject: Calculation of Hemoglobin, Hematocrit and Plasma Protein (the Copper Sulphate Method). The pertinent part of this letter dealt with the copper sulfate technique.

Circular Letter No. 38, Office of the Chief Surgeon, General Headquarters, U.S. Army Forces, Pacific, 20 August 1945, subject: Whole Blood. This letter covered the provision, delivery, and refrigeration of whole blood; equipment; directions for administration; and indications. It was pointed out in this letter that the condition of the casualty, not the type of wound, determined the amount of blood to be used; that blood was often necessary during and after operation as well as for resuscitation; and that surgery was often a part of resuscitation.

INDEX¹

- A substances, 54, 239
A₂ agglutinogens, 194
Aachen, 522
Abbott Laboratories, 292, 759, 794
Abdominal wounds, 22, 35, 39, 43-44, 705
 hemorrhage in, 705
 in Korean War, 803
 mortality rates from, in SWPA, 634
 plasma in, 393, 462, 697, 698
 transfusion in, 635
ABEL, J. J., 218
Absenteeism after blood donations, 153, 154
Acapnea theory of shock, 29
Accidents, compensation for, in ETOUSA, 530
Accounting practices—
 in ARC blood donor centers, 303
 in plasma program, 300-305
ACD solution. *See* Acid-citrate-dextrose solution.
Acetyl phenylalanine, 351
Acid-citrate-dextrose solution, 208, 209, 211, 213, 214-215, 225-228, 437, 467, 760
 changeover to, on ETOUSA airlift, 214-215, 491
 fibrin precipitation in, 226-227
 in Korean War, 743, 766, 774
 in Pacific airlift, 611-612
 in SWPA, 614
 incorporation of A and B substances in, 260
 selection of:
 before Korean War, 719
 for airlift to ETOUSA, 224-225, 226
 storage of red blood cells in, 318-319
 survival of red blood cells in, 226
 testing of, 225-226
Acid-hematin technique of hemoglobin determination, 43-44
Acidosis in—
 late shock, 34
 lower nephron nephrosis, 667
 shock, 35, 384
Acriflavine in group A serum, 16
Ad hoc committees, NRC, 75
ADAIR, M. E., 277, 278
Adapters, 553, 636
 shortages of, 544
Additives to dried plasma, 283-287
Additives to serum albumin, 349-352
Adjutant General, The, 475, 477, 528, 529, 541
Administrative action concerning—
 A and B substances, 260
 plasma reactions in ETOUSA, 669
Administrative considerations in—
 advance blood banks in ETOUSA, 505-506
 airlift in MTOUSA, 418, 419
 Army blood banks, 446
 blood banks in MTOUSA, 431
 Continental blood bank, 516-517
 deliveries in MTOUSA, 420, 421
 ETOUSA Blood Bank, 183-184, 496, 498-499, 547, 549-550
 field studies in Korean War, 803
 forward bleeding centers, 410-411
 127th Station Hospital Blood Bank, 513-514
 oversea blood program, 463
 payment of donors in MTOUSA, 423-424
 procurement of plasma equipment, 293-294
 6713th Blood Transfusion Unit (Ovhd.), 404, 406-407, 409-411
 transfusion units, 411
 Zone of Interior, 61-98
Administrative errors in blood banks, 244
Administrative Memorandum No. 150, Office of Chief Surgeon, ETOUSA, 27 Nov. 1944-660
Admiralty Group, 591
Adrenal exhaustion theory of shock, 29
Adrenal glands, 373
Adtevac technique of drying plasma, 278
Advance base in SWPA, Australian blood for, 585
Advance base blood bank facility no. 1. *See* Guam.
Advance Base Section, ETOUSA, 509
Advance blood bank detachments, ETOUSA Blood Bank, 553
Advance blood depots, ETOUSA Blood Bank, 214, 497, 498, 500, 501, 504, 505-507, 509
 during Normandy invasion, 512 513

¹ Unless otherwise indicated, all references in this index concern blood and its use in World War II. The term "transfusion," when not qualified, refers only to blood transfusion.

- Advance detachments, Continental Blood Bank, 518-522
- Advance Section, Communications Zone, 510, 517, 520, 521, 522, 550
- Advanced dressing stations, transfusions in, in World War I—6, 8
- Advantages of—
 ACD solution, 226
 dried plasma, 15, 35, 48, 51, 57
 sodium citrate technique in wartime, 6
 unit hospital system for provision of blood, 397
- Aerobacter aerogenes* test, 779
- Aero-Medical Laboratory, 206
- Agana Airfield, 614
- Age of blood, effect of, on transfusion incompatibility, 569
- Age of donors, 139
 in Blood for Britain, 14
 in Spanish Civil War, 11, 12
- Agenda—
 of General Board, ETOUSA, 574
 of staff inspections in Pacific areas, 590-591
- Agencies involved in blood program, 61
- Agglutination:
 in incompatible transfusion, 4
 in rare bloods, 240
 of red blood cells by recipient serum, 7
 caused by oxidized cotton, 380
 reactions:
 in Pillemer technique, 237
 in rabbit sera, 233, 234, 235
 technique, 229
 with grouping sera, 239
- Agglutinin titer(s), 442
 after massive plasma infusions, 671
 for airlift in Korean War, 743, 748
 of group O blood, 657
 of recipient plasma, 653
 tests for, at Walter Reed General Hospital, 696
- Agglutinins of recipient, 240
- Aging blood, reactions due to, 664
- Agitation—
 of blood during storage, 663, 664
 of slides in mass grouping, 240
- AGORE, L., 219
- Agranulocytosis, 142
- AH's, 628
- Aid posts, transfusion in, in World War I—8
- Air Adjutant General, 734
- Air conditioning, 112
- Air embolism, 693
- Air evacuation from Continent, 513
- Air filter, 193
 assembly for serum albumin package, 198
- Air Force:
 base hospitals, 176
 collecting centers in Korean War, 734
 Eighth, 529, 530
 Medical Service Corps, 741
 Ninth, 533-534
 personnel, donations from, 481, 486
 in Korean War, 734
- Air Headquarters, Norfolk House, London, 541
- Air hunger in shock, 384
- Air priorities for airlift from United Kingdom to Continent, 531
- Air raid casualties, 20, 266-267
- Air supremacy, necessity for, for airlift to Continent, 478
- Air Transport Command, 136, 213, 214, 418, 491, 496, 509, 531, 540, 560
- Airborne contamination, 193
- Airborne divisions:
 82d—521
 101st—521
- Airborne troops, serum albumin for, 347
- Aircraft, early lack of, 50
- Airfields (airstrips):
 for takeoff from United Kingdom to Continent, 532
 holding hospitals near, in ETOUSA, 513
 in Pacific area, 594
 in SWPA, 608, 614-615
 location of Army advance banks in relation to, 506
 movement of blood bank advance detachments with, 517
 on Continent, 520, 521, 522, 523, 536, 549-550
 on Luzon, 620
- Airlift:
 capability of, in 1941—268
 estimated capacity of, before Korean War, 773
 for Operation OLYMPIC, 639, 640
 for oversea transfusion service, 465-466
 from Australia to New Guinea, 581, 582, 587-588
 from collection centers in Korean War, 742, 744, 774
 from Guam to—
 Luzon, 621
 Okinawa, 622, 623

- from Italy to southern France, 417, 419, 448-449
- from Leyte to—
 - Luzon, 621
 - Okinawa, 623-624
- from Sydney to Finschhafen, 591
- from United Kingdom to Continent, 19, 459, 478, 510, 518, 531-532, 534-535
 - planning for, 531-535
- from United Kingdom to Norway, 19
- from ZI to ETOUSA, 48, 49, 50, 52, 70, 73, 111, 195, 203, 208-213, 217, 261, 319, 459, 460, 474, 475-476, 477, 478, 479, 481, 484, 486, 488-490, 537, 538-541, 545, 551-553, 557, 559-560, 589
 - analysis of, 211-213
 - delivery time of, 552
 - implementation of, 487-490
 - recommendations for, 222-223, 228, 466-467
 - selection of Alsever's solution for, 224-225, 228
- from ZI to Paris, 495-496, 536
- in British Army Transfusion Service, 17
- in ETOUSA, 521, 547
- in Italy, 417-420
- in Korean War, 713, 729, 739-757, 803-804
 - effect of, on blood, 803-804
- in MTOUSA, logistics of, 418-420
- in Soviet Union, 22
- in SWPA, 590
- in ZI for tests of transportability, 51, 220-221
- to Anzio beachhead, 418-420
- to Okinawa, 631, 639
- to Pacific areas, 73, 136, 213-214, 225, 227, 228, 262, 599-615, 638
 - blood from, for Leyte operation, 618
 - blood from, for Luzon operation, 619, 620
 - initial difficulties in, 602-605
 - operational factors in, 606-612
 - reaction rate in, 668
 - refrigeration for, 203-204, 206-208
 - requirements for, 203-204
 - supply and demand in, 600-602
 - termination of, 629
- Airplanes, serum albumin administration in, 702
- Air raids, provision of blood for casualties in, in United Kingdom, 479
- Airtemp Division, Chrysler Corp., 206
- Airtape, 620
- AKERROYD, Lt. Col. J. H., 803
- Alameda Army Medical Supply Depot, 741
- Alaska, 253
- Albany Hospital, 379
- Albedo, 378
- Albolene, 9
- Albumin. *See* Bovine albumin, Serum albumin.
- Albumin and By-Products Committee, NRC, 84, 240
- Albumin Testing Group, NRC, 300, 333, 334
- Albuminuria in lower nephron nephrosis, 658
- Alcohol:
 - in serum albumin production, 353
 - recovery of, in plasma fractionation, 348
 - sterilization of field transfusion unit, 191, 193
- Aldermaston, 532
- Aldobionic acid, 76, 379-380
- Aleutian Islands, 92, 170
- Alginic acid, 380
- Alkali reserve in shock, 384
- Alkalinization:
 - in exsanguinated casualties, 555
 - in incompatibility reactions, 656
 - in lower nephron nephrosis, 666, 667
 - with multiple transfusions, 444
- All India Institute of Hygiene and Public Health, 645
- ALLEN, J. G., 780
- Allergens in donor's blood, 650-651
- Allergic reactions, 572, 650-651, 660, 661-663, 668
 - etiology of, 650-651
 - to dextran, 793
 - to plasma, 650
- Allied Forces personnel, donations from:
 - in Korean War, 729
 - in MTOUSA, 422
- Allied Medical Departments in World War I—9
- Allied nations, provision of plasma for, 93-95
- Allocations of—
 - blood after D-day, 486-487
 - expendable transfusion sets in SWPA, 598
 - gamma globulin in Korean War, 783-784
 - plasma reserves in Korean War, 775-776
- Allowances of field transfusion units, ETOUSA, 544-545
- ALSEVER, J. B., 171, 222
- Alsever's solution, 208, 209-210, 214, 215, 222, 224-255, 322, 437, 444, 467, 469, 554, 696
 - comparison of, with ACD solution, 226-227

- Alsever's solution—Continued
 composition of, 222
 effect of, on resuspended red blood cells, 316, 317
 selection of, for airlift to ETOUSA, 224-225, 489, 491, 492, 493, 494, 553-554, 611
 ALTMANN, 277
 Alum-precipitated antigens in bovine albumin, 328
 Aluminum caps for intravenous solution bottles, 385-387
 American Airlines, 211
 American Association of Blood Banks, 719, 727
 American Bureau for Medical Aid to China, 642
 American Can Co., 168
 American Expeditionary Forces, 9
 American Federation of Labor, 125
 American Hospital Association, 727
 American Medical Association, 156, 727, 783
 American National Red Cross, 61, 71, 80, 83, 89, 91, 97, 101-137, 204, 205, 237, 252, 261, 267, 269, 271, 274, 276, 290, 291, 292, 293, 294, 295, 296, 301, 302, 303, 304, 306, 307, 309, 310, 311, 313, 314, 329, 337, 340, 343, 344, 376, 396, 424, 426, 451, 491, 493, 542, 552, 596, 618, 638, 675, 695, 713, 719, 721, 726, 733, 734, 737, 739, 740, 767, 774, 775, 784, 785
 assumption of blood program by, 102, 270
 blood donor centers, 76, 89, 101, 102, 111, 114, 257, 261, 290, 307, 345, 490, 491, 494, 759, 760, 606
 accounting practices in, 303
 closing of, 111, 310
 control of, by professional personnel, 76
 equipment for, 294-295
 facilities of, 111-114
 grouping at, 242
 in Korean War, 733-734
 nurses in, 109
 operation of, for Pacific airlift, 600-602
 personnel of, 145, 148
 screening tests for group O blood in, 253
 serologic testing at, 261, 262
 supply of Church containers at, 204
 volunteers in, 111
 Blood Donor Service, 15, 93, 103, 258-259, 313, 314, 464, 492, 560
 blood procurement by, before Korean War, 721, 724
 collection of blood for plasma by, in Korean War, 773-774
 conferences in, 118-119
 experience of, with grouping errors, 241-245
 field directors of, in Sicily, 396
 funds for, 103
 liaison of, with OTSG, 70
 local organization of, 108-111
 logistics of, 103
 management of red blood cell residues by, 313
 manuals, 104
 reorganization of, 103-106
 participation of, in Korean War blood program, 713, 726-727
 participation of, in Pacific airlift, 599-602
 personnel of, 103, 104, 106
 postwar activities of, 714
 professional personnel of, 109-110
 recommendations of, to Subcommittee on Blood Substitutes, NRC, 76
 reorganization of, 106-111
 responsibility of, for blood collected, 82
 role of, in plasma program, 267
 rotation of personnel in, 111
 routine of donations in, 145-148
 terms of agreement with, 103
 title of, to byproducts, 83-84
 transfer of surplus plasma to, 772
 Transport Service, 491
 Canteen Corps, 111, 148
 Hospital Corps, 111
 Medical Advisory Committee on National Blood Program, 727
 Medical and Health Advisory Committee, 83
 Medical and Health Service, 84
 Mobile bleeding units, 114, 118
 Motor Corps, 111, 603
 National Blood Procurement Program, 92
 National Blood Program, 727
 obstacles to procurement program of, 79
 participation of, in Korean War blood program, 713, 726-727
 post-World-War II activities of, 714
 Procurement Division, 294
 program, 713, 726-727
 in Pacific airlift, 599-602
 Public Information Service, 121
 Recreation Corps, 111
 responsibility of, for blood collected, 82
 role of, in plasma program, 267

- Staff Assistance Corps, 111
title of, to byproducts, 83-84
transfer of surplus plasma to, after World War II—772
Transport Service, 491
volunteer services, 111
American Society of Refrigerating Engineers, 203, 273
American Sterilizer Co., 388
American Sugar Refining Co., 794
Amino acids, 380, 797
Ammunition box, use of, for transfusion kit, 191
Amorphous bovine albumin, 330, 331, 332
Amount of donations in—
ARC blood donor centers, 139, 151
ETOUSA, 525
Korean War, 730
Soviet Union, 21
World War I—6, 7-9
MTOUSA, 482
Spanish Civil War, 11-12
Amount of transfusion, relation of, to severity of hemolytic reaction, 650
Amphibious Force flagship, 623
Ampules of blood for forward administration, 22
AMSPACHER, Col. W. G., 553
Amyloid, 327
degeneration due to gum acacia, 791
Anaerobic infection. *See* Clostridial myositis.
Analgesia in shock, 34
Analysis of—
airlift to ETOUSA, 211-213
Blood for Britain, 14-15
British blood program, 16
Anaphylactoid reactions to—
bovine albumin, 324, 331
dextran, 792, 793
gum acacia, 384
ANDERSON, Capt. W. M., 594
ANDREWS, K. R., 217, 230
Anemia:
after donations, 158-160
after multiple transfusions, 804
after shock, 35
after wounding, 805
as cause of failure of resuscitation, 44
as contraindication to serum albumin, 339
development of, during replacement therapy, 34
due to massive plasma infusions, 658
in burns, 697
in Chinese patients, 645-646
in clostridial myositis, 697
in female donors, 158-160
in shock, 34
in wounds of extremities, 703-705
production of, by plasma administration, 43
treatment of, by red blood cell residua, 312, 317, 318
in Korean War, 785
treatment of, in Rh-immunized persons, 249
Anterior poliomyelitis, 363
Anti-A agglutinin titers, in pooled plasma, 258-259
Anti-A agglutinins, 194, 259
Anti-A agglutininogen titer, 258
Anti-A globulins, 237
Anti-A grouping sera, 239
Anti-A rabbit serum, 236
Anti-B agglutinins, 259
Anti-B agglutininogen titer, 258
Anti-B globulins, 237
Anti-B grouping sera, 239
Anti-B rabbit serum, 236
Antibacterial agents, addition of, to serum albumin, 352-354
Antibodies—
in fractions II and III—362
in serum, 336
Antibody titer of pooled plasma, 266
Anticoagulant:
sodium citrate as, 651
See also Sodium citrate.
Anticoagulant solution, packaging of, with glass beads, 185
Antigenicity of—
aldobionic acid, 379
bovine albumin, 324, 326, 327
gelatin, 373, 374, 376
globin, 362
oxypolygelatin, 787
pectin, 378
replacement agents, 726
Antigens in blood substitutes, 373
Antihemophilic globulin, 359
Anti-Rh agglutinins, 246, 249
Anti-Rh antibodies in fraction III-1—359
Anti-Rh serum, production of, 250-251
Anuria—
after transfusion with group O blood, 444
after transfusion with hemolyzed blood, 657
after wounding, 803

- Anuria—Continued**
 from incompatibility reactions, 65-67, 654
 in crushing injuries, 696
 in fixed hospitals, 666
 in lower nephron nephrosis, 658, 666
 in plasma reactions, 671
- Anzio, 406, 407, 418, 440
 Anzio beachhead, 38, 40, 398, 402, 417, 418, 424, 425, 440, 489
 Anzio-Nettuno landings, 398
 APA's, 628
 APH's, 628
 Aplastic anemia, transfusions in, 635
 Appointments in ARC blood donor centers, 113
 Arabs, 424, 442
 ARC. *See* American Red Cross.
 ARC manual, 104, 784
 ARCHIBALD, R. M., 253
 Argonne National Laboratory, 793
 Armed Forces:
 blood banks before Korean War, 718-719
 donations from, in Korean War, 734
 Blood Donor Program, 713, 734
 Epidemiological Board, 781
 experience with mass blood grouping, 244-245
 Medical Advisory Committee, 715
 Medical Policy Council, DOD, 716, 717, 733, 775
 Medical Procurement Agency, 94
 need of, for measles antibodies, 83
 priorities of, for ARC blood in Korean War, 734
 Radio Station, Tokyo, 730
 recommendation for special shock and transfusion service in, 53, 76-79
 responsibility of, for blood in commercial laboratories, 82
 Whole Blood Processing Laboratory, Travis AFB, 739-743, 746
- Armed Services Blood and Blood Derivatives Group, DOD, 721, 722, 734, 740
- Armies:
 British Second Army, 5
 British Third Army, 8
 Eighth U.S. Army, 752, 754, 755, 756
 Fifteenth U.S. Army, 517
 Fifth U.S. Army 42, 391, 408, 445, 446-447, 482, 489
 First U.S. Army, 35, 42, 195, 460, 481, 484, 485, 488, 509, 512, 518, 520, 542, 543, 545, 551, 553, 555, 556, 557, 558, 669
 German Army, 11
 in ETOUSA, use of blood by, 561-566
 Ninth U.S. Army, 518, 520-521, 522, 523, 555
 Seventh U.S. Army, 445-457, 516, 517, 523, 537, 558, 564
 Sixth U.S. Army, 595, 604, 616-618, 619, 620, 633, 635
 Spanish Army, 11
 Tenth U.S. Army, 603, 622, 624
 Third U.S. Army, 460, 485, 487, 518, 520, 542, 545, 558, 669
- Armour Laboratories, 292, 326, 327, 328, 342, 345, 355, 774
 Army acceptance of plasma, 52-53
 Army Advance banks in ETOUSA, deliveries to, 505-506
 Army Advance Section, Communications Zone, ETOUSA, 532-533
 Army Air Forces, 61, 398, 408, 498, 529, 531, 532, 608, 702
 clinical testing of dextran in installations of, 793
 cooperation of, in transportation in southern France, 447
 donations from, in ETOUSA, 487
 responsibility of, for transportation from United Kingdom to Continent, 532
 Army Air resupply strips, 549-550
 Army area, need for blood in, 404-405
 Army Dental School, 87
 Army E flag, 127
 Army Forward Echelon, Communications Zone, ETOUSA, 532-533
 Army Ground Forces, 88
 Army Groups:
 1st—479, 482
 12th—498
 Army hospitals, blood banks in, before Korean War, 718-719
 "Army Hour," 126
 Army information department, 121
 Army installations, use of blood in, in ETOUSA, 561-566
 Army insulated shipping containers in World War II—214, 491, 760
 Army laboratories, 111, 292
 attachments of distributing centers to, 407
 Army Laboratory Manual (TM 8-227), 249
 Army liquid plasma centers, 129
 Army-Marine responsibility for Okinawa Operation, 622
 Army Medical Library, 786
 Army medical personnel in bleeding centers, 109-111

- Army Medical Procurement Agency, 267, 290, 342
 role of, in plasma program, 267
- Army Medical Purchasing Office, 305
- Army Medical Purchasing Officer, 298
- Army Medical Research and Development Board, 803
- Army Medical School, 37, 55, 61, 62, 67, 72, 86, 95, 171, 176, 177, 179, 195, 206, 207, 208, 209, 210, 211, 213, 224, 226, 228, 234, 236, 237, 241, 246, 250, 251, 269, 274, 285, 288, 296, 299, 304, 307, 308, 344, 385, 461, 468, 490, 491, 492, 539, 652, 694, 695, 698
 role of, in plasma program, 267
 training courses at, 86-87
- Army Medical Service Graduate School, 803
- Army Medical Supply Depot, Alameda, 741
- Army Munitions Board, 172, 293, 301
- Army-Navy Award Board, 128
- Army-Navy cooperation in airlift to Pacific, 599
- Army-Navy coordination in—
 Leyte operation, 618, 619
 Pacific, 590
 SWPA, 594
- Army-Navy plasma (serum albumin) package. *See* Plasma (serum) albumin package.
- Army POW's, transfusions for, 558, 565, 569, 570
- Army purchase of serum albumin from Navy, 342
- Army Regulations concerning record keeping, 300
- Army Regulations—
 No. 38-6520-302
 No. 40-1715, 15 Aug. 1942-526, 727
 No. 600-40, 22 June 1931-233
- Army representation in Blood for Britain, 13
- Army requirements for—
 plasma, 291, 293
 serum albumin, 344-345, 347-348
- Army responsibility—
 in ARC Blood Donor Service, 103
 for blood losses, 82
 for plasma contracts, 267
- Army role in plasma program, 267
- Army Service Forces (ASF), 604
 Manual M3, November 1944-86
- Army Signal Corps, 730
- Army supply catalog, listing of plasma in, 268
- Army transfer of ownership of byproducts to ARC, 83
- Army Transport Command, 492, 607
- Army Whole Blood Procurement Program, 259-260
- Army Whole Blood Procurement Service, 559, 560, 695, 696
- ARNEST, Col. R. T., 394, 400, 446
- Arras, 6
- Arterial pressure in shock, 36
- Arteriovenous aneurysm, transfusion in rupture of, 635
- Artery-to-vein transfusion, 3
- Arthritis, red blood cell transfusions in, 317
- Arthrus phenomenon, 324
- ARTZ, Maj. C. P., 799
- Ascending limbs of Henle in incompatibility reactions, 654, 655
- Ashby technique for determination of red blood cell survival, 221, 260, 318, 430, 657, 658
- ASHBY, W., 217, 260, 656
- Ashford General Hospital, 694
- Ashland, 781
- Asphyxia—
 in shock, 665
 of tissues in shock, 30, 56
- Assam, 642
- Assault operations, provision of blood for, 397
- Assistant Chief of Staff, G-1 (Personnel), 729
- Assistant Chief of Staff, G-4 (Logistics), SOS, ETOUSA, 515
- Assistant National Director, ARC, 121
- Assistant National Director, ARC Blood Donor Service, 105
- Assistant Secretaries of Defense, 716
- Assistant Secretary of Defense for Medical Affairs, 716, 795
- Assistant Secretary of Defense (Health and Medical), 716
- Associate Technical Director, ARC Blood Donor Service, 105, 258, 317
- Association of Voluntary Blood Donors, 15
- Asthma after transfusion, 651
- Atabrine, 595
 booster dose of, before transfusion, 423, 598
- Atlanta, 129, 291
- Atlantic City, 118, 695
- Atomic Energy Commission, 726
- Attu, 170
- Atypical pneumonia, 142
- Auburn, 695
- Australia, 582, 591, 598

- Australian blood:
 airlift of, from Port Moresby to U.S. bases, 587-588
 provision of, for U.S. installations in SWPA, 581, 585, 586-588, 591, 598, 630
 technique of blood banking, 581-582, 584
 use of aging blood, 581
- Australian blood bank, 581-582, 608-609, 611
- Australian Red Cross Blood Transfusion Service, 630
- Authorization of donor panel in ETOUSA, 524-525
- Autoclaves, shortages of, 462
- Autoclaving facilities in oversea hospitals, 193
- Autoclaving of transfusion equipment, 17
- Autohemafusion (autoinfusion). *See* Auto-transfusion.
- Autotransfusion, 23, 706
- Auxiliary surgical groups, 707
 2d-42, 693
 3d-556
 provision of field transfusion units for, 544
- Avitaminosis in reactors to plasma, 671
- Ayers, 695
- AYLWARD, F. X., 230
- Azores, 211, 212
- Azotemia in lower nephron nephrosis, 667
- B isoagglutinins, 425
- B recipients of group O blood, 541
- B substances, 54, 239
- Bacillus subtilis*, 379
- Backlog—
 of blood in United Kingdom, 554
 of surgical patients, 487
- Bacterial content of serum albumin, 353
- Bacterial examination of cadaveric blood, 24
- Bacteriologic tests in Blood for Britain, 14
- Bacteriophage, 362
- BAER, K. A., 384
- BAGDASAROV, Lt. Col. A. A., 21
- Bagnoli, 445
- Bailey Co., 760
- Bailey insulated shipping container in Korean War, 760-762
- BAILEY, O. T., 327, 332, 364, 367, 368, 381
- Baltimore, 211, 292
- BANG, Maj. F. B., 598
- Bank blood. *See* Preserved blood, Stored blood.
- Barbour falling drop technique of hematocrit determination, 253
- Barcelona Blood-Transfusion Service, 11
- BARER, A. P., 158
- Bari, 391
- BARKER, F., 3
- BARKER, Col. M. H., 678
- BARR, Col. R. H., 574
- Base collecting section of—
 Naples blood bank, 399, 404-405, 431, 439-440, 445
 training of personnel of, 412
- 6703d Blood Transfusion Unit (Ovhd.), 446-447, 451-452
- 6713th Blood Transfusion Unit (Ovhd.), 425
- Base collecting units, ETOUSA Blood Bank, 462
- Base deficiency in shock, 40
- Base depot of ETOUSA Blood Bank, 497, 498, 500, 546, 550
- Base hospitals:
 delivery of blood to, in MTOUSA, 442
 transfusion in, in MTOUSA, 444
- Base Section, ETOUSA Blood Bank, 501-505, 517
- Base Section, 6713th Blood Transfusion Unit (Ovhd.), 401, 406-407
- Base Section No. 3, SWPA, 582
- Base transfusion unit, British Army Transfusion Service, 16, 17
- Base troops, donations from—
 in ETOUSA, 476, 477
 in SWPA, 638
- Basic laboratory training, 412
- Battalion aid stations:
 plasma in, 57, 59
 reactions to dextran in, 793
 transfusions in:
 in Korean War, 805-806
 in MTOUSA, 406
 in SWPA, 635
- Battle casualties, management of, 471
- Battle casualty rates in MTOUSA, 37
- Battle of—
 Britain, 471
 Bulge, 558
 El Alamein, 32
 England, 498
 Flanders, 48
 Roer, 522-523
- Battlefield transfusions in Soviet Union, 22
- Baumanometer, 636
- Baxter bottles, 13-14, 65, 160, 179, 180, 193, 195, 220, 395, 437, 463, 467, 490, 544, 665

- for airlift to ETOUSA, 491, 492
- receipt of, in MTOUSA, 398, 435
- Baxter Co., 65, 171
- BAYLISS, W. M., 8, 80
- Baylor University College of Medicine, 251
- Beach operations in southern France, 447
- BEASLEY, Col. C. H., 521
- Bedsore, plasma in, 697
- BEECHER, Lt. Col. H. K., 31, 33, 35, 40, 41, 74, 355, 424, 425, 443, 684
- Beecher-Burnett study on shock, 40
- Belgium, 521, 522, 523
- BENEDICT, N. B., 2
- Ben Venue Laboratories, 175, 289, 292
- Benzidine test, 659
 - in incompatibility reactions, 654
 - in lower nephron nephrosis, 667
- BERGMAN, 5
- BERING, Lt. E. A., Jr., 364
- Berkeley, 747
- Berkshire, 532
- Bermuda, 209, 211, 212
- BERRY, Col. F. B., 21, 448, 455
- BEST, C. H., 266
- Beta globulins, 362
 - in bovine albumin, 327
- Beta-propiolactone in treatment of infected pooled plasma, 780
- Beth Israel Hospital, 239
- Biak Blood Depot, 590
 - in Leyte operation, 618
 - in Luzon operation, 620
- Biak Island, 590, 591, 616, 618, 621, 636
- Bilirubin level of blood in serum hepatitis, 781
- Bilirubinemia, 211, 249
 - after transfusion, 229
 - with high-titer group O blood, 260, 696
 - with outdated blood, 657
 - in incompatibility reactions, 654, 656
- Bilirubinuria:
 - losses due to, in MTOUSA, 441
 - rejection of donors with, in MTOUSA, 423
- Billings General Hospital, 695
- BILLROTH, T., 651
- Binnville, 520
- Biochemical similarity of plasma and serum, 268
- Biologic fluids:
 - testing, before transfusion, 239-240
 - testing, for group O blood, 239-240
 - transportation of, 16
- Biological laboratories, representation of, in Blood for Britain, 13
- Biologicals:
 - airlift of, with blood from United Kingdom to Continent, 534
 - handling of, by blood bank detachments in ETOUSA, 512
- Birmingham, 474
- BISCHOFF, T. L. W., 6
- Bizerte offensive, 438
- BLAKE, Lt. Cdr. H. S., 214, 492, 494, 602, 604, 610, 612, 614, 618, 670
- BLALOCK, A., 29, 32, 33, 74, 330, 331, 333, 706
- Blalock clamp, 374
- BLANK, Col. J. M., 585
- Blast injuries, limitation of transfusion in, 21, 34, 225
- Bleeding bottles, requests for, from MTOUSA, 435
- Bleeding center(s):
 - enlisted personnel in, 111
 - in 15th Medical General Laboratory, 406
 - in United Kingdom, 478
 - movement of, in Italy, 406-407
- Bleeding rooms in ARC blood donor centers, 113
- Bleeding schedules in ETOUSA Blood Bank, 501
- Bleeding teams:
 - in British Army Transfusion Service, 17
 - in ETOUSA, 478
 - workload of, in ETOUSA, 476
- Bleeding time after dextran therapy, 794
- Bleeding, training in techniques of, 412
- BLESSE, Brig. Gen. F. A., 398, 400
- BLISS, Brig. Gen. R. W., 489
- Blood:
 - allocation of, for plasma and serum albumin, 301
 - as item of medical supply, 479
 - British transportation of, in World War I—220
 - concept of, as perishable fluid, 16
 - criteria for quantitative replacement of, 559
 - dating periods of, 47, 50, 80, 179
 - deterioration of, after transportation, 50
 - distribution of, in MTOUSA, 420-421
 - donations of, in ZI, 61
 - early discussions of, in management of shock, 50-51
 - early provision of, in ETOUSA, 469-470
 - estimated requirements of, before Korean War, 718
 - evaluation of use of, in ETOUSA, 558-559
 - for ZI hospitals, 292

- Blood—Continued**
- increasing awareness of need for, in ETOUSA, 474-478
 - legal restrictions on use of, 93-94
 - local collection of, in ZI, 128
 - logistics of—
 - supply of, in North Africa, 55
 - use of, 269
 - need for, in combat casualties in North Africa, 394-395
 - obstacles to initial use of, 52-53
 - open collection of, overseas, 180, 193
 - ownership of, 82-84
 - physiology of, 2
 - potential dangers of, 16
 - properties of, 718
 - provision of:
 - for OCD, 91-93
 - in MTOUSA, by unit hospital system, 396-399
 - in ZI hospitals, 97
 - quantitative use of, on Continent, 556-566
 - rationale of replacement of, 57
 - refrigeration of, 203-215
 - in Spanish Civil War, 11
 - requirements for, for airlift, 206-208
 - relative need for, in Army and base areas, 35, 404-405
 - reported shortages of, in ETOUSA, 552
 - storage of, 50
 - for field use, 179
 - in British bottles, 193
 - in general hospitals overseas, 185
 - techniques of collection of, 104, 139, 148-152
 - tests of transportability of, 220-221
 - titration of, 258-260
 - transportability of, 220-221
 - transportation of, 47, 51, 52, 203-215
 - by rail in ZI, 204-205
 - by truck in ZI, 205-206
 - in MTOUSA, 414-417
 - in Spanish Civil War, 11
 - to commercial laboratories, 103
 - use of, in—
 - Army installations in ETOUSA, 561-566
 - France in 1940—19-20
 - versus blood substitutes, 34-35
 - versus plasma, 51, 55-59
- Blood and Blood Derivatives Division, Armed Services Medical Procurement Agency, DOD, 721, 722**
- Blood and Blood Derivatives Group, Armed Services Medical Procurement Agency, DOD, 721, 722, 723, 744, 767**
- Blood bank(s), 49, 78-79, 128**
- administrative considerations of, in MTOUSA, 431
 - before Korean War, 718-719
 - couriers, 419-420, 445, 448-449, 511, 512, 552, 591, 605, 621, 752
 - early discussion of, by NRC, 50
 - establishment of, without supervision, 91
 - first plans for, 101
 - in Armed Forces hospitals before Korean War, 718-719
 - in Army hospitals in Japan after World War II—727
 - in British casualty clearing stations in World War I—218
 - in evacuation hospitals, 406
 - in 15th Medical General Laboratory, 401-404
 - in forward hospitals, 395
 - in general hospitals, 195
 - in hospitals in Sicily, 395-396
 - in MTOUSA, 396-445, 489
 - in United Kingdom before World War II—15
 - limitations of, 706
 - logistics of, in MTOUSA, 397, 406-407, 420-421
 - 9th General hospital blood bank. *See* Leyte blood bank.
 - 19th Medical General Laboratory blood bank. *See* Manila blood bank.
 - on Continent, inspection of, 553-556
 - on LST 464—593, 594-595
 - on LST(H) 951—623
 - 127th Station Hospital Blood Bank, 518, 522, 545, 549
 - detachments of, 520-521, 522-523
 - movement of, to Continent, 522
 - 152d Station Hospital Blood Bank. *See also* ETOUSA Blood Bank.
 - personnel, 195
 - training of, 412-413
 - proposal for establishment of, in New Guinea, 582-586
 - sections in Korea, 728
 - 20th General Hospital, 642-643, 645-646
 - 27th General Hospital blood bank. *See* Hollandia blood bank.
 - See also* special banks.
- Blood bank Facilities Office, Base K, 607**

- Blood bank officer, for—
 Luzon operation, 620
 Okinawa operation, 622
- Blood Bank Storage Depot and Shipping Center, 406th Medical General Laboratory, 728
- Blood-casualty ratio, 460
 before Korean War, 719
 in ETOUSA, 485-486, 487, 556, 561, 565-566, 568
 in Korean War, 729, 752, 756
 in Luzon operation, 620
 in Middle East, 480
 in Okinawa operation, 631
 in Operation OLYMPIC, 640
 in SWPA, 615, 630, 633-634
 recommendations for, 574
- Blood compatibility, studies of, 569
- Blood depots in Korea in Korean War, 752
- Blood derivatives, 718
 inventory of stockpile of, before Korean War, 717
See also Plasma, Serum albumin, Fractions.
- Blood distribution center:
 for Okinawa operation, 622, 623
 on Guam, 614-615
 on Leyte, 630
- Blood donor centers—
 in Soviet Union, 21
See American National Red Cross blood donor centers.
- Blood donors. *See* Donors.
- Blood flow, reduction of rate of, in chock, 30
- Blood for Britain, 13-15, 101, 267, 270, 312
 analysis of operation, 14-15
 criteria of donors for, 14
 errors in, 15
 laboratory tests in, 14
 liquid plasma in, 13-15
 origin of program of, 13-15
 technique of bleeding in, 13-15
- Blood group O. *See* Group O, Universal donors, Dangerous universal donors.
- Blood grouping, 466
 after gelatin injections, 377
 at ARC blood donor centers, 76
 in MTOUSA, 429-442
 in processing laboratory, Travis AFB, 744
 in World War I—6-7
 technique of, 377
 training in, 412
- Blood groups, 237, 245-246, 333
 identification of, 4
- Blood loss:
 at operation, 686
 misconception of magnitude of, 31
 misconception of properties of, before Korean War, 720-721
 quantitative relation of—
 to blood pressure, 12
 to degree of shock, 31
See also Hemorrhage, Loss of circulating blood volume.
- Blood plane in MTOUSA, 418-420, 445, 448-449
- Blood plasma. *See* Plasma.
- Blood Plasma Conference, 299
- Blood Plasma Coordination Center, 95
- Blood Plasma Producers Association, 278
- Blood-plasma ratio, 462-463
 early concept of, 392-393
 estimates of:
 in ETOUSA, 482, 487
 in forward hospitals of ETOUSA, 566
 in forward hospitals of MTOUSA, 437-438
 in MTOUSA, 394, 396
- Blood-plasma replacement therapy, in Spanish Civil War, 11-12
- Blood Plasma Section, Office of Civilian Defense, 79
- Blood-plasma (serum) ratio, in Western Desert, 391
- Blood pressure:
 as index of—
 need for plasma, 697
 shock, 30
 determinations of, on shock wards, 710
 effect of dextran on, 793
 effect of gelatin on, 374, 376
 effect of glucose solutions on, 34
 effect of hemoglobin solutions on, 361
 effect of physiologic salt solution on, 34, 35, 383
 effect of plasma on, 298, 686
 effect of serum albumin on, 355
 elevation of, in resuscitation, 34, 690, 691
 in hematopneic shock, 56
 in incompatibility reactions, 654
 in lower nephron nephrosis, 667
 in plasma reactions, 670
 in reactions from contaminated blood, 665
 in relation to timing of operation, 40
 in shock, 559, 684
 increase of hemorrhage by elevation of, 686
 of donors, 139, 140, 145

- Blood pressure—Continued
 in Blood for Britain, 14
 quantitative relation of:
 to degree of oligemia, 43
 to degree of shock, 39
 to loss of circulating blood volume,
 43-44
 recurrent hemorrhage with restoration of,
 34
 relation of, to blood loss, 12
- Blood program:
 in British Army, 15-21
 in World War I—5-8
 in ETOUSA, 459-575
 in German Army, 22-23
 in Korean War, initial steps of, 717-721
 in MTOUSA, 57, 391-457
 in OTSG, 67-73
 in Soviet Union, 21-22
 in Spanish Civil War, 11-12
 in U.S. Army in World War I—8-10
 legal aspects of, 71, 81-85
 logistics of, in ETOUSA, 547-548
 status of, at onset of Korean War, 713-714
 termination of, after World War II—714
- Blood replacement, concepts of, in Spanish
 Civil War, 11-12
 in resuscitation, 689-693
 individualization of, 690
- Blood Research Division, Army Medical
 School, 95, 210, 224, 228, 274, 296, 304,
 490, 491, 652, 694, 698
 organization of, 61-62
- Blood research program, Army Medical
 School, 65-66
- Blood sludge, red blood cell residua from, 312
- Blood substitutes, 371-381
 criteria of, 372-373
 historical note on, 371
 in World War I—371
 literature of, 65
 nomenclature of, 55, 371
 processing of, 77
 properties of, 372-373
 storage of, in tissues, 373
 versus whole blood in shock, 34-35
See also Plasma expanders.
- Blood Transfusion Branch, OTSG, 721
- Blood transfusion companies: 6825th—445,
 523
- Blood transfusion units, 48
 administrative considerations of, 411
 establishment of, in MTOUSA, 398, 400-
 403
- 6703d Blood Transfusion Unit (Ovhd.),
 445-457, 516
- 6713th Blood Transfusion Unit (Ovhd.),
 404-411, 435, 440-442, 445, 446
- Blood volume:
 as index of shock, 30, 32
 determination of, 31
 under field conditions, 30
- BLUNDELL, J., 1
- Blutflussigkeitsersatz, 381
- Board for Coordination of Malarial Studies,
 144
- Board for Study of Severely Wounded,
 40-42, 426, 666
- BOLAND, C. R., 24
- Bolling Air Force Base, 794
- Bologna, 407, 442
- Bombing of hospital ships, 618
- BOND, D. B., 336
- Bone marrow damage after use of Periston,
 381, 788, 789
- Bone marrow, storage of dextran in, 791
- Bookkeeping methods in ETOUSA blood
 bank, 504
- BOONE, Rear Adm. J. T., 715
- BORDLEY, J., III, 650
- Boston, 111, 214, 221, 248, 331, 494, 600,
 697, 727
- Boston agreement, 727
- Boston Children's Hospital, 364
- Boston City Hospital, 697
- Bougainville, 594
- Boulogne, 20
- Boulogne base in World War I—5
- BOVARNICK, M., 379
- Bovine albumin, 65, 76, 325-335, 345, 359
 clinical testing of, 327, 328, 332, 333, 334-335
 criteria of, for military use, 329-330
 despeciation of, 328, 334
 development of, 326-328
 experimental studies on, 327-328
 globulin content of, 327, 331, 333
 in hemorrhage, 335
 multiple injections of, 327, 328, 330, 331
 production of, 326-327
 properties of, 326, 327, 328, 333
 reactions to, 325, 327, 330-332
- Bovine albumin program:
 suspension of, 331
 termination of, 333-334
- Bovine thrombin, 364
- BOWDRICH, H. P., 265
- Bowman-Gray School of Medicine, 374
- Boy Scouts, 121

- BOYD, M. C., 144, 261
 BOYNTON, M. H., 156
 BRACKEN, Lt. Col. M. M., 589, 590
 Bradycardia, 139
 Brain:
 damage to, in shock, 36, 56, 665
 storage of blood substitutes in, 373
 Brain tumors, fibrin film in surgery for, 368
 Breakage:
 estimated losses from, before Korean War, 773
 losses from, 300-301, 304, 305
 in ETOUSA, 567
 in Korean War, 747
 in MTOUSA, 438
 losses of plasma from, 15
 of plasma package, 163-165, 175
 Breakdown products of hemoglobin in recipient, 221
 BREM, W. W., 220
 Brisbane, 582, 591
 Bristol, 20, 192, 523
 Britain, Blood for, 13-15
 British Ambulance Unit, 12
 British appreciation of need for blood, 475
 British Army, 179, 193, 218
 British Army Blood Supply Depot, 470, 471, 508
 British Army Medical Services, 179
 British Army transfusion equipment, 179, 473, 660
 British Army Transfusion Service, 15-21, 67, 78, 391, 433, 462, 469, 473, 474, 475, 476, 480, 528, 530, 544-545, 706
 British base collecting units, 397
 British bleeding bottles, 193, 194, 195, 433, 525, 544
 British blood bank system, 396, 397, 404
 analysis of, 16
 British blood banks, donations to, by U.S. troops, 528-530
 British cooperation in blood program in OTSG, 54, 391
 British dextran, 791, 794
 British Eighth Army, 461, 532
 British Emergency Medical Service, 16-17, 179, 473, 529
 British Expeditionary Forces in World War I—7
 British experience—
 in France, 18-20
 in Middle East, 480
 in MTOUSA, 461-462
 in North Africa, 54-55, 177, 476, 478
 in Western Desert, 291
 in World War I—5-8
 with plasma additives, 285
 British field ambulance, 17
 British field dressing stations, 17
 British field surgical units, 17
 British field transfusion teams, 17-18, 397
 on Anzio beachhead, 403, 407
 British hospitals, care of U.S. troops in, 94
 British management of battle casualties, 471
British Medical Journal, 7, 19, 20, 265
 British Medical Liaison Officer, 54, 391
 British Medical Research Council, 15, 293
 British Medical Service, 220
 in World War I—6
 British Ministry of Health, 15
 British Naval Headquarters, 549
 British personnel, care of, in 127th Station Hospital, 513
 British provision of—
 blood for Anzio beachhead, 55, 398
 for station hospitals, 473
 in North Africa, 55
 intravenous fluids, 382, 397
 items for field transfusion sets, 544
 plasma, 469-470
 refrigerators before D-day, 541
 British purchase of plasma from commercial laboratories, 94
 British recipient set, 194
 British Red Cross, 529
 British supplies for ETOUSA Blood Bank, 508
 British training in intravenous therapy, 85
 British transportation of blood in World War I—220
 British transfusion units, 55, 397, 398, 440, 476
 British troops, donations from, in MTOUSA, 422
 British use of ACD solution, 226
 British War Office, 530
 Brittany Peninsula, 520
 BRODIE, T. G., 266
 BRONWELL, Capt. A. W., 799
 Brooke General Hospital, 695, 792
 Brooklyn, 50, 94, 290, 291, 342, 600
 BROWN, Lt. Cdr. H. R., 602, 603, 607, 614, 615, 632, 633, 640
 Brussels, 219
 Bryn Mawr Hospital, 65, 102, 266, 336
 BUCKLEY, E. S., Jr., 769-770
 Budgets for American Red Cross Blood Donor Service, 103

- Buenos Aires, 218
 Buffalo, 291
 Bulk of preservative solutions, 228
 Bulletin, Subcommittee on Blood Substitutes, NRC, 79
BUMED, 254
 BURCH, L. E., 23
 Bureau of Budget, 775
 Bureau of Prisons, U.S. Department of Justice, 781
 Burma, 642
 BURNETT, Maj. C. H., 424
 Burns:
 clinical resemblance of, to lower nephron nephrosis, 655
 dextran in, 793
 fibrin film in, 368
 fibrinogen film in, 364
 fragility curve in, 657
 gelatin in, 274, 377
 hemoconcentration in, 30
 incidence of, 77
 liquid plasma in, 270
 local use of plasma in, 590
 plasma in, 35, 55, 266-267, 297, 462, 617, 697
 replacement therapy by femoral vein in, 694
 replacement therapy in, 34
 serum albumin in, 338, 347, 354, 702
 serum in, 336
 shock in, 32, 374, 697
 thrombin in, 364
 BUSHBY, S. R. M., 210, 229
 Business firms, recruitment of donors in, 125
 Byproducts, 61, 76
 commercial production of, 71
 contracts for, 84, 267
 equipment for processing of, 84
 legal problems in commercial production of, 71
 license for production of, 81
 of plasma fractionation, 342, 347
 storage of, 82
 See also special byproducts.
- C-47 planes for transportation, in—
 ETOUSA, 533, 534-537, 550
 MTOUSA, 418-420
 C-64 planes for transportation on Continent, 535, 537
 Cabarrus Hospital, 65
 Cadaveric blood, 12, 23, 24
 investigation of, in Korean War, 785
 Cadres for transfusion teams in SWPA, 606
 Cairo, 382, 391
 Calcium content of blood:
 effect of citrate on, 770
 effect of ion exchange resins on, 770
 Calculated risk of plasma infusions in Korean War, 781
 Calcutta, 642, 645
 CALLENDER, Brig. Gen. G. R., 49, 61, 64, 228, 237, 382, 603
 Camouflage of expendable insulated containers, 214
 Canada, 159
 Canadian Army, 85
 Canadian National Research Council, 158, 347, 379
 Cancellation of appointments for donations, 120, 125
 Cancer, transfusion of cadaveric blood in, 24
 Cannes, 573
 CANNON, Lt. Col. W. B., 29, 49, 51, 73, 80, 85, 334, 336, 338
 Canteens in ARC blood donor centers, 111, 114, 148
 CANTWELL, 1
 Capacity of—
 commercial processing laboratories, 271
 ETOUSA Blood Bank, 480-481, 482, 485, 488, 500, 509
 refrigeration for D-day, 541-542
 Cape Gloucester, 591
 Capillary bed, red blood cell counts from, 30
 Capillary leakage of colloid solutions, 52
 Capillary permeability in shock, 30, 36
 Carbon dioxide combining power of blood in shock, 39
 Carbon dioxide poisoning:
 autotransfusion in, 23
 transfusion in, 7
 Carbon dioxide snow, 277, 278
 Carbon steel, 172
 CARBONNELL, Lt. Col. A. J., 722
 Cardiac embarrassment during transfusion, 12
 Cardiac failure:
 after plasma infusion, 570
 overloading of circulation in, 318
 Cardiac function in shock, 11
 Cardiac output:
 decrease of, in shock, 30, 32, 36
 relation of, to degree of shock, 36
 Cardiac tamponade in shock, 688
 Cardiorespiratory embarrassment in shock, 688

- Cardiovascular accidents after donations, 157**
Cardiovascular disease in donors, 142
Cardiovascular response to wounding, 39-40
Cargo LST's, blood on, in Luzon operation, 621
Cargo space for--
 airlift from United Kingdom to Continent, 532, 538-541
 airlift from ZI to ETOUSA, 538-539
 insulated containers for Australian airlift, 581
 insulated containers for Pacific airlift, 610
Carinola, 407
Carlisle Barracks, 54, 87
Carpopedal spasm after donations, 157
CARREL, A., 13
CARTER, Col. B. N., 48, 67, 88, 249, 461, 462, 464, 465, 492, 493, 551, 606, 694
Case fatality rates--
 after transfusion, 1, 2, 3, 5
 in lower nephron nephrosis, 667
 in severe shock, 44
Case histories on--
 concealed hemorrhage in serum albumin administration, 339
 effects of plasma infusion, 35
 fatal plasma reactions, 671-672
 fatality after transfusion with group O blood, 424
 hemostasis with fibrin foam, 355-367
 intravascular hemolysis of recipient's cells, 656
 lead encephalitis, 368
 lower nephron nephrosis, 658
 plasma infusions, 637
 reaction to group O blood by group A recipient, 424
 serum albumin in burns, 338
 serum albumin in shock, 337
 serum hepatitis, direct human transfer of, 678-679
 serum sickness after bovine albumin therapy, 330, 332, 333
 transfusion before surgery for multiple wounds, 569
 unwise use of blood in blast injuries, 21
Caserta, 453
Cash allotment to Office of Civilian Defense for emergencies, 91
Cassino, 39
Cassino campaign, 38, 40, 405, 418
 delivery of blood in, 417-418
CASTELLANOS, A., 312
CASTLE, W. B., 663
Casts--
 in lower nephron nephrosis, 659
 in plasma reactions, 671
Casualties:
 estimates of--
 in Okinawa operation, 624
 in Operation OLYMPIC, 638
 selection of, for surgery, 683-684
Catalog listing(s) of--
 components of improved transfusion set, 193
 plasma package, 166
 sodium chloride, 234
Cathode-ray irradiation of infected pooled plasma, 780
CATOR (Combined Air Transport Command Operations Room), 533, 540, 541
Causes of--
 allergic reactions, 650-651
 death in battle casualties, 38
 pyrogenic reactions, 652-653
 reactions, 649-650
CBI. See China-Burma-India.
Cell swelling during storage, 222
Cellophane tubing, 171, 463
Cellular fragility of preserved blood, 222
Cellular potassium in a preserved blood, 229
Cellulose tubing, 171
Central Blood Transfusion Institute of Moscow, 21, 24
Central control, advantages of, 511
Central distributing facility--
 for Luzon operation, 620-621
 on Guam, 600, 602, 607, 620-621
Central laboratory, recommendation for, in MTOUSA, 398
Central nervous system:
 effect of diffuse intracapillary agglutination on, 664
 injuries of, as cause of failure of resuscitation, 44
Central nervous system:
 limited transfusion in wounds of, 21
 shock in wounds of, 32
Central Pacific Area, 591, 594
Centrifugation technique of--
 blood grouping, 240, 243-244
 hematocrit determination, 254
 mass blood grouping, 238
 plasma production, 13, 293, 299
Centrifuge technique, 259
Centrifuged plasma, hemoglobin of, after transportation, 220-221

- Centrifuges, shortages of, 293, 294, 342
 for Pacific airlift, 603
 for serum albumin program, 343
 in CBI, 642
- Cerebral hemorrhage after donations, 157
- Changeover to—
 ACD solution on ETOUSA airlift, 214-215
 expendable insulated containers on
 ETOUSA airlift, 214-215
 large plasma package, 89-91
- Channel, 549
- Channel Base Section, ETOUSA, 524-525
- Channel ports, 514
- CHAPIN, M. A., 221, 260
- Chaplains, aid from, in securing donors, 396
- Chapter directors, ARC, 106, 108-109
- Charts for copper sulfate test, 254-255
- CHASNOFF, Lt. Col. J., 513
- Chef du Pont, 520
- Chelsea, 740
- Chemical adsorption, 277
- Chemical Division, Army Medical School,
 237, 296
- Chemical peritonitis, 705
- Chemical purity of serum albumin, 345
- Chemical similarity of human and bovine
 albumin, 326
- Chest:
 autotransfusion in wounds of, 23
 limited transfusion in wounds of, 21
 wounds of, 39, 43-44, 635, 688, 705-706,
 710
- Chicago, 119, 206, 292, 310, 600, 638, 719
- Chief Consultant in Medicine, ETOUSA,
 479
- Chief Consultant in Surgery, ETOUSA, 479,
 496
- Chief, Finance and Supply Division, Office
 of Chief Surgeon, ETOUSA, 496
- Chief of Ordnance, 515
- Chief of Staff, ETOUSA, 532
- Chief of transfusion service in Z1, 464
- Chief, Operations Division, Office of Chief
 Surgeon, ETOUSA, 479
- Chief, Plans and Operations, Office of Sur-
 geon, First U.S. Army, 553
- Chief, Professional Services Division, Office
 of Chief Surgeon, ETOUSA, 471-472,
 547
- Chief, Supply Division, Office of Chief
 Surgeon, ETOUSA, 494-495, 548
- Chief Surgeon, ETOUSA, 511
See also HAWLEY, Brig. Gen. P. R.
- Chief Surgeon, USAFFE, 755
- Chief Surgeon, USAFPAC, 629
- Chief Surgical Consultant, OTSG, 64, 464
See also RANKIN, Brig. Gen. F. W.
- Chief, Transportation Corps, ETOUSA, 531
- Children's Hospital, Boston, 248
- Children's Hospital, Cincinnati, 226
- Chilled blood, 636, 694
 for exsanguinated casualties, 555-556
- Chills:
 after early use of sodium citrate, 651
 after transfusion, with—
 citrated blood, 219
 group O blood, 424
 preserved blood, 22
 differential diagnosis of, 649
 due to Rh incompatibility, 249
- China, national blood program in, 642
- China-Burma-India theater, 387, 642-646
 complaints about intravenous solutions
 from, 385-387
- Chinatown, 642
- Chinese:
 provision of blood and plasma for, in CBI,
 645-646
 Rh factor in, 246
- Chloride levels of blood in shock, 38
- Chronic wound infection, 7
- Chronology—
 of pyrogenic reactions, 653
 of shock, 31-32
- Chrysler Corp., 206
- Chrysler refrigerator, 206, 208
- Church Co., 204, 206
- Church containers, 204-205, 206, 299, 603,
 744
- CHURCH, Maj. E., 204, 205
- Churches, cooperation of, in recruitment of
 donors, 118
- CHURCHILL, Col. E. D., 37, 55, 57, 391-392,
 394, 395, 425, 443, 462-463, 485, 683,
 684, 692, 697
- CHUTE, Maj. A. L., 382
- Cincinnati, 226, 291
- Circular—
 No. 73, Department of the Army, 20 Aug.
 1953-126
- Circular letters, 72, 604
 No. 3, Office of Surgeon, II Corps,
 NATOUSA, 7 Aug. 1943-422-423
 No. 22, Office of Surgeon General, 22 Feb.
 1943-91
 No. 27, Office of Surgeon, NATOUSA, 20
 Aug. 1943-423

- No. 38, Office of Chief Surgeon, USAFPAC, 20 Aug. 1945—629
- No. 51, Office of Chief Surgeon, ETOUSA, 5 Apr. 1943—472, 530
- No. 53, Office of Chief Surgeon, ETOUSA, 19 June 1945—680
- No. 88, Office of Surgeon General, 4 Sept. 1941—234
- No. 108, Office of Surgeon General, 27 May 1943—46-48, 72, 180, 192, 193, 194, 463-464, 465, 466
- No. 112, Office of Surgeon General, 26 Nov. 1941—234
- Circulating blood volume:
- bovine albumin in elevation of, 326
 - delay in restoration of, 683
 - determination of, 42-44
 - effect, of—
 - aging blood on, 555
 - crystalloid solutions on, 371
 - gelatin on, 377
 - plasma on, 462
 - further loss of, in untreated shock, 40
 - in air raid casualties, 266-267
 - in hematopneic shock, 56
 - loss of, as cause of shock, 29, 30, 32, 33, 36, 37, 54
 - quantitative relation of loss of, to blood pressure, 43-44
 - reduction of, in shock, 336, 665-666, 684
- Circulation:
- bovine albumin in reduction of, 326
 - concentrated plasma in embarrassment of, 50
 - delay in restoration of, 683
 - determination of, 42-44, 255
 - discovery of, 1
 - effect of—
 - aging blood on, 555
 - crystalloid solutions on, 371
 - gelatin on, 377
 - in air raid casualties, 266-267
 - maintenance (restoration) of, by plasma, 21, 462
 - overloading of, by transfusion, 12, 198
 - reduction of, in shock, 336, 665-666, 684
- Circulatory collapse in—
- infections, 32
 - intra-abdominal injury, 32
 - peritonitis, 32
 - reactions from contaminated blood, 665
- Cirrhosis of liver:
- globin in, 783
 - serum albumin in, 354
- Citrate transfusion technique in Spanish Civil War, 11
- Citrated blood:
- clotting of, 553-554
 - dating period of, 219
 - empirical use of, in shock, 31
 - first use of, 208
 - in World War I—9
- Citrated blood technique in British blood program, 17
- Citrated cadaveric blood, 24
- Citrated plasma, 166, 265, 266
- Citric acid as diluent for dried plasma, 76, 286-287
- Citrus fruit, yield of pectin from, 378
- Civic meetings, recruitment of donors at, 125
- Civilian blood banks, cooperation of ARC with, in Korean War, 738
- Civilian blood program in Germany, 22
- Civilian catastrophes, provision for, 91, 102, 271
- Civilian committees, studies by, in post-World-War II period, 715-717
- Civilian defense in Korean War, 714, 718
- Civilian distribution of excess blood in Luzon operation, 622
- Civilian donations—
- at Marseilles bleeding center, 453
 - in ETOUSA, 462
 - in Japan in Korean War, 729
- Civilian experience with shock, 29
- Civilian hospitals:
- blood supply to, by ARC, 713
 - care of military personnel in, 129
 - posttransfusion cleaning routine in, 652
- Civilian needs in Great Britain, 15, 16
- Civilian physicians, employment of, in bleeding centers, 109-110
- Civilian population, release of globulin to, 85
- Civilian possibilities for bovine albumin, 326
- Civilian practice, intravenous therapy in, 7
- Civilian requests for byproducts, 84
- Civilian requirements in Korean War, 735
- Civilian share of gamma globulin in Korean War, 783-784
- Civilian sources of blood, 101
- Civilian transfusion equipment, 177
- Civilian use of—
- byproducts, 84
 - gum acacia, 384
 - red blood cell residua, 312-319
 - surplus plasma, 310-311, 772
 - transfusion, 48

- CLARKE, H., 351
- Classification of shock, 39, 689
- Classification station in Spanish Civil War, 11
- Cleaning of—
 donor sets in MTOUSA, 432, 434, 436
 improvised transfusion equipment, 180, 186, 463
 recipient sets in MTOUSA, 440, 444
 transfusion equipment, 196, 219
 in field, 179, 190
 in hospital blood banks in ETOUSA, 474
- Clearing companies:
 blood for, in Luzon operation, 621
 blood for, in SWPA, 634
 donations from, 393, 569
 field transfusion units for, 544
 plasma reactions in, in SWPA, 673
- Clearing stations:
 field hospitals adjacent to, 684
 7th Division, 558
 transfusions in, 406
 use of expendable insulated containers in, 214
- Cleveland, 292
- Climate, effect of—
 on cellulose tubing, 171
 on plasma package, 172
 on reconstitution of plasma, 170
- Climatic conditions during airlift to ETOUSA, 213
- Clinical considerations—
 in ETOUSA, 497, 553-556
 in SWPA, 633-636
- Clinical course in incompatibility reactions, 654
- Clinical effects of hemolysis of recipient cells, 656, 806
- Clinical experience with crystalloid solutions in World War I—371
- Clinical picture in—
 lower nephron nephrosis, 666, 667
 plasma reactions, 670-672
 pyrogenic reactions, 653
 reactions, due to—
 contaminated blood, 665
 incompatibility, 653-654
 Rh incompatibility, 24C, 249
- Clinical studies—
 on dextran, 790, 791-794
 on dried plasma, 101-102
- Clinical testing of—
 bovine albumin, 327, 328-332, 334-335
 commercial plasma, 297
 fibrin film, 368
 fibrin foam, 365-367
 fraction II—363
 gelatin, 375, 376
 pectin, 379
 serum albumin, 337-339, 345, 354-355
 serum albumin, criteria of, 339
 thrombin, 364
See also Testing.
- Clinical use of liquid plasma, 96
- Clinical value of gum acacia, 384
- Clipper planes, 14
- Closed collection system, 15, 178, 180, 217, 266, 273, 274, 462, 468, 469
 in ARC blood donor centers, 148-152
 in Blood for Britain, 13
 in ETOUSA Blood Bank, 502
 in ETOUSA hospitals, 463
 in Spanish Civil War, 11
 on LST 464-595
 preparation of frozen plasma in, 273
 violation of, 307
- Closing of ARC blood donor centers, 111, 310
- Clostridial myositis, 24, 62, 140, 384, 546
 as cause of shock, 38, 39, 688
 plasma in, 697
- Cloth filters, 169-170
- Clotting:
 after use of gum acacia, 384
 during bleeding, 9, 435
 during transfusion, 4, 189, 193, 553-554
 in Korean War, 747
 losses from, 110
 in MTOUSA, 438
 in Okinawa operation, 627
 of plasma, 285, 309-310
 prevention of, 726, 770
- Clotting time, effect of oxidized cotton on, 380
- CO₂-cooled "pigs," 279
- Coagulating properties of thrombin, 363
- Coagulating time:
 after pectin injections, 377
 shortening of, from use of sodium citrate, 218
- COATES, Col. J. B., Jr., 475
- Cocktail transfusions, 428-429
- Cocoanut Grove disaster, 29, 249, 697
- COGA, A., 1
- COGGESHALL, L. R., 143

- COHN, E. J., 71, 74, 81, 82, 83, 84, 221, 237, 240, 241, 261, 271, 285, 325, 326, 327, 328, 331, 332, 333, 334, 336, 337, 340, 341, 342, 343, 344, 345, 347, 348, 349, 350, 352, 353, 354, 359, 363, 365, 374, 375, 378, 379, 380, 714, 725, 726, 769, 770
- COHEN, J. H., 374
- COLBY, Col. E. G., 607
- Cold isoagglutinins after transfusions with low-titer O blood, 806
- Collapsed veins, transfusing, 436
- Collected cases—
in World War I—5
of autotransfusion, 23
of early transfusions, 2
with cadaveric blood, 24
- Collecting bottles:
for ACD solution, 225, 227, 228
for Alesver's solution, 228
for Blood for Britain, 14
in Soviet Union, 22
siliconizing of, 726
- Collecting section of ETOUSA Blood Bank, 501-502
- Collecting stations, transfusions in, in MTOUSA, 406
- Collecting teams—
in ETOUSA, 463, 466
in Korean War, 714
- Collecting techniques—
in ARC blood donor centers, 104, 148-152
in MTOUSA, 426-428
- Collecting tubules in incompatibility reactions, 654, 655
- Collecting units in general hospitals in ETOUSA, 465
- Colloid solutions, properties of, 52
- Colmar Pocket, 450
- Color of expendable insulated containers, 214
- Colorado State Penitentiary, 259
- Colostomy, plasma after closure of, 705
- Columbia University College of Physicians and Surgeons, 74, 258, 380
- Columbus, 158, 160, 291
- Combat casualties:
donations from, in MTOUSA, 422
evolution of use of blood for, 47-59
ratio of transfusion sets to, in ETOUSA, 544-545
- Combat troops:
approval of bleeding of, in ETOUSA, 527
donations from:
in ETOUSA, 524, 529
in Korean War, 718
in MTOUSA, 396, 422
in SWPA, 595
- Combined Air Transport Operations Room (CATOR), 533, 540, 541
- Combined landing operations, serum albumin in, 347
- Command channels, logistics of transportation of blood in, 531-532
- Commandant, Army Medical School, 61
- Commander, Service Force, Pacific (Com-ServPac), 623
- Commander, U.S. Naval Forces, Europe, 511
- Commanding General—
ADSEC, 550
Army Air Force, ETOUSA, 531
Army Service Forces, 465
ETOUSA, 479, 485, 496, 524-525, 531
First U.S. Army, 533, 543, 545
1st Army Group, 479, 533
Ninth Air Force, 532, 533, 550
POA, 640
Third U.S. Army, 533
U.S. Strategic Air Force, 533
- Commanding officer, 1st Medical Laboratory, 511
- Commandos, 447
- Commercial blood banks before Korean War, 719
- Commercial processing laboratories, 71, 104, 108, 114
achievement of, 275
contamination at, 308
inspections of, 298-299
location of, 120
losses of blood in, 83
records of, 297
role of, in plasma program, 267
supervision of production of grouping sera in, 241
- Commercial procurement of intravenous fluids, 71, 382-383, 388
- Commercial production of—
A and B substances, 260
blood substitutes, 373
byproducts, 71
dextran, 794-795
equipment before Korean War, 719
for plasma program, 293-295
fat emulsions, 796
fibrin foam, 365

- Commercial production of—Continued
 fraction II—362
 gelatin, 373, 374, 375, 376
 Periston, 788–789
 plasma, 101, 269, 280–282, 289–293
 before Korean War, 719
 in Korean War, 734
 plastic apparatus, 759
 serum albumin, 71, 290, 341–347
 contracts for, 341–344
 specifications for, 348
 testing of, 344–347
- Commercial provision of plasma for Free French, 94
- Commercial refrigeration for plasma, 273
- Commercial Solvents Corp., 793, 794, 795
- Commercial transfusion equipment, 437, 464
 in ZI hospitals, 177
- Commission on Reorganization of Executive Branch of Government, 715
- Committee(s) appointed to study health and medical matters after World War II—715–717
- Committee(s) on—
 Blood and Blood Derivatives—
 ARC, 727
 NRC, 723, 724, 725, 726, 758, 766, 767, 769, 783, 790
 Blood and Related Problems, NRC, 769, 781, 785, 787, 790
 Medical and Hospital Services of Armed Forces, 715
 Medical Research, OSRD, 84, 229, 230, 329, 333, 326, 334, 354, 362, 365
 National Research Council, 73–75
 Shock, NRC, 724, 786
 Surgery, NRC, 30, 51, 714, 802
 Surgical Shock and Allied Conditions, NRC, 371
 Transfusion Equipment, NRC, 171, 184
 Transfusions, NRC, 33, 41, 47, 49, 51, 53, 61, 73, 74, 101, 102, 103, 220, 267, 269, 325, 336, 337, 371, 468, 706
See also Conferences, Subcommittees, Professional meetings, etc.
- Commonwealth of Massachusetts, 341
- Communications between Continental Blood Bank and advance detachments, 517
- Community collections, 92
- Comparative tests of ACD and Alsever's solutions, 226–227
- Compatible blood, hemolytic reactions after use of, 245–246
- Compatible donor cells, intravascular hemolysis of, 653
- Compatibility:
 criteria of, 4
 difficulties in paraplegics, 695
 tests, 4
- Compensation for accidents in ETOUSA, 530
- Complaints concerning intravenous solutions, 384–388
- Complement, 270, 273, 286, 287
 absence of, in serum albumin, 702
 components of, 359
 in serum, 336
- Complications of (reactions to)—
 plasma, 668–680
 transfusion, 649–668
See also Reactions, Special reactions.
- Components of—
 Ebert-Emerson transfusion set, 36–39
 expendable donor set, 196
 expendable recipient sets, 196
 field transfusion unit, 186–189
 improvised transfusion set, 193
 original plasma package, 163, 165
 pectin, 378
 plasma, 270, 273, 336
 plasma fractions, 359–360
 loss of, 286
 plasma package, 166–168, 169–172, 702
 serum albumin package, 198
- Composition of—
 ACD solution, 227–228, 229
 Alsever's solution, 222, 228
 Armed Services Blood and Blood Derivatives Group, 722
 blood substitutes, 372
 dextran, 790–791
 gelatin, 376
 modified DeGowin et al. solution, 222
 modified Rous-Turner solution, 219
 shock teams on Okinawa, 626
 6703d Blood Transfusion Unit (Prov.), 445–446
 "slough preservative," 221
- Compound fractures of femur, 392, 444, 698
- Concealed hemorrhage in serum albumin therapy, 339, 702
- Concentrated plasma, 50, 173, 270, 275, 276, 698
- Concentration of antibodies in fraction II—362
- Concept(s) of—
 blood as perishable fluid, 16

- blood replacement in Spanish Civil War, 12
- hemorrhage as cause of shock, 265, 706
- lower nephron nephrosis, 666
- need for whole blood in Pacific, 582
- plasma, 392, 706
 - in Pacific, 584
- professional handling of blood, 752-754
- replacement therapy after World War I—31
- replacement therapy as specialized branch of medicine, 76-79, 469
- resuscitation, 683
- shock, 29-33, 37-38, 41-42, 684-686
 - at outbreak of World War II—30-33
 - evolution of, 37-38
 - in World War I—7, 8-9, 31-32, 51
 - therapy, development of, in MTOUSA, 48-49
- transfusion, 29
 - as basic component of shock therapy, 47-49
 - in forward areas, 48-49
 - reactions, 657-658
 - reactions, errors in, 657-659
- value of plasma, 48, 310, 482
- whole blood for combat casualties, evolution of, 47-54
 - in Pacific, 586
 - replacement in MTOUSA, 54-57
- Conference(s) on—
 - Albumin, NRC, 338, 339, 340, 342, 345, 352
 - Albumin and Byproducts, NRC, 340, 342, 354, 381
 - Albumin Testing, NRC, 198, 331, 332, 343
 - Blood Donor Program, 118-119
 - Blood Grouping, NRC, 53, 82, 237, 238, 242, 248, 249, 464
 - Blood Group-Specific Substances A & B, NRC, 260
 - Blood Preservation, NRC, 110, 210, 213, 226
 - Blood Preservation and Red Cell Suspension, NRC, 229, 248-249
 - Blood Procurement, NRC, 109
 - Bovine Albumin, NRC, 330
 - Derivatives of Plasma Fractionation, NRC, 776, 781
 - Differential Agglutination of Erythrocytes, NRC, 769
 - Epidemiology of Poliomyelitis, 784
 - Fat Emulsions for Intravenous Administration, NRC, 795
 - Pectin, NRC, 377
 - Plasma Fractionation, NRC, 361
 - Preparation of Normal Human Plasma, NRC, 343
 - Preparation of Normal Human Serum Albumin, NRC, 198
 - Preserved Blood, NRC, 221, 229
 - Radioactive Dextran, NRC, 792-793
 - Resuspended Red Blood Cells, NRC, 260
 - Revision of Army Manual on Blood Grouping, NRC, 252
 - Shock, NRC, 258
 - Transfusion Equipment, NRC, 53
 - Transfusion Equipment and Procedure, NRC, 171, 221, 237
 - Uses of Gamma Globulin, NRC, 783
- Congenital anomalies, 368
- Conglutination of red blood cells caused by gelatin, 374, 375
- Congress, 716
- Congress of Industrial Organizations, 125
- Conservation of—
 - critical materials, 175
 - shipping space, 185
- Construction of—
 - Army insulated shipping containers, 214
 - Bailey insulated shipping containers, 760-761
 - ETOUSA Blood Bank, 498-499
 - Hollinger insulated shipping containers, 762-763
 - insulated shipping containers in MTOUSA, 417
 - Navy insulated shipping containers, 213-214, 609-610
- Consultant(s) in medicine—
 - Office of Surgeon General, 680
 - Third U.S. Army, 509
- Consultant(s) in resuscitation, Whole Blood and Shock for Okinawa operation, 603, 604
- Consultant(s) in surgery in—
 - ETOUSA, 469-470
 - Fifth U.S. Army, 391-392, 690
 - First U.S. Army, 486, 553
 - MTOUSA, 37, 398, 463
 - Sixth U.S. Army, 619, 633
 - SWPA, 639
 - Tenth U.S. Army, 624
- Consultant in Transfusion and Shock, ETOUSA, 472
- Contaminated blood, 304-305, 503, 552, 581-582, 638, 659, 720

- Contaminated blood—Continued
 accounting for, 302
 reactions from, 665
- Contaminated distilled water, 651, 673
 as cause of pyrogenic reactions, 652
 in MTOUSA, 434
- Contaminated liquid plasma, 96
- Contaminated plasma, 303, 304-305
 reactions to, 668, 671, 673-674
 serum albumin from, 88, 302, 306, 345-346, 347
 thrombin from, 365
 trial runs with, 343, 344
- Contamination:
 as cause of reactions, 650
 at commercial processing laboratories, 299, 308
 avoidance of, in closed collection system, 266
 during bleeding, 300-301
 during filtration of serum albumin, 353
 in Korean War, 743
 in SWPA, 607
 losses from, 304, 306-308
 in Blood for Britain, 14
 in MTOUSA, 442
 of blood overseas, 462
 of blood substitutes, 373
 of cadaveric blood, 785
 of donations, 145, 217
 of frozen plasma, 273
 of intravenous solutions, 386-387
 of liquid plasma, 270, 274, 306-308
 of peritoneal cavity as cause of shock, 39, 40
 of placental blood, 25
 of pleural cavity as cause of shock, 39
 of pooled plasma, 288
 of red blood cell residua, 313, 315
 of serum albumin, 350
 risk of, with open collection system, 180, 193
- Content of instructional courses in British blood program, 17
- Continent, 57, 195, 209, 459, 478, 480, 481, 482, 486, 487, 488, 495-496, 498, 510, 512, 513, 514, 515, 516, 518, 520, 522, 523, 530, 531, 532, 533, 534, 535, 536, 541, 546, 547, 549, 557, 559, 560, 561, 573
See also European theater.
- Continental Air Defense Command (CONAD), 452
- Continental Blood Bank, 212, 215, 247, 452, 495, 515-517, 522, 523, 543, 547, 553, 567, 665
 administrative considerations of, 516-517, 549
 advance detachments of, 445, 518-522
 authorization for, 513
 deliveries to, from ZI, 495-496, 510, 536
 detachments of, 516-517, 549-550
 equipment of, 516
 operations of, 516-522
 permanent location of, 516
 personnel of, 516-517
 transportation for, 516
See also ETOUSA Blood Bank.
- Contracts for—
 byproducts, 84, 267
 dried plasma, 172, 267, 289-293, 301, 304, 310
 fibrin foam, 365
 immune globulin, 363
 large plasma package, 173-175
 serum albumin, 267, 341-344
- Contraindications to fluid administration, 96
- Control—
 of blood program before Korean War, 719-720
 of hemorrhage, 12, 34, 56
- Controlled heating of pooled infected plasma, 779-780
- Controversy over acceptance of field transfusion unit, 192-195
- Contusions after donations, 157
- Convalescent serum, 276
- Convalescents as donors in World War I—9
- Conversion—
 of contaminated plasma into serum albumin, 88, 128, 302, 306, 345-346, 347
 of trucks for refrigeration : ETOUSA, 541-543
- Convulsions after donations, 142, 157
- Cook County Hospital, 379
- COOKSEY, W. B., 314
- Cooper Committee, 715, 716
- COOPER, C. P., 715
- Cooperating chapters, ARC, 113, 118
- Coordination of—
 blood agencies in National Blood Program, 735
 DOD with other agencies before Korean War, 719-720
 Travis AFB with other agencies, 740
- Coordinator, Army Whole Blood Procurement Service, 696

- COPE, O., 33
- Copper sulfate test, 34, 43, 159, 160, 252-258, 430, 626
 Thalhimer modification of, 257-258
- Corn Products Refining Co., 317
- Corn syrup, resuspension of red blood cells in, 317, 319, 494
- CORNELL, Col. V. H., 400, 401, 402, 413, 418, 445, 446, 448
- Coronary occlusion after donations, 157
- Corps:
- II—55, 392, 394, 422, 438
 - III Amphibious, 622, 623, 628
 - VII—243, 520, 574
 - VIII—520
 - XVIII—521
 - XXIV—623
- Corps of Engineers, 463, 516
- Corps troops, donations from, in MTOUSA, 398
- Corsica, 448
- Cost(s) of—
- ARC Blood Donor Service, 136-137
 - Baxter bottles, 195
 - insulated shipping containers, 765
 - plasma in Korean War, 782
 - plastic equipment, 749
 - processing byproducts, 83
 - processing laboratory, Travis AFB, 741
 - reprocessing blood derivatives, 718
 - serum albumin in Korean War, 782
 - transfusion equipment for field use, 179
- Cotentin Peninsula, 518
- Cough in donors, 142
- COULSON, Maj. F. H., 514
- Courier service in—
- airlift in MTOUSA, 419-420
 - ETOUSA, 511
 - Korean War, 752
 - Luzon operation, 621
 - MTOUSA, 419-420, 445, 448, 449
 - Pacific, 591
 - southern France, 448-449
 - SWPA, 605
 - transatlantic airlift, 552
- Courtill Airstrip, 520, 541
- CRISLER, Col. J. A., 486, 509, 553
- Courtland Laboratories, 774
- Crash ambulances, dried plasma for, 176
- Crews of planes, rejection of, as donors, 140
- Criteria for—
- acceptance of syphilitic donors, 262
 - blood substitutes, 372-373
 - bovine albumin for military use, 329-330
 - clinical testing—
 - of bovine albumin, 327
 - of serum albumin, 339
 - compatibility, 4
 - donors—
 - in MTOUSA, 422-423
 - of Blood for Britain, 14
 - to ARC program, 139-144, 261
 - dried plasma, 279-280
 - equipment for military use, 77-78
 - facilities for ARC blood donor centers, 113-114
 - gelatin for military use, 274, 276-277
 - grouping sera, 238-239
 - handling of blood, 574-575
 - in SWPA, 582-583
 - hemodynamic state in shock, 684-685
 - human serum albumin, 76
 - pectin, 378
 - plastic equipment, 758
 - preservation of blood, revision of, 770
 - preservative solutions, 217, 221, 222, 229
 - processing plasma, 95
 - quantitative blood replacement, 559
 - red blood cell resuspension, 143
 - size of transfusion in ETOUSA, 559
 - test for hematocrit determination, 253
 - titration techniques, 428
 - transfusion equipment for field use, 178-179, 186
 - use of red blood cells in Korean War, 785
- Critical materials, 77, 173, 186
- in plasma package, 175
 - in plasma program, 177
 - in serum albumin package, 343
 - in transfusion sets, 437
 - priorities of, 206
- Criticism(s)—
- of expendable transfusion equipment, 196-198
 - of field transfusion unit, 192-195
- Critique—
- of Okinawa operation, 627-628
 - of SOP for Operation OLYMPIC, 641-642
- Croix de Guerre, 521
- CROSBY, Lt. Col. W. H., 803
- Crossmatching, 53, 54, 97, 191, 235, 239, 244, 245, 394, 428, 433, 442, 650, 656, 719-720
- after multiple transfusions, 805
 - before use of odd bloods, 567
 - equipment for, 464
 - errors in, 425
 - in field, 194

- Crossmatching—Continued
 in Korean War, 743, 744, 748
 in resuscitation, 689, 690
 in SWPA, 598
 of plasma, 258, 266, 269
 of pooled plasma, 266
 techniques of, 693-694
- Crushing injuries, 655, 664, 665
 autotransfusion in, 23
 gelatin in, 377
 hemoconcentration in, 30
 in air raids on London, 666
 plasma in, 35, 55, 267, 696
 uremia in, 65-67
- Cryochem process, 278
- Crystalline bovine albumin, 327, 328, 330, 331, 332
- Crystalline serum albumin, 337
- Crystallization technique of plasma fractionation, 348
- Crystalloid content of Alsever's solution, 224
- Crystalloid solutions:
 equipment for administration of, 185
 field studies of, 80
 preparation of, in British base transfusion units, 17
 training and preparation of, 17
 use of, in France 1940-20
- CULBERTSON, Maj. J. W., 437
- Cultural spot checks in ETOUSA, 665
- Cummings Committee, 737, 775
- CUTLER, Brig. Gen. E. C., 52, 192, 194, 209, 469-470, 472, 473, 475, 476, 477, 478, 479, 480, 484, 485, 486, 487, 488, 493, 494, 496, 501, 524, 527, 528, 529, 530, 533, 555, 557, 683
- Cutter Laboratories, 173, 252, 289, 292, 345, 378, 379, 719, 747, 772, 774, 794
- Cyanosis after donations, 157
- Cyclotherm, 453
- D-day—
 in ETOUSA, 141, 195, 208, 226, 460, 466, 468, 474, 475, 479, 480, 484, 487, 488, 509, 510, 524, 526, 533, 537, 538, 542, 543, 544, 549, 561, 702
 effect of, on donations, 136
 in southern France, 447, 448
 on Lingayen Gulf, 620
 on Luzon, 634
- Daily report of requirements in—
 MTOUSA, 420
 southern France, 449
- Dallas, 292, 345, 355, 719
- Damage claims after red blood cell transfusion, 82
- Damage to red blood cells by gravity collection technique, 15
- Dangerous universal donors, 804, 806
- DART, Col. R. O., 583, 584, 629
- Data of blood program, records of, 70
- Dating period for—
 airlifted blood in Korean War, 744-745
 autotransfused blood, 23, 706
 blood, 47, 50, 180, 421, 638, 718, 726, 742
 airlifted to ETOUSA, 209, 212, 489, 490
 collected by open system, 462
 expiration of, 421
 for invasion of southern France, 447
 for Luzon operation, 621
 for Okinawa operation, 623, 624, 627, 639
 for Operation OLYMPIC, 641
 from Australian blood bank, 581, 587
 from ETOUSA Blood Bank, 476, 481, 483, 496, 548-549
 from Manila blood bank, 629
 in ACD solution, 226
 in Alsever's solution, 224-225, 228
 in CBI, 642
 in DeGowin's solution, 222
 in Denstedt's solution, 463
 in Korean War, 754-755, 803
 in MTOUSA, 426-428, 437
 in North Africa, 432
 in Soviet Union, 22
 in SWPA, 590, 611, 612-614, 632-633
 losses from expiration of in MTOUSA, 438, 439, 440
 on LST 464-595
 substitutes, 373
 tested for transportability, 220-221
 used in France, 1940, 20
- cadaveric blood, 24
- citrated blood, 219
- dried blood-grouping sera, 744
- fibrin film, 367
- fibrin foam, 365
- liquid plasma, 96
- locally collected blood, 46?
- placental blood, 24
- plasma, 270
- preserved blood, 179, 220, 222, 224, 230, 706
- red blood cell residua, 313, 494
- reprocessed plasma, 772
- resuspended red blood cells, 317, 318-319
 in World War I-6

- stored blood in Spanish Civil War, 12
 surplus plasma, 311
 unrefrigerated blood, 210
 DAVIS, H. A., 649, 796
 DAVIS, N. H., 101, 102, 103
 Dayton, 539
 DEBAKEY, M. E., 1, 81, 225, 245, 653, 673
 Debilitation in reactors to plasma, 671
 Decapsulation of kidney, 656
 Decision against airlift to ETOUSA, 465-466
 Decompensation in chest wounds with pulmonary edema, 706
 Decompression sickness, dried plasma in, 698
 Decrease—
 in peripheral blood volume in shock, 32
 in venous return as cause of shock, 30, 32
 of cardiac output in shock, 30, 32, 36
 Deferment of technical personnel, 343
 Defibrinated blood:
 intra-arterial transfusion with, 796
 transfusion with, 4
 Definition of—
 pectin, 377-378
 plasma, 267-268
 preservative solutions, 217
 serum albumin, 267-268
 shock, 31-33, 37-38
 DEGOWIN, E. L., 48, 52, 53, 54, 74, 76, 93, 159, 171, 219, 220, 221, 222, 223, 226, 240, 241, 242, 244, 471, 694
 DeGowin technique—
 of blood grouping, 236, 238, 242, 244
 of mass blood grouping, 238, 239
 Degradation of gelatin, 375, 376, 377
 Degradation products of hemoglobin, 654
 Dehydration, 383
 administration of supplemental fluids with serum albumin in, 339, 340-341, 699-700
 correction of, by crystalloid solutions, 34
 in donors, 157
 in shock, 254
 in SWPA, 637
 plasma in, 35, 55
 replacement therapy in, 34
 DEKLEINE, W., 101, 104
 DeLaval centrifuge, 345
 Delay in cleaning transfusion sets, 652
 Delayed management of hemorrhage, 462
 Delayed primary wound closure, 442
 Delayed reactions to bovine albumin, 332, 334, 335
 Delays—
 during airlift to ETOUSA, 211-212
 in production of large plasma package 173-175
 Deliveries—
 ashore during Normandy landings, 485, 510
 by advance depots of ETOUSA Blood Bank, 505-507
 by British base transfusion units, 17
 by LST's to Leyte, 616-617, 618
 from ETOUSA Blood Bank, 503-504
 from Marseille bleeding center, 452
 from SOS advance depots to Army depots, 510
 in Korean War, 752-754
 See also Transportation.
 Delivery time—
 of transatlantic airlift, 552
 to Continent from United Kingdom, 510
 to front in Soviet Union, 22
 to hospitals in Operation OLYMPIC, 640
 through supply channels in SWPA, 604
 under fire, 521
 Demonstration plasma packages, 87-91
 Demonstration training sets, 413
 Denaturization of plasma protein, 651
 Dengue, 142
 DENIS, J. B., 1
 DENIT, Brig. Gen. G. B., 585, 591, 593, 594, 597, 604, 616, 633, 639, 641
 Denmark, 791
 Denstedt modification of DeGowin et al solution, 222
 DENSTEDT, O. F., 221, 315
 Denstedt's solution, 73, 222, 444, 463, 464, 467
 effect of, on resuspended red blood cells, 316, 317
 Dental officers on shock wards, 710
 Dental patients as donors in World War I—6
 Denver, 292, 734, 756
 Denver Blood Donor Center, 96
 Department of Defense, 715, 716, 717, 719, 720, 721, 723, 726, 734, 737, 738, 774, 775, 784, 788, 794, 795
 Directive 5136.4—716
 responsibility of, for blood procurement program before Korean War, 719-720
 Department of Physical Chemistry, Harvard Medical School, 325, 359
 Department of Surgery, University of Minnesota Medical School, 325
 Department stores, recruitment booths in, 125

- Deposition
 of gelatin in tissues, 375
 of pectin in tissues, 378
- Depot G-45—515, 532, 533, 534, 546
- Deputy Assistant Secretary of Defense (Health and Medical), 715
- Deputy Surgeon General, Army, 84
- Deputy Theater Surgeon, ETOUSA, 513, 530
- Dermatitis after donations, 157
- Design of equipment for intravenous therapy, 464
- Despecciation of bovine albumin, 328, 334
- Desperate cases, transfusion in, in World War I—3, 5, 6, 7
- Destruction of plasmodia in refrigerated blood, 595
- Detachment personnel, donors from, 438
- Detachment(s) of—
 Continental Blood Bank, 516-517, 549-550, 553
 ETOUSA Blood Bank, movement of, to Continent, 518-520
 127th Station Hospital Blood Bank, 520-521, 522-523
- Deterioration—
 of red blood cells, 217
 without refrigeration, 227
 of rubber in plasma package, 171
- Determination of—
 circulating blood volume, 42-44, 255
 by copper sulfate technique, 34
 in shock, 31
 under field conditions, 30
 hematocrit, 42-44
 hemoglobin in shock, 31
 plasma protein concentration, 43
- Detroit, 292, 310, 313, 314, 319
- Detroit experience with red blood cell transfusions, 314-316
- Development of—
 blood program in MTOUSA, 48-49, 443
 bovine albumin program, 326-328
 expendable transfusion equipment 195-198
 field test for hematocrit determination, 252-258
 field transfusion unit in ETOUSA, 185-195
 gelatin as blood substitute, 373-377
 grouping sera, 236-239
 Periston in U.S., 788-789
 plastic equipment, 758-760
 preservative solutions, 221-228
 resuscitation in MTOUSA, 684
 serum albumin in laboratory, 336-337
 standard Army-Navy plasma package, 165-168
 transfusion equipment, 180-185
 in Army Medical School, 177
 whole blood program in ZI in Korean War, 733-738
- DEVERS, Lt. Gen. J. L., 41
- DeWitt General Hospital, 665
- Dextran, 381, 726, 787, 790-795
 addition of, to plasma demonstration package, 89
 clinical studies on, 791-794
 commercial production of, 794-795
 experimental studies on, 791-794
 in Korean War, 770-771
 packaging of, in plastic bags, 795
 properties of, 790-791
 stockpiling of, in Korean War, 795
- Dextrins:
 in corn syrup, 317-318
 molecular size of, 318
- Dextrose:
 addition of:
 to blood in ETOUSA, 503
 to blood in MTOUSA, 426, 437
 as plasma additive, 286
 concentration, effect of, on blood collected by ion-exchange technique, 770
 effect of—
 on hemolysis, 218, 219
 on resuspended red blood cells, 315-316
 in ACD solution, 226, 227, 229
 in Alsever's solution, 222
 in McGill solution, 222
 optimum concentrations of, 220
 solution, suspension of red blood cell residua in, 312
 solutions, 203
 properties of, 52
- Diabetic donors, 139
- Diagnosis of—
 early shock, 34
 incompatibility reactions, 655-656
 lower nephron nephrosis, 667
 reactions, 649
 serum hepatitis, 675
 shock, 252
- Diagnostic routine in resuscitation, 687, 689
- Dialysis of salts in plasma fractionation, 348
- DIAMOND, L. K., 248, 250
- Diaphragm-stoppered bottles, 149
- Diarrhea, plasma infusions in, 570

- Differential diagnosis of—
 incompatibility reactions, 655-656
 reactions, 649
 serum and infectious hepatitis, 675
- Differentiation agglutination techniques, 217
- Differentiation of—
 bovine and human serum albumin, 326
 hemolytic and pyrogenic reactions, 653
 shock and hemorrhage, 29, 51
- Difficulties—
 in initiation of airlift to Pacific, 602-605
 of changeover to large size plasma packages, 173-174
- Dihydric sodium citrate glucose solution, 581
- Dijon, 401, 445, 452
- Dijon Base Section, 453, 455
- Dilatation of heart during transfusion, 12
- Direct transfusion—
 before World War I—5
 in Spanish Civil War, 11
- Directives for ADSEC detachments, 549-550
- Director General—
 British Army Medical Services, 179
 British Emergency Medical Service, 529
- Director of Medical Services and Assistant to Secretary of Defense for Medical Affairs, 716
- Director of Medical Services, Office of Secretary of Defense, 717, 718, 720, 721, 725
- Director of Military Supply, Munitions Board, 720
- Director of Office of Defense Mobilization, 735
- Director of Procurement Division, OTSG, 301
- Director of Professional Services Division, Office of Chief Surgeon, ETOUSA, 530
- Directorate, Armed Services Medical Procurement Agency, 721, 775
- Directors of ARC blood donor centers, 121
- Disadvantages of—
 Church containers, 204
 forward distributing system, 399
 Rous-Turner solution, 219
 unit hospital system for provision of whole blood, 397
 whole blood, 462
- Disappearance—
 of dextran from bloodstream, 790
 of Periston from plasma, 789
- Discarded bloods—
 in MTOUSA, 426, 441
 in Pacific airlift, 213
- Discrepancies in statistics, 560
- Disease(s) in donors, 142-144
- Disodium citrate in ACD solution, 229
- Display of demonstration plasma packages, 89
- Disposition of surplus plasma after World War II—310-311, 772
- Dissemination of information, 79, 80
- Distal convoluted tubules in incompatibility reactions, 654, 655
- Distances—
 in Pacific, 606
 in SWPA, 468, 591
- Distilled water, 387-388
 accidental administration of, 656
 commercial procurement of, 382-383
 difficulties of production of, in ETOUSA, 573
 for reconstitution of plasma, 50
 from British sources, 470
 in North Africa, 433, 434
 in plasma package, 166, 168
 pyrogens in, 375
 role of, in pyrogenic reactions, 651
 shortages of, in 6703d Blood Transfusion Unit (Ovhd.), 453
 testing of, 344
- Distributing units overseas, 463, 467
- Distribution center(s):
 afloat for—
 Okinawa operation, 623, 627
 Operation OLYMPIC, 639, 640
 ashore for—
 Okinawa operation, 623-624
 Operation OLYMPIC, 640
 Pacific airlift, 594
 in Korean War, 752
 of 6713th Blood Transfusion Unit (Ovhd.), 407
 on Guam, 622, 623, 630, 638
 reports from, 631
- Distribution of—
 aging blood in—
 ETOUSA, 554-555
 MTOUSA, 397, 420-421, 440
 SWPA, 606-607, 630-631
 airlifted blood in Korean War, 752-755
 ARC collections, 136
 Australian blood, 582
 blood from Seventh U.S. Army blood bank, 455
 blood on Continent, 476, 532-533
 blood groups in donors in MTOUSA, 441
 field transfusion units in ETOUSA, 544-545

- Distribution of—Continued
 gamma globulin in Korean War, 783-784
 locally collected blood in ETOUSA, 477
 plasma components, 361
 red blood cell residua, 313-314
 refrigerators in ETOUSA, 542-543
- Distribution teams:
 for Okinawa operation, 623
 for Operation OLYMPIC, 641
 in SWPA, 604
 transportation for, 628
- Distribution through medical supply channels, 479, 574-575
- Division clearing stations, blood in, 479
- Division of Biologics Control, NIH, 305
- Division of Medical Sciences, NRC, 49, 73, 102-103, 104, 107, 313, 375, 769, 802
- Division of Surgical Physiology, Army Medical School, 55, 61-62, 67, 72, 171, 176, 177, 206, 208, 211, 212, 237, 251, 274-275, 299, 384, 461, 468, 539, 695-696
- Division(s):
 3d Infantry, 447
 29th Infantry, 529
 32d Infantry, 596-597
 36th Infantry, 447
 44th Infantry, 447
- DOAN, C. A., 158, 159, 160
- DOAN, Col. H. W., 529, 547
- Dobodura, 591
- DOCHEZ, A. R., 379
- DOD (Department of Defense).
- DOLE, Lt. V. P., 253, 254
- Donations:
 amount of:
 in ARC blood donor centers, 139, 151
 in Soviet Union, 21
 in World War I—6
 balance of, with needs for blood, 120
 before Korean War, 720
 by Army Air Force personnel—
 in ETOUSA, 481, 486
 in MTOUSA, 398
 by base troops in ETOUSA, 476, 477
 by civilian populations overseas, 466
 by clearing company personnel in ETOUSA, 569
 by combat troops, 396, 397, 422, 524, 529, 595, 718
 by corps troops, 398
 by hospital personnel in ETOUSA, 569
 by line troops, 445
 by military personnel in Japan in Korean War, 729
 by POW's in MTOUSA, 422
 by service troops, 399, 421-422, 445, 452-453, 462, 466, 476, 477, 478, 479, 481, 482-484, 516, 529
 by theater personnel, 48-49
 by walking wounded, 396, 422, 462, 476, 477, 486
 designation of, for Free French, 94
 distribution of, to commercial processing laboratories, 291-293
 during thermonuclear attacks, 786
 effect of rumors on, 329
 effect of, on donors, 139, 524, 525, 527
 excess of, 120
 exploitation of, by British base transfusion units, 17
 fasting before, 140
 for Blood for Britain, 13
 ownership of, 300
 reactions to, 153-158
 recognition of, 127-128
 routine of, 145-148
 spacing of, 139
 in Spanish Civil War, 12
 in World War I—9
 to British by U.S. troops, 528-530
- Donor(s), 92, 139-160
 age of, 139
 in Blood for Britain, 14
 blood pressure of, in Blood for Britain, 14
 campaigns for, 118
 causes of rejection of, 139, 140, 141-144
 criteria for, 139-144, 261
 in Blood for Britain, 14
 in MTOUSA, 422-423
 diseases in, 142-144, 643-644, 651, 679
 for Marseille bleeding center, 451-452
 for research in dried plasma, 101-102
 group recruitment of, 125-126
 hemoglobin level for, 257-258
 in Blood for Britain, 14
 history-taking in, 141-142
 in British blood program, 15
 in CPA, 594
 in ETOUSA, 496, 523-530, 550
 in German blood program, 22
 in Korean War, 729
 in MTOUSA, 421-422, 489-490
 in New Guinea, exhaustion of, 582
 in North Africa, 438
 in Soviet Union, 21
 in Spanish Civil War, 11, 12
 in SWPA, 586, 594, 595-598
 in United Kingdom, reduction of, 481-482

- in World War I—6, 9
 - on LST 464—595
 - overseas, 462
 - payment, of—
 - in ETOUSA, 528, 530
 - in MTOUSA, 423-424
 - in ZI, 695
 - presentation of emblems to, 128
 - procurement of, for 6703d Blood Transfusion Unit (Ovhd.), 452-453
 - race of, 139
 - recruitment of, 51, 101, 107, 111, 118, 119-128, 139
 - in ETOUSA, 474
 - in India, 642
 - in Korean War, 730-731, 733-734, 737-738
 - in MTOUSA, 442-443
 - in SWPA, 596
 - registration of, in MTOUSA, 435, 441
 - rejection of, 120, 148
 - for hemoglobin deficiency, 158-160
 - for history of jaundice, 675
 - in Korean War, 731
 - in MTOUSA, 441
 - requirements for, in Pacific, 582-583, 584, 598
 - selection of, overseas, 186
 - sex of, 139, 141
 - shortages of, 119-120
 - sources of, overseas, 393
 - special methods of solicitation of, 125-127
 - specifications for, 139-141
 - statistics for rejection of, 140-141
 - weight of, 140, 157
 - with major allergies, rejection of, 651
 - with malaria in CBI, 643-644
 - with possible hepatitis, 679
- Donor needles, 435, 436
- Donor panel(s):
- authorization of, in ETOUSA, 524-525
 - in base section commands in ETOUSA, 479
 - in British Army Transfusion Service, 18-19
 - in ETOUSA, 474, 478, 481, 482-483, 486, 487, 496, 510, 524-525, 527, 530
 - in MTOUSA, 422
 - in Seventh U.S. Army, 451-452
 - in SWPA, 595, 605
- Donor sets:
- for airlift to ETOUSA, 491, 492
 - for oversea transfusion, 463
 - improvisation of, in MTOUSA, 432-435
- See also* Expendable donor sets.
- Dosage of--
- dextran, 791
 - liquid plasma, 96
 - plasma, 172, 175, 697-698
 - serum albumin, 34, 338, 339
- Double-checking of group-specific blood, 650
- Double-processing of plasma, 165
- DOUGLAS, Brig. J. P., 542
- DREW, C. R., 14
- Dried human grouping serum, 16
- Dried plasma, 50, 52-53, 81, 121, 268, 275-312, 337, 462
 - additives to, 283-287
 - commercial potential of, before Korean War, 718
 - commercial processing of, 101, 269, 275-276, 280-282, 289-293
 - contracts for, 289-293
 - criteria for, 279-280
 - demonstration packages of, 87-91
 - equipment for processing of, 76, 163-177
 - first plans for, 101
 - for ZI hospitals, 96, 175-177
 - from British sources, 470
 - license for production of, 81
 - logistics of, 269
 - mass production of, 289-293
 - mercurials in, 351
 - packaging of, 163-177
 - for ZI hospitals, 176-177
 - preparation of, from serologically positive blood, 744
 - production of:
 - at Bryn Mawr Hospital, 65
 - in India, 642
 - program, implementation of, 102-104
 - provision of, for Office of Civilian Defense, 92
 - reactions to, in civilian hospitals, 669
 - requirements of, 289, 290-291
 - Soviet experience with production of, 95
 - stability of, 15
 - storage of, 15, 165
 - under refrigeration, 102
 - testing of, 50, 269
 - transmission—
 - of malaria by, 143-144
 - of serum hepatitis by, 310, 775, 776-782, 795
 - transportation of, 15
 - use of, as anticoagulant, 189-190

Dried rabbit sera, 194

Dried thrombin, 363

Drierite, 278

- Drip flowmeter, 436, 437
 Drip indicator, 198
 Drivers—
 in ARC blood donor centers, 111
 in ETOUSA Blood Bank detachments, 518
 Dry Ice, refrigeration with, 203
 in southern France, 454
 Drying of plasma, 173, 175
 difficulties of procurement of equipment for, 95
 equipment for, 65, 290
 historical note on, 276-279
 techniques of, 50, 76, 269, 270, 276-279, 280-282
 Drying of serum, 276
 DUNCAN, J., 23
 Dunkirk, 19
 Dura mater, replacement of, by fibrin film, 367
 Dural defects, protection of, by fibrin film, 367-368
 Dural substitute, fibrin film as, 359
 Dutch Harbor, 92
 Dye measurement of total plasma, 258
 Dysentery:
 in Chinese patients, 645-646
 transfusion for, in CBI, 642-643
 Dyspnea—
 in donors, 142
 in plasma reactions, 672
- E awards, 127
 Early shock, 34
 East Anglia, 480, 530
 Eastern Base Section, ETOUSA, 524-525
 Eastman Kodak Co., 364, 374
 Eberstadt Committee, 715
 EBERT, Lt. Col. R. V., 42, 185, 186, 192, 193, 194, 195, 480, 663
 Ebert-Emerson transfusion set, 42-44, 186-191, 543-544, 545
Eberthella typhosa, 362
 Ectopic pregnancy, 23
 Edema:
 after closure of colostomy, 705
 in burns, 702
 in crushing injuries, 696
 in donors, 142
 of larynx, 651
 serum albumin in, 338, 360
 Edible Gelatin Manufacturers' Research Society of America, 374
 Edinburgh, 23
 EHRLICH, P., 265, 276
- Eighth Air Force, 481
 Eindhoven-Nijmegen area, 521
 EISENHOWER, Gen. D. D., 533, 574
 El Alamein, Battle of, 32, 461
 Elective transfusions, booster dose of Atabrine before, 423
 Electric refrigerator, 203
 Electrolyte balance, 383
 regulation of, in incompatibility reactions, 656
 Electrolyte replacement in serum albumin therapy, 34, 270, 339
 Electrolytes:
 effect of, on hemolysis, 218
 loss of, as causes of shock, 33
 Electrophoretic analysis—
 of plasma, 343
 of serum albumin, 344, 345, 351
 Electrophoretic pattern of bovine albumin, 326
 Electroplated cans for serum albumin package, 198
 Eli Lilly & Co., 89, 91, 172, 173-175, 241, 286, 289, 291, 347, 349, 774
 Elimination of blood substitutes from body, 373
 ELKIN, D. C., 62
 ELKINTON, J. R., 266, 697
 ELLIOTT, Capt. J., 15, 47, 48, 65, 195, 211, 212, 213, 227, 237, 240, 241, 247, 249, 250, 251, 266, 336, 552, 661
 ELOESSER, L., 74
 ELSEY, W. J., 277
 Emaciation in reactors to plasma, 671
 Emblems, presentation of, to donors, 128, 148
 Embolism, 24
 Emergency deliveries—
 in Luzon operation, 622
 in SWPA, 608
 to Continent, 535, 537, 546
 Emergency distribution on Guam, 631
 Emergency donations in SWPA, 597
 Emergency landings during airlift to ETOUSA, 552
 Emergency Medical Tag, 634
 Emergency needs—
 in ETOUSA, 510
 in Pacific, 594
 Emergency provision of blood in Japan in Korean War, 729
 Emergency surgery for peritoneal contamination, 40
 Emergency transfusions:
 Atabrine before, 423, 598

- in ETOUSA, 524
- Emergency use of plasma expanders, 714
- EMERSON, Lt. Col. C. P., 42, 185, 186, 192, 193, 195, 252, 544, 656, 657, 658, 663, 664, 771
- EMERSON, Lt. K., 253
- Emotional factors, in postdonation reactions, 157
- Empirical use of citrated blood in shock, 31
- ENDERS, J. F., 261
- Engineering help in construction of ETOUSA Blood Bank facilities, 431
- Engineers' Development Laboratory, Armed Services Medical Procurement Agency, 208
- England, 5, 13, 14, 80, 211, 312, 512, 515, 549
 - prohibition of transfusion in, 1
- Eniwetok, 591
- Enlisted grades in ETOUSA Blood Bank, 498
- Enlisted personnel:
 - administration of blood by, 198
 - at ARC blood donor centers, 111
 - in collecting section of ETOUSA Blood Bank, 501-502
 - in distributing units, 467
 - in ETOUSA Blood Bank, 499, 509
 - in field transfusion units, 543
 - in Luzon operation, 620
 - in 127th Station Hospital Blood Bank, 514
 - in 6703d Blood Transfusion Unit (Ovhd.), 102
 - on shock wards, 463, 709-710
 - training of:
 - in British blood depot, 472
 - in MTOUSA, 442
 - in plasma administration, 637
 - in use of transfusion equipment, 179
 - in venipuncture, 526
- Enlisted technicians—
 - in blood donor centers, 490
 - on collecting teams, 466
 - on transfusion teams, 467
- Enzyme activity of blood collected by ion-exchange technique, 770
- Enzyme systems, 229
- Epidemiologic studies on gamma globulin in World War II—783
- Epinal, 451, 452, 453
- Epinephrine in allergic reactions, 651
- Equipment:
 - approval of, by NIH, 81
 - cleaning of, in Pacific, 587
 - commercial production of, before Korean War, 719
 - criteria of, for military use, 77-78
 - design of, 464
 - difficulties with, on Continent, 553-554
 - for airlift to ETOUSA, 227, 491, 492
 - for ARC blood donor centers, 76, 294-295
 - for Army transfusion services, 479
 - for blood program, 52, 148, 268
 - for commercial production of—
 - plasma, 293-295
 - serum albumin, 342-343
 - for CPA, 594
 - for distilled water, 387-388
 - for drying plasma, 13, 65, 76, 95, 277, 278-279, 290
 - for intravenous therapy, 77, 78
 - for large plasma package, 175
 - for LST 464—595
 - for Luzon operation, 620
 - for movement of ETOUSA Blood Bank to Continent, 515
 - for Okinawa campaign, 626, 628
 - for oversea transfusion service, 177-199, 463, 467
 - for plasma infusion, 163-177
 - for plasma program, 267, 293-295
 - for processing byproducts, 84
 - for processing laboratory, Travis AFB, 740-741
 - for reconstitution of plasma, 52
 - for replacement therapy in British Army, 16
 - for serologic testing, 492
 - for serum albumin program, 338, 340
 - shortages of, 343
 - for shell freezing dried plasma, 282, 283
 - for 6703d Blood Transfusion Unit (Ovhd.), 453
 - for 6713th Blood Transfusion Unit (Ovhd.), 407
 - for transfusion, 1, 4-5, 219
 - in British Army Transfusion Service, 17
 - in ETOUSA, 177
 - in France, 1940-20
 - in MTOUSA, 432-437
 - in NATOUSA, 177
 - in World War I—9
 - maintenance of, 17, 136
 - for ultraviolet sterilization of plasma, 778-779
 - in Pacific, 590, 598-599
 - in SWPA, 604
 - lax preparation of, as cause of pyrogenic reactions, 660, 668
 - modifications of, 81

- Equipment—Continued
- of ARC mobile bleeding units, 115-116
 - of base collection sections in MTOUSA, 431
 - of shock wards, 707-709
 - preparation of:
 - for ETOUSA Blood Bank, 502-503
 - for field transfusion units in ETOUSA, 543-544
 - for unit hospital system, 297
 - (PROCO) for Continental Blood Bank, 513, 516
 - procurement of:
 - before Korean War, 720
 - for blood donor program, 70
 - requisitions for, in SWPA, 593-594
 - shortages of:
 - in SWPA, 591
 - overseas, 462
 - standardization of, 727
 - sterilization of, 113
 - testing of, 464
 - at Army Medical School, 65
- ERNST, Col. K. F., 440
- Errors:
- in attribution of fatalities to transfusion, 657, 658-659, 660, 664
 - in Blood for Britain, 15
 - in concept of lower nephron nephrosis, 666
 - in crossmatching, 425
 - in diagnosis of hemolytic reactions, 653, 655
 - in distribution of blood for transfusion, 244
 - in early concepts of plasma, 706
 - in grouping, 552
 - at Red Cross blood donor centers, 242
 - in Korean War, 744, 748
 - on identification tags, 429, 444, 501, 567, 598
 - reactions after, 650
 - in handling of blood—
 - in ETOUSA, 546
 - in MTOUSA, 421
 - in SWPA, 604, 605
 - in mass grouping, in Armed Forces, 3, 5, 6, 7, 8, 233, 234-235, 239, 241-245
 - in posttransfusion cleaning of equipment, 652
 - in Rh testing, 249-250
 - in shock therapy overseas, 29
 - of accounting in plasma program, 301-302
 - responsible for pyrogenic reactions, 652
- E. R. Squibb & Sons, 292, 774
- Erythroblastosis, 248, 251
- Espiritu Santo, 591
- Essential Technical Medical Data—
- ETOUSA, September 1944—56
 - ETOUSA, October 1944—557
 - MTOUSA, 460
 - NATOUSA, December 1943—399
 - NATOUSA, March 1944—32
 - NATOUSA, 1 July 1944—48
 - USAFFE, November 1944—616
 - USAFFE, March-April 1945—636
- Establishment of ARC blood donor centers, 111
- Estimated ratio—
- of blood and plasma to casualties before Korean War, 773
 - of donors to casualties in MTOUSA, 398
- Estimated requirements—
- for Luzon operation, 620
 - for Okinawa operation, 624
- Estimates, blood losses caused by errors in, 567
- Estimates of—
- blood-casualty ratios in invasion of southern France, 447
 - blood requirements—
 - in ETOUSA, 561, 568
 - in ETOUSA after D-day, 509-510
 - in Korean War, 752
 - in MTOUSA, 437-438
 - overseas, 462-463
 - dried plasma requirements, 102, 289, 290-291
 - field transfusion unit requirements in ETOUSA, 544-545
 - need for whole blood in NATOUSA, 401
 - plasma requirements, 102, 269, 290-291
 - before Korean War, 773
 - procurement of group O blood, in ETOUSA, 481
 - requirements—
 - for invasion of Continent, 480-481
 - for Operation OLYMPIC, 640-641
 - for resuscitation in ETOUSA, 485-486
- Ethanol, 237
- Ethanol-water fractionation technique in preparation of bovine albumin, 326-327
- Ethyl alcohol in processing of dried plasma, 282
- Etiology of—
- lower nephron nephrosis, 657
 - serum hepatitis, 674
- ETOUSA (European Theater of Operations, U.S. Army). *See* European theater.
- Euglobins, 237

- European theater, 42, 57, 177, 185, 192, 194, 196, 211, 214, 225, 227, 247, 251, 261, 310, 391, 425, 445, 605, 624, 631, 633, 638, 653, 668, 680, 706
- blood program in, 459-575
- complaints about intravenous solutions in, 387
- incidence of serum hepatitis in, 676
- logistic transfer of 6703d Blood Transfusion Unit (Ovhd.) to, 452
- plasma reactions in, 657-659, 660-665
- European theater (ETOUSA) Blood Bank, 195, 212, 455, 459, 484, 488, 494, 495, 496, 513, 515, 517, 522, 523, 527, 532, 534, 538, 542, 543, 545, 546, 547, 560, 567, 573, 655, 665
- advance considerations of, 546-547, 549-550
- advance sections of, 501, 553
- base bank of, 501-505, 517
- capacity of, 481, 482, 483
- collecting section of, 501-502
- construction of, 498-499
- detachments of, 518-522, 553
- functions of, 496-498
- mobile bleeding teams of, 501-502
- movement of detachments of, to Continent, 518-520
- movement of, to Continent, 514, 515, 546, 549-550
- operational difficulties of, 550-551
- operational structure of, 501-507
- operations of, during Normandy invasion, 512-513
- organization of, 496-498
- personnel of, 505-506, 509
- processing section of, 502-503
- production of, 560-561
- progress report of, 508-509
- record section of, 501, 504
- security measures in, 548-549
- storage (shipping) section of, 503-504, 515
- technical procedures in, 497
- training of personnel of, 500, 501, 509
- transfer of personnel into, 499-500
- Evacuation:
- administration of plasma during, 392, 636-637, 698
- of casualties—
- in Korea by blood planes, 752
- on Continent, 535-536
- replacement therapy in line of, 51
- traumatic effect of, 31
- Evacuation hospitals, 180
- anuria in, 666
- attachment of distributing centers to, 407
- blood banks in, 406
- in Sicily, 395-396
- blood for, in Luzon operation, 621
- blood-plasma ratio in, 487, 556-557
- check of blood grouping in, 244-245
- deliveries to:
- during Normandy invasion, 518
- in ETOUSA, 480, 506, 510
- in MTOUSA, 414
- equipment in, 462
- field transfusion units for, in ETOUSA, 544
- in MTOUSA, 430, 432-433
- ratio of blood to casualties in, in ETOUSA, 556
- reactions in, in ETOUSA, 660-663, 670
- refrigeration in, 395, 397, 422, 454, 462
- resuscitation in, 443
- salvage of blood from, in MTOUSA, 440
- shock teams in, 463
- transfusion in, 392-393, 406, 464
- transfusion in, with improvised equipment, 180
- transfusion officers in, 420
- Evaluation of—
- grouping sera, 240-241
- insulated shipping containers, in Korean War, 763-766
- plasma in NATOUSA, 55-57
- replacement therapy in World War I—
- 9-10
- use of blood on Continent, 558-559
- work of ETOUSA Blood Bank detachments, 521-522
- EVANS, E. I., 35
- Evans Memorial Hospital, 221
- Evelyn colorimeter, 159, 160
- Everett, 382
- Evolution of concept of—
- shock, 37-38
- shock therapy in NATOUSA, 37-38, 54-57, 391-392
- whole blood for combat casualties in ZI, 29, 47-54
- Examining rooms in ARC blood donor centers, 113
- Exanthemata in donors, 142
- Excess blood—
- in Guam distribution center, utilization of, 630
- in Okinawa operation, utilization of, 624, 631

- Excess donations, 120
- Excess of byproducts, disposition of, 84
- Excessive reserves in Korean War, 756
- Exchange of equipment, on Normandy beaches, 511
- Exchange resins, 758, 759, 760, 769-771
- Excretion of—
- colloid solutions through kidneys, 52
 - dextran, 791, 792-793
 - gelatin, 375, 786
 - Periston, 788, 789
- Executive Officer, Officer of Surgeon, ETOUSA, 529, 546
- Executive Officer, 1st Army Group, 482
- Exhaustion of vasomotor center, 29
- Expansion of—
- blood program in ETOUSA, 480-484
 - peacetime program to wartime requirements, 720
 - plasma-stockpiling program in Korean War, 774
- Expendable donor sets, 196
- for airlift to ETOUSA, 492
 - in MTOUSA, 407, 444
 - MTOUSA criticisms of, 435-436
- Expendable equipment, 461, 462, 465, 467, 468
- development of, 195-198
 - in Continental Blood Bank, 516
 - in ETOUSA, 544, 545, 553, 554
 - in prophylaxis of pyrogenic reactions, 652-653
 - in unit hospital system, 397
 - receipt of, in MTOUSA, 660
- Expendable insulated containers—
- for oversea airlift, 213-215
 - for Pacific airlift, 609-611
- Expendable plastic equipment, 758-760
- Expendable recipient sets, 196, 436-437, 463, 469
- in MTOUSA, 435, 444
 - in SWPA, 598, 604
 - MTOUSA criticisms of, 436-437
 - on LST 464-595
- Experience tables, 480
- Experimental contamination of red blood cell residua, 315
- Experimental red blood cell transfusions, 317-318
- Experimental salvage of contaminated plasma, 303
- Experimental shock, plasma in, 266
- Experimental studies on—
- aldobionic acid, 379-380
 - bovine albumin, 327-328
 - crystalloid solutions in World War I—371
 - dextran, 791-794
 - fibrin film, 367
 - fibrin foam, 364-365
 - freezing whole blood, 771
 - gelatin, 374, 376, 787
 - gum acacia, 384
 - hemoglobin solutions, 361
 - hemorrhage, 265
 - intra-arterial transfusion, 796, 799
 - Merthiolate in serum albumin, 352-353
 - oxidized cotton, 380
 - pectin, 377-379
 - Periston, 381
 - plasma, 268
 - in hemorrhage, 51
 - radioactive dextran, 792-793
 - red blood cell residua, 312
 - Rh factor, 245-246
 - serum, 336
 - serum albumin, 337, 355
 - shock, 36, 37-38
 - between World Wars, 29-30
 - sodium citrate, 14, 218
 - sodium glycerol polysuccinate, 380
 - transfusion, 1
 - transmission of malaria by transfusion, 143-144
 - transportation of unrefrigerated blood, 210-213
- Exsanguinated casualties:
- chilled blood in, 555-556
 - reactions of, to aging blood, 555
- Exsanguination, 229
- multiple synchronous transfusions in, 21
 - transfusion techniques in, 693-694
- Extrapulmonary tuberculosis, in donors, 142
- Extravasation—
- of blood after donations, 157
 - of replacement fluids, 694
- Extravascular tissue spaces, loss of plasma into, 30
- Extremities:
- transfusion in wounds of, 635, 703-705
 - wounds of, 21, 22, 43-44
- Facilities of—
- ARC blood donor centers, 111-114
 - blood banks in MTOUSA, 431-432
 - processing laboratory at Travis AFB, 739, 740-741
 - shock wards, 707

- Failure of refrigeration:**
 losses from, 650, 664
 in ETOUSA, 567, 570-571
 in SWPA, 631-632, 664
 reactions caused by, 650
Failure of resuscitation, 44, 685, 705
Failure of transfusion, 12, 444
 as indication for surgery, 557, 558
Fainting after donations, 142, 157, 525
Fairfield-Suisin Air Force Base, 739, 742
Falalop Island, 607
Falciparum malaria, 144
Falling drop technique. See Copper sulfate technique.
False agglutinations, 242
False positive results in Rh testing, 250
False positive serologic tests:
 after multiple donations, 262-263
 after smallpox vaccination, 262
FANTUS, B., 336
Far East Command (FECOM), 722, 739, 740, 747, 756, 764, 766, 774, 782
Far East Research Unit, 803
Fasting before donations, 14, 140, 298
Fat content—
 of blood, 747
 of outdated plasma, 773
Fat embolism, 21
 after injection of bovine albumin, 331
Fat emulsions in Korean War, 795-796
Fatalities:
 after allergic reactions, 651
 after autotransfusion, 23
 after donations, 153, 156-157
 after gum acacia infusion, 10
 after intrasternal transfusion, 694
 after transfusion, 1, 2, 3, 464, 469, 649, 650, 657, 658-659, 660, 664
 with cadaveric blood, 24
 with contaminated blood, 665
 with group O blood, 425
 with hemolyzed blood, 657
 with incompatible blood, 425, 654
 caused by lack of blood, 438
 caused by Rh factor, 246, 247, 249, 260
 from citrated blood, 218
 from grouping errors, 233
 from improperly handled blood, 421
 from lower nephron nephrosis, 658, 666
 from serum hepatitis, 676
 from serum sickness, 332, 325
 from transfusion reactions in Filipinos, 668
 in forward hospitals, 566
 in hemolytic reactions, 653
 in plasma reactions, 671-674
 in presumed hemolytic reactions, 655
 in pyrogenic reactions, 653
 in volunteers for hepatitis studies, 781-782
 presumably due to transfusion, 657, 658-659, 660, 664, 668
Fatigue after donations, 155
Fatty foods, prohibition of, to donors, 140
FECOM. See Far East Command.
Federal Bureau of Investigation, 129
Federal Civil Defense Administration, 737, 775, 776, 784, 789
 plasma stockpiling for, 775-776
Federal Correctional Institution, Ashland, 781
Federal Security Agency, 91
FEISSLY, F., 377
Female donors, 158-160
 rejection rate of, 141, 160
Femoral arterial puncture in shock, 800-801
Femoral injection—
 of replacement fluids, 694
 of serum albumin, 338, 343, 694
Femur, compound fractures of, 444, 703-705
 plasma in fractures of, 392, 698
FENTON, Col. B., 515
Fenwal Co., 759
Fetal erythroblastosis, 248, 251
Fibrin:
 filtration of, during transfusion, 18
 flocculation of, in reconstituted plasma, 165
Fibrin-clot formation in ACD solution, 226-227
Fibrin content of fibrin film, 367
Fibrin film, 84, 359, 363-364, 367-368
Fibrin foam, 359, 363-367, 637
 clinical testing of, 365-367
Fibrin formation in—
 ACD solution, 226-227
 Alsever's solution, 228
 pooled plasma, 669-670
 preserved blood, 229
Fibrin precipitation in—
 filtered plasma, 287
 McGill solution, 224
 plasma, 273
 serum, 266
Fibrinogen, 76, 83, 240, 267-268, 270, 637
 conversion of, into fibrin foam, 364
 in burns, 364
 in fraction I—359
 loss of, during plasma filtration, 287
Fibrinolytic enzyme, 359

- Field armies:
 need for replacements in, 501
 provision of blood for, in ETOUSA, 498
- Field conditions, determination of blood volume under, 30
- Field Director, ARC, 165
- Field hospitals, 51, 707
 abdominal surgery in, 392
 anuria in, 666
 blood for, 466, 496, 479
 in Luzon operation, 621
 blood-plasma ratio in, in ETOUSA, 487, 556-557
 deliveries to, 414, 462, 467, 480
 during Normandy landings, 512, 518
 in ETOUSA, 506, 510, 551
 in invasion of southern France, 447
 on Continent, 522-523
 establishment of, in MTOUSA, 684
 experiences in, in ETOUSA, 568, 569-570
 mobile refrigeration in, 395, 397, 416, 464
 plasma reactions in, in SWPA, 673
 provision of field transfusion units in, 544
 reaction rates in, 660-663
 resuscitation in, 443
 salvage of aging blood in, 410
 shock teams in, 463
 suspension of deliveries to, in southern France, 450
 transfusions in, in MTOUSA, 180, 404-405, 437
- Field investigations, NRC proposal for, 23, 79-80, 468
- Field record of blood collected in ETOUSA Blood Bank, 504
- Field requirements for refrigeration, 206-208
- Field studies on—
 dextran in Korean War, 793-794
 gamma globulin in Korean War, 783
 gelatin in Korean War, 787
 intra-arterial transfusion, 160-161
 replacement therapy, 79-81
- Field training in use of plasma, 87
- Field transfusion equipment:
 cleaning of, 190
 controversy over acceptance of, 192-195
 development of, in ETOUSA, 185-195
 sterilization of, 190-191
 testing of, 192
- Field transfusion units:
 in British Army Transfusion Service, 16, 17-18
 in ETOUSA, 543-545
 obstacles to initial supply of, 53
 request for, from ETOUSA, 192
- Fifth U.S. Army blood bank. *See* Naples Blood Bank.
- FILATOV, A., 266
- Filerooms in ARC blood donor centers, 113
- Filipino civilians, fatal plasma reactions in, 671-674
- Filipinos, 671, 673
 reactions in, 668
 susceptibility of, to plasma infusions, 672, 673
- Film strip on resuscitation, 55
- Film strip 8-51—413
- Filter(s), 194, 463
 difficulties with:
 in ETOUSA, 553-554
 in SWPA, 598-599, 636
 for plasma, 168, 169-171, 287-288
 for serum albumin, 198, 353
 in expendable transfusion set, 197-198
 in plasma package, use of, in Ebert-Emerson set, 189
 lack of, in Ebert-Emerson transfusion set, 193
 pads, 287-288
 shortages of, 544
- Filtration—
 during transfusion, 193
 in fractionation of plasma, 343
 in production of serum albumin, 353
 of blood transported under refrigeration, 211
- Finance and Supply Division, Office of Chief Surgeon, ETOUSA, 541
- FINCH, C. A., 230
- Finland, 791
- FINNEY, Col. G. G., 624
- Finschhafen, 582, 588, 591, 616
- FIROR, W. M., 75
- First aid, plasma as component of, 57
- First Conference on Gelatin, NRC, 372, 373
- First Special Service Force, 447
- FISHER, A. M., 158
- Fitzsimons General Hospital, 96, 111, 603
- Fixed hospitals:
 anuria in, 666
 in Japan, blood supply for, in Korean War, 752
 use of Rh-negative blood in, in Korean War, 748
 reaction rates in, 660
 replacement therapy in, 51
 secondary anemia in, 703-705
 transfusion in, 193

- See also* Base hospitals, General hospitals, Station hospitals.
- Flanders, 20, 48
- Flat feet, donors with, in World War I—6
- Fleet, supply of, for Okinawa operation, 623
- Fleet Surgeon—
 CPA, 594
 SWPA, 604
 U.S. Pacific Fleet, 168
- Fleet units, deliveries to, in SWPA, 607-631
- Fliers, rejection of, as donors, 140
- Flight rations for civilian donors, 453
- Flight time of airlift to ETOUSA, 488-489
- Flocculation:
 after reconstitution of plasma, 165
 in plasma, 286
 in serum albumin, 345
 of plasma proteins, 274
- Florence, 406, 407, 418, 420, 442
- FLOSDORF, E. W., 65, 277, 278, 336
- Fluid administration:
 contraindications to, 96
 supplemental, to serum albumin therapy, 35, 332, 339, 340-341, 347, 637, 782
- Fluid balance in plasma reactions, 671
- Fluid loss as cause of death in combat casualties, 265
- Fluid regulation in incompatibility reactions, 656
- Fluid replacement therapy, responsibility for, in OTSG, 67
- Fluid shift in shock, 30
- Foggia, 398
- Followup studies on Periston, 789
- Food and Drug Administration, 788, 790, 795
- Force, VII Amphibious, 618
- Forecasts of daily needs—
 in ETOUSA, 510, 541, 546
 in SWPA, 615
- Foreign antibodies after multiple transfusions, 805
- Foreign body reactions to fibrin film, 368
- Foreign isohemolysins in recipient serum, 806
- Foreign proteins, introduction of, in transfusion components, 651
- Foreign relief, use of excess byproducts for, 84
- Formed Elements Group, NRC, 769
- Forms for plasma accounting, 301, 302, 303
- Forms used at ARC blood donor centers, 145
- FORRESTAL, Secretary J. V., 715
- Fort Hancock, 514
- Fort Lewis, 606
- Fort Sam Houston, 695
- Fort Totten, 208
- Fort Worth, 111, 292, 345
- Forward areas:
 concepts of transfusion in, 48-49
 provision of blood in, 35
 use of plasma in, 21
- Forward distributing center:
 in MTOUSA, 409-411, 414
 on Guam, 622, 623, 630, 631, 638
- Forward distributing section—
 in MTOUSA, 445
 of 6703d Blood Transfusion Unit (Ovhd.), 447, 449-450
- Forward hospitals:
 blood banks in, 395
 blood-plasma ratio in, in ETOUSA, 556-557
 cleaning of recipient sets in, in MTOUSA, 434-435, 444
- deliveries to:
 in MTOUSA, 399
 in Philippines, 607
 on Continent, 520-521, 522-523, 550, 551
- ETOUSA bank blood for, 555
- in Korea, 752
- in MTOUSA, use of blood in, 437-438
- in southern France, deliveries to, 451
- lack of transfusion equipment in, 180
- losses in, in SWPA, 633
- management of shock in, 268
- need for blood in, 461-462, 561-564
- of Fifth U.S. Army, 407-408
- of Seventh U.S. Army, 445
- procurement of blood by, 397
- reaction rate in, 660-663
- records in, 455
- refrigeration for:
 in ETOUSA, 478
 in southern France, 454
- reservation of blood bank blood for, 496
- transfusion officers in, 420
- transfusions in, 193, 194, 404-405
 in World War I—8
- use of blood and plasma in, in ETOUSA, 564-566
- use of plasma in, 180
- See also* Fixed hospitals, Evacuation hospitals, Casualty clearing stations.
- Forward surgery, role of British blood program in, 16
- FOWLER, W. M., 158, 159
- Fraction I—348, 359
- Fraction II—348, 359, 362, 363

- Fraction II + III— 237
 Fraction III—359, 363
 Fraction IV—348, 360
 Fraction V—348, 349, 353, 360
 Fraction VI—349, 360
 Fractionation of—
 gelatin, 374
 plasma, 336, 337, 343, 372
 plasma protein, 81
 Fractures, 39
 after donations, 157
 immobilization of, 56
 of femur, 392, 444, 698
 use of fibrin film in surgery of, 368
 Fragility—
 of recipient cells after pooled plasma infusions, 657
 of red blood cells:
 after airlift in Korean War, 804
 after airlift to ETOUSA, 211
 effect of ion exchange technique on, 770
 in ACD solution, 226
 in hemolytic reactions, 663
 Fragility index in red blood cell transfusions, 315-316
 Fragility tests, 222, 755
 France, 13, 17, 20, 119, 224, 447, 448, 451, 452, 453, 454, 488, 494, 514, 518, 520, 522, 538, 549, 554, 569
 airlift to, from United Kingdom, 19, 459, 478, 510, 518, 531-532, 534-535
 British experience in, 18-20
 fall of, 13
 legal prohibition of transfusion in, 1
 FRASER, Sir F. R., 529
 Fraternal meetings, recruitment of donors at, 125
 Frederick Stearns & Co., 378
 Free French, plasma for, 94
 FREEMAN, N. E., 30, 74
 Freezing, losses—
 due to, 397, 455
 in Korean War, 750, 771
 in ZI in Korean War, 774
 during airlift to ETOUSA, 552
 of reconstituted plasma in Korean War, 782
 French Army, 94
 French blood collected in North Africa, 448
 French civilians, employment of, in Continent Blood Bank, 516
 French electric current, 573
 French Government, 521
 French Military Medical Mission, 94
 Frozen plasma, 52, 65, 268-269, 270-273, 337
 military use of, 271
 properties of, 273
 provision of, for OCD, 92-93
 risks of storage of, 92
 storage of, 165
 thawing of, 273
 transmission of malaria by, 143
 Frozen thrombin, 363
 Fukuoka, 728, 729
 FULLERTON, A., 5
 Fulminating infection as cause of failure of transfusion, 444
 Functions of—
 Armed Services Blood and Blood Derivatives Group, 722-723
 base transfusion unit, British Army Transfusion Service, 16, 17-18
 chief of transfusion service in ZI, 464
 Committee on Blood and Blood Substitutes, NRC, 725
 Consultant in Transfusion and Shock in ETOUSA, 472
 Director of Medical Services, DOD, 725
 Division of Surgical Physiology, Army Medical School, 65-67
 enlisted personnel on shock ward, 710
 ETOUSA Blood Bank, 496-498
 home depot, British Army Transfusion Service, 16-17
 medical officers on shock wards, 710
 nonprofit blood banks before Korean War, 719
 personnel, 6713th Blood Transfusion Unit (Ovhd.), 408
 processing laboratory, Travis AFB, 740
 processing section, ETOUSA Blood Bank, 502-503
 special branch on shock and transfusion, 78
 Subcommittee on Blood Substitutes, NRC, 75-76
 Supply Division, Office of Chief Surgeon, ETOUSA, 545
 technical supervisors of ARC chapters, 108-109
 theater (FECOM) transfusion officer, 757
 theater transfusion officer, 467, 639
 transfusion officers overseas, 463
 ZI personnel, in procurement of blood for ETOUSA, 490-491
 Funds for ARC Blood Donor Service, 103
 Fungible blood, 94

- Fungus growth in intravenous solutions, 385-387
- G-4, ETOUSA, 536, 538, 539, 540
G-4, SOS, ETOUSA, 546
G-18 depot, 474
Galesburg, 695
Gallbladder surgery, 364
Gallon Club, 128, 731
Gamma globulin, 362, 363, 772
 allocation of, in Korean War, 783-784
 in Korean War, 783-784
 prophylactic use of, 679-680
 recovery of, from discards in Korean War, 784
Gamma-globulin antibodies, 359
Gangrene of hand, after intra-arterial transfusion, 801
Garches, 515
Garigliano offensive, 408
Gas-oxygen anesthesia, 7
Gasoline generator for field refrigerator, 206
Gassed casualties as donors in World War I-9
Gastric juice, A and B substances from, 260
Gastric ulcer, 317
Gastrointestinal disease, transfusion of cadaveric blood in, 24
Gelatin, 65, 76, 372-377, 726
 clinical testing of, 375, 376
 criteria of, 376-377
 effects of, 34
 fractionation of, 374
 gelling of, at room temperature, 786
 in Korean War, 786-787
 indications for use of, 377
 limitations of, 377
 production of, in Korean War, 786-787
 properties of, 373-374, 376, 377
 reactions of, 375
 special studies on, 373-374, 375-377, 786
 specifications for, for military use, 374
 stability of, 374, 375
 termination of investigation of, 377
 toxicity of, 375
 versus physiologic salt solution, 376
Gelatin (gel) caps, for distilled water bottles, 169
General Board, U.S. Forces, European Theater, 574-575
General Electric News, 205
General hospitals:
 blood banks in, 195, 395-396, 473
 in United Kingdom, 478-479
 collecting units in, 465
 distribution of ETOUSA bank blood to, 557-558
 ETOUSA, check of blood grouping in, 244-245
 evacuation hospitals functioning as, 442
 experiences in, in ETOUSA, 568, 570-574
 in ZI, 175-176, 319
 overseas, 180, 185
 collection of blood in, 462, 463
 refrigeration in, 463
 plasma reactions in, in SWPA, 673
 provision of field transfusion units for, 544-545
 reaction rate in, 660-663
 shortages of nurses in, 501
 storage of blood in, overseas, 463
 survey of serum hepatitis in, in ZI, 675-678
 transfusion in, 392-393, 465
 transfusion officers in, 463
 use of aging blood in, in United Kingdom, 554
 use of excess blood in, in SWPA, 630
General Memorial Hospital, 219
General Orders No. 128, ETOUSA, 574
General Surgical Team No. 25, 2d Auxiliary Surgical Group, 693
Generators for field refrigerators, 206, 414, 454
Genital sores, 262
George Washington University School of Business Administration, 310
German border, 43
German E-boats, 509
German experience, 22-23
German management of battle casualties, 22-23
German surrender, 111, 130
 in Italy, 22
Germany, 22, 23, 452, 522, 788, 789
Ghost cells, 555
GIBSON, J. G., 2d-210, 260, 335, 769
Gibson-Evans dye technique of plasma volume determination, 43
GILLESPIE, Col. F. S., 54, 55, 391
GINN, Col. L. H., Jr., 574
Glass beads for filtration, 185, 189, 193, 194
Glass cloth filters, 170
GLENN, Lt. Col. F., 619, 633
Glenn L. Martin plant, 129
Globin, 65, 128-129, 361-362

- Globulin, 76, 270
 content—
 of bovine albumin, 326, 327, 328, 331, 333
 of serum albumin, 337, 344, 345, 349
 flocculation of, in reconstituted plasma, 165
 in fraction I—359
 ownership of, 85
- Globulin fractions, 83, 236, 237
- Glucose:
 addition of, to blood—
 in ETOUSA, 476
 in MTOUSA, 426
 in SWPA, 589
 critical level of, in freezing whole blood, 771
 effect of, on resuspended red blood cells, 315-316
 recommendation for addition of, to stored blood, 222
- Glucose infusions, 437
- Glucose solutions, 50, 219, 598, 769
 commercial procurement of, 382
 effect of, in shock, 34
 indications for, 383
- Glutamyl polypeptide, 76, 379
- Glycerol content of fibrin film, 367
- Glycine, 363, 377
- Glycolysis, in preserved blood, 229
- GNOINSKI, H., 219, 649
- GOODALL, J. R., 24
- GORBY, Col. A. L., 486
- GORDON, Col. J. E., 245
- Gothic Line, 408
- Grady Hospital, 62, 144, 339
- GRANT, Maj. Gen. D. N. W., 733
- Gravity collection technique, 15, 195
- Gray Ladies, 111
- Great Britain, 5, 13
- GREAVES, R. I. N., 277, 278
- GREEN, Lt. Col. H. S., 574
- Greenham Common Airfield, 532, 533, 534
- GREGENSEN, M. I., 258
- GRIGGS, Lt. Col. O. B., 492
- Grosseto, 407
- Group A blood, 4
 collection of, for Seventh U.S. Army hospitals, 451, 453
 suggested use of, in Pacific, 583
- Group A donors, 397
- Group A recipients:
 of group O blood, 641
 reaction of, to high-titer group O blood, 696
- Group AB blood, 4, 234
- Group AB recipients:
 of group O blood, 641
 reaction of, to high-titer group O blood, 696
- Group B blood, 4, 245
- Group B recipients:
 of group O blood, 641
 reaction of, to high-titer group O blood, 696
- Group O blood, 4, 65, 234, 502, 526, 527, 567
 ARC collection of, 136
 call for donations of, in ETOUSA, 525
 collection of, in SWPA, 583
 estimates of procurement of, in ETOUSA, 481
 for airlift:
 in Korean War, 743
 to ETOUSA, 490
 for battlefield transfusions in Soviet Union, 22
 for forward hospitals, 466
 grouping errors in, 191
 in British blood program, 17
 in ETOUSA, 477, 478
 massive transfusions with, in Korean War, 804
 reactions after massive transfusions of, 663-664
 recommendation for universal use of, 53, 54, 462, 469
 red cell residua from, 313, 317
 risk of multiple transfusions with, 664
 safety of, 460
 screening test for, 251-252
 selection of:
 before Korean War, 719
 in MTOUSA, 424-426
 sensitization to, 651
 supply of, to ZI hospitals, 97
 testing of Alsever's solution with, 224
 titration of, for oversea use, 258
See also Universal donors; Dangerous universal donors.
- Group O donors:
 in Australian blood bank, 581
 in ETOUSA, 190, 194
 in MTOUSA, 397, 403
 recruitment of, 125-126
- Group O recipients, limitation of high-titer group O blood to, 424-426, 442, 444, 489-490, 496, 552

- Group-specific blood:
 in Korean War, 666, 729
 risk of military use of, 664
- Group-specific plasma:
 reactions to, 669
 use of, in Soviet Union, 22
- Group-specific transfusions:
 reactions after, 650
 with red blood cell residua, 312, 317
- Grouping:
 equipment for, 464
 errors in, 241-245, 552
 in Armed Forces, 77
 of blood:
 for ETOUSA, 490, 494
 in ARC blood donor centers, 491
 of hospital personnel:
 in Spanish Civil War, 11
 in World War I—9
 of plasma, 266, 269
- Grouping errors, reactions caused by, 650
- Grouping sera, 7, 11, 52, 77, 236-241, 442, 461
 criteria of, 238-239
 development of, 236-239
 for airlift to ETOUSA, 491, 492
 from discarded blood, 306
 in ETOUSA, 545
 in 1941—268
 testing of, 240-241
- Grow, Brig. Gen. M. C., 529, 530
- Guadalcanal, 253
- Guam, 211, 213, 594, 600, 602, 603, 605, 608, 607, 610, 611, 612, 614, 615, 618, 620, 621, 622, 623, 625, 630, 631, 632, 633, 638, 639, 640, 668
 location of advance base blood bank on, 614-615, 630, 638
- GUEST, G. M., 226
- GUIOU, Capt. N. M., 6
- Gum acacia, 265, 384
 amyloid degeneration from, 791
 continued use of, after World War I—371
 in World War I—7, 8, 9
 toxic reactions to, 371
- Gum acacia-salt solution, fatalities after use of, 10
- Gynecologic practice, Rh testing in, 249
- Halloran General Hospital, 84, 97, 695
- HALSTED, W., 23
- HAM, T. H., 663
- HAMILTON, P. B., 253
- HAMILTON, Capt. W. M., 574
- HAMPTON, Lt. Col. O. P., Jr., 443, 444, 703
- Hand centrifuge, 191
- Haneda AFB, 746, 754
- HARDIN, Lt. Col. R. C., 48, 85, 179, 192, 209, 212, 220, 225, 227, 247, 470-471, 472, 473, 477, 478, 480, 487, 488, 489, 493, 494, 496, 497, 498, 500, 501, 508, 509, 515, 524, 528, 529, 530, 546, 547, 548, 550, 551, 552, 553, 554, 555-556, 557, 657, 660, 661, 664, 665
- HARRIS, J. E., 219
- Harrisburg, 292
- Hartford, 292
- HARTFORD, Col. T. J., 482
- HARTMAN, Lt. F. W., 7, 171, 377, 379
- Hartman's technique of pectin production, 379
- Harvard Medical School, 70-71, 73, 74, 75, 81, 82, 237, 325, 326, 327, 328, 335, 338, 342, 343, 344, 346, 348, 351, 354, 359, 362, 367, 377, 379, 430, 714, 769
- Harvard pilot plant, 303
- Harvard-American Red Cross Hospital, 500
- HARVEY, W., 1
- HAVENS, W. P., 679
- Hawaii, 209, 338, 591, 603, 633
- Hawley Committee, 715, 716
- HAWLEY, Maj. Gen. P. R., 179, 192, 215, 244, 459, 472, 475, 477, 479, 481, 482, 483, 484, 485, 486, 487, 488, 489, 492, 496, 498, 500, 524, 527, 530, 531, 540, 544, 548, 549, 550, 553, 557, 558, 560, 664, 715
- Hay fever, in donors, 142
- HAYS, Col. S. B., 494, 536, 537, 538, 541, 542, 543, 546, 547, 558, 574
- Head injuries, 56
 as cause of shock, 38
 as contraindication to replacement therapy, 34
 plasma in, 696
 serum albumin in, 347, 702
- Headquarters, SOS, ETOUSA, 528
- Healing, effect of multiple transfusions on rate of, 444
- Health Resources Advisory Committee, Office of Defense Mobilization, 733, 735, 775, 784
- Health Resources Office, 716
- Heart:
 damage to, in shock, 36
 dilatation of, during transfusion, 12
 fibrin foam in surgery of, 365

- Heart failure in reactions from contaminated blood, 665
- Heat:
 effect of, on serum albumin, 345, 350, 351, 352
 in prevention of shock, 34
 in shock, 32
- HEINATZ, S. W., 266
- Helicopter transportation, in Korean War, 746, 752, 805
- Hell's Highway, 521
- Helmstedt, 522
- Hematochromatosis after multiple transfusions, 804
- Hematocrit:
 determination of, 42-44, 63, 252-258, 339, 430, 432, 618, 626, 710
 effect of oxidized cotton on, 380
 quantitative relation of, to blood loss, 255, 256, 691
- Hematocrit level(s)—
 as index of need for plasma, 697
 in burns, 697, 793
 in crushing injuries, 696
 in shock, 36, 38, 40, 43-44, 444
 in wounds of extremities, 703-704
- Hematologic response to transfusion, 805
- Hematopneic shock, 56
- Hematopoiesis of splenic sinusoids, 381
- Hematuria:
 after globin injections, 783
 in incompatibility reactions, 654
 in plasma reactions, 671
- Hemoclastic reactions in Korean War, 804
- Hemoconcentration:
 as indication for plasma infusion, 51
 in burns, 30, 338, 697
 in crushing injuries, 30, 696
 in shock, 30, 32, 40, 51, 706
- Hemodilution, 379, 444
 after dextran injections, 792
 after gelatin injections, 374, 376
 after injections of oxidized cotton, 380
 after plasma infusion, 686
 after serum albumin injection, 338, 339, 341
 in shock, 43-44
 relation of, to hemorrhage, 43-44
- Hemodynamic status in shock, criteria of, 684-685
- Hemoglobin:
 breakdown products of, in dextran therapy, 791
 delayed regeneration of:
 in female donors, 158-160
 in SWPA, 595
 effect of, on kidneys, 658-659
 effect of oxidized cotton on, 380
 in donors, 139, 140, 145
 in outdated blood, 657
 in professional donors, 158
 intravenous injection of, 655
 regeneration of, after donations, 158-160
 renal tolerance of, 555
 reutilization of breakdown products of, 221
- Hemoglobin content of—
 aging blood, 555
 centrifuged plasma after transportation, 220-221
 commercial plasma, 296
 dried plasma, 279, 300, 302
 supernatant plasma, 210, 211, 224, 426, 552
- Hemoglobin deficits, postoperative transfusion for, 691
- Hemoglobin determinations, 42-44, 430, 617-618, 626
 after red blood cell transfusion, 315, 316
 by copper sulfate technique, 253, 254, 255
 in MTOUSA, 442
 in shock, 31
- Hemoglobin level(s):
 after transfusion with unrefrigerated red blood cells, 210
 for donors, 140-141, 257-258
 in Blood for Britain, 14
 in burns, 338
 in preserved blood, 229
 rejection of donors for, 141
 with Alsever's solution, 222
- Hemoglobin molecule, studies on, by radioactive cell tagging, 221-222
- Hemoglobin solutions, 361
- Hemoglobinemia, 211
 after red blood cell transfusions, 318
 effect of, on shock kidney, 657
- Hemoglobinuria, 315, 668
 after red blood cell transfusions, 318
 in lower nephron nephrosis, 667
- Hemoglobinuric nephropathy after transfusion of A recipients with O blood, 425
- Hemoglobinuric nephrosis, 655, 658-659, 660
- Hemolysis:
 after biologic testing, 239-240
 after transportation, 20
 in World War I—6
 under refrigeration, 211

- after wounding, 805
 anemia caused by, 805
 caused by:
 blood substitutes, 373
 heating, 694
 outdating, 650
 degree of, as index of reactions, 569
 during airlift to ETOUSA, 552
 effect of dextrose on, 218
 effect of electrolytes on, 218, 219
 effect of sodium citrate on, 218
 effect of temperatures on, 203, 219
 in aging blood, 755
 in fractionation of plasma, 343
 in incompatible transfusion, 4
 in Korean War, 747
 in preserved blood, 217, 218, 221-224, 229
 in red blood cell transfusions, 315-316
 in SWPA, 585, 587, 607, 611, 612-614
 losses from, 306
 in ETOUSA, 567, 572
 in Korean War, 750
 in MTOUSA, 438, 441, 442, 631-632
 of donor cells, 265
 of plasma by donor's cells, 7
 of recipient cells, 663-664
 after plasma infusion, 259
 of resuspended red blood cells, 313, 314
 of unrefrigerated blood, 210
 relation of, to refrigeration, 570-571
 with ACD solution, 612
 with Asever's solution, 222, 224
 with plastic equipment, 759
 Hemolytic crisis in incompatibility reactions, 654
 Hemolytic reactions, 552, 572, 650, 653-659, 660, 661-664
 after plasma infusion, 259
 differential diagnosis of, 653
 effect of status of kidneys on, 650
 from blood of dangerous universal donors, 804
 in ETOUSA, 660
 to plasma, 668, 670-671
 relation of degree of, to amount transfused, 650
 with compatible blood, 245-246, 804
 Hemolytic shock, plasma for, 266
 Hemolyzed blood, transfusion with, 653
 Hemophilia, fibrin foam in, 365
 Hemorrhage:
 as cause of shock, 7, 8-9, 29, 31, 32, 33, 38, 41-44, 444
 as indication for transfusion, 1, 2, 7, 22
 blood regeneration after, 229
 bovine albumin in, 327, 335
 continuation of, as cause of failure of resuscitation, 444, 559
 control of, 12, 56
 in prevention of shock, 34
 on shock wards, 710
 differentiation of, from shock, 12, 29, 51
 early discussion of, by NRC, 50-51
 effect of gelatin preparation in, 376, 787
 effect of physiologic salt solution in, 8, 35, 383
 German management of, 23
 gum acacia in, 8, 384
 in abdominal wounds, 705
 incidence of, 77
 plasma in, 297, 391, 462
 quantitative relation—
 of, to degree of shock, 41, 42, 685-686
 of transfusion to, 559
 recurrence of, during replacement therapy, 34, 44, 685
 relation of:
 to hemodilution, 43-44
 to types of weapons, 616
 Ringer's solution in, 8
 serum albumin in, 354, 355
 serum in, 335, 336
 transfusion with cadaveric blood in, 24
 See also Blood loss; Loss of circulating blood volume; Shock.
 Hemorrhagic diseases, plasma in, 266
 Hemorrhagic shock, concept of, 265, 706
 Hemosiderosis after multiple transfusions, 804
 Hemostasis:
 in neurosurgery, 363-364, 367-368
 plasma for, 266
 Hemothorax:
 aspiration of, 710
 in shock, 688
 in World War I—23
 Henry Ford Hospital, 171, 379
 Hepatic cirrhosis, serum albumin in, 352
 Hepatic function, effect of Periston on, 789
 Hepatitis:
 plasma in, 297
 virus of, in thrombin, 364
 See also Infectious hepatitis.
 Hepatomegaly in Chinese troops, 646
 Hepatotoxic properties of dextran, 790-791
 Heterogenicity of commercial gelatin, 374
 Heterologous plasma, 266
 HEVL, J. T., 331, 332, 333, 335

- Hicks, B., 218
 Higginson enema syringe, 189, 190, 191, 553
 High anti-A (anti-B) agglutinin titers in MTOUSA, 426, 442
 High anti-A titer group O bloods in MTOUSA, 424-426
 High anti-B titer group O bloods in MTOUSA, 424-426
 High explosives, 391
 High-titer group O blood, 641
 fragility of recipient red cells after injection of, 657
 in Korean War, 745
 in MTOUSA, 259-260
 limitation of, to group O recipients, 258, 424-426, 442, 444, 489-490, 496, 552
 reactions due to, 664
 reactions to, in non-group-O recipients, 696
 risk of, to non-group-O recipients, 664
 use of, for non-group-O recipients, 656
 in Korean War, 804
 High-titer grouping sera, 194, 650
 High-velocity missiles, 266
 HIGHMORE, W., 23
 HILL, J. M., 251, 278, 280
 HILLMAN, Brig. Gen. C. C., 13, 49, 50, 51, 61, 64, 87, 109, 172, 291, 337, 602
 Hirudin, 218
 Historical note, 1-27
 on anticoagulant solutions, 217-220
 on blood substitutes, 371
 on development of Office of Assistant Secretary of Defense (Health and Medical), 714-717
 on drying of plasma, 276-279
 on gum acacia, 384
 on intra-arterial transfusion, 796
 on National Research Council, 73
 on Periston, 787-788
 on physiologic salt solution, 383
 on plasma, 265-267
 on preservative solutions, 217-220
 on pyrogenic reactions, 651-652
 on red blood cell residua, 312
 on Rh factor, 245-246
 on serum albumin, 335-336
 on shock, 29
 on sodium bicarbonate, 384
 on transfusion before World War I—1-5
 History-taking on donors, 141-142, 422-423
 HMS *City of Canterbury*, 515
 Hoarding in MTOUSA, 455
 Hodgkin's disease, red blood cell transfusions in, 317
 HOEV, Col. P. H., 714, 721
 Hoffman clamp, 196
 Hog stomach, derivation of A and B substances from, 260
 Holding hospitals in ETOUSA, 513
 Holland, 522, 791
 Hollandia, 588, 589, 590, 591, 593, 595, 597, 616, 620, 621, 630
 Hollandia Blood Bank, 597, 611, 616, 620, 630
 establishment of, 593
 in Luzon operation, 620
 workload at, 595
 Hollinger Corp., 762
 Hollinger insulated shipping container, 762-763, 765
 HOLMES-à-COURT, Maj., 6
 Home depot:
 British Army Transfusion Service, 16
 procurement of blood by, 17
 Homogeneity of gelatin, 374
 Homologous serum, experimental injection of, 265
 Honolulu, 591, 604, 624, 746
 Hook, Capt. F. R., 594
 Hoover Commission, 715
 Hoover, Ex-President H., 715
 Horse bottles, 293
 Horse serum, 88, 140
 Horse stomach, derivation of A and B substances from, 260
 HORT, E. C., 651
 HORWITZ, Lt. W. H., 314
 Hospital blood banks, 664
 after World War II—714
 Hospital carriers, deliveries by, 485, 512, 538
 Hospital Center, 813th—573
 Hospital Corps, ARC, 111
 Hospital detachments, donations from:
 in ETOUSA, 569
 in MTOUSA, 394
 in SWPA, 584, 595, 597
 Hospital experiences—
 in ETOUSA, 568-574
 in MTOUSA, 442-443
 Hospital of University of Pennsylvania, 364, 376
 Hospital ships:
 in British blood program, 17
 blood for, in Luzon operation, 621
 bombing of, 618
 serum albumin on, 637
 transportation of blood by, in SWPA, 587-588

- Hospitalization Division, Office of Chief Surgeon, ETOUSA, 498-499
- Hospitals, construction of, in SWPA, 599
- Hospitals, effect of location of, on use of blood, 437-438
- Hospitals, evacuation:
- 2d—487, 565
 - 5th—565
 - 9th—442
 - 10th—585-586
 - 11th—803
 - 12th—554
 - 14th—642
 - 16th—703
 - 38th—435
 - 45th—553
 - 59th—453
 - 67th—553
 - 73d—642
 - 77th—382-383, 393-394, 422, 433
 - 91st—659, 664
 - 97th—565
 - 128th—553
- Hospitals, field:
- 2d—631
 - 10th—447, 603
 - 11th—39, 447, 569
 - 13th—565
 - 31st—603
 - 33d—698
 - 42d—565
 - 47th—565
 - 60th—554
 - 77th—697
 - 84th—558
- Hospitals, general, numbered:
- 1st—549, 576
 - 2d—473, 474
 - 4th—474
 - 5th—42, 185, 192, 473
 - 6th—428
 - 12th—432
 - 16th—394
 - 20th—385-387, 642
 - 21st—442-443, 704
 - 23d—452, 704
 - 27th—589-590
 - 30th—473
 - 42d—582
 - 43d—570-573
 - 45th—366, 435, 442
 - 52d—474
 - 67th—474
 - 80th—634
 - 105th—582
 - 148th—626, 627
 - 152d—475, 479, 518
 - 182d—474, 558
 - 203d—515
 - 217th—513
 - 227th—573
 - 298th—474, 499, 573-574
 - 317th—606
- Hospitals in ZI:
- distilled water equipment in, 388
 - dried plasma for, 175-177
 - liquid plasma for, 95-96, 176, 195, 274-275
 - red blood cells for, 312
- Hospitals, location of, in Italy, 420
- Hospitals of Fifth U.S. Army, 455
- Hospitals, procurement of blood supply by, in Operation OLYMPIC, 641
- Hospitals, station:
- 118th—728, 729
 - 119th—634
 - 127th—452, 496, 500, 513-517
 - 152d—195, 212, 459, 475, 479, 495, 498-513, 515-522
 - 347th—513
- Hospitals, various:
- Chelsea Naval Hospital, 97, 740
 - Mare Island Naval Hospital, 741
 - Naval Hospital, Oakland, 739, 740, 741
 - Naval Hospital, Pearl Harbor, 338
 - U.S. Army Hospital, Yokohama, 732
 - U.S. Naval Base Hospital:
 - No. 18—613, 614
 - No. 19—607
 - No. 20—607
 - Yokosuka, 732
 - 7th Portable Surgical Hospital, 633
 - 27th Portable Surgical Hospital, 634
 - 46th Surgical Hospital, 805
 - 48th Surgical Hospital, 438
 - 8209th MASH (Mobile Army Surgical Hospital), 728, 803, 804
- House-to-house canvasses for donors, 125
- Housekeeping. *See* Administrative considerations.
- Houston, 345, 783
- HOWARD, Capt. J. M., 803
- Howard University, 14
- Hr antigen, 247, 248
- Huerter, 796
- HUGHES, W. L., Jr., 359
- Human errors as cause of reactions, 572-573
- Human grouping sera, 235, 237-238, 239
- Human protein, sensitization to, 651

- Human serum albumin. *See* Serum albumin.
- Humboldt Bay, 593
- HUSTIN, A., 4, 219
- Hygroscopic property, of rabbit grouping sera, 236
- Hyland Laboratories, 236, 279, 289, 292, 603, 719, 774
- Hyperpotassemia, 349
- Hypertension in—
donors, 140, 141
Japan in Korean War, 731
lower nephron nephrosis, 667
- Hypertonic effects of concentrated plasma, 276
- Hypertonic salt solution, 383
- Hypertonic serum albumin solutions, 349
- Hypertonicity of serum albumin, 702
- Hypochloremia in lower nephron nephrosis, 667
- Hypodermoclysis:
administration of plasma by, 698
with physiologic salt solution, 383
- Hypoproteinemia:
after donations, 159
globin in, in Korean War, 783
in Chinese, 645
in Filipinos, 672
plasma in, 297, 697
salt-poor serum albumin in, 352
serum albumin in, 338, 360, 702
transfusion in, 635
- Hypotension:
as cause of failure of resuscitation, 44
in donors, 157
effect of:
on alkali reserve, 384
on renal circulation, 658
See also Transfusion; Replacement therapy
- Ice, provision of, at ARC blood donor centers, 214
- Icing en route, 206
- Icterus index:
effect of red blood cell transfusions on, 315
in plasma reactions, 671
- Identification—
of blood groups, 4
of donors with latent hepatitis, 679
- Identification tags, errors in blood groups on, 429, 444, 501, 567, 598
- I. G. Farben Laboratories, 788
- Heocolitis in reactors to plasma, 671
- Immobilization of fractures, 56
- Immune globulin, 637
- Immune serum globulin, 362-363, 637
from discarded bloods in Korean War, 750
- Immunization, role of, in reactions to dextran, 793
- Immuno-hematologic response to multiple O-blood transfusions by non-O recipients, 805-806
- Immunologic studies on bovine albumin, 327-328, 333
- Impending shock, 39
transfusion in, 635
- Implementation of—
dried plasma program, 102-104
planning for Okinawa operation, 623-625
provision of blood for forward hospitals in ETOUSA, 496-498
recommendations for oversea transfusion service, 463-464
- Improvisations—
in Korean War, 713, 714
in SWPA, 594-595, 598
of equipment after D-day, 553
- Improvised equipment:
at 6703d Blood Transfusion Unit (Ovhd.), 453
in World War I—5, 9
- Improvised facilities for base collection centers in MTOUSA, 431-432
- Improvised refrigeration in ETOUSA Blood Bank, 504
- Improvised transfusion sets in ETOUSA, 185-191, 474
- Inadequate mobilization of fractures as cause of shock, 688
- Incidence of—
allergic reactions, 650
burns, 77
contamination:
in Blood for Britan, 14
in placental blood, 25
hemolysis, 438-439
hemolytic reactions, 653
hemorrhage, 77
posttransfusion chills, 219
pyrogenic reactions, 652-653
reactions, 649-650
after donations, 153-154, 155-156
after first use of sodium citrate, 651
at Mount Sinai Hospital, 651, 652
in ETOUSA, 247, 660
in Korean War, 756
of Rh agglutinin in general white population, 246

- of serum hepatitis in Korean War, 778, 781
 - of serum sickness, 335
 - of shock, 77
 - of wound infection, 57
 - on well controlled services, 649-650
 - with proper cleaning of equipment, 652
- Incompatible blood:**
- effect of, on recipient agglutinins, 240
 - fatalities after transfusion with, 435
- Incompatible (cadaveric) blood, 24**
- Incompatible donor cells, intravascular hemolysis of, 653, 656-657**
- Incompatible isoagglutinins, transfusion of, 663-664**
- Incompatible transfusion, 4, 259**
- Incompatibility:**
- anuria from, 65-67
 - effect of age of blood on, 569
 - reactions, 186, 650, 659, 663-664
 - differential diagnosis of, 655-656
 - in Korean War, 744, 804
- Incontinence after donations, 157**
- Increase—**
- of capillary permeability as cause of shock, 30
 - of hemoconcentration in shock, 32
- Incubation period of serum hepatitis, 679**
- India, 16**
- national blood program in, 642
- Indian Army, 642**
- Indian Medical Directorate, 643**
- Indianapolis, 118, 291, 695**
- Indications for—**
- fat emulsions, 795-796
 - fibrin film, 368
 - gelatin injections, 377
 - glucose infusions, 383
 - physiologic salt solution, 383
 - plasma, 297, 391, 462, 696-697
 - in Korean War, 796
 - in North Africa, 392
 - replacement therapy, 457
 - Rh testing, 248-250
 - serum albumin, 702
 - in Korean War, 796
 - transfusion, 1-3, 5, 34
 - in CBI, 642-643
 - in Chinese troops, 645-646
 - in Korean War, 796
 - in Soviet Union, 22
 - in Spanish Civil War, 11-12
 - in SWPA, 635
 - in World War I—7, 10
 - shown by copper sulfate test, 255-256
 - with group O blood, 239
- Indirect transfusion, 5**
- Individualization of—**
- blood replacement, 690
 - plasma infusions, 697
 - resuscitation, 559
- Indoctrination:**
- before Luzon operation, 619
 - in ETOUSA, 459-460
 - in Okinawa operation, 624-625
 - in serum albumin therapy in SWPA, 637
 - in SWPA, 607, 618, 630, 633-635
 - on plastic equipment, 759-760
- Inductees as donors, 129**
- Industrial Hygiene Foundation, 153**
- Industrial Mobilization Board, DOD, 774**
- Industrial plants, provision for accidents in, 91**
- recruitment of donors in, 118, 125
- Industry, role of in blood program, 491**
- Infected pooled plasma, storage of, at room temperature, 780**
- Infection:**
- absence of, after transfusions in France, 1940-20
 - after donations, 157
 - after transfusion, 5
 - as cause of circulatory collapse, 32
 - as cause of death, 56
 - as cause of failure of resuscitation, 44
 - as cause of shock, 34
 - as indication for transfusion, 10, 12
 - effect of multiple transfusions on, 444
 - in Korean War, 803
 - malnutrition complicated by, 569
 - plasma in, 266, 297
 - prophylaxis of, in wounds of extremities, 705
 - serum albumin in, 336
- Infectious diseases, rejection of donors with, in World War I—6**
- Infectious hepatitis, 352, 360, 423, 675, 678, 679**
- caused by fraction II—363
 - in potential donors in Japan in Korean War, 731
 - prophylaxis of, 359, 363
- Influenza, 362, 363**
- plasma infusions in, 7
- Influenza epidemic, 120**
- Information, dissemination of, 79, 80**
- INGRAHAM, F. D., 367, 368**

- Initial wound surgery:
 British provision of blood for, 397
 transfusion before, 395
 transfusion during, 55
- Inoculation of volunteers with treated plasma, 780
- Inoperable malignancy, red blood cell transfusions in, 317
- Inspection of—
 airlift to ETOUSA, 493, 495, 552
 blood bank operation, on Continent, 553-556
 commercial processing laboratories, 275, 298-299
 by NIH, 81
 facilities offered for plasma production, 312
 liquid plasma centers, 307-308
 plasma equipment firms, 293
- Inspection trips:
 request for permission for, 467-468
 to check distilled water facilities, 387-388
 to MTOUSA, 443-445
 to oversea theaters, 443-444, 466, 495, 590-595, 603-605
- Instability of fat emulsions, 796
- Institute of Experimental Medicine, Mayo Clinic, 62
- Institute of Tropical Diseases, Sydney, 590
- Instructions:
 for field transfusion units, 544
 on plasma package, 168
 on serum albumin package, 198
- Insulated containers:
 for airlift to ETOUSA, 214, 491, 760
 for Australian airlift, 581, 587, 608-609
 for emergency shipment of whole blood, 397
 for oversea transfusion service, 463
 for Pacific airlift, 208, 603, 609-611
 in British blood program, 17
 in ETOUSA, 573
 in Korean War, 760-766
 in Luzon operation, 620
 in MTOUSA, 208, 417, 447, 448, 450
 in southern France, 454
 in Soviet Union, 22
 in SWPA, 590, 604, 607
 in World War II—760
- Integration of civilian and military health resources after World War II—714-715
- Intercostal nerve block, 710
- Intergroup hemolysis of incompatible donor cells (A, B, O), 653, 657
- Intermediate metabolism in late shock, 34
- “Internal transfusion,” 8, 383
- International Equipment Co., 293
- International Health Division, Rockefeller Foundation, 275
- International (Landsteiner) classification of blood groups, 233
- Interstate commerce, 81
- Intestinal excretion of dextran, 790
- Intra-arterial transfusion—
 in Korean War, 796-801
 with plastic equipment, 759
- Intragroup hemolysis of incompatible donor cells (Rh), 653
- Intrasternal transfusion, 636, 694
- Intrathoracic injury as cause of circulatory collapse, 32
- Intravascular agglutination due to injection of isoagglutinins, 658
- Intravascular hemolysis of—
 compatible donor cells, 653
 incompatible donor cells, 653-656
 recipient cells, 653
- Intravenous fluids, ineffectiveness of, in shock, 31
- Intravenous solutions:
 commercial procurement of, 71, 382-383, 388
 complaints about, 384-388
 preparation of, by forward hospitals, 397
 provision of, in MTOUSA, 398
 reactions to, 385, 387
- Intravenous therapy:
 equipment for, 78
 logistics of, 77
 service in Armed Forces, recommendations for, 76-79, 464, 469, 472
 training in, 442
See also Transfusion; Replacement therapy.
- Invasion of Normandy, immediate preparations for, 547, 548
- Investigations of reactions, 649-650
- In vitro testing of fibrin foam, 364
- Ion-exchange column, 758, 759, 760, 769-771
- Iowa City, 220, 221, 242, 471
- Iron, administration of, to donors, 158, 159, 160
- Irradiation of plasma against hepatitis virus, 772-773
- Irreversible pathophysiology in shock, 443
- Irreversible shock, 36
- Ischemia:
 after intra-arterial transfusion, 801
 gelatin in, 377
- Isinglass, 379

- Island Command, 607, 628
- Isoagglutinin titer, of plasma, 669
- Isoagglutinins:
- in fraction II-1—359
 - in globulin fraction of plasma, 237
 - in high-titer blood, 656
 - in pooled plasma, 669
 - studies on, in Korean War, 806
 - suppression of, in pooled plasma, 51
- Isoagglutinogens, 4
- Isoantibodies in fractions II and III—362
- Isohemagglutinins, 83, 598
- in grouping sera, 240
 - in pooled plasma, 258
- Isotonic buffer solution, 222
- thawing of frozen red blood cells in, 771
- Isotonicity of preservative solutions with blood serum, 218
- Italian campaign, 38, 420, 435, 448
- Italy, 22, 55, 57, 192, 355, 391, 406, 407, 417, 418, 440, 442, 445, 448, 451, 452, 453, 459, 482, 484, 552, 692
- legal prohibition of transfusion in, 1
- Itinerary of—
- blood from ZI to Guam, 606-607
 - inspection trip to POA, 591
 - oversea airlift in Korean War, 746
- Iwo Jima operation, 615, 622, 627
- Jacksonian epilepsy, 368
- JANEWAY, C. A., 32, 261, 327, 328, 331, 335, 353, 362, 725, 726
- JANSKY, J., 4
- Japan, 311, 642, 739, 740, 741, 746, 748, 752, 754, 757, 763, 765, 803
- blood procurement in, in Korean War, 727-733
 - invasion of, 629
 - See Operation OLYMPIC.
- Japanese bloods, incidence of Rh-negative types in, 731-732
- Japanese donors in Korean War, 729-730
- Japanese Red Cross, 730
- Japanese-Russian Border War, 21
- Japanese surrender, 110, 130, 589
- Jaundice, 249
- after injection of serum albumin, 674
 - after red blood cell transfusions, 318
 - after transfusion, 225
 - with outdated blood, 657 - after yellow fever immunization, 674-675
 - in donors, 142
 - in MTOUSA, 399, 423 - plasma in, 297
 - rejection of donors with, 675 -
 - rejection of donors with history of, in SWPA, 598
- Jeeps, 414, 550, 551
- Johns Hopkins University School of Medicine, 75
- Johns Hopkins University School of Public Health, 744
- JOHNSON, R. M., 378
- Johnson, Secretary L., 726
- Johnston Island, 591, 607
- Joint Chiefs of Staff, 715
- Joint Logistic Command, Public Information Office, 730
- Journal of American Medical Association*, 79, 305, 309, 314, 669
- Junior Red Cross, 121
- K-30 Periston, 790
- Kahn test, 17, 111, 143, 262, 399, 404, 408, 412, 422, 426, 432-433, 442, 492, 503, 596, 643
- Kamikaze suicide bombings, 631
- Kansas City, 292
- KARTASEVSKI, N. G., 266
- KATZEN, E. M., 158
- KEITH, A. J., 80
- KEKWICK, A., 266
- KENDRICK, Col. D. B., 49, 53, 54, 55, 61-62, 64, 69, 72, 73, 76, 80, 81, 85, 87, 95, 97, 101, 159, 163, 166, 171, 173, 175, 180, 198, 206, 208, 228, 237, 240, 241, 271, 273, 286-287, 296, 299, 304, 309, 310, 332, 337, 340, 344, 385, 387, 388, 391, 421, 443, 444, 459, 461, 462, 463, 464, 465, 466, 467, 468, 492, 493, 495, 531-532, 554, 555-556, 558, 559, 567, 590, 591, 594, 599, 603, 604, 605, 611, 612, 616, 618, 619, 622, 623, 624, 628, 633, 636, 637, 639, 641, 666, 670, 707, 721, 733, 757, 796
- KENDRICKS, Col. E. J., 531
- Kerosene refrigerators, 416, 454
- Kharkov, 24
- Kidney(s):
- damage in shock, 56
 - decapsulation of, 656
 - fibrin foam in surgery of, 365
 - function of, effect of gelatin on, 377
 - deposition of pectin in, 378
 - effect of blood volume deficiency on, 665
 - effect of diffuse intracapillary agglutination on, 664
 - effect of oxidized cotton on, 380

- Kidney(s)**—Continued
 effect of status of, on hemolytic reactions, 650
 excretion of colloid solutions by, 52
 functional capacity of, in reactions, 650
 status of, after resuscitation, 666
- KILDUFFE, R. A.**, 1, 225, 245, 653
- Kimberton**, 65
- KIMBROUGH, Col. J. C.**, 471-472, 479, 480, 481, 482, 483, 485, 486, 487, 496, 509, 530, 546, 557
- Kimpton-Brown transfusion technique**, 5, 10
- KING, Brig. Gen. E.**, 594
- KIRK, Maj. Gen. N. T.**, 84, 223, 225, 311, 465, 488, 489, 490, 492, 540, 557, 560, 591, 599
- Kjedahl nitrogen technique**, 328
- Kline test**, 143, 581
- Knox Gelatin Co.**, 375
- Knox P-20 gelatin**, 377
- Kolmer test**, 262, 442
- Korean War**, 260, 279, 377, 381, 421, 575, 713-806
 blood program for, 727-738
 initial steps in blood procurement for, 717-721
 organizational developments in DOD before, 714-717
 plasma fractionation program in, 782-784
 plasma program in, 773-782
 refrigerated shipping containers in, 760-766
- KROULICK, Lt. J. T.**, 407
- Kwajalein**, 591, 607
- L-5 planes in MTOUSA**, 420
- Labeling of blood**, 503, 504
 at processing laboratory, Travis AFB, 744-745
 in MTOUSA, 426, 442
- Labels**—
 for plasma package, 167, 168, 169
 for serum albumin package, 343
- Labile components of plasma**, 273, 286
- Labile factor activities after storage**, 805
- Labor difficulties in commercial processing laboratories**, 295
- Labor-management committees in group recruitment of donors**, 126
- Labor unions, recruitment of donors through**, 125
- Laboratories:**
 attachment of blood bank collecting sections to, in MTOUSA, 431
 attachment of transfusion units to, 411
 in evacuation hospitals in MTOUSA, 432-433
- Laboratories, blood bank detachment**—
 48th—728
 8090th—728
- Laboratories, medical**—
 1st—403, 445, 446, 447, 451, 477, 479, 497, 499, 500, 503, 509, 513, 514, 525, 532, 548, 549
 2d—39, 403, 440, 441
 4th—451, 695
- Laboratories, medical general**—
 15th—400, 401-404, 408, 411, 417, 418, 422, 424, 425, 426, 440, 445-446, 447, 451, 453, 454, 489, 655
 19th—589, 629
 406th—728, 729, 739, 746, 752, 765, 803
- Laboratory for Blood Transfusion**, 22
- Laboratory Manual, Army Whole Blood Procurement Service, March 1945**—72
- Laboratory of Biologics Control**, 81, 725, 766, 776
- Laboratory specimens, transportation of, in MTOUSA**, 419
- Laboratory studies in shock**, 31
- Laboratory tests**, 466
 in Blood for Britain, 14
 in Naples blood bank, 428-430, 442
 in shock, 689
- Lacerations after donations**, 157
- Lackland Air Force Base**, 734
- Lahore**, 642
- LALICH, Capt. J. J.**, 38, 393-424
- Lalich study on shock**, 38-39
- LAMANTIA, E.**, 714
- LAMSON, P. D.**, 74, 361
- Lancet**, 5, 24
- Landing craft**—
 mechanized, 615
 vehicle personnel, 640
- Landing operations:**
 blood supply for, 639
 in SWPA, 634
 serum albumin in, 347
- Landing ship, tank (LST)**, 509
 blood for use on, 511
 deliveries by, in ETOUSA, 485
 loading of, for Normandy invasion, 512
 transportation by—
 on D-day, 549
 to Anzio, 417, 440
 to Leyte, 616-617, 618
 to Luzon, 620

- Landing ship, vehicle (LSV-6), 623
- Landings:
 blood for, in Operation OLYMPIC, 640-641
 in southern France, 447
- Landmines, 391, 703
- LANDOIS, L., 2
- Landsteiner classification of blood groups, 233
- LANDSTEINER, K., 4, 245
- Language difficulties in Korean War, 730
- Large plasma package, 172-175, 290, 311, 636
 delayed receipt of, in ETOUSA, 194
- Larynx, edema of, 651
- Lassitude after donations, 156, 157
- Late shock, 34
- Lateral ventricle, effect of thrombin on, 364
- Latex tubing, 171, 179, 595
 in serum albumin package, 328
- LAWRASON, F. D., 733
- Lawson General Hospital, 129
- Lax preparation of equipment as cause of pyrogenic reactions, 651-652
- Lead encephalitis, 368
- Leakage of rubber tubing with positive pressure technique, 553
- Learning curve, 42
- Le Bourget Airfield, 515, 535
- Lederle Laboratories (Division of American Cyanamid Co.), 241, 250, 280, 288, 289, 291, 342, 343, 365
- LEE, Lt. Gen. J. C. H., 524-525
- LEE, Maj. R. I., 7
- Leeds, 5
- Legal aspects, of—
 blood program, 71, 81-85, 145, 300
 commercial production of serum albumin, 341-342
 plasma program, 92-93
- Legal Division, OTSG, 71, 294
- Legal implications of gamma globulin allocations in Korean War, 784
- Legal prohibition of transfusion, 1
- Legal responsibility of ARC blood donor centers, 160
- Legal restrictions on use of donated blood, 93-94
- Leghorn, 418, 442
- Legislation for biologic standards for blood and derivatives, 720
- Lend-Lease provision of plasma to Free French, 94
- Leptospirosis, 656
- Lethal potentialities of blood, 605, 638
- Lethality of—
 hemolytic reactions, 653
 improperly handled blood, 575, 605
 shock, 665-666
 wounds, 56
- Letterman General Hospital, 741
- Leukemia:
 in donors, 142
 red blood cell transfusions in, 317
- Leukocytes after storage, 805
- Leukocytosis caused by blood substitutes, 373
- Leukopenia after injections of bovine albumin, 331
- LEVINE, M., 79
- LEVINE, P., 239
- Levinson-Oppenheimer technique of drying plasma, 278-279
- LEVINSON, S. O., 278, 279
- Lewisburg, 781
- LEWISOHN, R., 1, 4, 218, 219, 220, 651, 652, 796
- Leyte, 590, 595, 602, 603, 604, 605, 606, 607, 614, 615, 616, 618, 620, 621, 630, 631, 632, 633, 639
 blood bank, 620, 622, 632, 668
 operation, 589, 616-618, 619
- Liaison between—
 Army and Navy, 78
 British and U.S. medical officers, 469-470
 Navy and NIH, 81
 NRC and NIH, 81
 OTSG and ARC, 70, 464
 OTSG and Army Medical School, 63
 OTSG and Navy, 70-71, 72-73
 OTSG and NIH, 70, 81
 OTSG and pilot serum albumin plant, Harvard Medical School, 70-71
 OTSG and Subcommittee on Blood Substitutes, NRC, 70
- Liaison officer at British Blood Bank, 496, 528
- Liège, 521, 522
- "Life Line," 126-127
- Life of *plasmodium* in stored blood, 143-144
- Life of spirochetes in stored blood, 143
- Life of transfused red blood cells, 261
- Lightly wounded casualties as donors, 329, 422, 463, 476, 477
 in German program, 22
 in World War I—9
- Lilly Research Laboratories, 87

- Limitations(s) of—**
 blood banks, 706
 dosage of plasma, 284-285
 fluids in chest wounds, 21, 706
 in head injuries, 696
 in lower nephron nephrosis, 769
 gelatin, 377
 high-titer group O blood to group O recipients, 424-426, 442, 444, 489-490, 496, 552
 on-the-hoof collections, 466
 plasma, 48, 55-57, 391, 443, 461-462, 467, 686-687
 plasma expanders, 714
 serum albumin, 702
 transatlantic airlift, 475
 transfusion in blast injuries, 21
 in wounds of central nervous system, 21
- Limited approval of Periston in Korean War, 789, 790**
- Limited service personnel in 127th Station Hospital Blood Bank, 514**
- LINDEMAN, E., 4**
- Lingayen Gulf, 620**
- Lipemia, losses due to, in Korean War, 747, 750**
- Lipoid concentration in donors, 140**
- Lipoid excess, losses from, in Okinawa operation, 627**
- Lipoprotein, 359**
- Liquid plasma, 50, 65, 95, 268-269, 274-275, 462**
 British use of, 16
 clinical use of, 96
 contamination of, 270, 303, 306-308
 dating period of, 96
 dosage of, 96
 early use of, 266-267
 first plans for, 101
 for ZI hospitals, 95-96, 176, 195, 274-275
 from British sources in ETOUSA, 469
 from unrefrigerated blood, 210
 in Blood for Britain, 13-15
 in burns, 270
 in CBI, 642
 in World War I—7
 provision of—
 for Chinese in CBI, 645
 for Office of Civilian Defense, 92
 reactions to, 96, 669
 rate of injection of, 96
 relation of, to serum hepatitis, 674
 storage of, 195, 266, 273
 substitution of whole blood for, 192
 transmission of malaria by, 144
- Liquid plasma centers:**
 inspection of, 307-308
 techniques in, 307, 308
 training of personnel for, 86
- Lister bag, 383**
- Listing of plasma in Army Supply Catalog, 268**
- LISTON, Col. D. E., 501, 513, 530, 548, 558**
- Literature of—**
 blood substitutes, 65
 mercurial preservatives, 284-285
 pectin, 377
 plasma expanders, 785-786
 shock (plasma), 65
- Liver:**
 deposition of pectin in, 378
 effect of blood volume deficiency on, 665
 effect of diffuse intravascular capillary agglutination on, 664
 effect of Periston on, 381
 fibrin foam in surgery of, 365
 function studies to detect latent hepatitis in, 679
 rupture of, in Chinese soldiers, 646
 storage of blood substitutes in, 373
 storage of Periston in, 789
- Liver damage in shock, 35, 56**
- Loading of blood on LST's, 511**
- Local application of dried plasma, 698**
- Local blood donor committees, 121**
- Local blood loss as cause of shock, 29**
- Local collections of blood, 128**
 after Japanese surrender, 629
 in ETOUSA, 466
 overseas, 462, 465
- Local loss of fluid as cause of shock, 36**
- Local loss of plasma as cause of shock, 30**
- Local medical profession, relations of ARC donor centers with, 160**
- Local organization of ARC Blood Donor Service, 108-111**
- Local preparation of plasma, 128-129**
- Local procurement in SWPA, 582-586**
- Local reactions to donations, 155, 157**
- Localization of renal lesions in incompatibility reactions, 654-655**
- Locations(s) of—**
 advance base blood bank:
 facility on Guam, 614-615
 relation of, to operational efficiency, 615
 ARC blood donor centers, 120
 base collecting center, in southern France, 451

- 15th Medical General Laboratory, 406
 base collecting sections in Italy, 431
 distributing center, 6713th Blood Transfusion Unit (Ovhd.), 407
 ETOUSA Blood Bank, 499
 hospitals, effect of, on use of blood, 437-438
 hospitals in Italy, 420
 plasma-processing plants in Korean War, 774
 shock wards, 707
 SOS advance blood bank, 505-506
- Lockwood, J. S., 376
- Loeb, R. F., 33, 35, 52, 74, 221, 330, 339, 372, 373, 374, 375, 378, 379
- Logistic requirements of replacement therapy program, 717, 720
- Logistic transfer of 6703d Blood Transfusion Unit (Ovhd.) to ETOUSA, 452
- Logistic(s) of—
 airlift in MTOUSA, 418-421
 ARC Blood Donor Service, 103
 blood bank in MTOUSA, 420-421
 blood banks, 397, 406-407
 blood supply—
 in ETOUSA, 545
 in NATOUSA, 55
 to Armed Forces, 52, 54, 268, 269, 758
 delivery from United Kingdom to Continent, 531-532, 534-535
 dried plasma, 269
 forward distribution in southern France, 450
 intravenous therapy, 77
 oversea transfusion service, 463, 466-467
 plasma, 269
 serum albumin, 347, 352
 transfusion in forward hospitals, 465
See also Transportation, Storage, Airlift, Packaging, etc.
- London, 6, 514, 541, 666
- Long Island, 413
- Los Angeles, 209, 292, 310, 599, 600, 603, 606
- Los Negros Islands, 591
- Loss of circulating blood volume:
 as cause of shock, 29, 30, 36, 54, 336
 in hemorrhage, 265
 in shock, 266
 in untreated shock, 40
 quantitative relation of, to blood pressure, 43-44
- Loss of circulating red blood cell mass after trauma, 805
- Losses—
 due to breakage, 300-301, 304, 305
 in Korean War, 747, 773
 due to clotting, 300-301, 309-310
 in Korean War, 747
 due to collections by inexperienced personnel, 110
 due to contamination, 300-301, 304, 306-308
 in Blood for Britain, 14
 in MTOUSA, 442
 due to failure of refrigeration in ETOUSA, 570-571
 due to freezing in Korean War, 744, 750
 due to hemolysis, 306
 in Korean War, 747, 750
 due to incomplete filling of collection bottles, 304
 due to incorrect estimates of needs—
 in MTOUSA, 439, 442
 in ETOUSA, 561, 568
 due to lack of refrigeration, 212
 due to lipemia in Korean War, 747, 750
 due to outdated, 306
 in MTOUSA, 441, 442
 in Okinawa operation, 639
 due to positive serology, 261, 304, 504
 due to short storage periods, 222
 during airlift to ETOUSA, 552
 during landings in SWPA, 632
 during transportation, 397
 from discards on Pacific airlift, 213
 in Australian Blood Bank, 582
 in commercial laboratories, 82
 in ETOUSA, 566-567
 in Korean War, 747, 750
 in MTOUSA, 438-440, 441-442
 in Okinawa operation, 624, 627
 in plasma program, 305-310
 in 6825th Blood Transfusion Co., 455
 in southern France, 450
 in SWPA, 631-633
 in unit hospital system, 397
 of plasma, 300-301
 from breakage, 15
 from inadequate drying, 773
 from lipemia, 773
 from reprocessing, 772
- Louis XIV—1
- Louisville, 291
- Loutit-Mollison solution, 224, 225-228
- Loveday (L-day) for Okinawa operation, 623, 624, 625
- LOVELACE, W. R., III--716, 733

- LOVETT, R. D., 734, 737
 Low Countries, 19, 20
 Low titer agglutinins, 54
 Low-titer anti-A agglutinins, 194
 Low-titer group-O blood:
 desirability of use of, 259-260
 for airlift in Korean War, 743
 for resuscitation in Korean War, 745
 in MTOUSA, 424-426
 Lowell General Hospital, 97, 695
 Lower nephron nephrosis, 426, 569, 657-659, 665-667
 in incompatibility reactions, 654-655
 limitations of fluids in, 796
 LOWER, R., 1
 Lowry Air Force Base, 734
 LOZNER, Lt. Cdr. E. L., 144, 211
 LST(H)'s in Operation OLYMPIC, 639, 640
 LST 464, blood bank on, for Leyte operation, 594-595, 616, 617-618, 620
 LST(H) 929, blood bank on, for Okinawa operation, 622, 623, 627, 628
 LUCIANA, 265
 LUCK, J. M., 350, 351, 359
 Luer needles, 544, 554
 Luer syringe, 191
 Luer-type tip glass connector for needles, 198
 LULL, Maj. Gen. G. F., 84, 489
 LUNDY, J. S., 62, 74, 371, 792
 Lunéville, 452
 Lung, fibrin foam in surgery of, 365
 Luzon operation, 615, 619-622, 632, 634, 635
 Lymph nodes, storage of dextran in, 791
 LYONS, Maj. C., 443, 444, 703
 Lyophilizing process, destruction of spirochetes by, 261
- Maastricht, 522
Macaca mulatta, 364, 367
Macaca rhesus monkey, 246
 MACARTHUR, Gen. D., 730
 MACFEE, Col. W. F., 209, 487, 488, 489, 493
 Macrodex (Swedish dextran), 792
 Madrid Blood Transfusion Institute, 12
 MAGEE, Maj. Gen. J. C., 49, 50, 51, 102
 Magnesium sulfate in MIH solution, 24
 MAHONEY, E. B., 266, 336
 Maintenance of—
 blood bank vehicles in MTOUSA, 416
 equipment, 136
 on Continent, 550, 551
 plasma (plasma expanders) reserve, 720
 still, 387-388
 supply during invasion, 511
 transfusion equipment, 17
- MAINWARING, B. R. S., 230
 MAIZELS, M., 230
 Major allergies, rejection of donors with, 651
 Malaria, 422, 438
 in CBI, 643-644
 in Chinese patients, 645-646
 in donors, 142, 143-144
 in Japan in Korean War, 731
 in SWPA, 468, 582-583, 595, 597-598
 reactivation of, after donation, 144
 rejection of donors with:
 in German program, 22
 in MTOUSA, 397, 399, 423, 426
 in SWPA, 598
 in World War I—6
 transfusions for, in CBI, 642-643
 Malaria Conference, 144
 Malaria Research Group, 598
 Malarial blood, production of plasma from, in CBI, 643
 Male donors, 158
 rejection rate in, 141, 160
 MALLORY, Lt. Col. T. B., 41, 569-570, 655, 658
 Malnutrition:
 in Filipinos, 672
 postoperative transfusion for, 691
 Management of—
 allergic reactions, 651
 incompatibility reactions, 654, 656-657
 lower nephron nephrosis, 667
 plasma reactions, 671, 672
 shock, concepts of, 684-686
 urticarial reactions, 651
 Manila, 629, 631, 639, 640, 671
 Manila blood bank, 589, 629
 MANN, F. C., 31, 265, 335
 Manpower:
 losses from serum hepatitis, 775-776
 shortages of, 206
 in bleeding centers in MTOUSA, 408-409
 "Manual of Therapy," European Theater of Operations, 487
 Manual on blood grouping, 248-249
 Manual on shock, 30, 706
 Manual prepared for use with training film on plasma, 87
 Manuals prepared—
 by American Red Cross, 104, 107
 by Subcommittee on Blood Substitutes, NRC, 76
 for use of Office of Civilian Defense, 93

- Manufacturers of equipment, role of, in plasma program, 267
- Manus Islands, 591
- Manuscripts, review of, at Army Medical School, 65-67
- Margherita, 642
- Mariana Islands, 594, 606, 615
- Market Forge Co., 382
- Marking of vehicles in ETOUSA, 509, 542
- Marmite cans, 212, 504, 509, 532, 535, 539, 540, 541, 551
return of, from Continent, 551
- Marseille, 451, 452, 453, 573
- MARSHALL, Gen. G. C., 726, 727
- Marshall Islands, 591, 607
- Martha Dump (Medical Supply Depot, First U.S. Army), 518
- MARTIN, 276
- MARTIN, Brig. Gen. J. I., 398, 400, 440
- MARTIN, Col. W. B., 624
- Martinsburg, 695
- MASON, Col. J. B., 472, 479, 486, 496, 497-498, 500, 509, 520, 521, 531
- Mass bleeding—
for D-day, 549
of group O donors in ETOUSA, 525
- Mass grouping of military personnel, 233-236
- Mass production of dried plasma, 289-293
- Massachusetts Department of Correction, 331, 332
- Massachusetts General Hospital, 697
- Massachusetts Institute of Technology, 230, 378
- Massachusetts Memorial Hospital, 227, 230
- Massive hemorrhage:
red blood cell transfusions in, 317
replacement therapy in, 34
- Massive plasma infusions, 697, 698
- Massive transfusions, 22, 36, 225, 630
in Korean War, 803
in SWPA, 634, 635
in wounds of extremities, 21
- Matrix—
for fibrin film, 364
for thrombin, 364-366
- MAYCOCK, W. D'A., 20
- Mayo Clinic, 62, 371, 384
- Mayo General Hospital, 695
- McCloskey General Hospital, 677
- McCLURE, R. D., 266
- McFarlane, X-protein of, 359
- McGill modification of De Gowin et al. solution, 222
- McGill solution, 224
- McGill University, 221, 222
- McGraw, Maj. J. J., 69, 213, 259, 267, 274, 402, 443, 445, 460, 551-552, 603, 641
- McINTIRE, Adm. R. T., 102, 599, 726-727
- McNeil Island, 781
- McQUAIDE, D. H. G., 312
- Measles, 76
antibodies, 83, 84
gamma globulin in prophylaxis of, in Korean War, 784
prophylaxis of, 359, 362-363
- Mechanism of Rh immunization, 246-248
- Mediastinum, puncture of, 694
- Mediate transfusion, 4
- Medical Administrative Corps, 500
- Medical administrative personnel in blood banks, 411
- Medical Advisory Committee on ARC National Blood program, 727
- Medical Advisory Council, Department of Defense, 716
- Medical and Health Advisory Committee, ARC, 83
- Medical and Health Service, ARC, 84
- Medical battalions:
plasma reactions in, in SWPA, 673
58th Medical Battalion, 450
- Medical Bulletin No. 14, Office of Chief Surgeon, ETOUSA, 474
- Medical Committee, Industrial Hygiene Foundation, 153
- Medical Department Suppl Catalog, 234
- Medical depot companies:
1st—512, 553
31st—520
34th—621
- Medical Director, Veterans' Administration, 716
- Medical Field Service School, 54, 87
- Medical personnel:
for ARC blood donor centers, 70
transportation of, by blood plane in MTOUSA, 419
See also Personnel, Professional personnel, and Enlisted personnel.
- Medical Policy Council, DOD, 795
- Medical Research Council of Great Britain, 80, 293, 371, 496, 581
- Medical Section, Joint Logistic Command, 731
- Medical Service Division, Office of Secretary of Defense, 715-716
- Medical Supply, blood as item of, 479

- Medical Supply Board, Office of Chief Surgeon, ETOUSA, 543-544
- Medical supply channels:
 distribution of blood through, 420-421, 479, 545-546, 574-575, 604, 638, 641
 handling of blood through, in Korean War, 752-754, 757
- Medical supply depots, blood bank sections of, in Korea, 728
- Medical supply platoons: 15th (Aviation), 622
- Medical Supply Section, USASOS, SWPA, 616
- Medicolegal aspects of collection of blood, 145
- Mediterranean theater, 37, 43, 48, 54-57, 69, 193, 208, 258, 259, 310, 391, 457, 459, 460, 461, 468, 476, 482, 484, 489, 500, 530, 564, 605, 624, 631, 633, 653, 658, 678, 684, 703, 706, 707
 development of concept of shock therapy in, 48-49
 development of shock therapy in, 37-38
 incidence of serum hepatitis in, 676
 lower nephron nephrosis in, 424-426, 666-667
 organization of transfusion service in, 48
 reactions in, 659-660
 requirements for resuscitation in, 485
- Meetings. *See* Professional meetings.
- Meiji Park, 731
- MEILING, R. L., 716, 721, 725, 727
- MELENEY, F. L., 14
- Memorial Hospital, 74, 103
- Mendelian dominant, 246
- Meningocerebral adhesions, 363
- Mepacrine (quinacrine hydrochloride), 644
- Mercurial preservatives, toxicity of, 283-286
- Mercurials, addition of:
 to dried plasma, 351
 to serum albumin, 351
- Merthiolate, 237, 307
 addition, of—
 to bovine albumin, 334
 to dried plasma, 284
 to liquid plasma, 14, 96, 283
 to serum albumin, 352, 354
- Mesentery, wounds of, 685-686
- Metabolic changes in shock, 36
- Metabolic rate, effect of hemoglobin solutions on, 361
- Metabolism of red blood cells, 203
- Methyl alcohol, 237
- Methyl Cellosolve, 278, 282
- Methylene blue in group B serum, 16
- Methylene blue test for bilirubinuria, 423, 426, 430, 441, 442
- Metz, 520
- METZ, Maj. H., 697
- MIDDLETON, Col. W. S., 475, 496, 524
- Mignano, 40
- MIH solution, 24, 219
- MIH. *See also* Moscow Institute of Hematology.
- Military advantages of plasma, 48, 51, 57
- Military Air Transport Service, 741, 746
- Military Air Transport Service Group, Pacific Division, 739
- Military-civilian medical coordination after World War II—715-717
- Military donors with syphilis, 262-263, 503
- Military Medical Advisory Council, DOD, 717
- Military Medical Advisory Group, DOD, 721
- Military personnel, mass grouping of, 233-236
- Military requirements for refrigerators, 203-204
- Military significance of Rh factor, 246-248, 249
- Military testing of fraction II—362-363
- Military Transport Services, 614
- Military use—
 of bovine albumin, criteria for, 329-330
 of frozen plasma, 271
- Milk route delivery in ETOUSA, 510
- Milk run (flight) from United Kingdom to Continent, 534-535
- Mills Industries, Inc., 206, 208
- Milne Bay, 587, 591
- Milwaukee, 291
- Minimum hemoglobin level for donors, 139, 140, 158-160
- Minimum requirements for dried plasma (NIH), 142, 284, 287, 288, 290, 303
- Minimum standards for cooperating blood banks, 727
- Minimum titer against A₂ and B cells, 16
- Minneapolis, 292
- Minor injuries, donors with, in World War I—6
- Misconception of—
 handling of blood before Korean War, 720-721
 magnitude of total blood loss, 31
 properties of plasma, 31, 47, 51, 55-56, 57, 310, 482

- wounding effects on containing membranes, 31
- Misuse of transfusion, 649
- Mission to ZI concerning airlift to ETOUSA, 487-489
- Mitoses in embryonic cells after Periston therapy, 789
- Mobile bleeding unit(s), 89, 110, 114-118, 154, 159, 293
 in ETOUSA, 501-502, 569
 in Japan in Korean War, 731
 in Marseille collecting center, 451
 in MTOUSA, 406-407
- Mobile hospitals, refrigeration in, 397
- Mobile surgical units in ETOUSA, 463, 476
- Mobilization, transfusion activities in OTSG during, 98
- Modification(s) of—
 aluminum refrigerator for airlift, 206
 British bleeding bottles in North Africa, 433
 DeGowin et al. preservative solution, 222
 Ebert-Emerson transfusion set, 185-189
 equipment, 81
 expendable transfusion set, 554
 plasma equipment, 163
 plasma package, 166
 Rous-Turner solution, 219-220
 Schulz technique of globin production, 362-363
 suggestions for, in plasma equipment, 177
 techniques of drying plasma, 280
 transfusion sets, 488
 tubing for plasma infusion, 171
- Moisture content—
 of dried plasma, 279, 296
 of fibrin film, 367
- Molar acetyl tryptophan, 352
- Molar glycine, 363
- Molar mandelic acid, 352
- Molar sodium chloride, addition of, to serum albumin, 350, 352
- Molar sodium phenylacetate, 350
- Molecular size of dextrans, 318
- Molecular weight of—
 dextran, 791
 gelatin, 374
 pectin, 378
 Periston, 381
 plasma, 52
 X-protein of McFarlane, 359
- Molecule of bovine albumin, despeciation of, 328, 334
- MOLLISON, P. L., 221, 230, 312, 315, 475
- Monobasic sodium phosphate, 222
- MONAGHAN, J. F., 336
- Montefiore Hospital, 319
- Montreal, 24
- MOON, V. H., 32
- MOORE, C. V., 159, 160, 726
- MOORE, Capt. F. R., 59
- Moral restrictions on use of donated blood, 93-94
- Morale:
 effect of donations on, 148, 155
 effect on, of provision of blood for casualties, 8
- "Moore Than Meets the Eye," 59
- MORGAN, Brig. Gen. H. J., 680
- Morlaix, 520
- Morphine in shock, 32
- Mortality rates:
 in Iwo Jima operation, 627
 in Okinawa operation, 627
 influence of whole blood on, 57, 395
- Mortars, 391
- Moscow, 21, 24
- Moscow Institute of Hematology, 24, 219
- Moss, W. L., 4
- Motion pictures of blood bank activities in MTOUSA, 413
- Motor mechanics, 454
- Motor torpedo boats, transportation in, 448
- Motorcycles for field transfusion units, 543, 550-551
- Mount Sinai Hospital, 1, 218, 319, 651, 652
- Mountain fighting, airlift in, 420
- Move to Continent—
 of 127th Station Hospital blood bank, 522
 of 152d Station Hospital blood bank, 546, 549-550
- Movement, effect of, on blood pressure in shock, 686-687
- Movements of forward distributing section, 6703d Blood Transfusion Unit (Ovhd.), 449-450
- Moving picture theaters, recruitment of donors in, 120, 121, 125
- MOYNIHAN, B., 5
- MTOUSA (Mediterranean Theater of Operations, U.S. Army). *See* Mediterranean theater.
- MUCKENFUSS, Col. R. S., 477, 480, 482, 497, 498, 509, 511, 513, 546, 548
- MUDD, S., 65, 277, 278, 336
- Mueller nephelometer, 351
- MUETHER, R. O., 217, 230
- MUIRHEAD, Lt. E. E., 594, 595, 616

- Multiple depots in Korea, effect of, on reserves, 756
- Multiple donations, 119, 120, 158
by professional male donors, 158
effect of, on hemoglobin, 158-160
estimates of in ETOUSA, 481
false positive serologic tests after, 262-263
- Multiple injections of—
blood substitutes, 373
bovine albumin, 327, 328, 330, 331
serum albumin, 338, 339, 344
- Multiple injuries from high-velocity missiles, 266, 616
- Multiple synchronous transfusions, 437, 635, 636, 689, 799
- Multiple transfusions, 444
alkalinization during, 444
compatibility problems after, 695
in Korean War, 748, 804
in Leyte operation, 617
reactions due to, 660
Rh factor in, 246, 247, 248, 249
risk of high-titer O blood in, 657
with plastic equipment, 758
- Mumps, 76, 362, 363
after donation, 345
- Munich crisis, 15
- Munitions Board, 720
- Murder, charge of, after fatal transfusion, 1
- MURRAY, R., 776
- Muscle as matrix for thrombin, 365
- Muscle damage, role of, in lower nephron nephrosis, 667
- MYDANS, C., 59
- Myocardial insufficiency:
as cause of failure of resuscitation, 44
overloading of circulation in, 225
serum albumin in, 702
- Myoglobinuria in lower nephron nephrosis, 667
- Namur, 522, 523
- Nancy, 452
- Naples, 398, 401, 406, 407, 413, 418, 424, 425, 440, 442, 445, 446, 447, 448, 449, 451, 452, 455, 500, 659
- Naples blood bank, 42, 180, 396-445, 660
- Nasogastric suction, plasma infusion with, 697
- National Academy of Sciences, 73
- National Advertising Council, 734
- National Blood Program, 713, 735-738, 784
- National blood program, necessity for, before Korean War, 720
- National Director, of—
ARC, 292
ARC Blood Donor Service, 92, 104, 105, 106, 107, 294
- National emergency, blood-plasma needs in, 725
- National Formulary*, 377
- National Foundation for Infantile Paralysis, 784
- National Guard, 85
- National Headquarters, ARC, 109, 118, 121, 127, 136
- National Institute(s) of Health, 61, 70, 81, 84, 104, 109, 118, 142, 165, 169, 173, 206, 261, 269, 279, 283, 284, 287, 288, 290, 294, 303, 304, 305, 345, 353, 354, 672, 673, 719, 725, 726, 727, 767, 776, 779, 781
minimum requirements of, for dried plasma, 142, 284, 287, 290, 303
- National Library of Medicine, 786
- National Military Establishment, 715, 726, 727
- National Naval Medical Center, 72, 258, 297
- National Research Corp., 95
- National Research Council, 36, 50, 61, 73, 78, 79, 80, 81, 84, 103, 118, 172, 215, 267, 271, 293, 326, 371, 381, 460, 461, 464, 714, 721, 738, 767, 784, 786, 788, 795
activities of, in post-World-War II period, 724, 726
historical note on, 73
in Korean War, 714
organization of committees of, 73-75
role of, in blood program, 49-54, 267
studies on shock by, 33-36
- National Security Act of 1947—715, 716
- National Security Resources Board (NSRB), 715, 727
- National Supervisory Group for ARC Blood Donor Service. *See* Subcommittee on Blood Substitutes.
- Native globin, 362
- NATOUSA (North African Theater of Operations, U.S. Army). *See* North African theater.
- Naval Air Transport Service, 136, 214, 604, 607
- Naval base hospitals in SWPA, 631
- Naval Medical Research Institute, 258, 297
- Naval Medical School, 143, 211, 269, 274, 298, 308, 344

- Naval Medical Supply Depot, Oakland, 740, 741
- Naval personnel, donations from, in MTOUSA, 422
- Navy:
- acceptance of plasma by, 52-53
 - construction battalions in, 628
 - contracts for—
 - byproducts of plasma fractionation, 267, 347
 - fibrin foam, 365
 - serum albumin, 111, 237, 267, 342, 351
 - cooperation in invasion of southern France, 447
 - distribution teams, for Operation OLYMPIC, 641
 - E award emblem, 127
 - educational program in serum albumin, 341
 - experience with ADC solution, 228
 - information department of, 121
 - insulated containers, 208, 211, 213-214
 - in Korean War, 763, 765
 - laboratories in, 292
 - liaison of—
 - with Army, 78
 - with commercial laboratories, 299
 - with OTSG, 72-73
 - medical personnel:
 - on LST 464, donations from, 595
 - use of, in bleeding centers, 109-111
 - preference—
 - for plasma, 50
 - for serum albumin, 340, 341, 699
 - procurement of serum albumin from, in Korean War, 782
 - representation of, in Blood for Britain, 13
 - requirements, for—
 - dried plasma, 271, 289, 291, 293
 - Luzon operation, 620
 - serum albumin, 341, 342, 344-345, 355
 - responsibility—
 - for Pacific airlift, 225, 599
 - in ARC Blood Donor Service
 - role of, in plasma program, 267
 - specifications for commercial serum albumin, 344
 - surgery by personnel of, on LST's, 511
 - transfer by, of ownership of byproducts to ARC, 83
 - utilization by, of Pillemer serum, 241
- Navy Air Forces, 608
- Navy-Army Coordination—
 - in Leyte operation, 618, 619
 - in SWPA, 590, 594
- Navy Department, 726
- Navy-Marine operation on Iwo Jima, 622
- Navy Medical Center, 669
- Navy Medical Corps, 49
- Navy Medical Department, 33
- Need for blood:
 - for combat casualties, 461-462, 464
 - increasing awareness of, in ETOUSA, 474-484
- Needles:
 - difficulties with, 553-554
 - for field transfusion units, shortages of, 544
 - for plasma infusion, 168
 - for recipient sets, 436
 - gage of, in plasma package, 165
- NEEFE, J. R., 679
- Negroes, Rh factor in, 246
- Nephelometers, 351
- Nephelometry, 328, 332
- Nephritis:
 - plasma in, 698
 - red blood cell transfusions in, 317
- Nephrosis, globin in, 783
- Nephrotic properties of dextran, 790-791
- Nephrotic syndrome, serum albumin in, 352, 354
- NESSET, N., 266
- Neurosurgery:
 - fibrin film in, 363-364, 367-368
 - fibrin foam in, 363-367
- New Britain, 591
- New Caledonia, 385, 591, 594
- New Delhi, 643
- New Guinea, 582, 587, 590, 591, 597, 620, 630
 - donors on, 582-583
- New Hebrides, 591
- Newark, 239
- Newfoundland, 212
- NEWHOUSE, Capt. L. R., 53, 72, 73, 76, 81, 84, 101, 144, 159, 163, 166, 171, 175, 198, 209, 213, 228, 269, 271, 286, 296, 299, 300, 340, 343, 351, 387, 468, 492, 590, 591, 594, 599, 616, 636, 637, 670, 717
- Newton D. Baker General Hospital, 695
- New Orleans, 292, 355
- New South Wales Red Cross Blood Transfusion Service, 581-582
 - See also Australian Blood Bank.
- New York Academy of Medicine, 219
- New York ARC Blood Donor Center, 105
- New York Blood Transfusion Association, 13, 101, 158, 236, 283

- New York Chapter, ARC, 15, 101
 New York City, 21, 104, 109, 110, 111, 119, 128, 204, 214, 218, 291, 305, 309, 310, 312, 319, 387, 490, 492, 493, 494, 600, 642, 719
 New York City Board of Medical Control, 13
 New York City Cancer Institute, 377
 New York City Department of Health, 144
 New York City experience with red blood cell transfusions, 113-118, 317
New York State Journal of Medicine, 275
 Newspaper releases, 121
 Nice, 573
 NICHOLSON, Lt. (jg.) G. E., 614
 Nielson Airfield, 622
 NIH. *See* National Institute(s) of Health.
 Nitrogen losses:
 globin in, 783
 in lower nephron nephrosis, 769
 in shock, 380
 Nitrogen, packaging of plasma in, 168, 169, 172
 Nitrogen retention—
 in incompatibility reactions, 654
 in lower nephron nephrosis, 666, 667
 Noemfoor Island, 595, 620
 NOGUCHI, H., 276
 Nomenclature of—
 blood groups, 4
 blood substitutes, 55, 371
 serum albumin, 343
 serum hepatitis, 674
 shock, 31-33, 37
 Special Representative to the Surgeon General on Blood and Plasma Transfusions, 98
 Nominal labeling of plasma, 128
 Nonexpendable equipment in unit hospital system, 397
 Nonfasting donors, 650
 Nonhemorrhagic shock, plasma in, 617
 Nonpolar anions, 360
 Nonprofit blood banks in operation before Korean War, 719
 Nonprotein nitrogen of blood in shock, 38
 Norfolk State Prison Colony, 331, 332
 Normandy, 55, 520, 537, 549
 British supply of blood for U.S. casualties in, 55
 landings, 119, 136, 171, 699
 North African theater, 35, 37, 55, 57, 94, 177, 192, 194, 244, 394, 395, 421, 430, 432, 435, 443, 448, 462, 480, 482, 532, 552, 556, 675
 British experience in, 54, 55
 British supply of blood for U.S. casualties in, 55
 See also Mediterranean theater.
 Northern Ireland Base Section, ETOUSA, 525
 Norway, airlift to, from Great Britain, 19
 Notification of military donors with syphilis, 262-263
 Nottingham, 473
 Nouméa, 591, 595
 Novgorod, 219
 Novocain, 149, 191
 NRC. *See* National Research Council.
 Nuck, 1
 Nurses:
 administration of blood by, 198
 in ARC blood donor centers, 109, 111, 120, 145, 149
 in ARC mobile bleeding units, 116
 in ETOUSA Blood Bank, 499-501
 Nutrient factor, effect of, on stored red blood cells, 663
 Nutrition:
 effect of gelatin on, 663
 failure of, as indication for transfusion, 2
 of red blood cells in ACD solution, 226
 Nutritional deficiencies, postoperative transfusions for, 691
 Nutritional edema:
 plasma infusions in, 570
 serum albumin in, 354
 Nutritional problems in Korean War, 795-796
 Oakland, 221, 292, 600, 603, 606, 610, 739, 742
 Obstetric service, Rh testing on, 248, 249
 Obstetric shock:
 plasma in, 266, 336
 serum in, 266, 336
 Occupational restrictions in blood donors, 140
 OCD. *See* Office of Civilian Defense.
 O'CONNOR, B., 599-600
 Odd bloods:
 in ETOUSA blood bank, 503, 567
 losses from, 567
 Offensives:
 estimated need for blood in, 442
 relation of need for blood in, 439
 Offers of plasma from other countries, 95
 Office buildings, recruitment booths in, 125
 Office of Adjutant General, 526

- Office of Assistant Secretary of Defense (Health and Medical), 715
- Office of Chief Surgeon, ETOUSA, 528, 660, 669
- Office of Civilian Defense, 76, 79, 81, 91-93, 128, 171, 276
- Office of Defense Mobilization, 733, 735, 737, 783, 784, 795
- Office of Medical Services, DOD, 716
- Office of Scientific Research and Development, 334, 335
- Office of Secretary of Defense, 715, 716, 717, 725, 734
- Office of Surgeon, Communications Zone Forward, ETOUSA, 541
- Office of Surgeon, First U.S. Army, 553
- Office of Surgeon, Luzon Base Section, 673
- Office of Surgeon, NATOUSA, 401
- Office of The Surgeon General, 48, 54, 55, 61, 62, 64, 71, 82, 85, 94, 97, 129, 177, 192, 194, 205, 208, 209, 213, 215, 224, 233, 234, 245, 269, 291, 293, 294, 298, 304, 319, 391, 395, 492-493, 551-552, 604, 641, 671, 680
- blood program in, 67, 73
- Office of War Information, 121
- Office space in ARC blood donor centers, 113
- Ohio State University, College of Medicine, 158
- OHLER, Maj. W. R., 8, 31, 384
- Okinawa, 603, 606, 615, 622, 638
- Okinawa operation, 615, 622, 629, 631, 632, 638, 639, 640
- Oligemia:
- as cause of failure of resuscitation, 44
- quantitative relation, of:
- degree of, to hypotension, 43
- to blood volume deficit, 43
- Oligemic shock, 658
- Oliguria:
- after transfusion with group O blood, 424
- in incompatible reactions, 654
- in lower nephron nephrosis, 658
- limitation of fluids in, 796
- OLIPHANT, J. W., 776
- Omaha Beach, 515, 518, 558
- On-the-hoof bleeding in ETOUSA, 466, 478, 481-482, 547
- Oozing after multiple transfusions, 804
- Open collection system, 193, 462
- reactions caused by, 649
- Operation COBRA, 520
- inadequacy of plasma in preparation for, 56
- of blood plane in MTOUSA, 418-420
- of hospital blood banks in ETOUSA, 474
- Operation OLYMPIC, 638, 639-641
- Operation OVERLORD, 480, 482, 509-513
- reactions during, 651
- Operation TIGER, 509
- timing of, in relation to resuscitation, 36, 39, 40
- transfusion during, 36
- in World War I—7
- traumatic effect of, 31
- whole blood in preparation for, 57, 177
- Operational factors in airlift to Pacific, 606-612
- Operational responsibility for blood program in Korean War, 720-723
- Operational structure of ETOUSA Blood Bank, 501-507
- Operation(s) of—
- ARC mobile bleeding units, 118
- blood bank in Japan in Korean War, 727-729
- Continental Blood Bank, 516-522
- ETOUSA Blood Bank, 550-551
- during Normandy invasion, 512-513
- 6703d Blood Transfusion Unit (Ovhd.), 446-447
- Operations Division, Office of Chief Surgeon, ETOUSA, 497, 498, 499, 500, 527
- Operations Officer, Blood Plasma Branch, Surgery Service, OTSG, 492
- Operations Section, Office of Chief Surgeon, ETOUSA, 527
- OPPENHEIMER, F., 275, 278, 279
- Optimum dilution factor of ACD solution, 226
- Ordnance, cooperation of, in move of ETOUSA Blood Bank to Continent, 515
- Organic heart disease, overloading of circulation in, 225
- Organization of—
- ARC Blood Donor Service, 103-106
- blood program in OTSG, 67
- Blood Research Branch, Army Medical School, 61-62
- blood supply from ZI for ETOUSA, 476-477
- British Army Transfusion Service, 16-18
- ETOUSA Blood Bank, 496-498
- medical division, Department of Defense, post-World-War II period, 715-717
- National Research Council, 73
- New South Wales Transfusion Service, 581-582

- Organization of—Continued
 127th Station Hospital Blood Bank, 513-514
 Pacific airlift, 599
 6703d Blood Transfusion Unit (Prov.), 445-456
 6713th Blood Transfusion Unit (Prov.), 404-406
 Soviet Union blood program, 21-22
 whole blood supply for ZI hospitals, 97
 Orley Field, 496
 Oro Bay, 587, 591, 597
 Orthotoluidine reactions, 671
 Osaka, 727
 Osmotic activity of plasma proteins, 31
 Osmotic effects of—
 bovine albumin, 326
 crystalloid solutions, 371
 serum albumin, 339
 Osmotic fragility of preserved blood, 222
 Osmotic fragility test, 229
 Osmotic function of plasma proteins, 266, 336-337
 Osmotic pressure of—
 aldobionic acid, 379
 blood substitutes, 372
 gelatin, 373, 374, 376
 gum acacia, 384
 oxidized cotton, 380
 pectin, 378
 Periston, 381
 physiologic salt solution, 383
 serum albumin, 336-337, 349
 Osmotic resistance of red blood cells, 229
 OTSG. *See* Office of The Surgeon General.
 OTTENBERG, R., 1, 4
 Outdated blood:
 effect of, in exsanguination, 229
 hemolysis caused by, 650
 in ETOUSA, 554-555, 567
 in MTOUSA, 441, 442
 losses from:
 in ETOUSA, 572
 in Okinawa operation, 627, 639
 in SWPA, 632-633
 processing of, into plasma, 473, 474
 reactions to, 633, 657, 668
 salvage of, 511
 successful use of, in France, 1940-229
 use of, in SWPA, 514
 Outdated plasma:
 before Korean War, 772
 losses from, 307
 Outdated serum albumin in Korean War, 782
 Outdoor advertising space, contributions of, 121
 Output of Armed Forces blood banks, before Korean War, 719
 Overhydration in chest wounds, 635
 Overloading of circulation, 127, 198, 444, 804
 Oversea preparation of intravenous fluids, 282
 Oversea stocks of dried plasma, 1945-311
 Oversea transfusion program:
 initial activities for, in ZI, 461-464
 logistics of, 465, 466-467
 Overseas Branch, Supply Division, Office of Surgeon General, 213, 531
 Overwater operations, provision of blood for, 397, 399
 Owi, 591
 Ownership—
 of donated blood, 92, 300
 and its components, 82-84
 of surplus plasma, 311
 Oxalate-centrifugation technique of hematocrit determination, 43
 Oxidized cotton, 380
 Oxygen capacity technique for hemoglobin determination, 254
 Oxygen-carrying corpuscles, need for, in shock therapy, 31
 Oxygen-carrying properties:
 lack of, in gelatin, 787
 lack of, in plasma, 35
 of red blood cells, 8, 52
 of whole blood, 54-55, 391, 416
 Oxygen deficiency—
 in secondary anemia, 56
 in shock, 384
 Oxygen therapy, training in, 442
 Oxypolygelatin, 726, 786-787
 Pacific areas, 81, 169, 171, 208, 214, 227, 254, 258, 262, 391, 425, 581-641, 653
 airlift to, 213-214, 262, 599-615
 donors in, 595-598
 staff visits to, 590-595
 training of transfusion teams in, 78
 use of reserve stocks of dried plasma in, 93
 Pacific coast, establishment of unsupervised blood banks on, 91
 Packaging of—
 anticoagulant solution with glass beads, 185
 blood in Spanish Civil War, 11
 dried plasma for ZI hospitals, 176-177

- fibrin foam, 366
 field transfusion units in ETOUSA, 544
 plasma, 50, 52, 75, 163-177, 636
 serum albumin, 75, 198
- Pack-drawn mountain troops, serum albumin for, 347
- Pain, relief of, in shock, 56
- Palawan Task Force, 634
- Panel on Plasma Volume Expanders, NRC, 789
- Panel on Preservation of Whole Blood and Red Cells, NRC, 771
- Paper cups for ARC blood donor centers, 172, 295
- Parachute delivery, 538
 in Luzon operation, 622
 in Okinawa operation, 623
 of penicillin, 534
- Parachute drops—
 for testing in SWPA, 613
 of insulated containers in Pacific airlift, 214, 610
- Paradoxical respiration, 688
- Paraffin-tube technique of transfusion, 10
- Paralytic poliomyelitis, gamma globulin in prophylaxis of, 783-784
- Paraplegics:
 compatibility difficulties in, 695
 plasma for bedsores in, 697
- Parenteral fluids, inclusion of, in transfusion service, 53
- Paris, 24, 58, 210, 211, 212, 214, 215, 247, 452, 496, 511, 515, 516, 517, 522, 523, 535, 549, 558, 573, 665
- Paris Blood Bank. *See* Continental Blood Bank; ETOUSA Blood Bank.
- Parke, Davis and Co., 173, 175, 289, 292, 312
- PARKER, Col. R. L., 515
- PARSONS, E., 29, 32
- PARSONS, Maj. W. B., 586
- Passive transfer of sensitivity, 650-651
- Patent rights, infringement of, 290
- PATERSON, J. H., 230
- Pathogenesis of—
 incompatibility reactions, 655
 lower nephron nephrosis, 665-666
 posttransfusion kidney, 655
- Pathologic process in incompatibility reactions, 654-655
- Patrol craft, escort (rescue) (PCE(R))'s, 622
- Patrol torpedo boats, transportation in, 448
- PAUL, J. R., 679
- PAULING, L., 362
- Payment of donors—
 at Marseille bleeding center, 453
 in ETOUSA, 473, 482-483, 528, 530
 in MTOUSA, 423-424
 in ZI, 695
- PEACOCK, W. C., 230
- Pearl Harbor, 34, 53, 111, 119, 136, 168, 213, 289, 338, 339, 582, 591, 594, 607, 610, 694
 experience with serum albumin at, 338-339
- Pectin, 65, 76, 375, 377-379
 criteria of, for military use, 378
 experimental studies on, 377-379
 properties of, 378
 yield of, from citrus fruit, 378
- Peleliu, 607
- PELOSI, Lt. Col. J. J., 492
- Penalty clause in plasma contracts, 302, 304
- PENFOLD, W. J., 651
- Penicillin:
 airlift of, with blood from United Kingdom to Continent, 534, 546
 handling of, by blood bank detachments, 512
 in SWPA, 591
 introduction of, in MTOUSA, 443
 local administration of, with dried plasma, 698
 local use of—
 with fibrin film, 367
 with fibrin foam, 364-365
 transportation of, by blood plane in MTOUSA, 419
- Penicillin-transfusion therapy in MTOUSA, 703-705
- Peninsular Base Section, MTOUSA, 401
 404, 423, 445, 446
- Penrose drains, 308
- Pentagon, 110
- Peptic ulcer complicated by transmitted malaria, 597
- Peptone, 218, 312
- PEPYS, S., 1
- Peripheral nerve suture, fibrin film in, 368
- Peripheral vessels in shock, 32
- Periston, 380-381, 726, 776, 787-790
 cancellation of contracts for, 795
 special studies on, 789-790
 stockpiling of, in Korean War, 789, 790
- Peritoneal contamination in shock, 40, 688
- Peritonitis:
 as cause of shock, 32, 38
 serum albumin in, 354
- PERRY, M. C., 219
- PERRY, Col. W. L., 496, 497, 541, 542
- Personal equation in blood grouping, 242-244

Personnel:

- augmentation of, in ETOUSA Blood Bank, 500
- conservation of, in blood program, 195
- deferment of, 343
- for direct transfusion, 4
- for Kimpton-Brown transfusion technique, 5
- for Luzon operation, 619, 620
- for Okinawa operation, 623
- for oversea transfusion service, 185, 463-464
- for production of equipment, 78
- in advance depots of ETOUSA Blood Bank, 505-506
- in ARC blood donor centers, 145, 148, 492
- in ARC Blood Donor Service, 103, 104-106
- in bleeding centers in Japan in Korean War, 730
- in blood banks overseas, 78-79, 195, 467
- in blood program before Korean War, 717
- in plasma program, 267
- in SWPA, 590, 604
- of blood bank unit in Japan in Korean War, 728
- of British bleeding teams, 17
- of British field transfusion units, 17
- of collecting teams overseas, 467
- of Continental blood bank, 516-517
- of Division of Surgical Physiology, Army Medical School, 62-63
- of ETOUSA Blood Bank, 498, 499-501, 509
 - training of, 501
 - transfer out of, 501
- of field transfusion units, 543
- of 15th Medical General Laboratory Blood Bank, 401-404
- of General Board, ETOUSA, 574
- of LST 464-593, 595
- of Madrid Blood Transfusion Institute, 12
- of mobile bleeding units, ARC, 116-118
- of 127th Station Hospital Blood Bank, 514, 522
- of oversea distributing teams, 467
- of processing laboratory, Travis AFB, 741
- of shock wards, 709-710
- of 6703d Blood Transfusion Unit (Prov.), 445-446
- of 6713th Blood Transfusion Unit (Ovhd.), 407-411
- of Supply Division, Office of Chief Surgeon, ETOUSA, 546
- of transfusion service in SWPA, 605-606
- of transfusion teams in Spanish Civil War, 11
- of ZI centers supplying—
 - ETOUSA airlift, 490-491, 492-493
 - Pacific airlift, 599
- role of, in pyrogenic reactions, 651-652
- shortages of, in SWPA, 591
- training of, in SWPA, 608
- Personnel Branch, OTSG, 492
- Personnel Division, Office of Chief Surgeon, ETOUSA, 487
- Personnel Division, OTSG, 599, 606
- Peter Bent Brigham Hospital, 329, 364, 365, 770
- PETERS, Col. F. H., 582, 586
- PEYTON, Col. R. E., 527
- PFEIFFER, D. C., 278, 280
- P fibrin film, 367
- pH for plasma fractionation, 359
- pH of—
 - ACD solution, 228, 229
 - Alsever's solution, 228
 - blood collected by ion-exchange technique, 770-771
 - blood preserved in ACD solution, 226, 228
 - Periston, 381
 - reconstituted plasma, 286-287
 - resuspended red blood cells, 315
- Phagocytosis—
 - of free iron pigment, 229
 - of Periston, 788
- PHALEN, Col. J. A., 101
- Pharmaceutical firms, representation of, in Blood for Britain, 13
- Pharmacia, 790, 791, 794
- PHEMISTER, D. B., 32
- Phenol as plasma additive, 283
- Phenylmercuric borate, 96, 285
- Phenylmercuric nitrate, 96, 285
- Philadelphia, 102, 292, 310, 600
- Philippine Island Civil Affairs Unit, 622
- Philippines, 595, 604, 606, 607, 616, 629, 630, 671
- PHILLIPS, Lt. R. A., 253
- Phosphorus retention in lower nephron nephrosis, 667
- Photoelectric colorimeters, 159
- Physical disabilities, personnel with, in bleeding centers, 110
- Physical examination:
 - in resuscitation, 687-688
 - of donors, 423
 - traumatic effect of, 31
- Physical reasons for rejection of donors, 120

- Physicochemical studies of pectin, 378
- Physiologic functions, depletion of, in shock, 32
- Physiologic salt solution, 383, 391, 461
addition of gelatin to, 376, 377
commercial procurement of, 382
effects of, 34
in hemorrhage, 8, 35
in shock, 8, 34
in World War II—7, 9
properties of, 52
- Physiologic studies in field, 79–80
- Physiology of blood, 2
- PICKELS, E. G., 275, 279
- Pigment excretion in incompatibility reactions, 655
- Pigment nephropathy—
in battle casualties, 655
in crushing injuries, 696
- Pigmented casts in incompatibility reactions, 654
- PILLEMER, Lt. L., 237, 239, 241
- Pillemer technique of blood grouping, 237
- Pilot run on Pacific airlift, 602
- Pilot studies on bovine albumin, 325
- PINCOFFS, Col. M. C., 583, 584
- Pisa, 406, 418, 442
- Pitressin therapy in shock, 34
- Pittsburgh, 292
- Pittsburgh Blood Donor Center, 110
- Placental blood, 23, 24–25
- Plane crash, loss of blood in, 567
- PLANK, Maj. Gen. E. G., 521
- Planning Branch, Operations Division, Office of Chief Surgeon, ETOUSA, 483
- Planning for—
airlift to Continent from United Kingdom, 531–535
airlift to ETOUSA from ZI, 490–491
donors in ETOUSA, 478, 524–525
ETOUSA Blood Bank, 496–498
Leyte operation, 616–617
local supplies of blood in SWPA, 582–586
Operation OVERLORD, 509–513
wartime activities, cooperating agencies in, 727
- Plans and Operations Division, Office of Chief Surgeon, ETOUSA, 511, 547
- PLANTIER, Lt. J. A., 521
- Plasma, 336, 457, 464, 468, 488, 600
adequacy of, 480
for resuscitation, 465
administration of—
before evacuation, 698
by hypodermoclysis, 698
during first aid, 687–688
in resuscitation, 690
advantages of, 35, 48, 51, 57, 157
after closure of colostomy, 705
alleged toxicity of, 79
allergic reactions to, 650
between World Wars, 266–267
biochemical similarity of, to serum, 268
clotting of, 285
coagulation of, on recalcification, 270
collections of blood for, 61, 102–104, 109
in Blood for Britain, 13–15
in Korean War, 767–769
commercial production of:
before Korean War, 717
in Korean War, 734
comparison of, with gelatin, 376
components of, 270, 273, 336, 361
contracts for, 267, 301, 304, 310
convenience of transportation of, 35
crossmatching of, 266, 269
dating period of, 270
definition of, 267–268
demonstration packages of, 87–91
disposition of surplus of, 310–311, 714–725
dosage of, 172, 175, 697–698
double-processing of, 165
early concepts of, 310, 392, 438, 584, 706
early discussion of, by NRC, 50–51
early preference for, in ZI hospitals, 695
early provision of, in ETOUSA, 469–470
effects of, 34–35
emergency use of, for Allied casualties, 93–94
equipment for—
administration of, 163–177
commercial production of, 293–295
reconstitution of, 52
estimates of requirements for, before Korean War, 773
evaluation of, in NATOUSA, 55–57
experimental studies on, 51, 268
fibrinogen content of, 268
field studies of, 80
filters for administration of, 169–171, 287–288
filtration of, 19
flocculation of, 286
for Allied nations, 93–95
for Free French, 94
fractionation of, 237, 261, 336, 343, 372, 590
from lower animals, 50

Plasma—Continued

- group-specific and unpooled, 22
- grouping of, 269
- gum acacia as replacement for, 8
- hemoglobin content of, 300
 - after airlift, 803
 - after storage, 805
- hemoglobin, determination of, 805
- historical note on, 265-267
- in battalion aid stations, 57-59
- in burns, 35, 55, 617
- in crushing injuries, 35, 55, 267
- in decompression sickness, 698
- in experimental shock, 266
- in German blood program, 22
- in heat dehydration, 55
- in hematopneic shock, 56
- in hypoproteinemia, 635
- in incompatibility reactions, 654, 656
- in intravascular hemolysis of recipient cells, 656-657
- in Leyte operation, 617, 618
- in Luzon operation, 622
- in obstetric shock, 336
- in resuscitation, 175, 684
 - in Korean War, 803
- in shock, 13, 34, 268
 - in North Africa, 392, 393
 - in Sicily, 396
 - in SWPA, 616, 634, 635, 636-637
- in World War I—265
- indications for, 696-697
 - in Korean War, 796
- investigation of, in Pacific, 590
- lack of oxygen-carrying properties in, 35
- legal aspects of transfer of, to OCD, 92-93
- legal obstacles to use of, for Free French, 94
- legal problems of commercial production of, 71, 81-85
- limitations of, 48, 55-57, 391, 443, 461-464, 467, 476, 686-687
 - dosage of, 284-285
 - for preoperative preparation, 56
- literature of, 65
- local use of, in burns, 590
- logistics of, 269
- loss of—
 - as cause of shock, 30, 33, 286
 - during infusion, 43-44
 - in processing laboratories, 300-301
 - in relation to red blood cell loss, 43-44
 - stability of, 165
- maintenance (restoration) of circulation by, 21
- manual on, 76
- military advantages of, 48, 51, 57
- misconception of properties of, 31, 47, 51, 55-56, 57, 465, 482
- Navy preference for, 50
- NIH minimum requirements for, 142, 284, 287, 288, 290, 303
- nominal labeling of, 128
- parachute delivery of in Luzon operation, 622
- processing of:
 - from Chinese donors, 645
 - from excess blood in Pacific airlift, 602
 - from outdated blood, 473, 474, 567, 590
- procurement of:
 - before Korean War, 773
 - in Korean War, 773-776
- production of:
 - before Korean War, 719
 - in Korean War, 774-776
- protein concentration in burns, 697
- protein content, 52, 296-297, 430
 - damage of, from ultraviolet radiation, 779
 - determination of, 43, 626, 710
 - effect of gelatin on, 377
 - elevation of, with serum albumin, 362
 - estimate of, by copper sulfate technique, 253, 254, 255
 - flocculation of, 274
 - fractionation of, 81, 359
 - in shock, 38, 40
 - osmotic activity of, 31
 - osmotic function of, 266, 336-337
 - regeneration of, after donations, 159
 - sensitization to, 651
 - status of, after ultraviolet sterilization, 776
- provision of—
 - for Chinese in CBI, 645-646
 - for ZI hospitals, 95-96
- quantitative relation of administration of, to degree of shock, 39, 267
- quantitative use of, on Continent, 556-566
- rate of administration of, in burns, 697-698
- rationale of—
 - early use of, 47
 - initial acceptance of, 52-53
 - selection of, for Armed Forces, 268-270
 - use of, in shock, 57, 266-267

- reactions to (complications of), 50, 52, 79, 258, 259, 269, 298, 566, 668-674
in civilian hospitals, 669
in ETOUSA, 669-671
in SWPA, 669, 671-674
- reconstitution of, 50, 88, 698
- refreezing of, 273
- refrigeration of, 50
- release of, to Office of Civilian Defense, 83-84, 91-93
- replacement of, in experimental hemorrhage, 265
- reprocessing of, before Korean War, 772, 773
- reserves, allocation of, in Korean War, 775-776
- reserves in Korean War, 733, 737
- retention of, in bloodstream, 44
- return of, from overseas, 310
- role of, in shock therapy, 31
- seepage of, in shock, 254
- shipment of, in Blood for Britain, 14
- stockpile inventory of, before Korean War, 717
- stockpiling of, 50
before Korean War, 718, 772-773
in Korean War, 775-776
- storage of, 51, 273
- synthesis of, 371
- technique of administration of, 698
- temporary storage of, in frozen state, 271
- testing of, 296-298
- thawing of frozen red blood cells in, 771
- toxicity of preservatives in, 354
- training in field use of, 87
- training in reconstitution of, 91, 413
- transmission of serum hepatitis by, 510, 674-680
in Korean War, 713, 775, 776-782, 795
- transmission of virus infections by, 726
- transportability of, 48, 51
- transportation of, by blood plane in MTOUSA, 419
- ultraviolet sterilization of, 776, 778-779, 781-782
- use of:
at Pearl Harbor, 582
at Tarawa, 9
for Allied casualties, 528
in ETOUSA, 486, 566
in forward hospitals, 21, 180
- value of:
in Pacific fighting, 582
in protein depletion, 569-570
- versus serum albumin, 35
- versus whole blood, 51, 55-59
- war reserves of, 720
- yield of, 268, 285-286, 299-300, 303, 304, 782
gamma globulin from, 363
globin from, 362
See also Liquid plasma; Dried plasma, Concentrated plasma, etc.
- Plasma-blood ratio:
estimates of, 461-462
before Korean War, 719
in ETOUSA, 482, 487, 556-557
in forward hospitals in ETOUSA, 566
- Plasma-blood replacement therapy in Spanish Civil War, 11-12
- Plasma bottles, rubber stoppers for, 169
- Plasma-casualty ratio in ETOUSA, 556-557
- Plasma expanders, 371, 723
in Korean War, 712, 714, 783, 785-796
limitations of, 714
literature of, 785-786
war reserve of, 720
See also Blood substitutes.
- Plasma fraction(s), 359-368
components of, 359-360
conservation of blood by use of, 361
sensitivity to, 361
storage of, 359
See also Byproducts; special fractions.
- Plasma Fractionation Laboratory, Department of Physical Chemistry, Harvard Medical School, 343
- Plasma fractionation program in Korean War, 782-785
- Plasma fractionation studies:
continuation of, after World War II—714
techniques of, 348, 359
use of discarded bloods for, in Korean War, 747
- Plasma infusions:
anemia due to, 43, 658
equipment for, 168
hemolytic reactions to, 259
incidence of serum hepatitis after, in Korean War, 778
individualization of, 697
rate of, 165
- Plasma package, 50, 52, 75, 128, 163-177, 636, 698
breakage of, 175
components of, 166-168, 169-172
development of, 165-168
increase in size of, 172-175

- Plasma package—Continued
 labels for, 167, 168, 169
 testing of, 168-169
 tin cans for, 172, 175
 tubing for, 171
 use of, overseas for transfusion, 184-185
- Plasma potassium, 803-804
 content of aging blood, 555
- Plasma-processing facilities in Korean War, 774-775
- Plasma program, 265-319, 491
 accounting practices in, 300-305
 after World War II—772
 equipment for, 293-295
 in Korean War, 713, 772-782
 losses in, 305-310
 priorities for, 293-294
 properties of, 48, 51, 52-53, 266, 391, 466
 prophylactic administration of, 392
 termination of—
 after World War II—714
 in Korean War, 780-782
- Plasma protein concentration in burns, 697
- Plasma substitutes not derived from human blood, 371
- Plasma supply in CBI, 642
- Plasma therapy, 696-698
- Plasma volume:
 decrease of, in burns, 697
 determination of, 43
 effect of dextran on, 792
 effect of gelatin on, 787
 effect of serum albumin on, 354-355
 increase of, in lower nephron nephrosis, 667
- Plasmin, 359
- Plasminogen, 359
- Plasmodia, destruction of, in refrigerated blood, 589-590, 595
- Plasmodium knowlesi*, 143
- Plasmodium*, life of, in transfused blood, 143-144
- PLASS, E. D., 50, 51, 52, 74, 219, 220, 471
- Plastic bags, packaging of dextran in, 795
- Plastic equipment, 758-760
 criteria for, 758
- Plastics, replacement of rubber by, 78
- Platelets after storage, 805
- Pneumothorax in shock, 688
- Po Valley offensive, 408, 420
- Policies:
 evolution of, in MTOUSA, 391-392
 of ARC mobile bleeding units, 118
- Poliomyelitis, 363
- Polycythemia—
 after excessive transfusion, 804
 after multiple transfusions, 805
- Polyvinyl alcohol polymers, 788
- Polyvinyl esters, 788
- Polyvinylpyrrolidone. *See* Periston.
- Pompeii, 454
- Pooled plasma, 140, 276, 306, 363
 contamination of, 288
 controlled heating of, 779-780
 crossmatching of, 266
 effect of multiple infusions of, 663
 fragility of recipient cells after infusions of, 657
 grouping of, 266
 isohemagglutinins in, 51, 258
 number of bloods in, 306, 674, 781
 relation of, to serum hepatitis, 674
 risk of multiple infusions of, 664
 suggested use of red blood cells in, 319
- Pooling of donor bloods in Australian Blood Bank, 581
- Pooling technique of collection in SWPA, 589
- Poor-risk casualties, transfusion in, in World War I—7
- POPPER, H., 379
- Port Moresby, 587
- Port of Embarkation (PEMBARK), 494-495, 536, 540
- Portable kit for copper sulfate test, 253
- Portable refrigerators for ARC mobile bleeding units, 115
- Portable surgical hospitals in SWPA, 534, 621
- Portland, England, 509
- Portland, Oreg., 292, 600
- Positive pressure technique—
 of plasma administration, 697
 of transfusion, 553
- Positive serology:
 in SWPA, 596
 losses from, 304, 504
 in ETOUSA, 567, 568, 572
 in MTOUSA, 441
- Postdonation anemias in female donors, 158-160
- Post mortem findings—
 after dextran therapy, 791, 793, 794
 after Periston therapy, 789
 in incompatibility reactions, 654
 in lower nephron nephrosis, 658, 666
 in plasma reactions, 672
 in reactions from contaminated blood, 665

- Postoperative plasma infusions, 691-692
- Postoperative transfusions, 691-692
in World War I—7
- Postpartal hemorrhage:
as indication for transfusion, 1
autotransfusion in, 23
- Postpartal transfusion with red blood cell
residua, 314
- Posttransfusion kidney, 655
- Postural measures in prevention of shock, 34
- Post-World-War II interim, 714-717
- Potassium chloride in MIH solution, 24
- Potassium content—
of blood, effect of ion exchange resins on,
770
of preserved blood, 222
- Potassium level after storage, 805
- Potassium salts, addition of, to serum albu-
min, 349
- Potency of rabbit grouping sera, 233, 234
- Potential contamination of blood, 151
- Practice runs in commercial production of
serum albumin, 343, 344
- Precautions against sabotage, 129, 295
- Precautions necessary with group-specific
blood, 503, 650
- Precipitation of fibrin, 224, 273
- Precipitation tests of bovine albumin, 328
- Precipitin tests of serum albumin, 326
- Precombat preparations for transfusion in
World War I—8
- Prefabricated huts for base collection sec-
tions in MTOUSA, 431
- Pregnancy:
Rh factor in, 246, 249
transfusion with red blood cell residua in,
313
- Pregnant donors, rejection of, 139
- Preoperative preparation, 461-462
See also Resuscitation.
- Preparation of donor sets in MTOUSA, 407
- Preparation of equipment in ETOUSA Blood
Bank, 502-503
- Presbyterian Hospital, 104, 312
- Preservation of blood, techniques of, 85
- Preservative(s):
in liquid plasma, 96
in serum albumin, 353, 354
toxicity of, in blood substitutes, 354
- Preservative solutions, 50, 51, 52, 179, 217-
230, 461, 468, 726
containing dextrose, 203
criteria of, 217, 221, 222
definition of, 217
development of, 221-228
effect of, on red blood cell survival, 260-
261
for airlift to ETOUSA, 208
in Korean War, 766-769
in MTOUSA, 437
in 1941—268
in SWPA, 606, 611-612
isotonicity of, with blood serum, 218
testing of, at Army Medical School, 224-
225
tests of, 229
- Preserved blood, 50, 52
dating periods for, 220, 222, 224
definition of, 217
hemoglobin levels of, 229
in German program, 22
rate of hemolysis in, 217
reactions to, in German Army, 22
recommendations to Armed Forces on
use of, 221
storage of, 222, 463
studies on, 217-220
survival of red blood cells in, 217
transfusion with, in World War I—5-6
- Pressure-bulb collection technique, 193
- Pressure-bulb transfusion technique, 193, 194
- Pressure gravity transfusion technique, 635,
636
- Pressure transfusion techniques, 693
- Prestwick, 209, 212, 488, 489, 493-494, 527,
536, 540, 541, 554, 560
- Preventive Medicine Division, Office of
Chief Surgeon, ETOUSA, 245
- Preventive Medicine Division, Office of
Surgeon General, 235, 680
- Prewar studies on bovine albumin, 325-326
- Principles of—
ARC Blood Donor Service, 103
National Blood Program, 735-738
replacement therapy in Korean War,
796-801
resuscitation, 683-684
- Priorities:
for airlift—
from United Kingdom to Continent,
533-534
in SWPA, 591
to ETOUSA, 495, 546
for allocation of blood in National Blood
Program, 738
for changeover to large plasma package,
173-175

- Priorities—Continued**
 for equipment for ARC blood donor centers, 294-295
 for plasma program, 293-294
 for surgery, determination of, on shock wards, 710
 in SWPA, 604, 608
 in transportation in ETOUSA, 479, 496, 545-546
 in wartime, 713
 of critical materials, 206
 of transfusion teams for SWPA, 606
- Priorities Division, War Production Board, 294**
- Prisoner-of-war donors—**
 in ETOUSA, 530
 in MTOUSA, 422
- Prisoners, donations from, 407**
- Processing laboratories:**
 distribution of donations to, 291-293
 serologic testing at, 261-262
- Processing of blood—**
 for Korean airlift, 743-745
 for Pacific airlift, 599, 600, 603
 in ETOUSA, 476, 477
- Processing of blood substitutes, 77**
- Processing of dried plasma, 275-276**
 Soviet experience with, 95
- Processing of liquid plasma at Army Medical School, 65**
- Processing of plasma:**
 criteria of, 95
 in closed system, 266
 in small laboratories, 312
- Processing of serum albumin, 76**
- Processing section of ETOUSA Blood Bank, 502-503**
- Procurement Division, American Red Cross, 294**
- Procurement of—**
blood—
 for airlift to ETOUSA, 477, 490, 491-492, 494
 for Pacific airlift, 599-602
 for serum albumin program, 340, 343, 355
 in Seventh U.S. Army, 445
 problems of, 718
 demonstration plasma packages, 89-91
 donors in Korean War, 733-734
 donors in Soviet Union, 21
 equipment for blood donor program, 70
 equipment for plasma program, 293-294
 plasma in Korean War, 773-776
- Production—**
 facilities for plasma:
 after D-day, 484-485
 dismantling of, 772
 of blood substitutes, 372
 of dextran, 790, 791
 of plasma at Army Medical School, 65
 of serum albumin, 361
- Production capacity for gamma globulin in Korean War, 783-784**
- Production capacity of ETOUSA Blood Bank, 560-561**
- Production techniques, role of, in plasma reactions, 670**
- Products of plasma fractionation, 590**
- Professional donors, 94, 158**
 handling of blood from, 421, 575, 638, 639, 752-754
- Professional meetings—**
 Albumin and By-Products Group, NRC—
 10 May 1943—240
 28 July 1943—84
 17 Nov. 1943—365
 Albumin Testing Group, NRC—
 22 Mar. 1943—300, 333
 Allied Conference on Shock and Transfusion—
 May 1945—20
 American Medical Association—
 June 1942—156
 American Society of Refrigerating Engineers—
 7 Dec. 1943—203, 273
 Armed Forces Medical Policy Council, DOD—
 17 Mar. 1952—775
 28 Apr. 1952—775
 16 May 1952—775
 Blood and Plasma Conference, NRC—
 24 Mar. 1943—299
 Blood Procurement Conference—
 14 Feb. 1942—91
 Committee on Blood and Blood Derivatives, NRC—
 3 Dec. 1949—725, 726, 790
 Committee on Medical Research, OSRD—
 7 July 1942—329
 25 Mar. 1943—334
 Committee on Transfusions, NRC—
 31 May 1940—49-51, 101, 220, 269, 325, 326, 371, 468, 706
 24 July 1940—51

- Conference for Revision of Army Manual on Blood Grouping, NRC—
24 June 1943—248-249, 252-253
- Conference of Albumin and By-Products Group, NRC—
28 July 1943—354, 362, 376, 381
14 Dec. 1943—354, 376, 763
- Conference of Blood Donor Service officials—
15-16 Dec. 1943—119, 125, 127
18-19 Jan. 1944—118-119, 125, 127
- Conference on airlift of blood to ETOUSA—
15 Aug. 1944—209-210
- Conference on Albumin, NRC—
5 Jan. 1942—339-340, 342, 352, 694
11 Feb. 1942—340
22 Mar. 1943—345
19 July 1943—352-353
- Conference on Albumin and By-Products, NRC—
15 Apr. 1942—342
26 May 1942—340
10 May 1943—83
- Conference on Albumin Testing, NRC—
19 Oct. 1942—198, 331, 332, 343
- Conference on Blood Group Specific Substances A & B, NRC—
19 Mar. 1945—260
- Conference on Blood Grouping, NRC—
23 Mar. 1943—53, 82, 238, 239-240, 242, 248, 249
24 June 1943—248
- Conference on Blood Preservation, NRC—
19 Jan. 1945—110, 210, 213, 226
8 Feb. 1945—226-227
2 Dec. 1949—769-770
- Conference on Blood Preservation and Red Cell Resuspension, NRC—
6 Dec. 1945—229, 248
- Conference on Blood Transfusion Equipment, OTSG—
6 Dec. 1943—194-195
- Conference on Bovine Albumin, NRC—
16 July 1942—328, 330
- Conference on Derivatives of Plasma Fractionation, NRC—
28 Oct. 1953—776
- Conference on Differential Agglutination of Erythrocytes, NRC—
17 Sept. 1952—769
- Conference on Epidemiology of Poliomyelitis, NRC—
14 Feb. 1953—884
- Conference on Fat Emulsions for Intravenous Therapy, NRC—
24 May 1951—795
19 Mar. 1953—795
- Conference on Fibrinolysis, 769
- Conference on general problems of Blood Donor Service, ARC—
19-20 Jan. 1943—119
- Conference on Globin, NRC—
21 Apr. 1944—362
- Conference on Immune Globulins, NRC—
8 Feb. 1953—362
- Conference on Pectin, NRC—
24 Feb. 1943—377
- Conference on Plasma Fractionation, NRC—
14 Mar. 1945—361
- Conference on Preparation of Normal Human Plasma—
5-6 June 1942—198, 343
- Conference on Preserved Blood—
25 May 1943—221-222, 229
- Conference on Production of Normal Human Serum Albumin and Its By-Products, NRC—
19 July 1943—353
- Conference on Radioactive Dextran, NRC—
29 Aug. 1951—792-793
- Conference on Resuspended Blood Cells, NRC—
18 May 1945—260
- Conference on Shock and Transfusion, ETOUSA—
25 May 1945—15-16, 656
- Conference on Technical Operations of Blood Donor Service, ARC—
7 June 1942—118
- Conference on Transfusion Equipment and Procedure, NRC—
25 Aug. 1942—76, 85, 184, 221, 238
- Conference on Uses of Gamma Globulin, NRC—
5 Aug. 1952—783
- Cooperating agencies—
11-12 July 1950—727
- First Conference on Gelatin, NRC—
10 Nov. 1942—372-374
- First Conference on Shock, NRC—
21 June 1941—33

Professional meetings—Continued

- Fourth Congress of Ukrainian Surgeons,
1930—24
- Malaria Conference, 144
- Panel on Preservation of Whole Blood and
Red Cells, NRC—
28 Mar. 1951—771
- Research Society of American Red Cross
in France—
22-23 Nov. 1919—9-10
- Second Conference on Blood Storage,
NRC—
2 Mar. 1944—223-224
- Second Conference on Gelatin, NRC—
23 Feb. 1943—374-375
- Second Conference on Shock—
1 Dec. 1943—34-35, 258
- Société Nationale de Chirurgie, Paris,
1932—24
- Southern Surgical Association, December
1944—55
- Special Conference on Albumin, NRC,
9 July 1942—343
- Subcommittee for Standardization of
Dispensing Equipment, NRC—
8 May 1941—337
- Subcommittee on Albumin and By-
Products, NRC—
22 Jan. 1943—237, 349, 362, 364
- Subcommittee on Blood and Blood Deriva-
tives, NRC—
3 Apr. 1951—783
- Subcommittee on Blood Procurement,
NRC—
18 Aug. 1951—104
- Subcommittee on Blood Substitutes,
NRC—
31 May 1940—79-81
30 Nov. 1940—52, 80, 101, 270, 283,
325, 336-337
19 Apr. 1941—37, 52-53, 85, 163, 165,
169, 177, 269, 270-271, 290, 327,
329
8 May 1941—163, 275, 279, 329
23 May 1941—165, 236, 275, 283, 291,
306, 337, 698
18 July 1941—165-166, 236, 239, 269,
271, 275, 341
18 Aug. 1941—104, 139, 203
19 Sept. 1941—283, 338
3 Nov. 1941—53, 284, 378
10 Mar. 1942—143, 329, 342, 373
12 May 1942—143, 242, 340, 669, 674
23 June 1942—81-82, 91, 143, 242, 329,
343, 694
20 Oct. 1942—53, 79, 221, 332, 372, 373,
379, 674
10 Nov. 1942—374, 380
15 Dec. 1942—53, 173, 261, 333
24 Feb. 1943—674
9 Apr. 1943—80, 180, 184, 345, 382, 468
13 May 1943—54, 240-241, 345-346,
362, 364, 372, 381
28 July 1943—241
10 Aug. 1943—222, 241, 249
24 Sept. 1943—53, 80, 222, 224, 241,
381, 468
17 Nov. 1943—222-223, 241, 362, 375
5 Jan. 1944—159, 223, 376
3 Mar. 1944—224, 225-226, 362, 376
21 Apr. 1944—362, 376
2 June 1944—140, 226, 251, 335, 699
13 July 1944—142, 144
16 Mar. 1945—313, 352, 362, 381
18 May 1945—260, 263
- Subcommittee on Shock, NRC—
1 Dec. 1943—253
14 Oct. 1950—786, 791
11 Dec. 1950—782, 794
30 Jan. 1951—792
14 Nov. 1951—714
13 Feb. 1952—793
1 Oct. 1952—793
9 Dec. 1952—802
- Subcommittee on Sterilization of Blood
and Plasma—
8 Oct. 1952—781
4 Feb. 1953—781-782
- Symposium on Blood Preservation,
NRC—
2 Dec. 1949—758, 771
- Symposium on Structure and Cellular
Dynamics of Red Blood Cells, NRC—
11-12 June 1953—169
- Third Conference on Blood Storage,
NRC—
30 Aug. 1944—224, 226
- Third Conference on Gelatin, NRC—
4 Sept. 1943—375
- Professional personnel:
in ETOUSA, indoctrination of, 459-460
of forward distributing centers, 409
operation of ARC blood donor centers by,
76, 109, 110
- Professional responsibility for airlift to
ETOUSA, 492-493

- Professional Services Division, Office of
 Chief Surgeon, ETOUSA, 476, 497, 524,
 529, 546, 547, 557
 Office of Surgeon General, 61, 192
Professional supervision—
 of blood program in ETOUSA, 547
 of dried plasma program, 102
Progress report(s)—
 of ETOUSA Blood Bank, 508-509
 of hospital blood banks in ETOUSA,
 473-474
Prohibition of shipment of transfusion
 equipment overseas, 435
Projects for Continental Operations
 (PROCO), 541, 542
 (PROCO III), 543
Promotional material—
 for ARC Blood Donor Service, 121
 for group recruitment of donors, 126
 through labor unions, 125
Promotions in ETOUSA Blood Bank, 498
Properties of—
 blood, 718, 719-720
 blood substitutes, 372-373
 blood used in Korea, 806
 bovine albumin, 326, 327, 328
 colloid solutions, 52
 corn syrup, 317-318
 crystalloid solutions, 371
 dextran, 790-791
 dried plasma, 271, 279-280
 fibrin foam, 364, 367
 frozen plasma, 273
 gelatin, 373-374, 376, 377
 gum acacia, 384
 isinglass, 379
 oxidized cotton, 380
 Pectin, 378
 Periston, 381
 plasma, 48, 51, 52-53, 55-57, 266, 391
 rabbit grouping sera, 236
 serum, 336
 serum albumin, 337, 340, 341, 344, 345,
 352, 353, 699
Prophylactic administration of plasma, 392
Prophylactic transfusion, 460, 690
 in Luzon operation, 635
Prophylactic use of physiologic salt solution
 in shock, 35
Prophylaxis of—
 early shock, 34
 experimental shock by plasma, 266
 hemolytic reactions, 657
 infections in wounds of extremities, 705
 infectious hepatitis, 359, 363
 influenza, 363
 lower nephron nephrosis, 667
 measles, 359, 362-363
 mumps, 363
 paralytic poliomyelitis, 783-784
 poliomyelitis, 363
 pyrogenic reactions, 653
 reactions, 650
 scarlatina, 363
 serum hepatitis, 363, 679
 shock, 33-34, 36
Proposal—
 for standardization of British transfusion
 equipment, 179
 for use of supply channels for distribution
 of blood, 420-421
Prostration after donations, 158
Protein chemists, 325, 336
Protein component of fibrin film, 367
Protein concentration of rabbit typing sera,
 236
Protein content of plasma, 52
Protein deficits, postoperative transfusion
 for, 691
Protein depletion, plasma in, 697
Protein determinations, 618
Protein Foundation, 359
Protein losses, amino acids in, 380
Protein supplement, use of globin as, in
 Korean War, 783
Proteinuria—
 in incompatibility reactions, 654
 in lower nephron nephrosis, 667
Prothrombin, 270, 273, 286, 287, 362, 363,
 770
 content of plasma, 702
 in fraction III-2-359
PROUDFIT, Capt. W. S., 451
Provision—
 for intravenous fluids in MTOUSA, 398
 for transfusion in North Africa, 394
 of blood—
 by unit hospital system, 396-399
 for Office of Civilian Defense, 91-93
 for oversea hospitals, 393
 for ZI hospitals, 97
 in forward areas, 35
 of plasma for Office of Civilian Defense,
 91-93
 of professional personnel for ARC blood
 donor centers, 70
Provo, 783
Proximal tubules, necrosis of, 655

- PAYOR, Lt. R. E.,** 533, 535
Pseudoagglutination after gelatin injections, 375
Pseudoglobulins, 237, 243
Psychic factors in postdonation reactions, 157
Psychic stimuli in shock, 32
Psychrophilic contamination, 659
Public Information Office, General Headquarters, in Korean War, 730
Public Information Office, Joint Logistic Command, in Korean War, 730
Public Information Service, ARC, 121
Public Law 196, 77th Congress, 30 July 1941—423
Publicity—
 for ARC Blood Donor Service, 107, 110, 111, 119, 120, 129
 for ARC mobile bleeding units, 118
 in early campaigns for donors, 121
Publicity kits, 121
 on inauguration of Pacific airlift, 602–603
Puerperal hemorrhage, transfusion for, 1
Puerto Rico, 143
PULASKI, Lt. Col. E. J., 792
Pulmonary damage—
 as cause of failure of resuscitation, 44
 as contraindication to replacement therapy, 34
Pulmonary edema—
 after plasma infusions, 570
 after serum albumin administration, 702
 after transfusion, 20–21, 225
 in chest wounds, 706
 in lower nephron nephrosis, 667
 in plasma reactions, 667
 in shock, 42
 risk of, with multiple transfusions, 437
Pulmonary irritation, as contraindication to transfusion, 34
Pulse:
 effect of plasma on, 298, 698
 in incompatibility reactions, 654
 in plasma reactions, 670, 672
 in reactions from contaminated blood, 665
 in shock, 559, 684
 of donors, 139, 145
Pulse pressure, effect of hemoglobin solutions on, 361
Purchasing and Contracting Office, New York Army Medical Depot, 301
Pure Food and Drug Administration, 375
Purpose of mass blood grouping, 234
Purpuric reactions to bovine albumin, 335
Pusan, 728, 752
PUTNAM, T., 364
Pyrogen-free blood, 195
Pyrogen tests—
 on intravenous solutions, 384–385
 on serum albumin, 345
Pyrogenic reactions, 193, 219, 429, 461, 552, 572, 612, 651–652, 656, 660, 661–663
 causes of, 179, 651–653
 differential diagnosis of, 653
 due to hemolysis, 663
 due to lax preparation of transfusion sets, 660
 in ETOUSA, 652–653, 660
 resemblance of, to Rh-incompatibility, 246
 role of distilled water in, 382, 651
 to bovine albumin, 330, 335
 to plasma, 669, 670, 672–673
 with plastic equipment, 758
Pyrogenicity of fat emulsions, 796
Pyrogens:
 in fractionation of plasma, 343
 in gelatin, 375, 376
 in intravenous solutions, 385
 in oxidized cotton, 380
 in pooled plasma, 672–673
 in production of—
 blood substitutes, 372
 gelatin, 373
 serum albumin, 344, 348
 sensitivity to, after multiple transfusions, 804
Qualifications of transfusion officer, 472
Quantitative administration of plasma, 697–698
Quantitative blood replacement, 690–691
 criteria for, 559
Quantitative errors in transfusion in North Africa, 393
Quantitative factor in incompatibility reactions, 650, 654
Quantitative relation of—
 blood loss and shock, 8–9
 blood pressure to degree of shock, 39
 plasma administration to degree of shock, 39
 replacement therapy to degree of shock, 39
 transfusion to degree of shock, 34, 39, 635
 transfusion to hemorrhage, 559
Quantitative replacement therapy, 20
Quantitative use of blood—
 in MTOUSA, 437–438
 on Continent, 556–566

- Quantitative use of plasma, 267
 on Continent, 556-566
- Quartan malaria, 144
- Quartermaster Corps, 463
- Quartermaster Refrigerator Co., 621
- Queries about blood program, 128
- Questionnaire—
 in plasma package, 168
 to donors, 155-156
- Quinine, 423
- Quotas in ARC Blood Donor Service, 120
- Rabbit grouping sera, 236-237, 239
 for mass military use, 233, 236-237
- Rabbit thermal test of serum albumin, 344, 345
- Rabies, 140, 142
- Race of donors, 139
- Radio notification of arrival of blood on Luzon, 621
- Radio publicity, 120
 in ETOUSA, 573
- Radio requests for blood from Australia, 586-587
- Radioactive cell-tagging technique, 217, 221-222, 227, 229, 260, 430
- Radioactive studies on Periston, 789
- Radioautographs after Periston therapy, 790
- Rail transportation in—
 Japan in Korean War, 729, 742, 744
 ZI, 204-205
- Railway Brotherhoods, 125
- Railway Express Agency, Inc., 204-206, 603, 726, 744
- RANE, L., 288
- Rangers, 447
- RANKIN, Brig. Gen. F. W., 64, 69, 80, 211, 213, 464, 465, 467, 468, 489, 490, 492, 493, 579, 599, 680
- RAPPAPORT, Maj. E. M., 679
- Rate of—
 blood flow in shock, 30
 hemolysis:
 effect of temperature on, 203
 in stored blood, 218
 plasma infusion, 96, 165
 red blood cell survival in preserved blood, 217
 rejection of commercial plasma, 296
 transfusion, 4, 12, 21, 22, 34, 36, 194, 198, 553, 636, 690, 799
- Ratings—
 in ETOUSA Blood Bank, 498
- of enlisted personnel at ARC bleeding centers, 111
- Ratio of—
 blood to casualties, 180, 460
 before Korean War, 719
 in ETOUSA, 482, 485-486, 487, 509, 561, 565-566, 568, 574
 in evacuation hospitals in ETOUSA, 556
 in Korean War, 729, 752, 756
 in Luzon operation, 620
 in Middle East, 480
 in MTOUSA, 398
 in Okinawa operation, 631
 in Operation OLYMPIC, 640
 in SWPA, 615, 630, 633-634
 blood to plasma, 461-463
 blood-plasma-casualty requirements before Korean War, 773
 plasma to casualties in ETOUSA, 556-557
 replacement fluids to each other in British Eighth Army, 461-462
 transfusion sets to combat casualties, 544
- Rationale of—
 acceptance of plasma, 52-53
 concentrated plasma, 275
 flying unrefrigerated blood to ETOUSA, 209-211
 initial acceptance of plasma, 52-53
 plasma in shock, 266-267
 plasma replacement, 57, 265
 in burns, 697
 selection of—
 plasma, 268-270
 serum albumin, 336, 339-340
 separate intravenous therapy service in Armed Forces, 76-79
 whole blood replacement, 57, 177-179
- RAVDIN, Brig. Gen. I. S., 338, 339, 385, 716, 786, 792, 794
- Reaction(s), 50, 52, 77, 179, 429, 464, 469, 569, 649-680
 after donations, 145, 153-158
 causes of, 649-650
 confusion of, with preexisting conditions, 649
 differential diagnosis of, 649
 due to—
 allergy, 650-651
 contamination, 650
 failure of refrigeration, 650
 grouping errors, 650
 hemolysis, 650, 664
 improper cleaning of recipient sets, 444

Reaction(s)—Continued

due to—Continued

improper cleaning of tubing, 434
 incompatibility, 186, 650
 pyrogens, 193, 219, 650
 reuse of equipment, 461
 Rh factor, 260
 Rh factor, after multiple transfusions, 246, 247, 248, 249
 Rh incompatibility, 246, 249
 erroneous concepts of, 657-659
 in ETOUSA, 657-659, 660-665
 in evacuation hospitals in ETOUSA, 670
 in Filipinos, 668
 in general hospitals, 572
 in Korean War, 756, 804, 806
 in MTOUSA, 659-660
 in Okinawa operation, 627
 in SWPA, 635, 783
 incidence of, 650
 at Mount Sinai Hospital, 651-652
 at Walter Reed General Hospital, 652, 696
 in ETOUSA, 247, 660-661, 664-665
 with properly cleaned equipment, 652
 nonrecognition of, 649
 prophylaxis of, 650
 of tissues to fibrin film (foam), 365, 367-368
 role of distilled water in, 651
 routine investigation of, 649-650
 to blood airlifted to—
 ETOUSA, 661-663
 SWPA, 213
 to bovine albumin, 325, 327, 330-332, 335
 to cadaveric blood, 24
 to contaminated blood, 665
 to dextran, 791, 792, 793
 to fraction II—362
 to gelatin injections, 375, 386
 to globin in Korean War, 783
 to group-specific blood after massive group-O transfusions, 805
 to gum acacia-salt solution, 10
 to hemoglobin solutions, 361
 to high-titer group O blood, 424-426, 696
 to high-titer plasma, 259
 to homologous serum, 266
 to intravenous solutions, 385, 387, 558
 to liquid plasma, 96
 to outdated blood, 633
 to placental blood, 25
 to plasma, 50, 52, 79, 258, 259, 269, 298, 566, 636, 668-680

to plasma fractions, 361
 to preserved blood in German Army, 22
 to red blood cell transfusions, 312, 316
 to serum, 336
 to serum albumin, 338, 339, 344, 345
 to transfusion—
 in World War I—6, 9
 with ACD solution, 612
 with Alsever's solution, 225
 with DeGowin et al. solution, 200
 with incompatible blood, 186
 with modified Rous-Turner solution, 224
 with red cells from unrefrigerated blood, 210
 with unrefrigerated blood, 210
See also Complications; Sequelae of donations.
 Reactivation of World War II Subcommittee on Blood Substitutes, NRC, 724-725
 Rear hospitals, Rh testing in, 248
 REARDON, Lt. H. H., 485, 521
 Recalcification—
 of contaminated plasma, 302, 303
 of plasma, 270
 Reception rooms in ARC blood donor centers, 113
 Recipient, passive transfer of sensitivity to, 140
 Recipient blood, survival of red blood cells in, 220
 Recipient cells:
 hemolysis of, 663
 intravascular hemolysis of, 653
 replacement of, by transfused cells, 805
 Recipient sets, 508
 delivery of, to FECOM, 765
 for airlift to ETOUSA, 491, 492
 initial shortages of, 494-495
 for Luzon operation, 620
 improvisation of, in MTOUSA, 423-434
 in plasma package, 171
 in SWPA, 593
 preparation of, in MTOUSA, 659-660
 return of, from Continent, 551
 shortages of:
 in ETOUSA, 483
 in MTOUSA, 440, 694
 space for, in shipping containers, 761
 Recipient susceptibility, 653-654
 Recipient urine, bovine albumin in, 327
 Recognition of donations, 127-128
 Recommendation(s):
 for ACD solution for airlift to ETOUSA, 226

- for addition of:
 - A and B substances to blood, 260
 - glucose to stored blood, 222
- for additional personnel for blood banks, 454
- for additional refrigerator truck equipment for blood banks, 454
- for additives to serum albumin, 352
- for administration of blood program in OTSG, 91
- for advance blood banks in ETOUSA, 510
- for airlift, to—
 - ETOUSA, 209-210, 212-213, 466-467, 481, 486-487, 490-491
 - oversea theaters, 465
- for blood bank facilities, 431
 - in Japan in Korean War, 756-757
- for blood donors with malaria, 144
- for blood for combat casualties, 53, 461-464, 465-466, 467, 468-469
- for blood supply in—
 - Central Pacific, 594
 - South Pacific, 594
 - SWPA, 591-595
- for central laboratory in MTOUSA, 398
- for change to serum albumin in Korean War, 781
- for commercial procurement—
 - of intravenous fluids, 382-383
 - of serum albumin, 340
- for distribution center afloat in Okinawa operation, 628
- for distribution of ZI blood by ETOUSA Blood Bank, 486
- for double transfusion units, 408-409
- for facilities for transfusion overseas, 393
- for field investigations, NRC, 79-80
- for group-specific transfusions after group O transfusions, 805
- for handling of blood in SWPA, 604-605
- for hemoglobin level of donors, 159-160
- for indoctrination of amphibious task force personnel, 628
- for intravenous therapy service in Armed Forces, 53, 76-79
- for limitation of use of plasma in Korean War, 781
- for location of SWPA blood bank, 591-594
- for modification of Chrysler refrigerator, 206
- for operation of blood bank on LST 464—594-595
- for organization of transfusion unit, NATOUSA, 401
- for oversea airlift, 222-223, 476
- for oversea transfusion service to The Surgeon General, 462-464, 465-467
- for plasma, 75, 76, 268, 269, 337, 474, 629
 - from serologically positive blood, 744
- for preservative solutions in MTOUSA, 444
- for professional supervision of distribution teams, 628
- for provision of blood:
 - for plasma program by ARC, 101
 - in MTOUSA by unit hospital system, 398
- for purchase of plasma by Armed Forces, 290
- for record-keeping on ETOUSA airlift, 212
- for reprocessing of outdated plasma before Korean War, 773
- for shock teams in amphibious operations, 629
- for standardization—
 - of field refrigerators, 208
 - of plasma equipment, 165
- for stockpiling of—
 - plasma before Korean War, 773
 - transfusion equipment before Korean War, 773
- for studies on—
 - blood substitutes, 75
 - human serum albumin, 75
 - infectious hepatitis, 352
- for survey of needs for blood in ETOUSA, 466
- for syphilitic donors, 143
- for Table of Organization for Army blood banks, 446
- for temperature for transportation, 226
- for termination of plasma program in Korean War, 784
- for testing of serum albumin, 344
- for training in plasma and transfusion, 85-91
- for transfusion overseas with improvised equipment, 180-185
- for transfusion service in Korean War, 756-757
- for treatment of shock by transfusion, 35
- for universal use of group O blood, 53, 54
- for use of—
 - preserved blood, 221
 - serum albumin, 337, 339-340
 - stored blood, 53
- of civilian committees in post-World-War II period, 715-717

- Recommendation(s)—Continued**
of General Board, ETOUSA, 574
of Subcommittee on Blood Substitutes, NRC, to ARC, 76
of Task Group on blood program before Korean War, 719-721
on ownership of byproducts, 83-84
to Secretary of Defense on blood in Korean War, 726
- Reconstitution of plasma**, 34, 50, 88, 91, 165, 698
- Record-keeping:**
in ETOUSA Blood Bank, 501, 504
in processing laboratory, Travis AFB, 740
in ZI, 455
on shock wards, 710
- Record section, ETOUSA Blood Bank**, 501, 504
- Recording of blood groups on identification tags**, 233, 235, 238, 242, 244, 429, 444
- Records—**
in ARC blood donor centers, 145, 152-153
in forward hospitals, 455
of ARC Blood Donor Service, 70, 103
of plasma infusions, 676-677
of reactions, discrepancies in, 649
of transfusions—
at Walter Reed General Hospital, 696
in Spanish Civil War, 11
with red blood cell residua, 313
on airlift to ETOUSA, 214
required of commercial processing laboratories, 297
- Recovered Allied Military Personnel**, 565, 569, 570
- Recovery ward, reactions in**, 651
- Recreation Corps, ARC**, 111
- Recruitment of donors**, 107, 111, 118, 119-128, 139
by groups, 125-126
in ETOUSA, 474, 524-527
in India, 642
in Korean War, 730-731, 737-738
in MTOUSA, 421-422, 442-443
in SWPA, 596-597
- Recrystallization of bovine albumin**, 327, 328
- Recumbency after donations**, 145
- Red Ball Coaster Freight Service**, 509, 537
- Red blood cell count—**
after transfusion with unrefrigerated red blood cells, 210
from capillary bed, 30
in combat casualties, 461
- Red blood cell formation, inhibition of, after wounding**, 805
- Red blood cell residua**, 312-319
clinical experiences with, 313, 314-319
dating period of, 318-319
distribution of, 313-314
historical note on, 312
in Blood for Britain, 312
regulations for use of, 313
technique of collection of, 313-314
- Red blood cells:**
effect of—
oxidized cotton on, 380
transportation on, 220-221
from unrefrigerated blood, 210
in Korean War, 785
loss of, in relation to plasma loss, 43-44
metabolism of, 203
nutrition of, in ACD solution, 226
of recipient:
effect of serum albumin on, 336
effect on, of blood from dangerous universal donor, 804
oxygen-carrying properties of, 8, 31, 52, 54-55
preparation of globin from discards of, in Korean War, 783
preservation of, in Korean War, 769
proposed airlift of, to ETOUSA, 490, 493, 494
reduction of, in burns, 338
release of, to ZI hospitals, 82
selective destruction of, after O-blood transfusions, 806
storage of, 82
suggested field use of, 319
survival of:
after transfusion, 227, 229, 260-261, 769
in ACD solution, 226
in dextrose-preserved blood, 220
transfusion with, 143
in World War I—5-6
value of, in chest wounds, 706
- Reduction—**
of rate of blood flow in shock, 30
of volume flow of blood in shock, 30
“Reference” grouping sera, 241
- Refined Syrups and Sugars Corp.**, 794
- Reflex vasomotor paralysis theory of shock**, 29
- Refreezing of plasma**, 273
- Refreshments after donations**, 148
- Refrigerated trucks**, 212
in British blood program, 17

- in ETOUSA, 467, 478
- in MTOUSA, 414-416
- Refrigerating capacity of stops during ETOUSA airlift, 212
- Refrigerating equipment, 468
- Refrigeration, 203-215, 227, 421, 718, 719
 - after deplanement, 208, 209
 - before enplanement, 208, 209
 - development of, 416
 - early lack of, 50
 - facilities for ARC blood donor centers, 114, 152
 - failure of, 567, 650, 664
 - for airlift, from—
 - United Kingdom to Continent, 478, 532, 538
 - ZI to ETOUSA, 208-213, 227, 476, 489, 491, 492, 493, 494, 538-539, 540, 541
 - for ARC mobile bleeding units, 115
 - for base collection centers in MTOUSA, 431
 - for detachments on Continent, 520, 521
 - for ETOUSA blood bank, 496, 502, 503-504, 510, 511
 - for field use, 52, 454, 543
 - in 1941-268
 - for forward hospitals, 464
 - for freezing plasma, 65
 - for Leyte operation, 617
 - for Luzon operation, 620, 621
 - for Normandy landings, 512, 518
 - for Okinawa operation, 623-624, 627, 628
 - for Operation OLYMPIC, 639, 640
 - for oversea transfusion service, 206-208, 213-215, 461, 462, 463, 467, 469
 - for processing laboratory, Travis AFB, 744
 - for 6803d Blood Transfusion Unit (Ovhd.), 454
 - for storage of dried plasma, 102
 - in Australia Blood Bank, 581
 - in British field transfusion units, 17
 - in CBI, 642
 - in ETOUSA, 212, 476, 541-543
 - in evacuation hospitals, 180
 - in MTOUSA, 422
 - in FECOM, 766
 - in forward hospitals—
 - in ETOUSA, 478
 - in MTOUSA, 395, 422
 - in general hospitals in United Kingdom, 473, 474
 - in Korean War, 804
 - in MTOUSA, 414-417, 454
 - in proposed unit hospital system, 397
 - in southern France, 446, 448, 450
 - in Spanish Civil War, 111
 - in SWPA, 584, 585, 587, 590, 593, 598, 604, 605, 606, 607, 608, 611, 612, 614
 - in ZI hospitals, 695
 - losses from failure of—
 - in ETOUSA, 570-571
 - in SWPA, 631-632
 - maintenance of:
 - in British Army Transfusion Service, 17
 - on Continent, 550, 551
 - of grouping sera, 236
 - of liquid plasma, 274
 - of placental blood, 24
 - of plasma, 50
 - of plastic equipment, 759
 - of replacement agents, 51
 - of resuspended red blood cell residua, 313
 - of serum albumin, 349, 637
 - of shipping containers, 765-766
 - on Guam, 614
 - on LST 464-595
 - on Naval vessels, 50
 - on Normandy beaches, 485, 509, 512, 518
 - reactions caused by failure of, 650
 - requirements in ETOUSA, 541-543
 - responsibility of Supply Division for, in ETOUSA, 546
 - role of, in reactions, 668
 - specifications for, 203-204
 - training in, 412
 - with Alsever's solution, 224
 - Refrigeration, mechanics of, 416
 - in ETOUSA Blood Bank, 498, 506, 514
 - in southern France, 454
 - Refrigerators, standardization of, 208
 - Regeneration—
 - of hemoglobin after donations, 158-160
 - of plasma proteins after donations, 159
 - Regimental aid posts in World War I-6
 - Regional programs of ARC in Korean War, 737
 - Regional technical supervisors in ARC program, 119
 - Regrouping of blood, 97, 476
 - Regulations for use of red blood cell residua, 313
 - Reichel Division of Wyeth, Inc., 252, 289
 - Reichel Laboratories, Inc., 65, 163, 289, 292
 - REICHEL, Maj. J., Jr., 65, 95, 336
 - Reichel modification of Sharp & Dohme technique of drying plasma, 280

- Re-icing—
 on airlifts, 214
 on test airlift, 221
- Rejection of—
 donors, 120, 139, 140, 141-144
 causes of, 140-141
 in Korean War, 731
 with major allergies, 651
 with syphilis, 261, 262
 recommendation for, oversea transfusion
 service by OTSG, 74, 78, 465-466,
 469, 480, 490, 491
- Rejection rate of commercial plasma, 296
- Relation of degree of hemolytic reaction to
 amount transfused, 650
- Release required before donations, 140-141,
 145
- Relief of pain in shock, 56
- Religious meetings, recruitment of donors
 at, 125
- Remodeling of facilities for ARC blood
 donor centers, 112
- Renal changes in incompatibility reactions,
 654-655
- Renal complications—
 after globin injections, 782, 783
 in incompatibility reactions, 653-656
- Renal damage—
 from Merthiolate, 284
 in serum sickness, 331
- Renal dysfunction in shock, 555
- Renal excretion of dextran, 790
- Renal failure, plasma potassium in, 803
- Renal function:
 effect of Periston on, 789
 in combat casualties, 786
 in lower nephron nephrosis, 667
- Renal tolerance of hemoglobin, 555
- Renegotiation Division, OTSG, 301, 304
- Renegotiation phase of plasma program,
 301-312
- Reorganization of ARC Blood Donor Serv-
 ice, 106-111
- Reorganization Plan No. 6, DOD, 716
- Reparative surgery in wounds of extrem-
 ities, 703-705
- Replacement:
 of recipient red blood cells by transfused
 cells, 805
See also Intravenous therapy, Transfusion.
- Replacement agents, 726, 684
 in World War I-8
 responsibility for, of Surgical Consultant,
 ETOUSA, 470
- Replacement depot(s):
 Continent, 515
 donors from, in MTOUSA, 422
 24th—453
- Replacement therapy:
 as specialized branch of medicine, 464,
 469, 472
 British equipment for, 16
 concepts of, after World War I—31
 development of anemia during, 34
 effects of, 34-35
 evaluation of, in World War I—9-10
 field studies in, 80-81
 hemoglobin solutions in, 361
 in line of evacuation, 51
 in prevention of shock, 34
 in shock, 36
 in Soviet Union, 21-22
 in SWPA, 637-638
 indications for, 457
 on shock wards, 710
 principles of, in Korean War, 796-801
 quantitative administration of, 20
 quantitative relation of, to degree of
 shock, 39
 recurrence of hemorrhage during, 34
 requirements of, in CBI, 645-646
 standardization of equipment for, 467
 training in, in British blood supply depot,
 470-472
- Report(s) of—
 blood movements at Prestwick, 541
 bovine albumin program, 327-328
 1950 Task Group to Secretary of Defense,
 718-721
- Reporting of—
 military donors with syphilis, 262-263, 503
 plasma reactions in SWPA, 668, 669, 673-
 674
 reactions in ETOUSA, 660-661
- Reprocessing—
 of plasma before Korean War, 772, 773
 of World War II blood derivatives, 718
- Republic Army Medical Corps, 11
- Republic of Korea, 755, 756
- Republic of Korea Army hospitals, blood
 supply of, 803
- Request(s) for—
 blood from ZI in Korean War, 713, 729,
 739
 surplus plasma, 310-311
- Requirements Coordination, Munitions
 Board, 720

- Requirements for—
 airlift, 203-204
 Armed Forces in Korean War, 733
 blood after D-day, 485
 in ETOUSA, 471
 in MTOUSA, 437-438
 blood program before Korean War, 721
 donors in Pacific, 582-583, 584
 dried plasma, 142, 284, 287, 288, 289, 290-291, 471
 Normandy landings, 471, 480-481
 Operation OLYMPIC, 639
 oversea transfusion service, 461
 replacement therapy in CBI, 645-646
 serum albumin, 342, 344
- Requisitions for—
 blood supplies—
 in ETOUSA, 510, 541, 546, 547, 615
 in SWPA, 615
 equipment—
 for hospital ships in CPA, 594
 in SWPA, 593-594
- Research—
 during Korean War, 738
 on blood preservation before Korean War, 720
 on dried plasma, volunteer donors for, 101-102
- Research contracts before Korean War, 725
- Research Department, California Fruit Grower's Exchange, 378
- Research Division, Army Medical School, 652
- Research section, ETOUSA Blood Bank, 500
- Research Society, American Red Cross in France, 9
- Reserves of blood, excess of, in Korean War, 752, 756
- Residual impurity in bovine albumin, 328
- Respiratory insufficiency as cause of death, 56
- Rest camps, donors from, 462
- Restoration—
 of blood pressure in shock, 34
 of blood volume as basis of shock therapy, 30
- Resuscitation, 443, 455, 471
 by British field transfusion units, 16, 17-18
 concepts of, 683
 development of, in MTOUSA, 684
 diagnostic routine in, 687
 estimates of blood for, in ETOUSA, 485-486
 failure of, 44, 285
 film strips on, 55
 in Korean War, 781
 in Okinawa operation, 626
 individualization of, 559
 plasma in, 175, 565
 principles of, 683-684
 problems of, in Korean War, 803
 recurrence of shock after, 56
 renal function after, 666
 surgery in failure of, 705
 timing of operation in relation to, 36, 39, 40
 training in, 87, 442
 for Okinawa operation, 624
 whole blood requirement in, 57, 192
 with whole blood in North Africa, 395
- Resuscitation officers, 463
- Resuscitation (shock) wards, 683
- Resuscitation teams in World War I—7-8, 384
- Retention of—
 oxypolygelatin in blood stream, 787
 Periston in body, 789
 personnel in ETOUSA Blood Bank, 501
 plasma in bloodstream, 44
- Reticuloendothelial system, 229
- storage—
 of dextran in, 791
 of Periston in, 788
- Return—
 of marmite cans from Continent, 50
 of transfusion equipment from Continent, 195
- Review of manuscripts at Army Medical School, 63-67
- Reynolds Metal Co., 214
- Rh agglutination, natural incidence of, 247
- Rh factor, 65, 245-251, 656, 719
 early determination of, 250
 fatalities caused by, 246, 247, 249, 260
 in Korean War, 748
 in pregnancy, 246, 249
 in reactions, 651
 in red blood cell transfusions, 314
 in SWPA, 598
 military significance of, 246-248, 249
- Rh groupings in MTOUSA, 442
- Rh immunization, 246-248, 249
- Rh incompatibility, 245-251
- Rh-incompatible cells, survival of, 246, 247, 250
- Rh-negative bloods, 582
 incidence of, in Japan in Korean War, 731-732

- Rh-negative bloods--Continued
 shipments of
 to ETOUSA, 250, 251
 to Korea, 748
 Rh-negative persons, 246, 247, 248, 249
 Rh-positive bloods, 424
 Rh-positive cells in Rh-negative recipients
 after transfusion, 656
 Rh-positive persons, 246, 247, 248, 249
 Rh-positive recipients, effect of red blood
 cell transfusions on, 315
 Rh sensitivity, reactions due to, 660
 Rh-specific bloods in Korean War, 729
 Rh testing, 111
 indications for, 248-250
 Rh testing serum, 248-251
 Rh-verified blood for airlift in Korean War,
 743
Rhesus monkeys, 143
 Rhine River, 522, 523, 537
 RHOADS, C. P., 74, 82, 103
 RICHARDS, A. N., 333, 372
 RICHARDSON, Lt. Col. G. S., 509
 Ringer's solution, 8, 383
 Risk(s)
 of airlift of unrefrigerated blood, 208
 of transfusion, 78-79
 ROBERTSON, L. B., 5, 7
 ROBERTSON, Maj. O. H., 5, 6, 8, 74, 80, 218,
 312, 384
 ROBINSON, Col. E. S., 353
 ROBINSON, G. C., 92, 101, 104, 107, 109, 139,
 144, 205, 242, 262, 290, 294, 301, 313
 Rochester, 291
 Rockefeller Foundation, 24, 144
 Rockefeller Institute for Medical Research,
 13, 253, 257
 Roentgenologic examination:
 in resuscitation, 689
 traumatic effect of, 31
 Roer River, 522
 ROGERS, Brig. Gen. J. A., 550, 557
 ROK. *See* Republic of Korea.
 Role
 of National Research Council in Blood
 Program, 49-54
 of Subcommittee on Blood Substitutes,
 NRC, in blood program, 49-54
 Rome, 406, 407, 418, 420, 440, 446
 Room temperature, storage of infected
 pooled plasma at, 780
 ROSE, Capt. H. W., 717
 ROSENAU, 276
 ROSENTHAL, N., 219, 651, 652
 Ross, Capt. J. B., 229
 Ross, J. F., 221, 230, 260
 Rotation
 of blood bank personnel, 413
 of personnel in bleeding centers, 111
 Rouleaux formation
 after gelatin injections, 377
 in slide technique of blood grouping, 240
 Rous, P., 203, 217, 219, 222, 223, 265, 312,
 383
 Rous-Turner solution, 217-218, 219-220
 modifications of, 222, 223-224
 Routes of administration of serum albumin,
 341
 Routine
 at Hollandia Blood Bank, 595-596
 of donations in ARC blood donor centers,
 145-148
 of blood collection during Korean War,
 743-744
 of blood replacement in resuscitation,
 689-693
 of posttransfusion cleaning of equipment,
 at
 Mount Sinai Hospital, 651-652
 Walter Reed General Hospital, 652
 ROWNTREE, L. G., 218
 Royal Air Force, training of personnel of, in
 blood program, 16
 Royal Army Medical Corps, 78, 396, 528
 training of personnel, of in blood program,
 16
 Royal Infirmary, Salisbury, 473
 Royal Navy, training of personnel of, in
 British program, 16
 Royal Society of Medicine, 1
 Rubber components of transfusion sets,
 improper cleaning of, 651, 652
 Rubber diaphragm of stoppers for intra-
 venous solutions, 385-387
 Rubber plasma tubing in improvised trans-
 fusion set, 189
 Rubber stoppers for
 distilled water, 385
 plasma package, 163, 165, 166, 169
 serum albumin package, 198
 transfusion bottles, 196
 Rubber tubing, 463
 durability of, in SWPA, 638
 for donor set, 435-436
 for plasma package, 175
 for recipient set, 436
 for serum albumin package, 338, 343, 344
 for transfusion set, 196

- shortages of, in ETOUSA, 544
 RUDDER, F., 62
 Ruhr Basin, 517
 Rumors, effects of on donations, 125, 129, 329
 Rumpel-Leede test, 335
 Ruptured ectopic pregnancy, 23
 RUSK, H. A., 716, 735
 Russian Red Cross, 95
 Russo-Finnish War, 1940-41-40
 Rusting of intravenous plasma needles, 172

 Sabotage, 129, 295
 Saccharose, 218
 SACHS, H., 243
 Safety—
 of airlift of unrefrigerated blood to
 ETOUSA, 208, 209-213
 of pooled plasma, 258, 259
 Sahli-Hellige hemoglobinometer, 43
 Saint-Lô, 486, 520
 St. Louis, 160, 291
 Saint Mawgan, 211, 212
 St. Paul, 292
 Saint-Trond, 521, 523
 Saipan, 591, 594, 605, 607, 614, 615, 622, 626,
 640
 SAKO, Capt. Y., 799
 Sale of plasma, rumors concerning, 129
 Salerno, 398, 405
 Salerno-Cassino campaign, 438
 Salisbury, England, 195, 211, 212, 480, 481,
 493, 494, 499, 500, 512, 513, 516, 532,
 534, 546, 549
 Salisbury, N.C., 211
 Saliva:
 A substance in, 806
 derivation of A and B substances from, 260
 Salt-free plasma, 285-286
 Salt-free serum albumin, 351-352, 354-355,
 360
 Salvage of aging blood in—
 ETOUSA, 511, 550
 MTOUSA, 440
 Salvaged materials from wrecked planes, 424
 SAMMONS, M. E., 230
 Sample testing of commercial plasma, 296
 San Antonio, 292, 734
 San Diego, 292, 600
 San Fernando, 622
 San Francisco, 213, 220, 292, 310, 489, 599,
 600, 603, 606, 615, 618, 719, 741, 742,
 782
 San Lazaro Hospital, 671, 673
 Sanidad Militar of Spanish Republic, 12

 Sanitary Corps, 111, 500
 Sansapor, 620
 Sarrebourg, 452
 SARTWELL, Maj. P. E., 675, 680
 SATUNOV, 219
 SAXTON, R. S., 12
 Scabies, patients with, as donors in World
 War I—9
 Scandinavian countries, 790
 Scarletina, 363
 SCATCHARD, G., 345, 359, 381
 Schedules of delivery to processing labora-
 tories, 153
 Schenectady, 291
 Schenley Corp., 788-789, 794
 School of Tropical Research, 642
 Schools, drives for parental donations in, 125
 Schouten Group, 591
 Schulz technique of globin production, 362
 SCHWARTZ, Lt. Col. F. N., 69, 71, 205, 302,
 492, 493, 603
 Scotland, 212, 488, 494, 512, 514, 536
 Screening test—
 for group O blood, 251-252
 in MTOUSA, 442
 SCUDDER, J., 74, 230, 312
 Second Conference on—
 Blood Storage, NRC, 223
 Gelatin, NRC, 374
 Shock, NRC, 34
 Secondary anemia, oxygen deficit in, 56
 Secondary hemorrhage:
 gelatin in, 374
 transfusion for, 485-486
 Secondary hypotension, 803
 Secondary shock, 32, 59
 Secretary of Air Force, 716
 Secretary of Defense, 715, 716, 717, 721, 726,
 733, 734, 737, 776
 Security measures in ETOUSA, 548-549
 Sedimentation—
 before airlift in Korean War, 746
 caused by dextranlike substances, 791
 in Continental Blood Bank, 552
 in SWPA, 607, 613
 Sedimentation constant of bovine albumin,
 326
 Sedimentation rate:
 after gelatin injections, 374, 375
 effect of blood substitutes on, 373
 Sedimentation technique of plasma produc-
 tion, 13, 286, 293
 SEELEY, Col. S., 61, 62, 800
 SEIBERT, F. B., 651

- Seitz filter, 287, 326, 353
 passage of malarial blood through, 143
- Selection of—
 ACD solution for ETOUSA airlift, 224-225
 Asever's solution for ETOUSA airlift, 224-225, 489, 491, 492, 493, 494, 553-554, 611
 casualties for surgery, 683-684
 by British field transfusion teams, 17
 donors overseas, 186
 group O donors in MTOUSA, 424-426
- Selective Service, 70
- Semi-closed collection technique, in CBI, 642
- Senior Consultant(s) in—
 Medicine, Office of Chief Surgeon, ETOUSA, 475
 Shock and Transfusion, Office of Chief Surgeon, ETOUSA, 496, 547
 Surgery, Office of Chief Surgeon, ETOUSA, 193, 475, 508
- Sensitivity:
 passive transfer of, 650-651
 to blood substitutes, 373
 to dextran, 793
 to group O blood, 651
 to horse serum, 140
 to human proteins, 651
 to plasma proteins, 651
 to pyrogens after multiple transfusions, 804
 to sulfonamides, 140
- Seoul, 752
- Sepsis:
 as cause of shock, 688
 plasma in, 462
- Septic sore throat in donors, 142
- Septicemia—
 after donation, 157
 as indication for transfusion in World War I—7
- Sequelae of donations, 139, 153-160, 730
- Serologic testing, 97, 142-143, 151, 261-263, 275, 462, 463, 466, 476
 before ETOUSA airlift, 490, 491, 494
 before Pacific airlift, 603
 in ETOUSA Blood Bank, 501, 502
 in German blood program, 22
 in Korean War, 744
 in MTOUSA, 430
 in processing laboratories, 297
 of cadaveric blood, 24
 on LST 464—595
- Serologically positive blood:
 dried plasma from, 643, 744
 in ETOUSA, 426, 568
 in Japan in Korean War, 731
 in MTOUSA, 441
- Serum, 65
 agglutination of, by recipient's red blood cells, 4
 complement in, 336
 drying of, 276
 in burns, 336
 in experimental shock, 265
 in German blood program, 22
 in infections, 336
 in shock, 266, 268
 precipitation of fibrin in, 266
 processing of:
 at 20th General Hospital, 642
 from Chinese donors in CBI, 645
 from discarded Australian bloods, 582
 production of, in India, 642
 properties of, 336
 reactions to, 266, 336
 use of, in Pacific, 585
 yield of, 52, 268
- Serum albumin, 65, 84, 109, 300, 335-355, 359, 398, 457, 464, 467, 600, 664
 addition of antibacterial agents to, 349-351, 352-354
 administration of—
 isotonic fluids with, 270
 supplemental fluids with, 347
 allergic reactions to, 650
 Army requirements for, 347-348
 clinical testing of, 337-339, 345, 354-355
 commercial processing of, 71, 76, 84, 237, 290, 341-347, 361
 contamination of, 350
 definition of, 267-268
 dosage of, 34, 338, 339
 effects of, 34
 equipment for commercial production of, 342-343
 field studies of, 80
 filtration in production of, 353
 freezing of, in Korean War, 782
 historical note on, 335-336
 in burns, 354
 in fraction V—360
 in hemorrhage, 354, 355
 in hepatic cirrhosis, 352, 354
 in hypoproteinemia, 352
 in Korean War, 713, 781, 782
 in nephrotic syndrome, 352, 354

- in nutritional edema, 354
 - in peritonitis, 354
 - in plasma reactions, 671
 - in resuscitation, 690
 - in shock, 34, 352, 354, 355
 - in SWPA, 637
 - indications for, 702
 - in Korean War, 796
 - jaundice after injection of, 674
 - laboratory development of, 336-337
 - legal problems in commercial production of, 71
 - license for production of, 81
 - limitations of, 702
 - logistics of, 347, 352
 - multiple injections of, 339
 - Navy contracts for, 111, 267
 - nomenclature of, 343
 - osmotic pressure of, 336-337
 - Pearl Harbor experience with, 338-339
 - processing of, from—
 - contaminated plasma, 88, 302, 306, 345-346, 347
 - discarded bloods in Korean War, 750
 - outdated plasma in Korean War, 773
 - properties of, 326, 353
 - provision of, for OCD, 92
 - rationale of—
 - selection of, 339-340
 - use of, 336
 - reactions to, 337, 338, 339, 344, 345-346
 - recommendation of, to Armed Forces, 339-340
 - refrigeration of, 349
 - specifications for commercial production of, 348
 - stability of, 345, 360
 - sterility of, 353
 - stockpiles of, after World War II—772
 - storage of, 341
 - supervision of commercial production of, 340, 342
 - techniques of processing of, 337
 - toxicity of preservatives in, 354
 - training in use of, 341, 463
 - versus plasma, 35
 - viscosity of, 353
 - yield of, 127, 342, 346-347, 782
- Serum albumin package, components of, 198, 702
- Serum albumin program, 120, 491
 - procurement of blood for, 109, 343
 - termination of, 355
- Serum albumin therapy, 699-702
- Serum groupings, in MTOUSA, 442
- Serum hepatitis, 142, 310
 - diagnosis of, 675
 - in Korean War, 713, 775, 776-782, 795, 803
 - in World War II—310, 775, 776, 795
 - in ZI hospitals, 674
 - incidence of, in Korean War, 778, 781
 - prophylactic gamma globulin in, 679-680
 - prophylaxis of, 363
 - sterilization against virus of, 775, 776, 782
 - testing of serum albumin for, 310
 - in Korean War, 782
 - transmission of, by—
 - plasma, in Korean War, 775, 776, 782, 795
 - transfusion, 720
- Serum sickness, 327, 328, 330-331, 335
 - fatalities from, 325, 332
- Seventh U.S. Fleet, 616
- Service Commands:
 - First, 274-275
 - Second, 274-275
 - Third, 274-275
 - Fourth, 274-275
- Service personnel, donations from, 462, 466
 - in ETOUSA, 473, 476, 477
 - in MTOUSA, 399, 421-422, 445, 452-453
 - in SWPA, 584, 600
- Services of Supply, 477
- Sex distribution of donors—
 - in Soviet Union, 21
 - in ZI, 21, 139, 141
- SHACKELL, L. D., 276-277
- SHAINMARK, Capt. A. C., 522
- Shaking:
 - during tests of Aisever's solution, 225
 - effect of, on red blood cells, 220
- SHAMOV, 24
- SHAPIRO, Capt. S. L., 41
- Sharp & Dohme, 65, 163, 240, 275, 280, 289, 290, 292, 309, 336, 719, 774, 783
- Sharples centrifuges, 342, 343
- SHAULSON, Lt. P. S., 521
- Shell-freezing technique of drying plasma, 273, 276, 281-283, 774
- Shell-frozen dextrose (glucose) in demonstration plasma packages, 88
- Sheppard Air Force Base, 734
- SHEPPARD, S. E., 374
- Shipping section, ETOUSA Blood Bank, 503-504, 515

- Shipping space:
 conservation of, 185
 for intravenous fluids, 382
 shortages of, 180
- Shock, 29-44, 628
 after gelatin injections, 787
 amino acids in, 380
 and transfusion service, recommendation for, 53, 76-79
 anemia after, 35
 anesthesia as cause of, 32, 34
 arterial pressure as criterion of, 36
 as cause of lower nephron nephrosis, 426
 as indication for transfusion, 22
 in World War I—7
 asphyxia in, 665
 base deficiency in, 40
 blood pressure as index of, 30
 blood volume as index of, 30
 bovine albumin in, 327, 331
 British experience in, 37
 burns as cause of, 32
 capillary permeability in, 36
 cardiac function in, 11, 30
 chronology of, 31-32
 classification of, 39, 689
 clostridial myositis as cause of, 38, 39
 concepts of, 29-33, 37-38, 41-42, 684-686
 in World War I—7, 8-9, 31-32
 controlled laboratory studies in, 31
 decrease of—
 blood volume flow in, 32
 cardiac output in, 30-32
 peripheral circulatory blood volume as cause of, 32
 venous return as cause of, 30, 32
 definition of, 31-33, 37-38
 degree of, 39, 559
 depletion of physiologic functions in, 32
 determination—
 of blood volume in, 31
 of hemoglobin in, 31
 dextran in, 792
 differentiation of, from—
 hemorrhage, 12, 29, 51
 incompatibility reaction, 655-656
 early concept of prophylaxis of, 706
 early diagnosis of, 252
 early discussions of, by NRC, 50-51
 effect of—
 glucose solution in, 34
 physiologic salt solution in, 8, 34, 383
 empirical use of citrated blood in, 31
 estimates of blood needed in, 480-481
 evolution of—
 concepts of, 37-38
 concepts of management of, in MTOUSA, 53-57
 therapy of, 37-38
 experimental studies on, 36, 37-38
 between World Wars, 29-30
 field studies in, 80-81
 fluid shift in, 30
 gelatin in, 374, 376
 German management of, 43
 globin in, 783
 gum acacia in, 384
 head injuries, as cause of, 38
 heat in, 32
 heat in prevention of, 34
 hematocrit in, 40
 hemoconcentration in, 30, 40, 43-44, 51
 hemoglobin solutions in, 361
 hemoglobinuric nephrosis in, 655
 hemorrhage as cause of, 7, 8-9, 31-32, 33, 38, 41-44, 444
 historical note on, 29
 impairment of renal function in, 555
 in burns, 697
 in dysentery in CBI, 642-643
 in incompatibility reactions, 654
 in lower nephron nephrosis, 666-667
 in malaria in CBI, 642-643
 in plasma reactions, 670
 in reactions from contaminated blood, 665
 in SWPA, 616
 incidence of, 77
 increase of capillary permeability as cause of, 30
 increase of hemoconcentration in, 32
 ineffectiveness of gelatin in, 787
 infection as cause of, 34
 initial concepts of, 30-33
 intra-arterial transfusion in, 799-801
 lethality of, 56, 665-666
 literature of, 65
 loss of—
 circulating blood volume as cause of, 29, 30, 33, 36, 37, 40, 54
 local fluid as cause of, 29, 36
 plasma as cause of, 30
 management of, in forward hospitals, 268
 metabolic changes in, 36
 morphine in, 32
 nomenclature of, 31-33, 37
 oliguria in, 424
 on operating table, 443
 overtransfusion in, 804

- pectin in, 379
peritoneal contamination, as cause of, 39
peritonitis, as cause of, 38
plasma in, 13, 31, 34, 266-267, 268, 297, 298, 480, 617
 in North Africa, 392-393
plasma protein concentration in, 40
pleural contamination as cause of, 39
postural measures in prevention of, 34
prophylaxis of, 33-34, 36
psychic stimuli in, 32
pulmonary edema in, 42
quantitative relation of:
 to amount of hemorrhage, 31, 41, 42, 685-686
 transfusion to degree of, 39
rate of transfusion in, 22
recommendation(s)—
 for studies of blood substitutes in, 75
 of plasma for treatment of, 268-269
recurrence of, after resuscitation, 56
reduction of—
 rate of blood flow in, 30
 volume flow of blood in, 30
relation of cardiac output to degree of, 36
renal effect of hemoglobinemia in, 657
replacement therapy in, 34
replacement therapy, in prevention of, 34
resemblance of severe malnutrition to, 570
Ringer's solution in, 8
salt-poor serum albumin in, 352
serum albumin for, 34, 270, 325, 335, 336, 354, 355, 360, 702
serum for, 34, 262, 266-268
skeletal trauma as cause of, 35
sodium bicarbonate in, 384
sodium glycerol polysuccinate in, 380
sources of blood for management of, 476-477
special studies on, 38-44
splinting in prevention of, 34
status of vasomotor center in, 30
studies on blood substitutes for, in World War I—371
studies on, in World War I—29
theories of:
 between World Wars, 29-30
 in World War I—29
therapy of, 32, 50-51, 683-710
 by British methods, 471
 initial errors in, 29
 need for oxygen-carrying corpuscles in, 31
timing of therapy of, 36
tissue anoxia in, 36
tissue asphyxia in, 30
tone of peripheral vessels in, 32
toxemic theory of, 29, 30
transfusion as basic component of therapy of, 41-42, 472
transfusion with cadaveric blood in, 24
use of aging blood in, in ETOUSA, 555
vasoconstriction in, 32, 194
vasodilatation in, 32
visceral damage in, 36, 41-42
wounds, as cause of, 32
wounds of central nervous system, as cause of, 32
Shock centers, in World War I—8
Shock Committee, in World War I—29
Shock position, 32
Shock Reports, NRC, 33-36
Shock (resuscitation) wards, 683
 reactions on, 707-710
Shock teams, 668, 706-707
 in ETOUSA, 463, 472
 in North Africa, 393
 in Okinawa operation, 625, 626-627
 in SWPA, 668
SHOOK, Col. C. F., 67, 175, 204, 294
Short collections, losses due to, in Korean War, 747, 750
Shortage(s) of—
 anti-Rh serum, 249-251
 autoclaves, 462
 Baxter bottles in ETOUSA, 193
 blood—
 after D-Day, 460, 486-487, 561
 in ETOUSA, rumors concerning, 552
 in North Africa, 438
 centrifuges, 293, 294, 342
 for serum albumin program, 343
 in CBI, 642
Church containers, 204-205
components of improvised transfusion set, 193
distilled water—
 in MTOUSA, 453
 in North Africa, 434
donors, 119-120
equipment—
 for ARC blood donor centers, 294-295
 for plasma production, 290, 291
 for serum albumin program, 343
 in ETOUSA Blood Bank, 508-509
 in SWPA, 591, 598-599
 overseas, 462

- Shortage(s) of—Continued
- items for field transfusion units in ETOUSA, 544, 545
 - laboratory supplies for Pacific airlift, 603
 - latex, 171
 - nurses—
 - for bleeding centers, 109
 - in general hospitals in ETOUSA, 501
 - paper for publication of experimental studies, 79
 - personnel, 206
 - for plasma production, 290, 291
 - in ARC bleeding centers, 408-409
 - in SWPA, 591
 - in 6703d Blood Transfusion Unit (Ovhd.), 446
 - professional personnel for bleeding centers, 109-110
 - recipient sets in—
 - ETOUSA, 483
 - first ETOUSA shipments, 494-495
 - MTOUSA, 440, 694
 - shipping space, 180, 465-466
 - specialist personnel in ETOUSA Blood Bank, 499
 - stainless steel filters, 170-171
 - still, 462
 - technical personnel overseas, 462
 - tin for plasma package, 172
 - transfusion equipment, in—
 - ETOUSA, 469
 - North Africa, 432-434, 438
 - vehicles, for deliveries in MTOUSA, 420
 - Shuttle delivery on Continent, 535-536
 - Sicily, 57, 395-396, 422, 556
 - invasion of, 395, 396
 - Siegfried Line, 557
 - Signal Corps Photographic Center, 413
 - Silicon-coating of collecting bottles, 727
 - SIMEONE, Col. F. A., 41
 - SIMMONS, Brig. Gen. J. S., 680
 - Sinusitis in donors, 142
 - Sioux City, 783
 - Skeletal trauma, transfusion in, 35
 - Skin testing with bovine albumin, 329-330
 - Sklifosovsky Institute, 24
 - Slide agglutinin titrations in MTOUSA, 442
 - Slide technique—
 - of grouping, 243-244
 - of mass grouping, 237, 238, 240
 - Slightly wounded casualties, donations from, 396
 - "Slough preservative," 221
 - Sludging, 791
 - Smallpox vaccination, false positive serology after, 262
 - Smears, examination of, for Plasmodia in—
 - ETOUSA, 462, 463, 466
 - MTOUSA, 399, 411, 423, 442, 453
 - SWPA, 595, 596, 660
 - SMITH, DEW., 311
 - SMITH, Capt. L. D., 41
 - SNYDER, Col. H. E., 23, 393, 395, 424, 425, 437, 438, 690
 - Sodium bicarbonate, 384
 - Sodium butyrate, 352
 - Sodium chloride:
 - addition of:
 - to plasma, 285-286, 287
 - to serum albumin, 349-352
 - in Alsever's solution, 222
 - in MIH solution, 24
 - Sodium chloride concentration in rabbit sera, 237
 - Sodium chloride solution, intra-arterial infusion with, 796
 - Sodium citrate, 180, 186, 193, 491
 - anticoagulant properties of, 217
 - as plasma additive, 285
 - attribution of reactions to, 651
 - effect of—
 - on hemolysis, 218
 - on red blood cell survival, 261
 - in ACD solution, 227
 - in Alsever's solution, 222
 - in filtration of plasma, 287
 - in McGill solution, 222
 - in MIH solution, 24
 - loss of, in bleeding bottles, 309
 - shortages of—
 - in ETOUSA, 189, 545
 - in North Africa, 393
 - special studies on, 218-219
 - toxicity of, 142
 - Sodium citrate solution in Baxter bottles, 437
 - Sodium citrate technique of transfusion, 4
 - in World War I—6, 9, 10
 - Sodium glycerol polysuccinate, 380
 - Sodium hydroxide in McGill solution, 222
 - Sodium mandelate, 350, 351
 - Sodium oxalate, 218
 - Sodium-r-lactate, 444
 - Sodium sulfathiazole, addition of, to blood
 - in SWPA, 589-590
 - SOFIELD, Col. H. A., 624
 - Soft glass, 385
 - Soft-tissue wounds in shock, 688
 - SOKOLOW, N. I., 266

- SOLANDT, D. Y., 266
- SOLOC (Southern Line of Communications).
- Solubility of—
- bovine albumin, 326
 - commercial plasma, 279, 296-297
 - lyophilized serum, 336
 - serum albumin, 340
- Soluble cellulose, 365
- Solution for joint collection of whole blood and blood for plasma, 767-769
- Solvac giving set, 581, 587
- SOP. *See* Standing Operating Procedure.
- SOS (Services of Supply).
- SOS, function of, in transportation from United Kingdom to Continent, 531
- SOS advance blood banks in ETOUSA, 505-506
- SOS troops, donations from:
- in ETOUSA, 477, 478, 479, 481, 482-483, 487, 496, 525, 529
 - on Continent, 516
- SOS type advance depots of ETOUSA Blood Bank, 498
- Sources—
- of donations in World War I—6, 9
 - of pectin, 377-378
- South America, 95
- South Pacific Area, 591
- recommendations for blood supply in, 594
- Southampton, 515, 518, 549
- Southern Base Section, ETOUSA, 499, 509, 524-525, 526, 530
- Southern France, 417, 442, 445, 446, 447, 449, 450, 451, 516, 552
- Southern Line of Communications, 450
- Southern Surgical Association, 55
- Southmead Hospital, 471, 472
- Southwest Pacific Area, 467, 591
- complaints about intravenous fluids in, 3, 385
 - plasma reactions in, 671-674
 - reactions in, 668
 - request for visit of inspection to, 467-468
- Southwestern Pennsylvania Chapter, ARC, 102, 269
- Soviet Union, 21, 24, 95
- blood program in, 21-22
 - experiences of, in production of dried plasma, 95
 - medical sanitary battalion, 22
 - regimental medical aid station, 22
- Space, allotment of, for airlift from United Kingdom to Continent, 531
- Spacing of donations, 139
- in Soviet Union, 21
 - in Spanish Civil War, 12
 - in World War I—9
- Spacing of transfusions, 318
- Spanish Civil War, 11-12, 15, 47
- Special Conference on Albumin, NRC, 343
- Special emergency treatment group, 500
- Special Representative on Blood and Plasma Transfusions, OTSG, 53, 54, 63, 67, 69, 95, 294, 459-460, 492, 558, 603, 641, 673
- Special studies:
- A and B substances, 260
 - Accuracy of blood grouping, 242-244
 - ACD solution, 226-227, 229, 767-769
 - addition of Merthiolate to serum albumin, 352-353
 - Alsever's solution, 224-225
 - asymptomatic donors, 679
 - blood clotting, 309-310
 - blood compatibility, 569
 - blood loss in severe wounds, 557
 - blood preservatives, 229-230
 - blood substitutes in World War I—371
 - bovine albumin, 325-326, 327-328
 - versus human albumin, 335
 - clinical use of liquid and dried plasma, 297-298
 - DeGowin's solution, 220
 - dried plasma, 65, 101-102
 - effects of high-titer O blood on incompatible recipients, 696
 - fibrin film, 367
 - fibrin foam, 364-365
 - field studies in Korean War, 802-806
 - field test of dextran in Korean War, 793-794
 - filtration of serum albumin, 353
 - gelatin, 65, 373-374, 375-377
 - German management of battle casualties, 22-23
 - globin, 65, 361-362
 - group O blood, 65, 110
 - gum acacia, 384
 - hemoglobin solutions, 361
 - hematologic response to transfusion in Korean War, 805
 - hemorrhage, 265
 - intra-arterial transfusion, 796, 799
 - ion exchange resins, 770-771
 - isinglass, 379
 - keeping properties of blood, 19
 - laboratory studies in shock, 31

- Special studies—Continued
- liquid plasma, 65
 - lower nephron nephrosis, 666-667
 - measles antibodies, 83
 - merits of blood substitutes, 19
 - need for plasma and blood, 391-392
 - oxypolygelatin, 787
 - pectin, 65, 377-379
 - Periston, 789-790
 - plasma reactions in ETOUSA, 670-671
 - preservative solutions, 229-230
 - preserved blood, 52, 217-220
 - red blood cell survival in Naples Blood Bank, 430
 - red blood cell transfusions, 107-112, 314-319
 - refrigerated blood, 210-211
 - Rh factor, 245-246
 - Rous-Turner solution, 223-224
 - salt content of serum albumin, 350-352, 355
 - salt-free (salt-poor) serum albumin, 351-352, 354-355
 - serum, 336
 - serum albumin, 337, 338, 339
 - serum hepatitis, 675-678, 778
 - serum in experimental shock, 265
 - shock, 33-36, 38-44, 62
 - between World Wars, 29-30
 - in World War I—29
 - sodium citrate, 218-219
 - sodium glycerol polysuccinate, 380
 - solutions and equipment, 55
 - stored blood, 217
 - survival of red blood cells in recipient, 217, 260-261
 - survival of spirochetes, 261
 - synthetic plasma, 65
 - thrombin, 364
 - titration of blood (plasma), 258-260
 - transfusions of incompatible isoagglutinins, 663-664
 - transportation, 52, 220-221
 - of unrefrigerated blood, 210-213
 - use of blood and blood substitutes, ARC, 101
 - specific gravity of urine in lower nephron nephrosis, 667
 - specific gravity measurements of hematocrit, 253
- Specifications for—
- accounting by commercial processing laboratories, 301
 - Army insulated containers, 215
 - blood bank on LST, 593
 - commercial production of serum albumin, 348
 - donors, 139-141
 - gelatin for military use, 374
 - processing of plasma, 81
 - refrigeration, 203-204
 - serum albumin, 340
 - transportation, 203-204, 206
- Speed shock, 36, 96
- Spinal cord tumors, 368
- Spine, wounds of, 43
- Spirochaeta pallidum*, 261
- Spirochetes, destruction of, in refrigerated blood, 261, 589-590
- Splanchnic block, 656
- Spleen:
- blood loss in wounds of, 685-686
 - deposition of—
 - blood substitutes in, 373
 - pectin in, 378
 - fibrin foam in surgery of, 365
 - hemostasis in surgery of, 364
 - rupture of, in Chinese troops, 646
- Splenomegaly, 423
- after Periston therapy, 381
 - in Chinese troops, 646
 - in malaria, 144
- Splinting in prevention of shock, 34
- Spot radio announcements, 121
- Sprains, donors with, in World War I—6
- SPURLING, Col. R. G., 364
- Stability:
- loss of, in plasma, 165
 - of blood substitutes, 373
 - of bovine albumin, 326, 328, 332, 333
 - of dried plasma, 15
 - of gelatin, 374, 375, 787
 - of serum albumin, 337, 340, 341, 344, 345, 349, 352, 360
- Stabilization of plasma (serum) by removal of water component, 265
- Staff Assistance Corps, ARC, 111
- Staff sergeants at bleeding centers, 111
- Staff visits to Pacific, 590-595
- Staffing of shock wards, 709-710
- Staging areas, donors from, in MTOUSA, 422
- Stainless steel for plasma needles, 172, 175
- Stainless steel filters, 170-171, 193, 196, 224
- Standardization of—
- A and B substances, 260
 - ACD solution, 437
 - bleeding techniques, 145-148

- equipment, 101
 before Korean War, 720, 727
 by Army and Navy jointly, 73
 for ARC blood donor centers, 76
 for replacement therapy, 467
 fibrin foam, 365
 ion-exchange collection technique, 771
 plasma equipment, 270
 procedures before Korean War, 727
 processing equipment for plasma program,
 294
 refrigerators, 208
 thrombin, 365
 transfusion equipment in MTOUSA, 435-
 437
 Standing Operating Procedure for—
 delivery of blood to Continent, 520-521
 invasion of Continent, 511-512
 Leyte invasion, 616
 Luzon operation, 620
 Okinawa operation, 622-623
 Operation OLYMPIC, 639-640
 27th Station Hospital Blood Bank, 589-
 590
 STANDLEE, Col. E., 404-405, 408-411, 431
 Stanford University, 350, 351
Staphylococcus aureus, contamination by,
 307, 308, 673
Stars and Stripes, 451, 574, 730
 STATE, D., 79
 State University of Iowa College of Medicine,
 51, 52, 74, 158, 210, 220, 224, 471, 694
 State University of Iowa Hospital, 85
 Staten Island, 695
 Station hospitals, 87
 conversion of, into ETOUSA Blood Banks,
 489-499, 513
 in ETOUSA, check of blood grouping in,
 244-245
 in ZI, 175-176
 overseas, 180
 provision of field transfusion units for,
 544-545
 reaction rate in, 660-663
 Statistics:
 absenteeism, after donations, 153
 airlift—
 to Anzio Beachhead, 418
 to ETOUSA, 559-560
 Anzio beachhead, 440
 ARC Blood Donor Service, 109-110, 120,
 130, 137
 Australian Blood Bank, 582
 Barcelona Blood-Transfusion Service, 11
 battle casualty rates in MTOUSA, 37
 blood bank in—
 Japan in Korean War, 731-733
 MTOUSA, 489
 blood clotting, 309-310
 blood collections, 15th Medical General
 Laboratory, 403
 Blood for Britain, 13
 blood grouping sera, processing laboratory,
 Travis AFB, 744
 blood in SWPA, 629-633
 blood loaded on LST's for Normandy
 landings, 512
 blood replacement in MTOUSA, 692-693
 Board for Study of Severely Wounded,
 40-42
 British use of blood in Western Desert, 391
 casualties in landings in southern France,
 447
 clinical testing of—
 gelatin, 376
 serum albumin, 338, 339, 344
 clinical use of—
 dried and liquid plasma, 297-298
 red blood cell residua, 312
 collections:
 at ETOUSA Blood Bank, 480-481
 at U.S. hospitals in United Kingdom,
 473
 in British blood program, 17
 commercial production of—
 dried plasma, 289, 291-292
 serum albumin, 345-347
 comparative blood grouping study, 242-
 244
 Continental Section, ETOUSA Blood
 Bank, 212
 deaths from shock without hemorrhage, 38
 deliveries:
 by C-64 planes on Continent, 536
 in Okinawa operation, 623-624, 625
 of donations to processing laboratories,
 291-293
 to ZI hospitals, 97
 discrepancies, in ETOUSA figures, 660-
 663
 distribution center on Guam, 631
 donations, at—
 ARC blood donor centers, 119
 Marseille bleeding center, 453
 early use of plasma, 265-267
 errors in blood grouping in Armed Forces,
 244-245

Statistics—Continued

- estimates, for
 - airlift to ETOUSA, 494
 - Luzon operation, 720
 - Operation OLYMPIC, 640-641
- European theater, 556-568
- experimental studies on pectin, 378
- fatalities:
 - after transfusion, 650
 - from contaminated blood, 665
- fibrin film, 368
- fibrin foam, in neurosurgery, 365
- 43d General Hospital blood bank, 572
- group recruitment of donors, 126
- hemolytic reactions, 653
- high-titer group O blood in MTOUSA, 428
- incidence of transfusion reactions, 649
- issue of blood in Luzon operation, 622
- large plasma package, 173
- Leyte operation, 618
- losses—
 - from contamination in Blood for Britain, 14
 - from syphilis, 261
 - in plasma program, 305-306, 309-310
 - in SWPA, 631-633
 - of preserved blood, in ETOUSA, 566-567
- malarial donors in MTOUSA, 423
- mobile bleeding units, ARC, 114, 118
- modified Rous-Turner solution, 223-224
- multiple donations, 158
- Naples Blood Bank, 437-442
- Navy airlift to Pacific, 213, 600, 603, 615
- nontransportable casualties, 42-44
- 127th Station Hospital blood bank, 514
- oversea airlift in Korean War, 739, 747-750
- Periston therapy, 789
- plasma fractionation, 361
- plasma production —
 - before Korean War, 719
 - in Korean War, 774
- plasma reactions, 79
- processing laboratory, Travis AFB, 747-748
- professional male donors, 158
- provision —
 - of liquid plasma for ZI hospitals, 96
 - of plasma for OCD, 93
- pyrogen tests on serum albumin, 345
- ratio, of casualties to blood requirements on Continent, 480-481
- reactions, 649
 - at Mount Sinai Hospital, 652
 - at Walter Reed General Hospital, 401, 696
 - in ETOUSA, 660-665
 - in SWPA, 598, 668
 - to donations, 155-157
 - with ACD solution, 612
- red blood cell transfusions, 314-316, 317, 318-319
- rejection of donors, 140-141, 160
- Rh incompatibility reactions, 249
- serum albumin production, 338, 343
- serum hepatitis, in ZI hospitals, 675-678
- shipments:
 - of Rh-negative blood to ETOUSA, 251
 - to Seventh U.S. Army, 516
- shock and hemorrhage, MTOUSA, 39
- 6703d Blood Transfusion Unit (Ovhd.), 455
- 6713th Blood Transfusion Unit (Ovhd.), 406-407, 440-442
- stockpiles of plasma after World War II — 772
- supplies, for invasion of southern France, 447
- supply of Australian blood to U.S. Bases in SWPA, 588
- surplus plasma, after World War II— 772
- timing of operation in MTOUSA, 40
- tin cans for plasma packages, 172
- titration of pooled plasma, 258-259
- Tokyo Blood Depot, 757
- training courses in Army Medical School, 87
- transfusion(s):
 - in Army and base areas, MTOUSA, 404-415
 - in fractures of long bones, 703-704
 - of incompatible blood, 259
 - with cadaveric blood, 24
 - with DeGowin et al. solution, 220
- use of blood —
 - by shock teams on Okinawa, 627
 - in forward hospitals in MTOUSA, 437-438
 - in France, 1940-20
- volunteer services, Blood Donor Service, ARC, 111
- weekly quotas, in ARC blood donor centers, 113
- yields of plasma from blood, 299-300

- Status—
 of heart in shock, 30
 of vasomotor center in shock, 30
STAYER, Maj. Gen. M. C., 40, 401
 Steam ejector technique, of drying plasma, 279
STEER, Lt. Col. A., 755, 756, 757
STEFFEN, G. I., 277
STEIN, Lt. E. E., 521
STEPHENSON, Capt. C. S., 49, 50, 329, 337, 344
 Stephenville, 212
 Sterile technique for collection of blood, 148-152, 431
 Sterility of—
 frozen plasma, 271
 intravenous solutions, 385
 plasma fractions, 343, 359
 samples of plasma, 304
 serum albumin, 341, 353
 Sterility tests—
 in commercial processing laboratories, 297
 on red blood cell residua, 313
 Sterilization—
 against hepatitis virus in Korean War, 775, 776-782
 of A and B substances, 260
 of blood substitutes, 373
 of distilled water, 382
 of donor sets, 196
 of equipment, 113
 of gum acacia, 384
 of transfusion equipment, 9, 652
 in field, 190-191
 in hospital banks in ETOUSA, 474
 Sterilizing properties of alcohol, 353
STEWART, Col. J. D., 39
 Stewart-Warner study on shock, 39-40
 Stick measurements of plasma losses, 303
 Still pictures of blood bank activities, MTOUSA, 413
 Stills, shortages of, 462
 Stockpiles of serum albumin after World War II—772
 Stockpiling of—
 dextran in Korean War, 795
 plasma, 50
 before Korean War, 772-773
 Periston, in Korean War, 789, 790
STOKES, J., Jr., 336, 359, 362, 679
STONE, Col. W. S., 717
 Stoppers, 78
 for Blood for Britain, 14
 for collecting bottles for ACD solution, 227
 for intravenous solution bottles, 387
 Storage:
 at forward distributing center, 414
 cell swelling during, 222
 effect of, on red blood cell survival, 260-261, 805
 of A and B substances, 260
 of blood, 50
 for field use, 179
 of blood substitutes in viscera, 373
 of byproducts, 82
 of dried plasma, 15, 102, 165
 of frozen plasma, 165, 273
 of gelatin in tissues, 374
 of gum acacia in tissues, 371
 of infected pooled plasma at room temperature, 780
 of liquid plasma, 16, 51, 87, 266, 268, 273
 of Periston in body, 789, 790
 of plasma fractions, 259
 loss of components during, 286
 of preserved blood, 222
 of red blood cells from unrefrigerated blood, 210
 of serum albumin, 341
 temperatures for, 349
 of thrombin, 363
 of unrefrigerated blood, 210
 on Continent, 510
 optimum temperatures for, 203
 under vacuum, 220
 Storage facilities:
 at advanced base in SWPA, 586
 in British bottles, 193
 in ETOUSA, 481
 in general hospitals overseas, 185
 in MTOUSA, 422
 in open containers overseas, 180
 in SOS advance banks, in ETOUSA, 505-506
 in Spanish Civil War, 12
 Storage section of ETOUSA Blood Bank, 503-504, 515
 Storage space in ARC blood donor centers, 113, 215
 Stored blood:
 definition of, 217
 effect of temperature on, 210, 222
 in Spanish Civil War, 11
 rate of hemolysis in, 218
 recommendation—
 for addition of glucose to, 222
 for use of, 53

- Stored blood—Continued
 special studies on, 217-220, 229-230
 transmission—
 of experimental syphilis by, 143
 of malaria by, 143-144
- STRNAD, Maj. J. J., 574
- STRODE, G. K., 24
- STRONG, L. E., 359
- STRUMIA, M. M., 65, 74, 93, 101, 102, 159, 163, 165, 166, 171, 222, 227, 266, 267, 269, 270-271, 274, 280, 285, 286, 287, 288, 296, 309, 336, 362, 385, 669, 771, 785
- STURGIS, C. C., 74, 80
- Styrofoam, 763
- Subcommittee on—
 Albumin and By-Products, NRC, 237, 349, 362, 364, 365
 Anesthesia and Shock, NRC, 33
 Blood, Health Resources Advisory Committee, 735, 737, 775, 784
 Blood Procurement, NRC, 75, 104
 Blood Substitutes, NRC, 13, 16, 35, 42-54, 70, 74, 75, 76, 77, 78, 79, 80, 81, 83, 84, 85, 92, 93, 101, 104, 106, 107, 109, 110, 139, 140, 142, 143, 144, 158, 159, 163, 165, 169, 173, 180, 184, 202, 220, 221, 222, 224, 225-226, 228, 230, 236, 240, 241, 242, 244, 249, 251, 260, 261, 262, 267, 268, 269, 271, 275, 279, 283, 284, 285, 289, 291, 296, 300, 306, 309, 313, 325, 327, 328, 329, 332, 333, 335, 336, 337, 340, 341, 342, 381, 382, 384, 385, 392, 461, 464, 467, 468, 669, 674, 694, 698, 702, 721, 724, 725, 776, 787, 790, 802
 Burns, Committee on Surgery, NRC, 726
 Shock, NRC, 33, 74, 253, 376, 384, 714, 782, 787, 788, 789, 790, 791, 793, 794, 795, 802
 Standardization of Dispensing Equipment, NRC, 163, 165, 337
 Sterilization of Blood and Plasma, NRC, 781
- Succinate therapy in late shock, 34
- Sucking wounds of chest, 688, 710
- Sucrose, 315-316, 790
- Suction collection technique, 14, 151, 186, 195
- Suggestions from public, 128
- Sulfadiazine, local use of—
 with fibrin film, 367
 with fibrin foam, 364-365
- Sulfathiazole, sensitivity to, 140
- Sulfonamide derivatives as plasma additives, 285
- Sulfonamides:
 sensitivity to, 140, 655
 use of, by donors, 140
- Sulfonated polystyrene copolymer, 758
- Sulfuric acid as desiccant, 277
- SULLIVAN, Lt. Col. E. R., 41, 394, 395, 400, 401, 402, 421, 443, 460
- Superintendent of Hospitals, City of New York, 128
- Supernatant plasma:
 hemoglobin content of, 210, 211, 426, 552
 recovery of, 273
- Supervision—
 of blood program overseas by trained personnel, 185
 of commercial production of serum albumin, 341-342
- Supplies:
 in ZI for Operation OLYMPIC, 641
 testing of new lots of, 344
- Supply:
 and demand, adjustment of, in—
 ETOUSA airlift, 557-558, 567
 Luzon operation, 621
 Pacific airlift, 600-602
 SWPA, 612, 630, 632, 638
 field studies in, 80-81
 of blood—
 in CBI, 642-643
 to Continent from United Kingdom after D-day, 484-487
 to Fifth U.S. Army, 398-403
 to ZI hospitals, 97
- Supply Catalog listing—
 of expendable donor set, 435
 of expendable recipient set, 436
 valves for donor set, 435
- Supply channels:
 delivery of equipment through, in MTOUSA, 420-421, 435
 distribution of blood through, 574-575, 638
 in ETOUSA, 479, 545-546
 in Korean War, 752-755
 in SWPA, 604
 limitations of, in blood program, 16
 proposal for use of, 420-421
- Supply Division:
 Office of Chief Surgeon, ETOUSA, 485, 510, 545-548, 575
 Office of The Surgeon General, 70, 293, 387, 492, 541, 740-741

- Suppression of isoagglutinins in pooled plasma, 51
- Suppressive treatment of malaria in SWPA, 595
- Supreme Allied Commander, 574
- Supreme Allied Headquarters, Allied Expeditionary Force, 495
- Surface craft, delivery by, during Normandy landings, 518
- Surface transportation—
 from United Kingdom to Continent, 537-538
 in Okinawa operation, 622, 623, 627, 631
 in Operation OLYMPIC, 639
 in SWPA, 587-588, 590, 594
- Surgeon:
 ADSEC, 550
 Eighth Air Force, 529
 First U.S. Army, 550, 557
 Forward Echelon, Headquarters, Communications Zone, ETOUSA, 487
 NATOUSA, 680, 683, 692
 VII Corps, 574
 Sixth U.S. Army, 633
 Subbase D (Port Moresby), 586-587
 Third U.S. Army, 520
 12th Army Group, 486, 521
 United Kingdom Base, ETOUSA, 530
 U.S. Army Forces in Far East (USAFFE), 589
 U.S. Army Forces, Pacific Ocean Areas (USAFPOA), 606
- Surgeon General:
 Air Force, 715, 716
 Army, 15, 50, 53, 61, 69, 71, 75, 76, 77, 80, 93, 101, 102, 110, 127, 172, 179, 192, 204, 215, 221, 222, 237, 258, 262, 271, 273, 275, 293, 295, 311, 319, 339-340, 394, 404, 408-409, 411, 431, 435, 443, 464, 465, 466, 468, 469, 475, 477, 480, 488, 489, 490, 491, 492, 493, 495, 552, 599, 605, 606, 636, 674, 715, 716
 Navy, 15, 53, 61, 76, 77, 80, 83, 102, 110, 127, 221, 237, 273, 339-340, 363, 599, 603, 715, 716
 U.S. Public Health Service, 716
- Surgery:
 after forward transfusion in World War I—6
 as phase of resuscitation, 683-685, 691
 failure of transfusion as indication for, 557, 558, 559, 705
 influence of transfusion on, 490
 Surgery Division, OTSG, 55, 67, 69, 88, 461, 469, 490, 491, 493, 538
 Surgical Consultant, Sixth U.S. Army, 604
 Surgical Consultants Division, OTSG, 48, 666
 Surgical emergencies, plasma in, 57
 Surgical preparation before venipuncture, 150
 Surgical Research Team in Korean War, 803-806
 Surgical risk:
 in wounds of extremities, 703
 reduction of, by transfusion, 443
 Surgical shock. *See* Shock.
 Surgical technicians, training of, in ETOUSA Blood Bank, 500
 Surplus blood derivatives, 724-725
 Surplus equipment for plasma production after World War II—772
 Surplus gamma globulin, distribution of, by ARC after World War II—784
 Surplus plasma:
 distribution of, 310-311, 772
 ownership of, 311
 Survey of—
 airlift to ETOUSA, 551-553
 blood-plasma needs before Korean War, 725
 blood program in MTOUSA, 443-445
 German management of battle casualties, 22-23
 serum hepatitis in ZI general hospitals, 675-678
 transfusion facilities in MTOUSA, 395, 500-501
 transfusion practices in ZI hospitals, 694-696
 whole blood experience:
 recommendation for, in ETOUSA, 466
 in FECOM, 754, 755-757
- Survival of—
 red blood cells, 217, 220, 227, 229, 260-261, 317-318, 769, 785
 after airlift in Korean War, 803, 804
 experiments on, 221-224
 in ACD solution, 226
 in dextrose-preserved blood, 220-221
 in stored blood, 318-319, 430, 663
 resuspended red blood cells, 316
 Rh-incompatible cells, 246, 247, 250
 spirochetes, 261
 Survival rate after intra-arterial transfusion, 799
 Sweden, 790, 791

- Swedish dextran, reactions to, 792, 793, 794
 Swedish experience with dextran, 791
 SWIGART, R., 733
 Swindon, 513
 SWPA. *See* Southwest Pacific Area.
 Sydney, 582, 590, 591, 616, 618
 SYMINGTON, Secretary W. S., 716, 727
 Symposium—
 on Blood Preservation, NRC, 758
 on Structure and Cellular Dynamics of Red Blood Cells, NRC, 769
 Synchronous transfusions, 437
 Synthesis of—
 new hemoglobin from breakdown hemoglobin products, 221
 Periston, 788
 plasma, 50, 65, 371
 Synthetic blood substitutes, 336
 Synthetic rubber stoppers, 169
 Synthetic serum albumin, 325-326
 Synthetics, replacement of rubber by, 78
 Syphilis, 422, 438
 donors with, 6, 142-143, 261, 262-263, 423
 in German Blood program, 22
 losses from, in Blood for Britain, 14
 transmission of, by transfusion, 261, 744
 Syphilitic donors, acceptance of, overseas, 262
 Syphilitic military donors, reporting of, 262
 Syringe-cannula technique in World War I—5
 Syringe technique of transfusion, 4, 10

 Tables of—
 equipment for blood transfusion units, 48
 organization:
 for blood transfusion units
 for ETOUSA Blood Bank, 497-498
 organization and equipment, 15 Dec. 1944--604
 Tacloban, 621
 Tactical employment of transfusion units, 463
 Tactical situation:
 in Italy, 420
 in MTOUSA, 399
 on Okinawa, 624
 relation of, to blood requirements, 752
 Tallqvist hemoglobin technique, 158, 159
 Tape for plasma package, 168
 Tarawa, 59
 Task Force on Federal Medical Services (Voorhees Committee), 715
 Task Force on National Security (Eberstadt Committee), 715
 Task Group:
 to study replacement therapy requirements before Korean War, 717-721
 report of, 718-721, 773
 implementation of proposals of, in Korean War, 721-723
 TATUM, W. L., 266
 TAYLOR, Maj. E. S., 91, 104, 156, 158, 159, 204, 205, 258, 269, 286-287, 294, 299, 302, 304, 305, 309, 317, 349, 492
 TAYLOR, F. H. L., 270
 Teams in ARC blood donor centers, 145-149
 Technical Consultant, Volunteer Donor Service, ARC, 492
 Technical difficulties of administration, losses from, in Okinawa operation, 527
 Technical Director, ARC Blood Donor Service, 91, 104, 105, 106, 258, 294, 317
 Technical directors, ARC chapters, 108-109, 119
 Technical Division, OTSG, 208
 Technical errors:
 in blood grouping, 242-243
 in transfusion with cadaveric blood, 24
 role of, in plasma reactions, 673, 674
 Technical Memorandum No. 13, Office of Chief Surgeon, USAFFE, 21 Sept. 1944--589
 Technical personnel:
 deferment of, from military service, 70
 shortages of, overseas, 462
 Technical procedures in ETOUSA Blood Bank, 497
 Technical ratings of personnel in ETOUSA Blood Bank, 498, 499
 Technical sergeants at ARC blood donor centers, 111
 Technical supervisors of ARC chapters, 106
 Technicians, training of, at Naples Blood Bank, 413
 Technique(s):
 at liquid plasma centers, 307, 308
 of administration of—
 dried plasma, 698
 serum albumin, 702-703
 of blood collection, 14, 87, 104, 309
 at ARC blood donor centers, 148-152, 491-492
 at 20th General Hospital blood bank, 642
 at 27th General Hospital blood bank, 589-590

- effect of, on hemolysis, 438
- in Blood for Britain, 13-15
- in British Army Transfusion Service, 17
- in ETOUSA hospitals, 474
- in Korean War, 729-730, 743-744
- in MTOUSA, 426-428
- in SWPA, 610
- training in, 412
- of preservation of blood, 85
- of production—
 - of plasma, 293
 - of serum albumin, 337
- of removal of cadaveric blood, 785
- of screening test for group O blood, 251-252
- of test for Rh-incompatibility, 250-251
- of testing of serum albumin, 344
- of titration, 428, 552
- of transfusion, 3-5, 85, 196, 466, 636, 693-694
 - in Spanish Civil War, 11
 - in World War I—5-6, 9, 10
 - with Ebert-Emerson equipment, 186
 - with red blood cells, 313, 314
 - with red blood cells in World War I—5-6
- of ultraviolet sterilization of plasma, 778-779
- standardization of, 101
- See also* special techniques.
- Telephone rooms in ARC blood donor centers, 113
- Temperature(s):
 - during airlift:
 - from United Kingdom to Continent, 535
 - to ETOUSA, 211-212, 489, 494, 541
 - to FECOM, 767
 - during Australian airlift, 581
 - effect of—
 - hemolysis on, 219
 - on Alsever's solution, 224-225
 - on fraction II—362
 - on gelatin, 377
 - on intravenous fluids, 386
 - on rate of hemolysis, 203
 - on reconstitution of plasma, 170
 - on stored blood, 210, 222
 - elevations of:
 - after first use of sodium citrate, 651
 - after gelatin injections, 374
 - differential diagnosis of, 649
 - for airlift, 226
 - for controlled heating of infected pooled plasma, 780
 - for drying of plasma, 277, 282
 - for fractionation of plasma, 359
 - for optimum freezing of whole blood, 771
 - for refrigeration, 203, 719
 - for storage, 599, 657, 771
 - in SWPA, 614
 - of plasma, 273
 - of serum albumin, 341, 349
 - for transportation, 203, 476
 - in SWPA, 610
 - in incompatibility reactions, 654
 - in Pacific areas, 606
 - in plasma reactions, 670, 672
 - in pyrogenic reactions, 653
 - in reactions from contaminated blood, 665
 - in SWPA, 612, 638
 - maintenance of, with Dry Ice, 454
 - of blood, effect of, on plasma yield, 300
 - of donors, 139, 140, 145
 - of preserved blood, 217
 - of room storage of infected pooled plasma, 780
 - of storage of resuspended red blood cells, 313
 - of stored blood on Luzon, 621
 - of transported blood in ETOUSA, 504
 - on trial runs with Army-insulated containers, 215
 - stability tests of, in fractionation of plasma, 343
- Temperature chart on airlift to ETOUSA, 212, 213
- Temperature coefficients in hematocrit determinations, 253
- Tension pneumothorax, 688, 710
- Tentage of shock wards, 707
- Terms of agreement, with ARC Blood Donor Service, 103
- Terrain in MTOUSA, 420
- Terre Haute, 795
- Tertian malaria, 144
- Test(s):
 - before transfusion, 462
 - for differentiation of hemolytic and non-hemolytic reactions, 655-656
 - for in vivo survival of red blood cells, 229
 - of blood substitutes for toxicity, 372
 - of transportability, 220-221
- Test injection in lieu of blood grouping, 6-7, 22
- Testing of—
 - ACD solution, 225-226
 - commercial products, 71
 - commercial serum albumin, 344-347
 - concentrated plasma, 275

- Testing of—Continued
 distilled water, 344
 dried plasma, 50, 269
 equipment—
 at Army Medical School, 65
 for intravenous therapy, 464
 field transfusion unit, 192
 fraction II—362
 grouping sera, 240-241
 intravenous solutions, 384-385
 Navy insulated container, 214
 plasma, 296-298
 plasma equipment, 759-760
 plasma package, 168-169
 preservatives, 224-225, 229
 rabbit sera, 236-237
 serum albumin for serum hepatitis virus, 782
- Tetanus, 140
 Tetany after donations, 157
 Thalhimer modification of copper sulfate test, 159, 160, 257-258
 Thalhimer technique of diluting red blood cells, 494
 THALHIMER, W., 79, 105, 159, 240, 494, 669
 Thatcham, 532, 544, 545
 Thawing of frozen plasma, 273
 Theater Chief Surgeon, ETOUSA, 192, 470, 475, 479, 480, 521, 524
 Theater Personnel, procurement of blood from, 48-49
 Theater Surgeon, NATOUSA, 37, 398
 Theater transfusion officer, 638, 639
 Theories of shock—
 between World Wars, 29-30
 in World War I—29
 Theory of drying of plasma, 279
 Therapy:
 of reactions after donations, 157
 of shock, 32, 50-51, 638-710
 evolution of, 37-38
 transfusion, as basic component of, 41-42
 traumatic effect of, 31
 Thermonuclear attack, 786
 Thermos jugs, transportation of blood in, in SWPA, 590
 Third Conference—
 on Blood Storage, NRC, 224, 226, 229
 on Gelatin, NRC, 375
 Thomas M. England General Hospital, 97, 695
 THOMAS, R. A., 277
 THOMPSON, Capt. W. T., Jr., 435
 Thoracoabdominal wounds, 706
 THORPE, Capt. H. H., 607, 619, 621, 632
 Thrombin, 76, 83, 84, 359, 362, 363, 364, 365, 637, 770
 matrix for, 364-366
 special studies on, 364
 virus of hepatitis in, 364
 Thromboplastin, 359
 Thrombosis after pectin injections, 377
 Tilton General Hospital, 97
 TIME, 548, 549
 Time of death in—
 incompatibility reactions, 654
 lower nephron nephrosis, 666, 667
 plasma reactions, 672
 Timelag:
 between wounding and hospitalization, 566
 between wounding and resuscitation, 40, 558-559, 683
 effect of, on resuscitation, 487
 in use of reconstituted plasma, 284
 Timing of—
 blood supply in combat areas, 639
 collection of blood for D-day, 548-549
 donations by combat troops, 529
 operation in relation to resuscitation, 39, 40
 pretransfusion blood grouping, 494
 shock therapy, 36
 transfusion, 48
 in World War I—7
 Tin cans—
 for plasma package, 163-165, 168, 172, 175
 for serum albumin package, 198
 Tinian, 607
 Tisdall centrifuge technique of titration, 259
 TISDALL, Maj. L. H., 259, 600, 696
 Tissue anoxia in shock, 36
 Tissue asphyxia in shock, 30, 56
 Tissues:
 deposition of gelatin in, 374, 375
 reaction of, to—
 fibrin film, 367-368
 fibrin foam, 365
 muscle matrix, 365
 storage of gum acacia in, 371
 Titer of—
 anti-Rh serum, 250
 globulin preparations, 240
 grouping sera, 235, 238, 239, 240
 human grouping sera, 237
 plasma in modified hemolytic reactions, 671
 rabbit grouping sera, 236

- Titration of blood**, 111, 258-260
 for ETOUSA, 552
Titration determinations—
 in hemolytic reactions, 656
 in incompatibility reactions, 656
Titration techniques, 428, 552, 657
 criteria of, 428
Tokyo, 728, 729, 732, 739, 746, 757, 765
Tone of peripheral vessels in shock, 32
Tonnage for airlift:
 from United Kingdom to Continent, 532, 534, 537
 to ETOUSA, 538-539
Tonsillectomy, 364
Tooth extractions, 140, 365
Toploading of blood on speedboats, 537
Torney General Hospital, 97
Tourniquets, 34
TOWNER, COL. A. A., Jr., 717
Toxemia from clostridial myositis, 39
Toxic theory of shock, 29, 30
Toxic reactions after gelatin infusions, 786
Toxicity of—
 anticoagulant agents, 218
 blood substitutes, 372, 373
 cadaveric blood, 24
 gelatin, 373, 375
 globin, 362
 gum acacia, 371
 hemoglobin solutions, 361
 mercurial preservatives, 283-286
 pectin, 378
 Periston, 381
 plasma, 79
 preservatives in blood substitutes, 354
 replacement agents, 726
 sodium citrate, 142
 sodium glycerol polysuccinate, 380
Toxicity controls in Blood for Britain, 14
Toxicity tests in commercial processing laboratories, 297
Toxins—
 in blood substitutes, 373
 in crushing injuries, 664
Trained supervision of—
 airlifted blood in MTOUSA, 419-420
 blood, 420-421
Training, 412-413, 694
 at Naples Blood Bank, 413
 British methods of, 706-707
 demonstration sets for, 413
 effect of, on losses from clotting, 309
 for commercial production of serum albumin, 342
 in British Blood Supply Depot, 470-472
 in handling of plasma, 271
 in intravenous therapy, 77, 78
 in management of shock in British depot, 471
 in mass blood grouping, 241
 in MTOUSA hospitals, 442
 in operation of blood donor centers, 86
 in oversea theaters, 85
 in production of grouping sera, 241
 in reconstitution of plasma, 271
 in replacement therapy, 442, 463, 469
 in resuscitation, 87
 in serum albumin administration, 341
 in transfusion techniques in World War I—8
 in use of—
 dried plasma, 177, 463
 resuspended red blood cells, 494
 transfusion equipment, 179
 in wound management, 87
 in ZI, 85-91
 of blood bank personnel, 398, 412-413
 before Korean War, 717
 in Korean War, 738
 of British transfusion personnel, 17, 706-707
 of Chinese personnel in ZI, 642
 of enlisted personnel—
 in ETOUSA Blood Bank, 500
 in plasma administration, 637
 of ETOUSA Blood Bank personnel, 500, 501, 509
 of personnel—
 in processing laboratory at Travis AFB, 741
 in SWPA, 607, 608
 of 127th Station Hospital Blood Bank, 514
 of 6703d Blood Transfusion Unit (Ovhd.), 445-446
 of transfusion teams, 706-707
 for SWPA, 606
 recommendations for, by Subcommittee on Blood Substitutes, NRC, 85-91
Training courses:
 at Army Medical School, 86-87
 for operation of liquid plasma processing center, 87
Training films, 87
Training functions of home depot, British Army Transfusion Service, 16-17

- Transfer(s) of—
 personnel:
 from Continental Blood Bank, 516
 to ETOUSA Blood Bank, 499-500
 surplus plasma to ARC, 311
- Transfixing collapsed veins, 436
- Transfused isoagglutinins, 806
- Transfusion(s), 3, 20-21, 36, 266
 after operation in World War I—7
 amount of, in—
 ETOUSA, 482
 Spanish Civil War, 11-12
 World War I—7, 9
 as basic component of shock therapy, 41, 42
 before initial wound surgery, 395
 British experience with, 37
 case fatality rates in, 1, 2, 3
 in World War I—5, 6
 clotting during, 553-554
 concept(s) of, 29, 47-49
 criteria for amount of, in ETOUSA, 559
 dilatation of right heart during, 12
 during anesthesia, 54-55
 during operation, 686, 687, 691
 in World War I—7
 effects of, 34-35
 evaluation of, in World War I—9-10
 evolution of use of, for combat casualties, 47-59
 experimental, 1
 failure of, 12
 as indication for surgery, 557, 558, 559
 fatalities after, 1, 2, 3, 469, 649, 650, 651
 field studies in, 80-81
 for MTOUSA, 398
 for oversea use, 177-179
 hematocrit determinations as indications for, 255-256
 hemorrhage:
 as indication for, 1, 2
 as indication for, in World War I—7 during, 44
 improvisation of, in ETOUSA, 192, 194
 in base hospitals in MTOUSA, 444
 in British blood program, 17
 in casualty clearing stations in World War I—5-6, 265
 in civilian practice, 48
 in desperate cases, 3
 in World War I—5, 6, 7
 in ETOUSA, 177
 in evacuation hospitals, 180, 392-393
 in fixed hospitals, 193
 in forward hospitals, 180, 193, 194
 in Spanish Civil War, 11
 in France, 1940—20
 in general hospitals, 180, 185, 392-393
 in massive hemorrhage, 34
 in MTOUSA, 397, 432-437
 in North Africa, 177, 392, 393, 394-395, 438
 in unit hospital system, 397
 in World War I—5-10
 in wounds of extremities, 703-705
 in ZI hospitals, 177, 269, 694-696
 incidence of serum hepatitis after, in Korean War, 778
 indications for, 1-3, 5, 34, 255-256
 in Chinese troops, 645-646
 in Korean War, 796
 in Soviet Union, 22
 in Spanish Civil War, 11-12
 in SWPA, 635
 in World War I—7
 infection—
 after, 5
 as indication for, 7, 10
 influence of, on—
 incidence of wound infection
 mortality rates, 57
 kidney, 569
 lack of, in North Africa, 194, 392, 393-394
 legal prohibition of, 1
 limitation of, in—
 blast injuries, 21
 chest injuries, 21
 wounds of central nervous system, 21
 maintenance of, 17
 manual on, 76
 misuse of, 649
 overseas with improvised equipment, 180-185
 postpartal hemorrhage as indication for, 1
 precombat preparations for, in World War I—8
 pressure techniques of, 193, 194, 466, 693
 puerperal hemorrhage as indication for, 1
 pulmonary edema after, 20-21
 quantitative errors in, 393
 quantitative relation of, to—
 degree of shock, 34, 39, 635
 hemorrhage, 559
 rate of, 4, 12, 21, 22, 34, 36, 194, 198, 533, 636, 690, 799
 requests for, from MTOUSA, 435
 risks of, 78-79

- septicemia as indication for, in World War I—7
- shock as indication for, in World War I—7
- shortages of, in—
 ETOUSA, 469
 North Africa, 432-435
- sodium citrate technique of, 10
- spacing of, 318
- timing of, 48
 in World War I—7
- transmission, of—
 leukemia by, 142
 malaria by, 143-144, 720
 malaria by, in CBI, 643-644
 malaria by, in MTOUSA, 397
 malaria by, in SWPA, 597-598
 measles by, 720
 mumps by, 345
 serum hepatitis by, 143, 261, 720, 744
 syphilis by, 143, 261, 744
- vital signs as indication for, in World War I—7
- with defibrinated blood, 4
- with DeGowin et al. preserved blood, 220
- with incompatible blood, 4, 24
- with preserved blood in World War I—5-6
- with red blood cells, 317, 319
 in World War I—5-6
- Transfusion Branch, OTSG, 67-73, 97, 110, 192-193, 319, 468
- Transfusion equipment, 1, 4-5, 476
- availability of, for oversea use, 185
- before Korean War, 717
- cleaning of, 219
 under field conditions, 179, 186, 190
- development of, 180-185
 at Army Medical School, 177
- development of expendable type of, 195-198
- for field use, 178-179
- Transfusion kit, 191
- Transfusion officer(s):
 in ETOUSA, 48
 in distributing units, 467
 in evacuation hospitals, 420
 in SWPA, 605
 lack of, in Korean War, 756, 757
 MTOUSA, 401
 on staff of theater surgeon, 463, 467
 overseas, 463
- Transfusion-penicillin therapy in wounds of extremities, 703-705
- Transfusion practices in German Army, 23
- Transfusion reactions (complications), 3, 464, 649-668
- from aging blood in ETOUSA, 554-555
- in France, 1940-20
- in World War I—6, 9
- lack of records of, 649
- to blood airlifted to SWPA, 213
- Transfusion service:
 in British Army, 15-18
 in hospitals in ETOUSA, 480
 inclusions of all parenteral fluids in, 53
 organization of, in MTOUSA, 48
- Transfusion sets:
 criteria of, for oversea use, 186
 modifications of, 488
- Transfusion teams, 465, 477
- for Operation OLYMPIC, 641
- in mobile surgical units, 476
- in Spanish Civil War, 11
- in SWPA, 604, 605-606
- Transfusion technique(s), 3-4, 5, 85, 196
- in Spanish Civil War, 11
- in SWPA, 636
- in World War I—5-6
- training in, in World War I—8
- training of British transfusion unit personnel in, 17
- with Ebert-Emerson equipment, 186
- Transfusion units:
 establishment of, in MTOUSA, 398, 400-403
- training of, in British Army Transfusion Service, 16-17
- Transit hospitals, blood supply for, 512
- Transmissible diseases in donors, 142-144
- Transmission of—
 leukemia by transfusion, 142
 malaria by—
 plasma, 143-144
 transfusion, 376, 720
 transfusion in CBI, 643-644
 transfusion in SWPA, 597-598
 serum hepatitis by plasma, 310, 795
 in Korean War, 775, 776-782
 syphilis by transfusion, 143, 261, 720, 744
 virus infections by plasma, 726
- Transport Air Group, 604, 607
- Transportability:
 of casualties, 710
 of plasma, 48, 51
 tests of, 220-221

- Transportation, 203-215**
 effect of, on red blood cells, 220-221
 for ARC mobile bleeding units, 115-116
 for Continental Blood Bank, 516
 for detachment of ETOUSA Blood Bank, 520
 for donors, 453
 for field transfusion units, 543
 for Leyte operation, 614-618
 for move of ETOUSA Blood Bank to Continent, 515
 for 6703d Blood Transfusion Unit (Ovhd.), 454
 from collection centers—
 in Korean War, 742, 744
 to airport in ZI, 492
 in CBI, 642
 in ETOUSA, 541-543
 in MTOUSA, 414-417
 in southern France, 448, 450
 in Soviet Union, 22
 in SWPA, 590, 604, 606-608
 in ZI, 204-206
 maintenance of, on Continent, 550, 551
 of biologic fluids, 16
 of blood, 47, 50, 51, 52
 by truck, 205-206
 for British Eighth Army, 532
 in France, 1940-20
 in Spanish Civil War, 11
 to front in ETOUSA, 476-477
 to processing laboratories, 103, 152-153
 to processing laboratories, cost of, 136-137
 of delivery teams, 467
 of donors to bleeding centers in MTOUSA, 406-407
 of dried plasma, 15
 of frozen plasma, 271
 of red blood cell residua, 313
 of unrefrigerated blood, 208-213
 overseas, 463
 relation of hemolysis to, 613-614
 specifications for, 203-204
 testing of Alsever's solution by, 224
See also Airlift, Delivery, Storage, Packaging.
- Transports:**
 attack (APA's), 622
 for wounded (APH's), 622
- Transworld Airlines, 211**
Trauma to red blood cells, tests of effect of, 220-221
- Traumatic amputation(s), 703**
 loss of red blood cell mass after, 805
- Traumatic rupture of liver (spleen) in Chinese troops, 646**
- Travis AFB blood processing laboratory, 739-743, 760, 761, 763, 765**
- Trench fever, 6**
- Trévières, 520**
- Trial distribution of blood in East Anglia, 480**
- Trial runs—**
 on Pacific airlift, 213, 611, 612
 with ACD solution, 215
 with Army insulated container, 215
- TRIMBLE, Col. I. R., 639**
- Triple-distilled water, 652**
- Trisodium citrate, 219**
- Troop Carrier Command, 418, 488, 531-532, 533**
- Truck(s):**
 misuse of, for other purposes on Continent, 194, 551
 refrigeration of, 206, 212
- Truck drivers:**
 in ETOUSA Blood Bank, 500
 training of, in ETOUSA Blood Bank, 500
- Truck requirements in ETOUSA, 541-543**
- Truck transportation, 205-206**
 in Korean War, 742, 744
 in MTOUSA, 414-416
 in United Kingdom, 532
 on Continent, 536-537
- TRUETA, J., 12**
- TRUMAN, President H. S., 715, 735**
- Tube racks in Seventh U.S. Army Blood Bank, 453**
- Tuberculosis:**
 in donors, 142
 red blood cell transfusions in, 317
 rejection of donors with, in German program, 22
- Tubing in plasma package, 171**
- Tunisia, 381, 392, 398, 692, 698**
- Tunisian campaign, 37, 38, 55, 438**
- Turbidity of reconstituted plasma, 280**
- TURNER, J. R., 203, 217, 218, 219, 222, 223, 212**
- TURNER, T. B., 744**
- Tuscany, 420**
- Tyndall's phenomenon, 238**
- Typhus fever, 306**
- Typing. *See* Grouping, Mass grouping.**
- Ulithi, 607, 624**

- Ultracentrifugal analysis of serum albumin, 351
- Ultracentrifuge studies of Periston, 381
- Ultraviolet sterilization of plasma, 776, 778-779, 781-782
- Ultraviolet therapy, 65
- Unavoidable error in red blood cell counting, 318
- Undulant fever in donors, 142
- UNGER, L. J., 4
- Unit hospital system for blood supply in MTOUSA, 397-399
- United Kingdom, 16, 459, 473, 475, 477, 478, 479, 481, 489, 498, 504, 510, 511, 513, 514, 517, 518, 523, 526, 527, 531, 532, 535, 536, 537, 543, 554, 560, 567, 568, 669
- United Kingdom Base, ETOUSA, 527
- United Nations, 756
- United States. *See* U.S., and Zone of Interior.
- U.S. Army Blood Procurement Program, 529
- U.S. Army Forces:
 Far East (USAFFE), 589, 755
 Pacific (USAFPAC), 629, 641
 Pacific Ocean Areas (USAFPOA), 603, 606
 Western Pacific (USAFWESPAC), 629
- U.S. Army Services of Supply, SWPA (USASOSSWPA), 595, 605
- U.S. civilians, donations from, in MTOUSA, 422
- U.S. Disciplinary Barracks, Indianapolis, 695
- U.S. experience in World War I—8-10
- U.S. liaison officer at British Blood Supply Depot, 478
- U.S. medical personnel, training of, in British blood program, 17
- U.S. Naval Air Base Dispensary, 631
- U.S. Naval Medical Center, 274
- U.S. Naval Medical School, 7
- U.S. Naval Medical Supply Depot, 346
- U.S. Naval Preflight School, 242
- U.S. Penitentiary:
 in Lewisburg, 781
 in McNeil Island, 781
- "U.S. Pharmacopeia," 352
- U.S. Public Health Service, 84, 92, 143, 222, 269, 290, 783
- U.S.S.:
 Achinar, 628
 Ancon, 623
 Bozer, 730
 Samaritan, 594
 Solace, 623
- Universal donors, 4, 239-240
 titer of blood of, 259
 See also Group O blood, Dangerous universal donors.
- University of—
 Chicago School of Medicine, 74, 780
 Illinois College of Medicine, 379
 Louisville School of Medicine, 374
 Michigan Medical School, 74
 Minnesota Graduate School of Medicine, 74
 Minnesota Medical School, 74, 325
 Pennsylvania Graduate School of Medicine, 74, 376, 377, 788
 Pennsylvania School of Medicine, 65, 336, 376, 377, 788
 Upsala, 381
 Wisconsin School of Medicine, 74
- Unrefrigerated blood:
 reactions to transfusion with, 210
 studies on, 210-213
- Upjohn Co., 292, 300, 375, 774
- Upper respiratory infections:
 after donations, 155, 156
 in donors, 142
- Urea, addition of, to gelatin solution, 786
- Urea clearance, 786
- Uremia:
 in crushing injuries, 65-67
 in incompatibility reactions, 654
 in lower nephron nephrosis, 658
- Urinalysis—
 after red blood cell transfusions, 315
 in incompatibility reactions, 654
- Urinary acidity in lower nephron nephrosis, 667
- Urinary excretion of—
 aldobionic acid, 379
 gelatin, 374, 375
 oxidized cotton, 380
 pectin, 377
- Urinary output, effect of serum albumin on, 338
- Urobilinemia, 222
- Urobilinogen output, 229
- Urticarial reactions, 651
 in Korean War, 756, 804
 management of, 651
 to plasma, 269, 298, 636, 668, 669, 673, 674
- Utah beach, 518, 522, 523
- Utilization of blood substitutes in body, 373
- V-1 bombing, 521
- Vacuum drying of frozen plasma, 276-277

- Vacuum-drying equipment for plasma, 65
 Vacuum-sealed storage of blood, 220
 Vacuum-sealing of plasma package, 169
 Vacuum technique of blood collection, 15
 hemolysis in MTOUSA, 439
 in Blood for Britain, 14
 Valves for—
 donor sets, 435
 in Pacific, 595
 oversea transfusion set, 463
 VAN SLYKE, D. D., 253, 254, 257
 Van Slyke kidney, 655
 Vanderbilt University School of Medicine,
 33, 74
 Vascular injuries in Korean War, 803
 Vasoconstriction in shock, 32, 194
 Vasodilatation in shock, 32
 Vasomotor center, status of, in shock, 30
 Vasomotor response to wounding, 39-40
 V-E Day, 522
 Vegetable refrigerators, 447
 Vehicles:
 for ETOUSA Blood Bank, 506, 509
 for invasion of southern France, 446
 in British blood program, 17
 marking of, in ETOUSA, 509
 shortages of, in MTOUSA, 420
 Vein-to-vein transfusion, 3
 Veins, collapse of, 684, 693, 698
 VELDEE, M. V., 81, 82, 205, 206, 261, 262,
 271, 279, 284, 285, 290, 300, 303, 305
 Venafro, 40
 Venereal Disease Division, U.S. Public
 Health Service, 143
 Venipuncture, training in, 412
 Venous pressure technique of blood collec-
 tion, 14
 Venous return in shock, 30, 32
 Verona, 407, 442
 Veterans' Administration, 716, 725, 726
 Vice Chairman:
 American Red Cross, 311
 in Charge of Domestic Operations, ARC,
 101
 VICKOREN, Col. A., 151
 Vinyl acetate tubing, 171
 Vinylite resin, 758
 Vipule, 163
 Virus of hepatitis in thrombin, 364
 Virus infections in donors, 142
 transmission of, by plasma, 726
 Viscera, asphyxia of, 56
 Visceral changes in shock, 36, 41-42
 Visceral damage in late shock, 34
 Viscometry, 374
 Viscosity of—
 blood (plasma), 265
 blood substitutes, 373
 bovine albumin, 326
 gelatin solutions, 373, 374, 377
 gum acacia, 384
 Periston, 381
 serum albumin, 337, 353
 Viscosity measurements of dextran, 731
 Visit of inspection to—
 combat areas, 466, 467-468
 ETOUSA, 459
 ZI hospitals, 387-388
 Vital signs:
 as indication for transfusion in World
 War I—7
 in donors, 139, 140, 145
 in shock, 684
 observation of, in serum albumin testing,
 339
 Vitamin-coenzyme systems in late shock, 34
 Vitry-sur-Seine, 516
 VOGELAAR, J., 377
 Volume of Alsever's solution, 437
 Volunteer Aid Detachments, 17
 Volunteer Special Services, ARC, 111
 Volunteers in—
 ARC blood donor centers, 111
 ARC mobile bleeding units, 118
 bovine albumin program, 325, 330, 331-
 332
 hepatitis studies, fatalities among, 778, 781
 testing of gelatin, 375
 VON ZIEMSEN, H., 4
 Voorhees Committee, 715
 Vycor envelopes, 778

 WAGNER, J. A., 336
 Wake Island, 746
 WAKIM, K. G., 796
 Wales, 512
 WALKER, J. A., 788
 WALKER, Capt. K., 6, 7
 Walking wounded, donations from, 486
 WALTER, C. W., 75, 758, 759, 771
 Walter Reed Army General Hospital, 62,
 110, 171, 246, 259, 337, 364, 365, 652,
 694, 695-696, 760, 792, 794, 800
 Walter Reed Army Medical Center, 606,
 669, 800
 WANGENSTEEN, O. H., 74, 325, 329, 330,
 331, 333, 334, 335, 375, 686

- War Activities Committee, Motion Picture Industry, 121
- War Department, 233, 543, 604, 726
- War Department Circular—
No. 123, 24 June 1941—233
No. 70, 14 July 1941—233, 234
- War Department Technical Bulletin (TB MED), 24 Oct. 1945—72, 650
- War Medicine, 48
- War Production Board, 171, 172, 175, 204, 293, 343-344
- War reserve:
before Korean War, 720
of plasma (plasma expanders) before Korean War, 720
- War reserve stockpile, 723
- WARD, G. R., 7, 265, 266
- WARD, Lt. J. F., 574
- WARNER, Capt. F. B., Jr., 39
- WARREN, S., 33
- Warsaw, 219
- Wastage—
in British system, 397
in MTOUSA due to outdating, 437
- Washington, 72, 211, 214, 271, 292, 310, 387, 480, 492, 494, 591, 600, 652
- Washington Blood Donor Center, 86, 96, 490
- Washington University School of Medicine, 159
- WATERS, R. M., 74
- WATSON, G., 7
- W.D., AGO Form No. 24 (Service Record), 233
- W.D., M.D., Form No. 81 (Immunization Register), 233
- Weakness after donations, 156, 157
- Weapons carriers, in—
MTOUSA, 414, 417, 459
southern France, 448, 450, 454
- WEARN, J. T., 74
- Weather, effect of—
on airlift:
in MTOUSA, 448
on Continent, 536-537
to ETOUSA, 560
to Pacific, 632, 638
on deliveries in southern France, 450
on donations, 120
- WEED, L. H., 49, 80, 82, 83, 102, 103
- Weekly Newsletter No. 136, Division of Medical Sciences, NRC, 226-227
- Weight of donors, 140, 157
- WEIL, Lt. Col. N., Jr., 509
- WEIL, R., 4, 219
- WEISS, S., 284
- Welfare Island, 331, 375, 377
- Welsbach gas mantles, 544
- WESTERFELT, Col. F. B., 603, 622
- Western Base Section, ETOUSA, 524-525
- Western Desert, 16, 391
- Wet lung in shock, 688
- Wet plasma. *See* Liquid plasma.
- W fibrin film, 367
- WF fibrin film, 367
- Whatman filter, 287
- Whisky after donations, 148, 424, 482, 597
- WHITBY, Brig. Sir L. E. H., 12, 15, 17, 18, 20, 67, 192, 462, 469, 472, 476, 528, 542, 657
- White blood cell counts, 432
- White Sulphur Springs, 694
- Whole blood. *See* Blood, Replacement therapy, Transfusion.
- Whole Blood and Blood Derivatives Program, 721
- Whole Blood Processing Laboratory, Travis AFB, 739-743, 760, 761, 763, 765
- Whole Blood Service Committee, ETOUSA, 496
- Wichita Falls, 734
- WIENER, A. S., 240, 245, 251
- WILKINSON, J. F., 230
- WILLIS, Brig. Gen. J. M., 603, 606, 627
- WILSON, G. W., 265, 383
- WILSON, Lt. Col. W. C., 32
- WILSON, President W., 73
- WINTERNITZ, M. C., 783
- WITEBSKY, E., 239, 260
- Witebsky's A and B group-specific substances, 429
- Woendi Islands, 591
- Women's Army Corps (WAC), 501
- Wood, Brig. Gen. J. R., 791
- WOODHOUSE, Col. K. W., 509
- Worcester, 474
- Workload of—
bleeding centers in MTOUSA, 408-409
bleeding teams in ETOUSA, 476
collecting sections of ETOUSA Blood Bank, 502
processing laboratory, Travis AFB, 742-743
6703d Blood Transfusion Unit (Ovhd.), 446
shock wards, 709
- WORKMAN, Lt. W. G., 349, 744, 766
- Workrooms in ARC blood donor centers, 113

- World War I:
 blood banks in, 218
 blood grouping in, 6-7
 blood substitutes in, 371
 British experience in, 5-8
 British transportation of blood in, 220
 citrated blood in, 9
 concepts—
 of replacement therapy after, 31
 of shock in, 8-9, 31-32, 51
 donors in, 9
 gum acacia in, 384
 hemothorax in, 23
 indications for transfusion in, 7
 Medical General Laboratory at Dijon in, 401
 National Research Council in, 73
 physiologic salt solution in, 7
 plasma in, 265
 reactions to transfusion in, 9
 replacement therapy in, 8, 9-10
 resuscitation teams in, 7-8, 384
 shock centers in, 8
 techniques of transfusion in, 9, 10
 timing of transfusion in, 7
 transfusion:
 before, 1-5
 in, 5-10
 with preserved blood in, 5-6
 with red blood cells in, 5-6, 312
 transfusion equipment in, 9
 U.S. experience in, 8-10
- Wound(s):
 as cause of shock, 32
 influence of blood on incidence of, 57
 lethality of, 56
 proposal to use plasma for, 266
 training in management of, 87
See also wounds of special regions.
- Wound dehiscence, 796
 Wound healing in nutritional deficiencies, 796
 Wound infection as indication for transfusion, 12
 Wound shock, 38
 Wounding agents in SWPA, 616
 WREN, Sir C., 1
 WRIGHT, D. G., 336
 Wright Field, 539
 Writers' War Board, 121
 WYCKOFF, R. W. G., 279
 Wyckoff-Lagsden "pig" technique of drying plasma, 279, 280
- X-protein of McFarlane, 359
- YATES, J. L., 23
 Yellow fever, 142
 immunization against, 674-675
 Yield of—
 gamma globulin from plasma, 363
 globin from plasma, 362
 pectin from citrus fruit, 378
 plasma from blood, 52, 127, 268, 285-286, 299-300, 303, 304
 serum from blood, 52, 268
 serum albumin from blood, 342, 346-347, 782
 Yokohama, 729, 732, 757
 Yon-tan Airstrip, 623
 YOUNG, I. M., 230, 315
 YUDIN, S. S., 12, 24
- Zephiran, 283
 ZI. *See* Zone of Interior.
 ZOLLINGER, Col. R. M., 193, 487, 509, 556, 789
- Zone of Interior:
 administrative considerations in, 61-98
 development of—
 blood program in, 29, 47-54
 expendable transfusion equipment in, 195-198
 evolution of concept of transfusion in, 47-54
 initial activities in, for oversea transfusion service, 461-464
 malaria in blood donors in, 143
 oversea briefing in, 391-392
 procurement of intravenous fluids in, 382
 provision of—
 dried plasma for, 95-96, 175-177
 frozen plasma for, 271-272
 liquid plasma for, 195, 274-275
 red blood cells for, 97, 319
 whole blood for, 97, 292
 record-keeping in, 455
 refrigeration for airlift in, 206-208
 request for blood from, in Korean War, 729, 739
 Rh-testing in, 248
 Rh-testing for airlift in, 251
 serum hepatitis in, 674
 stocks of dried plasma in, 311
 training in, 85-91
 transfusion equipment in, 177
 transportation in, 85-91
 use of blood in, 269, 694-696
- Zone of Interior hospitals, equipment for distilled water in, 388

History of the Medical Department, U.S. Army in World War II

DISTRIBUTION LIST

BLOOD PROGRAM IN WORLD WAR II

Active Army:

OSD (1)	OS Maj Comd (2)	WRAIR (5)
OSA (1)	except	AFIP (5)
OUSofA (1)	USAREAR (4)	DEF LOG SPT CEN (1)
ASA (FM) (1)	SHAPE (2)	DEF MEDSPT CEN (1)
ASA (I&L) (1)	OS Base Comd (1)	USAPERSCEN (1)
ASA (R&D) (1)	Log Comd (2)	USA Trans Tml Comd
USASA (1)	MDW (1)	(1)
DASA (1)	Armies (3)	Army Terminal (1)
DCSPER (2)	Corps (1)	PG (1)
ACSI (1)	Div (2)	Med Lab (1)
DCSOPS (2)	SFGp (1)	USA MED R&D UNITS
DCSLOG (2)	Med Gp (2)	& Lab (1)
ACSFOR (2)	Med Bn (1)	AFES (1)
ACSRC (1)	USATC (1)	Arsenals (1)
CARROTC (1)	USMA (3)	Med Fld Maint Shops
CofF (1)	Svc College (2)	(1)
CINFO (1)	Br Svc Sch (1)	DB (1)
CNGB (1)	MFSS (5)	Disp (1)
CLL (1)	Med Spec Sch (2)	USA Corps (1)
CRD (1)	USAMEDS V Sch (1)	MAAG (1)
CMH (1)	Med Sec GENDEP	Mil Msn (1)
TAG (1)	(OS) (1)	JBUSMC (1)
TIG (1)	Med DEP (OS) (1)	Units under following
TJAG (1)	Gen Hosp (5)	TOE's:
TPMG (1)	Named Army Hosp (4)	8-500 Team AH (1)
CofCh (1)	USA Hosp (25-100 Bed)	8-510 (1)
Tech Stf, DA (1)	(1) (100-500 Bed) (2)	8-551 (5)
TSG (30)	(500-750 Bed) (4)	8-581 (1)
Med Bds (1)	Med Cen (1) except	Historical Unit,
USCONARC (2)	WRAMC (5)	USAMEDS (1600)
ARADCOM (1)	BAMC (5)	

NG: State AG (1); Div (1).

USAR: Log Comd (1); Div (1); TOE's 8-500 Team AH (1); 8-510 (1); 8-551 (1); 8-581 (1); Med Gp (2); Bde (1); USA Hosp (1).

Request copies remaining on hand after initial distribution be returned to The Historical Unit, USAMEDS, Forest Glen Section, Walter Reed Army Medical Center, Washington, D.C. 20012.