

AL/CF-TR-1993-0101

AD-A279 577

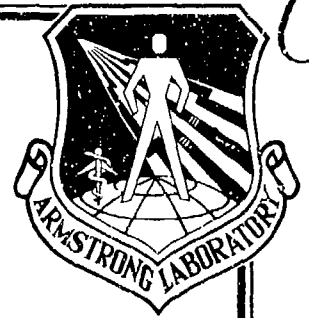

EFFECT OF LAGS ON HUMAN PERFORMANCE
WITH HEAD-COUPLED SIMULATORS (U)

R. H. Y. So
M. J. Griffin

HUMAN FACTORS RESEARCH UNIT
INSTITUTE OF SOUND AND VIBRATION RESEARCH
UNIVERSITY OF SOUTHAMPTON
SOUTHAMPTON, S09 5NH,
UNITED KINGDOM

ARMSTRONG

LABORATORY

94-15372



9096

JUNE 1993



FINAL REPORT FOR THE PERIOD 1 JULY 1992 to 30 NOVEMBER 1992

Approved for public release; distribution is unlimited

AIR FORCE MATERIEL COMMAND
WRIGHT-PATTERSON AIR FORCE BASE, OHIO 45433-7022

NOTICES

When US Government drawings, specifications, or other data are used for any purpose other than a definitely related Government procurement operation, the Government thereby incurs no responsibility nor any obligation whatsoever, and the fact that the Government may have formulated, furnished, or in any way supplied the said drawings, specifications, or other data, is not to be regarded by implication or otherwise, as in any manner licensing the holder or any other person or corporation, or conveying any rights or permission to manufacture, use, or sell any patented invention that may in any way be related thereto.

Please do not request copies of this report from the Armstrong Laboratory. Additional copies may be purchased from:

National Technical Information Service
5285 Port Royal Road
Springfield, Virginia 22161

Federal Government agencies and their contractors registered with the Defense Technical Information Center should direct requests for copies of this report to:

Defense Technical Information Center
Cameron Station
Alexandria, Virginia 22314

DISCLAIMER

This Technical Report is published as received and has not been edited by the Technical Editing Staff of the Armstrong Laboratory.

TECHNICAL REVIEW AND APPROVAL

AL/CF-TR-1993-0101

This report has been reviewed by the Office of Public Affairs (PA) and is releasable to the National Technical Information Service (NTIS). At NTIS, it will be available to the general public, including foreign nations.

This technical report has been reviewed and is approved for publication.

FOR THE COMMANDER

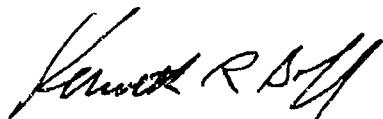

KENNETH R. BOFF, Chief
Human Engineering Division
Armstrong Laboratory

REPORT DOCUMENTATION PAGE

Form Approved
OMB No. 0704-0188

Public reporting burden for this collection of information is estimated to average 1 hour per response, including the time for reviewing instructions, searching existing data sources, gathering and maintaining the data needed, and completing and reviewing the collection of information. Send comments regarding this burden estimate or any other aspect of this collection of information, including suggestions for reducing this burden, to Washington Headquarters Services, Directorate for Information Operations and Reports, 1215 Jefferson Davis Highway, Suite 1204, Arlington, VA 22202-4302, and to the Office of Management and Budget, Paperwork Reduction Project (0704-0188), Washington, DC 20503.

1. AGENCY USE ONLY (Leave blank)		2. REPORT DATE June 1993	3. REPORT TYPE AND DATES COVERED Final, 1 Jul 92 to 30 Nov 92	
4. TITLE AND SUBTITLE Effect of Lags on Human Performance with Head-Coupled Simulators			5. FUNDING NUMBERS PE 62202F PR 7184 TA 19 WU 01	
6. AUTHOR(S) R.H.Y. So and M.J. Griffin				
7. PERFORMING ORGANIZATION NAME(S) AND ADDRESS(ES) Human Factors Research Unit Institute of Sound and Vibration Research University of Southampton Southampton SO9 5NH, England			8. PERFORMING ORGANIZATION REPORT NUMBER ISVR 92/33	
9. SPONSORING / MONITORING AGENCY NAME(S) AND ADDRESS(ES) Armstrong Laboratory, Crew Systems Directorate, Human Systems Center Air Force Materiel Command Wright-Patterson AFB OH 45433-7022			10. SPONSORING / MONITORING AGENCY REPORT NUMBER AL/CF-TR-1993-0101	
11. SUPPLEMENTARY NOTES				
12a. DISTRIBUTION / AVAILABILITY STATEMENT Approved for public release; distribution is unlimited.			12b. DISTRIBUTION CODE	
13. ABSTRACT (Maximum 200 words) This report reviews factors contributing to the effects of lags in head-coupled systems. A model of head tracking behavior is defined with appropriate feedback loops. The relevant lags and their possible effects on operator performance are defined. Twenty-one head-coupled simulators and operational head-coupled airborne systems are listed and grouped according to their feedback loops. Studies of the effects of lags within individual feedback loops are reviewed. The feedback loops investigated were the head-coupled visual loop, the head-slaved weapon control loop, the manual control loop, the eye-coupled visual loop, and the eye-slaved weapon control loop. The effects of relevant task and simulator variables, such as target velocity and motion cues are also discussed.				
14. SUBJECT TERMS helmet-mounted displays, human factors engineering, performance (human), head-coupled systems, lag effects, display lag, lag compensation			15. NUMBER OF PAGES 90	
			16. PRICE CODE	
17. SECURITY CLASSIFICATION OF REPORT UNCLASSIFIED	18. SECURITY CLASSIFICATION OF THIS PAGE UNCLASSIFIED	19. SECURITY CLASSIFICATION OF ABSTRACT UNCLASSIFIED	20. LIMITATION OF ABSTRACT UNLIMITED	

THIS PAGE INTENTIONALLY LEFT BLANK

SUMMARY

This report reviews factors contributing to the effects of lags in head-coupled systems. A model of head tracking behavior is defined with appropriate feedback loops. The relevant lags and their possible effects on operator performance are defined. Twenty-one head-coupled simulators and operational head-coupled airborne systems are listed and grouped according to their feedback loops. Studies of the effects of lags within individual feedback loops are reviewed. The feedback loops investigated were the head-coupled visual loop, the head-slaved weapon control loop, the manual control loop, the eye-coupled visual loop and the eye-slaved weapon control loop. The effects of relevant task and simulator variables, such as target velocity and motion cues, are also discussed.

Within a head-coupled visual loop, many studies have shown that lags degrade head tracking performance (these lags are referred to as 'display lags'). Lag compensation by continuous head position prediction and image deflection have been shown to be very effective. In a head-slaved weapon control loop, the visual feedback of a lag in the form of a reticle lagging behind the operators' line-of-sight (i.e., reticle lags) has been found to degrade head tracking performance. Within an eye-slaved weapon control loop, eye tracking error increases with increasing lag (eye-reticle lag). Systematic investigations of the effects of reticle lag, eye-reticle lag and display lag on target acquisition performance are recommended.

The handling qualities of a head-coupled helicopter simulator have been reported to be degraded by lags in the manual control loop. It is desirable to consider whether the results of equivalent studies with panel-mounted displays can be extended to head-coupled displays. Lags in the dynamic response of an eye-slaved high resolution insert (eye display lags) have been shown to degrade lateral manual tracking performance.

Interactions between the lags in different feedback loops have been studied in a few cases but there are many variables and the results are insufficient to draw general conclusions.

It is recommended that future experimental studies of the effects of lags are conducted in the context of an appropriate model of the head-coupled system.

for	<input type="checkbox"/>
	<input checked="" type="checkbox"/>
	<input type="checkbox"/>
	<input type="checkbox"/>

Distribution/Availability	
Availability Codes	
Dist	Avail and/or Special
A-1	

CONTENTS

	Page No.
1.0 INTRODUCTION	1
2.0 OBJECTIVES	1
3.0 APPROACH TO CATEGORIZATION	1
4.0 MODELING THE HEAD TRACKING SYSTEM	2
4.1 Experience from manual control modeling	2
4.2 Head-coupled simulator modeling (operator-in-the-loop)	8
5.0 MODELS OF VARIOUS HEAD-COUPLED SIMULATORS	8
6.0 EFFECTS OF VARIABLES ASSOCIATED WITH INDIVIDUAL FEEDBACK LOOPS	15
6.1 Head-coupled visual loop	15
6.2 Head-slaved weapon control loop	40
6.3 Manual control loop	43
6.4 Eye-coupled visual loop	47
6.5 Eye-slaved weapon control loop	51
7.0 Previous research on interactions among lags in various feedback loops	55
8.0 DISCUSSION AND FUTURE WORK	56
9.0 REFERENCES	64
APPENDIX A Structure of categorization: conceptual description and visual illustration	73
APPENDIX B Summaries of literature concerned with the effects of lags on manual control with panel-mounted displays	77

1.0 INTRODUCTION

This report reviews the effects of lags on human performance with head-coupled simulators. The research has been conducted by the Institute of Sound and Vibration Research at the University of Southampton with the support of the United States Air Force through Logicon Technical Services Inc. (F33615-89-C-0532). The report summarizes the work performed over the period 1 July 1992 to 30 November 1992.

2.0 OBJECTIVES

The objectives of the study were:

- (i) to categorize factors that may contribute to the lags in a head-coupled simulator;
- (ii) to determine the effect of each categorized factor by reference to previous experimentation on the effects of lags on human performance or human acceptance; the effect of manipulating engineering parameters, such as bandwidth, phase and gain was also to be reviewed;
- (iii) to identify the published studies concerning interactions among different lags within a simulator.

The above objectives are slightly different from the original objectives in the prime contract (F33615-89-C-0532). The changes came about at the request of Logicon Technical Services, Inc. (subcontract: 07-014-35S).

3.0 APPROACH TO CATEGORIZATION

There are only a few published studies concerned with the effects of lags on operator performance with a head-coupled simulator. Comprehensive categorization of the contributions of individual variables towards pilot performance is therefore not yet possible. It is proposed to categorize the contribution of individual feedback loops, and their associated variables, on the effects of lags on pilot performance. A systematic procedure is outlined and a detailed explanation of Stage 1 is presented in Appendix A.

- Stage 1 identify the system architecture of the head-coupled simulator under investigation so that a model can be constructed (Section 5.0).
- Stage 2 identify variables associated with each feedback loop and the effects of these variables on performance within the model (Section 6.0).
- Stage 3 survey published studies of interactions among lags in various feedback loops (Section 7).

4.0 MODELING THE HEAD TRACKING SYSTEM

4.1 Experience from manual control modeling

Review of the literature showed that there are few published head tracking models compared to the vast amount of literature concerning hand tracking models. Therefore, it was decided to develop established theories of manual tracking for application to head tracking. Section 4.1.1 outlines the development of quasi-linear approaches to tracking. The concept of modeling the amount of target information perceived during manual tracking is described in Section 4.1.2.

4.1.1 Overview of quasi-linear approaches to the modeling of manual tracking behavior

The pioneer researcher on the manual control of dynamic systems was Arnold Tustin. In 1944 he reported attempts to find an approximately linear relationship (within the range of practical requirements) between movement and error so that the well-developed theory of 'linear servomechanisms' could be applied. Figure 4.1 shows a block diagram of a typical remote position control servo system (Whiteley, 1947). Tustin reported that operators in manual control systems responding to randomly moving visual forcing functions, exhibited a type of behavior analogous to that of a servo system as shown in Figure 4.1. It was concluded that manual tracking response is non-linear, but that the relationship may, to a useful extent, be approximated by a linear law, namely that the speed of a hand controller movement is proportional to both the tracking error and the rate of change of error, subject to a lag which corresponds to that involved in nerve transmission (Tustin 1947).

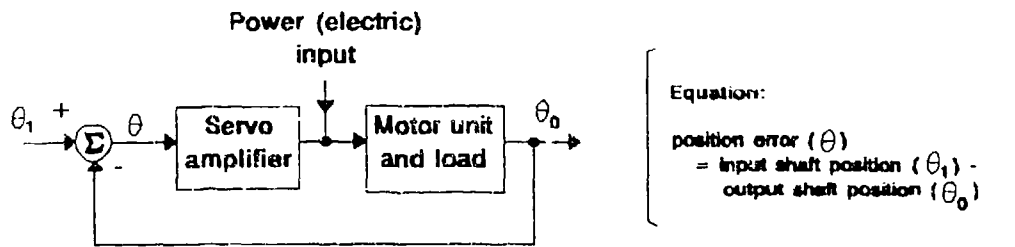

Figure 4.1 Block diagram of a typical remote position control servo process (adapted from Whiteley, 1947).

Until 1960, most of the research in this field was devoted to understanding the characteristics of the human as a single-loop linear controller of a single variable, the error (i.e., the difference between the target position and the human control output). This tracking behavior was later described as compensatory tracking by Krendel and McRuer (1960). In this paper, other types of tracking mechanisms, pursuit and pre-cognitive, were also reported. Details of compensatory, pursuit and pre-cognitive tracking are discussed in Section 3.1.2. McRuer and Krendel published a report in 1965 summarizing two decades of work concerning compensatory tracking models. The basic structure of the manual control model developed by McRuer is shown in Figure 4.2. Since 1965, research on manual control dynamics has diversified. At System Technology Inc. (STI), McRuer and his colleagues extended their model to describe manual pursuit tracking and conducted numerous studies with variables such as secondary tasks and order of control dynamics (e.g. Allen *et. al*, 1970).

At the Bolt, Beranek and Newman Laboratory (BBN), Levison *et. al* (1969) applied the optimal control theory (Kalman, 1963) in modeling compensatory manual tracking behavior. This led to the development of an optimal human operator control model (Figure 4.3, Kleinman *et al.*, 1970). So far, the human operator models mentioned above were developed under the assumption that during a tracking exercise, the human operator behaves linearly for most of the time. These models were called quasi-linear operator models, that is, models consisting of a linear input-output describing function and a remnant to represent the non-linearity (McRuer and Krendel, 1965). In 1971, Astrom and Eykoff proposed a general set of mathematical models for human tracking responses. The

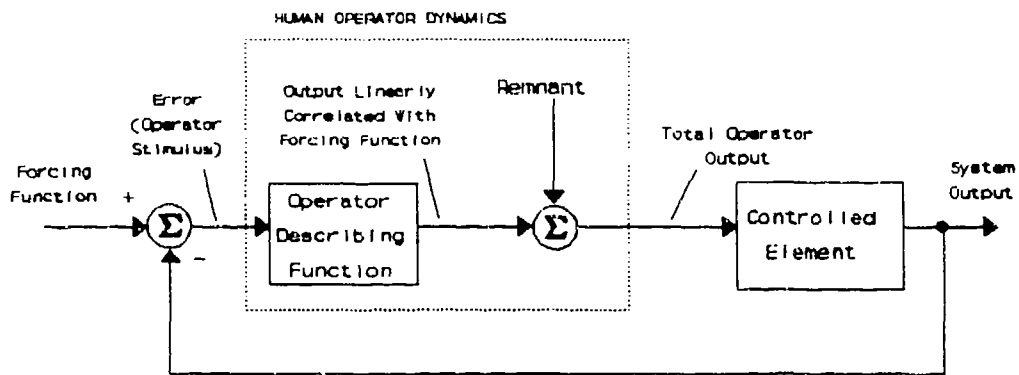

Figure 4.2 Basic structure of a generalized single-loop model for compensatory control developed at STI (adapted from McRuer and Krendel, 1965).

quasi-linear model was included in a sub-set called 'Noise-Free' model (Figure 4.4). Based on Astrom's general model, Balakrishna proposed an 'Auto Regressive Moving Average' (ARMA) model to describe compensatory tracking behavior. Once excited, this ARMA model requires only previous outputs and an external noise input to simulate the next output (Balakrishna, 1975). That is, tracking was modeled as a self generated behavior rather than a response to a visual input. Despite the claim that this ARMA model produces better prediction for manual compensatory tracking response than some quasi-linear models (Balakrishna, 1975), the latter was considered more suitable in describing head tracking behavior. The reasons were two-fold: (i) head tracking is not a self generated behavior but a response to a visual input, (ii) there is no single physical equivalent for the external noise source used in the ARMA model.

4.1.2 Perceptual organization: amount of information perceived

4.1.2.1 Review of literature

In 1960, Krendel and his colleagues explained motor skill development in terms of organization of perceived target information. They reported that as skills develop, "Successive Organizations of Perception" (SOP) enables an operator to take increasing advantage of the predictability of perceived target information. A model was presented to describe how the predictability of input signals could be made more apparent to a

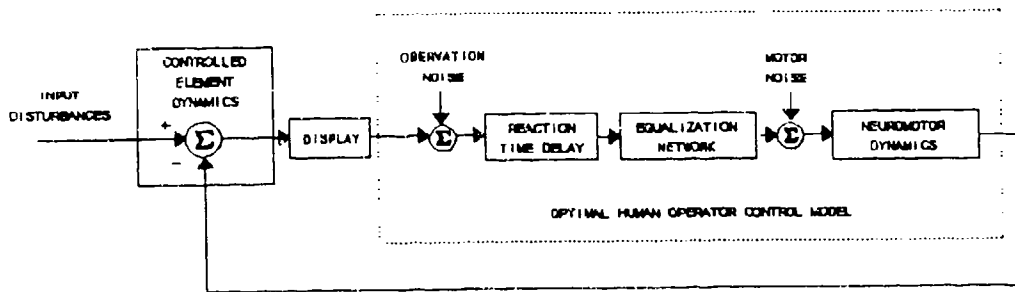

Figure 4 3 Block diagram of the optimal human operator control model (OCM) developed at BBN (adapted from Kleinman *et al.*, 1970).

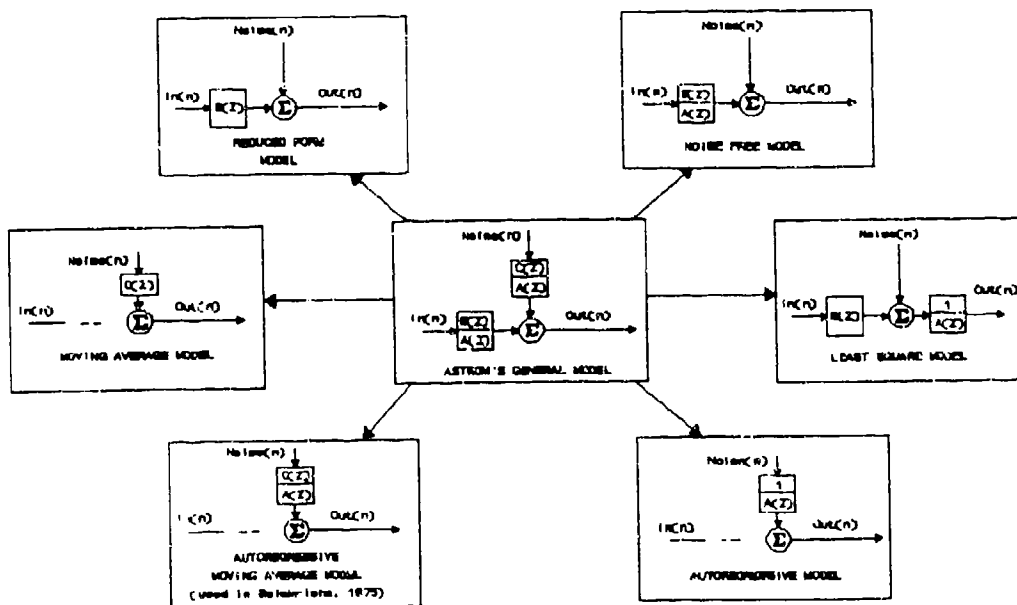

Figure 4.4 Astrom's general model for manual tracking behaviour and the Auto Regressive Moving Average model by Balakrishia (adapted from Astrom and Eykoff, 1971 and B. akrishia, 1975).

human operator by appropriate displays (Figure 4.5). They extended this idea to predict the level of skill exercised during a tracking task by identifying the type of display used. The three levels of skill are compensatory, pursuit and pre-cognitive. They are described

in the following sections with their representative displays in Figure 4.5:

(i) Compensatory

During a compensatory tracking task, only one moving marker is displayed (Figure 4.5a). The purpose of the task is to minimize the distance between the marker and the center point reference. The marker motion is the difference between the system input motion, $i(t)$, and the control response, $o(t)$. The visually displayed movement of the control response is not distinguished from the input target movement. Hence, no anticipation of the target is possible.

(ii) Pursuit

Unlike compensatory tracking, two moving markers are displayed during a pursuit tracking task (Figure 4.5b). One represents the system input motion, $i(t)$, and the other represents the control response, $o(t)$. In this form of tracking the control response can be distinguished from the system input motion. Consequently, an operator can anticipate the future target motion based on past target movement and previous control responses. Nevertheless, such anticipation will not be perfect and the operator must operate in a closed-loop fashion relying on visual feedback.

(iii) Precognitive

This condition exists when the operator has complete information about the future system input, and so it is no longer necessary to maintain continuous closed-loop control of the perceived error. Although precognitive control is not really tracking, tracking approaches this condition occasionally. For example, tracking with periodic target motions: this involves the "Synchronous Generator" within the human operator model where an input stimulus triggers a series of practiced responses (Figure 4.5c). Such open-loop behavior is achieved through learning and can happen with pursuit displays. Another example will be driving on a familiar road whose curves, dips and rises are all visible far ahead so that an appropriate maneuver is made in advance. This situation can be simulated by the "Precognitive Display" in which the next target position is shown in advance. Such a display enables the operator to function in an open-loop fashion for periods of time that depend on a range of variables such as target motion velocity and control dynamics.

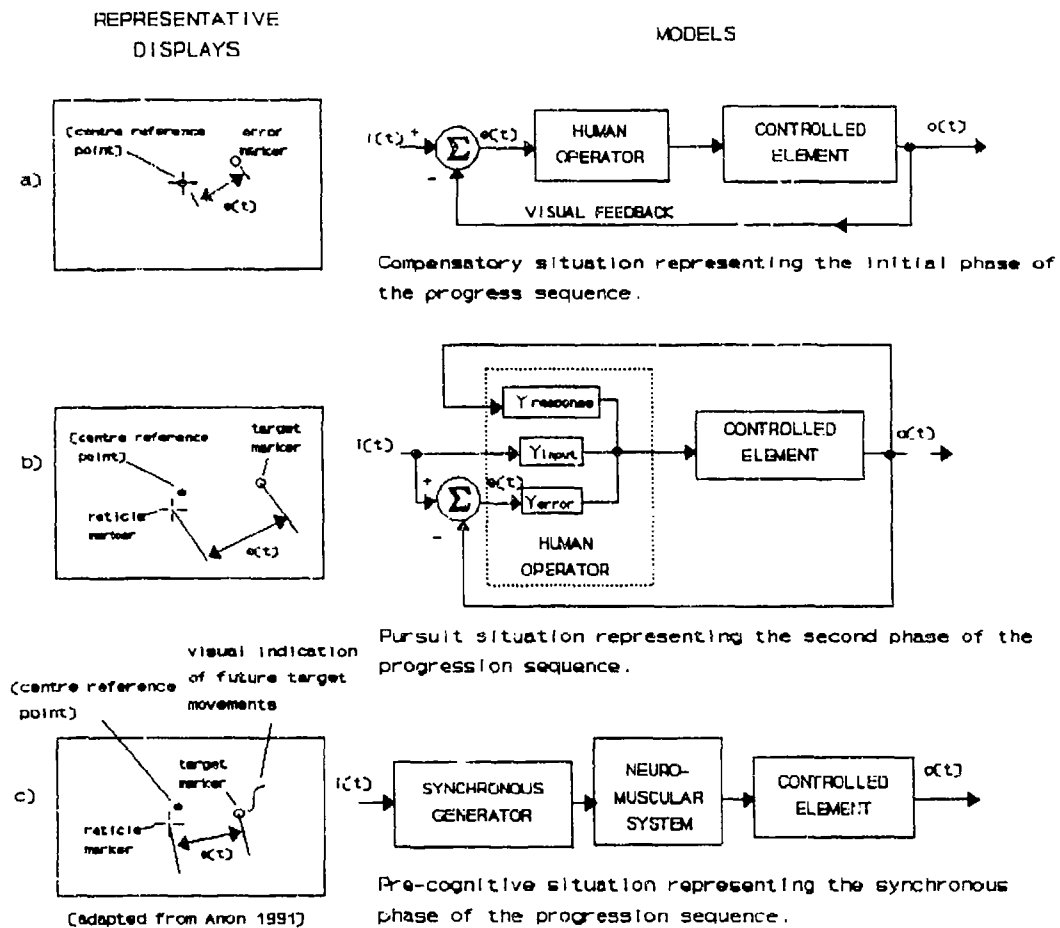

Figure 4.5 Model illustration of the three phases in Successive Organization of Perception with their representative displays (adapted from Krendel and McRuer, 1960).

4.1.2.2 Applications to head tracking

When tracking with a head-coupled system, using visual and proprioceptive inputs (Figure 4.6), an operator perceives both the movements of the target position marker and the reticle position marker. The pointing angle of the reticle position marker is the same as that of the helmet-mounted display. Within the context of this research, head tracking

behavior is modeled as pursuit tracking. However, when under stress, an operator may not take full advantage of the input information and regress back to compensatory tracking (Allen and Jex, 1968). Because the target motions are assumed to be random, progress to the precognitive stage is considered impossible.

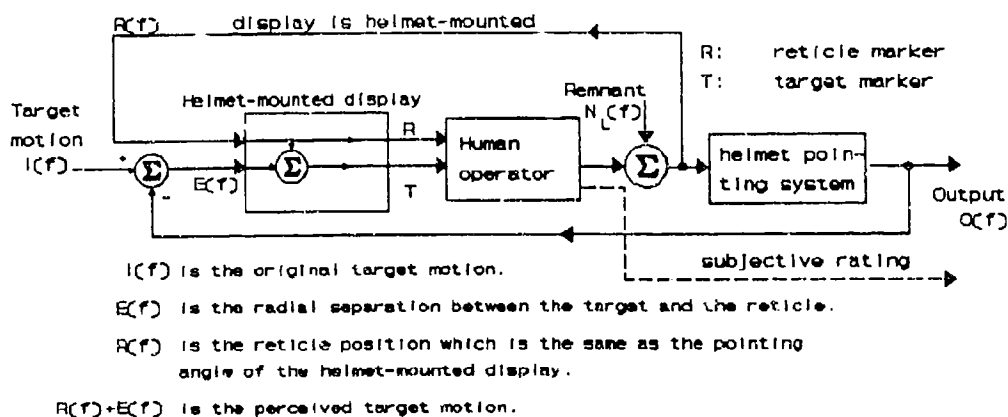

Figure 4.6 A quasi-linear pursuit model of a typical head tracking loop within a head-coupled system.

4.2 Head-coupled simulator modeling (operator-in-the-loop)

A model of a basic operator-in-the-loop head-coupled simulator is shown in Figure 4.7. This model contains only one feedback loop and the whole system is described as the 'head-coupled visual loop'. Examples of variables involved in this loop are listed in Appendix A. Simulator components are added to the 'head-coupled visual loop' system to form a more complex head-coupled simulation system; this results in more feedback loops (see Figure 4.8).

5.0 MODELS OF VARIOUS HEAD-COUPLED SIMULATORS

A review of published literature concerning various head-coupled systems has been conducted. The systems reviewed are listed in Tables 5.1 and 5.2 and included both operational systems and research simulators.

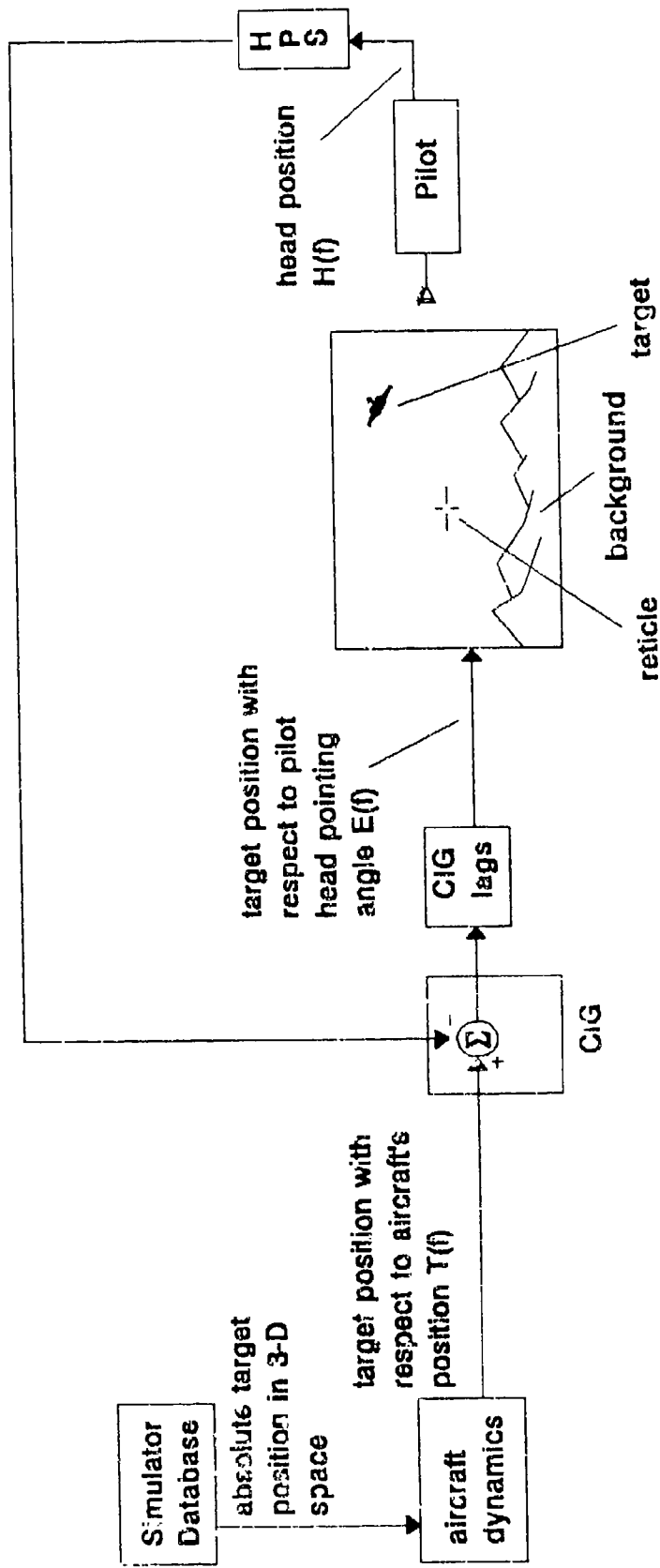

Figure 4.7 Diagrammatic illustration of a model of a simple pilot-in-the-loop head-coupled simulator.

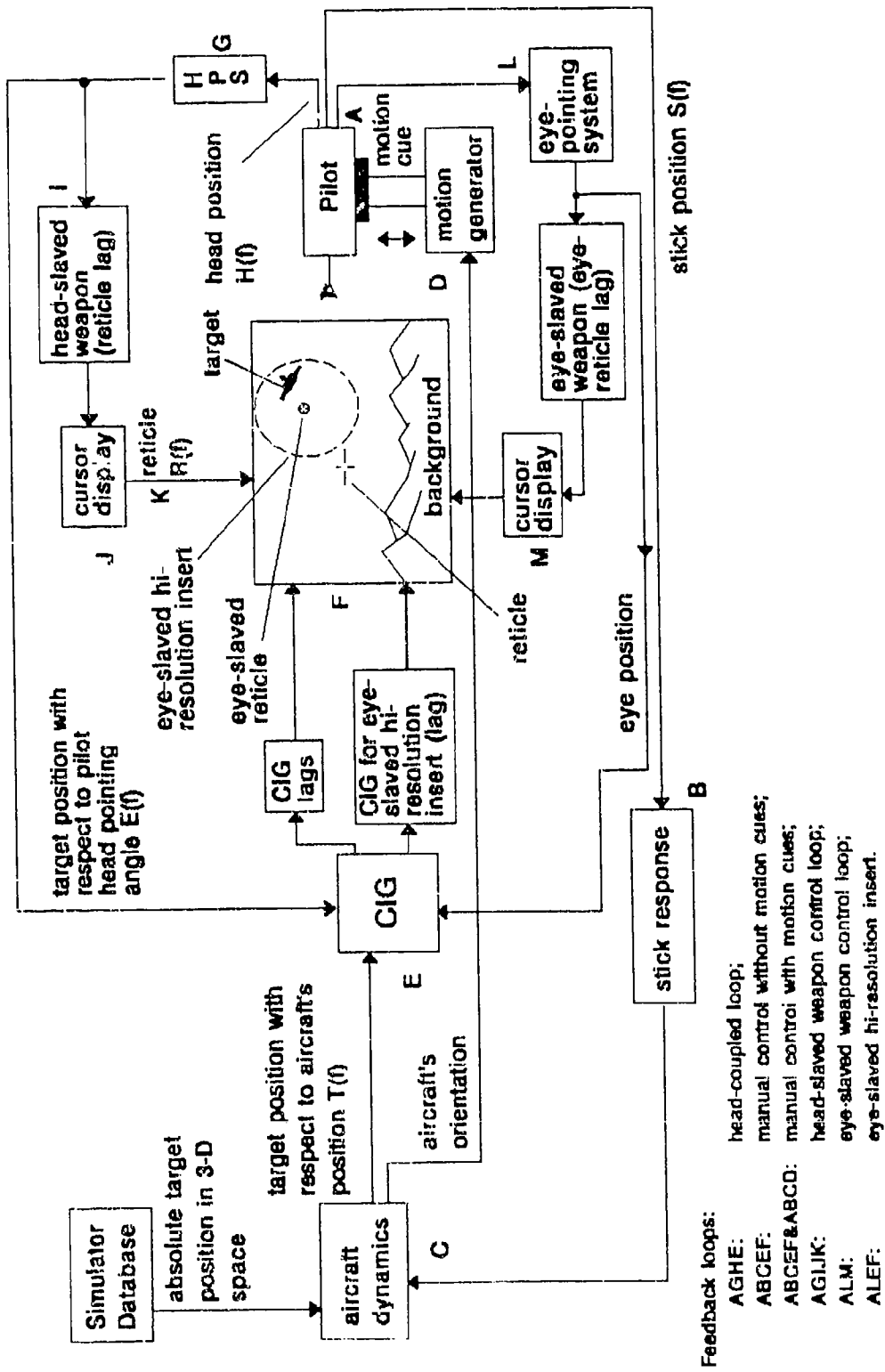

Figure 4.8 Diagrammatic illustration of a model of a typical pilot-in-the-loop head-coupled simulator.

Table 5.1 Structure of head-coupled simulators described in known published literature.

Authors of the references	Name of the simulator	Head-coupled simulator components												
		head-coupled visual loop						head-steered weapon control loop			manual control loop		eye-coupled visual loop	eye-slaved weapon control loop
		dome/panel screen	data base	CIG	HMD	HPS	FLIR/camera	reticle feedback	stick	vehicle dynamics	motion cues	high resolution insert	reticle feedback	
Allen and Hebb (1983)	The feasibility model of an advance visual display system for flight simulation, NTSC, Orlando, FL	1	1	1	0	1	0	0	1	0	0	0	1	0
Browder and Chambers (1988)	Visual Display Research Tool (VDRIT) at Advanced Simulation Concepts Division, NTSC, Orlando, FL	1	1	1	0	1	0	0	1	1	0	0	1	0
Browder and Chambers (1988) Gettmacher (1988)	Eye Slaved Projector Raster Insert visual Test bed (ESPRIT), Link Flight Simulation	1	1	1	0	1	0	0	1	1	0	0	1 (180° circular)	
Casey and Meizer (1991)	Kaiser Wide-Eye™ helmet integrated display		1	1	b	1	0							
Drew et. al (1987)	AH-64 Apache Combat Mission Simulator	1	1	1	m	1	1	1	1	1	1	0	0	0
Eye and Griffin (1991) Eye and Griffin (1992)	experimental head-coupled system; at ISVR, University of Southampton, UK	0	1	1	b	1	0	1	0	0	0	1	0	1

Key: 0 = component not present; 1 = component present; * = to be developed, m = monocular HMD, b = binocular HMD.

Blank = not mentioned in the document(s) reviewed.

.../ to be continued

.../ continued from Table 5.1

Authors of the references	Name of the simulator	Head-coupled simulator components															
		head-coupled visual loop						manual control loop					eye-coupled visual loop	eye-slaved weapon control loop			
		dome/panel screen	data base	CIG	HMD	HPS	FLIR/camera	reticle feedback	stick	vehicle dynamic	motion cues	high resolution insert			reticle feedback		
Geltmacher (1988)	McDonnell Douglas simulator at AFHRL, William AFB, AZ	1	1	1	0	1						1	1	0	1		0
Geltmacher (1988) Kruk and Langrige (1985) Casey and Meizer (1991) Bernard and Smith (1994)	simulator with CAE FOHMD at AFHRL, William AFB, AZ	0	1	1	b	1						1	1	0	1		0
Grunwald et. al (1991)	experimental system at Faculty of Aerospace Eng., Haifa, Israel	0	1	1	m	1				entire view as simulated FLIR	0	1	1	0	0		0
Keys et. al (1990)	Virtual Environment Integration Laboratory at RAE, UK		1	1	*b	1				1							*
Lypczewski et. al (1987) Haworth and Bucher (1988) Starley and MacCauley (1991)	Craw Station Research and Development Facility (with CAE FCHAD) at NASA Ames	0	1	1	b	1				1 (as insert)	0	1	1	0	*		0
So and Griffin (1991a,b)	experimental head-coupled system at ISVR, University of Southampton, UK	0	0	1	m	1				0	1	0	0	0	0		0

Key: 0 = component not present, 1 = component present, * = to be developed, blank = not mentioned in the document(s) reviewed.
 m = monocular HMD, b = binocular HMD.

.../ to be continued

.../ continued from Table 5.1

Authors of the references	Name of the simulator	Head-coupled simulator components												
		head-coupled visual loop						manual control loop			eye-coupled visual loop	eye-slaved weapon control loop		
		dome/panel screen	data base	CIG	HMD	HFS	FLIR/camera	head-slaved weapon control loop	stick	vehicle dynamics	motion cues	high resolution insert	reticle feedback	
Swenson et. al (19...)	Vertical Motion Simulator at NASA Ames with Honeywell RADSS	1	1	s	m	1				1	1	1	0	0
Weils et. al (1989)	Visually Coupled Airborne Systems Simulator (VCASS) at AAMRL, Wright-Patterson AFB, OH.	0	1	1	b	1			1	1				
Wolkamp and Rasmacher-Jan (1988)	McDonnell Douglas helicopter simulator	1	1	1	0	1				1	1		0	0

Key: 0 = component not present, 1 = component present, * = to be developed, blank = not mentioned in the document(s) reviewed.
 m = monocular HMD, b = binocular HMD, s = symbology only.

Table 5.2 Structure of head-coupled airborne systems (operational or awaiting to be operational) described in known published literature

Authors of the references	Name of the head-coupled units	Head-coupled system components												
		head-coupled visual loop					head-slaved weapon control loop			manual control loop			eye-coupled visual loop	eye-slaved weapon control loop
		dome/panel screen	data base	CIG	HMD	HPS	FLIR/ camera	reticle feedback	stick	vehicle dynamics	motion cues	high resolution insert	reticle feedback	
Böhm et. al. (1991)	GEC KNIGHT HELM: (flight tested with Germany/France anti-tank helicopter)	0		s	b	1	night vision goggle		helicopter		0		0	
	Honeywell MONARC helmet (flight tested with Germany, France anti-tank helicopter)	0			b'	1	night vision goggle		helicopter		0		0	
	Kaiser STRIKE EYE	0			b'		night vision goggle		helicopter		0		0	
Böhm and Schraner (1990) Böhm et. al. (1991)	Pilot Vision System in TIGER (Germany/France anti-tank helicopter)	0		s	m	1			helicopter		0		0	
Butterfield (1990)	Honeywell Oxygen Mask mounted display (flight tested with F-16)	0		s	m		0		F-16		0		0	
	GEC ALPHA helmet (flight tested with F-16)	0		s	b'		0		F-16		0		0	
Drew et. al. (1987)	Honeywell IHADSS in AH-64 Apache helicopter	0		s	m	1			helicopter		0		0	

Key: 0 = component not present, 1 = component present, * = to be developed, blank = not mentioned in the document(s) reviewed.
 m = monocular HMD, b' = binocular HMD, s = symbology only.

6.0 EFFECTS OF VARIABLES ASSOCIATED WITH INDIVIDUAL FEEDBACK LOOPS

This section reviews published studies concerned with the effects of lags within individual feedback loops in head-coupled systems. One problem with selecting papers for this review is that the papers' authors were not always primarily concerned with the effect of lags and so all of the desired information is not always available.

The studies are presented in a style similar to that of the Engineering Data Compendium (Boff and Lincoln, 1988). Studies concerned with the effect of lags within the same feedback loop are grouped (subsections 6.1 to 6.5).

6.1 Head-coupled visual loop

A block diagram showing a head-coupled visual loop within a simulator is shown in Figure 4.8.

The variables investigated in this section are listed as follows:

- (i) lag-induced image position error (Section 6.1.1);
- (ii) display lag (Section 6.1.2);
- (iii) exponential display lag (Section 6.1.3);
- (iv) time lead and display lag (Section 6.1.4).
- (v) lag compensation by image deflection and head position prediction (Section 6.1.5).

6.1.1 Lag-induced image position error

General description

Head-coupled systems comprise helmet-mounted displays, helmet-pointing systems and host computers for graphics generation. Such systems enable an operator to view continuously information appropriate to the instantaneous line-of-sight of the head. Problems arise with the inevitable lags between the moment at which head orientation is sampled and the moment at which the image is presented on the display. This type of lag has previously been referred to as target presentation lag (ref. 5), transmission lag (ref. 2) and display lag (ref. 3). The lag represents the dynamic response of the entire visual field of a head-coupled system to head movement and will be hereafter referred to as 'display lag'. Within the context of this report, an aiming reticle is not included as part of the visual field and is not subjected to the display lag.

With a display lag and continuous head movement, head-coupled images are displayed at incorrect positions. The generation of such image position error is illustrated in Figure 6.1. This image position error has been referred to as display orientation error (ref. 1). The display lag increases linearly with increasing frame period or graphic update time (Figure 6.2, ref. 2). The image position error also increases linearly with the head movement velocity (Figure 6.3) and the magnitude of the display lag.

Applications

Understanding of any degradation in visual control performance with head-coupled systems.

Methods

Two studies, reported by different authors, are reviewed here. The study in ref. 2 investigated the position error introduced by the display lag from an engineering point-of-view and no human response was considered. The study in ref. 6, however, included human response to the display lag in the measurements of lag-induced position error.

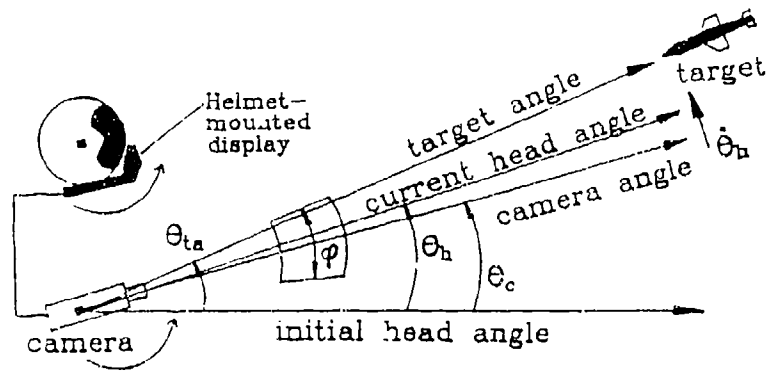

images seen on the display :

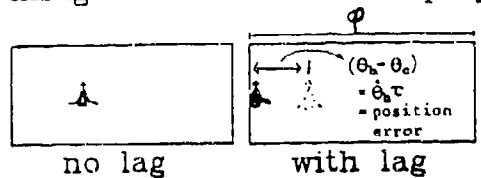

Figure 6.1 Diagrammatic illustration of the effect of lag between head movement and image captured by a head-slaved camera (The effect is similar to that of display lags, adapted from ref. 6).

Test conditions (ref. 2)

- Display (transmission) lags were measured with different graphic update times (10 ms to 300 ms). Measurements were repeated when a data buffer was inserted into the head-coupled system to generate extra lags (a data buffer may be treated as a frame store in terms of its time delay characteristic).
- Image position errors for head-coupled images were measured with different graphic update times (10 ms to 300 ms) and different head (tracker) translational velocities (0.0221 m/s to 0.0558 m/s).

Experimental details (ref. 2)

- Independent variables: graphic update time; head (tracker) velocity; the presence of a data buffer.
- Dependent variables: display lag; image position error.

- Experimenter's task: move the head tracker at a pre-arranged velocity.

- No subject was used.

Test conditions (ref. 6)

- Image position errors for head-coupled images were measured with different display lags (40 ms to 420 ms). These errors were compensated by image deflection and measured in terms of the amount of deflection needed Figure 6.4, (see Section 6.1.5 for details on the image deflection technique).

- The target motions used in both pitch and yaw axes were random signals integrated twice and band-pass filtered between 0.01 and 0.63 Hz.

Experiment details (ref. 6)

- Independent variable: display lag.

- Dependent variables: image position error in terms of the amount of deflection needed.

- Subject's task: track a moving target with the head.

- Twelve male subjects participated.

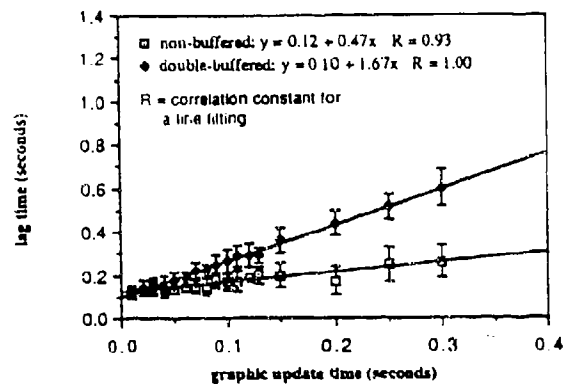

Figure 6.2 Display lags for different graphic update times with and without a data buffer (line fittings are given, adapted from ref. 2).

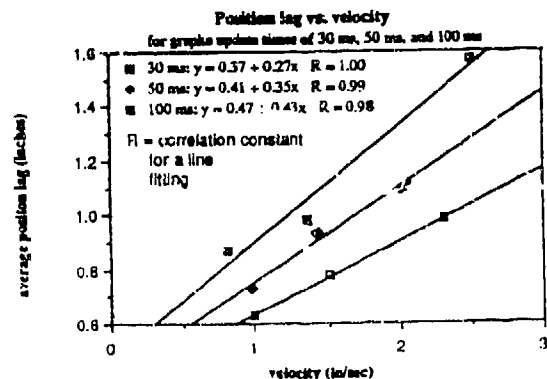

Figure 6.3 Position errors versus head (tracker) velocity for graphics update times of 30, 50 and 100 ms (adapted from ref. 2).

Results

• The visual effect of display lag on a head-coupled image is illustrated in Figure 6.1. Although computer-generated images were used in all the studies reviewed, a head-slaved camera is used for illustration. Figure 6.1 shows the effect on the displayed image when the head of an operator moves to acquire a stationary target at a constant angular velocity, $\dot{\theta}_h$, assuming the head-slaved camera follows with a constant time delay, τ . After a time, t , the head has traveled an angle of:

$$\theta_h = \dot{\theta}_h t$$

but the camera and images captured have only moved to θ_c , where:

$$\begin{aligned} \theta_c &= \dot{\theta}_h (t - \tau) \\ &= \theta_h - \dot{\theta}_h \tau \end{aligned}$$

Therefore, the image position error, $\dot{\theta}_h \tau$, is proportional to the head velocity, $\dot{\theta}_h$.

• The relationship between display lag and graphic update time is modeled as follows (Figure 6.2):

$$\text{display lag} = a + b \times (\text{graphic update time})$$

where

a = lag of the helmet-pointing system (tracker) + the processing time of the host computer to generate a complete graphic frame.

b = a constant proportional to the number of data buffers within the head-coupled visual loop of a head-coupled system.

• Image position errors in head-coupled displays increase linearly with head (tracker) velocity (Figure 6.3). This agrees with Figure 6.1.

• Image position errors in head-coupled displays increase linearly with display lag (Figure 6.4).

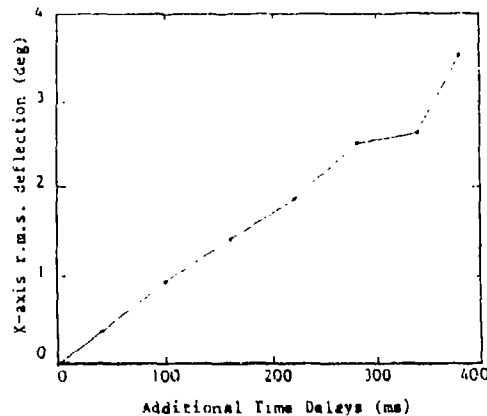

Figure 6.4 Yaw-axis r.m.s. image displacement by deflection (i.e. position error) for different display lags (adapted from ref. 6).

Comparison with other studies

• The reported linear relationship between the position error and the head velocity was confirmed by the result of a study reported in ref. 5. With display lags from 0 ms to 160 ms, changing the velocity of a target motion by scaling its displacement produced no significant effect on head tracking performance other than the linear changes due to displacement scaling (the system display lag was 40 ms).

References (*: key reference(s))

- | | |
|----------------------------|-------------------------------|
| 1. Allen and Hebb (1983) | *2. Bryson and Fisher (1990) |
| 3. Eyre and Griffin (1992) | 4. Lewis <i>et. al</i> (1987) |
| 5. So and Griffin (1991a) | *6. So and Griffin (1991b) |

6.1.2 Display lags

General description

Image movements on all head-coupled systems are subject to display lags (see Section 6.1.1 for definition, Figure 6.5). For a band-limited random target motion, head tracking performance can be significantly degraded by imposed display lags greater than, or equal to, 40 ms (Figure 6.6, the system display lag was 40 ms). Ref. 3 reported that in the presence of display lags, no significant improvement in head tracking performance was found through practice (Figure 6.7). Display lags were shown to increase the gains and the phase lags in head tracking transfer functions with a band-limited random target motion (Figure 6.8). These increases resulted in increased input-correlated tracking errors (Figure 6.9).

Applications

Design of control systems with head-coupled visual feedback.

Methods

Two studies are reviewed here, they were reported by the same authors and the head-coupled systems used in both experiments were the same (Figure 6.5). The helmet-mounted display used was a monocular system and the eye of presentation was the right eye.

Test conditions (ref. 4)

- Mean radial head tracking error and subjective difficulty rating were measured with different imposed display lags (0 ms to 380 ms, Figure 6.6). The system display lag was 40 ms.
- The target motions used in both pitch and yaw axes were random signals integrated twice and band-pass filtered between 0.01 and 0.63 Hz. The duration was 60 seconds.

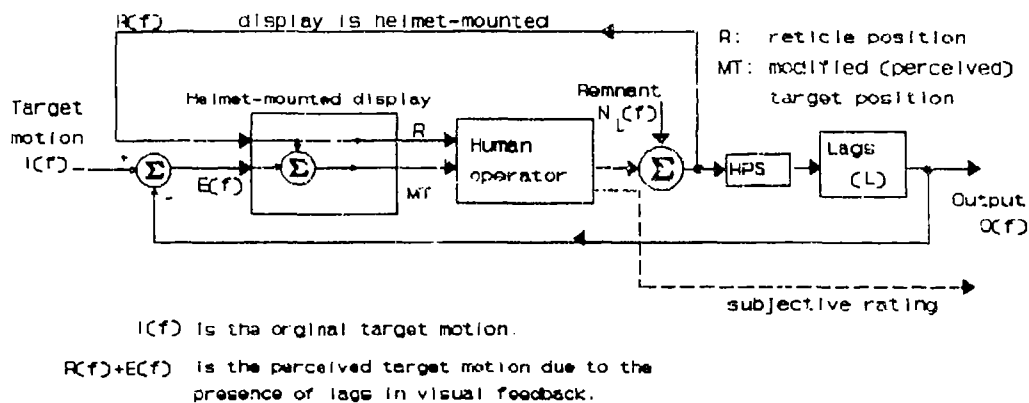

Figure 6.5 A diagrammatic illustration of a head-coupled system with a display lag.

Experimental details (ref. 4)

- Independent variable: display lag.
- Dependent variables: mean radial head tracking error and subjective difficulty rating.
- Subject's task: track a moving target with a reticle. Both the target and the reticle were presented on a monocular helmet-mounted display at optical infinity. The reticle was presented at the center of the display.

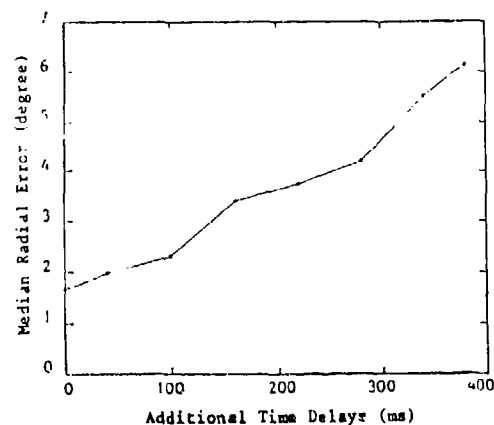

Figure 6.6a Mean radial tracking error with different display lags (Median of 12 subjects, adapted from ref. 4).

- Twelve male subjects participated. They were either students or researchers.

Test conditions (ref. 3)

- With 0 ms and 80 ms imposed display lags, mean radial head tracking error was measured for ten consecutive trials to study learning effects (Figure 6.7). The system display lag was 40 ms.
- Head tracking transfer functions and both input-correlated and uncorrelated tracking error spectra were measured with different imposed display lags (0 ms to 160 ms,

Figures 6.8 and 6.9).

- The target motions used in both pitch and yaw axes were random signals integrated once and then low-pass filtered at 0.7 Hz (24 dB/octave) and 1 Hz (120 dB/octave). The duration was 120 seconds.

Experimental details (ref. 3)

- Independent variables and subject's task are the same as in ref. 4.

- Dependent variables: head displacement (pitch and yaw axes) expressed as mean radial error, head tracking transfer function and input-correlated and uncorrelated error spectra.

- Eight male subjects participated. They were either students or researchers.

Results

- Head tracking performance was found to be degraded for imposed display lags greater than, or equal to, 40 ms (Figure 6.6, the system display lag was 40 ms). About 65% of the increase in total tracking error was input-correlated (Figure 6.9).

- No significant improvement in head tracking performance in the presence of 0 ms and 40 ms imposed display lags was found through practice (Figure 6.6).

- Both the gains and the phase lags in head tracking transfer functions increased with

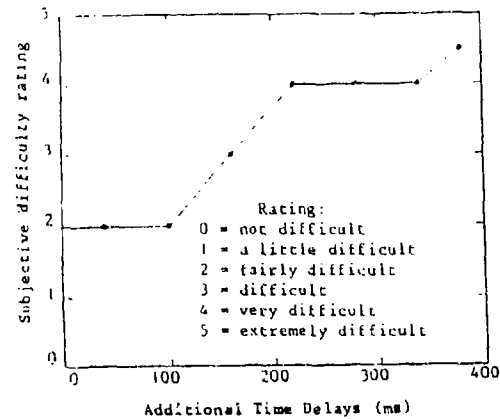

Figure 6.6b Subjective difficulty rating with different display lags. (Median of 12 subjects, adapted from ref. 4).

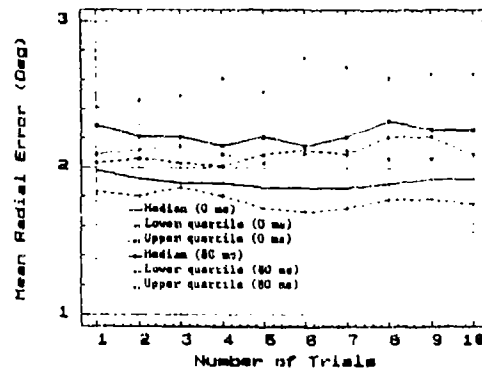

Figure 6.7 Mean radial error for 10 learning stages with 80 and 120 ms display lags (median and inter-quartile range for 8 subjects, adapted from ref. 3).

increasing display lag (Figure 6.8). This indicated that the operator tracking strategy may have been affected by the display lags.

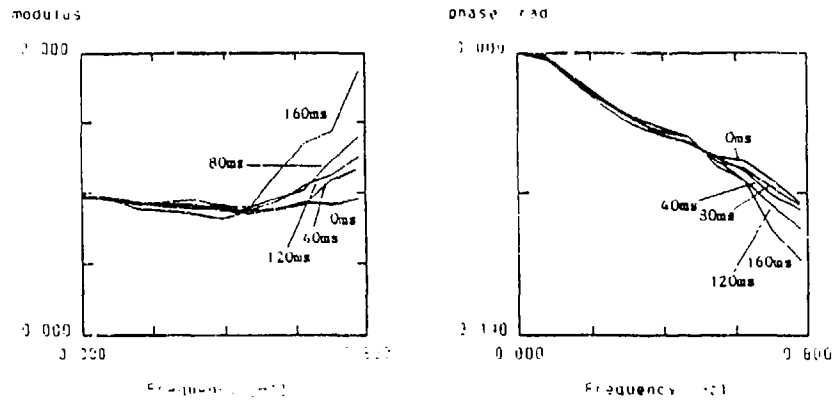

Figure 6.8 Mean head tracking transfer functions in the yaw-axis with different display lags (Hanning window, 144 degrees of freedom, 0.09 Hz resolution, adapted from ref. 3).

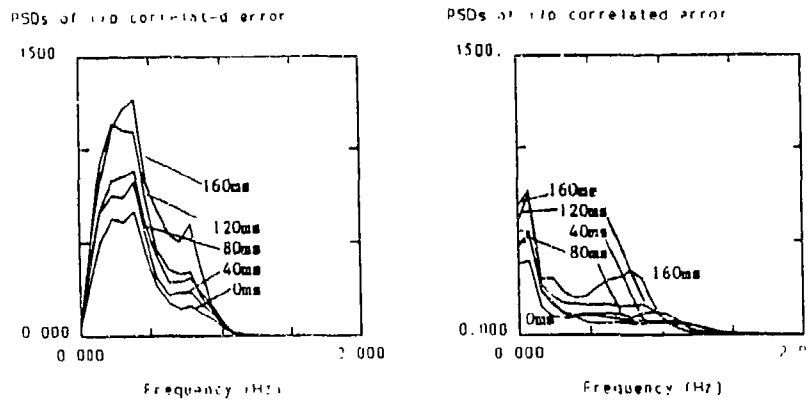

Figure 6.9 Mean input-correlated and uncorrelated yaw-axis head tracking error spectra with different display lags (Hanning window, 144 degrees of freedom, 0.09 Hz resolution, adapted from ref. 3).

Comparison with other studies

- Figure 6.10 indicates a similar finding from ref. 1 for the effect of display lag on head tracking performance. The experimental head-coupled system used in ref. 1 was different from that used in ref. 4 (see Table 5.1, Section 5.0).

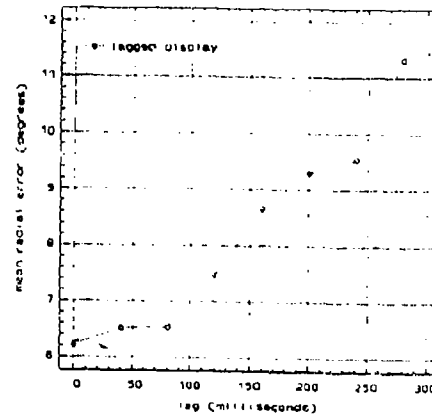

Figure 6.10 Mean radial head tracking error with different display lags (adapted from ref. 1).

- Ref. 2 reported that display lags can cause motion sickness.

- Ref. 6 reported that in a helicopter combat mission simulation, the computer scene could not keep up with the high turn rates inherent in an aggressive maneuver, the simulator had a display lag of 120 ms.

- A monocular helmet-mounted display (HMD) was used in both studies (refs. 3 and 4). The eye of presentation of the HMD was always the right eye. Ref. 5 investigated the effect of the eye of presentation during head aiming and tracking, no significant effect on performance was reported.

Constraints

- The studies were focused on the effects of display lag on continuous tracking. Other tasks such as target acquisition involving ballistic head movement may need further attention.

References (*: key reference(s))

1. Eyre and Griffin (1992)
2. Friedman *et. al* (1992)
- *3. So and Griffin (1991a)
- *4. So and Griffin (1991b)
5. Wells and Griffin (1987b)
6. Williams (1987)

6.1.3 Exponential display lags

General description

When a head-coupled system is used to present images captured by a head-slaved camera, the delay (i.e. display lag, see Section 6.1.1 for definition) is replaced by an exponential lag. This exponential lag represents the dynamic response of the head-slaved camera and is hereafter referred to as exponential display lag (Figure 6.11). When such head-coupled systems are used to search and identify visual objects, the effect of increasing the delay time constant (τ) of an exponential lag is likely to increase the searching time (Figures 6.12 and 6.13) and constrains an operator from making fast head motions (Figure 6.14).

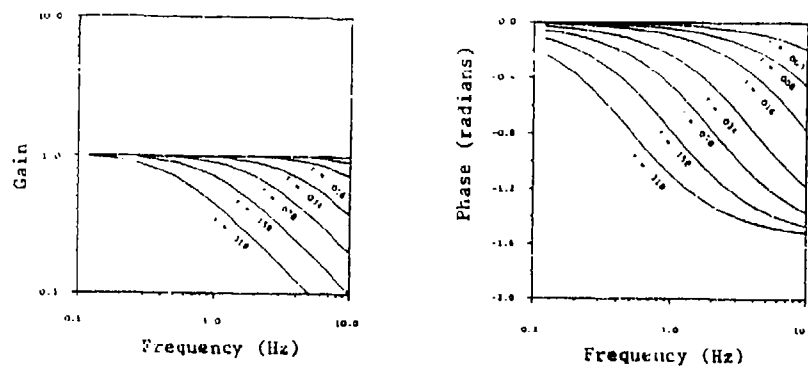

Figure 6.11 Frequency responses of exponential display lag of different time constants (adapted from ref. 2).

Applications

Design of tele-operated systems and head-coupled forward looking infrared radiation (FLIR) systems.

Methods

Test conditions (ref. 2)

- One-dimensional character search with a head-coupled system; the characters were the twenty-six letters of the alphabet presented in a random order. Character position was

generated randomly between -70° to -10° and from $+10^\circ$ to $+70^\circ$ from boresight along the horizontal median.

- Percentage reading error and total time taken to complete the task were measured with different exponential display lags ($e^{-t/\tau}$; τ from 0.003 to 0.318 seconds corresponding to a 1st order low-pass filter with cut-off frequencies from 50 to 0.5 Hz).

Test conditions (ref. 1)

- Estimation of the flight path in a simulated straight or curved level flight with a head-coupled system (see Experimental Details section for a summary of the estimation procedure).

- Estimation error, time and yaw-axis movement and velocity were measured with and without a 1st order exponential display lag ($e^{-t/0.5s}$). The error and head velocity measurements were represented by their standard deviations, since their means were approximately zero. Their standard deviations were approximately equal to the r.m.s. values.

Experimental details (ref. 2)

- Independent variable: exponential display lag.
- Dependent variables: percentage reading error and reading time.

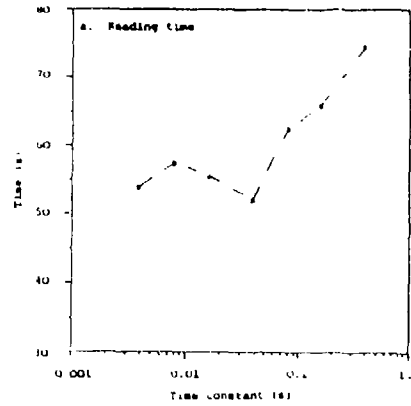

Figure 6.12 Time taken to search and recognize 26 letters with different exponential display lags (adapted from ref. 2).

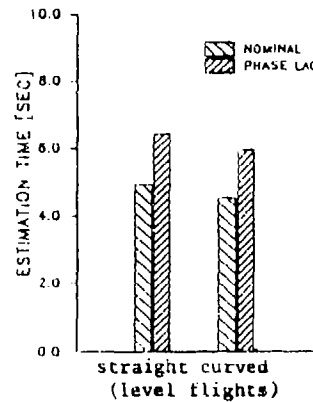
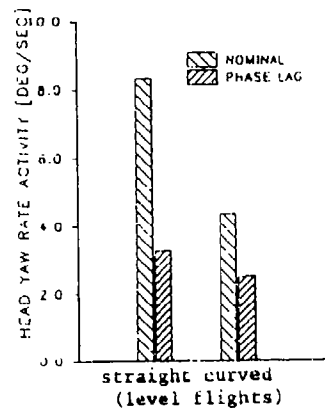

Figure 6.13 Flight path estimation time with and without an exponential display lag of $e^{-t/0.5s}$ (adapted from ref. 1).

- Subject's task: start from a forward facing position, turn the head to the left until a character is located, call out the character and turn the head to the right until another character is located. This is repeated until all of the twenty-six characters have been read.



- Seven male subjects participated.

Experimental details (ref. 1)

Figure 6.14 Yaw-axis head motion velocities (standard deviation) in the flight path estimation task with and without an exponential display lag of $e^{-t/0.5s}$ (adapted from ref. 1).

- Independent variable: exponential display lag.

- Dependent variables: flight path estimation error and time; standard deviations of yaw-axis head movement and velocity.

- Subject's task: on pressing a response button, a simulated helicopter flight was presented. Within the visual field, a marker was placed on the ground level, at zero yaw angle and at a specified depth. Subjects were asked to place the marker along the anticipated flight path at the specified depth and press the response button when finished.

- Eight male and one female trained subjects participated.

Results (ref. 2)

- Figure 6.12 shows that for a time constant greater than, or equal to, 0.04 seconds, there was a consistent degradation in reading time with increasing exponential display lag.

- Reading errors were not consistently affected by the exponential display lag (data not shown here, see ref. 2). In a character search task, when a subject is under stress, a trade-off would normally be expected between reading time and reading error.

Results (ref. 1)

- When an exponential display lag with a time constant of 0.5 seconds ($e^{-t/0.5s}$) was introduced, the average estimation time of the flight paths in simulated helicopter flights increased by 30% (Figure 6.13).

- The effect of the exponential lag on the flight path estimation error was slight (4% increases, data not shown here).

- With the exponential display lag ($e^{-t/0.5s}$), yaw-axis head velocity decreased by approximately 53% (Figure 6.14). In contrast, the yaw-axis head displacement increased by 14% (Figure 6.15). This may suggest that the exponential display lag constrained the subjects from making fast head motions, requiring them to make more corrections, and resulted in larger estimation times.

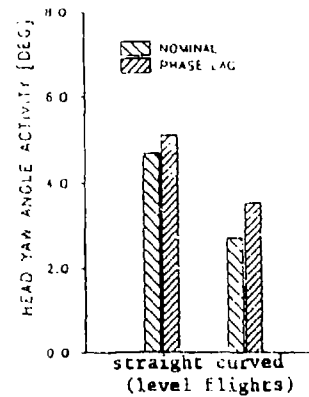

Figure 6.15 Yaw-axis head displacements (standard deviation) in the flight path estimation task with and without an exponential display lag of $e^{-t/0.5s}$ (adapted from ref. 1).

Constraints

- The findings from the two studies (refs. 1 and 2) cannot be compared directly, because flight path estimation is more complicated than a character search task. The performance of the former task is more dependent on subject experience.

- Only one dimensional character search was studied.

References (*: key reference(s))

*1. Grunwald *et. al* (1991)

*2. Lewis *et. al* (1987)

6.1.4 Combined effect of time lead and display lag

General description

In previous sections (6.1.1 to 6.1.4), the degradation effects of display lag on performance have been discussed. A solution to this lag-induced problem is to predict the future head position by a signal processing algorithm. For random movements of the head, prediction is, by definition, impossible. However, due to the limited tracking bandwidth of the human head (up to 1 Hz, Wells and Griffin, 1987b), prediction of head position becomes possible. A model of a head-coupled visual loop with a head position predictor is shown in Figure 6.16. With imposed lags greater than, or equal to, 80 ms the use of an optimized phase lead filter with 48 ms lead reduced the mean radial head tracking error (Figures 6.17 and 6.18). In the case of the optimized phase lead filter with 117 ms lead, the mean radial head tracking error was reduced when the imposed lag was equal to 100 ms (the system display lag was 40 ms). It was reported that the gain amplification of the filter, above the target motion frequency range of 0 to 0.7 Hz, magnified the measurement noise which, in turn, caused the visual images to jitter. The jittering of the images were found to force the human operator to adopt a different strategy that produced more tracking error (Figure 6.19).

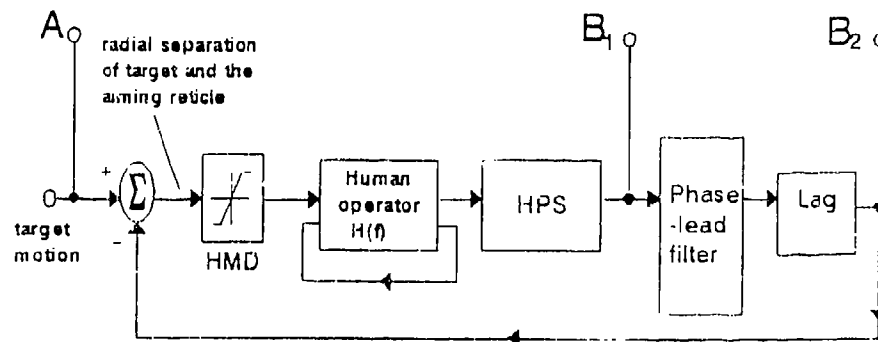

Figure 6.16 Block diagram of a head-coupled visual loop with a display lag and a head position predictor (adapted from ref. 6).

Applications

Design of helmet-pointing system and head-coupled simulator.

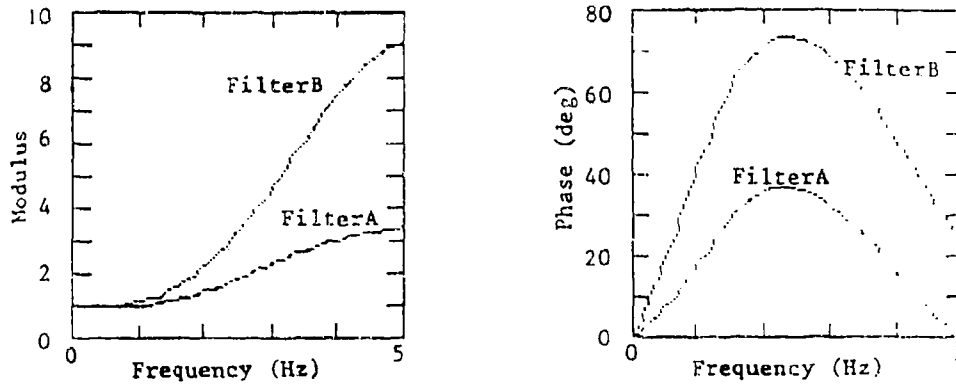

Figure 6.17 Frequency responses of the two phase lead filters used in ref. 5.

Methods (ref. 6)

Test conditions

- Mean radial head tracking error was measured with different imposed display lags (0 ms to 100 ms) and three filtering conditions (no filter, filters A and B, Figure 6.17).
- The two phase lead filters (A and B) were optimized so as to produce time lead at the frequency range 0 to 0.6 Hz. Their equations are (sampling rate = 50 Hz):

$$H(z) = \left[\frac{a_0 + a_1 z^{-1} + a_2 z^{-2}}{1 + b_1 z^{-1} + b_2 z^{-2}} \right] \left[\frac{a_3 + a_4 z^{-1} + a_5 z^{-2}}{1 + b_4 z^{-1} + b_5 z^{-2}} \right]$$

	Filter A	Filter B
a_0	14.6324	3.1022
a_1	-24.7464	4.336
a_2	10.7239	1.63
a_3	0.0619	1.0
a_4	0.1237	-1.7348
a_5	0.0619	0.7651
b_1	-0.0068	0.4075
b_2	-0.383	-0.3897
b_4	-1.1837	-1.3086
b_5	0.4312	0.5788

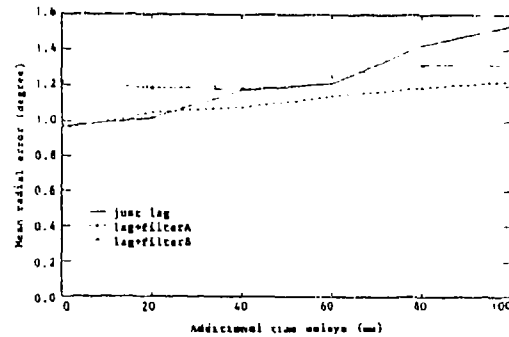

Figure 6.18 Mean radial error with different display lags and phase lead filters (adapted from ref. 6).

The frequency responses of Filter A and Filter B are shown in Figure 6.17.

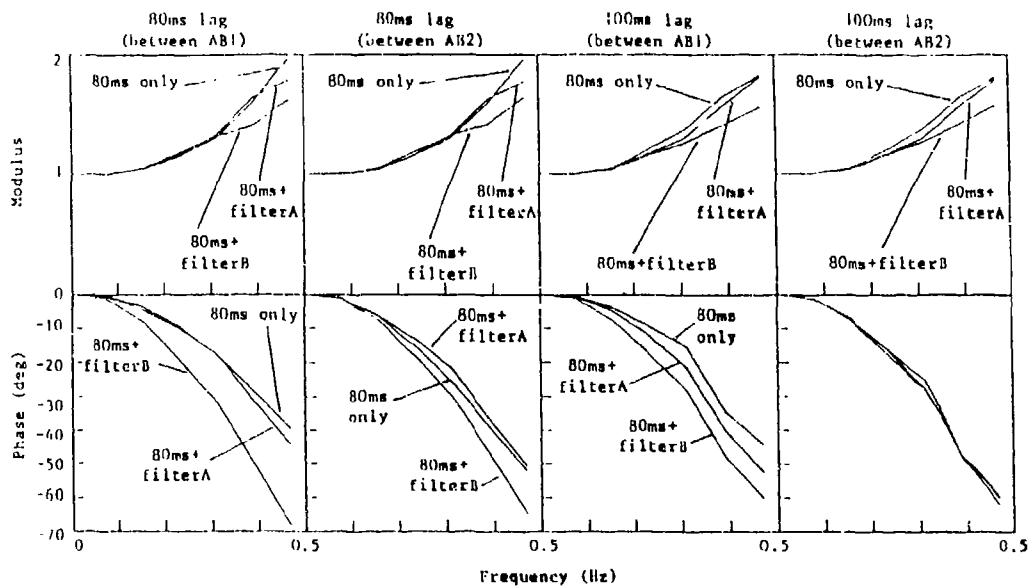

Figure 6.19 Mean head tracking transfer functions measured between A and B1 and between A and B2 (Figure 6.1) with 80 ms and 100 ms imposed lags and different filtering conditions (0.078 Hz, 124 degrees of freedom, adapted from ref. 6).

- The target motions used in both pitch and yaw axes were random signals integrated twice and band-pass filtered between 0.01 and 0.64 Hz (48 dB/octave). The duration of each task was 90 seconds.

Experimental details

- Independent variables: display lag and phase lead filtering.
- Dependent variables: mean radial tracking error and head tracking transfer functions.
- Subject's task: track a moving target with a reticle. Both the target and the reticle were presented on a monocular helmet-mounted display at optical infinity. The reticle was presented at the center of the display.
- Six male subjects participated. They were either students or researchers.

Results

- With the use of filter A, which had a 48 ms lead, mean radial error was significantly reduced when the imposed lag was greater than, or equal to, 100 ms ($p < 0.05$, Wilcoxon matched-pairs signed ranks tests).
- For imposed time delays less than, or equal to, 20 ms however, mean radial error was significantly increased with the use of filter B, which had 117 ms lead ($p < 0.05$, Wilcoxon). This was because the time lead produced by the filter was greater than the total display lag present (total lag = imposed lag + system lag).
- From Figure 6.19, it can be observed that the use of filter B forced the subjects to adopt new tracking strategies which produced more phase lags. Consequently, with the 100 ms time delay condition, the use of filter B produced less improvement in the tracking error than filter A, even though filter B had a longer prediction time (Figure 6.17). The changes in tracking strategy when filter B was used were thought to have been due to the jittering of images produced by amplified measurement noise. Lag compensation by filter B induced a higher subjective difficulty rating for the tracking tasks than lag compensation by filter A (data not shown here).

Comparison with other studies

- Ref. 3 reported a computer simulation study of the use of a simple non-linear prediction algorithm to compensate for lags occurring during high velocity step movements of the head. The algorithm used acceleration data and was reported to have been successfully implemented in a fiber optic helmet-mounted display.
- Ref. 1 utilized an adaptive least-mean-square predictor to predict pilot head look direction. Computer simulations showed that the predictor was capable of good predictions for input signals that change their characteristics linearly with time (e.g. a swept sine with decreasing amplitude) but needed improvement to predict head movements whose characteristics change randomly with time.

References (*: key reference(s))

1. Albrecht (1989)
2. Bernard and Smith (1984)
3. List (1983)
4. So and Griffin (1991a)
5. So and Griffin (1991b)
- *6. So and Griffin (1992)
7. Sobiski and Cordullo (1987)

6.1.5 Lag compensation by image deflection and head position prediction

General description

Images on a head-coupled system are positioned incorrectly due to display lag (see Section 6.1.1 for details of lag-induced position error). By deflecting the lagged image to the currently correct angular position, the image maintains correct correspondence with the outside world. The principle of the image deflection technique is explained in Method Section. Image deflection significantly improved two dimensional head tracking performance in the presence of imposed display lags (up to 380 ms, system display lag was 40 ms) and performance was restored to that without an imposed lag (Figures 6.20 and 6.21). The amount of image deflection required to compensate for the display lags increased with increasing lag (Figure 6.22). The image deflection reduced the field-of-view and introduced parallax errors (see Method Section). Both were expected to degrade tracking performance although their effects were not apparent in the tracking measurements (Figure 6.20). The explanations reported were: (i) images used were not in three dimensional perspective, therefore parallax error did not affect the image quality and (ii) the target was always captured near the center of the field-of-view, therefore reduction of the field-of-view had little effect on the perception of the target. For imposed display lags less than 280 ms, the use of a simple head position prediction algorithm significantly reduced the amount of image deflection required (Figure 6.22) and would therefore reduce parallax errors and reductions of the field-of-view. The principle of the simple head position prediction algorithm is illustrated in Table 6.1.

Applications

Design of head-coupled simulator.

Methods (ref. 5)

Test conditions

- Mean radial head tracking error and subjective difficulty rating were measured with different imposed display lags (0 ms to 380 ms, system display lag was 40 ms), with and

without image deflection, and with and without head position prediction.

- The amount of deflection used to compensate for different imposed display lags was measured.

- The target motions used in both pitch and yaw axes were random signals integrated twice and band-pass filtered between 0.01 and 0.63 Hz. The duration was 60 seconds.

Experimental details

- Independent variables: display lag, lag compensation by image deflection, head position prediction and combined image deflection with head position prediction.

- Dependent variables: mean radial head tracking error, subjective difficulty rating and the amount of image deflection.

- Subject's task: track a moving target with a reticle. Both the target and the reticle were presented on a monocular helmet-mounted display at optical infinity. The reticle was presented at the center of the display.

- Twelve male subjects participated. They were either students or researchers.

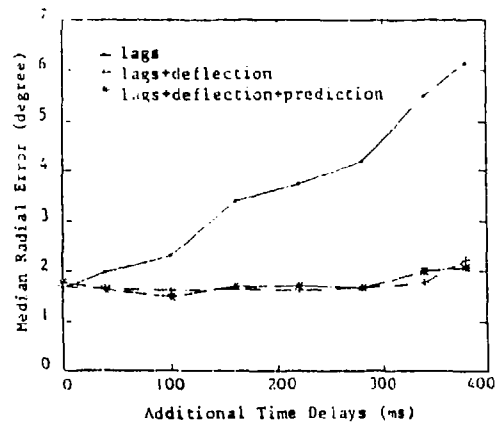
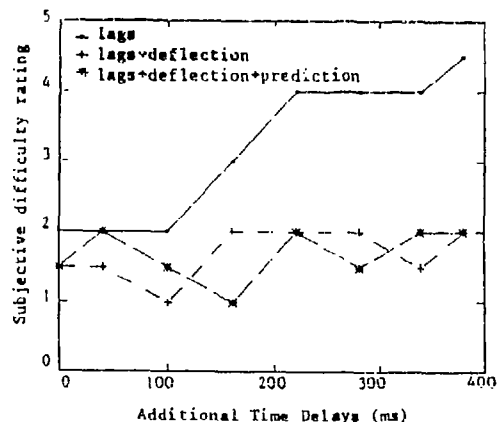

Figure 6.20 Mean radial head tracking error with different display lags and 3 lag compensation techniques (median of 12 subjects, adapted from ref. 5).



Rating:
 0 = not difficult 3 = difficult
 1 = a little difficult 4 = very difficult
 2 = fairly difficult 5 = extremely difficult

Figure 6.21 Subjective difficulty rating with different display lags and 3 lag compensation techniques (median of 12 subjects, adapted from ref. 5).

Technical details

• Image deflection: benefits

The visual effect of display lag, and the benefits of image deflection on a head-coupled image is illustrated in Figure 6.23. Although computer-generated images were used in all the studies reviewed, a head-slaved camera is used for illustration. Figure 6.23 shows the effect on the displayed image when the head of an operator moves to acquire a stationary target at a constant angular velocity, $\dot{\theta}_h$, assuming the head-slaved camera follows with a constant time delay, τ . After a time, t , the head has traveled an angle of

$$\theta_h = \dot{\theta}_h t \quad (1)$$

but the camera and images captured have only moved to θ_c , where

$$\begin{aligned} \theta_c &= \dot{\theta}_h (t - \tau) \\ &= \theta_h - \dot{\theta}_h \tau \end{aligned} \quad (2)$$

Therefore, by deflecting the screen with an offset of $\dot{\theta}_h \tau$, the image is restored to its correct position.

• Image deflection: reduction in field-of-view

Suppose the target is separated from the initial head position by an angle, θ_{ts} , and that the field-of-view (FOV) of the camera subtends an angle of ψ . The image of the target will only be captured if it falls within the FOV of the camera:

$$\text{i.e. } \theta_{ts} - \theta_c \leq \psi/2 \quad (3)$$

substituting θ_c from (2):

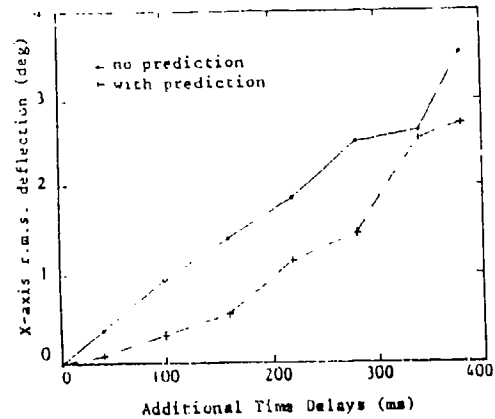

Figure 6.22 The amount of image deflection used to compensate for different display lags with and without head position prediction (median of 12 subjects, adapted from ref. 5).

Table 6.1 The simple head position prediction algorithm (adapted from ref. 5).

$$\hat{H}(t+n) = H(t) + (\text{head velocity}) \times (n)$$

where

$$\text{head velocity (instantaneous)} = \frac{H(t) - H(t-4t_s)}{4t_s}$$

Key:

- $H(t)$ = measured head position at time t ms
- n = prediction time (ms)
- $\hat{H}(t+n)$ = predicted head position at $(t+n)$ ms
- t_s = 20 ms (sampling period)

$$\theta_{ia} - \theta_h + \dot{\theta}_h \tau \leq \varphi/2 \quad (4)$$

If we arrange equation (4), we get:

$$\theta_{ia} - \theta_h \leq (\varphi - 2\dot{\theta}_h \tau)/2 \quad (5)$$

where $(\varphi - 2\dot{\theta}_h \tau)$ is defined as the effective FOV, which is two times the maximum angular separation allowable between the target and the observer's line-of-sight so that the target will fall within display.

From equation (5), one can see that this effective FOV is reduced by any time delay (τ) .

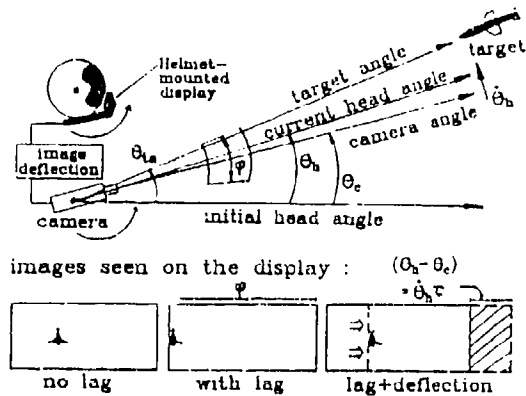

Figure 6.23 Illustration of effects of lags between head movement and image movement on images captured by a head-slaved camera. The effect of image deflection is also shown (adapted from ref. 5).

Results (ref. 5)

- The image deflection technique (both with and without head position prediction) significantly reduced radial error and improved the subjective difficulty rating (Figures 6.20 and 6.21). This is confirmed by the results of the Friedman two-way analysis of variance by ranks.

- The amount of deflection required to compensate for the lags in the yaw-axis increased with increasing imposed display lags (Figure 6.22). The result in the pitch-axis was similar but is not shown here.

- The simple head position prediction algorithm (Table 6.1) was shown to reduce the amount of deflection used in both the pitch and yaw axes (the pitch-axis data is shown in Figure 6.22).

Comparison with other studies

- Ref. 1 reported the use of an image deflection technique to compensate the lag in a head-coupled visual loop of a head-coupled simulator. The simulator used a dome screen with head-coupled projector rather than a helmet-mounted display, therefore the restriction

in the field-of-view was not important. Detailed description of the deflection technique used was included in ref. 1 and it was patented (ref. 2), however no human experimentation was reported.

- The simple head position algorithm used in ref. 5 was replaced with phase lead filters (ref. 6). With imposed display lags, similar head tracking performance was obtained with less reduction in the field-of-view and parallax error as compared to the results in ref. 5. These filters were optimized to produce time leads in the frequency range 0 to 0.6 Hz.

Constraints

- Studies were conducted in laboratory environments. The benefits of lag compensation by combined head position prediction and image deflection in operational head-coupled simulator should be investigated.

References (*: key reference(s))

*1. Allen and Hebb (1983)

3. Lewis *et.al* (1987)

*5. So and Griffin (1991b)

2. Allen *et. al* (1984)

4. So and Griffin (1991a)

*6. So and Griffin (1992)

6.2 Head-slaved weapon control loop

A block diagram showing a head-slaved weapon control loop within a simulator is shown in Figure 4.8. This loop provides the position control of a head-slaved device and feeds back this position in terms of the position of a reticle. The variables investigated in this section include head reticle lag and the visual feedback of the position of a head-slaved device lagging behind the line-of-sight.

6.2.1 Reticle lag

General description

In addition to presenting information to operators, head-coupled systems can be used for aiming and target designation. One such application will be the head-slaved turret gun in a combat helicopter: as a pilot turns his or her head to track the target, the gun follows. The instantaneous position of the head-slaved gun may be displayed as a reticle on a helmet-mounted display (HMD). Due to the inevitable lag in the head-slaved device (turret gun), the reticle will always lag behind the head-pointing angle. Hence, the lag has been referred to as 'reticle lag'. Tracking performance with a head-slaved device was found to be significantly degraded by lags greater than, or equal to, 80 ms (Figure 6.24, the system has a 40 ms display lag and no reticle lag). With head tracking transfer function measurements, it was reported that as the lag increased, the subject decreased his gain from unity and the phase lag became larger which, in turn, increased the tracking error (Figure 6.25).

Applications

Design of head-slaved devices.

Methods (ref. 2)

Test conditions

- Mean radial tracking error and head tracking transfer functions were measured with

different reticle lags (0 ms to 400 ms). The system had a 40 ms display lag and no reticle lag.

- The target motions used in both pitch and yaw axis were random signals integrated once, high-pass filtered at 0.01 Hz (24 dB/octave) and low-pass filtered at 1.2 Hz (120 dB/octave).

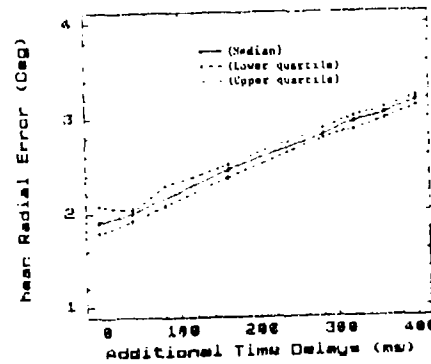

Figure 6.24 Mean radial error in degree with different reticle lags (median of 8 trials, 1 subject, adapted from ref. 2).

Experimental details

- Independent variable: reticle lag.
- Dependent variables: mean radial error and head tracking transfer function.
- Subject's task: track a moving target with a head-slaved reticle. Both the target and the reticle were presented on a monocular helmet-mounted display at optical infinity. The reticle had an open-cross shape with an inner diameter of 1.2 degrees.
- One male subject participated. Eight trials were recorded.

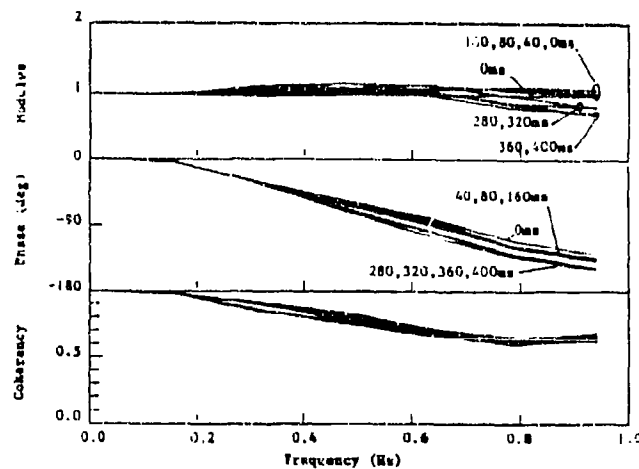

Figure 6.25 Head tracking transfer functions in the yaw-axis with different reticle lags (average of 8 trials, 1 subject, adapted from ref. 2).

Results (ref. 2)

- Mean radial error increased significantly for reticle lags greater than, or equal to, 80 ms ($p < 0.05$, Wilcoxon matched-pairs signed ranks tests).
- Head tracking transfer functions in the yaw-axis are shown in Figure 6.25. The transfer functions in the pitch-axis were similar and are not shown. As the lag increased, the subject decreased his gain from unity and the phase lag became larger which, in turn, increased the tracking error.

Comparison with other studies

- Figure 6.25 (ref. 1) indicated that mean radial head tracking error increased with increasing reticle lag. However, a threshold lag was not reported. The experimental head-coupled system used in ref. 1 was different from that used in ref. 2 (see Table 5.1, Section 5.0). 8 male subjects were used in ref. 1.

- Ref. 1 reported that with imposed reticle lags greater than, or equal to, 80 ms, head tracking performance improved when the visual feedback in the form of a reticle lagging behind the operator's line-of-sight was removed.

Constraints

- Only one male subject was used in ref. 2.

References (*: key reference(s))

1. Eyre and Griffin (1992)
2. So and Griffin (1991a)

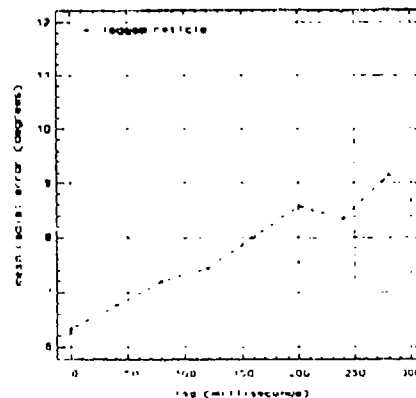

Figure 6.26 Mean radial tracking error with different reticle lags (Median of 8 subjects, adapted from ref. 1).

6.3 Manual control loop

A block diagram showing a manual control loop within a simulator is shown in Figure 4.8. The variables investigated in this section are as follows:

- (i) manual display lag (Section 6.3.1);
- (ii) time lead with lag (Section 6.3.2);
- (iii) lag in motion cue presentation (Section 6.3.3).

Sections 6.3.1 to 6.3.2 concern the effects of time delay variables whilst Section 6.3.3 concerns the related effects of a simulator hardware variable.

6.3.1 Manual display lag

General description

In the manual control loop of a head-coupled system, lags occur between the input from a hand controller and the resultant change in the visual output. Similar lags occur in manual control systems with panel-mounted displays and their effects have been the subject of many studies (transmission lag, Boff and Lincoln (1988), Warrick (1949); simulator delay, Riccio *et. al* (1987); system transport delay, Gum and Albey (1977)).

In a head-coupled system, this type of lag has previously been referred to as 'throughput lag'. Since, like display lag, it affects the orientation of the entire visual field, this type of lag will hereafter be referred to as 'manual display lag'. If a head-coupled system is used as a helicopter simulator, as the manual display lag increases, the Cooper-Harper rating increases, so indicating degradation of helicopter simulated handling qualities (Figures 6.27 and 6.28).

Applications

Design of head-coupled simulators and tele-operated vehicle system.

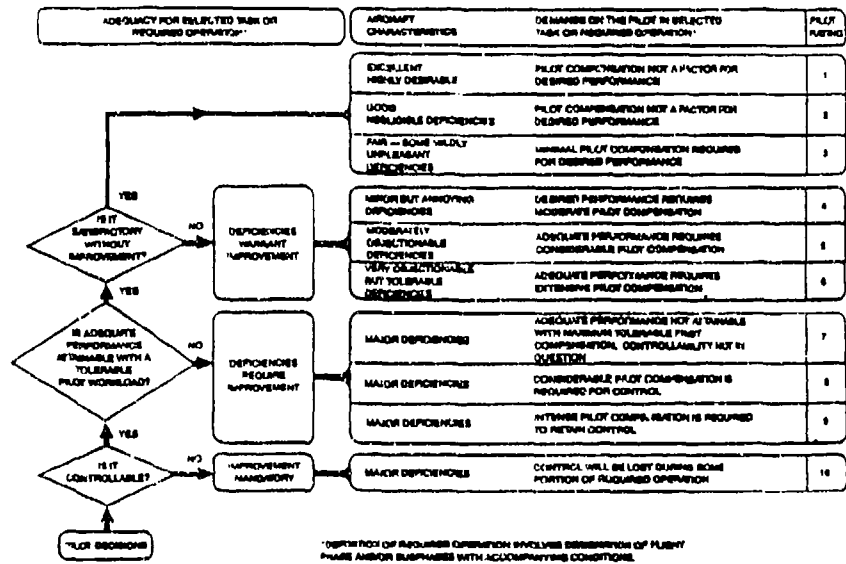

Figure 6.27 Cooper-Harper rating (adapted from ref. 1 and Cooper and Harper, 1969).

Methods

Test conditions (ref. 1)

- Simulated helicopter maneuvers: narrow slalom or dolphin (high speed), serpentine (low speed-hover) and longitudinal quick stop (transition between high and low speed).

- Task evaluation with Cooper-Harper rating were taken with different manual display lags (87 ms to 254 ms).

Experimental details (ref. 1)

- Independent variables: helicopter maneuver and manual display lag.

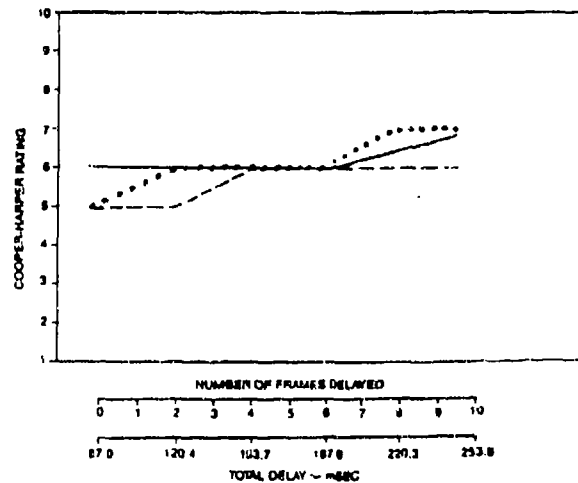

Figure 6.28 Effects of manual display lags (, ,) of flight manoeuvres (Median of 4 subjects, adapted from ref. 1).

- Dependent variables: subjective evaluation of the task with Cooper-Harper rating.
- Subject's task: fly a simulated high performance helicopter in three types of maneuver. Each maneuver took approximately 40 minutes.
- Four former military helicopter pilots participated. Their total flight time ranged from 2650 to 7300 hours.

Results (ref. 1)

- It was found that with increased manual display lag the Cooper-Harper rating increased indicating degradation in perceived handling qualities (Figure 6.28).
- For the types of helicopter simulated, there was not a definite manual display lag at which the ratings changed abruptly.

References (*: key reference(s))

- *1. Woltkamp *et. al* (1988)

Cross references

Ref. 1 in Section 6.1.3. Effects of an exponential display lag on simulated helicopter flight path estimation tasks with head-coupled systems.

6.3.2 Time lead with manual display lag

During this literature survey, few published studies concerned with the effects of lag within the manual control loop of a head-coupled system were found and only one of them dealt with lag compensation by prediction (Friedmann *et. al.*, 1992). Although time histories indicating the potential benefits of lag compensation by a Kalman filter were shown in that study, no objective data such as tracking error or time-on-target were reported. This approach to lag compensation in a manual control loop with a panel-mounted display has been the subject of many studies. Various methods have been proposed to improve the performance: single interval lead filters, Taylor series extrapolations, trapezoidal integration algorithm and split-path non-linear filters. They have been tested in manual simulation environments and the results have been published in Gum and Albery (1977), Malone and Horowitz (1987), McFarland (1988), Jewell and Clament (1987) and Hess and Myers (1985).

It is the intention of this review to concentrate on the effect of lags within head-coupled systems. Therefore, detailed reviews of the above studies have not been included in this section. Brief summaries of some of the references mentioned above are attached as Appendix B.

6.3.3 Lags in motion cue presentation

As with Section 6.3.2, no published study which dealt with the effects of lags in manual controlled motion cues within a head-coupled system was found. Similar effects of lags in motion cue presentation within a manual control loop with a panel-mounted display have been the subject of several studies. Boff and Lincoln (1988) have reviewed studies concerned with the effect of temporal mismatch of motion and visual displays on continuous tracking with simulated aircraft dynamics. Millar and Riley (1976) reported that as task difficulty increased, the amount of acceptable time delay between visual and motion cues decreases. The task difficulty was quantified by the Cooper-Harper aircraft handling quality ratings and the target frequency content.

Detailed reviews of the above studies have not been included in this section. Brief summaries of some of the references mentioned above are attached as Appendix B.

6.4 Eye-coupled visual loop

A block diagram showing an eye-coupled visual loop within a simulator is shown in Figure 4.8. This loop could provide an eye-slaved high resolution insert that blends into the visual field of the simulator. The variable investigated in this section is eye-display lag (Section 6.4.1).

6.4.1 Eye-display lag

General description

In a simulator, the concept of using an eye-slaved high resolution graphic insert in a low resolution background has been developed to provide an image scene of high detail and resolution at a reasonable cost and speed (ref. 2). This insert has previously been referred to as eye-slaved area of interest (AOI, refs. 1, 3 and 4). Two different approaches have been taken to implement this concept. The first approach was to project the insert on the inside of a dome or flat display screen (ref. 1). The second approach was to present the insert on a wide field-of-view helmet-mounted display (refs. 3 and 4). The structure of various simulators with eye-slaved insert can be found in Table 5.1, Section 5.0. In both implementations, lags occur between the onset of head and eye movement and the moment at which the eye-slaved insert responds. The sources of this lag include eye-tracker, head tracker, computer image generation and servo driven mirror assembly that steer the insert optically (refs. 1, 3 and 4). Such a lag will hereafter be referred to as 'eye-display lag'. The effect of eye-display lags on a combined target identification and manual control task was studied (ref 1). With an imposed eye-display lag less than, or equal to, 50 ms (system eye-display lag was 140 ms), little performance variation was observed. Beyond 50 ms, performance degraded appreciably (ref. 1). To locate, aim and recognize a target with saccadic eye movements, an imposed eye-display lag of 50 ms had only a minor effect on aiming accuracy, however the number of target recognized was reduced.

Applications

Development of eye-slaved high resolution graphic inserts in head-coupled simulators.

Methods (ref. 1)

Two studies from ref. 1 are reviewed here. The head-coupled system used was the Eye-Slaved Projector Raster Inset (ESPRIT) visual test bed (see Table 5.1, Section 5.0). The system eye-display lag reported was 140 ms and extra eye-display lags were additional to this 140 ms eye-display lag. The ESPRIT system comprised a flat display screen, a fixed background projector, a control stick, a graphics image generator, a helmet with integrated head and eye tracker and an eye-slaved insert projector. The background image resolution was 11 minutes of arc and its field-of-view (FOV) was $76^\circ \times 64^\circ$. The eye-slaved insert had a resolution of 2.5 minutes of arc and a FOV of 18° (circular).

Test conditions (study 1)

- Detailed performance measurements were not reported. However, they were likely to be manual tracking error and target recognition error with different imposed eye-display lags (0 ms to 150 ms, in addition to the system eye-display lag of 140 ms).
- The eye-slaved insert size was set to 18 degrees (circular).

Experimental details (study 1)

- Independent variable: imposed eye-display lag.
- Dependent variables: overall performance (it may consist of manual tracking error and target recognition error).
- Subject's task: manually steer a simulated aircraft through a narrow canyon. The aircraft's altitude and speed were fixed and lateral steering was controlled by subjects. A drift factor was introduced to add some difficulty to the task. The canyon had a narrow path on its floor for the aircraft to follow, randomly placed targets and decoys were presented along the canyon for target detection and identification. A picture of the canyon is shown in Figure 6.29.
- Twenty subjects participated. Some of whom were pilots.

Test conditions (study 2)

- Target acquisition time, reading (fixation) time for each target, and target recognition error were measured with different imposed eye-display lags (0 ms to 50 ms, in addition to the system eye-display lag).

Experimental details (study 2)

- Independent variable: imposed eye-display lag.

- Dependent variables: target acquisition time; target reading (fixation) time and recognition error.

- Subject's task: locate a target,

identify the target, and then look to the next target rapidly. Each target, if properly recognized, would provide information needed for the next saccade. Targets were presented at the four corners of the flat display screen. Each target provided a short radial line pointing towards the next target (Figure 6.30).

- Twenty-six subjects participated. Some of whom were pilots.

Results

- With an imposed eye-display lag less than, or equal to, 50 ms (system eye-display lag was 140 ms), little performance variation was observed. Beyond this level, performance degraded appreciably (ref. 1).

- To locate, aim and recognize a target with saccadic eye movements, an imposed eye-

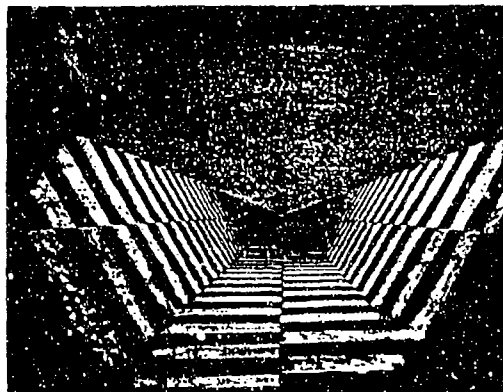

Figure 6.29 Canyon with textured floor and walls, presented on the ESPRIT system, adapted from ref. 1.

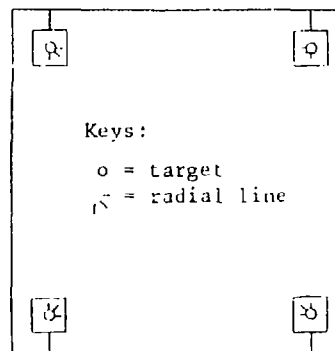

Figure 6.30 Diagrammatic illustration of the target configuration for study 2, adapted from ref. 2.

display lag of 50 ms had only a minor effect on aiming accuracy, however the number of targets recognized was reduced (see subject's task for the meaning of a properly recognized target).

Constraints

- No measurements or statistical data were shown in ref. 1.

References (*: key reference(s))

- *1. Browder and Chambers (1988)
2. Eyre and Griffin (1992)
3. Geltmacher (1988)
4. Lypaczewski *et. al* (1987)
5. Longridge *et. al* (1990)

6.5 Eye-slaved weapon control loop

A block diagram showing an eye-slaved weapon control loop within a simulator is shown in Figure 4.8. This loop enables the position control of an eye-slaved device and feeds back this position as a reticle presentation. The variables investigated in this section include eye-reticle lag and the visual feedback of the position of an eye-slaved device lagging behind the gaze angle.

6.5.1 Eye-reticle lag

General description

Similar to a head-slaved weapon (Section 6.2), lags occur in controlling an eye-slaved weapon. The position of an eye-slaved weapon is fed back to an operator as a reticle lagging behind the gaze angle. Such a lag has previously been referred to as reticle lag (refs. 1 and 2) and will hereafter be referred to as 'eye-reticle lag'. Figure 6.31 shows a diagrammatic illustration of the apparatus during the study in ref. 1. With a two dimensional band-limited random tracking task, mean radial tracking error increased with increasing eye-reticle lag (Figure 6.32). It is possible to withdraw the eye-slaved reticle feedback, in which case an operator will track in an open-loop fashion. That is, despite the lag in the dynamic response of an eye-slaved weapon, an operator will track a target as if no lags existed. Although there will be no visual indication for the eye-reticle lag, such lag remains and affects the tracking performance of an eye-slaved weapon. This lag will be referred to as a 'dynamic response lag', its magnitude will be the same as that of the eye-reticle lag. It was found that for imposed eye-reticle lags of 160 ms and below, the presentation of a reticle degrades eye tracking performance. For eye-reticle lags greater than 160 ms and up to 320 ms, no significant difference in tracking performance with and without reticle presentation was found. The system eye-reticle lag was 60 ms.

Applications

Design of eye-slaved devices and their visual interfaces with operators.

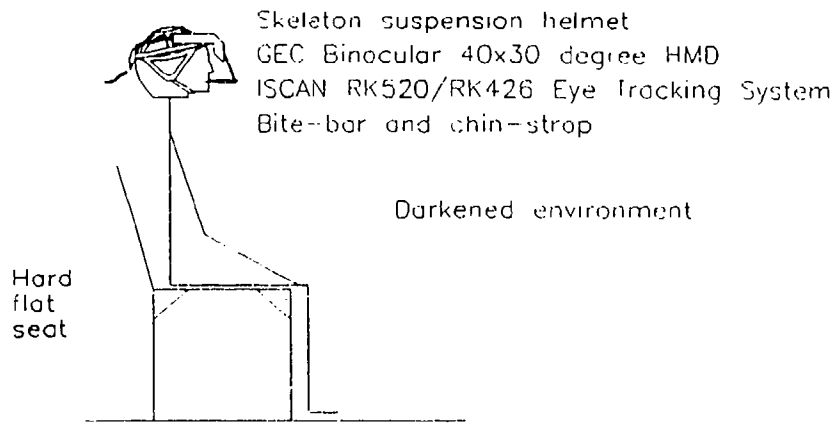

Figure 6.31 Apparatus used to investigate the effect of eye-reticle lag on eye tracking performance (adapted from ref. 2).

Methods (ref. 2)

Test conditions

- Mean radial eye tracking error was measured with different imposed eye-reticle lags (0 ms to 320 ms, with a system eye-reticle display lag of 60 ms).
- Subjects were asked to track a target with their eyes without an eye-reticle, eye displacement time histories in both pitch and yaw axes were measured. Lags from 0 ms to 320 ms were added to these time histories and mean radial tracking errors were calculated with reference to the target motion time history.

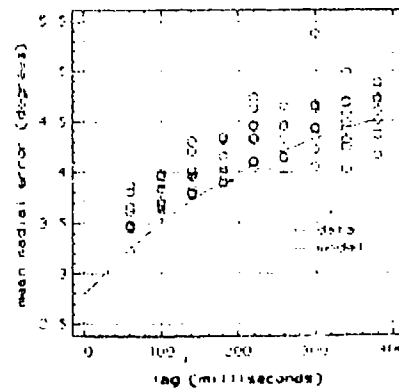

Figure 6.32 Mean radial eye tracking error with different eye-reticle lag (a curve fitting was also shown, adapted from ref. 2).

- The target motions used in both pitch and yaw axes were random signals band-pass filtered between 0.01 and 2.0 Hz (60 dB/octave roll-off). The duration was 120 seconds.

Experimental details

- Independent variables: eye-reticle lag, eye-reticle feedback and lag within an eye-slaved weapon control loop (dynamic response lag) when no eye-reticle was used.
- Dependent variables: eye displacement time history and mean radial eye tracking error.
- Subject's task: track a moving target with an eye-slaved reticle or the gaze. Both the target and the reticle were presented on a binocular helmet-mounted display at optical infinity. The reticle had a 2° radius.
- Ten male subjects participated. They were either students or researchers.

Results (ref. 2)

- Mean radial eye tracking error increased with increasing eye-reticle lag (Figure 6.32).
- Without reticle feedback, mean radial eye tracking error increased with increasing dynamic response lag of an eye-slaved weapon (Figure 6.32).
- With dynamic response lags less than, or equal to, 160 ms, there was a significant degradation in tracking performance with the addition of an eye-slaved reticle ($p < 0.01$, Wilcoxon matched-pair signed ranks two-tailed). The system eye-reticle lag was 60 ms.
- For the addition of lags greater than 160 ms and up to 320 ms, no significant difference in tracking performance with and without reticle presentation was found.

Constraints

- These findings may only apply when the target motion is band-limited random.

● Only continuous eye tracking was studied. The effect of eye-reticle lag on tasks, such as target acquisition, was not investigated.

References (*: key reference(s))

*1. Eyre and Griffin (1991)

2. Eyre and Griffin (1992)

7.0 PREVIOUS RESEARCH ON INTERACTIONS AMONG LAGS IN VARIOUS FEEDBACK LOOPS

A survey of literature has been conducted concerning the effects of interactions among lags in head-coupled simulators. The results are shown in Table 7.1.

Table 7.1 List of references concerning effects of lags in a head-coupled simulator

Lag source	head-coupled visual loop			head-slaved weapon control loop	manual control loop		eye-coupled visual loop	eye-slaved weapon control loop
	CIG	HPS	FLIR/camera	head reticle	stick	motion cues	eye visual insert	eye reticle
CIG	X			4.8	3.9		2	1.4
HPS		X		4.8	3.5,9		2	1.4
FLIR/camera			X		6			
head reticle	4.8	4.8		X				
stick	3.9	3.5,9	5		X	6.7		
motion cues					6.7	X		
eye visual insert	2	2					X	
eye reticle	1.4	1.4						X

1. Barnes (1990)
2. Browder and Chambers (1988)
3. Held (1990)
4. Eyre and Griffin (1992)
5. Grunwald *et al* (1991)
6. Miller and Riley (1976)*
7. Reid and Nahon (1987)*
8. So and Griffin (1991a)
9. William (1987)

* studies with panel-mounted display

More than 100 papers concerning the effects of lags within head-coupled systems were found. Most of the studies involved more than one lag source, but only a few investigated the interactions between individual lags.

8.0 GENERAL DISCUSSION, CONCLUSIONS AND RECOMMENDATIONS

8.1 Effects of variables within a head-coupled visual loop

8.1.1 General discussion

Head-coupled systems enable an operator to view continuously information appropriate to the instantaneous line-of-sight of the head. However, head-coupled image movements suffer lags in their responses to head movements (display lag). This type of lag causes a head-coupled image to be positioned incorrectly on a helmet-mounted display. This position error has been shown, both theoretically and experimentally, to increase linearly with increasing display lag and target velocity. Studies have shown that as display lag increased, head tracking performance decreased. In the light of the experimental findings, it is hypothesized that with a display lag within a head-coupled system, the degradation of head tracking performance is mainly due to the incorrect target position feedback (i.e. position error).

Display lag compensation by image deflection has been shown to be effective. However, the associated parallax error and the reduction in field-of-view may degrade performance when complex images in three dimensional perspective are used. The benefits of display lag compensation solely by head position prediction have been found to be restricted by high frequency noise, perceived as jittery image movement.

With display lags up to 380 ms, the combined use of a simple head position prediction and image deflection technique has been shown to restore tracking performance with less parallax error, less reduction in field-of-view and smoother image movement than the use of either image deflection or image prediction alone. The simple head position predictor was replaced by several phase lead filters, and similar head tracking performance was obtained with further reduction in both the parallax errors and the restriction of the field-of-view. These filters were optimized to produce time leads over the frequency range 0 to 0.6 Hz. So far, studies concerned with lag compensation by combined head position prediction and image deflection have only been conducted in laboratory conditions. The benefits of this lag compensation technique in a simulator environment have yet to be confirmed.

Studies of the effects of display lag have been focused on continuous head tracking tasks. Other tasks, such as target acquisition, may need further attention.

With 'search and read' tasks, exponential display lags with time constants of 0.04 second or more have been found to increase reading time. The use of combined head position prediction and image deflection to compensate the effects of exponential display lags has not been studied.

8.1.2 Conclusions and recommendations

Lag-induced position error increases linearly with increasing display lag and target velocity.

For two dimensional continuous head tracking tasks, performance has been found to be significantly degraded for display lags greater than, or equal to, 40 ms (in addition to a system display lag of 40 ms).

Measurements of mean radial error showed that the image deflection technique greatly improved head tracking performance with display lag.

The amount of deflection needed to compensate for the display lag, and the consequent reduction of field-of-view, increased in proportion to the lag. This also introduced parallax errors.

Mean radial head tracking errors were reduced by using head position prediction with phase lead filters. These filters were optimized to give time leads over the frequency range 0 to 0.6 Hz.

With lag compensation by optimized phase lead filters, the inevitable amplifications at frequencies higher than the prediction range introduced jittery image movement. This was subjectively disturbing and degraded the image quality.

With display lags, measurements of mean radial tracking error and subjective difficulty rating showed that combined image deflection and head position prediction techniques greatly improved tracking performance with less parallax error, less reduction of field-of-

view and a smoother image movement.

Studies of the effects of display lag have been focused on continuous head tracking. Other tasks, such as target acquisition, may need further attention.

The benefits of lag compensation by combined image deflection and head position prediction in a simulator environment has yet to be confirmed.

With 'search and read' tasks, exponential display lags with time constants of 0.04 second or more increased the reading time.

8.2 Effects of variables within a head-slaved weapon control loop

8.2.1 General discussion

Head-coupled systems can be used to search and designate a target. One such application is the head-slaved weapon. The instantaneous orientation of a head-slaved device can be displayed as a reticle on a helmet-mounted display. Due to the lag in the dynamic response of the head-slaved device, the reticle will always lag behind the head-pointing angle (reticle lag). The mean radial tracking error was found to increase with increasing reticle lag. With reticle lags greater than, or equal to, 80 ms head tracking performance improved when the visual feedback (in the form of a reticle lagging behind the operator's line-of-sight) was removed. However, this visual feedback may be necessary while performing operations such as 'aim and shoot' tasks, when decisions to shoot are made on the basis of tracking accuracy. As one of the key references reviewed in Section 6.2 contains results from only one subject, further studies to confirm the finding are needed. Investigations have been focused on continuous tracking so as to obtain head tracking transfer functions. However, one use of a head-slaved weapon will be to search and designate a target. Studies to investigate the effect of reticle lag in a target acquisition task are required.

8.2.2 Conclusions and recommendations

Mean radial tracking error was found to increase with increasing reticle lag.

With reticle lags greater than, or equal to, 80 ms head tracking performance improved when the visual feedback (in the form of a reticle lagging behind the operator's line-of-sight) was removed.

Studies to investigate the effect of reticle lag in a target acquisition task are recommended as this task represents a common use of a head-slaved device.

8.3 Effects of variables within a manual control loop

8.3.1 General discussion

The effects of lags on manual control performance with panel-mounted displays have been the subject of many studies: lags associated with control orders (Allen and Jex, 1968) (Privosnik *et. al.*, 1985), pure lags (Bailey and Knotts, 1987; Riccio *et. al.*, 1987), modeling the effects of lags (Levison *et. al.*, 1979; Levison and Papazian, 1987), lag compensation by phase lead filters (Crane, 1983), lag compensation by non-linear filters (Hess and Myers, 1985), lags in motion cues (Miller and Riley, 1976).

Boff and Lincoln (1988) and Boff *et. al.* (1986) have reviewed studies concerned with the effects of lags on continuous tracking whilst Merriken and Riccio (1987) have reviewed studies concerned with the effects of lags in flight simulators.

In comparison with the numerous studies on panel-mounted displays, there are relatively few publications on the subject of the effect of lags in manual control performance with head-coupled displays (manual display lag). Woltkamp *et. al.* (1988) reported that manual display lag degrades the perceived handling qualities of a head-coupled helicopter simulator. From an engineering point-of-view, it is expected that if an operator keeps his head stationary during a manual control task, the effects of manual display lag should be similar to those encountered in front of a comparable panel-mounted display. However, further studies are needed to test this hypothesis.

When an operator moves his head during a manual control task with a head-coupled display, two types of lag are present: manual display lag and display lag. Section 7.0 summarizes the results of a survey of published studies of the interactions between these

lags in a head-coupled system. In a head-coupled system, both the manual control loop and the head-coupled visual loop enable an operator to control the orientation of the entire visual field. When both loops are in operation, their visual effects may not be distinguishable. For example, an operator who pulls up the nose of an aircraft in a simulator, may tilt the head upwards rather than pull back the control stick. With the provision of adequate training this confusion may be reduced by displaying the appropriate information. However, the presence of lags in both control loops is likely to escalate the problem. Some form of lag compensation may be beneficial.

8.3.2 Conclusions and recommendations

Manual display lag was found to degrade the perceived handling qualities of a head-coupled helicopter simulator.

Studies are recommended to test the following hypothesis: in the presence of lags in both the manual control loop and the head-coupled visual loop, an operator may not be able to identify the visual feedback from an individual loop and hence performance may be degraded.

8.4 Effects of variables within an eye-coupled visual loop

8.4.1 General discussion

In head-coupled simulators, an eye-slaved high resolution graphic insert to a low resolution background is frequently used to reduce the need to compute a high resolution background covering a large field-of-view. Inevitable lags occur between the onset of a head and eye movement and the moment at which an eye-slaved insert responds (eye display lag). Imposed eye display lags greater than 50 ms have been shown to degrade lateral manual tracking performance. The simulator had a system eye display lag of 140 ms and the effect of the lag on performance was unknown. To study the effect of this lag, a system with an eye display lag of less than, or equal to, 50 ms is recommended.

Studies to investigate the effect of eye display lag on performance with continuous tracking tasks (smooth pursuit eye movement) and target acquisition tasks (saccadic eye

movement) are recommended.

In order to compensate for the eye display lag, the lag sources need to be identified. Eye display lag is reported to have been introduced in the following processes: head position measurement, eye position measurement, computer image generation and eye-slaved insert projection (Browder and Chamber, 1988). Although the relative contributions from each process varies across different head-coupled systems (Geltmacher, 1988), eye display lag is mainly introduced during eye position measurement and computer image generation. The prediction of the final eye position of a saccadic eye movement has previously been studied (Bahill and Kallman, 1983). The feasibility of applying lag compensation by means of eye position prediction and image deflection should be investigated. Simulator variables such as the size of the insert have been investigated and no significant effect was reported (Browder and Chambers, 1988). However, the combined effect of increasing eye display lag and reducing eye-slaved insert size have not yet been studied.

8.4.2 Conclusions and recommendations

Imposed eye display lags greater than 50 ms have been shown to degrade lateral manual tracking performance.

To study the effects of eye display lag, a head-coupled system with an eye display lag less than, or equal to, 50 ms is recommended.

Studies are recommended to investigate the feasibility of applying lag compensation by means of head position prediction and image deflection in systems where eye display lag is present.

8.5 Effects of variables within an eye-slaved weapon control loop

8.5.1 General discussion

The ability to use the eyes to direct an aiming device towards a target is of great potential. However, lags occur in controlling an eye-slaved weapon. The position of an eye-slaved weapon can be fed back to an operator as a reticle lagging behind the gaze angle (eye-

reticle lag). Mean radial eye tracking error increased with increasing eye-reticle lag. With eye-reticle lags, it has been shown that eye tracking performance improved when the visual feedback in the form of a reticle lagging behind the gaze angle was removed. Studies have been focused on continuous eye tracking (i.e. smooth pursuit tracking). As one use of a human eye is to search and locate a target, effects of eye-reticle lag on tasks such as target acquisition should be investigated. Such tasks are likely to involve saccade eye movements. It is hypothesized that the effect of eye-reticle lag will be more severe with saccadic eye movements than with smooth pursuit tracking movements.

8.5.2 Conclusions and recommendations

Mean radial eye tracking error increased with increasing eye-reticle lag.

With eye-reticle lags, the removal of the visual feedback in terms of a reticle lagging behind the gaze angle was shown to improve eye tracking performance.

Studies are recommended to investigate the effects of eye-reticle lag on a target acquisition task so as to test the following hypothesis: the effect of eye-reticle lag will be more severe in target acquisition tasks (saccadic eye movements) than during continuous tracking (smooth pursuit tracking).

8.6 Effects of interactions among lags in various feedback loops

8.6.1 General discussion

During the period of this research, few published studies concerning the interactions among the lags in head-coupled systems were found. Further review of the literature consulted may reveal further information.

As indicated in Section 5.0, a head-coupled simulator consists of many feedback loops, each with its associated lag. The interactions among these lags are unknown and may cause performance degradation (Section 8.3.1). However, studies to investigate these interactions may be difficult as many variables will be involved. To optimize the research effort, modeling the effects of lags on performance is required when conducting

experimental studies. The models should be developed on the basis of the following assumptions and hypotheses: (i) in a simulator, most of the lags affect an operator through their effects on the visual presentation, (ii) with an imposed lag, the degradation of performance is mainly due to the lag-induced incorrect visual feedback (Section 8.1.1) and (iii) the effects of the individual lags on performance can be linearly combined with appropriate weightings for each effect. Assumptions (i) and (ii) can be tested with laboratory experiments. For example, with display lags and reticle lags, the effects on performance can be described in two stages: (a) the lag-induced position errors in target or reticle movements and (b) the effects of these position errors on performance. Assuming there is no interaction between the two lags, their combined effects on performance can then be predicted by summing the previously known effects of individual lags. These predicted effects can again be described in two stages: (a) the position errors in target and reticle movements and (b) the effects of these position errors on performance. Experimental studies can be conducted to investigate the effects of imposed display lags and reticle lags on performance so as to test these predictions. The ratios between the measured effects and the predicted effects on performance can be calculated for different combinations of display lags and reticle lags. These ratios can then be used to establish weightings for the contributions to the overall effects from individual lags.

8.6.2 Conclusions and recommendations

Few published studies of the interactions among the lags in a head-coupled system have been found.

Experimental studies to investigate the combined effects of display lags and reticle lags on performance are recommended. It is suggested that these studies should be accompanied by a model for the prediction of the combined effects of lags.

9.0 REFERENCES

Albrecht, R.E. (1989) An adaptive digital filter to predict pilot head look direction for helmet-mounted displays. MSc thesis, University of Dayton, Dayton, Ohio.

Allen, J.H., Portoghese, J., Hebb, R.C. and Breglia, D.R. (1984) Raster Shifting Delay Compensation System. U.S. Government-owned Patent, PAT-APPL-6-442, AD-D010023.

Allen, J.H. and Hebb, R.C. (1983) Helmet-mounted display feasibility model. Advanced Simulation Concepts Laboratory, Naval Training Equipment Center, Report TR-NAVTRAEQUIPCEN IH-338, February 1983.

Allen, R.W., Clement, W.F. and Jex, H.R. (1970) Research on display scanning, sampling and reconstruction using separate main and secondary tracking tasks. NASA contractor report, CR-1569, July, 1970.

Allen, R.W. and DiMarco, R.J. (1985) Effects of transport delays on manual control system performance. p.185 - p.200. Proc. of the 20th Annual Conference on Manual Control. NASA Ames Research Center, CA., USA.

Allen, R.W. and Jex, H.R. (1968) An experimental investigation of compensatory and pursuit tracking displays with rate and acceleration control dynamics and a disturbance input. NASA Contractor Report CR-1082 prepared by System Technology, Inc. under Contract No. NAS-2-3746.

Astrom, K.J. and Eykoff, P. (1971) System identification - a survey, Automatica, vol.7, No.2, 1971, pp.123-162.

Bahill, A.T. and Kallman, J.S. (1983) Predicting final eye position half-way through a saccade. Institute of Electrical and Electronic Eng. Trans. on Biomedical Eng. BME-30, (12), 781-786.

Bailey, R.E. and Knotts, L.H. (1987) Effect of time delay on manual flight control and flying qualities during in-flight and ground-based simulation (AIAA 87-2370). Paper presented at the AIAA Flight Simulation Technologies Conference, 17th-19th August 1987, Monterey, CA., USA.

Balakrishna, S. (1975) Time domain and time series models for human activity in compensatory tracking experiments. PhD. Thesis. School of Automation, Indian Institute of Science, Bangalore, Oct., 1975.

Barnes, G.R. (1990) Predictive control of head and eye-movements during head-free pursuit in humans. *Journal of Physiology - London*, 1991, vol. 438.

Bernard, R. and Smith, Jr. (1984) Digital head tracking and position prediction for helmet-mounted visual display systems (AIAA 84-0557). Paper presented at the 22nd AIAA Aerospace Sciences meeting, 9th-12th Jan. 1984, Reno, Nevada.

Boff, K.R. and Lincoln, J.E. (1988) *Engineering Data Compendium. Vol.III, Human Engineering Division, Armstrong Aerospace Medical Research Laboratory, Wright-Patterson Air Force Base, OH 45433.*

Boff, K.R., Kaufman, L. and Thomas, J.P. (1986) *Handbook of Perception and Human Performance.* New York: John Wiley and Sons, 1986, ISBN 0-471-85061-6.

Böhm, H-DV. and Schraner, R. (1990) Requirements of an HMS/D for a Night-Flying Helicopter. *SPIE vol.1290, Conference on HMDs II, 19-20, April, Orlando, Florida, 1990.*

Böhm, H-DV, Schreyer, H. and Schraner, R. (1991) Helmet-mounted sight and display testing. *SPIE vol.1456, Conference on Large-Screen-Projection; Avionic and Helmet-mounted displays.*

Browder, G.B. and Chambers, W.S. (1988) Eye-slaved area-of-interest display systems: demonstrated feasible in the laboratory (AIAA 88-4636-CP).

Bryson, S. and Fisher, S.S. (1990) Defining, modeling, and measuring system lag in virtual environments. SPIE vol. 1256. Conference on stereoscopic display and applications, Santa Clara, 1990.

Butterfield, B.L. (1990) F-16 Helmet-mounted display flight evaluations. SPIE vol. 1290, Conference on HMDs II, 19-20, April, 1990.

Casey, C.J. and Melzer, J.E. (1991) Part-Task Training with a Helmet Integrated Display Simulator System. SPIE vol. 1456, Large-Screen-Projection, Avionic and Helmet-mounted displays.

Cooper, G.E. and Harper, R.P. Jr. (1969) The use of pilot rating in the evaluation of aircraft handling qualities. NASA TN D-5153, April.

Crane, D.F. (1983) Compensation for time delay in flight simulator visual display systems. Paper presented at the AIAA Flight Simulation Technologies Conference, Niagara Falls, 1983.

Drew, E., George, G. and Knight, S. (1987) AH-64 combat mission simulator tactical system (AIAA 87-2575). Paper presented at the AIAA Flight Simulation Technologies Conference, 17th-19th August 1987, Monterey, CA., USA.

Eyre, J.R.S. and Griffin, M.J. (1991) The effect of reticle lag on eye tracking performance. Proceedings of the Ergonomics Society's Annual Conference, Southampton, England, 16-19 April.

Eyre, J.R.S. and Griffin, M.J. (1992) Combined head and eye tracking. Final report submitted to Defence Research Agency, Farnborough, UK on research agreement 2040/462.

Friedmann M., Starner, T. and Pentland, A. (1992) Synchronization in virtual realities. Presence: vol. 1, No. 1.

Geltmacher, H.E. (1988) Recent advances in computer image generation simulation. Aviation, Space and Environmental Medicine, Vol. 59, No. 11, Section II, Nov. 1988, A39 45.

Grunwald, A.J., Kohn, S. and Merhav, S.J. (1991) Visual field information in Nap-of-the-earth flight by teleoperated helmet-mounted displays. SPIE vol.1456. Conference on large-screen-projection, avionic and helmet-mounted displays, 1991.

Gum, D.R. and Albery, W.B. (1977) Time-delay problems encountered in integrating the advance simulator for undergraduate pilot training. Journal of Aircraft, vol.14, no.4. April 1977, pp.327.

Haworth, L.A. and Bucher, N.M. (1988) Wide field-of-view helmet-mounted display systems for helicopter simulation (AIAA 88-4575-CP).

Held, R. (1990) Correlation and decorrelation between visual displays and motor output. Motion sickness, visual displays, and armoured vehicle design (pp. 64-75). Aberdeen Proving Ground, MD. Ballistic Research Laboratory.

Hess, R.A. and Myers, A.A. (1985) A nonlinear filter for compensating for time delays in manual control systems. p.93 - p.116. Proc. of the 20th Annual Conference on Manual Control, NASA Ames Research Center, CA., USA.

Jewell, W.F. and Clement, W.F. (1985) A method for measuring the effective throughout time delay in simulated displays involving manual control. p.173 - p.183. Proc. of the 20th Annual Conference on Manual Control, NASA Ames Research Center, CA., USA.

Jewell, W.F., Clement, W.F. and Hogue, J.R. (1987) Frequency response identification of a computer-generated image visual simulator with and without a delay compensation scheme (AIAA 87-2425). Paper presented at the AIAA Flight Simulation Technologies Conference, 17th-19th August 1987, Monterey, CA., USA.

Johnson, W.V. and Middendorf, M.S. (1988) Simulator transport delay measurement using steady-state techniques (AIAA-88-4619-CP).

Kalman, R.E (1963) New methods in Wiener filtering theory. Proc. First Symp. on Eng. Applic. of Random Function Theory and Prob., pp.270 - 388, Wiley, New York (1963).

Kaye, M.G., Ineson, J., Jarrett, D.N. and Wickham, G. (1990) Evaluation of virtual cockpit concepts during simulated missions. SPIE vol.1290, Conference on HMDs II, 19-20, April, 1990.

Kleinman, D.L., Baron, S. and Levison, W.H. (1970) An optimal control model of human response. Part I: theory and validation. Automatica, vol 6, pp.357-369. Pergamon Press, 1970.

Krendel, E.S. and McRuer, D.T. (1960) A servomechanisms approach to skill development. J. Franklin Inst., vol 269, No.1, Jan. 1960, pp.24-42.

Kruk, R.V. and Longridge, T.M. (1985) Psychophysical research in development of a fibre-optic helmet-mounted display. Proc. of the 20th Annual Conference on Manual Control. NASA Ames Research Center, CA., USA.

Lee, D.R. and McGreary, R.B. (1984) Anti-flutter apparatus for head mounted visual display. United States Patent No. 4,437,113. Mar. 13.

Levison, W.H., Lancraft, R.E. and Junker, A.M. (1979) Effects of simulator delays on performance and learning in a roll-axis tracking task. (AF FDL-TR-79-3134). Proceedings of the Fifteenth Annual Conference on Manual Control, Dayton, Ohio, WPAFB, Air Force Flight Dynamics Laboratory.

Levison, W.H., Kleinman, D.L. and Baron, S. (1969) A model for human controller remnant. IEEE, Trans. Man-Machine Syst., 10, December, 1969.

Levison, W.H. and Papazian, B. (1987) The effects of time delay and simulator mode on close-loop pilot/vehicle performance: model analysis and manned simulation results (AIAA 87-2371). Paper presented at the AIAA Flight Simulation Technologies Conference, 17th-19th August 1987, Monterey, CA., USA.

Lewis, C.H., Higgins, A.F., Wells, M.J. and Griffin, M.J. (1987) Stabilization of head-coupled systems for rotational head motion. Final Report for MacAulay-Brown Incorporated in Support of Prime Contract. T33613-82-0513, 71-72D.

List, U.H. (1983) Non-linear prediction of head movements for helmet-mounted displays. AFHRL Technical paper 83-45, Operations training division, Williams Air Force Base, AZ 85224, USA.

Longridge, T.M., Gainer, G.A. and Wetzel, P.A. (1990) Development of a head and eye slaved display system for a rotary wing research simulator. The Royal Aeronautical Society Conference on progress in helicopter and V/STOL aircraft simulator, 1-2, May, 1990.

Lypaczewski, P.A., Jones, A.D. and Voorkees, J.W. (1987) Simulation in support of advanced cockpit development (AIAA 87-2572). Paper presented at the AIAA Flight Simulation Technologies Conference, 17th-19th August 1987, Monterey, CA., pp.134-140.

Malone III, H.L., Horowitz, S. (1987) The impact of network delay on two-ship air-to-air combat simulation (AIAA 87-2373). Paper presented at the AIAA Flight Simulation Technologies Conference, 17th-19th August 1987, Monterey, CA., USA.

McFarland, R.E. (1988) Transport delay compensation for Computer-Generated Imagery systems. NASA Technical Memorandum 100084, NASA Ames, CA., USA.

McRuer, D. and Krendel, E. (1965) Human Pilot dynamics in compensatory systems. AFFDL-TR-65-15, July 1965. Air Force Flight Dynamics Lab Research and Technology Division, Air Force System Command, WPAFB, Ohio.

Merriken, M.S., Johnson, W.V. and Cress, J.D. (1988) Time delay compensation using supplementary cues in aircraft simulator systems (AIAA 88-416 CP).

Merriken, M.S. and Riccio, G.E. (1987) Temporal fidelity in aircraft simulator visual systems (AIAA 87-2372). Paper presented at the AIAA Flight Simulation Technologies Conference, 17th-19th August 1987, Monterey, CA., USA.

Miller, G.K. and Riley, D.R. (1976) The effect of visual-motion time delay on pilot performance in a pursuit tracking task. Paper presented at the AIAA Visual and Motions Simulation Conference, Dayton, OH, 1976, pp 55-62.

Privoznik, C.M., Berry, D.T. and Bartoli, A.G. (1985) Measurements of pilot time delay as influenced by controller characteristics and vehicle time delays. Proc. of the 20th Annual Conference on Manual Control, pp. 210-221, NASA Ames Research Center, C.A. p.210-221.

Queijo, M.J. and Riley, D.R. (1975) Fixed-based simulator study of the effect of time delays in visual cues on pilot tracking performance. Technical Note NASA TN D-8001, October 1975.

Riccio, G.E., Cress, J.D. and Johnson, W.V. (1987) The effects of simulator delays on the acquisition of flight control skills: Control of heading and altitude. Proc. of the Human Factors Society, 31st Annual Meeting, 1987.

Sharkey, T.J. and McCauley, M.E. (1991) The effect of global visual flow on simulator sickness (AIAA 91-1975-CP). Paper presented at the AIAA Flight Simulation Technologies Conference, 12th-14th August, New Orleans, LA., USA.

So, R.H.Y. and Griffin, M.J. (1991a) Optimising the response of head-coupled systems to dynamic head movements. Final report to European Office of Aerospace Research and Development (EOARD) on Grant Number AFOSR-87-0231. Report No. 91/20.

So, R.H.Y. and Griffin, M.J. (1991b) Effects of time delays on head tracking performance and the benefits of lag compensation by image deflection. (AIAA 91-2926). Paper presented at Flight Simulation Technology Conference, 12-14 August.

So, R.H.Y. and Griffin, M.J. (1992) Phase lead algorithms for head position prediction. Institute of Sound and Vibration Research Contract Report 92/06, University of Southampton, Southampton, England.

Sobiski, D.J. and Cordullo, F.M. (1987) Predictive compensation of visual system time delays (AIAA 87-2434). Paper presented at the AIAA Flight Simulation Technologies Conference, 17th-19th August 1987, Monterey, CA., USA.

Swenson, H.N., Zelenka, R.E., Hardy, G.H. and Dearing, M.G. (1991) Simulation evaluation of a low-altitude helicopter flight guidance system adapted for a helmet-mounted display. IEEE 10th Conference on Digital Avionics Systems, Los Angeles, CA, pp.115-124.

Tustin, A. (1947) The nature of the operator's response in manual control, and its implications for controller design. Journal of the Institution of Electrical Engineers, vol 94. Part IIA, No.2, 1947, pp.190-202.

Warrick, M.J. (1949) Effect of transmission-type control lags on tracking accuracy (AF-5916) Wright-Patterson AFB, OH: Air Material Command (DTIC No. AD630292).

Wells, M.J. and Griffin, M.J. (1987a) A review and investigation of aiming and tracking performance with head-mounted sights. IEEE Transactions on System, Man, and Cybernetics, SMC-17, (2), 210-221.

Wells, M.J. and Griffin, M.J. (1987b) Performance with helmet-mounted sights. Institute of Sound and Vibration Research, Report No. 152, University of Southampton, Southampton, England.

Wells, M.J., Venturino, M. and Osgood, R.K. (1989) The effect of field-of-view size on performance at a simple simulated air-to-air mission. Proceedings of SPIE Conference on Helmet-mounted Displays, 28-29 March 1989, Orlando, Florida, vol 1116.

Whiteley, A.L. (1947) Fundamental principles of automatics regulators and servo mechanisms. Journal of the Institution of Electrical Engineers, vol.94. Part IIA, No.1, pp.5-19.

Williams, J.N. (1987) A piloted simulation investigating handling qualities and performance requirements of a single-pilot helicopter in air combat employing a helmet-driven turreted gun. M.Sc. Thesis, Naval Postgraduate School, Monterey, California, Sept. 1987 (AD-A186878).

Woltkamp, J. and Ramhandran, S. (1988) Determination of helicopter simulator time delay and its effects on air vehicle development (AIAA 88-4620-CP). Paper presented at the AIAA Flight Simulation Technologies Conference, Aianta, Sept. 1988.

APPENDIX A

Structure of categorization: conceptual description and visual illustration

The conceptual description

This section describes the categorization process involved in Stage 1 described in Section 3.0.

An operator-in-the-loop head-coupled simulator can be modelled as a combination of feedback loops, with the 'head-coupled loop' as the base (Figure 4.7). These feedback loops are formed by combinations of simulator components with their associated sources of lag. It is the objective of this stage to identify the system architecture of a head-coupled simulator by its simulator components. Examples of feedback loops with their simulator components and sources of lags are listed as follows:

<u>Feedback loop</u>	<u>Simulator component</u>	<u>Source of lag</u>
head-coupled loop;	simulator database; computer image generator; helmet-mounted display; head-pointing system;	computer image generator; head-pointing system head position predictor;
manual control loop without motion cues;	aircraft stick control; aircraft dynamics simulator;	stick response; aircraft dynamics simulator;
manual control loop with motion cues;	aircraft stick control; aircraft dynamics simulator; motion platform;	stick response; aircraft dynamics simulator; vibrator response;
head-slaved weapon control loop.	head-slaved weapon simulator; cursor display unit to project an aiming reticle.	dynamic response of the weapon represented by a delayed aiming reticle.

The above lists are not meant to be exhaustive, for example simulator components such as sound cues and eye-trackers are not listed. Having identified the components within the head-coupled simulator, a model of the specified pilot-in-the-loop head-coupled simulator can be constructed (e.g. Figure 4.8).

Visual illustration of the categorization process

As discussed in Section 3.0, the detailed matrix classification of the variables suggested in the contract has been replaced by a combination of simulator modeling and categorization of variables according to the feedback structure of the model (see Section 5.0). Consequently, the matrix layout has been replaced by a series of diagrammatic illustrations (Stages 1 to 3 are outlined in Section 3.0):

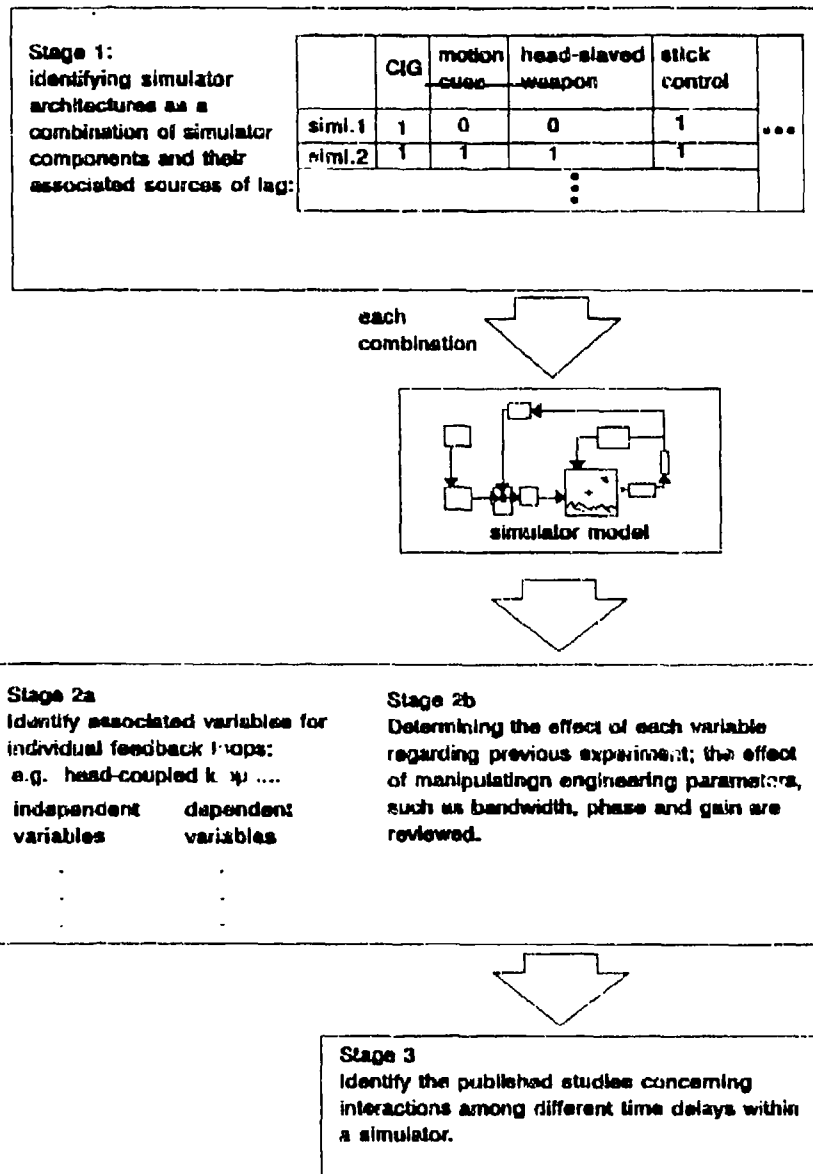

APPENDIX B

**Summaries of literature concerned with the effects of lags on manual control with
panel-mounted displays**

Author: Allen R.W., DiMarco, R.J. (1985).

Aim: To further understand the effect of various potential sources of transport delays, a computer model analysis was undertaken using a generic vehicle control model. (Manual control).

Equipment: Computer modeling.

Task: Basic control example for the analysis model concerns generic vehicle tracking (e.g. dog-fighting).

Subjects: None.

Conditions: Three sources of computational delay:

- 1) Equivalent delay for vehicle handling qualities. (0/ for analog vehicle; 0.075 second for modern digital aircraft).
- 2) Delay for display system. (0/ for analog processor; 100 ms for general CGI raster scan devices).
- 3) Delay for motion feedback (no delay or 250 ms for typical simulator).

Conclusions:

- Control bandwidth of the operator/vehicle system drops dramatically as various delays are added into the simulation loop.
- Maximum vehicle heading deviation nearly doubles in the worst delay case compared to the no delay condition.

Author: Bailey, R.E., Knotts, L.H. (1987)

Aim: Generation of guidelines and development of a data foundation for the specification of allowable time delay in ground-based simulators.

Equipment: USAF Flight Dynamics Laboratory NT-33A variable stability aircraft modified as in-flight simulator.

Tasks: Marriage of flying qualities and manual control concerns:

- fly the simulator with step-and-ramp attitude command
- compensatory attitude tracking tasks.

Subjects: 3 evaluation pilots.

Conditions:

- Addition of time delay in pitch and roll axes from 0 to 240 msec.
- 4 aircraft configurations (F-16; C-21; C-17; C-141)
- Motion cuing (Fixed base/Inflight).

Conclusions: For in-flight simulation of highly manoeuvrable and highly responsive fighter, total delay of up to 150 ms (100 ms plus 50 ms experimental added delay) are tolerable in a simulation environment.

The above experiment was replicated using the NT-33A as a ground simulator. Significant flying qualities differences were shown to exist particularly for a highly responsive, aggressively flown aircraft.

Author: Gum, D.R., Albery, W.B. (1976).

Aim: Investigating the time delay problems, delay compensation and the disparity of motion and visual system cue in the Advanced Simulator for Undergraduate Pilot Training.

Equipment: Advanced Simulator for Undergraduate Pilot Training (ASUPT). It comprised: 1) two basic T-37B simulators 2) two wide-angle visual displays, and 3) a shared visual computer image generator.

Task: Formation flight capability, approach and landing manoeuvres.

Subjects: Unknown.

Conditions: Two delay compensation techniques: 1) single interval lead 2) Taylor series extrapolation plus single interval lead.

Conclusions: The approximate delays and contributions from the visual, motion and G-seat system are identified and measured. The greatest impact of delays seemed to be in formation flight and control of aircraft roll position which required more precise and rapid control than other tasks like approach and landing manoeuvres.

Attempts to extend the extrapolation resulted in an objectionable lack of smoothness. Recommendation was made to abandon Taylor series extrapolation in favor of using only the single-interval lead.

Authors: Hess, R.A., Myers, A.A. (1985)

Aim: Analyses and experimental evaluation of a non-linear filter configured to provide phase lead without accompanying gain distortion.

Equipment: Simple arrangement of CRT display and an isometric control stick.

Task: Single-axis compensatory tracking task involving a human operator.

Subjects: Five subjects were used.

Conditions: Four different combinations of delay and compensation methods were used: 1) no delay, no compensation (nominal case); 2) 0.25 second delay, lead-lag compensation; 3) 0.25 second delay, split-path nonlinear filter (SPAN) filter; 4) 0.25 second delay, no compensation.

Conclusions: The non-linear SPAN filter is superior to a linear lead/lag compensator in its ability to maintain system stability. However, SPAN does not increase tracking accuracy over the lead-lag filter. Computer analysis indicated that this is caused by the harmonics produced and is most noticeable for low frequency inputs. Finally, a new arrangement for a SPAN filter was proposed which allows low frequency inputs.

Authors: Jewell, W.F., Clement, W.F. (1985)

Aim: Describe the critical task tester algorithm which can both measure the effective time delay of a modern flight simulator and quantify the performance of the closed-loop pilot simulator system relative to the "real world" (manual control).

Equipment: Not specified.

Task: The particular manual control task was to stabilize an unstable controlled element using the critical tracking task.

Subjects: Not specified.

Conditions: Not specified.

Conclusions: Performance with 100 ms throughout delay was degraded by about 26 percent and, at 200 ms, by 49 percent. The technique, called the split path nonlinear filter or SPAN was proposed for lag compensation.

Author: Jewell W.F., Clement, W.F. and Hogue, J.R. (1987)

Aim: Describing the technique and results in a frequency response identification of a computer-generated image (CGI) visual simulator (Manual control).

Equipment: Vertical Motion Simulator (VMS) in National Aeronautics and Space Administration (NASA) Ames Research Center (ARC). It was configured to simulate UH-60A

Task: Pitch attitude and heading control.

Subject: One UH-60A test pilot.

Conditions: With and without a novel delay compensation scheme.

Conclusions: Results show that the CGI compensation scheme can eliminate the phase lag due to a pure time delay up to about 2 Hz, but above this frequency, the CGI response has phase lead and gain amplification.

Author: Johnson, W.V., Middendorf, M.S. (1988)

Aim: Describe a flight simulator transport delay measurement technique along with detailed apparatus descriptions and application consideration.

Equipment: PDP11/60 digital computer was used for real time simulation computer. The graphics computer was a Silicon Graphics Inc. IRIS 3020 and the visual display was presented on a 19 inch diagonal raster scan monitor. Primary delay measurement instrument was a Befco Inc. frequency response analyzer model 916.

Task: The phase shift through the simulation, from stick input to display device, was measured at a fixed frequency.

Subjects: -----

Conditions: -----

Conclusion: The frequency domain measurement technique proved to be useful in measuring and identifying time delay contributions from each part of the simulation system.

Patent

Inventors: Lee, D.R., McCreary, R.B. Mar 13, 1984.

Assignee: The United States of America as represented by the Secretary of the Air Force, Washington, D.C.

Abstract: An anti-flutter apparatus for a head-mounted visual display having servo-controlled reflective surfaces to provide corrections to head rotations which occur before a visual scene generation system is able to respond to the head movement.

Summary of the invention:

The computer generated imagery is projected via a mirror system to a head mounted display system. A central computer which controls the image generating system, generates an error signal which is derived from a head position sensor and the relative position of the generated scene. The error signal is applied to the servo actuator unit to correct the visual image for the measured head position.

Authors: Levison, W.H., Papazian, B. (1987)

Aim: Explore the effects of time delay and simulator mode on close-loop pilot/ vehicle performance by model analysis and experimentation (Manual control).

Equipment: **Model:** Optimal control mode (OCM).
Experiment: Ground base and in-flight simulations (NT-33).

Task: Target-tracking task in roll axis and pitch axis.

Subjects: 3 test pilots.

Conditions: - "F 16" and "C-H1".
- Ground based and in-flight simulation.
- Addition of 0 or 180 msec delay.

Conclusions: Trends predicted by pre-experiment model analysis were largely confirmed by the experimental study and replicated by post-experimental model analysis. Specifically,
- Addition of 180 msec delay caused an increase (around 22%) in r.m.s tracking error.
- Delay had larger effect on generic fighter flown aggressively ("F-16") than on the generic heavy transport ("C-141") flown in a more relaxed manner.
- Error scores were slightly larger in the ground-based simulation than in the in flight simulations.

Authors: Malone H.L., Horowitz S. (1987)

Aim: Determine the maximum tolerable between-simulator transport delay (BSTD) that could be accepted before a pilot would make a change in tactics during a combat air-to-air network simulation. The use of a predictor was also investigated.

Equipment: Air Combat Manoeuvring Instrumentation (ACMI) at Luke AFB.

Task: The manoeuvres cover those most commonly used in an A/A engagement: a gun tracking shot, missile shot, high deflection gun shot, and a defensive manoeuvre.

Subjects: Five highly experienced fighter pilots.

Conditions: - BSTD delays of 0, 0.2, 0.5, 1.0 and 1.5 seconds.
- Two conditions: with and without the predictors.

Conclusion: For the manoeuvres tested, a delay of 250 ms can be accepted with little degradation. Additionally, a simple first order predictor can extend this maximum delay to 500 ms.

Authors: Merriken, M.S., Johnson, W.V. (1988)

Aim: Investigate the effects of providing real-world supplementary information to the visual and tactile modalities to reduce the deleterious effects of a delayed primary display on operator control performance.

Equipment: A fixed-base simulator and an in-cockpit motion simulator. In addition, the dynamic seat of the Advanced Low Cost G-cuing system (ALCOGS) in-cockpit motion device was used for the motion supplementary cue condition.

Task: A disturbance regulation task where the subjects were required to maintain constant altitude over a flat terrain grid and remain parallel with the longitudinal lines. (All tasks had a transport delay of 200 ms).

Subjects: Forty two non-pilot subjects participated. They were parsed into 7 groups of 6 subjects: 6 experimental and one control group.

Conditions:

- Two transport delays for supplementary cues: 67 ms and 200 ms.
- Three cuing conditions:
 - (1) dynamic seat motion cue.
 - (2) altitude indicator cue.
 - (3) peripheral horizon cue.
- One control condition = no cuing.

Conclusion: Faster updating secondary cues produced better r.m.s. error performance for altitude control. The trend was the same for heading control but was not statistically significant. When compared to the control condition (no cuing), none of slower cuing conditions produced statistically significant performance improvement for either heading or altitude control. However, in all cases, performance was better with faster cuing.

Authors: Merriken M.S., Riccio G.E. (1987)

Summary: Contains a review of the literature concerning the effects of visual feedback delay on pilot flight-control performance in simulation environments. A summary of research to date and future research approaches taken by the Human Engineering Division of the Armstrong Aerospace Medical Research Laboratories is also presented.

Author: Miller, G.K., Riley, D.R. (1976)

Aim: Determine the effect of visual-motion time delays on pilot performance of a simulated pursuit training task.

Equipment: Langley Research Center Visual-Motion Simulator (VMS).

Task: Primary - track a target aircraft that was performing sinusoidal oscillation. (Manual tracking).
Secondary - tapping alternative strips (to increase the pilot workload).

Subjects: Unknown.

Conditions: Time delay = 0.047 to 0.547 second in steps of 0.03125.
Task difficulties = 15 handling quality.
Target frequency effects (50% & 100% increase).
Motion cues = with/without.

Conclusion: As task difficulty (determined by airplane handling qualities or target frequency) increased, the amount of acceptable time delay decreased. However, when relatively complete motion cues were included in the simulation, the pilot could maintain his performance for considerably longer time delays.

Authors: Privoznik, C.M., Berry, D.T. (1985)

Aim: Measurement of pilot time delay as influenced by controller characteristics and vehicle time delays.

Equipment: Three control stick configurations: space shuttle stick and conventional general-purpose sticks with two different spring constants. The shuttle cockpit simulator in Ames Dryden Simulation laboratory was used.

Task: First-order, closed-loop, compensatory tracking task in pitch axis was used.

Subjects: Four test pilots and one non-pilot engineer.

Conditions: Three control stick configurations and two system delays: 48 and 236 ms.

Conclusion: The data indicate that the heavy conventional controller had the lowest effective pilot time delay values associated with it, with and without the added system delay. Each control stick experiment showed an increase in pilot time delay when there was an increase in total delay.

Changes in pilot time delay because of increases in system time delay were much more significant than changes because of manipulator characteristics.

A secondary experiment using the critical task tester indicated that the pilot time delay was unaffected by previous piloting experience but was influenced by video game experience.

Author: Queijo M.J., Riley D.R. (1975)

Aim: Investigate the acceptable time delay in visual cues during simulated pilot tracking exercise.

Equipment: Langley Research Center Visual-Motion Simulator (VMS).

Task: Primary - track a target aircraft which was performing a sinusoidal oscillation in altitude (Manual tracking).
Secondary - tapping two metal strips alternately as rapidly as convenient.

Subjects: Two.

Conditions: Delay in steps of 0, 1, 2, 3, 4, 5 and 8 were used. (One step = 0.03125 second).

Conclusions: 1) Increasing the task complexity or degrading the vehicle handling qualities reduces the acceptable level of visual-scene time delay.
2) Even small delays in the order of 0.047 second can have an adverse effect on pilot performance for some aircraft configurations. The maximum acceptable time delay was about 0.141 second.

Authors: Riccio, G.E., Cress, J.D. (1987)

Aim: Investigate the effects of simulator delays on performance, control behavior, and transfer of training (Manual control).

Equipment: Flight dynamics simulation by digital computer PDP11/60 and display through high-resolution raster-graphics system (Silicon Graphics 2400).

Task: Maintain constant heading and altitude in the presence of pseudo-random roll-rate and pitch-rate disturbances.

Subjects: Thirty-six people participated. They were assigned to four groups of nine subjects, none of the subjects were pilots.

Conditions: Four time-delays: 50, 100, 200 or 400 ms.
Two aircraft types: Highly responsive dynamics or sluggish dynamics.

Conclusions: Simulator delay degrades control performance throughout the learning process, however, the effects of adding a small amount of delay (100 ms) is negligible. No important effects of small delays (100-200 ms) on transfer performance (transfer of training to a system with smaller delays) was found. However, delays larger than 200 ms may be problematic.

Authors: Sobiski, D.J., Cardullo, F.M. (1987)

Aim: Effect of delays in flight simulation is explored and a predictive method of compensation is tested in an experimental environment (Manual control).

Equipment: 80286 based desk-top computer programmed to simulate an executive class jet aircraft dynamics.

Task: Manual control task (pitch and roll) of a linear model of executive class jet aircraft dynamics with input disturbances.

Subjects: 9 subjects (all had simulator experience).

Conditions: 1) With no predicting filter on the output.
2) With the lead/lag filter.
3) With a full state feedback predictor filter with state estimation.
4) With a reduced order predictor filter on the output.
Time delays of 200, 400 and 800 ms are inserted for each experiment.

Conclusions: Frequency analysis shows the state predictor filter can restore phase and gain margins to the system for delay as long as 800 ms.

Authors: Wolfkamp, J., Ramahandran, S. (1988)

Aim: Determine the actual simulator hardware time delay and its effect on pilot performance.

Equipment: McDonnell Douglas Helicopter Company simulators including GEC CompuScene IV (CIV) digital image generation system, McFadden hydraulic system and a Servo Optical Projection System (SOPS) that optically combined the images, and positioned the projection lens through servo control in either a fixed forward mode or in a head-tracking mode.

Task: Pilots required to fly three different types of course: narrow slalom/dolphin; serpentine and longitudinal quickstop.

Subjects: 4 pilots took part.

Conditions: Pilots were exposed to 0, 2, 4, 6 and 10 frames delay. (One frame delay is 16.7 ms)

Conclusions: Measurements showed that the average throughput delay was approximately 87 ms.
No dramatic changes due to increased simulator delay were found but pilot control activity was increased in the low speed, high gain tasks.