

AD-A278 261



2

Logistics Management Institute

Armaments Coproduction at a Crossroads

U.S. Policy Options After the Cold War

IR305LN1

DTIC
SELECTE
APR 19 1994
S F D

Frans Nauta

This document has been approved
for public release and sale; its
distribution is unlimited.

THIS DOCUMENT IS UNCLASSIFIED

94-11690



6508



94 4 18 14 7

April 1993

Armaments Coproduction at a Crossroads

U.S. Policy Options After the Cold War

IR305LN1

Accession For	
NTIS CRA&I	<input checked="" type="checkbox"/>
DTIC TAB	<input type="checkbox"/>
Unannounced	<input type="checkbox"/>
Justification	
By	
Distribution /	
Availability Codes	
Dist	Avail and/or Special
A-1	

Frans Nauta

DTIC QUALITY INSPECTED 3

Prepared pursuant to Department of Defense Contract MDA903-90-C-0006. The views expressed here are those of the Logistics Management Institute at the time of issue but not necessarily those of the Department of Defense. Permission to quote or reproduce any part except for Government purposes must be obtained from the Logistics Management Institute.

Logistics Management Institute
6400 Goldsboro Road
Bethesda, Maryland 20817-5886

PREFACE

LMI undertook this study to reexamine U.S. Government policy on licensed production or coproduction of U.S. weapon systems in light of the dramatic changes in the global defense environment. The end of the cold war, the resulting decline in defense procurement budgets, and the increasing globalization of defense technology have altered the traditional frame of reference that has guided U.S. policy in the past. Although their net impact would be difficult to generalize, these changes, we believe, could raise the long-term costs of defense technology exports for licensed/coproduction (because of adverse long-term impact on U.S. defense industry's global market share) and reduce the benefits to the United States (in terms of traditional security assistance objectives). If true, this shift should be reflected in a more discriminating, case-by-case evaluation of proposed coproduction programs or technology export license applications, to reduce or eliminate potentially adverse impacts on the U.S. defense industrial base. Alternatively, reciprocal arms collaboration could replace coproduction as it has been practiced in the past.

While the industrial base impact is only one of many issues associated with licensed/coproduction, it is arguably the most controversial and intractable one. It is also an issue largely ignored in the past when politico-military considerations were paramount. To address this issue, we conducted case studies of tactical missiles that have been offered for licensed/coproduction in the past 30 years. The case studies identify the factors that, seen in retrospect, influence or determine long-term impacts on the U.S. defense industrial base. This approach could be developed into a decision support system that would give the cognizant approval authorities – State, Defense, and Commerce – a more systematic methodology for case review.

The paper describes lessons learned from three tactical missile coproduction programs and from one commercial export of missile production technology; critiques the processes used in making coproduction and technology transfer decisions; argues the need for a new paradigm to guide international armaments cooperation after the cold war; draws some conclusions; and reviews options open to U.S. policymakers. An annotated briefing and documentation of the case studies are at Tabs A and B, respectively.

The case studies were conducted with the help of C. Bruce Baird, consultant to LMI, whose contribution is acknowledged and appreciated.

**ARMAMENTS COPRODUCTION AT A CROSSROADS:
U.S. Policy Options After the Cold War**

Over the past three decades, the U.S. Government has approved the export of technical data, manufacturing process technology, tooling, and parts in support of foreign production – in whole or in part – of more than 140 U.S.-designed weapon systems. An important question is whether this practice of licensed production – or “coproduction” when done through the Foreign Military Sales (FMS) system – is still in the best interest of the United States or whether a more reciprocal form of arms collaboration would be more effective in preserving the competitive posture and viability of the declining U.S. defense industrial base.

BACKGROUND

Coproduction became a tool of U.S. foreign policy in the 1950s. Through the associated massive transfer of American technology, coproduction was used as an effective mechanism to help rebuild the defense industries of the European NATO countries, thus enhancing their defense preparedness and self-sufficiency. Ever since, the Department of Defense (DoD) has supported coproduction with U.S. allies and other friendly nations in accord with foreign policy and national security objectives. The emphasis, however, has shifted over the years from enhancing allied military capabilities (1960s) to promoting security assistance sales (early 1970s and 1980s) to fostering standardization and interoperability (late 1970s) to reducing alliance-wide duplicative research and development (R&D) costs (1980s). Formal DoD policy, as articulated in DoD Directive (DoDD) 2000.9, issued in 1974, is to encourage and support coproduction with “eligible countries” when it improves their military readiness or promotes U.S.-allied standardization of equipment and interoperability of forces, thus enhancing combined operational capabilities.

The traditional U.S. policy on transferring technology to allied or friendly countries was justified during much of the Cold War era, when the politico-military objectives of coproduction outweighed the potential economic-industrial ramifications. Those technology transfers, however, have been a mixed blessing for the U.S. defense industry. On the one hand, they provided a dominant position for

U.S. technology in the global arms market of the past. In some cases, the U.S. offer of coproduction forestalled the development of competitive foreign technologies (e.g., Germany) or preempted similar offers by other countries (e.g., France). On the other hand, in many countries these technology transfers have helped accelerate foreign technological and industrial advances to a level of approximate parity with U.S. defense industry, resulting in strong and growing competition for market share in next-generation weapon systems.

Since the early 1980s, the Congress has expressed concern about possible adverse impacts of coproduction on the U.S. defense industrial base, viewing coproduction as a form of counter-trade or "offset" (a compensatory arrangement required by the buyer as a condition of purchase). In essence, coproduction had become a marketing tool for arms sales rather than a form of armaments cooperation. The ensuing debate has focused on the *direct* impacts of these transactions, especially the perceived loss of U.S. jobs in the defense sector subtiers. Those concerns, however, were easily countered by executive branch data showing that total offsets amounted to only 25 percent of defense exports, on a delivery basis, with "direct offsets" (involving the goods or services being procured) representing less than half of that total, and licensed or coproduction less than half of direct offsets, or approximately 5 percent of defense exports. As a result, the Office of Management and Budget concluded that "the economic and industrial benefits of military export sales made possible by offsets significantly outweigh the costs of those offsets."

We believe that a more balanced assessment of the costs and benefits of coproduction should include consideration of the *indirect*, long-term impacts of technology transfers, particularly the creation of foreign competitors for follow-on weapon systems at the expense of the U.S. defense industry's opportunities in the global market. The argument has been offered that those long-term impacts are very difficult to assess. Although that is partly true, it simply points to the woefully inadequate knowledge base available to U.S. decision makers and the need for conducting field research or intelligence gathering. Such investigations would focus on specific industrial capabilities of U.S. allies and their exploitation of U.S. defense technology and production information beyond the confines of the licensed/coproduction arrangement. We traced a number of specific defense technology transfer cases to find out whether such research would be feasible and fruitful for assessing the long-term impacts.

CASE STUDIES

Our examination of a number of tactical missile coproduction programs indicates that some programs have been beneficial, some detrimental, to the U.S. defense industrial base. The difference, we found, can be explained as a function of program characteristics (e.g., the extent and significance of technology transfer; weapon system complexity), partner country characteristics (defense trade and industrial policy, technological and industrial capabilities), market conditions (demand for the weapon system in question, competing foreign candidates, foreign rate of innovation), and the pace of U.S. weapon system modernization. For example, coproduction programs involving only limited or insignificant technology transfer (e.g., "co-assembly") invariably have been beneficial in terms of raising U.S. defense exports without risking future competition resulting from foreign advances based on the transferred technology. In contrast, when the entire production capability and know-how were transferred to other countries, the effect depended on the other factors cited above.

In the case of *Hawk* coproduction, a medium air defense system, the overall effect was beneficial. The complexity of this undertaking with NATO (the number of countries and subcontractors involved) and of the system itself (the number of major end items and interfaces) may have impeded, we believe, the foreign exploitation of transferred technologies for the development of their own follow-on systems. Moreover, two decades of sharing U.S. product improvements with the coproducing consortium resulted in a close relationship between licensor and licensees over the life cycle of the system, benefiting both sides. The transferred technology, as the record shows, "evaporated" in all but one of the participating countries. In our assessment, the considerable U.S. sales generated by this coproduction program easily outweighed the impact of one country's (France) exploitation of the *Hawk* technology for its development of an indigenous short-range point air defense system, the *Crotale*.

In the case of *Stinger* coproduction, however, the effects are less clear. After several years of preparation, foreign production is just beginning at the very time that U.S. demand is dwindling. This follows the closure of the domestic dual source shortly after it had been created at a cost of \$130 million to engender more competition in domestic procurement. Survival of the remaining single domestic source until the follow-on system emerges will depend on successful exports in the face of intense foreign competition offering independently developed and innovative

system solutions. Moreover, in view of the coproducer's proven technological capabilities, there is considerable risk that foreign innovation may result in a next-generation man-portable missile system fully competitive with U.S. developments. With hindsight, we believe that this coproduction program with Germany (as lead nation) did not serve the U.S. defense industry's long-term interests. While coproduction is frequently justified by U.S. contractors with the argument that "half a loaf is better than none," we believe that in this case there were alternatives that were not considered at the time. The contention that Germany otherwise might have proceeded with a competitive French coproduction offer for a similar system, the *Mistral*, is misleading because the original *Stinger* coproduction MOU (1983) predated the *Mistral's* entering production (1988). The *Stinger* coproduction program, essentially, was the result of a political decision.

In a more recent case, with the Republic of Korea seeking licensed production of either *Stinger* or *Mistral*, the U.S. Government refused to transfer the missile's guidance and warhead technology, leaving the contract to the French. This U.S. refusal, however, was based on concerns about potential diversion of this technology rather than the potential industrial base impact. In contrast, the separate *Stinger* coproduction arrangement with Switzerland can only be viewed in positive terms, we believe: the program involves less transfer of technology than in the above cases and is actually closer to a co-assembly arrangement with high U. S. content; moreover, there is little risk of Swiss derivatives of the transferred technology that would compete for market share in the follow-on market.

Importantly, the traditional U.S. paradigm for coproduction with advanced industrial countries (limiting coproduction to systems whose U.S. production is ending, with follow-on systems ready to enter production, in order to ensure the U.S. technology lead despite technology transfers) evidently has become inoperative since the mid-1980s. Recent programs have involved current-generation U.S. systems having no successor in engineering and manufacturing development or having a tardy development cycle outpaced by the foreign rate of innovation. In either case, foreign competition in the follow-on market can be the unavoidable consequence. For example, German improvements to the license-produced AIM-9L *Sidewinder* missile resulted in a missile comparable to the U.S. follow-on (AIM-9M), which not only was fielded later but was not releasable to foreign customers for several years. As a result, German industry took the European *Sidewinder* missile upgrade market away from the U.S. prime contractor — a business volume estimated to total about

\$350 million in the 1990s. Moreover, European missile developments appear to offer better prospects than do the current U.S. paper designs to satisfy the future *Sidewinder* follow-on requirement. In contrast, the earlier AIM-9B *Sidewinder* coproduction program with NATO countries had no such adverse repercussions, since it complied strictly with the above paradigm: the much improved successor version, AIM-9D, was being fielded with U.S. forces when the coproduction program for the B version got under way.

In addition to these coproduction programs, we examined other forms of defense technology transfer conducted on a strictly commercial, industry-to-industry basis – a form of technology transfer destined, we believe, to become more prevalent in the 1990s as a result of the globalization of the defense industry. An example is the recent export of the technology for the VT-1 missile – a missile designed, developed, and manufactured by a U.S. defense contractor under a commercial arrangement with a French firm without any DoD involvement beyond export licensing. Originally aimed at the international market as well as at the U.S. Army's forward area air defense system (FAADS) program, this venture became a technology giveaway when the French firm, after losing the FAADS competition, exercised its option to terminate missile production in the United States. As a result, the entire U.S.-origin technology (technical data, production engineering, and tooling), together with competitive pricing information, was transferred to Europe after the initial U.S. production run. The superior quality of this missile (in terms of performance vs. cost), which was used to upgrade the capabilities of the French *Crotale* to the *Crotale-NG*, allowed the French company and its European associate contractors to capture a growing share of the global market for ground-launched short-range air defense missile systems.

We assess this commercial defense technology transfer as detrimental to the U.S. defense industrial base. It demonstrates the potential for diverging interests between individual U.S. companies (fighting to enter a new market) and the U.S. defense industry at large (dependent on maintaining its competitive advantage over foreign competitors). It also shows that a government, apart from national security and foreign policy considerations, cannot leave defense trade activity to free market forces if the sovereign claim to a viable defense industrial base is to be secured.

GOVERNMENT REVIEW PROCESSES

Although this small sample of missile technology transfer cases may not fairly represent the over 140 coproduction programs of the past three decades, our findings raise some serious questions about the Government's review of coproduction agreements and export license applications for defense technology. We examined both processes and found that neither adequately considers the potential risks of foreign technology "breakout" stemming from U.S. technology transfers and the resulting repercussions for the U.S. defense industry's competitive posture in the global arms market.

The State Department's munitions export control system, which governs the export of defense articles and technical data, essentially is designed to keep significant military equipment, technical data, and services out of the reach of potential U.S. foes. License applications for defense technology exports to nonembargoed countries are normally referred by the State Department to the cognizant DoD office, the Defense Technology Security Administration (DTSA), for advice on technology releasability. DTSA makes its determination partly on the basis of foreign availability of like technology. It follows a policy of "phased releasability" to allied and friendly countries for advanced conventional weapon systems technologies, other than the most exotic ones that are restricted to maintain the U.S. technological edge – at least that is the theory. Because industry is generally well aware of what is not releasable, the typical application for export of conventional weapons technology to a nonsuspect company located in one of the CoCom (Coordinating Committee for Multilateral Export Controls) countries is routinely approved – it is more a matter of notification than of export restriction. The only conditions for approval are the existence of a license or technical assistance agreement between the applicant (the licensor) and the foreign company (the licensee), an end-user certificate that extends U.S. Government (USG) controls over the export of production output, and arrangements for annual production reports to be filed by the licensee. In sum, within some broad restrictions to prevent leakage of significant technology, commercial license production arrangements for defense equipment are left to free market forces, subject to notification. There is no consideration of the potential commercial implications of helping to advance foreign technological capabilities that might hurt U.S. market share in the future.

For governmental coproduction agreements, the Defense Security Assistance Agency (DSAA) is the DoD focal point for MOU (Memorandum of Understanding)

review and approval; it also has oversight authority over program implementation and management by the Military Departments when the coproduction program does not involve USG funding or commitments (that is, with some exceptions, the typical coproduction program of the past). By regulation, as articulated in the Security Assistance Management Manual (DoD 5105.38-M), DSAA's review of proposed coproduction agreements considers a wide variety of factors. For example, the Country Team is to provide DSAA with its assessment of the foreign country's technical capability to produce the equipment, the economic impact on the country as compared to that of direct sale, and the sufficiency of demand for economic production (thus indicating potential pressure to export). Additionally, the cognizant Military Department is to provide its recommendation to DSAA with backup rationale including the validity of the military need, the implications of the proposed technology transfer, the transfer's impact on the U.S. defense industrial base, the views of the U.S. contractors involved, and possible impacts on other coproduction programs involving the same items.

However, examination of the forms and logic used by the Military Departments to provide this information to DSAA shows that their assessment of "defense industrial base impact" tends to be limited to determining whether or not the coproduction program would interfere with U.S. procurement schedules. Furthermore, their comments on technology transfer implications are very limited or nonexistent, and the views of U.S. prime contractors are normally not solicited, except in the case of a sole source, because doing so is perceived to conflict with the Competition in Contracting Act. (In the case of more than one source, contractor selection by the foreign government occurs typically after the coproduction agreement has been signed). In sum, even though DSAA's review of a coproduction agreement is quite comprehensive, it does not directly address, even in rudimentary form, the potential commercial implications of helping to advance foreign technological and industrial capabilities.

Importantly, in the early 1980s, a DoD Task Group on Coproduction, chartered in 1981 to examine DoD policy and procedures for international arms collaboration in light of the changes in market conditions since the 1960s, developed a very systematic and elaborate approach for evaluating costs and benefits of coproduction programs. The approach included (1) establishing 10 broad criteria with thresholds to identify programs for high-level review; (2) systematically assessing the military, political, and economic costs and benefits to each country participating in a

coproduction program; and (3) analyzing defense industrial base impacts in terms of nine criteria, including any adverse impact on the U.S. technology lead that might result from the transfer of vital industrial technology to foreign sources. Although the Office of the Secretary of Defense (OSD) endorsed the Task Group's recommendations in promulgating its 1983 report (popularly known as the "Denoon Report"), follow-through and implementation have been piecemeal at best. Elements of DSAA's review process, as summarized above, can be traced to this report. Other traces can be found in the draft revisions to DoDD 2000.9 that have never been promulgated. For example, in the current draft document, the policy statement of U.S. objectives for international armaments cooperation has been expanded to include support of the U.S. defense industrial base and commercial interests. The recommended assessment methodology, however, has never been implemented.

In addition to the two governmental review processes described above (one by State for munitions export licensing and one by Defense for coproduction programs), a third review process of more recent vintage is the industrial base impact assessment conducted by the Department of Commerce (DoC) for each coproduction agreement. The mandate for those assessments is the Fiscal Year (FY) 1989 National Defense Authorization Act, which, for the first time, required a case-by-case assessment of potential impacts of international codevelopment or coproduction agreements on U.S. competitiveness and designated DoC to provide analytical support to DoD for such assessments. (While earlier legislation, such as the Defense Production Act Amendments of 1984 and 1986 and the Omnibus Trade and Competitiveness Act of 1988, imposed various requirements to report on the impacts of offsets, the reports were not required on a case-by-case basis). As a result of the FSX controversy with Japan, the FY90 National Defense Authorization Act further strengthened DoC's role in the MOU review process by giving the Commerce Secretary the unilateral option, subject to Presidential approval, to require interagency review of any MOU that DoC believes detrimental to U.S. industry.

DoC's lead office for this industrial base impact assessment is the Office of Industrial Resource Administration, Bureau of Export Administration (BXA/OIRA). Upon examination, we found that assessment to be limited in scope and depth: it is based on incomplete information, has a short time window, and lacks a systematic methodology. Essentially, those assessments are *ad hoc* reviews of program finances, production workshares, technology transfers, and defense trade balance, based on the available program documents, supplemented with information provided by the U.S.

companies involved and by other DoC activities, specifically the International Trade Administration and the National Institute of Standards and Technology. In sum, DoC's assessment of a coproduction program's impact on the defense industrial base is focused upon the direct, short-term impact of the transaction itself. It does not consider the long-term commercial implications of advancing foreign capabilities through technology transfer with the potential for increased foreign competition in the aftermath of the coproduction program.

In our view, given these three review processes for the transfer of U.S. defense technology, the *de facto* policies and practices seem quite clear. The USG position on defense technology transfers has been one of minimal interference in the free marketplace, within a very broad framework of national security interests, foreign policy objectives, and foreign releasability of advanced defense technology. If anything, USG policy has been to encourage rather than to restrict the transfer of defense technology to U.S. allies. Recent congressional attempts to promote U.S. commercial interests in such transactions have tended to focus upon short-term effects and to ignore the more important long-term implications for U.S. competitiveness. Furthermore, those attempts have been unsuccessful to date in permanently affecting the USG policy stance.

GLOBAL CHANGE

The dramatic global changes that have occurred in recent years will have a profound effect, we believe, on the coproduction market for the foreseeable future. The key changes and their ramifications for international armaments cooperation, including coproduction, may be summarized as follows.

First, with the collapse of the former Soviet military threat, the traditional concept of national security has changed: in the post-Cold War era, it merges with national economic security – a notion strongly supported by the new Administration. The implication for coproduction is that economic or commercial considerations should carry as much weight as the traditional politico-military motivations for coproduction, changing the cost-benefit calculation of coproduction and licensed production arrangements.

Second, the ongoing decline in DoD budgets is causing a disproportionately steep decline in defense procurement (with most of the cuts taken in force structure and procurement, not R&D), with consolidation and downsizing of the defense industrial base the unavoidable consequence. The new acquisition strategy, espoused

by Defense Secretary Les Aspin and designed to maintain the U.S. technological edge despite the procurement decline, encompasses four elements: "selective upgrading" (product improvements to currently fielded weapon systems); "selective low-rate production" (limited procurements to keep specific, vitally needed suppliers alive independent of DoD's procurement needs); "rollover-plus" (prototyping new developmental items for proof-of-principle and field testing, but not entering production unless the technology works and offers a breakthrough capability required to counter an evolving threat); and "silver bullet" procurements (highly capable systems in limited quantities, for maximum U.S. leverage). The implication for coproduction is that the traditional form of coproduction of U.S. weapon systems will dwindle: U.S. procurement programs for new systems will be few and far between, and most will be withheld from coproduction in order to preserve the U.S. technological edge; instead, product improvements to U.S.-origin fielded weapon systems will represent the substance of coproduction activity.

The third key change, which has been under way for some years, is the globalization of defense industry and technology – a trend that can only accelerate in the 1990s. The United States no longer occupies a dominant position in defense technologies across the board; in some technologies it is ahead, in others it is behind. The implication for coproduction is that foreign governments may well elect to develop their own product improvements to coproduced U.S.-origin weapon systems rather than procuring them from the United States as in the past. Hence, coproduction activity may dwindle unless DoD shifts to a policy of involving foreign coproducers in cooperative product improvement programs. Moreover, DoD stands to benefit from such cooperative programs in those technology areas where the United States is lagging behind.

CONCLUSIONS

Our examination of the defense industrial base aspects of coproduction yields the following two conclusions on the issue posed at the outset of this paper – whether licensed/coproduction is still conducive to the viability of the U.S. defense industrial base or whether a different form of arms collaboration with allied and friendly countries would be more beneficial.

First, the record shows that licensed/coproduction can have either positive or negative impacts on the U.S. defense industrial base. The impact depends on the time horizon (short-term vs. long-term) and the specific characteristics of the

program, the technologies involved, the partner countries, and market conditions. Yet, long-term industrial base impact has not been a consideration for either the State Department or DoD in export licensing or coproduction MOU negotiations; for the Commerce Department, it is a matter of concern that, however, has escaped quantitative analysis. Although the potential long-term defense industrial base impact of a specific defense technology transfer is very difficult, if not impossible, to predict, we conclude that a systematic risk assessment is both feasible and necessary in order to identify and avoid licensed or coproduction program arrangements with a high risk of adverse impact. An outline of such a risk assessment methodology is provided below. If this approach is developed into a decision support system, implemented through policy revisions, and routinely applied in the Government's review process for export license applications and coproduction MOUs, the traditional practice of licensed/coproduction of U.S. armaments with U.S. allies and friendly countries could continue without hurting the long-term competitiveness of the U.S. defense industrial base.

Second, the dramatic changes triggered by the end of the cold war and the increasing globalization of defense technology have created a new environment that is not conducive to the continued viability of coproduction as practiced in the past, at least with respect to the advanced industrial countries. Those countries have little to gain from licensed/coproduction of U.S. weapon systems when leading-edge technologies would be restricted under the new policy outlined above; instead, they would have every incentive to develop and produce their own. Yet, the viability of the U.S. defense industry, even after consolidation and restructuring, will depend on foreign markets to a larger degree than in the past. We conclude that, with regard to those countries, the notion of coproduction has become outdated as the underlying paradigm ("transfer our old technology when we are ready to field the next generation") has become inoperative. A more beneficial form of defense cooperation with those countries would be to shift from coproduction, which is dwindling, to codevelopment, which can grow as long as there is a balance in reciprocal technology exchanges and transfers. In sum, while the old paradigm undergirding coproduction still has relevance for U.S. defense cooperation with developing countries, it should be superseded by a new paradigm for defense cooperation with the advanced industrial countries – namely, equitable balance between inbound and outbound technology flows.

CONCEPT FOR RISK ASSESSMENT

A systematic risk assessment of international technology transfers under coproduction MOUs or industry-to-industry licensed production agreements should provide an estimate of the likelihood of foreign diffusion and exploitation of the transferred technology that would increase foreign competitiveness at the expense of the U.S. defense industry. While this likelihood may depend on many factors, the key parameters identified by our case studies are those shown in the figure below. A first-order methodology could be based on empirically derived or expert-opinion-based relationships between those parameters and level of risk. Those "if-then" inference rules would be applied in processing the parameters associated with a proposed agreement to derive an overall risk estimate and to identify any conditions required to reduce the risk to an acceptable level. An extensive data base describing the world of defense industry, technology, and markets would be required for such a decision support system.

- **Program Screen**
 - ▶ Complexity (cost) of weapon system
 - ▶ Intellectual property rights
 - ▶ Structure of coproduction program
 - ▶ Number of countries involved
- **Technology Screen**
 - ▶ Extent of technology transfer
 - ▶ Significance of transferred technology
 - ▶ Foreign availability of technology
 - ▶ Pace of U.S. modernization
- **Market Screen**
 - ▶ Number of U.S. sources
 - ▶ Market demand and U.S. share
 - ▶ Competing foreign candidates
- **Country Screen**
 - ▶ Defense trade policy
 - ▶ Acceptability as dual source for U.S. procurement
 - ▶ Technological capabilities and pace of innovation

FIG. 1. KEY PARAMETERS FOR RISK ASSESSMENT

For example, if the technology transfer is limited (e.g., "co-assembly") or insignificant (widely available, old technology), the program would be rated as low-risk regardless of the other factors. However, if the technology transfer is extensive (e.g., "dual production"), the transferred technology is significant (e.g., in terms of "critical technology"), and foreign availability is limited, then the program would be high-risk. Unless there are offsetting factors (e.g., the U.S. modernization cycle is outpacing foreign innovation, or the partner country is not an arms exporter and the technology has no commercial application), such a program either would be unacceptable or would be conditional on revising its terms (limiting the most advanced components to U.S. manufacture only, i.e., "black-boxing"). The program screen parameters tend to moderate the likelihood of technology diffusion: high

weapon system complexity (in terms of number of end items and interfaces), especially when several countries participate, reduces the chance of technology exploitation by any one country. The market screen parameters may influence the acceptable risk level: the existence of a single U.S. source that is underutilized, of a small U.S. market share, or of a competing foreign coproduction offer might all be reasons for accepting some higher risk than otherwise warranted, depending on the country involved.

U.S. POLICY OPTIONS

The U.S. Government in essence can choose among at least four policy options. The first two options are obvious: leave current policy unchanged, or terminate coproduction of U.S. weapon systems entirely. Paradoxically, either option would probably have the same adverse consequences for the defense industrial base: a long-term decline in business volume and competitiveness. They could also lead to identical adverse consequences for DoD: procurement cost escalation and loss of the U.S. leading edge in fielded technology.

The more attractive options lie in between those two extremes, with more emphasis on arms collaboration than in the past. A third option is to take a more businesslike approach to coproduction and to other forms of defense technology transfers by systematically assessing the risk they pose to the U.S. defense industry's future competitive posture. The purpose is to avoid any one-way technology transfers that present a measurable risk of having an adverse impact on the U.S. defense industry in the future. Because the traditional coproduction business will be drying up, however, this shift to a business approach in coproduction should be complemented by a more cooperative approach in product improvement programs. The latter will be the mainstay of coproduction activity in the future, but they will be lost to U.S. defense industry unless DoD converts them into joint R&D efforts with U.S. allies.

The fourth option goes beyond coproduction to include cooperative R&D and codevelopment, with the principle of equitable balance between inbound and outbound technology transfers as the single most important criterion for cooperation — a notion that is missing from current policy.

A policy shift toward the last two options would support the competitive posture of the declining U.S. defense industrial base at a time when it is growing more dependent on foreign sales to survive. This shift, however, should be governed by the

tradeoffs between costs and benefits of such collaboration. While lower defense budgets put a higher value both on codevelopment and on access to foreign markets, they also hinder the U.S. ability to recover from any adverse consequences of defense technology transfers. Hence, systematic technology risk assessment is an essential prerequisite for this policy shift – an assessment not only of the risk of technology leakage to potential foes (the past focus) but especially of potential adverse impacts on U.S. industry's competitive posture.

IMPLEMENTATION

To make such a shift will not be easy, since changes will be necessary in DoD organizational responsibilities, policies, and processes. The division of responsibilities between the various offices overseeing FMS, coproduction, and cooperative programs would make it difficult to restructure coproduction into a more cooperative life-cycle relationship, from development through product improvement, with a balance in reciprocal technology transfers. Several DoD policies on coproduction and international cooperative programs are outdated and would have to be revised. Legal interpretations of contracting laws and regulations apparently prevent DoD from soliciting and obtaining industry input to MOU negotiations. Neither DoD nor DoC has a systematic methodology for assessing the long-term costs and benefits of proposed cooperative projects, including coproduction. And the interagency coordination process appears to be ineffective (witness the inability to reach an unified U.S. position with respect to the draft "NATO Code of Conduct in Defense Trade" developed with NATO allies at U.S. behest over the past three years).

We believe that taking the following steps would help preserve the competitive posture and viability of the declining U.S. defense industrial base:

- Provide more scrutiny of outbound defense technology transfers by conducting more systematic technology risk assessment.
- Structure international programs to achieve a more equitable balance in reciprocal technology exchanges and transfers.
- Streamline DoD management of all international activities.
- Ensure that the U.S. Government speaks with one voice.

ANNOTATED BRIEFING

LMI

ARMAMENTS COPRODUCTION AT A CROSSROADS: U.S. Policy Options After the Cold War

February 1993

**Logistics Management Institute
Bethesda, Maryland**

Study Team

**Frans Nauta
C. Bruce Baird**

Sponsor

**LMI IRAD Program
Task IR218/305**

SLIDE 1

Coproduction, or the foreign manufacture of U.S.-origin weapon systems, is one of many forms of international armaments collaboration that have been pursued by the U.S. Government throughout the Cold War era in support of foreign policy and national security objectives. Coproduction is a relatively complex subject because it links a number of fundamental issues in the political, military, and economic domains. It also has become a controversial issue in the United States since the 1980s, specifically with the concerns about "U.S. competitiveness" and the debates on "industrial offsets" in foreign defense procurement of U.S. equipment.

The genesis of our independent study effort, initiated in mid-1992, was the realization that the end of the Cold War has changed the entire frame of reference for coproduction, putting the continuation of traditional policy in question. Because it has been ten years since the last thorough review of U.S. policy on coproduction – the 1983 DoD Task Group on International Coproduction/Industrial Participation Agreements, better known as the "Denoon Report" – we anticipated that a DoD policy review on international armaments collaboration, including coproduction, would be both likely and desirable, especially if a new Administration were to take office. Our study effort was to prepare LMI to support DoD in such a policy review.

PURPOSE

- **Key Issues:**
 - **Does U.S. policy on licensed production or coproduction of U.S. weapon systems make sense, given the dramatic changes in the global defense environment?**
 - **If not, what policy changes are necessary?**
- **Key Questions:**
 - **What has been the U.S. defense industrial base impact of past coproduction programs?**
 - **What are the distinct program features that separate programs with beneficial impacts from those with adverse impacts?**
 - **How do the global changes affect the coproduction business?**
 - **What are the U.S. policy options and their ramifications?**

SLIDE 2

The purpose then of our study is to examine whether U.S. policy on coproduction, as articulated in U.S. law, DoD directions or instructions, and other policy guidance documents, still makes sense after the Cold War. The corollary issue is what, if any, changes are necessary.

We approach this issue primarily from a defense industrial base perspective, for several reasons. *First*, defense industrial base impact has been the main bone of contention in the controversy between proponents and critics of coproduction. *Second*, the viability of the defense industrial base has become the most difficult and critical challenge in the new defense environment, defined by massive drawdown of forces, declining DoD procurement budgets, and DoD's new acquisition strategy as articulated by Secretary of Defense Les Aspin in his "Finding the Right Resource Strategy for a New Era," February 1992. A *third*, and purely pragmatic reason is that the costs and benefits of coproduction in a political and military sense are largely intangible and difficult to quantify, whereas the industrial base impacts are more tangible and measurable.

Thus, the key questions for our inquiry into coproduction are as shown on this viewgraph. They define the scope of our study and ultimately the findings that resulted.

BRIEFING ROADMAP

- The what, why, and how of coproduction
- Conflicting views on licensed/coproduction
- Lessons learned from selected case studies:
 - Infrared-guided missiles
 - Radar-guided missiles
- Impacts of global change
- Policy options and implications

SLIDE 3

My briefing will proceed as indicated here. The first dozen viewgraphs present a primer on coproduction. This portion of the briefing offers little news to the cognoscenti of coproduction but describes the what, why, and how of coproduction for those who may be unfamiliar with the subject. After this primer, I will try to summarize the reasons for the controversy between proponents and critics of coproduction. Then I will switch to the case studies that we conducted to answer the first two key questions: industrial base impact and identification of factors for classifying programs into two groups: those with adverse industrial base impacts vs. those with beneficial ones. The case studies themselves are packaged into a separate briefing within a briefing (Tab B).

The final viewgraphs cover the remaining key questions: the effect of the revolutionary changes in the global defense environment on coproduction, and U.S. policy options.

WHAT IS COPRODUCTION?

- **Coproduction:**
Any program in which the U.S. Government enables an eligible foreign government, international organization, or designated commercial producer to acquire the technical data and know-how to manufacture or assemble in whole, or in part, an item of U.S. defense equipment for use in the defense inventory of the foreign government. It excludes (1) licensed production, and (2) provision of technical data solely for maintenance, repair, overhaul, or operation of a defense item. (DoDD 2000.9, draft)
- **Licensed Production:**
Overseas production of a U.S.-origin defense article, based on transfer of technical information under commercial arrangements between a U.S. manufacturer and a foreign government or producer. U.S. Government involvement is limited solely to issuance of an export license. (DoDD 2000.9, draft)
- **Varied Arrangements:**
 - ▶ Integrated vs. Parallel
 - ▶ Co-assembly – Workshare – Dual Production
- **Broad Definition:** Any arrangement involving cross-border technology transfer enabling foreign production based on U.S.-origin technology.

SLIDE 4

DoD terminology makes a distinction between "coproduction" and "licensed production." Coproduction refers to foreign manufacture, in whole or in part, of U.S. defense equipment when the U.S. Government is signatory of the agreement, typically a memorandum of understanding (MOU). In contrast, licensed production is the term used for a direct industry-to-industry production license agreement, whereby U.S. Government involvement is limited to issuing an export license. The definitions shown here are cited from DoD Directive 2000.9, "International Coproduction Projects and Agreements Between the U.S. and Other Countries or International Organizations," issued in 1974 and under revision since 1979; the current draft revision dates from 1990 but has not been promulgated because of nonconcurrence by senior officials.

Implementation of a coproduction agreement is normally done through a separate Implementation Agreement between participating governments and a License and Technical Assistance Agreement between the participating contractors. Thus, the difference between coproduction and licensed production is one of degree of government involvement. The actual licensed production arrangement can assume many different forms. One distinction is whether the U.S. and foreign production lines mutually support each other ("integrated") or whether they are independent of each other ("parallel"). Another distinction is the extent of work performed by the foreign licensee; this may range from a minimum level of putting U.S.-manufactured components together ("co-assembly") to a maximum level of complete duplication of the U.S. production line ("dual production") or any level in between (x percent workshare).

For the sake of convenience, I will use the term "coproduction" to refer to any or all of such arrangements involving the transfer of U.S. technology to enable foreign production. Technology transfer is the critical difference between coproduction and direct sales.

INTERNATIONAL TECHNOLOGY TRANSFER

- **Technology:** The information and know-how (whether in tangible form, such as models, blueprints, or manuals, or in intangible form, such as training or technical services) that can be used to design, produce, manufacture, utilize, or reconstruct goods, including computer software and technical data, but not the goods themselves. (50 USC Appx., Section 2415)
- **Transfer Mechanisms:**
 - Training/education: technical assistance
 - Technical exchanges: RDT&E reports (under DEAs), scientist & engineer exchanges (ESEP)
 - Technical data: TDP (under LOA)
 - Tooling/processing equipment: production license
 - Cooperative project: joint R&D (governments), joint venture (industry)
 - Foreign direct investment: turnkey plant, affiliation, merger/acquisition.
- **TT Dimensions:**
 - Technology: product (know-what), production process (know-how), design (know-why)
 - Client: government agency vs. industrial firm vs. individual persons
 - Process: institutional vs. cultural, formal vs. informal, active vs. passive.

SLIDE 5

The legal definition of "technology," cited from the pertinent section of the United States Code, covers both tangible and intangible forms of information and know-how, but not the goods embodying the technology itself. Thus, the transfer of an item of defense equipment is not considered a technology transfer in and by itself, even though the item may be used frequently as a test article to complement a transfer of technical data.

There are many different mechanisms for technology transfer, and most of the mechanisms shown here are used extensively by DoD in the international arena. For example, under the Defense Data Exchange Program, the DoD has bilateral agreements with many countries providing for the reciprocal exchange of R&D information in specific areas that are mutually agreed upon in Data Exchange Annexes (DEAs) to the basic agreements. With most of those countries, under the Exchange of Scientists and Engineers Program, DoD also has bilateral agreements for the reciprocal exchange of scientists and engineers. Other technology transfer mechanisms include the provision of technical data, which might be technical manuals for operation and maintenance of a weapon system or a complete production technical data package. The transfer of production equipment in the framework of a production license is another important mechanism for technology transfer, since it embodies much of the manufacturing know-how.

Technology transfer practitioners frequently distinguish three dimensions of technology transfer that influence or determine the appropriate and most effective mechanism to accomplish the intended transfer: the type of technology involved, the client, and the transfer process. For weapon system coproduction, the transfer pertains to manufacturing process know-how; the transfer is to an industrial firm either directly or through a government agency; and the transfer process is institutional, formal, and active because technical assistance and U.S. inspection are normally part of the arrangement.

LICENSED/COPRODUCTION FRAMEWORK CAN PROVIDE EFFECTIVE TT

Effectiveness of Technology Transfer According to Transfer Mechanism	
Transfer Effectiveness	Transfer Mechanism
Highly Effective	Turnkey Factories Licenses with Extensive Tech Assistance Joint Ventures Technical Exchange with Ongoing Contact Training in High-Technology Areas
Effective	Processing Equipment (With Know-How) Engineering Documents & Technical Data Consulting Licenses (With Know-How)
Moderately Effective	Proposals (Documented) Processing Equipment (w/o Know-How)
Low Effectiveness	Commercial Visits Licenses (w/o Know-How) Sale of Products (w/o Maintenance & Operations Data) Commercial Literature Trade Exhibits

Source: ODDR&E, *An Analysis of Export Control of U.S. Technology: A DoD Perspective*. Washington, DC, 1976.

SLIDE 6

According to a much-cited DSB study conducted in 1976, the "Bucy Report," coproduction as practiced by DoD provides a framework for technology transfer that can be highly effective in achieving the intended outcome. The matrix shown here is taken from the cited source and categorizes the various technology transfer mechanisms according to their effectiveness. Only one other mechanism, turnkey factories, rates higher than a production license agreement that includes technical assistance (i.e., the typical arrangement for coproduction of defense equipment).

In sum, the point that I want to bring across is that coproduction, particularly when it involves more than just co-assembly, is a very effective vehicle for technology transfer. It permits the foreign licensee to pick up the manufacturing know-how for a weapon system that may have been the culmination of many years of development and expertise of the U.S. defense contractor. If a foreign company engages in this practice repeatedly in the same weapon system technology area, it will sooner or later acquire sufficient know-how to elevate itself to the next higher level of technology, design technology ("know-why"). Therefore, coproduction accelerates foreign technological and industrial capabilities to the extent that they are behind their U.S. peers.

CONTRACTUAL DEFINITIONS OF TECHNICAL DATA AND COMPUTER SOFTWARE

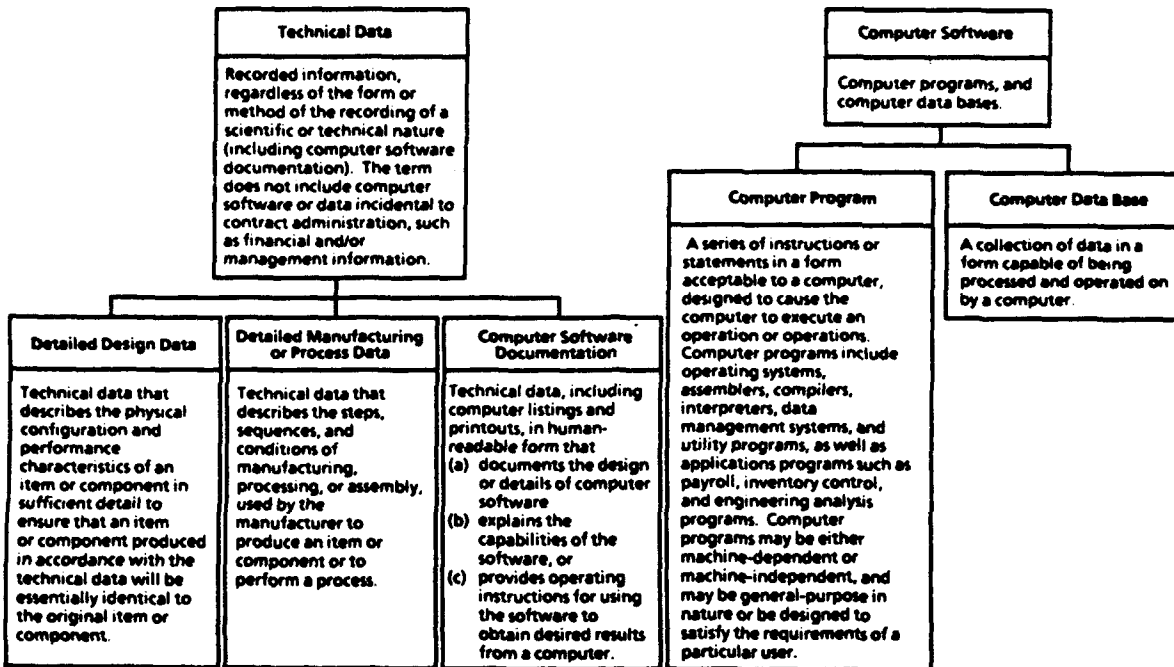

Note: Prepared from DAC #88-2 Reconciliation with 1991 Edition of DFARS Subpart 227.4, "Rights in Data and Copyrights" (Effective 31 Dec 1991) Pending

SLIDE 7

Technology in tangible form is defined as "technical data and computer software" in DoD procurement regulations. This viewgraph summarizes the formal definitions of those terms. For the record, I note that there has been some inconsistency in the use of these terms over the years with respect to computer software. The current definitions, reconstructed from the cited provisions of the DoD Federal Acquisition Regulation Supplement (DFARS), still are nonspecific on the subject of object code *vs.* source code. Moreover, the DoD Advisory Panel on Streamlining and Codifying Acquisition Laws, established pursuant to the FY91 National Defense Authorization Act, recommended in its January 1993 report to the Congress that the definition of "technical data" be expanded to include data bases, contrary to current practice.

While seemingly an arcane matter, proper and consistent definitions are important for at least two reasons: (1) the increasing importance of embedded software and firmware in modern weapon systems, and (2) the tie-in to Government rights in data. For example, the F-16 source code became a "cause celebre" in the FSX program with Japan (not strictly a coproduction program but a Japanese-funded and developed derivative of the F-16 baseline as transferred to Japan); the source code was not released because that would have advanced capabilities of the Japanese in the one area they are still behind, not only making Japan more self-sufficient in defense equipment than it already is, but also offering significant commercial potential for Japan's aircraft industry.

Statutory provisions deal with the rights in data created and used in the acquisition process (10 U.S.C. §2320) and permit DoD to acquire any rights in intellectual property when necessary to carry out its mission (10 U.S.C. §2386). Evidently, a contractor has every incentive not to use a technology with strong commercial potential in the performance of a DoD contract unless it is assured to retain intellectual property protection in that technology — an assurance that under current provisions appears limited. This rights-in-data issue has been controversial when DoD exercised its rights to create domestic dual sources for the sake of competition. It is even more controversial when DoD exercises its rights to export an advanced technology to a foreign company for the sake of coproduction.

EXPORT CONTROLS

- U.S. Policy
 - Arms Export Control Act (AECA), 1976; authorizes controls on export/import of defense articles, services, and munitions -- Munitions List, administered by DOS, Center for Defense Trade, and contained in the ITAR.
 - Export Administration Act (EAA), 1969 and 1979:
 - "Short supply"
 - "National security" - Commodity Control List (CCL), administered by DoC; based on DoD's MCTL (IDA-led TWG's with industry/academia/government). List includes Nuclear Referral List (DOC/DOE)
 - "Foreign policy;" restrictions to further U.S. foreign policy or international obligations
- Multilateral Controls: COCOM, MTCR, etc.
- DSB Study (Bucy Report), 1976, raised emphasis on controlling defense-related technology rather than hardware only, within scope of East-West trade. Implications of tech transfer to Western allies or neutral states only considered in view of potential re-transfer to Eastbloc countries. Rationale for MCTL.
- Since 1991, major scrub of CCL to reduce controls to COCOM "Core List."
- Recent NAS study urged major reform and simplification.
- Key Point: U.S. technology export controls do not, and cannot under current law, consider notions of industrial strategy to advance DIB interests at large.

SLIDE 8

Because coproduction involves cross-border technology transfer, the subject of U.S. export controls cannot be avoided. U.S. export controls involve a multiplicity of statutes, agencies, and control systems, with overlapping and sometimes conflicting regulations, and a complex system of control lists that are both confusing and outdated. Recent studies by the National Academies of Sciences and Engineering, pursuant to the 1988 Omnibus Trade and Competitiveness Act, have called for major reform and simplification of the entire export control system, with the Department of Commerce put in charge instead of the multiplicity of departments that now share authority and responsibilities (*Finding Common Ground: U.S. Export Controls in a Changed Global Environment*. Washington, D.C.: National Academy Press, 1991).

For our purposes here, the two statutes that govern trade in armaments, "dual-use" goods with significant military utility and associated technical data, are the Arms Export Control Act (AECA) of 1976, which superseded the Battle Act of 1954, and the Export Administration Act (EAA) of 1969, which superseded the Export Control Act of 1949. The AECA authorizes the President to control the export and import of defense articles and services for the stated objective "to further U.S. foreign policy, world peace, and security." This authority is implemented in the International Traffic in Arms Regulations (ITAR), which contain the U.S. Munitions List (USML) identifying the defense articles and services that are controlled. The State Department has the exclusive delegated authority to determine what is a defense article, but the ITAR list four considerations for that determination: (1) items "inherently military in character," (2) items with "predominantly military application," (3) dual use status is not relevant for an item's classification as a defense article, and (4) intended use is also not relevant. The USML is organized into 21 broad categories (firearms, artillery, ammo, naval vessels, aircraft, etc.); "technical data" is category 18. The list is administered and updated by the State Department's Center for Defense Trade (CDT) in consultation with DoD (primarily DSAA and DTSA) and to a lesser extent DoC (Bureau of Export Administration). The CDT resulted from the 1990 reorganization of the State Department's Office of Munitions Control to expedite the arms export licensing process. The CDT, under the Assistant Secretary for Politico-Military Affairs, comprises the Office of Defense Trade Controls and the Office of Defense Trade Policy. Incidentally, the ITAR will soon be renamed "Defense Trade Regulations" (DTR).

The EAA and its implementation are more complex. It authorizes export controls for three stated objectives: (1) short supply -- "to protect the domestic economy from the drain of scarce materials and reduce inflationary impact of foreign demand;" (2) national security -- "to restrict export of goods and technology which would make significant contribution to the military potential of any other country ... detrimental to U.S. national security;" and (3) foreign policy -- "to restrict export of goods and technology when necessary to further U.S. foreign policy or fulfill its international obligations." Implementation of the EAA is the primary responsibility of DoC, in consultation with other departments. The principal vehicle for national security controls is

EXPORT CONTROLS

- U.S. Policy
 - Arms Export Control Act (AECA), 1976; authorizes controls on export/import of defense articles, services, and munitions – Munitions List, administered by DOS, Center for Defense Trade, and contained in the ITAR.
 - Export Administration Act (EAA), 1969 and 1979:
 - "Short supply"
 - "National security" – Commodity Control List (CCL), administered by DoC; based on DoD's MCTL (IDA-led TWG's with industry/academia/government). List includes Nuclear Referral List (DOC/DOE)
 - "Foreign policy:" restrictions to further U.S. foreign policy or international obligations
- Multilateral Controls: COCOM, MTCR, etc.
- DSB Study (Bucy Report), 1976, raised emphasis on controlling defense-related technology rather than hardware only, within scope of East-West trade. Implications of tech transfer to Western allies or neutral states only considered in view of potential re-transfer to Eastbloc countries. Rationale for MCTL.
- Since 1991, major scrub of CCL to reduce controls to COCOM "Core List."
- Recent NAS study urged major reform and simplification.
- Key Point: U.S. technology export controls do not, and cannot under current law, consider notions of industrial strategy to advance DIB interests at large.

SLIDE 8 (Continued)

the Commodity Control List (CCL). Administration of this list involves extensive technical review, policy inputs, and internal dispute resolution. The main reference document used in the operation and review of the CCL is the Military Critical Technologies List (MCTL), which is developed by DoD pursuant to the EAA. The MCTL is maintained by technical working groups involving IDA and representatives from industry, government, and academia. It is essentially a complete listing of all advanced technologies and key equipment that, if exported, would permit significant advances in other countries' military capabilities. The MCTL is reviewed continuously and is published every three years. Another key input into the CCL review process is the assessment of "foreign availability," defined in the EAA to exist when the item or technology is available from a non-U.S. source in sufficient quantity and comparable quality to make U.S. export restriction ineffective. This means that an affirmative finding of foreign availability normally should lead to decontrol of the item in question unless the foreign source(s) agree to also control the item. In addition to the national security controls, the foreign policy controls involve a variety of countries, commodities, and objectives, including human rights, anti-terrorism, embargoed countries, regional stability, NBC weapons, etc.

The United States is also party to various multilateral control regimes, including COCOM (Coordinating Committee for Multilateral Export Controls), MTCR (Missile Technology Control Regime), NSG (Nuclear Suppliers Group), Australia Group (concerned with chemical weapons precursors), and the Biological Weapons Convention. I will briefly summarize the COCOM arrangement because it is the most important one. COCOM was established in 1949 to coordinate national export control policies with NATO countries with respect to the Eastbloc; other countries that have joined COCOM are Australia and Japan. Like the U.S. national controls, COCOM maintains three lists: the International Munitions List (IML), the International Atomic Energy List, and the Industrial List (IL), covering dual-use technologies. COCOM members collectively determine proscribed destinations, general exceptions, differential licensing requirements for nonmember third countries and for intra-COCOM trade, and changes to the lists. In 1990, COCOM agreed to a complete overhaul of the IL, replacing it with a so-called "core list" ("fewer items, higher fences"). The core list was approved in May 1991. In turn, this led to a complete restructuring of the U.S. CCL, which now is identical to the COCOM core list, supplemented with a smaller list of items that the U.S. controls for foreign policy purposes. The new CCL is a "positive" list, specifying the items under control, in contrast to the old CCL, which was a "negative" list (items being under control except when specifically exempted), i.e., a major change in mindset.

In summary, the export controls are focused on "East-West" trade and designed to prevent leakage of militarily significant technology to potential foes. The recent shift to decontrol resulted not only from the collapse of the Soviet threat but also the recognition that U.S. exports are hurt when U.S. controls are tighter than those of other countries. Intra-COCOM trade is essentially license-free. Current laws do not permit the U.S. Government to restrict a technology export to an allied country just for the purpose of exploiting a technology advantage to the benefit of the U.S. defense industrial base. Thus, within some broad constraints, the USG leaves the export of defense equipment manufacturing technology to the free market.

MUNITIONS EXPORT CONTROL PROCESS

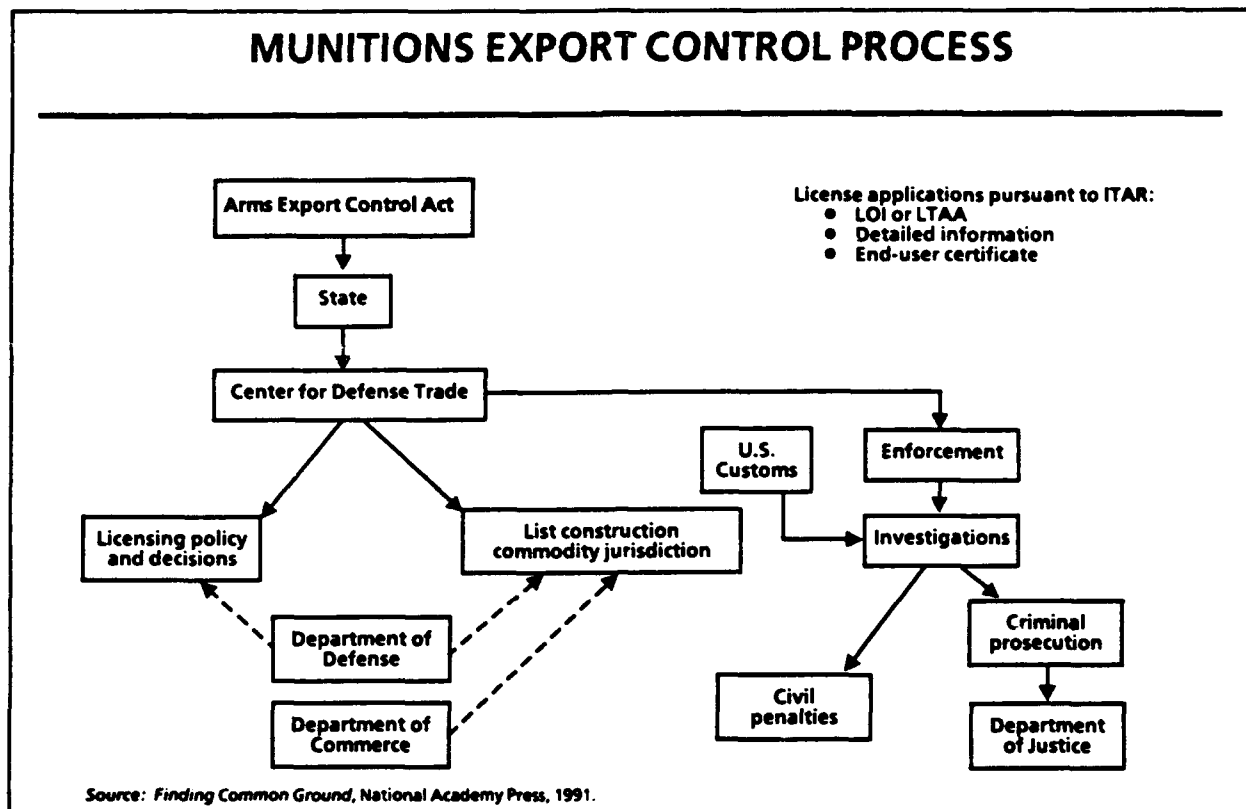

SLIDE 9

This viewgraph briefly illustrates how the export licensing and enforcement processes actually work for items on the USML. All manufacturers of items contained in the USML are obligated to register with the CDT, whether or not they are exporters. The ITAR require exporters to obtain a license for the export of any item on the USML, with two general exceptions: certain exempted items such as small arms and ammo for personal use, and minor components costing less than \$100; and one country exception, Canada. The ITAR also provides guidance on the kinds of license applications that are not likely to be approved, including those for countries that are disbarred from receiving U.S. weapons. A license application for the export of weapons must include a firm order ("Letter of Intent"), detailed information on the proposed sale, and an "end-user certificate;" this last document certifies that the country designated on the license application as the country of destination is indeed the country of end use and that the equipment will not be diverted to another country without prior USG approval, even if the equipment has been incorporated into another end item. This end-user certificate requirement is unique to the United States; no other country in the world imposes such an extra-territorial right over equipment after it has been exported. The U.S. rationale for such reexport controls is that in the absence of such controls, third-party middle men could make sales that are prohibited for U.S. firms, thus undercutting U.S. export control purposes as well as disadvantaging U.S. exporters. On the other hand, those controls have caused foreign defense equipment manufacturers to design-out American components to avoid U.S. controls over their exports, costing U.S. producers untold billions in exports. For example, one previous study, known as the "Allen Report," estimated that the total impact of export controls on the U.S. economy was \$9.3 billion in 1985, measured in terms of lost West-West and East-West export sales. (NAS, *Balancing the National Interest: U.S. National Security Export Controls and Global Economic Competition*, National Academy Press, 1987.) In recent years, the State Department has tended to soften its stance on reexport controls to reduce the adverse impact on U.S. defense industry by providing advance approval of potential reexports to selected countries.

For the export of production technical data, the license application requires a production license agreement or a technical assistance agreement between the companies involved. An end-user certificate is also required. Additionally, the recipient normally is required to provide annual reports to State Department on sales of the licensed weapons.

The number of munition license applications is over 50,000 a year. About 70 percent are "noncontroversial," i.e., not referred by the CDT to other agencies, with an average processing time of 4 days in 1990. The remaining 30 percent are referred to DoD (DTSA), DoC, or the intelligence community, with an average processing time of 36 days in 1990.

NATIONAL SECURITY EXPORT CONTROL PROCESS

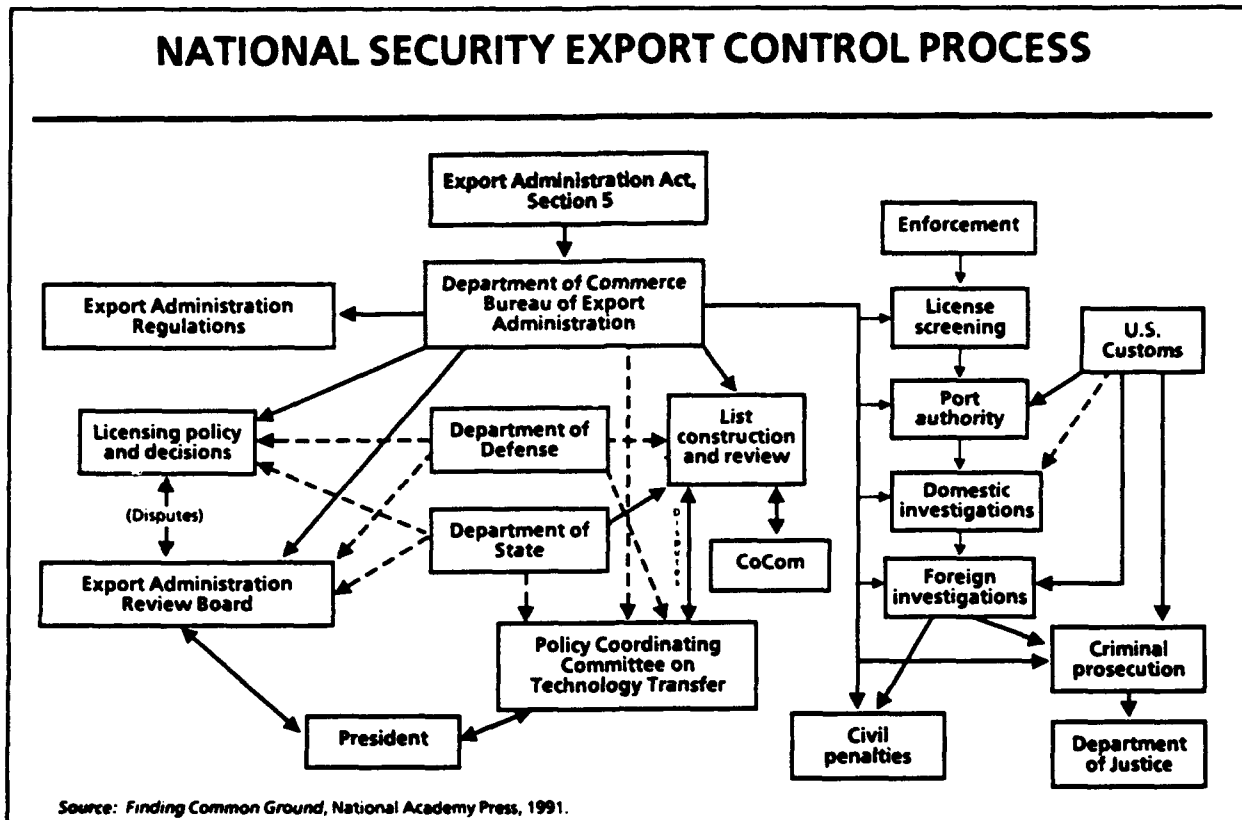

SLIDE 10

This is a similar illustration for national security controlled items and technologies that have been determined to come under the jurisdiction of DoC rather than of DoS. (There is considerable overlap between the USML and the CCL.) For those dual-use items, the license application process is similar to that for a munitions export license; one difference is that the reexport control retained by the USG on exported items provides for a minimum allowance of 25 percent (10 percent if the destination is one of seven specific countries controlled for foreign policy reasons). That is, the USG claim to reexport control applies to foreign-made goods with a U.S. content of 25 percent, or 10 percent respectively, in U.S. origin parts and components that were exported under a license for national security purposes. Even though this is a less onerous restriction than that applied by DoS for munitions export licenses, the data collected for the previously cited *Allen Report* indicate that compliance with these U.S. reexport controls is minimal among foreign companies that are independent of U.S. firms.

Another difference from the previous chart is that in contrast to munitions export licenses, the dual-use technology export licensing process has a multi-level dispute resolution procedure. One pertains to the CCL itself, while the other pertains to agency positions on license approval. Disputes over the CCL are resolved through the Economic Defense Advisory Council (EDAC), either at working-group level or at the plenary council level (deputy assistant secretaries from DoD, DoC, and other agencies as required, chaired by the State Department). Disputes not resolved at his level are elevated to one of two policy coordinating committees reporting to NSC, either the PCC on Technology Transfer (for COCOM-related issues at the under secretary level, chaired by NSC) or the PCC on Non-Proliferation (for NBC- and SSM-related issues, chaired by the State Department). Disputes over licensing decisions are resolved through the Export Administration Review Board (EARB) structure: Operating Committee (director-level body, chaired by Director BXA with membership from DoS and DoD); Advisory Committee (assistant secretary level); and the cabinet-level EARB itself (Commerce, Defense, State).

The Export Administration Regulations (EAR), published annually by DoC to indicate how the EAA will be implemented, describes the items subject to export control and the licensing requirements. There are essentially three types of licenses: "general," "special," and "individual validated" licenses. A general license is a broad grant of authority to all exporters for certain categories of goods to a broad class of destinations without prior USG approval, only notification to Census Bureau; e.g., GCT (inter-COCOM), GFW (free-world), G-COCOM, G-CEU (certified end users), GCG (cooperating governments), etc. Both special and individual licenses require prior USG approval, with a special license allowing multiple transactions under one validation, while individual licenses must be validated on a case-by-case basis.

The number of license applications processed by DoC in recent years was over 120,000 a year. In 1989, this included roughly 80,000 individual cases (valued at \$132 billion) and 40,000 general cases (\$34 billion). About 70 percent of the individual cases are held pending referral or dispute resolution, with average processing time ranging from 50 days (free world destinations) to 130 days (PRC). Nonreferred cases are processed in 4 days (COCOM) to 28 days (East bloc). Since DoC's adoption of the "core list," the number of licenses processed by DoC has declined to less than 40,000 in 1991.

COPRODUCTION HAS BEEN A GROWING GLOBAL BUSINESS

Estimated Worldwide Licensed Production of Major Conventional Weapon Systems, 1960-88

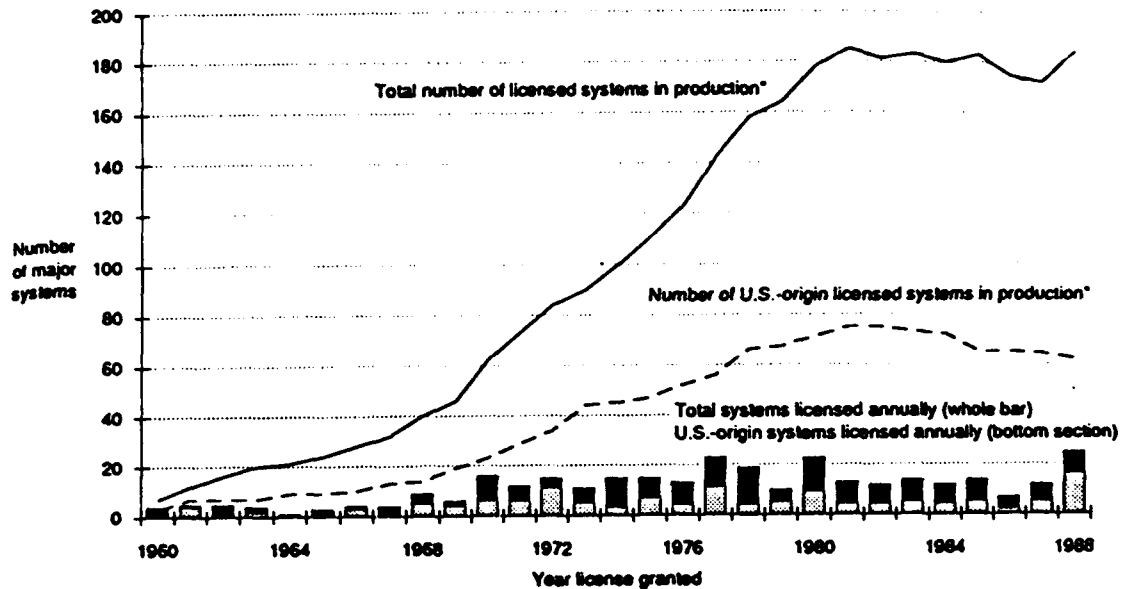

*Estimates based on the assumption that an average system is produced under license for 12 years.
 Source: Office of Technology Assessment, *Global Arms Trade*, 1991.

SLIDE 11

After all these preliminaries, I can now focus on coproduction itself and try to put it into some perspective. This viewgraph and the next two provide some idea of the size and trends of the global licensed production market.

This viewgraph, adopted from the Office of Technology Assessment (OTA), illustrates the overall trend in licensed production worldwide. The bars at the bottom of the chart depict the total number of major weapon systems that have been licensed for production, in whole or in part, to other countries, in each of the past thirty years. The dotted portion of each bar applies to U.S.-origin weapon systems; the black portion to weapons developed in countries other than the United States. Since the late 1950s, when coproduction first became popular, the overall trend in production licenses has been up, although it seems to have leveled off at around 20 weapon systems per year. The U.S. portion of this total has varied considerably over the years.

The lines drawn in the chart represent the estimated number of weapon systems that are in licensed production at any point in time. The solid line is the global total; the dotted line pertains only to U.S.-origin systems. Those lines assume that, on the average, weapon systems remain in licensed production for 12 years. While that is approximately the average time before a coproduction case is closed out by DSAA, the actual production run for U.S.-origin weapons is normally much shorter. In any event, under those assumptions, the graph shows that by the late 1980s, about 180 weapons were in licensed production worldwide, including 60 U.S.-origin weapon systems.

U.S.-ORIGIN WEAPONS ACCOUNT FOR LARGE SHARE

Worldwide Licensed Production of Major Conventional Weapon Systems, by Country Issuing License, 1960-88

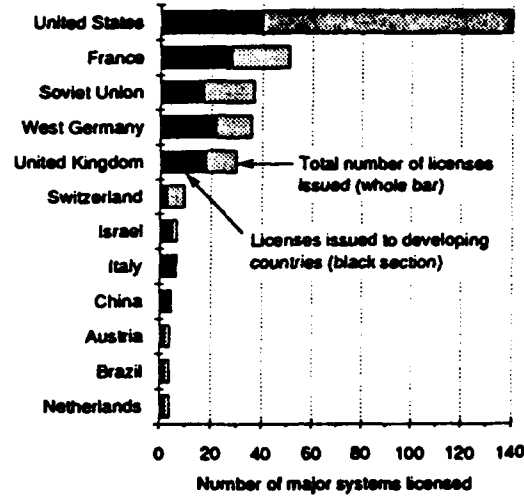

Note: 10 other countries issuing fewer than 4 licenses not shown.
Source: Office of Technology Assessment, *Global Arms Trade*, 1991.

- U.S.-origin weapon systems account for approximately 40 percent of the global total, corresponding roughly to U.S. share of global defense expenditures.

SLIDE 12

This graph shows the breakout of weapon system production licenses by issuing country. The horizontal bars show the total number of production licenses issued by each country, with the black portion applying to licenses issued to developing countries and the dotted portion to advanced industrial countries. Thus, the United States, according to OTA figures, issued 140 production licenses for major conventional weapon systems between 1960 and 1988; most (over 60 percent) were granted to advanced industrial countries.

In total, about 22 countries are in the business of issuing weapon system production licenses to other countries. With a total of approximately 350 weapon systems production licenses, the U.S. share is 40 percent, which coincidentally roughly corresponds to the U.S. share of global defense expenditures in the past. The other three major sources for production licenses in the free market are the European "big three:" France, Germany, and the U.K. Interestingly enough, the former Soviet Union has also engaged in licensing the production of its weapons to other countries. With only 35 known production licenses issued, however, the Soviet Union can be said to be underrepresented in the licensed production business in comparison to its defense expenditures and its role as a major weapons producer.

WORLDWIDE LICENSED PRODUCTION BY RECEIVING COUNTRY

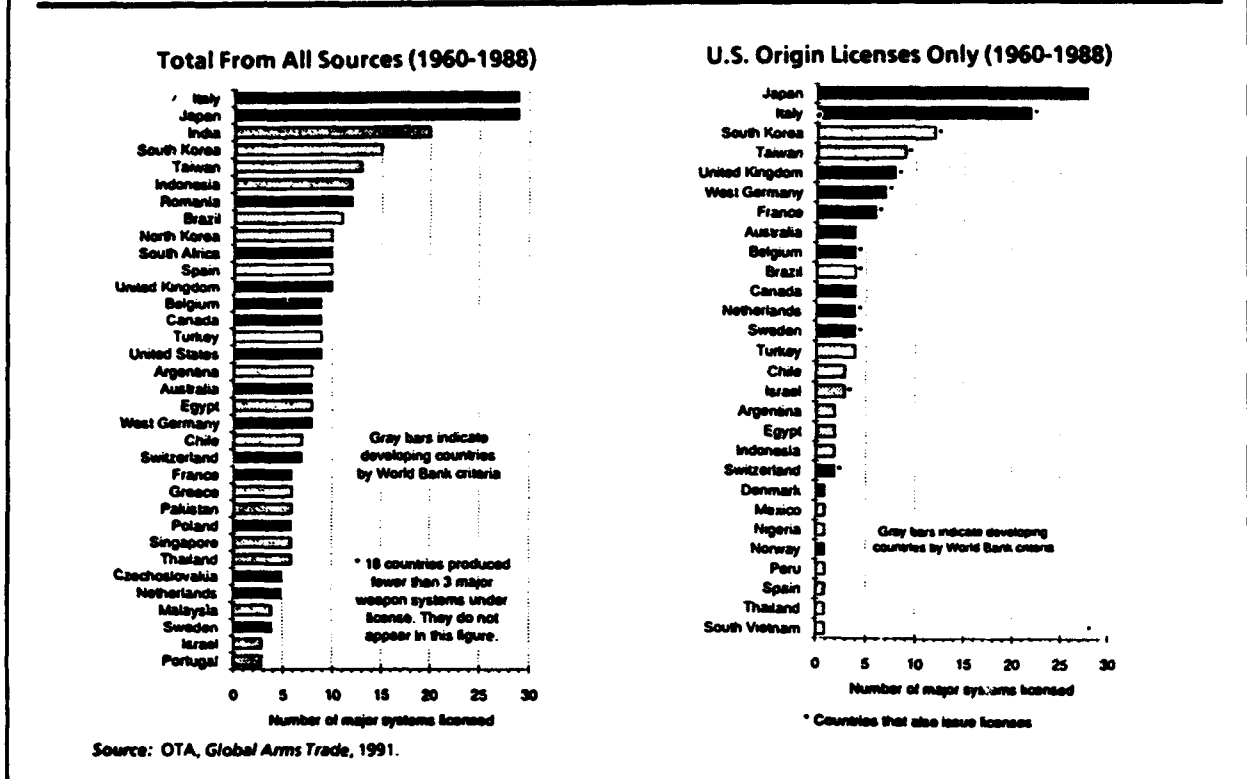

SLIDE 13

This graph shows who is receiving all these production licenses. The bar chart to the left shows the total number of production licenses by receiving country. The bar chart to the right applies to U.S.-origin weapons only. The different shading of the bars places each country in either advanced industrial status (solid black) or developing country status (dotted bars). The countries that have routinely met new defense requirements through licensed production instead of straight buys or indigenous development are first of all Italy and Japan, and to a lesser extent some of the Pacific countries and Brazil. By comparing the two bar charts, one can assess U.S. penetration of each country's licensed production market. For example, close to 100 percent of Japan's licensed production is U.S.-source; France - 100 percent; Germany - 7 out of 8; and U.K. - 80 percent.

Importantly, the United States has received 9 production licenses for major weapon systems, a number that is comparable to that of the other major NATO countries. In contrast, the Soviet Union has never received a production license for a foreign weapon system. Instead, it has frequently obtained technical data by illegal means and proceeded to copy or reverse-engineer weapon systems from the West, including some notable examples in tactical missiles that I will return to in our case studies. China (PRC) is also notable by its absence in the left-hand bar chart; much of its production was based on Soviet-origin designs. However, these are the official data as collected by the Office of Technology Assessment.

ORGANIZATIONAL RESPONSIBILITY FOR COPRODUCTION VS. ARMAMENTS COOPERATION

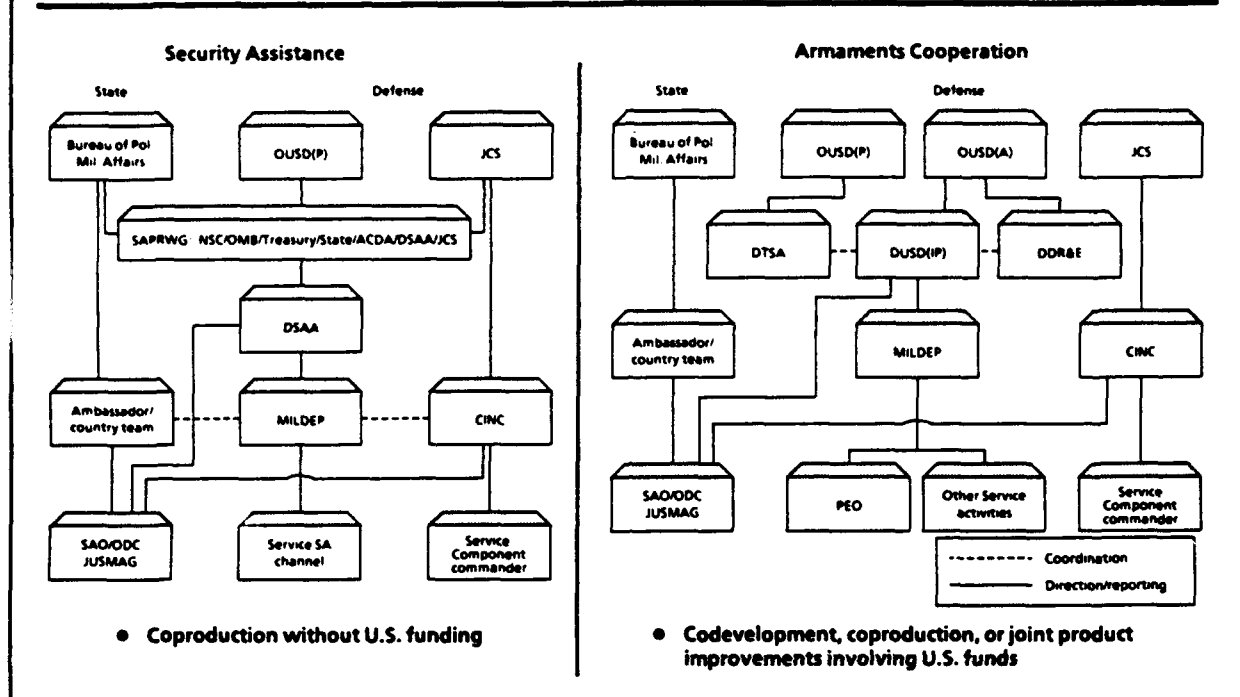

SLIDE 14

The next part of this briefing summarizes U.S. policy and procedures for coproduction. As a start, this viewgraph provides a wiring diagram of the key players in security assistance (lefthand) and other forms of arms cooperation (righthand) reflecting the strict distinction in responsibilities between the two. The diagram applies to the DoD organization of the recent past – an organizational structure that has been relatively stable since the late 1970s, when the function of USD(P) was first established. Of course, with the major organizational changes introduced by the new Secretary of Defense in 1993, this chart may now be out of date.

The key point is that coproduction, whether under government-to-government MOU or under commercial arrangements, falls under security assistance when no U.S. commitment or funding is involved. Because this has been the traditional format for coproduction, most coproduction programs have been conducted through security assistance channels under the overall oversight of the Defense Security Assistance Agency (DSAA). In contrast, any international cooperative activity in defense materiel or technology that *does* involve U.S. funding is considered an acquisition function and falls under the primary responsibility of the Deputy Under Secretary of Defense for International Programs, DUSD(IP).

This division of responsibilities between two organizations with diametrically opposed "cultures," arms sales vs. cooperation, has had some serious implications, we believe, for the way in which DoD has approached coproduction. For example, treating coproduction as an arms-length sales transaction leaves little incentive for the foreign partner to invest in R&D efforts to improve the U.S. design or production engineering and share the results with the U.S. licensor. As a result, "technology flowback" under the traditional clause in coproduction MOUs and LOAs (requiring royalty-free information on all design modifications and improvements by the coproducer) has been minimal, as documented in a previous LMI study sponsored by OSD (*Technology Flowback from International Coproduction of U.S. Weapon Systems*, LMI Report IP101.03RD1, November 1992). For the same reason, in most instances the U.S. ends up paying unilaterally for product improvements to coproduced weapons, with the results shared with coproducers, frequently with a waiver of nonrecurring cost recoupment charges. The only exception to this practice occurs when the coproduction program is an "integrated" U.S.-foreign production arrangement such as the F-16 coproduction program and its present Midlife Update Program. Clearly, a more efficient way of doing business is to let foreign coproducers pay up-front for planned product improvements by shifting production from an arms length sales transaction to a long-term cooperative arrangement – but this type of flexibility in orchestrating and managing coproduction is impeded by the present split in organization responsibilities, a fracture in OSD organizational structure that is mirrored in the Military Departments.

POLICY AND PROCESS FOR COPRODUCTION

- DoDD 2000.9, "International Coproduction Projects and Agreements," 23 January 1974
- Revisions have been in the works since 1979, but not issued because of lack of consensus
- Policy (draft DoDD 2000.9):
 - ▶ International armaments cooperation in all forms must support U.S. foreign policy objectives for region/country involved, U.S. security interests, valid operational requirements, and U.S. DIB and commercial interests [Note: not in current 2000.9]
 - ▶ DoD supports coproduction programs that directly benefit the United States in following terms:
 - (1) cost-effective solution to country's military requirement
 - (2) improved compatibility of equipment or interoperability of forces
 - (3) enhanced allied military and industrial capabilities consistent with U.S. interests
 - (4) improved base for mutual logistic support
- Process:
 - ▶ DSAA is executive agent for coproduction when financed with foreign or SA funding
 - ▶ Factors cited in SAMM:
 - Country Team to comment on: nation's capability to produce the items, its reason for desiring coproduction, economic impact on country compared to that of straight sale, and demand sufficiency for economic production run
 - DoD Component backup for recommendations to DSAA including: supporting rationale for approval, implications of proposed tech transfer, exceptions to NDP-1, impact on DIB, views of prime contractor and subcontractors involved, impact on mobilization base, any impact on other copros for same item.

SLIDE 15

The provisions of formal DoD policy on coproduction can be found in DoD Directive 2000.9. Although the current issue, dating back to 1974, is very much out of date, revisions have not been promulgated to date because of disagreements between the Military Departments and different factions within OSD. The policy objectives shown on this viewgraph are paraphrased from the current draft version of 1991. Importantly, the broad policy objectives for armaments cooperation (the first bullet) include a reference to "U.S. defense industrial base and commercial interests," language that is missing from the 1974 version. With respect to coproduction specifically, DoD policy supports it when it benefits the U.S. in terms of any of the four stated measures. Because the latter three are inherent to coproduction, DoD policy in fact can be said to be supportive of coproduction whenever it is cost-effective for the country concerned. Even this is not a very hard criterion, because in most cases a direct procurement from the U.S. will be considerably cheaper than domestic production, as a result of learning curve and production quantities. The bottom line, in plain language, is that DoD supports coproduction when a foreign country demands it, as long as it does not distort the regional balance or conflict with U.S. national security interests.

Coproduction program discussions can be initiated in various ways. For programs involving the U.S. Government, DSAA is the central focal point, and the Security Assistance Management Manual (SAMM) provides the basic guidance. The bottom of the viewgraph identifies the main factors cited in the SAMM as affecting USG approval or rejection of a coproduction arrangement. The U.S. Embassy's Country Team, which includes the Chief of the Security Assistance Organization (SAO), is to comment on the foreign country's technical capability, the economic impact of coproduction vs. direct FMS, and the country's acquisition objective compared to economic production quantity, thus assessing any need or pressure for export. Additionally, the cognizant DoD Component is to provide backup rationale for approval that includes the factors cited at the bottom. Although those factors are supposed to include an analysis of the impact on the U.S. DIB, our examination of the specific forms and process used in the U.S. Army indicates that this is just a formality or checkmark, not a systematic assessment. The focus of the Service involved is on any interference with U.S. production or other coproduction programs for the same item, not the future health of the U.S. DIB. Furthermore, whenever there is more than one source for the end item in question, the views of U.S. prime contractors and subcontractors are normally not solicited, contrary to this guidance, because that is perceived to conflict with the requirements of the Competition in Contracting Act (CICA). We believe that these limitations apply also to the other Services but cannot vouch for that.

In sum, the coproduction review process within DoD does not include a systematic assessment of the possible repercussions of technology transfer for U.S. industry's competitive posture in the aftermath of the coproduction program.

U.S. RATIONALE FOR SUPPORTING COPRODUCTION

- 1950s – 1960s:
 - › Help rebuild defense industry of allied nations
 - › Enhance allied defense preparedness and military capability
- 1970s
 - › Standardization and Interoperability
- 1980s
 - › Avoidance of duplicative R&D – growing concern about escalating costs
 - › Inefficiency of multiple national programs meeting similar requirements:
 - USDR&E's armaments cooperation initiatives, 1979
 - Attempts to foster cooperative R&D ("Nunn Program")

Formal objectives of copro
in 1974 issue of DoDD 2000.9

SLIDE 16

If DoD policy has been very supportive of coproduction with U.S. allies and friendly countries, the basic question remains, "why." This viewgraph summarizes what I believe has been the basic rationale for this traditionally lenient policy – a rationale that has shifted over the years. In the 1950s, when coproduction was first adopted as a formal tool of U.S. foreign policy, the declared purpose was to help rebuild the European defense industry to make the European NATO countries more self-sufficient. In the 1960s, the policy continued for the express purpose of enhancing allied defense preparedness, while in the 1970s the issue of standardization of equipment and interoperability of forces received more emphasis. Both of those objectives are cited in the 1974 issue of DoDD 2000.9 as the key purpose or benefit of coproduction. Then in the 1980s the emphasis shifted somewhat to the economic perspective – coproduction was viewed as an effective approach to eliminating duplicative and wasteful R&D expenditures alliance-wide in the acquisition of new weapon systems at a time when R&D costs were escalating. The same concern about wasteful spending triggered a variety of other initiatives to improve armaments cooperation, essentially to get "more bang for the buck."

Specifically, among those initiatives should be mentioned those by Dr. Perry, then-USDR&E (now, the new Deputy Secretary of Defense), who in 1979 tried to reinvigorate armaments cooperation by advocating the three principles of "Family of Weapons," Coproduction, and General & Reciprocal MOUs on Defense Procurement to open up defense trade with U.S. allies. A few years later, the Congress expressed its support for improved armaments cooperation by appropriating moneys for cooperative R&D, known as the Nunn Program.

In sum, for over three decades the DoD viewed coproduction as an important tool for armaments cooperation with alliance-wide benefits in political, military, and economic terms. Until the mid-1980s there was never any concern about the possible creation of foreign competitors who would come back to bite the hand that fed them advanced technology.

COPRODUCTION BECAME CONTROVERSIAL IN THE 1980s

- Advocates
 - Alliance relations
 - Allied defense preparedness and capabilities
 - RSI
 - Save duplicative R&D costs
- Critics
 - Technology give-away
 - Arms proliferation – loss of U.S. control
 - Adverse impacts on DIB (subtiers): “offsets”
 - Creation of foreign competitors
- Industrial Base Impact Assessment
 - DPA Amendments of 1984 and 1986
 - Omnibus Trade and Competitiveness Act of 1988
 - National Defense Authorization Act of 1989 and 1990/1991.

SLIDE 17

In the course of the 1980s, the warm feelings about coproduction encountered a rude awakening. Coproduction became increasingly controversial, both in the United States and in allied countries. While U.S. advocates continued to articulate the traditional perceived benefits of coproduction, U.S. critics began to focus on areas of adverse impact of technology transfer under coproduction, including the U.S. economy (loss of jobs, especially in the defense subtiers), U.S. sovereignty (loss of U.S. control in the global defense market), and U.S. competitiveness (loss of U.S. technological lead by giving the technology away to foreign competitors). Interestingly enough, allied governments at the same time began to resent coproduction as a form of U.S. dominance over their weapon system acquisition and pushed hard for a shift to codevelopment, which in their view would better utilize their technical capabilities and give them a more equitable vote in weapon system development.

In the United States, the controversy eventually came to a head in the Congress, which took the view that coproduction was just another form of “offset” (i.e., a commercial compensatory practice required by the foreign buyer as a condition of purchasing U.S. defense goods or services). Such mercantilistic behavior on the part of our allies, according to the Congress, was responsible for the loss of U.S. jobs and for the declining defense industrial base. It decided to keep a closer eye on coproduction and to restrain DoD from entering coproduction programs with adverse impacts on the United States. In a series of legislative steps, summarized at the bottom of the viewgraph, the Congress first demanded an annual report on the impact of offsets on the defense preparedness, industrial competitiveness, employment, and trade of the United States (DPA Amendments of 1984 and 1986). Next, it also required the establishment of an interagency group on countertrade, chaired by Commerce, to review U.S. policy on offsets (Omnibus Trade and Competitiveness Act of 1988). And third, the 1989 National Defense Authorization Act required the President to establish a comprehensive policy on offsets and pursue an international agreement on limiting offsets; to report on a detailed assessment of the costs and benefits to U.S. defense industry resulting from offsets and alternative policy options; to notify the Congress on contractual offset arrangements; and to limit transfers of U.S. defense technologies that would have an adverse impact on the U.S. DIB. It also required, for the first time, a case-by-case assessment of potential impacts of international codevelopment or coproduction agreements on U.S. competitiveness and designated the DoC to provide analytical support to DoD for such industrial base impact assessments. The statutory role of DoC’s participation in the MOU review process was further strengthened in the FY90 Defense Authorization Act (giving the Secretary of Commerce the unilateral option to require interagency review of any MOU that DoC believes is detrimental to U.S. industry) and the FY91 Defense Authorization Act, expanding DoC’s role to include assessment of G&R MOUs.

We examined the various executive branch studies and initiatives that resulted from this legislation. For the purposes of this briefing, two findings are germane. One is that the previous administration’s assessment of the costs and benefits of coproduction is positive. For example, the 5th annual report by the interagency group led by OMB, in response to the DPA Amendments, concluded that “the economic and industrial benefits of military export sales made possible by the offsets significantly outweigh the costs of those offsets.” Second, the industrial base impact assessment process instituted by the DoC (lead office is BXA/OIRA) is an *ad hoc* review of the transactions involved (i.e., workshare and money flows) and does not address the potential implications of technology transfer in the aftermath of the program with respect to competition for follow-on systems.

SUMMARY OF CASE STUDIES

Program	Long-Term Impact on U.S. DIB
NATO HAWK/HAWK/PIPs Coproduction	+ +
NATO Sidewinder AIM-9B Coproduction	+
German Sidewinder AIM-9L Coproduction	- -
European Stinger Dual Production	-
Swiss Stinger Coproduction	0
VT-1 Missile Technology Transfer	- - -

Legend: + + Very positive - Negative
 + Positive - - Very negative
 0 Neutral - - - Extremely negative

SLIDE 18

In view of this controversy, it is of interest to note that little empirical study has been conducted on the long-term implications of technology transfer under coproduction. The material published to date has focused upon the transactions associated with a coproduction program (i.e., flows of money and workshare), not on the aftermath of a coproduction program when the consequences of technology transfer might become visible in the form of derivative and competitive defense products. We decided to conduct a number of case studies to examine the facts. Our case studies are documented in Tab B. This viewgraph summarizes our findings.

A positive impact or benefit is measured in terms of additional U.S. sales generated by the coproduction program. A negative impact or cost is measured in terms of enhanced foreign competition as a result of coproduction and the associated loss of U.S. market share in follow-on systems in the same mission area covered by the coproduction program. While the balance between costs and benefits for any program may include some subjective judgment, the details of each case study explain how we arrived at these assessments.

Although one may quibble about the precise, quantitative impact on the U.S. defense industrial base, it is clear that some programs have been beneficial, some detrimental. More importantly, however, these case studies helped us to identify a series of factors associated with a coproduction program that explain whether or not a program is likely to have an adverse impact.

These two findings, combined with the findings discussed previously, yield our main conclusions as presented on the following viewgraph.

CONCLUSIONS

- (1) **The U.S. Government Review Process Is Inadequate**
 - Reviews of coproduction MOUs ignore long-term DIB impact
 - State: Foreign Policy Criteria
 - Defense: Releasability of Technology
 - Commerce: Financial Flows/Workshares
 - Commercial production license agreements are overtaking Government coproduction arrangements
 - Munitions export controls over defense production technology exports ignore competitive implications
- (2) **The Loss of Technological Dominance makes the Traditional Paradigm Inoperative**
 - Traditional paradigm for coproduction: obsolete technology only to ensure U.S. technological lead
 - Many recent coproduction programs contrary to this paradigm
 - Contributing factors: slower pace of U.S. modernization, more rapid pace of foreign innovation
- (3) **The Likelihood of Adverse Impacts on the DIB Has Grown but Could Be Controlled**
 - With the traditional paradigm inoperative, the risk of technology transfers to foreign competitors has grown
 - The parameters we identified through the case studies could be used for a systematic risk assessment
 - While future impact is uncertain, programs with a high risk of adverse impact should be rejected or restructured
- (4) **Systematic assessment of coproduction programs is not a novel idea but hard to implement**
 - 1983 DoD task group on coproduction/Industrial Participation Agreements ("Denoon Report")
 - Systematic assessment approach and criteria endorsed by OSD principals, USDR&E/USD(P)
 - Never implemented - refer to draft revisions of DoDD 2000.9

SLIDE 19

Our main conclusions from what we have learned about coproduction in the course of this study are stated here. First, the Government review process is clearly inadequate for the identification of program arrangements that pose a high risk of adverse impact on U.S. industry in the future. The organizations involved in the review process look at particular aspects of a coproduction program, but no one considers the aftermath beyond the program in question in terms of increased competition in follow-on systems. Moreover, DoC's industrial base impact assessment looks only at government-to-government MOUs. Commercial industry-to-industry license agreements escape the DoC review entirely, even though their trend is up and they are becoming more preponderant than government agreements.

Second, the traditional paradigm for coproduction, designed to limit adverse impacts by limiting coproduction to outdated technology (i.e., systems approaching the end of U.S. production, with successor systems in development and close to entering production), is no longer operative under current conditions. With the U.S. modernization cycle slowing down, there are many recent examples of coproduction programs for weapon systems still in U.S. production without a successor system in engineering and manufacturing development (EMD) - i.e., examples that are in conflict with the traditional paradigm. We have also found examples that, despite complying with this paradigm, came back to hurt U.S. industry because the foreign rate of innovation far exceeded that of the U.S. Third, while nobody can predict future impacts with certainty, the factors that we have identified from our case studies lend themselves to a quantitative risk assessment of proposed coproduction programs in terms of probability of long-term adverse impact on U.S. defense industry. In other words, a more careful, structured review of the detailed parameters of a coproduction arrangement can provide a realistic assessment of potential future risks to U.S. industry.

I will describe those factors shortly. Finally, our fourth conclusion is that systematic evaluation of coproduction programs is not entirely a novel idea but is apparently very hard to implement. Back in 1983, a DoD Task Group was convened to address issues in international arms collaboration and to develop a new perspective and criteria for coproduction. Its report, known as the *Denoon Report*, recommended a set of criteria for systematic evaluation of the costs and benefits to the United States from coproduction. Even though the recommended approach and criteria were approved by the cognizant DoD principals, USDR&E and USD(P), for promulgation "as part of a DoD collaborative programs directive," this apparently never happened. The only tangible result thus far has been the inclusion of the terms "U.S. defense industrial base and commercial interests" in the draft revision of 2000.9, as I showed previously.

PROPOSED DECISION LOGIC TO AVOID ADVERSE INDUSTRIAL BASE IMPACT

- **Program Screen**
 - Complexity/Cost of weapon system
 - Intellectual property rights
 - Structure of coproduction program
 - Number of countries involved
- **Technology Screen**
 - Extent of technology transfer
 - Significance of transferred technology
 - Foreign availability of technology
 - Pace of U.S. modernization
- **Market Screen**
 - Number of U.S. sources
 - Market demand and U.S. share
 - Competing foreign candidates
- **Country Screen**
 - Defense trade policy
 - Acceptability as dual-source for U.S. procurement
 - Technological capabilities and pace of innovation
- **Potential Outcomes**
 - No objections to coproduction
 - Conditional on "black-boxing" of U.S. advanced technology components
 - Conditional on "quid pro quo" arrangement for foreign technologies
 - Coproduction unacceptable due to adverse impact on DIB or U.S. technology lead

SLIDE 20

This viewgraph summarizes the factors that we found to be predictive of long-term adverse impact. They are organized into four screens applicable to four categories of factors: program characteristics, technology parameters, market conditions, and country characteristics. Applied in a systematic fashion, these screens would put any proposed coproduction deal into one of the outcomes shown at the bottom: go ahead, unacceptable, or conditions in between.

For example, a program involving a highly complex weapon system (measured in terms of separate end items and interfaces) and a large number of participating countries might pass the program screen because the risk of technology diffusion into derivative foreign weapon systems might be relatively small. On the other hand, that same program might not pass the technology screen if the extent of technology transfer is complete (i.e., dual production line), the transferred technology is significant (in terms of critical technologies), and the technology is available only in a few countries besides the United States. The market screen, however, might indicate that the program would be in the U.S. interest when there is only one U.S. source, which is underutilized, and there is a foreign competing system that is being offered for coproduction. The country screen might reinforce the market screen result and moderate the technology screen result when the countries involved in the proposed program are not aggressive defense exporters, are acceptable as potential dual-sources for U.S. procurement, and lag behind the U.S. in the pace of technical innovation.

Obviously, at this time, this decision logic is only a think piece. The point I want to make is simply that it is clearly feasible to conduct a comprehensive risk assessment for any proposed coproduction arrangement on the basis of a few items of information that are readily available at the outset of coproduction MOU review and negotiations. Using this type of approach would help avoid making the wrong decisions on coproduction MOUs and technology export licenses.

GLOBAL CHANGES HAVE MADE U.S. POLICY OBSOLETE

- ***Collapsing Military Threat***
 - ▶ U.S. loss of influence over allies
 - ▶ Foreign policy aims, the crutch for coproduction in the past, more complex
 - ▶ Broader view of national security, including economic security.

- ***Shrinking Defense Procurement Budgets***
 - ▶ New acquisition strategy: Upgrades, LRIP, "Rollover-Plus," and "Silver Bullet" programs
 - ▶ Consolidating DIB
 - ▶ Increased dependency on defense exports
 - ▶ Domestic dual sourcing no longer affordable

- ***Globalization of defense industry and technology***
 - ▶ No national fences around technology regardless of export control regime
 - ▶ More international competition in global arms market
 - ▶ U.S. DIB no longer in technological lead position in many technologies
 - ▶ International mergers, acquisitions, joint ventures, and partnerships are market reality.

SLIDE 21

So far I have addressed the first two key questions: actual long-term impacts of coproduction on U.S. defense industry, and factors that differentiate programs with adverse impacts from those with beneficial impacts. I am shifting now to the third key question, the impact of global change on the coproduction business in the 1990s. This viewgraph lists the key changes and their implications, in our assessment, for international arms cooperation, including coproduction. Our bottom-line conclusion is the heading of the viewgraph.

First, with respect to the collapse of the former Soviet military threat, it is apparent that national security now equates to economic security. Even though the formal statement of national security objectives has not yet been updated accordingly, the implication for coproduction is that economic considerations must outweigh the traditional politico-military rationale for coproduction, changing the cost-benefit calculation dramatically.

Second, with respect to the shrinking defense procurement budget, the main message is that production of new weapon systems will be the exception (the so-called "silver bullet" programs of Les Aspin), and those will not be open for coproduction, in order to maintain the U.S. technological edge. Most of the defense procurement business will consist of product improvements to currently fielded systems.

Third, with respect to globalization of defense technology, the main message is that the United States has long since lost its position of dominance in defense technology. It is an anachronism to believe that we can control the diffusion of U.S. technology to foreign markets and that we can do without the infusion of foreign technology into our market.

In sum, the implications of those global changes in our assessment are twofold. First, coproduction as done in the past will be a dwindling business. Second, the United States would benefit more from rethinking its lukewarm approach to arms collaboration and emphasizing cooperative product improvement arrangements.

U.S. POLICY OPTIONS AND RAMIFICATIONS

- **Option #1 - Continue Traditional Policy on Coproduction**
 - ▶ Proliferation of advanced weapons manufacturing throughout the world is not in U.S. interests.
 - politically: USG loss of control
 - economically: U.S. loss of sales and market share, rampant competition
 - technically: U.S. loss of leading edge in fielded weapon systems
 - DIB: decline.

- **Option #2 - Terminate Coproduction Completely**
 - ▶ Isolationist policy in weapon system production not in U.S. interest either
 - U.S. no longer in a position to force allies to buy U.S. weapons
 - Offset has become standard market practice in defense procurement
 - Sole-source dependency might lead to cost escalation
 - Policy would have same effects as Option #1.

SLIDE 22

We are now arriving at the end of the briefing with a discussion of USG policy options. The first two options are obvious: we can do nothing and muddle through (Option 1) or terminate coproduction altogether (Option 2). The viewgraph lists the counterarguments for either option and the adverse implications the option would have. Either option, in our view, would have the same ultimate consequences for the defense industrial base - unavoidable decline in business volume and competitiveness - and the same consequences for DoD - cost escalation and loss of leading edge in fielded technology.

U.S. POLICY OPTIONS AND RAMIFICATIONS (Continued)

- **Option #3 – Scrutinize Coproduction Proposals and Export License Applications to Avoid Adverse Impacts**
 - ▶ Preferred option if combined with elements of Option #4
 - USG: Make PIPs collaborative effort with partner R&D contributions up front
 - Industry: Need to reconcile conflicting interests of overall DIB and individual companies.

- **Option #4 – Shift to cooperative programs that offer equitable balance in tech transfers**
 - ▶ New acquisition strategy emphasizes ATDs, prototypes, PIPs in lieu of new production; hence international cooperation must shift to cooperative R&D
 - U.S. no longer has dominant lead across the board
 - Need to tap foreign technologies where they are ahead
 - Without cooperative R&D, U.S. will lose its lead in fielded weapons technology.

SLIDE 23

The more promising options are somewhere in between the extremes of the first two options. Option 3 is to take a more businesslike approach to coproduction and other forms of technology transfers by adopting a systematic assessment process to ensure that any long-term adverse impacts on U.S. industry will be avoided. As previously indicated, the trend is away from new procurement to product improvement programs (PIPs). To have any meaning for the 1990s, therefore, Option 3 must include fostering cooperative PIPs with partner countries contributing their share in R&D expenditures and effort up-front rather than the old way of doing business by giving them the U.S.-funded PIP and receiving a penny on the dollar through NRC recoupment charges (which have frequently been waived).

The final option, Option 4, pertains to forms of arms cooperation other than coproduction and adopts a single criterion for any form of cooperation, whether data exchanges or cooperative R&D projects: an equitable balance between inbound and outbound technology transfers.

We advocate a combination of Options 3 and 4 as the most effective policy to help preserve the competitive posture of the declining U.S. defense industrial base. To have a lasting effect, development and implementation of this policy, including the decision support system that is required for systematic evaluation of the risks associated with defense technology transfers, should be an effort sponsored jointly by Defense and Commerce.

TACTICAL MISSILE CASE STUDIES

LMI CASE STUDIES

- **Purpose:**
 - Assess the long-term defense industrial base impact
 - Identify program factors and conditions that explain the impact
 - Relate these factors to U.S. policy, case review process, and export control regime
- **Case Studies:**
 - Coproduction programs: Hawk, Sidewinder, Stinger
 - Other international ventures involving export of U.S. technology: VT-1 missile

SLIDE 1

In view of the controversy about the costs and benefits of coproduction, we decided to conduct a number of case studies, not only to find out what the long-term impact actually was but also to determine the feasibility of predicting the long-term impact on the basis of program characteristics that are known at the outset of a coproduction program. If there exists a systematic relationship between program characteristics and long-term industrial base impact, then it should be applied in a decision support system for the negotiation and review of coproduction MOUs, to avoid an arrangement that would hurt the U.S. defense industrial base.

For our purposes, benefits are measured in terms of additional sales of U.S. defense equipment (parts and tooling) and services generated by the coproduction program. Costs are measured in terms of reductions in future market opportunities (potential sales lost) resulting from strengthened foreign competition derived from the technology transferred under the coproduction program in question.

We selected our case studies within the tactical missile area, both air-to-air and surface-to-air missiles. This selection was based, in part, on the relatively large number of missile coproduction programs in the past and the intense international competition in recent years. Because we focused on one area, despite the various technologies involved (both infrared homing and radar guided missiles), we do not know for certain whether our findings are representative for coproduction in general. For each of the selected programs (*HAWK*, *SIDEWINDER*, *STINGER*) the following viewgraphs without further annotations present a brief description of the system, the U.S. acquisition program, the coproduction agreement, and our assessment of the resulting impacts on the U.S. defense industrial base. The fourth case study pertains to a technology transfer arrangement under a commercial venture rather than a coproduction MOU. Our summary assessment of industrial base impacts and the program factors related to them are presented in the main briefing (Tab A).

HAWK SYSTEM DESCRIPTION/CONCEPT OF OPERATIONS

- **Medium-range SAM, providing all-weather, day/night air defense protection for installations and maneuver forces against low-to-medium-altitude aircraft attack**
- **Semiactive homing missile, guiding itself to target intercept using proportional navigational laws. Missile detects the energy reflected off the target when illuminated by the High Power Illuminator Radar. Missile also receives a reference signal from the HPIR for in-flight guidance. Missile has a two-stage solid propellant rocket motor; attains supersonic speed; and has HE warhead with proximity fuze.**
- **System underwent major product improvements and organizational changes over past 3 decades:**
 - **IHAWK: RAM improvements to Basic Hawk; partially solid state; new missile (rocket motor and guidance seeker)**
 - **PIPs Phase I: RAM; Phase II: "computer-assisted;" Phase III: "computer driven"**

HAWK SYSTEM DESCRIPTION/CONCEPT OF OPERATIONS (Continued)

- **Organizational changes affected the quantity of major end items in a battery**

Major item	IHAWK Bty.		Phase II/III PIP IHAWK Bty.
	Triad	Standard	
Pulse Acquisition Radar	1	1	1
CW Acquisition Radar	3	1	2
*Range Only Radar	1	1	0
*Information Coord. Central	1	1	0
*Battery Control Central	1	1	0
Platoon Command Post	3	1	2
High Power Illuminator Radar	3	2	2
Launcher	9	6	6
Missiles	(27)	(18)	(18)
Quantity of items per battery	22	14	13
Number of batteries per battalion	3	4	3

*Items eliminated in Phase II PIP.

HAWK BATTERY - PHASE III

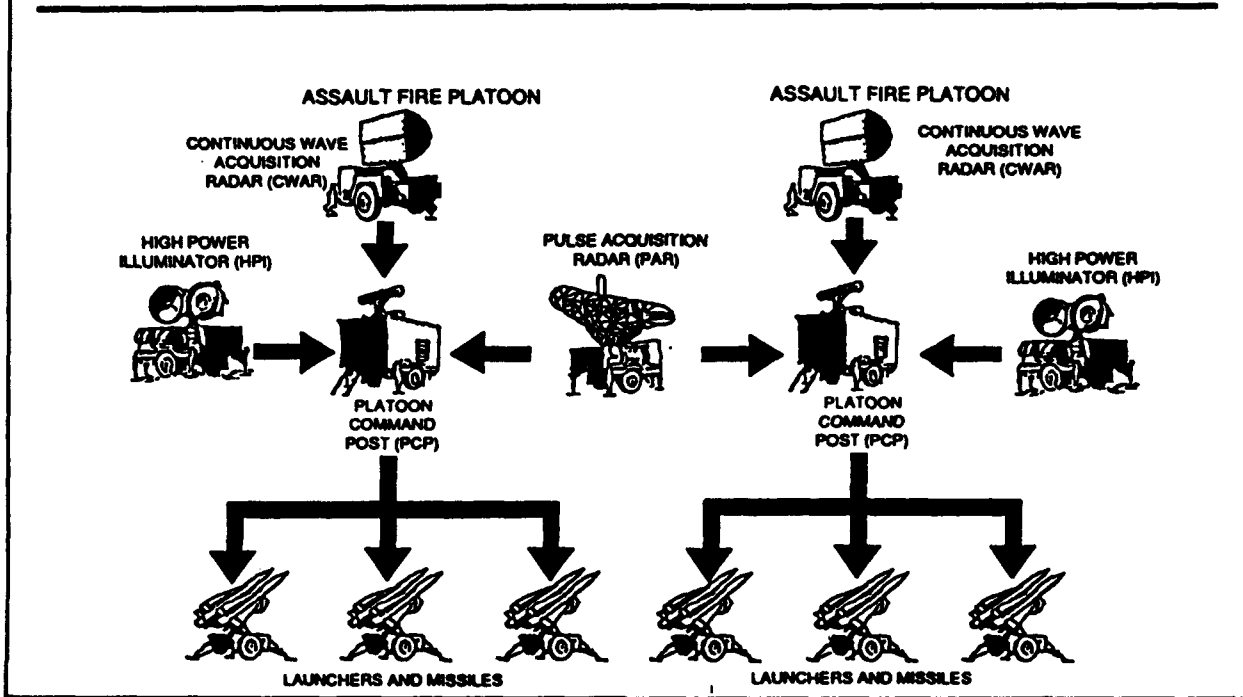

MAJOR MILESTONES

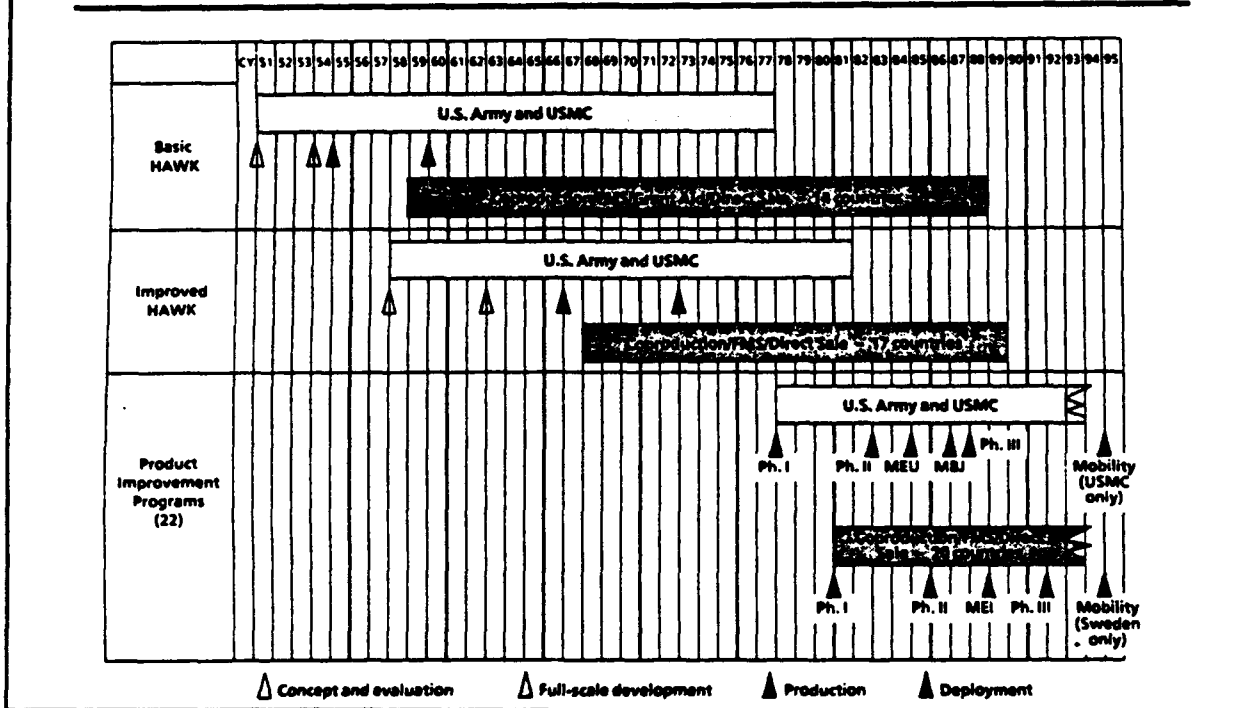

COPRO PROGRAM HISTORY

- Late 1950's:
 - ▶ Basic HAWK selected by NATO to be coproduced in Europe – NHPLO formed (5 countries – GE, FR, NL, IT, and BE)
- 1959:
 - ▶ Signing of "Weapons Production Program" Agreement
- 1968:
 - ▶ NHPLO decision to upgrade Basic HAWK in concert with U.S. – two countries added (DE and GR) (HELIP Agreement)
- 1966 through 1973:
 - ▶ Japan obtains Basic HAWK through foreign military sales/military assistance program – 1967 MOU for coproduction
- 1967/68 to present:
 - ▶ NATO and Japan update agreements to include product improvements through Phase III

COSTS AND BENEFITS TO U.S.

- U.S. Industry:
 - ▶ Total Army expenditures on HAWK program, FY63 through FY93 approximately \$2.1 billion (R&D: \$406 million; Proc: \$1,670 million)
 - ▶ Global gross sales approximately \$12 billion
 - ▶ U.S. content of coproduced HAWK equipment approximately 25 percent (Japan) to 35 percent (NATO)

U.S. sales from Copro	NATO (\$ millions)	Japan (\$ millions)
Basic HAWK	\$768	\$99
IHawk/PIPs	\$344 ^a	\$445
Total	\$1,112	\$544

^aExcludes Phase III PIPs and \$16 million NRC recoupment charges.

COSTS AND BENEFITS TO U.S.(Continued)

- **U.S. Government:**
 - ▶ Transferred entire PTDP and manufacturing license (no "blackboxing") to both NATO consortium and Japan (NATO decision to leave missile G&C section in U.S.)
 - ▶ Received in return:
 - Basic HAWK, NATO: 4 battery sets (applied by USG to grant aid MAP, value - \$28 million)
 - IHAWK/PIPs, NATO: \$40 million NRC recoupment (\$30 million R&D; \$10 million production)
 - NRC recoupments, Japan: N/A
 - ▶ Total NRC recoupment through FMS and Copro: \$200 million (\$132 million R&D; \$68 million production)
 - ▶ Technology flowback:
 - ~12 ECPs from NATO, 1 adopted by U.S. (rotary pump for cooling of HPI transmitter)
 - Many ECPs from Japan, no value
 - ▶ Any increase in foreign sales reduces USG procurement cost; copro may reduce U.S. O&M cost
 - ▶ Intangibles: allied air defense capabilities; S&I; allied industrial development

COST AND BENEFITS: FOREIGN

- **Foreign Industry:**
 - ▶ Obtained enhanced American manufacturing technology and know-how through on-site technical assistance from U.S. prime contractors and subcontractors. Notable technology areas: manufacture of antennas, missile guidance and control package, rocket motors, complex radars, and warheads
 - ▶ Expertise gained with HAWK program obviously helped these companies in advancing their capabilities to design, develop, and manufacture other systems like Crotale (Thomson-CSF), Roland (MBB), and Tan-SAM (Mitsubishi)
 - ▶ No evidence of HAWK derivatives competing with U.S. HAWK improvements, but Crotale technology derived from HAWK coproduction (industry view)
- **Foreign Governments:**
 - ▶ Succeeded in spending large portion of their air defense expenditures within national borders, benefiting national economies and justifying public support for defense budgets
 - ▶ This political aim was achieved at a high price:
 - NATO's unit production cost is double, Japan's triple, the cost of direct purchase from United States (FMS or DCS)

CONCLUSIONS AND OBSERVATIONS

- Besides foreign policy considerations, the HAWK coproduction programs with European NATO countries and Japan have provided net benefits to the United States and the defense industrial base. They also paved the way for PATRIOT coproduction.
- Major controversy with NATO, concerning the Missile Electronic Counter-Countermeasures Improvement (MEI), soured the relationship and made Raytheon "persona non grata" in the European MSAM program efforts.
 - [USG/Army/Raytheon did not disclose IHAWK susceptibility to ECM until the MEI program was completed in 1984. Informed about the deficiency as well as high cost of the needed improvement, NATO requested kits to do the missile upgrade in Europe. Raytheon quoted the same price as having the upgrade done by Raytheon.]
- Factors that may have contributed to avoiding adverse impact on U.S. DIB:
 - ▶ High complexity and cost of the system, combined with the large numbers of different companies of different countries involved in the technology transfer.
 - ▶ Low density of this type of system in each nation's force structure, resulting in low demands and small production runs, leaving U.S. defense industry in the driver's seat.
 - ▶ Life-cycle cooperative relationship
 - ▶ By nature of technology and market, European defense industry focused on SHORAD market until late 1980s, but now entering the HIMAD market.

SIDEWINDER (AIM-9) MISSILE CASE STUDY

Mission: All-weather, short-range, air-to-air missile. Also adopted for surface-to-air role, both ground (Chaparral) and naval (Sea Chaparral)

Characteristics: Passive Infrared Homing Missile. Lock-on before launch, fire-and-forget operation. Original versions were "revenge weapon," with target acquisition possible only dead aft of the target for launch. Starting with AIM-9L, the missile provides all-aspect and dogfight capability. Starting with AIM-9M, the missile has improved IRCCM capability.

Guidance: Passive IR
Diameter: 5.12 inches
Length: 10 feet
Weight: 172/190 lbs
Fin span: 22 inches

Speed: Mach 2.5
Range: 11 miles
Mission time: 60 secs
Look angle: all aspects
Off-boresight capability

Program Status: Versions in U.S. production: AIM-9M, P, and S
 Upgrade program AIM-9R terminated in 1991
 COEA for AIM-9X planned for October 1993

Contractors: Loral (formerly Ford Aerospace) and Raytheon; Total production 160,000 +

Coproducers: Germany (lead in NATO consortium) (AIM-9B and L)
 Japan
 Egypt
 Taiwan

SLIDE 1

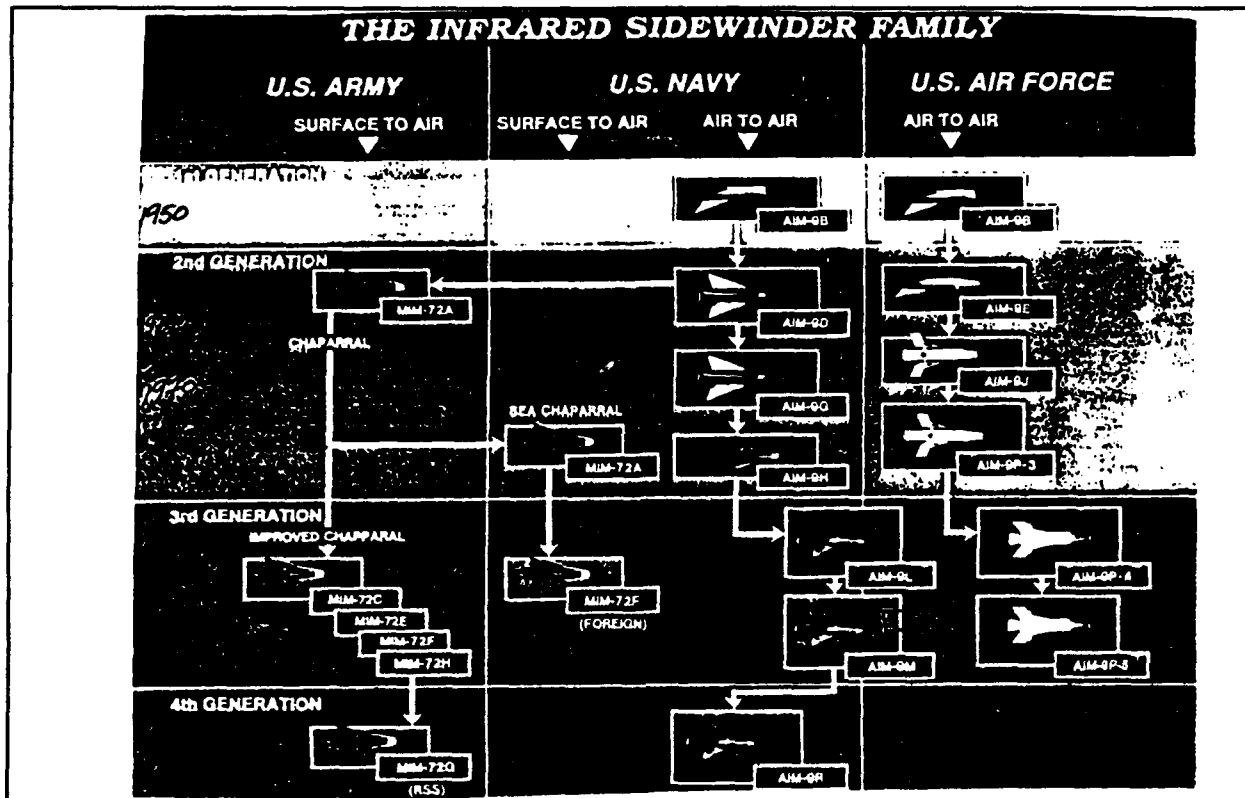

AIM-9L/M/S AND AIM-9P-4/5 COMPARISON

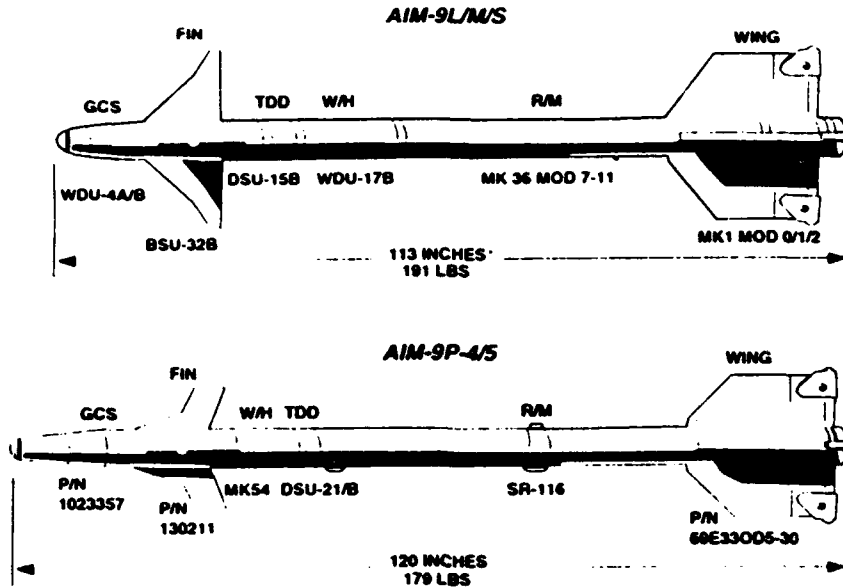

SIDEWINDER PROGRAM MILESTONES

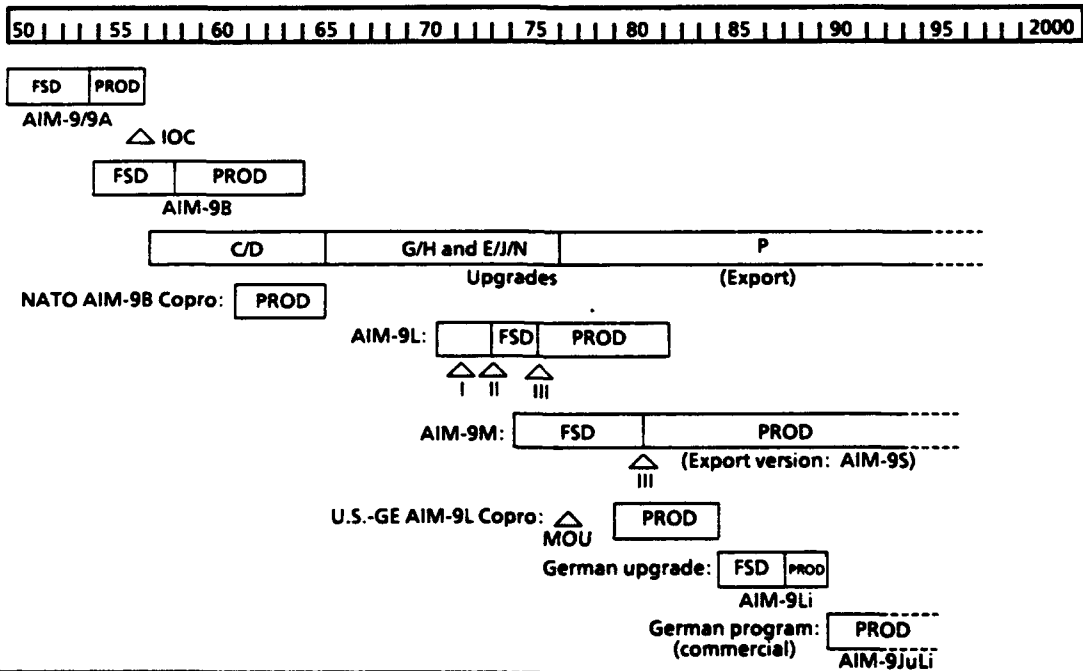

FIRST GERMAN COPRODUCTION MOU HISTORY

- AIM-9B Coproduction Agreement with NATO, 1959
 - ▶ USG adopted policy in late 1950s of offering coproduction to NATO allies as mechanism to reduce U.S. tax burden of MAP grant aid and help rebuild European defense industry
 - ▶ NATO international staff, in aftermath of 1957 Sputnik, assumed active role in collecting/disseminating information on weapon systems from which national representatives were to select those for pooled production in Europe
 - ▶ Hawk and Sidewinder were the first U.S. weapons selected in this evolving process for coproduction by multinational consortium. (Earlier license production arrangements were limited to individual nations)
 - ▶ Sidewinder WG first met January 1959. Following DPC approval, the NATO Sidewinder Production Organization was established in December 1959: BOD-reps. of participating nations: 8 nations, (BE, DE, GE, GR, NL, NO, PO, TU) and U.S.; Program Office – set up in designated lead country (GE), collocated at designated prime contractor, Fluggeraetewerke, GmbH, now known as Bodenseewerk Geraetetechnik (BGT). (At the time, FGW was 95 percent owned by Perkin-Elmer; the German company Diehl bought out Perkin-Elmer in 1989. BGT is now co-owned by MATRA, 20 percent)
 - ▶ Agreement provided for transfer of entire TDP, technical assistance by U.S. contractors, production of 15,800 missiles, waiver of NRC and royalties except for seeker: USG owned the TDP (developed at China Lake) except for Dr. McLean's patent on the IR seeker, developed at Cal Tech in 1947 before he joined the Naval Weapons Center to head development of Sidewinder
 - ▶ NATO program fairly complex: 11 subcontractors from 9 nations, and over 200 suppliers
 - ▶ Nonparticipation by UK and France explained by national development programs

GERMAN IMPROVEMENTS TO AIM-9B

- AIM-9B
 - ▶ Designed to kill high-altitude, nonmaneuvering bombers
 - ▶ Operational limitations: dead zone around sun (20°), spurious lock-on to reflected energy (clouds, water)
 - ▶ Seeker head featured uncooled PbS detector; glass dome; and vacuum tube electronics
- AIM-9B/FGW Mod 2
 - ▶ FGW-developed modifications to seeker head to improve missile performance at lower altitude and in adverse conditions: CO₂-cooled PbS detector, Si dome, and solid-state electronics
 - ▶ Performance improvements: higher seeker sensitivity, improved background suppression, dead zone around sun reduced to 5°
 - ▶ Achieved at expense of 11 lbs weight growth and 10cm increase in length of missile
- AIM-9D
 - ▶ In U.S. production since 1961
 - ▶ Incorporated similar and several other improvements such that its performance exceeded that of the German version, except for reliability (solid-state electronics was introduced only with the later H and J models)
- European Experience
 - ▶ The Sidewinder BOD claims that the unit cost of the European-produced missiles was comparable to that of U.S. production if adjusted for production run
 - ▶ Also claims "considerable spinoffs" in the form of gains in technology and know-how

SECOND GERMAN COPRODUCTION MOU HISTORY

- AIM-9L was the first U.S. system in a "second wave" of coproduction starting in late 1970s, generally attributed to the USDR&E's advocacy of improved arms collaboration (1979 initiatives).
- Actually, with the "L" still under development, USN and German MOD signed a 1975 agreement in principle for Germany to purchase or coproduce "L", if it went into U.S. production, and to terminate its development (with Norway) of the similar Viper missile, being developed by BGT. To protect Germany against risk of the L not going into production, the agreement provided following back-up arrangement:
 - ▶ USN provides NWC test facilities and tech assist for German tests of Viper seeker
 - ▶ USN provides tech data of AIM-9H for German design and development of integrating Viper seeker with "H" ("ALASCA:" all-aspect capability)
 - ▶ USN will provide complete TDP of H (less seeker head) for use in German production of "ALASCA"
 - ▶ Germany pays direct costs of ALASCA project while U.S. bears cost of AIM-9L development
- The novel feature of the BGT seeker head developed for the German Viper program was its use of an external gimbal system in lieu of the free gyro powered via head coils (used in Sidewinder), with the complete modulating system, including detector and cooling system, moving as a unit. German simulations indicated Viper was superior to AIM-9L in performance at the limits of the firing envelope, although this edge could not be exploited in tactical scenarios.
[Note: Experts suggest that the BGT-type design would be essential in future follow-on seeker heads that use FPA instead of single detector cell. Reportedly, the aborted AIM-9R had similar design.]

SECOND GERMAN COPRODUCTION MOU HISTORY (Continued)

- Possible motivations for this arrangement:
 - ▶ Common interest in advanced short-range missile with all-aspect capability
 - ▶ USN interest in BGT seeker
 - ▶ German concern about escalating cost of Viper and meeting 1978 fielding requirement
- AIM-9L completed Techeval/Opeval in 1975, with production go-ahead early 1976. Initial production contract awarded to Raytheon, April 1976; full-rate production in 1978, competed between dual sources (Ford Aerospace (now Loral) and Raytheon)
- U.S.-GE Coproduction MOU, October 1977
 - ▶ USG agrees to sell to GE the PTDP of AIM-9L (excluding fuze, AOTD) and grants GE the right to use it for production purposes without payment of royalties or NRC recoupment
 - ▶ USG will sell components, supplies, and services, including AOTD, as needed through LOAs, waiving royalties and NRC recoupment charges. Technical assistance for production and maintenance to be provided on cost-reimbursable basis
 - ▶ GE agrees technical data will not be transferred to third countries other than Norway and any other NATO coproducers (with exception of detector unit and gyro assembly components of GCS)
 - ▶ GE agrees not to manufacture items for sale to third countries without prior USG consent except for sale/transfer to Norway and other accepted NATO coproducers
 - ▶ Parties agree to objective of common configuration, at least physical interchangeability: FRG will produce AIM-9L in conformance with PDTP and changes in accordance with Configuration Management Program; U.S. modification to baseline only after consultation; GE representative on CCB for duration of the program

SECOND GERMAN COPRODUCTION MOU HISTORY (Continued)

- CNAD Activities, 1976-1979
 - ▶ NAD discussions attempted to combine national concepts into single development program: UK-Taildog (SRAAM75); FR-Matra R550 "MAGIC;" GE-Viper; US-AIM-9L
 - ▶ Eventually, CNAD agreement to pick one system to complete development on national basis, with other parties granted licensed production rights
 - ▶ Disagreement on which one to pick. U.S.: NAD proposed competitive fly-off: no-go
 - ▶ Eventually, after U.S.-GE MOU, UK decided to terminate its program
 - ▶ May 1979: UK and IT signed up with Germany in AIM-9L copro program
- U.S.-GE MOU Amendment #1, March/April 1978
 - ▶ GE to provide all technical information/data on design and manufacturing changes, modifications, and improvements "developed under this coproduction program" and incorporated in the AIM-9L by GE, NO, or other NATO coproducers
 - ▶ GE to provide cost-free to USG technical information/data on inventions (whether or not patentable) conceived or first actually reduced to practice in AIM-9L production, except as they pertain to major performance changes not incorporated in AIM-9L in GE, NO, and other coproducers; and royalty-free right for USG to use those inventions for defense purposes
 - ▶ U.S. to provide – at no cost to FRG, NO, and other NATO coproducers – technical information/data on design and manufacturing changes, modifications, and improvements incorporated in AIM-9L except as it pertains to fuze (AOTD) and "major performance changes not intended to be incorporated in AIM-9L" (i.e., the ongoing U.S. AIM-9L PIP that eventually became the AIM-9M)
 - ▶ Same clause on U.S. inventions, with the same exception

SECOND GERMAN COPRODUCTION MOU HISTORY (Continued)

- Implementation
 - ▶ Workshare arrangement in proportion to national procurements
 - ▶ BGT competed most of the tooling between Raytheon and Loral, with Loral the winner
 - ▶ Production run of 8,800 missiles completed in 1983
- Aftermath
 - ▶ GE discovered AIM-9L was susceptible to IRCM (flares)
 - ▶ Consulted USG on problem and learned that IRCCM was major focus of AIM-9L PIP that was excepted from copro MOU.
 - ▶ Requested design information/tech data on PIP or copro on AIM-9M. Request rejected.
 - ▶ Immediately proceeded with German PIP that was developed and produced within 3 years: single electronic module replacing one in the seeker head.
 - ▶ Offered PIP to USN. Experts at China Lake impressed, but AIM-9M already in production.
 - ▶ BGT decided to package the Li improvement as an upgrade to earlier Sidewinders in NATO -- JuLi program
 - ▶ U.S. prime upset when BGT was caught selling the JuLi upgrade to Spain
 - ▶ DSAA rang the bell. U.S. asserts GE activity beyond MOU bounds. GE disagrees. Diplomatic stand-off. Secretary of Defense Cheney compromise: U.S. consent, if 30 percent workshare and GE pays NRC recoupment charge, \$5K per JuLi missile
 - ▶ Loral and BGT trying to work out some arrangement

TOTAL U.S. REVENUES FROM GERMAN AIM-9L COPRO

AIM-9L Coproduction Program: - more than 1,000 missiles bought via FMS case in the U.S., test equipment, devices for the BGT production line - material (including 7000 AOTDs) to the value of \$17,150 per missile produced in Europe (14,000)	U.S. \$250 Million U.S. \$240 Million
AIM-9L Improved Program: - material for 12,000 missiles, to the value of \$1,250 per missile	U.S. \$15 Million
AIM-9JuLi Program: - subcontract with Loral - NRC charge of \$1,302 per missile (800)	U.S. \$20 Million U.S. \$1 Million
Total "flow-back" to U.S.	approx. U.S. \$526 Million

SOURCE: German Embassy, Washington, DC, November 1992.

U.S. COSTS AND BENEFITS FROM GERMAN COPRO

- **USG**
 - ▶ Some limited recoupment of R&D investment: \$1,300 NRC charge per JuLi missile sold outside copro program passed through to U.S. Treasury
 - ▶ Well-intended program, in accord with U.S. cooperation policy, that went sour
 - ▶ In retrospect, DSAA is on record it would not have approved the program if it had known what would occur
- **U.S. Industry**
 - ▶ Short-term gain: about \$500M sales that would not have occurred had the U.K. and German development programs continued into production.
 - ▶ Long term loss: Sidewinder missile upgrade market (to Li or M standard) lost to BGT. This market is approximately \$360M business within NATO (12,000 older Sidewinder missiles) and a similar number globally. The Li upgrade of L version and the JuLi upgrade of J version are cheaper than the M upgrade and offer same capability as M5/6 version, fielded in 1991 (less than M8/9 version still to be fielded).

GERMAN COSTS AND BENEFITS FROM COPRO

- **MOD**
 - ▶ Write-off R&D investment (\$125M) in the Viper program, but cost of meeting the military requirement and schedule risk are lower with copro
 - ▶ Delays in copro forced 2-year buy of AIM-9Ls from U.S. production line
 - ▶ Resentment of U.S. uncooperative attitude in correcting IRCCM deficiency of missile:
 - GE forced into Li program to make missile effective; cost \$12M, shared by 3 nations
 - GE in full compliance with MOU: it provided 3 Li seeker heads to China Lake for T&E pursuant to interoperability clause; U.S. did not reciprocate in kind
 - GE NAD, in 1989, proposed to U.S. NAD to conduct joint evaluation of M and Li in effort to produce the best possible IRCCM solution, but U.S. declined
 - ▶ GE feels tricked by U.S.; in retrospect, would not have favored this program
 - ▶ Sweden bought AIM-9L from U.S. and asked for Li upgrade from Germany because U.S. rejected sale of M upgrade
 - ▶ The controversial JuLi program is BGT initiative, without MOD involvement
- **Industry**
 - ▶ BGT developed the JuLi upgrade kit in response to inquiry by Spain, which wanted to upgrade its J/N/P missiles. Spain compared Loral's P4/S upgrade bid with JuLi and chose the latter, because it offered better performance at lower cost than the former
 - ▶ European participating companies gained additional know-how from the transferred U.S. manufacturing technology
 - ▶ BGT lost Viper development and production, but gained NATO missile upgrade market

CONCLUSIONS AND OBSERVATIONS

- Overall, this coproduction program had adverse impact on U.S. DIB
- According to U.S. industry insiders, the program advanced foreign industry capabilities by 4 years
- U.S. industry also complains about confused U.S. technology release policy: once USG decides to release technology, it should release it to any allied or friendly country to forestall foreign developments; current selective release practice has the opposite effect (e.g., IRCCM capability currently releasable only to selected countries; phased releases of AIM-9M and -9PS).
- Some of the major competitors acquired their capability in part through U.S. tech transfers, especially:
 - ▶ IAI – Python ← Shafir ← AIM-9B
 - ▶ BGT – AIM-9L and B coproduction
 - ▶ Mitsubishi, Selenia, and BAe
- Factors contributing to the adverse nature of AIM-9L coproduction program with GE:
 - ▶ Organizational separation of coproduction and cooperation
 - ▶ "NIH" attitude of program office officials
 - ▶ Lack of consideration of technological capabilities of partner countries in framing MOU
 - ▶ Limited appreciation of potential commercial spinoffs by participating companies outside partner government channels
 - ▶ Earlier release of "M" to Germany would have prevented the entire problem

STINGER MANPORTABLE AIR DEFENSE SYSTEM (MANPADS)

- Type
 - › Optical aiming, passive infrared homing
 - › Lock-on-before-launch, fire-and-forget operation
 - › Shoulder-fired missile also adapted for firing from land vehicles and helicopters
- Performance
 - › Mach 3 flyout
 - › Range from 1,000 feet to 6 miles
 - › Altitude from 30 to 16,000 feet
- Dimensions
 - › Missile: length 5 feet, diameter 2.75 inches
 - › Total weight: 34.5 lbs (missile: 22.3 lbs)
- Components
 - › Missile round - Gripstock launcher - IFF Interrogator
- Coproduction
 - › European Dual Production (GE, TU, NL, GR)
 - › Swiss Coproduction

SLIDE 1

MULTI-ROLE MISSION SYSTEM

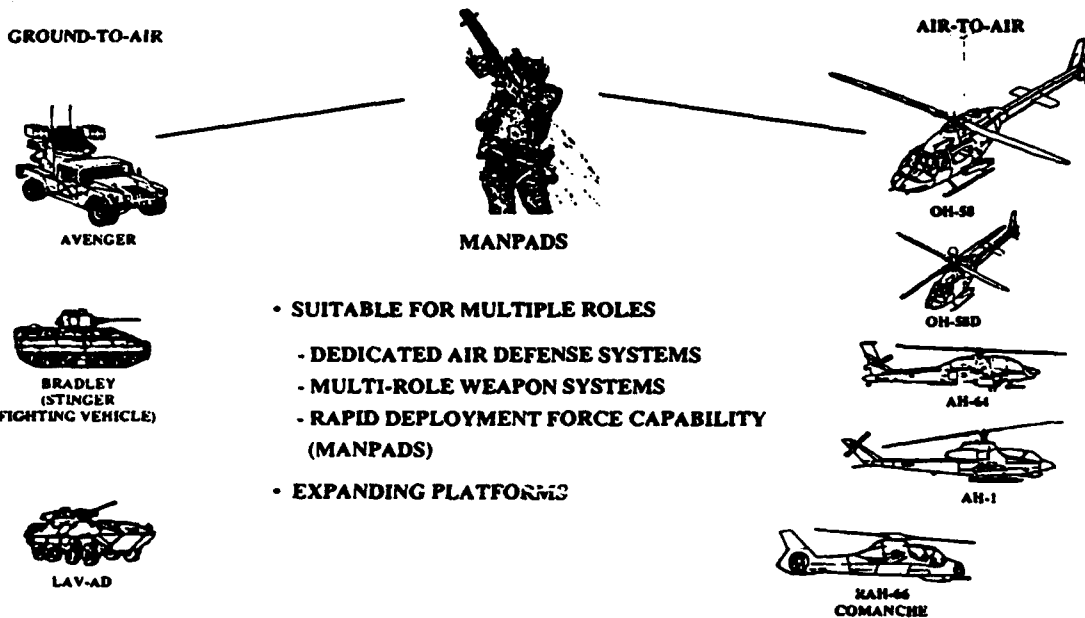

MILESTONES IN U.S. MANPADS PROGRAMS

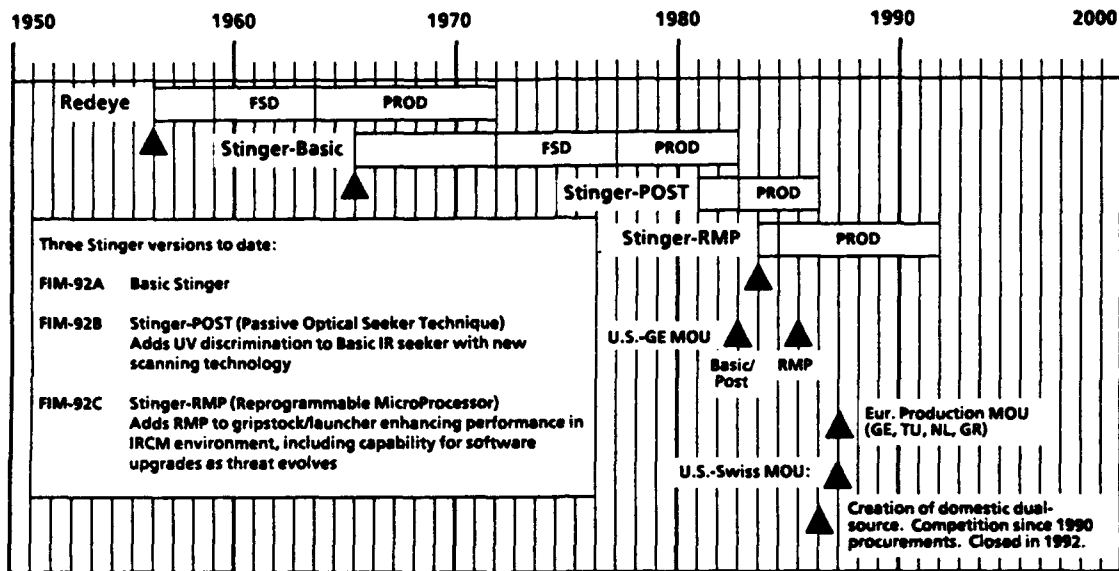

COSTS AND BENEFITS TO THE UNITED STATES (Swiss Stinger Coproduction Program)

- **Cost:**
 - ▶ Minor loss of potential revenues compared to direct FMS, considering the small quantities involved.
 - ▶ Modest transfer of U.S. manufacturing technology due to the limited nature of the production, bordering on "co-assembly." (The production technology transferred may actually lag behind the inherent capabilities of the Swiss industrial base.)
- **Benefits:**
 - ▶ Significant revenue share to the United States due to the relatively small size and co-assembly nature of the production program.
 - ▶ Projected expenditures in the U.S. of \$104 million in a program with estimated value of \$231 million (about 45 percent).
 - ▶ Switzerland does not export armaments – little risk of technological breakout and future competition in the global defense marketplace.
 - ▶ Standard provisions for royalty-free technology flowback of all design changes, modifications, and improvements.
 - Some benefits in technology flowback reported by General Dynamics in learning Swiss digital system checkout techniques with possible application to follow-on systems.

MOU PROVISIONS FOR EUROPEAN STINGER DUAL PRODUCTION

- U.S.-GE MOU, 27 April 1983 (Stinger Basic/POST); amendment 1, 26 March 1986 (Stinger-RMP):
 - ▶ Authorized quantity: 12,135 missiles; 3,219 gripstocks (less reprogrammable module); and training sets, battery chargers, and coolant recharging units
 - ▶ GE, as licensee, may transfer portions of TDP to participating NATO countries subject to separate MOUs
 - ▶ Use of TDP for production is subject to royalty fees to GD as follows:
 - Participating nations: 5 percent of unit price of latest U.S. Army procurement contract
 - Sales to U.S.: 0 percent
 - Sales to other, non-participating NATO nations: 8 percent
 - ▶ Transfer of TDP and sales to other, non-participating countries subject to USG approval
 - ▶ Right to manufacture guidance section is subject to separate license agreement with GD

MOU PROVISIONS FOR EUROPEAN STINGER DUAL PRODUCTION (Continued)

- ▶ Participating nations must deploy Stinger with one of the following identification devices to ensure capability of interrogating NATO aircraft equipped with MK XII or XV IFF transponders:
 - Stinger IFF (AN/PPX-3)
 - Any IFF device in accordance with STANAG 4162
 - Until NIS available, a radar-directed IFF device with direct commolink to Stinger
- European MOUs:
 - ▶ September 1983: Preparation Phase MOU: GE, IT, TU, GR, NL, BE
 - ▶ April 1988: Production MOU: GE, TU, NL, GR
 - ▶ Final cost shares: GE - 36 percent; TU - 41 percent; NL - 14 percent; and GR - 9 percent
- Excluded items:
 - ▶ Microprocessor, cadmium sulfate crystals, and external firmware module
 - ▶ European SPG paid \$20.9 million license fees to GD for manufacture of guidance section

COSTS AND BENEFITS TO THE UNITED STATES (European Stinger Program)

- **Costs:**
 - ▶ **Loss of political influence and armaments-related industrial preeminence to Germany – the clear winner in the overall program:**
 - Political leadership in establishing, negotiating, and managing the European program versus the U.S.
 - System prime contractor role and production of key guidance technologies retained by German industry
 - Enhanced German political and defense industrial relationships with Turkey, the Netherlands, and Greece
 - ▶ **Loss of revenues, trade balances, and production scale economies for U.S. buys as a result of lost foreign military sales to NATO**
 - ▶ **Export of high-technology miniaturized missile production technology and industrial know-how gained from over thirty years of experience**
 - ▶ **Exposure to European-variant design breakout and product improvements by German industry in future systems development**
 - ▶ **Germany is establishing test range facilities in Spain for the program, resulting in some potential loss of visibility versus tests conducted at WSMR**

COSTS AND BENEFITS TO THE UNITED STATES (European Stinger Program) (Continued)

- **Benefits:**
 - ▶ **Some major NATO forces will be equipped with a U.S. standard air-defense system – assurances were obtained on doctrine and IFF.**
 - Potentially beneficial in future coalition warfare scenarios.
 - ▶ **Establishes Germany as a strong counterweight to France, as well as the former Soviet Union, China, and Egypt, in the passive "fire-and-forget" man-portable guided-missile-system global marketplace.**
 - Strong controls on third-country sales and additional competition against the UK family of command-guided systems.
 - The former Soviet Union has excellent systems that would be strong competitors in the world market. (SA-16 Gimlet export price: \$21K for gripstock, \$60K for missile)
 - ▶ **Projected expenditures in the United States of \$140 million in a program with an estimated value of \$735 million (about 19 percent).**
 - ▶ **Standard provisions for royalty-free technology flowback of all design changes, modifications, and improvements.**

CONCLUSIONS

- Overall, the creation of an entire Stinger production line in Europe is affecting the U.S. DIB adversely, from both an economic and competitive risk perspective:
 - ▶ One year before Copro MOU was signed, U.S. Army invested approximately \$150 million to create a domestic dual source (Raytheon), which was terminated in 1991 because of dwindling demand
 - ▶ Survival of the single remaining U.S. source, until a successor system is ready for production, depends on foreign sales
 - ▶ A German variant with improved performance, not subject to technology flowback, is very likely
- Factors contributing to this adverse impact:
 - ▶ Although advanced technology, scores low on complexity (stand-alone item)
 - ▶ Total transfer of entire production package (except reprogrammable module)
 - ▶ No follow-on U.S. system ready for production
 - ▶ European sales to third countries, while subject to USG approval, may be politically difficult to prohibit
 - ▶ German technological capabilities in this area are at least equal to those of U.S. industry

CONCLUSIONS (Continued)

- U.S. marketshare in MANPADS has declined; 1991 market survey:
 - ▶ Stinger - 60 percent (Hughes: 60 percent; SPG: 40 percent)
 - ▶ Mistral - 25 percent
 - ▶ RBS70 - 10 percent
 - ▶ Strela - 5 percent

VT-1 MISSILE

- Not coproduction but a U.S. technology transfer under a direct commercial arrangement between Thomson-CSF (France) and LTV Aerospace and Defense Company (now split up into Loral Vought Systems Corp. and Vought Aircraft Company).
- The arrangement was aimed at the global market for air defense missiles, including the competition for the U.S. Army's Forward Area Air Defense System (FAADS) Program for the Line of Sight, Forward/Heavy (LOS-F/H) element, replacing DIVAD.
- DIVAD was canceled in August 1985. The two companies began discussions shortly thereafter.
- Case study covers:
 - FAADS NDI (nondevelopment item) Competition
 - VT-1 Missile Program
 - Impacts on U.S. DIB

SLIDE 1

FAADS-LOS-F/H COMPETITION

- | | | |
|------------|---|--|
| JAN 1986 | - | SECDEF Program Review of FAADS
Approval of concept and acquisition strategy
RFI release to industry |
| JUL 1986 | - | DSARC Review
RFP release |
| JUN 1987 | - | Army awards \$2 million contracts to 4 candidates to
participate in "fly-off" |
| JUL-OCT 87 | - | Firing trials |
| NOV 1987 | - | SSEB and Source Selection Council pick Liberty as
winner. Army Under Secretary Ambrose selects
ADATS as least-risk approach to meet schedule |
| 1992 | - | ADATS program terminated (cost growth and
affordability) |

FAADS-LOS-F/H COMPETITION (Continued)

	<u>Liberty</u>	<u>ADATS</u>	<u>Rapier</u>	<u>Paladin</u>
	Thomson-CSF and LTVAD	Oerlikon-Buhrle and Martin Marietta	British Aerospace and Norden Systems and FMC Corp.	Aerospatiale and MBB (Euromissile) and Hughes Missile Systems
	Evolution of Crotale/Shahine with improved missile	Modular ADATS mounted on M113 or M3 chassis	Rapier variant on M2 chassis	Roland version mounted on M1 tank chassis
<u>Hits:</u>	5	8	3	3
<u>MTBF (hrs)</u>	50	20	30	30

VT-1 MISSILE PROGRAM HISTORY (JAN 1986 – DEC 1992)

- Thomson approaches LTVAD for development of new low-cost, high-velocity, short-range, all-weather air defense missile suitable for the Crotale NG (= Liberty)
- Thomson awards contract to LTVAD to perform feasibility study and prepare proposal for VT-1 missile
- Program-go-ahead: LTVAD authorized to commence FSD with incremental funding
- Companies sign Agreement on Contractor Team Arrangement for FAADS RFP
- Thomson awards FFP contract for FSD and options for production engineering planning (PEP) and production

VT-1 MISSILE PROGRAM HISTORY (JAN 1986 – DEC 1992) (Continued)

- **Development flight tests**
 - **Thomson exercises options for PEP and first production option**
 - **First production missile delivered**
 - **Thomson notifies LTVAD it will not exercise the remaining production options. Instead, it announces that Euromissile has been selected for VT-1 production, while Euromissile announces its adoption of the VT-1 for Roland upgrade, terminating the Roland RM-5 development effort**
 - **Negotiations with LTVAD on related business: navalization of VT-1 and technical assistance in transferring production to Aerospatiale and MBB**

LICENSING AND TECH TRANSFER AGREEMENTS

- MAR 86** – **Thomson and LTVAD sign Technical Assistance Agreement for the purpose of transferring to Thomson certain "technical data" generated by LTVAD related to R&D of VT-1 Missile (subject to export license)**
- OCT 87** – **Companies sign License Agreement and Development Contract simultaneously**

USG EXPORT LICENSES

- **Munitions export licenses are not public information**
- **In general, export licenses would contain the following types of provisions:**
 - **Approval of export of "technical data" from the U.S. firm to its foreign counterpart pursuant to their technical assistance agreement**
 - **Approval of manufacture of the "munitions item" by the foreign company in accordance with the License Agreement**
 - **Approval of marketing and sales in specific countries ("primary sales territory")**
 - **Approval of marketing in specific other countries ("secondary sales territory")**
 - **Approval of specific other "countries of manufacture"**

OBSERVATIONS ON THE VT-1 CASE

- ***From Thomson's perspective, a very attractive arrangement:***
 - **It tapped the superior missile engineering capabilities of LTVAD at modest cost (FFP)**
 - **Opportunity to gain access to U.S. market (FAADS)**
 - **Unlimited rights and manufacturing license, royalty-free**
 - **Obtained U.S. missile manufacturing technology**
 - **Derivatives will be beyond USG export controls (sales or production).**
- ***From LTVAD's perspective, a mixed deal:***
 - **For the FAADS competition, the deal made sense though the terms were stiff**
 - **Once FAADS was lost, the deal was a wash: LTVAD came out even with the first production lot**
 - **Only reasonable explanation is the assumption that FAADS contract would be a sure win.**

OBSERVATIONS ON THE VT-1 CASE (Continued)

- ***From U.S. DIB perspective, a bad deal:***
 - › True technology giveaway, without any *quid pro quo*
 - › Helping a foreign firm to enhance its global market position with our technology is not in U.S. defense industry's interest
 - › ADATS (if fielded) not competitive with CROTALE-NG in export markets
 - › The exported missile manufacturing know-how can easily be diffused to other purposes.

- ***Conclusions:***
 - › The export licensing process considers "foreign availability" but not industrial base impacts
 - › Interests or actions of individual companies may diverge from overall U.S. interests.

REPORT DOCUMENTATION PAGE

Form Approved
OPM No. 0704-0188

Public reporting burden for this collection of information is estimated to average 1 hour per response, including the time for reviewing instructions, searching existing data sources gathering, and maintaining the data needed, and reviewing the collection of information. Send comments regarding this burden estimate or any other aspect of this collection of information, including suggestions for reducing this burden, to Washington Headquarters Services, Directorate for Information Operations and Reports, 1215 Jefferson Davis Highway, Suite 1204, Arlington, VA 22202-4302, and to the Office of Information and Regulatory Affairs, Office of Management and Budget, Washington, DC 20583.

1. AGENCY USE ONLY (Leave Blank)		2. REPORT DATE April 1993	3. REPORT TYPE AND DATES COVERED Final	
4. TITLE AND SUBTITLE Armaments Coproduction at a Crossroads: U.S. Policy Options After the Cold War			5. FUNDING NUMBERS C MDA903-90-C-0006 PE 0902198D	
6. AUTHOR(S) Frans Nauta				
7. PERFORMING ORGANIZATION NAME(S) AND ADDRESS(ES) Logistics Management Institute 6400 Goldsboro Road Bethesda, MD 20817-5886			8. PERFORMING ORGANIZATION REPORT NUMBER LMI-IR305LN1	
9. SPONSORING/MONITORING AGENCY NAME(S) AND ADDRESS(ES) Independent Research and Development			10. SPONSORING/MONITORING AGENCY REPORT NUMBER	
11. SUPPLEMENTARY NOTES				
12a. DISTRIBUTION/AVAILABILITY STATEMENT A: Approved for public release; distribution unlimited			12b. DISTRIBUTION CODE	
13. ABSTRACT (Maximum 200 words) <p>The changes wrought by the end of the Cold War and the increasing globalization of defense technology are compelling reasons to reexamine U.S. policy on the coproduction or licensed production of U.S.-designed weapon systems by allied and friendly nations. During the Cold War era, U.S. national security and foreign policy objectives justified the transfer of technical data and manufacturing know-how to U.S. allies to enable their production of U.S.-designed weapon systems in meeting their legitimate defense needs. In today's world, with national security defined both in politico-military and economic terms, the long-term commercial interests of U.S. defense industry can no longer be ignored in such technology transfer decisions.</p> <p>We advocate the institution of a systematic risk assessment methodology in the Government's review of coproduction or production licensing agreements to reduce or avoid potential adverse impacts on the U.S. defense industrial base. We also argue the case in favor of a policy shift from one-way defense technology transfers toward a more cooperative form of arms collaboration based on equitable balance between inbound and out-bound technology transfers.</p>				
14. SUBJECT TERMS Coproduction, Licensed Production, Export Controls, Defense Industrial Base, Technology Transfer, Security Assistance, Arms Collaboration			15. NUMBER OF PAGES 64	
			16. PRICE CODE	
17. SECURITY CLASSIFICATION OF REPORT Unclassified	18. SECURITY CLASSIFICATION OF THIS PAGE Unclassified	19. SECURITY CLASSIFICATION OF ABSTRACT Unclassified	20. LIMITATION OF ABSTRACT UL	