

AD-A274 019



2

**Overwhelming Force, Indecisive Victory:
The German Invasion of Yugoslavia, 1941**

**A Monograph
by**

Major Michael R. Barefield

Armor

S DTIC
ELECTE
DEC 22 1993
A



**School of Advanced Military Studies
United States Army Command and General Staff College
Fort Leavenworth, Kansas**

Second Term AY 92-93

**THIS MONOGRAPH CONTAINS COPYRIGHT MATERIAL
Approved for Public Release; Distribution is Unlimited**

93-30904



93 12 22 01 8

REPORT DOCUMENTATION PAGE

Form Approved
OMB No. 0704-0188

Public reporting burden for this collection of information is estimated to average 1 hour per response, including the time for reviewing instructions, searching existing data sources, gathering and maintaining the data needed, and completing and reviewing the collection of information. Send comments regarding this burden estimate or any other aspect of this collection of information, including suggestions for reducing this burden, to Washington Headquarters Services, Directorate for Information Operations and Reports, 1215 Jefferson Davis Highway, Suite 1204, Arlington, VA 22202-4302, and to the Office of Management and Budget, Paperwork Reduction Project (0704-0188), Washington, DC 20503.

1. AGENCY USE ONLY (Leave blank)	2. REPORT DATE	3. REPORT TYPE AND DATES COVERED MONOGRAPH
----------------------------------	----------------	---

4. TITLE AND SUBTITLE OVERWHELMING FORCE, INDECISIVE VICTORY: THE GERMAN INVASION OF YUGOSLAVIA, 1941	5. FUNDING NUMBERS
---	--------------------

6. AUTHOR(S) MAJOR MICHAEL R. BAREFIELD	
--	--

7. PERFORMING ORGANIZATION NAME(S) AND ADDRESS(ES) SCHOOL OF ADVANCED MILITARY STUDIES ATTN: ATZL-SWV FORT LEAVENWORTH, KANSAS 66027-6900 COMM (913) 684-3437 DDN 552-3437	8. PERFORMING ORGANIZATION REPORT NUMBER
--	---

9. SPONSORING/MONITORING AGENCY NAME(S) AND ADDRESS(ES)	10. SPONSORING/MONITORING AGENCY REPORT NUMBER
---	---

11. SUPPLEMENTARY NOTES

12a. DISTRIBUTION / AVAILABILITY STATEMENT APPROVED FOR PUBLIC RELEASE; DISTRIBUTION UNLIMITED.	12b. DISTRIBUTION CODE
--	------------------------

13. ABSTRACT (Maximum 200 words) SEE ATTACHED SHEET.
--

14. SUBJECT TERMS YUGOSLAVIA WORLD WAR II BALKANS WAR PLANS OPERATIONAL ART CAMPAIGN GERMANY GERMAN ARMY YUGOSLAV ARMY	15. NUMBER OF PAGES
	16. PRICE CODE

17. SECURITY CLASSIFICATION OF REPORT UNCLASSIFIED	18. SECURITY CLASSIFICATION OF THIS PAGE UNCLASSIFIED	19. SECURITY CLASSIFICATION OF ABSTRACT UNCLASSIFIED	20. LIMITATION OF ABSTRACT UNLIMITED
--	---	--	---

SCHOOL OF ADVANCED MILITARY STUDIES

MONOGRAPH APPROVAL

Major Michael R. Barefield

Title of Monograph: Overwhelming Force, Indecisive
Victory: The German Invasion
of Yugoslavia, 1941

Approved by:



LTC Douglas L. Tystad Monograph Director

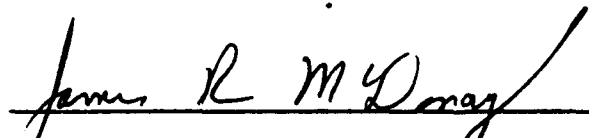

COL James R. McDonough, MS Director, School of
Advanced Military
Studies



Philip J. Brookes, Ph.D. Director, Graduate
Degree Program

Accepted this 13th day of May 1993

ABSTRACT

**OVERWHELMING FORCE, INDECISIVE VICTORY: THE GERMAN
INVASION OF YUGOSLAVIA, 1941** by MAJ Michael R.
Barefield, USA, 69 pages.

The purpose of this monograph is to determine the significant lessons that the German invasion of Yugoslavia in 1941 offers for modern campaign planners when considering operations in that part of the world.

The monograph first reviews the history of the invasion in 1941. The monograph then analyzes the campaign from both the German and Yugoslav perspectives using modern operational design criteria. Lastly, the monograph analyzes the lessons to be learned by operational planners from this campaign that are relevant to the conditions that exist today in Yugoslavia.

The monograph concludes that Germany, despite its effective military campaign and decisive victory in 1941, failed to create peace for Yugoslavia. Because it did not envision the full scope or uniqueness of the problems that existed in that region of Europe, Germany's victory turned indecisive. When considering campaigns in this region, operational planners must remember that a military campaign using overwhelming force can produce a decisive victory in the short term. However, creating a long term solution requires more than the application of military power alone.

DTIC QUALITY INSPECTED 3

Accession For	
NTIS GRA&I	J
DTIC TAB	
Unannounced	
Justification	
By	
Date	
Availability Codes	
Dist	Avail and/or Special
A-1	

Table of Contents

I.	Introduction.....	1
II.	Historical Overview.....	4
	The Strategic Setting.....	4
	The German Plan for Operation 25.....	7
	The Yugoslav Defense Plan.....	11
	The Invasion of Yugoslavia.....	15
	Results of Operation 25.....	22
III.	Analysis of the Operation.....	24
IV.	Implications for Modern Operational Planners.....	34
	Appendix 1 (Directive 25).....	44
	Appendix 2 (Operation 25 Deployment and Initial Objectives).....	46
	Appendix 3 (German Army Order of Battle).....	47
	Appendix 4 (German Air Force Order of Battle).....	48
	Appendix 5 (Yugoslav Army Order of Battle).....	49
	Appendix 6 (Yugoslav Army Dispositions).....	51
	Appendix 7 (Yugoslav Air Force Order of Battle)...	55
	Appendix 8 (Yugoslav Air Force Dispositions).....	56
	Appendix 9 (German Campaign in Yugoslavia).....	60
	Appendix 10 (German Partitioning of Yugoslavia)...	61
	Endnotes.....	62
	Bibliography.....	67

INTRODUCTION

Hitler's invasion of Yugoslavia appeared a remarkable achievement at the time. Within twenty four days, the German military assembled overwhelming combat power that decimated an enemy army over one million strong in a decisive victory with extremely low casualties. Hitler was happy with the twelve day victory because it secured his strategic flank, protected the Romanian oil fields, and delayed his invasion of Russia only a few weeks. He had also kept the German people happy with another swift victory that cost little in manpower or equipment casualties.

However, neither Hitler nor his German High Command had a full grasp of the political, cultural, or geographical conditions that existed in Yugoslavia. A pro-Serbian coup had just overthrown the recognized government. This was causing deep-seated divergent ethnic interests to boil up, tearing the delicate fabric of Yugoslav culture. Finally, the historical blending of the society with the terrain created a people hardened by ethnic conflict.

Neither the German High Command or Hitler took a hard look at the realities of their desired end state of operations in Yugoslavia upon victory over her armed forces. A government recognized and accepted by the people was absent. A deadly civil war based on ethnic diversity spread throughout the country. In many parts

of the country, acts of insurrection grew in number each day.

Hitler's basic aim in respect to Yugoslavia was to maintain peace to ensure the flow of economic resources from the region with a minimum of combat forces.¹ His military invasion achieved this short-term aim. However, Hitler failed to assess the long-term effects of the invasion or his policies on the Yugoslav people. This shortsightedness would draw Germany into a protracted partisan conflict in which one of seven German soldiers committed to the theater and one in seven Yugoslavs would be killed.² The victory became indecisive.

The objective of this monograph is to determine the significant lessons that the German invasion of Yugoslavia in 1941 offers for modern campaign planners when considering operations in that part of the world. Today, what was once called Yugoslavia has no central government or national unity and a civil war based on ethnic diversity tears it apart. As the probability for the use of U.S. military force to restore order in Yugoslavia increases, the value of studying history for preparing for future operations must be assessed.

The first part of the monograph will review the history of the invasion in 1941. The strategic setting and the offensive and defensive plans will be examined. The invasion of Yugoslavia will then be discussed to

see how well the plans were executed and the military end state achieved.

The second part of the monograph analyzes the operation from both German and Yugoslav perspectives using modern operational design as the criteria. These are: strategic aims, centers of gravity, operational objectives, and culminating points. The intent of this part of the monograph is to determine if the respective operational planners used these criteria to design their operations to achieve the desired military end state.

The third part of the monograph analyzes the lessons to be learned by operational planners from this campaign. The importance of understanding the enemy and analyzing the political end state of military actions will be reviewed, as will the provisioning of military forces with ways and means to achieve strategic military aims. These conclusions are relevant to the conditions that exist today in Yugoslavia. With these lessons in mind, the monograph concludes with implications for campaign planners when considering operations in Yugoslavia.

HISTORICAL OVERVIEW

THE STRATEGIC SETTING

Hitler's Balkan strategy for 1940 was simple-- maintain peace through diplomacy to ensure receipt of raw materials essential to his war economy. Safeguarding the supply of Romanian oil was the first priority in his planning.³ The Danube waterway was vital to this aim, for it was the primary transportation route not only for agricultural products, but also for oil from Romania.⁴

Italy broke the peace in the Balkan region on 28 October 1940, by invading Greece through Albania. This forced Greece to give up her neutrality, opening a new theater for the British to use in threatening Germany's flank.⁵ It also forced Germany to take action. Hitler, who could not afford to have his Italian ally defeated or Germany's oil supplies threatened, decided to invade Greece.

The decision to attack Greece made the courtship of Yugoslavia essential to success.⁶ The Danube river, which ran through Yugoslavia, as well as Yugoslavia's railroads were critical to moving economic and military supplies to and from Germany. To achieve freedom of access to those resources, Hitler masterfully used diplomatic power to the fullest on Prince Paul, the regent of Yugoslavia. Hitler's plan was to bring

Yugoslavia into his circle of partners by treaty rather than force-of-arms.

Prince Paul carefully weighed his strategic options. First, Germany was at the zenith of its military and diplomatic power. Yugoslavia's Army was impotent in the face of the German Army in capabilities and supplies. Second, Germany had surrounded Yugoslavia. Yugoslavia's northern frontier was indefensible, its railroads were inadequate to support national mobilization or movement of forces, its capital could be easily outflanked, and a successful defense of the country required abandoning the capital and major industrial centers to the enemy. Third, Prince Paul feared that bolshevism would make an appeal to a population tired of dictatorial rule and enraged at Yugoslavia's military impotence. Finally, he wanted a solution to the Serbian-Croatian dispute.⁷ However, a war could dissolve his rule and prohibit any solution to the ethnic problems.⁸ Signing Hitler's Tripartite Pact not only preserved the peace and territorial integrity of Yugoslavia, but was also Prince Paul's last bid for retaining power.⁹

The terms of the agreement that Hitler presented to the Prince met all of the goals that the regent had wanted. First, Yugoslavia's territorial integrity and sovereignty would be respected. Second, no military assistance from Yugoslavia or passage of German troops would be required for the duration of the war. Last,

in the reorganization of Europe, Yugoslavia's claim to a free outlet in the Aegean Sea at Salonika would be considered.¹⁰ After consulting with his ministers, Prince Paul authorized his representatives to sign Yugoslavia to the Tripartite Pact, which they did on 25 March in Vienna.

The signing of the Tripartite Pact by Prince Paul's representatives was the excuse used for a¹¹ coup. A group of Serbian military officers used their positions and influence to lead loyal Serbian military members in a coup to correct erring politicians on behalf of national interests.¹² The coup, executed during the night of 26 March with lightning swiftness, was bloodless. The new government helped the Prince and his family quickly leave the country for Greece. General Simovic, commander of the Yugoslav Air Force and coup conspirator, became the new Regent.

Simovic never realized the difficult situation that faced Yugoslavia. Initially, he would neither denounce nor ratify the pact.¹³ He convincingly spoke¹⁴ that there would be no war with Germany. He assured government officials that the German army was incapable of operating in the restrictive terrain of Yugoslavia and would break under Yugoslav resistance. However, the one thing he did not want was to give Germany a¹⁵ reason to invade.

On 30 March 1941, Simovic's government announced to Germany that they would comply with the monarchy's previous signature to the Tripartite Pact.¹⁶ With this, Simovic attempted to continue the policy used to justify the coup. However, as Simovic had misjudged the levels of popular support and military preparedness, he also misread how Germany's head of state had received the news of the coup on 27 March 1941.

Hitler was furious over the coup.¹⁷ He felt that the Serbians, who had provoked the First World War, had dared to disregard his agreement. No diplomatic explanation or declaration of loyalty was acceptable.¹⁸ Hitler decided to smash Yugoslavia as a political entity and accomplish by force his strategic aims in the region. That same day, Hitler briefed his military heads and issued Directive 25 (see Appendix 1), which ordered the simultaneous invasions of Yugoslavia and Greece.

THE GERMAN OPERATIONAL PLAN

Directive 25 caught the Army High Command completely off guard.¹⁹ Execution of the plans for the invasion of Greece in late March and the invasion of Russia in early summer was in progress. Yugoslavia's signing of the Tripartite Pact had supposedly solved

the problem and so no plans existed for operations there.

As Hitler briefed his intent on 27 March, the heads of the German military recognized that the time to bring together the means to attain the desired end into some assemblage of a plan was short. A few hours after the briefing, a hastily devised plan titled Operation 25 came into being.²⁰ Military leaders calculated the initial requirements. However, before further plans could be made, details had to be coordinated with ongoing operations and coalition partners. General Halder, the Army Chief of Staff, selected General Von Paulus, a very capable subordinate, to coordinate details with the Twelfth Army staff executing Operation Marita in Bulgaria and with coalition partners while Halder coordinated the army staff operations.

The Germans had to make several assumptions about any plan they might make. The first was an assessment of the Yugoslav terrain coupled with an estimate of the Yugoslav Army's capabilities. The mountainous terrain combined with the tenacity of the Yugoslav soldier did not encourage the Germans that this would be a swift operation.

The second assumption dealt with the coalition partners. Germany presumed its allies in the Balkans (Italy, Hungary, Romania, and Bulgaria) would participate in the invasion with military forces.

Their goals would be to receive a partition of the lands of Yugoslavia.

The third assumption concerned the Yugoslav peoples. Estimates determined that the Yugoslav population, except the Serbians, would be supportive of the Tripartite Pact. The Germans estimated that the population in certain parts of Yugoslavia would welcome the invasion force as liberators.

The last assumption dealt with Operation Marita. The German Army High Command coordinated both Operations Marita and 25 as closely as possible. The assumption was that Second Army would be successful in its bypass of the Metaxas Line, Greece's main defensive line, by attacking through southern Yugoslavia. This would ensure the relief of the Italian forces in Albania and closure of the Vardar River valley as an escape route for the Yugoslav Army.²¹

Limitations applied as well. The timetable for the invasion of Russia was just starting and selection of units for Yugoslavia could not inhibit movements for that operation.²² Limited railroads were available into the Yugoslav border areas which required the employment of motorized units to quickly mass the force.²³ Finally, there was the problem of the Danube River. If bridges could not be seized intact, the bridging units assigned to an army could not build a suitable replacement to cross motorized forces.²⁴

The resultant plan for Operation 25 had three distinct objectives (see map at appendix 2). The first was to produce tremendous psychological shock by air strikes on Belgrade. The shock would continue to build by air attacks concentrating on cutting the Yugoslav Army's retreat route to Greece and on destroying the Yugoslav Air Force. Second was to disrupt communications and engage the Yugoslav Army from several directions by superior forces using frontal and enveloping operations. Third was to eliminate the Yugoslav Army units piecemeal.

Operation 25 was to start upon Operation Marita's successful closure of the Yugoslav Army's escape route. The plan had three independent attacks all aimed at Belgrade, where planners estimated that the Yugoslav Army would mass to defend. The first group was to advance toward Belgrade from the Sofia area to capture Belgrade and open the Danube River. The second group was to advance toward the south from Austria and Hungary, smash the enemy forces in Croatia, and then to advance rapidly with motorized forces toward Belgrade. A third group attacked from vicinity Timisoara in Romania directly toward Belgrade. The triple envelopment would prevent the Yugoslav Army from executing an orderly withdrawal into the mountains. A supporting attack was to be launched toward Zagreb. Finally, the Italian Army was to advance from the

vicinity of Trieste along the Adriatic to relieve their base at Zadar and secure the coastal plain.

The German High Command provided the operation with significant ground and air resources to ensure a swift, overwhelming victory. Army ground forces consisted of the Second Army, XLI Panzer Corps, and elements of the Twelfth Army (see appendix 3 for a complete order of battle). Second Army organized with four corps and positioned around Graz, Austria.²⁶ XLI Panzer Corps, an independent command, positioned in Hungary. First Panzer Group, composed of three corps and assigned to the Twelfth Army, positioned in Bulgaria.

The German Air Force committed the forces of three air groups (see appendix 4 for a complete order of battle). Fourth Air Fleet, located in Austria, had 576 aircraft to support the Second Army.²⁷ VIII Air Corps, located in Bulgaria, had 414 aircraft to support both First Panzer Group and the Twelfth Army in its attack on Greece. In addition, X Air Corps in Sicily, with the mission of supporting Italian operations in Albania and the Adriatic, made 168 additional aircraft available.

The time to develop and implement Operation 25 amounted to an astonishing ten days. In that time, the German High Command commenced a massive military movement from all over Europe, put together an innovative invasion plan that complemented ongoing

operations for the invasions of Greece and Russia, and positioned itself to achieve the assigned strategic end. All that was needed now was a successful execution.

THE YUGOSLAV DEFENSE PLAN

Development of war plans by the Yugoslav General Staff were reactions to situations along its borders. War Plan S was the response to the German absorption of Austria in March 1938.²⁸ The creation of War Plan R-40 soon followed because of Italy's occupation of Albania. It mirrored War Plan S in calling for an initial cordon defense of the western and northern borders, a stubborn resistance on the Bulgarian frontier to prevent separation of the army from Greek and British allies, and a fighting withdrawal of all forces in a southeastern direction down the Vardar Valley toward Salonika.²⁹ It anticipated a German invasion and included an attack on the Italian base at Zadar and defense of the Albanian border. It also committed seventy percent of the available forces to the frontier defense.³⁰

When the Germans moved into Bulgaria in March of 1941, War Plan R-41 came into being. This plan anticipated a German attack from Hungary, Romania, and possibly Bulgaria and a joint action with the Greeks to eliminate the Italians in Albania.³¹ It dictated

heavier troop concentrations in Macedonia to protect the Skopje-Salonika withdrawal route. It committed eighty eight percent of its ground forces to the cordon defense. However, R-41 did not reach the field commanders until 31 March. By the day of the invasion,³² R-40 was still the operative plan.

The intent of both Yugoslav plans was to stop a German invasion at the frontiers.³³ Each plan committed the land forces to a cordon defense of the entire 3,000 kilometer frontier of Yugoslavia. Failure to achieve the intent meant that most of the Yugoslav infrastructure, transportation networks, and industry would fall into the invader's hands. If it failed, then the intent was to do what the Serbian army had done in World War One--withdraw south, link up with allies, and continue the fight.

Certain assumptions and limitations formed the basis for the operational plan.³⁴ The first was the assumption that an enemy invasion would enter Yugoslavia from the north. Therefore, this dictated placement of the main effort.

A second assumption was that Yugoslavia, before it entered a war, would be part of a coalition with a western democratic power.³⁵ However, in a 3 April meeting with Greek and British representatives, no coordinated plans were negotiated.³⁶

Simovic, leader of the coup government, brought in the third assumption when he said that the Germans

required a minimum of fourteen days to organize a
successful invasion. ³⁷ Simovic was almost right. Yet
a military attache in Berlin reported the exact details
of the German attack down to the exact day. ³⁸ Simovic
did not believe the reports, believing instead that he
had plenty of time before the Germans would attack.

Significant limitations existed for the Yugoslavs.
However, both of the Yugoslav war plans recognized
them. The first limitation was the fundamental
weakness of the Yugoslav Army. ³⁹ It was a system of
large units that depended primarily on animal draft
power for transportation that resulted in low march
speed and lack of maneuverability.

Second, the Yugoslav Air Force owned a handful of
main airfields near population centers that were easy
to locate and target for destruction. . Construction
started on about one hundred auxiliary airfields twelve
months before hostilities. By the invasion, fifty were
ready. ⁴⁰ However, in wet weather those airfields were
useless to all except light aircraft.

The third limitation, unrecognized in the War
Plan, was Yugoslavia's terrain. The benefits of its
rugged and constricted terrain accrued to small unit
actions. The terrain, because of its lack of roads and
undeveloped nature, suited a guerrilla war. However, a
guerrilla conflict would require the backing of the
populace and a strong national ideology, which did not
exist in the 1941 Yugoslav military. ⁴¹

The resources of the Yugoslav military forces were significant once fully mobilized. The strength of regular and mobilized army units was about one million, two hundred thousand soldiers.⁴² The strength of the army lay in its infantry, since it had no modern tanks and little artillery. Ammunition reserves for small arms were at seventy-five days, one hundred days for artillery, and two to seven days for air defense guns.⁴³ There was no antitank training. Appendix 5 shows the Yugoslav Army order of battle. Appendix 6 shows the locations of its subordinate units at the time of the invasion fielded in three army groups and a separate army.

The Yugoslav Air Force had on hand 459 military aircraft. Despite its modern aircraft, spare parts and replacement aircraft were not available. The Yugoslav Air Force dispersed its aircraft throughout the country much like the army units. Appendix 7 shows its order of battle and Appendix 8 shows its peacetime and dispersal locations at the time of the invasion.

The Yugoslav Navy performed coastal and Danube River patrol functions. Its resources consisted of four destroyers, four submarines, two river monitors, six torpedo and ten motor torpedo boats.⁴⁴ It did not have a prominent part in any of the plans because its personnel were primarily Croatian, which caused it to be suspect by the government.

The Simovic government elected not to go to full mobilization, but to continue with partial incremental mobilization. Simovic disregarded the intelligence, the status of his military, and his lack of a coalition. His conviction was that any German invasion would be "the beginning of Hitler's downfall."⁴⁵

THE INVASION OF YUGOSLAVIA

Operation 25 can be divided into two phases (see appendix 9).⁴⁶ The first was the decisive overpowering of the Yugoslav defenses from 6 to 10 April. The second was the capture of vital territory and the surrender of the Yugoslav armed forces.

The invasion started at 0645 hours on 6 April with Operation Punishment, a massive air attack on the city of Belgrade that decimated the government and crippled the Yugoslav Army headquarters and its ability to control the field armies.⁴⁷ In addition, the German Air Force immediately attacked the Yugoslav Air Force, which managed a scattered response against several targets. By the end of the day, the Yugoslav Air Force units responsible for protecting the withdrawal route of the army had ceased to function.

Twelfth Army also attacked on 6 April. XL Panzer Corps moved across the frontier toward Skopje to seal the Yugoslav withdrawal route.⁴⁸ It immediately encountered stiff resistance from the Yugoslav Third

Army. By 7 April, it had overpowered the resistance and took Skopje.⁴⁹ Yugoslavia's War Plans R-40 or R-41 could no longer be implemented.

As early as 1 April, Second Army, under the direction of the German Army High Command, seized bridges over the Danube at Barcs and Koprivnica.⁵⁰ Estimating that Yugoslav frontier guards would not make a stand along the border, it then seized bridges over the Drava and Sava Rivers near the frontier on 6 and 7 April before Yugoslav forces could destroy them.

By 7 April, the Yugoslav High Command was in trouble but did not know it. The Yugoslav Third Army Group was still fighting the Italians in Albania, but had lost Macedonia. The Yugoslav Air Force had now lost sixty percent of its operational aircraft. Most important, the Yugoslav High Command's field armies did not know what to do since the withdrawal route was no longer open.

On 8 April, 1st Panzer Group launched the first pincer of the envelopment from assembly areas near Sofia in the direction of Nis to destroy strong enemy forces concentrated near there. It had subsequent objectives of Kragujevac and Belgrade. Despite stiff resistance from the Yugoslav Fifth Army, 1st Panzer Group occupied Nis on 9 April, opening the way to Belgrade.⁵¹

At this point, the German High Command recognized that it had overestimated the Yugoslav's military

strength. It had anticipated that a decisive battle
would occur around Nis.⁵² When this did not occur, the
High Command sensed that the Yugoslav Army was
withdrawing to Belgrade. The Yugoslav Fourth and
Seventh Armies in northwest Yugoslavia began
withdrawing southward on 9 April.⁵³

On the 10th of April, the two remaining prongs of
the German Army's envelopment launched across the
Yugoslav border. The second prong, XLI Panzer Corps,
attacked from lodgements in Romania with an objective
of quickly capturing Belgrade. It immediately met
resistance from the Yugoslav Sixth Army.

The third prong was the Second Army's XLVI Panzer
Corps.⁵⁴ It moved from positions vicinity Barcs to
attack through the Yugoslav Fourth Army in an
enveloping attack on Belgrade. Its route would be
between the Drava and Sava Rivers. It successfully
routed the Yugoslav Fourth and Second Armies and by 11
April reached Novi Sad.⁵⁵ One division of the corps
attacked southwest to seize Zagreb in concert with LI
Corps.

The LI Corps, Second Army's main effort, launched
its attack from south of the Graz area to seize Zagreb.
After successfully penetrating and capturing several
units of the Yugoslav Seventh Army, it captured Zagreb
on 11 April and received a rousing welcome by the
residents.⁵⁶

The XLIX Mountain Corps attacked from Klagenfurt to seize critical passes and tunnels in Slovenia. By 11 April it had captured Celje and accepted the surrender of Yugoslav units in Slovenia. ⁵⁷

The LII Corps had not closed in theater by 10 April. The Army High Command detached it from Second Army and designated it Army High Command reserve with a mission of following Second Army's main effort upon its closure.

Interestingly, on 11 April, the Italian Second Army attacked from the vicinity of Triest down the coast of Yugoslavia. It had become clear that no enemy resistance worth mentioning was to be expected and that the Italian High Command's estimate of thirteen Yugoslav divisions opposing their Second Army was incorrect. Their attack encountered almost no resistance and found 30,000 Yugoslav soldiers concentrated near Delnice waiting to surrender.

By 11 April, the Yugoslav Army was still active, but increasingly disorganized, in a state of confusion, without orders, and continuing to withdraw from contact. Mass Yugoslav Army unit surrenders were occurring. Despite its significant losses of aircraft, the Yugoslav Air Force continued to receive requests for and provided limited air support. However, each day the sorties became less. On 12 April, a German air raid on Bjeljina destroyed the bulk of what remained. ⁵⁸

By the night of 12 April, the three pincers of the German envelopment had surrounded Belgrade. The expected decisive battle failed to materialize. On 13 April, elements of First Panzer Group and XLI Panzer Corps entered Belgrade without resistance. Almost immediately, the Army High Command attached First Panzer Group to the Second Army. Also, Second Army⁵⁹ ordered XLVI Panzer Corps to head south for Sarajevo. On this day, most of the German Air Force effort, less the Fourth Air Fleet, moved to support Twelfth Army and Operation Marita.

The German Army now sensed that the Yugoslav Army was attempting to withdraw to the rugged mountainous regions of Serbia. Speed was now essential to finish off the Yugoslav Army and redirect units for the next operation. The main object was to find the resistance centers, disarm the enemy, and quickly pacify the remainder of the country.⁶⁰ Sarajevo became the focal point.⁶¹

Second Army was now responsible for all operations in Yugoslavia. Demonstrating the flexibility of task organization that would later characterize German Army operations, it reorganized its forces into two pursuit groups. It ordered the western group, operating under the newly arrived LII Corps headquarters, to move southeast from the Zagreb area to seize Sarajevo. Two infantry divisions under the XLIX Corps and two infantry divisions under the LI Corps composed LII

Corps. Reporting directly to the LII Corps, the 14th Panzer Division was already on the way to Sarajevo from the northeast. The eastern pursuit group was the First Panzer Group that attacked toward Sarajevo via Uzice⁶² and the Morava Valley. Fourth Air Corps was to neutralize an anticipated concentration of the Yugoslav Army near Mostar-Sarajevo, where rumors pinpointed open hostilities breaking out between Croats and Serbians.

The Yugoslav Supreme Command, located near Sarajevo, was trying to withdraw what remained of the army to the mountainous territory southwest of Belgrade. Concentrated around airfields at Mostar, Trebinje, and Niksic were around 40,000 Yugoslav airmen⁶³ and the remnants of the Yugoslav Air Force.

On 13 April, Simovic, now concerned with saving face under the circumstances, transferred the function of Chief of the Supreme Command to General Kalafatovic⁶⁴ with instructions to ask for an armistice. His mentor and creator of the coup, General Mirkovic, handed over control of the Yugoslav Air Force to the commander of the Fourth Air Brigade at Mostar with orders for remaining aircraft to fly to Greece and link up with Allied forces. All other equipment was to be destroyed and personnel were to surrender.

The Yugoslav government received the news of the German forces' movements from a location near Sarajevo. On 14 April, they departed by car for Niksic, 160

65
kilometers away. After an Italian raid on the
airfield at Niksic, government officials and what
remained of the monarchy departed by Yugoslav Air Force
aircraft for Greece over the next two days. 66

On 14 April the Germans sensed victory. First
Panzer Group reported occupying Krusevac and receiving
Yugoslav Army officers attempting to negotiate a
surrender. 67 Resistance had become sporadic and a
decisive battle had not materialized. This suggested
no need for additional combat forces. The High Command
ordered follow on forces enroute to Yugoslavia to
return to Germany or Romania immediately. 68

By 15 April, elements of the 14th Panzer Division
entered Sarajevo to the welcome of cheering crowds.
Also staying for the enveloping German units was the
Yugoslav Supreme Command, waiting to surrender. 69
After short negotiations, a message went out for all
Yugoslav units to lay down their arms and surrender.

For the Yugoslav Navy, the order to surrender was
not a problem. On the first day of the invasion, the
Supreme Command ordered the Navy to stay in port and
prepare to evacuate the king and the government by ship
to Greece. 70 The Supreme Command issued no further
orders for the Navy's evacuation to a friendly port and
apparently forgot them. On 17 April, the Yugoslav
Navy, minus two motor torpedo boats and a submarine
that elected to escape to Egypt, surrendered in port to
the Italians. 71

The Yugoslav Air Force did not comply with the cease-fire order. On 15 April, forty four planes flew to Greece, but a German raid on the airfield on which they landed destroyed most of them.⁷² Of the few planes that did escape, most were obsolete in capabilities.

The remainder of Yugoslav units complied with the cease-fire order. The Second Army set up an armistice for unconditional surrender to be signed in Belgrade on 17 April.⁷³ However, since no recognized government existed in Yugoslavia, suitable representatives to sign the document could not be found. The choice fell on General Jankovic, the Deputy Chief of Staff of the Supreme Command, and Cincar-Markovic, former foreign minister who had no official position.

RESULTS OF OPERATION 25

The invasion required only twelve days. "It was a fight in which tanks and other modern weapons were opposed by ox carts," declared the commanding general of the Yugoslav Fourth Army.⁷⁴ The Germans took over 360,000 soldiers prisoner, mostly Serbians, and captured vast military stores.⁷⁵ The cost to the Germans was 151 dead and 407 other casualties. On 18 April, Hitler issued instructions that partitioned the conquered territory, handing out parcels to his partners in the invasion (see appendix 10).⁷⁶ By 23

April, the majority of motorized and panzer units were redeploying out of Yugoslavia for use in Operation Barbarossa.⁷⁷ The Germans appeared to have their quick decisive victory.

The conquered nation of Yugoslavia had lost its sovereignty and ability to influence its own destiny. No national government remained to represent Yugoslavia's interest at the surrender negotiations. It had fled to safe havens provided by the British. The delicate fabric of cooperation that existed between the Serbians, Croatians, and other Yugoslav minorities had started to tear with no means of repair available. No high level military leadership or organizations remained. However, a large number of Yugoslav soldiers evaded capture as did some of the army's tactical leadership. The Germans were not able to secure a vast amount of weapons and other war material throughout the country.⁷⁸ The invasion forces did not have the manpower or the time to find it all. Unfortunately for Germany, these bypassed soldiers and equipment, combined with the escalating ethnic strife, would form the basis for Yugoslavia's civil war and intensifying resistance over the next four years.

ANALYSIS OF OPERATION 25

Operation 25 left Hitler and the German High Command jubilant and the Yugoslav people trying to figure out what had happened. The decimation of Yugoslavia took only twelve days and rendered its political and military powers as well as its national will impotent. How could Germany create such a victory and Yugoslavia create such a defeat? An analysis of the operation using campaign design concepts provides an assessment of the methods used by the two nations' military forces to match their ways and means to the ends to create such results.

The first element of operational design to be analyzed is the opposing nations' military end state assigned by the political leadership. This end state links the use of military power to political objectives. The military end state is the required conditions that must be met to achieve these political objectives. FM 100-5 states that "determining the end state and ensuring that it accomplishes the national objectives are the critical first steps in the operational planning process."⁷⁹

Hitler laid the groundwork for Operation 25 by declaring in previous directives that the primary aim for the operations in the Balkans was to prevent the Allies from threatening Italy and the Romanian oil fields.⁸⁰ This was initially stated in Directive 20,

the planning directive for Operation Marita, the invasion of Greece, and reaffirmed in Directive 22, when he believed that diplomatic means would suffice in attaining his aims.

Hitler issued his guidance for the invasion of Yugoslavia in Directive 25. However, his strategic aim was flawed. He expressed the end state to be achieved in Yugoslavia as the defeat of the Yugoslav armed forces, access to mineral deposits and transportation routes essential to the war economy, and making internal tensions in Yugoslavia more serious. Hitler did not have a clear end state in mind as to how Yugoslavia would look following the invasion. In Directives 26 and 27 as well as a memorandum dated 18 April 1941, Hitler directed how the territory of the ex-nation of Yugoslavia was to be broken up and the type and amount of military forces assigned for occupation duties.

Yugoslavia's strategic aim on the other hand was to stay out of the war and Hitler's path. When Simovic's political abilities failed in this respect, Yugoslav War Plan R-40 became the driving document for the strategic end state. It envisioned an acceptable end state as a territorially secure Yugoslavia still capable of deciding its own fate. To attain this, the government planned for a coalition effort with a western democracy.

The next element to be analyzed is the opposing nations' center of gravity. A center of gravity is "that characteristic, capability, or location from which enemy and friendly forces derive their freedom of action, physical strength, or the will to fight."⁸²

Capturing or neutralizing the center of gravity enables the greatest benefit for the least expenditure of resources.⁸³ The objective of any operation is to mass the available combat resources to destroy or neutralize the enemy's main source of power, thereby causing the enemy to weaken and fall.

Germany's operational center of gravity was its panzer divisions. Limited access to staging areas and Yugoslavia's terrain dictated the use of these fast-moving panzer divisions. However, these divisions were equally critical to the success of Operation Barbarossa, because their loss would upset the Barbarossa timetable. The Germans protected their center of gravity by building fast-moving, flexible combined arms formations around the panzer divisions to quickly overwhelm the defenders.

Yugoslavia's operational centers of gravity were its Third and Fifth Armies. The mission of these armies was to protect the withdrawal corridor of the Yugoslav Army through the Vardar River Valley into Greece. Their failure invalidated War Plan R-40, which had no branches for such an event. The Yugoslavs failed to protect their center of gravity. The Third

and Fifth Armies received the lowest priorities for fortifications or additional combat units.

From centers of gravity, operational planners determine what objectives their operation should achieve. Operational objectives orient on achieving the desired end state through destroying the enemy's center of gravity. They also should contain provisions for protecting the friendly center of gravity to prevent its destruction and subsequent defeat.

German planners decided that the appropriate objectives for their attack were the towns of Nis, Belgrade, and Zagreb. Nis and Belgrade were decisive points where the Germans expected the Yugoslav Army to defend the heaviest, enabling it to be destroyed. Capture of Zagreb, the capital of Croatia, would show Germany's resolve to support Croatian independence. Sarajevo was not initially considered an objective until after the capture of Belgrade when an estimate placed the bulk of the Yugoslav Army in that area. German planners also determined that tempo was critical for the operation to deny the Yugoslavs the use of the Vardar River Valley. They therefore sequenced their operation to allow the Twelfth Army, which would also execute Operation Marita, to first attack into Greece with the dual objectives of denying the Yugoslavs their withdrawal route and linking up with the Italians in Albania. Then Second Army would attack to destroy the Yugoslav Army.

Yugoslavia's War Plan R-40 dictated that units conduct a fighting withdrawal as required through the nation if the frontiers could not be held. Yugoslav planners determined that the cordon defense established along the frontier would require a defense in depth. However, the budgetary resources given to the Yugoslav Army to prepare fortifications were sufficient only for the frontier area, and then only in certain areas. Fortifications did not exist in depth. Using their limited resources, the Yugoslav High Command gave priority to the building of fortifications in the north, because it was the most likely invasion route.

Operational planners must understand the concept of culminating points and address the concept in their plans. For an attacker, this is a specific time or location when his combat power no longer exceeds that of the defender.⁸⁴ The attacker risks counterattack or defeat if the attack continues. The defender, who culminates when he can no longer successfully defend, attempts to lead the attacker to his culminating point and then attack him when he has exhausted his resources.

Germany never addressed culminating points although they existed. If the Yugoslav Army held in the south and executed a fighting withdrawal to the south with the remainder of its forces, it would have prolonged the invasion. This would have forced Hitler to choose between continuing the invasion of Yugoslavia

or invading Russia as planned. If the choice was Russia, it would create the necessity for an operational pause so that the panzer and motorized units could move to staging areas for the Russian invasion. Less capable units would have to finish the Yugoslav invasion, which would have weakened Operation Barbarossa. A pause for rotation of units was not part of the German plan, showing that the German planners did not plan on reaching their culminating point.

Based on War Plan R-40, Yugoslavia's defense culminated upon the penetration of the Third or Fifth Armies and closure of the Vardar River valley. If this happened, there was no withdrawal route for the army, which could then be surrounded and destroyed. In their war plans, the Yugoslavs identified the valley's critical importance, yet made no provision, such as a branch or sequel, to account for its loss or to continue the fight.

There were two other factors, not normally considered components of a campaign or major operation, that had a significant impact on Operation 25. The first was the formation of coalitions. Participating with Germany in the invasion were air and ground units from Italy and Hungary. However, the Italian invasion of Albania proved Mussolini's imperialistic plans to Hitler. Despite this, Hitler allowed Italy to participate in the invasion and occupation of Yugoslavia. Later Italy, without coordinating with

Germany, declared Montenegro an independent state which sparked a major uprising in that state. Italy's continual overestimation of its military and political power and risky independent actions caused Germany to continuously divert combat forces in an unimportant direction to bail Italy out. Far worse in the long term, it prevented consolidating occupation efforts or a common strategy in Yugoslavia. This proved fatal to Hitler's war effort in the Balkans.

The second factor was understanding the enemy. Germany, working through its arms dealers and embassy staff, acquired a thorough knowledge of the organization and doctrine of the Yugoslav military forces. This understanding of the enemy pointed out weaknesses that could be exploited. Since the Yugoslav Army planned a cordon defense using primarily foot-mobile infantry, German planners were quick to organize their forces into combined arms teams capable of rapidly penetrating and bypassing such a defense. Because the Yugoslavs assigned their army and air force units evenly to sectors versus massing for a main effort, the Germans planned to achieve overwhelming force at several penetration points. Because they knew their enemy, the Germans had prepared to exploit their doctrine, strengths, and weaknesses.

The past actions of the German military did not go unnoticed by the Yugoslavs. The Yugoslav High Command steadily watched the buildup and conquests of the

German military, acquiring knowledge and respect for their doctrine, organization, and equipment. However, they did not apply any knowledge of the Germans that they had acquired to their own doctrine or organizations. The anti-tank capability of the infantry divisions stayed at the same low levels, anti-tank training received no emphasis, and their tank forces remained small and obsolete. The Yugoslav High Command initiated the organization and training of units for unconventional mountain warfare, but did not prepare any doctrine to guide the use of these forces. When the invasion came, they did not and could not exploit the identified weaknesses of the German Army in Yugoslavia's restrictive terrain.

The essence of an operational plan is to correctly estimate an enemy's center of gravity and then set objectives where completion will ensure the destruction of that center of gravity and subsequent defeat of the enemy. Germany correctly estimated that the Yugoslav center of gravity was the Third and Fifth Armies and that the correct operational objectives were the penetration of those armies while maintaining a rapid tempo throughout the operation to finish quickly. Yugoslavia did not understand Germany's center of gravity and established operational objectives that could not be achieved. Operation 25 demonstrates the usefulness of campaign design criteria in planning campaigns and major operations. It provides valuable

lessons that campaign planners should consider in the design of campaigns.

IMPLICATIONS FOR MODERN OPERATIONAL PLANNERS

The invasion of Yugoslavia seemed to prove that overwhelming force ensured quick decisive victory. No Yugoslav military force proved capable of being able to resist the overwhelming German forces. The victory's low cost in men and materiel pleasantly surprised the German military. The invasion dissolved the Yugoslav nation and left it divided among the victors. Within a few months, however, the conquered nation had ethnic civil wars raging in some of its states that caused Germany's decisive victory to start unraveling.

Today, a different situation exists in Yugoslavia than did in 1941. First, the nation of Yugoslavia no longer exists and it has dissolved into autonomous states. The prime international concern at the time of this writing is the state of Bosnia-Herzegovina, where Serbian-backed forces are conducting irregular warfare and "ethnic cleansing"⁹¹ against a lightly armed and generally unprotected civilian population. Second, the identification of organized units against which military force can be applied is extremely difficult.

Yet, several similarities to the situation Germany found in 1941 remain today. The terrain is as restrictive as it was in 1941. The ethnic diversity of the country remains the same. Also, the formation of a coalition remains difficult in the best of circumstances. As operational planners consider

possible operations in enforcing a peace on this conflict, there are relevant conclusions from the German's 1941 campaign that apply today.

The first conclusion to be drawn from the campaign with implications for today is that of understanding an enemy. When Hitler invaded Yugoslavia, he decided to pit the Croats against the Serbs by granting Croatian independence. This illustrated the poor understanding held by the Germans on the deep ethnic currents that flowed in Yugoslavia. Germany considered the end state of the invasion to be the same as for the other nations it had invaded. The populations of those nations passively complied with Germany's will and Germany, therefore, thought that Yugoslavia would follow suit.

However, Yugoslavia was not a France or Poland. Those countries, before their invasions by Germany, had established stable governments and possessed a secure culture in which the different ethnic groups had come to consensus. Moreover, over a period of two centuries, they had developed a deep sense of national unity that they retained despite suffering military defeat. Yugoslavia became a nation only after World War I and possessed a culture split into six major ethnic factions--Croats, Serbs, Moslems, Bosnians, Macedonians, and Hercegovinians. Its society still had clan traditions and a feudal system that persisted.⁹² Before the invasion, the monarchy of

Prince Paul held together Yugoslavia's national unity. However, the coup had a telling affect on the fabric of Yugoslav culture. What unity had existed dissolved. It exposed the coup for what it was--a Serbian government "of the few, by the few, and for the few" with no acceptance of the other ethnic members of the country and no desire to resolve the differences or grievances between the ethnic groups. ⁹³ The ethnic groups, much like today, returned to the methods that had worked through their own unique history--settling their differences by force.

Hitler thought that increasing Croatian-Serbian tensions would facilitate security operations in the area. Neither Hitler nor his military foresaw the actual impact that the combination of ethnic conflict with the decision to increase tensions would have on operations. ⁹⁴ In later directives, Hitler divided Yugoslavia among his allies without any consideration of the ethnic makeup of the different areas of Yugoslavia. This, combined with repressive military occupation policies, caused further alienation of the ethnic minorities in Yugoslavia.

In addition, no coordination of Hitler's occupation policies regarding treatment of ethnic factions was made or agreed upon with his allies. They had other policies in effect that did not complement the German efforts. The result of these uncoordinated and repressive policies was the eruption of an ethnic

civil war fueled only further by any German solution. It would prove to be the primary reason for Germany's decisive victory in Yugoslavia turning indecisive.

Understanding the military capabilities of the enemy is important, but an understanding of the enemy's political and cultural history, its ethnic makeup, and the effect that these underpinnings have on the enemy's national will is essential. Vital to reaching a solution with any ethnic conflict, equitable policies of treatment and grievance redress must be in place and enforced with very detailed rules of engagement. Without addressing the underpinnings of the ethnic civil war, no operation in Yugoslavia can be decisive.

Another associated conclusion to be drawn from the campaign with implications for today concerns the formation of coalitions for operations in Bosnia-Herzegovina. In 1941 Germany formed a coalition to ensure an allied front and sufficient overwhelming forces were committed to the invasion. However, Germany's haste in withdrawing their overwhelming combat forces from Yugoslavia to be replaced by weak security forces prohibited the disarmament of the countryside. Sufficient weapons and ammunition remained to allow the Yugoslavs to start and sustain a bloody ethnic civil war.

Today, a coalition will be required for not only presenting an allied front and international resolve, but to obtain the necessary military forces. Any

effort in Yugoslavia will require the initial use of massive, overwhelming military forces to disarm the countryside of the weapons being used to prosecute the civil war. The United States, because of its post-Cold War military drawdown and international commitments, cannot fulfill this requirement alone. It will require the formation of a coalition to ensure the provision of adequate force levels.

Along with the formation of a coalition, operational policies for the assistance of Bosnia-Herzegovina must be established and agreed upon before operations begin. Continuous coordination will be required with coalition partners to ensure correct and equitable policies throughout the area of operations. Otherwise, Germany's failures in 1941 could be repeated.

The third conclusion to be drawn from the campaign concerns military planners and their understanding of the political end-state. When he discovered that Yugoslavia's signature to the Tripartite Pact was invalid because of a coup, an enraged Hitler decided to erase Yugoslavia as a state, destroying the national government as well as the nation's military power. However, his initial instructions to his military did not include any political end state provisions.

On 18 April, Hitler issued a decision document that outlined the political end state that he expected
95
at the end of Operation 25. It redefined the

internal boundaries of Yugoslavia (see appendix 10), parceling out a different zone to each coalition victor. It also established combat force levels for occupation duties. It stated that political and military involvement in areas occupied by his allies, Italy, Hungary, Bulgaria, and Croatia, was to be of no interest to Germany.

German military planners planned every detail for accomplishing the military aim. Their vision attempted to look at the most dangerous and most likely military contingencies and design flexible operations to enable accomplishment of the assigned military aim. Yet they envisioned, planned, and coordinated only military contingencies with their allies. Planners gave no consideration to the political contingencies that could be encountered as a result of combat operations. Under Germany's political system at the time, the General Staff did not have the opportunity to question or comment on the political directives they received. Hitler was convincing himself that he was his best general. If military planners had the opportunity to do so, they could have noted the disjointed occupation and lack of coherent or coordinated policies and could have taken appropriate action to call this to Hitler's attention.

Operational planners must plan and coordinate every detail of the military end state. At the same time, the political end state must be understood and

the effect of military operations on that political end state must be estimated. When military operations have the potential of producing an unacceptable political end state, military planners must have the flexibility to honestly report such to the strategic level leadership for resolution.

The fourth conclusion to be drawn from the campaign is that of the difficulty of marshalling forces to enable a quick entry into Yugoslavia. When Germany invaded Yugoslavia, it did so from nations adjacent to Yugoslavia. Germany had acquired positioning rights for its forces either through diplomatic alliances, as in the case of Austria, Romania, and Bulgaria, or by operational coordination, such as that accomplished by General Halder for the marshalling of forces in Hungary. This enabled Germany to prepare frontier and river crossing points and poise their forces to rapidly execute the invasion. Also, logistical staging bases had been emplaced in Austria and Bulgaria prior to the invasion which enabled sustainment during the short duration of the operation.

As operations are considered for the enforcement of peace in Bosnia-Herzegovina, operational planners will note that it is not surrounded by states that are sympathetic to stopping the conflict. Croatia, Slovenia, and Serbia could prove unfriendly to peace enforcement operations. There is no opportunity to prepare and protect river crossings to poise forces for

a rapid ground entry. Also, there are no logistical staging bases in place. Yet, a successful overwhelming entry into Bosnia-Hercegovina cannot be achieved without the use of land lines of communication to employ and sustain the operational force. Operational planners must consider this in the design of any campaign for Bosnia-Hercegovina to ensure that planned operations do not endanger the entry or sustainment of forces.

The last conclusion to be drawn from the campaign is related to properly providing the military force with adequate resources to accomplish the assigned aim. When Germany attempted to bring peace to Yugoslavia, it used military power throughout its occupation. There was no attempt to influence the population to keep the peace by other means. Economic, political, or social tools were not viable options to Hitler. He felt that force was the only means a nation of Slavs understood. Yugoslavia's oppressed, sensing no opportunity to improve their plight, expressed their discontent through civil war.

In the recent past, U.S. operational planners have been very successful in planning and executing military operations to achieve a military decision. However, Operations Urgent Fury, Just Cause, Desert Storm, and Provide Comfort serve as examples of how operations in war are planned in detail and of how peace enforcement operations are rarely planned in advance. Military

force was efficiently used in defeating the enemy and bringing combat operations to a close. However, at this point, the operational plan concluded, leaving peace enforcement to be conducted on an ad-hoc basis. Other means were found to be required for successful peace enforcement. However, these other means were an after thought to the operational plan.

For operational planners, military forces are not the only tools for creating success in Bosnia-Herzegovina. Cessation of the ethnic civil war that now plagues the state will require a long term commitment during which different tools must be applied over time to create success. Military forces have their place in the creation of a solution, as do the forces required to restore law and order, rebuild civic infrastructure, educate the population, provide security, and provide economic recovery opportunities. These tools must be made available to and planned for by the military force to ensure a continued decisive peace in Bosnia-Herzegovina.

To resolve Yugoslavia's current ethnic violence and to bring peace to Bosnia-Herzegovina is no simple task. It will require study, flexibility, intuition, ingenuity, and tenacity. Any solution will require the closely coordinated application of all elements of coalition or United Nations power to attain a common, achievable end. Hitler, despite his effective military campaign and decisive victory in 1941, failed to create

peace for Yugoslavia. Because he did not envision the full scope or uniqueness of the problems that existed in that region of Europe, Germany's victory turned indecisive. When considering campaigns in this region, operational planners must remember the lessons that history provides.

APPENDIX 1
DIRECTIVE NO. 25

The Fuehrer and Supreme Commander
of the Armed Forces

Fuehrer Headquarters
27 Mar. 1941

OKW/WFSt/Abt.L(I Op) Nr. 44379/41 g.K.Chefs. No. 2 of twelve copies

Top secret

Directive No. 25

1. The military coup in Yugoslavia has changed the political situation in the Balkans. Yugoslavia is to be regarded as an enemy. Even if she were to affirm her loyalty to us she would still have to be destroyed as quickly as possible.

2. It is my intention to break into Yugoslavia with a concentric operation moving in the general direction of Belgrade and the south, one arm coming from the Fiume-Graz area and the other from the area around Sofia; to administer a crushing defeat to the Yugoslav armed forces; and, in addition, to detach the southernmost portion of Yugoslavia from the rest of the country and to use it as a base for continuing the German-Italian offensive against Greece.

The early reopening of Danube traffic and the seizure of the copper mines at Bor are important for the war economy.

We must attempt to induce Hungary and Bulgaria to participate in the operations by extending to them the hope of regaining Banat and Macedonia.

Political promises made to the Croats will render the internal tension in Yugoslavia more acute.

3. My detailed orders are as follows:

a. As soon as sufficient forces are available and the weather situation permits, the Air Force is to destroy the city of Belgrade and the ground organization of the Yugoslav air force by means of continuous day and night attacks.

b. If possible at about the same time - certainly not earlier - operation "Marita" is to begin, with the limited objective, for the time being, of occupying the Salonika basin and getting a foothold on the heights of Edessa (Vodena). The XVIII Army Corps can move into position for this attack by way of Yugoslav territory.

In order to prevent the enemy from establishing an organized front between Mount Olympus and the heights of Edessa (Vodena) we must make use of any favorable opportunities which offer themselves.

c. All forces still available in Bulgaria and Rumania may be utilized for the attacks which are to be launched toward the northwest from the region around Sofia, and toward the west from the region of Kynstendil-Gorna Dzhumaya, except that a force of the approximate size of a division (in addition to anti-aircraft troops) must remain for the protection of the Rumanian oil fields.

For the time being, the protection of the Turkish boundary is to be left to the Bulgarians. A German formation, a panzer division if possible, is to be kept in readiness behind them as a reserve.

d. The attack coming from the general direction of Graz and moving southeastward is to be launched as soon as the necessary forces have been assembled. The decision as to whether Hungarian soil will be used for the push against the Yugoslav border will be left up to the Army.

Security measures at the Yugoslav frontier are to be strengthened at once.

Important points may be seized at the Yugoslav border just as on the Bulgarian borders even before the general attack begins. These actions should be timed to coincide with the air attack on Belgrade.

e. Two attack groups of the Air Force are to support the operations of the 12th Army and those of the assault group to be formed in the Graz area, concentrating the forces according to the progress of the Army operations. The Hungarian ground organization can be utilized for assembly and the actual operation.

It is to be investigated whether the X Air Corps should be employed, based on Italian territory. However, escort of the transports to Africa must be assured.

Preparations for the occupation of Lemnos island should be continued; however, it should not be executed until I issue the order.

Adequate anti-aircraft protection should be provided for Graz, Klagenfurt, Villach, Leoben, and Vienna.

4. Basic agreements with Italy will be reached by the Armed Forces High Command to begin with.

The Army is to provide for liaison staffs for the Italian 2nd Army and for Hungary.

The Air Force is empowered to reach agreements at the present time with the Italian and Hungarian Air Forces concerning borders of the air operations areas. Preparations can be made at once to set aside the supplies for the Hungarian ground organization.

5. The Commanders in Chief will report to me through the Armed Forces High Command concerning the planned operations and the related command questions.

signed: Adolf Hitler

SOURCE NOTE: Directive 25 was obtained from Naval History Division, "Fuehrer Directives and Other Top-Level Directives of the German Armed Forces, 1939-1941," Vol. 1, Washington: Office of the CNO, 1948, 161-163.

APPENDIX 2

THE CAMPAIGNS IN THE BALKANS
DEPLOYMENT AND INITIAL OBJECTIVES

— SINGLE TRACK
— DOUBLE TRACK
— RETRACTION AREA WITH ONLY
RETAINING CAPACITY
— ROAD LINE WITH ONLY
RESERVE CAPACITY
— METEOR LINE

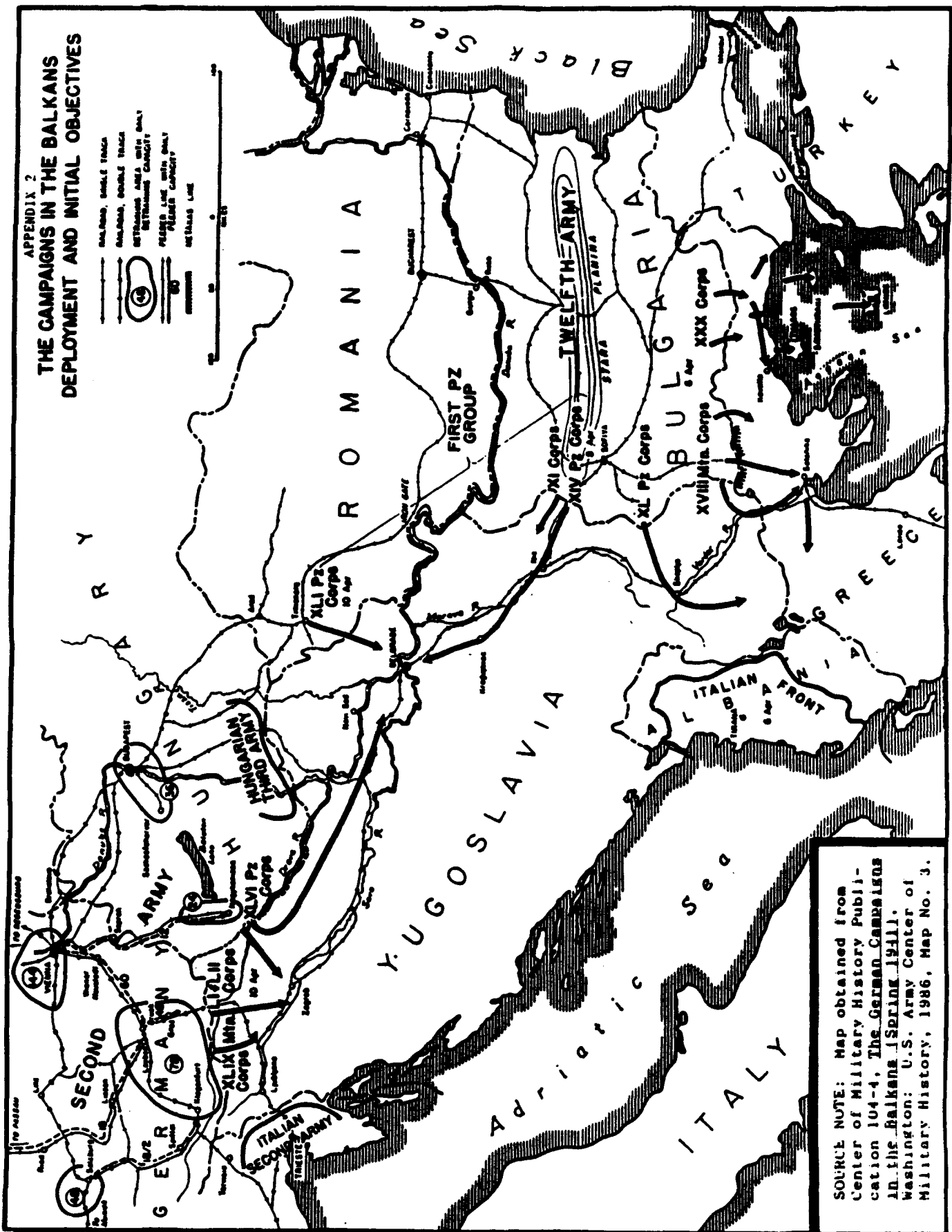
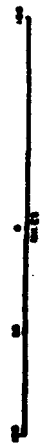

SOURCE NOTE: Map obtained from Center of Military History Publication 104-4, The German Campaigns in the Balkans, Spring 1941. Washington: U.S. Army Center of Military History, 1986, Map No. 3.

**APPENDIX 3
GERMAN ARMY ORDER OF BATTLE**

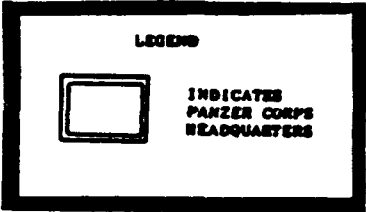
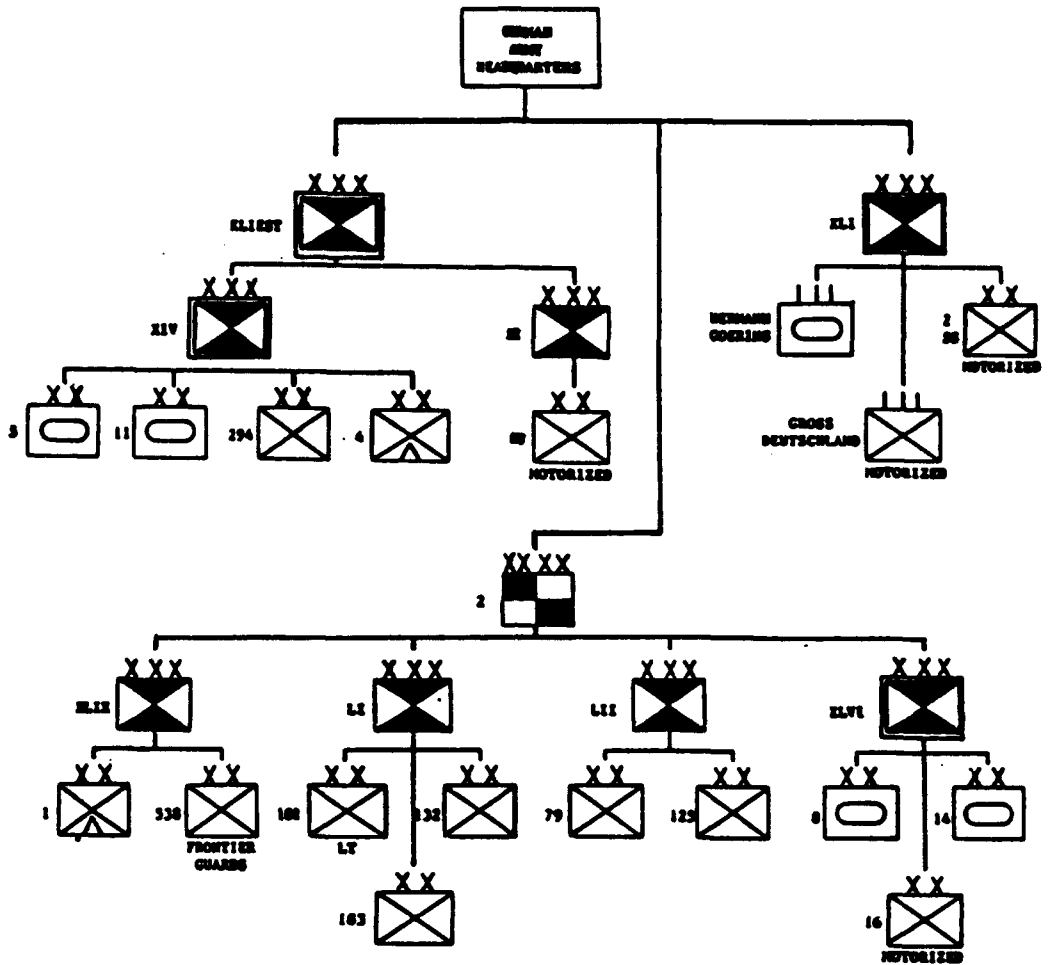

SOURCE NOTE: German Army Order of Battle data obtained from Center of Military History Publication 104-4, The German Campaigns in the Balkans (Spring 1941), Washington: Center of Military History, 1986, 39 & 41.

**APPENDIX 4
GERMAN AIR FORCE ORDER OF BATTLE**

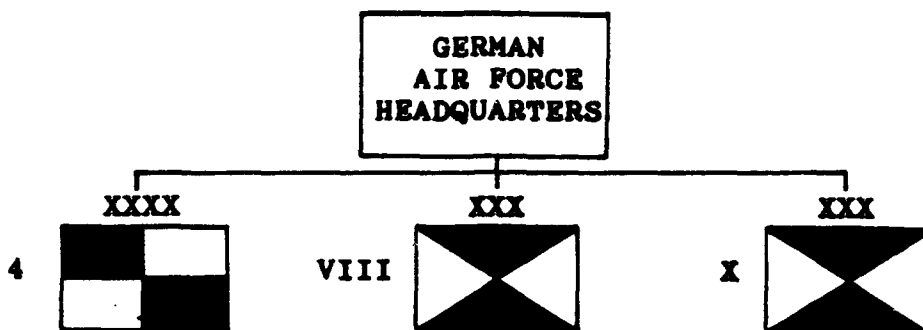

COMPOSITION OF AIR ORGANIZATIONS

<u>TYPE AND SIZE UNIT</u>	<u>4TH AIR FLEET</u>	<u>VIII AIR CORPS</u>	<u>X AIR CORPS</u>
BOMBER GROUP	1	1	4
DIVE BOMBER GROUP	7	4	
TWO ENGINE FIGHTER GROUP	2	2	1
SINGLE ENGINE FIGHTER GROUP	7	4	
SINGLE ENGINE FIGHTER SQUADRON	3	1	1
RECONNAISSANCE SQUADRON	1	1	
FLOATPLANE SQUADRON		1	
ARMY RECONNAISSANCE SQUADRON	7	6	
TOTAL AVAILABLE AIRCRAFT	576	414	168

NOTE:

- A Group consists of 30 to 36 aircraft.
- A Squadron consists of 9 to 12 aircraft.
- Army Reconnaissance Squadrons normally attached to Army corps-sized maneuver units.

SOURCE NOTE: Order of Battle and strength data obtained from analysis of information contained in sources by Christopher Shores and Brian Cull, Air War for Yugoslavia, Greece, and Crete, London: Grub Street, 1987, 171, 173, and 180, and by Paul Deichmann, German Air Force Operations in Support of the Army, USAF Historical Study No. 163, Air University, 1962.

**APPENDIX 5
YUGOSLAV ARMY ORDER OF BATTLE**

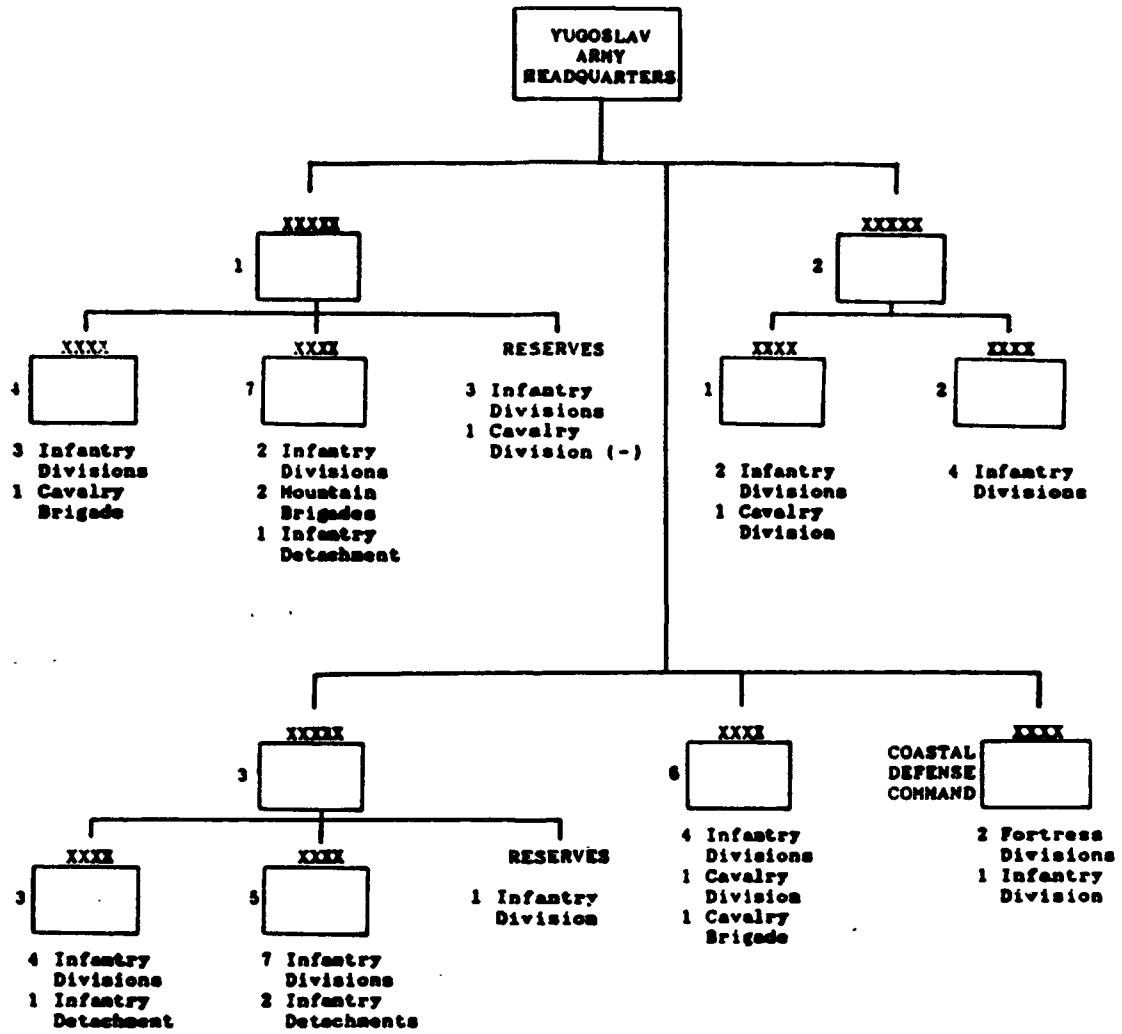

RECAPITULATION:

<u>TYPE UNIT ASSIGNED</u>	<u>1ST ARMY GROUP</u>	<u>2D ARMY GROUP</u>	<u>3D ARMY GROUP</u>	<u>6TH ARMY</u>	<u>COASTAL DEFENSE COMMAND</u>	<u>TOTALS</u>
INFANTRY DIVISION	8	6	12	4	1	31
INFANTRY DETACHMENT	1		3			4
CAVALRY DIVISION	1	1		1		3
CAVALRY BRIGADE				1		1
MOUNTAIN BRIGADE	2					2
FORTRESS DIVISION					2	2
TOTALS	<u>12</u>	<u>7</u>	<u>15</u>	<u>6</u>	<u>3</u>	<u>43</u>

REMARKS:

- Infantry Detachments ranged in size from a brigade to a battalion.
- Fortress Divisions were infantry divisions assigned to specific geographic locations for the purpose of manning fortifications and protecting a specific approach.

SOURCE NOTES: Yugoslav Army Order of Battle determined by analysis of the following three sources:

1. Ronald L. Tarnstrum, Handbooks of the Armed Forces: The Balkans Part II, Lindsborg: Trogen Books, 1983, 128-129.
2. Military-Historical Institute of the Yugoslav People's Army, Prepared By, Historical Atlas of the Liberation War of the Peoples of Yugoslavia 1941-1945, Beograd: Jugoslaviya, 1957, Map No. 1.
3. Center of Military History Publication 104-4, The German Campaigns in the Balkans (Spring 1941), Washington: Center of Military History, 1986, 36-37.

APPENDIX 6
THE INVASION OF YUGOSLAVIA
YUGOSLAV ARMY DISPOSITIONS
5 APRIL 1941

----- DEMOTES ARMY GROUP BOUNDARY
 0 20 40 60 80 100 120 140 160 180 200
 SCALE OF MILES

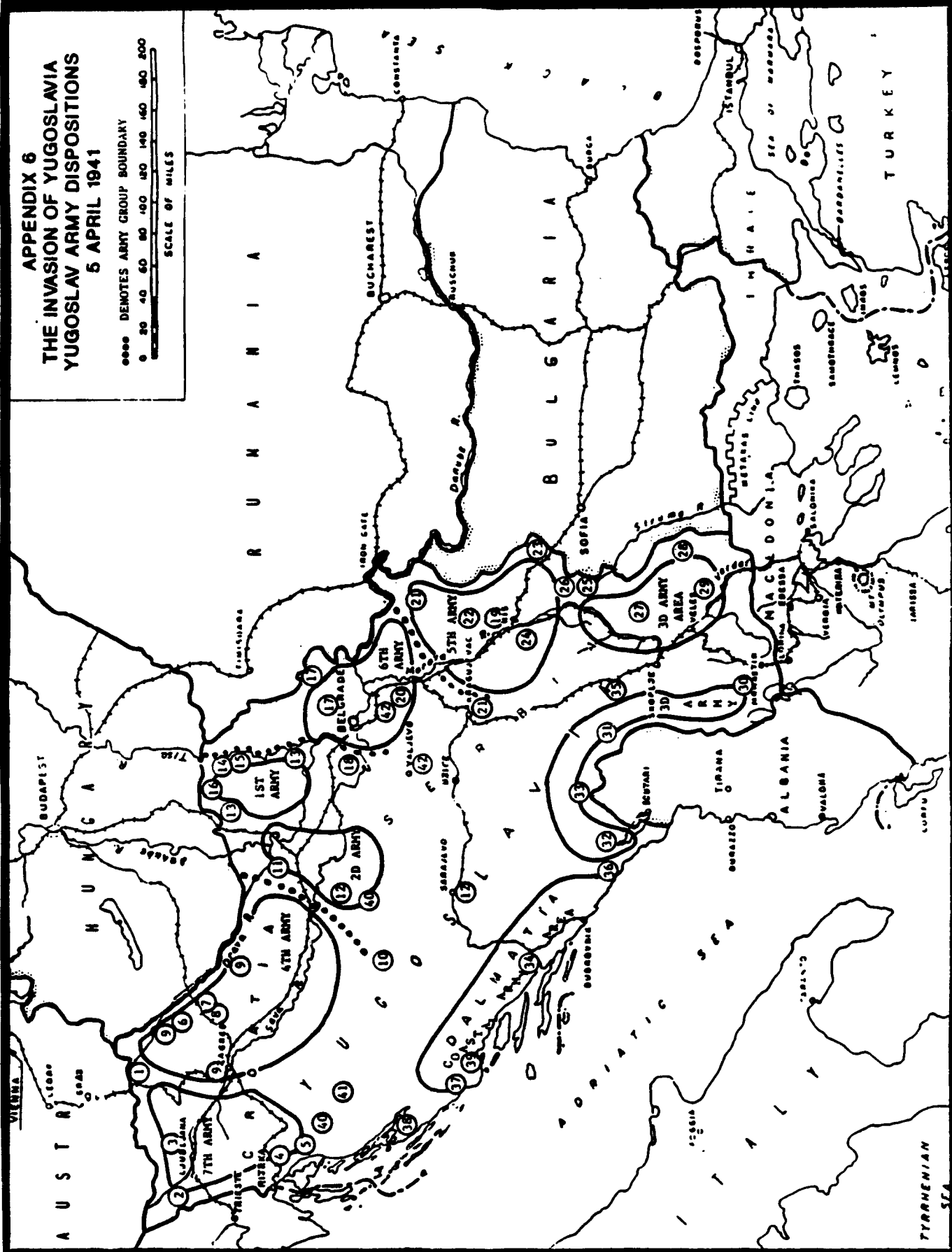

**APPENDIX 6
YUGOSLAV ARMY DISPOSITIONS
LEGEND**

In using this legend, refer to accompanying map.

MAP ID#: A circled number on the accompanying map designating the location of the unit on 6 April 1941.

UNIT: Unless otherwise noted, all units are infantry.

STATUS:

1--Unit mobilized less staff and rear units.

2--Unit partly mobilized and moving to concentration area or assigned frontier.

3--Unit in process of mobilization.

ASGD ARMY: The numbered army that the unit is assigned to. If there is no number, unit is assigned to a numbered army group. CDC stands for Coastal Defense Command.

ASGD ARMY GROUP: The numbered army group that the unit is assigned to. If there is no number, higher headquarters was the Yugoslav Army High Command.

<u>MAP ID#</u>	<u>UNIT</u>	<u>STATUS</u>	<u>ASGD ARMY</u>	<u>ASGD ARMY GROUP</u>	<u>REMARKS</u>
1	DRAVA DIV	3	7th	1st	
2	TRIGLAV MTN DET	1	7th	1st	
3	TRIGLAV DIV	3	7th	1st	
4	RISNJAK MTN DET	1	7th	1st	
5	LIKA DET	1	7th	1st	
6	MURA DIV	3	4th	1st	

<u>MAP ID#</u>	<u>UNIT</u>	<u>STATUS</u>	<u>ASGD ARMY</u>	<u>ASGD ARMY GROUP</u>	<u>REMARKS</u>
7	SAVA DIV	3	4th	1st	
8	SLAVONIA DIV	2	4th	1st	
9	1ST CAVALRY DIV	3	4th	1st	Majority of division asgd as 1st Army Grp Reserve
10	VRBAS DIV	2	2d	2d	
11	OSIJEK DIV	3	2d	2d	
12	BOSNA DIV	2	2d	2d	Reserve
13	POTISJE DIV	3	1st	2d	
14	3D CAVALRY DIV	3	1st	2d	
15	SENTA DIV	3	1st	2d	
16	SOMBOR DIV	3	1st	2d	
17	BANAT DIV	1	6th		
18	SREM DIV	2	6th		
19	2D CAVALRY DIV	2	6th		
20	DUNAV DIV	3	6th		
21	KRAJINA DIV	2	6th		Reserve
22	TIMOK DIV	3	5th	3d	
23	TOPLICA DIV	1	5th	3d	
24	DRINA DIV	1	5th	3d	
25	VLASINA DET	1	5th	3d	
26	KALNA DET	1	5th	3d	
27	MORAVA DIV	1	5th	3d	
28	BREGALNICA DIV	1	3d	3d	
29	SUMADIJA DIV	1	3d	3d	
30	VARDAR DIV	3	3d	3d	

<u>MAP ID#</u>	<u>UNIT</u>	<u>STATUS</u>	<u>ASGD ARMY</u>	<u>ASGD ARMY GROUP</u>	<u>REMARKS</u>
31	KOSOVO DIV	1	5th	3d	
32	ZETA DIV	3	3d	3d	
33	KOM DET	1	3d	3d	
34	HERCEGOVENA DIV	2	CDC		
35	IBAR DIV	2		3d	Reserve
36	BOKA KORTORSKA COMMAND	3	CDC		
37	SIBERNIK COMMAND	3	CDC		
38	JADRAN DIV	3		1st	Reserve
39	DINARA DIV	3		1st	Reserve
40	LIKA DIV	3	2d	2d	
41	UNA DIV	2		1st	Reserve
42	CER DIV	2	6th		Reserve

SOURCE NOTES:

a. Map and legend data determined by an analysis of the following three sources:

(1) Jozo Tomasevich, The Chetniks, Stanford: Stanford University Press, 1975, 66.

(2) Ronald L. Tarnstrom, Handbooks of the Armed Forces: The Balkans Part II, Lindsborg: Trogen Books, 1983, 128-129.

(3) Military-Historical Institute of the Yugoslav People's Army, Prepared By, Historical Atlas of the Liberation War of the Peoples of Yugoslavia 1941-1945, Beograd: Jugoslavija, 1957, Map No. 1.

b. Map outline obtained from United States Military Academy, A Military History of World War II--Atlas, West Point: Department of Military Art and Engineering, 1953, Map No. 20.

**APPENDIX 7
YUGOSLAV AIR FORCE ORDER OF BATTLE**

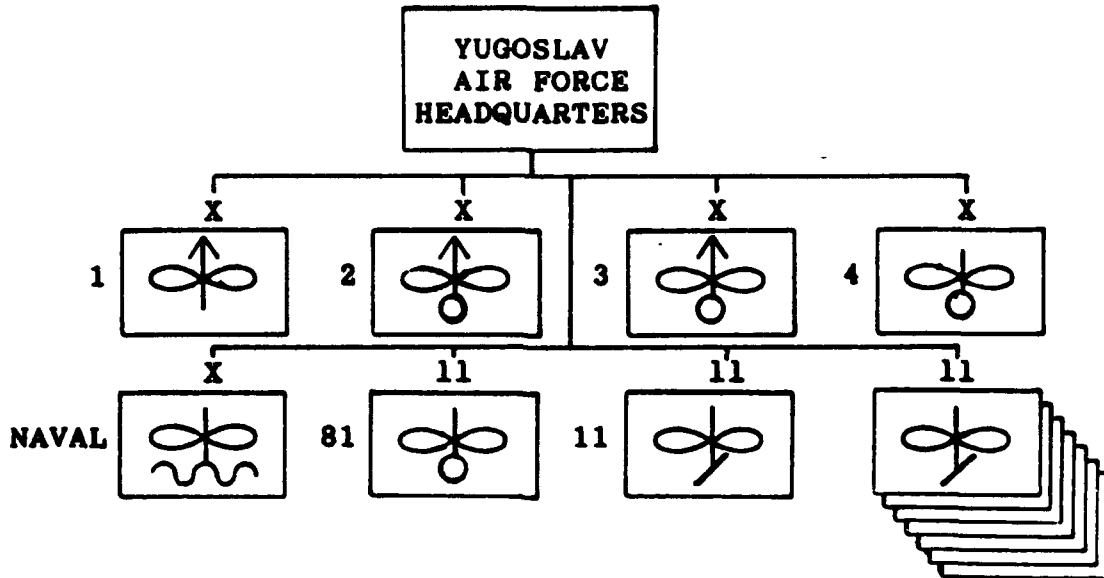

COMPOSITION OF AIR ORGANIZATIONS

TYPE SQUADRONS ASSIGNED	AIR FORCE HQ	1ST AIR BDE	2D AIR BDE	3D AIR BDE	4TH AIR BDE	NAVAL AIR BDE
BOMBER	1		2	2	4	
FIGHTER		4	2	2		
RECONNAISSANCE	1					
ARMY RECON	8					
HYDROPLANE						4
TOTAL ASSIGNED AIRCRAFT	156	80	54	92	51	70

REMARKS:

- Two squadrons normally formed a regiment, while two regiments formed a brigade.
- Army Recon Squadrons were normally attached to army-level ground maneuver units.
- Total available aircraft does not include training aircraft. Ten training units were in operation and used primarily obsolete aircraft.

SOURCE NOTE: Order of Battle and strength data obtained from analysis of information contained in a source by Christopher Shores and Brian Cull, Air War for Yugoslavia, Greece, and Crete, London: Grub Street, 1987, 171, 173, and 180.

APPENDIX 8
THE INVASION OF YUGOSLAVIA
YUGOSLAV AIR FORCE DISPOSITIONS
5 APRIL 1941

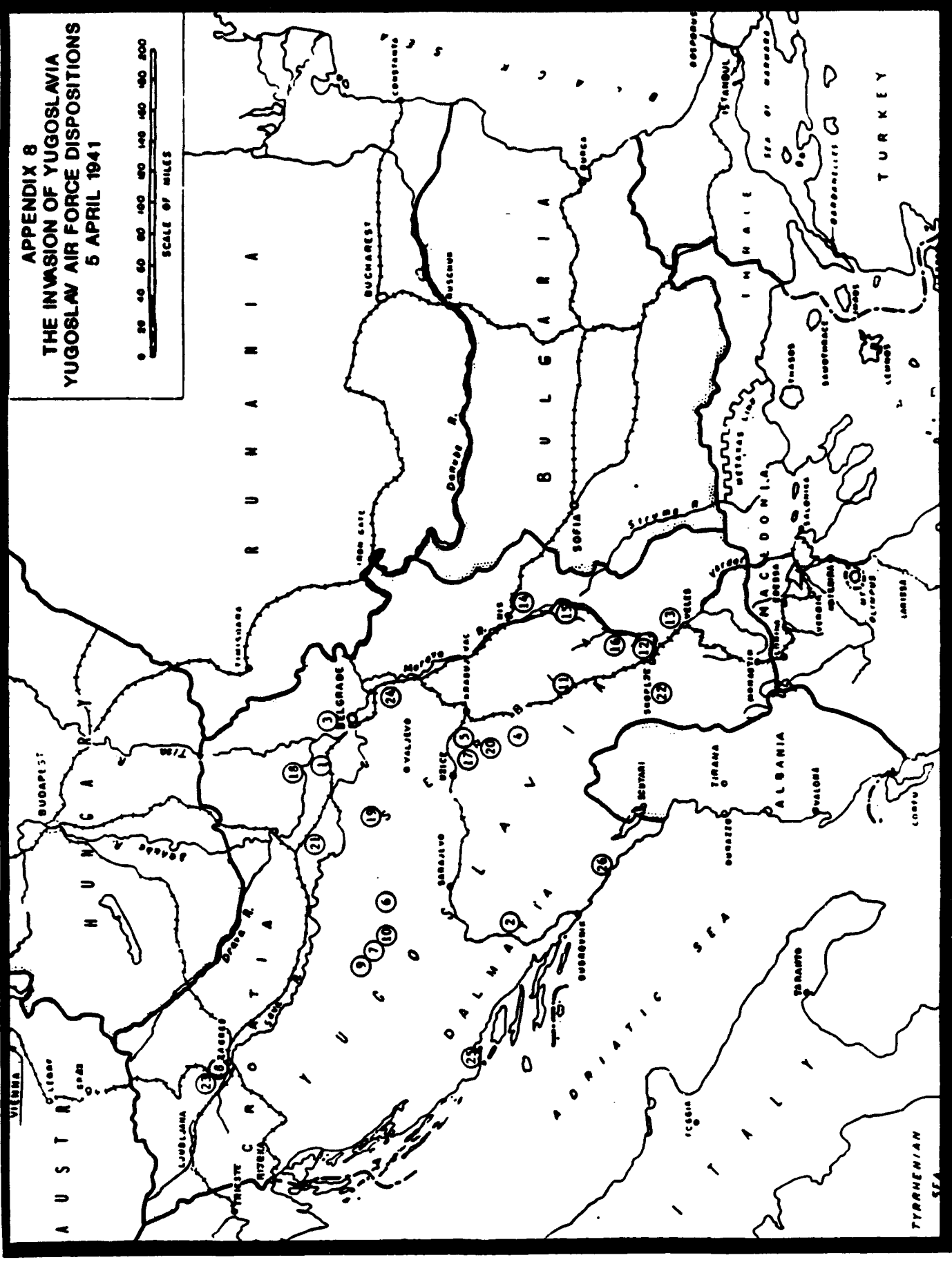

**APPENDIX 8
YUGOSLAV AIR FORCE DISPOSITIONS
LEGEND**

In using this legend, refer to accompanying map.

MAP ID#: A circled number on the accompanying map designating the location of the unit on 6 April 1941.

UNIT: Describes type of air force unit.

LOCATION: The airfield to which the unit dispersed upon mobilisation.

EQUIPMENT: The quantity and primary type of equipment assigned to the unit.

AIR FORCE UNITS

MAP ID#	UNIT	LOCATION	EQUIPMENT
1	YUGOSLAV AIR FORCE HQ	LJESNICA*	
1	701ST LIAISON UNIT	LJESNICA*	
1	11TH INDEPENDENT (LONG RANGE RECON) GROUP	RUMA	9 BLENHEIM
2	81ST BOMBER GROUP	MOSTAR-ORTIJES	14 S.79, 3 ME109, 3 HURRICANE
3	1ST FIGHTER AIR BDE	BELGRADE-ZEMUN*	
4	2D FIGHTER REGT	KRALJEVO*	
5	31ST FIGHTER GROUP	KNIC	19 ME109
5	52D FIGHTER GROUP	KNIC	15 HURRICANE
3	6TH FIGHTER REGT	BELGRADE-ZEMUN*	
6	32D FIGHTER GROUP	PRNJAVOR	27 ME109
3	51ST FIGHTER GROUP	BELGRADE-ZEMUN	10 ME109, 6 IK-2
7	2D MIXED AIR BDE	NOVA TOPOLA*	

<u>MAP ID#</u>	<u>UNIT</u>	<u>LOCATION</u>	<u>EQUIPMENT</u>
8	4TH FIGHTER REGT	ZAGREB*	
9	33D FIGHTER GROUP	BOSANSKI ALEXSANDROVAC	13 HURRICANE
9	34TH FIGHTER GROUP	BOSANSKI ALEXSANDROVAC	7 HURRICANE, 8 IK-2
8	8TH BOMBER REGT	ZAGREB*	
10	68TH BOMBER GROUP	ROVINE	12 BLENHEIM
10	69TH BOMBER GROUP	ROVINE	12 BLENHEIM
11	3D MIXED AIR BDE	STUBOL*	
12	3D BOMBER REGT	SKOPLJE*	
13	63D BOMBER GROUP	PETROVAC	30 DO17
13	64TH BOMBER GROUP	PETROVAC	30 DO17
14	5TH FIGHTER REGT	NIS*	
15	35TH FIGHTER GROUP	KOSANCIC	15 HAWKER FURY
16	36TH FIGHTER GROUP	REZANOVACKA KOSA	15 HAWKER FURY
17	4TH BOMBER AIR BDE	LJUBIC*	
18	1ST BOMBER REGT	NOVI SAD*	
19	61ST BOMBER GROUP	BJELJINA	11 BLENHEIM
19	62D BOMBER GROUP	BJELJINA	12 BLENHEIM
2	7TH BOMBER REGT	MOSTAR*	
20	66TH BOMBER GROUP	PRELJINA	13 S.79
20	67TH BOMBER GROUP	GOROBILJE	13 S.79
25	NAVAL AIR FORCE HQ	KASTEL LUKSIC*	
25	2D HYDROPLANE CMD	DIVULJE	29 AIRCRAFT**
26	3D HYDROPLANE CMD	BOKA KOTORSKA	34 AIRCRAFT**

* Indicates peacetime location for the unit. Although no record could be found that the various headquarters moved from their peacetime headquarters location, it is

presumed that most headquarters relocated vicinity their subordinate units.

** Units were made up of various models of obsolete sea planes.

AIR FORCE UNITS ASSIGNED TO ARMY COMMANDS

<u>MAP ID#</u>	<u>UNIT</u>	<u>LOCATION</u>	<u>ASGD ARMY</u>
1	1ST AIR RECON GRP	RUMA	1ST ARMY
15	2D AIR RECON GRP	SORLINCE	5TH ARMY
21	3D AIR RECON GRP	STARO TOPOLJE	2D ARMY
8	4TH AIR RECON GRP	VELIKA GORICA	4TH ARMY
22	5TH AIR RECON GRP	TETOVO	3D ARMY
23	6TH AIR RECON GRP	CERKLJE & BREGA	7TH ARMY
24	7TH AIR RECON GRP	SMEDEREVSKA PALANKA	6TH ARMY
2	COASTAL RECON FLIGHT	JESENICA-MOSTAR	COASTAL DEFENSE COMMAND

These units were attached to the Yugoslav Army to give the army commanders' their own air reconnaissance capability. Number of aircraft per unit varied from 14 to 19 aircraft. All assigned aircraft types were obsolete.

SOURCE NOTES:

a. Map and legend data determined by analysis of information listed in a source by Christopher Shores and Brian Cull, Air War for Yugoslavia, Greece, and Crete, London: Grub Street, 1987.

b. Map outline obtained from United States Military Academy, A Military History of World War II--Atlas, West Point: Department of Military Art and Engineering, 1953, Map No. 20.

SOURCE NOTE: Map obtained from Center of Military History Publication 104-4, The German Campaigns in the Balkans (Spring 1941). Washington: U.S. Army Center of Military History, 1986, Map No. 4.

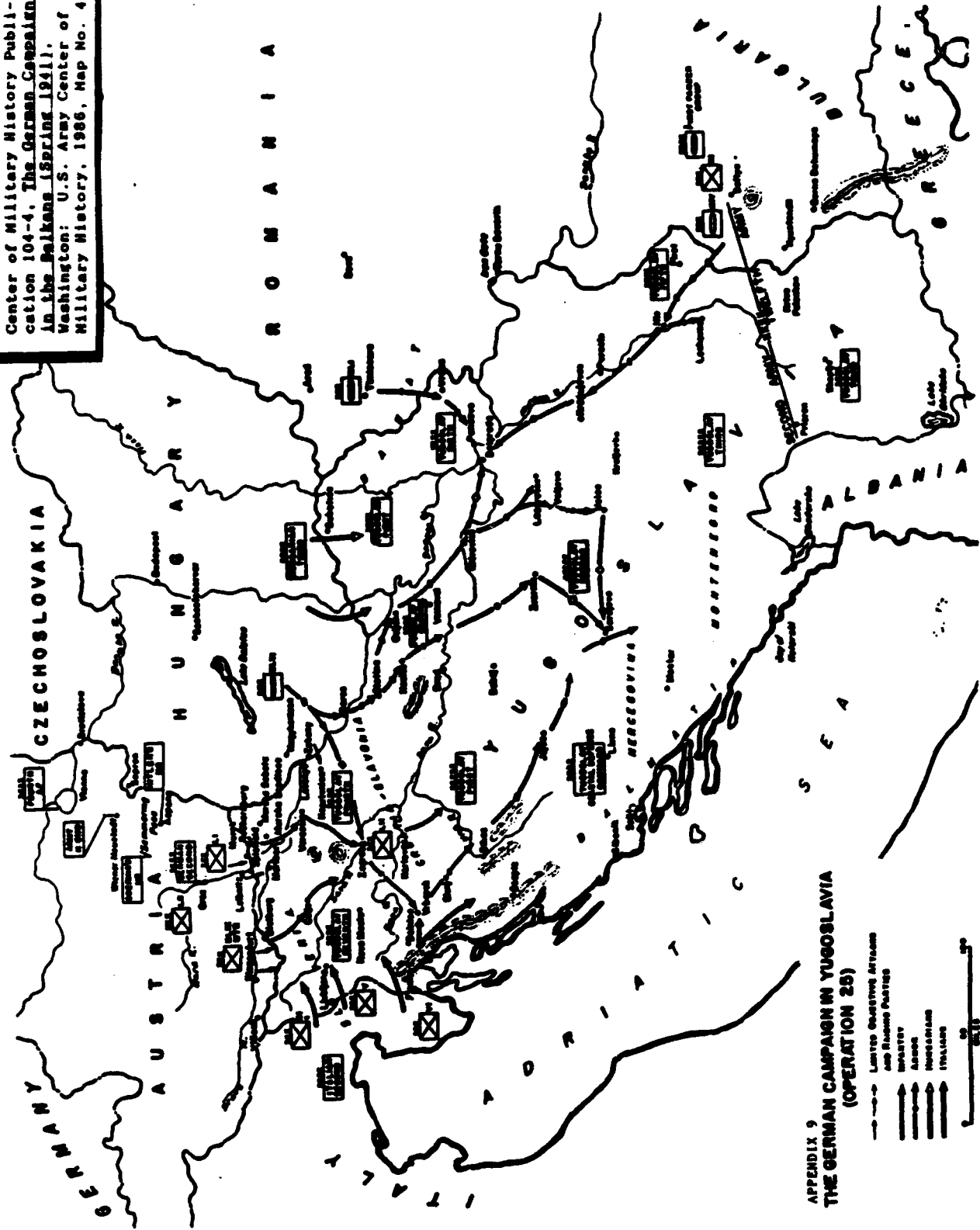

APPENDIX 9
THE GERMAN CAMPAIGN IN YUGOSLAVIA
(OPERATION 25)

- → → → → Luftwaffe Operations
- → → → → Army
- → → → → Mountain Troops
- → → → → Italian



APPENDIX 10
GERMAN PARTITIONING OF YUGOSLAVIA

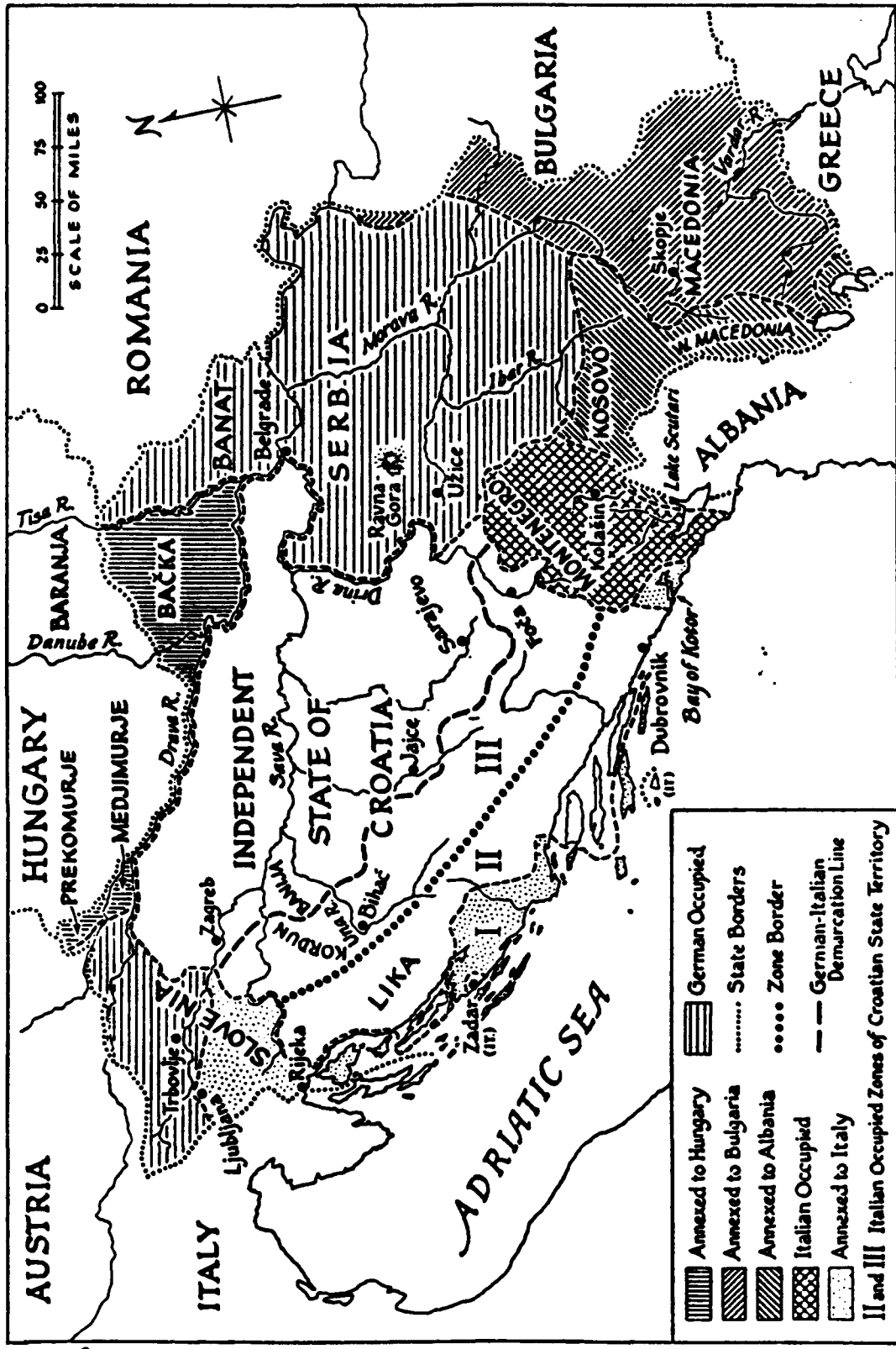

SOURCE NOTE: Map obtained from Jozo Tomasevich, *The Chetniks*, Stanford: Stanford University Press, 1975, 90.

ENDNOTES

1. Martin Van Crevald, Hitler's Strategy 1940-1941 The Balkan Clue, London: Cambridge University Press, 1973, 65.
2. Ilija Jukic, The Fall of Yugoslavia, New York: Harcourt Brace Jovanovich, 1974, 7.
3. Jukic, 77.
4. Hermann Burkhardt Mueller-Hillebrand, "The German Campaign in the Balkans, 1941: A Model of Crisis Planning," Washington, D.C.: U.S. Army Chief of Military History, Report Number MS P-030, August 1950, 24.
5. Hans von Greiffenberg, "Supplement to the Study "The Balkan Campaign" (The Invasion of Yugoslavia)," U.S. Army Europe Historical Division, Military Studies Branch, Report Number MS B-525, 9 June 1947, 5.
6. Van Crevald, 79.
7. Ever since the Yugoslav nation was established in 1920, Serbian, Croatian, and other minority concerns had clashed. Serbians felt that Croatia and the other non-Serbian territories that had been conquered had few rights. Croatia understood its political position, but stood up for equal representation in the monarchy's parliamentary process. Other minorities, such as the Slovenes and Bosnians, equally expressed their discontent through the political process. Prince Paul wanted to resolve this dispute, but only through his own efforts. If the differing factions came to an agreement on their own, they would have no need for the monarchy.
8. Milija M. Lasic-Vasojevic, Enemies on All Sides: The Fall of Yugoslavia, Washington, D.C.: North American International, 1976, 243.
9. Jozo Tomasevich, The Chetniks, Stanford: Stanford University Press, 1975, 41.
10. Van Crevald, 128.
11. J. B. Hoptner, Yugoslavia in Crisis 1934-1941, New York: Columbia University Press, 1962, 259.
12. Van Crevald, 142.
13. Ibid, 143.

14. Frank C. Littlefield, Germany and Yugoslavia, 1933-1941, Boulder: East European Monographs, 1988, 126-127.
15. Arnold Toynbee and Veronica M. Toynbee, eds., Survey of International Affairs 1939-1946: The Initial Triumph of the Axis, New York: Oxford University Press, 1958, 348.
16. Time-Life Books, ed., Conquest of the Balkans, Alexandria: Time-Life Books, 1990, 32.
17. Littlefield, 129.
18. Van Crevald, 145-146.
19. Larry H. Addington, The Blitzkrieg Era and the German General Staff, 1865-1941, New Brunswick: Rutgers University Press, 1971, 150-151.
20. The German High Command did not have time to select an appropriate code name for the operation. For the sake of expediency and simplicity and to avoid confusion, the operation was titled 'Operation 25,' which was the same number as Hitler's Directive 25 that directed the operation.
21. Mueller-Hillebrand, 18-19.
22. Van Crevald, 150-151.
23. Mueller-Hillebrand, 20.
24. V. Vietinghoff, "Balkan Campaign 1941," Washington, D.C.: U.S. Army Chief of Military History, Report Number MS B-334, 31 January 1947, 5.
25. Tomasevich, 69-70.
26. Mueller-Hillebrand, 55-59.
27. I. S. O. Playfair, The Mediterranean and Middle East. The Germans Come to the Help of Their Ally (1941). Vol. II, London: Her Majesty's Stationery Office, 1956, 85.
28. Wayne S. Vuchinich, ed., Contemporary Yugoslavia, Berkeley: University of California Press, 1969, 69-70, and Tomasevich, 55.
29. Dragisa N. Ristic, Yugoslavia's Revolution of 1941, Univeristy Park: The Pennsylvania State University Press, 1966, 127.
30. Tomasevich, 56.

31. Ibid, 56.
32. Vuchinich, 70.
33. Littlefield, 129-130.
34. Lasic-Vasojevic, 246-247.
35. Tomasevich, 56.
36. L. S. Stavrianos, The Balkans Since 1453, New York: Rinehart Company, 1958, 757.
37. Littlefield, 127.
38. Ibid, 125-126.
39. Tomasevich, 58.
40. Christopher Shores and Brian Cull, Air War for Yugoslavia, Greece, and Crete, London: Grub Street, 1987, 174.
41. Vuchinich, 70-71.
42. Tomasevich, 57.
43. Ibid, 59.
44. Ronald L. Tarnstrom, Handbooks of the Armed Forces: The Balkans, Part II, Lindsborg: Trogen Books, 132.
45. Ristic, 155.
46. Tomasevich, 70.
47. Time-Life Books, 44.
48. Van Crevald, 158-160.
49. Tomasevich, 71.
50. Center of Military History Publication 104-4, The German Campaigns in the Balkans (Spring 1941), Washington, D.C.: U.S. Army Center of Military History, 1986, 52.
51. Van Crevald, 158-160.
52. Addington, 154.
53. Tomasevich, 68.
54. Center of Military History Publication 104-4, 33.

55. Van Crevald, 127.
56. Center of Military History Publication 104-4, 58.
57. Ibid, 60.
58. Shores, 223.
59. Vietinghoff, 10.
60. Grieffenberg, 24.
61. Center of Military History Publication 104-4, 61.
62. Van Crevald, 160-162.
63. Shores, 226.
64. Vuchinich, 71-72.
65. Shores, 227.
66. Vuchinich, 72.
67. Van Crevald, 160-162.
68. Mueller-Hillebrand, 64-65.
69. Tomasevich, 68-69.
70. P. D. Ostovic, The Truth About Yugoslavia, New York: Roy Publishers, 1952. 166. Prince Paul was selected as the Regent because the legitimate king, King Peter II, was not considered of sufficient age to take the throne. When the coup occurred, Simovic had King Peter II crowned as the king in a state ceremony immediately following the coup. At that time, King Peter II was not yet eighteen years old.
71. Tomasevich, 72.
72. Tarnstrom, 132.
73. Vuchinich, 72-73.
74. Constantine Fotitch, The War We Lost, New York: The Viking Press, 1948, 97.
75. Jukic, 72.
76. Toynbee, 356-357.
77. Mueller-Hillegrand, 65.

78. Paul N. Hehn, The German Struggle Against Yugoslav Guerillas in World War II, Boulder: East European Quarterly, 1979, 21.
79. Army Field Manual 100-5, Operations (Final Draft), Washington: Headquarters, Department of the Army, 19 January 1993, 7-2.
80. Naval History Division, "Fuehrer Directives and Other Top-Level Directives of the German Armed Forces, 1939-1941," Vol. 1, Washington, D.C.: Office of the CNO, 1948, 125-127.
81. Ibid, 164-171.
82. Army Field Manual 100-5, 7-9.
83. James M. Dubik, "A Guide to the Study of Operational Art and Campaign Design," (Paper, School of Advanced Military Studies, 1991), 14.
84. Army Field Manual 100-5, 7-11.
85. Hehn, 4.
86. Grieffenberg, 6.
87. Hehn, 6.
88. Ibid, 7.
89. United States Military Academy, Early Campaigns of World War II, West Point: Department of Military Art and Engineering, 1951, 127.
90. Van Crevald, 158.
91. Ethnic Cleansing is the act of subjugating (imposing another group's customs, language, or social views upon the ethnic minority) or exterminating (genocide) an ethnic minority in a geographical location. The ethnic minority group normally falls back on its ethnic uniqueness as a defensive measure when it feels threatened by a majority group, thereby expanding any conflict.
92. Hehn, 10.
93. Tomasevich, 86.
94. Grieffenberg, Rpt MS B-525, 30.
95. Naval History Division, 164.

BIBLIOGRAPHY

I. BOOKS

Addington, Larry H., The Blitzkrieg Era and the German General Staff, 1865-1941, New Brunswick: Rutgers University Press, 1971.

Fotitch, Constantine, The War We Lost, New York: The Viking Press, 1948.

Hehn, Paul N., The German Struggle Against Yugoslav Guerrillas in World War II, Boulder: East European Quarterly, 1979.

Hoptner, J.B., Yugoslavia in Crisis 1934-1941, New York: Columbia University Press, 1962.

Jukic, Ilija, The Fall of Yugoslavia, New York: Harcourt Brace Jovanovich, 1974.

Lasic-Vasojevic, Milija M., Enemies on All Sides: The Fall of Yugoslavia, Washington, D.C.: North American International, 1976.

Littlefield, Frank C., Germany and Yugoslavia, 1933-1941, Boulder: East European Monographs, 1988.

Military-Historical Institute of the Yugoslav People's Army, prepared by, Historical Atlas of the Liberation War of the Peoples of Yugoslavia 1941-1945, Beograd: Jugoslavija, 1957.

Ostovic, P.D., The Truth About Yugoslavia, New York: Roy Publishers, 1952.

Playfair, I. S. O., The Mediterranean and Middle East, The Germans Come to the Help of Their Ally (1941), Vol. II, London: Her Majesty's Stationery Office, 1956.

Ristic, Dragisa N., Yugoslavia's Revolution of 1941, Univeristy Park: The Pennsylvania State University Press, 1966.

Shores, Christopher, and Brian Cull, Air War for Yugoslavia, Greece, and Crete, London: Grub Street, 1987.

Stavrianos, L. S., The Balkans Since 1453, New York: Rinehart Company, 1958.

Tarnstrom, Ronald L., Handbooks of the Armed Forces: The Balkans, Part II, Lindsborg: Trogen Books, 1983.

Time-Life Books, ed., Conquest of the Balkans,
Alexandria: Time-Life Books, 1990.

Tomasevich, Jozo, The Chetniks, Stanford: Stanford
University Press, 1975.

Toynbee, Arnold, and Veronica M. Toynbee, eds., Survey
of International Affairs 1939-1946: The Initial
Triumph of the Axis, New York: Oxford University
Press, 1958.

United States Military Academy, A Military History of
World War II--Atlas, West Point: Department of
Military Art and Engineering, 1953.

United States Military Academy, Early Campaigns of
World War II, West Point: Department of Military Art
and Engineering, 1951.

Van Creveld, Martin L., Hitler's Strategy 1940-1941 The
Balkan Clue, London: Cambridge University Press, 1973.

Vuchinich, Wayne S., ed., Contemporary Yugoslavia,
Berkeley: University of California Press, 1969.

II. PAPERS

Dubik, James M., "A Guide to the Study of Operational
Art and Campaign Design," Paper, School of Advanced
Military Studies, 1991.

Greiffenberg, Hans von, "Supplement to the Study "The
Balkan Campaign" (The Invasion of Yugoslavia)," U.S.
Army Europe Historical Division, Military Studies
Branch, Report Number MS B-525, 9 June 1947.

Mueller-Hillebrand, Hermann Burkhart, "The German
Campaign in the Balkans, 1941: A Model of Crisis
Planning," Washington, D.C.: U.S. Army Chief of
Military History, Report Number MS P-030, August 1950.

Naval History Division, "Fuehrer Directives and Other
Top-Level Directives of the German Armed Forces,
1939-1941," Vol. 1, Washington, D.C.: Office of the
CNO, 1948.

Vietinghoff, V., "Balkan Campaign 1941," Washington,
D.C.: U.S. Army Chief of Military History, Report
Number MS B-334, 31 January 1947.

III. MILITARY PUBLICATIONS

Army Field Manual 100-5, Operations (Final Draft),
Washington: Headquarters, Department of the Army, 19
January 1993.

Center of Military History Publication 104-4, The German Campaigns in the Balkans (Spring 1941), Washington, D.C.: U.S. Army Center of Military History, 1986.