

UNCLASSIFIED

9
110

AD-A267 255



LIVE FIRE TEST AND EVALUATION OF M113A3
ARMORED PERSONNEL CARRIER SPALL LINERS (U)



DTIC
ELECTE
JUL 29 1993
S E D

~~RESTRICTED STATE~~
Approved for public release
Distribution Unlimited

OUSD(A) Log No. S-2/LFT01
1 May 1993

93 7 23 044

UNCLASSIFIED

93-16700

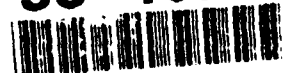

56 P

UNCLASSIFIED

LIVE FIRE TEST AND EVALUATION OF M113A3 ARMORED
PERSONNEL CARRIER SPALL LINERS

DTIC QUALITY INSPECTED 8

Accession For	
NTIS CRA&I	<input checked="" type="checkbox"/>
DTIC TAB	<input type="checkbox"/>
Unannounced	<input type="checkbox"/>
Justification	
By	
Distribution /	
Availability Codes	
Dist	Avail and/or Special
A-1	

Statement A per telecon Col. Paul Severance
OSD/ODT&E/L&MP The Pentagon
Washington, DC 20301-3000

NWW 7/28/93

UNCLASSIFIED

UNCLASSIFIED

LIVE FIRE TEST AND EVALUATION OF M113A3 ARMORED
PERSONNEL CARRIER SPALL LINERS

TABLE OF CONTENTS

Glossary v

Preface vii

SUMMARY 1

 A. LFT&E Issues 1

 B. Test Design and Execution 2

 C. Significant Findings and Evaluation 4

DISCUSSION 7

 A. Background 7

 B. LFT&E Issues 8

 C. Test Design and Execution 11

 1. Weapon Selection 11

 2. Calibration Shots 11

 3. Vehicle Shots 14

 4. Off-Line Ballistic Shots 20

 D. Significant Findings and Evaluation 20

 1. Levels of Spall Protection 20

 2. Levels of Respirable Liner Particles 31

 3. Levels of Liner Fragments and Particles Hazardous to the Eye 31

 4. Evaluation 32

References R-1

Appendix A - Ballistic Damage Photographs for VIPER Shaped Charge and 30mm
APDS Shots

LIST OF FIGURES

1. Spall Protection Effectiveness 9

2. Vehicle and Instrumentation Layout 13

3. Forward Panel Sections, Right Side 15

4. Foil Panel and BAD Pack, Vehicle Shot 17

5. Cyclone Filter 18

6. Open-Faced Filters 19

UNCLASSIFIED

7.	Overhead View, Off-Line TOW Shaped Charge Shots.....	21
8.	Damage, Front of S-2 Glass Liner, TOW Shaped Charge Versus S-2.....	23
9.	Damage, Rear of S-2 Glass Liner, TOW Shaped Charge Versus S-2.....	24
10.	Damage, Front of BAD Pack, TOW Shaped Charge Versus S-2.....	25
11.	Damage, Rear of BAD Pack, TOW Shaped Charge Versus S-2.....	26
12.	Damage, Front of Kevlar Liner, TOW Shaped Charge Versus Kevlar.....	27
13.	Damage, Rear of Kevlar Liner, TOW Shaped Charge Versus Kevlar.....	28
14.	Damage, Front of BAD Pack, TOW Shaped Charge Versus Kevlar.....	29
15.	Damage, Rear of BAD Pack, TOW Shaped Charge Versus Kevlar.....	30

LIST OF TABLES

1.	M113A3 Spall Liner LFT&E: Issues Addressed.....	3
2.	M113A3 Spall Liner LFT&E: Test Design Matrix.....	3
3.	Summary of Findings on M113A3 Spall Protection.....	4
4.	Summary of M113A3 Spall Liner Evaluation.....	5
5.	M113A3 Spall Liner LFT&E: Summary of Issues and Tests.....	12
6.	Materials Along Shotlines in Vehicle Shots.....	16
7.	Summary of Findings on Spall Protection.....	22
8.	Summary of Evaluation.....	32

UNCLASSIFIED

GLOSSARY

ACGIH	American Conference of Governmental Industrial Hygienists
APDS	Armor Piercing Discarding Sabot
BAD	Behind-Armor Debris
BRL	Ballistic Research Laboratory
CSTA	Combat Systems Test Activity
DTP	Detailed Test Plan
IEP/TDP	Independent Evaluation Plan/Test Design Plan
LFT&E	Live Fire Test and Evaluation
ODDT&E/LFT	Office of the Deputy Director Test and Evaluation/Live Fire Test
OTSG	Office of the Surgeon General
TACOM	Tank Automotive Command
TOW	Tube-Launched Optically-Tracked Wire-Guided Antitank Missile
VIPER	Small Developmental Hand-Held Antitank Weapon
VLAMO	Vulnerability/Lethality Assessment Management Office

UNCLASSIFIED

UNCLASSIFIED

PREFACE

This report is submitted in compliance with Sections 2362 and 2366 of Title X of the US Code. Questions and comments should be provided to the Office of the Deputy Director Test and Evaluation/Live Fire Test (ODDT&E/LFT), Office of the Secretary of Defense, AV 227-5733. Technical support for this analysis was provided by the Institute for Defense Analyses under Contract MDA903 89-C-0003, Task Order T-N9-493, for the ODDT&E/LFT.

UNCLASSIFIED

SUMMARY

The M113A3 Armored Personnel Carrier (APC) Program Manager would like to have the option of fabricating the spall liners from either Kevlar (currently used) or S-2 Glass, to allow competitive procurement. Since spall liners can have a significant impact on armored vehicle crew casualties and system vulnerability the Army agreed with the Office of the Deputy Director, Test and Evaluation/Live Fire Test (ODDT&E/LFT) on the need to assess the equivalency of Kevlar and S-2 Glass spall liners in the M113A3 through side-by-side Live Fire Test and Evaluation (LFT&E).

The objective of the LFT&E of the M113A3 spall liner was to compare the effectiveness of the S-2 Glass liner as a vulnerability reduction measure with that of the existing Kevlar liner in the M113A3 configuration. The comparison was based on side-by-side Live Fire Tests.

Since spall liner effectiveness is dependent on its material, its physical placement in the vehicle, and the threats, the liners were tested as they would be installed on the M113A3 and the following findings are limited to the configuration tested.

When attacked by shaped charge or penetrator munitions, the Kevlar and the S-2 Glass spall liners for the M113A3 APC provided comparable ballistic protection from spall. Neither produced additional hazards from respirable fibers or ballistic liner fragments.

A. LFT&E ISSUES

The primary purpose of the spall liners is not to reduce damage from the main penetrator, but to reduce casualties and vehicle damage from spall fragments, while not introducing additional hazards to the crew. The spall liners in the M113A3 are detached spall liners since they are installed 16 inches behind the 1.75 inch exterior armor, rather than being attached thereto. In the absence of specific Army requirements, the following LFT&E issues were identified for assessing the comparative performance of S-2 Glass and Kevlar spall liners in the M113A3.

UNCLASSIFIED

Issue 1: Levels of Spall Protection

What are the levels of spall protection provided by Kevlar and S-2 Glass detached spall liners when the M113A3 is defeated by TOW shaped charge warheads and 30mm Armor Piercing Discarding Sabots (APDS) threat surrogate rounds?

Issue 2: Levels of Respirable Liner Particles

What are the levels of respirable spall liner particles that may be inhaled by the crew when the M113A3 is defeated by a TOW shaped charge warhead and a 30mm APDS threat surrogate round?

Issue 3: Levels of Liner Fragments and Particles Hazardous to the Eye

What are the levels of liner "fragments" that may be hazardous to the crew and the levels of particulates in the crew sponson areas, given that each of the two spall liners is perforated by a TOW shaped charge warhead and a 30mm APDS threat surrogate round?

In order to address these issues, the Army conducted a series of Live Fire Tests from December 1991 through February 1992. The ODDT&E/LFT reviewed and commented on the Independent Evaluation Plan/Test Design Plan (IEP/TDP) and the Detailed Test Plan (DTP), and its representatives witnessed all Live Fire Tests. This report addresses the adequacy of the M113A3 spall liner LFT&E and provides an independent evaluation of the results.

B. TEST DESIGN AND EXECUTION

Calibration shots indicated that the TOW shaped charge (5-1/4 inch diameter) was an overmatch to the test instrumentation and panel attachment structure. In accordance with the approved test plan, the Army substituted the VIPER shaped charge (2-1/2 inch diameter) for the TOW shaped charge for all vehicle shots, which addressed the levels of respirable and hazardous liner particles.

The test series consisted of vehicle shots and off-line ballistic shots to address the LFT&E issues (see Tables 1 and 2). The vehicle shots for each liner material consisted of two firings of the VIPER shaped charge and two firings of the 30mm APDS at an existing M113 Ballistic Hull, modified to represent M113A3 ballistic protection and spall liners on

UNCLASSIFIED

Table 1. M113A3 Spall Liner LFT&E: Issues Addressed

LFT&E ISSUE	THREAT WEAPON		
	TOW	VIPER	30mm APDS
1. Ballistic Protection	X	X	X
2. Respirable Particles		X	X
3. Eye Injury		X	X

Table 2. M113A3 Spall Liner LFT&E: Test Design Matrix

Test Type	Threat	Spall Liner Material	
		KEVLAR	S-2 Glass
Off-line Ballistic Shots	TOW	2	2
Vehicle Shots	VIPER	2	2
	30mm APDS	2	2

the right side. These shots included a Behind-Armor Debris (BAD) pack to record ballistic spall protection data, aluminum foil and gelatin blocks to capture hazardous ballistic fibers, and filters to collect respirable and non-respirable particles.

Four off-line ballistic shots were added to address the levels of spall protection against the TOW shaped charge. The off-line shots for each liner material consisted of two firings of the TOW shaped charge at a fixture to which the aluminum armor and the spall liner were attached 16 inches apart.

C. SIGNIFICANT FINDINGS AND EVALUATION

For the material composition and physical placement of the M113A3 spall liners, the differences between S-2 Glass and Kevlar spall liners were assessed to be insignificant with regard to the LFT&E issues. This conclusion cannot be generalized to other cases without further tests.

UNCLASSIFIED

Table 3 summarizes the test findings with regard to the levels of spall protection. With respect to crew casualties, the number of fragments and fragment cone angles behind S-2 Glass liners are comparable to those behind Kevlar liners for the VIPER and the 30mm APDS shots. For the off-line TOW shots, although S-2 Glass had 20 percent more fragments than Kevlar, its cone angle was 30 percent smaller. Both S-2 Glass and Kevlar liners were equally effective in stopping spall for TOW/VIPER and 30mm APDS munitions.

Table 3. Summary of Findings on M113A3 Spall Protection

THREAT	PROTECTION PARAMETER	FINDINGS	
		S-2	KEVLAR
TOW shaped charge	Average number of fragments behind liner	164	136
	Average fragment cone angle behind liner	35°	48°
VIPER shaped charge	Average number of fragments behind liner	20	22
	Average fragment cone angle behind liner	25°	25°
30mm APDS	Average number of fragments behind liner	2	1
	Average fragment cone angle behind liner	8°	10°

Analysis of filter samples (respirable and non-respirable particles) from shots into S-2 Glass and Kevlar indicated large quantities of aluminum particles, some copper particles, and negligible quantities of liner material. Since the number of non-metallic liner particles is insignificant when compared to the large number of respirable and non-respirable metallic particles, the relative effect of liner materials as a respirable hazard becomes insignificant. X-ray dot mapping of S-2 Glass particles indicated no particles in the respirable range.¹ Scanning Electron Microscope (SEM) examination of Kevlar particles indicated none in the respirable range. Although X-ray dot mapping provides

¹ The American Conference of Governmental Industrial Hygienists (ACGIH) considers particles less than 5 microns in diameter to be respirable. The cyclone filters used in the vehicle shots can capture particles with diameter greater than 0.3 microns.

UNCLASSIFIED

more accurate data, it could not be used for Kevlar since Kevlar contains carbon, which makes X-ray dot mapping ineffective.

Gelatin blocks and the 0.002-inch aluminum foil indicated no S-2 Glass or Kevlar fragments that could pose a ballistic hazard to the eye. The gelatin blocks and the aluminum foil simulated the upper and the lower bound penetration resistance of the eye respectively.

There appears to be little potential for skin or eye irritations from S-2 Glass or Kevlar particles after a vehicle is hit by either a shaped charge or a 30mm APDS round. Test personnel and observers did not experience any skin or eye irritations inside the vehicle after each shot.

Table 4 summarizes the differences between Kevlar and S-2 Glass spall liners in the M113A3 with regard to the LFT&E vulnerability issues.

Table 4. Summary of M113A3 Spall Liner Evaluation

LFT&E Concern	Difference Between S-2 and Kevlar
Spall protection	Insignificant
Level of respirable liner particles	None
Level of liner particles hazardous to the eye	None

This test compared two spall liners with different physical characteristics but identical configurations within the vehicle (16 inch stand-off between the armor and the spall liner). Since spall liner effectiveness depends on the physical characteristics of the liner, its configuration in the vehicle, and the threat munitions impacting the vehicle, the findings from this test should not be extrapolated to other vehicle applications.

UNCLASSIFIED

DISCUSSION

A. BACKGROUND

The technical data package for spall liner kits for the M113A3 Armored Personnel Carrier conversion program specifies that detached spall liners (installed 16 inches behind the armor) will be fabricated from Kevlar. To allow competitive procurement while maintaining interchangeability, the M113 Program Manager would like future contractors to have the option of fabricating these kits from either Kevlar or S-2 Glass.

The Kevlar spall liners tested had 34 ply laminates with an average liner thickness of 19.51mm and average areal density of 22.70 kg/m². The S-2 Glass spall liners tested had 25 ply laminates with an average liner thickness of 12.57mm and average areal density of 25 kg/m².

Since S-2 Glass particles and fibers were considered to have a potential of posing a major hazard to the unprotected crew, ODDT&E/LFT raised concerns (Ref. 1) on the impact of S-2 Glass on crew protection. These concerns pointed to the need for conducting Live Fire Tests on S-2 Glass spall liners to verify that the replacement of Kevlar with S-2 Glass does not increase the vulnerability of the M113A3 or its occupants.

In response to ODDT&E/LFT concerns, several meetings were held between the representatives of Combat Systems Test Activity (CSTA), Vulnerability/Lethality Assessment Management Office (VLAMO), Tank-Automotive Command (TACOM), Ballistic Research Laboratory (BRL), and the manufacturers of Kevlar and S-2 Glass. VLAMO was given the lead role. VLAMO requested guidance from the Office of the Surgeon General (OTSG) (Ref. 2) on health hazards, test parameters, and instrumentation. Reference 3 provides a preliminary assessment of the health hazard issue.

Previous tests conducted to compare Kevlar and S-2 Glass spall liners (Ref. 4) did not indicate major differences in ballistic spall protection between Kevlar and S-2 Glass. However, these and other tests (Refs. 5, 6) did not address the differences between Kevlar and S-2 Glass with regard to hazard from respirable liner particles and from liner fragments impacting the eye. Also, these tests were not conducted under identical conditions and the sample size was small.

UNCLASSIFIED

The ODDT&E/LFT and the Army agreed on the need to assess the differences between Kevlar and S-2 Glass spall liners in the M113A3 through Live Fire Testing. The Army identified the LFT&E issues, developed the Independent Evaluation Plan/Test Design Plan (IEP/TDP) (Ref. 7), and the Detailed Test Plan (DTP) (Ref. 8). ODDT&E/LFT reviewed the IEP/TDP and DTP and provided comments.

The Live Fire Tests were conducted from December 1991 through February 1992. The ODDT&E/LFT representatives witnessed these tests.

B. LFT&E ISSUES

The LFT&E issues for the M113A3 S-2 Glass spall liner were focused on comparative performance of Kevlar and S-2 Glass spall liners with respect to:

- Levels of spall protection
- Levels of respirable liner particles
- Levels of liner fragments and particles hazardous to the eye.

The following LFT&E issues and subissues were identified by the Army to assess the comparative performance of S-2 Glass and Kevlar spall liners.

Issue 1: Levels of Spall Protection

What are the levels of spall protection provided by Kevlar and S-2 Glass detached spall liners when the M113A3 is defeated by TOW shaped charge warheads and 30mm APDS threat surrogate rounds?

1.1 What are the spall cone angles and the number of fragments (and their locations) for each of the liners when the M113A3 base armor is defeated by a TOW shaped charge warhead?

1.2 What are the spall cone angles and the number of fragments (and their locations) for each of the liners when the M113A3 base armor is defeated by a 30mm APDS threat surrogate round?

Although the spall liners are not intended to reduce damage from the main penetrator, they should protect the crew from the spall (see Figure 1), reducing the spall dispersion in the crew compartment. The level of spall protection is measured by the spall cone angle and the number of spall fragments within the cone angle.

UNCLASSIFIED

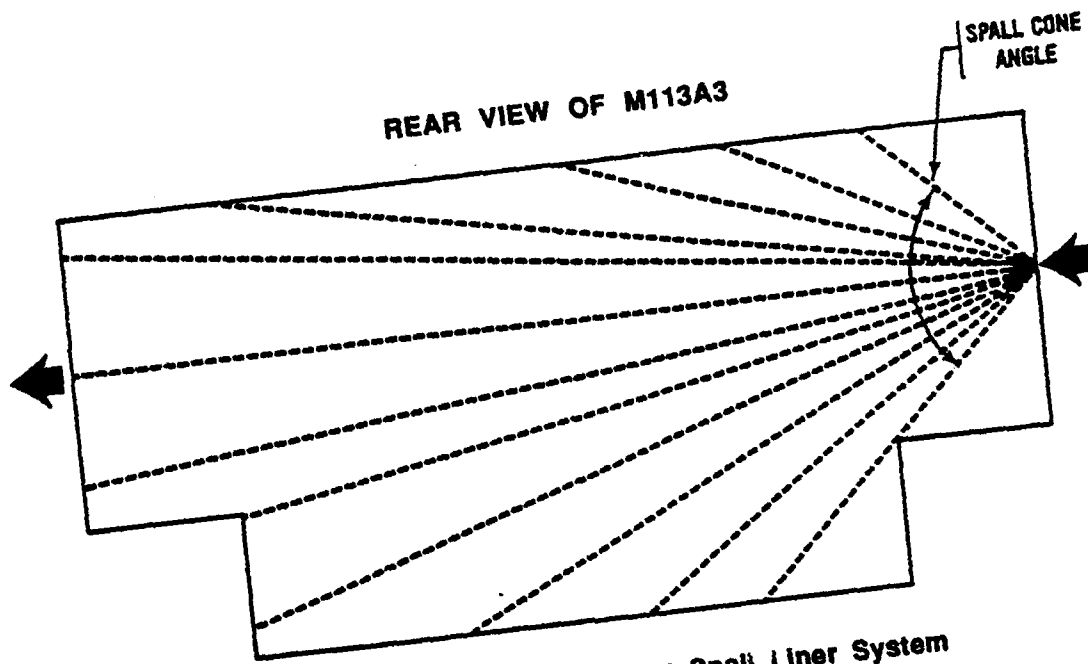

a. Spall Dispersion Without Spall Liner System

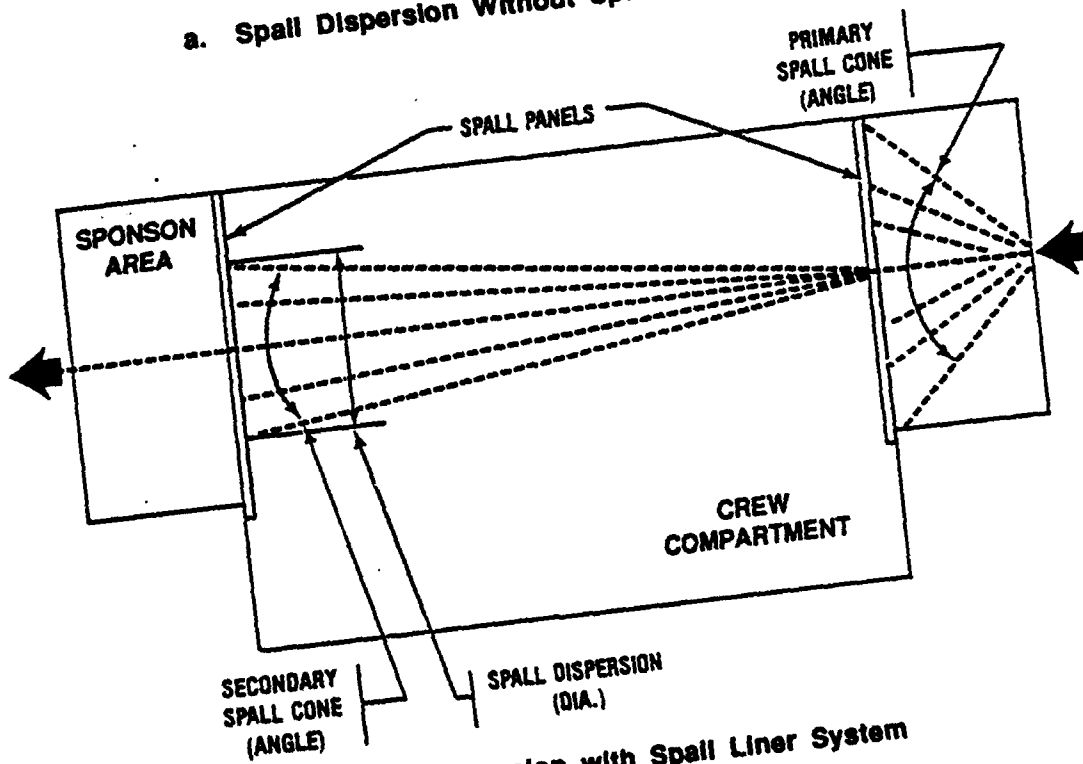

b. Spall Dispersion with Spall Liner System

Figure 1. Spall Protection Effectiveness

UNCLASSIFIED

Issue 2: Levels of Respirable Liner Particles

When a spall liner is penetrated by the main penetrator and spall, there is a potential for the liner material to break up into respirable particulates. If significant quantities of respirable liner particles are identified, their potential for causing a health hazard to the crew should be evaluated. Hence, the following issues were identified:

What are the levels of respirable spall liner particulates that may be inhaled by the crew when the M113A3 is defeated by a TOW shaped charge warhead and a 30mm APDS threat surrogate round?

2.1 What levels of respirable particulates are generated in M113A3 crew/squad compartment given that the base armor and spall liner are perforated by a TOW shaped charge warhead?

2.2 What levels of respirable particulates are generated in M113A3 crew/squad compartment given that the base armor and spall liner are perforated by a 30mm APDS threat surrogate round?

Issue 3: Levels of Liner Fragments and Particles

When a spall liner is penetrated by the main penetrator and spall, there is a potential for the liner material to break up into respirable and non-respirable particles and ballistic fibers, which may still pose a hazard to the crew. The ballistic fibers might cause eye injuries, and the particles might cause skin irritation. Hence, the following issues were identified:

What are the levels of liner "fragments" that may be hazardous to the crew and the levels of particulates in the crew sponson areas, given that each of the two spall liners is perforated by a TOW shaped charge warhead and a 30mm APDS threat surrogate round?

3.1 What levels of liner "fragments" with potential to cause eye damage are generated in the crew area given that the M113A3 base armor and spall liner are perforated by a TOW shaped charge warhead on a 30mm APDS threat surrogate round?

3.2 What levels of particulates are generated in the crew and sponson areas given that the base armor and the spall liner are perforated by a TOW shaped charge and a 30mm threat surrogate round?

UNCLASSIFIED

C. TEST DESIGN AND EXECUTION

The test series consisted of calibration shots, vehicle shots, and off-line ballistic shots. Table 5 shows the issues addressed by these tests.

1. Weapon Selection

A detailed threat assessment was not conducted in support of this test. Weapons were selected, however, to represent the two main kill mechanisms expected from weapons that could engage the M113A3 – shaped charges and penetrators. Weapons that could not perforate the armor or that would produce little or no spall were excluded since the spall liner was the focus of the test. Weapons that were so overmatching that they would be expected to destroy the spall liner and cause a catastrophic loss of the vehicle were also excluded. The 30mm was selected as the penetrator weapon because it is a primary threat to light armored vehicles and because large tank-fired penetrators would destroy the vehicle. The TOW warhead was initially selected as being representative of antiarmor shaped charge weapons that would overmatch the armor but still provide reasonable expectation of some crew survival. Since there was some possibility that such a large warhead could overwhelm the filters used to collect particle data, calibration shots were scheduled prior to the test. The smaller VIPER shaped charge was selected as a backup warhead to be used if the TOW proved to be impractical. The VIPER is representative of hand held antiarmor weapons employed worldwide against light armored vehicles.

2. Calibration Shots

The calibration shots were used to check out the instrumentation and were fired against an M113 ballistic hull outfitted with a surrogate 1/2-inch thick aluminum spall liner. Figure 2 shows the overall test configuration. Two TOW shaped charge and one VIPER shaped charge were fired. Based on the results, it was found that the TOW shaped charge was an overmatch to the instrumentation and panel attachment structure. Hence, in accordance with the approved test plan, the Army substituted the VIPER shaped charge for the TOW shaped charge for all vehicle shots, to address the levels of respirable and liner particles potentially hazardous to the eye (Issues 2 and 3). Four off-line ballistic shots were added to address the levels of spall protection against the TOW shaped charge (Issue 1).

UNCLASSIFIED

Table 5. M113A3 Spall Liner LFT&E: Summary of Issues and Tests¹

LFT&E ISSUE	LINER	THREAT	STANDOFF/ VELOCITY	NUMBER OF SHOTS
LEVELS OF SPALL PROTECTION Spall cone angle, number and location of fragments <u>Note:</u> Since TOW was over-matching for the vehicle, it was shot in off-line tests. Other tests were vehicle shots.	Kevlar S-2	TOW Shaped Charge TOW Shaped Charge	Built-in Built-in	2 2
	Kevlar S-2	VIPER Shaped Charge VIPER Shaped Charge	2-cone dia 2-cone dia	2* 2*
	Kevlar S-2	30mm APDS 30mm APDS	3400+50 fps 3400+50 fps	2* 2*
LEVELS OF RESPIRABLE LINER PARTICLES Mass/number of respirable spall liner particulates in crew/squad compartment	Kevlar S-2	VIPER shaped charge VIPER shaped charge	2-cone dia 2-cone dia	2* 2*
	Kevlar S-2	30mm APDS 30mm APDS	3400+50 fps 3400+50 fps	2* 2*
LEVELS OF LINER FRAGMENTS AND PARTICLES 1. Number of liner fragments in the crew area with potential to cause eye damage 2. Mass/number of particulates in the crew/sponson areas	Kevlar S-2	VIPER shaped charge VIPER shaped charge	2-cone dia 2-cone dia	2* 2*
	Kevlar S-2	30mm APDS 30mm APDS	3400+50 fps 3400+50fps	2* 2*

¹ All VIPER and 30mm APDS shots were vehicle shots fired on the right side of the vehicle with zero degree obliquity. Calibration shots are not included in the table.

* There were two VIPER shots and two 30mm APDS shots per liner.

UNCLASSIFIED

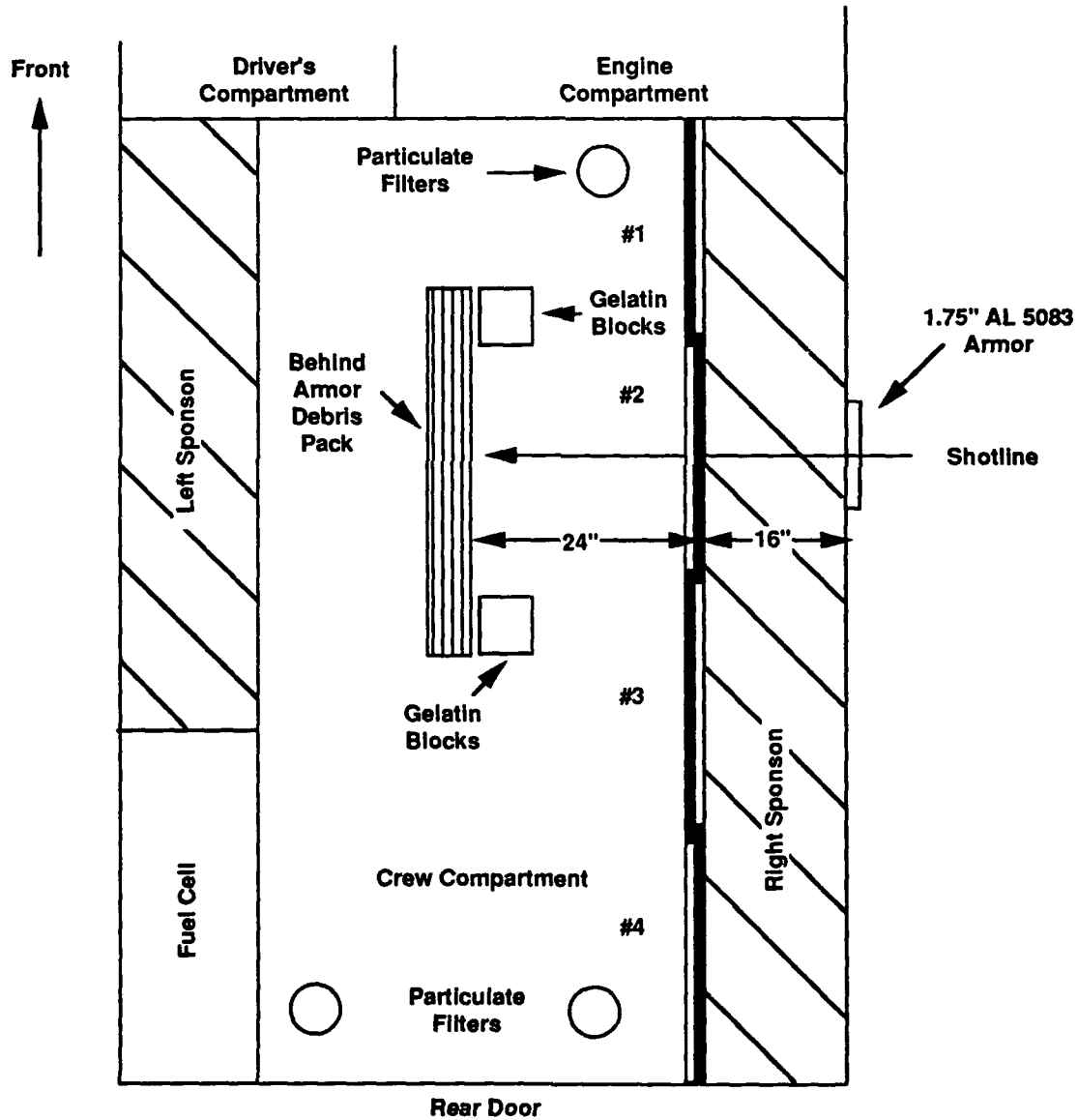
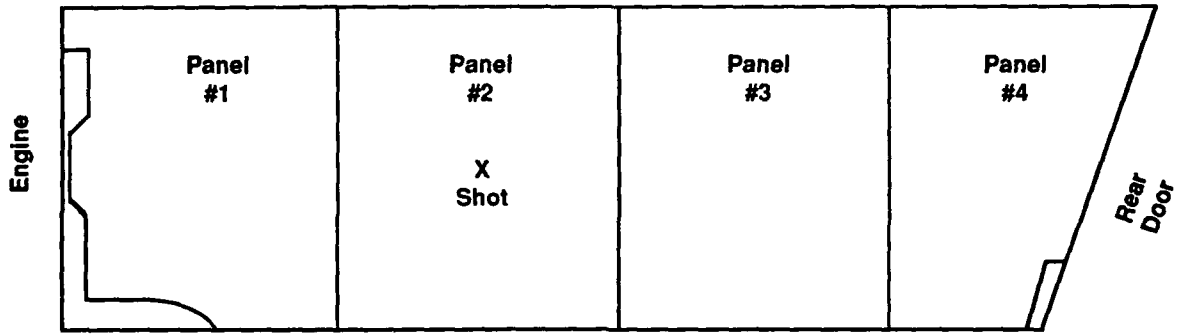

Figure 2. Vehicle and Instrumentation Layout

UNCLASSIFIED

3. Vehicle Shots

The vehicle shots consisted of two VIPER shaped charge shots and two 30mm APDS threat surrogate rounds for each type of liner – Kevlar and S-2 Glass. An existing M113 was modified to represent the M113A3 in terms of ballistic protection of the right side of the crew compartment, where the spall liners were installed. Test shots were fired from the right side of the vehicle at zero degree obliquity, impacting at the center of number 2 spall liner panel. Figure 2 shows the overall test configuration. As shown in Figures 2 and 3, spall liners in M113A3 consist of four rigid panels, which slide on rails at top and bottom, similar to shower doors, separating the crew and sponson areas. The sponson area is normally used to store squad equipment such as duffel bags and ammunition. Spall liners are installed on both sides of M113A3. The materials along the shotline from the vehicle's external armor to the Behind-Armor Debris (BAD) pack are as shown in Table 6.

The instrumentation and data collection package consisted of the BAD pack shown in Figure 4, high-speed video, six cyclone filters (Figure 5), and six open-faced filters (Figure 6). Figure 2 shows the location of the filters and the BAD pack for vehicle shots. The BAD pack was designed to collect data on spall protection and on liner fragments and particles that may be hazardous to the eye.

The 0.002-inch aluminum foil on the face of the BAD was used to simulate penetration resistance of the eye, and 20 percent gelatin blocks were used to simulate eye muscle tissue. Reference 9 indicates that 0.002-inch aluminum has been used by the Army to simulate the eye in qualifying certain protective spectacle systems. Reference 10 indicates that 20 percent gelatin simulates the average human tissue response in terms of projectile penetration depth and retardation. The aluminum foil and the gelatin block respectively simulated the lower and upper bounds of eye resistance.

A potential limitation noticed during the test was that the gelatin blocks were spaced too far apart to capture any liner fragments. However, the aluminum foil can indicate whether any liner fragment penetrates in this region.

The open-faced filters were used to collect particles of all sizes, without separating them. The cyclone filters were able to separate respirable and non-respirable particles. The video camera was used to record the events following the threat penetration.

UNCLASSIFIED



Figure 3. Forward Panel Sections, Right Side

UNCLASSIFIED

Table 6. Materials Along Shotlines in Vehicle Shots

Layer No.	Material	Thickness (Inch)
1	5083 aluminum armor	1.75
2	Air (space)	16
3	Kevlar/S-2 Glass Liner	0.75/0.5
4	Air (space)	24
5 (Behind Armor Debris Pack)	20% Gelatin* (4 blocks 15 x6x6)	6
	Aluminum foil	0.002
	Styrofoam	1
	Steel	0.031
	Styrofoam	1
	Steel	0.031
	Styrofoam	1
	Steel	0.125

*The gelatin block were taped to the aluminum foil at the four corners of the BAD pack as shown in Figure 4.

UNCLASSIFIED

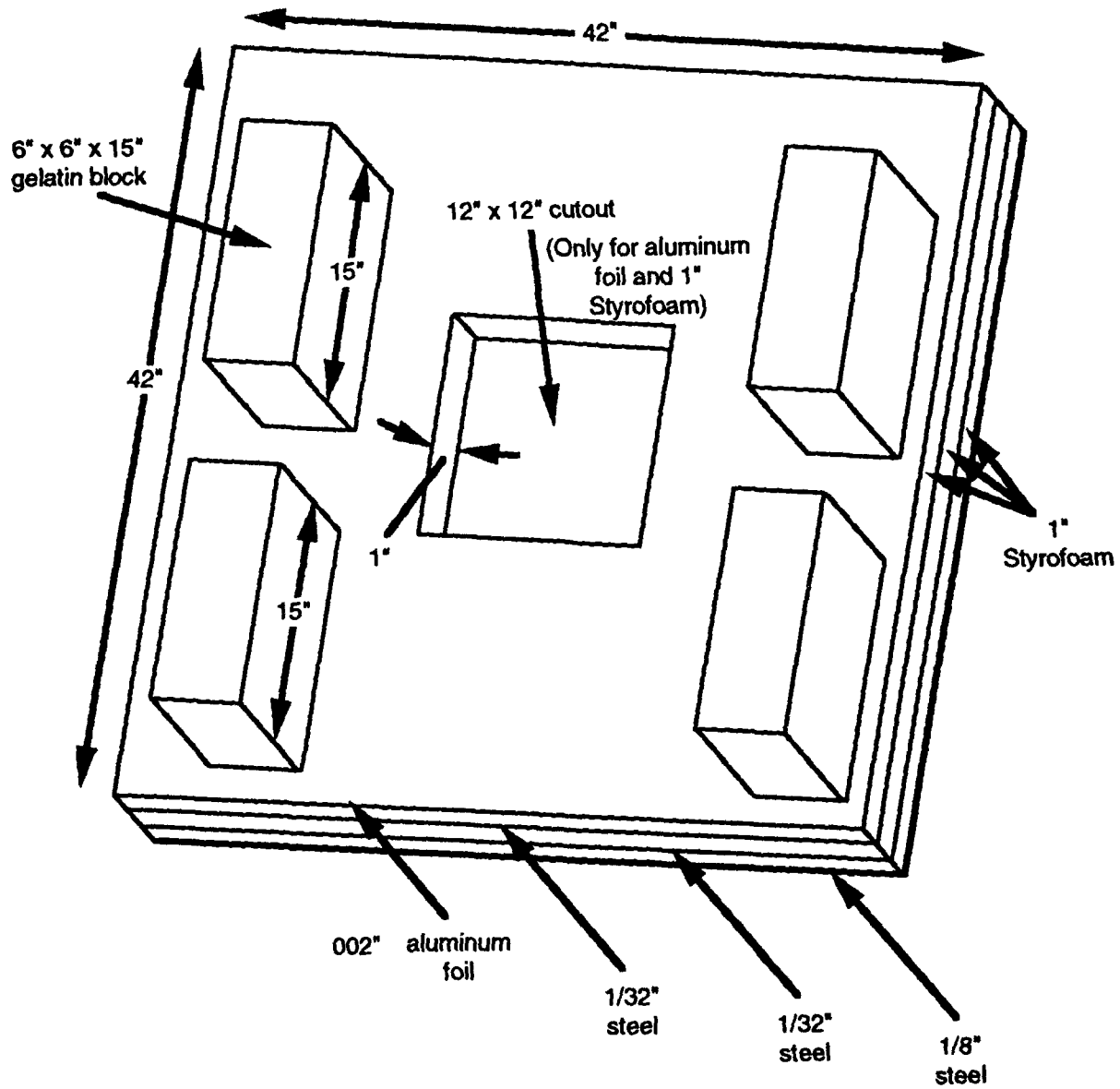

Figure 4. Foil Panel and BAD Pack, Vehicle Shot

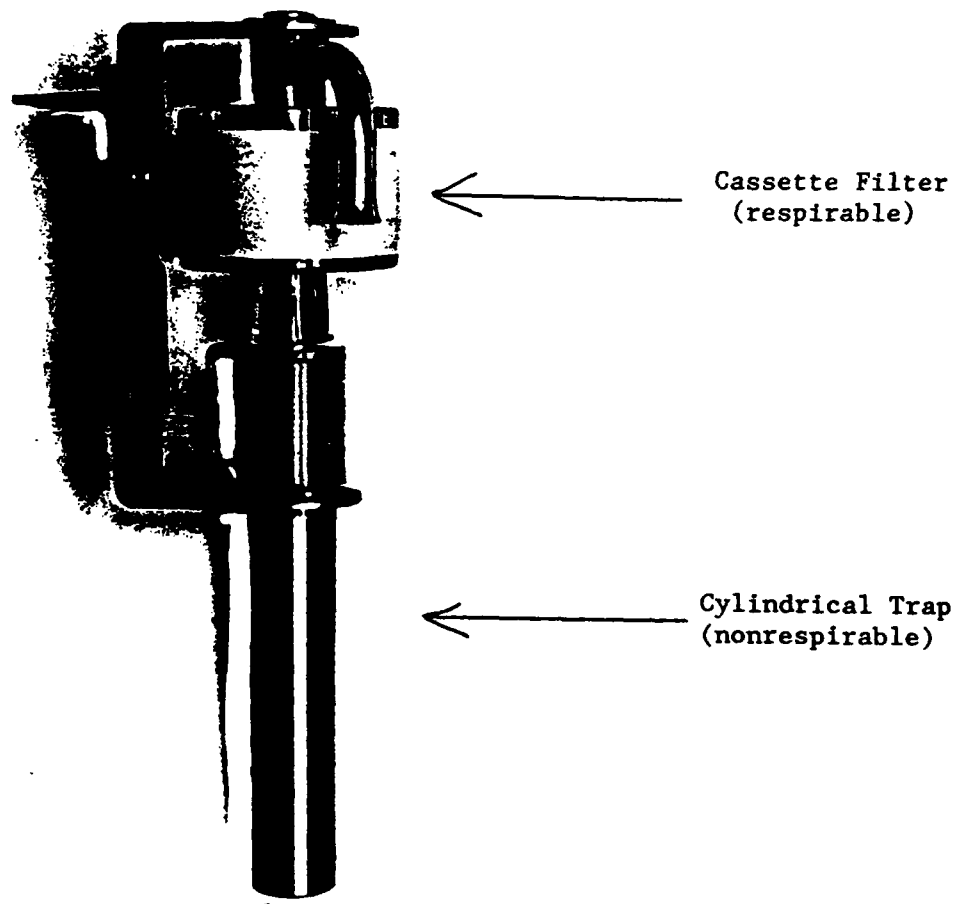

Figure 5. Cyclone Filter

UNCLASSIFIED

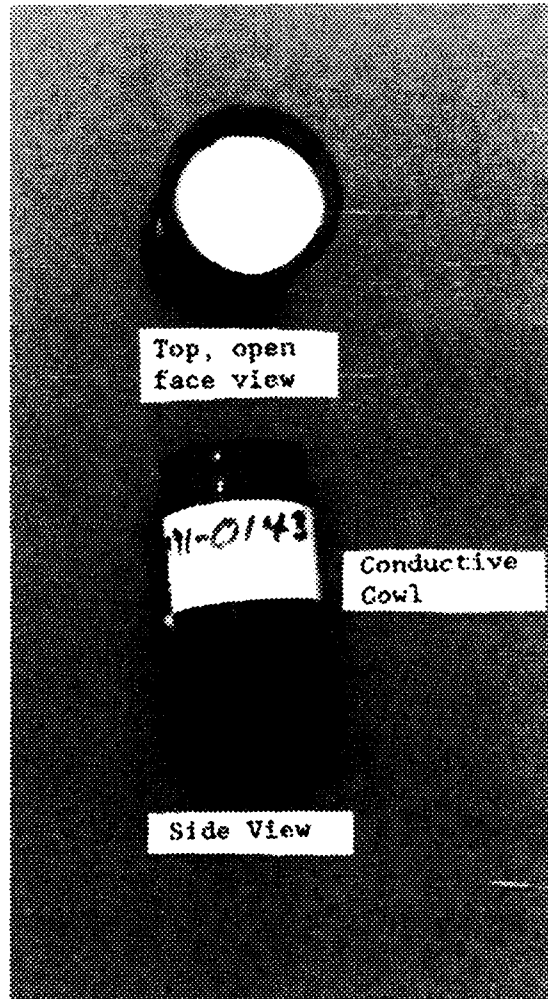

Figure 6. Open-Faced Filters

UNCLASSIFIED

4. Off-Line Ballistic Shots

The off-line shots were fired against an 1.75-inch aluminum 5083 armor attached to a massive fixture. Figure 7 shows the off-line test configuration. The armor was followed by a 16-inch air gap, Kevlar/S-2 Glass spall liner (29.5 inches x 24 inches), 24-inch air gap, and finally a BAD pack. The BAD pack consisted of five mild steel plates 1/32-, 1/32-, 1/8-, 1/8- and 1/8-inch, each separated by 1-inch Styrofoam. There were two TOW shaped charge shots for Kevlar liner panels and two for S-2 Glass liner panels.

Levels of spall protection were recorded using a BAD pack placed 24 inches behind the spall liner panel. The TOW warhead was placed with its nose against the armor plate. No other instrumentation was used in the off-line shots.

D. SIGNIFICANT FINDINGS AND EVALUATION

The findings reported here were based on the data provided in Reference 11.

1. Levels of Spall Protection

The basis for comparing different liner materials for the level of spall protection is the relative number of fragments that penetrate the liner and the respective cone angles behind the liner. These data were obtained from the first 1/32-inch steel plate in the BAD pack for each of the shots. Table 7 summarizes the findings. The data show the following:

- Average number of fragments behind the S-2 Glass and Kevlar liners and the respective cone angles are almost identical for the VIPER shots.
- Both S-2 Glass and Kevlar liners are equally effective in reducing the number of fragments and the cone angle behind the liner for the 30mm APDS shots.
- For the TOW shots the results are mixed. Although the S-2 Glass liner has 20 percent more fragments, its cone angle is 30 percent less than that of Kevlar liner.

Damage photographs (Figures 8 through 15) indicate that the damage is considerably reduced behind both the S-2 Glass and the Kevlar liners. Thus, S-2 Glass and Kevlar spall liners are equally effective in stopping the spall. Figures 8 through 11 show the damage from TOW shaped charge shots with S-2 Glass liner. Figures 8 and 9, respectively, show the damages on front and back of the S-2 Glass panel. Figures 10

UNCLASSIFIED

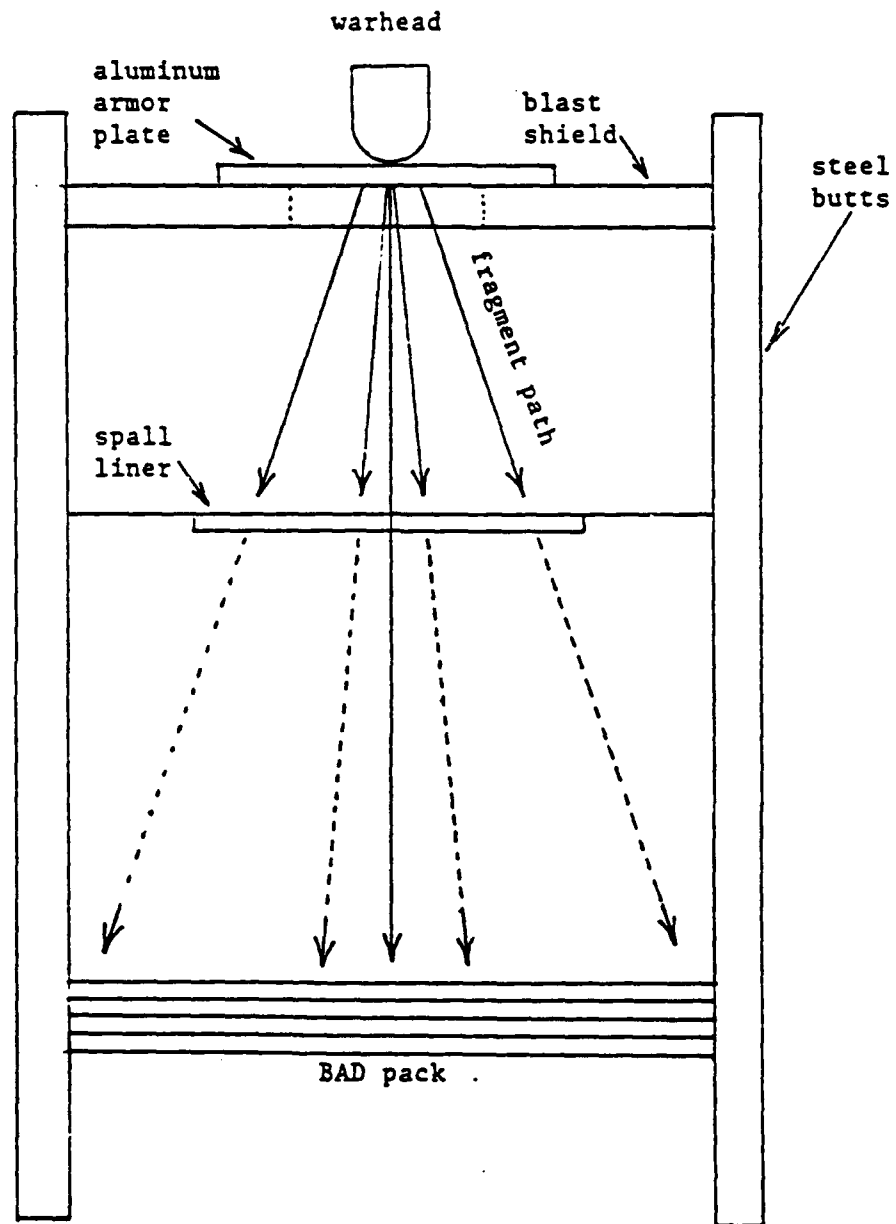

Figure 7. Overhead View, Off-Line TOW Shaped Charge Shots

21
UNCLASSIFIED

UNCLASSIFIED

Table 7. Summary of Findings on Spall Protection

Threat	Protection Parameter	Shot	Findings	
			S-2	Kevlar
TOW shaped charge	Number of fragments behind liner (both liner and jet particles)	1	159	137
		2	169	134
		Average	164	136
	Fragment cone angle behind liner (secondary spall cone angle)	1	36°	46°
		2	34°	50°
		Average	35°	48°
VIPER shaped charge	Number of fragments behind liner (both liner and jet particles)	1	19	22
		2	20	21
		Average	20	22
	Fragment cone angle behind liner (secondary spall cone angle)	1	29°	22°
		2	21°	28°
		Average	25°	25°
30mm APDS	Number of fragments behind liner (both liner and projectile particles)	1	0	0
		2	4	2
		Average	2	1
	Fragment cone angle behind liner (secondary spall cone angle)	1	-	-
		2	16°	20°

UNCLASSIFIED

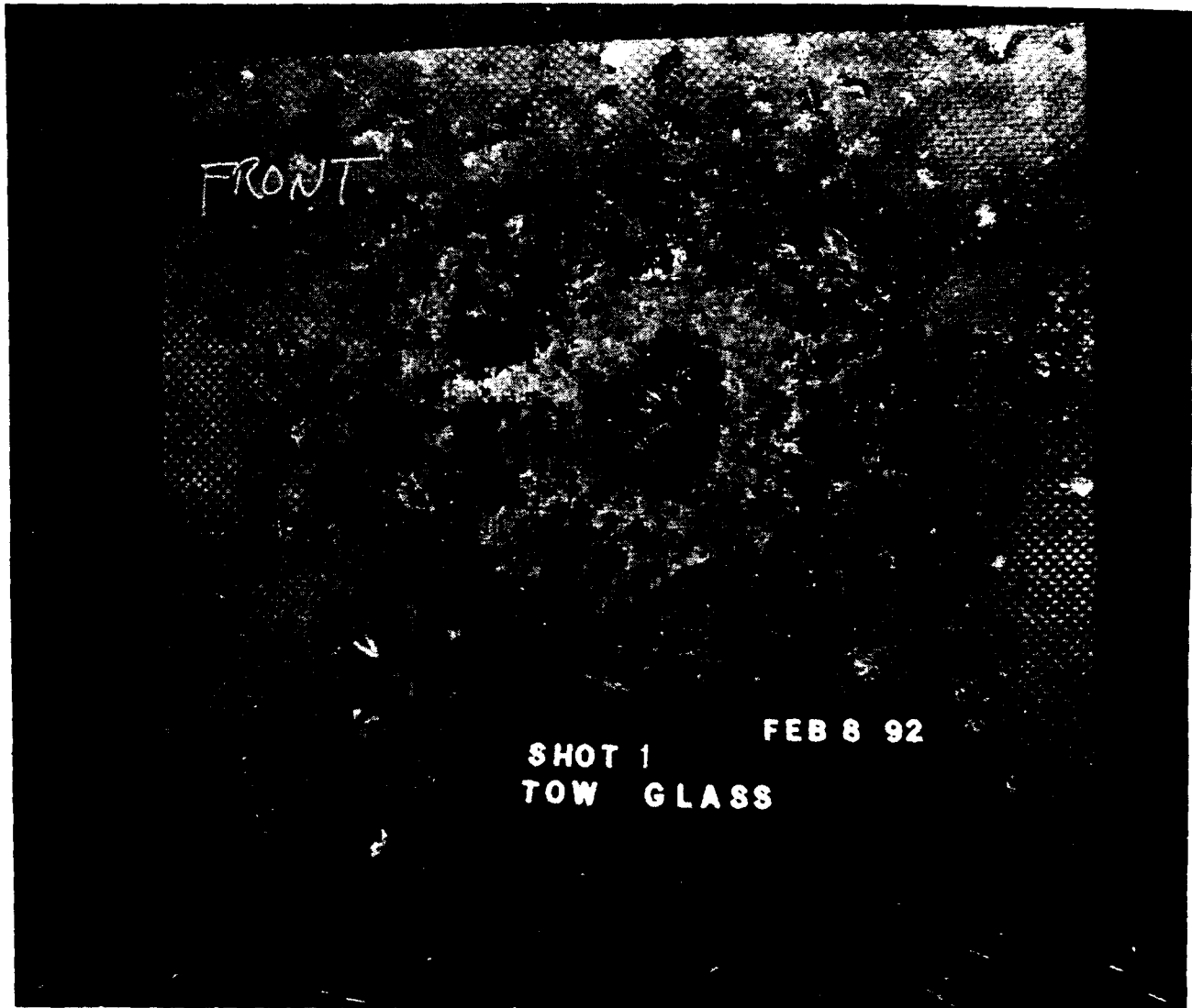

Figure 8. Damage, Front of S-2 Glass Liner, TOW Shaped Charge Versus S-2

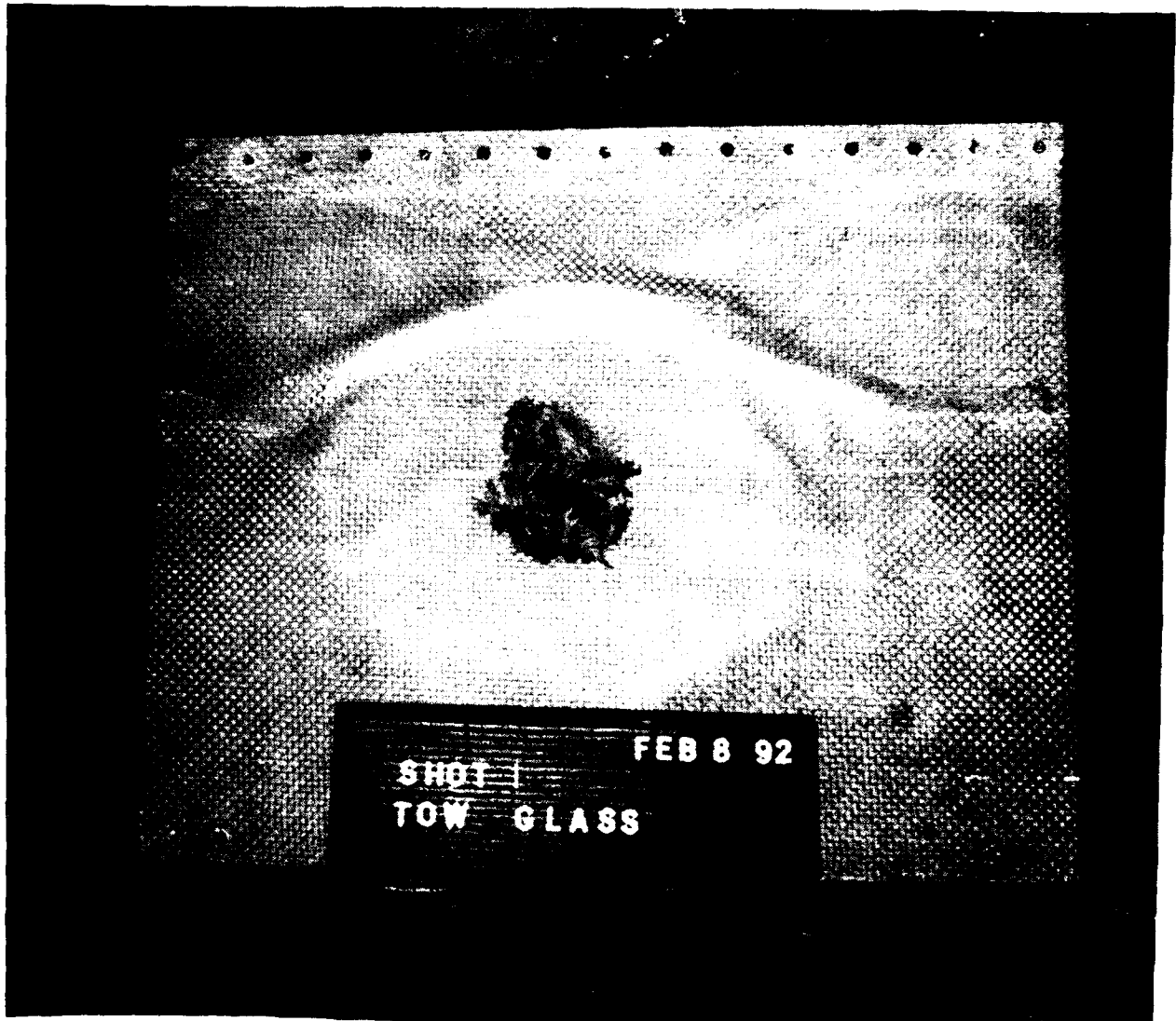

Figure 9. Damage, Rear of S-2 Glass Liner, TOW Shaped Charge Versus S-2

UNCLASSIFIED



Figure 10. Damage, Front of BAD Pack, TOW Shaped Charge Versus S-2

UNCLASSIFIED



Figure 11. Damage, Rear of BAD Pack, TOW Shaped Charge Versus S-2

UNCLASSIFIED

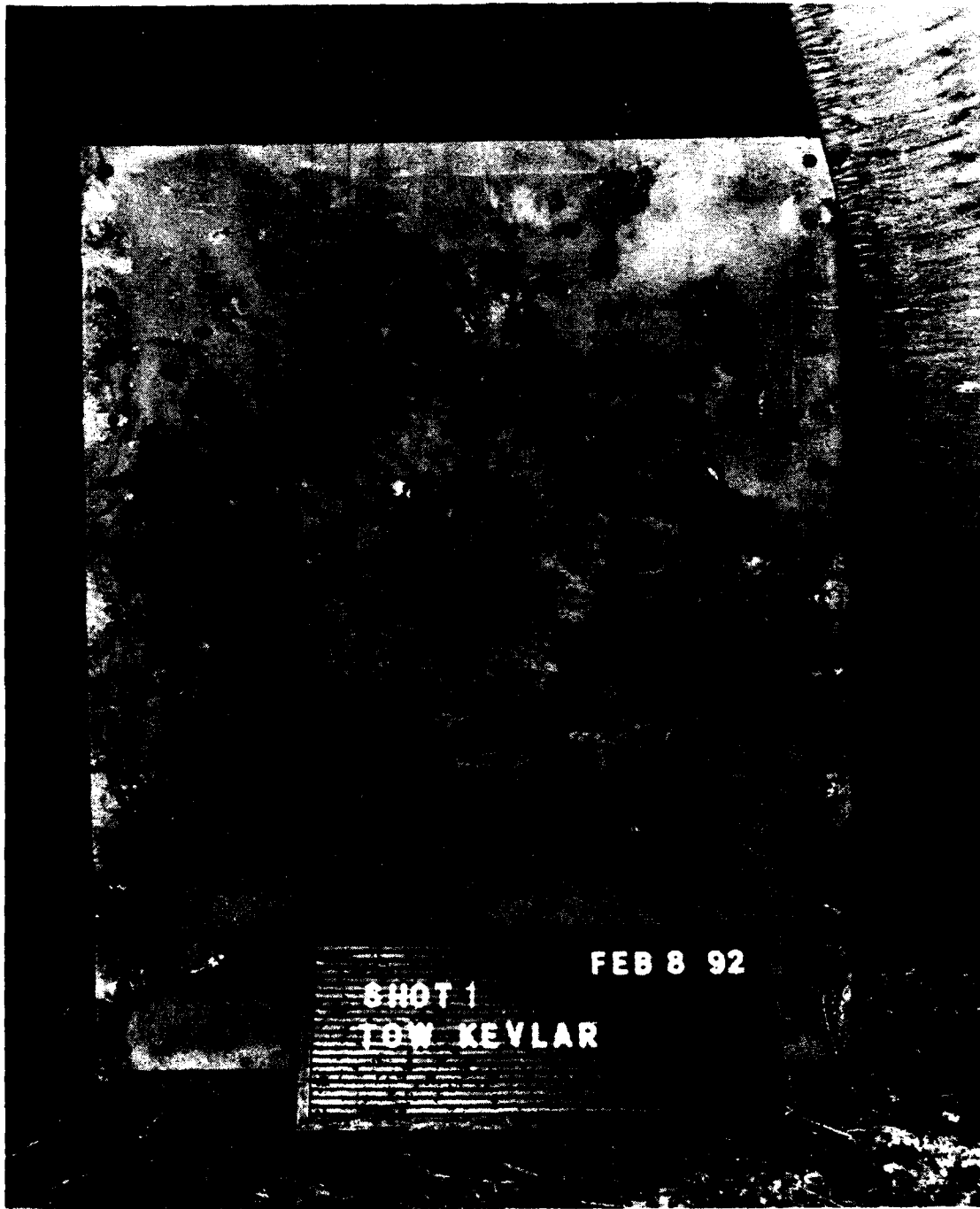

Figure 12. Damage, Front of Kevlar Liner, TOW Shaped Charge Versus Kevlar

UNCLASSIFIED

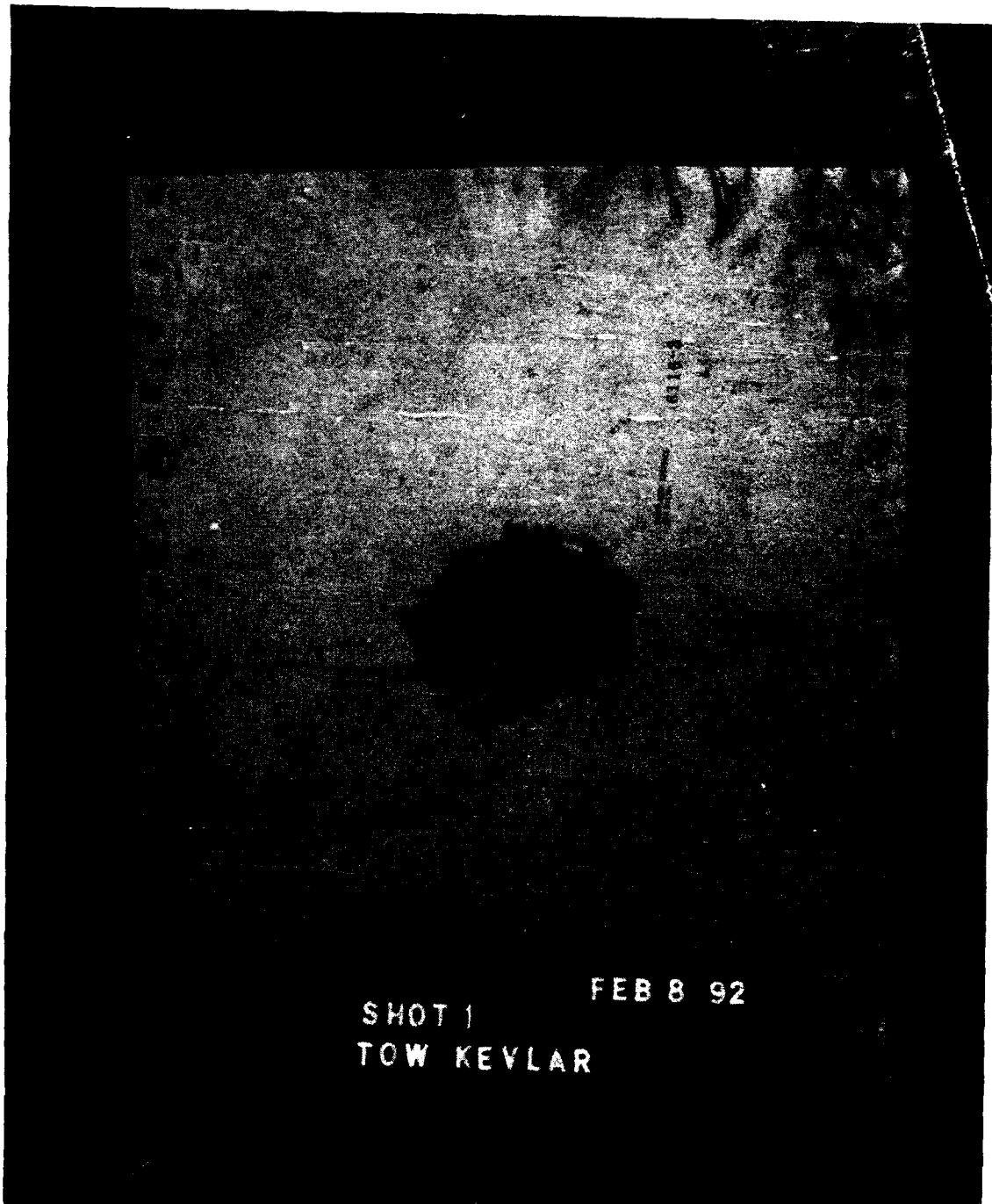

Figure 13. Damage, Rear of Kevlar Liner, TOW Shaped Charge Versus Kevlar

UNCLASSIFIED

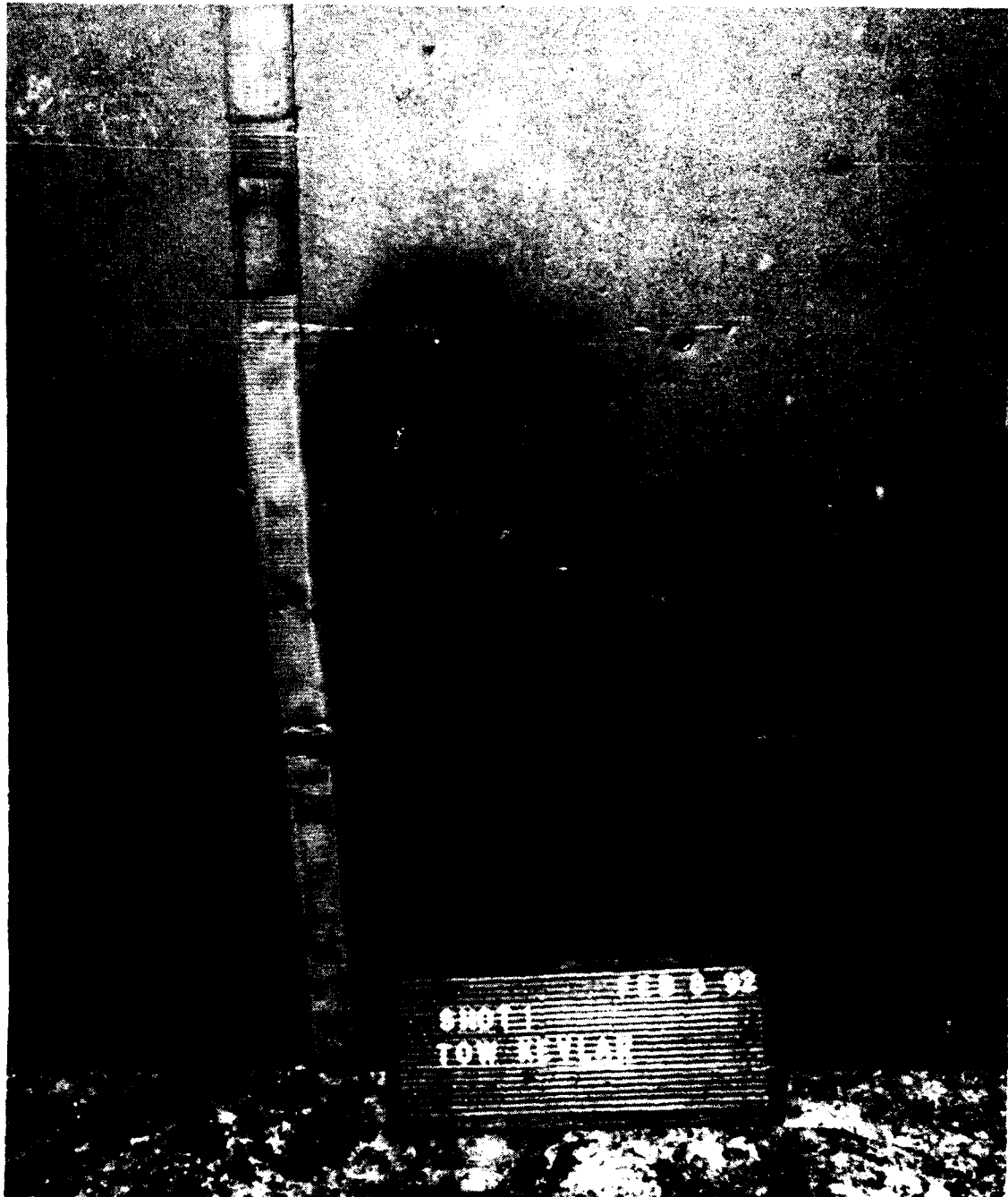

Figure 14. Damage, Front of BAD Pack, TOW Shaped Charge Versus Kevlar

UNCLASSIFIED

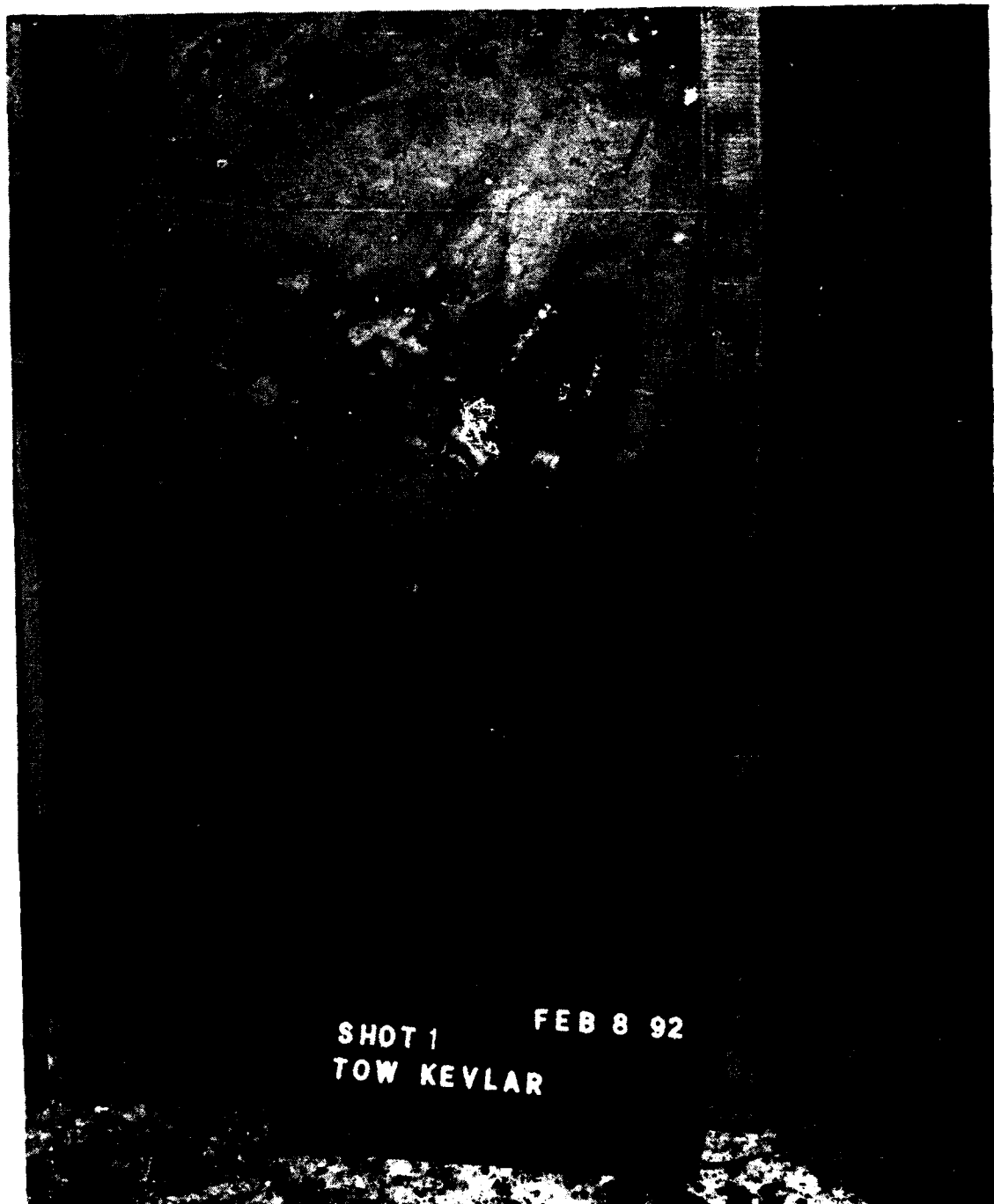

Figure 15. Damage, Rear of BAD Pack, TOW Shaped Charge Versus Kevlar

UNCLASSIFIED

and 11, respectively, show the damages on front and back plates of the BAD pack. Similarly, Figures 11 through 14 show the damage from the TOW shaped charge shots with the Kevlar liner. Appendix A presents similar results for the VIPER shaped charge shots and the 30mm APDS shots. These figures show that the ballistic damage and damage from fragments and spall are comparable for the S-2 Glass and the Kevlar liners.

2. Levels of Respirable Liner Particles

Data on respirable liner particles were obtained from three locations inside the crew area for the purpose of comparing the Kevlar and S-2 Glass spall liners. Each of these locations had two open-faced and two cyclone filters. These filters could have captured particles with diameter greater than 0.3 microns.

Analysis of filter samples from the Kevlar and the S-2 Glass shots indicated large quantities of aluminum particles and some copper particles, but only negligible quantities of liner material. This suggests that the amount of particles from the Kevlar or S-2 Glass liners was negligible compared to other particles in the air inside the crew compartment. X-ray dot mapping of S-2 particles indicated none in the respirable range. The American Conference of Governmental Industrial Hygienists (ACGIH) considers particles less than 5 microns in diameter to be respirable. SEM examination of Kevlar particles indicated none in the respirable range. Although X-ray dot mapping provides more accurate data, it could not be used for Kevlar, since Kevlar contains carbon which make X-ray dot mapping ineffective.

3. Levels of Liner Fragments and Particles Hazardous to the Eye

Examination of the gelatin blocks indicated no S-2 or Kevlar fibers. Examination of the 0.002-inch aluminum foil indicated no S-2 or Kevlar fibers outside the penetrator area. The absence of S-2 Glass or Kevlar fibers in the aluminum foil indicates that the gelatin blocks would not have caught any fibers even if they had been located closer to the center of the BAD pack, since the aluminum foil is easier to penetrate than the gelatin block. Thus, a potential test limitation identified earlier, wide spacing of gelatin blocks, did not have any impact on the findings. Holes within the cone angle observed for the VIPER shaped charge shots were attributed to the jet and armor spall particles. Thus, there was no indication of potential eye hazard from liner fibers.

UNCLASSIFIED

Test personnel and observers did not experience any eye or skin irritations inside the vehicle after each shot, which provides further evidence that there is no potential for eye or skin irritations from S-2 Glass or Kevlar particles.

4. Evaluation

In the absence of specific requirements, the LFT&E assessment of S-2 Glass and Kevlar spall liners is based on the findings on differences in the following areas:

- Level of spall protection
- Levels of respirable liner particles
- Levels of liner particles hazardous to the eye

Table 8 summarizes the differences between the Kevlar and S-2 Glass spall liners with regard to the LFT&E vulnerability issues. For the material composition and physical placement of the M113A3 spall liners, the differences between S-2 Glass and Kevlar are assessed to be insignificant with regard to the LFT&E issues. This conclusion cannot be generalized to other cases without further tests.

Table 8. Summary of Evaluation

LFT&E Concern	Difference Between S-2 and Kevlar
Level of spall protection	Insignificant
Level of respirable liner particles	None
Level of liner particles hazardous to the eye	None

UNCLASSIFIED

REFERENCES

1. DDDR&E(T&E)/LFT, letter dated 1 March 1989, Subject: Testing Issues Relative to Spall Liner Modifications, UNCLASSIFIED.
2. VLAMO, AMSLC-VL-CB, letter dated 11 July 1989, Subject: Health Hazards From Composite Armors, UNCLASSIFIED.
3. U. S. Army, "Health Hazard Assessment for Composite Armors," 7 May 1990, UNCLASSIFIED.
4. TACOM, "Ballistic Test of Owens Corning Fiberglass Liner," 21 August 1987, UNCLASSIFIED.
5. USACSTA, "Special Study (SS) of Spall Liners for Combat Vehicles," 3 October 1988, UNCLASSIFIED.
6. AMMRC, "Ballistic Testing of Kevlar Spall Suppression System for M113 APC," June 1988, CONFIDENTIAL.
7. Independent Evaluation Plan/Test Design Plan, October 1991, UNCLASSIFIED.
8. USACSTA Detailed Test Plan Live Fire Test of M113A3 Spall Liners, January 1992, UNCLASSIFIED.
9. American Optical Corporation, "Technical Data Package for Protective Spectacles System," Prepared for U.S. Army Medical Research Acquisition Activity, 22 April 1987, UNCLASSIFIED.
10. Neades, David N., "The Modeling and Application of Small Arms Wound Ballistics," BRL Memorandum Report MR-3929, August 1991, UNCLASSIFIED.
11. Fillinger, L., "Independent Evaluation for the Live Fire Test of Kevlar Versus S-2 Glass Spall Liners for the M113A3," June 1992, UNCLASSIFIED.

UNCLASSIFIED

APPENDIX A

**BALLISTIC DAMAGE PHOTOGRAPHS FOR VIPER
SHAPED CHARGE AND 30mm APDS SHOTS**

UNCLASSIFIED

UNCLASSIFIED

APPENDIX A

**BALLISTIC DAMAGE PHOTOGRAPHS FOR VIPER SHAPED
CHARGE AND 30mm APDS SHOTS**

This Appendix presents ballistic damage photographs for VIPER shaped charge and 30mm APDS shots. Figures A-1 through A-4 present VIPER shaped charge damage for the case of S-2 Glass. Figures A-5 through A-8 present VIPER shaped charge damage for the case of Kevlar. Figures A-9 through A-12 and A-13 through A-16 similarly present 30mm APDS damages for S-2 Glass and Kevlar, respectively.

UNCLASSIFIED

UNCLASSIFIED

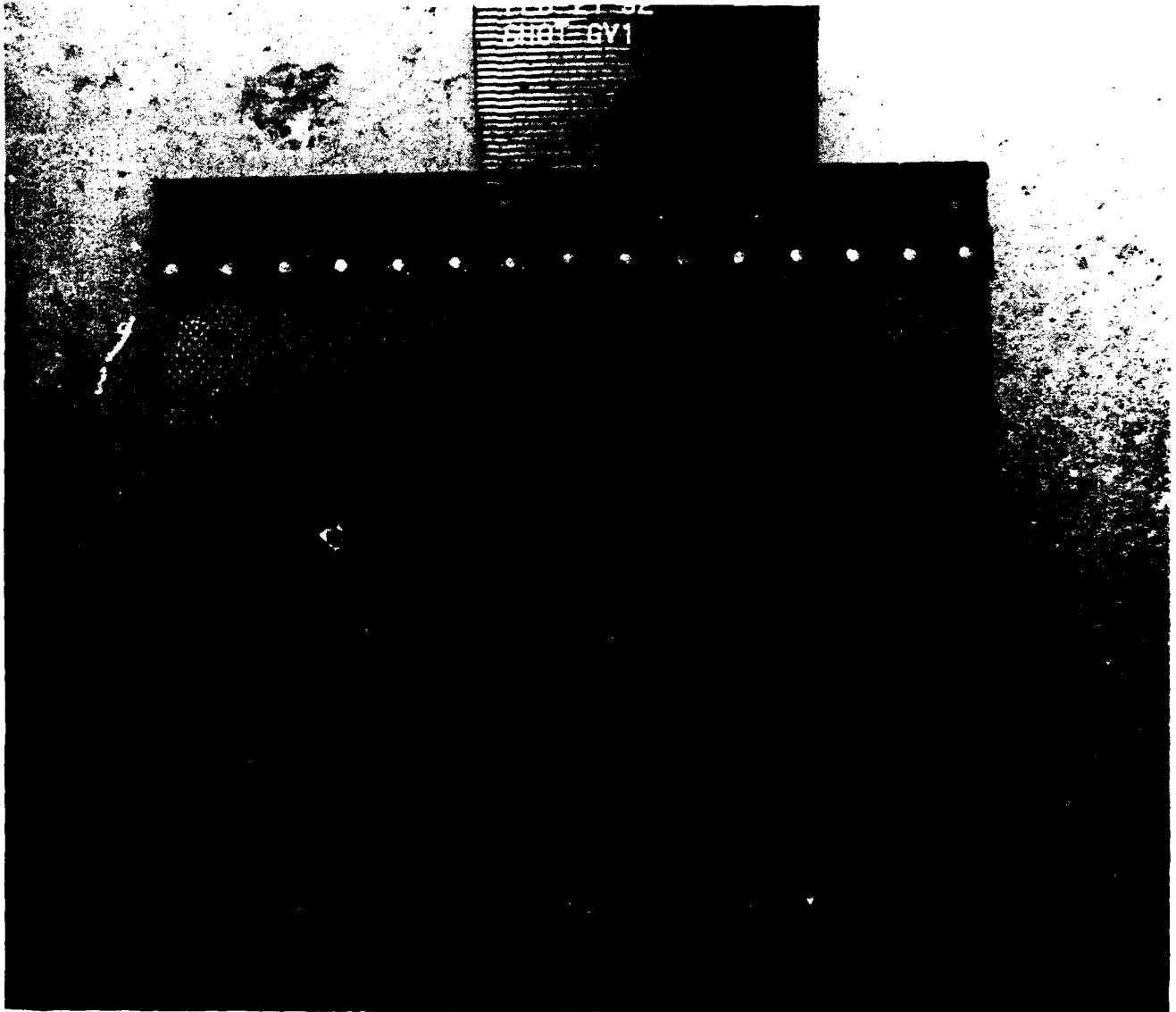

Figure A-1. Damage, Front of S-2 Glass Liner, VIPER Shaped Charge Versus S-2

A-2

UNCLASSIFIED

UNCLASSIFIED

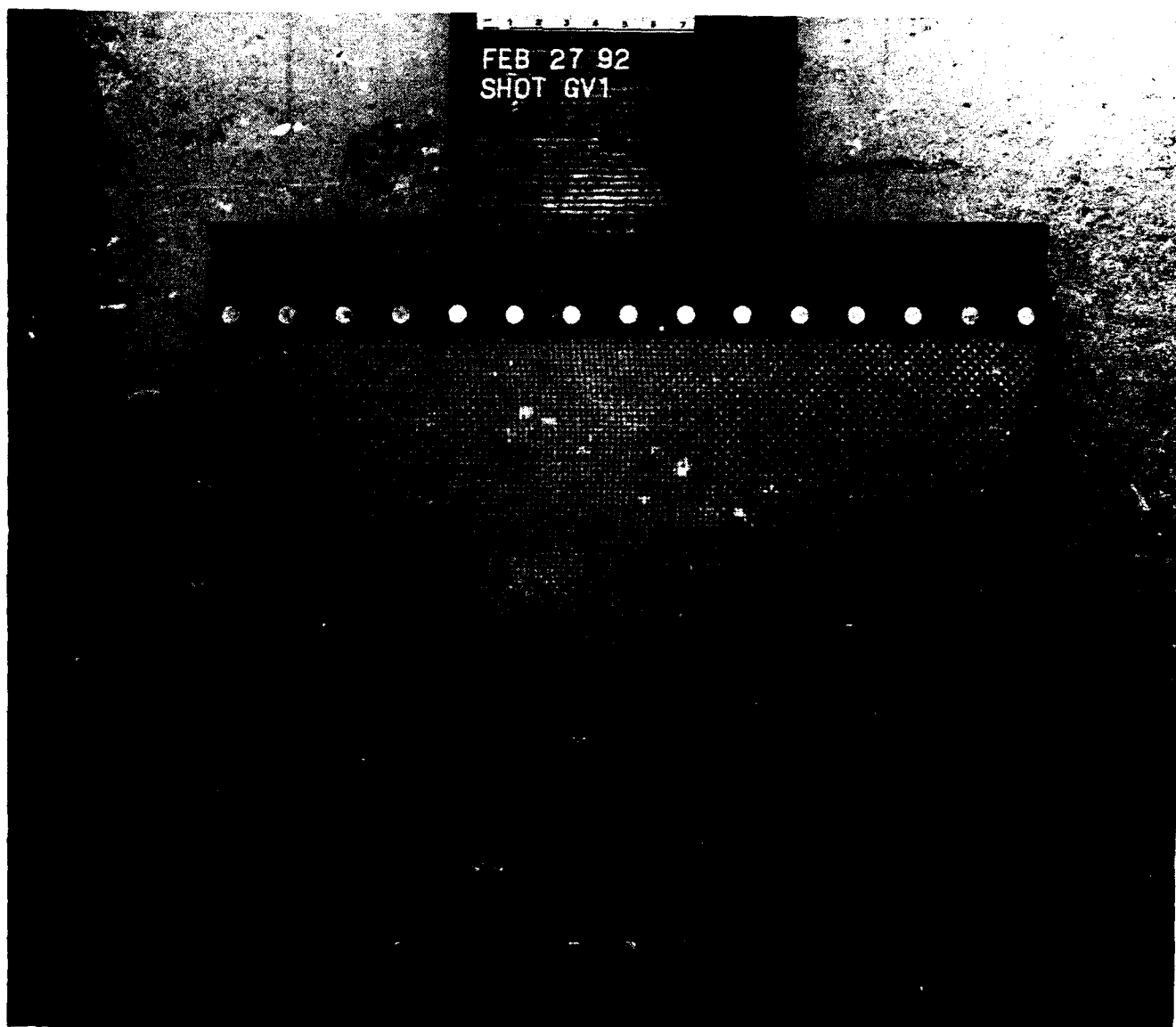

Figure A-2. Damage, Rear of S-2 Glass Panel, VIPER Shaped Charge Versus
S-2

A-3

UNCLASSIFIED

UNCLASSIFIED



Figure A-3. Damage, Front of BAD Pack, VIPER Shaped Charge Versus S-2

A-4

UNCLASSIFIED

UNCLASSIFIED



Figure A-4. Damage, Rear of BAD Pack, VIPER Shaped Charge Versus S-2

A-5

UNCLASSIFIED

UNCLASSIFIED

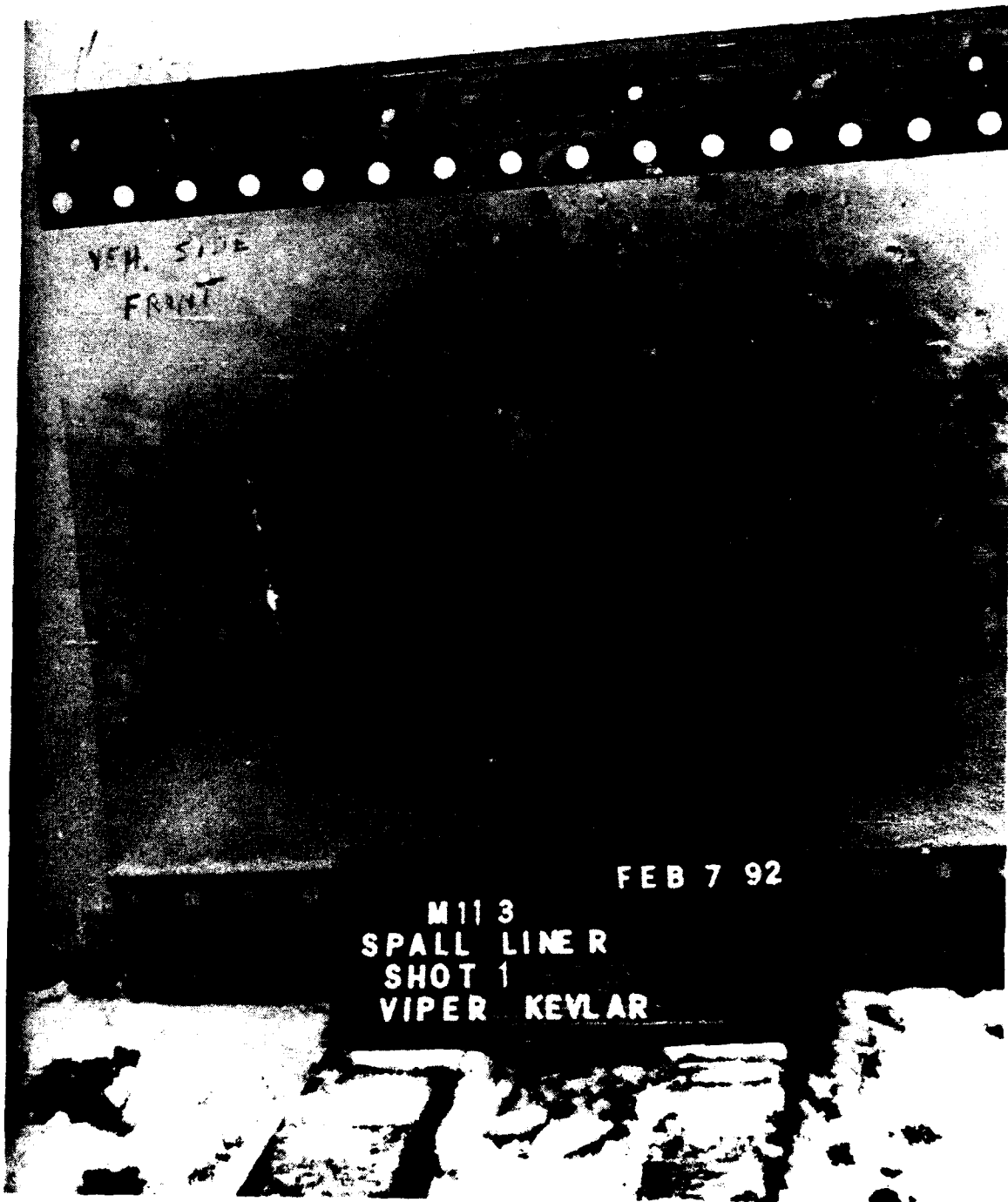

Figure A-5. Damage, Front of Kevlar Liner, VIPER shaped Charge Versus Kevlar

A-6

UNCLASSIFIED

UNCLASSIFIED

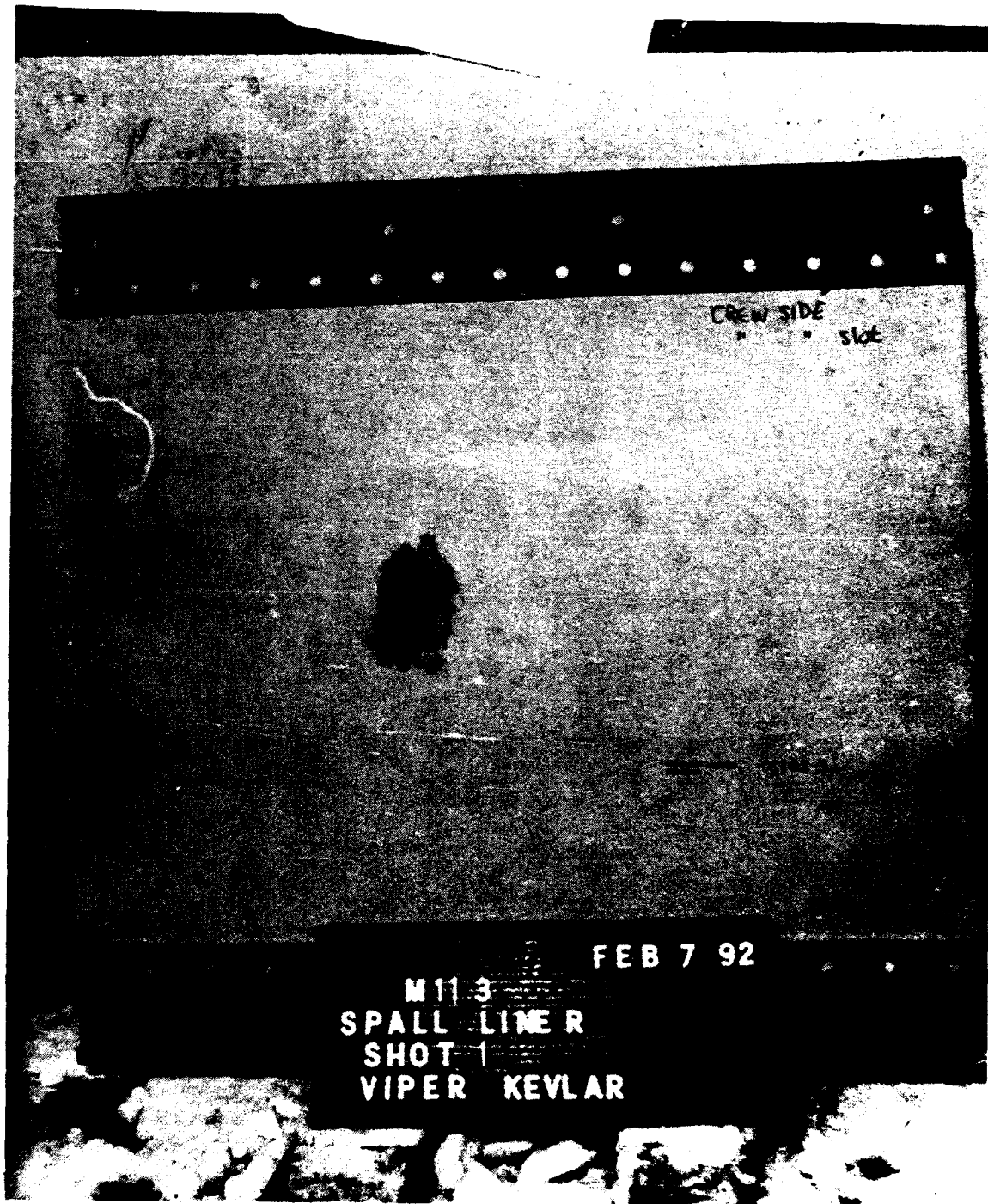

Figure A-6. Damage, Rear of Kevlar Liner, VIPER Shaped Charge Versus Kevlar

A-7

UNCLASSIFIED

UNCLASSIFIED



Figure A-7. Damage, Front of BAD Pack, VIPER Shaped Charge Versus Kevlar

A-8

UNCLASSIFIED

UNCLASSIFIED

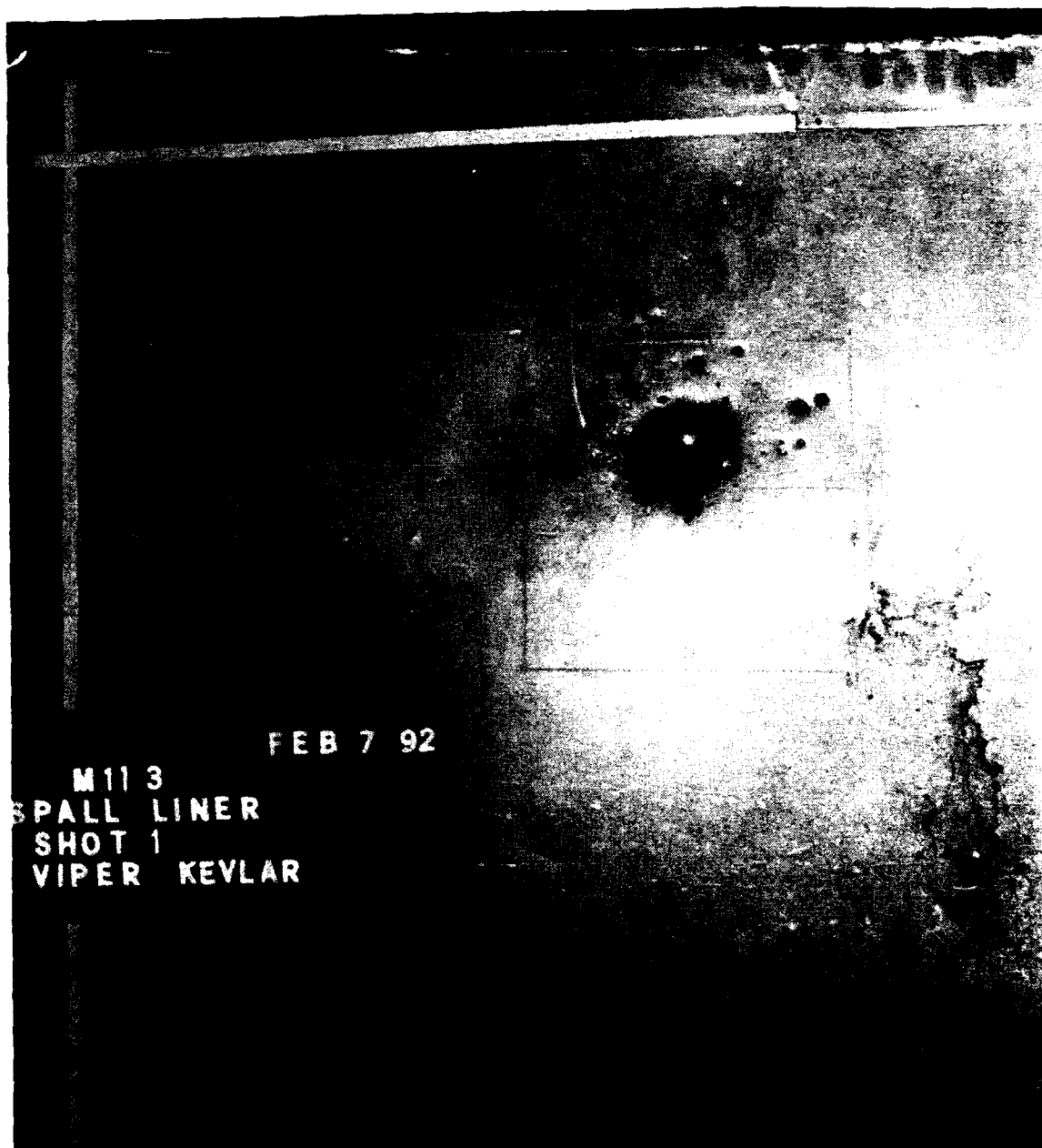

Figure A-8. Damage, Rear of BAD Pack, VIPER Shaped Charge Versus Kevlar

A-9

UNCLASSIFIED

UNCLASSIFIED

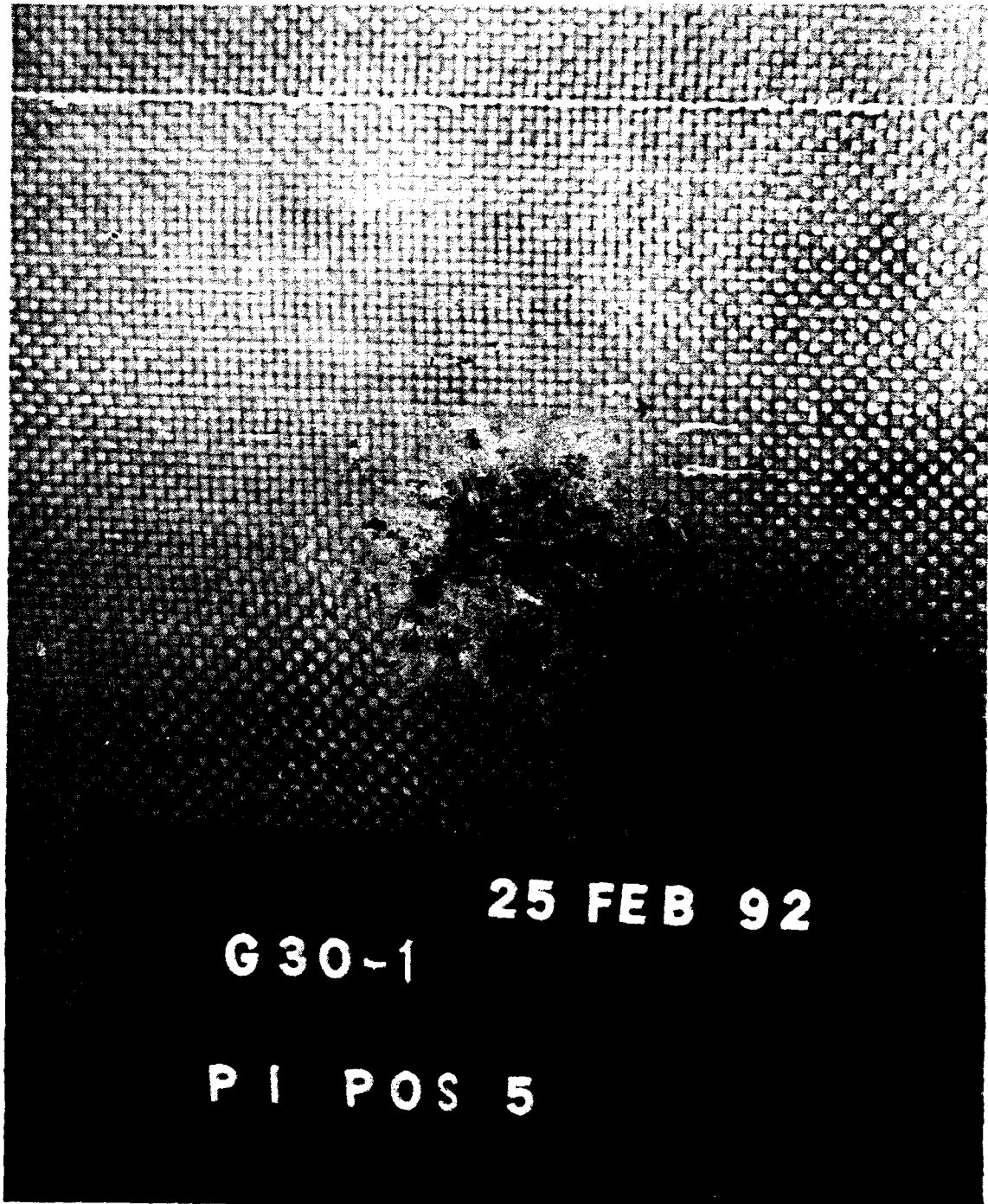

Figure A-9. Damage, Front of S-2 Glass Liner, 30mm APDS Versus S-2

A-10

UNCLASSIFIED

UNCLASSIFIED

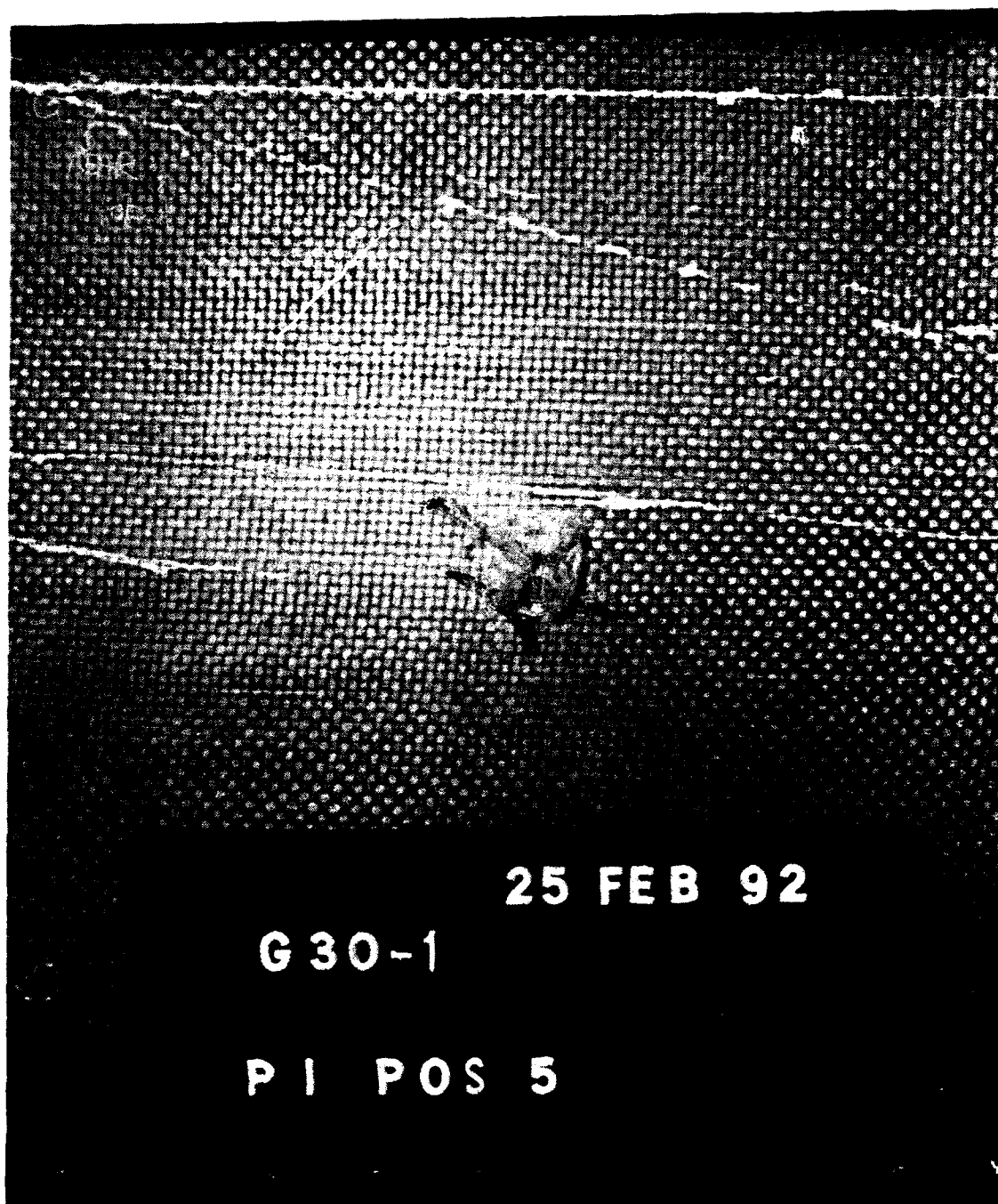

Figure A-10. Damage, Rear of S-2 Glass Liner, 30mm APDS Versus S-2

A-11

UNCLASSIFIED

UNCLASSIFIED

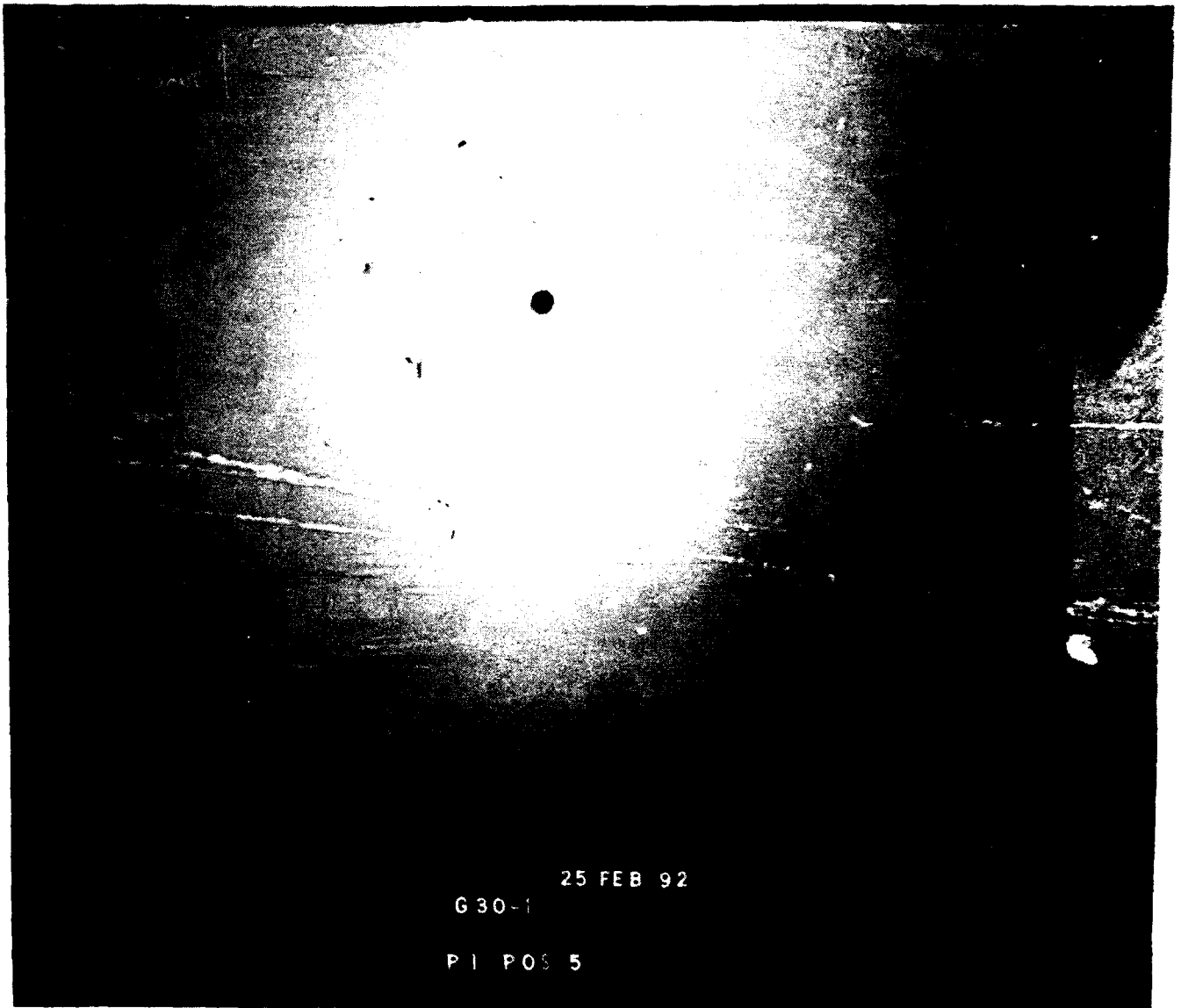

Figure A-11. Damage, Front of BAD Pack, 30mm APDS Versus S-2

A-12

UNCLASSIFIED

UNCLASSIFIED

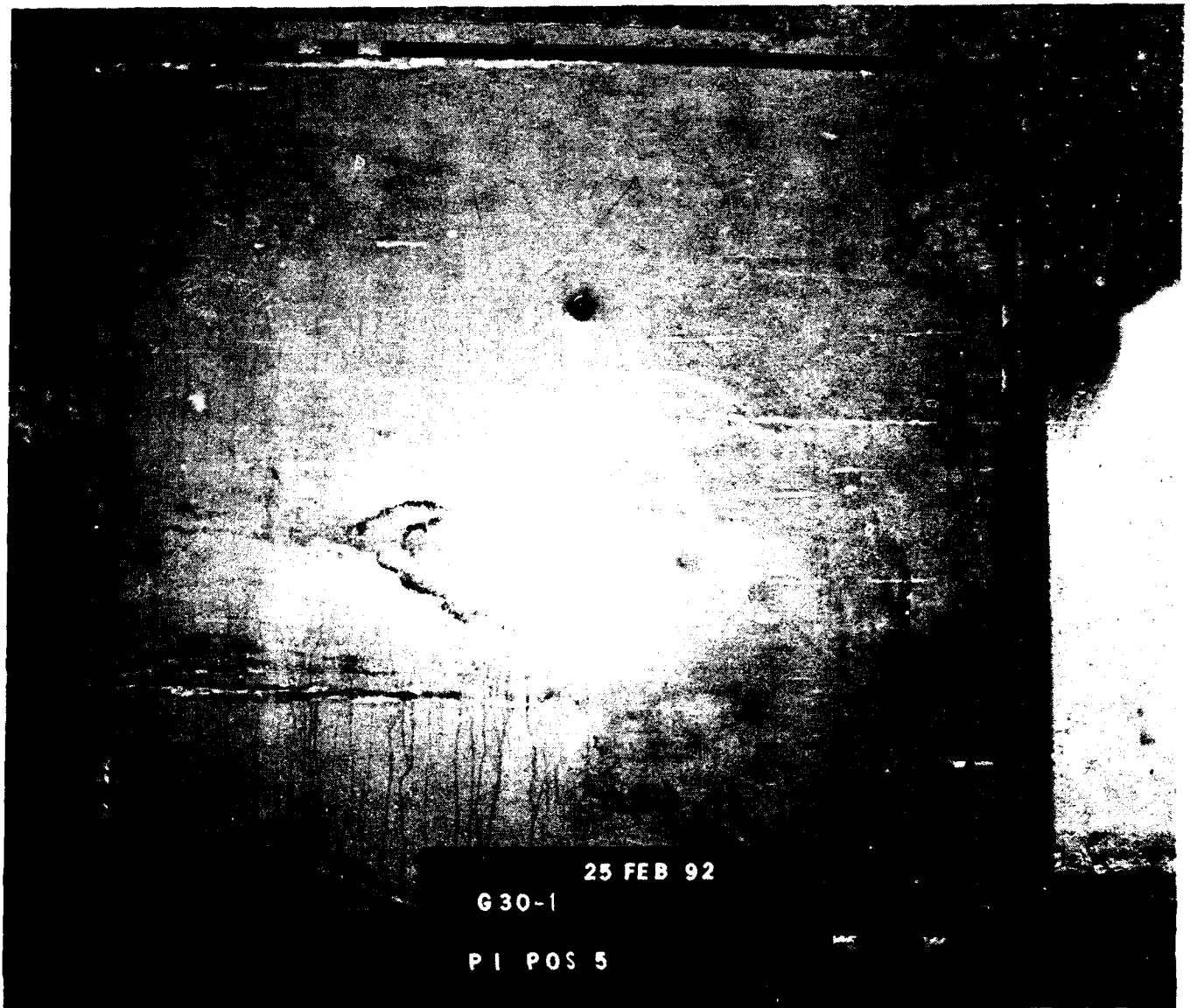

Figure A-12. Damage, Rear of BAD Pack, 30mm APDS Versus S-2

A-13

UNCLASSIFIED

UNCLASSIFIED

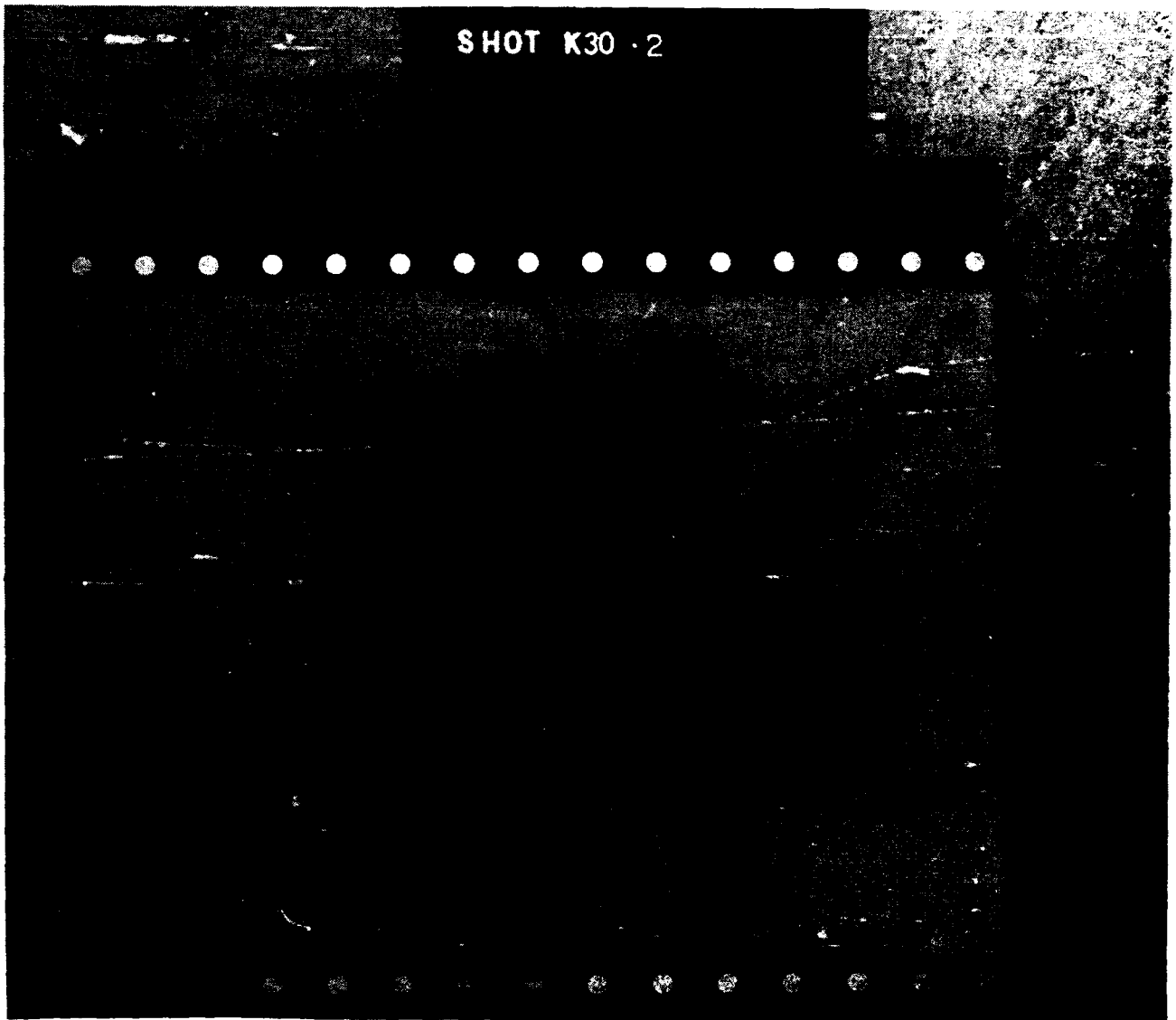

Figure A-13. Damage, Front of Kevlar Liner, 30mm APDS Versus Kevlar

A-14

UNCLASSIFIED

UNCLASSIFIED



Figure A-14. Damage, Rear of Kevlar Liner, 30mm APDS Versus Kevlar

A-15

UNCLASSIFIED

UNCLASSIFIED

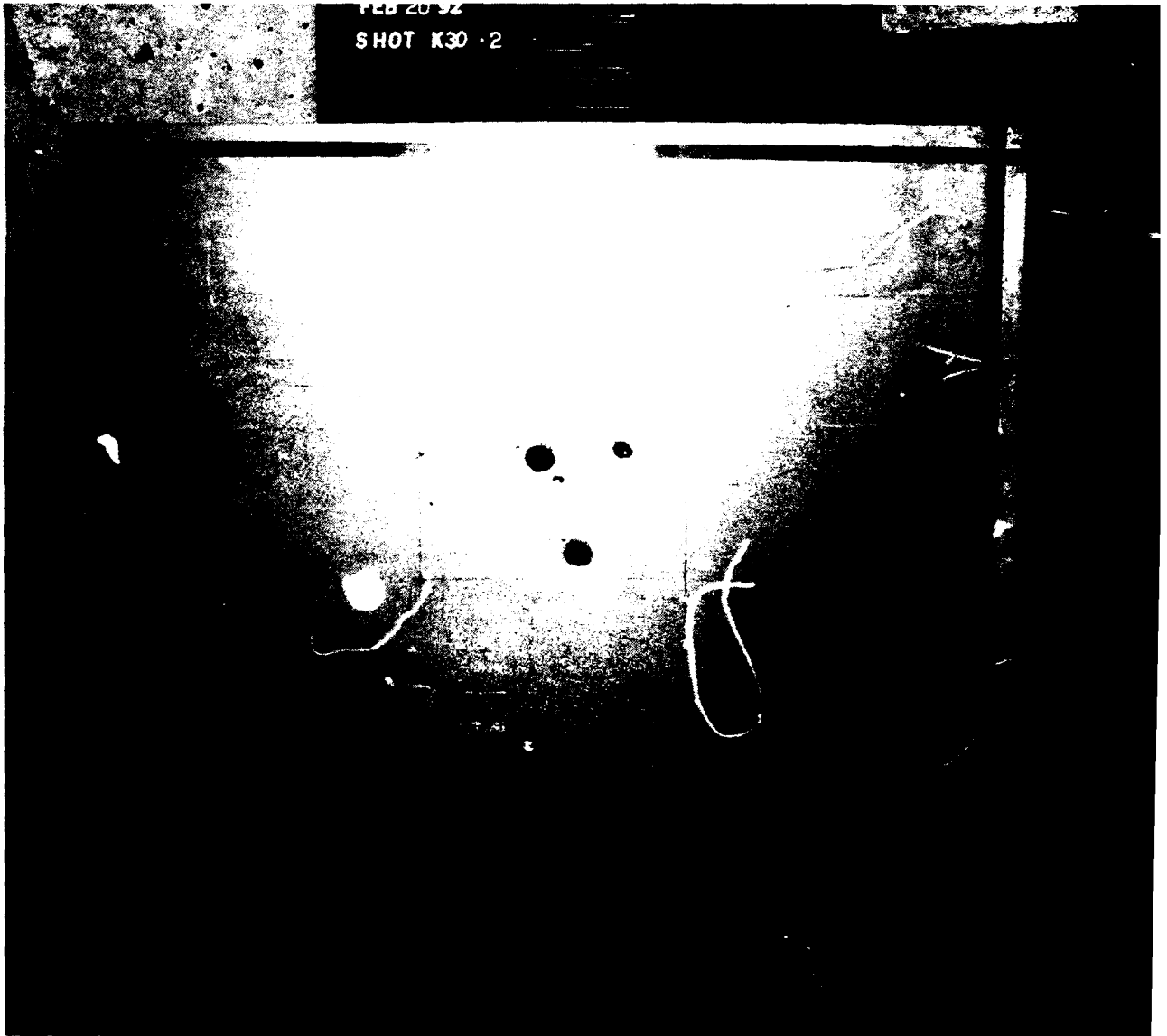

Figure A-15. Damage, Front of BAD Pack, 30mm APDS Versus Kevlar

A-16

UNCLASSIFIED

UNCLASSIFIED



Figure A-16. Damage, Rear of BAD Pack, 30mm APDS Versus Kevlar

A-17

UNCLASSIFIED