

AD-A265 080

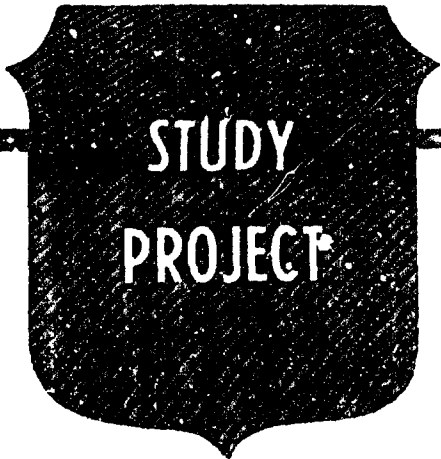

2



The views expressed in this paper are those of the author and do not necessarily reflect the views of the Department of Defense or any of its agencies. This document may not be released for open publication until it has been cleared by the appropriate military service or government agency.

**THE BREACH OF SADAM'S DEFENSIVE LINE:  
RECOLLECTIONS OF A DESERT STORM  
ARMOR TASK FORCE COMMANDER**

BY

**LIEUTENANT COLONEL DAVID F. GROSS**  
United States Army

**S**  
**DTIC**  
**ELECTE**  
**MAY 28 1993**  
**A**  
**D**

**DISTRIBUTION STATEMENT A:**  
Approved for public release.  
Distribution is unlimited.

USAWC CLASS OF 1993

Reproduced From  
Best Available Copy



U.S. ARMY WAR COLLEGE, CARLISLE BARRACKS, PA 17013-5050

98 5 25 200

93-11790

REPORT DOCUMENTATION PAGE

Form Approved  
OMB No. 0704-0188

1a. REPORT SECURITY CLASSIFICATION <b>Unclassified</b>		1b. RESTRICTIVE MARKINGS <b>None</b>	
2a. SECURITY CLASSIFICATION AUTHORITY <b>N/A</b>		3. DISTRIBUTION/AVAILABILITY OF REPORT <b>Unlimited</b> <i>Approved for public release. Dist. is unlimited</i>	
2b. DECLASSIFICATION/DOWNGRADING SCHEDULE <b>N/A</b>			
4. PERFORMING ORGANIZATION REPORT NUMBER(S)		5. MONITORING ORGANIZATION REPORT NUMBER(S)	
6a. NAME OF PERFORMING ORGANIZATION <b>U.S. Army War College</b>		6b. OFFICE SYMBOL <i>(if applicable)</i>	
7a. NAME OF MONITORING ORGANIZATION		7b. NAME OF MONITORING ORGANIZATION	
8a. ADDRESS (City, State, and ZIP Code) <b>FORBES AVE, ROOT HALL, BLDG 122 CARLISLE, PA 17013-5050</b>		8b. ADDRESS (City, State, and ZIP Code)	
9a. NAME OF FUNDING SPONSORING ORGANIZATION <b>STRATEGIC STUDIES INSTITUTE</b>		9b. OFFICE SYMBOL <i>(if applicable)</i> <b>AWCI</b>	
10. PROCUREMENT INSTRUMENT IDENTIFICATION NUMBER		11. SOURCE OF FUNDING NUMBERS	
12. ADDRESS (City, State, and ZIP Code) <b>FORBES AVE, ROOT HALL, BLDG 122 CARLISLE, PA 17013-5050</b>		PROGRAM ELEMENT NO.	PROJECT NO.
		TASK NO.	WORK UNIT ACCESSION NO.
13. TITLE (Include Security Classification) <b>The Breach of Saddam's Defensive Line: Recollections of a Desert Storm Armor Task Force Commander</b>			
14. PERSONAL AUTHOR(S) <b>LTC David F. Gross</b>			
15a. TYPE OF REPORT <b>MSP</b>	15b. TIME COVERED FROM _____ TO _____	15c. DATE OF REPORT (Year, Month, Day) <b>93/04/15</b>	15d. PAGE COUNT <b>104</b>
16. SUPPLEMENTARY NOTATION			
17. COSATI CODES		18. SUBJECT TERMS (Continue on reverse if necessary and identify by block number)	
FIELD	GROUP	SUB-GROUP	
		<b>Gulf War; 1 Inf Div (M); TF 3/37; breaching operations; command and control; training</b>	
19. ABSTRACT (Continue on reverse if necessary and identify by block number)  <b>See reverse.</b>			
20. DISTRIBUTION/AVAILABILITY OF ABSTRACT <input checked="" type="checkbox"/> UNCLASSIFIED/UNLIMITED <input type="checkbox"/> SAME AS RPT. <input type="checkbox"/> DTIC USERS		21. ABSTRACT SECURITY CLASSIFICATION <b>Unclassified</b>	
22a. NAME OF RESPONSIBLE INDIVIDUAL <b>Dr. DOUGLAS V. JOHNSON II</b>		22b. TELEPHONE (Include Area Code) <b>(717) 245-4057</b>	22c. OFFICE SYMBOL <b>AWCI</b>

This is the story of how Task Force 3/37 Armor, 2nd Brigade, 1st Infantry Division (MECH) attacked and breached Iraqi defenses along the Iraqi-Saudi Arabian border during the opening hours of the Operation Desert Storm ground offensive. It is told by the task force commander and provides his perspective on the events preceding the attack and the specific combat actions that occurred during the breach of the Iraqi defenses. The narrative highlights the unit's pre-deployment and deployment activities. It describes in detail the task force's tactical battle plan, organization for combat, command and control procedures, the specific techniques used to breach the Iraqi defenses, and lessons learned. The period covered is from the alert notification of the unit for deployment to South West Asia (SWA) on the 8th of November, 1990, through the 24th of February, 1991 (G-DAY), the first day of the Coalition ground offensive.

USAWC MILITARY STUDIES PROGRAM PAPER

DISTRIBUTION STATEMENT A: Approved for public release; distribution is unlimited.

THE BREACH OF SADAM'S DEFENSIVE LINE:  
RECOLLECTIONS OF A DESERT  
STORM ARMOR TASK FORCE COMMANDER

INDIVIDUAL STUDY PROJECT

by

Lieutenant Colonel David F. Gross  
United States Army

Professor Douglas V. Johnson II  
Project Advisor

The views expressed in this paper are those of the author and do not necessarily reflect the views of the Department of Defense or any of its agencies. This document may not be released for open publication until it has been cleared by the appropriate military service or government agency.

U.S. Army War College  
Carlisle Barracks, Pennsylvania 17013

Accession For	
NTIS - CR&I	J
DIC - TAB	12
Unannounced	12
Justification	
By	
Distribution	
Availability Codes	
Dist	Availability or Special
A-1	

## ABSTRACT

**AUTHOR:** David F. Gross, LTC, USA

**TITLE:** The Breach of Saddam's Defensive Line: Recollections of a Desert Storm Armor Task Force Commander

**FORMAT:** Individual Study Project

**Date:** 15 April 1993 **PAGES:** 104. **CLASSIFICATION:** Unclassified

This is the story of how Task Force 3/37 Armor, 2nd Brigade, 1st Infantry Division (MECH) attacked and breached Iraqi defenses along the Iraqi-Saudi Arabian border during the opening hours of the Operation Desert Storm ground offensive. It is told by the task force commander and provides his perspective on the events preceding the attack and the specific combat actions that occurred during the breach of the Iraqi defenses. The narrative highlights the unit's pre-deployment and deployment activities. It describes in detail the task force's tactical battle plan, organization for combat, command and control procedures, the specific techniques used to breach the Iraqi defenses, and lessons learned. The period covered is from the alert notification of the unit for deployment to South West Asia (SWA) on the 8th of November, 1990, through the 24th of February, 1991 (G-DAY), the first day of the Coalition ground offensive.

## INTRODUCTION

On February 24, 1991, Task Force 3/37 Armor, 2nd Brigade, 1st Infantry Division (MECH) attacked and breached Iraqi defenses along the Iraqi-Saudi Arabian border. The task force, one of the 1st Infantry Division's four "breaching" battalions, attacked thirty kilometers into Iraq, penetrated the first echelon enemy positions, and established a breach in the defenses. The British 1st Armored Division conducted a forward passage of lines through the breach and attacked Iraqi forces deployed in depth. This combat operation was the opening move by the VII (US) Corps in the General Schwarzkopf's "Hail Mary" operational maneuver to fix and destroy the Iraqi Republican Guards forces during Operation Desert Storm.

The purpose of this paper is to record task force activities which preceded the attack and the specific combat actions that occurred during the breach of the Iraqi defenses. The unit's alert notification, pre-deployment and deployment activities are highlighted. The task force's tactical battle plan, organization for combat, command and control procedures, and the specific techniques used to breach the Iraqi defenses are described in detail. The paper concludes with a review of lessons learned.

The intent of the paper is not merely to echo the many success's of the war as presented by the American media. Its intention is to demonstrate "how" well trained soldiers, armed with the best equipment in the world, and led by courageous,

competent, and hard working young leaders, overcame great challenges and difficulties, to execute successfully an extremely difficult mission, and make it look easy on television.

## THE BATTALION

The 3rd Battalion 37th Armor regiment is a tank battalion assigned to the 2d Brigade, 1st Infantry Division (MECH), Fort Riley, Kansas. The battalion traces its lineage back to the 37th Tank Battalion of World War II fame. The battalion was commanded by the legendary LTC Creighton W. Abrams. During the Battle of the Bulge, Abrams and the battalion spearheaded the attack of General George S. Patton's 3rd Army, to relieve the encircled 101st Airborne Division at Bastone, Belgium.

In November 1990, the battalion was equipped with fifty-eight M1 Abrams main battle tanks and one hundred and fifteen other vehicles ranging from M3 cavalry fighting vehicles to HUMVEE light trucks. The authorized strength for the battalion was forty-two officers and five-hundred and eight enlisted soldiers. The assigned strength was forty-one officers and four-hundred and eighty enlisted soldiers. Slightly over three-hundred family members of unit soldiers resided in the Fort Riley area.

The battalion's Cold War mission was to deploy to Germany and fight as a part of VII Corps. In executing this mission, unit personnel, with a limited amount of equipment, would travel sixty miles to Forbes Airfield in Topeka, Kansas, board aircraft, fly to Germany, draw tanks and other major equipment from pre-positioned stocks, and fight to stop attacking Soviet forces.

## ALERT NOTIFICATION

On November 8, 1990, the battalion was alerted for deployment to Saudi Arabia, and participation in Operation Desert Shield. The alert notification caught the soldiers and their families focused on California, not Iraq. Unit personnel were busy loading shipping containers with unit equipment for rail shipment to the National Training Center (NTC) at Fort Irwin, California. The battalion's family support group and various post agencies were preparing for an evening of pre-deployment family support activities at the Custer Hill Activities Center, Fort Riley. The activities were part of the battalion's preparation for a November-December training deployment to the NTC.

In early September, the battalion had task organized to a balanced task force with two tank companies and two mechanized infantry companies: Bravo and Delta companies 3/37 Armor, and two mechanized infantry companies, Alpha and Delta companies, from the 2nd Battalion, 16th Infantry Regiment. Alpha company, 3/37 Armor was attached to 2/16th Infantry battalion. Charlie company, 3/37 Armor was not scheduled to go to the NTC and most its soldiers were reassigned to the other tank companies. This was the task organization the task force planned to use at the NTC.

Home station training in preparation for the NTC rotation included platoon live fire exercises in September, and company-team and task force external tactical evaluations during October. Tank and mechanized infantry platoons had undergone platoon training and evaluations in late July and early August.



The alert notification brought a quick change to the battalion's task organization. Charlie company, with its remaining thirteen assigned personnel, would deploy and fight with task force 3/37 Armor. Delta company was detached from the task force attached to Task Force 2/16 Infantry.

Rumors of the 1st Division's alert notification for deployment to South West Asia (SWA) provided the chain of command the opportunity to hedge the reconstitution of Charlie company. A strong leadership cadre led by the company commander, executive officer, first sergeant, several experienced NCOs and three new platoon leaders was maintained in the company. They, along with new armor crewmen assigned to the battalion, conducted tank gunnery and tactical training as the task force prepared for the NTC. As additional replacements arrived, tank crews were quickly assembled. By deployment day, the company was at one hundred percent strength.

The preparation for the NTC rotation had a positive impact on the training status and overall combat readiness of the battalion. With the exception of Charlie company, personnel fill in the battalion was nearly one hundred percent. Shortages in specific personal specialties existed, but leadership positions were filled. Training for the rotation had increased unit tactical proficiency and gone a long way to cementing task organization relationships so necessary to team building. Leaders and soldiers had a solid understanding of the task force standard operating procedures (SOP). We also had a good appreciation of

what we didn't do well and needed improvement.

## THE DIVISION'S MISSION

Within hours of the announcement confirming the Division's pending deployment to Saudi Arabia and Operation Desert Storm, MG Thomas G. Rhame, the Division commander, was enroute to Saudi Arabia. Immediately upon his return, he briefed subordinate commanders on the probable nature of Division operations in SWA. The Division would lead the VII Corps attack into Iraq.

The mission was simple, but difficult. The Division would attack and breach the first echelon Iraqi defenses. VII Corps' three armored divisions would then pass through breach and continue the attack to destroy Iraqi Republican Guard forces. The location for the operation was not disclosed, but the initial intelligence estimate indicated we would be in for a tough and dangerous fight.

## PREPARATION FOR DEPLOYMENT

The remainder of November and much of December were filled with pre-deployment preparation. Major activities included an intense maintenance effort, a complete individual training program, uploading tanks, infantry fighting vehicles (IFVs) and mortar carriers with ammunition, and the integration of new soldiers into the unit.

The maintenance effort was precipitated by a two month period from late August to early November in which few parts, to include major assemblies, were available in the supply system.

Understandably, priority had gone to early deploying units to SWA.

The forty-plus days the battalion spent in preparation for the NTC training rotation came with a significant maintenance price tag. When the Task Force external tactical evaluations ended in late October, the battalion had twenty-six M-1 tanks in a non-operationally ready-deadlined-status. A shortage of engines, transmissions, and air filters were the primary reasons for the high deadline rate. Shortly after alert notification, the supply system was turned on the 1st Division and the operational rate improved dramatically.

### SHIPPING THE EQUIPMENT

The preparation of the equipment for deployment ended with the painting of battalion equipment over Thanksgiving. Every piece of unit equipment was painted desert sand. Within ten days, the equipment was rail loaded and on its way to the port of embarkation--Houston, Texas.

### TRAINING CONTINUES

With all unit equipment shipped, all attention was focused training and developing the tactical concept for the attack and refining breaching operations. Individual training continued and included individual qualification with the new 9mm pistols issued to the battalion. Tank crews also conducted transition tank gunnery training on M1A1 tanks shipped to Fort Riley from Fort Knox, Kentucky. A mobile training team conducted gunnery training

for all Division tank crews. The training served to reinforce the growing rumor that the Division would receive M1A1 tanks in Saudi Arabia.

A second mobile training team arrived at Fort Riley with tank plows and mine rollers, and selected tankers received training in countermine operations. This training removed any doubt about the nature of the Division's combat mission. Planning for the breach intensified.

### A CONCEPT FOR THE BREACH

Planning for the operation followed the doctrinal planning process. A thorough mission analysis was conducted and preliminary intelligence preparation of the battlefield was completed. Possible courses of action were developed in accordance with tactical doctrine. The lone exception to fairly consistent adherence to doctrine was the actual technique used to breach the Iraqi defenses.

There was little reference in doctrine to how to execute a division breach. Doctrine for task force breaching operations using new equipment and techniques was in final draft stages. The entire chain of command was brought into the development of the plan. LTC Steve Hawkins, the Division's engineer battalion commander led the effort to develop a workable breaching plan. The plan would incorporate the use of mechanical counter mine equipment to include: the Mine Clearing Line Charge (MICLIC); Mine Plows and Mine Rollers mounted on M1 tanks; Mine Rakes, mounted on Combat Engineer Vehicles (CEV); and the Armored Combat

Engineer (ACE) vehicle. The counter-mine equipment was fairly new to the Army inventory. Only a few engineers had seen the equipment. No one in 3/37 Armor had any on-hands experience with the equipment!

The Brigade concept for the breach was fairly simple. Bring the weight of artillery and close air support (CAS) on the enemy sector of the breach. Then shift the artillery fire to suppress enemy artillery and direct fire systems, as two balanced infantry/armor task forces breached lanes through the enemy mine fields and trenches. Once the lanes were established, the Brigade's armor battalion would pass through the breach and attack to destroy enemy armor moving to the breach location.

As the plan developer, Colonel Anthony A. Moreno, the 2nd Brigade commander, took the brigade staff, the battalion commanders and their operations officers (S3) to the Tactical Commanders Development Course (TCDC) at Fort Leavenworth. The brigade plan was executed using the TCDC computers and instructors, with the brigade's commanders making the operational decisions. This wargame of the plan was very beneficial. It assisted greatly in developing a common understanding of what we were up against and what we would have to do to be successful.

The computer generated enemy, employing Iraqi tactics and equipment, defeated the brigade and prevented a successful breach of their defenses. The actual breaching operation had taken too long. The enemy was able to mass both artillery and direct fire on the task forces conducting the breach. Both breaching

task forces became combat ineffective during the breaching operations. Massed enemy artillery destroyed part of the tank battalion as it moved through the breach sites. Enemy armor reserves were maneuvered to counter and destroy the armor battalion as it exited the breach sites.

The Brigade plan was refined to make better use of massed artillery and to better synchronize battlefield activities. More artillery was needed to keep the enemy artillery from pounding the breach forces. The tank and engineer platoons needed to breach the enemy defenses rapidly and not give the enemy the opportunity to defeat the task force breaching operations with massed artillery. The specific techniques for breaching were refined and wargammed to increase the efficiency of the breaching operations.

## DEPLOYMENT

On 8 January, the battalion deployed to Saudi Arabia on commercial aircraft flying from Topeka, Kansas, to the airport of Daharan, Saudi Arabia. The majority of the battalion was deployed within forty-eight hours. Upon arrival in country, buses transported personnel to high rise apartment buildings in the city of Al Khobar, Saudi Arabia. Within twenty-four hours of arrival in Saudi, all attention turned to the port of Ad Dammam, the port of debarkation for the battalion's equipment.

## DOWN LOADING THE SHIPS

Any thoughts of quickly unloading ships for deployment to

the Division tactical assembly area in the Saudi desert evaporated when shipping manifests were received. The battalion's equipment would come on eight different ships! Most of the track vehicles would arrive first, followed by the wheeled cargo trucks which were necessary to transport soldiers, and move equipment and supplies.

During the next ten days, the battalion was fully committed receiving equipment at the port and preparing for deployment to the desert. During this period we learned the task force would not receive M1A1 tanks. The 1st Brigade had received M1A1s at the port, prior to their departure to the Division's tactical assembly in the Saudi desert. The 2nd Brigade tanks had not arrived and were not expected to arrive until after the brigade was fully deployed to the desert. Task Force 3/37 Armor would attack with M1s.

### ESCAPE FROM THE PORT

The start of Operation Desert Storm caught the battalion as it prepared for deployment to the desert. The upload of the battalion's track vehicles on transport trucks and the three-hundred mile movement of the tracks to the Division's Tactical Assembly Area (TAA), is best described as controlled chaos. The assembly of trucks massed to move track vehicles was diverse and fairly uncontrolled. Most trucks were commercial and driven by third country nationals. In some cases they had U.S. soldiers as shotguns, in other cases, units provided the shotguns. Trucks were allocated by VII Corps to each division.

The basis for allocation was the number of track vehicles projected for movement and the ever changing availability of transportation assets. Given unexpected shortages of trucks and the pressure of getting out of the port, it was not uncommon for spirited disagreements to occur between units competing for the trucks. The recurring SCUD missile attacks directed at the port staging areas further increased the desire to depart the port.

There was virtually no control of convoys of commercial trucks leaving the port. Once convoys cleared the port they quickly dissolved. Some truckers moved independently, but most moved in small groups of trucks driven by like speaking third country nationals. All moved at their own pace, often stopping to eat, pray, or simply take extended breaks. If trucks had mechanical problems, the tracked vehicles they were carrying, were often abandoned.

Crews for tracked vehicles being moved by truck, moved in city transit buses. Some moved with the truck convoys. Most moved independently of the track movement because of allocation mistakes and the failure of units to return their buses to the port once the trip to forward assembly areas was complete. Deploying units ended up providing drivers for many of the buses. It was common to see abandoned buses along the deployment route and throughout the desert.

## BUILDING COMBAT POWER

The majority of the battalion's combat vehicles deployed on the 18th and 19th of January. The battalion S3, Major Paul Izzo,



was sent forward to the Division's TAA Roosevelt, with a battalion advance party. His mission was to refine the task force's assembly area defensive plans and coordinate the movement of the battalion into the assembly area.

Much of the deployment was conducted in rainstorms while in nuclear, biological and chemical (NBC), mission oriented protective posture (MOPP) IV (Complete NBC protective clothing to include the protective mask). The SCUD attacks against Saudi Arabia were not having much military impact, but they were making life very difficult. The battalion executive officer (XO), Major Tom Connors, and battalion Command Sergeant Major (CSM) Marvin Alston closed out the battalion's port operations and moved the wheel vehicles to the tactical assembly area.

Arrival of equipment and personnel in the Division's TAA mirrored the departure from the port. Equipment and personnel were policed from military police holding areas and units began to form. Several tanks were recovered from abandoned commercial transport trucks. One was over one-hundred miles away from the TAA. Battalions were responsible for finding and recovering their vehicles and personnel.

Task organization for combat was accomplished as units arrived in the TAA. The final combat upload of equipment shipped from Fort Riley, the test firing of weapons, the mounting of mine plows and rollers, and equipment maintenance were the task force's primary activities during the first few days in the assembly area.

The major maintenance problems were making communications equipment work and replacing transmissions and engines on tanks. Once tanks began making the one-hundred kilometer round trip to test fire weapons at the Corps gunnery range, the added tons of ammunition and equipment on them, began to take its toll. Weak engines and transmissions simply gave up. This was especially true of the tanks mounted with plows and rollers. Ammunition and other logistical challenges were soon overshadowed by refining the breach plan and completing dress rehearsals of the plan.

### THE CORPS PLAN MATURES

The original VII Corps attack plan had the three armored divisions--1st Armored, 3rd Armored, and the British 1st Armored--pass through the 1st Infantry Division's breach and attack the Republican Guard forces. By the third week of January the plan was changed and only the British would pass through the Division. The remainder of the Corps would cross the Saudi Arabian border and attack into Iraq on the left (West) flank of the Division. The Division was also given the mission to move with the Corps and attack Republican Guard forces, once the British Division passed through the breach.

### THE DIVISION SCHEME OF MANEUVER

The Division planned to attack to penetrate and destroy enemy defenses with two brigades abreast--1st Brigade on the left (West) and 2nd Brigade, the Division main effort, on the right (East). Each brigade would breach eight lanes through the Iraqi

defenses and continue the attack to establish a "bridgehead" or defensive arc to protect the breach sites.

The 3rd Brigade would then attack through the 2nd Brigade and continue the attack with 1st Brigade to expand the perimeter of the Division breach and complete the destruction of the defending Iraqi divisions. The Division would then pass the British 1st Armored Division through and, on order, continue the attack to destroy Republican Guard forces.

### THE BRIGADE CONCEPT OF OPERATION

The 2nd Brigade concept of operation was to conduct a reconnaissance/counter reconnaissance fight from Phase Line (PL) VERMONT, the berm dividing Iraq and Saudi Arabia, to destroy the enemy security zone forces south of the enemy main defensive positions. This would be accomplished on the first day of the attack. The Division plan called for the brigade to assume a hasty defense until the following morning, G+1.

Following a two and one-half hour artillery preparation, the brigade would conduct a deliberate attack in zone with Task Force 3/37 Armor and Task Force 2/16 Infantry abreast to breach and penetrate enemy defensive positions along PL WISCONSIN, the forward line of the Iraqi defenses.

Task Force 4/37 Armor would conduct a demonstration in sector east of the breach location. Task Force 3/37 Armor and Task Force 2/16 Infantry would each simultaneously breach four lanes through the Iraqi defenses. Once the breach lanes were established, Task Force 3/37 Armor would continue the attack

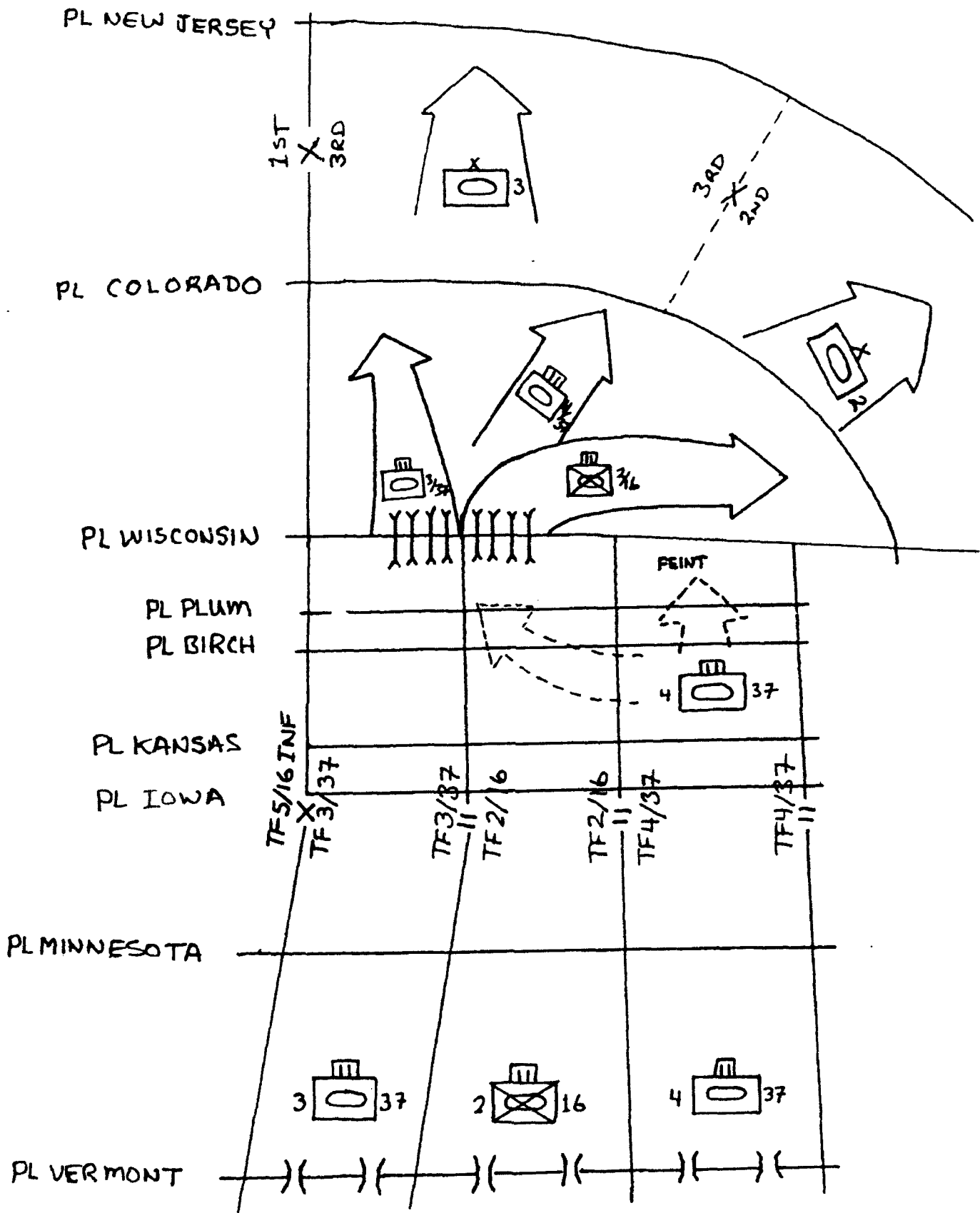

Figure 1. 2nd Brigade Attack Plan.

north to PL COLORADO, destroy enemy armor in sector and establish defensive positions to prevent enemy direct fire on the breached lanes. Task Force 2/16 would turn right to the east and place fires into the enemy positions from the flank and rear. Task Force 4/37 would complete its demonstration and move through the breach lanes, and attack northeast between Task Force 3/37 and Task Force 2/16 to establish defensive positions along PL COLORADO.

The 3d Brigade, 2nd Armored Division would then pass through 2d Brigade and attack northeast in sector. The 2d Brigade would conduct a supporting attack with Task Force 4/37 in the north and Task Force 2/16 in the south. The attack would begin at PL COLORADO and go to PL NEW JERSEY. Task Force 3/37 Armor would follow and support Task Force 2/16 Infantry and on order, assume its mission. On order, the brigade would continue the attack to PL OMAHA.

### THE BREACH PLAN - A ROUGH DRAFT

Two tank teams, task organized with an engineer platoon and equipped with counter-obstacle equipment, constituted the breach force of Task Force 3/37 Armor. Each tank team was responsible for breaching two, single vehicle lanes through the obstacles with a breach team. The breach team consisted of an M1 tank mounting a mine plow (plow tank), an armored bridge layer (AVLB) mounting a mine clearing charge (MICLIC), an M1 tank mounting a mine roller, and an engineer squad mounted in an M113 armored personnel carrier. The hybrid version of the AVLB without its

bridge, mounted with one or two MICLICs was known as a AVLM.

The technique used to breach the complex obstacle was fairly simple, but dangerous. A plow tank would move forward followed by a AVLM and roller tank. When mines are identified or suspected the plow tank would stop approximately sixty meters from the leading edge of the mine field. The AVLB would then raise the MICLIC rocket and fire. If everything went right, the rocket would pull the line charge over the plow tank and the first one-hundred meters of the mine field. Once the line charge was deployed on the ground, the AVLM crew would fire the charge. The line charge would create a shallow trench about ten meters wide and one-hundred meters in depth. The plow tank would then move forward and begin plowing the "lane" created by the MICLIC. This would remove any mines not detonated by the line clearing charge.

Simultaneously, the AVLM would move slightly left from the lane to allow the roller tank to pass. The roller tank, following the plow tank, would detonate any mines that slid back into the plowed lane as the plow tank moved forward.

If the plow tank became disabled or destroyed, the roller tank would by pass and continue the breach on its own. The roller tank would trigger at least two mines before it was stopped by a mine. If it was near the end of the mine field, it had a good chance of completing a cleared lane. An engineer squad followed the roller tank and was responsible for marking the cleared lane. If the mounted breach effort failed, the squad would attempt to

clear remaining mines. Each of the tank teams also had an extra mine plow tank capable of moving forward to continue lane clearing. M1s, M2s, and VULCAN air defense systems provided suppressive fires on the flanks of the lanes and into enemy positions forward of the breaching teams as they cleared their lanes.

If the mine field extended past the one-hundred meters of lane cleared by the MICLIC, an additional MICLIC would fire to extend the cleared lane another one-hundred meters. If the MICLIC failed or the breach team ran out of MICLIC charges, the plow tanks would continue to clear a lane through the mine field.

If the breach team encountered anti-tank ditches or berms, it would be augmented with an ACE with its dozer blade. The ACE would create a "hole" in the berm and fill in anti-tank ditches.

Once the mine fields were breached, the two tank heavy teams would quickly move through the cleared lanes and attack to expand the penetration. This would prevent enemy direct fire from targeting the cleared lanes. Simultaneously, the plow tanks would turn perpendicular to the enemy trenches and begin to "plow" them closed. The two mechanized infantry teams would continue to provide supporting fires while the trenches were closed. ACE's would also assist in "closing" the trenches, bunkers, or other defensive positions. The intent was to either kill or force the surrender of the defending enemy soldiers without having to dismount infantry to clear the trenches.

## THE DRESS REHEARSALS

During the last ten days of January, the task force refined and practiced the breach operation. Rehearsals were conducted at a simulated Iraqi defensive complex north of TAA Roosevelt. The defensive position, constructed by Division and corps engineers, was designed to represent a tougher challenge than the actual enemy defenses the Division expected to encounter. The position was comprised of wire obstacles, mine fields, earth berms, anti-tank ditches, dug-in armored fighting vehicle positions, and infantry fighting positions. The battalion's first experience at the rehearsal site was less than spectacular.

The first rehearsal doubled as a demonstration of the breaching technique. The entire leadership of the Division assembled at the Iraqi defensive complex. The breaching teams of both Bravo and Charlie team were present. After an informal discussion of the breaching operation, Charlie team conducted a dry run of a single lane breach.

After a quick after action review of the dry run, the Division leadership, along with at least one hundred casual observers, retreated to an earthen berm several hundred meters from the point the MICLIC would fire during the live run of the breach. Less than a handful of those present--two or three engineers--had ever seen a MICLIC fired. The rest of us were taking no chances! The breach team moved out per the plan. Everything went as planned until the point the MICLIC was to fire --nothing happened. This was the first of several unplanned dry



runs which ended in the failure of the MICLIC rocket to fire.

Within forty-eight hours, the stage was set for a second try. The engineers had corrected the electrical detonator problem with the MICLIC rockets. This time, the rocket worked and the crew of Charlie team's plow tank experienced the thrill of a MICLIC launch and detonation. The rocket flew over the plow tank without a hitch and was detonated with the anticipated effects. Neither the rocket nor the detonation of the line charge had any impact on the plow tank. The detonation left a smoking, one hundred-meter long, shallow trench in the ground. The explosive force of the line charge vented to the sides of the charge and not back toward the plow tank. There was little doubt that the charge would detonate any mines in the trench. Iraqi soldiers, near the flanks of the line charge, would also become casualties from the effects of the charge.

The plow tank lunged forward within seconds of the detonation. As it approached the mine field, it lowered its mine plow and began to plow a lane toward the near end of the smoking lane cleared by the line charge. At this point, the plow tank crew and the observers knew we had a problem.

The plow tank was too close to the mine field when it stopped. The line charge had landed in the mine field but missed approximately the first fifteen to twenty meters of the mine field. It also missed the triple strand wire obstacle marking the forward edge of the mine field.

The plow tank continued to plow forward. It was about thirty



A MICLIC rocket fired by a breach team during Task Force 3/37  
Armor rehearsals in TAA Roosevelt.

meters into the mine field when the wire obstacle began to wrap itself into the tanks tracks and suspension. The tank continued plowing to the end of the mine field and stopped. It took several hours to clear the wire from the tracks of the tank. The wire did not prevent the plow tank from clearing the lane through the mine field, but it was doubtful the tank could move much farther.

The rehearsal continued and a second plow tank from Charlie team moved forward to assume the mission of the first plow tank. The next obstacle in the defense was an anti-tank berm almost three meters high. Behind it was an anti-tank ditch. The breaching concept called for an ACE to augment the breach team to reduce a berm or fill-in an anti-tank ditch. Since we had never tried to reduce a berm with a plow tank, the commander made the decision to attempt it. The plow tank made several runs at the berm without punching a hole through it. On its fourth attempt the tank literally launched over the berm and ended up nose down in the anti-tank ditch! The tank crew was stunned and bruised, but not seriously injured. The tank was quickly pulled from the anti-tank ditch and examined for damage. The mine plow was bent and unusable. The decision was made not to reduce berms with a plow tank.

Within a few minutes the breaching operation continued. An ACE raced forward to replace the plow tank and quickly cut a lane through the berm while simultaneously filling in the anti-tank ditch. The rehearsal validated the breach drill and highlighted

three significant problems with the breaching concept: mine field identification; range estimation; and timing.

We anticipated the problem of correctly identifying the mine field and stopping approximately sixty meters from it. The plow tank crews had practiced estimating sixty meters. They could get within ten meters consistently, but reduced visibility and simulated operations in a chemical environment further reduced their accuracy.

In the best case, the mine field would be marked by a wire obstacle and the challenge for the plow tank crew was simply the problem of knowing when it was sixty meters from the mine field. If it found itself too close to a mine field and a wire obstacle was present, it would have to back up. The AVLM would also have to back up. This would probably be a fairly difficult task if it was conducted under enemy fire. Backing up was added to the breach drill and range estimation practice was continued.

To further increase the mine field identification skills of the plow tank crews, several crew members and the tank team commanders were flown to an actual anti-tank mine field. The possibility of seeing buried mines with the M1s thermal sight had surfaced and part of this exercise was to determine the validity of the concept. In theory, the mines would be heated by sunlight. As temperatures dropped during periods of low visibility, the mines would remain warmer than the sand they were buried in and become visible to the thermal sights. The crews were not successful at identifying mines using this technique. Perhaps the

weather and relative temperature conditions were not right when the test was conducted.

The greatest challenge we faced with the breaching technique was the speed of execution. It took the plow tank and AVLM nearly two minutes to stop, fire the MICLIC, and detonate the line charge. Given the suspected intensity of enemy fire directed toward the plow tank and the AVLM, two minutes was too long. After many practice runs, the time was reduced to about forty seconds. The time was still too long, but it was realistic given the mechanics of firing the MICLIC.

The success of the breaching trials allowed us to turn our attention to task force level rehearsals of the breach. The S3 developed a task force operations plan (OPLAN) for the attack of the Iraqi defensive complex. It used the same scheme of maneuver and graphic control measures we used for the actual attack. The plan was over-layed on a seven kilometer maneuver box which included the defensive position. The OPLAN was issued and the task force assembled on the rehearsal field.

The first rehearsal was conducted during daylight. The results were less than spectacular. It was like the first day of high school spring football practice. Everyone knew the play but no one was quite sure how to execute it. The initial challenge was getting the one hundred and five armored vehicles in the task force attack formation dress right dress. We assumed our tactical training for the NTC had prepared us to quickly organize for combat and move out. This was not the case.

Leaders had a mental picture of how their unit would look on the battlefield, but since the task force had no standard for spacial relationships--distances between vehicles and the various sub-units, each leader had a different vision of the same picture.

After a considerable amount of effort, which included the use of a helicopter to identify subordinate units, the task force conducted a ragged movement to the enemy defenses and executed a rather uncoordinated attack. Once the breaching teams reached the enemy defenses, they executed the breach as rehearsed. Their primary problem was finding the right location to establish the lanes. This caused the timing of the operation to lengthen and disrupted the massed effects of mutually supporting weapons. We needed to use Magellan Global Positioning Systems (GPS) to get the plow tanks to the start point for the lanes. (The task force had twenty-four GPSs, but we had not fully realized the navigation potential of the system.)

In short, we executed two independent company sized breaching operations without getting many of the task force weapons into the fight. The fire support elements were unsure of what was happening and the fire support plan was not executed as planned. Fortunately we weren't using ammunition.

The after action review (AAR) of the rehearsal was humbling. It was clear the ability to effectively command and control the operation was tied to establishing a formal, fairly rigid, battle formation at the task force level. A "template" of the task force

would dictate the spacial relationships between vehicles and units relative to movement and the breach of the Iraqi defenses. Battle drill would be executed from this standard formation. Any chance of successfully executing the attack during the night, in an NBC environment, rested in our ability to develop and practice the standard formation and associated battle drill. The S3 and the company-team commanders were tasked to develop the template. The ARR ended with the S3 issuing instructions for the next task force rehearsal and the upcoming brigade dress rehearsal. The task force would not have the benefit of another full scale rehearsal.

### CHANGE OF MISSION

The Iraqi attack of the Saudi Arabian city of Kafji during the last week of January demonstrated the enemy's ability and willingness to conduct offensive operations. The attack triggered a Division operation to protect a vulnerable logistics base being developed to support the VII Corps offensive. The logistics base, known as Junction City, was located approximately one hundred and twenty-five kilometers northwest of TAA Roosevelt. It would support the Division attack into Iraq. The attack of Kafji highlighted the vulnerability of the base. There we no Coalition forces between it and the Saudi-Iraqi border. The Division's 1/4th Cavalry Squadron, commanded by LTC Bob Wilson, was given the mission to move to a position North of the base, and protect it from any enemy incursion across the border.

On 31 January, Task Force 3/37 Armor received a warning

order to prepare for movement to link-up with, and reinforce the cavalry squadron, south of the Iraqi/Saudi border. The task force mission was to assume part of the cavalry sector and conduct screening operations with the squadron. The alert came just as the task force was preparing to conduct its second rehearsal. The rehearsal was cancelled and the task force feverishly prepared for movement. The task force would not have the opportunity to participate in the coming brigade and Division rehearsals.

### MOVEMENT FORWARD

At 1700, on 3 February, the task force advance party departed on its night move to link-up with the 1/4 Cavalry. It was organized with combat elements from each company-team, elements of the task force command post, and most of the support platoon's fuel trucks. The following morning, at 0500, the main body of the task force, began the one-hundred and thirty-six kilometer march toward the new task force sector.

The Division's tactical command post (TAC) and a company from the military intelligence battalion moved with the task force. The 1/5th Field Artillery (FA) Battalion, commanded by LTC Harry Emerson also moved forward. The artillery battalion, the direct support battalion for the 1st Brigade, was given the mission to provide artillery support to the cavalry squadron and the task force. This grouping, of combat and combat support units, was commanded by the Assistant Division Commander for Maneuver (ADCM), BG William Carter and was formally designated Combat Command (CC) Carter.



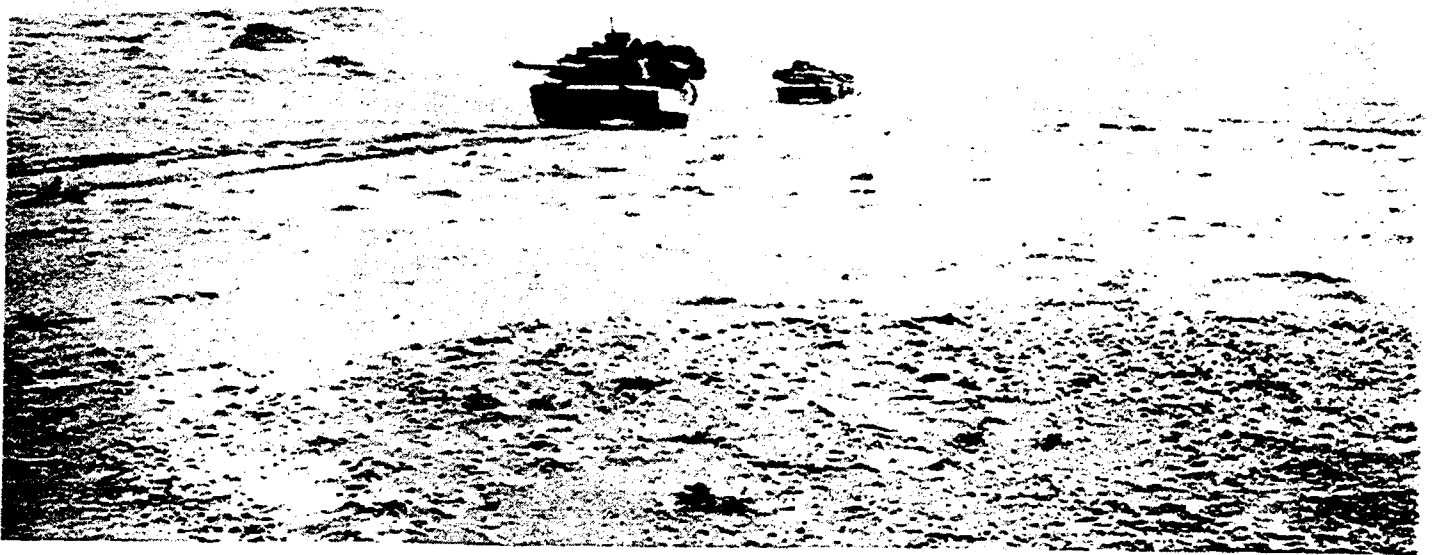

Charlie Team, Task Force 3/37 Armor, moving toward  
the Combat Command Carter screen line south of  
the Iraqi border.

The tactical move took the task force west, across the Wadi al-Batin, and then north toward Iraq. By noon, the task force was in the wadi, immersed in a sand storm. Visibility was less than twenty-five meters, and movement was very slow. By 1500, the lead elements of the task force reached the task force refuel site. By 1700 most elements were closed at the new task force location.

The value of the GPS became apparent during the movement. Every subordinate unit in the task force hit the refuel point, even though it was nearly invisible in the sand storm. GPS's assistance in accurately identifying the location of disabled vehicles also became clear.

The task force trains, under the control of the task force XO, were forced to lager in the sand storm and would not reach the task force until late the next day. The CSM was left in TAA Roosevelt, with the mission to clear the assembly area.

### THE TASK FORCE SCREEN

Early on 4 February, the task force deployed into a twenty-five kilometer screen line to the right (East) of the cavalry squadron. The general trace of the task force was aligned with a slight ridge line running east to west.

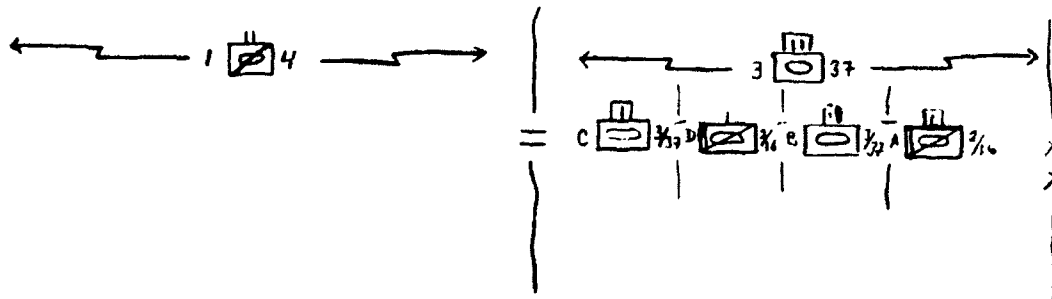

Figure 2. The Task Force Screen

Charlie team, with three tank platoons and an infantry platoon was positioned on the task force left, adjacent to the cavalry screen. Two desert trails met forward of the Charlie team sector and formed a possible enemy axis to the south, toward the support base. Delta company (-), with two infantry platoons, occupied the broken ground between Charlie and Bravo team.

Bravo team, organized with two tank platoons and one mechanized infantry platoon was positioned astride a desert trail running north to south. Alpha team, with two mechanized infantry platoons and a tank platoon was positioned on the task force right (East) flank. It was responsible for maintaining contact with elements of the 1st Cavalry Division located on its right flank.

Observation posts, occupied by M1s and M2s, supported by a dismounted infantry section, were positioned along the screen line. The length of the screen line prevented the task force from maintaining a tank company behind the screen line as a counter attack force. One tank platoon from Charlie team was maintained as the task force reserve. Ground surveillance radars (GSR) were positioned with the teams to cover possible avenues of approach and dead space. Mortar sections were positioned behind the tank teams.

Scout platoon sections augmented the screen line. The scouts primary mission was to insert and extract Division Long Range Surveillance Detachment (LRSD) teams. The LRSD teams were positioned forward (North) in the task force sector. Their

mission was to conduct surveillance along the South side of the earth berm along the Iraq-Saudi border.

The nature of the mission required the task force to implement two mission specific SOPs. The first was a simple rule of engagement (ROE). Intercepting and capturing deserting Iraqi soldiers was an implied task. Every effort would be made to permit them to surrender. A warning burst of machine gun fire would be fired to the left of any dismounted Iraqi soldiers, giving them the chance to surrender. Enemy armor vehicles would receive killing fire.

The possibility of "green" untested soldiers and leaders becoming involved in a fratricide was very real and dictated the need for a second SOP. No movement of vehicles would occur after darkness or during sand storms without the approval of the team commander and knowledge of the task force tactical operations center (TOC). Control of fires and vehicle movement was paramount. This was especially true during periods of reduced visibility and darkness. The exact location of each vehicle and dismounted position was recorded with a GPS and reported to the TOC by team commanders each day at 1700. The TOC maintained a matrix with the current location and activity of each vehicle on the screen line.

## THE IRAQI CAMEL ATTACK

The first night on the screen line tested the task force's ability to identify and intercept the enemy. Intelligence reports from the cavalry indicated suspected dismounted and vehicular

enemy activity south of the border berm. As dusk fell, the task force was engaged in an intense surveillance operation. The first activity was the enemy's use of indirect illumination. Numerous spot reports indicated the enemy was using artillery or mortars to illuminate the general trace of the border. It was difficult to determine how far the illumination was from the border. None of the task force observation posts could clearly identify the border berm.

By 2000 the cavalry was reporting dismounted and vehicular movement in their sector. The task force GSRs soon identified vehicles moving into the task force sector. They were moving from east to west and would periodically stop. No M1s or M2s were able to identify the targets with their thermal sights.

After notifying the Division TAC of the enemy contact, the targets began moving at a high rate of speed into Charlie teams sector. The reserve tank platoon was scrambled and moved to a position which would enable them to intercept and engage the targets. After several minutes of silence on the task force command radio net, a spot report was sent by Charlie team. The platoon had the enemy fixed but was pretty sure the ROE prohibited them from shooting camels. A camel herd, nationality unknown, had provided the task force with an intense rehearsal. The task force had executed its mission, while maintaining strict fire discipline-no rounds were fired. We had passed our first test.

The first days on the screen line were fairly calm and gave

the task force time to re-group from the tactical move and become comfortable with its new command and mission. The scouts immediately began inserting the Division LRSD teams. The company-teams refined their positions, conducted maintenance and test fired small arms weapons. The mortar platoon registered its guns and the task force engineer company quickly dug in the task force TOC and the Division TAC.

BG Carter assembled his command group each afternoon to discuss the current situation, maintenance status, issue guidance and determine if anyone had received a "care package" containing cigars. Tobacco products, especially cigars, were hard to come by and were eagerly shared by the combat command commanders.

The lack of cigarettes in the task force became a morale problem. This seems like a minor point, but soldiers preparing for battle tend to smoke. Tobacco was removed from rations years earlier and was not available in the supply system. The only way to obtain it was through the Post Exchange (PX) system. Units were authorized to establish a PX. The catch was dedicating a truck and sergeant to the task of making a distant round trip to a rear logistics base to obtain the goods. Our expected move had stalled task force efforts to get the system working.

The CSM was a step ahead of the problem and brought a "PX truck" with him to our new location. Now all the soldiers needed was cash to buy the goods. Unfortunately there were no cigars in the "PX truck" inventory.

The ad hoc group of units in the combat command quickly

jelled as a team and became a credible combat force. Cavalry air operations forward in the combat command sector were coordinated and executed. LRSD teams were inserted and withdrawn. The combat command developed a contingency plan for the defense of LOG BASE JUNCTION CITY. The task force mission was to collapse the screen line, move and establish a hasty defense to stop an enemy attack of the base. The cavalry squadron would continue to screen and cover our move to the defensive position.

The only activity that wasn't going well in the task force was our effort to capture Iraqi enemy prisoners of war (EPWs). The cavalry squadron, augmented with Apache helicopters, had reported several instances of vehicles and personnel operating in the vicinity of the border in their sector. Most activity was centered around a small group of buildings on the border known as the "town". On 6 February, they captured several EPWs. No one in Task Force 3/37 Armor had seen an Iraqi.

Enemy activity in the task force sector during the first few days was limited to the nightly illumination of the battlefield. Each night they would fire numerous illumination rounds. Occasionally, high explosive impacts were observed during the periods of illumination. We concluded the enemy was using the illumination as a part of his surveillance plan. We speculated the illumination rounds were being fired to identify Iraqi soldiers trying to desert and not enemy reconnaissance elements. Our first significant enemy contact, since the camel attack, occurred on 7 February, and gave us cause to reconsider our

conclusion about the intent of the enemy surveillance operation.

### STINGER VERSUS RPV

At about 1900, on the 7th, the task force TOC began receiving reports of an unidentified aircraft in the sector. Several spot reports indicated it was a propeller powered aircraft, with three flashing red lights. Occasionally, it flashed a white light which appeared to be a photo flash. The XO made a visual sighting as the aircraft circled the task force trains location. He confirmed the reports. During the next two hours the aircraft was observed by all the units in the combat command, but was not engaged.

Intelligence personnel in the units and the Division TAC quickly dug out enemy equipment documents to determine if it was an Iraqi aircraft. Negative responses to requests to confirm it was a friendly remotely piloted vehicle (RPV) indicated it was not friendly. It returned on the night of the 8th of February. Both the cavalry squadron and the task force requested permission to engage the aircraft. Requests were denied.

When the aircraft returned the following night, 9 February, it was one of many activities occurring in the combat command sector. During the day several radio nets in the task force were apparently "jammed". The combat command's intelligence company could not locate the source of the jamming but suspected it was coming from the enemy. During the previous twenty-four hours the cavalry had identified enemy activity around the "town" (a small group of buildings) in their sector. By 1900, they were reporting



additional mounted and dismounted activity in their sector.

During the afternoon meeting with BG Carter, the possibility of the "town" being the source of the jamming, the staging base for the RPV, and an observation post for enemy artillery observers was discussed. The cavalry had observed an antenna on the large building in the "town". This, and the enemy activity around the town indicated it the enemy was using it for some purpose. The cavalry was given the mission to destroy the antenna with an Apache Hellfire missile. We would also try to engage and destroy the RPV.

"Lock on and engage." With this command, BG Carter unleashed the air defenses of Combat Command Carter. In fact, the cavalry had engaged the aircraft with small arms fire when it entered their sector at dusk. Carter's order to fire came at 2014. At 2033 a STINGER air defense missile was fired at the RPV by an air defense gunner. Seconds later, the STINGER self-destructed at maximum range and RPV continued to fly toward the 1-5 FA command post. The events of the intervening eighteen minutes between the order to fire and the actual launch of the missile were an object lesson in who controls air defense assets.

Upon receipt of the order to fire the air defense platoon leader called his battery commander for permission to fire. Since the aircraft was not committing a hostile act he could not engage with out authorization. The platoon leader could not raise the battery commander on his radio. Following SOP, he radioed the Division Air Management Element (DAME) and requested permission

Division Air Management Element (DAME) and requested permission to fire. The DAME authorized the engagement. (Note: the DAME the platoon leader contacted was located at the Division TAC, BG Carter's location when he issued the order to engage the aircraft.)

After receiving authorization to fire, the air defense platoon leader instructed the STINGER squad leader to "lock on" the RPV. The squad leader reported lock on and the platoon leader then requested permission to fire for the second time. The order to fire was repeated and the missile was fired. All eyes were on the horizon as the missile self-destructed. The target was out of range.

Several lessons were learned during the engagement. Air defenders follow the current rules of engagement and execute battle drill in war the way they've trained in peacetime. We failed to kill the target because we failed to rehearse the engagement.

We had ample opportunity to practice the engagement. From the first spot report on the RPV two days earlier, the intent to engage the aircraft was well understood. We requested permission to engage the aircraft on the previous night, but the request was denied. We anticipated we would get permission but failed to take the steps to ensure success when the opportunity came. The next night, the task force failed to accomplish another mission. Again, we failed to rehearse.

## THE APACHE AND THE COPPERHEAD

At the 1600 commanders meeting on 10 February, BG Carter directed the task force attempt to destroy an antenna on a building along the border in the task force sector. The previous night's attempt to destroy the antenna in the "town" with a HELLFIRE missile had inconclusive results. This time we would use the Apache to designate the target for the 1-5 FA Battalion. They would engage the target with a COPPERHEAD round fired by a 155mm self-propelled howitzer.

In theory this was a fairly simple operation. Position the Apache where it could designate the target with its fire control laser. Once the target was identified and designated, the artillery would fire the COPPERHEAD round and the round would "see" the laser beam and follow it to the target. In practice, this mission would require detailed coordination between the three units involved. In reality, neither the Apache gunner or the artillery unit had ever practiced the engagement.

The necessary coordination was completed and the aircraft arrived on station in the task force sector at about 1930. The first problem surfaced when the Apache identified the wrong target. There were two buildings in the task force sector. One was on the Iraqi side of the border, the other was on the Saudi side of the border. The buildings were nearly two kilometers apart. We were restricted to only engaging targets on the Saudi side of the border. Our target was the building with the antenna. It was on the south side of the border berm.

As the Apache pilot read the grid coordinates of his target over the task force command radio net, it was clear he was targeting the wrong building. The task force S3 talked him onto the right target and we continued with the mission. The second problem surfaced as the mission was being executed. The Apache gunner announced he had his laser on the target. The COPPERHEAD was fired. As the round was in the air several seconds, the Apache gunner asked if he needed to continue designating the target. You could hear tank commanders throughout the sector close their hatches. Soldiers in one of the task force observation posts reported they observed a ground burst of artillery about two kilometers from their location. The round had come closer to hitting us than the enemy. Fortunately the aircraft was out of station time and the mission was canceled.

This episode highlighted the difficulty of trying to do something in combat that you've never done in training. The 4/5th Artillery spent several days and rounds perfecting their COPPERHEAD gunnery. Failing to shoot down the RPV and destroy the antenna bruised the pride of the task force. Morale improved dramatically the next day as the task force captured its first EPWs.

## THE ENEMY

Since the first planning for the attack, intelligence estimates indicated we would encounter one or more Iraqi Infantry Divisions, reinforced with artillery and armor. Initial planning was done against the doctrinal template of an Infantry division

defense.

The Iraqis would employ a security zone forward of the main defensive positions. The security zone would consist of dismounted infantry positions supported by artillery and armor. The main defensive positions would consist of bermed, triangular shaped, battalion strong points arrayed in depth. The strong points would be protected by mine fields, tank ditches, and earthen berms. Mine fields, consisting of anti-tank and anti-personnel mines, would cover forward positions and channel enemy armor into engagement areas. Direct and indirect fire would be employed against enemy in the engagement area. Tank heavy reserve would be used to counterattack enemy armor forces.

By the time the task force arrived in TAA Roosevelt, intelligence reports from higher headquarters, indicated the enemy infantry divisions in the 1st Infantry Division's attack sector were not employing triangular strong points. They were deployed in a more traditional linear defense employing the U.S. Army Command and General Staff Officers College (CGSC) school solution of two up and one back. Two infantry brigades were deployed on line with a third brigade defending behind the forward brigades.

This battlefield symmetry was also employed within the battalion and company defenses. The Iraqis were employing a security zone with dismounted infantry, armor, and artillery. Our experiences to date, indicated the Iraqi's were employing a fairly aggressive reconnaissance and counter-reconnaissance force

from the border to the main defenses along PL WISCONSIN.

At this point, the principal shortfall in the task force enemy situation template was a lack of specific locations of enemy positions and obstacles. Detailed aerial photograph's of the enemy defenses in the brigade's sector, accompanied by clear and detailed interpretations, were provided to the task force. Unfortunately, they did not come with specific map grid reference points. Some photos had latitude and longitude markings, but we weren't skilled enough to translate them to grid reference points. Additionally, there was no reference with regard to the scale of the photos.

There was no way to accurately identify the location of the enemy positions. The 1:50,000 scale operations maps in the task force showed little identifiable terrain. Since the aerial photo's did not show any identifiable terrain, there was no way to match similar terrain on the photos to terrain on the maps.

### THE EPWS

During the period 11 through 13 February, the task force captured fifteen Iraqi soldiers. The soldiers were all deserters. The first group of seven EPWs were captured by Charlie team on the morning of the 11th. The EPWs were all Kurds and claimed to be from the 110th Brigade of the 26th Infantry Division. They were armed with one AK47 rifle. Only two of the Kurds spoke Arabic well enough to be interrogated.

The second group of five EPWs were captured by Bravo team at about 1230 on the 11th. They were all Iraqis and claimed to be

from the 434th Brigade of the 26th Infantry Division. Three additional EPWs were captured by Charlie team on the morning of the 12th. They were Iraqi and claimed they were from the 110th Brigade of the 26th Division.

The information the EPWs revealed during their interrogation literally "fleshed out" the enemy situation in the task force attack sector. The enemy defenses were about 17 kilometers from the border berm. The infantry brigades were arrayed with two battalions up and one back. Some battalions employed two companies forward with one back. Others seemed to employ three companies on line with platoon reserves.

The infantry positions consisted of various types of fighting positions. As expected the primary position was a single trench approximately one-hundred meters long. The trenches were generally less than a meter wide and only shoulder depth. Most trenches had individual or collective bunkers built into the walls. Collective bunkers held from five to twenty-five soldiers.

There were far fewer enemy obstacles than expected. Some battalions had emplaced anti-personnel mine fields in their defenses but there were no reports of anti-tank mines. There were no berms in the defenses and the only obstacles in addition to the mines were rows of single strand wire. There were not enough anti-personnel mines.

Artillery positions were located from three to seven kilometers behind the front line battalions. The artillery had suffered the brunt of the Air Force attacks. There were

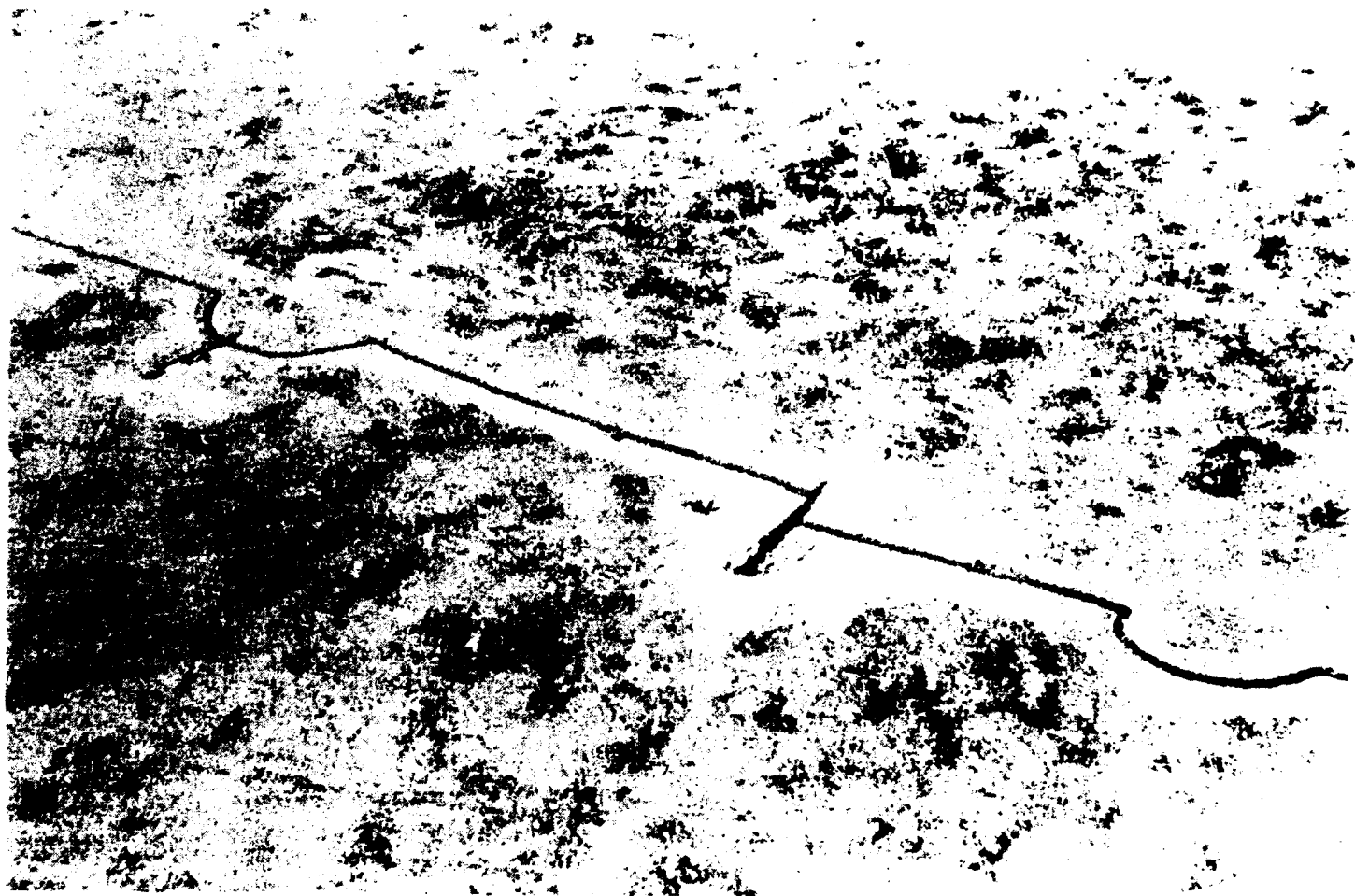

The Iraqi trench line at PL WISCONSIN. (Photo of a section of the trench line in the 1s Brigade sector, just west of the 1st and 2nd Brigade boundary. (The photo was taken after the battle and shows a section of trench line not "closed" during the attack on G-DAY, 24 February, 1991.)



indications of some type of chemical munitions in the ammunition storage areas. The possible presence of these munitions was tempered by the low level of NBC training of the EPWs. They all claimed to have NBC protective masks but few knew how to use them.

The infantry battalions were armed with the doctrinal array of weapons. Soviet rocket propelled grenades (RPG) 7s and AT-9 SPIGOT recoilless rifles were the primary dismounted anti-armor weapons. There were no reports of anti-armor missiles such as the Soviet SA-3 SAGGER.

Each brigade had a tank regiment with four companies of four tanks each. The EPW descriptions of the "tanks" confirmed earlier cavalry spot reports. The infantry brigades were probably equipped with Brazilian made Jararaca scout cars, and Urutu armored personnel carriers armed with heavy machine guns, and Cascavel armored cars (tanks) armed with a 90mm cannon. Additional Soviet OT64 light armor vehicles and T55 tanks reinforced the infantry brigades and formed the nucleus of the reserve armor forces. None of these systems posed a significant threat to the M1 tank.

The morale of the enemy appeared to be very low. The EPWs claimed they had received little food and water. They had dug "wells" and were drinking the salty water they produced. A shortage of fuel prevented them from cooking the rice and other food they had received. Many Iraqis had deserted or been killed by the air attacks. Some units were at fifty percent of

authorized personnel strength.

The psychological leaflets "dropped" on the enemy had encouraged the EPWs to desert. They believed the leaflets were their "free passes" and were afraid to surrender without them. One group of EPWs shared a single pass, each holding on to a part of the pass as they surrendered.

The EPWs were surprised to find U.S. forces south of their positions. They were equally surprised we didn't execute them. They had been told U.S. forces would kill any Iraqi they found! To a soldier, every EPW believed Syrian or Egyptian forces were the only forces deployed so far west in Saudi Arabia. The implication was clear. The Coalition plan to achieve surprise was working.

### THE ENEMY SITUATION TEMPLATE

The information provided by the EPWs, when combined with the existing enemy situation template, answered most specific intelligence requirements. The task force attack would split along the boundary of two Iraqi infantry brigades. The battalions were deployed with companies on line with platoons in depth. We would only have to breach a single line of defenses (Figure 3). There were no continuous anti-tank mine fields and no berms and tank ditches to complicate the breaching operation.

The template indicated the greatest threat to the operation would come from an reserve tank company located in the 110th Infantry Brigade. The company could remain in position or counterattack toward the breach location. Unfortunately it was

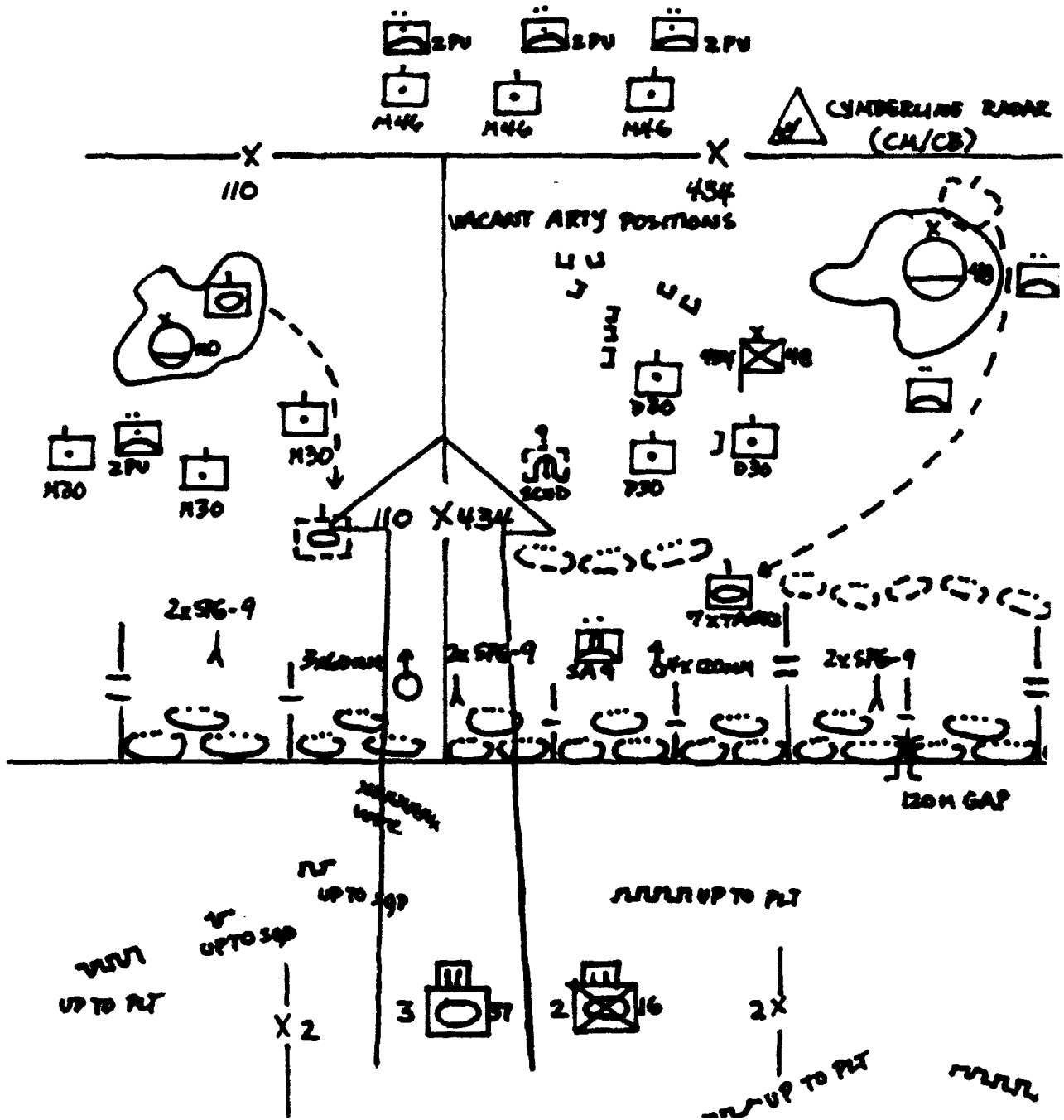

Figure 3, Enemy Situation Template.

located just across the 2nd Brigade boundary, in the 1st Brigade sector. We would need to fire across the brigade boundary to engage and destroy it. We had coordinated the breach operation with Task Force 5/16 Infantry, the 1st Brigade breaching force on our left flank. Their mission did not have them attacking north toward the tank company. Instead, the 1/34 Armor Battalion would move north of 5/16 Infantry to the vicinity of the tank company. More coordination was required.

As a result of the EPW interrogations, a debate started over the identification of the Division the brigade would attack. Intelligence estimates identified the 48th Infantry Division. The EPW reports indicated the division was really the 26th Infantry Division. The task force situation template used the 48th Division. In any case, the enemy situation was becoming very clear.

### END OF MISSION

On 12 February, the task force received a warning order to prepare for a change of mission. On 14 February, the 3rd Brigade, would assume the screen mission from Combat Command Carter and extend the screen north toward the border. The cavalry squadron would be attached to the 3rd Brigade and Task Force 3/37 Armor would revert to the command and control of 2nd Brigade. The 2nd Brigade main body was moving into positions in the vicinity of the task force sector during the next forty-eight hours.

Task Force 1/41 Infantry of the 3rd brigade would conduct a forward passage of lines through Task Force 3/37 Armor, and

assume our mission. They and the 1/4th Cavalry would move the screen line north, closer the international boundary. The cavalry would clear the "town" as they extended the screen north with Task Force 1/41 Infantry. The S3 immediately began coordination to ensure a smooth transition with Task Force 1/41 Infantry.

On 13 February, the task force received instructions from the Division TAC to send two mechanized infantry platoons to 1/4 Cavalry to assist in clearing the "town". A clarification of the tasking indicated the cavalry needed an infantry company for the mission. Task Force 3/37 Armor would maintain its screen for twenty-four hours while the infantry was attached to the cavalry squadron. The commitment for the infantry company meant we would need to withdraw either Delta company or Alpha team from the screen line.

Attaching Alpha team to the cavalry was not a viable course of action. They had become very good at maintaining contact with 1st Cavalry Division elements on their right flank. Their mission was complicated by the 1st Cavalry's practice of rotating different battalions through their sector on our right flank. The units were due to for another rotation. A potential problem developed as this change was coordinated by Alpha team. The movement of the 3rd Brigade north in the 1st Division sector was not being mirrored by the 1st Cavalry Division. The result would be a considerable gap in the boundary between the two Divisions. The Division TAC was told of the potential problem. While the problem was being sorted out, it was imperative that Alpha team

maintain contact with the 1st Cavalry.

The mission to assist the cavalry fell to Delta company. Charlie team was instructed to return its infantry platoon to Delta company and expand its screen line to include the sector vacated by Delta company. Delta company was attached to the 1/4th Cavalry. They moved to link-up with the cavalry squadron on the evening of 13 February.

### THE ATTACK OF THE "TOWN"

My knowledge of the events surrounding the attack of the "town" on 14 February, is second hand and was related to me by Captain Mark Hammond, the Delta company commander and LTC Wilson the cavalry squadron commander. The company was given the mission of clearing the town. The enemy situation was unsure, but there was a possibility there were Iraqi soldiers in the small complex of buildings.

The concept of the operation was to use M2s to fire 25mm rounds into the complex as an assault platoon moved to the complex and dismounted soldiers to clear it. Little resistance was expected. As the company moved from its attack position to the "town" a unsubstantiated report indicated the possible presence of enemy on the roof of the large building in the complex. As the dismounted elements of the company entered the complex they began firing and using grenades to clear the compound. Command and control of the operation was lost and the result was two casualties from friendly fire. One soldier was wounded by an M-16 round. The other was wounded as a grenade was

thrown into a corrugated steel structure. A third soldier cut his hand during the operation and was counted as the third fratricide casualty. Once the firing was stopped, the building was cleared without finding any enemy soldiers. The requisite investigation of the incident was quickly done with the expected result. The company commander had simply failed to command and control his outfit.

One irony of the operation was that Delta company was featured in an Associated Press article several weeks earlier. Soldiers in the company were interviewed while the company was test firing weapons at the VII Corps gunnery complex. Several soldiers, including one that was wounded in the incident, were quoted as they described their ability to successfully conduct dismounted operations against Iraqi positions.

A second irony was, that here in the middle of the desert, we would become involved in clearing a built-up area! None of the training for the NTC had included urban operations and we did not expect to do this type operation at the NTC or in the deserts of SWA.

Urban operations were not on the task force Mission Essential Task List (METL). In fact, during my initial tour of training facilities at Fort Riley, I was shown the location where the combat in the cities training facility used to be. It was torn down sometime earlier. Never the less, the soldiers of Delta company were capable of successfully executing the operation. Their "first battle" had turned out like many others before them.

## CONTROLLING THE DIRECT FIRE FIGHT

Delta company's attack of the town and its fratricide casualties, triggered a rigorous discussion about the command and control of direct fire. COL Moreno quickly addressed the issue and provided the soldiers in the brigade with sound, simple and clear guidance. "Leaders control fires." He expanded his guidance to explain that commanders were responsible for approving fires of their subordinate elements. Approval for firing was contingent on a correct understanding of the current situation. The correct understanding of the current situation required leaders to know the location of friendly and enemy forces.

Given the range of weapons relative to the spatial relationship of forces on the battlefield, the company-team commanders and the battalion commander were the leaders capable of having the level of understanding. Accordingly, they were the leaders that approved fires. This did not relieve subordinate vehicle commanders, platoon sergeants, and platoon leaders of the responsibility to identify the enemy and initiate fires. It did emphasize the point that they were responsible for knowing when they were cleared to shoot and when they needed to request permission to fire. Engaging the enemy in an act of self-preservation did not require authorization. If leaders were doing their job, there would be no doubt, that fire directed at them was enemy fire.

The ugly situation with Delta Company and its chain of command tainted the task forces performance as a part of Combat



Command Carter. It had the potential for becoming a significant distraction to our preparation for the attack. COL Moreno turned a bad situation into a positive teaching tool. He immediately directed the company commander to begin a tour of every company in the brigade. His mission was to conduct an AAR of the attack of the "town" to highlight what had gone wrong and present lessons learned.

COL Moreno also spent a considerable amount of time discussing the operation with the members of the company. Morale was very low in the company, but significantly improved after his visits to the company. This action, along with the briefings conducted by the company commander, brought the company back to life. The brigade commander had provided us with a textbook example of professional leadership in action.

### THE ROLE OF THE COMMANDER IN COMBAT

During the period on the screen line MG Rhame had given me some very specific instructions on the role of the commander in combat. The incident with Delca company drove his instructions home. His counsel began with two specific orders: "Keep your hand off the trigger," and "don't break trail." He then clearly outlined his thoughts on both orders. The commanders job is to command and control the outfit. There are ample weapons and crews to do the killing. Get them to the right place, at the right time on the battlefield, and let them do their job. He did not prohibit the commander from commanding forward and when necessary putting himself in harms way. He did make the point that

effective command and control would usually negate any need to personally engage in the direct fire fight. His guidance on not "breaking trail" was equally straight forward. Keep your tank tracks in the tracks of another tank and you'll never find yourself too far forward or the casualty of an anti-tank mine.

Rhame's instructions clarified my thoughts about my role as the task force commander. Massing weapons and soldiers at the decisive point on the battle field at the right time, was clearly the primary task of the task force commander. My vision of when, and where, to become personally involved with the direct fire fight was not so clear. I had previously attempted to envision the situations in which I would engage in the direct fire fight. Self-defense, against a dismounted infantry team, armed with light anti-tank weapons, or an enemy tank, at close range, were easy decisions. Both were situations I would engage the enemy in self-defense.

A tougher task was to determine the possible situations in which I would enter the direct fire fight to influence its outcome. The action at the breach was clearly the most likely circumstance. If the breaching effort was stalled, I would move to the point I could influence the fight and if necessary, attempt to establish a lane through the defenses. The task force engineer company commander, Captain Robert L. Savatorelli, understood that he would come forward with his CEV equipped with a mine rake, if the breaching operation was having trouble. We would lead an attempt to establish a lane through the defenses.

To increase my field of view while "buttoned-up" in my tank, my machinegun, mount and sight were removed. Although my intent was to see better, most observers felt it was removed to emphasize the fact that the task force commander would command the outfit rather than fight his tank. My close associates knew the truth. I really need to see better and was not enamored with the capability of the machinegun. They also knew from previous gunnery exercises that employing it was not one of my strong points. The S3 openly displayed his delight with the act. His tank moved directly to my left front per the command group SOP!

Given the nature of the threat, my crew carried a heat round in the main gun.

I had not thought about the technique of staying in another vehicle's tracks. It made sense. I adopted it as one of my personal SOPs and informed the S3 and the team commanders to do the same. The XO had already issued similar instructions to the driver of the M577 command track he rode in.

### THE TASK FORCE MISSION

On 12 February, during the most hectic period on the screen line, the task force published its operations order for the attack. The order incorporated the refinements to correct deficiencies identified during the rehearsals, additional information from higher headquarters, and our recently acquired knowledge of the enemy.

The task force mission was to attack to penetrate Iraqi defensive positions, destroy enemy first echelon forces in zone,

establish a breach head at PL COLORADO, and conduct the forward passage of 3d Brigade, 2AD. On order, the task force would continue the attack to PL NEW JERSEY, and then PL OMAHA.

## ORGANIZATION FOR COMBAT

The task force organization for combat was generally a mirror image of the organization the task force had used during the screen mission. Four company-team maneuver elements: two tank heavy teams, a mechanized infantry heavy team, and an infantry company minus (-), formed the maneuver force.

Alpha team (mechanized infantry heavy) was organized with two organic infantry platoons, and a tank platoon (1st Platoon, Bravo Company, 3/37 Armor).

Bravo team (tank heavy) was organized with two organic tank platoons, a mechanized infantry platoon (1st Platoon, Alpha Company, 2/16 Infantry), an engineer platoon (3rd Platoon, Charlie Company, 1st Engineer Battalion), and a VULCAN platoon (2nd Platoon, Charlie Battery, 2-3rd Air Defense Battalion).

Charlie team (tank heavy) was organized with three organic tank platoons, a mechanized infantry platoon (1st Platoon, Delta Company, 2/16 Infantry), a VULCAN air defense platoon (1st Platoon, Bravo Battery, 2-3 Air Defense Battalion), and an engineer platoon (1st Platoon Charlie Company, 1st Engineer Battalion).

Delta Company (-) consisted of two organic mechanized infantry platoons.

The engineer platoons in both tank heavy teams were

reinforced with two AVLMS. Both teams had three mine plow tanks and three roller tanks.

Each of the maneuver teams/companies had a fire support team (FIST) from the 4/5th FA, the 2nd Brigade direct support artillery battalion.

Attaching the air defense platoons directly to the teams violated Army doctrine but was necessary to ensure they were effectively controlled and employed during the breaching operations. We intended to use the VULCAN air defense guns in a ground support role if no enemy air threat materialized during the operation. The positioning of the VULCANS and the control of their fires in the ground support role was clearly the business of the tank team commanders. (Note: the air defense platoons were listed under task force control in the actual OPORD.)

ion.

The scout platoon, mortar platoon, a GSR team (Bravo Company, 101st Military Intelligence Battalion), the remainder of Headquarters and Headquarters Company, 3/37 Armor, and Charlie Company (-), 1st Engineer Battalion, remained under task force control. Task force also had its doctrinal fire support element (FSE) from the 4/5th FA. Two photographers from the Department of Defense rounded out the task force organization for combat.

The total personnel strength, counting soldiers assigned, attached and or in direct support to the task force was one thousand and thirty-eight. There were two hundred and seventy-three combat, combat support, or combat service support vehicles

in the task force. We never bothered to count the total number of weapons in the outfit!

### COMMANDERS INTENT

My intent was issued verbally and was very simple: "punch a hole through the first defensive line; kill or capture the enemy that get in the way; and protect the breach from enemy direct fire, so follow-on forces can get through the hole." Every soldier in the task force understood how and why we would force the breach.

### CONCEPT OF OPERATION

The operation would begin with task force movement to contact from PL VERMONT to PL BIRCH. The task force would destroy enemy counter-reconnaissance elements in the security zone while conducting a zone reconnaissance as it moved forward.

The movement to contact would be done in a task force box formation with the scout platoon screening forward, followed by Charlie Team of the left and Bravo Team on the right. Alpha and Delta teams followed with the mortar platoon moving between the tank and infantry teams (Figure 4).

The task force command group would move in the middle of the box and was followed by the remainder of the attached engineer company and the task force TOC. The task force combat trains consisting of the task force administrative and logistics operations center (ALOC), the primary and jump medical aid station, a maintenance and recovery section, and a class III

emergency resupply of three fuel trucks with seventy-five hundred gallons of fuel, would move directly behind the task force formation. The task force field trains moved as a part of the brigade field trains.

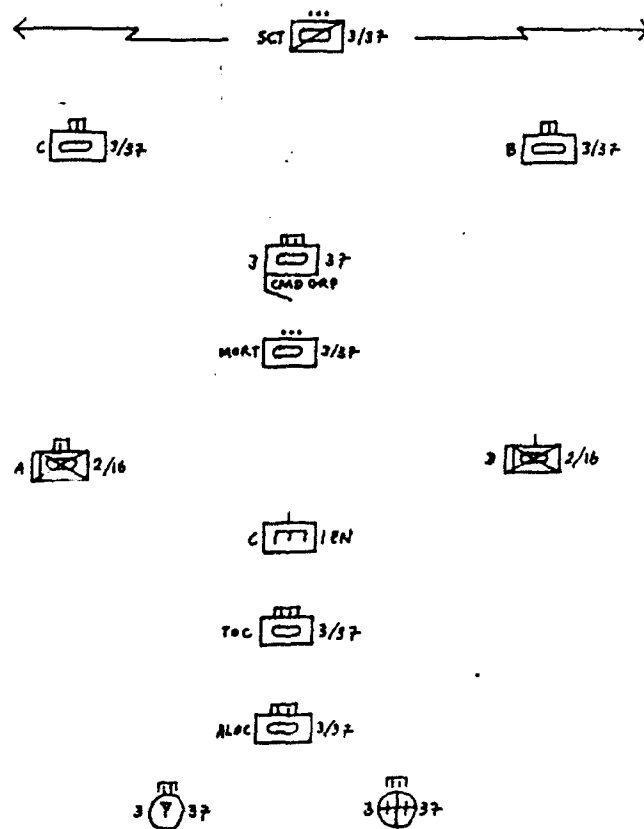

Figure 4, Task Force Box Formation.

## THE TASK FORCE BOX FORMATION

The BOX formation was not doctrinal movement to contact formation. The DIAMOND formation, with an advance guard company-team followed by two teams abreast with a team trailing, is the suggested formation a task force should use when conducting a movement to contact. The box formation had several advantages over the doctrinal formation.

The movement to contact to PL Birch had the potential to become a meeting engagement. We expected enemy outposts consisting of dug-in infantry with some light anti-armor capability. The EPW reports of numerous RPGs made security zone dismounted infantry a credible threat against the lightly armed M2s and M3s. We also expected the positions to employ some protective mine fields, which would be the real threat to the force.

The fire power and protection provided by two tank teams forward would ensure a successful seventeen kilometer movement through the Iraqi security zone. Given our expected advantage of out-ranging and acquiring enemy armor, the tank teams provided the task force with an immediate edge in a meeting engagement. The breaching tank platoons, with their mine plows and MICLICs gave the task force the ability to breach mine fields in stride.

The box formation also facilitated command and control of the task force. The command group was able to observe much of the task force as it moved. Once contact was made with the enemy, the command group quickly shifted its location to a point in the



formation which afforded an accurate assessment of the situation. If radio communications failed, the command groups ease of movement improved the chances for timely face to face communication between commanders.

Finally, the BOX formation was the formation the task force would use as we attacked the enemy defenses. The task force attack template developed after our full scale rehearsal back in TAA Roosevelt assigned each vehicle as specific location on the battlefield during the attack (Figure 5). The template also lent itself to movement in the BOX formation. Vehicles moved in generally the same positions during the movement in the formation. The movement to contact would provide practice moving in this formation, something the task force had not done since the task force rehearsal in TAA Roosevelt, nearly a month earlier.

## THE FRONTAL ATTACK

At PL BIRCH, the task force would move into attack position. Following a night of artillery fires and an early morning two and one-half hour artillery preparation, the task force would conduct a frontal attack to breach the enemy defenses.

The concept of operation for the breach was a refinement of the rough plan used in the dress rehearsals in TAA Roosevelt (Figure 6). Charlie Team, the task force main effort, would breach LANES INDIA and JULIET on the task force left. Bravo Team, would breach LANES KILO and LIMA on the task force right.

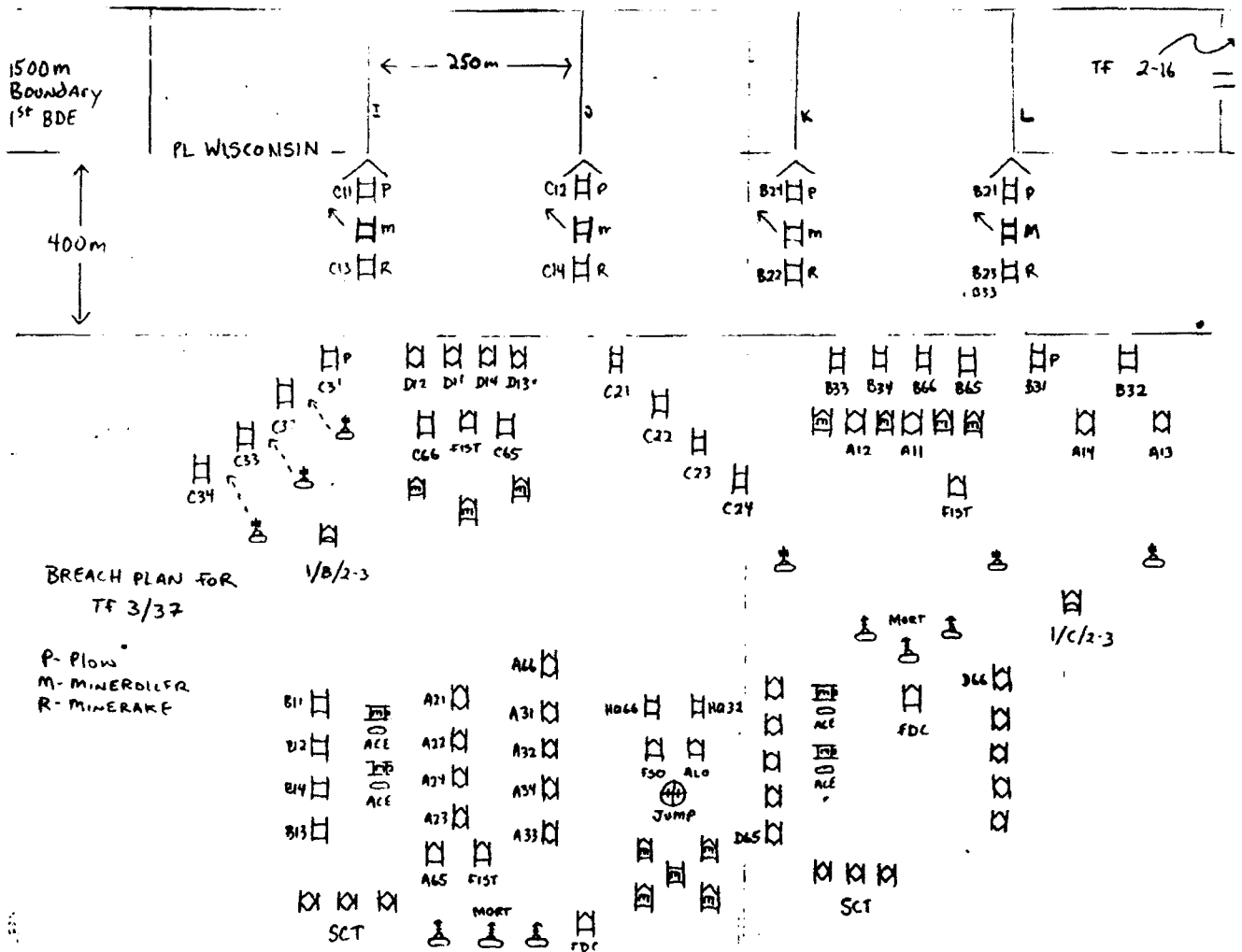

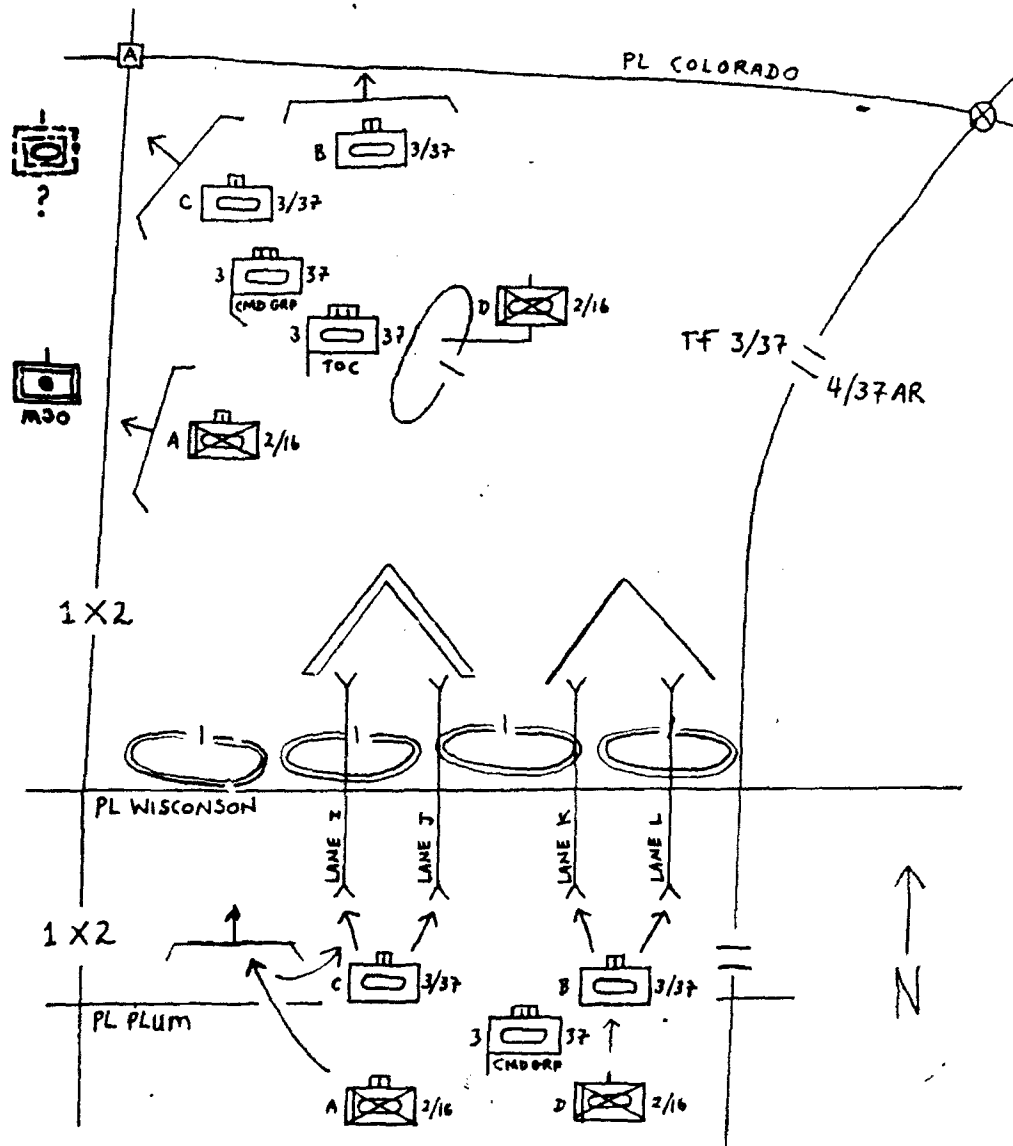

Figure 6, Attack Scheme of Maneuver.

The lateral distance between each lane would be approximately two hundred and fifty meters. GPS's on two of the plow tanks would insure the relatively accurate start points for the breach teams.

Alpha team would move up from behind Charlie Team and a occupy a support by fire position on Charlie teams left flank. Alpha would assist Charlie with suppressive fires as the breach teams moved forward and established the lanes through the defenses.

As the lanes were cleared by the breach teams and marked by the engineer squads, Bravo and Charlie would begin moving their tank platoons through the lane. Once through the lanes both teams would temporarily assume a hasty defense on the north side of the enemy positions. The Plow tanks would begin closing the trench line as the tank platoon moved through the lanes. Alpha team and Delta company (-) would continue to overwatch the trench line and suppress the entrenched infantry with 7.62mm machinegun fire. Alpha team would then follow Charlie team and take up attack by positions on the task force left flank.

As Alpha team moved through the breach Charlie and Bravo teams would continue the attack north to engage and destroy any counterattacking armor. The tank company just across the brigade boundary was their primary target. As the attack continued a cleared zone, similar to a bridge head in a river crossing operations, would be established and expanded.

Delta company would be the last task force maneuver team to move through the breach. Their mission was to take control of

the breach area and ensure all positions were cleared of enemy soldiers and destroyed. They were also responsible for EPWs control and processing. ACEs would assist in destroying and closing the enemy defensive positions.

The task force scouts mission was to stay south of the breach lanes and link-up and lead elements of 4/37 Armor through the lanes. The scouts would then proceed north, staying on the left flank of 4/37 Armor and establish a contact point between 3/37 and 4/37. They would also screen the northeast portion of the task force sector along PL Colorado until Bravo team expanded its hasty defensive position to the east.

### FIRE SUPPORT

The attack would be preceded by a two and one-half hour artillery preparation on the enemy trench line and artillery positions. When the preparation ended and the attack began, fires would be shifted north of PL WISCONSIN to reserve positions and artillery positions. The fires would shift north as the breachhead expanded. If required, the mortar platoon would fire smoke to obscure the breach site from enemy fire. The brigade fire support plan was detailed and complete. All the task force commander and fire support officers had to do was shift and adjust fires as the task force expanded the bridgehead. CAS, would be directed against targets north of the breach location.

### ENGINEERS

The engineer MICLICs and platoons were committed to the

attack per the task organization..The company commander retained one CEV with a Mine Rake as a reserve. If necessary he would bring the CEV forward to augment the breach teams. This was the event that would take the task force commander into the "breach" and involve him in the directly in the fight! Since the enemy had not used berms or tank ditches, the ACES would not be a part of the breach teams but would be used to destroy and close Iraqi defensive positions.

Once the initial breach was accomplished, the engineer company was responsible for assisting in the destruction of the enemy positions and improving the breach lanes. They would also establish additional lanes for rearward movement. These lanes would support casualty evacuation. If time permitted, the ACES would also be used to prepare fighting positions for Charlie and Bravo teams.

### AIR DEFENSE

Per the task organization the air defense platoons were "attached" to the tank teams. If required, they would provide supporting ground fires with their VULCANS. STINGERS would provide the task for with air defense at the breach.

### CHEMICAL

The toughest tactical problem faced by the task force would be the presence of chemical agents at the breach. Mustard or blister agents in chemical mines or delivered by heavy mortars or artillery was the most likely situation. Our NBC protective

clothing provided protection against these agents and the plan was to continue the fight contaminated until the breach was complete and then secured from direct fire. The problem was contaminated casualties-friend and foe.

The task force XO, NBC officer, Medical Platoon leader, developed a plan to handle chemical casualties at the breach. After war gaming the challenge they determined two separate medical systems were necessary: a "clean" aid station and evacuation vehicles to handle uncontaminated casualties; and a contaminated aid station and evacuation vehicles to handle the "dirty" casualties.

The plan required the task force to create a chemical triage team capable of quickly determining contamination and injury status of the casualties. This team would move with the main aid station--the contaminated aid station--in one M577 and remain on the south side of the breach. The jump aid station--the "clean" aid station in the other M577 would move right behind the task force command group and move to the north side of the breach.

The sequence was based on the belief that there was a good chance the lead elements of the task force could get through the breach before chemicals were used on the breach site. This would put the tank teams, the task force command group, and the jump aid station through the breach and deployed to north side of the breach free of contamination. Casualties from these elements would be evacuated to the jump aid and then evacuated on alternate clean evacuation routes around the contaminated area.

The brigade breach plan had engineers cutting additional return routes in the brigade sector which would provide return routes for evacuation to alternate casualty collection points. "Dirty" casualties or casualties suspected of being contaminated would be evacuated south, to the main aid station. If the lead elements didn't make it through the breach lanes "clean", it wouldn't cause the plan to collapse. At this point all casualties would probably be contaminated and both aid stations would operate "dirty."

Since the medical platoon did not have enough medics to form the needed team, task force cooks volunteered to fill the team. The remainder of the cooks were trained as a hasty decontamination team. They would employ standard personnel decontamination procedures and use the new SNADR decon equipment to decontaminate vehicles and equipment.

### SERVICE SUPPORT

Combat service support operations for the attack were generally organized along doctrinal norms. The task force had enough water and rations for a minimum of five days of operations. The remainder of available transportation was committed to ammunition and fuel. The task force carried enough ammunition to fight for several weeks! We had about two basic loads of ammunition for each M1 and M2. This was the VII Corps policy.

The number of fuel trucks in the task force had grown to twenty-three. This really exceeded the requirements of a balanced



task force. If we didn't suffer many battle losses of fuel trucks, and the Division pushed fuel forward, fuel would not be a problem. The key to success was keeping the fuel trucks close to the task force and refueling at every opportunity.

To accomplish this, the fuel trucks were split into two sections. One was under the control the support platoon leader, 2LT Herb Franklin, and the other was controlled by the Headquarters and Headquarters Company commander, Captain Mike Alexander. A constant shuttle of fuel sections between the task force and the Division or brigade refuel point would keep the task force "topped off" with fuel. Making a company commander a fuel section "commander" might appear as over kill, but it did ensure the success of fuel operations in the task force.

### COMMAND AND CONTROL

The task force would use a doctrinal command and control structure for the attack. The command group consisting of the task force commander, S3, Fire Support Officer (FSO), and Air Liaison Officer (ALO) would provide direct command and control of the operation. The S3 and myself were mounted in our M1s. We each had two FM radios. I would stay on the task force command net and the brigade command net. The S3 would operate on the same radio nets. When necessary, he would "move" to subordinate unit internal radio nets. He would also "move" to the nets of units outside the task force to coordinate operations. The FSO and ALO, mounted in M113 Armored Personnel Carriers, would communicate on their doctrinal radio nets.

The task force XO served as the Second In Command (2IC) and operated from the TOC operations M577 command track. He, along with other doctrinal members of the TOC, kept track of the battle, provided intelligence and situation updates to the task force, kept the brigade apprised of the task force situation, and prevented the command group from making any wrong decisions. It was in fact an alter ego to the command group. When necessary, the 2IC talked directly to the brigade commander. Coordination with adjacent task forces was also conducted by the 2IC.

The Administrative and Logistics Operations Center (ALOC) operated as the task force alternate TOC and was responsible for coordinating CSS operations. The ALOC moved with the task force Combat Trains.

The task force Headquarters and Headquarters Company maintained a mobile command post with the field trains. They moved with the brigade trains and operated from the Brigade Support Area (BSA).

## EXECUTION MATRIX

The task force OPORD used execution matrices to simplify the execution of the task force scheme of maneuver. The task force movement to contact and the attack were outlined on two matrices. Each were kept as simple as possible so they were easily memorized.

The matrices were supplemented with the brigade and Division check points, contact points, coordination points, and the start and end points for the four task force breach lanes.

The primary control measures used were attack by fire and support by fire positions. In order to cover the plan and its possible branches, one hundred of positions were designated by grid coordinate and direction of orientation.

The GPS gave us the flexibility of designating this many positions on a rather featureless terrain. Task force commanders, scouts, mortars, selected platoon leaders, the TOC, the ALOC, the FSO, and the ALO were able to pre-program their GPS with the positions they would use to execute their part of the plan. As the fight progressed they could quickly delete unneeded positions and insert new positions. In theory and practice the GPS would serve to guide us from location to location throughout the fight.

### A SOVIET LIKENESS

As we reviewed the plan it became apparent the task force organization for combat and scheme of maneuver for the breach resembled the organization and tactics of our former enemy, the Soviet Army. The task force's fifteen hundred meter attack frontage was in line with our former enemy's attack frontages. The correlation of maneuver and artillery forces equalled or exceeded the Soviet norms for the attack. Our "deliberate attack" appeared to be a mirror image of the Soviet attack "from positions in contact."

There was no doubt the task force, with its substantial fire support, had the potential to achieve the principle of Mass and accomplish the penetration of the defenses. If executed with violence, skill, and speed, our seemingly rigid tactical concept

would provide VII Corps with a successful breach and the ability to execute the Operational Maneuver necessary to destroy the Republican Guard armor formations.

### MORE REHEARSALS

The completion of the task force OPORD and termination of the screen mission permitted the task force to begin intensive rehearsals of the attack. The task force had missed the full-up mounted rehearsals the brigade and Division conducted in TAA Roosevelt. We were behind the power curve. Terrain restrictions and current operations precluded another full-up task force dress rehearsal. The task force turned to dismounted rehearsals.

Wood blocks, representing company, platoon and section sized subordinate elements, replaced actual vehicles. The blocks were arrayed and moved on a large terrain mock-up on the ground per the task force plan. Maneuver and fire control measures were over-laid on the mock-up with tape and pre-made plywood symbols. Each phase of the task force plan was rehearsed in detail. Fire support, medical evacuation, and CSS operations also received additional, focused, rehearsals.

### FRIENDLY SUB-MUNITIONS

The question of dealing with friendly munitions, surfaced during one team rehearsal. Per the fire support plan, supporting tube artillery would only fire high explosive artillery rounds in the area of the breach. The task force ALO reported Air Force strikes against the enemy in the area of the breach were using

anti-armor and anti-personnel munitions. Additionally, the multiple launch rocket system (MLRS) rockets, used to attack specific command and control and artillery targets in the task force sector, would probably leave unexploded sub-munitions on the ground. We concluded there was a significant threat of fratricide casualties from artillery and aircraft sub-munitions.

Our doctrinal manuals and the Desert Shield/Storm handbooks and guides did not include any reference to the danger of sub-munitions. We had extensive data on the types of mines we might encounter, but nothing on our own munitions. A crash effort was made to come up with some type of training aid to assist in training troops about the munitions.

Our inclination was to believe our plan to keep soldiers mounted in their vehicles and a warning not to step on or pickup anything of the ground would suffice. Given human nature we concluded that the best way to keep combat soldiers, as well as the support soldiers following the tank and infantry teams, from becoming casualties was to show them what the munitions would look like.

The FSO and ALO produced detailed hand drawn pictures of the sub-munitions. No one in the task force had actually seen either of the sub-munitions in a 155mm Dual Purpose Improved Conventional Munitions (DPICM) round fired by the brigade's direct support artillery battalion. The sketches were reproduced and distributed to subordinate commanders. In the final briefings before the attack, the commanders used them to quickly train

soldiers of their dangers. No soldiers in the task force were casualties from friendly unexploded munitions during the attack or in subsequent operations during and after the ground war.

### CURRENT OPERATIONS - 15 THROUGH 23 FEBRUARY

During the days between the end of the screen mission and G-Day, the 24th of February, the task force was involved with several missions in addition to the general preparation for the attack. On the 17th, the task force moved into a defensive position just south of the border (PL VERMONT). The scout platoon occupied the berm and screened in front the task force position. They also conducted reconnaissance of the locations the engineers would cut lanes through the berm.

The 3rd Brigade was deployed approximately ten kilometers to the north of the berm, across the Division sector. They had crossed the berm shortly after tasking the screen mission from CC Carter. On the night of the 17th they reported significant enemy activity. As Task Force 1/41 Infantry reacted to enemy contact, an Apache from the Division attack helicopter battalion mistakenly engaged and destroyed two of the task force's vehicles, killing two soldiers.

Two days after the incident the 3rd Brigade was withdrawn to positions south of PL VERMONT. During the rearward passage of lines, one of the tanks in Task Force 1/41 Armor was hit by an Iraqi artillery round. Fortunately, only one soldier was wounded. These incidents got the attention of the task force soldiers. Once again we saw how deadly combat could be.

After the brigade was withdrawr no friendly forces were permitted to occupy positions on the Iraqi side of the border. The task force was given the mission to conduct a dismounted sweep of the berm to ensure there were no Iraqi reconnaissance teams hiding in the berm. On the 20th, Charlie team conducted a tank sweep twelve-hundred meters north of the berm along the task front. A deserted Iraqi observation post was found. It appeared the position was abandoned when the 3rd Brigade crossed the berm.

During this time frame, Apaches from the Division attack battalion conducted nightly reconnaissance missions across the berm. The missions turned up several possible mine fields and defensive positions. Artillery units moved forward hourly and engaged suspected or confirmed Iraqi position. The Air Force continuously attack the enemy defensive positions.

On the morning of 22 February the scouts captured seven Iraqi deserters. The were in very poor shape and confirmed the the effectiveness of the artillery and air attacks.

### MORALE IS HIGH

We were feeling good about our prospects on G-Day. The British were using their RPVs to identify Iraqi unit locations. Their primary purpose for flying the missions was target identification and battle damage assessment for their artillery. Since they would pass through the 2nd Brigade on the second day of the attack, they were anxious to share the aerial photos with us. The photos served to confirm the intelligence gleaned from the EPWs.



The Task Force Scouts Capture Iraqi Deserters Along the Border Berm (PL VERMONT).



There was still confusion about which enemy division we were attacking. It really didn't matter who they were. Where they were and how they were deployed was important. Thanks to the EPWs, the British RPVs and the U.S. Air Force, we had fairly complete answers to the later questions.

The tank sweeps and the operations forward of the berm were not giving any indications of increased enemy activity in the task force sector. If there had been significant activity as reported by 3rd Brigade, it had greatly decreased once they had withdrawn south across the berm. The only enemy activity that continued as scheduled was their nightly use of illumination. There were sporadic enemy artillery impacts in the vicinity of the border. With the exception of the 3rd Brigade tank hit by indirect fire, the artillery was ineffective.

BDA reports indicated that friendly artillery fire and Air Force Air Interdiction (AI) were having just the opposite effects on the enemy. Both were destroying enemy armor and artillery.

### OFFENSIVE AIR SUPPORT

The Air Force ALOs were boasting air power had destroyed most of the armor and artillery in the brigade sector. Once G-DAY was established as 24 February, the Air Force began nearly non-stop attacks against the enemy first echelon positions.

Surprisingly, the task force received an allocation of CAS missions prior to and during the attack. The surprise was not that we were allocated the missions, but that they were planned and executed up to thirty kilometers forward of the task force.

The depth of the CAS missions was the direct result of the Corps Fire Support Coordination Line being shifted north of the enemy positions along Phase Line WISCONSIN.

Prior to the movement of the FSCL, the Air Force was not required to clear attacks against targets in this area. They were Air Interdiction (AI) targets. Since the air and ground short (South) of the FSCL now belonged to the ground commander, the Air Force needed clearance to attack the targets. In most cases the targets were those requested by the Division or the brigade. In some cases airborne forward air controllers (FACs) transmitted suspected targets to the task force ALO who cleared targets for pre-planned CAS missions. The FAC then directed the attack of the target by the CAS sorties. Years of contesting how deep the Air Force would fly CAS during tactical exercises and training were overcome by the reality of the battlefield.

The considerable distance the Air Force would fly missions in front of the ground forces provided ground commanders with a real time reconnaissance source. Colonel Moreno was a master of using CAS for reconnaissance. He used his Air Force "cavalry" to obtain information on the enemy prior to the attack and during the subsequent exploitation across Iraq and Kuwait.

On the 22d and 23rd of February the Air Force executed its most impressive CAS missions. B52 bombers struck the Iraqi positions the task force would attack. On the 23rd they dropped two "blue lights" (15,000 pound air-fuel mixtures) on the enemy. The explosions caused by the "bombs" were clearly visible. The

impact of the bombs rumbled like distant thunder. The ALOs had good reason to be optimistic about the success of offensive air operations.

### SURPRISE OR DECEPTION

Our positive view of the enemy situation was challenged by the ADC for Support. During a visit to the brigade TOC, he postulated the belief that the current intelligence estimates were not accurate. He felt the Iraqi's were deceiving us, and were lying in wait for the first tank to cross the berm. His pessimism quickly and correctly, tempered our optimism and reminded us of the realities of the battle field. Don't underestimate the enemy's capabilities or intentions. In less than forty-eight hours we would know the truth.

### LAST MINUTE PREPARATIONS

The day before the attack was filled with pre-combat checks, maintenance, last minute meetings, and letter writing. The engineers were busy cutting additional gaps in the border berm. Delta Company (-) moved up to the south side of the berm and relieved the scouts. The scouts withdrew to the vicinity of the task force TOC to prepare for the attack.

Charlie team conducted a final tank sweep of task force sector three kilometers north of the berm to locate the mine fields, OPs, and mortar firing positions identified by the Apaches. The "possible" mine fields were not found and the mortar positions were deserted. The only excitement during the operation

occurred as it ended.

Charlie team moved through the berm and "swept" the task force front from east to west. They ended their move facing west, along the 1st and 2nd Brigade boundary. As they prepared to displace south, back through the berm, indirect fire impacted to their direct front. The task force TOC had coordinated the sweep with Task Force 5/16 Infantry, the 1st Brigade unit on our left flank. Some how, their mortar platoon failed to get the word. They fired a platoon mission which impacted close enough to raise the ire of a normally calm and collected team commander, Captain Tim Norton. The troops were getting tense. It was time to attack.

By 1800 on the 23rd, the task force ALOC was moved to PL Cherry and prepared to assume the mission of the Task Force TOC. Per SOP, the ALOC would function as the TOC as the task force moved across the border the next morning. Once the TOC was across the berm and moving with the task force, control would revert back to the TOC. Soldiers took their nerve agent pill as scheduled.

At 1900 the task force was instructed to maintain current radio frequencies. We would not change frequencies until the ground war ended. The message was passed throughout the task force. Alpha and Bravo teams were hastily "swapping out" non operational vehicles. Alpha traded an M2. Bravo exchanged an M1. Major fire control and automotive components were not available in the "maintenance system" and it was easier to exchange a non-operational vehicle than repair it.

The artillery and the Air Force continued to pound the Iraqi positions. Throughout the night the MLRS rockets lit the sky like giant "Roman Candles". Few soldiers in the task force slept.

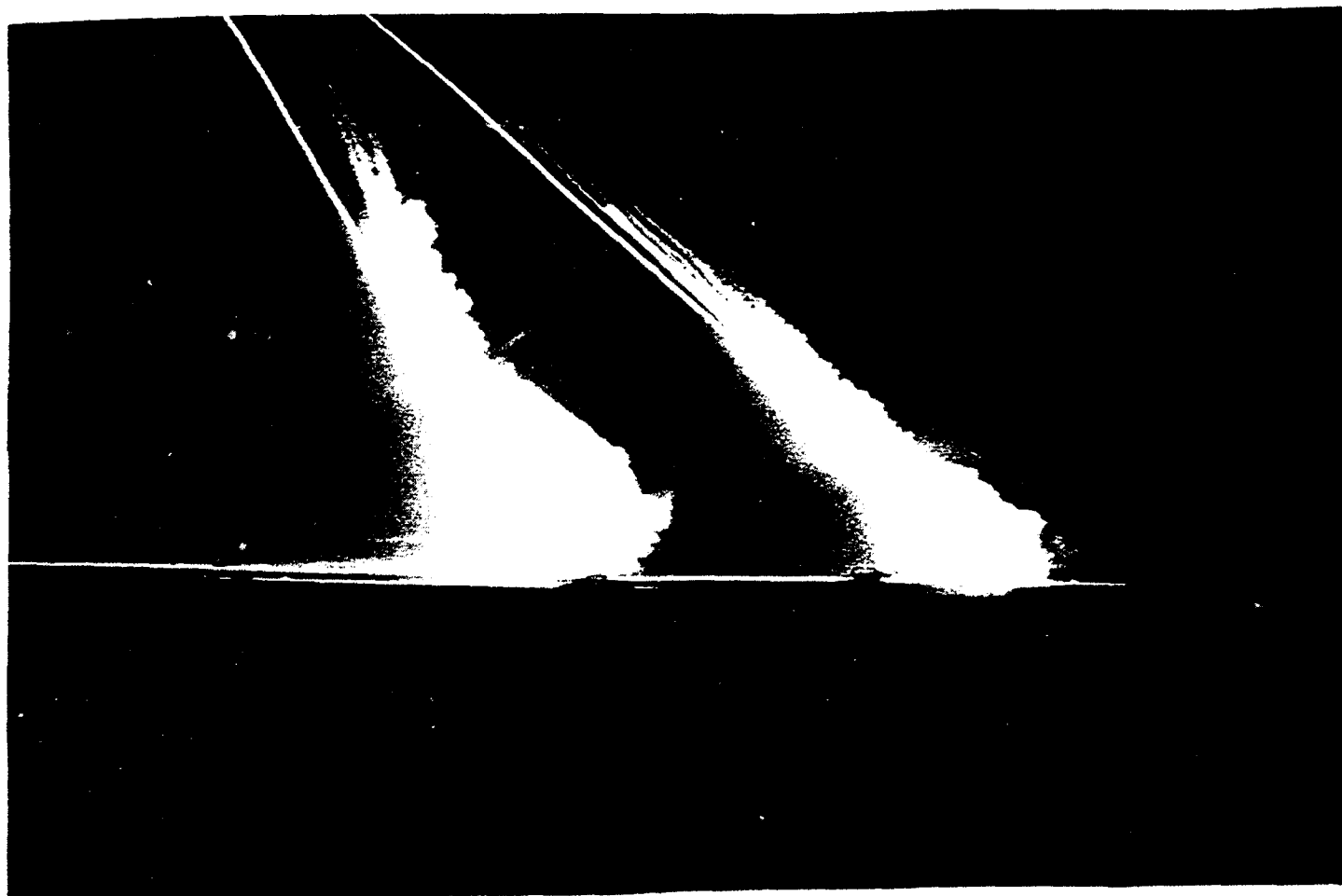

MLRS Fires on the Night Before the Attack.

One loader on a plow tank would later relate the conversation he overheard between his platoon sergeant and his platoon leader. Both were tank commanders on plow tanks. The platoon leader told his sergeant they probably would not make it through the next days fight. The platoon sergeant agreed and added that they must not let down the task force. Before the tanks moved out for the attack, the platoon sergeant encouraged his crewmen to do their duty. He assured them things would be alright and they would get through the fight.

### G-DAY

24 February, 0300. The command group was dressing for combat. It really was sort of ritualistic. In order, we each made a run in the dark to relieve ourselves, unsure how long we might be confined in our NBC protective clothing. Previous experience had proven there was nothing worse than getting the urge while outfitted in NBC protective gear. We finished dressing and shook hands. Not much was said. We tried to convince each other we would meet again on the objective.

The previous night the S-3 was instructed to move our command tanks to a position close to the bunker complex the command group would sleep in. I wanted to make sure we could find the tanks in the dark and be ready to move at 0430. After dressing, we went to mount our tanks. No luck. We couldn't find the tanks! The noise and light discipline was perfect. The noise we made as we looked for the tanks drew the attention of the scouts. They were going to the TOC to receive their intelligence

update. They led us to the command tanks, which were located less than fifty meters from the bunker complex. It was very dark. We mounted the tanks and quickly made radio checks. All stations responded. The lone exception was the brigade commander.

Colonel Moreno had received his command M2A1 the night before the attack. The crew had spent the night getting the track prepared for combat. After mounting, he'd discovered his radios were not working correctly. His crew quickly fixed the problem and he was soon up on the brigade net. He would later discover his crew had not transferred his personal map to the track and he would operate during the first day of the battle from memory. He knew the plan so well, he really didn't need a map!

At 0415, the scout platoon, departed the task force TOC after receiving a final enemy situation update. No changes. With some expected difficulty, they found and passed through crossing sites eleven and twelve on the berm (PL VERMONT) and continued their reconnaissance to PL PINE. At 0537 the main body of the task force moved through the berm into Iraq (Figure 7).

Team Alpha moved through first and established a temporary defensive position north of the berm. Their mission was to cover the movement of the remainder of the task force as it moved through the berm. With Alpha set, the scouts began moving north at 0645.

At day break there was fog and the sky was overcast. The wind had shifted and was blowing from the south. The temperature was in the forties. The weather report predicted thunderstorms

and high winds in the Division sector. These conditions did not favor the enemy's use of chemical weapons. They did make the NBC over garments we were wearing bearable and would favor our use of smoke at the breach.

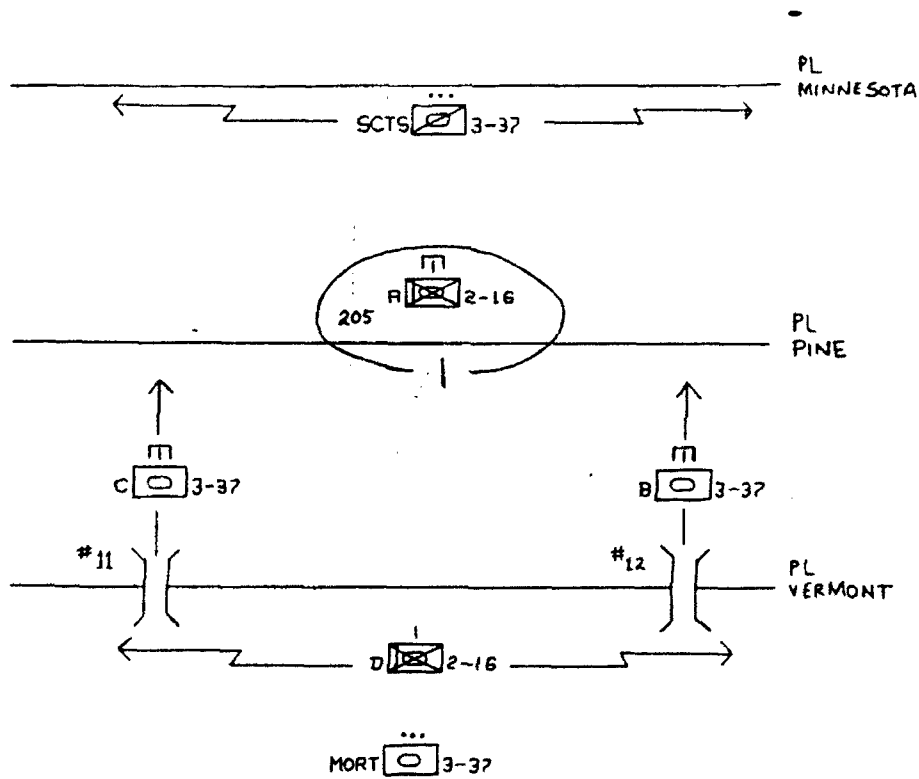

Figure 7, Crossing the Berm (PL VERMONT).



By 0715 Bravo and Charlie teams had moved through the berm, past Alpha team, and established temporary defensive positions. Delta team and the mortars remained along the south side of the berm covering the task force move. On the report that Bravo and Charlie teams were set, Delta team and the mortars displaced forward and assumed their positions in the task force box formation.

This initial move was simple and lock step. It was executed in total darkness and night vision goggles (NVGs) were of little use. The darkness and the anxiousness that comes with the first move of an attack were anticipated. The move was designed to over-come these challenges. Additionally, task forces to the left and right were beginning their moves. They shared the same darkness and anxiety.

In fact, the task force was conducting a move through two defiles a single vehicle at a time, and was vulnerable to enemy direct and indirect fire. If enemy contact occurred during the move, we would need a great deal of effective command and control to keep the situation from going to hell. Many of the soldiers had become simulated casualties at the NTC while executing just such a move.

As if on que, Delta company made contact with the enemy and captured seven prisoners. By 0805 Alpha team had prisoners. The scouts and the tank teams by passed the Iraqi's in the dark. No rounds were fired by attacker or enemy. During this same thirty minute period the scouts received fire from across the brigade

boundary on their left flank. They were attempting to make visual contact with the scouts of Task Force 5/16 Infantry and believed the fire was friendly. Had the Iraqi's been as tough and clever as the opposing forces (OPFOR) at the NTC, we'd have determined the strength of our simple defile plan.

The reported fire from the adjacent task force was our first experience dealing with the difficulty of maintaining contact and coordination with a moving flank unit. The prior coordination with Task Force 5/16 Infantry to prevent such an occurrence had not worked. Plans and radio frequencies were exchanged and potential problems of cross boundary fire and fratricide were discussed. The solution was doctrinal. Keep flank elements cross talking and ensure everyone knows where everyone is. Easier said than done. At the time the scouts received fire, the task force was monitoring the 5/16 Infantry command net and the scouts were attempting to contact the adjacent scouts on their internal radio net.

By 0825 the scouts were set in a screen along PL IOWA. At 0838 the task force was set in attack positions south of PL IOWA, waiting for the planned B-52 strike against the enemy positions along PL WISCONSIN. The strike was cancelled and the task force continued its move toward PL KANSAS. The scouts reported six unidentified enemy vehicles moving south. The enemy appeared to be reacting to the attack. By 0937 the task force was at PL KANSAS and the scouts were moving toward PL BIRCH. As the scouts closed on PL BIRCH, one section engaged a bunker forward of

BIRCH. Almost immediately, a white flag and Iraqi soldiers emerged from the bunker. Similar actions occurred throughout the task force sector: security zone forces were surrendering.



Security Zone Forces Surrender.

The plan was to stop and assume a hasty defense between KANSAS and PL BIRCH for the night. The light resistance drove a change in the plan: continue the attack at 1500. This encouraging situation was tempered by reports of the Marines encountering chemical mines in Kuwait. (The report later proved to be incorrect.)

By 1300 the task force passed through the scout screen and moved into attack formation just south of PL PLUM. As anticipated, we were on the reverse slope of the slight ridge forward of PLUM. The enemy positions along PL WISCONSIN, were on the opposite reverse slope. This was not a surprise. The analysis conducted by the task force and brigade intelligence sections had templated the enemy in reverse slope positions. The advantage of not having visual contact with the enemy positions was offset by the enemy's inability to see the task force.

After conferring with Colonel Moreno, I instructed Captain Norton, and Captain John Long, Bravo team commander, to move forward with their breaching tanks. Their instructions were to get a good look at the enemy defenses and determine if we were still on the plan. They were also instructed not to get shot.

Norton and Long moved to positions that allowed them to see the enemy trench line. Just as Long and his plow tank commanders, LT Leonard Weinstein and SFC David Lane prepared to move forward they received what appeared to be mortar or artillery fire. Norton and Long moved to positions which allowed them to observe the enemy positions. Despite their exposure, they remained in

position long enough to study the enemy defenses. The expected fortifications were not obvious.

The general trace of the positions were identified but the location of the expected mine fields were not observed. Long reported several enemy soldiers leaving trenches and moving toward the same location in the defensive line. This suggested the presence of some type of mine field directly in front of the trench line. Norton confirmed the observation. We drew the conclusion we were in luck. The enemy defenses were simple, as we anticipated. We would not use the MICLICs. We would breach with the plows and save the MICLICs.

This reconnaissance had taken the better part of an hour. The adjusted time for the artillery preparation was 1430. Instead of pulling back for the preparation, Norton and Long were attempting to inch forward. A spirited discussion of the merit of such action ended as the preparation began.

Thirteen Multiple Launch Rocket Systems (MLRS) and tube artillery battalions from the combined artillery of the Division, reinforcing corps units and the British 1st Armored Division engaged the enemy positions along and north of PL WISCONSIN for thirty minutes. The impact of 11,000 artillery rounds along the Division front created a continuous roar.

Every soldier in the task force watched the MLRS rockets slowly arc deep into the sector, seeking enemy artillery and command and control targets. Great clouds of smoke and dust rose in the air just behind the slight rise hiding the Iraqi trench

line. Long and Norton still in their forward positions, confirmed the accuracy of the high explosive rounds as they impacted on the first trench line.

At 1500, COL Moreno ordered the brigade to attack. As the task force rolled forward, the order was countermanded. Artillery was still firing and the Division stopped moving forward until the errant guns ceased firing. Within minutes the problem was solved and the attack continued.

Per the 2d Brigade plan, British artillery, in support of the brigade, had shifted fires to targets behind the first trench line. When the firing continued after the preparation fires were scheduled to end, the Division's reaction was to hold the attack. Doctrine calls for the shifting of fires behind the objective during attack. The most unusual aspect of this episode is not that artillery continued to fire, but that only 2d brigade had planned to use continuous artillery fire in accordance with tactical doctrine.

As the artillery shifted north, the plow tanks began to roll forward, LT Roderick Hardin in C11 and SGT Michael Calvert in C12 quickly reached the start points of LANES INDIA and JULIET. Hardin had the Magellan and the other plow tank commanders were guiding on him. Two hundred and fifty meters to their right, 2LT Weinstein in B21 approached the start point for LANE KILO. To his right, SFC Lane in B24 lowered his plow and began to clear LANE INDIA. The friction of war struck.

Harden's plow was stuck in the raised position. Captain

Norton directed 2LT Carl Nasatka in C31, the back-up plow tank to move forward and assume Harden's mission. Within minutes four plow tanks were clearing lanes through the Iraqi positions. Tank commanders were leaning out of their hatches, to ensure their plows were at the right depth to push aside buried mines. If the plow is too high it passes over the mines and the plow tank crew become casualties. Too low and the mines fall back into the plowed lanes. No anti-tank mines were spotted. Sporadic enemy small arms fire resumed on the task force left flank. Several heavy mortar or 122mm rounds impacted to the task force front.

On the right flank, task force 2/16 Infantry was sharing our success but experiencing greater resistance. They were encountering and destroying enemy light armor vehicles as they breached. Task Force 5/16 was breaching forty-five hundred meters left of Charlie team and was not visible to the task force command group. Their radio transmissions indicated they were breaching.

The speed of the breach went faster than expected. Norton and Long, were in the cleared lanes behind the plow tanks. The engineers move forward and begin marking the lanes. Captain Thomas Rouse, Alpha team commander, reported adjusted artillery or mortar rounds were "moving" toward his support by fire position.

Earlier in the day, an air force FAC had reported all enemy artillery north of PL Wisconsin destroyed. Task Force 4/37 Armor would soon report destroying artillery as the unit moved through

its sector to PL COLORADO.

As the command group moved forward to the breach lanes Captain Rouse requested permission to move forward on Charlie teams left flank. He believed the artillery was being adjusted toward his position. Instead of moving through lanes INDIA and JULIET as planned, he asked to cross PL WISCONSIN left of LANE INDIA. We had discussed this branch to the plan. The deviation to the plan would only occur if there was little risk of encountering anti-tank mines and the enemy situation on the left flank required more combat power forward. We had not considered the possibility of enemy indirect fire triggering the move. The conditions to trigger the change were present and Rouse's request was approved (Figure 8).

The flanking move by Alpha team violated Division orders that all vehicles would move through the breach lanes. Months later, the Division G3, Terry Bullington, recalled how MG Rhame had ripped him for not using a cleared lane to move across PL WISCONSIN. He had moved behind the task force and followed Alpha teams tracks in the sand. The CG had apparently caught him in the act.

The experience of the breach left lasting memories. The speed of the operation probably surprised us as much as it did the Iraqi's. The plow tanks cut one thousand meter lanes through the defenses in minutes. Within fifteen minutes four lanes were established through the enemy defenses. Charlie and Bravo teams were moving through the breach and taking up hasty defensive



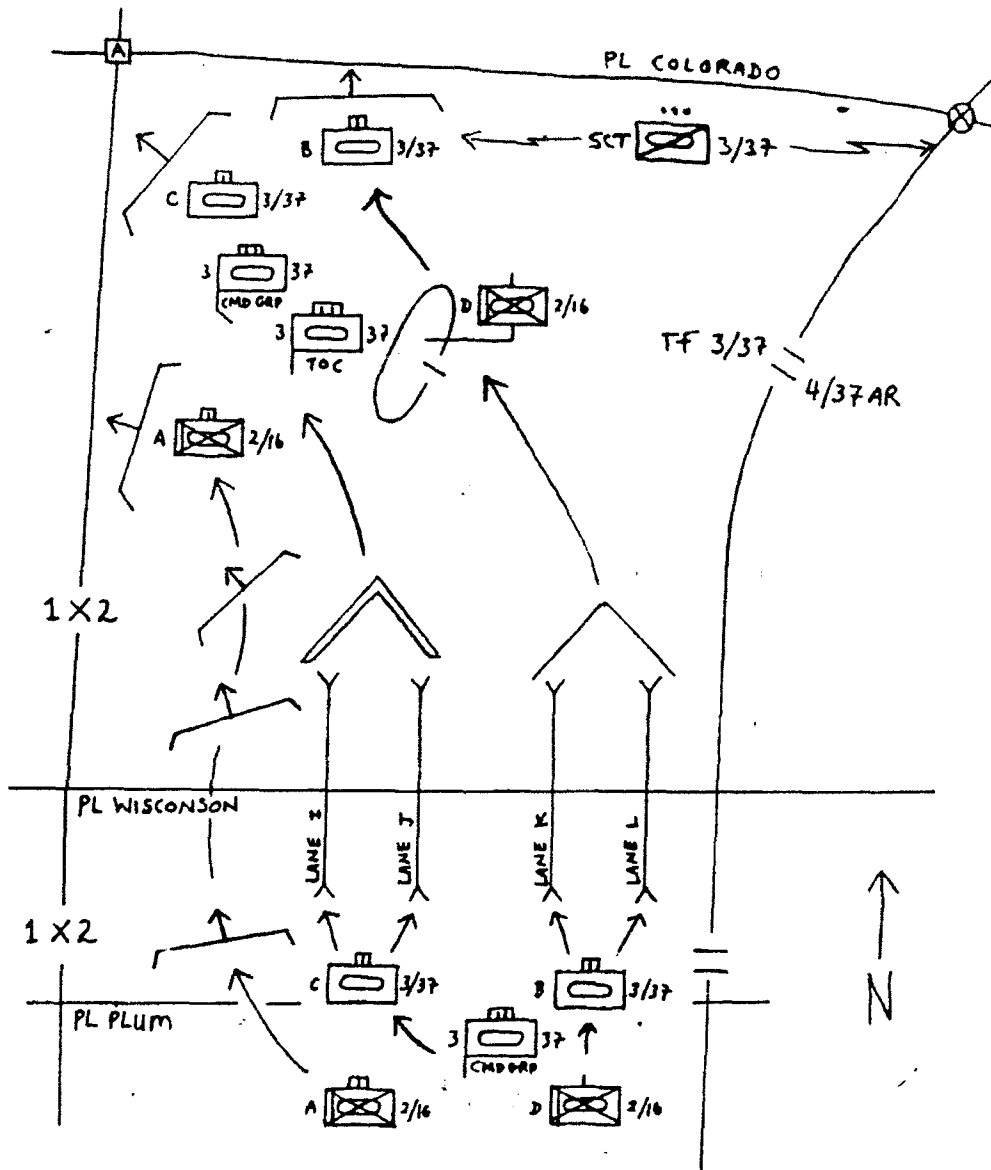

Figure 8, Alpha Team Moves Across the Trench Line.

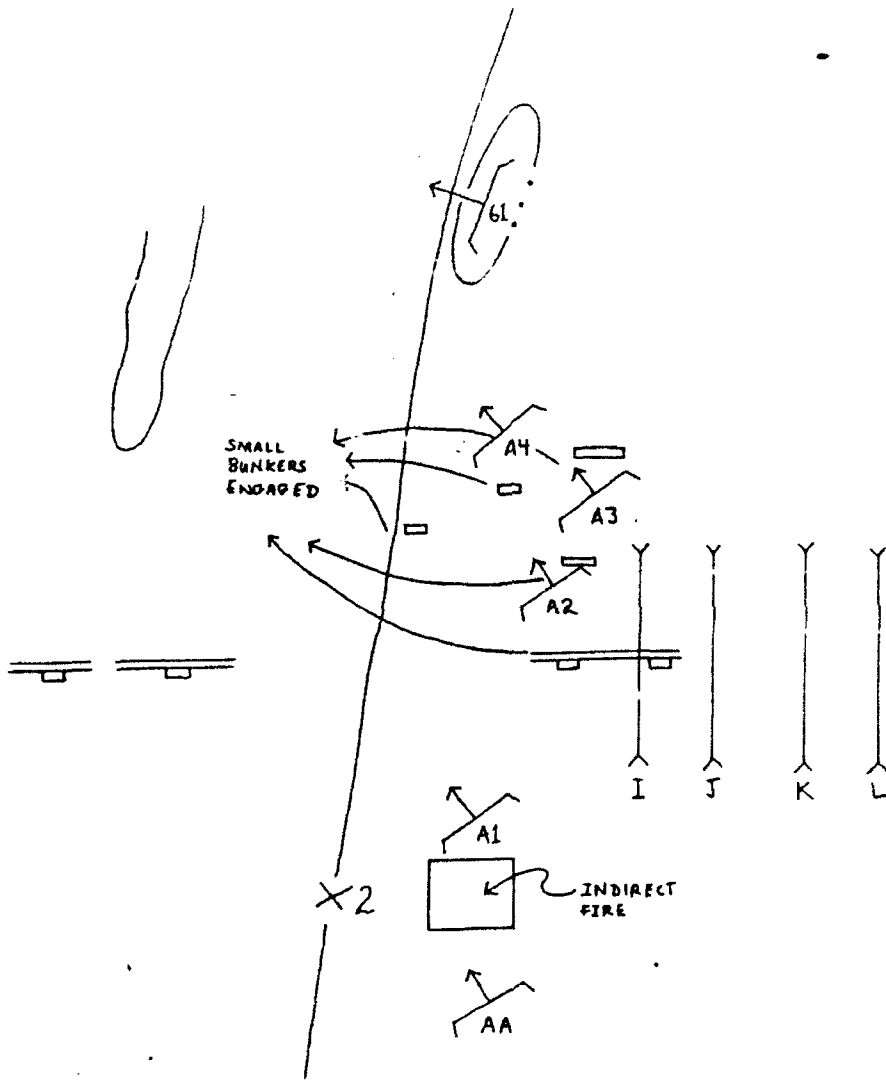

Figure 9, Alpha Team Attacks the Enemy Bunkers.

burning trucks destroyed by Alpha team was also drifting across the ridge. Quick radio transmissions between Charlie team and the converging tank company stopped the firing.

The task force TOC was monitoring the 1/34 Armor command net and immediately informed them of the situation. The task force had coordinated with the unit before the attack and we were aware of their scheme of maneuver. We hadn't planned on the ridge being where we anticipated generally flat terrain. The action ended and a lesser contact was established between the two company-teams as planned.

By 1730 the situation in the task force sector had stabilized. The Iraqi defensive positions were closed and EPWs were being evacuated to the collection point. The teams were refining their hasty defenses and preparing to refuel. There was no enemy resistance in the sector. The task force had completed its mission without suffering a casualty.

As night fell the Iraqi positions to the north of PL COLORADO began firing illumination rounds and the task force suffered its first "casualty". An infantryman in Bravo team was cleaning his individual weapon when the illumination began. He jumped behind his M2 just as the vehicle commander was backed-up to be in a better position. The vehicle had a ground guide and the rear of the vehicle had been cleared. The soldier was knocked to the ground and the M2 ran up on his hip.

Medics moved to assist the soldier. Not taking any chances, they requested an air medivac. The TOC passed the

request and an aircraft was dispatched. As the aircraft approached the Bravo team position south of PL COLORADO, it was instructed to land near the flare fired by the team. The approach of the aircraft triggered an enemy response. They fired additional illumination rounds.

The aircraft mistakenly flew toward the illumination rounds. As they crossed PL COLORADO flying north toward the enemy, they were instructed to turn back toward another flare fired by Bravo team. Spot reports indicated small arms fire was fired at the aircraft. The aircraft finally landed at the sight of the accident and the soldier was evacuated. This was as close a call as we had experienced during the attack.

The task force settled down to a night of surveillance and preparation for the 0500 forward passage of line with the 3rd Brigade. There was no enemy action in the task force sector. A single group of three enemy soldiers was tracked by Charlie team during the night. As the enemy soldiers moved across the brigade boundary toward the 1/34 Armor sector, they requested assistance from the task force mortar platoon. The mortars fired a single mission across the brigade boundary in support of the armor battalion. Within hours, the task force passed through elements of the 3rd Brigade.

During the remaining four days of the war the task force attacked an additional two-hundred and thirty kilometers through Iraq and into Kuwait, cutting Highway Six, the road between Kuwait City and Basra, Iraq. A series of engagements

against armor forces of the 12th and 17th Iraqi Armor Divisions as the task force entered Kuwait on G+3, 27 February, would precede the seizure of a road junction and the subsequent link-up with the 1/4 Cavalry Squadron on Highway Six on the last day of the ground offensive.

On 1 March, the task force, as a part of a 2nd Brigade task force, moved to Safwan, Iraq, and assisted in securing the airfield and city of Safwan for the cease fire negotiations conducted between the Coalition Forces and representatives of the Iraqi government. For much of March, the task force was again deployed conducting screening operations along the cease fire demarcation line between Kuwait and Iraq.

In early May, the task force moved back to Saudi Arabia and prepared equipment for shipment to Fort Riley. On 14 May, the unit began redeployment to Fort Riley. On 6 July, 1992 the Task Force 3/37 Armor was presented the Valorous Unit Award for its combat operations during Operation Desert Storm.

## OBSERVATIONS AND LESSONS LEARNED

Nearly a month after the battle, Colonel Moreno and I flew back to the ridge to survey the battlefield and establish a clear picture of it. The intervening days had given me time to reflect on the scope of the operation. We stood on top of the ridge, near the bunker Charlie team had engaged, and looked south, at the axis our attack had come. It was clear the enemy had prepared for the last war. The Iraqi infantry divisions were prepared to fight a dismounted infantry force, reinforced by armor.

The sheer mass of our deliberate attack and the mounted breaching technique were the keys to success. The old adage that "more is better" was borne out by the effects of offensive air and artillery operations on the enemy. The physical and psychological effects of massed fires on the battlefield was readily apparent. Much of the enemy artillery and armor was destroyed or disabled by the time the task force penetrated the enemy defenses. The remaining elements were unable to mass enough fires or forces to be a credible threat. The physical effects of the air and artillery fires on the enemy soldiers was not as apparent.

The expected carnage resulting from the tremendous volume and ferocity of the artillery preparation on the trench line did not materialize. The converse appeared to be the rule. Few enemy bodies were observed in the area of the breach. Few captured soldiers were wounded. As the attack progressed through the trench line, enemy soldiers continued to appear from the trench lines and the bunkers built into the sides of the trenches.

The scale of the artillery appeared to have been swallowed up by the size of the area attacked, the hardness of the soil, and the protection the trenches and bunkers provided the enemy. The high explosive 155mm rounds used on the trenches was not as effective as expected, but was probably in line with the doctrinal number of rounds required to suppress, neutralize and destroy. The limited effects of the artillery indicated the preparation had accomplished suppression and in some cases the

ten percent casualty effects required to achieve neutralization.

The psychological effect of the fires, when combined with the fire power and shock effect of the maneuver forces, had a profound effect on the enemy soldiers. An enemy soldier occupying the bunker on the ridge was able to see much of the Division as it attacked. The initial employment of the plow tanks, with their foreboding plows extended, plowing lanes and then turning to plow the trenches closed was a convincing reason to surrender.

We never questioned the legality or humaneness of plowing closed the trenches. The disastrous breaching operation experienced on the JANUS simulation at Ft. Leavenworth and the routine failure of units at the NTC to successfully conduct this operation, had conditioned us to expect a deadly fight at the trench line. Initial casualty estimations for the breach were around thirty percent. No commander was willing to accept this level of casualties. Hence, the decision to conduct the breach mounted.

The decision to stay mounted, and plow trenches and bunkers closed rather than expose soldiers to close was validated by the lack of friendly casualties during the breach. The number of enemy soldiers actually buried in their trenches is certainly unknown. Back briefs of the operation by the breaching teams did confirmed soldiers were buried. This was the exception, not the rule. What is clear, is the psychological impact the combination of direct and indirect fires and the sight of plow tanks closing trenches had on the enemy: the vast majority surrendered rather

than fight.

Enemy that resisted appeared to fall into two categories: those who appeared to fire their weapons and then immediately surrender; and those that were ready to really fight. It appeared that those that fired a weapon and then immediately surrendered were fulfilling a commitment to God or country. In several instances throughout the ground campaign tank commanders instinctively followed the rules of engagement used on the screen line two weeks earlier.

Tank gunners, conditioned to fire to the left of enemy soldier to convince them to surrender peacefully, were engaged by enemy soldiers who fired and then surrendered. Instead of returning killing fire, they fired to the left or right of the enemy, giving them the opportunity to surrender. Once soldiers understood the light intensity of resistance they intuitively employed the level of force necessary. The inherent danger of such actions is obvious.

The most difficult command and control challenge during the attack was maintaining contact and coordination with the 1st Brigade units on the task force's left flank. We did everything by the book and it was still very difficult. The GPS's were critical in determining and passing the location of subordinate elements between task forces, but they did not solve the problem of controlling fires.

Direct fire control measures don't work very well in the desert. There are no terrain features to mark boundaries and



serve as a backstop for direct fire. The range of the 25mm on the M2 and the main gun on the M1 greatly extend the down range distance of rounds fired across unit boundaries. The problem is especially tough in gradually rising and descending terrain. This situation creates inter-visibility lines which are nearly invisible to moving ground forces. Often, fire directed at targets in front of or on the inter-visibility line becomes grazing fire on enemy or friendly forces hidden behind the line.

This situation becomes deadly when the enemy is located between converging friendly forces. This was the case with Charlie team when they were inadvertently fired on along PL COLORADO. GPS and other types of "friend or foe" devices will only help to solve this problem.

The key to overcoming this problem is the commander, his knowledge of the location and status of his subordinate units, and his ability to transmit his understanding of the situation to flank elements.

The journey that led to the hill overlooking the battlefield was long and hard. The one-hundred and six days between alert notification and the day of the attack, were filled with many challenges, disappointments, and successes. Careers were made and lost. The one truism that remained constant throughout the period was the often quoted adage that "soldiers and outfits fight the way they train".

Every success or failure shared by the task force was the direct result of its training and experience. The failures

experienced on the screen line were the result of a lack of training and experience. The combat experience gained from the actions, the extensive rehearsals and preparations for the attack, were the factors which made the breach a successful operation. Simply stated: Soldiers trained long and hard to make a very difficult and dangerous task appear easy in execution.

In the end, the courage, skill and determination of soldiers had carried the day. The great equipment, with its technological edge, had certainly helped, but was not the end-all to the equation for battlefield victory.