



Project Report  
CJP-60  
Rev. 1

# A Bandwidth Extrapolation Technique for Improved Range Resolution of Coherent Radar Data

DTIC  
ELECTE  
DEC 21 1992  
S E D

K.M. Cuomo

4 December 1992

**Lincoln Laboratory**  
MASSACHUSETTS INSTITUTE OF TECHNOLOGY  
LEXINGTON, MASSACHUSETTS



Prepared for the Department of the Air Force  
and the Department of the Army under Air Force  
Contract F19628-90-C-0002.

Approved for public release; distribution is unlimited.

92-32361

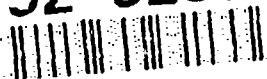

217

92 12 10 004

This report is based on studies performed at Lincoln Laboratory, a center for research operated by Massachusetts Institute of Technology. The work was sponsored in part by the Foreign Technology Division, Department of the Air Force and in part by the Department of the Army under Air Force Contract F19628-90-C-0002.

This technical report has been reviewed and is approved for publication.

FOR THE COMMANDER

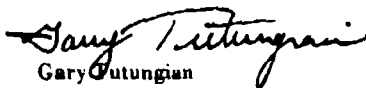

Gary Cutungian  
Administrative Contracting Officer  
Directorate of Contracted Support Management

Non-Lincoln Recipients

PLEASE DO NOT RETURN

Permission is given to destroy this document  
when it is no longer needed.

MASSACHUSETTS INSTITUTE OF TECHNOLOGY  
LINCOLN LABORATORY

**A BANDWIDTH EXTRAPOLATION TECHNIQUE FOR IMPROVED  
RANGE RESOLUTION OF COHERENT RADAR DATA**

*K.M. CUOMO*  
Group 34

PROJECT REPORT CJP-60, Rev. 1

4 DECEMBER 1992

Accession For	
NTIS CRA&I	<input checked="" type="checkbox"/>
DTIC TAB	<input type="checkbox"/>
Unannounced	<input type="checkbox"/>
Justification .....	
By .....	
Distribution /	
Availability Codes	
Dist	Avail and/or Special
A-1	

Approved for public release; distribution is unlimited.

DTIC QUALITY ASSURED 1

LEXINGTON

MASSACHUSETTS

## ABSTRACT

A linear predictive bandwidth extrapolation (BWE) technique is introduced as a means of significantly improving the range resolution of pulse-compressed coherent radar data. Pulse compression schemes based on conventional Fourier techniques are efficient and robust; however, they often suffer from relatively poor resolution. This report describes the use of an autoregressive (AR) time-series model to extrapolate the spectral bandwidth of each uncompressed radar return signal. Subsequent Fourier transformation of the expanded spectral signal yields recompressed pulses with better range resolution than obtainable from conventional Fourier techniques. The linearity of the BWE process produces recompressed pulses that have a calibrated amplitude and phase response, thus allowing for a meaningful interpretation of the RCS and phase signatures of the target. In addition, high resolution range-Doppler images of the target can be generated since the coherence properties of the recompressed pulses are maintained by the BWE process. Simulations, radar range data, and applications of this technique to field data show very promising results.

## TABLE OF CONTENTS

Abstract	iii
List of Illustrations	vii
1. INTRODUCTION	1
2. BANDWIDTH EXTRAPOLATION (BWE) TECHNIQUE	3
2.1 Implementation	3
2.2 Range Gate Truncation Considerations	5
3. SIMULATION AND RADAR RANGE DATA	9
3.1 Simulated Point Scatterers	9
3.2 Two Spheres Target	9
3.3 Sphere-Cone-Cone Target	12
4. NOISE SENSITIVITY RESULTS	17
4.1 Single Point Scatterer	17
4.2 Two Closely Spaced Point Scatterers	23
5. CONCLUSIONS	25
REFERENCES	27

## LIST OF ILLUSTRATIONS

Figure No.		Page
1	Bandwidth extrapolation technique.	4
2	Spectral distortion effects.	6
3	Bandwidth extrapolation: simulated point scatterers.	10
4	Bandwidth extrapolation: two spheres target.	11
5	Pulse profile data for sphere-cone-cone target.	13
6	Bandwidth extrapolated pulses for sphere-cone-cone target.	14
7	Range-Doppler image comparison.	15
8	Pulse profile overlays: single point scatterer.	18
9	Peak RCS residuals versus SNR.	19
10	Phase residuals versus SNR.	20
11	Peak position residuals versus SNR.	21
12	Pulse profile overlays: two closely spaced point scatterers.	24

## LIST OF TABLES

Table No.		Page
1	Noise Sensitivity Results for 0-dBsm Point Scatterer	22

## 1. INTRODUCTION

Coherent wideband radars can achieve fine slant range resolution by transmitting a pulse that has a large frequency bandwidth (BW). In cases where the transmitted waveform corresponds to a linear FM chirp, the received signal ( $[I,Q]$  of uncompressed pulse) can be sampled and inverse Fourier transformed to yield the target's scattering intensity (amplitude and phase) as a function of range (compressed pulse). Thus, the temporally received signal can be interpreted as the target's frequency response (spectral domain) and the compressed pulse as the target's range profile (time domain). The spectral and time domains form an analytic Fourier transform pair. Properties of the compressed pulse, such as resolution and sidelobe levels, are determined by the extent and shape of the spectral window function applied to the uncompressed data samples.

Pulse compression schemes based on conventional Fourier techniques have the advantage of being efficient and robust; however, they often suffer from relatively poor resolution especially when the data record is short compared to the periodicities being estimated. The poor resolution of Fourier techniques can be attributed to the unrealistic assumptions regarding unavailable data; Fourier transforms implicitly assume that the unavailable data samples are zero outside the window region, which is not correct in most cases. In many practical applications, there is often some knowledge of the deterministic properties of the received signal. For example, if the range profile of a target consists of a superposition of discrete scattering centers, then the target response in the spectral domain consists of a superposition of sinusoids. Therefore, in these cases, a parametric time-series model of the data that exploits these sinusoidal properties can be expected to make reasonably realistic assumptions regarding the unavailable data.

This report discusses the application of an autoregressive (AR) time-series model to improve the slant range resolution of the pulse compression process. This AR approach was investigated by S. B. Bowling of Lincoln Laboratory in 1977 as a means of improving resolution for Doppler-Time-Intensity (DTI) analysis [1]. These same AR techniques can be used to improve range resolution. However, past attempts to significantly improve the range resolution of pulse-compressed radar data collected on realistic targets were not successful. As this report will show, significant improvements in range resolution can be obtained by expanding the original AR approach. Another reason for this success may be due to the use of data collected by

higher center frequency radars since 1977. It has been shown that, at sufficiently high microwave frequencies, the scattering field of a complex object can be approximated by superposition of the fields of discrete scattering centers [2]. This means that the spectral content of the received signal consists of a superposition of sinusoids. Autoregressive linear prediction methods are especially well-suited to this type of problem.

Using the Burg algorithm, the unknown coefficients of the AR model are computed independently for the spectral data of each radar pulse. The coefficients are then used in linear prediction filters to extrapolate the received signal prior to pulse compression via Fourier transformation. The linear prediction filters exploit the assumed sinusoidal periodicities in the received signal, and are expected to represent the signal at larger effective bandwidths. The degree of improvement in resolution depends primarily on the ability to fit the measured data with a few AR model parameters and to perform an accurate bandwidth extrapolation (BWE).

In Section 2, the implementation of a BWE technique is presented. In Section 3, the simulation and static range results will demonstrate that a factor of 2 to 4 improvement in range resolution is readily achievable. A radar imaging example is included to demonstrate that the coherence properties of the improved resolution pulses are maintained. In Section 4, a Monte Carlo approach is used to estimate the RCS, phase, and peak position residuals of a single point scatterer at various SNRs, before and after BWE processing. Also, the ability of BWE to consistently resolve two closely spaced point scatterers at various SNRs is demonstrated. Conclusions of the study are presented in Section 5. Detailed results with field data will be presented in a separate report.



## 2. BANDWIDTH EXTRAPOLATION (BWE) TECHNIQUE

### 2.1 IMPLEMENTATION

The primary processing steps involved with bandwidth extrapolation (BWE) of coherent radar data are illustrated in Figure 1. First, the radar pulses (amplitude and phase of compressed pulse) are Fourier transformed into their (I,Q) spectral components. If the radar data are available in terms of uncompressed (I,Q) samples, then the FFT step can be eliminated. If a weighting function was applied to the spectral data, for range sidelobe reduction purposes, then it need be removed prior to linear prediction processing. This prevents the spectral components near the center frequency from dominating the extrapolation. The extrapolation process improves when all spectral components receive equal weighting, since data at the edges of the spectrum contribute as much as data near the center frequency.

The linear prediction processor is based on the Burg algorithm [3], which determines the "best" coefficients for an AR time-series model of the input spectral data. The coefficients are used to form forward and backward linear prediction filters that extrapolate the input spectral data forward and backward in the frequency domain, thus increasing the effective BW of the input pulse. The extrapolations are consistent with the measured data and have a maximum entropy interpretation. For sidelobe reduction purposes, a weighting function can be applied to the expanded spectral signal prior to inverse Fourier transformation. A detailed development of these linear prediction principles and the source code for computing the Burg coefficients can be found in the report by Bowling [1].

The linear prediction filters create new spectral samples that are consistent with the original data set. In order for the amplitudes of the recompressed pulse to be accurate, the energy in the original and extrapolated signals must be considered. It has been pointed out that the correct normalization factor for the inverse Fourier transformation of the expanded spectral signal is given by the relationship [4]:

$$N = (\sigma^2_L N_L + \sigma^2_O N_O + \sigma^2_R N_R) / \sigma^2_O \quad (1)$$

The original data set consists of  $N_O$  samples with a variance equal to  $\sigma^2_O$ . The backward filter

167401 \*

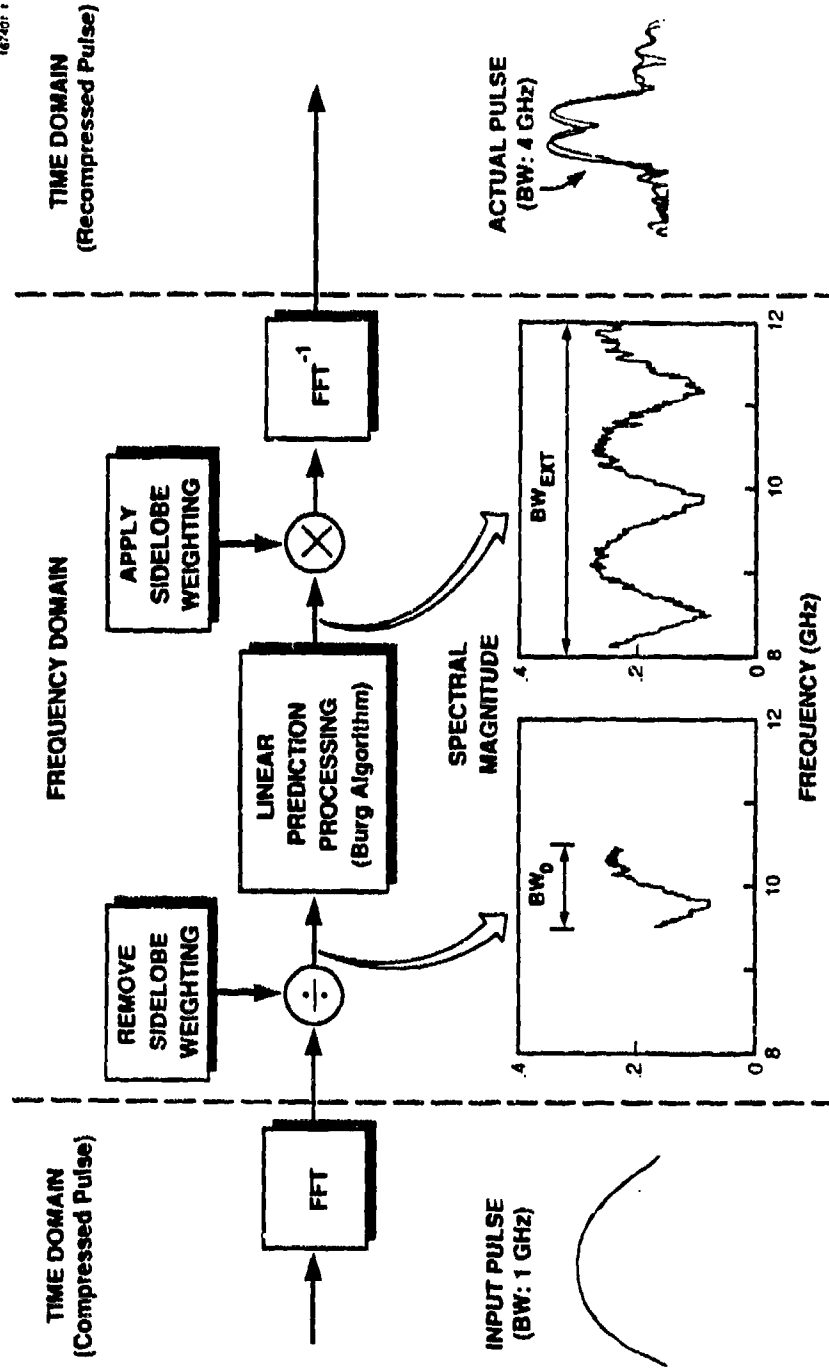

Figure 1. Bandwidth extrapolation technique.

predicted  $N_L$  samples to the left, and the forward filter predicted  $N_R$  samples to the right.

Variances  $\sigma_L^2$  and  $\sigma_R^2$  are calculated independently for the  $N_L$  and  $N_R$  samples, respectively.

Figure 1 also displays an actual input pulse shape and its spectral components as measured on a radar range. The target consists of two 3/8-inch spheres placed 4 inches apart. The range radar operated at a 10-GHz center frequency and a 4-GHz bandwidth. The input pulse was reduced to a 1-GHz bandwidth by pulse compressing the spectral data measured in the 9.5- to 10.5-GHz region. The spectral magnitude of the input pulse before and after linear prediction processing is shown. The number of filter coefficients chosen for the extrapolations is equal to one-third of the number of input data samples. This choice for the number of coefficients has worked well, and is used for all the BWE results presented in this report. As illustrated, the effective BW has been increased by a factor of 4. For comparison, the actual 4-GHz BW pulse shape is overlaid with the extrapolated BW pulse. Note the excellent agreement between pulses. In addition, the illustrated BWE process is linear, which produces recompressed pulses that have a calibrated amplitude and phase response. Calibrated responses allow for a meaningful interpretation of the RCS and phase signatures of BW extrapolated pulses.

## 2.2 RANGE GATE TRUNCATION CONSIDERATIONS

In cases where only a subset of range gate samples of the compressed pulse is available for BWE processing, spectral distortion effects exist after these data are Fourier transformed into their spectral components. In order to perform an accurate BW extrapolation, these spectral distortion effects should be avoided. Figure 2 shows a simulation of a single 0-dBsm point scatterer and the spectral distortion effects caused by processing a subset of range gates from the complete compressed pulse. The upper plots show the compressed pulse with all of the range gate samples (1024) and the resulting spectral magnitude after Fourier transformation. The spectral magnitude is constant, as expected for a single point scatterer. The lower left plot shows the center 200 range gates of the compressed pulse. After Fourier transformation, the spectral magnitude shows distortion effects at the edges of the spectrum. The range gate truncation of the compressed pulse results in a convolution of the true spectral components with a discrete sinc function. A simple solution to this problem is to eliminate the spectral data samples near the

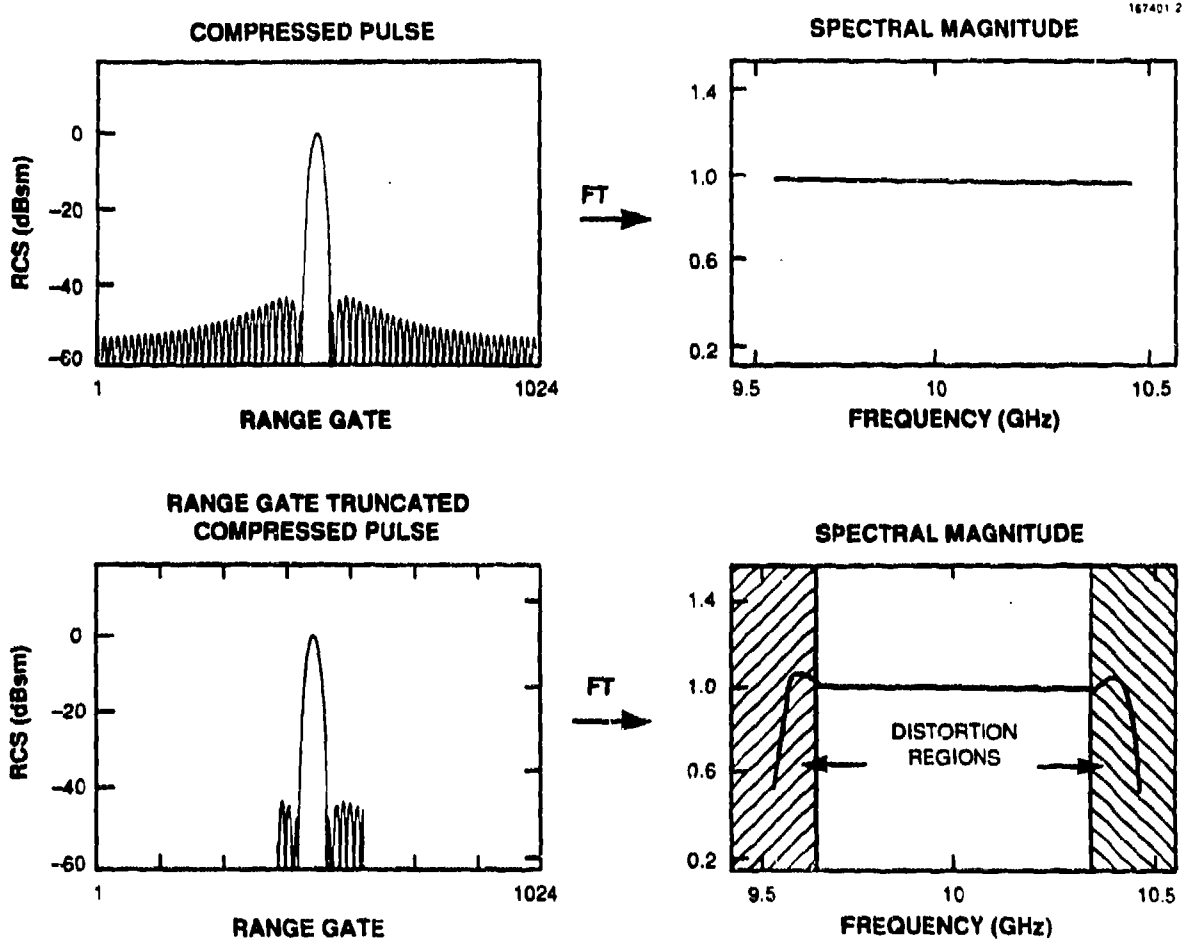

Figure 2. Spectral distortion effects.

edges of the spectrum, prior to BW extrapolation.

An accurate determination of the number of spectral data samples to eliminate prior to BW extrapolation can be obtained from a simple Fourier relationship. Equation (2) represents the truncated pulse as a multiplication of a rectangular function with the complete compressed pulse.

$$P_N(r) \times \text{Rect}_{N_1}(r) = > P_N(k) * \left\{ \frac{\sin[\pi k(N_1+1)/N]}{\sin[\pi k/N]} \right\} \quad (2)$$

$P_N(r)$  is the complete compressed pulse consisting of  $N$  samples,  $\text{Rect}_{N_1}(r)$  is the rectangular function consisting of  $N_1$  non-zero values,  $P_N(k)$  is the true signal spectrum, and the bracketed term is the discrete sinc function. The asterisk denotes circular convolution. It is suggested that a spectral width equal to the fifth zero location of the sinc function be eliminated from the edges of the signal spectrum in order to obtain an accurate BW extrapolation. An expression in terms of the number of spectral data samples to eliminate is given in Equation (3).

$$k_{\text{amp}} = 5N/(N_1+1) \quad (3)$$

In the simulation, pulse compression was performed with an FFT size ( $N$ ) equal to 1024, and only 200 ( $N_1$ ) samples were used to start the BWE process. Equation (3) suggests that approximately 25 samples, out of a total of 1024, should be eliminated from both edges of the signal spectrum. Note that approximately 5 percent of the signal spectrum is eliminated prior to BW extrapolation. This is a small price to pay for a more accurate BW extrapolation.

*If data samples are not eliminated at the edges of the spectrum, then the recompressed pulse will exhibit high sidelobes and not achieve a significant improvement in resolution. This step has greatly benefited the BWE process, and is considered a major contribution toward the successes of this technique.*

### 3. SIMULATION AND RADAR RANGE DATA

#### 3.1 SIMULATED POINT SCATTERERS

Figure 3 shows the complex spectral domain signal (I,Q) and the corresponding compressed pulse for a target consisting of three ideal point scatterers. The simulation used a 10-GHz center frequency and a 4-GHz BW at an extremely high SNR that was limited only by the computer precision. Since the target consists of a collection of discrete scattering centers, the spectral signal consists of a superposition of sinusoids. The linear prediction methods discussed in Section 2 are ideal for extrapolating signals of this form.

The 4-GHz BW pulse was reduced to a 1-GHz BW pulse by pulse compressing the spectral data between 9.5 and 10.5 GHz. The 1-GHz BW pulse shape is shown in the lower right plot. Bandwidth extrapolation was then performed on the reduced BW pulse. As shown, the spectral data between 9.5 and 10.5 GHz were extrapolated forward and backward using linear prediction filters, with AR coefficients determined from the Burg algorithm. The number of filter coefficients chosen for the predictions is equal to one-third of the number of input data samples. In this case, 11 filter coefficients were used. The resulting extrapolated spectral data (dashed curves) and the corresponding compressed pulse are shown in the lower plots in an overlay fashion with the 1-GHz BW data. There is excellent agreement between the actual 4-GHz BW data (upper plots) and the BW extrapolated data (lower plots).

#### 3.2 TWO SPHERES TARGET

Figure 4 shows the complex spectral domain signal (I,Q) and the corresponding compressed pulse for a target consisting of two 3/8-inch spheres placed 4 inches apart. The data in the upper part of the figure were collected at a static range facility using a radar operating at a 10-GHz center frequency and a 4-GHz BW. The sinusoidal behavior of the spectral components is evident in those plots.

The 4-GHz BW pulse was reduced to a 1-GHz BW pulse by pulse compressing the spectral data between 9.5 and 10.5 GHz. The 1-GHz BW pulse shape is shown in the lower right plot. Bandwidth extrapolation was then performed on the reduced BW pulse. As shown, the spectral data between 9.5 and 10.5 GHz were extrapolated forward and backward using linear

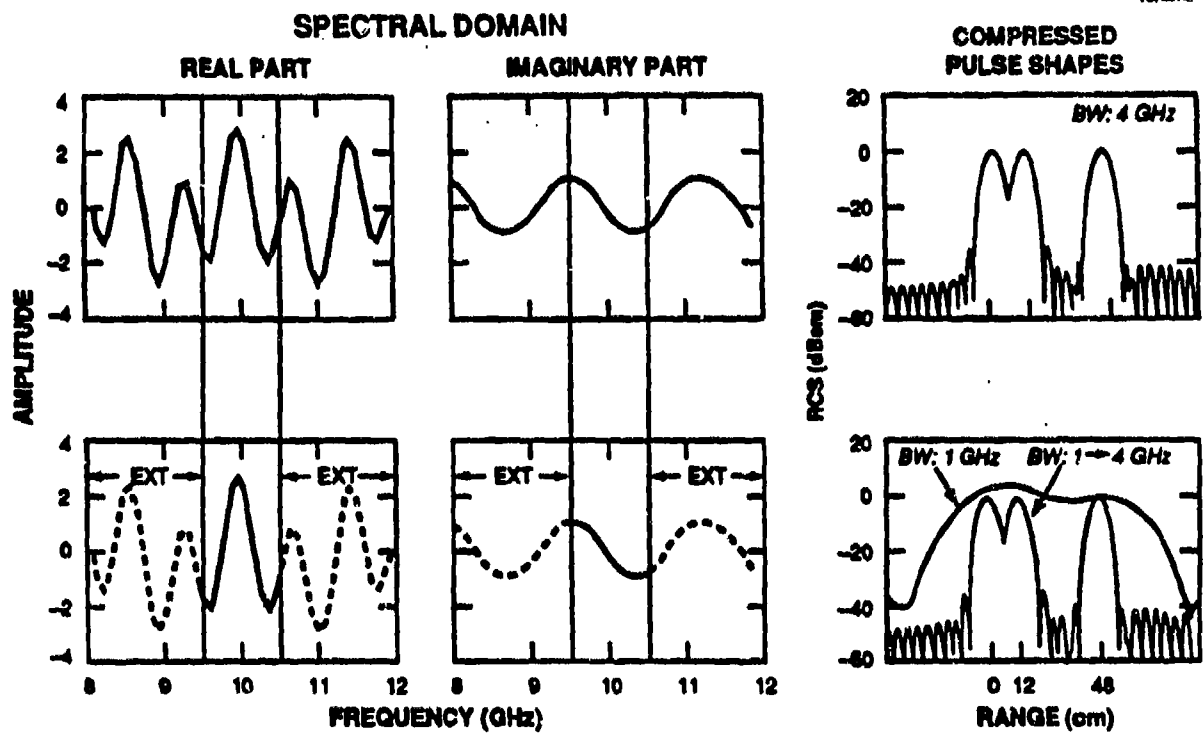

Figure 3. Bandwidth extrapolation: simulated point scatterers.

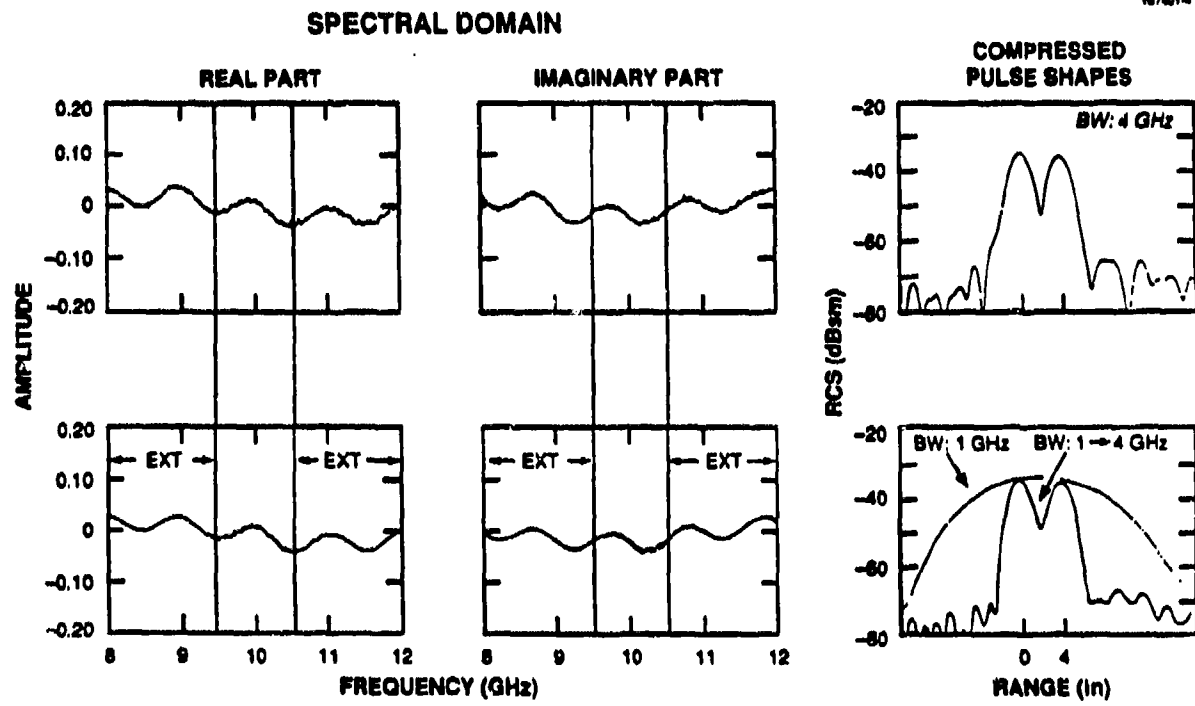

Figure 4. Bandwidth extrapolation: two spheres target.



prediction filters, with AR coefficients determined from the Burg algorithm. In this case, 21 filter coefficients were used. The resulting extrapolated spectral data and corresponding compressed pulse are shown in the lower plots in an overlay fashion with the 1-GHz BW data. There is excellent agreement between the actual 4-GHz BW data (upper plots) and the BW extrapolated data (lower plots).

### 3.3 SPHERE-CONE-CONE TARGET

Figure 5 shows a pulse profile history plot of a spinning sphere-cone-cone target. The data were collected at a static range facility using a radar operating at a 10-GHz center frequency and a 2-GHz BW. The left plot shows the actual data collected over a complete roll cycle of the target. The lead scattering center corresponds to the nosetip return. There is some interference observed from returns near the conic junction location. The trailing scattering is from the base edge and support structure.

The right plot shows the corresponding reduced BW (1 GHz) pulses, which were generated by recompressing the spectral data collected in the 9.5- to 10.5-GHz region. Figure 6 shows the BW extrapolated pulses, which were generated by applying the BWE technique illustrated in Figure 1 to each reduced BW pulse independently. The BW of each pulse was extrapolated from 1 GHz to 2 GHz. A comparison between the extrapolated BW pulses (Figure 6) and the actual 2-GHz pulses (Figure 5, left frame) shows excellent agreement in terms of both amplitude and phase profiles. BWE ratios of up to 4:1 have worked well with this target.

Bandwidth extrapolation improves the range resolution while maintaining the coherence properties of the compressed pulses. This is demonstrated by generating range-Doppler (RD) images of the target, before and after BWE processing. Figure 7 shows a RD image comparison corresponding to the original data, collected at a BW of 2 GHz, and BW extrapolated data. The RD images are represented as contour plots with a 5-dB contour spacing. The lowest level contour corresponds to a threshold value of -50 dBsm. The middle and right image plots correspond to extrapolated bandwidths of 4 GHz and 6 GHz, respectively. The RD images that were generated from BW extrapolated data are significantly more resolved in range; scattering centers are more sharply defined, and target responses which appeared to arise from single scattering centers in the original data are resolved into multiple closely spaced scattering centers. These additional scattering centers are physically present on the target, but are unresolved with

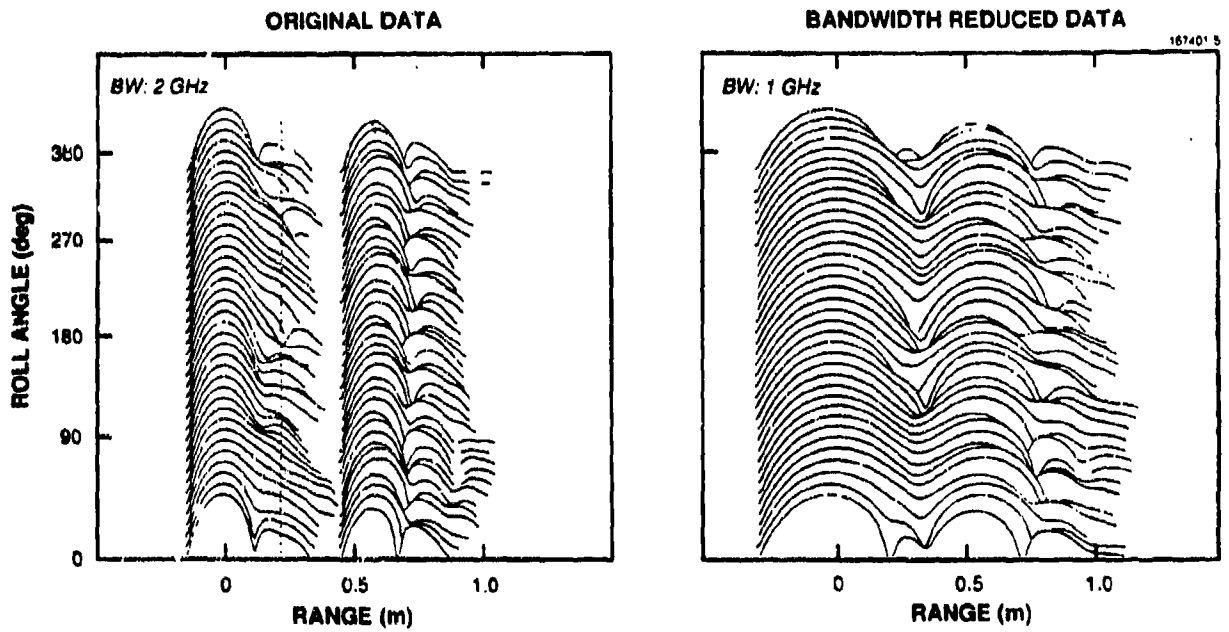

Figure 5. Pulse profile data for sphere-cone-cone target.

BANDWIDTH EXTRAPOLATED DATA

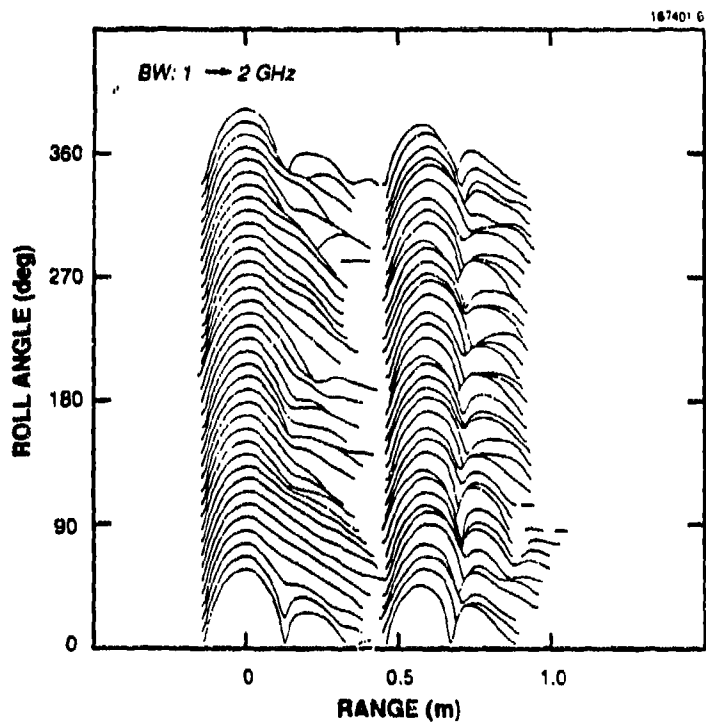

Figure 6. Bandwidth extrapolated pulses for sphere-cone-cone target.

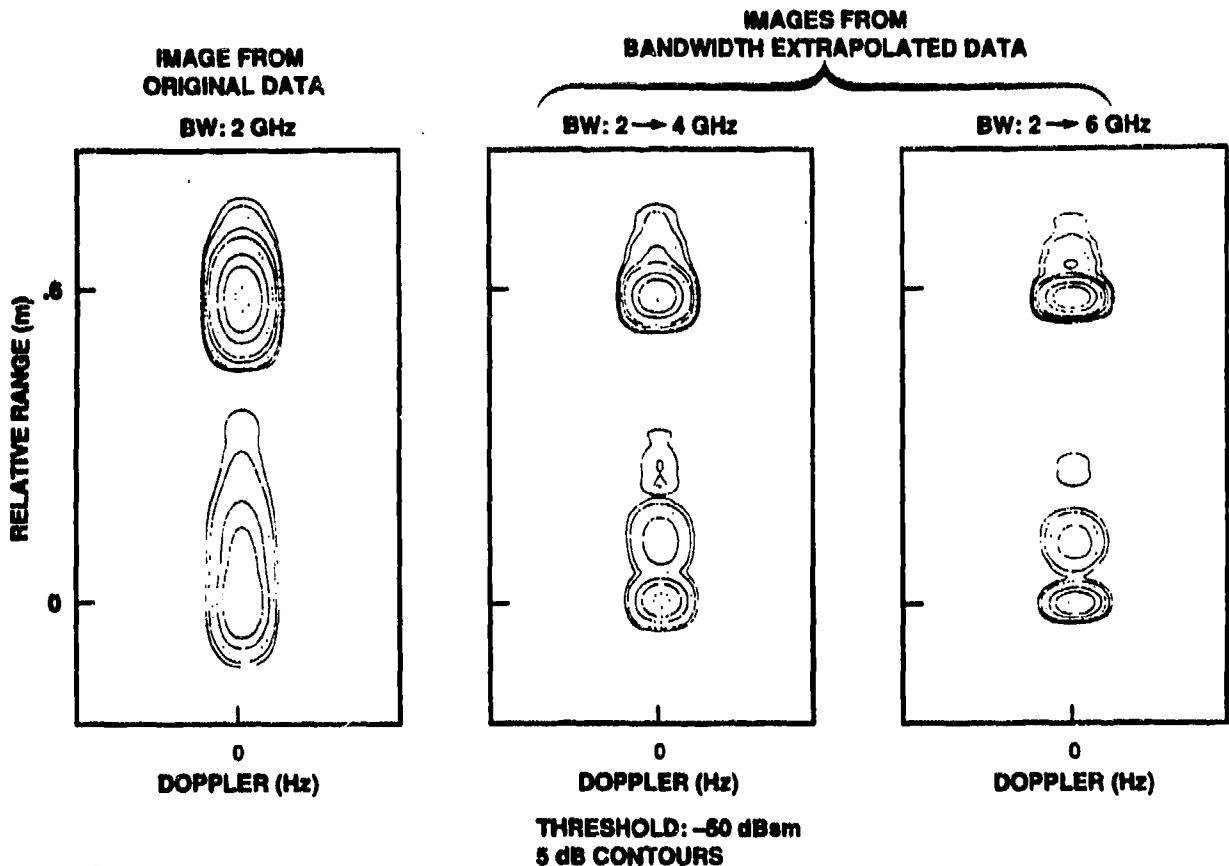

Figure 7. Range-Doppler image comparison.

the 2-GHz BW data. The Doppler sidelobe levels in the RD images are close to the theoretical values, even after BWE processing. This indicates that the coherence properties of the improved resolution data are maintained.

## 4. NOISE SENSITIVITY RESULTS

### 4.1 SINGLE POINT SCATTERER

A Monte Carlo approach is used to estimate the RCS, phase (or phase-range), and peak position (envelope-range) residuals of a single 0-dBsm point scatterer, before and after BWE processing. This allows the performance and robustness of BWE in the presence of Gaussian noise to be evaluated. A bandwidth of 1 GHz is simulated at SNR levels of 10, 20, and 30 dB, where SNR is defined as the ratio of peak signal power to mean noise level in the compressed pulse. In this case, the Gaussian noise is added to the complex spectral samples of a simulated point scatterer.

Figure 8 shows 100 superimposed compressed pulses at the three different SNRs tested, before and after BWE processing. These plots are useful for visualizing the effects of noise on the pulse shapes, since the width of the traces is indicative of SNR. A bandwidth extrapolation factor of 3:1 was selected. For these examples, the number of filter coefficients used for the extrapolations (33) is equal to one-third of the number of input data samples. Note that BW extrapolated pulses have a lower mean noise level and are more resolved, even in the low SNR case.

Figure 9 shows the peak RCS residuals (peak RCS relative to 0 dBsm) for the superimposed pulses in Figure 8. The standard deviation has increased from the values shown for the original pulses. No significant biasing of the mean RCS for the BW extrapolated pulses is observed.

Figure 10 shows the phase residuals (phase of pulse at peak RCS) for the superimposed pulses of Figure 8. The standard deviation has increased slightly from the values shown for the original pulses. No biasing of the mean phase residuals is observed. The increase in phase residuals is so slight that coherent processing of the BW extrapolated pulses does not show any significant degradation compared to the original pulses.

Figure 11 shows the the peak position residuals (envelope-range location of peak RCS) for the superimposed pulses in Figure 8. In this case, the standard deviation has increased slightly from the original values for the 20 and 30 dB SNR cases, but has decreased in the 10 dB SNR case. No biasing of the mean peak position residuals is observed.

## SINGLE POINT SCATTERER

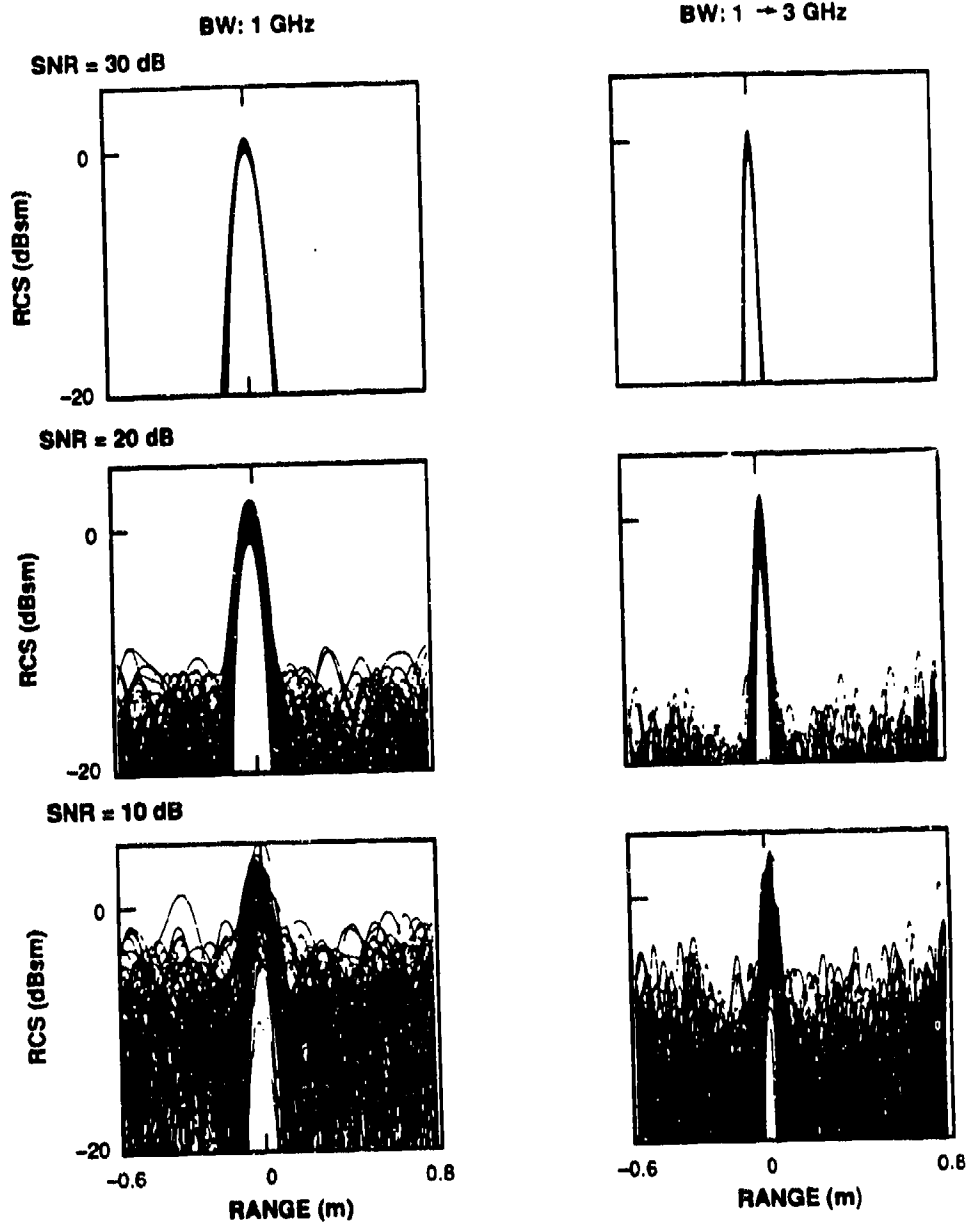

Figure 8. Pulse profile overlays: single point scatterer.

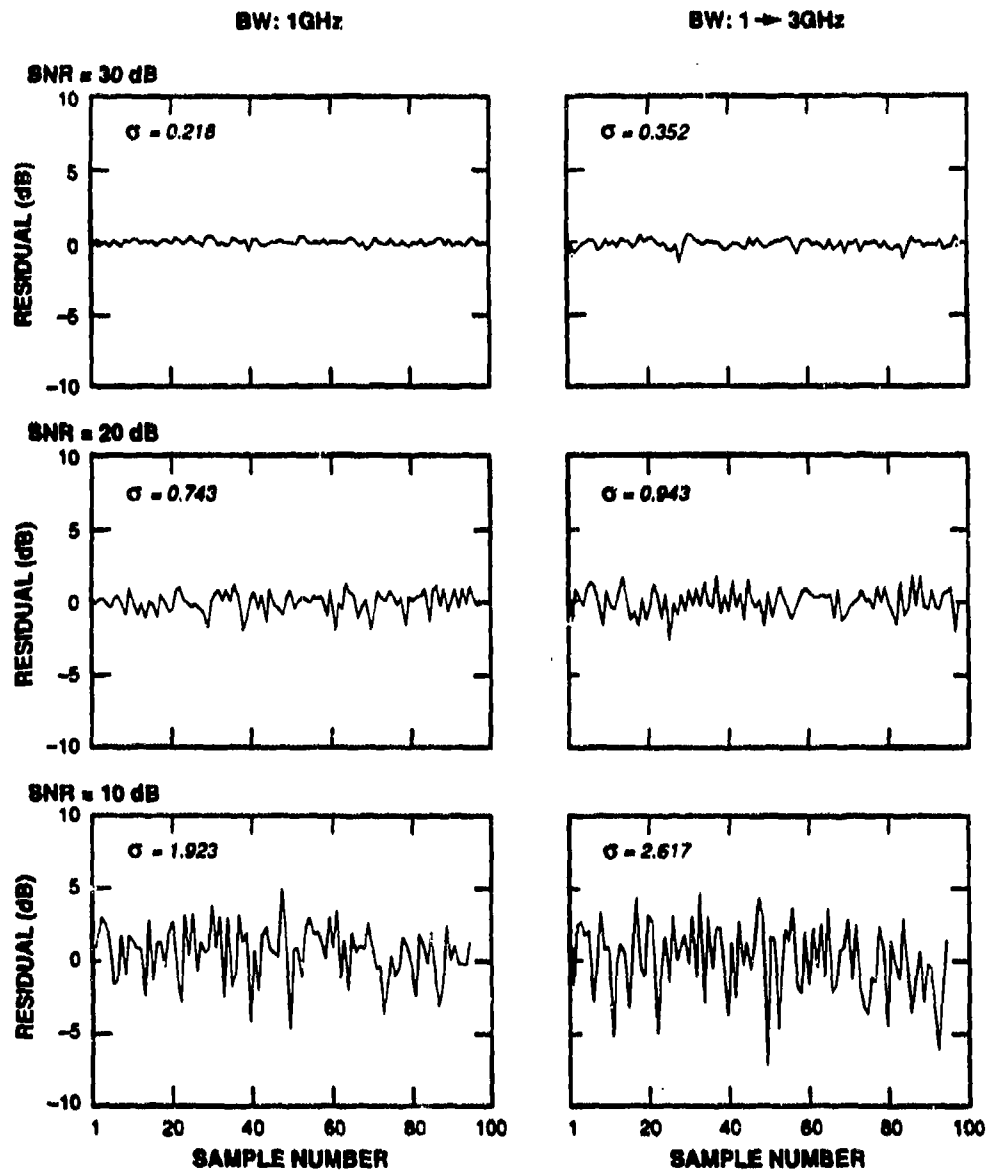

Figure 9. Peak RCS residuals versus SNR.



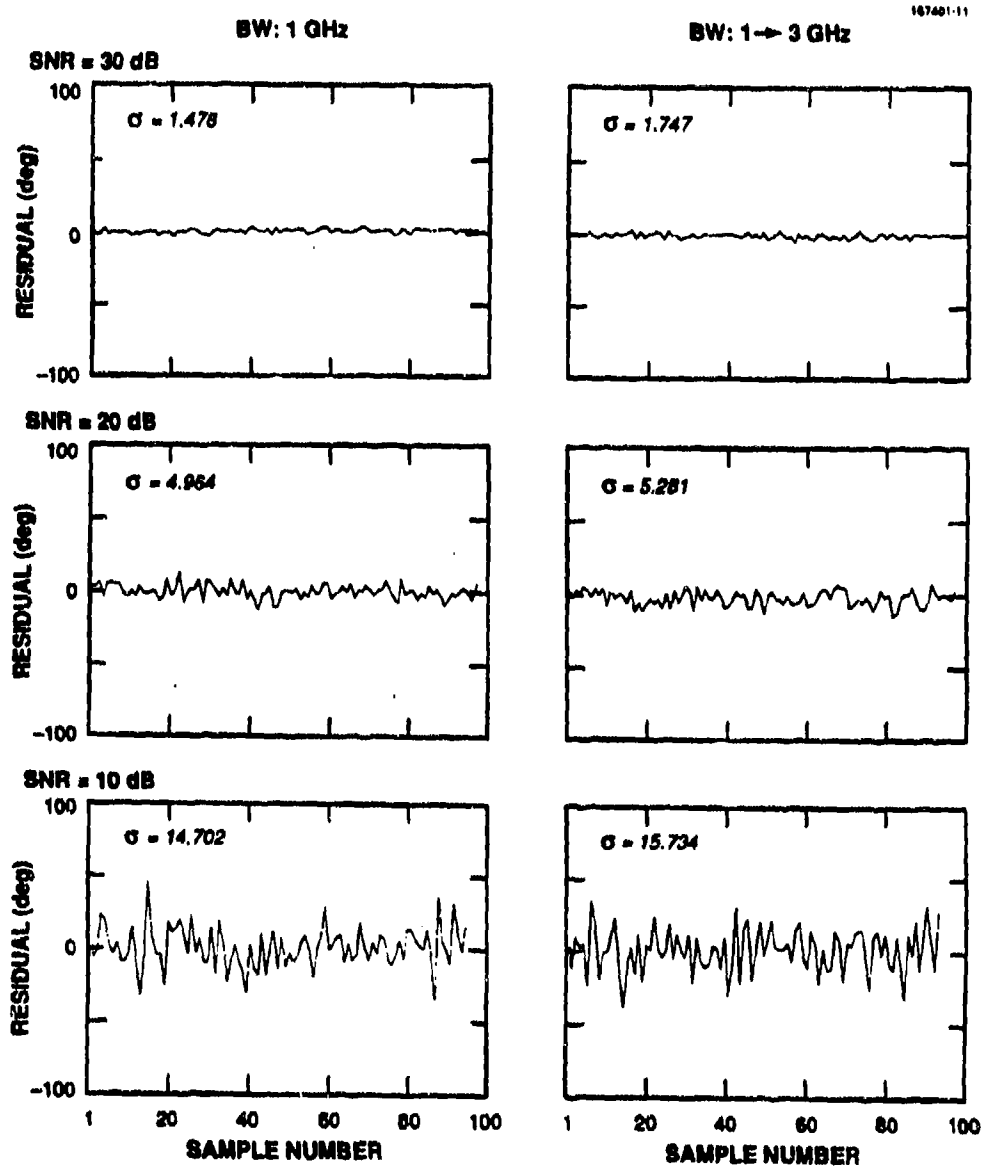

Figure 10. Phase residuals versus SNR.

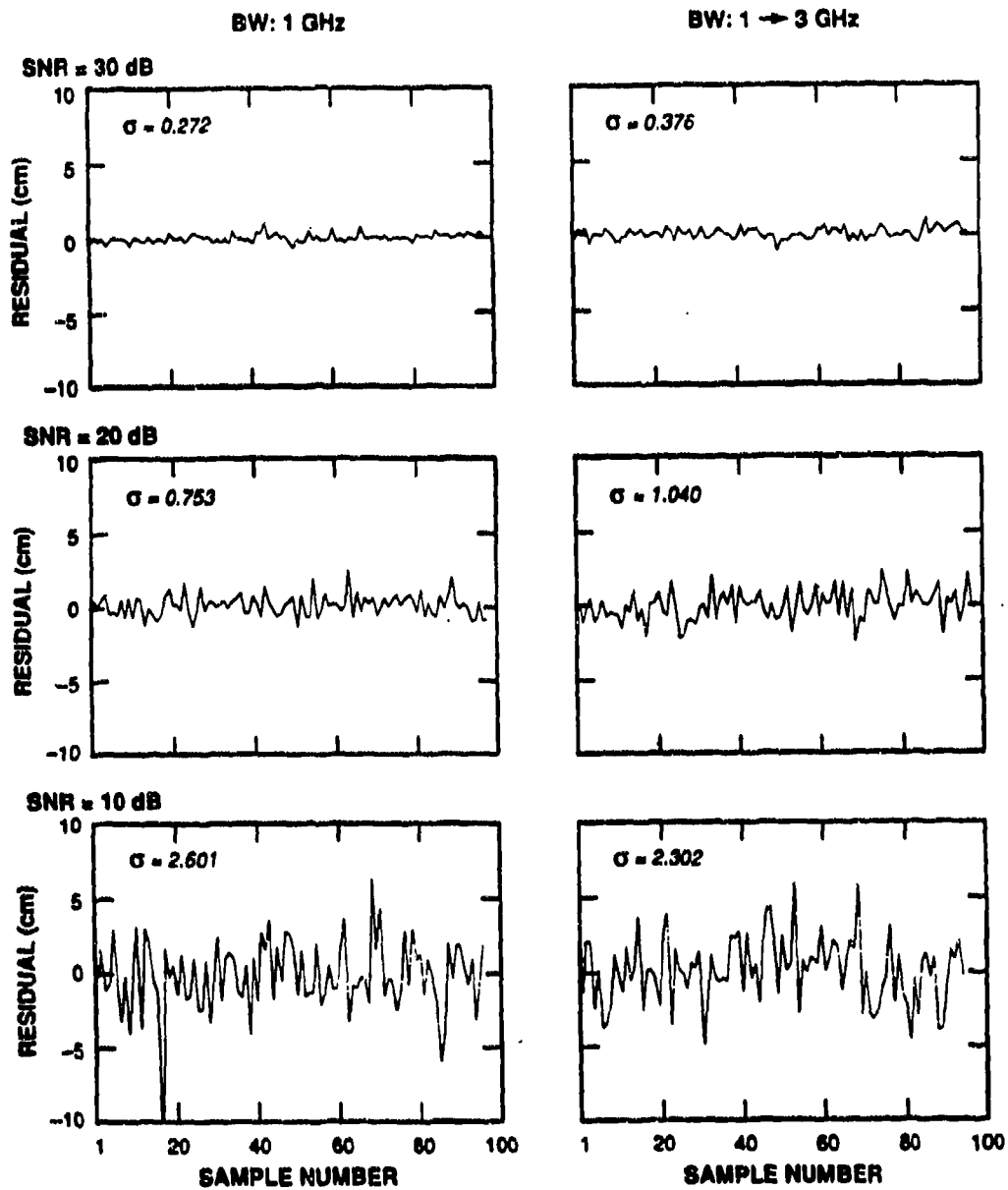

Figure 11. Peak position residuals versus SNR.

The results of Figures 9, 10, and 11 are summarized in Table 1. Theoretical values are included for comparison.

**TABLE 1**  
Noise Sensitivity Results for 0-dBsm Point Scatterer

<b>SNR</b>	<b>Residual Estimated</b>	<b>Std. Dev. (No. BWE)</b>	<b>Std. Dev. (BWE [3:11])</b>	<b>Theoretical<sup>1</sup> Std. Dev.</b>
30	RCS	0.218 dB	0.352 dB	0.194 dB
	Phase	1.478 deg	1.747 deg	1.281 deg
	Position	0.272 cm	0.376 cm	0.216 cm
20	RCS	0.743 dB	0.943 dB	0.615 dB
	Phase	4.964 deg	5.281 deg	4.051 deg
	Position	0.753 cm	1.040 cm	0.690 cm
10	RCS	1.923 dB	2.617 dB	1.753 dB
	Phase	14.702 deg	15.734 deg	12.812 deg
	Position	2.601 cm	2.302 cm	2.181 cm

As indicated in Table 1, BW extrapolation performs well, even with low SNR data. In general, the standard deviations of the BW extrapolated data increase relative to the values for the original data; however, the results remain close to the theoretical values. Thus, the BWE pulse shapes do not show any serious noise sensitivity problems.

---

<sup>1</sup> These values are lower bounds for the standard deviations of the individual parameters, when each parameter is considered as the only unknown.

## 4.2 TWO CLOSELY SPACED POINT SCATTERERS

This section will demonstrate the ability of BWE to resolve two closely spaced point scatterers in the presence of noise if the BW is extrapolated to yield range resolution cells that are smaller than the point spacing. The two point scatterers are spaced 15 cm apart, making them unresolved in range when simulating with a radar bandwidth of 1 GHz (range resolution  $\sim 25$  cm). Gaussian noise is added to the complex spectral data samples of the simulated point scatterers. SNR levels of 10, 20, and 30 dB will be simulated, where SNR is defined as the ratio of the peak signal power to mean noise level in the compressed pulse.

Figure 12 shows 100 superimposed compressed pulses at the three different SNRs tested, before and after BWE processing. The plots on the left correspond to the 1-GHz BW pulses. Since the two unresolved scatterers are adding coherently in amplitude and phase, the mainlobe response is slightly broader than it would be for a single point scatterer, and the peak RCS has increased from the true 0-dBsm values of each point. The plots on the right correspond to the BW extrapolated pulses. A bandwidth extrapolation factor of 3:1 was selected, in an attempt to resolve the two points. In the 20 and 30 dB SNR cases, the two point scatterers are consistently resolved, with an average separation of approximately 15 cm. Also, the average peak RCS of the two points is approximately 0 dBsm, in agreement with their true values. In the 10-dB SNR case, the two points are also resolved; however, the greater position jitter makes their separation more difficult to visualize. Coherent averaging (not shown here) of a few pulses would show a reduction in the position jitter, thus allowing for a clearer identification of the two points.

In the simulations, the mean noise level of the BW extrapolated pulses decreased relative to the original pulses, and there was no observable increase in the range sidelobe levels. This is the result to be expected, since the linear prediction filters produce new spectral samples that are consistent with the original set. Furthermore, the noise has lesser effects in the expanded BW regions, thus increasing the effective SNR of the recompressed pulses. However, the presence of noise can mask the deterministic behavior of the target signal and can eventually lead to inaccurate extrapolations if the SNR is very poor.

### TWO POINT SCATTERERS

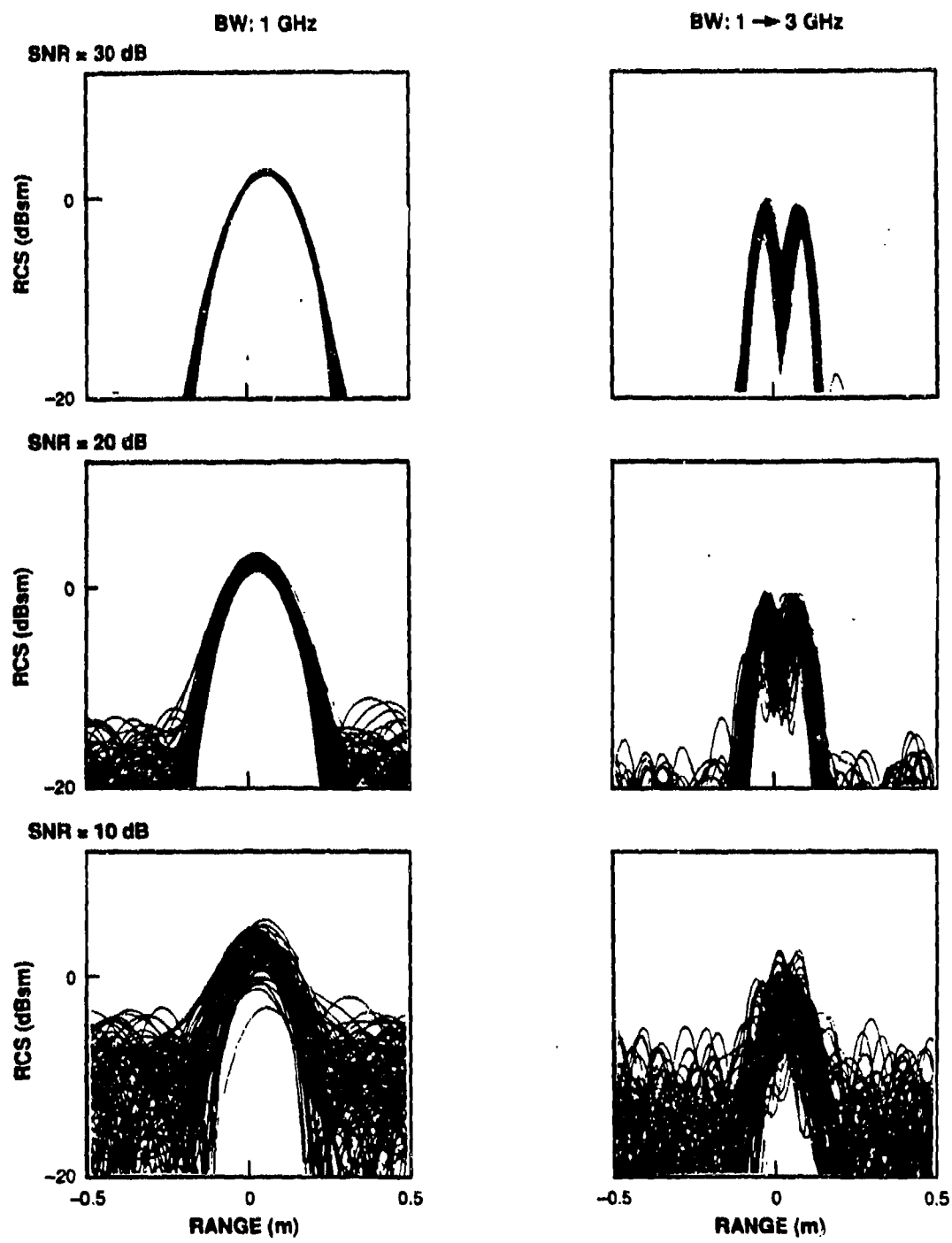

Figure 12. Pulse profile overlays: two closely spaced point scatterers.

## 5. CONCLUSIONS

The bandwidth extrapolation (BWE) form of pulse compression offers improved slant range resolution, but not better range accuracy, than conventional Fourier processing. Examples in this report demonstrate that a factor of 2 to 4 improvement in range resolution is readily achievable with simulated and static range data. In addition, these factors of improvement in range resolution have been obtained with field data (field data results will be presented in a separate report).

It should be noted that the BW extrapolated pulses are not generally equivalent to true high-BW pulses. Extrapolations are based on parameter estimates that are subject to noise effects and modeling constraints, whereas the true high-BW pulses are not. In Section 4, it was shown that the slant range accuracy of a single point scatterer did not improve with an increase in extrapolated BW. With true high-BW pulses, the accuracy will improve as the BW is increased. Very high BW data would, however, be more expensive to generate, but nonetheless would more accurately represent the true target-scattering characteristics. For example, for target effects that are not predictable from the measured spectral signal, such as resonance or other frequency dependencies, the BW extrapolated data may not accurately represent the true high-BW data. The BWE results are useful, however, to the extent that the constraints placed on the spectral signals (autoregressive model in this report) accurately represent the true signals at larger BWs. If, in addition, there is adequate SNR that allows the deterministic nature of the signals to be identified, then significant improvements in range resolution can be obtained.

Further efforts are in progress to explore the performance and limitations of BWE processing with static range and real field data. Detailed results obtained with field data will be presented in a separate report.

## REFERENCES

1. S.B. Bowling, "Linear Prediction and Maximum Entropy Spectral Analysis for Radar Applications," Project Report RMP-122, MIT Lincoln Laboratory (24 May 1977). AD A042817
2. Hsueh-Jyh Li, Ta-Yung Liu, and Sheng-Hui Yang, "Superhigh Image Resolution for Microwave Imaging," International Journal of Imaging Systems and Technology Vol. 2, pp. 37-46 (1990).
3. J.P. Burg, "Maximum Entropy Spectral Analysis," Proc. 37th Meeting of the Society of Exploratory Geophysicists (1967).
4. Private Communication.

# REPORT DOCUMENTATION PAGE

*Form Approved*  
**OMB No. 0704-0188**

Public reporting burden for this collection of information is estimated to average 1 hour per response, including the time for reviewing instructions, searching existing data sources, gathering and maintaining the data needed, and completing and reviewing the collection of information. Send comments regarding this burden estimate or any other aspect of this collection of information, including suggestions for reducing this burden, to Washington Headquarters Service, Directorate for Information Operations and Reports, 1215 Jefferson Davis Highway, Suite 1204, Arlington, VA 22202-4302, and to the Office of Management and Budget, Paperwork Reduction Project (0704-0188), Washington, DC 20503.

1. AGENCY USE ONLY (Leave blank)	2. REPORT DATE 4 December 1992	3. REPORT TYPE AND DATES COVERED Project Report	
4. TITLE AND SUBTITLE  A Bandwidth Extrapolation Technique for Improved Range Resolution of Coherent Radar Data		5. FUNDING NUMBERS  C -- F19628-90-C-0002 PE -- 63215C PR -- 345	
6. AUTHOR(S)  Kevin M. Cuomo		7. PERFORMING ORGANIZATION NAME(S) AND ADDRESS(ES)  Lincoln Laboratory, MIT P.O. Box 73 Lexington, MA 02173-9108	
8. PERFORMING ORGANIZATION REPORT NUMBER  CJP-60, Rev. 1		9. SPONSORING/MONITORING AGENCY NAME(S) AND ADDRESS(ES)  Electronic Systems Center Hanscom AFB, MA 01731-5000	
10. SPONSORING/MONITORING AGENCY REPORT NUMBER  ESC-TR-92-172		11. SUPPLEMENTARY NOTES  None	
12a. DISTRIBUTION/AVAILABILITY STATEMENT  Approved for public release; distribution is unlimited.		12b. DISTRIBUTION CODE	
13. ABSTRACT (Maximum 200 words)  A linear predictive bandwidth extrapolation (BWE) technique is introduced as a means of significantly improving the range resolution of pulse-compressed coherent radar data. Pulse compression schemes based on conventional Fourier techniques are efficient and robust; however, they often suffer from relatively poor resolution. This report describes the use of an autoregressive (AR) time-series model to extrapolate the spectral bandwidth of each uncompressed radar return signal. Subsequent Fourier transformation of the expanded spectral signal yields recompressed pulses with better range resolution than obtainable from conventional Fourier techniques. The linearity of the BWE process produces recompressed pulses that have a calibrated amplitude and phase response, thus allowing for a meaningful interpretation of the RCS and phase signatures of the target. In addition, high resolution range-Doppler images of the target can be generated since the coherence properties of the recompressed pulses are maintained by the BWE process. Simulations, radar range data, and applications of this technique to field data show very promising results.			
14. SUBJECT TERMS			15. NUMBER OF PAGES 38
			16. PRICE CODE
17. SECURITY CLASSIFICATION OF REPORT Unclassified	18. SECURITY CLASSIFICATION OF THIS PAGE Unclassified	19. SECURITY CLASSIFICATION OF ABSTRACT Same as Report	20. LIMITATION OF ABSTRACT None