

AD-A256 634

DTIC

4

4

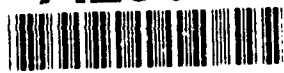

ELECTE

OCT 15 1992

CR 92.011

NCEL

C

D

August 1992

Contract Report

An Investigation Conducted by
EG&G Idaho, Inc.

ADVANCED TRANSFORMER DEMONSTRATION AND VALIDATION PROJECT SUMMARY REPORT BASED ON EXPERIENCES AT NAS, NORTH ISLAND, SAN DIEGO, CA

Abstract The Idaho National Engineering Laboratory and the Naval Civil Engineering Laboratory (NCEL) participated in an advanced transformer demonstration and validation program. The key objectives of the Advanced Transformer Demonstration and Validation Project were to verify the operational characteristics of advanced transformer technologies, determine their applicability to Navy use, and provide NCEL with lessons learned in the installation of these transformers at an active Navy base.

Ten new transformers were installed on the Naval Air Station (NAS), North Island, CA. These special advanced technology units replaced polychlorinated biphenyl-filled units in and around buildings on NAS, North Island. The new transformers included cast coil, amorphous core, and vacuum pressure impregnated units. This report summarizes the experiences gained during the NAS, North Island advanced transformer demonstration and validation project.

92 1

394554

92-27103



057
RYS

NAVAL CIVIL ENGINEERING LABORATORY PORT HUENEME CALIFORNIA 93043-5003

Approved for public release; distribution is unlimited.

METRIC CONVERSION FACTORS

Approximate Conversions to Metric Measures				Approximate Conversions from Metric Measures			
Symbol	When You Know	Multiply by	To Find	Symbol	When You Know	Multiply by	To Find
		LENGTH				LENGTH	
in	inches	2.5	centimeters	mm	millimeters	0.04	inches
ft	feet	30	centimeters	cm	centimeters	0.4	inches
yd	yards	0.9	meters	m	meters	3.3	feet
mi	miles	1.6	kilometers	km	kilometers	1.1	yards
		AREA				0.6	miles
in ²	square inches	6.5	square centimeters	cm ²	square centimeters	0.16	square inches
ft ²	square feet	0.09	square meters	m ²	square meters	1.2	square yards
yd ²	square yards	0.8	square meters	km ²	square kilometers	0.4	square miles
mi ²	square miles	2.6	square kilometers	ha	hectares (10,000 m ²)	2.5	acres
		MASS (weight)					
oz	ounces	28	grams	g	grams	0.035	ounces
lb	pounds	0.45	kilograms	kg	kilograms	2.2	pounds
	short tons (2,000 lb)	0.9	tonnes	t	tonnes (1,000 kg)	1.1	short tons
		VOLUME					
tsp	teaspoons	5	milliliters	ml	milliliters	0.03	fluid ounces
Tbsp	tablespoons	15	milliliters	ml	liters	2.1	pints
fl oz	fluid ounces	30	milliliters	ml	liters	1.06	quarts
c	cups	0.24	liters	l	liters	0.26	gallons
pt	pints	0.47	liters	l	cubic meters	35	cubic feet
qt	quarts	0.95	liters	l	cubic meters	1.3	cubic yards
gal	gallons	3.8	liters	l			
ft ³	cubic feet	0.03	cubic meters	m ³			
yd ³	cubic yards	0.76	cubic meters	m ³			
		TEMPERATURE (exact)					
°F	Fahrenheit temperature	5/9 (after subtracting 32)	Celsius temperature	°C	Celsius temperature	9/5 (then add 32)	Fahrenheit temperature

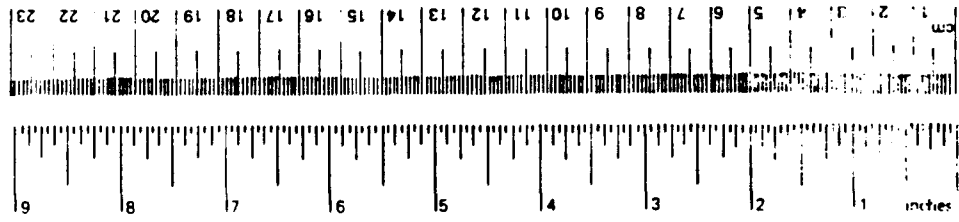

*1 in. = 2.54 exactly. For other exact conversions and more data, see table on back of this book. Misc. Publ. 286, Units of Weights and Measures, Price \$2.25. GPO: 1974 O-313-16-786

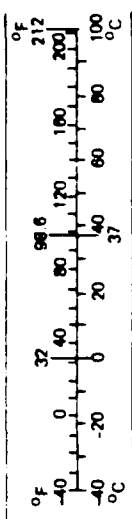

REPORT DOCUMENTATION PAGE			Form Approved OMB No. 0704-018	
Public reporting burden for this collection of information is estimated to average 1 hour per response, including the time for reviewing instructions, searching existing data sources, gathering and maintaining the data needed, and completing and reviewing the collection of information. Send comments regarding this burden estimate or any other aspect of this collection information, including suggestions for reducing this burden, to Washington Headquarters Services, Directorate for Information and Reports, 1215 Jefferson Davis Highway, Suite 1204, Arlington, VA 22202-4302, and to the Office of Management and Budget, Paperwork Reduction Project (0704-0188), Washington, DC 20503.				
1. AGENCY USE ONLY (Leave blank)	2. REPORT DATE August 1992		3. REPORT TYPE AND DATES COVERED Final; 1 Oct 1988 - 31 May 1992	
4. TITLE AND SUBTITLE ADVANCED TRANSFORMER DEMONSTRATION AND VALIDATION PROJECT SUMMARY REPORT BASED ON EXPERIENCES AT NAS, NORTH ISLAND, SAN DIEGO, CA			5. FUNDING NUMBERS PR - 74-021 (PWCS.D) C - N68305-89-WR-00028 N68305-89-WR-00160 WU - DN669075	
6. AUTHOR(S) Scott McBride				
7. PERFORMING ORGANIZATION NAME(S) AND ADDRESS(ES) Idaho National Engineering Laboratory EG&G Idaho, Inc. Idaho Falls, Idaho 83415			8. PERFORMING ORGANIZATION REPORT NUMBER CR 92.011	
9. SPONSORING/MONITORING AGENCY NAME(S) AND ADDRESS(ES) Navy Public Works Center / Naval Civil Engineering San Diego, CA 922136-5113 Laboratory, Code L74 Port Hueneme, CA 93043			10. SPONSORING/MONITORING AGENCY REPORT NUMBER	
11. SUPPLEMENTARY NOTES				
12a. DISTRIBUTION/AVAILABILITY STATEMENT Approved for public release; distribution is unlimited.			12b. DISTRIBUTION CODE	
13. ABSTRACT (Maximum 200 words) The Idaho National Engineering Laboratory and the Naval Civil Engineering Laboratory (NCEL) participated in an advanced transformer demonstration and validation program. The key objectives of the Advanced Transformer Demonstration and Validation Project were to verify the operational characteristics of advanced transformer technologies, determine their applicability to Navy use, and provide NCEL with lessons learned in the installation of these transformers at an active Navy base. Ten new transformers were installed on the Naval Air Station (NAS), North Island, CA. These special advanced technology units replaced polychlorinated biphenyl-filled units in and around buildings on NAS, North Island. The new transformers included cast coil, amorphous core, and vacuum pressure impregnated units. This report summarizes the experiences gained during the NAS, North Island advanced transformer demonstration and validation project.				
14. SUBJECT TERMS Advanced transformers, non-PCB transformers, cast coil, amorphous core, vacuum pressure impregnated units			15. NUMBER OF PAGES 325	
			16. PRICE CODE	
17. SECURITY CLASSIFICATION OF REPORT Unclassified	18. SECURITY CLASSIFICATION OF THIS PAGE Unclassified	19. SECURITY CLASSIFICATION OF ABSTRACT Unclassified	20. LIMITATION OF ABSTRACT UL	

DISCLAIMER NOTICE

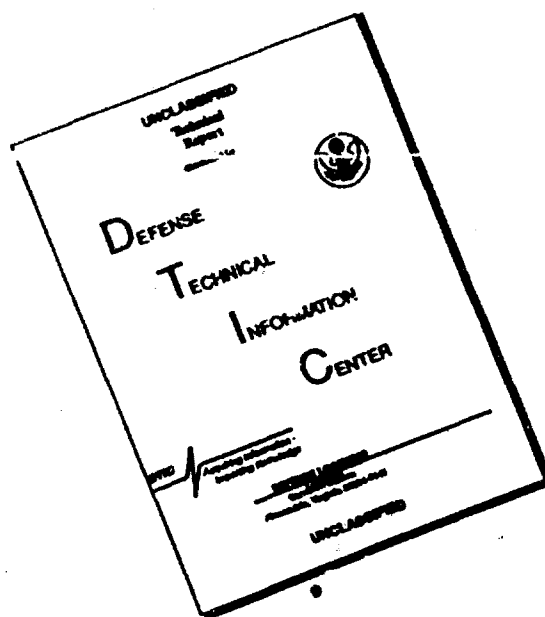

THIS DOCUMENT IS BEST QUALITY AVAILABLE. THE COPY FURNISHED TO DTIC CONTAINED A SIGNIFICANT NUMBER OF PAGES WHICH DO NOT REPRODUCE LEGIBLY.

CONTENTS

ABSTRACT	ii
ACRONYMS	v
1. INTRODUCTION	1
2. BASE HISTORY	2
3. PROJECT SUPPORT AND ADMINISTRATION	4
3.1 Specifications	4
3.2 Subcontracts	4
3.3 Field Office	5
3.4 Quality Assurance	5
3.5 Timing and Coordination	5
3.6 Documentation	6
3.7 Security	6
4. HARDWARE INSTALLATION	7
4.1 Building 94	7
4.2 Building 342	8
4.3 Building 378	8
4.4 Building 379	10
4.5 Building 472	11
4.6 Building 473	11
4.7 Building 489	12
5. TYPES OF TRANSFORMER CONSTRUCTION	13
5.1 Cast Coil Transformers	14
5.2 Vacuum Pressure Impregnated/Encapsulated Transformers	15
5.3 Liquid Filled/Amorphous Core Transformers	15
6. RECOMMENDATIONS AND CONCLUSIONS	17
APPENDIX A--SPECIFICATIONS	A-1

APPENDIX B--TEST REPORTS B-1
APPENDIX C--OPERATING AND MAINTENANCE MANUALS AND PRODUCT INFORMATION . . C-1

ACRONYMS

INEL Idaho National Engineering Laboratory
 NCEL Naval Civil Engineering Laboratory
 NASNI Naval Air Station, North Island
 PCB polychlorinated biphenyl
 PWC Public Works Center
 VPI/E vacuum pressure impregnated/encapsulated

Accession For	
NTIS CR&I	<input checked="" type="checkbox"/>
DTIC TAB	<input type="checkbox"/>
Unannounced	<input type="checkbox"/>
Justification	
by	
Distribution/	
Availability Codes	
Dist	Special
A-1	

v

DTIC QUALITY INSPECTED 1

ADVANCED TRANSFORMER DEMONSTRATION AND VALIDATION
SUMMARY REPORT BASED ON EXPERIENCES
AT NAVAL AIR STATION, NORTH ISLAND
SAN DIEGO, CALIFORNIA

1. INTRODUCTION

The Idaho National Engineering Laboratory (INEL) and the Naval Civil Engineering Laboratory (NCEL) are cooperatively participating in an advanced transformer demonstration and validation program. This task is part of a polychlorinated biphenyl (PCB) Mitigation and Risk Management Assessment Program being performed at the Naval Air Station, North Island (NASNI) in San Diego, California. This report details the specific lessons learned during the NASNI installations to date and addresses the advantages and disadvantages of these transformers for Navy use.

As a part of this program, eight efficient, low-loss cast coil (CC) dry-type transformers, one vacuum pressure impregnated (VPI) transformer, and one low-loss amorphous core transformer were installed at the NASNI to replace existing PCB-filled transformers. The specific advantages and disadvantages of each type of transformer are discussed in the following sections.

2. BASE HISTORY

The electrical distribution system currently in operation at the NASNI contains several hundred devices, several of which are filled with PCB-filled/contaminated insulating fluid. The continued use of PCBs as a electrical device insulating liquid was outlawed in late 1977, and the NASNI is faced with retrofilling or retrofitting the remaining PCB devices (transformers, capacitors, oil switches, and oil-filled circuit breakers).

The PCB transformers are installed in locations including pole mounts, vaults, and various power distribution system locations; many transformers are located near the ocean. Transformers near the ocean are sensitive installations because of the hazardous location and the extreme environmental risks associated with either transformer fires or leaks involving a PCB liquid-filled device near or over the ocean. Most of the NASNI boundaries are surrounded by water. The salt laden air is very corrosive to electrical devices. These criteria were seriously considered during the replacement process and new transformers were installed that greatly reduced or eliminated the safety and environmental concerns associated with the older PCB-filled units.

The INEL supervised the replacement and load consolidation of 13 PCB transformers with 10 new advanced technology transformers during this portion of the Mitigation and Risk Management Program. The locations and sizes of these units are identified in Table 1.

Table 1. Locations and sizes of transformers installed during the NASNI Advanced Transformer Demonstration and Validation Project

<u>Building</u>	<u>Units Removed^a</u>	<u>Units Installed^b</u>	<u>Comments</u>
94	1-500 kVA PCB 2-112.5 kVA PCB	1-750 kVA CC 1-300 kVA CC	2 for 3 replacement oil switches removed
342	1-112.5 kVA PCB	1-112.5 kVA CC	1 for 1 replacement
378	1-1000 kVA PCB 2-500 kVA PCB	1-750/1000 kVA CC 2-500 kVA CC	3 for 3 replacement
379	3-167 kVA PCB	1-300 kVA VPI	1 3 ϕ for 3 1 ϕ replacement
472	1-1500 kVA PCB	1-1500 kVA CC	1 for 1 replacement
473	1-112.5 kVA PCB	1-112.5 kVA AC	1 for 1 replacement
489	1-1500 kVA PCB	1-1500 kVA CC	1 for 1 replacement

a. PCB = existing PCB-filled unit.

b. CC = cast coil
AC = amorphous core
VPI = vacuum pressure impregnated.

3. PROJECT SUPPORT AND ADMINISTRATION

The following sections detail several project support tasks and administrative elements that were completed during this project.

3.1 Specifications

Two transformer specifications (EG&G ES-51333 Rev. B and ES-51334 Rev. B) were written by the INEL. Specification ES-51333 details the construction and installation requirements for liquid-filled transformers, and Specification ES-51334 details the construction and installation requirements for cast coil and VPI transformer. Data sheets and design details for each transformer installation were included in both specifications. This enabled the INEL engineering team to make device selections that met the particular facility needs and optimized the research element around which this project was centered. The specifications required the manufacturer to perform some nontypical factory testing on the new transformers, field testing on the old transformers being removed, and field testing on the new transformers being installed to support the ongoing advanced transformer evaluation work. The specifications are included in Appendix A of this report.

Appendix B contains the final acceptance testing reports of the ABB Service Company 112.5 kVA amorphous core transformer, the National Industrial cast coil transformers, the Square-D 300 kVA VPI transformer, and transformer schematic drawings.

3.2 Subcontracts

Three subcontracts were awarded during this project. Subcontract No. C90-132540 was awarded to Square D Company for manufacturer and installation of one 300 kVA VPI transformer. Subcontract No. C90-132708 was awarded to ABB Service Company for manufacturer and installation of the nine remaining transformers. Subcontract No. C90-132830 was awarded to Rollins Chempak for destruction of the PCB fluid and transformer carcasses. All certificates of destruction of the PCB fluid and carcasses were issued to the San Diego Public

Works Center (PWC). Appendix C contains operating and maintenance manuals and product information for the transformers and their supporting instrumentation.

3.3 Field Office

An INEL field office was established as part of the PCB Mitigation and Risk Management Program before the transformer installations. This office served as a common point for the manufacturers and their subcontractors to coordinate activities with both the Navy PWC and the INEL and supported coordination with other NCEL tasks being performed concurrently at the NASNI.

3.4 Quality Assurance

Quality assurance is a requirement during both the manufacturing process and installation. The possible consequences of failures caused by poor quality assurance can easily exceed the cost of a consistent quality assurance program. The INEL performed a comprehensive field quality assurance engineering program during the course of this project. The program included supervision during factory testing, field testing, and installation of the new transformers. This program verified that these objectives and specifications of the retrofit program were adequately met.

3.5 Timing and Coordination

The INEL and NCEL were responsible for project and outage coordination and planning. INEL and NCEL coordination for this project was minimized because the contractors delivered a turn-key product. Thus, the riggers, hazardous waste handlers, and installers were coordinated by the prime contractors (manufacturers). The Navy PWC and INEL interfaced with the manufacturers to coordinate the outages and installations.

A majority of this project was conducted during the Persian Gulf Crisis. This contributed significantly to the amount of planning required to complete the changeouts without impacting Base operations. The INEL resident engineers negotiated facility power outages with the Navy PWC and the manufacturers to

minimize the impact to the Base. The INEL resident engineers also arranged base access and clearance for the manufacturers and their subcontractors.

3.6 Documentation

These installations removed and replaced PCB-filled devices with new high efficiency, new technology transformers. The PWC has been notified, and it is recommended that both the records of the PWC and the fire department should be updated to reflect the removal of PCBs from these locations.

3.7 Security

Security is a major concern on the Navy Base. Compliance with security measures is mandatory and requires a substantial amount of time. Security on Base was increased substantially during the Persian Gulf Crisis. Proper procedures were followed to arrange for access and clearances for those personnel performing the installations. Advance arrangements reduced delays and made it easier for contractors to obtain access to the installation sites on Base.

Some facilities have minimum levels of security while others are tightly controlled. During this project, all operations went smoothly because of the preplanning and communication with security personnel and the coordination with the Naval Air Rework Facilities and PWC personnel.

4. HARDWARE INSTALLATION

4.1 Building 94

The Building 94 installation consisted of removing three existing PCB-filled transformers (as identified in Table 1) and replacing them with two new cast coil transformers. The three existing units were removed from Building 94; they were located on an overhead mezzanine (Pad 2) approximately 35 ft above finished floor. This installation was performed beginning at 1630 hours on September 26, 1990, and concluded at 1630 hours on September 28, 1990.

Before the outage, the new 750/1000 kVA cast coil dual rated outdoor unit substation transformer with a new 15 kV primary fused switch was set in place on a new concrete pad outside of Building 94. The contractor performed as much electrical work before the outage as the job would allow. This minimized the outage requirements for the installation.

The 750/1000 kVA transformer has a 2400 V/12000 V reconnectable primary winding constructed using five sections. The five sections are connected in series for the 12000 V configuration and in parallel for the 2400 V configuration. Vertical busses mounted external to the coils are used to make the series/parallel connections. High voltage taps are provided on the primary 12000 V configuration only. The unit was installed in the 2400 V configuration by extending the existing 2400 V feeder from the mezzanine to the new outside location. The existing 2400 V distribution systems are currently being upgraded to 12 kV by the Navy. The dual voltage transformers make the transition from 2400 to 12000 V in the facilities more cost effective. New secondary switchgear was also installed on this unit substation to feed the existing loads and the new 300 kVA transformer. The 300 kVA transformer is fed by the 480 V output of the 750/1000 kVA transformer. The secondary voltage of the 300 kVA unit is 208/120 V and will be used to feed one existing 208 V panel and one existing 240 V panel. The INEL addressed the option of providing only 208 V to the 240 V panel with the San Diego PWC. The PWC stated that all existing 240 V loads would operate acceptably at the reduced voltage.

This installation presented the contractor with several unique difficulties. Most importantly, the existing PCB-filled transformers were located approximately 35 ft over an aircraft rework facility. Extreme care had to be taken to protect the adjacent aircraft and shop equipment from any physical or environmental damage while removing the hazardous waste (liquid and solid) and installing the new electrical equipment. In addition, with the conflict in the Persian Gulf, the operations of this aircraft rework facility were intensified. This placed added pressure on the construction crew to minimize outage and installation time. Extensive planning was needed to avoid problems and outage extensions that would have caused significant impact to the facilities operations.

In spite of several interim problems that were encountered during this installation, ABB Service Company was able to react quickly to the directions of the Navy and the INEL field engineer to successfully complete the task.

4.2 Building 342

The Building 342 installation consisted of removing an existing 112.5 kVA PCB transformer and replacing it with a new 112.5 kVA cast coil unit substation transformer with a dual voltage primary winding (2400 and 12,000 V). The existing oil fused cutouts were also removed and replaced with a new 15 kV fused switch. This installation was performed beginning at 0600 hours on December 15, 1991, and concluded at 0600 hours on December 16, 1991.

The new transformer was initially installed in the 2400 V configuration. The dimensions of the new transformer required that the concrete pad be extended and the safety fence be modified. The concrete and fence work was performed after the new transformer was energized. No other problems were encountered during this installation.

4.3 Building 378

The Building 378 installation consisted of removing three existing PCB transformers in three different locations (pads 378-1, 378-2, and 378-6);

replacing them with three new cast coil transformers in two locations; and consolidating power feeders.

The pad 378-1 installation is located in a vault and consisted of removing a 1000 kVA PCB transformer and two PCB-filled voltage regulators and replacing them with a 1000 kVA cast coil transformer and a 500 kVA transformer. The transformer that was removed had a 2400 V primary and a 208 V secondary. The primary voltage to the vault was upgraded to 12 kV by tapping into an existing pothead in pad 378-2. The new 1000 kVA cast coil transformer was constructed as a unit substation with a new 15 kV fused switch and 480/277 V secondary switchgear. The secondary of the new transformer was 480/277 V grounded wye. The 500 kVA cast coil transformer was installed in the vault to step down the output of the 1000 kVA unit from 480 to 208 V. The output of this second unit was connected to the existing 208 V switchgear.

The pad 378-2 installation consisted of removing a 500 kVA PCB transformer and feeding the panel from the new switchgear on the 1000 kVA transformer in vault 378-1. No new transformer was installed at pad 378-2. A local main disconnect breaker was retrofitted to the back of the existing load panel, and new supports had to be fabricated to support the load panel that was originally mounted directly to the PCB transformer. This load consolidation reduced the power losses, reduced the transformer cost, and provided environmentally safe and efficient power delivery.

The pad 378-6 installation consisted of a direct one-for-one replacement of a 500 kVA PCB transformer with a new 500 kVA cast coil transformer. The existing secondary switchgear and primary air interrupter switch were reused. The new transformer was physically larger than the original unit; thus, the concrete pad had to be extended. The size increase is common when liquid-filled transformers are retrofitted with dry-type transformers. During this installation it was noted that the insulation on the existing conductors connecting the primary switch to the transformer was in poor condition; therefore, the conductors were removed and new conductors were installed.

This installation required a great amount of planning. Very little work could be performed before the outage because of the space limitations in the

facility. The doorway entering the vault was slightly smaller than the dimensions of the old transformer that was to be removed. Thus, the contractor needed to cut one of the termination throats from the transformer. A significant problem was encountered during this process. The contractor failed to clean the inside of the throat before using the cutting torch. The bushings inside the throat had leaked transformer fluid into the throat and the fluid contained PCBs. The material began to smoke immediately after heat was applied. The contractor was immediately stopped. The environmental waste handling crew then cleaned the throat with solvent to remove the PCBs. Once the throat had been cleaned, the PWC environmental office inspected the throat and gave the contractor permission to complete the cut, which was completed without further incident. The existing 2400 V feeder (three conductor lead sheathed cable) to the old transformer in vault 378-1 could not be removed and had to be capped and abandoned in place. The contractor attempted to remove the cable and could not pull it. The San Diego PWC stated that the cable should be capped and abandoned in place.

4.4 Building 379

The Building 379 installation consisted of removing three existing 167 kVA PCB-filled, single phase, polemount transformers that were connected in a three phase bank and replacing them with a single 300 kVA Square D Company VPI dry-type transformer. This task also involved removing another PCB-filled transformer from the roof of Building 379. The loads, which were fed by this transformer, were then alternately fed using another existing transformer. Ultimately, four PCB transformers were removed from the facility and replaced with a single modern dry-type transformer. The Square D Company hired a local subcontractor (Chula Vista Electric) to perform the actual removal and installation.

The new 300 kVA transformer is uniquely constructed with a dual rated primary winding. The winding can be connected in a 2400 V or a 12000 V delta configuration. The new transformer was installed in the 2400 V configuration using the existing oil filled cutouts.

The original installation was very congested. The three 167 kVA transformers were packed into a very confined space on an overhead wooden mezzanine with little or no clearance for maintenance personnel. The new transformer was constructed to slip into the installation without having to modify the roof support structure. The new installation provides a clean transformer enclosure design and small size, allowing adequate clearance around the unit so maintenance can be performed on the unit. Installing this unit involved an intricate rigging configuration that had to be well planned. The installation went smoothly without incident.

4.5 Building 472

This installation is in a corrosive environment. The transformer and primary and secondary switchgear are located between two stack assemblies. The moisture and corrosives emanating from the stacks have caused extensive corrosion to the existing transformer enclosure and the existing primary and secondary switchgear. The task involved removing the existing 1500 kVA PCB-filled transformer and replacing it with a new 1500 kVA cast coil ventilated dry-type transformer with future forced air provisions. Cast coil transformers are extremely resistant to corrosives and are environmentally inert; thus, the new transformer could be installed in the same location as the old unit. New code requirements require a substantially greater distance between the facility and a standard oil-filled transformer. A new mineral-oil filled transformer could not have been installed without performing substantial facility modifications. The high efficiency cast coil dry-type transformer was installed outside on the existing pad without any facility modification. This installation was performed on November 3 and 4, 1990, by ABB Service Company and their subcontractors.

4.6 Building 473

The installation at this facility was delayed. The specification detailed the design requirements of the new transformer; however, the contractor manufactured the new extremely high efficiency amorphous core transformer with the wrong secondary voltage. A new transformer was manufactured and was installed on February 22, 1992. Building 473 was a prime

candidate for an amorphous core transformer. The building was being served by a 112.5-kVA PCB liquid-filled transformer that was lightly loaded.

The transformer no-load loss (core loss) remains constant at all levels of transformer loading. The load loss, however, increases proportionally to the loading. Under lightly loaded conditions, the no-load loss comprises a more significant portion of the total losses of a transformer. Building 473 is only occasionally heavily used and typically has minimal loading. The extremely low no-load loss of the amorphous core transformer will reduce the power consumption at Building 473 considerably. No problems were noted during this final installation.

4.7 Building 489

The original 1500 kVA transformer feeding Building 489 failed and the replacement was added to this project. Following the failure, the failed unit was removed and a temporary 3750 kVA unit substation transformer was installed by the Navy PWC. This unit provided temporary power to the facility until this permanent replacement was installed. The existing 15 kV class primary switch had been damaged during the transformer failure but had to be rebuilt and placed back into service concurrent with installation of a new transformer.

This installation began with the removal of the 3750 kVA temporary transformer. The San Diego PWC removed the temporary 3750 kVA unit. A new 1500 kVA cast coil transformer was then installed by the ABB Service Company. The new unit has a 12000 V delta primary and a 480/277 V grounded wye secondary. The original 15 kV fused switch was rebuilt by the ABB Service Company and placed back into service with the new transformer. The ABB Service Company had not anticipated needing new fuses for the primary switch and had to obtain them before the new transformer could be energized. No other problems were identified during this installation.

5. TYPES OF TRANSFORMER CONSTRUCTION

Cast coil transformers provide an acceptable and preferable alternative to PCB transformers. They are self-extinguishing and, therefore, offer high levels of fire safety compared to liquid-filled transformers, they are efficient, and they perform exceptionally in the corrosive environments common to Navy installations.

Liquid-filled transformers have been used for severe duty applications for many years. High fire point insulating liquids allow the use of liquid-filled transformers in locations where there is a risk of fire. The most commonly used high fire point liquid is commonly referred to as Askarel and is primarily comprised of PCBs. Use of PCBs was outlawed in 1977 because of health problems, primarily caused from the by-products of combustion of these fluids such as furans and dioxins. Thus, alternative transformer types or fluids must be used.

The primary alternatives for PCB-filled transformer replacements are "less flammable" liquid-filled transformers (insulating liquids with a minimum fire point of 300°C are classified as "less flammable" by UL and Factory Mutual) and dry-type transformers. The first alternative, "less flammable" liquid insulated transformers, is a good alternative but will not work in all locations. For example, certain restrictions or requirements apply when installing liquid-filled transformers. There are several currently available "less flammable" transformer insulating liquids. They are typically high molecular weight hydrocarbons. The second alternative is to use dry-type transformers. "Less flammable" liquid-filled transformers are not an option where vault requirements or fire codes restrict their use.

There are two general dry-type transformers to evaluate: standard and CC. The standard dry-type transformers, open wound and VPI, are not designed to withstand the stress, use, and physical abuse of a comparable liquid-filled transformer. Issues such as temperature rise, basic impulse level, and short-circuit strength are common weaknesses of standard dry-type transformers when compared to liquid-filled transformers. However, cast coil dry-type transformers perform with ratings equal to or greater than those of comparable

liquid-filled designs. The following characteristics of liquid-filled and cast coil dry-type transformers were compared:

- Basic impulse level
- Sound level
- Short time overload capability
- Weight
- Thermal rating (temperature rise capability)
- Load losses.

In all cases, cast coil transformers met or exceeded liquid-filled transformer parameters for these characteristics.

5.1 Cast Coil Transformers

Cast coil transformers are dry-type transformers with vacuum cast coil assemblies. The manufacturers of cast coil transformers use two basic methods of coil construction. One design uses fiberglass cloth to provide mechanical support along with a thin layer of epoxy encapsulation. The other design uses a thick layer of silica-filled epoxy to provide both the dielectric and mechanical strength.

Cast coil transformers are available with both copper and aluminum conductors. The aluminum units are somewhat less expensive to manufacture but typically are larger and less efficient. The design that uses the thin layer of epoxy requires that the coils must be cast in precision molds (i.e., they require high quality control). This requirement for precision molds depends directly on the design of the coils and adds significantly to the mold fabrication cost. The manufacturers that use precision molds are typically limited to building only the coils for which they have molds, and they typically cannot build custom units. This is a problem for loss evaluated units in which a larger amount of conductor is used in the coils to reduce the resistive losses. The manufacturers that use the thick epoxy have more flexibility because they can often afford to build a mold or use an existing mold for a custom transformer if needed.

These types of transformers are currently available with either copper or aluminum windings to sizes of approximately 10,000 kVA.

For additional information on cast coil transformers refer to EG&G reports EGG-2591, February 1990, Cast Coil Transformers Fire Susceptibility and Reliability Study, and EGG-EE-8652, August 1989, Cast Coil Transformer Summary Report Based on Experiences at Norfolk Naval Base.

5.2 Vacuum Pressure Impregnated/Encapsulated Transformers

Vacuum pressure impregnated/encapsulated (VPI/E) transformers are dry-type transformers with coils that are impregnated (or encapsulated) with a silicone, polyester, or epoxy resin while under vacuum. The resin is intended to provide a barrier against moisture, dust, and corrosives and increase overall coil insulation. The relatively thin resin coating does not provide added mechanical strength as does the CC. The vacuum pressure encapsulation process was specifically developed for the Navy to improve impregnation and moisture resistance of the windings. This enabled the Navy to use high voltage dry-type transformers aboard ships especially in the high moisture environment. These types of transformers are currently available with either copper or aluminum windings to sizes of approximately 10,000 kVA.

5.3 Liquid Filled/Amorphous Core Transformers

Liquid-filled amorphous core transformers are currently being produced in industry from 15 to 2500 kVA. These extremely efficient transformers have a significantly reduced magnetic loss characteristic. The only difference between the typical and amorphous core liquid-filled transformer is in the core construction.

Amorphous metals, developed and patented by Allied Corporation under the trade name of Metglas, are a new class of metallic materials. Unlike other metals or alloys of metals, amorphous metals do not have grain structure; they are more characteristic of glass. When normal metals or alloys cool from the molten state, the atoms arrange themselves into an orderly lattice of crystals. The intercrystalline boundaries play a major role in the hysteresis

losses experienced by steel when subjected to the alternating current in a transformer. In the Metglas process, an alloy of iron, boron, and silicon is cooled at approximately 1 million °C/s. This rapid cooling causes the atoms to arrange themselves in a random fashion as they do in glass, rather than in the highly structured crystalline lattices found in metals. The end result of this process is a material that, used in the core of a transformer, cuts the no-load losses to about 25 to 40% of the losses of an equivalent silicon-steel core.

For more information on Amorphous Core Transformers refer to NCEL Report N-1801, August 1989, 25 kVA Amorphous Metal-Core Transformer Developmental Test Report, and EGG-EE-8748, June 1991, Retrofill/Retrofit Study of PCB Electrical Transformers U.S. Navy Public Works Center Pearl Harbor, Hawaii.

6. RECOMMENDATIONS AND CONCLUSIONS

The San Diego Advanced Transformer Evaluation and Validation Project was completed successfully. It would be useful to consider these recommendations for future transformer installation and operation:

- Provide on-line documentation and tracking for the replaced transformers. This information must be provided to the PWC, the fire department, and any other organizations who need it so that their records can be updated to show that the hazardous wastes (PCBs) have been mitigated.

A previous incident at the Norfolk Naval Base involved a PCB transformer that had been replaced with a new transformer. The new unit caught on fire, and the fire department would not enter the vault to put the fire out because their records listed the unit as PCB filled. The damage to the unit and vault could have been reduced substantially if the proper records would have been updated.

- Install cast coil transformers in environmentally sensitive areas and areas with high power rates. They also are excellent for use in facilities that experience cyclical loads where the transformers are or can be shut down for long periods of time or when varying loads are experienced.
- Evaluate amorphous core transformers when life-cycle costs indicate that small increases in purchase price will be recovered by the reduced losses of the transformer.
- Conduct a follow-on study on the VPI transformer installed in Building 379. The operational data will provide the Navy with verification of the performance of a VPI transformer in a shore-based Navy application.

- Thoroughly investigate the replacement sites for access, floor space, and other interface requirements that could possibly cause problems during the installation. Any findings should be pointed out to the contractors before installation to minimize impact.
- Strictly monitor the installation schedule and coordination with the PWC. Ensure that all aspects are properly scheduled and that all needed resources and personnel are available.
- Strictly monitor the contractor to ensure that all areas are thoroughly cleaned after the installations are complete and that all materials and debris are removed from the job site.

The transformer installations illustrate technology evaluation, operational performance, fire code compliance, and sizing. These types of transformers each have their specific applications and advantages and serve as excellent replacements for PCB-filled/contaminated transformers in Navy applications. Each of the types of transformers demonstrated during this project will provide the Navy with environmentally safe and efficient power delivery alternatives to PCB-filled transformers.

Appendix A
Specifications

ES — 51333 Rev. B

DATE — May 4, 1990

SPECIFICATION

FOR

THE PURCHASE AND INSTALLATION OF LIQUID FILLED TRANSFORMERS
AT THE SAN DIEGO NAVAL FACILITY

PROJECT NO.

015341

Approved for Release:

Engineering Graphics
EG&G Idaho, Inc.

DOCUMENT APPROVAL SIGNATURE SHEET

Title of Document ENGINEERING SPECIFICATION	Document No. ES-51333
-------------------------------------------------------	---------------------------------

SPECIFICATION FOR THE PURCHASE AND INSTALLATION OF LIQUID FILLED TRANSFORMERS AT THE SAN DIEGO NAVAL FACILITY

Prepared By <u>S. A. MORRIS</u>	Ext. <u>9330</u>
Originated By <u>G.D. SEIFERT</u>	Ext. <u>9522</u>

(PRINT OR TYPE NAME IN SPACE ABOVE SIGNATURE)

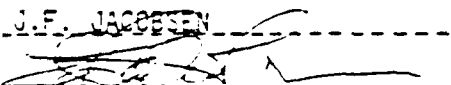
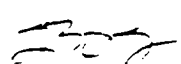
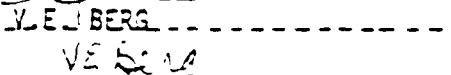
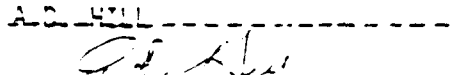
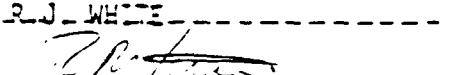
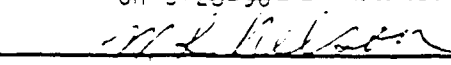
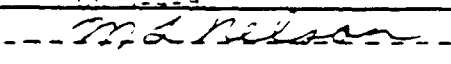
Approval and Review Signatures	Organization	Mail Address	Date
<u>J.F. JACOBSEN</u> 	INEL - POWER SYSTEMS ENGINEERING		<u>11/22/89</u>
<u>V.E. JENSEN</u> 	INEL - Quality Engineering	<u>3508</u>	<u>11-20-89</u>
<u>A.D. HILL</u> 	INEL - ELECTRICAL SAFETY	<u>3423</u>	<u>11-20-89</u>
<u>R.J. WHITE</u> 	NCEL - EE PROGRAM MANAGER	<u>2302</u>	<u>11/20/89</u>
Revision A per DRR EGB-736 Released by Engineering Graphics on 3-28-90 			
Revision B per DRR EGB-753 Released by Engineering Graphics on 5-4-90 			
A-4			

CONTENTS

<u>Section</u>	<u>Page</u>
1. SCOPE	A-7
1.1 Scope	A-7
1.2 Applicability	A-7
2. APPLICABLE DOCUMENTS	A-7
2.1 American National Standards Institute (ANSI).....	A-8
2.2 American Society of Testing & Materials (ASTM).....	A-8
2.3 National Electric Manufacturers Association (NEMA).....	A-9
2.4 National Fire Protection Association (NFPA) Publication	A-9
2.5 Others	A-9
3. TECHNICAL REQUIREMENTS	A-10
3.1 General	A-10
3.2 Electrical Products	A-11
3.3 Condition of Products	A-11
3.4 Uniformity	A-11
3.5 Test Point Observation	A-11
3.6 Performance Requirements	A-11
3.7 Environmental Conditions	A-15
3.8 Accessory	A-15
3.9 Tank Construction	A-18
3.10 Paint	A-18
3.11 Miscellaneous Requirements.....	A-18
3.11.1 Insulated Phase Barriers.....	A-18
3.11.2 Undercoating.....	A-18
3.11.3 Warning Signs.....	A-18
3.12 Provisions for Fan Cooling.....	A-19
3.13 Testing	A-19
3.13.1 Coolant Tests.....	A-19
3.13.2 Factory Electric Tests	A-20
3.13.3 Field Tests.....	A-20
4. QUALITY ASSURANCE PROVISIONS	A-21
5. PACKAGING	A-22
6. SUBMITTALS	A-22
6.1 Shop Drawings and Manufacturer's Data	A-22
6.2 Certified Laboratory Test Data	A-22
7. DEMOLITION AND CONSTRUCTION	A-23
7.1 Demolition and Construction General Requirements	A-23
7.2 Draining	A-24
7.3 Transportation and Disposal	A-24

ES-51333

APPENDICES

A.	Transformer Data Sheet	A-25
B.	Vendor Data Requirements List	A-53
C.	Construction Details	A-55
D.	Spill Prevention, Control, and Countermeasures Plan	A-66
E.	Switchgear Specification	A-72

SPECIFICATION
FOR THE PURCHASE AND INSTALLATION OF
LIQUID FILLED TRANSFORMERS AT THE
SAN DIEGO NAVAL FACILITY

1. SCOPE

1.1 Scope. This specification covers the design, fabrication, testing, installation, and inspection of new liquid filled, power transformers and the removal of the existing polychlorinated biphenyl (PCB) filled transformers, handling of PCB fluid, and obtaining the permits required for hauling hazardous waste. The intent is to make a turnkey replacement with advanced technology transformers including any equipment needed to replace the existing transformers. They will be used to provide the Navy with performance data on these advanced technology devices.

1.2 Applicability. It is not the intent to specify details of design and construction except where necessary to establish performance requirements, nor is it intended to set forth those performance requirements, which are adequately specified in applicable standards.

All components of the transformers shall function in a satisfactory manner within their rated capacity under the specified service conditions regardless of whether all necessary specific performance requirements are set forth herein or in applicable standards.

2. APPLICABLE DOCUMENTS

The following documents form a part of this specification to the extent specified herein. The issue of a document and amendments in effect on the date of publication of this specification shall apply.

2.1 American National Standard Institute (ANSI).

- ANSI-C57 12.00 General Requirements for Liquid Immersed
Distribution Power and Regulating Transformers
- ANSI-C57 12.13 Requirements for Conformance Liquid Filled
Transformers Used in Unit Installation including
Unit Substations
- ANSI-C57 12.27 Conformed Requirements for Liquid Filled
Transformers Distribution Used in Pad Mounted
Installation, including Unit Substations
- ANSI-C57 12.80 Terminology for Power and Distribution
Transformers
- ANSI-C57 12.90 Test Code for Liquid Immersed Distribution, Power,
and Regulating Transformers
- ANSI-C57 12.91 Test Code for Dry Type Distribution and Power
Transformers
- C2-1989 National Electrical Safety Code
- ANSI-C57-13 Requirements for Instrument Transformers
- Z35.1 Specifications for Accident Prevention Signs

2.2 American Society of Testing and Materials (ASTM).

- ASTM D 92-78 Flash and Fire Points by Cleveland Open Cup
- ASTM D-877 Dielectric Breakdown Voltage of Insulating Liquids
- ASTM D-923 Sampling Electrical Insulating Liquids

ASTM D-924	Power Factor and Dielectric Constant
ASTM D-974	Neutralization Number
ASTM D-1533	Water in Insulating Liquid
ASTM D-2225	Methods of Testing Silicone Fluids Used for Electrical Insulation
ASTM D-3487	Mineral Insulating Oil Used in Electrical Apparatus
ASTM D-4652	Standard Specification for Silicone Fluid Used for Electrical Insulation

2.3 National Electric Manufacturers Association (NEMA).

NEMA TRI-1974	Transformers, Regulators, and Reactors
---------------	----------------------------------------

2.4 National Fire Protection Association (NFPA) Publication.

NFPA 70	National Electrical Code
---------	--------------------------

2.5 Others.

IEEE 400-1980	IEEE Guide for Making High Direct Voltage Tests on Power Cable Systems in the Field
NEESA 20.2-028a	PCB Compliance, Assessment, and Spill Control Guide
OPNAVINST 5090.1	Environmental and Natural Resources Protection Manual
29 CFR	General Industry Safety and Health Standards

40 CFR 263	Standards Applicable to Transporters of Hazardous Waste
40 CFR 172	Hazardous Materials Tables and Communications Standards
49 CFR 173	General Requirements for Shipping and Packaging
40 CFR 761	Polychlorinated Biphenyls (1979)
PWC San Diego	Utility Standards
California CAC Title 22, Division 4	Environmental Health
MIL-P-28641	Primer Coating, Vinyl Chlorine Acetate, Copolymer, High Build (for steel and masonry)
MIL-Q-9858A	Quality Program Requirements

3. TECHNICAL REQUIREMENTS

3.1 General. The transformers shall have low loss metal core and shall be three phase, three-winding, fluid-immersed, self-cooled, dead front, suitable for installation indoors or outdoors, or as specified in the individual data sheets in Appendix A. They shall have primary and secondary compartments that shall enclose all termination devices so that no live parts are exposed when the transformer is energized. Unit substation transformer installations are exempt from the dead front requirement. The transformer and installation shall meet all applicable requirements of the ANSI, ASTM, NEC, and NEMA publications as specified herein. The transformer shall be of new construction. The successful bidder shall be responsible for all field modifications and measurements and provide installation and checkout, and turn the transformer over to the operations department, PWC San Diego, through the EG&G Idaho, Inc. Resident Engineer ready for operation.

A

3.2 Electrical Products. All materials, appliances, equipment, or devices shall be new and conform to the applicable standards of the Underwriter's Laboratories, Inc. (UL) and applicable chapters of the National Electrical Code (NFPA 70), where such standards exist. All materials, appliances, equipment, or devices shall be listed and/or labeled by UL, where such standards exist.

3.3 Condition of Products. Except as otherwise indicated, new electrical products free of defects and harmful deterioration shall be provided at the time of installation. Each product provided shall be complete with trim, accessories, finish guards, safety devices, and similar components specified or recognized as integral parts of the product, or required by the governing regulations.

3.4 Uniformity. Where multiple units of a product are required for the electrical work, identical products shall be provided by the same certified and approved manufacturer without variations except for sizes and specific variations as indicated.

3.5 Test Point Observation. The successful bidder shall supply EG&G Idaho with a flow sheet for the manufacture of each transformer indicating all test points. The successful bidder shall notify EG&G Idaho, in writing, of the date that each test will be conducted at least 14 days before that test and will admit EG&G Idaho and government representatives to witness the tests.

3.6 Performance Requirements. Each transformer shall comply with the following performance requirements as specified in ANSI-C57 12.00, except as noted in the data sheets in Appendix A.

Transformer Rating	As specified in Appendix A.
Auxiliary Cooling	Forced air provisions, fan mounts, and temperature sensor access points as a minimum shall be provided for future. Refer to the data sheets in Appendix A for special instructions.

Primary Voltage As specified in Appendix A. Note special dual voltage requirements.

Primary Connection As specified in Appendix A.

Frequency and Phase 60 Hertz, 3 Phase

Secondary Voltage As specified in Appendix A.

Secondary Connection Wye connection with neutral to be brought out through an insulated bushing with external ground strap.

Insulating Liquid The insulating liquid shall be "less flammable" as defined in the NFPA with 284°C minimum flashpoint and 312°C minimum firepoint and shall have less than 30 ppm water content per ASTM D-4625. The liquid shall be as specified in the data sheets; however, evaluated options of alternatives will be considered if they are to the best advantage of the U.S. Government.

Silicone liquid with 300°C minimum flashpoint and 340°C minimum firepoint and shall have less than 30 ppm water content per ASTM D-4652. Askarel and insulating liquids containing PCBs shall not be provided.

or

The insulating liquid shall be RTEMP with 284°C minimum flashpoint and 312°C minimum firepoint and shall have less than 5 ppm water content.

Insulating Paper	There shall be less than 1% moisture by dry weight in the paper insulation.
Temperature Rise	55°C per NEMA TRI-1974.
Taps - No Load	Minimum of five full capacity high voltage taps (two 2-1/2% taps above and two 2 1/2% taps below normal voltage and tap position indicators).
Insulation Levels	
Primary Voltage	95 KV BIL for Insulation Class 15 KV and 75 KV BIL for Insulation Class 5 KV. Based on specific voltage ratings, which are in the data sheets in Appendix A.
Secondary Voltage	30 KV BIL for Insulation Class 600 V. For specific voltage ratings, see the data sheets in Appendix A.
Core Material (General)	The core shall be constructed of low loss silicon steel sheets except where specified as amorphous. The specific type of low loss silicon steel is to be determined by the manufacturer to meet the lowest total operating costs and optimize no-load losses. However, the intent of this replacement program is to install advanced technology transformers wherever it is economically feasible. The use of amorphous metal, laser etched steel, or other advanced technology core material is encouraged in order to meet low operating cost criteria.

Core Material
(Amorphous)

The following applies to those transformers specified as amorphous core. The transformer shall be constructed of low loss amorphous metal. The complete core assembly shall be fully encapsulated with a protective coating of approved material to eliminate sharp edges and prevent flaking particles from entering the coolant during normal operation. The no-load losses shall be less than 45% of those no-load losses of comparable silicon steel core designs. It is known that a wound core is standard. However, a few of the options in the data sheet specifically require stacked core. This stacked core will be treated as a research project to get a "new" technology unit. The other amorphous core device can be wound (or stacked) at the manufacturer's discretion.

Impedance

As specified in the data sheets in appendix A with the following guidelines:

1. The minimum allowable impedance for transformers 750 KVA and above is 4.0 percent.
2. The minimum allowable impedance for transformers 500 KVA is 3.5 percent.
3. The tolerance is +/- 7 1/2 % except for the transformers with dual rated primaries which shall have an impedance tolerance of +/- 10 %

A

No-Load Loss

The no-load losses (core losses) shall be optimized per the evaluation formula provided in the bid package/Request For Proposal (RFP).

Load Loss The load losses (winding losses) shall be optimized per the loss evaluation formula provided in the bid package/RFP.

Sound Level Shall not exceed noise level per NEMA standards.

3.7 Environmental Conditions.

Elevation 50 feet above sea level

Location Indoor/outdoor (See Appendix A.)

Temperature Range 0°C to 40°C

3.8 Accessories. The transformer shall have the following accessories as a minimum. The accessories shall be constructed and located as described in ANSI-C57 12.00.

- Elbow terminators, fuses, load break switches, and tap changers as called out in Section 3.6, primary connection section, and per individual data sheets in Appendix A.
- Magnetic liquid level gauge with 25°C level marking.
- Dial type thermometer with alarm contact of sufficient capacity to control the future fan contactor and an additional contact for a future utility control system.
- Pressure - both a vacuum bleeder device and a high volume pressure relief device rated at a minimum of 100 SCFM at 15 psi. Additional pressure relief capacity will be required and installed per UL classification, if RTEMP fluid is used.

- 1 inch NPT boss and plug in tank top situated such that a 1/2 inch fiberglass instrument rod could be inserted (in the future by others) into the fluid (straight down) without contacting any part of the bus or core assembly.
- Upper Filler Connection - 1 inch nipple with plug.
- Drain Valve - 1 inch globe valve.
- Lower Sampling Valve - min. 3/8 inch at tank bottom (may be part of drain valve assembly).
- Upper Sampling Port - min. 3/8 inch boss in tank wall and valve (with cap) approximately 1 inch below top fluid level to allow future diagnostic instrumentation access (by others).
- Lifting, moving, and jacking provisions.
- Stainless steel/aluminum nameplate with information required in ANSI-C57 12.00 at two locations: one on the transformer exterior and one in the secondary cubicle. (note: stainless steel is preferred) A
- A junction box shall be located on the transformer nameplate side and contain a terminal board for all electrical circuits entering or leaving the junction box. The junction box shall have a hinged door with a gasket and a handle with provisions for padlocking. All electrical circuits from components mounted within the transformer shall run to this terminal board.
- An optional top oil temperature sensing thermocouple shall be mounted in the prevailing transformer top oil thermal hot spot. As a minimum, the thermal well housing must be included, even if the optional top oil temperature sensing thermocouple is not added. The thermocouple shall be A

installed in a thermal well housing that will allow maintenance. This thermocouple will provide input to an electronic temperature monitor. This instrument shall respond to the top oil temperature and automatically display this reading. An analog meter shall continuously display the top oil temperature and indicate the maximum temperature reached over a period of time. Light emitting diodes are not acceptable. The highest temperature shall also be used to initiate alarm and trip functions and is stored for future recall until the maximum temperature memory is cleared. Fail safe alarm relay circuits automatically actuate if supply power has been lost. Maximum temperature can be recalled even if supply power has been interrupted. A self-test procedure allows set points to be determined and their operation verified. Alarm and trip set points will be tested from the front panel. Open thermocouple circuits are detected and indicated, but do not affect instrument operation. Manual control of alarm and test functions shall be provided. All input and output connections shall be made to the terminal blocks on the back of the instrument. The set points of this thermal device shall be adjustable, and two sets of alarm and trip contacts shall be provided. The alarm contacts on the temperature indicator shall be factory wired and brought out to terminal blocks on the exterior of the transformer enclosure. The terminal blocks shall be mounted in the junction box. A thermometer with a remote sensing bulb is not acceptable. The thermocouple shall be removable without disconnecting the electrical wiring. The temperature monitor system shall be graduated in degrees centigrade and shall be tested at 200°C before installing on the transformer. The thermally operated device shall be coordinated with the transformer design and shall be connected and set to function as follows:

- First stage shall be adjustable and set at 75°C temperature at which the substation audible bell alarm can be activated (connected in future by others).

- Second stage shall be adjustable and set at 100°C temperature at which the transformer is isolated by removing the electric load and tripping all the power circuit breakers via the circuit breakers' shunt trip coils (connected in future by others).

3.9 Tank Construction. The tank shall be of welded steel construction designed to withstand a pressure 25% greater than the maximum operating pressure and normal working vacuum. The cover shall be provided with access holes or manholes, lifting eyes, and pressure relief. The base shall permit rolling or skidding with pulling eyes and be equipped with ground pad.

3.10 Paint. The color of the finished transformer shall be C37.20 Federal Standard 595 dark forest green enamel.

3.11 Miscellaneous Requirements.

3.11.1 Insulated Phase Barriers. Primary and secondary insulated phase barriers shall be provided.

3.11.2 Undercoating. Transformers, which have bases that come in contact with concrete, shall have the underside of their bases coated with a corrosion resistant coating that conforms to Military Specification MIL-P-28641 (or an equivalent) with a minimum thickness of 4 mils.

3.11.3 Warning Signs. In accordance with ANSI Z35.1, warning signs shall be provided for the enclosures of electrical transformers having a nominal voltage rating of 500 volts or above.

3.12 Provisions for Fan Cooling. The transformer, 500 KVA and larger, shall have provisions for future fan cooling (by others). As a minimum, fan mounting brackets and dial thermometers with control contacts shall be provided.

3.13 Testing. The following tests shall be performed in accordance with NEMA TRI, ANSI-C57 12.90, and ASTM Standards as listed by the associated tests. All testing, except the field tests, shall be done at the factory, and the certified results shall be submitted to the buyer for approval before shipment of the transformer. Field tests shall be performed unless specifically denied by EG&G Idaho and shall also have certified test procedures and results if opted by EG&G Idaho. All testing included in this Specification shall be performed and costs must be included in the transformer purchase price.

A

The purchaser reserves the right to witness any or all tests, and the vendor shall notify the purchaser 14 days in advance of the date for conducting any test (see Section 3.5).

Field tests shall be conducted by representatives of the manufacturer and shall be completed after the transformer has been set in place and before the primary and secondary connections are made. These tests shall be as described in Section 3.13.3.

The tests below shall be made on the transformer as a minimum requirement. The order of listing does not necessarily indicate the sequence in which the tests shall be conducted.

3.13.1 Coolant Tests.

ASTM D-877	Dielectric Breakdown Voltage
ASTM D-923	Sampling Electrical Insulating Liquids
ASTM D-924	Power Factor
ASTM D-974	Neutralization Number
ASTM D-1533	Water in Insulating Liquid (field test only)
ASTM D-2225	Silicone Fluids if Silicone.

PCB contamination certification requires stating either that PCB content is less than 5 ppm or that the transformer is PCB free and contains no PCB. A stainless steel label clearly stating the PCB content shall be attached to the transformer.

3.13.2 Factory Electric Tests.

1. Coil resistance measurements of all windings on the rated voltage connection and at the tap extremes.
2. Turns ratio test on the rated voltage connection.
3. Polarity and phase relation tests on the rated voltage connection.
4. No-load loss at rated secondary voltage on the secondary voltage connection (field and factory test).
5. Exciting current at rated voltage on the rated voltage connection.
6. Impedance and load loss at rated current on the rated voltage connection and on tap extremes.
7. Temperature tests under conditions specified in ANSI Standards for transformers. (Typical temperature rise of the "exact" design may be substituted with written approval.)

Applied potential test.
9. Induced potential test.
10. Impulse test.
11. Insulation power factor.

3.13.3 Field Tests. Field tests shall be performed as part of installation. Test reports shall be certified for methodology and accuracy.

- No-load loss as measured from the secondary winding at ambient temperature (ANSI-C57 12.90). Record both ambient and top oil

temperatures. Conduct this test on both existing transformers to be removed and the new transformers. Record ambient temperature on the test reports.

- Water content in oil at ambient temperature (ASTM D-1533). Record both ambient and top oil temperatures.
- Insulation power factor (Method II ANSI-C57 12.90, Section 10.9) Doble Test or equal. (Insulation power factor to be 0.9 or less.)
- Before energizing the transformer, test the transformer turn ratio (TTR) at all tap settings. Megger all leads before connecting them to the transformer and check the leads for grounds using VOM before any connections are made. Any lead with a Megger reading of less than 10 megohms shall be replaced.

4. QUALITY ASSURANCE PROVISIONS

Unless otherwise specified, the supplier is responsible for all examinations and inspections as specified herein. The vendor shall maintain a Quality Assurance Program in accordance with MIL-Q-9858A or an approved equal during the performance of the contract, which provides adequate quality assurance and control throughout design, fabrication, testing, inspection, and shipping of the transformer. The vendor shall provide the documents describing the Quality Assurance Program and containing the procedure that will be invoked to comply with the above. An Inspection and Test Procedure shall be prepared and submitted to the buyer for approval. Final inspection and test reports as required by this Specification shall be submitted to the buyer for approval. The vendor shall maintain a calibration system for the periodic calibration of test instruments to standards traceable to the National Bureau of Standards.

Vendor data shall be submitted per attached "Vendor Data Requirements Lists" (see Appendix B).

5. PACKAGING

The transformer shall be prepared for shipment within the Continental United States. All accessories shall be protected from damage. The transformer shall be sealed to prevent entry of moisture or foreign materials during shipment. Documents as indicated in Appendix B shall be required. Shipping is the responsibility of the supplier as part of the total installation package.

6. SUBMITTALS

Within 30 days of receipt of the order, the vendor shall furnish the purchaser with all necessary outline drawings and weights of the transformers.

6.1 Shop Drawings and Manufacturer's Data. Shop drawings for transformers shall indicate, but shall not be limited to, the following:

Overall dimensions, front view, interfaces with existing equipment, and sectional views.

Ratings and sizes of lugs, impedance, taps, and fans if applicable.

Manufacturer's published information on the main secondary breaker and feeder devices at each transformer to allow owner to review settings, which will ensure that proper protection and coordination will be achieved.

Complete list of spare parts and/or supplies with current unit prices and source of supply.

6.2 Certified Laboratory Test Data. Certified copies of reports of all tests shall be submitted as required.

6.2.1 Transformer Tests. Transformer test shall be performed in accordance with the ANSI-C57 12.90 - for liquid filled (ANSI-C57 12.91 - for dry-type) standard test code and Section 3.13. Certified copies of test data for the following tests shall be submitted and shall receive approval before delivery of equipment to the project site. Field test data sheets shall be submitted within 14 days after test completion.

7. DEMOLITION AND CONSTRUCTION

7.1 Demolition and Construction General Requirements. The vendor shall furnish technical personnel to be present at the site to perform, as a minimum, the following tasks (see Appendix C). Permits for PCB fluid and transformer casing transport shall be obtained by the successful bidder before removal. Note that OSHA regulations require workers handling PCBs to be properly trained and certified.

Request and have operating Contractor (PWC personnel) de-energize the existing transformers.

Test the existing transformers for no-load loss, record data, and submit in writing to the Resident Engineer.

Drain the PCB fluid from each transformer into approved drums, seal, and deliver it to the interim hazardous waste storage area at the base.

Purge the transformer case with dry nitrogen gas and seal.

Remove and deliver the transformers to the interim hazardous waste storage area at the base, as designated by the Resident Engineer.

Provide and install new transformers and test per Section 3.13.3.

Request PWC personnel to energize the system.

Verify proper operation and turn the operating transformer over to EG&G Idaho for remanding to PWC San Diego.

The EG&G Idaho Resident Engineer shall coordinate all outages and provide interface between the successful bidder's, installers, and the operating Contractor (PWC). PWC Code 640 is responsible for manifesting all PCB (hazardous waste) activity, and PWC shall be contacted through the EG&G Idaho Resident Engineer.

7.2 Draining. Service shall include removal, packaging, and transporting [to a Defense Reutilization and Maintenance organization (DRMO) hazardous waste staging area] of the PCB or PCB contaminated fluid initially drained from the transformers. DRMO waste shall be clearly labeled with contents, level of contamination, its source, and manifested by PWC Code 640.

The Subcontractor must review and comply with the minimum Outline Spill Prevention, Control, and Countermeasures (SPCC) Plan before draining fluid from a liquid cooled transformer (see Appendix D). Appendix D details the SPCC requirements that the Subcontractor must observe.

7.3 Transportation and Disposal. All hazardous waste material shall, as a minimum, be contained in Department of Transportation (DOT) approved containers from point of removal until delivered to the final disposal site. The following are methods of handling the wastes and are subject to the requirements of 40 CFR, Part 263 and 49 CFR, Parts 172 and 173 and shall be superseded if the regulations are amended.

1. Drums shall be DOT approved for hazardous waste: 17E for fluids, 17H for porous solids, and 17H for rags and solvent.
2. Bulk containers shall be six sided, welded steel construction, lined with a minimum of 10 mil plastic sheet, and watertight. The container shall be handled by a truck specially fitted to transport the container from generation point to disposal point.

ES-81333

APPENDIX A
TRANSFORMER DATA SHEETS

TRANSFORMER DATA SHEET

Transformer Identification	<u>(PWC69-OLD) CC69-NEW</u>	*
Location	<u>BLDG 94 OUTDOORS</u>	
Size	<u>750/1000 KVA</u>	**
Primary Voltage	<u>2.4/12 KV DUAL</u>	***
Primary Winding Type	<u>DELTA</u>	
Secondary Voltage	<u>480 V</u>	
Secondary Winding Type	<u>WYE-GROUNDED</u>	
Percent Impedance	<u>5 %</u>	
Primary Switch	<u>NEW 3 POLE 15 KV 600 AF/300 AT FUSED SWITCH</u>	
Primary Connection	<u>PROVIDE TRANSITION CUBICLE TO NEW SWITCH</u>	
Secondary Connections	<u>PROVIDE NEW COPPER BUS CONNECTIONS TO NEW SECONDARY SWITCHGEAR. PROVIDE AND INSTALL NEW SECONDARY SWITCHGEAR PER SKETCHES. (SEE APPENDIX E OF THIS DOCUMENT.)</u>	
Secondary Breaker	<u>PROVIDE AND INSTALL NEW SWITCHGEAR PER ATTACHED SKETCHES</u>	
Maximum No-Load Loss	<u>DETERMINED PER LOSS EVALUATION IN RFP</u>	
Maximum Full-Load Loss	<u>DETERMINED PER LOSS EVALUATION IN RFP</u>	

- * This is a replacement of transformer PWC #69, an existing 500 KVA 3 phase 480 V PCB transformer.
- ** Supply fan to achieve higher rating.
- *** Dual voltage primary winding is an option. Regardless of whether the option is exercised, the 2400 VAC primary must be supplied. If the option is exercised then taps shall be provided for the higher rating (12 KV).

TRANSFORMER DATA SHEET

Transformer Identification	<u>(PHOTO-OLD) 0070-NEW</u>
Location	<u>BLDG 94</u>
Size	<u>300 KVA</u>
Primary Voltage	<u>480 V</u>
Primary Winding Type	<u>DELTA</u>
Secondary Voltage	<u>208/120 V</u>
Secondary Winding Type	<u>WYE-GROUNDED</u>
Percent Impedance	<u>3.0</u>
Primary Switch	<u>N/A</u>
Primary Connection	<u>NEW FEED FROM NEW SWITCHGEAR (SEE 0069)</u>
Secondary Connections	<u>NEW CABLE AND CONDUIT CONNECTIONS TO EXISTING SWITCHGEAR (2 places)</u>
Secondary Breaker	<u>EXISTING BREAKER PER ATTACHED SKETCH</u>
Maximum No-Load Loss	<u>DETERMINED PER LOSS EVALUATION IN RFP</u>
Maximum Full-Load Loss	<u>DETERMINED PER LOSS EVALUATION IN RFP</u>

* Consolidation replacement of existing PCB transformers (#70 and #71). See sketches SD 1, 2, and 3 for additional information.

REV A
 18 08 10 00
 RECEIVED 2000 V PRIORITY
 A

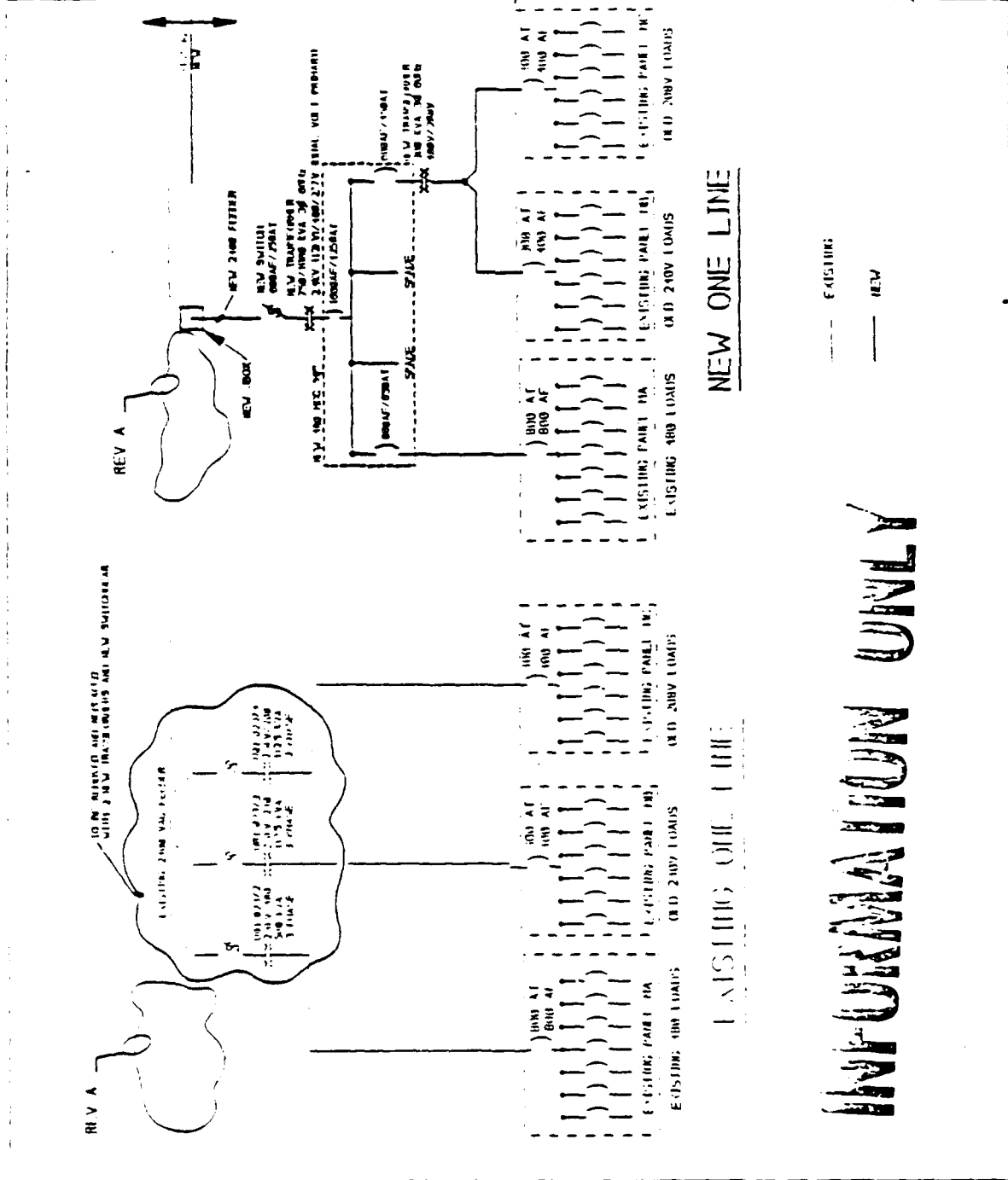

10000
 DRAWN BY: [Signature]
 DATE: [Date]
 CHECKED BY: [Signature]
 REVISED: [Date]
 PROJECT: [Project Name]
 SHEET: [Sheet Number]

NEW ONE LINE

EXISTING
 NEW

EXISTING ONE LINE
 NEW ONE LINE

A

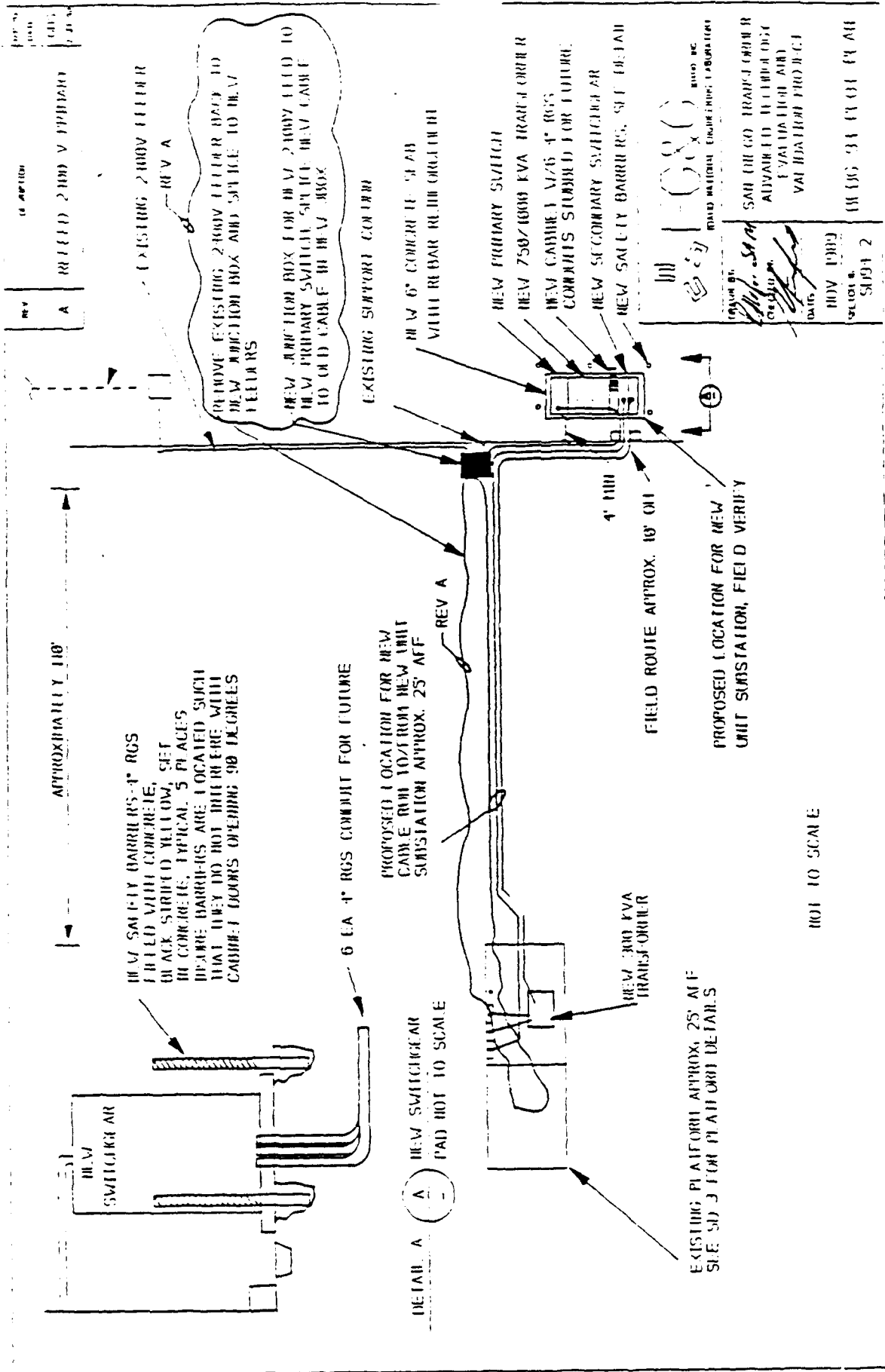

15-011333

REV
DATE
BY

REVISED DRAWING

EXIST 2000 FEET

IF SE SWITCH CIRCUITS FIED THE TRANSFORMERS THAT WILL BE REMOVED, TRANSFORMERS AND HIGH VOLTAGE CIRCUITS WITH A NEW PRIMARY CAPPED SWITCH TO BE INSTALLED ON THE MAIN FLOOR

FOR FIED TRANSFORMERS TO BE REMOVED, AND REMOVED WITH THE NEW CARGO WATED SERVICE

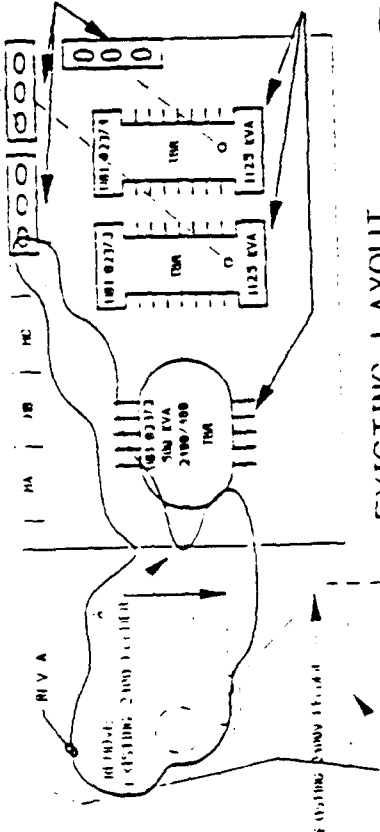

EXISTING LAYOUT

PLANT ARE LOCATED IN THE CENTER OF THE FACILITY APPROXIMATELY 25 FEET ABOVE THE GRADE FLOOR

A-30

NOTES

- 1) NOTE THAT THE ELECTRICAL DESIGN IS SUBJECT TO CHANGE. ANY CHANGES WILL BE NOTICED.
- 2) THE TO BE: REVISION

3) RGS, W/B 2500V/110V & 110V EG

REV A

EXIST 400 PAINT
EXIST 200/210 PAINTS
TO BE REMOVED

PROVIDE AND INSTALL
NEW 400 FEET FROM THE NEW SWITCHGEAR

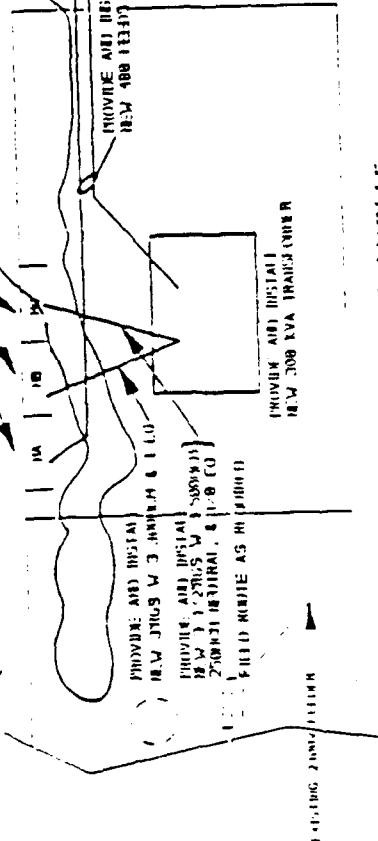

NEW LAYOUT

INFORMATION ONLY

10800
BUILT NATIONAL CREDIT RISK MANAGEMENT

DATE: 10/15/1989
BY: [Signature]
PROJECT: [Signature]

SHEET 3

REVISIONS TO THIS DRAWING ARE LISTED IN THE REVISION LOG

REV A
REV B
REV C
REV D
REV E

REV A
REV B
REV C
REV D
REV E

REV A
REV B
REV C
REV D
REV E

EXIST 2000 FEEDER

PLEASE SWITCH CIRCUITS FEED THE TRANSFORMERS THAT WILL BE RELOCATED (READ, REMOVE, AND RE-AGE CIRCUITS WITH A NEW PRODUCT FUSED SWITCH TO BE INSTALLED ON THE MAIN FLOOR)

FOR CITED TRANSFORMERS TO BE LOCATED REMOVED, AND REPLACED WITH THE NEW GENERATOR SERVICE

NOTES

- 1) STATE THAT THE TRANSFORMERS TO BE REMOVED AND REPLACED WITH THE NEW SERVICE THAT BE REQUIRED
- 2) THIS TO BE REMOVED

EXISTING LAYOUT

PLATFORM LOCATED IN THE CENTER OF THE FACILITY APPROXIMATELY 25 FEET ABOVE THE GROUND FLOOR

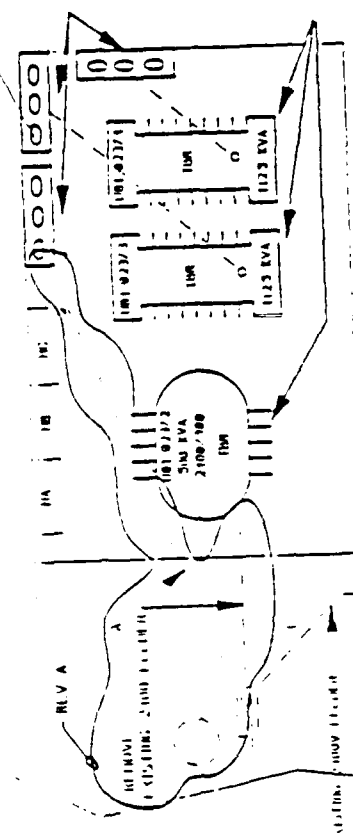

REV A

EXIST 400 PAINT LATEST 200/210 PANELS TO BE REVISED

PROVIDE AND INSTALL NEW 180 FEEDER FROM THE NEW SWITCHGEAR

PROVIDE AND INSTALL NEW 350 EVA TRANSFORMER

PROVIDE AND INSTALL NEW JING W J BRN 11 & 1 ED PROVIDE AND INSTALL NEW 3 1/2 250/5 V 1 SHORREN 250/250 INTRINSAL & 11/0 LG FUSED SERVICE AS REQUIRED

NEW LAYOUT

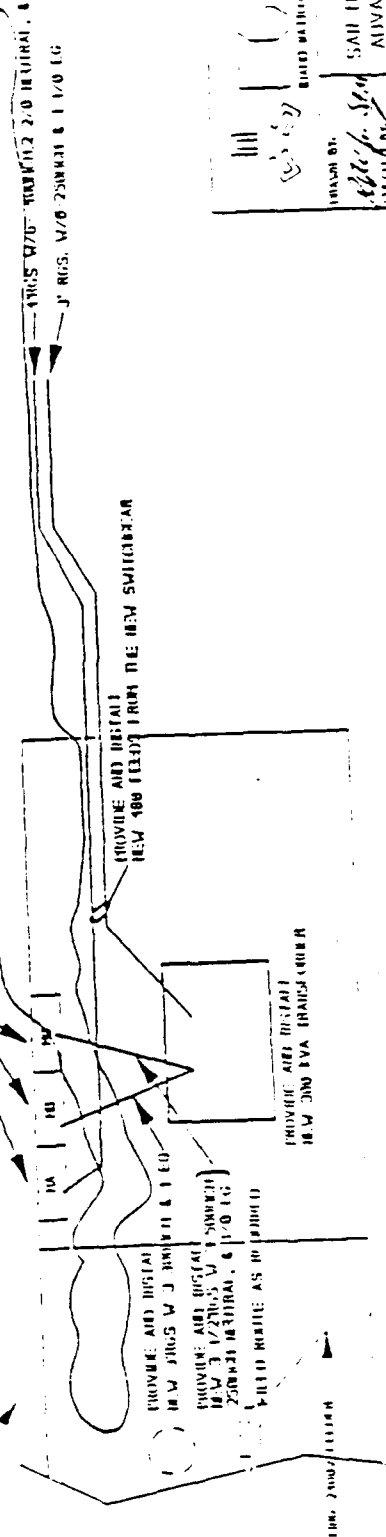

INFORMATION ONLY

THOMSON DT

[Signature]

SAID THE GO THAI-CHUEN R
MEMBER OF THAI GROUP OF
F VALUATION FLOOR C
VALUATION FLOOR C

THOMSON DT
THAI-CHUEN R
MEMBER OF THAI GROUP OF
F VALUATION FLOOR C
VALUATION FLOOR C

THAI-CHUEN R
MEMBER OF THAI GROUP OF
F VALUATION FLOOR C
VALUATION FLOOR C

REV A
REV B
REV C
REV D
REV E

TRANSFORMER DATA SHEET

Transformer Identification	<u>(PWC16-OLD) CC16-NEW</u>	*
Location	<u>BLDG 342</u>	
Size	<u>112.5 KVA</u>	**
Primary Voltage	<u>2.4/12 KV DUAL</u>	***
Primary Winding Type	<u>DELTA</u>	
Secondary Voltage	<u>480/277 V</u>	
Secondary Winding Type	<u>WYE-GROUNDED</u>	
Percent Impedance	<u>3.0</u>	
Primary Switch	<u>NEW 3 POLE 15KV 50AF FUSED</u>	
Primary Connection	<u>TRANSITION AND CABLE TO NEW SWITCH</u>	
Secondary Connections	<u>REUSE EXISTING --- SPLICE TERMINATION FOR CONNECTIONS TO EXISTING SWITCHGEAR</u>	
Secondary Breaker	<u>REUSE EXISTING BREAKER -NO CHANGES</u>	
Maximum No-Load Loss	<u>DETERMINED PER LOSS EVALUATION IN RFP</u>	
Maximum Full-Load Loss	<u>DETERMINED PER LOSS EVALUATION IN RFP</u>	

- * Replacement of existing 112.5 KVA PCB transformer.
- ** Optionally propose and construct this unit with an amorphous stacked core, as per specification.
- *** Dual voltage primary winding is an option. Regardless of whether the option is exercised, the 2400 VAC primary must be supplied. If the option is exercised then taps shall be provided for the higher rating (12 KV).

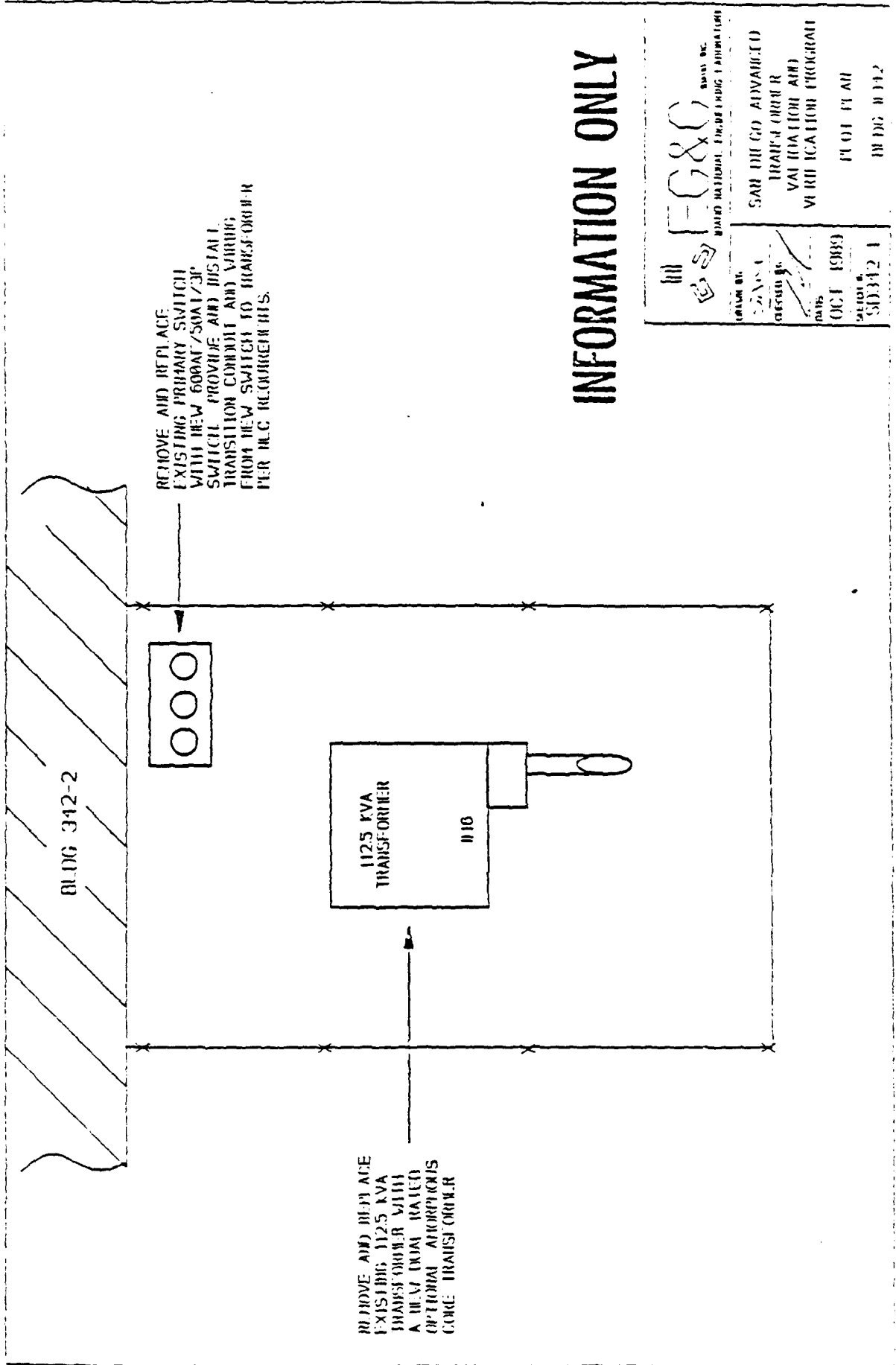

INFORMATION ONLY

EG&C ENGINEERING & CONSULTANTS

SAR DIE GO ADVANCED TRANSPORTATION VEHICULAR PROGRAM

PROJECT NO. 1111111111

NO. 1111111111

DATE: OCT 1989

SHEET: 1111111111

TRANSFORMER DATA SHEET

Transformer Identification	<u>(PWC48-OLD) 0048-NEW</u>
Location	<u>BLDG 473</u>
Size	<u>112.5 KVA</u>
Primary Voltage	<u>2.4 KV</u>
Primary Winding Type	<u>DELTA</u>
Secondary Voltage	<u>208/120</u>
Secondary Winding Type	<u>WYE-GROUNDED</u>
Percent Impedance	<u>3.0</u>
Primary Switch	<u>REUSE EXISTING SWITCH</u>
Primary Connection	<u>NEW TRANSITION TO EXISTING SWITCH</u>
Secondary Connections	<u>PROVIDE AND INSTALL NEW SECONDARY TRANSITION CUBICLE</u>
Secondary Breaker	<u>REUSE EXISTING SWITCHGEAR</u>
Maximum No-Load Loss	<u>DETERMINED PER LOSS EVALUATION IN RFP</u>
Maximum Full-Load Loss	<u>DETERMINED PER LOSS EVALUATION IN RFP</u>

* Replacement of existing PCB transformer.

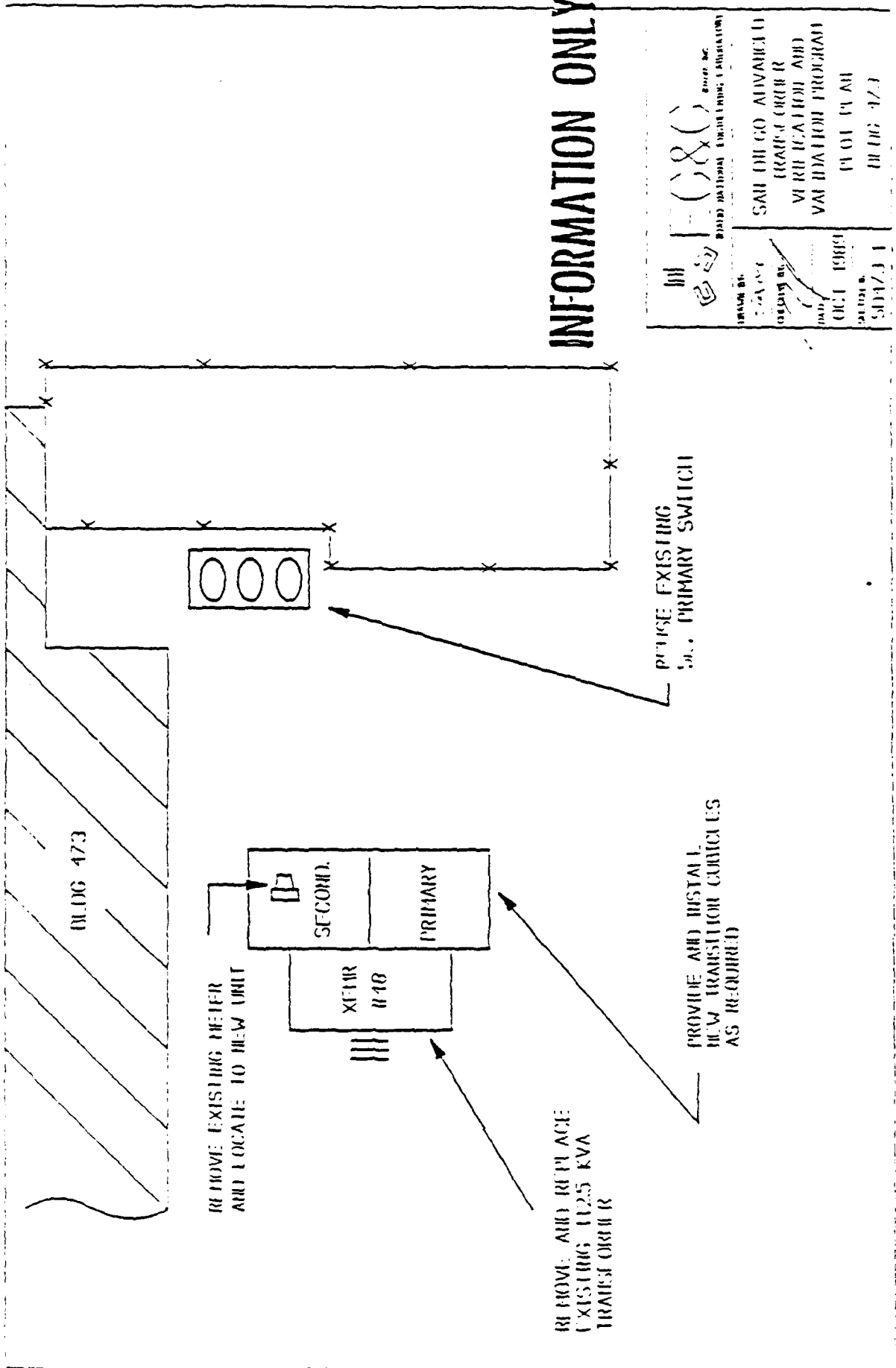

INFORMATION ONLY

SAE THE GO AHEAD
 (RAMP) ORDER
 VERIFICATION AND
 VALIDATION PROGRAM

DATE: OCT 1 1989
 TIME: 5:04:31
 USER:

PROJECT: BLDG 473

REMOVE EXISTING METER AND LOCATE TO NEW UNIT

REMOVE AND REPLACE EXISTING 112.5 KVA TRANSFORMER

PROVIDE AND INSTALL NEW TRANSITION CIRCLES AS REQUIRED

RETUSE EXISTING 100 AMP PRIMARY SWITCH

BLDG 473

TRANSFORMER DATA SHEET

Transformer Identification	<u>1PWC45-OLD</u>	<u>0045-NEW</u>	*
Location	<u>BLDG 472 OUTDOORS</u>		**
Size	<u>1500 KVA</u>		
Primary Voltage	<u>12 KV</u>		
Primary Winding Type	<u>DELTA</u>		
Secondary Voltage	<u>480/277 V</u>		
Secondary Winding Type	<u>WYE-GROUNDED</u>		
Percent Impedance	<u>5.75</u>		
Primary Switch	<u>REUSE OF EXISTING SWITCH</u>		***
Primary connection	<u>NEW TRANSITION TO EXISTING SWITCH</u>		
Secondary Connections	<u>COPPER BUS CONNECTIONS TO NEW SWITCHGEAR</u>		
Secondary Breaker	<u>REUSE EXISTING BREAKER AND SWITCHGEAR</u>		***
Maximum No-Load Loss	<u>DETERMINED PER LOSS EVALUATION IN RFP</u>		
Maximum Full-Load Loss	<u>DETERMINED PER LOSS EVALUATION IN RFP</u>		

- * This will replace existing PCB 1500 KVA transformer.
- ** Use corrosion resistant external packaging, NEMA 3R minimum. Also provide optional cost to include stainless steel rain cap.
- *** Include cost proposal to replace these switches as an option.

6' TALL CONCRETE WALL

EXISTING CONCRETE PAD

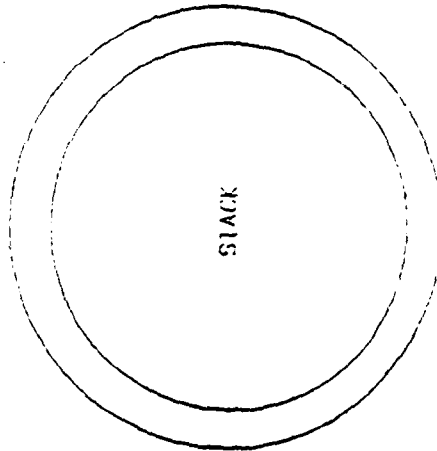
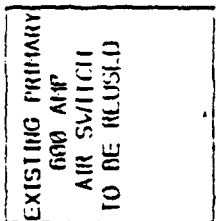
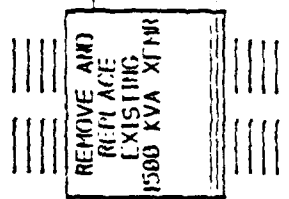
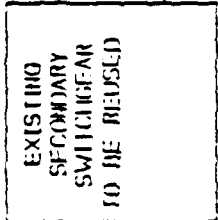
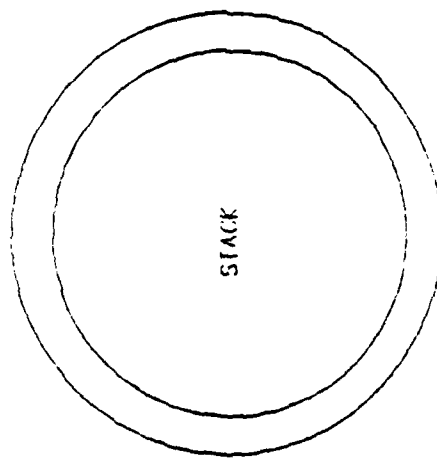

3/4" CONCRETE NEEDS TO BE RELOCATED AS REQUIRED

BUDG 4/2

INFORMATION ONLY

NOTE: A CRANE WILL BE REQUIRED TO REMOVE THE EXISTING TRANSFORMER AND TO INSTALL THE NEW TRANSFORMER. REPLACEMENT OF PRIMARY AND SECONDARY SWITCHGEAR IS NOT REQUIRED, BUT REPLACEMENT PROPOSALS WILL BE SOLICITED AS OPTIONS IN THIS PACKAGE.

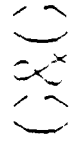
 E & C
 ENGINEERING, INC.
 1000 WASHINGTON LANE, SUITE 1000, FARMINGTON, CT 06030

SAH THE GO ADVANCED
 TRADE ORDER
 VALUATION AIRS
 VEHICLE APPRAISAL PROGRAM
 REV 11 01 11 AM
 BOB DIBS 9/2

DRAWN BY: [Signature]
 CHECKED BY: [Signature]
 DATE: NOV 1993
 SCALE: 1/4" = 1'-0"
 SHEET: 1

TRANSFORMER DATA SHEET

Transformer Identification	(24006-OLD) 0006-NEW
Location	BLDG 378-6 OUTDOOR
Size	500 KVA
Primary Voltage	12 KV
Primary Winding Type	DELTA
Secondary Voltage	480/277 V
Secondary Winding Type	WYE-GROUNDED
Percent Impedance	5.75
Primary Switch	REUSE EXISTING AIR INTERRUPTER SWITCH 600 A
Primary Connection	TRANSITION FROM EXISTING SWITCH
Secondary Connections	PROVIDE AND INSTALL NEW CONNECTIONS TO EXISTING SWITCHGEAR EXTEND IF REQUIRED
Secondary Breaker	REUSE EXISTING 800 A SECONDARY BREAKER AND SWITCHGEAR
Maximum No-Load Loss	DETERMINED PER LOSS EVALUATION IN REF
Maximum Full-Load Loss	DETERMINED PER LOSS EVALUATION IN REF

* Replacing existing 500 KVA PCB transformer.

No diagram provided.

TRANSFORMER DATA SHEET

Transformer Identification	<u>(PWC27-OLD) 00074-NEW</u>	*
Location	<u>BLDG 378-1</u>	
Size	<u>750/1000 KVA</u>	**
Primary Voltage	<u>12 KV</u>	
Primary Winding Type	<u>DELTA</u>	
Secondary Voltage	<u>480 V</u>	
Secondary Winding Type	<u>WYE-GROUNDED</u>	
Percent Impedance	<u>5.75</u>	
Primary Switch	<u>PROVIDE AND INSTALL NEW 15 KV CLASS PRIMARY SWITCH AND NEW 12 KV FEEDER</u>	
Primary Connection	<u>TRANSITION TO NEW SWITCH</u>	
Secondary Connections	<u>NEW COPPER BUS CONNECTIONS TO NEW SWITCHGEAR</u>	
Secondary Breaker	<u>P & I NEW SWITCHGEAR. SEE SKETCH BREAKER AND SWITCHGEAR</u>	
Maximum No-Load Loss	<u>DETERMINED PER LOSS EVALUATION IN REF</u>	
Maximum Full-Load Loss	<u>DETERMINED PER LOSS EVALUATION IN REF</u>	

* This unit is replacing an existing 1000 KVA PCS filled transformer.
 ** Supply fans to achieve higher rating.

ES-51333

TRANSFORMER DATA SHEET

Transformer Identification	<u>(PWC27-OLD) CC27B-NEW</u>
Location	<u>BLDG 378-1</u>
Size	<u>500 KVA *</u>
Primary Voltage	<u>480 V</u>
Primary Winding Type	<u>DELTA</u>
Secondary Voltage	<u>208 V</u>
Secondary Winding Type	<u>WYE-GROUNDED</u>
Percent Impedance	<u>5.75</u>
Primary Switch	<u>PROVIDE AND INSTALL NEW SWITCHGEAR SEE SKETCH</u>
Primary Connection	<u>TRANSITION FROM NEW SWITCHGEAR</u>
Secondary Connections	<u>NEW COPPER BUS CONNECTIONS TO EXISTING SWITCHGEAR</u>
Secondary Breaker	<u>REUSE EXISTING SWITCHGEAR</u>
Maximum No-Load Loss	<u>DETERMINED PER LOSS EVALUATION IN RFP</u>
Maximum Full-Load Loss	<u>DETERMINED PER LOSS EVALUATION IN RFP</u>

* No primary voltage taps are required on this transformer due to the high current level. Note requested optional price for addition of standard primary voltage taps on this unit in the pricing schedule.

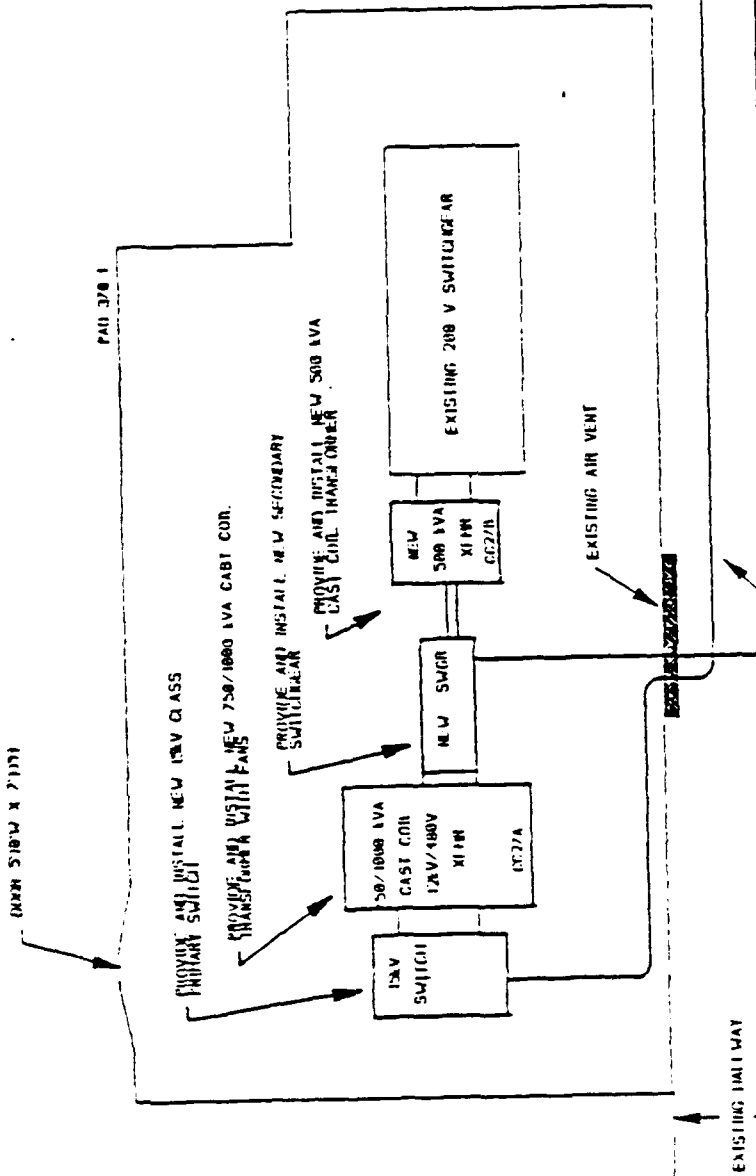

TO EXISTING STATION
370 2

INFORMATION ONLY

DRAWN BY: [Signature]

 CHECKED BY: [Signature]

 DATE: NOV 1989

 PROJECT: PAD 370 1 IN TAB

 SHEET NO: 50170 1

 REV: 0001 0000 370

PROVIDE AND INSTALL 12 KV 12KV
 FEEDER TO 12KV PRIMARY SWITCHGEAR
 PROVIDE AND INSTALL 301/30 42 CIRCUIT
 FIB TO 12KV SWITCHGEAR AND VENT TO
 NEW 12KV 500 IVA SWITCHGEAR WITH
 COORDINATE CONTACTS AND TAGS TO
 EXISTING 400 V PANEL IN THE
 EXISTING DUCTWAY. PROVIDE AS PART OF CONTRACT.

PROVIDE AND INSTALL NEW FIB TO
 EXISTING 400 V PANEL. 4\"/>

TO BE REMOVED AND REPLACED

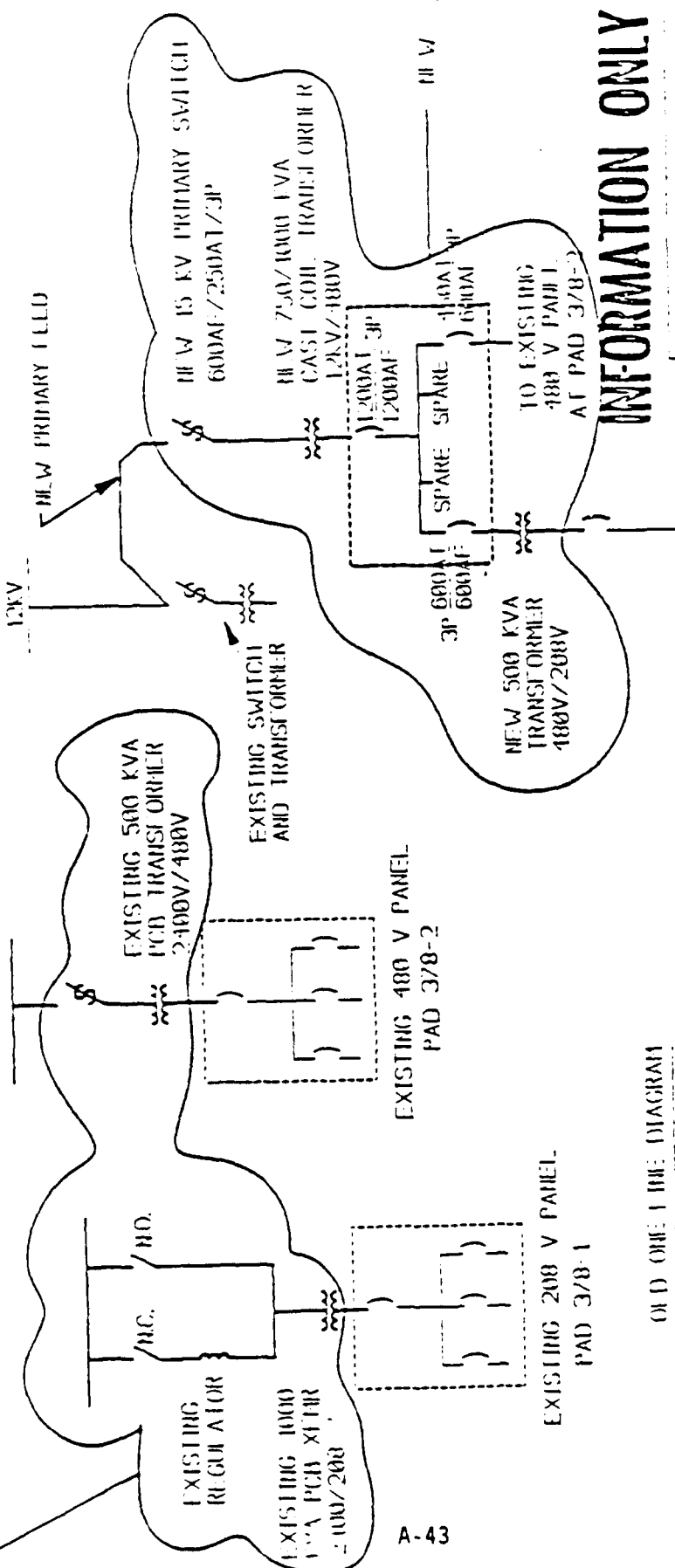

A-43

INFORMATION ONLY

OLD ONE LINE DIAGRAM

TO EXISTING 208 V PANEL

NEW ONE-LINE DIAGRAM
PAD 3/8 1

FESCO

 BOARD NATIONAL ENGINEERING LABORATORY

 DRAWN BY: [Signature]

 CHECKED BY: [Signature]

 DATE: 10/01/83

 SHEET NO: 50/1/03

 500 THE GO ADVANCED TRANSFORMER EVALUATION AND VOLTAGE REGULATION

 PAD 3/8 1,2 OR 1 DRG

 10/01 DRG 1/8

TRANSFORMER DATA SHEET

Transformer Identification	<u>(PWC49-OLD) CC49-NEW *</u>
Location	<u>BLDG 489-1</u>
Size	<u>1500 KVA</u>
Primary Voltage	<u>12 KV</u>
Primary Winding Type	<u>DELTA</u>
Secondary Voltage	<u>480/277 V</u>
Secondary Winding Type	<u>WYE-GROUNDED</u>
Percent Impedance	<u>5.75</u>
Primary Switch	<u>REINSTALL EXISTING PRIMARY SWITCH</u>
Primary Connection	<u>CONNECT EXISTING SWITCH</u>
Secondary Connections	<u>NEW COPPER BUS CONNECTIONS TO EXISTING SWITCHGEAR</u>
Secondary Breaker	<u>EXISTING SWITCHGEAR</u>
Maximum No-Load Loss	<u>DETERMINED PER LOSS EVALUATION IN RFP</u>
Maximum Full-Load Loss	<u>DETERMINED PER LOSS EVALUATION IN RFP</u>

- * The existing PCB unit is already missing and will not have to be handled as part of this changeout.

Note: This unit will be installed in an existing station. The installer will have to remove an existing temporary transformer and place it aside for removal by others prior to installing the new transformer. The installer will also have to reinstall the existing primary switch, which was disconnected while the temporary transformer was installed. The existing temporary transformer is a 3750 KVA unit and will require an oversized crane to lift out and set on the ground. This unit is nonPCB and will not require additional handling.

No diagram provided.

TRANSFORMER DATA SHEET

Transformer Identification	<u>(PWC1-220,1,2-OLD) CC1-220-NEW</u>	*
Location	<u>BLDG 379-3</u>	
Size	<u>300 KVA</u>	
Primary Voltage	<u>2.4/12 KV DUAL</u>	**
Primary Winding Type	<u>DELTA</u>	
Secondary Voltage	<u>240 V</u>	
Secondary Winding Type	<u>WYE-GROUNDED</u>	
Percent Impedance	<u>4.5</u>	
Primary Switch	<u>REUSE EXISTING PRIMARY SWITCH</u>	***
Primary Connection	<u>PROVIDE NEW CABLE CONNECTIONS TO EXISTING SWITCH</u>	
Secondary Connections	<u>PROVIDE NEW CONDUIT AND CONDUCTORS TO EXISTING SWITCHGEAR</u>	
Secondary Breaker	<u>REUSE EXISTING SWITCHGEAR</u>	
Maximum No-Load Loss	<u>DETERMINED PER LOSS EVALUATION IN RFP</u>	
Maximum Full-Load Loss	<u>DETERMINED PER LOSS EVALUATION IN RFP</u>	

- * This new three phase transformer is replacing three existing 167 KVA single phase PCB transformers.
- ** Dual voltage primary winding is an option. Regardless of whether the option is exercised, the 2400 VAC primary must be supplied. If the option is exercised then taps shall be provided for the higher rating (12 KV).
- *** There are three oil-fused contactors which are feeding the transformer to be removed. It is believed that the three contactors are PCB-contaminated, and they should not be disturbed.

EXISTING BRICK WALL
SECOND FLOOR
TRANSFORMER RELOCATION
SEE DETAIL THIS DWG



EXISTING PLATFORM
#379 3

PROVIDE AND INSTALL NEW
225A7P OVR IN NEW CURBICLE
ATTACHED TO SIDE OF
EXISTING SWITCHGEAR

PROVIDE AND INSTALL NEW
240 V FEED FROM H/W BKR
TO EXISTING PANEL "ICP".
NEW FEED 2 1/2" RGS
WITH 3-250NICH #12GRD

REMOVE EXISTING FEED FROM TRANSFORMER
#379 8 TO EXISTING PANEL "ICP".
ADDITION CONDUITS IN PLACE AND LABEL
AS SPARE AT BOTH ENDS.

EXISTING PANEL "ICP"
LOCATED ON FLOOR

EXISTING 225 KVA TRANSFORMER
LOCATED ON ROOF: PAD #379 8

APPROX. 75'
APPROX. 75'
PURTRITE EXISTING BRICK WALL

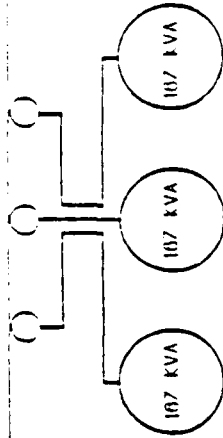

REMOVE 3 x 107 KVA PCB TRANSFORMERS
REPLACE WITH 1 x 300 KVA
DRY TYPE TRANSFORMER PROVIDE H/W
PRIMARY FEED FROM EXISTING PRIMARY SWITCHES

PAD 379 3 DETAIL



A-46

APPROX.
75'

INFORMATION ONLY

REMOVE EXISTING PCB TRANSFORMER
LOCATED ON PAD 379 8 (ROOF OF BUILDING)
REMOVE TRANSITION CIRCULES, CAP CONDUITS
AND ABANDON IN PLACE. RELOCATE TRANSFORMER
AND PCB OIL (IN BULK) TO THE DROD.

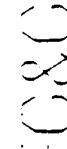

O&C ENGINEERING INC.

PROJECT NO. 379

S. THERON

DATE

NOV 1969

STATION

50379 1

SAU DIE GO ADVANCED
TRANSFORMER VERIFICATION
AND VALIDATION PROGRAM

PARTIAL FLOOR PLAN
BUILDING 379

TRANSFORMER DATA SHEET

Transformer Identification	<u>(PWC1-158-OLD) C01-158-NEW</u>	*
Location	<u>BLDG 333-1</u>	**
Size	<u>112.5 KVA</u>	
Primary Voltage	<u>480 V</u>	
Primary Winding Type	<u>DELTA</u>	
Secondary Voltage	<u>208/120 V</u>	
Secondary Winding Type	<u>WYE-GROUNDED</u>	
Percent Impedance	<u>4.5</u>	
Primary Switch	<u>PROVIDE AND INSTALL NEW 480 V BREAKER IN NEW SWITCHGEAR. SEE SKETCHES</u>	
Primary Connection	<u>SEE SKETCHES</u>	
Secondary Connections	<u>TRANSITION TO EXISTING PANEL</u>	
Secondary Breaker	<u>REUSE EXISTING</u>	
Maximum No-Load Loss	<u>DETERMINED PER LOSS EVALUATION IN RFP</u>	
Maximum Full-Load Loss	<u>DETERMINED PER LOSS EVALUATION IN RFP</u>	

- * This unit replaces the existing 112.5 KVA PCB transformer.
 ** This transformer will be installed on a mezzanine located approximately 30 feet AAF. Extra rigging and PCB handling efforts will be required.

TRANSFORMER DATA SHEET

Transformer Identification	<u>(PWC)-157-OLD</u>	<u>001-157-NEW</u>	*
Location		<u>BLDG 333-1</u>	**
Size		<u>112.5 KVA</u>	
Primary Voltage		<u>480 V</u>	
Primary Winding Type		<u>DELTA</u>	
Secondary Voltage		<u>240 V</u>	
Secondary Winding Type		<u>WYE</u>	
Percent Impedance		<u>4.5</u>	
Primary Switch		<u>PROVIDE AND INSTALL NEW 480 V BREAKER IN NEW SWITCHGEAR. SEE SKETCHES.</u>	
Primary Connection		<u>SEE SKETCHES</u>	
Secondary Connections		<u>TRANSITION TO EXISTING PANEL</u>	
Secondary Breaker		<u>REUSE EXISTING BREAKER</u>	
Maximum No-Load Loss		<u>DETERMINED PER LOSS EVALUATION IN RFP</u>	
Maximum Full-Load Loss		<u>DETERMINED PER LOSS EVALUATION IN RFP</u>	

* This unit is replacing the existing 112.5 KVA PCB transformer.

** This transformer will be installed on a mezzanine located approximately 30 feet AFF. Extra rigging and PCB handling efforts will be required.

REMOVE EXISTING 2400 V FEEDS FROM THE EXISTING TRANSFORMERS BOTH TO THE EXISTING SPINICE BOX LOCATED UNDER THE MEZZANINE AND CAP THE 2400V FEEDERS WITH INSULATED CAP AND ABANDON IN PLACE. REMOVE COMMENTS FROM SPINICE BOX TO EXISTING TRANSFORMERS.

REMOVE EXISTING 2400 V FEEDS FROM THE EXISTING TRANSFORMERS BOTH TO THE EXISTING SPINICE BOX LOCATED UNDER THE MEZZANINE AND CAP THE 2400V FEEDERS WITH INSULATED CAP AND ABANDON IN PLACE. REMOVE COMMENTS FROM SPINICE BOX TO EXISTING TRANSFORMERS.

STAIRS FROM ROOF

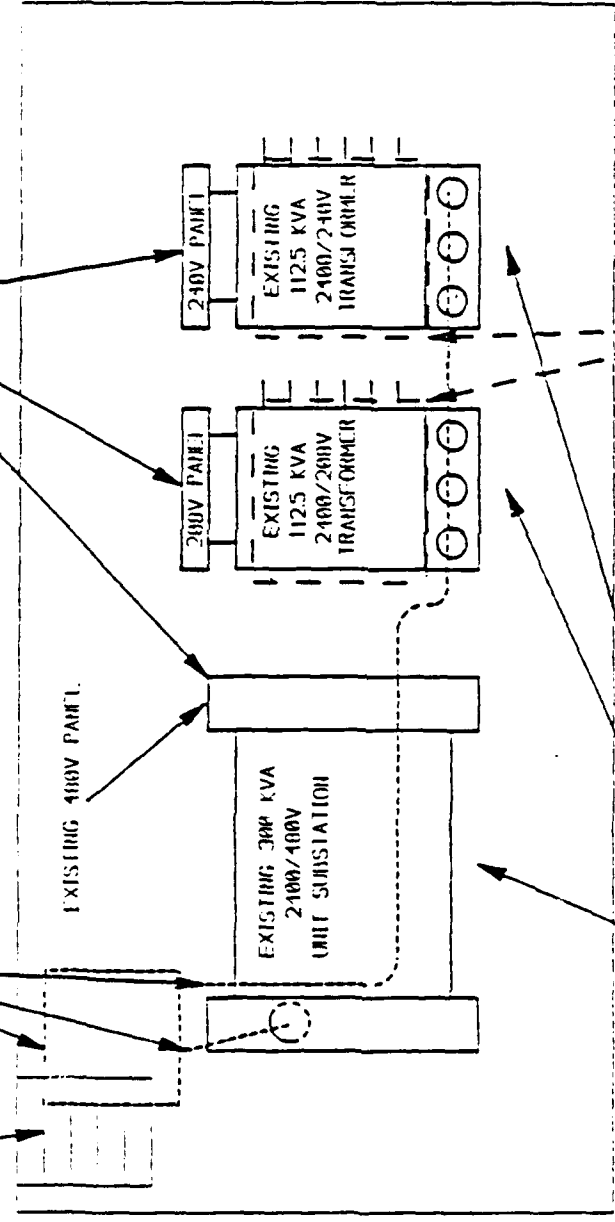

EXISTING 400V PANEL

EXISTING SPINICE BOX TO BE MARKED WITH 2400V LABEL

PROPOSED LOCATION FOR NEW XITMRS

REMOVE THREE EXISTING TRANSFORMERS FROM MEZZANINE IN CENTER OF BLDG. SEE REMOVE THE 2400 V PRIMARY SWITCHES ASSOCIATED WITH THESE THREE TRANSFORMERS

INFORMATION ONLY

W. J. RAY & CO. INCORPORATED
 1000 NATIONAL ENGINEERING LABORATORY
 BETHESDA, MARYLAND

DATE: **OCT 1969**
 DRAWING NO: **500333-1**

SCALE: **AS SHOWN**

PROJECT: **EXISTING ELECTRICAL**
 BUILDING: **311**

REVISIONS:
 NO. 1: **NOV 1969**
 BY: **WJR**
 CHECKED BY: **WJR**

FOR THE GOVERNMENT
 THROUGH VARIOUS AGENCIES
 AND MAIL DELIVERY PROGRAM
 EXISTING ELECTRICAL
 BUILDING 311

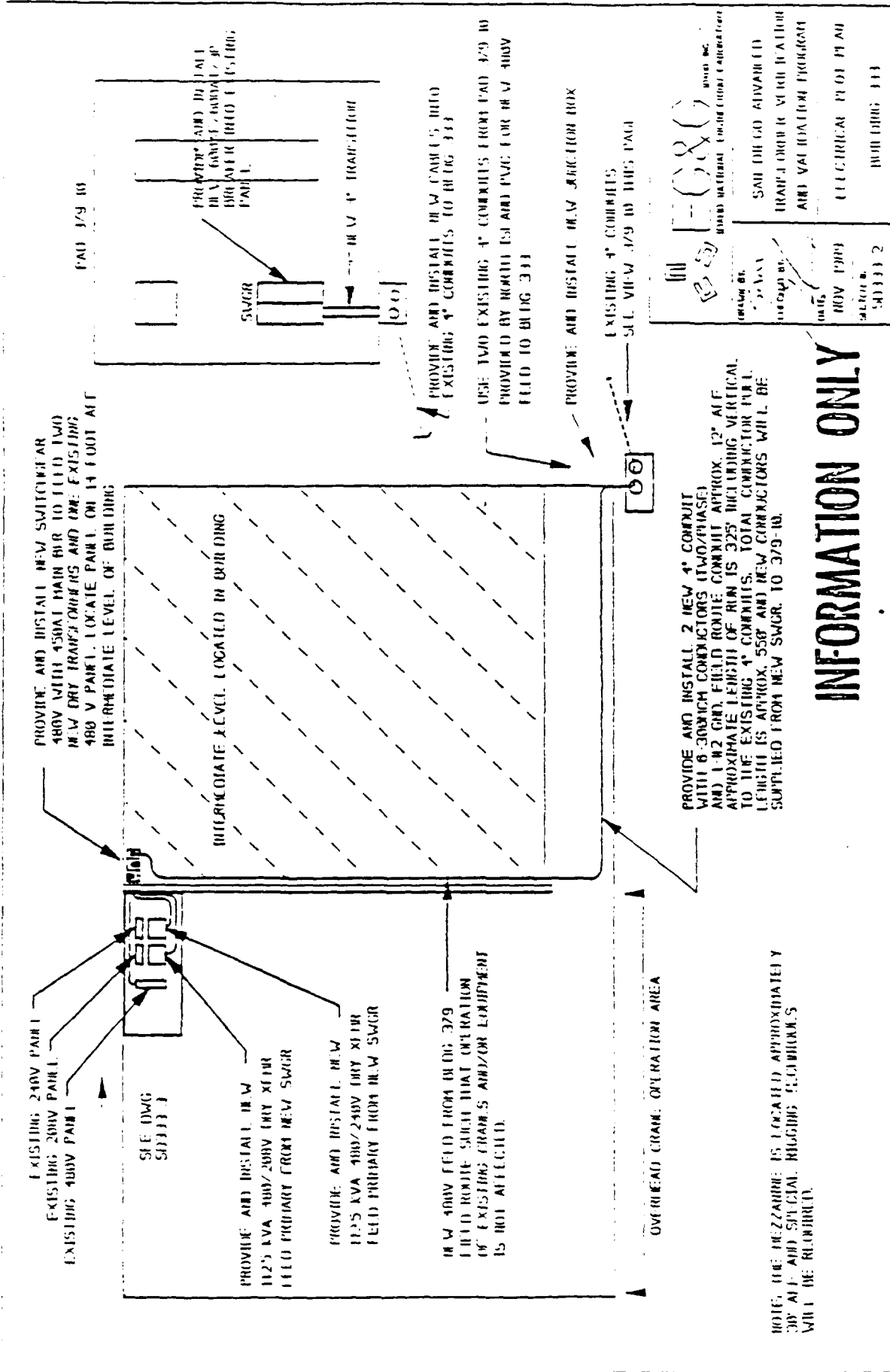

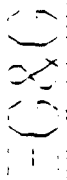

 EECO Electrical Engineering Co. Inc.

 1000 NATIONAL CENTER DRIVE

 SAN DIEGO, CALIF. 92108

 SAN DIEGO AIRFIELD

 TRAFFIC CONTROL BUILDING

 AIR QUALITY CONTROL PROGRAM

 ELECTRICAL PLAN # 10

 BUILDING 333

INFORMATION ONLY

NOTE: THE MEZZAURE IS LOCATED APPROXIMATELY 300' AIF. ADD SPECIAL RELONG DIMENSIONS WILL BE REQUIRED.

PROVIDE AND INSTALL NEW FEED TO EXISTING 240V PANEL, 4C WITH 30A/0 & R2GRD

PROVIDE AND INSTALL NEW FEED TO EXISTING 200V PANEL, 4C WITH 40A/0 & R2GRD

STAIRS FROM ROOM

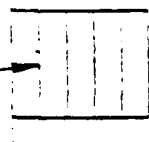

EXISTING 480V PANEL

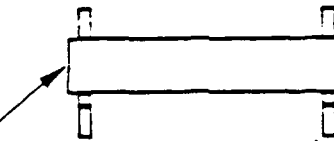

PROVIDE AND INSTALL NEW CRUSHED PANEL SUPPORT ASSEMBLIES TWO PER PANEL FOR THREE PANELS

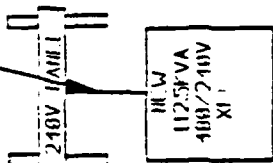
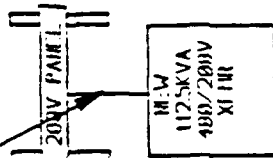

TO NEW SWGR

INFORMATION ONLY

PROVIDE AND INSTALL NEW 480V FEED FROM NEW SWGR TO EXISTING 480V PANEL, 4C WITH 40A/0 & R2GRD

PROVIDE AND INSTALL TWO EACH NEW 400V FEEDS TO TWO NEW DRY TRANSFORMERS (ONE 400/200V AND ONE 400/240V EACH FEED SHALL BE 2C WITH 40A/0 & R2 GRD)

DRAWN BY: [Signature]
 CHECKED BY: [Signature]
 DATE: OCT 1989
 SHEET NO: 500033
 BUILDING: 111

EPCOR
 ENVIRONMENTAL ENGINEERING LABORATORY

SAN DIEGO ADVANCED
 TRADE CENTER VIBRATION
 AND VIBRATION PROGRAM

NEW YORK
 ORLANDO
 RICHMOND
 WASHINGTON

MEZZANINE PLAN VIEW NEW INSTALLATION

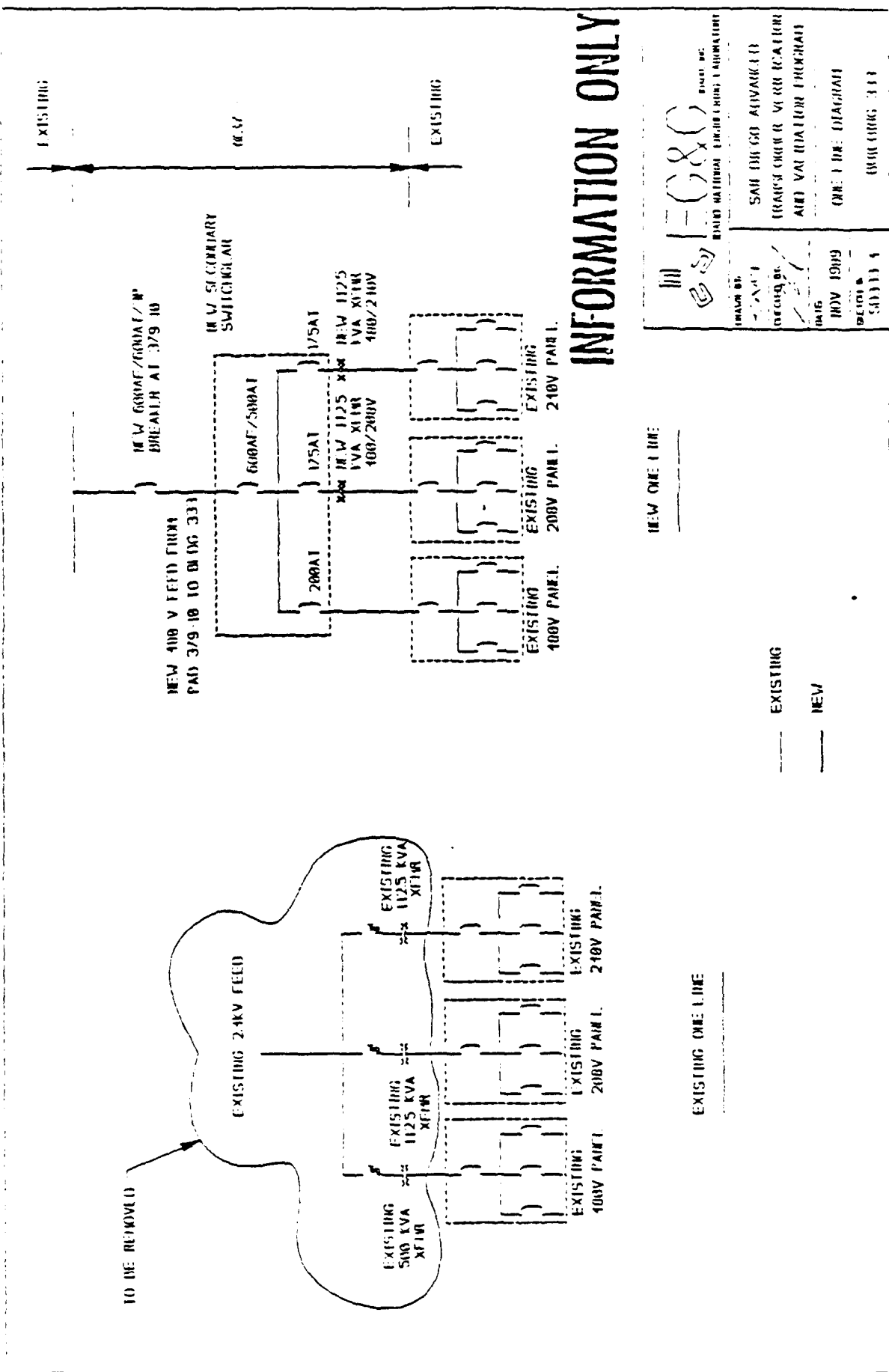

INFORMATION ONLY

EG&C
 ENGINEERING & CONSULTING
 1000 NATIONAL ENGINEERING LABORATORY
 SUITE 1000
 1000 NATIONAL ENGINEERING LABORATORY
 WASHINGTON, DC 20004
 PHONE: (202) 462-1000
 FAX: (202) 462-1001
 WWW: WWW.EG&C.COM

NEW ONE LINE

EXISTING ONE LINE

— EXISTING
 - - - NEW

ES-61333

APPENDIX B

VENDOR DATA REQUIREMENT LIST

APPENDIX B					
VENDOR DATA REQUIREMENTS LIST					
Description	* When Required	Copies Required	No. of Reference Paragraph	** Approval Req'd. by	
1. Drawings, sketches, schematics and other data shall be submitted with the bid sufficient for evaluation of contract proposal.	BC	12	NA	R	AB/DE
2. Quality Manual and Procedures	BC	12	4.0	R	AB/DE
3. Inspection and Test Procedures	BFR	12	3.2, 3.10	I	AB/DE
4. Inspection and Test Results	PS	12	3.10	R	AB/DE
5. Maintenance manual which includes as a minimum: installation instructions, operating instructions, preventive and corrective maintenance tasks, the frequency of each task, the tools, equipment, and procedures with special emphasis on safety precautions for the accomplishments of each task.	PS	12	5.0	I	AB/DE
6. Priced spare parts list and recommended spares.	PS	12	5.0	I	AB/D
7. Guaranteed performance data and name plate data.	PS	12	5.0	I	AB/DE
8. As-built shop drawings schematics and wiring diagram.	PS	12	5.0	R	AB/DE
9. Installation schedule.	PS	12	5.0		AB/DE
10. PCB fluid disposal plan and certification.	PS	12	5.0		AB/DE
11. Spill Prevention, Control, and Countermeasures Plan	BFR	12	NA	R	AB/DE
12. Certification for Hazardous Waste Handlers	PS	12	NA	R	AB/DE

- * BFR = Before Fabrication Release * BC = Before contract is awarded
 * PS = Prior to Shipment ** R = Required
 ** I = Information Only ** AB = Approval By Buyer
 ** DE = Approval By Design Engineer

ES-81333

APPENDIX C

CONSTRUCTION DETAILS

CONSTRUCTION DETAILS

ELECTRICAL GENERAL PROVISIONS

PART 1 - GENERAL

DESCRIPTION OF WORK:

Summary: The electrical work can be generally summarized in the following manner, but this is not by way of limitation:

- Obtain permits for moving hazardous waste.
- Check and mark phase rotation before de-energizing system.
- Have PWC personnel de-energize the existing transformers.
- Test existing transformer for no-load losses. Drain the PCB fluid from each transformer into standard DOT approved drums and deliver it to the interim hazardous waste storage area on the base as designated by the Resident Engineer (all work shall comply with OSHA and EPA regulations).
- Purge the transformer case with dry nitrogen and seal.
- Deliver the existing transformer to the interim hazardous waste storage area on the base (comply with OSHA and EPA regulations).
- Provide and install new transformers.
- Connect new transformers and test.
- Request PWC personnel to energize the system.
- Verify proper operations and turn the operating transformer over to EG&G Idaho, Inc. for remanding to PWC San Diego.

PART 2 - MISCELLANEOUS AND ANCILLARY PRODUCTS

GENERAL:

Furnish all labor, materials, equipment, and appliances required to complete the installation of the complete electrical systems. All labor, materials, service, equipment, and workmanship shall conform to the applicable chapters of the NEC (NFPA 70) and other authorities having lawful jurisdiction pertaining to the work required. All modifications required by these codes, rules, regulations, and authorities shall be made by the Subcontractor without additional charge to the Contractor.

Underwriter's Laboratories (UL): All materials, appliances, equipment, or devices shall conform to the applicable standards of UL where such standards exist. All material, appliances, equipment, or devices shall be listed and/or labeled by UL where such standards exist.

Completed electrical system shall conform with applicable provisions of the Special Conditions, the Technical Specification, and the attached subcontract drawings.

CONDITION OF PRODUCTS:

Except as otherwise indicated, provide new electrical products, free of defects and harmful deterioration at the time of installation. Provide each product complete with trim, accessories, finish guards, safety devices, and similar components specified or recognized as integral parts of the product, or required by governing regulations.

UNIFORMITY:

Where multiple units of a product are required for the electrical work, provide identical products by the same manufacturer without variations except for sizes and similar variations as indicated.

PART 3 - EXECUTION:

COORDINATION OF ELECTRICAL WORK:

General: It is recognized that the subcontract documents are diagrammatic in showing certain physical relationships that must be established within the electrical work and in its interface with other work, including utilities and mechanical work, and that such establishment is the exclusive responsibility of the Subcontractor.

Arrange electrical work in a neat, well-organized manner with conduit and similar services running parallel with the primary lines of the building construction and with a minimum of 7 feet overhead clearance where possible.

Locate operating and control equipment properly to provide easy access and arrange entire electrical work with adequate access for operation and maintenance.

RESIDENT ENGINEER:

The EG&G Idaho Resident Engineer will ensure that the installation complies with drawings, specifications, and witness testing.

TRANSFORMERS

PART 1 - GENERAL

WORK DESCRIPTION:

Provide and install transformers of sizes, ratings, and types as shown on the referenced data sheets and engineering specification.

PART 2 - PRODUCTS

MATERIALS:

The transformers shall be as shown on the attached data sheets and shall be installed at the location indicated on the drawings.

The transformer enclosure shall be suitable for the environment that the transformer is installed in.

PART 3 - EXECUTION

INSTALLATION:

Install transformers as indicated on the drawings and in accordance with manufacturer's written instructions, applicable requirements of NEC and the NEC Association's "Standard of Installation," and complying with recognized industry practices to ensure that products serve intended functions.

TESTING:

Visually inspect to determine that equipment installation conforms to NEC, these specifications, and the drawings and testing as described under the testing section of the specification.

GROUNDING

PART 1 - GENERAL

WORK DESCRIPTION:

Provide and install grounding on all transformer cases and tie into the existing grounding system.

PART 2 - PRODUCTS

MATERIALS:

Grounding electrode wire shall be a minimum of No. 2 AWG bare stranded copper and comply with NEC Table 250-94.

Ground grid welds shall be made by the Thermit process.

PART 3 - EXECUTION

INSTALLATION:

Install a complete grounding system for the transformers in accordance with applicable requirements of NEC and complying with recognized industry practices to ensure that products serve intended functions and comply with requirements. All exposed noncurrent-carrying metallic parts of electrical equipment, conduits, grounding conductor of nonmetallic sheathed cables, and neutral conductor of the wiring system shall be grounded.

Exothermic Welds: Exothermic welds shall be made in accordance with the manufacturer's written recommendations. No mechanical connector is required at exothermic weldments.

TESTING:

Visually inspect to determine that ground installation conforms to NEC, these specifications, and the drawings.

CABLE, WIRE, CONNECTORS AND MISCELLANEOUS DEVICES

PART 1 - GENERAL

WORK DESCRIPTION:

Provide and install conduit systems, cables, wires, and wiring connectors of sizes, ratings, materials, and types as shown on the drawings.

PART 2 - PRODUCTS

WIRING MATERIALS 5 KV AND 15 KV CLASS:

All 5 KV and 15 KV cable shall be shielded and properly terminated. Cable shall be EPR MV-90 shielded cable and shall have a 133% insulation level.

HIGH VOLTAGE SPLICES:

Splices in high voltage cables. Splices shall be suitable for continuous immersion in water and shall be made only in accessible locations in manholes.

Certification. High voltage cable splicer/terminator certification of competency and experience shall be submitted 30 days before splices or terminations are made in high voltage cables. Splicer/terminator experience during the past 3 years shall include performance in splicing and terminating all cables of the type and classification being provided under this contract.

Kit Methods. High voltage splices shall be made using a "kit," which shall be the product of one manufacturer and shall have the approval in writing of the manufacturer of the cable that is to be spliced. The Contractor shall provide for continuous submersion in water.

Heat-Shrink Method. All splices for 600 volt and less cables shall be done by the heat-shrink method. Provide heavy-wall heat-shrinkable splice tubing rated for sealed underground connector systems. Tubing shall be available uncoated, or with a thermoplastic adhesive-sealant that adheres to PVC, neoprene, polyolefin, and EPR aluminum or steel.

Splices in High Voltage Cables. Splices shall be suitable for continuous immersion in water and shall be made only in accessible locations in manholes.

Certification. High voltage cable splicer/terminator certification of competency and experience shall be submitted 30 days before splices or terminations are made in high voltage cables. Splicer/terminator experience during the past 3 years shall include performance in splicing and terminating cables of the type and classification being provided under this contract.

Kit Methods. High voltage splices shall be made using a "kit," which shall be the product of one manufacturer and shall have the approval in writing of the manufacturer of the cable that is to spliced. The contractor shall provide the Contracting Officer or Contractor's Quality Control representative with a copy of the manufacturer's instructions before splicing is started. Splices shall be made only in manholes.

Splices in Shielded Cables. Splices in shielded cables shall include covering the spliced area with metallic tape, or like material, to the original cable shield and connecting it to the cable on each side of the splice. Provide a No. 6 AWG bare copper ground connection brought out in a water tight manner and ground to a 3/4 inch x 10 feet ground rod as part of the splice installation. Wire shall be trained to the sides of the enclosure in a manner to avoid interference with the working area.

Phasing and Rotation. Contractor to record the phasing and rotation of the existing electrical system before cable splicing, cable removal, termination, and/or any work that could alter the phasing and rotation of the system. After completion of the work and before connecting any load to the system, the contractor shall verify that the phasing and rotation is as it existed and has not been altered.

WIRING MATERIALS, 600 V CLASS:

Conductors shall be stranded for all sizes of wire and cable.

Conductors shall be copper for all sizes.

Wire insulation shall be type THHN/THWN for all 600 volt conductors unless otherwise noted.

Minimum size of power conductors shall be No. 12.

Splices for 600 Volt Cables. Splices in underground systems shall be made only in accessible locations, such as manholes and handholes, using a compression connector of the conductor and by insulating and water proofing by a method suitable for continuous submersion in water.

Heat-Shrink Method. All splices for 600 volt and less cable shall be done by the heat-shrink method. Provide heavy-wall heat-shrinkable splice tubing rated for sealed underground connector systems. Tubing shall be available uncoated, or with a thermoplastic adhesive-sealant that adheres to PVC, neoprene, polyolefin, and EPR aluminum or steel.

CONNECTORS:

Compression and/or lug type connectors, such as "Burndy", shall be used for splicing No. 6, and larger 600 volt cable.

High Voltage Cable Terminations. IEEE 48, Class 2. Except as otherwise indicated, terminators for extruded insulation nonmetallic jacketed cables shall be porcelain insulator type. Apply terminator to single conductor cables or to each conductor of multiple conductor cable that are to the weather. Terminator shall not exude any filler compound under either test or service. The terminator shall consist of a porcelain insulator, cable connector-hoodnut assemble, and aerial lug, as required, metal body and supporting bracket, sealed cable entrance, and internal stress relief device for shielded cable, and insulating filler compound or material.

Terminator, Modular, Molded Rubber Type. IEEE 48, Class 2. Provide terminator as specified herein for terminating single conductor, or the single conductor of multiconductors, solid insulated, nonmetallic jacketed type cables for service voltage up to 35 KV outdoor. The terminator shall consist of a stress control, ground clamp, nontracking rubber skirts,

crimp-on connector, rubber cap, and aerial lug. Provide heat-shrinkable elbow sealing adaptor as shown on plans, allowing the metallic cable shielding to be externally grounded and sealed. Separate parts of copper or copper alloy shall not be used in contact with aluminum or aluminum alloy parts in the construction and installation of the terminator.

Wire/Device Identification: All cable systems, major conduits, and devices shall be permanently marked. Conduits shall have stainless steel tags at every 60 feet or where wall or building penetrations occur. All conductors shall be identified with self-adhering oil and moisture resistant vinyl labels, covered with clear heat shrink tubing or white heat shrink tubing with black typed on letters with nonsmearing ink as manufactured by Brady, T&E, or approved equal. Hand lettered labels shall not be used. All conductors shall be clearly marked with the proper phase identification.

CONDUIT SYSTEM:

All conduits shall be RGS or IMC with exception of underground, which can be PVC, and which shall be 3 feet minimum below grade and encased in 2 inches minimum red concrete. All bends must be RGS or IMC. Conduit systems shall be completed per the NEC.

PART 3 - EXECUTION

INSTALLATION:

General: Install electrical cable, wire, and connectors as indicated on the drawings, in accordance with the manufacturer's written instructions, applicable requirements of NEC and NECA's "Standard of Installation", and in accordance with recognized industry practices to ensure products serve intended functions.

Pull conductors together where more than one is being installed in a raceway. Do not exceed the conductor manufacturer's recommended pulling tension or as specified in the IPCS Handbook. Use pulling compound or lubricant, where

necessary; compound must not deteriorate conductor or installation. Tension shall be monitored when pulls involve more than 40 feet or when 3 or more 90 degree turns are in the system.

Use pulling means including fish tape, cable, or rope which cannot damage raceway.

Install splices and taps in an accessible junction box that has mechanical strength and insulation rating equivalent-or-better than conductor.

Use splice and tape connectors that are compatible with conductor material.

TESTING:

High Potential: After installation and installing stress cones, all 15 KV cable shall be tested at twice the normal operating voltage plus 1000 volts. The test duration shall be 15 minutes on each cable. See IEEE standard 400-1980 (IEEE guide for making high-direct-voltage tests on power cable systems in the field).

Meggering: Before terminating, test all cable or wire for insulation resistance with 500 volt megger. Any wire with less than 10 megohms to ground or other conductors shall be replaced before proceeding with the terminating. List conductors tested on required test data submittal sheet.

ELECTRICAL CONTINUITY AND PHASE ROTATION:

After conductor connectors are installed and conductors are labeled, but before termination to terminals or devices, an electrical continuity test shall be performed on each conductor using a battery powered buzzer or ohmmeter to determine that all power, control, grounding, and other conductors are properly installed and identified. List all conductors tested on required test data submittal sheets.

After initial energizing of the transformer, check for proper phase rotation.

ES-51333

APPENDIX D

OUTLINE SPILL PREVENTION, CONTROL, AND COUNTERMEASURES PLAN

OUTLINE SPILL PREVENTION, CONTROL, AND COUNTERMEASURES PLAN

MINIMUM SPILL PREVENTION REQUIREMENTS

The following shall be performed before the start of and during any fluid removal from a liquid cooled transformer (i.e., PCB filled, oil filled, or silicone filled).

- a. A layer of 6 mil polyethylene sheeting shall be placed around the transformer.
- b. If drains are present, measures will be taken to eliminate the potential for any fluids from entering the drains. This includes, but is not limited to, constructing a dike, trenching around the drain, and/or plugging the drain.
- c. Before pumping the fluids, all hoses shall be inspected for any holes, cracks, or deterioration. Fittings shall be inspected to ensure a proper connection. Any gaskets utilized in the pumping operations shall be inspected for integrity. Approved hoses, pumps, and gaskets shall be used.
- d. Drip pans shall be placed under pumps and connections.
- e. Pumps and hoses shall be positioned so as to minimize any tripping hazard.
- f. Personnel will monitor the pumping operation at all times.
- g. An adequate supply of absorbent materials and cleanup equipment shall be readily available in the event of a mishap.

This includes the following, but not limited to:

1. Shovels
2. Brooms
3. DOT drums: 17E, 17H, and 85 gallon recovery drum
4. Ample supply of rags
5. Vermiculite (Speedi-Dry)
6. Absorbent booms and/or absorbent pads
7. Assorted corks, plugs, and emergency seals
8. Material Safety Data Sheets (MSDS).

h. All safety equipment shall be inspected before use.

CONTROL

In the event of a spill or leak, the following procedure shall be implemented:

- a. Stop the source of the spill. Below is a list of probable source of spills when working with liquid cooled transformers, and the remedial action to be taken to eliminate the problem.

Source 1. Transformer

1. Location of leaks: valves. Remedial action: plug valve to reduce or stop spill. Pump fluid below valve and replace faulty valve.
2. Location of leak: bushing. Remedial action: Pump fluid below bushing level. Replace gaskets, or if necessary, replace bushing.

3. Location of leak: tank wall or radiator pipe. Remedial action: pump fluid below level of leak and either epoxy or weld close the leak source. If the source of the leak is small, a vacuum can be pulled on the transformer before applying the epoxy sealant or welding. Pulling a vacuum on the transformer eliminates the need for any pumping operations.
4. Location of leak: tap changer, liquid level gauge, or temperature gauge. Remedial action: remove fluid below level and replace packing material, gaskets, or thread sealant where applicable.

Source 2. Pumps or Hoses

Remedial action: Stop all pumping operations and place apparatus into an adequate container to capture any fluids.

Source 3. Drums

Remedial action: In the event that the drum is seeping at the seams, the fluid shall immediately be transferred to another drum. Should a drum rupture or become punctured, an oversized recovery drum will be used. The recovery drum is placed over the top of the leaking drum. Then, the recovery drum is placed upright, containing the leaking drum.

- b. Stop the migration of any spilled fluid. This can be done by placing the berm around perimeter of the spill. A berm can be constructed using any type of absorbent material, i.e., vermiculite (Speedi-Dry), sand, rags, absorbent boom or pads.
- c. Solidify any free standing fluid.

- d. Safety apparel shall be worn when dealing with spills involving PCB fluids.

COUNTERMEASURES

The countermeasure operations are the cleanup and disposal of all contaminated material that is a result of the spill. The primary goal of all cleanup activity is to maintain a safe environment.

a. Cleanup

1. Fluids: If the volume of fluids is great enough to where solidification is impractical, the liquid shall be pumped into DOT 17E drums. These drums must be properly labeled and dated.
2. Solids: Any porous solids (soils, asphalt, wood, paper, etc.) contaminated by the spill shall be placed into DOT 17H (removal head) drums. These drums must be properly labeled and dated.
3. Major Spills: In the event that the spill exceeds the control and cleanup capabilities that are onsite, an outside contractor, who specializes in environmental cleanup and has all permits and licenses required, must be contacted. This contractor must be equipped to handle various types of spills.

Analysis. During the cleanup operations, sampling, and analysis must be performed. The analytical data are needed to present an accurate picture of the following:

1. The extent of the spill
2. The effectiveness of the cleanup operations

3. The point in time when the environment has been decontaminated.

- b. Disposal. The disposal of all contaminated materials must be in accordance with the applicable EPA regulations (40 CFR 761).

All work will be inspected by the EG&G Idaho, Inc. representative.

Transportation of hazardous waste to the disposal site shall conform to 40 CFR, Part 263. All Federal, state, and local permits and labeling and approvals shall be completed before the shipment of waste from the transformer site.

ES-51333

APPENDIX E

SWITCHGEAR SPECIFICATION

SWITCHGEAR SPECIFICATION

1.0 GENERAL

Provide and install switchgear with the transformer as referenced in the data sheets. The switchgear shall consist of one or more enclosed vertical sections joined together to form a rigid, free standing assembly. The construction of the switchgear shall meet the requirements of the NEC.

2.0 PRODUCTS

600 Volt: Switchgear shall be suitable for operation for 480 volt, 3 phase, 3 wire, 60 Hertz grounded service.

Vertical Sections: Vertical sections shall support the horizontal and vertical buses, covers, and doors, and shall be designed to allow for easy rearrangement of units. Vertical sections shall have structural supporting members formed of a minimum of 13 gauge hot-rolled steel. All finished surfaces shall be blemish-free. Each section shall be 90 inches high and shall have 7 gauge steel, 3 inches high, removable lifting angle and two 1-1/2 inches high base channels. Complete control center lineups shall be divided into shipping splits no wider than approximately 60 inches. A lifting angle shall be provided on the top of each shipping split and shall extend the entire width of the shipping split. Lifting angles shall be designed to support the entire weight of the switchgear and shall have access points or lifting eyes to facilitate handling. Base channels shall be provided with holes to permit bolting the switchgear to the floor. The entire assembly shall be constructed and packaged to withstand all stresses induced in transit and during installation. Switchgear shall be designed so that matching vertical sections of the same current rating and manufacture can be added later at either end of the lineup without use of transition sections and without difficulty. Removable end closing plates shall be provided to close off openings on

the end of the lineup. A removable top plate shall be provided on each vertical section and shall be of one piece construction for added convenience in cutting conduit holes. The design shall allow use of the standard conduit entrance area without significant sag or deformation of the top plate.

Vertical sections shall be designed to accommodate plug-on units in front-of-board construction. Vertical sections housing plug-on units shall be 15 inches deep.

Vertical sections shall be provided with both horizontal and vertical wireways. Sufficient clearances shall be provided in the horizontal wireway so that no restriction is encountered in running wires from the vertical to horizontal wireway. Wireways shall be in accordance with the wireways section contained in this document.

Horizontal Wireways: Horizontal wireways shall be provided in the top and bottom of each vertical section and shall be arranged to provide full length continuity throughout the entire assembly. The top horizontal wireway shall have a cross sectional area of not less than 20 square inches with openings between sections of not less than 11-1/2 square inches. The bottom horizontal wireway shall extend through the length and depth of the 11-1/2 square inches to allow for full length continuity throughout the entire assembly. The bottom horizontal wireway height shall be not less than 9-1/4 inches. Covers for all wireways shall be equipped with captive type screws to prevent loss of hardware during installation. All wireways shall be isolated from the bus bars.

Vertical Wireways: A vertical wire trough shall be located on the right-hand side of each vertical section and shall extend from the top horizontal wireway to the bottom of the available unit mounting space. Each vertical wire trough shall have a cross-sectional area of not less than 19 square inches and shall be isolated from the bus bars to guard against accidental contact. A separately hinged door having captive type screws shall cover the vertical wire trough to provide easy access to control wiring without disturbing the unit.

Reusable wire ties shall be furnished in each vertical wire trough for the purpose of grouping and securely holding wires in place for a neat and orderly installation.

Bus Bars: A continuous main 3-conductor horizontal bus shall be provided over the full length of the switchgear. When necessary, the bus shall be split to allow for ease in moving and handling. Splice bars will be supplied to join the bus whenever a split has been made. All splice connections shall be made with at least 2 bolts. Horizontal busbars shall be mounted edgewise and supported by insulated bus supports. Insulation shall be used as required by NEMA standards and shall be dated at no less than 600 VAC.

For distribution of power from the main horizontal bus to each unit compartment, a 3-phase vertical bus shall be provided. The vertical bus shall be firmly bolted to the horizontal bus for permanent contact.

The main horizontal and vertical buses shall be made of copper and the entire length shall be electrolytically tin plated to provide maximum protection to the bus bars from normal or adverse atmospheric conditions.

The main horizontal bus rating shall be a minimum 800 amperes continuous. Vertical bus rating shall be a minimum of 300 amperes for adequate current carrying capacity. Continuous current ratings shall be in accordance with temperature rise specifications set forth by UL, ANSI, and NEMA standards.

A copper ground lug shall be provided in each incoming line vertical section capable of accepting No.8 to 350 MCM cable. A horizontal (and vertical) tin plated copper ground bus shall be provided in each section of the switchgear. Horizontal ground bus shall run continuously throughout the switchgear except where splits are necessary for ease of shipment and handling in which case splice bars shall be provided. Ground bus shall be tin plated copper. Horizontal ground bus shall be located at

the bottom of the switchgear. Vertical ground bus shall run parallel to the power distribution bus in each vertical section. Design shall be such that for any plug-on unit the ground bus shall make contact with the ground bus before the power bus contact is made.

Bus Barriers: Insulated horizontal and vertical bus barriers shall be furnished to reduce the hazard of accidental contact with the bus. Barriers shall have a red color to indicate proximity of energized buses. Vertical bus barriers shall have interlocking front and back pieces to give added protection on all sides and shall segregate the phases to reduce the possibility of accidental "flash over." Small, separate openings in the vertical bus barriers shall permit unit plug-on contacts to pass through and engage the vertical bus bars. Bottom bus covers shall be provided below the vertical bus to protect the ends of the bus from accidental contact with fish tapes or other items entering from the bottom of the enclosure.

Controls and Meters: All new service panels shall be equipped with the following:

Kilowatt Meters. Type II, Class 3, Style B and shall have provisions for pulse initiation. Kilowatt meters shall be flush switchboard type as indicated on the drawings and shall be totally compatible to each particular application. Kilowatt meters shall be of one manufacturer, secondary type.

- The meters shall have an electronic demand register. The register shall be used to indicate maximum kilowatt demand as well as cumulative basis. It shall have provisions to be programmed to calculate demand on a rolling interval basis.
- The register shall be of modular design. The electronic module, containing all the program variables, shall be able to be easily removed from the mechanical register for programming, maintenance and trouble shooting.

the bottom of the switchgear. Vertical ground bus shall run parallel to the power distribution bus in each vertical section. Design shall be such that for any plug-on unit the ground bus stab shall make contact with the ground bus before the power bus contact is made.

Bus Barriers: Insulated horizontal and vertical bus barriers shall be furnished to reduce the hazard of accidental contact with the bus. Barriers shall have a red color to indicate proximity of energized buses. Vertical bus barriers shall have interlocking front and back pieces to give added protection on all sides and shall segregate the phases to reduce the possibility of accidental "flash over." Small, separate openings in the vertical bus barriers shall permit unit plug-on contacts to pass through and engage the vertical bus bars. Bottom bus covers shall be provided below the vertical bus to protect the ends of the bus from accidental contact with fish tapes or other items entering from the bottom of the enclosure.

Controls and Meters: All new service panels shall be equipped with the following:

Kilowatt Meters. Type II, Class 3, Style B and shall have provisions for pulse initiation. Kilowatt meters shall be flush switchboard type as indicated on the drawings and shall be totally compatible to each particular application. Kilowatt meters shall be of one manufacturer, secondary type.

- The meters shall have an electronic demand register. The register shall be used to indicate maximum kilowatt demand as well as cumulative basis. It shall have provisions to be programmed to calculate demand on a rolling interval basis.
- The register shall be of modular design. The electronic module, containing all the program variables, shall be able to be easily removed from the mechanical register for programming, maintenance and trouble shooting.

- All electronic modules shall be physically identical and interchangeable.
- A frictionless optical assembly, mounted directly to the meter frame, generating 12 pulses per meter disc revolution for input to the electronic register shall be provided.
- Each kilowatt meter shall also be complete with a 5-dial mechanical kilowatt hour register.
- Meters shall be 3 stator, 120 volt for use on a wire Y, 3-phase system.
- Meter multiplier shall be shown on the face plate and shall be the product of the indicated current transformer and potential transformer ratio.
- Draw out arrangement for meter removal incorporating automatically short circuit current transformer circuits.
- Meter covers shall be polycarbonate resin.
- Meter detent to prevent negative registration by restricting the backward rotation of the disk.
- The normal billing data scroll shall be fully programmable. The following items shall be displayed in the data scroll:
 - Kilowatt hours
 - Maximum demand
 - Cumulative or continuously cumulative
 - Number of demand resets
 - Time remaining in interval
 - End-of-interval indication
 - New maximum demand indication

- The register shall incorporate a built-in test mode that allows it to be tested without the need for any special tools or other accessories and saves data and constants before start of the test. The following quantities shall be available for display in the test mode:
 - Time remaining in demand interval
 - Present interval's accumulating demand
 - Maximum demand
 - Number of impulses being received by the register
- Pulse initiator with programmable ratio selection.
- Battery with battery port for quick changes.
- Meters shall be programmed after installation.
- Meters shall be tested, calibrated, and certified after installation.
- Self-monitoring to provide for stored data check sum error, ROM and RAM checksum error, battery fault, and unprogrammed register.
- Liquid crystal display, 9 digits, blinking squares confirm register operation.. Large digits for data and smaller digits for display identifier.
- Display operations, programmable sequence with display identifiers. Display identifiers shall be selectable for each item. Continually sequence with time selectable for each item.

Circuit Breakers: Molded e circuit breakers shall be furnished in branch feeder units using circuit breakers as a disconnect means. All circuit breakers will have a push-to-trip test feature for testing and exercising the trip mechanism. Breakers shall be UL listed for a minimum of 22,000 amperes RMS symmetrical fault withstandability.

Main breakers (480 volt panels only) shall be equipped with auxiliary contacts and shunt trip coils. Optional electrical operation mechanisms shall be proposed for possible use if funding levels are adequate.

Identification: A control center identification nameplate with factory identification numbers and characteristics shall be fastened on the vertical wire trough door of every section. Each unit shall have its own identification nameplate fastened to the unit saddle. These nameplates shall have suitable references to factory records for efficient communication with supplier. Each unit shall also have an engraved nameplate fastened to the outside of the unit door for ease in identification and for making changes when regrouping units. Main breakers (480 panels only) shall be equipped with auxiliary monitoring contacts and shall be equipped with short trip controls. Optional electrical operations shall be proposed for possible use if funds are adequate.

Wiring: The switchgear wiring shall be NEMA Class II, Type B.

As defined by NEMA Standard ISC-2-322, Class II switchgear shall include the necessary electrical interlocking and interwiring between units.

Type B wiring shall include terminal blocks mounted on lift out brackets in the units.

Terminal blocks shall be quick separating pull-apart solderless box lug type or equal.

Finish: All metal structural and unit parts shall be completely painted using an electrodeposition process so that the interior and exterior surfaces as well as bolted joints have a complete finish coat on and between them.

3.0 TESTS

3.1 Following tests shall be performed and results recorded. All the equipment tests shall be performed in accordance with IEEE, NEMA, and ANSI Standards where such standards are definitive. All test data including but not limited to test circuitry, faulty equipment, and remedial action will be recorded, certified, correlated, bound, and furnished to the Owner.

- a. Wiring continuity - point to point check and verification with the wiring diagrams.
- b. Wiring insulation - check to ground - megger at 600 volts.
- c. Power of proper amplitude and frequency shall be applied to all AC and DC circuitry. Three-phase potential and current of proper frequency, shall be applied to all applicable AC connections.
- d. Polarity tests of all AC and DC circuitry. Three-phase power and phase angle meter shall be used to make AC polarity test on power feeds and metering circuits.
- e. Functional tests shall be performed on all equipment to indicate proper operation of all protection, metering, and control equipment. Power circuit breaker simulators shall be employed for the primary bus to verify proper operation of all equipment.
- f. The Owner may at his option provide specific relay and metering test forms to be complied with, otherwise the Seller shall submit 2 copies of Seller's standard test forms for review by the Engineer.
- g. All "as left" test values shall be recorded and shall be within manufacturer's tolerances. Manufacturer's tolerances shall be indicated on the test forms.

n. The intent of the acceptance test is to determine that the meters and relays have not sustained damaged during shipment from the manufacturer and that the meters and relay calibrations have not been disturbed. If the examination or test indicates that re-adjustment is necessary, the relay shall be repaired and/or calibrated as per manufacturer's instructions.

3.2 The Owner and/or Engineer may elect to visit the Seller's facilities on completion of fabrication of the equipment to inspect the equipment and witness testing as outlined in Section 3.1.

ES — 51334 Rev. B

DATE — May 4, 1990

SPECIFICATION

FOR

THE PURCHASE AND INSTALLATION OF CAST COIL TRANSFORMERS
AT THE SAN DIEGO NAVAL FACILITY

PROJECT NO.

015341

Approved for Release:

Engineering Graphics
EG&G Idaho, Inc.



DOCUMENT APPROVAL SIGNATURE SHEET

Type of Document ENGINEERING SPECIFICATION	Document No. ES-51334
------------------------------------------------------	---------------------------------

TITLE SPECIFICATION FOR THE PURCHASE AND INSTALLATION OF CAST COIL TRANSFORMERS AT THE SAN DIEGO NAVAL FACILITY

Prepared By <u>S.A. MCBRIDE</u> <i>[Signature]</i>	Ext. <u>9330</u>
Originated By <u>G.D. SEIFERT</u>	Ext. <u>9522</u>

(PRINT OR TYPE NAME IN SPACE ABOVE SIGNATURE)	Organization	Mail Address	Date
<u>J.F. JACOBSEN</u> <i>[Signature]</i>	INEL - POWER SYSTEMS ENGINEERING	<u>2702</u>	<u>11/20/89</u>
<u>V.E. BERG</u> <i>[Signature]</i>	INEL - Quality Engineering	<u>3508</u>	<u>11-20-89</u>
<u>A.D. HILL</u> <i>[Signature]</i>	INEL - ELECTRICAL SAFETY	<u>3423</u>	<u>11-20-89</u>
<u>R.W. WHITE</u> <i>[Signature]</i>	NCEL - EE PROGRAM MANAGER	<u>2302</u>	<u>11/20/89</u>
----- Revision A per DRR EGB-737 Released by Engineering Graphics on 3-28-90 <i>[Signature]</i>			
----- Revision B per DRR EGB-758 Released by Engineering Graphics on 3-4-90 <i>[Signature]</i>			

CONTENTS

<u>Section</u>	<u>Page</u>
1. SCOPE	A-87
1.1 Scope	A-87
1.2 Applicability	A-87
2. APPLICABLE DOCUMENTS	A-87
2.1 American National Standards Institute (ANSI)	A-88
2.2 National Electric Manufacturers Association (NEMA)	A-88
2.3 National Fire Protection Association (NFPA) Publication	A-88
2.4 Others	A-89
3. TECHNICAL REQUIREMENTS	A-89
3.1 General	A-89
3.2 Electrical Products	A-90
3.3 Condition of Products	A-90
3.4 Uniformity	A-90
3.5 Test Point Observation	A-90
3.6 Performance Requirements	A-91
3.7 Environmental Conditions	A-91
3.8 Accessories	A-94
3.9 Enclosure Construction	A-96
3.10 Paint	A-96
3.11 Miscellaneous Requirements	A-96
3.11.1 Insulated Phase Barriers	A-96
3.11.2 Undercoating	A-97
3.11.3 Warning Signs	A-97
3.12 Provisions for Fan Cooling	A-97
3.13 Testing	A-97
3.13.1 Factory Electric Tests	A-98
3.13.2 Field Tests	A-99
4. QUALITY ASSURANCE PROVISIONS	A-99
5. PACKAGING	A-100
6. SUBMITTALS	A-100
6.1 Shop Drawings and Manufacturer's Data	A-100
6.2 Certified Laboratory Test Data	A-100
7. DEMOLITION AND CONSTRUCTION	A-101
7.1 Demolition and Construction General Requirements	A-101
7.2 Draining	A-102
7.3 Transportation and Disposal	A-102

APPENDICES

A. Transformer Data Sheet	A-103
B. Vendor Data Requirements List	A-130
C. Construction Details	A-132
D. Spill Prevention, Control, and Countermeasures Plan	A-143
E. Switchgear Specification	A-149

SPECIFICATION
FOR THE PURCHASE AND INSTALLATION OF
CAST COIL TRANSFORMERS AT THE
SAN DIEGO NAVAL FACILITY

1. SCOPE

1.1 Scope. This specification covers the design, fabrication, testing, installation, and inspection of cast coil, dry-type, power transformers and the removal of existing polychlorinated biphenyl (PCB) transformers, handling of PCB fluid, and obtaining the permits required for hauling hazardous waste. The intent is to make a turnkey replacement with advanced technology transformers including any equipment needed to replace the existing transformers. They will be used to provide the Navy with performance data on these advanced technology devices.

1.2 Applicability. It is not the intent to specify details of design and construction except where necessary to establish performance requirements, nor is it intended to set forth those performance requirements, which are adequately specified in applicable standards.

All components of the transformers shall be new and function in a satisfactory manner within their rated capacity under the specified service conditions regardless of whether all necessary specific performance requirements are set forth herein or in applicable standards.

2. APPLICABLE DOCUMENTS

The following documents form a part of this specification to the extent specified herein. The issue of a document and amendments in effect on the date of publication of this specification shall apply.

2.1 American National Standard Institute (ANSI).

- ANSI-C57 12.01 General Requirements for Dry-Type Distribution and Power Transformers
- ANSI-C57 12.70 Terminal Markings and Connections for Distribution and Power Transformers
- ANSI-C57 12.80 Terminology for Power and Distribution Transformers
- ANSI-C57 12.91 Test Code for Dry Type Distribution and Power Transformers
- ANSI-C57 12.94 Recommended Practice for Installation Application, Operation, and Maintenance of Dry-Type General Purpose Distribution and Power Transformers
- ANSI-C57 12.96 Loading Dry-Type Distribution and Power Transformers
- ANSI-C57 12.98 Guide for Transformer Impulse Tests
- C2-1989 National Electrical Safety Code
- Z35.1 Specifications for Accident Prevention Signs

2.2 National Electric Manufacturers Association (NEMA).

- NEMA TRI-1974 Transformers, Regulators, and Reactors

2.3 National Fire Protection Association (NFPA) Publication.

- NFPA 70 National Electrical Code

2.4 Others.

IEEE 400-1980	IEEE Guide for Making High Direct Voltage Tests on Power Cable Systems in the Field
NEESA 20.2 - 028a	PCB Compliance, Assessment, and Spill Control Guide
OPNAVINST 5090.1	Environmental and Natural Resources Protection Manual
29 CFR	General Industry Safety and Health Standards
40 CFR 263	Standards Applicable to Transporters of Hazardous Waste
40 CFR 761	Polychlorinated Biphenyls (1979)
49 CFR 172	Hazardous Materials Tables and Communications Standards
49 CFR 173	General Requirements for Shipping and Packaging
California CAC Title 22, Division 4	Environmental Health
PWC San Diego	Utility Standards
MIL-P-28641	Primer Coating, Vinyl Chlorine Acetate, Copolymer, High Build (for steel and masonry)
MIL-Q-9858A	Quality Program Requirements

3. TECHNICAL REQUIREMENTS

3.1 General. The transformers shall have low loss metal cores and shall be three phase three-winding, self-cooled, dead front, suitable for installation indoors or outdoors, or as specified in the attached data sheets in

Appendix A. They shall have primary and secondary compartments that shall enclose all termination devices so that no live parts are exposed when the transformer is energized. Unit substation transformer installations are exempt from the dead front requirement. The transformer and installation shall meet all applicable requirements of the ANSI, ASTM, NEC, and NEMA publications as specified herein. The transformer shall be of new construction. The successful bidder shall be responsible for all field modifications, measurements, provide installation and checkout, and turn the transformer over to the operations department, PWC San Diego, through the EG&G Idaho, Inc. Resident Engineer, ready for operation. | A

3.2 Electrical Products. All materials, appliances, equipment, or devices shall conform to the applicable standards of the Underwriter's Laboratories, Inc. (UL) and applicable chapters of the National Electrical Code (NFPA 70), where such standards exist. All materials, appliances, equipment, or devices shall be listed and/or labeled by UL, where such standards exist.

3.3 Condition of Products. Except as otherwise indicated, new electrical products free of defects and harmful deterioration shall be provided at the time of installation. Each product provided shall be complete with trim, accessories, finish guards, safety devices, and similar components specified or recognized as integral parts of the product, or required by the governing regulations.

3.4 Uniformity. Where multiple units of a product are required for the electrical work, identical products shall be provided by the same certified and approved manufacturer without variations except for sizes and specific variations as indicated.

3.5 Test Point Observation. The successful bidder shall supply EG&G Idaho with a flow sheet for the manufacture of each transformer indicating all test points. The successful bidder shall notify EG&G Idaho, in writing, of the date that each test will be conducted at least 14 days before that test and will admit EG&G Idaho and government representatives to witness the tests.

3.6 Performance Requirements. Each transformer shall comply with the following performance requirements as specified in ANSI-C57 12.00, except as noted in the data sheet in Appendix A.

Transformer Rating	As specified in Appendix A.
Auxiliary Cooling	Forced air provisions, fan mounts, and temperature sensor access points as a minimum shall be provided for future. Refer to the data sheets in Appendix A for special instructions.
Primary Voltage	As specified in Appendix A. Note special dual voltage requirements.
Primary Connection	As specified in Appendix A.
Frequency and Phase	60 Hertz, 3 Phase
Secondary Voltage	As specified in Appendix A. Note special dual voltage requirements.
Secondary Connection	Wye connection with neutral to be brought out through an insulated bushing with external ground strap.
Temperature Rise	80°C, per NEMA TRI-1974
Taps - No-Load	Minimum of five full capacity high voltage taps (two 2 1/2% taps above and 2 1/2% taps below normal voltage and tap position indicators).

Insulation Levels

Primary Voltage

95 KV BIL for Insulation Class 15 KV and 75 KV BIL for Insulation Class 5 KV. Based on specific voltage ratings, which are in the data sheets in Appendix A.

Secondary Voltage

30 KV BIL for Insulation Class 600 V. For specific voltage ratings, see the data sheets in Appendix A.

Coil Construction

HV and LV windings shall be cast as separate rigid tubular coils and arranged coaxially. Transformers 300kVA and under may be constructed using approved non-tubular connected coils. Each cast coil shall be fully reinforced with fiberglass cloth and tape (or equivalent) and cast under vacuum in a mold to ensure complete, void-free resin impregnation throughout the entire insulation system. Coils shall be supported by cast epoxy bottom supports and spacer blocks (or equivalent) and spring loaded top blocks (or equivalent) and have no rigid mechanical connection. Both primary and secondary windings shall be copper or approved low loss aluminum. Approval is based upon showing optimal loss evaluation cost performance values.

A

Impedance

As specified in the data sheets in Appendix A with the following guidelines:

1. The minimum allowable impedance for transformers 750 KVA and above is 4.0 percent.
2. The minimum allowable impedance for transformers 500 KVA is 3.5 percent.

ES-51334

3. The tolerance is +/- 7 1/2 % except for the transformers with dual rated primaries which shall have an impedance tolerance of +/- 10 %.

A

No-Load Loss

The no-load losses (core loss) shall be optimized per the evaluation formula provided in the attached bid package/Request for Proposal (RFP).

Load Loss

The load losses (winding losses) shall be optimized per the loss evaluation formula provided in the attached bid package/RFP.

Sound Level

Shall not exceed noise level per NEMA standards.

Core Material
(General)

The core shall be assembled with low loss, silicon steel sheets and shall be properly braced and assembled. The specific type of low loss silicon steel is to be determined by the manufacturer to meet the lowest total operating costs and optimize no-load losses. However, the intent of this replacement program is to install advanced technology transformers wherever it is economically feasible. The use of amorphous metal, laser etched steel, or other advanced technology core material is encouraged in order to meet low operating cost criteria.

Core Material
(Amorphous)

This section only applies to those devices specified with an amorphous metal core. The transformer shall be constructed of low loss amorphous metal in a wound or stacked core design as designated in the RFP. The complete core assembly shall be fully

ES-51334
encapsulated with a protective coating of approved material to eliminate sharp edges and prevent flaking particles and to protect the core from corrosive products. The no-load loss shall be less than 45% of those for comparable silicon steel core designs. It is known that wound core is standard. However, a few of the options in the data sheets specifically require that stacked core will be treated as a research project to get a "new" technology unit. The other amorphous core devices can be wound (or stacked) at the manufacturer's discretion.

3.7 Environmental Conditions.

Elevation	50 feet above sea level
Location	Indoor/outdoor (See Appendix A.)
Temperature Range	0°C to 40°C

3.8 Accessories. The transformer shall have the following accessories as a minimum. The accessories shall be constructed and located as described in ANSI-C57 12.00.

- Elbow terminators, fuses, and load breaker switches as called out in Section 3.6, primary connection section, and per individual data sheets in Appendix A.
- Dial type thermometer with alarm contact of sufficient capacity to control the future fan contactor and an additional contact for a future utility control system. Thermometer shall monitor the hottest secondary coil phases.
- Tap changer (de-energized operation only).
- Lifting, moving, and jacking provisions.

- Stainless steel/aluminum nameplate with information required in ANSI-C57 12.00 on the transformer exterior. (note: stainless steel is preferred)
- Ground pads.
- A junction box shall be located on the transformer nameplate and contain a terminal board for all electrical circuits entering or leaving the junction box. The junction box shall have a hinged door with a gasket and a handle with provisions for padlocking. All electrical circuits from components mounted within the transformer shall run to this terminal board.
- An optional coil surface temperature sensing thermocouple shall be mounted in the prevailing transformer thermal hot spot for each secondary phase coil. As a minimum, provisions for adding a future thermocouple shall be provided even if the option for the coil surface temperature sensing thermocouple is not added. Each thermocouple shall be installed such that it will preclude circulating air influence. These three thermocouples will provide input to an electronic temperature monitor. This instrument shall respond to the hottest phase temperature and automatically display this reading. An analog meter shall continuously display the hottest phase temperature and indicate individual phase readings or the maximum temperature reached over a period of time. Light emitting diodes are not acceptable. The highest temperature shall also be used to initiate alarm and trip functions and is stored for future recall until the maximum temperature memory is cleared. Fail safe alarm relay circuits automatically actuate if supply power has been lost. Maximum temperature can be recalled even if supply power has been interrupted. A self-test procedure allows set points to be determined and their operation verified. Alarm and trip set points will be tested from the front panel. Open thermocouple circuits are detected and indicated, but do not affect instrument operation. Manual control of alarm and test functions shall be provided. All input and output connections shall be made to the terminal blocks on the back of the instrument. The set points of this thermal device shall be

A

adjustable, and two sets of alarm and trip contacts shall be provided. The alarm contacts on the temperature indicator shall be factory wired and brought out to the terminal blocks on the exterior of the transformer enclosure. The terminal blocks shall be mounted in the junction box. A thermometer with a remote sensing bulb is not acceptable. The thermocouple shall be removable without disconnecting the electrical wiring. The temperature monitor system shall be graduated in degrees centigrade and shall be tested at 200°C before installing on the transformer. The thermally operated device shall be coordinated with the transformer design and shall be connected and set to function as follows:

- First stage shall be adjustable and set at 140°C temperature at which the substation audible bell alarm is activated.
- Second stage shall be adjustable and set at 155°C temperature at which the transformer is isolated by removing the electric load and tripping all the power circuit breakers via the circuit breakers' shunt trip coils (by others in the future).

3.9 Enclosure Construction. The enclosure shall be constructed of heavy gauge painted sheet steel. All ventilating openings shall be in accordance with NEMA and National Electric Code standards for ventilated enclosures. The base shall be constructed of structural steel members to permit skidding or rolling in any direction. Stainless steel enclosures for outdoor transformers are not required, but optional prices for stainless enclosures are requested.

The core shall be grounded to the frame in accordance with applicable NEMA and ANSI standards.

3.10 Paint. The color of the finished transformer shall be C37.20 Federal Standard 595 dark forest green enamel.

3.11 Miscellaneous Requirements.

3.11.1 Insulated Phase Barriers. Primary or secondary insulated phase barriers shall be provided.

3.11.2 Undercoating. Transformers, which have bases that come in contact with concrete, shall have the underside of their bases coated with a corrosion resistant coating that conforms to Military Specification MIL-P-28641 (or an equivalent) with a minimum thickness of 4 mils.

3.11.3 Warning Signs. In accordance with ANSI Z35.1, warning signs shall be provided for the enclosures of electrical transformers having a nominal voltage rating of 500 volts or above.

3.12 Provisions for Fan Cooling. The transformer, 500 KVA or larger, shall have provisions for future fan cooling (by others). As a minimum, fan mounting brackets and dial thermometers with control contacts shall be provided.

3.13 Testing. The following tests shall be performed in accordance with NEMA TRI, ANSI-C57 12.91, and ASTM Standards as listed by the associated tests. All testing, except the field tests, shall be done at the factory, and the certified results shall be submitted to the buyer for approval before shipment of the transformer. Field tests shall be performed unless specifically denied by EG&G Idaho and shall also have certified test procedures and results if opted by EG&G Idaho. All testing included in this Specification shall be performed and costs must be included in the transformer purchase price.

The purchaser reserves the right to witness any or all tests, and the vendor shall notify the purchaser 14 days in advance of the date for conducting any test (see Section 3.5).

Field tests shall be conducted by representatives of the manufacturer and shall be completed after the transformer has been set in place and before the primary and secondary connections are made. These tests shall be as described in Section 3.13.2.

The tests below shall be made on each transformer as a minimum requirement. The order of listing does not necessarily indicate the sequence in which the tests shall be conducted.

3.13.1 Factory Electric Tests.

1. Coil resistance measurements of all windings on the rated voltage connection and at the tap extremes.
2. Turns ratio test on the rated voltage connections.
3. Polarity and phase relation tests on the rated voltage connection.
4. No-load loss at rated secondary voltage on the secondary voltage connection.
5. Exciting current at rated voltage on the rated voltage connection.
6. Impedance and load loss at rated current on the rated voltage connection and on tap extremes.
7. Temperature rise tests under conditions specified in ANSI Standards for transformers (typical temperature rise of the "exact" design may be substituted with written approval).
8. Dielectric test.
9. Applied potential test.
10. Induced potential test.
11. Impulse test.
12. Partial discharge test (Note: this test is not covered by ANSI-C57 12.91), test at 1.5 times the rated voltage and 400 Hertz (or equal). If partial discharge does not extinguish by 110% of rated voltage, the transformer shall be rejected. Optional standard factory test methods must be approved by the Resident Engineer before they can be substituted for this test.

3.13.2 Field Tests. Field tests shall be performed as part of installation. Test reports shall be certified for methodology and accuracy.

No-load loss as measured from the secondary winding at ambient temperature (ANSI-C57 12.9). Record both ambient and top oil temperatures. Conduct this test on both the existing transformers to be removed and the new transformers. Record ambient temperatures on the test reports.

Insulation power factor (Method II ANSI-C57 12.90, Section 10.9) Doble Test or equal. (Insulation power factor to be 0.9 or less.)

Before energizing transformer, test transformer turns ratio (TTR) at all tap settings. Megger all leads before connecting them to the transformer and check the leads for grounds using a VOM before any connections are made. Any lead with a Megger reading of less than 10 megohms shall be replaced.

4. QUALITY ASSURANCE PROVISIONS

Unless otherwise specified, the supplier is responsible for all examinations and inspections as specified herein. The vendor shall maintain a Quality Assurance Program in accordance with MIL-Q-9858A or an approved equal during the performance of the contract, which provides adequate quality assurance and control throughout design, fabrication, testing, inspection, and shipping of the transformer. The vendor shall provide the documents describing the Quality Assurance Program and containing the procedures that will be invoked to comply with the above. An Inspection and Test Procedure shall be prepared and submitted to the buyer for approval. Final inspection and test reports as required by this Specification shall be submitted to the buyer for approval. The vendor shall maintain a calibration system for the periodic calibration of test instruments to standards traceable to the National Bureau of Standards.

Vendor data shall be submitted per attached "Vendor Data Requirements List" (see Appendix B).

5. PACKAGING

The transformer shall be prepared for shipment within the Continental United States. All accessories shall be protected from damage. The transformer shall be sealed to prevent entry of moisture or foreign materials during shipment. Documents as indicated in Appendix B shall be required. Shipping is the responsibility of the supplier as part of the total installation package.

6. SUBMITTALS

Within 30 days of receipt of the order, the vendor shall furnish the purchaser all necessary outline drawings and weights of the transformers.

6.1 Shop Drawings and Manufacturer's Data. Shop drawings for transformers shall indicate, but shall not be limited to, the following:

Overall dimensions, front view, interfaces with existing equipment, and sectional views.

Ratings and sizes of lugs, impedance, taps, and fans.

Manufacturer's published main secondary breaker and feeder devices at each transformer to allow designer to provide settings, which will ensure that proper protection and coordination will be achieved.

Complete list of parts and/or supplies with current unit prices and source of supply.

6.2 Certified Laboratory Test Data. Certified copies of reports of all tests shall be submitted as required.

6.2.1 Transformer Tests. Transformer test shall be performed in accordance with the ANSI-C57 12.91 for dry-type transformers standard test code and Section 3.13. Certified copies of test data for the tests shall be

submitted and shall receive approval before delivery of equipment to the project site. Field test data sheets shall be submitted within 14 days after test completion.

7. DEMOLITION AND CONSTRUCTION

7.1 Demolition and Construction General Requirements. The vendor shall furnish technical personnel to be present at the site to perform, as a minimum, the following tasks (see Appendix C). Permits for PCB fluid and transformer casing transport shall be obtained by the successful bidder before removal. Note that OSHA regulations require workers handling PCBs to be properly trained and certified.

Request and have the operating Contractor (PWC personnel) de-energize the existing transformers.

Test the existing transformers for no-load loss, record data, and submit in writing to the Resident Engineer.

Drain the PCB fluid from each transformer into approved drums, seal, and deliver it to the interim hazardous waste storage area at the base.

Purge the transformer case with dry nitrogen gas and seal.

Remove and deliver the transformers to the interim hazardous waste storage area at the base as designated by the Resident Engineer.

Provide and install new transformers and test per Section 3.13.2.

Request PWC personnel to energize the system.

Verify proper operation and turn the operating transformer over to EG&G Idaho for remanding to PWC San Diego.

The EG&G Idaho's Resident Engineer shall coordinate all outages and provide interface between the successful bidders, installers, and the operating

Contractor (PWC). PWC Code 640 is responsible for manifesting all PCB (hazardous waste) activity, and PWC shall be contacted through the EG&G Idaho Resident Engineer.

7.2 Draining. Service shall include removal, packaging, and transporting [to a Defense Reutilization and Maintenance Organization (DRMO) hazardous waste staging area] of the PCB or PCB contaminated fluid initially drained from the transformers. DRMO waste shall be clearly labeled with the contents, level of contamination, its source, and manifested by PWC Code 640.

The Subcontractor must review and comply with the minimum Outline Spill Prevention, Control, and Countermeasures (SPCC) Plan procedure before draining fluid from a PCB transformer (see Appendix D). Appendix D details the SPCC requirements that the Subcontractor must observe.

7.3 Transportation and Disposal. All hazardous waste material shall, as a minimum, be contained in Department of Transportation (DOT) approved containers from point of removal until delivered to final disposal site. The following are methods of handling wastes and are subject to the requirements of 40 CFR, Part 263 and 49 CFR, Parts 172 and 173 and shall be superseded if the regulations are amended.

1. Drums shall be DOT approved for hazardous waste: 17E for fluids, 17H for porous solids, and 17H for rags and solvent.
2. Bulk containers shall be six sided, welded steel construction, lined with a minimum of 10 mil plastic sheet, and watertight. The container shall be handled by a truck specially fitted to transport the container from generation point to disposal point.

ES-51334

APPENDIX A
TRANSFORMER DATA SHEETS

TRANSFORMER DATA SHEET

Transformer Identification	<u>(PWC69-OLD) CC69-NEW</u>	*
Location	<u>BLDG 94 OUTDOORS</u>	
Size	<u>750/1000 KVA</u>	**
Primary Voltage	<u>2.4/12 KV DUAL</u>	***
Primary Winding Type	<u>DELTA</u>	
Secondary Voltage	<u>480 V</u>	
Secondary Winding Type	<u>WYE-GROUNDED</u>	
Percent Impedance	<u>5 %</u>	
Primary Switch	<u>NEW 3 POLE 15 KV 600 AF/300 AT FUSED SWITCH</u>	
Primary Connection	<u>PROVIDE TRANSITION CUBICLE TO NEW SWITCH</u>	
Secondary Connections	<u>PROVIDE NEW COPPER BUS CONNECTIONS TO NEW SECONDARY SWITCHGEAR. PROVIDE AND INSTALL NEW SECONDARY SWITCHGEAR PER SKETCHES. (SEE APPENDIX E OF THIS DOCUMENT.)</u>	
Secondary Breaker	<u>PROVIDE AND INSTALL NEW SWITCHGEAR PER ATTACHED SKETCHES</u>	
Maximum No-Load Loss	<u>DETERMINED PER LOSS EVALUATION IN RFP</u>	
Maximum Full-Load Loss	<u>DETERMINED PER LOSS EVALUATION IN RFP</u>	

- * This is a replacement of transformer PWC #69, an existing 500 KVA 3 phase 480 V PCB transformer.
- ** Supply fan to achieve higher rating.
- *** Dual voltage primary winding is an option. Regardless of whether the option is exercised, the 2400 VAC primary must be supplied. If the option is exercised then taps shall be provided for the higher rating (12 KV).

A

TRANSFORMER DATA SHEET

Transformer Identification	<u>(PW070-OLD) CC70-NEW</u> *
Location	<u>BLDG 94</u>
Size	<u>300 KVA</u>
Primary Voltage	<u>480 V</u>
Primary Winding Type	<u>DELTA</u>
Secondary Voltage	<u>208/120 V</u>
Secondary Winding Type	<u>WYE-GROUNDED</u>
Percent Impedance	<u>3.0</u>
Primary Switch	<u>N/A</u>
Primary Connection	<u>NEW FEED FROM NEW SWITCHGEAR (SEE CC69)</u>
Secondary Connections	<u>NEW CABLE AND CONDUIT CONNECTIONS TO EXISTING SWITCHGEAR (2 places)</u>
Secondary Breaker	<u>EXISTING BREAKER PER ATTACHED SKETCH</u>
Maximum No-Load Loss	<u>DETERMINED PER LOSS EVALUATION IN RFP</u>
Maximum Full-Load Loss	<u>DETERMINED PER LOSS EVALUATION IN RFP</u>

* Consolidation replacement of existing PCB transformers (#70 and #71). See sketches SD 1, 2, and 3 for additional information.

REV A
 RECEIVED 2500 V PRIVATE
 DATE: 11/14/00
 BY: [Signature]

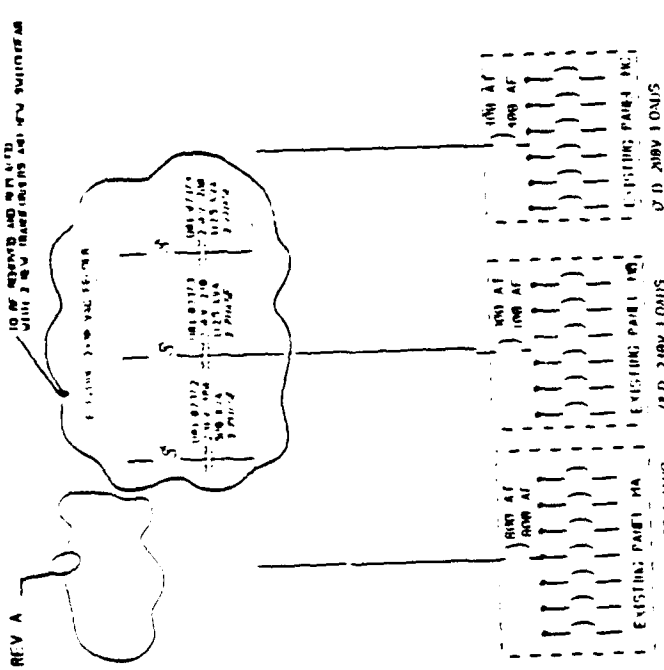
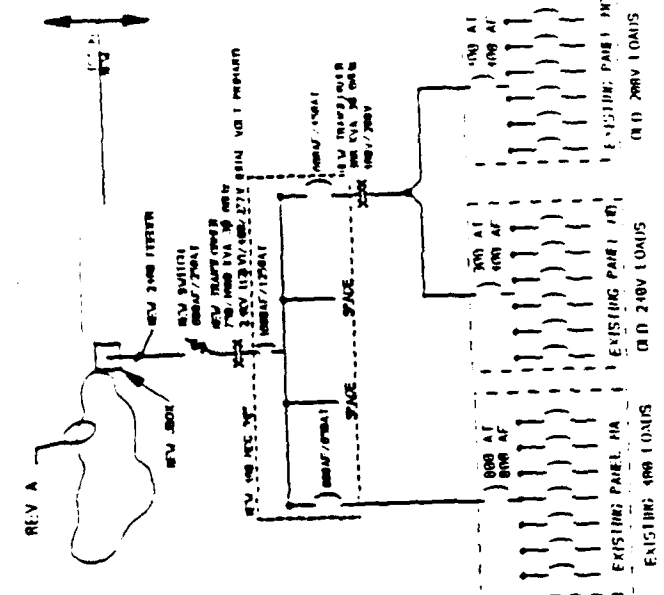

NEW ONE LINE

EXISTING ONE LINE

INFORMATION ONLY

 S&B ENGINEERING LABORATORY
 SAN DIEGO TRAFFIC CENTER
 ADVANCED TELECOM ONLY
 EVALUATION PROJECT
 ONE LINE DIAGRAMS
 BRING 94
 DRAWN BY: S&B
 CHECKED BY: [Signature]
 DATE: 11/14/00
 DESIGNED BY: [Signature]

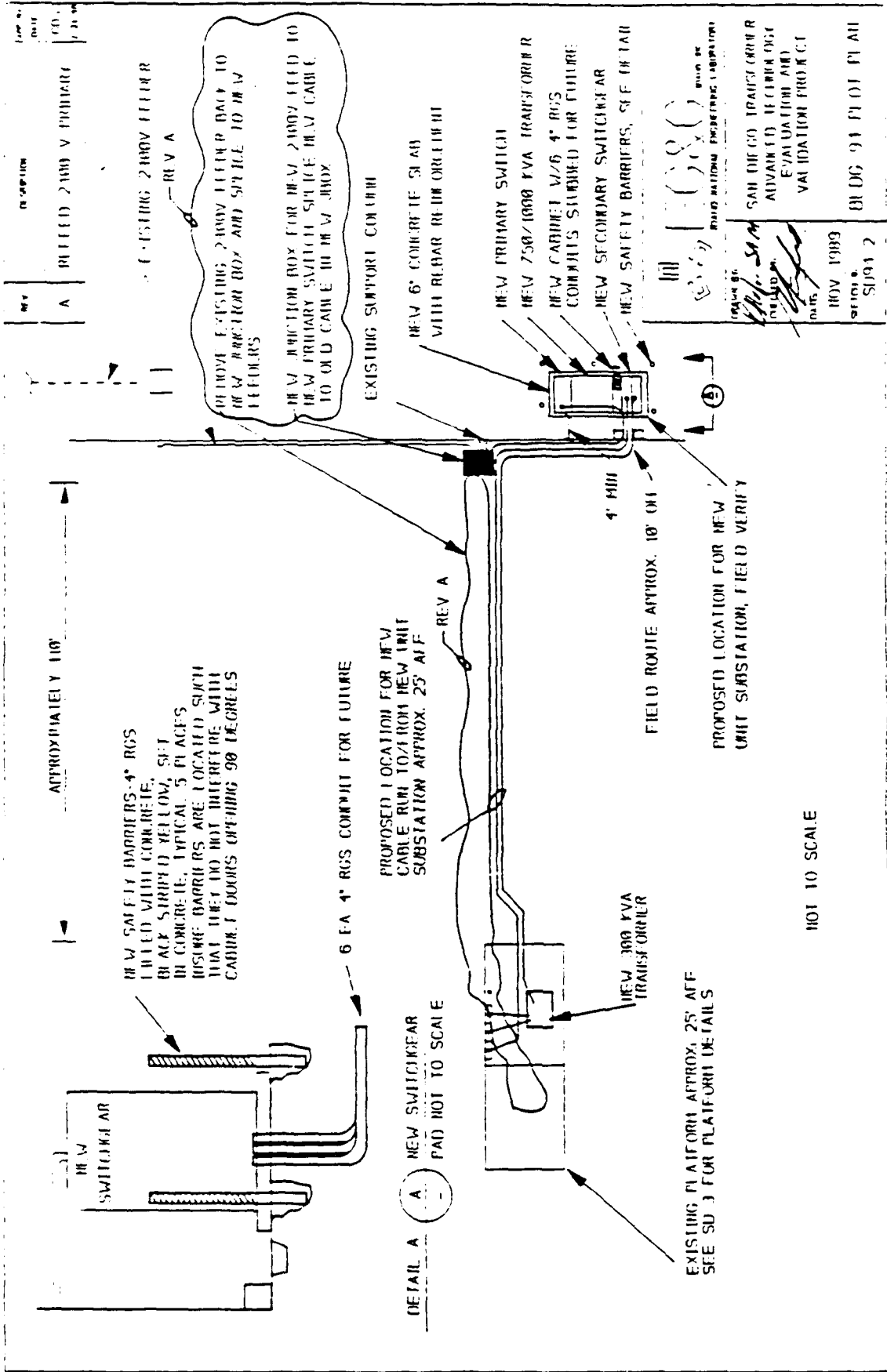

INFORMATION ONLY

REV 1
DATE 11/11/93
BY [Signature]

EXISTING 2400 FEET

THESE SWITCH GEARINGS USED BY TRANSFORMERS THAT WILL BE REINSTALLED WILL BE REINSTALLED WITH A NEW PRIMARY LV-D SWITCH TO BE INSTALLED ON THE MAIN FLOOR

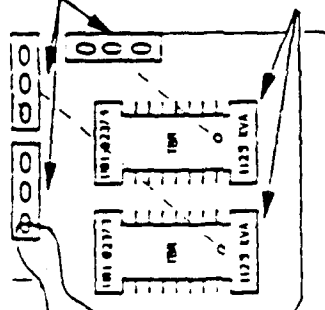

NOTES

- 1) CONFIRM THAT THE PLANTION IS INSTALLED AND THAT PROPER AMT. OF ISLAND SUPPORT MAY BE REQUIRED
- 2) TMR TO BE REMOVED

FOR UNLTD. TRANSFORMERS TO BE INSTALLED REMOVE, AND REWASD WITH THE NEW CONSIDERED SERVICE

EXISTING LAYOUT

PLANTION LOCATED IN THE CENTER OF THE FACILITY APPROXIMATELY 25 FEET ABOVE THE GROUND FLOOR

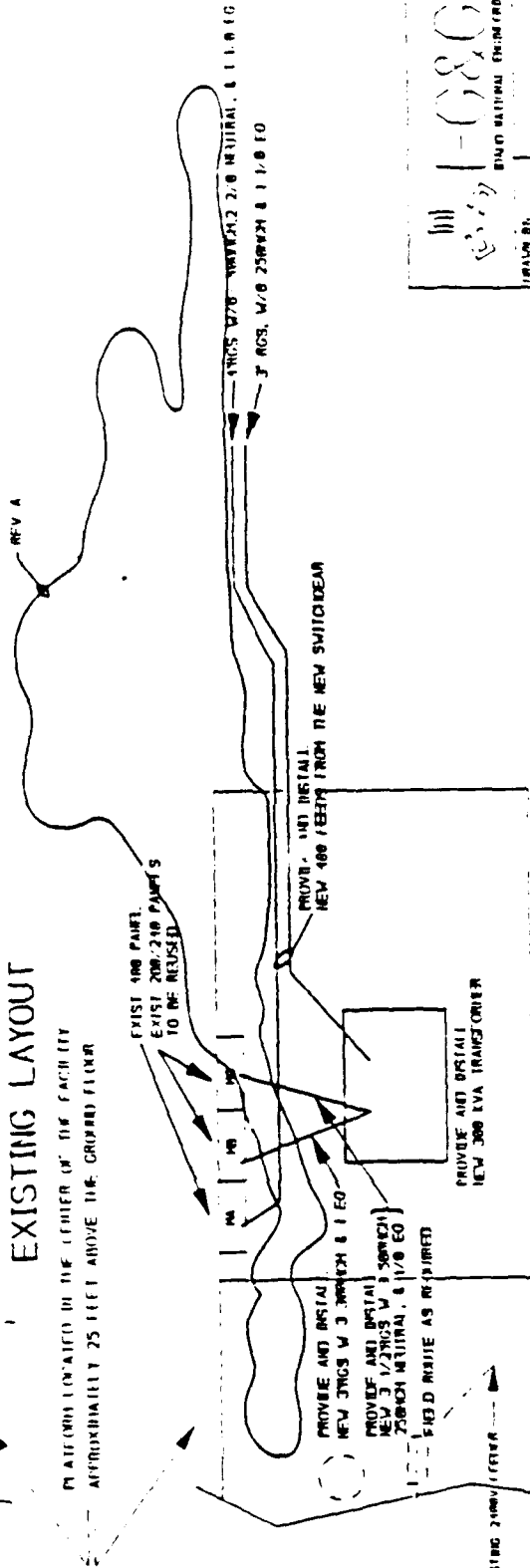

NEW LAYOUT

SAH DIEGO TRANSFORMER ADVANCED TECHNOLOGY EVALUATION PROJECT

VALUATION PROJECT

TRANSFORMER PLANTION IN TAB. IN US 94

11/11/93

11/11/93

INFORMATION ONLY

TRANSFORMER DATA SHEET

Transformer Identification	(PWC16-OLD) CC16-NEW	*
Location	BLDG 342	
Size	112.5 KVA	**
Primary Voltage	2.4/12 KV DUAL	***
Primary Winding Type	DELTA	
Secondary Voltage	480/277 V	
Secondary Winding Type	WYE-GROUNDED	
Percent Impedance	3.0	
Primary Switch	NEW 3 POLE 15KV 50AF FUSED	
Primary Connection	TRANSITION AND CABLE TO NEW SWITCH	
Secondary Connections	REUSE EXISTING --- SPLICE TERMINATION FOR CONNECTIONS TO EXISTING SWITCHGEAR	
Secondary Breaker	REUSE EXISTING BREAKER -NO CHANGES	
Maximum No-Load Loss	DETERMINED PER LOSS EVALUATION IN RFP	
Maximum Full-Load Loss	DETERMINED PER LOSS EVALUATION IN RFP	

* Replacement of existing 112.5 KVA PCB transformer.

** Optionally propose and construct this unit with an amorphous stacked core, as per specification.

*** Dual voltage primary winding is an option. Regardless of whether the option is exercised, the 2400 VAC primary must be supplied. If the option is exercised then taps shall be provided for the higher rating (12 KV).

A

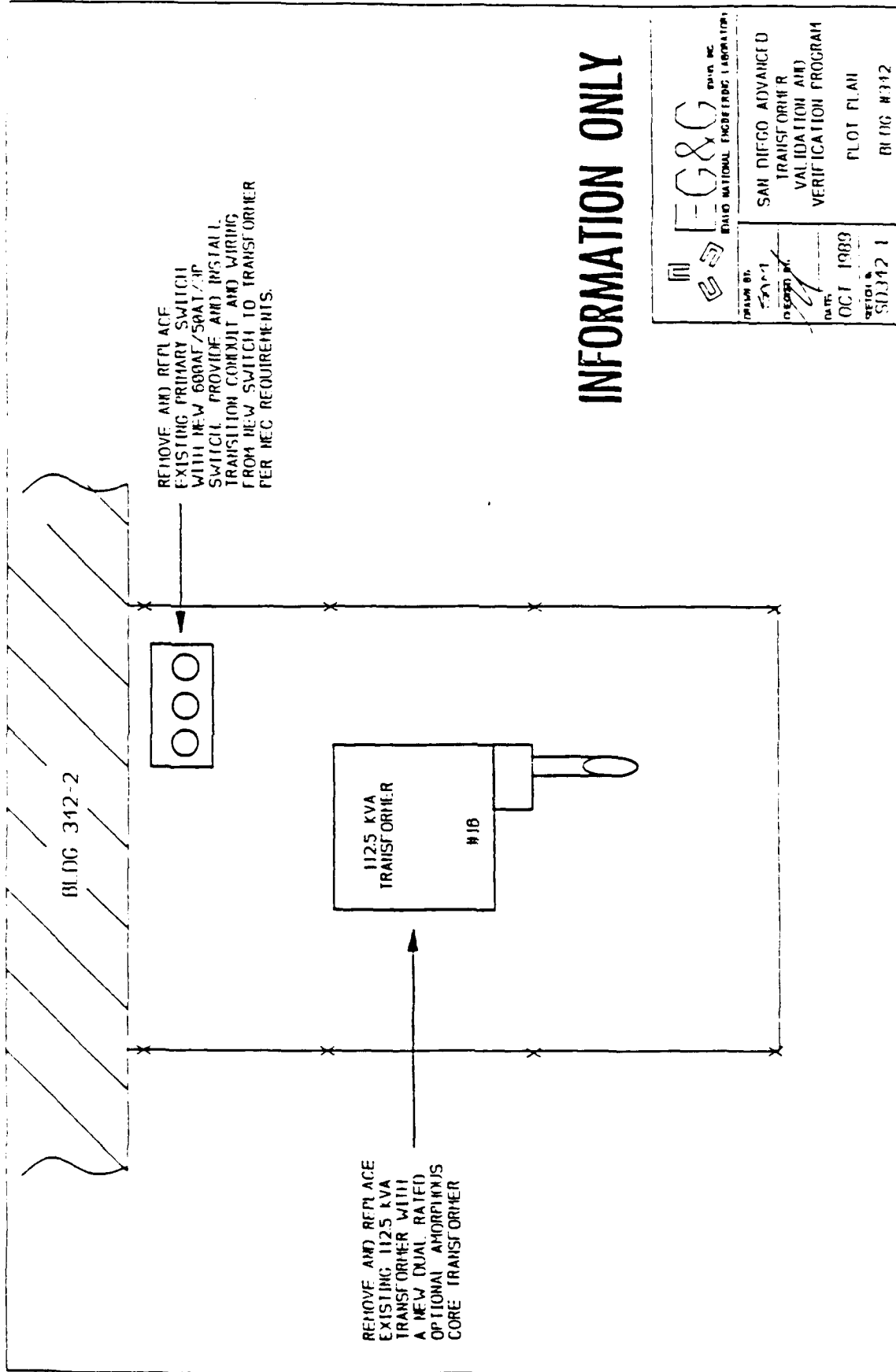

INFORMATION ONLY

EG&G SAFETY GROUP INC.
 ERICO NATIONAL ENGINEERING CORPORATION

SAH DIEGO ADVANCED TRANSFORMER VALIDATION AND VERIFICATION PROGRAM

DATE: OCT 1989
 REVISION: S0342 1

BLDG #312
 PLOT PLAN

TRANSFORMER DATA SHEET

Transformer Identification	<u>(PWC48-OLD) CC48-NEW</u>	*
Location	<u>BLDG 473</u>	
Size	<u>112.5 KVA</u>	
Primary Voltage	<u>2.4 KV</u>	
Primary Winding Type	<u>DELTA</u>	
Secondary Voltage	<u>208/120</u>	
Secondary Winding Type	<u>WYE-GROUNDED</u>	
Percent Impedance	<u>3.0</u>	
Primary Switch	<u>REUSE EXISTING SWITCH</u>	
Primary Connection	<u>NEW TRANSITION TO EXISTING SWITCH</u>	
Secondary Connections	<u>PROVIDE AND INSTALL NEW SECONDARY TRANSITION CUBICLE</u>	
Secondary Breaker	<u>REUSE EXISTING SWITCHGEAR</u>	
Maximum No-Load Loss	<u>DETERMINED PER LOSS EVALUATION IN RFP</u>	
Maximum Full-Load Loss	<u>DETERMINED PER LOSS EVALUATION IN RFP</u>	

* Replacement of existing PCB transformer.

INFORMATION ONLY

 EGG & G ENGINEERING LABORATORY	SAN DIEGO ADVANCED TRANSFORMER VERIFICATION AND VALIDATION PROGRAM
	FLOT PLAN BLDG 473
DRAWN BY: DATE:	OCT 1989
CHECKED BY: DATE:	50473 1

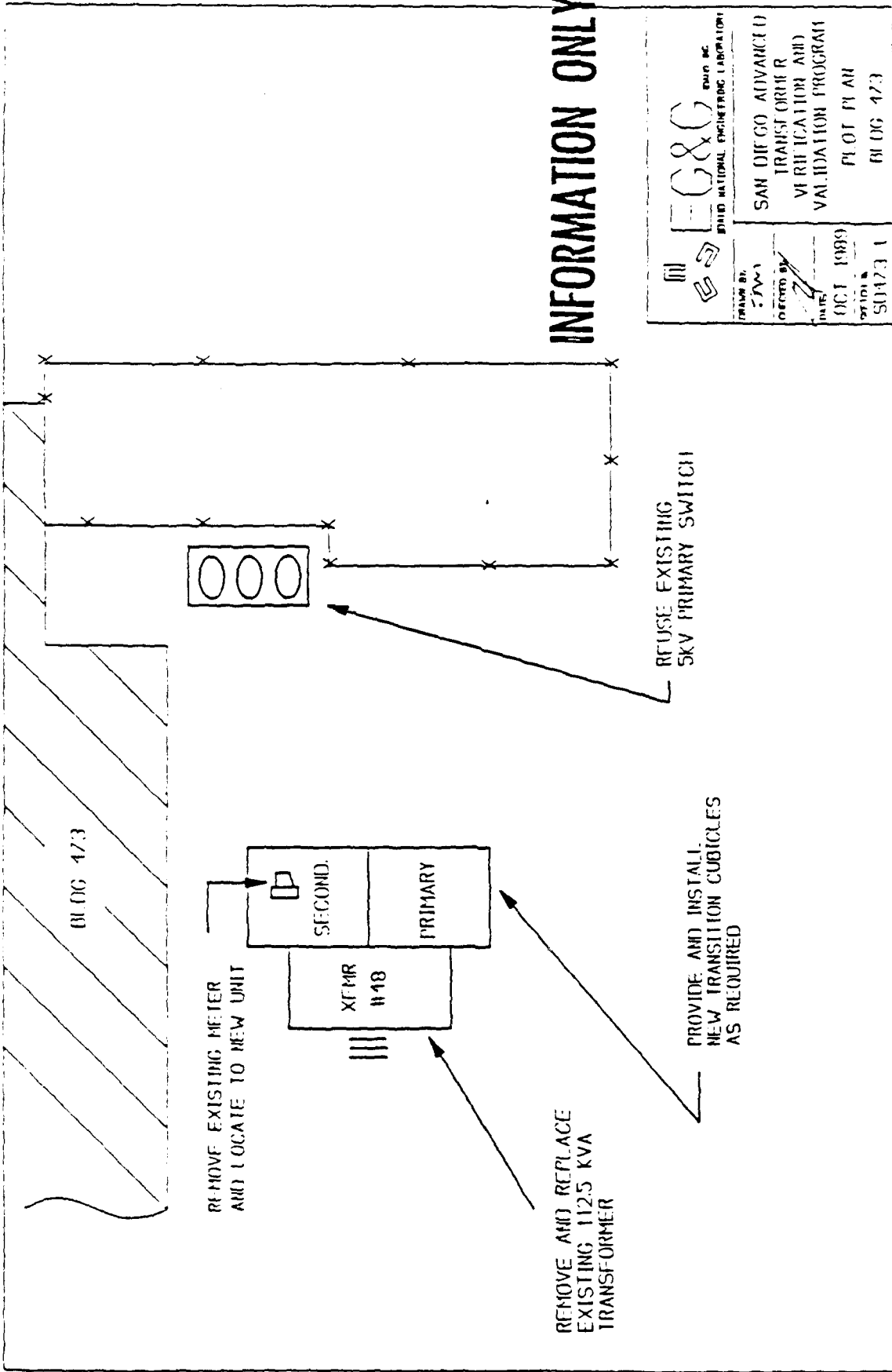

TRANSFORMER DATA SHEET

Transformer Identification	<u>(PWC45-OLD) CC45-NEW</u>	*
Location	<u>BLDG 472 OUTDOORS</u>	**
Size	<u>1500 KVA</u>	
Primary Voltage	<u>12 KV</u>	
Primary Winding Type	<u>DELTA</u>	
Secondary Voltage	<u>480/277 V</u>	
Secondary Winding Type	<u>WYE-GROUNDED</u>	
Percent Impedance	<u>5.75</u>	
Primary Switch	<u>REUSE OF EXISTING SWITCH</u>	***
Primary connection	<u>NEW TRANSITION TO EXISTING SWITCH</u>	
Secondary Connections	<u>COPPER BUS CONNECTIONS TO NEW SWITCHGEAR</u>	
Secondary Breaker	<u>REUSE EXISTING BREAKER AND SWITCH-GEAR</u>	***
Maximum No-Load Loss	<u>DETERMINED PER LOSS EVALUATION IN RFP</u>	
Maximum Full-Load Loss	<u>DETERMINED PER LOSS EVALUATION IN RFP</u>	

- * This will replace existing PCB 1500 KVA transformer.
- ** Use corrosion resistant external packaging, NEMA 3R minimum. Also provide optional cost to include stainless steel rain cap.
- *** Include cost proposal to replace these switches as an option.

6' TALL CONCRETE WALL

EXISTING CONCRETE PAD

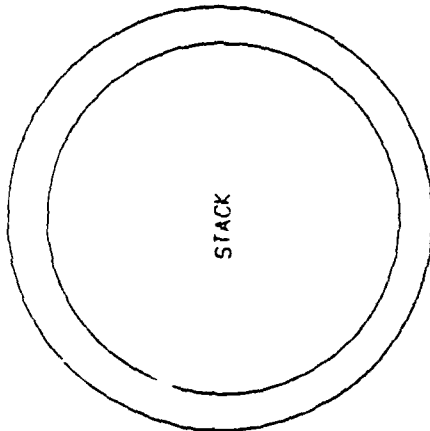

EXISTING SECONDARY SWITCHGEAR TO BE REUSED

REMOVE AND REPLACE EXISTING 1500 KVA XFMR

EXISTING PRIMARY 600 AMP AIR SWITCH TO BE REUSED

3/4" CONDUIT NEEDS TO BE RELOCATED AS REQUIRED

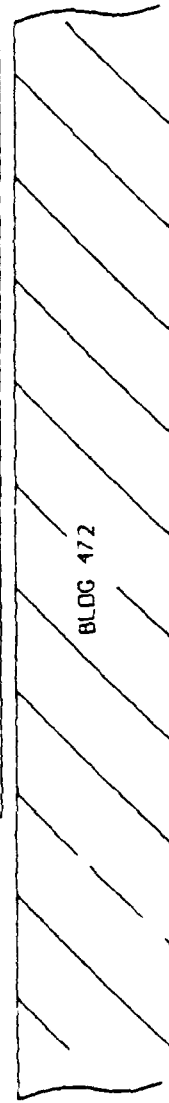
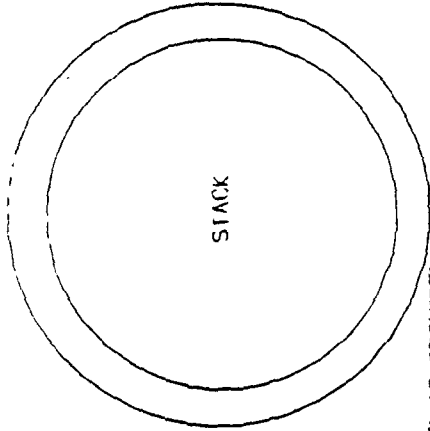

BLOC 472

NOTE: A CRANE WILL BE REQUIRED TO REMOVE THE EXISTING TRANSFORMER AND TO INSTALL THE NEW TRANSFORMER. REPLACEMENT OF PRIMARY AND SECONDARY SWITCHGEAR IS NOT REQUIRED, BUT REPLACEMENT PROPOSALS WILL BE SOLICITED AS OPTIONS IN THIS PACKAGE.

INFORMATION ONLY

 EG&C <small>UNITED NATIONAL ENGINEERING LABORATORY</small>	<small>DATE</small> 3-2-89 <small>BY</small> [Signature] <small>NO.</small> 100V 1989 <small>REV.</small> 50172-1
	SAN DIEGO ADVANCED TRANSFORMER VALIDATION AND VERIFICATION PROGRAM NEW PLOT PLAN BUILDING 472

TRANSFORMER DATA SHEET

Transformer Identification	<u>(PWC26-OLD) CC26-NEW</u> *
Location	<u>BLDG 378-6 OUTDOOR</u>
Size	<u>500 KVA</u>
Primary Voltage	<u>12 KV</u>
Primary Winding Type	<u>DELTA</u>
Secondary Voltage	<u>480/277 V</u>
Secondary Winding Type	<u>WYE-GROUNDED</u>
Percent Impedance	<u>5.75</u>
Primary Switch	<u>REUSE EXISTING AIR INTERRUPTER SWITCH 600 A</u>
Primary Connection	<u>TRANSITION FROM EXISTING SWITCH</u>
Secondary Connections	<u>PROVIDE AND INSTALL NEW CONNECTIONS TO EXISTING SWITCHGEAR EXTEND IF REQUIRED</u>
Secondary Breaker	<u>REUSE EXISTING 800 A SECONDARY BREAKER AND SWITCHGEAR</u>
Maximum No-Load Loss	<u>DETERMINED PER LOSS EVALUATION IN RFP</u>
Maximum Full-Load Loss	<u>DETERMINED PER LOSS EVALUATION IN RFP</u>

* Replacing existing 500 KVA PCB transformer.

No diagram provided.

TRANSFORMER DATA SHEET

Transformer Identification	<u>(PWC27-OLD) CC27A-NEW</u>	*
Location	<u>BLDG 378-1</u>	
Size	<u>750/1000 KVA</u>	**
Primary Voltage	<u>12 KV</u>	
Primary Winding Type	<u>DELTA</u>	
Secondary Voltage	<u>480 V</u>	
Secondary Winding Type	<u>WYE-GROUNDED</u>	
Percent Impedance	<u>5.75</u>	
Primary Switch	<u>PROVIDE AND INSTALL NEW 15 KV CLASS PRIMARY SWITCH AND NEW 12 KV FEEDER</u>	
Primary Connection	<u>TRANSITION TO NEW SWITCH</u>	
Secondary Connections	<u>NEW COPPER BUS CONNECTIONS TO NEW SWITCHGEAR</u>	
Secondary Breaker	<u>P & I NEW SWITCHGEAR, SEE SKETCH BREAKER AND SWITCHGEAR</u>	
Maximum No-Load Loss	<u>DETERMINED PER LOSS EVALUATION IN RFP</u>	
Maximum Full-Load Loss	<u>DETERMINED PER LOSS EVALUATION IN RFP</u>	

- * This unit is replacing an existing 1000 KVA PCB filled transformer.
 ** Supply fans to achieve higher rating.

ES-51334

TRANSFORMER DATA SHEET

Transformer Identification	<u>(PWC27-OLD) CC27B-NEW</u>
Location	<u>BLDG 378-1</u>
Size	<u>500 KVA *</u>
Primary Voltage	<u>480 V</u>
Primary Winding Type	<u>DELTA</u>
Secondary Voltage	<u>208 V</u>
Secondary Winding Type	<u>WYE-GROUNDED</u>
Percent Impedance	<u>5.75</u>
Primary Switch	<u>PROVIDE AND INSTALL NEW SWITCHGEAR SEE SKETCH</u>
Primary Connection	<u>TRANSITION FROM NEW SWITCHGEAR</u>
Secondary Connections	<u>NEW COPPER BUS CONNECTIONS TO EXISTING SWITCHGEAR</u>
Secondary Breaker	<u>REUSE EXISTING SWITCHGEAR</u>
Maximum No-Load Loss	<u>DETERMINED PER LOSS EVALUATION IN RFP</u>
Maximum Full-Load Loss	<u>DETERMINED PER LOSS EVALUATION IN RFP</u>

* No primary voltage taps are required on this transformer due to the high current level. Note requested optional price for addition of standard primary voltage taps on this unit in the pricing schedule.

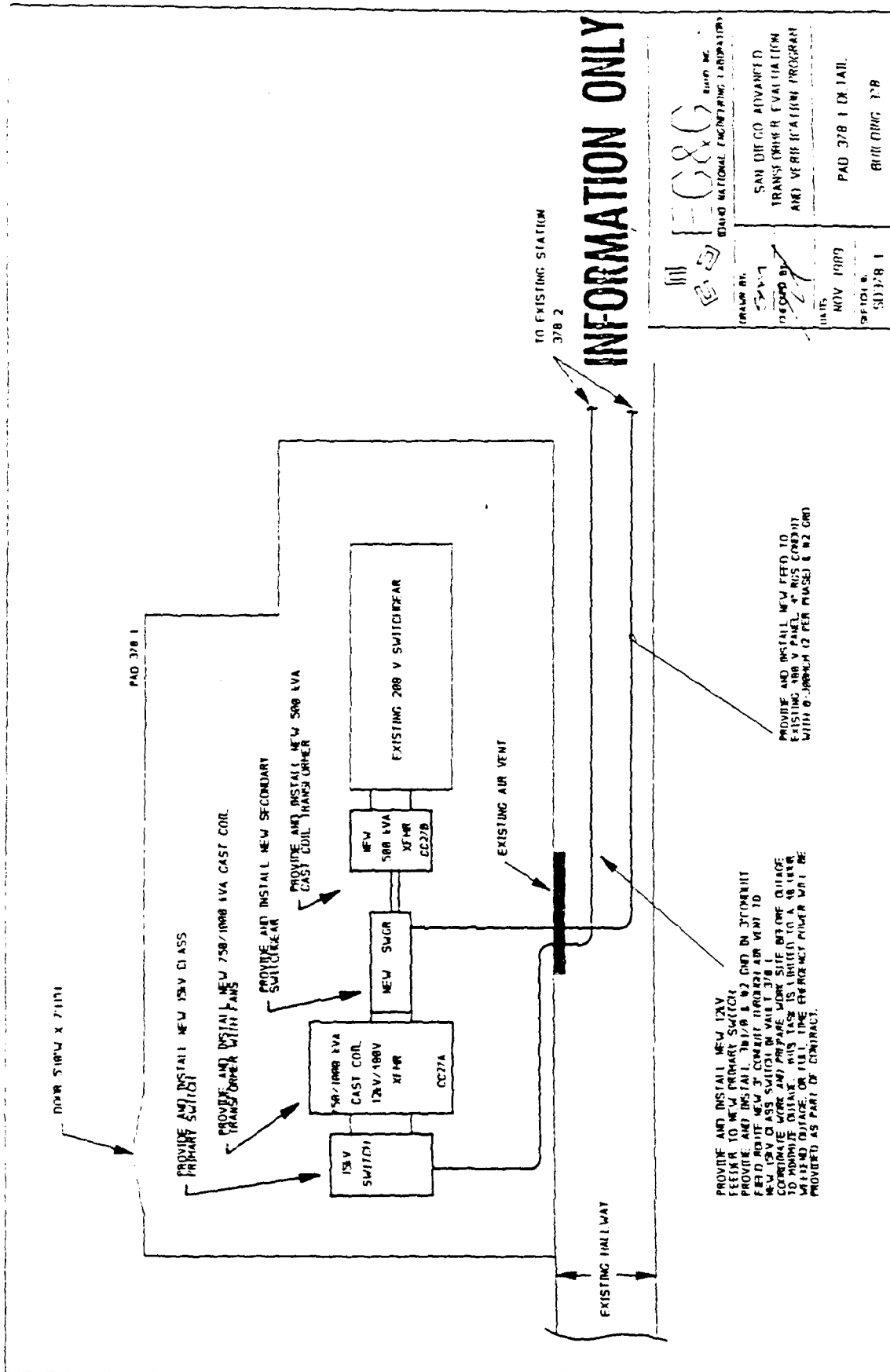

INFORMATION ONLY

	DRAWN BY: DATE: CHECKED BY: DATE:	NOV 1989 SF101 B 50378 1
	E&G BOND NATIONAL ENGINEERING CORPORATION SAN DIEGO ADVANCED TRANSFORMER EVALUATION AND VERIFICATION PROGRAM	PAD 378 1 DR 1A11 BRIC DRWG 7-9

REV 1
NO DATE CHANGE
UP SECTION

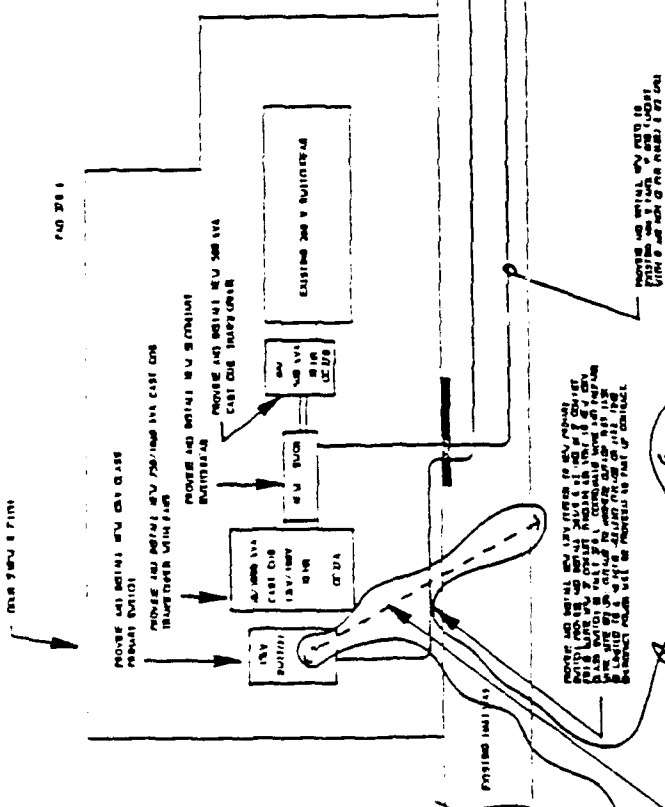
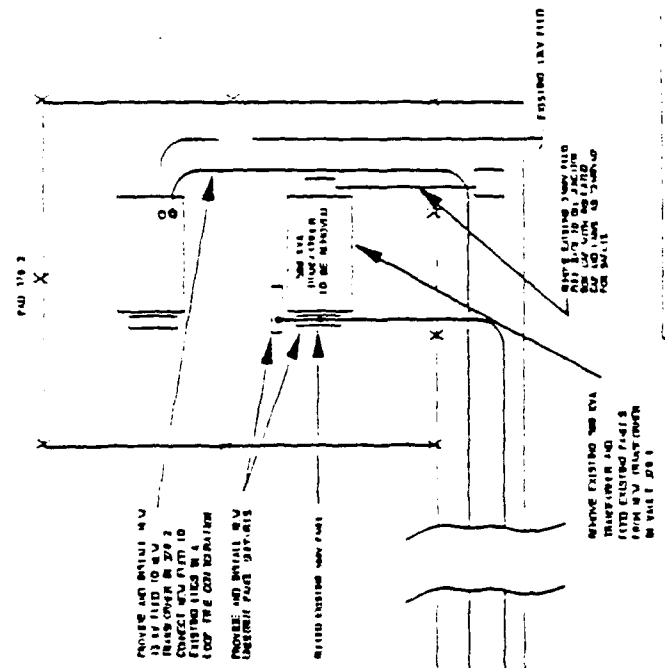

REV 1
NO DATE CHANGE
UP SECTION

REV 1
NO DATE CHANGE
UP SECTION

REV 1
NO DATE CHANGE
UP SECTION

REV 1
NO DATE CHANGE
UP SECTION

INFORMATION ONLY

REV 1
NO DATE CHANGE
UP SECTION

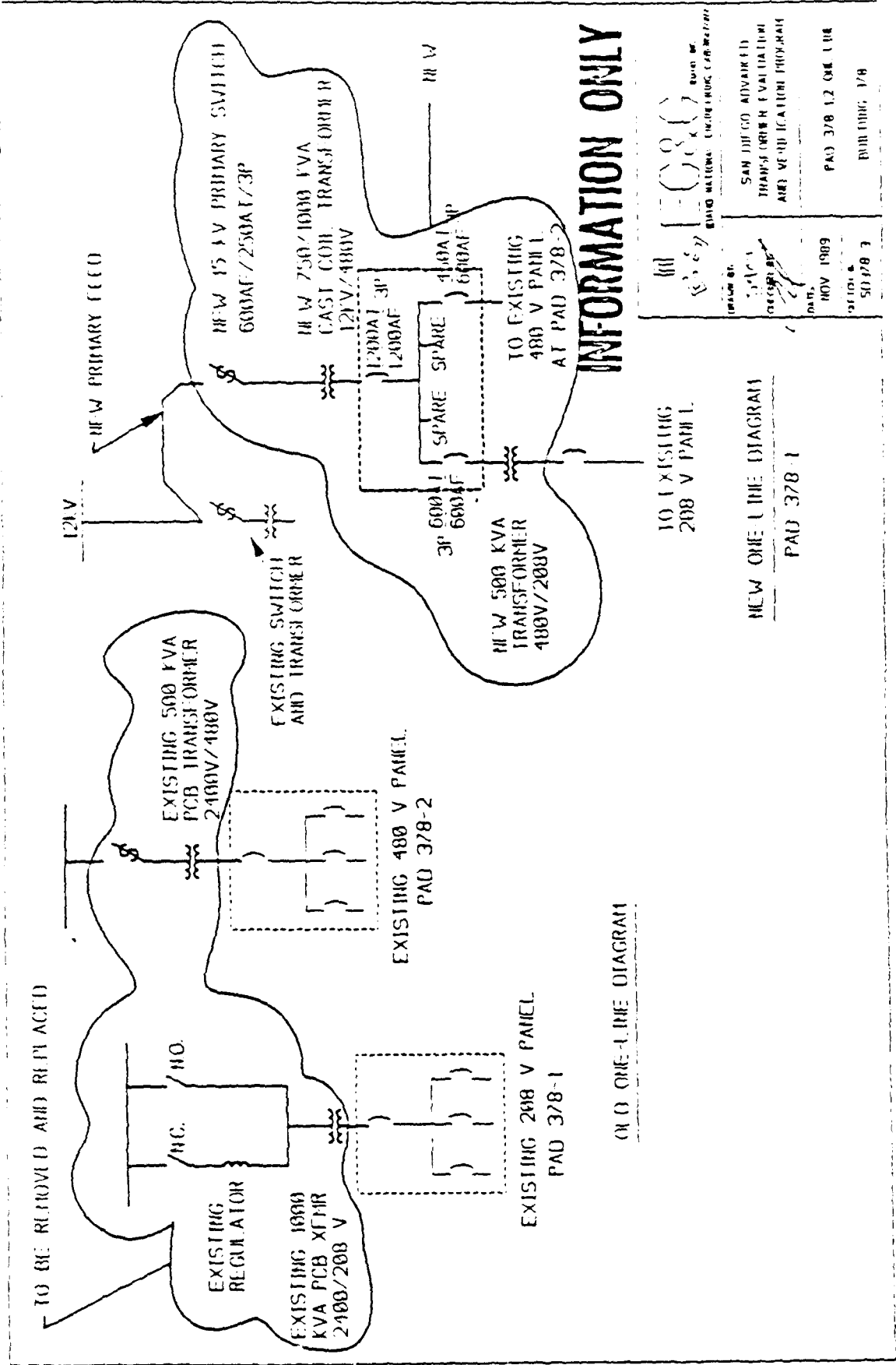

INFORMATION ONLY

SAN DIEGO ADVANCED
 TRAFFIC ORIGIN EVALUATION
 AND VENTILATION PROGRAM
 PAID 378 1.2 ONE LINE
 BUILDING 178

TO EXISTING
 208 V PANEL
 NEW ONE-LINE DIAGRAM
 PAID 378-1

EXISTING ONE-LINE DIAGRAM

TRANSFORMER DATA SHEET

Transformer Identification	<u>(PWC49-OLD) CC49-NEW *</u>
Location	<u>BLDG 489-1</u>
Size	<u>1500 KVA</u>
Primary Voltage	<u>12 KV</u>
Primary Winding Type	<u>DELTA</u>
Secondary Voltage	<u>480/277 V</u>
Secondary Winding Type	<u>WYE-GROUNDED</u>
Percent Impedance	<u>5.75</u>
Primary Switch	<u>REINSTALL EXISTING PRIMARY SWITCH</u>
Primary Connection	<u>CONNECT EXISTING SWITCH</u>
Secondary Connections	<u>NEW COPPER BUS CONNECTIONS TO EXISTING SWITCHGEAR</u>
Secondary Breaker	<u>EXISTING SWITCHGEAR</u>
Maximum No-Load Loss	<u>DETERMINED PER LOSS EVALUATION IN RFP</u>
Maximum Full-Load Loss	<u>DETERMINED PER LOSS EVALUATION IN RFP</u>

- * The existing PCB unit is already missing and will not have to be handled as part of this changeout.

Note: This unit will be installed in an existing station. The installer will have to remove an existing temporary transformer and place it aside for removal by others prior to installing the new transformer. The installer will also have to reinstall the existing primary switch, which was disconnected while the temporary transformer was installed. The existing temporary transformer is a 3750 KVA unit and will require an oversized crane to lift out and set on the ground. This unit is nonPCB and will not require additional handling.

No diagram provided.

TRANSFORMER DATA SHEET

Transformer Identification	<u>(PWC1-220,1,2-OLD) CC1-220-NEW</u>	*
Location	<u>BLDG 379-3</u>	
Size	<u>300 KVA</u>	
Primary Voltage	<u>2.4/12 KV DUAL</u>	**
Primary Winding Type	<u>DELTA</u>	
Secondary Voltage	<u>240 V</u>	
Secondary Winding Type	<u>WYE-GROUNDED</u>	
Percent Impedance	<u>4.5</u>	
Primary Switch	<u>REUSE EXISTING PRIMARY SWITCH</u>	***
Primary Connection	<u>PROVIDE NEW CABLE CONNECTIONS TO EXISTING SWITCH</u>	
Secondary Connections	<u>PROVIDE NEW CONDUIT AND CONDUCTORS TO EXISTING SWITCHGEAR</u>	
Secondary Breaker	<u>REUSE EXISTING SWITCHGEAR</u>	
Maximum No-Load Loss	<u>DETERMINED PER LOSS EVALUATION IN RFP</u>	
Maximum Full-Load Loss	<u>DETERMINED PER LOSS EVALUATION IN RFP</u>	

A

- * This new three phase transformer is replacing three existing 167 KVA single phase PCB transformers.
- ** Dual voltage primary winding is an option. Regardless of whether the option is exercised, the 2400 VAC primary must be supplied. If the option is exercised then taps shall be provided for the higher rating (12 KV).
- *** There are three oil-fused contactors which are feeding the transformer to be removed. It is believed that the three contactors are PCB-contaminated, and they should not be disturbed.

A

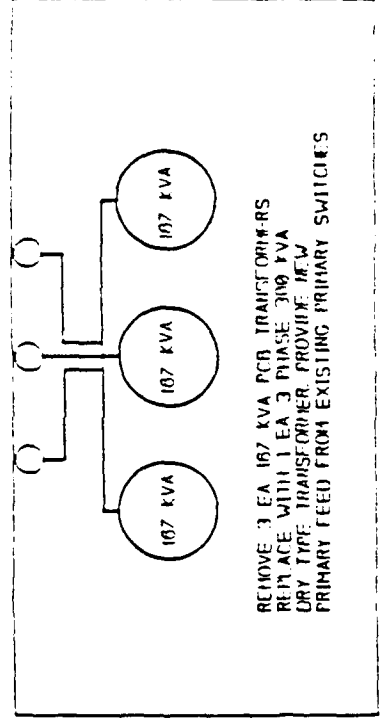
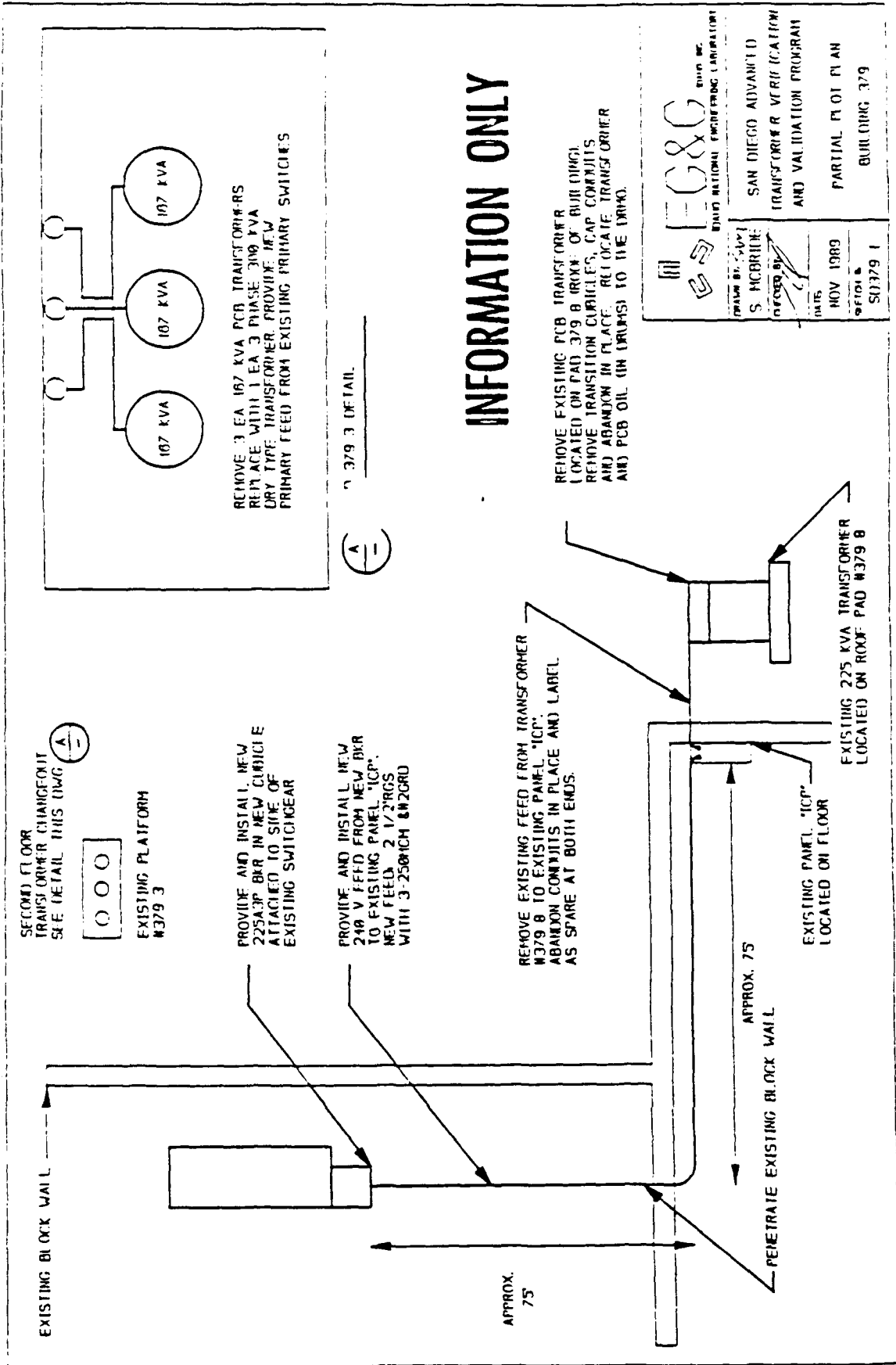

379.3 DETAIL



INFORMATION ONLY

REMOVE EXISTING PCB TRANSFORMER
 LOCATED ON PAD 379.8 (RUMBLE OF BUILDING)
 REMOVE TRANSITION CIRCUITS, CAP CIRCUITS
 AND ABANDON IN PLACE. RELOCATE TRANSFORMER
 AND PCB OIL (IN DRUMS) TO THE DRUM.

 DAVID NELSON ENGINEERING CORPORATION	DRAWN BY: S. HOBRIE	DATE: NOV 1989	PROJECT: PARTIAL FLOOR PLAN BUILDING 379
	CHECKED BY:	DATE:	SHEET: S17379.1

SECOND FLOOR
 TRANSFORMER CHANGEOUT
 SEE DETAIL THIS DWG



EXISTING PLATFORM
 #379.3

PROVIDE AND INSTALL NEW
 225A:3P BRK IN NEW CIRCUIT
 ATTACHED TO SIDE OF
 EXISTING SWITCHGEAR

PROVIDE AND INSTALL NEW
 240 V FEED FROM NEW BRK
 TO EXISTING PANEL "ICP".
 NEW FEED 2 1/2" RGS
 WITH 3-250NCH & W20RD

REMOVE EXISTING FEED FROM TRANSFORMER
 #379.8 TO EXISTING PANEL "ICP".
 ABANDON CIRCUITS IN PLACE AND LABEL
 AS SPARE AT BOTH ENDS.

APPROX. 75

APPROX. 75

EXISTING PANEL "ICP"
 LOCATED ON FLOOR

EXISTING 225 KVA TRANSFORMER
 LOCATED ON ROOF PAD #379.8

ES-51334

TRANSFORMER DATA SHEET

Transformer Identification	<u>(PWC1-158-OLD) CC1-158-NEW</u>	*
Location	<u>BLDG 333-1</u>	**
Size	<u>112.5 KVA</u>	
Primary Voltage	<u>480 V</u>	
Primary Winding Type	<u>DELTA</u>	
Secondary Voltage	<u>208/120 V</u>	
Secondary Winding Type	<u>WYE-GROUNDED</u>	
Percent Impedance	<u>4.5</u>	
Primary Switch	<u>PROVIDE AND INSTALL NEW 480 V BREAKER IN NEW SWITCHGEAR. SEE SKETCHES</u>	
Primary Connection	<u>SEE SKETCHES</u>	
Secondary Connections	<u>TRANSITION TO EXISTING PANEL</u>	
Secondary Breaker	<u>REUSE EXISTING</u>	
Maximum No-Load Loss	<u>DETERMINED PER LOSS EVALUATION IN RFP</u>	
Maximum Full-Load Loss	<u>DETERMINED PER LOSS EVALUATION IN RFP</u>	

- * This unit replaces the existing 112.5 KVA PCB transformer.
- ** This transformer will be installed on a mezzanine located approximately 30 feet AAF. Extra rigging and PCB handling efforts will be required.

TRANSFORMER DATA SHEET

Transformer Identification	<u>(PWC1-157-OLD) CC1-157-NEW</u>	*
Location	<u>BLDG 333-1</u>	**
Size	<u>112.5 KVA</u>	
Primary Voltage	<u>480 V</u>	
Primary Winding Type	<u>DELTA</u>	
Secondary Voltage	<u>240 V</u>	
Secondary Winding Type	<u>WYE</u>	
Percent Impedance	<u>4.5</u>	
Primary Switch	<u>PROVIDE AND INSTALL NEW 480 V BREAKER IN NEW SWITCHGEAR. SEE SKETCHES.</u>	
Primary Connection	<u>SEE SKETCHES</u>	
Secondary Connections	<u>TRANSITION TO EXISTING PANEL</u>	
Secondary Breaker	<u>REUSE EXISTING BREAKER</u>	
Maximum No-Load Loss	<u>DETERMINED PER LOSS EVALUATION IN RFP</u>	
Maximum Full-Load Loss	<u>DETERMINED PER LOSS EVALUATION IN RFP</u>	

* This unit is replacing the existing 112.5 KVA PCB transformer.

** This transformer will be installed on a mezzanine located approximately 30 feet AFF. Extra rigging and PCB handling efforts will be required.

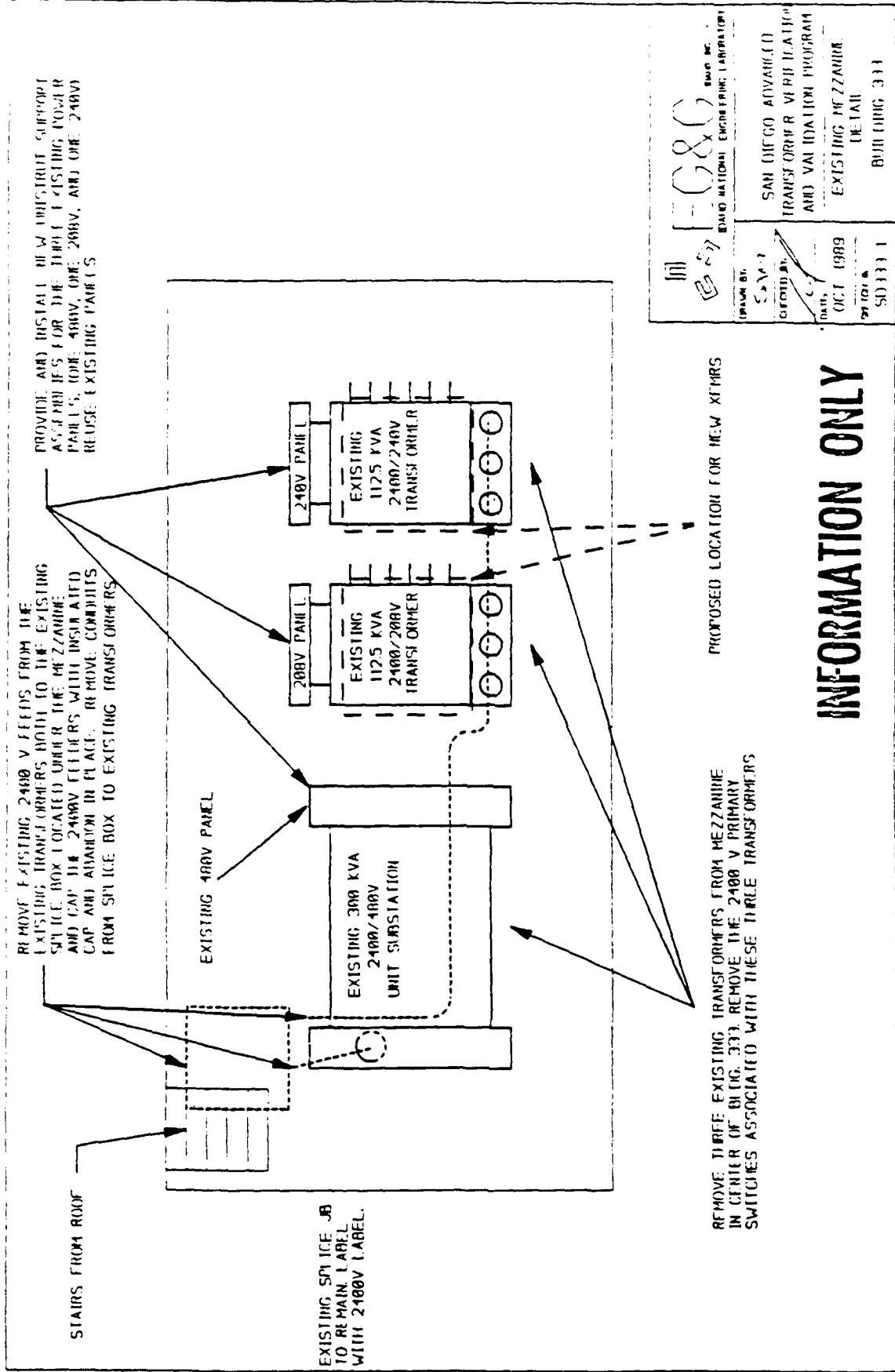

 E.C. & S.
 DAVID NATIONAL ENGINEERING LABORATORY
 SAN DIEGO ADVANCED
 TRANSFORMER VERIFICATION
 AND VALIDATION PROGRAM
 EXISTING MEZZANINE
 DETAIL
 BUILDING 333
 DATE: OCT 1989
 DRAWN BY: [Signature]
 CHECKED BY: [Signature]

INFORMATION ONLY

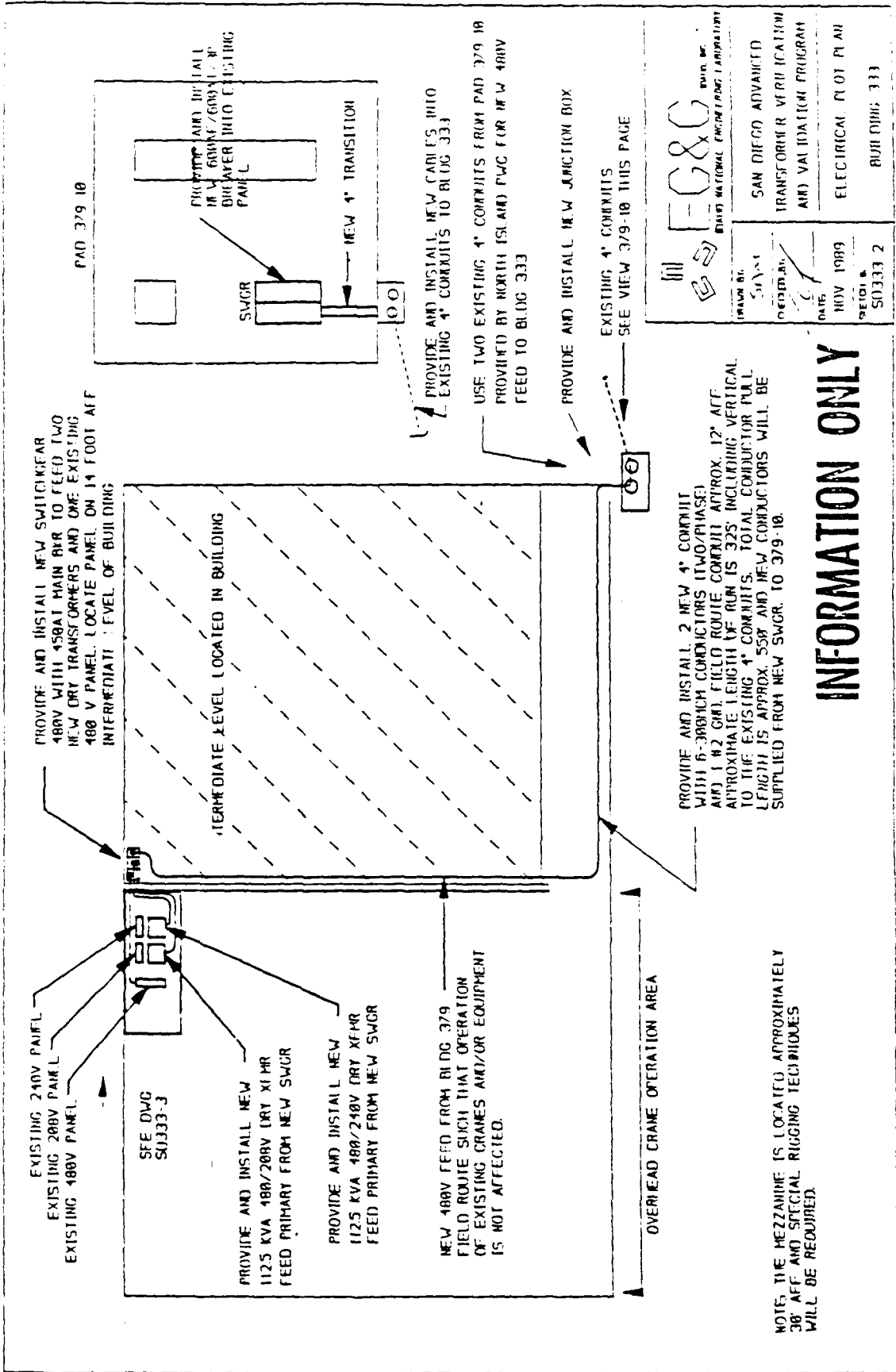

EG&G
ELECTRICAL ENGINEERING LABORATORY

DATE: NOV 1989
PROJECT: 50333 2

SAN DIEGO ADVANCED TRANSFORMER VERIFICATION AND VALIDATION PROGRAM

ELECTRICAL FLOOR PLAN
BUILDING 333

INFORMATION ONLY

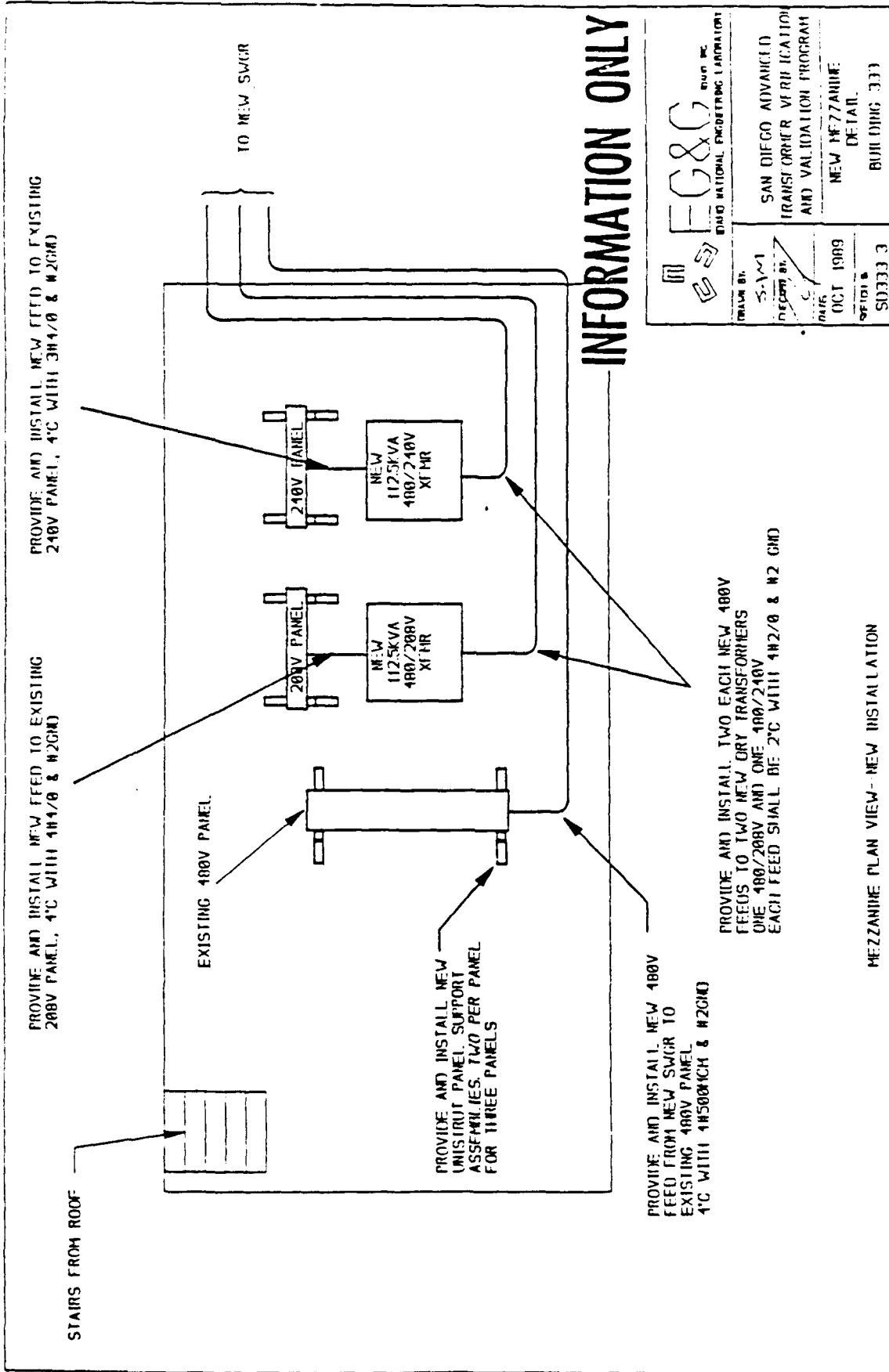

PROVIDE AND INSTALL NEW FEED TO EXISTING 240V PANEL, 4" WITH 3#4/0 & #2GND

PROVIDE AND INSTALL NEW FEED TO EXISTING 200V PANEL, 4" WITH 1#4/0 & #2GND

EXISTING 480V PANEL.

PROVIDE AND INSTALL NEW UNISUIT PANEL SUPPORT ASSEMBLIES, TWO PER PANEL FOR THREE PANELS

PROVIDE AND INSTALL NEW 480V FEED FROM NEW SWGR TO EXISTING 480V PANEL 4" WITH 1#500KCH & #2GND

PROVIDE AND INSTALL TWO EACH NEW 480V FEEDS TO TWO NEW DRY TRANSFORMERS ONE 480/208V AND ONE 480/240V EACH FEED SHALL BE 2" WITH 1#2/0 & #2 GND

TO NEW SWGR

INFORMATION ONLY

 EGG ENGR INC. CIVIL NATIONAL ENGINEERING LABORATORY	
DRAWN BY: S.M.V.	SAN DIEGO ADVANCED TRANSFORMER VERIFICATION AND VALIDATION PROGRAM
CHECKED BY: C.	NEW MEZZANINE DETAIL
DATE: OCT 1989	BUILDING 333
SHEET NO: S0333 3	

MEZZANINE PLAN VIEW--NEW INSTALLATION

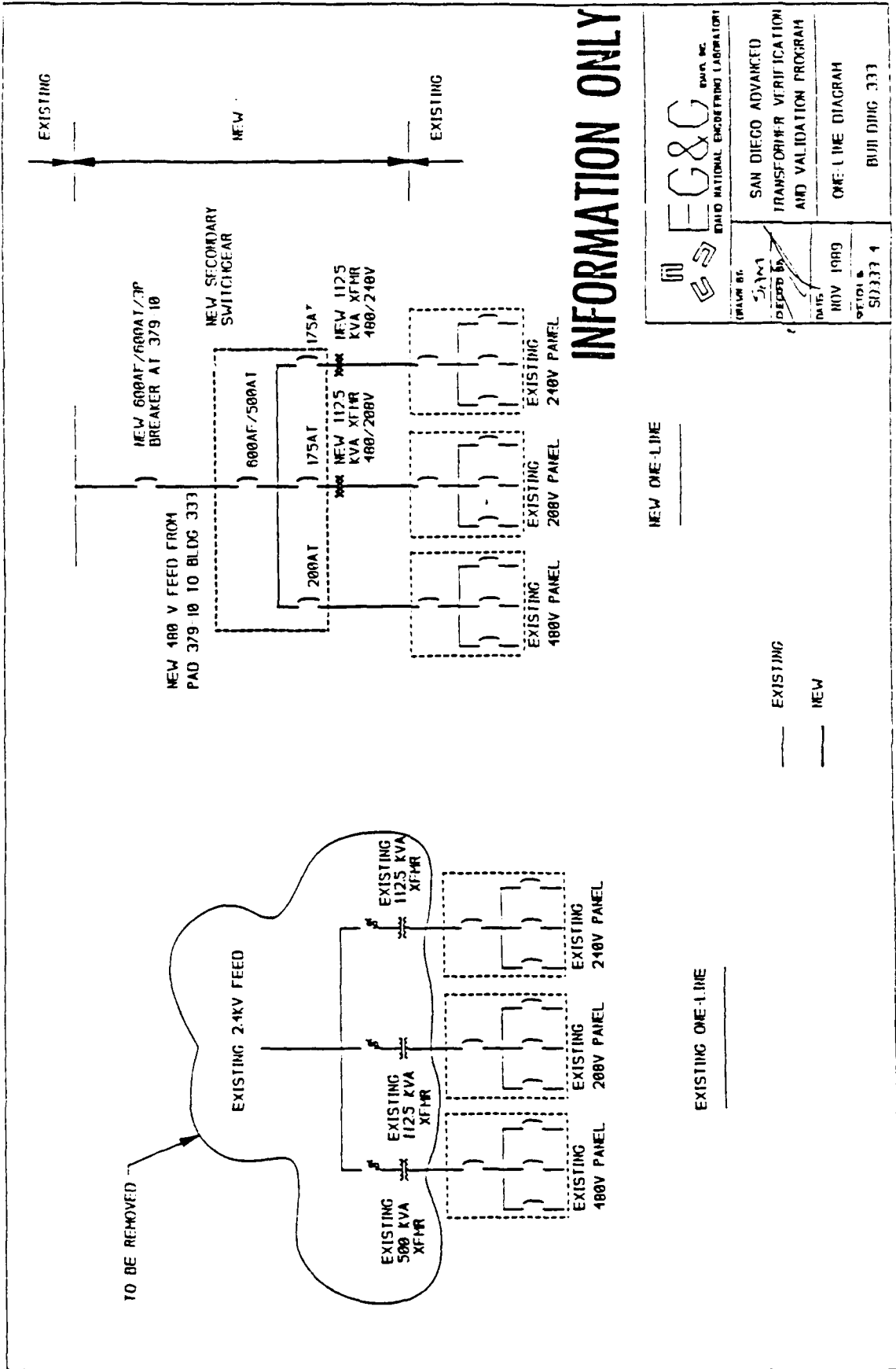

INFORMATION ONLY

EG&C ENR, INC.
 EDWARD NATIONAL ENGINEERING LABORATORY

SAN DIEGO ADVANCED
 TRANSFORMER VERIFICATION
 AND VALIDATION PROGRAM

ONE-LINE DIAGRAM
 BUILDING 333

DATE: NOV 1989
 PROJECT: 50333 4

NEW ONE-LINE

EXISTING ONE-LINE

— EXISTING
 - - - NEW

ES-51334

APPENDIX B

VENDOR DATA REQUIREMENT LIST

APPENDIX B					
VENDOR DATA REQUIREMENTS LIST					
Description	* When Required	Copies Required	No. of Reference Paragraph	** Approval Req'd. by	
1. Drawings, sketches, schematics and other data shall be submitted with the bid sufficient for evaluation of contract proposal.	BC	12	NA	R	AB/DE
2. Quality Manual and Procedures	BC	12	4.0	R	AB/DE
3. Inspection and Test Procedures	BFR	12	3.2, 3.10	I	AB/DE
4. Inspection and Test Results	PS	12	3.10	R	AB/DE
5. Maintenance manual which includes as a minimum: installation instructions, operating instructions, preventive and corrective maintenance tasks, the frequency of each task, the tools, equipment, and procedures with special emphasis on safety precautions for the accomplishments of each task.	PS	12	5.0	I	AB/DE
6. Priced spare parts list and recommended spares.	PS	12	5.0	I	AB/D
7. Guaranteed performance data and name plate data.	PS	12	5.0	I	AB/DE
8. As-built shop drawings schematics and wiring diagram.	PS	12	5.0	R	AB/DE
9. Installation schedule.	PS	12	5.0		AB/DE
10. PCB fluid disposal plan and certification.	PS	12	5.0		AB/DE
11. Spill Prevention, Control, and Countermeasures Plan	BFR	12	NA	R	AB/DE
12. Certification for Hazardous Waste Handlers	PS	12	NA	R	AB/DE

- * BFR = Before Fabrication Release * BC = Before contract is awarded
 * PS = Prior to Shipment ** R = Required
 ** I = Information Only ** AB = Approval By Buyer
 ** DE = Approval By Design Engineer

ES-51334

APPENDIX C

CONSTRUCTION DETAILS

CONSTRUCTION DETAILS

ELECTRICAL GENERAL PROVISIONS

PART 1 - GENERAL

DESCRIPTION OF WORK:

Summary: The electrical work can be generally summarized in the following manner, but this is not by way of limitation:

- Obtain permits for moving hazardous waste.
- Check and mark phase rotation before de-energizing system.
- Have PWC personnel de-energize the existing transformers.
- Test existing transformer for no-load losses. Drain the PCB fluid from each transformer into standard DOT approved drums and deliver it to the interim hazardous waste storage area on the base as designated by the Resident Engineer (all work shall comply with OSHA and EPA regulations).
- Purge the transformer case with dry nitrogen and seal.
- Deliver the existing transformer to the interim hazardous waste storage area on the base (comply with OSHA and EPA regulations).
- Provide and install new transformers.
- Connect new transformers and test.
- Request PWC personnel to energize the system.
- Verify proper operations and turn the operating transformer over to EG&G Idaho, Inc. for remanding to PWC San Diego.

PART 2 - MISCELLANEOUS AND ANCILLARY PRODUCTS

GENERAL:

Furnish all labor, materials, equipment, and appliances required to complete the installation of the complete electrical systems. All labor, materials, service, equipment, and workmanship shall conform to the applicable chapters of the NEC (NFPA 70) and other authorities having lawful jurisdiction pertaining to the work required. All modifications required by these codes, rules, regulations, and authorities shall be made by the Subcontractor without additional charge to the Contractor.

Underwriter's Laboratories (UL): All materials, appliances, equipment, or devices shall conform to the applicable standards of UL where such standards exist. All material, appliances, equipment, or devices shall be listed and/or labeled by UL where such standards exist.

Completed electrical system shall conform with applicable provisions of the Special Conditions, the Technical Specification, and the attached subcontract drawings.

CONDITION OF PRODUCTS:

Except as otherwise indicated, provide new electrical products, free of defects and harmful deterioration at the time of installation. Provide each product complete with trim, accessories, finish guards, safety devices, and similar components specified or recognized as integral parts of the product, or required by governing regulations.

UNIFORMITY:

Where multiple units of a product are required for the electrical work, provide identical products by the same manufacturer without variations except for sizes and similar variations as indicated.

PART 3 - EXECUTION:

COORDINATION OF ELECTRICAL WORK:

General: It is recognized that the subcontract documents are diagrammatic in showing certain physical relationships that must be established within the electrical work and in its interface with other work, including utilities and mechanical work, and that such establishment is the exclusive responsibility of the Subcontractor.

Arrange electrical work in a neat, well-organized manner with conduit and similar services running parallel with the primary lines of the building construction and with a minimum of 7 feet overhead clearance where possible.

Locate operating and control equipment properly to provide easy access and arrange entire electrical work with adequate access for operation and maintenance.

RESIDENT ENGINEER:

The EG&G Idaho Resident Engineer will ensure that the installation complies with drawings, specifications, and witness testing.

TRANSFORMERS

PART 1 - GENERAL

WORK DESCRIPTION:

Provide and install transformers of sizes, ratings, and types as shown on the referenced data sheets and engineering specification.

PART 2 - PRODUCTS

MATERIALS:

The transformers shall be as shown on the attached data sheets and shall be installed at the location indicated on the drawings.

The transformer enclosure shall be suitable for the environment that the transformer is installed in.

PART 3 - EXECUTION

INSTALLATION:

Install transformers as indicated on the drawings and in accordance with manufacturer's written instructions, applicable requirements of NEC and the NEC Association's "Standard of Installation," and complying with recognized industry practices to ensure that products serve intended functions.

TESTING:

Visually inspect to determine that equipment installation conforms to NEC, these specifications, and the drawings and testing as described under the testing section of the specification.

GROUNDING

PART 1 - GENERAL

WORK DESCRIPTION:

Provide and install grounding on all transformer cases and tie into the existing grounding system.

PART 2 - PRODUCTS

MATERIALS:

Grounding electrode wire shall be a minimum of No. 2 AWG bare stranded copper and comply with NEC Table 250-94.

Ground grid welds shall be made by the Thermit process.

PART 3 - EXECUTION

INSTALLATION:

Install a complete grounding system for the transformers in accordance with applicable requirements of NEC and complying with recognized industry practices to ensure that products serve intended functions and comply with requirements. All exposed noncurrent-carrying metallic parts of electrical equipment, conduits, grounding conductor of nonmetallic sheathed cables, and neutral conductor of the wiring system shall be grounded.

Exothermic Welds: Exothermic welds shall be made in accordance with the manufacturer's written recommendations. No mechanical connector is required at exothermic weldments.

TESTING:

Visually inspect to determine that ground installation conforms to NEC, these specifications, and the drawings.

CABLE, WIRE, CONNECTORS AND MISCELLANEOUS DEVICES

PART 1 - GENERAL

WORK DESCRIPTION:

Provide and install conduit systems, cables, wires, and wiring connectors of sizes, ratings, materials, and types as shown on the drawings.

PART 2 - PRODUCTS

WIRING MATERIALS 5 KV AND 15 KV CLASS:

All 5 KV and 15 KV cable shall be shielded and properly terminated. Cable shall be EPR MV-90 shielded cable and shall have a 133% insulation level.

HIGH VOLTAGE SPLICES:

Splices in high voltage cables. Splices shall be suitable for continuous immersion in water and shall be made only in accessible locations in manholes.

Certification. High voltage cable splicer/terminator certification of competency and experience shall be submitted 30 days before splices or terminations are made in high voltage cables. Splicer/terminator experience during the past 3 years shall include performance in splicing and terminating all cables of the type and classification being provided under this contract.

Kit Methods. High voltage splices shall be made using a "kit," which shall be the product of one manufacturer and shall have the approval in writing of the manufacturer of the cable that is to be spliced. The Contractor shall provide for continuous submersion in water.

Heat-Shrink Method. All splices for 600 volt and less cables shall be done by the heat-shrink method. Provide heavy-wall heat-shrinkable splice tubing rated for sealed underground connector systems. Tubing shall be available uncoated, or with a thermoplastic adhesive-sealant that adheres to PVC, neoprene, polyolefin, and EPR aluminum or steel.

Splices in High Voltage Cables. Splices shall be suitable for continuous immersion in water and shall be made only in accessible locations in manholes.

Certification. High voltage cable splicer/terminator certification of competency and experience shall be submitted 30 days before splices or terminations are made in high voltage cables. Splicer/terminator experience during the past 3 years shall include performance in splicing and terminating cables of the type and classification being provided under this contract.

Kit Methods. High voltage splices shall be made using a "kit," which shall be the product of one manufacturer and shall have the approval in writing of the manufacturer of the cable that is to spliced. The contractor shall provide the Contracting Officer or Contractor's Quality Control representative with a copy of the manufacturer's instructions before splicing is started. Splices shall be made only in manholes.

Splices in Shielded Cables. Splices in shielded cables shall include covering the spliced area with metallic tape, or like material, to the original cable shield and connecting it to the cable on each side of the splice. Provide a No. 6 AWG bare copper ground connection brought out in a water tight manner and ground to a 3/4 inch x 10 feet ground rod as part of the splice installation. Wire shall be trained to the sides of the enclosure in a manner to avoid interference with the working area.

Phasing and Rotation. Contractor to record the phasing and rotation of the existing electrical system before cable splicing, cable removal, termination, and/or any work that could alter the phasing and rotation of the system. After completion of the work and before connecting any load to the system, the contractor shall verify that the phasing and rotation is as it existed and has not been altered.

WIRING MATERIALS, 600 V CLASS:

Conductors shall be stranded for all sizes of wire and cable.

Conductors shall be copper for all sizes.

Wire insulation shall be type THHN/THWN for all 600 volt conductors unless otherwise noted.

Minimum size of power conductors shall be No. 12.

Splices for 600 Volt Cables. Splices in underground systems shall be made only in accessible locations, such as manholes and handholes, using a compression connector of the conductor and by insulating and water proofing by a method suitable for continuous submersion in water.

Heat-Shrink Method. All splices for 600 volt and less cable shall be done by the heat-shrink method. Provide heavy-wall heat-shrinkable splice tubing rated for sealed underground connector systems. Tubing shall be available uncoated, or with a thermoplastic adhesive-sealant that adheres to PVC, neoprene, polyolefin, and EPR aluminum or steel.

CONNECTORS:

Compression and/or lug type connectors, such as "Burndy", shall be used for splicing No. 6, and larger 600 volt cable.

High Voltage Cable Terminations. IEEE 48, Class 2. Except as otherwise indicated, terminators for extruded insulation nonmetallic jacketed cables shall be porcelain insulator type. Apply terminator to single conductor cables or to each conductor of multiple conductor cable that are to the weather. Terminator shall not exude any filler compound under either test or service. The terminator shall consist of a porcelain insulator, cable connector-hoodnut assemble, and aerial lug, as required, metal body and supporting bracket, sealed cable entrance, and internal stress relief device for shielded cable, and insulating filler compound or material.

Terminator, Modular, Molded Rubber Type. IEEE 48, Class 2. Provide terminator as specified herein for terminating single conductor, or the single conductor of multiconductors, solid insulated, nonmetallic jacketed type cables for service voltage up to 35 KV outdoor. The terminator shall consist of a stress control, ground clamp, nontracking rubber skirts,

crimp-on connector, rubber cap, and aerial lug. Provide heat-shrinkable elbow sealing adaptor as shown on plans, allowing the metallic cable shielding to be externally grounded and sealed. Separate parts of copper or copper alloy shall not be used in contact with aluminum or aluminum alloy parts in the construction and installation of the terminator.

Wire/Device Identification: All cable systems, major conduits, and devices shall be permanently marked. Conduits shall have stainless steel tags at every 60 feet or where wall or building penetrations occur. All conductors shall be identified with self-adhering oil and moisture resistant vinyl labels, covered with clear heat shrink tubing or white heat shrink tubing with black typed on letters with nonsmearing ink as manufactured by Brady, T&B, or approved equal. Hand lettered labels shall not be used. All conductors shall be clearly marked with the proper phase identification.

CONDUIT SYSTEM:

All conduits shall be RGS or IMC with exception of underground, which can be PVC, and which shall be 3 feet minimum below grade and encased in 2 inches *minimum red concrete*. All bends must be RGS or IMC. Conduit systems shall be completed per the NEC.

PART 3 - EXECUTION

INSTALLATION:

General: Install electrical cable, wire, and connectors as indicated on the drawings, in accordance with the manufacturer's written instructions, applicable requirements of NEC and NECA's "Standard of Installation", and in accordance with recognized industry practices to ensure products serve intended functions.

Pull conductors together where more than one is being installed in a raceway. Do not exceed the conductor manufacturer's recommended pulling tension or as specified in the IPCS Handbook. Use pulling compound or lubricant, where

necessary; compound must not deteriorate conductor or installation. Tension shall be monitored when pulls involve more than 40 feet or when 3 or more 90 degree turns are in the system.

Use pulling means including fish tape, cable, or rope which cannot damage raceway.

Install splices and taps in an accessible junction box that has mechanical strength and insulation rating equivalent-or-better than conductor.

Use splice and tape connectors that are compatible with conductor material.

TESTING:

High Potential: After installation and installing stress cones, all 15 KV cable shall be tested at twice the normal operating voltage plus 1000 volts. The test duration shall be 15 minutes on each cable. See IEEE standard 400-1980 (IEEE Guide for making high-direct-voltage tests on power cable systems in the field).

Meggering: Before terminating, test all cable or wire for insulation resistance with 500 volt megger. Any wire with less than 10 megohms to ground or other conductors shall be replaced before proceeding with the terminating. List conductors tested on required test data submittal sheet.

ELECTRICAL CONTINUITY AND PHASE ROTATION:

After conductor connectors are installed and conductors are labeled, but before termination to terminals or devices, an electrical continuity test shall be performed on each conductor using a battery powered buzzer or ohmmeter to determine that all power, control, grounding, and other conductors are properly installed and identified. List all conductors tested on required test data submittal sheets.

After initial energizing of the transformer, check for proper phase rotation.

ES-51334

APPENDIX D

OUTLINE SPILL PREVENTION, CONTROL, AND COUNTERMEASURES PLAN

OUTLINE SPILL PREVENTION, CONTROL, AND COUNTERMEASURES PLAN

MINIMUM SPILL PREVENTION REQUIREMENTS

The following shall be performed before the start of and during any fluid removal from a liquid cooled transformer (i.e., PCB filled, oil filled, or silicone filled).

- a. A layer of 6 mil polyethylene sheeting shall be placed around the transformer.
- b. If drains are present, measures will be taken to eliminate the potential for any fluids from entering the drains. This includes, but is not limited to, constructing a dike, trenching around the drain, and/or plugging the drain.
- c. Before pumping the fluids, all hoses shall be inspected for any holes, cracks, or deterioration. Fittings shall be inspected to ensure a proper connection. Any gaskets utilized in the pumping operations shall be inspected for integrity. Approved hoses, pumps, and gaskets shall be used.
- d. Drip pans shall be placed under pumps and connections.
- e. Pumps and hoses shall be positioned so as to minimize any tripping hazard.
- f. Personnel will monitor the pumping operation at all times.
- g. An adequate supply of absorbent materials and cleanup equipment shall be readily available in the event of a mishap.

This includes the following, but not limited to:

1. Shovels
 2. Brooms
 3. DOT drums: 17E, 17H, and 85 gallon recovery drum
 4. Ample supply of rags
 5. Vermiculite (Speedi-Dry)
 6. Absorbent booms and/or absorbent pads
 7. Assorted corks, plugs, and emergency seals
 8. Material Safety Data Sheets (MSDS).
- h. All safety equipment shall be inspected before use.

CONTROL

In the event of a spill or leak, the following procedure shall be implemented:

- a. Stop the source of the spill. Below is a list of probable source of spills when working with liquid cooled transformers, and the remedial action to be taken to eliminate the problem.

Source 1. Transformer

1. Location of leaks: valves. Remedial action: plug valve to reduce or stop spill. Pump fluid below valve and replace faulty valve.
2. Location of leak: bushing. Remedial action: Pump fluid below bushing level. Replace gaskets, or if necessary, replace bushing.

3. Location of leak: tank wall or radiator pipe. Remedial action: pump fluid below level of leak and either epoxy or weld close the leak source. If the source of the leak is small, a vacuum can be pulled on the transformer before applying the epoxy sealant or welding. Pulling a vacuum on the transformer eliminates the need for any pumping operations.

4. Location of leak: tap changer, liquid level gauge, or temperature gauge. Remedial action: remove fluid below level and replace packing material, gaskets, or thread sealant where applicable.

Source 2. Pumps or Hoses

Remedial action: Stop all pumping operations and place apparatus into an adequate container to capture any fluids.

Source 3. Drums

Remedial action: In the event that the drum is seeping at the seams, the fluid shall immediately be transferred to another drum. Should a drum rupture or become punctured, an oversized recovery drum will be used. The recovery drum is placed over the top of the leaking drum. Then, the recovery drum is placed upright, containing the leaking drum.

- b. Stop the migration of any spilled fluid. This can be done by placing the berm around perimeter of the spill. A berm can be constructed using any type of absorbent material, i.e., vermiculite (Speedi-Dry), sand, rags, absorbent boom or pads.

- c. Solidify any free standing fluid.

- d. Safety apparel shall be worn when dealing with spills involving PCB fluids.

COUNTERMEASURES

The countermeasure operations are the cleanup and disposal of all contaminated material that is a result of the spill. The primary goal of all cleanup activity is to maintain a safe environment.

- a. Cleanup

1. Fluids: If the volume of fluids is great enough to where solidification is impractical, the liquid shall be pumped into DOT 17E drums. These drums must be properly labeled and dated.
2. Solids: Any porous solids (soils, asphalt, wood, paper, etc.) contaminated by the spill shall be placed into DOT 17H (removal head) drums. These drums must be properly labeled and dated.
3. Major Spills: In the event that the spill exceeds the control and cleanup capabilities that are onsite, an outside contractor, who specializes in environmental cleanup and has all permits and licenses required, must be contacted. This contractor must be equipped to handle various types of spills.

Analysis. During the cleanup operations, sampling, and analysis must be performed. The analytical data are needed to present an accurate picture of the following:

1. The extent of the spill
2. The effectiveness of the cleanup operations

3. The point in time when the environment has been decontaminated.

b. Disposal. The disposal of all contaminated materials must be in accordance with the applicable EPA regulations (40 CFR 761).

All work will be inspected by the EG&G Idaho, Inc. representative.

Transportation of hazardous waste to the disposal site shall conform to 40 CFR, Part 263. All Federal, state, and local permits and labeling and approvals shall be completed before the shipment of waste from the transformer site.

ES-51334

APPENDIX E
SWITCHGEAR SPECIFICATION

SWITCHGEAR SPECIFICATION

1.0 GENERAL

Provide and install switchgear with the transformer as referenced in the data sheets. The switchgear shall consist of one or more enclosed vertical sections joined together to form a rigid, free standing assembly. The construction of the switchgear shall meet the requirements of the NEC.

2.0 PRODUCTS

600 Volt: Switchgear shall be suitable for operation for 480 volt, 3 phase, 3 wire, 60 Hertz grounded service.

Vertical Sections: Vertical sections shall support the horizontal and vertical buses, covers, and doors, and shall be designed to allow for easy rearrangement of units. Vertical sections shall have structural supporting members formed of a minimum of 13 gauge hot-rolled steel. All finished surfaces shall be blemish-free. Each section shall be 90 inches high and shall have 7 gauge steel, 3 inches high, removable lifting angle and two 1-1/2 inches high base channels. Complete control center lineups shall be divided into shipping splits no wider than approximately 60 inches. A lifting angle shall be provided on the top of each shipping split and shall extend the entire width of the shipping split. Lifting angles shall be designed to support the entire weight of the switchgear and shall have access points or lifting eyes to facilitate handling. Base channels shall be provided with holes to permit bolting the switchgear to the floor. The entire assembly shall be constructed and packaged to withstand all stresses induced in transit and during installation. Switchgear shall be designed so that matching vertical sections of the same current rating and manufacture can be added later at either end of the lineup without use of transition sections and without difficulty. Removable end closing plates shall be provided to close off openings on

the end of the lineup. A removable top plate shall be provided on each vertical section and shall be of one piece construction for added convenience in cutting conduit holes. The design shall allow use of the standard conduit entrance area without significant sag or deformation of the top plate.

Vertical sections shall be designed to accommodate plug-on units in front-of-board construction. Vertical sections housing plug-on units shall be 15 inches deep.

Vertical sections shall be provided with both horizontal and vertical wireways. Sufficient clearances shall be provided in the horizontal wireway so that no restriction is encountered in running wires from the vertical to horizontal wireway. Wireways shall be in accordance with the wireways section contained in this document.

Horizontal Wireways: Horizontal wireways shall be provided in the top and bottom of each vertical section and shall be arranged to provide full length continuity throughout the entire assembly. The top horizontal wireway shall have a cross sectional area of not less than 20 square inches with openings between sections of not less than 11-1/2 square inches. The bottom horizontal wireway shall extend through the length and depth of the 11-1/2 square inches to allow for full length continuity throughout the entire assembly. The bottom horizontal wireway height shall be not less than 9-1/4 inches. Covers for all wireways shall be equipped with captive type screws to prevent loss of hardware during installation. All wireways shall be isolated from the bus bars.

Vertical Wireways: A vertical wire trough shall be located on the right-hand side of each vertical section and shall extend from the top horizontal wireway to the bottom of the available unit mounting space. Each vertical wire trough shall have a cross-sectional area of not less than 19 square inches and shall be isolated from the bus bars to guard against accidental contact. A separately hinged door having captive type screws shall cover the vertical wire trough to provide easy access to control wiring without disturbing the unit.

Reusable wire ties shall be furnished in each vertical wire trough for the purpose of grouping and securely holding wires in place for a neat and orderly installation.

Bus Bars: A continuous main 3-conductor horizontal bus shall be provided over the full length of the switchgear. When necessary, the bus shall be split to allow for ease in moving and handling. Splice bars will be supplied to join the bus whenever a split has been made. All splice connections shall be made with at least 2 bolts. Horizontal busbars shall be mounted edgewise and supported by insulated bus supports. Insulation shall be used as required by NEMA standards and shall be dated at no less than 600 VAC.

For distribution of power from the main horizontal bus to each unit compartment, a 3-phase vertical bus shall be provided. The vertical bus shall be firmly bolted to the horizontal bus for permanent contact.

The main horizontal and vertical buses shall be made of copper and the entire length shall be electrolytically tin plated to provide maximum protection to the bus bars from normal or adverse atmospheric conditions.

The main horizontal bus rating shall be a minimum 800 amperes continuous. Vertical bus rating shall be a minimum of 300 amperes for adequate current carrying capacity. Continuous current ratings shall be in accordance with temperature rise specifications set forth by UL, ANSI, and NEMA standards.

A copper ground lug shall be provided in each incoming line vertical section capable of accepting No.8 to 350 MCM cable. A horizontal (and vertical) tin plated copper ground bus shall be provided in each section of the switchgear. Horizontal ground bus shall run continuously throughout the switchgear except where splits are necessary for ease of shipment and handling in which case splice bars shall be provided. Ground bus shall be tin plated copper. Horizontal ground bus shall be located at

the bottom of the switchgear. Vertical ground bus shall run parallel to the power distribution bus in each vertical section. Design shall be such that for any plug-on unit the ground bus stab shall make contact with the ground bus before the power bus contact is made.

Bus Barriers: Insulated horizontal and vertical bus barriers shall be furnished to reduce the hazard of accidental contact with the bus. Barriers shall have a red color to indicate proximity of energized buses. Vertical bus barriers shall have interlocking front and back pieces to give added protection on all sides and shall segregate the phases to reduce the possibility of accidental "flash over." Small, separate openings in the vertical bus barriers shall permit unit plug-on contacts to pass through and engage the vertical bus bars. Bottom bus covers shall be provided below the vertical bus to protect the ends of the bus from accidental contact with fish tapes or other items entering from the bottom of the enclosure.

Controls and Meters: All new service panels shall be equipped with the following:

Kilowatt Meters. Type II, Class 3, Style B and shall have provisions for pulse initiation. Kilowatt meters shall be flush switchboard type as indicated on the drawings and shall be totally compatible to each particular application. Kilowatt meters shall be of one manufacturer, secondary type.

- The meters shall have an electronic demand register. The register shall be used to indicate maximum kilowatt demand as well as cumulative basis. It shall have provisions to be programmed to calculate demand on a rolling interval basis.
- The register shall be of modular design. The electronic module, containing all the program variables, shall be able to be easily removed from the mechanical register for programming, maintenance and trouble shooting.

- All electronic modules shall be physically identical and interchangeable.
- A frictionless optical assembly, mounted directly to the meter frame, generating 12 pulses per meter disc revolution for input to the electronic register shall be provided.
- Each kilowatt meter shall also be complete with a 5-dial mechanical kilowatt hour register.
- Meters shall be 3 stator, 120 volt for use on a wire Y, 3-phase system.
- Meter multiplier shall be shown on the face plate and shall be the product of the indicated current transformer and potential transformer ratio.
- Draw out arrangement for meter removal incorporating automatically short circuit current transformer circuits.
- Meter covers shall be polycarbonate resin.
- Meter detent to prevent negative registration by restricting the backward rotation of the disk.
- The normal billing data scroll shall be fully programmable. The following items shall be displayed in the data scroll:
 - Kilowatt hours
 - Maximum demand
 - Cumulative or continuously cumulative
 - Number of demand resets
 - Time remaining in interval
 - End-of-interval indication
 - New maximum demand indication

- The register shall incorporate a built-in test mode that allows it to be tested without the need for any special tools or other accessories and saves data and constants before start of the test. The following quantities shall be available for display in the test mode:
 - Time remaining in demand interval
 - Present interval's accumulating demand
 - Maximum demand
 - Number of impulses being received by the register
- Pulse initiator with programmable ratio selection.
- Battery with battery port for quick changes.
- Meters shall be programmed after installation.
- Meters shall be tested, calibrated, and certified after installation.
- Self-monitoring to provide for stored data check sum error, ROM and RAM checksum error, battery fault, and unprogrammed register.
- Liquid crystal display, 9 digits, blinking squares confirm register operation. Large digits for data and smaller digits for display identifier.
- Display operations, programmable sequence with display identifiers. Display identifiers shall be selectable for each item. Continually sequence with time selectable for each item.

Circuit Breakers: Molded case circuit breakers shall be furnished in branch feeder units using circuit breakers as a disconnect means. All circuit breakers will have a push-to-trip test feature for testing and exercising the trip mechanism. Breakers shall be UL listed for a minimum of 22,000 amperes RMS symmetrical fault withstandability.

Main breakers (480 volt panels only) shall be equipped with auxiliary contacts and shunt trip coils. Optional electrical operation mechanisms shall be proposed for possible use if funding levels are adequate.

Identification: A control center identification nameplate with factory identification numbers and characteristics shall be fastened on the vertical wire trough door of every section. Each unit shall have its own identification nameplate fastened to the unit saddle. These nameplates shall have suitable references to factory records for efficient communication with supplier. Each unit shall also have an engraved nameplate fastened to the outside of the unit door for ease in identification and for making changes when regrouping units. Main breakers (480 panels only) shall be equipped with auxiliary monitoring contacts and shall be equipped with short trip controls. Optional electrical operations shall be proposed for possible use if funds are adequate.

Wiring: The switchgear wiring shall be NEMA Class II, Type B.

As defined by NEMA Standard ISC-2-322, Class II switchgear shall include the necessary electrical interlocking and interwiring between units.

Type B wiring shall include terminal blocks mounted on lift out brackets in the units.

Terminal blocks shall be quick separating pull-apart solderless box lug type or equal.

Finish: All metal structural and unit parts shall be completely painted using an electrodeposition process so that the interior and exterior surfaces as well as bolted joints have a complete finish coat on and between them.

3.0 TESTS

3.1 Following tests shall be performed and results recorded. All the equipment tests shall be performed in accordance with IEEE, NEMA, and ANSI Standards where such standards are definitive. All test data including but not limited to test circuitry, faulty equipment, and remedial action will be recorded, certified, correlated, bound, and furnished to the Owner.

- a. Wiring continuity - point to point check and verification with the wiring diagrams.
- b. Wiring insulation - check to ground - megger at 600 volts.
- c. Power of proper amplitude and frequency shall be applied to all AC and DC circuitry. Three-phase potential and current of proper frequency shall be applied to all applicable AC connections.
- d. Polarity tests of all AC and DC circuitry. Three-phase power and phase angle meter shall be used to make AC polarity test on power feeds and metering circuits.
- e. Functional tests shall be performed on all equipment to indicate proper operation of all protection, metering, and control equipment. Power circuit breaker simulators shall be employed for the primary bus to verify proper operation of all equipment.
- f. The Owner may at his option provide specific relay and metering test forms to be complied with, otherwise the Seller shall submit 2 copies of Seller's standard test forms for review by the Engineer.
- g. All "as left" test values shall be recorded and shall be within manufacturer's tolerances. Manufacturer's tolerances shall be indicated on the test forms.

h. The intent of the acceptance test is to determine that the meters and relays have not sustained damaged during shipment from the manufacturer and that the meters and relay calibrations have not been disturbed. If the examination or test indicates that re-adjustment is necessary, the relay shall be repaired and/or calibrated as per manufacturer's instructions.

3.2 The Owner and/or Engineer may elect to visit the Seller's facilities on completion of fabrication of the equipment to inspect the equipment and witness testing as outlined in Section 3.1.

Appendix B
Test Reports

TRIP REPORT
FINAL ACCEPTANCE TESTING OF
ABB 112.5 KVA AMORPHOUS CORE TRANSFORMER
FOR SAN DIEGO NORTH ISLAND NAVAL BASE

Trip Date: Jan. 15-17, 1991
Location: Jefferson City, Missouri
Attendees: J.S. Bertrand & S.A. McBride
Objective: Attend witness testing of amorphous core transformer for the San Diego North Island Naval Base.

FACILITY:

ABB's Jefferson City Missouri distribution transformer manufacturing facility is comprised of engineering, administration, shipping & receiving, and manufacturing in a single 600,000 square foot facility. The plant has a high degree of modern automation, utilizing robotic welders, conveyers, painting apparatus, presses, etc. for a majority of the manufacturing. ABB uses an extensive Computer Aided Design And Manufacturing (CADAM) system to simplify the process of producing 200 to 300 transformers per day.

Factory Testing:

The following transformer contracted with ABB is being manufactured by ABB in Jefferson City Missouri:

<u>#</u>	<u>Order Number</u>	<u>Location</u>	<u>Size(kVA)</u>	<u>PWC#</u>
1	V25E123YVY	473	112.5	CC48

The following sections will detail all testing performed on this unit. Engineering drawings and certified test data are attached to this report as available.

Tests:

1. Turns ratio, polarity, and phase rotation test
2. Demagnetization (exciting current)
3. Half wave & full wave impulse test
4. Applied voltage test of high voltage coils test
5. Applied voltage test of low voltage coils test
6. Induced voltage test (400Hz)
7. No-load loss test
8. Resistance, impedance, and load loss test
9. Temperature rise test

Shop Order #804001 Style #V25E123YVY

This transformer was specified and constructed as a 112.5 kVA OA outdoor padmounted unit. The transformer has a 2400 volt delta primary winding and a 480/277 volt grounded wye secondary winding. The cooling fluid is 193 gallons of RTEmp (high molecular weight hydrocarbon). The following tests were performed on January 16-17, 1991 on the linear test line as illustrated in the Electrical Testing Program--Jefferson City Booklet (PDL 46-300-TT-K Page 4-5).

<u>TEST</u>	<u>TATUS</u>
Turns ratio test 8:00am	Failed. The first ratio test indicated that the secondary windings were improperly connected. This should have been identified during a preliminary ratio test which normally is performed prior to installation of the cooling oil. The transformer was removed from the test line and placed in the repair area. The cooling fluid was then drained out of the tank to a level just below the top of the core/coil assembly. This would allow reconnection of the secondary windings. Extreme caution had to be used to avoid introducing any foreign objects into the tank during repair (such as bolts, nuts, washers, etc.). The root cause of the connection problems was determined to be that the wrong connection diagram was given to the internal construction team. The designer subsequently located the proper connection diagram and the connections were altered to the new configuration. The cooling fluid was then very slowly reintroduced into the tank. Caution was used to minimize the introduction of air bubbles into the fluid. The transformer was then taken to the vacuum chamber where it was subjected to two complete vacuum cycles to draw any air from the transformer. The transformer was then brought back to the test line.
11:00am	
2:30pm	
4:30pm	
Demagnetization 5:00pm	Passed. This test is performed to remove any residual magnetism in preparation for the impulse tests. It also serves as a means to measure the exciting current.

<p>Impulse test 5:15pm</p>	<p>Each of the three high voltage windings was subjected to a half wave impulse test and a full wave impulse test. The test engineer tested the windings to 60 kV BIL. I reviewed the specification and informed him that the requirement was for 75 kV BIL. I stated that the 60 kV BIL test was not adequate and that they will be required to perform another test to the required 75 kV BIL. Based on the configuration of their test line it was not possible to go backwards and repeat the test. The unit would have to be reintroduced to the lineup following completion of the other tests. They assured that they would perform the impulse test to 75 kV BIL. I was contacted on January 22, 1991 and informed that the 75 kV BIL test had passed without incident. This plant does not have the capability to perform impulse testing of the low voltage windings. Therefore the 30 kV BIL tests of the 480 volt secondary windings were not performed.</p>
<p>Applied voltage</p>	<p>Both the high and low voltage tests passed.</p>
<p>Induced voltage</p>	<p>The 400 Hz induced voltage test passed.</p>
<p>No-load loss 6:00pm</p>	<p>The no-load loss was measured to be 86 watts. This value was 8 watts above the quoted value of 78 watts.</p>
<p>Load loss 6.15pm</p>	<p>The load loss was measured to be 1529 watts. This value was 29 watts below the quoted value of 1558 watts.</p>
<p>Resistance</p>	<p>Passed.</p>
<p>Impedance</p>	<p>The transformer impedance was measured to be 3.32%. This value is at the maximum limit of the specified impedance and is acceptable.</p>
<p>Temperature rise Jan. 17, 1991 (24 hours)</p>	<p>54.5 degrees celsius</p>

The tests on this unit were all performed with exclusion of the impulse testing on the secondary windings. During the tests several problems were identified. These items which require further attention are listed below:

ACTION ITEMS:

1. The transformer nameplate identified the unit as a 65 degree celsius rise. It should be 55 degree celsius rise.
2. The transformer nameplate identifies the transformer HV BIL as 60 kV. It should be 75 kV.
3. The transformer nameplate identifies the impedance as 2.76%. It was measured to be 3.32%.
4. Drawing J801R4Q shows item #12 (Pressure relief device, 350CFM at 15 psig) located on the front of the transformer inside the secondary compartment. This high volume pressure relief device which is required with the use of RTEmp fluid must be installed on the top of the unit (due to space limitations). I asked specifically what their intentions were and they informed that the required high volume PRD would be installed on one of the hand hole cover plates on top of the unit.
5. Jim Hankins will contact us with the proposed shipping information as soon as it is available.
6. ABB (Jim Hankins) will issue us a Certified Test Report as soon as it is available.

CONSLUSION:

The transformer passed an acceptable series of tests. The particular test series used by ABB is almost completely computer controlled. This makes it very difficult for the observer to know what is going on. Specific pass/fail criteria have been loaded into the computer system based on the experience of many thousands of successful units. Data from each of the tests are digitized and sent to the computer for analysis, the computer then either accepts the test results or rejects them. This application is designed for a volume production environment in lieu of a special/custom transformer environment. All things considered this is a very impressive manufacturing plant. Technology, personnel, design, and materials are for the most part outstanding.

January 1990

Electrical Testing Program - Jefferson City

General Testing Program

Factory tests are performed on a transformer to confirm that it is properly designed and constructed to carry rated load and that it will withstand the conditions it will be exposed to in service. Factory tests are evidence of the reliability of a transformer, although the ultimate proof is trouble-free service over its expected life.

The Jefferson City testing program is based on applicable ANSI, IEEE, and IEC standards and can be divided into 5 broad categories:

1. Test Data
 - A. Test Parameters
 - B. Test Results
2. Preliminary Tests
 - A. Core Loss Test
 - B. Turns Ratio Test
 - C. First Preliminary Ratio Test
 - D. Second Preliminary Ratio Test
3. Routine Tests
 - A. Ratio
 - B. Demagnetization
 - C. Full Wave Impulse
 - D. Applied Voltage Test of the HV Circuit
 - E. Applied Voltage Test of the LV Circuit
 - F. 400 HZ Induced Test
 - G. No-Load Loss and Exciting Current
 - H. Load Loss, Resistance and Impedance
 - I. Final Continuity Check
 - J. Circuit Breaker Test
4. Special Tests
 - A. Sound
 - B. Temperature
5. Calibration

1. Test Data

Test data consists of a set of test parameters and a set of test results for each individual transformer. Test data is entered in the office mainframe computer. Test parameters are sent to the test floor and stored within the test floor computer system for later retrieval. As transformers are tested, the results are held within the test floor computer system, then transferred to the mainframe.

A. TEST PARAMETERS

A unique set of parameters is used to test each individual transformer. This set is generated from a combination of three sources:

1. Customer Specification

This includes all of the transformer ratings such as HV, LV, kVA, winding temperature rise, and frequency. The customer may specify special design tests such as sound, temperature rise, or RIV. He may require that the transformer be tested according to IEC standards or ANSI. If no-load loss, total loss, impedance, or exciting current is quoted to the customer, then 'not to exceed' values based on the quote are sent to the test floor as limits.

2. Transformer Standards (IEC, ANSI, IEEE, etc.)

The standards specify the routine tests that must be performed on every transformer. Test voltage levels, test durations and pass/fail criteria are included. Examples are:

- 400 HZ Induced Voltage level
- Full-wave Impulse Voltage
- Applied Voltage of the HV Circuit
- Applied Voltage of the LV Circuit

3. Design Performance Criteria

If values such as no-load loss, total loss, impedance, and exciting current were not quoted to the customer, then values based on the design and/or past performance of the transformer style are sent to the test floor as pass/fail criteria. Examples are:

- 400 HZ Induced Voltage Test Current Limit
- Minimum and Maximum % Impedance Limits
- No-load Losses and Exciting Current Limits
- HV and LV Coil Resistances
- Total Losses
- Load Losses

The Design Engineering Department may specify special design or "type" tests to verify new designs such as chopped-wave impulse test, short circuit test, temperature test, sound or RIV.

B TEST RESULTS

A set of test results is recorded for each transformer. Some of the values are sent directly to the customer when requested, examples are no-load loss, total loss, % impedance, % exciting current, and the formal notification that the transformer did receive and pass all required tests (Certified Test Report).

The test results are recorded in the design database to establish actual performance characteristics of new designs and to dynamically update performance characteristics of existing designs as materials vary and manufacturing processes are improved.

The test results are analyzed by the Quality Assurance Department to monitor, report trends, and take action as required to assure that quality manufacturing practices are followed.

2. Preliminary Tests

The preliminary tests are performed primarily to establish the acceptance of core-coil assembly. Four preliminary tests are performed:

A CORE LOSS TEST

This test is performed on each core loop to measure the core loss at the (design) induction level. The cores are graded according to their measured losses, later combined as required to meet the no-load losses guaranteed for each complete core-coil assembly.

B TURNS RATIO TEST

This test is performed as an audit of completed coils. It verifies that the number of turns is correct in each winding section.

C FIRST PRELIMINARY RATIO TEST

The first preliminary ratio test is located in the core-coil build area prior to the core-coil bake oven. Ratio tests are performed on all core-coil assemblies at the rated voltage connection and at all tap voltages. A small voltage (approximately 10 volts) is applied to the primary winding. The voltage applied and the secondary voltage are measured by a digital ratio meter. The meter displays the secondary voltage by the primary voltage and displays the ratio. For three phase transformers, the test is done separately on each phase.

D SECOND PRELIMINARY RATIO TEST

A second preliminary ratio test is performed in the internal assembly area prior to vacuum oil fill. This ratio test is performed in the same manner as the first test, except that it is made with all bushings installed to verify that internal connections to the bushings are made with the correct polarity.

3. Routine Tests

Routine tests are performed on all transformers to verify that proper manufacturing practices were followed in the construction of each transformer and to establish performance characteristics. The following are routine tests:

- Ratio
- Demag
- Full Wave Impulse
- Applied Voltage Test of the HV Circuit
- Applied Voltage Test of the LV Circuit
- Induced Test
- No-load Loss and Exciting Current
- Load Loss and Impedance
- Final Continuity Check
- Circuit Breaker Test

A RATIO TEST

The ratio test is given to verify that the transformer's ratio, polarity and phase rotation are correct.

Twenty volts is applied to the secondary terminals. The voltage applied and the induced primary voltage are measured and compared for ratio and phase relationship. The voltage is applied in three separate connection configurations for three phase units.

B DEMAG TEST

The demag test is given to remove any residual magnetism in preparation for an impulse test. Also, it serves as a no-load exciting current test. Power is applied to the low voltage windings. The voltage is ramped from zero to rated secondary voltage and then back to zero volts. A transformer is considered to have passed this test if the exciting current does not exceed the limit specified for the design of the transformer under test.

C FULL WAVE IMPULSE TEST

The full wave impulse test attempts to simulate a lightning disturbance that travels some distance along a transmission line before it reaches the transformer. At the transformer, this wave shape rises from zero to crest in 1.2 microseconds and decays to one-half value in 50 microseconds. The peak value is specified by ANSI standards according to the transformer rating.

Each HV bushing is tested by impulsing that bushing while grounding one end of all windings and the tank. Each HV bushing receives an impulse shot at one-half the rated value and then another shot at the full impulse value. The ground current waveforms are recorded for both shots on a winding and compared. The current waveshape at the reduced impulse shot is taken first to establish the characteristic waveshape for the winding while the insulation is still considered to be sound. If the current waveshape of the full impulse shot is very similar to that of the reduced shot, the winding is considered to have passed the test.

D. APPLIED VOLTAGE TEST OF HV CIRCUIT (HLIC)

The HLIC test is performed to check the insulation design and to verify proper construction. The HLIC test verifies the major insulation between the HV circuit to the LV circuit and to ground. (The acronym "HLIC" stands for "high to low/iron continuity".)

The test is performed by connecting all HV terminals together and applying a specified voltage from the HV terminals to ground for one minute at 60 HZ while all other terminals and the tank are grounded. The voltage applied is specified by ANSI according to the transformer's ratings. A transformer is considered to have successfully passed the test if no appreciable current flows.

E APPLIED VOLTAGE TEST OF LV WINDINGS (LHIC)

The LHIC test is also performed to check the insulation design and to verify proper construction. The LHIC test verifies the insulation between the LV circuit to the HV circuit and to ground. (The acronym "LHIC" stands for "low to high/iron continuity".)

The test is performed by connecting all LV terminals together and applying a specified voltage from the LV terminals to ground for one minute at 60 HZ while all other terminals and the tank are grounded. The voltage applied is specified by ANSI according to the transformer ratings. A transformer is considered to have successfully passed the test if no appreciable current flows through the transformer.

F. 400 HZ INDUCED POTENTIAL TEST

The 400 HZ test is performed on all transformers to check insulation design and verify proper construction. Although this test also verifies the major insulation between the HV and LV circuits, its main purpose is to check the turn-to-turn and layer-to-layer insulation within the HV and LV windings. Also, this test checks the insulation between phases in the HV and LV circuits.

A 400 HZ voltage is applied to the low voltage terminals for eighteen seconds. The voltage can be from two to four times rated (determined by the transformer ratings according to ANSI standards). The transformer is considered to have successfully completed this test if the current does not exceed a calculated value, based on the transformer's design.

JEFFEF

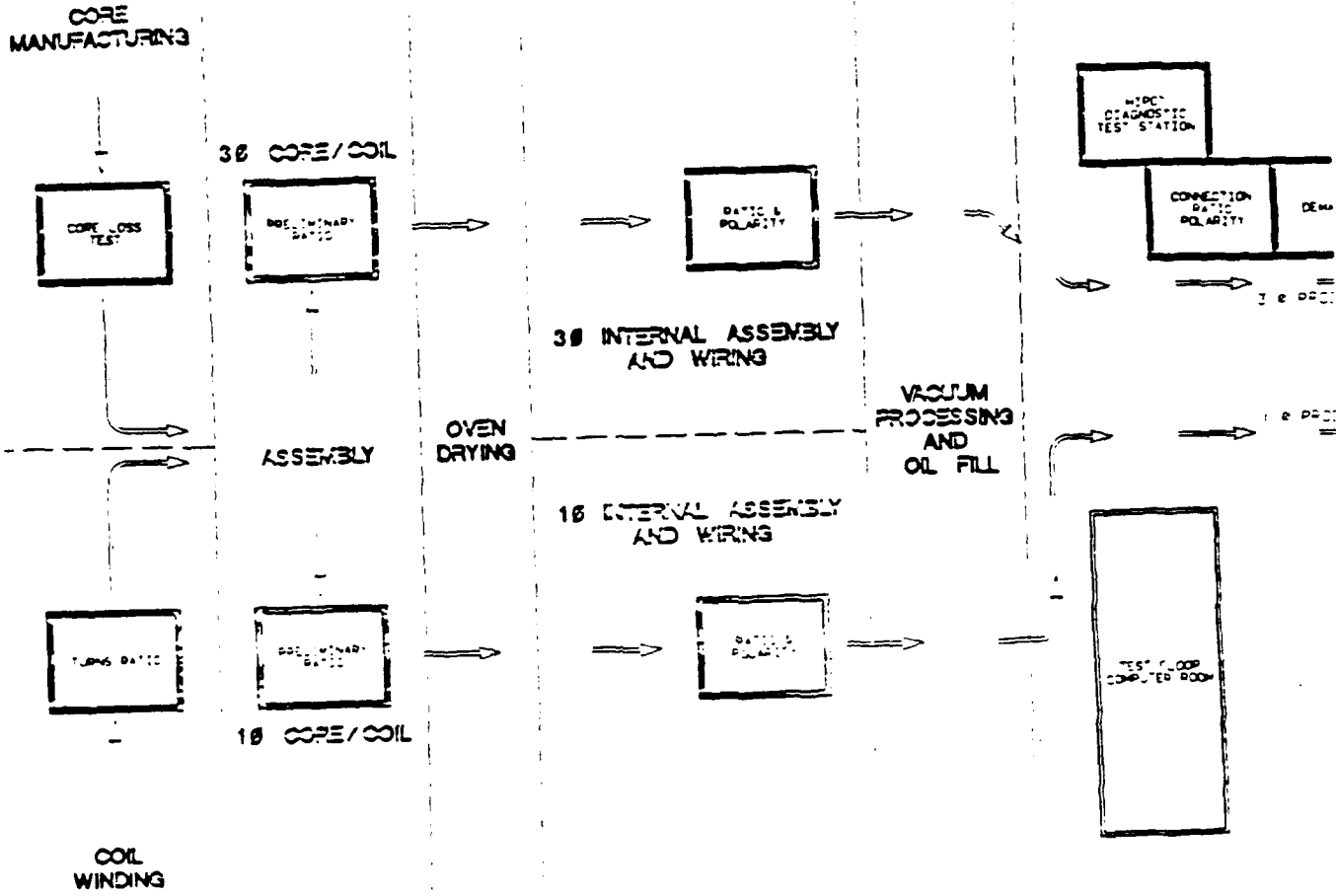

ON CITY TRANSFORMERS ELECTRICAL TESTS

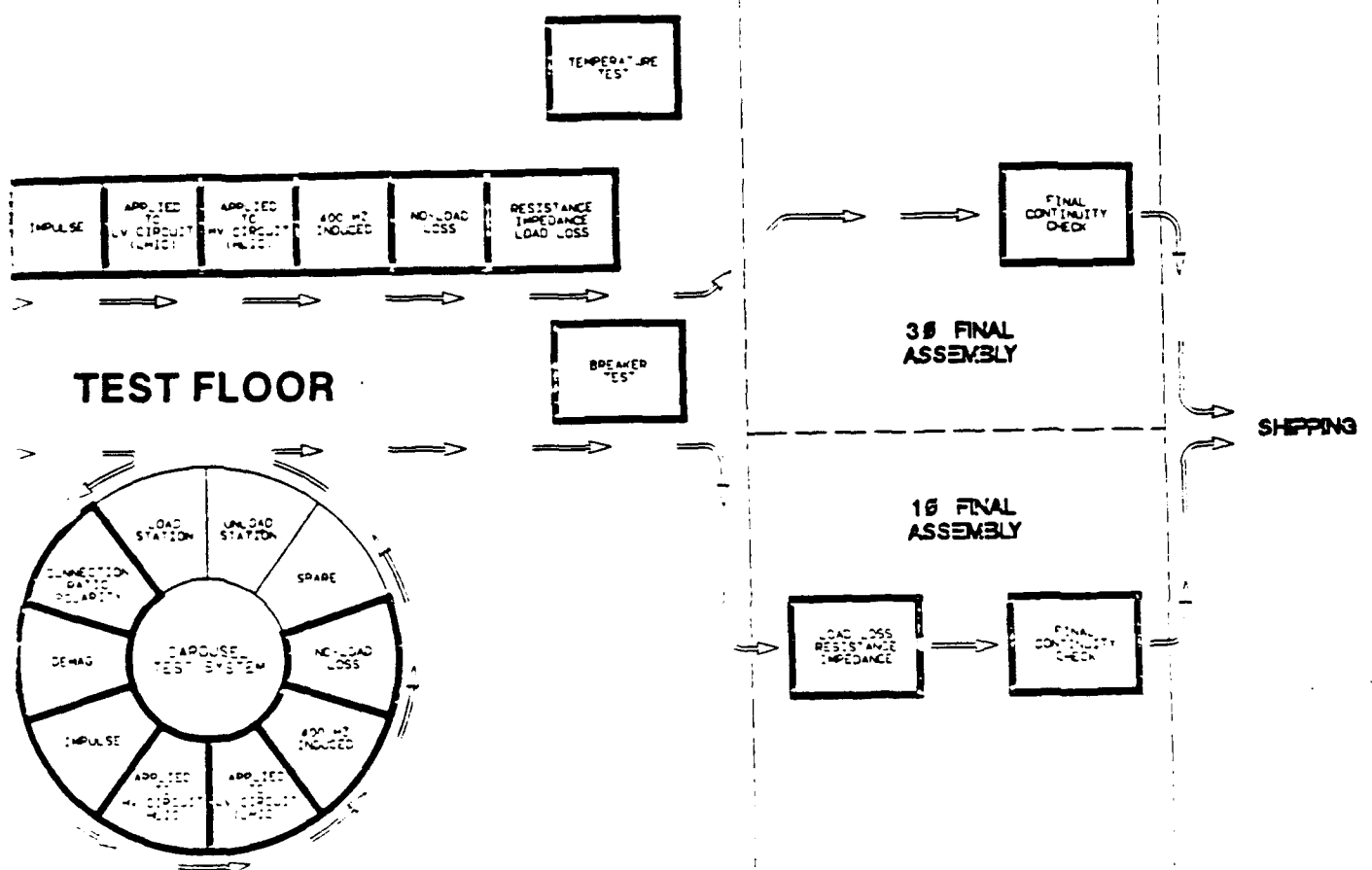

G NO LOAD LOSS AND EXCITING CURRENT

The no-load losses are losses of a transformer excited at rated voltage but not supplying load that is, when only exciting current flows through the energized winding. The no-load loss consists of the iron loss in the core, dielectric loss, and the loss in the windings due to the exciting current.

Rated voltage is applied to the low voltage terminals with the high voltage terminals open circuited. Simultaneous readings are made of voltage applied, power input, and excitation current.

The no-load loss TW (true watts) is the value read by a wattmeter measuring the power input. The % excitation current is the percent of rated current drawn during this test.

The no-load loss AW (apparent watts) is the product of the applied voltage and the exciting current (also, times the square root of 3 if a three phase transformer).

H LOAD LOSS, RESISTANCE AND IMPEDANCE TEST

The load loss of a transformer is the loss created by current flow through the transformer windings. Current flow through the windings creates the following two types of losses:

- a. I²R loss. The I²R loss is the real power consumed (or heat created) by load current passing through the winding resistance.
- b. Stray loss. The stray loss is the eddy current losses caused by leakage flux. The stray loss is generally less than five percent of total losses.

The impedance voltage is the voltage drop due to load current passing through the inductance and resistance of the windings. The impedance is expressed as a percentage of rated high voltage.

The test is performed by shorting the LV bushings together and applying sufficient excitation to the HV bushings to circulate rated current through the HV circuit. Measurements are taken for power input, voltage applied, current, and oil temperature. Winding resistances are measured. Then, the impedance and load loss are calculated at the rated operating temperature (normally 85°C).

I FINAL CONTINUITY CHECK

A continuity test is performed on all transformers. This test will assure our customers that the transformer fulfills their specifications and prevent possible safety hazards due to incorrectly wired transformers.

The continuity test is performed in Final Assembly after all HV, LV and accessory markings (stencil, decals, etc.) have been applied to the transformer. The following checks are made:

- a. The nameplate is compared to manufacturing information for style, serial number, kVA, HV rating, LV rating, tap voltages, impedance, conductor materials and coil BIL rating.
- b. The quantity of bushings, electrical accessories, and fuses on the unit is verified to agree with the nameplate and manufacturing information. The bushing identification on the unit is checked against the nameplate.
- c. An ohmmeter is then used to check the unit and verify that the internal wiring and the operation of all devices (breakers, switches, pull-out fuses, etc.) agrees with the nameplate.

CIRCUIT BREAKER TEST

Each transformer that has an under-oil breaker is routed to the breaker test station. There, each pole of the breaker is tested by circulating sufficient current to trip the breaker within twenty seconds. This is an operational test which assures that the breaker was correctly installed and is mechanically and electrically sound.

4. Special Tests

Special tests are performed at the option of the customer or the design engineer.

A SOUND TESTING

Some customers specify a maximum allowable transformer sound level. The sound generated by a transformer is affected by the core geometry, flux density, tank design, and the quality of assembly of all of the transformer component into a completed unit.

Sound measurements are made on the "A" weighted scale. The "A" characteristic best relates how a young listener (with normal hearing) hears the complex transformer-generated sound. For reference, zero dB is a sound level just barely below the minimum detectable sound level of the "young listener". The noise level in a large office usually is between 50 and 60 dB. Very loud sounds such as nearby airplanes and railroad trains may exceed 100 dB.

Sound level tests require an ambient sound level at least five, and preferably ten, decibels lower than the sound level of the transformer and ambient combined. The tests are performed in the shipping warehouse and are scheduled during off-shifts to obtain the lowest practical ambient sound level (approximately 36 dB).

Sound tests are made with the unit powered at 100% and 110% of rated voltage under no-load conditions.

Sound measurements are made at three-foot intervals on a stretched string contour around the tank at half the tank height. The points begin at the drain valve and proceed clockwise around the tank. The sound instrument nozzle is pointed horizontally at the string with the end of the instrument one foot from the string.

The measurement values are averaged to obtain an average "A" weighted sound level.

B TEMPERATURE TESTS

Core losses and coil losses are the primary sources of heating within the transformer. Temperatures within the transformers are a function of:

- a. Losses generated by the core and coil
- b. Core, coil and tank construction
- c. The transformer's external environment (primarily the surrounding air temperature)

In general, our transformers are guaranteed to have an average coil winding temperature of no more than 65°C rise over ambient air temperature when operated at rated voltage and load conditions. (Other winding temperature rises may be specified.)

The temperature test is performed to determine the thermal characteristics of the transformer and to verify that these characteristics are within design limits.

The Compromise Method (or Short Circuit Loading Method) is used to simulate rated operating conditions. The low voltage winding terminals are shorted and sufficient current is circulated through the HV windings to generate a loss within the transformer equivalent to the core loss plus the load loss. The transformer tap changer is connected to its maximum loss (lowest voltage) position and total losses are applied to the transformer.

$$\text{Total Loss} = \text{Iron Loss} + \text{Load Loss}$$

The purpose of this initial loading is to establish the maximum oil rise temperature of the transformer. Thermocouples are used to monitor the top and bottom oil temperatures and the ambient air temperatures. The transformer is operated at this loading until the increase in the oil temperature over ambient does not change more than 1°C in three hours.

After a three-hour period of stable oil temperature, the loading is cut back to rated current and continued for one hour. The transformer is then disconnected from the power source. Immediately, resistance measurements are taken as the transformer cools. The initial resistance readings on each winding are taken within four minutes after the transformer is de-energized. Three additional readings are taken, up to a maximum time of ten minutes after the transformer was de-energized.

The resistance of a winding prior to de-energizing the transformer can be found by plotting the resistance readings versus time and extrapolating the curve back to zero time. Knowing the resistance, the winding temperature at the instant of shutdown can be calculated. Following are useful performance data obtained from the temperature test:

$$\text{Avg. Oil Rise} = (\text{Top Oil @ Cutback} + \text{Bottom Oil @ Cutback}) \div 2$$

$$\text{Coil Diff.} = \text{Winding Rise} - \text{Top Oil Rise}$$

$$\text{Top Oil Rise} = \text{Top Oil @ Cutback} - \text{Amb. @ Cutback}$$

$$\text{Gradient} = \text{Winding Rise} - \text{Avg. Oil Rise}$$

$$\text{Winding Rise} = \text{Wind. Temp} - \text{Ambient @ Cutback} + (\text{Top Oil @ Cutback} - \text{Top Oil @ Shutdown})$$

5. Calibration

The test equipment is periodically calibrated to assure that the tests are valid and accurate.

More detailed information about the calibration program is in the Electrical Calibration Procedure, QAP302.

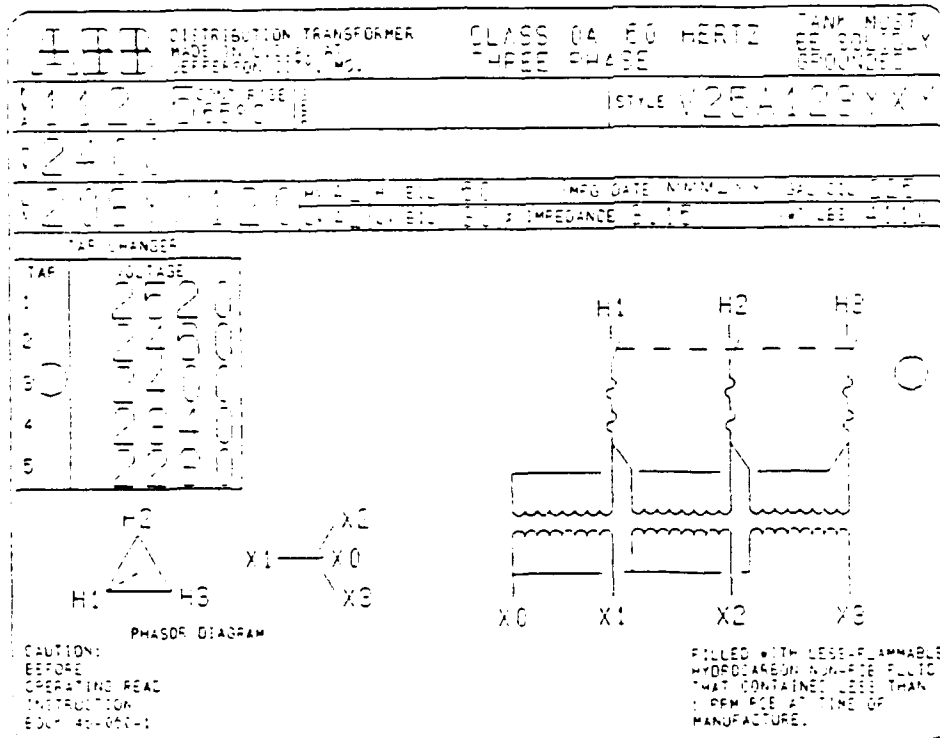

TRANSMITTAL
FORM 345760

SEND APPROVALS OR INQUIRIES TO:

ABB POWER T&D COMPANY INC.
11161 CROSSROADS PARKWAY NORTH, STE. 220
CITY OF INDUSTRY, CA 91746

TRANSMITTAL DATE

S.O. NO.	PROD. CODE	ATTN: ORDER SERVICE REP. PAT DEL VILLAR	CUST. ORDER NO. LS-01528-C	G.O. NO. & C/R DATE EJA15280-RJ3
VCS&G IDABC INC BOX 1625 DUARCO VALLEY, CA 92415		ULTIMATE USER AND/OR MARKINGS SAN DIEGO NAVAL BASE		

11/10/91
NOV 14 1991

FOR APPROVAL TO MAINTAIN SHIPPING SCHEDULE. APPROVED
DRAWINGS MUST BE RECEIVED BY ABB ON
DRAWINGS ARE IN COMPLIANCE WITH YOUR SPECIFIED REQUIREMENTS. DRAWINGS
"APPROVED" OR "APPROVED WITH MODIFICATIONS" AUTHORIZE ABB TO
PROCEED WITH THE MANUFACTURE. MODIFICATIONS NOT IN THE CONTRACT OR
MODIFICATIONS MADE DURING OR AFTER DRAWING APPROVAL MAY RESULT IN A
PRICE CHANGE AND/OR SHIPMENT DELAY.

FOR CONSTRUCTION
OR INSTALLATION
THE EQUIPMENT SHOWN ON THESE
DRAWING(S) HAS BEEN RELEASED
FOR MANUFACTURE. ANY MODIFI-
CATION MAY RESULT IN PRICE
CHANGE OR SHIPMENT DELAY.

APPROVAL BY: _____

DRAWINGS		CONSTRUCTION		INST.		RPD		TEST		SPECIFIC CUSTOMER INSTRUCTIONS ARE DETAILED IN NOTES TYPE OF REPRC
APPROVAL	OF INSTALL	BOOKS	UN- BND	BND	STG	REV. PRICED	REPORTS			
10		3								112.5 KVA TRANSFORMER ABOVE BOARD ATTN: P.A. DEL VILLAR REF: E340 IDABC INC, P.O. BOX 1625 OF SAN DIEGO NAVAL BASE PROJECT 01194 LANDGRAF GIERRELL ASSOC 5011 ARDSON AVE., STE 11 HUNTINGTON BEACH, CA 92645 ATTN: TROY KULTNER
17/S										ABB CITY OF INDUSTRY ATTN: P.A. DEL VILLAR

QTY	DESCRIPTION
1	112.5 KVA Transformer, Style V2SA123VNY, J8012K4 Outline, Nameplate per style

DWG. NO.	SUB	DRAWING TITLE	DWG. NO.	SUB	DRAWING

THIS TRANSMITTAL IS COMPLETE
 PARTIAL WITH DRAWINGS NOTED ABOVE OR ON ATTACHED SHEET TO BE SENT BY *J.C. Mkt.*

This drawing contains information proprietary to ABB Power T&D Company Inc.; it is submitted in confidence and is to be used solely for the purpose for which it is furnished and returned upon request. This drawing and such information is not to be reprinted, transmitted, disclosed or used otherwise in whole or in part without the written authorization of ABB Power T&D Company Inc.

A B B POWER I & D COMPANY, INC.
DISTRIBUTION TRANSFORMER DIVISION

CERTIFIED TRANSFORMER TEST INFORMATION BY STYLE.

FOR: INDUSTRIAL & CONSTRUCTION

PHASE HERTZ KVA LOW VOLTAGE HIGH VOLTAGE
3PH 60 112.5 208Y/120 2400

LOSSES ARE REPORTED AT 100 PERCENT OF RATED VOLTAGE AT 85 DEG. C.
NO LOAD LOSSES REPORTED AT 85 DEG. C AND LOAD LOSSES AT 85 DEG. C.

CUST. PO. LS 01528 C
CUST.ID.

ABB PO/ITM EJ15280 1
ABB STYLE V25A123YXY

INVOICE
NUMBER

SERIAL NUMBER	NO LOAD	LOAD	TOTAL	PERCENT IMPED.	EXCITING CURRENT	REGULATION AT 80%	SHIP DATE	INVOICE NUMBER
91J033082	72.9	1421.3	1494.2	3.00	.56	2.65	1.30	##/##/##

REPORT AVERAGE 72.9 1421.3 1494.2 3.00 .56 2.65 1.30

QUOTED LOSSES

TOTAL UNITS 1

RISE OF WINDINGS BY RESISTANCE AT 65 DEG. C. GUARANTEED.

----- INSULATION TESTS -----

IMPULSE TEST: 60 KV FULL WAVE IMPULSE TEST APPLIED TO THE HIGH VOLTAGE TESTS SECONDS
APPLIED POTENTIAL TESTS: VOLTAGE RATING TEST VOLTAGE APPLIED IN KV 60
HIGH VOLTAGE WINDING: 2400 19 60
LOW VOLTAGE WINDING: 208 18
INDUCED POTENTIAL TEST: 2.0 TIMES THE RATED VOLTAGE ACROSS FULL WINDING APPLIED FOR 18 SECONDS AT 400 HERTZ ,UNITS RATIO AND POLARITY TESTED.

WE CERTIFY THAT THE ABOVE INFORMATION IS A TRUE REPORT BASED ON FACTORY TESTS MADE IN ACCORDANCE WITH THE LATEST TRANSFORMER TEST CODE OF THE AMERICAN NATIONAL STANDARDS INSTITUTE, AND THAT THE ABOVE TRANSFORMERS WITHSTOOD THESE TESTS.

TRIP REPORT
FINAL ACCEPTANCE TESTING OF
NATIONAL INDUSTRI CAST COIL TRANSFORMERS
FOR SAN DIEGO NORTH ISLAND NAVAL BASE

Trip Date: Oct. 8-11, 1990
Location: Hampton VA
Objective: Attend witness testing of cast coil transformers
for the San Diego North Island Naval Base.

Factory Testing:

The following eight transformers contracted with ABB are being manufactured by ABB/National Industri Transformer Inc. in Hampton, VA:

<u>#</u>	<u>Shop Order</u>	<u>Location</u>	<u>Size(kVA)</u>	<u>PWC #</u>
1	2897	94	750/1000	CC69
2	2898	94	300	CC70
3	2899	378-1	750/1000	CC27A
4	2900	378-1	500	CC27B
5	2901	472	1500	CC45
6	2902	489	1500	CC49
7*	2903	342	112.5	CC16
8	2904	378-6	500	CC26

* Shop order # 2903 had not been constructed at the time of this trip. It is scheduled to be completed in late November.

The following sections will detail all testing performed on each of the transformers. The certified testing reports issued by National Industri are included in the appendix of this trip report should you need further information.

Tests:

1. Coil resistance test
2. Turns ratio test
3. Polarity & phase rotation
4. No-load loss
5. Impedance & load loss
6. Temperature rise test
7. Impulse (BIL) test
8. Applied potential test
9. Induced potential test
10. Partial discharge test

Shop Order #2897:

This transformer is a 750/1000 kVA AA/FA outdoor unit substation complete with a 15kV fused primary switch and secondary switchgear. The transformer has a 2400V/12000V reconnectable primary winding and a 480/277V secondary winding. Each primary winding is constructed using five sections. These five sections are connected in series for the 12000V configuration and in parallel for the 2400V configuration. Vertical busses mounted external to the coils are used to make the series/parallel connections. High voltage taps are provided on the primary 12000V configuration only. The primary switch was built in as part of the unit. The secondary switchgear was not present. It is assumed that ABB will be supplying this switchgear themselves. Note that the transformers are painted a non-standard color and that the secondary switchgear will need to be painted to match. The tests performed on this unit and the results were as follows:

<u>TEST</u>	<u>STATUS</u>
Coil Resistance	See test sheet.
Turns Ratio Test	See test sheet.
Pol. & Ph. Rotat.	Tests okay.
No-load Loss	Measured no-load losses = 2491 watts. This is substantially less than the guaranteed maximum of 2800 watts.
Load Loss	Measured load losses = 5728 watts. This is slightly over the guaranteed maximum of 5700 watts, however, it is within the +/- 5% tolerance required in the RFP.
Impedance	Measured to be 5.21%--this value is within tolerance of 5% (+/- 10% dual voltage only).
Temperature Rise	AA measured (celsius) Max 73.1 FA measured (celsius) Max 68.3 These values are within the required 80 degree C maximum. Note that the transformer failed the first FA heat run test, however, passed the second attempt.
Impulse Test	All impulse tests passed. However, problems were encountered on the H3 coil. The second chopped wave test on H3 failed. Several modifications to the test connections were performed of which none solved the problem. Finally it was determined that the clearance between the fan blade and the primary coil was not sufficient. For 95kV BIL, a minimum of 5.5 inches is needed. The fan blade was

approximately 2.5 inches from the primary coil. The fan appeared not to be damaged by the failures. See narrative for further discussion.

Applied Potential	Passed, no problems detected
Induced Potential	Passed, no problems detected
Partial Discharge	The partial discharge tests were performed using new equipment in the "Corona Room". The levels of detected partial discharges were recorded for both 110% and 150% of rated primary voltage at both the top and bottom of each high voltage coil. The levels monitored contain a substantial amount of background noise and therefore and not completely indicative of the actual level of partial discharge in the coil. The transformer was determined to pass the test in lieu of the misleading results obtained.

The transformer successfully passed all tests, however, several problems were experienced during the process. The load loss was measured to be 28 watts over the guaranteed maximum of 5700. However, the no-load loss was measured substantially under the guaranteed maximum. The end result is a lower total loss over what was guaranteed. This transformer required four heat runs, AA (ambient air) 2400V, FA (forced air) 2400V, AA 12000V, and FA 12000V. Both of the AA heat runs passed without incident, however, the FA heat runs failed. The transformer had been designed and constructed with 6 cooling fans. Prior to temperature testing, the design engineer had determined that this design would not be sufficient and that 12 fans would be required to maintain adequate cooling. The design engineer then issued an "Engineering Change Notice ECN" to change the design. This ECN was not executed prior to testing the transformer. The transformer was then modified to incorporate the 12 fan design. The FA heat tests were rerun and passed successfully. This modification caused another problem. When the additional 6 fans were installed the clearance between the fan blades and the high voltage bus was reduced from 6 inches to 2.5 inches. This spacing proved inadequate as the 95kV impulse tests failed. It turned out that another ECN had been drafted and not implemented. The design engineer had proposed a bussing modification which would allow adequate spacing of 5.5 inches. We performed the bussing modifications in the impulse bay and were able to pass all impulse tests without further incident. The final problem encountered while testing this unit was during the partial discharge testing. The "corona room" is used to perform partial discharge testing. The large transformers however will not fit in their corona room, thus, accurate isolated testing is not possible. The result is a substantial amount of noise overlaid on the partial discharge display (lissajous figure). No problems with the transformer were detected during this testing, however, they are in

the process of upgrading their test equipment so that more accurate testing can be performed.

Shop Order #2898

This transformer is a 300kVA indoor padmount unit with a 480V delta primary winding and a 208/120V grounded wye secondary. The following tests were performed on this unit.

<u>TEST</u>	<u>STATUS</u>
Coil Resistance	See test sheet.
Turns Ratio Test	See test sheet.
Pol. & Ph. Rot.	Tests okay.
No-load Loss	The measured no-load loss = 1318 watts. This is under the guaranteed maximum of 1400 watts.
Load Loss	The measured load loss = 3200 watts. This is over the guaranteed maximum of 3100 watts.
Impedance	The impedance was measured to be 3.16%. This is within tolerance.
Temperature Rise	AA measured (celsius) maximum 49.3
Impulse Test	All tests passed at 30kV.
Applied Potential	Passed, no problems detected
Induced Potential	Passed, no problems detected
Partial Discharge	This transformer had to be partial discharge tested in the transformer test bay #1. No problems were detected.

Overall, all tests passed and no problems were identified. The clearances in the unit are very tight, however, the unit passed all 30kV impulse tests so the spacing proved to be adequate.

Shop Order #2899

This transformer is a 750/1000kVA AA/FA indoor unit substation complete with a new 15kV fused primary switch and new secondary switchgear. The transformer has a 12kV delta connected primary and a 480/277V grounded wye secondary.

No tests were witnessed on this unit. I have reviewed the certified test report for this unit and no problems were

identified. The losses, impedance, temperature rise, and configuration is within specification. Refer to the appendix for further information.

Shop Order #2900

This transformer is a 500kVA AA indoor padmount. It has a 480V delta connected primary and a 208/120V grounded wye connected secondary. The transformer has a very high primary current and such no primary voltage taps are required. The primary winding is wound as two sections connected in parallel to supply the high current required. The tests performed on this unit were as follows:

<u>TEST</u>	<u>STATUS</u>
Coil Resistance	See test sheet.
Turns Ratio Test	See test sheet.
Pol. & Ph. Rot.	Tests okay.
No-Load Loss	The measured no-load loss = 1483 watts. This is less than the guaranteed maximum of 1600 watts.
Load Loss	The measured load loss = 6204 watts. This is greater than the guaranteed maximum of 5900 watts. This value is 9 watts over the +/- 5% tolerance level.
Impedance	The measured impedance = 6.22%. This value is slightly over the tolerance value.
Temperature Rise	AA measured (celsius) maximum = 54.5
Impulse Test	All tests passed at 30kV.
Applied Potential	Passed, no problems detected.
Induced Potential	Passed, no problems detected.
Partial Discharge	This transformer had to be partial discharge cested in transformer test bay #1. No problems were detected.

All factory tests passed. Note that a stripped out insulator on the primary bus was detected and replaced. During the impulse testing intermittent problems were encountered while testing the H3 terminal. Nothing was found out of order with the transformer. The test gear was reset then the tests were rerun and each test passed without incident. The problem was thus assumed to be in the test equipment.

Shop Order #2901

This transformer is a 1500kVA outdoor retrofit padmount unit. It has a 12000V delta primary and a 480/277V secondary. The following tests were performed on this unit:

<u>TEST</u>	<u>STATUS</u>
Coil Resistance	See test sheet.
Turns Ratio Test	See test sheet.
Pol. & Ph. Rot.	Tests okay.
No-Load Loss	The measured no-load loss = 3689 watts. This is below the guaranteed maximum of 3900 watts.
Load loss	The measured load loss = 9441 watts. This is below the guaranteed maximum of 9600 watts.
Impedance	The measured impedance = 5.6%. This is within tolerance.
Temperature Rise	AA temperature (celsius) maximum = 67.4
Impulse Test	Passed, no problems detected.
Applied Potential	Passed, no problems detected.
Induced Potential	Passed, no problems detected.
Partial Discharge	This transformer had an uncharacteristically good response under the partial discharge test. No problems were detected.

All tests on this unit went well. No problems were identified.

Shop Order #2902

This transformer is a 1500kVA outdoor retrofit padmount unit. It has a 12000V delta connected primary and a 480/277V grounded wye secondary. It will be installed to replace a temporary 3750kVA unit substation. The existing primary switch will be re-installed. The following tests were performed on this unit:

<u>TEST</u>	<u>STATUS</u>
Coil Resistance	See test sheet.
Turns Ratio Test	See test sheet.
Pos. & Ph. Rot.	Tests okay.

No-Load Loss	The measured no-load loss = 3759 watts. This value is below the guaranteed maximum of 3900 watts.
Load loss	The measured load loss = 9429 watts. This value is below the guaranteed maximum of 9600 watts.
Impedance	The measured impedance = 5.77%. Within tolerance.
Temperature Rise	Not received yet.
Impulse Test	Passed, no problems detected.
Applied Potential	Passed, no problems detected.
Induced Potential	Passed, no problems detected.
Partial Discharge	Passed.

The tests were all performed, however, the certified test report has not been received. The report was inadvertently not placed in the transmittal package. The test results presented for this unit were taken directly from my field notes. The temperature rise information is not available as I did not witness the overnight temperature rise tests. The data will be reviewed when the certified test report is received. Two of the high voltage bus sections have very sharp edges. These edges cause very high stress regions on the bus bars. I recommended that they grind the edges smooth to eliminate this problem. They agreed that it could cause a problem and stated that they would eliminate the sharp edges. Several problems were observed while performing the partial discharge tests. A majority of the problems were corrected by removing the buswork and adjusting the test apparatus connections to the coils. It was determined that no problems existed in the transformer coils. Removal of the sharp edges should eliminate a majority of the remaining problems.

Shop Order #2903

This unit has not been built. It is scheduled for construction by late November. No tests were performed on this unit.

Shop Order #2904

This transformer is a 500kVA outdoor padmount unit. It has a 12000V delta primary and a 4.1/277V secondary. The following tests were performed on this unit:

<u>TEST</u>	<u>STATUS</u>
Coil Resistance	See test sheet.
Turns Ratio Test	See test sheet.
Pol. & Ph. Rot.	Tests okay.
No-Load Loss	The measured no-load loss = 2244 watts. This is under the guaranteed maximum of 2400 watts.
Load Loss	The measured load loss = 4499 watts. This is under the guaranteed maximum of 4700 watts.
Impedance	The measured impedance = 5.57%. This is within tolerance.
Temperature Rise	Not received yet.
Impulse Test	All tests passed.
Applied Potential	Passed, no problems detected.
Induced Potential	Passed, no problems detected.
Partial Discharge	Passed.

The tests were all performed, however, the certified test report has not been received. The report will be sent with the one for unit #2902. The data will be reviewed when the report is received. Note that this unit did not have future forced air fan mounting brackets. These brackets should be added prior to shipping from National Industri. They informed me that the brackets would be added. We will want to follow up in the field and verify that they did get installed.

CONCLUSION:

The tests went well in spite of several challenges. Transformers #2897 through 2904 except #2903 are ready for installation. Unit #2903 will be completed in late november.



2520 58th Street
Hampton, Virginia 23661

NATIONAL INDUSTRI

Telephone
(804) 838-8080

Telex
82-3646

Telefax
(804) 838-8905

TRANSMITTAL LETTER

FOR

CERTIFIED TEST REPORT

RE: ABB SERVICE CO.
2382 E. ARTESIA BLVD.
LONG BEACH, CA 90805

DATE: 07 16 1987

SHOP ORDER NO: 28970

ATTENTION: ROGER RATICAN

JOB NAME: TBA

CUSTOMER: ABB SERVICE CO

P.O.NO: LS-01446-C

We are transmitting herewith four (4) copies of the Certified Test Report for your records.

If you have any questions, please do not hesitate to contact me.

Sincerely,

Patty Dorris
Admin. Assist. Mkt.



EB CORPORATION - A MEMBER OF THE ASEA BROWN BOVERI GROUP

CERTIFIED TEST REPORT

SHOP ORDER 02897-1 STYLE NO. 840750B057 TEST DATE 10-09-90

NOMINAL VOLTAGE: 12000 Delta / 480 Grd-Wye Three Phase 60 Hertz
 KVA: 750/1000 CLASS: AA/FA AVG WDG RISE: 75 DEG C.
 INSULATION RATED AT 185 DEGREE C BIL (kv): HV- 95 LV- 30

CUSTOMER: ABB SERVICE CO. PO# LS-01446-C
 LONG BEACH, CA. 90805

```

*****
*   *   *   *   *   *   *   *   *   *   *   *   *   *   *   *   *   *   *   *   *   *   *
* KVA * NO LOAD *   *   *   * TAP * LOAD *   *   * TOTAL SERIES *   *   *
*   * * LOSSES * % Iex *   *   * * LOSSES * % Z * RESISTANCE @ 95 C *   *   *
*   * * 24 C * 24 C *   *   * * 95 C * 95 C * PRIMARY SECONDARY *   *   *
*   * * (watts) *   *   * (volts) * (watts) *   *   * (ohms) (ohms) *   *   *
*****
*   *   *   *   *   *   *   *   *   *   *   *   *   *   *   *   *   *   *   *   *   *
* 750 * 2491 * 0.906 * 12000 * 5728 * 5.21 * 7.02239 * 0.002762 *
*   *   *   *   *   *   *   *   *   *   *   *   *   *   *   *   *   *   *   *   *
*****
    
```

```

*****
*   *   *   *   *   *   *   *   *   *   *   *   *   *   *   *   *   *   *   *   *
*   *   *   *   *   *   *   *   *   *   *   *   *   *   *   *   *   *   *   *   *
* APPLIED VOLTAGE *   *   *   * INDUCED VOLTAGE *   *   * NOMINAL RATIO *   *   *
* HV LV *   *   *   * 400 Hz, 18 SEC. *   *   *   *   *   *   *   *   *   *
* (kv) (kv) *   *   *   * (volts) *   *   *   *   *   *   *   *   *   *
*****
*   *   *   *   *   *   *   *   *   *   *   *   *   *   *   *   *   *   *   *   *
* 34 4 *   *   *   * 960 *   *   * A/B 43.405 *   *   *
*   *   *   *   *   *   *   *   *   *   *   *   *   *   *   *   *   *   *   *   *
*   *   *   *   *   *   *   *   *   *   *   *   *   *   *   *   *   *   *   *   *
*   *   *   *   *   *   *   *   *   *   *   *   *   *   *   *   *   *   *   *   *
*****
    
```

ANSI STANDARD IMPULSE TEST PERFORMED AT 95 KV BIL.

AA MEASURED TEMPERATURE RISE (C): HV - 73.1 LV - 60.8

FA MEASURED TEMPERATURE RISE (C): HV - 68.3 LV - 51.1

IMPEDANCE AND LOAD LOSSES AT TAPS:
 (1-2) = 5.10% AND 5445 WATTS, (5-6) = 5.28% AND 5787 WATTS.
 PARTIAL DISCHARGE TEST PERFORMED, SEE ATTACHED FOR TEST RESULTS.
 POWER FACTOR TEST PERFORMED AT 2.5 KV:
 H-G = .747, L-G = .350 AND H-L = .436

CERTIFICATION:

TEST TECHNICIAN *[Signature]* ENGINEER *[Signature]*

NATIONAL INDUSTRIES TRANSFORMERS, INC.
 HAMPTON, VA. 23661



PARTIAL DISCHARGE TEST DATA

SHOP ORDER 02897-1
 STYLE NO. 840750B057
 KVA 750
 TEST DATE OCTOBER 9, 1990

```

*****
* TOP * % VOLTAGE * COIL 1 * COIL 2 * COIL 3
*****
* * * * *
* INCEPTION * 150 * 40 pc * 20 pc * 20 pc
*****
* * * * *
* EXTINCTION * 110 * 5 pc * 10 pc * 10 pc
*****
  
```

```

*****
* BOTTOM * % VOLTAGE * COIL 1 * COIL 2 * COIL 3
*****
* * * * *
* INCEPTION * 150 * 10 pc * 20 pc * 50 pc
*****
* * * * *
* EXTINCTION * 110 * 3 pc * 10 pc * 15 pc
*****
  
```

TRANSFORMER IMPULSE TEST REPORT

Purchaser ARR SERVICE CO.
 Date of Test 10/10/90 Purchaser's Order No. LS-016 Mfr's. Ref. 84470-15
 Type CWV Phase 3 Hertz 60 Insulating Fluid _____
 H Winding 750 KVA X Winding 750 KVA Y Winding _____ KVA
12000 BETA-A Volts 4800004 12-77 Volts _____ Volts
9510 3L 30 kV 3L _____ 3L

Serial No.	Terminal Surged	Test	Crst Voltage KV	Wave Shape of Peak or Rise	Time to Reinover	Oscillogram Number	Swamp Time or Timing Wave Freq. 1/4 Sec.	Comments
12897-1	H-1	RFV	47.5	1.25/49 μ s		1	10	CRASH
		RFV				10	10	CRASH
		CWV	95		2.40 μ s	2	2	
		CWV	95		3.66 μ s	3	2	
		FV	95	1.25/49 μ s		4	10	
		FV				5	10	
	H-2	RFV	47.5	1.25/49 μ s		5	10	
		RFV				5	10	
		CWV	95		1.90 μ s	6	2	
		CWV	95		1.80 μ s	7	2	
		FV	95	1.25/49 μ s		8	10	
		FV				8	10	
	H-3	RFV	47.5	1.25/49 μ s		9	10	
		RFV				9	10	
		CWV	95		1.80 μ s	10	2	
		CWV	95		1.85 μ s	11	2	
		FV	95	1.25/49 μ s		12	10	
		FV				12	10	

• RFWV Reduced Full-Wave Voltage, RFWC Reduced Full-Wave Current, FWV Full-Wave Voltage, FWC Full-Wave Current, CWV Chopped-Wave Voltage, FCWV Front of Wave Volt. is.
 GRD Terminals grounded, ARR Terminals connected to arrester, RES Terminals connected to ground through linear resistance.

Tests Witnessed by Scott McBride (1646)

I hereby certify that this is a true report based on factory tests made in accordance with USA Standard Test Code for Distribution, Power and Regulating Transformers, C57.12 or latest revision thereof, and that each transformer withstood the above tests.

Signed [Signature] B-30 Date 10/10/90 Approved [Signature]

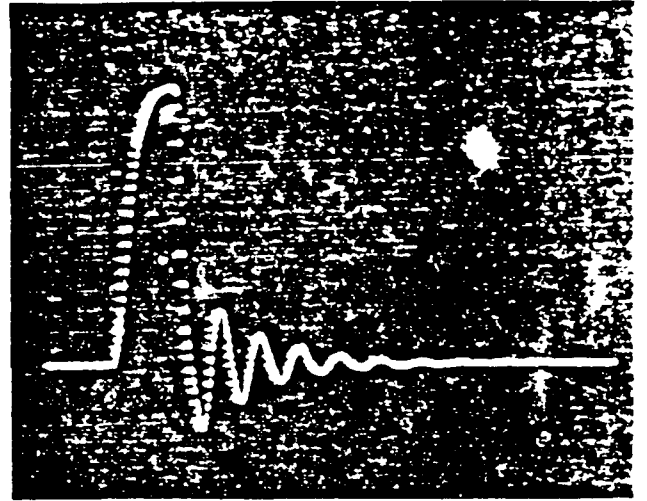
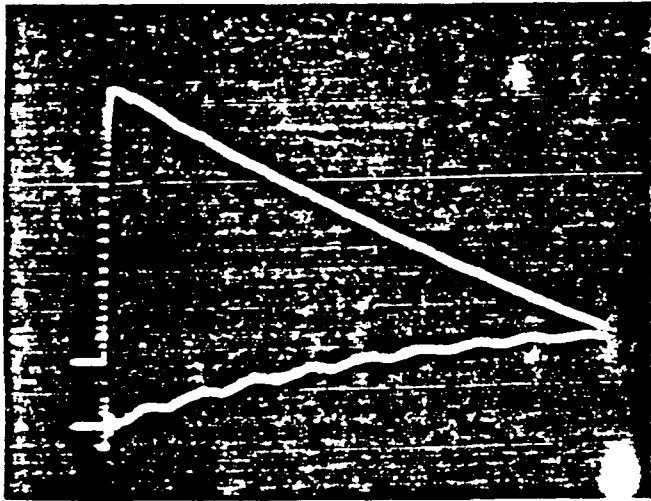

Graph 10-10-1950 10-10-1950 10-10-1950 10-10-1950 10-10-1950

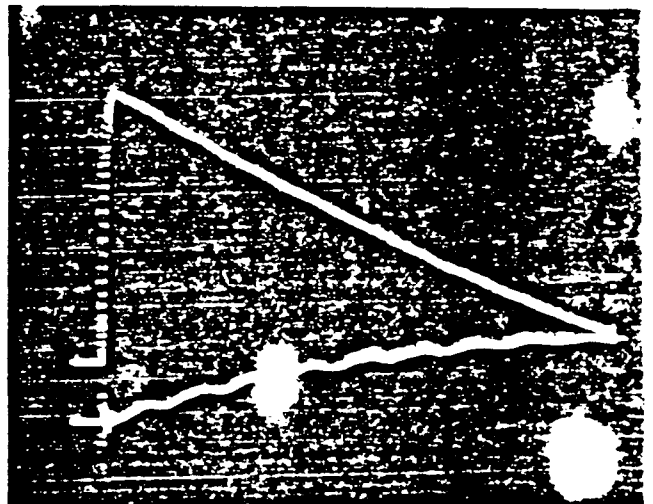
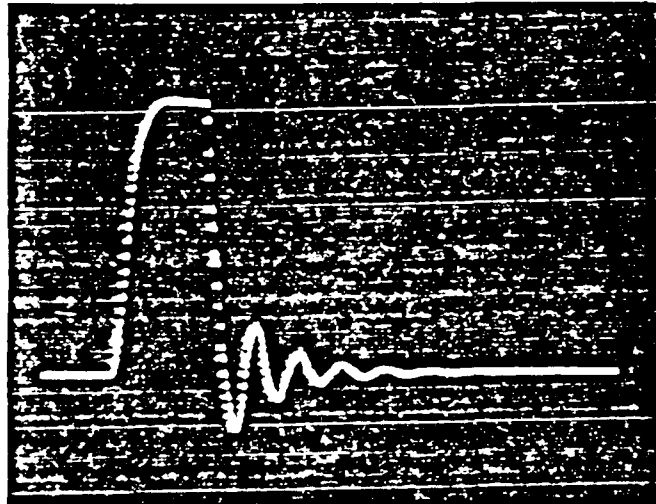

Graph 10-10-1950 10-10-1950 10-10-1950 10-10-1950 10-10-1950

10-10-1950

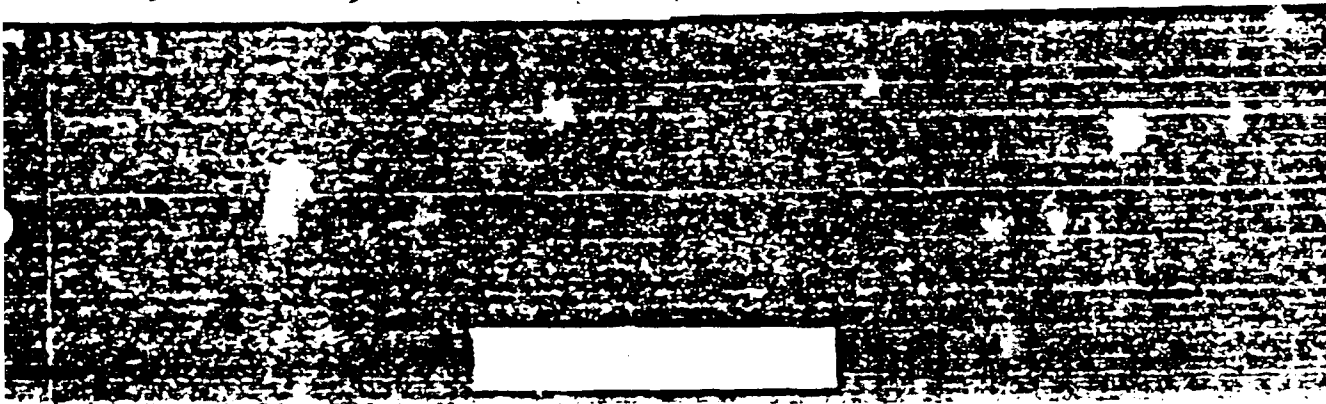
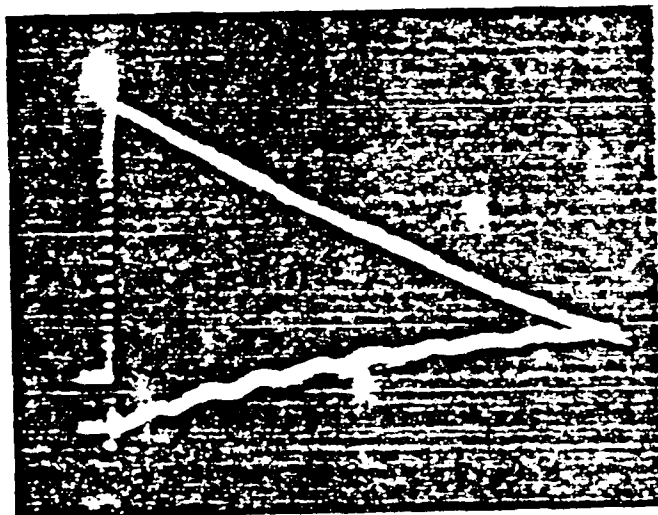
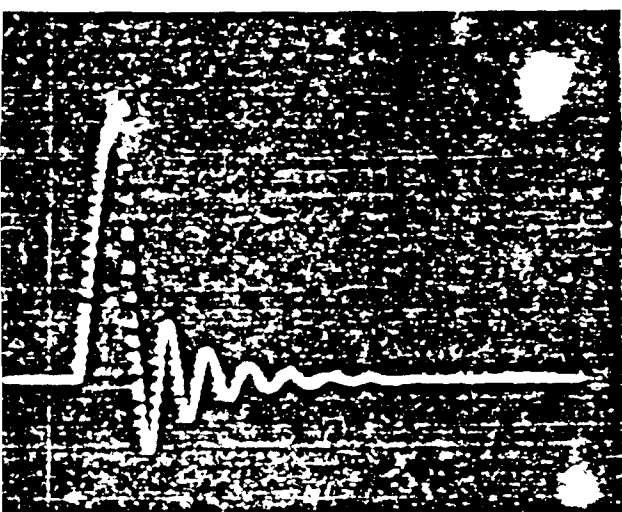
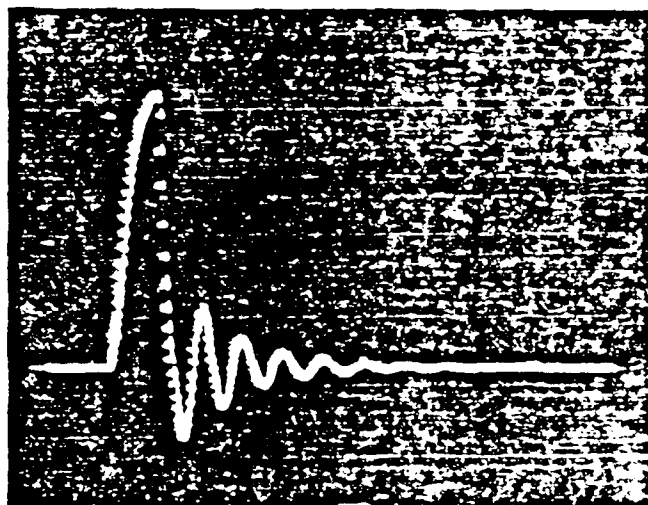
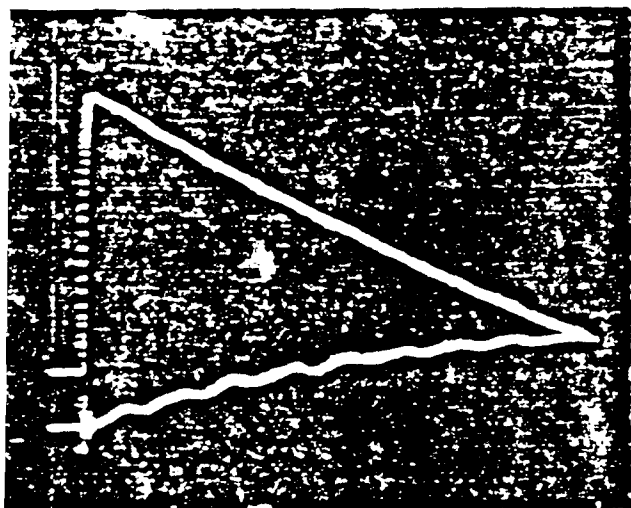

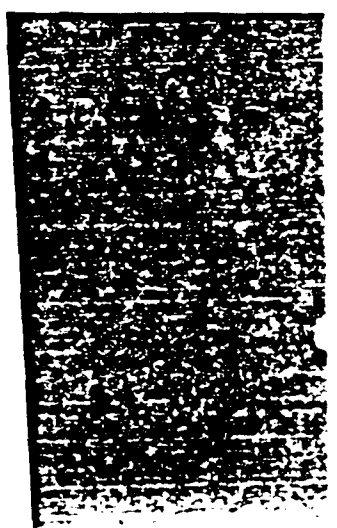
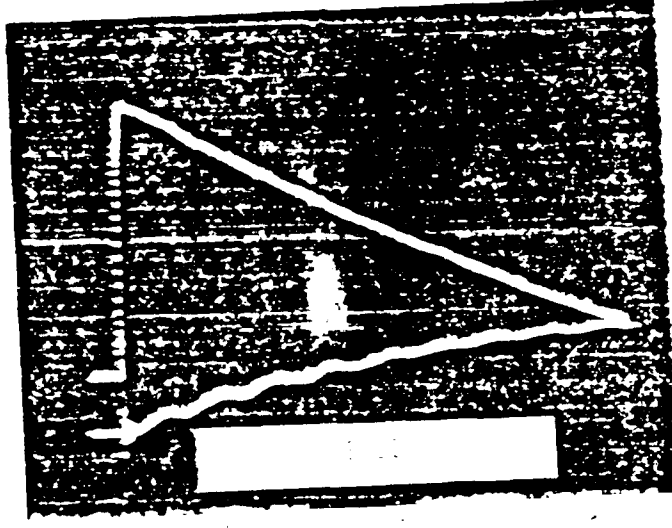
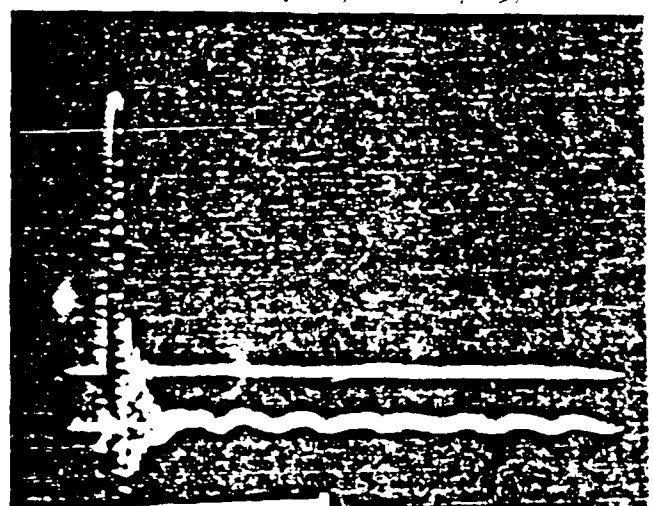
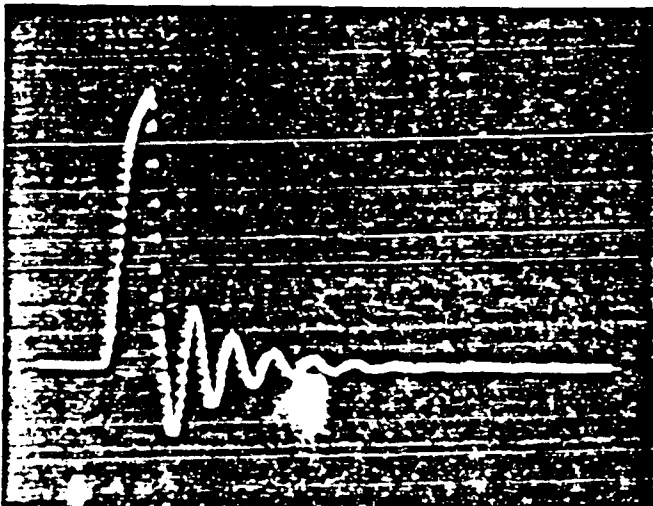
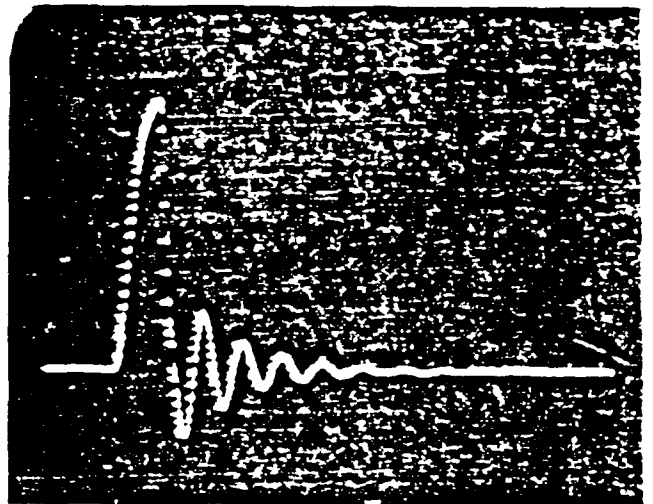
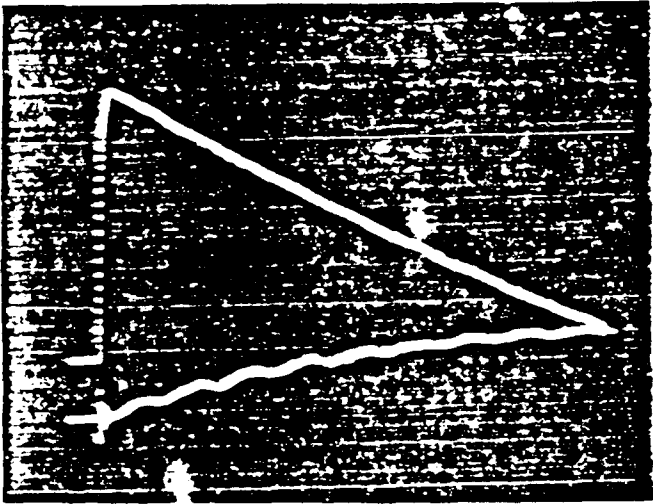

TRANSFORMER IMPULSE TEST REPORT

Purchaser APP SERVICES CO.

Date of Test 10/9/90 Purchaser's Order No. LS-01446-C Mfr's. Ref. SU-170-7057

Type CAT/CAST Phase 3 Hertz 60 Insulating Fluid _____
 H Winding 7500 KVA X Winding 750 KVA Y Winding _____ KVA
2400 DELTA Volts 4750 LRV/1277 Volts _____ Volts
3.0k SIL 2.0k SIL _____ SIL

Serial No.	Terminal Surged	Test	Crest Voltage KV	Wave Shape or Rise of Rise	Time to Recover	Oscillogram Number	Speed Time or Timing Wave Prod. 4 Sec.	Connect of Lines Minor Terminals
97-1A	H-1	RFWV	15	1.33/59 μ s		1	10	Grounded through
		RFWC				1c	10	Grounded through
		CMV	30		1.35 μ s	2	2	
		CMV	3		1.35 μ s	3	2	
		FWV	30	1.33/59 μ s		4	10	
		FVC				4c	10	
	H-2	RFWV	15	1.33/59 μ s		5	10	
		RFWC				5c	10	
		CMV	30		1.50 μ s	6	2	
		CMV	30		1.50 μ s	7	2	
		FWV	30	1.33/59 μ s		8	10	
		FVC				8c	10	
	H-3	RFWV	15	1.33/59 μ s		9	10	
		RFWC				9c	10	
		CMV	30		1.35 μ s	10	2	
		CMV	30		1.45 μ s	11	2	
		FWV	30	1.33/59 μ s		12	10	
		FVC				12c	10	

• RFWV Reduced Full-Wave Voltage, RFWC Reduced Full-Wave Current, FWV Full-Wave Voltage, FVC Full-Wave Current, CMV Crossed-Wave Voltage, FOWV Front of Wave Voltage.

GRD Terminals grounded, ARR Terminals connected to arresters, RES Terminals connected to ground through linear resistance.

Tests Witnessed by Scott McPride (5646)

I hereby certify that this is a true report based on factory tests made in accordance with USA Standard Test Code for Distribution, Power and Regulating Transformers, CS7.12 or latest revision thereof; and that each transformer withstood the above tests.

B-34

Signed Scott McPride Date 10/10/90 Approved Bill Owens

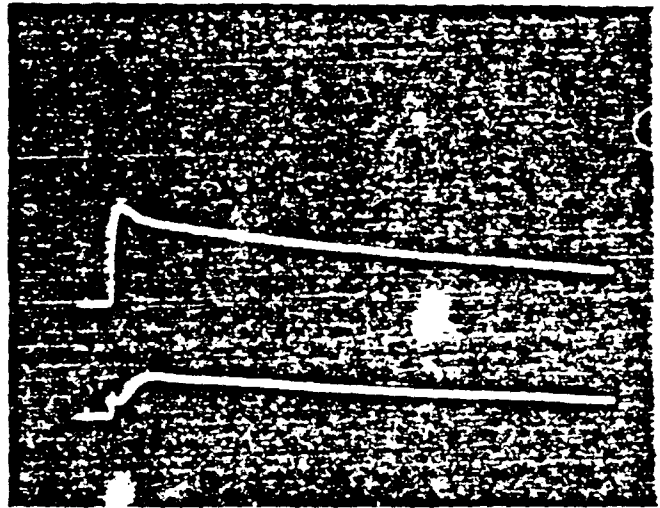
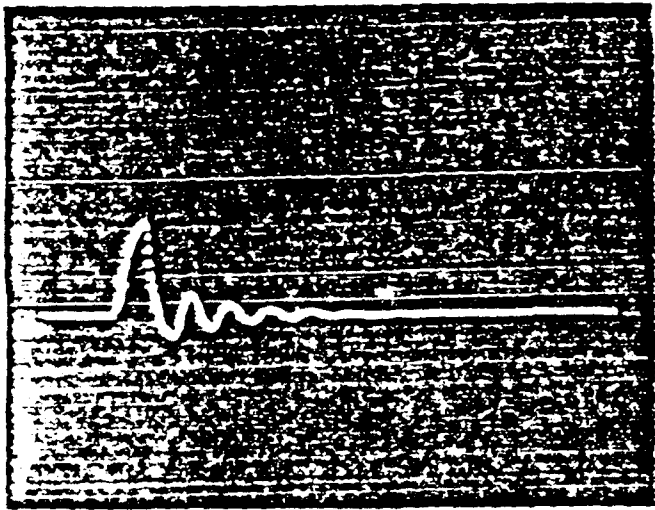
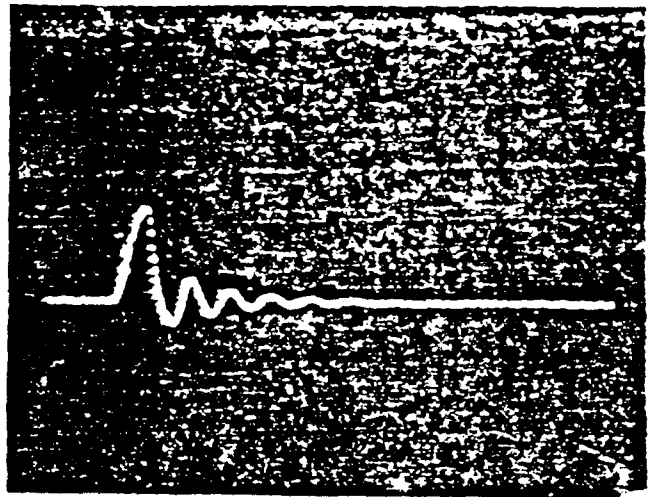
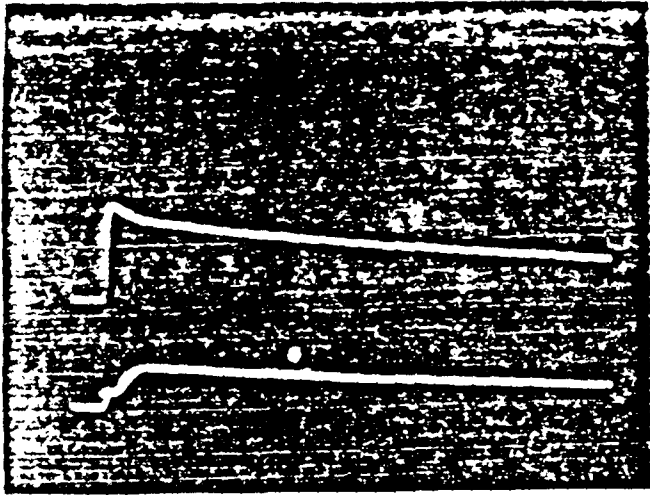

8-88

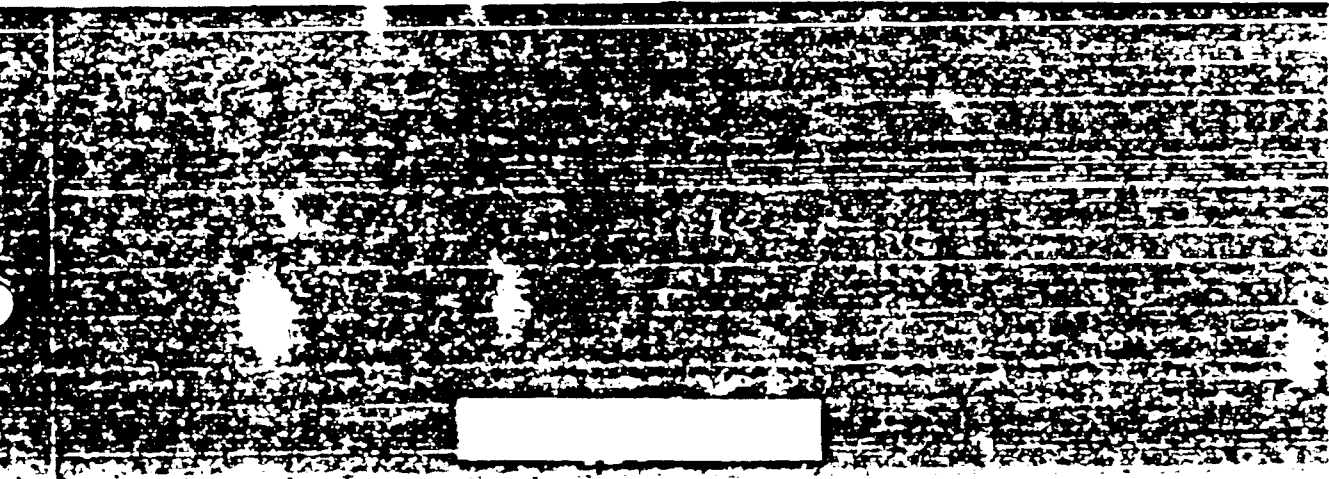
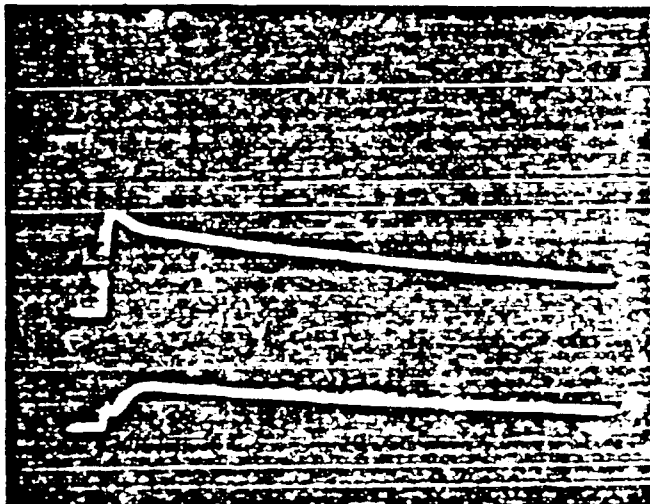
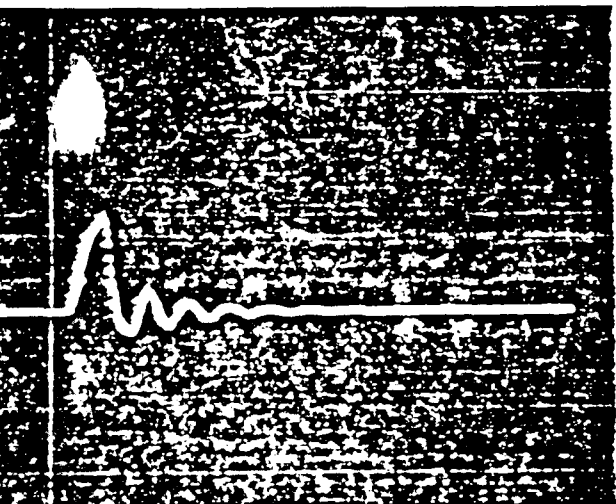
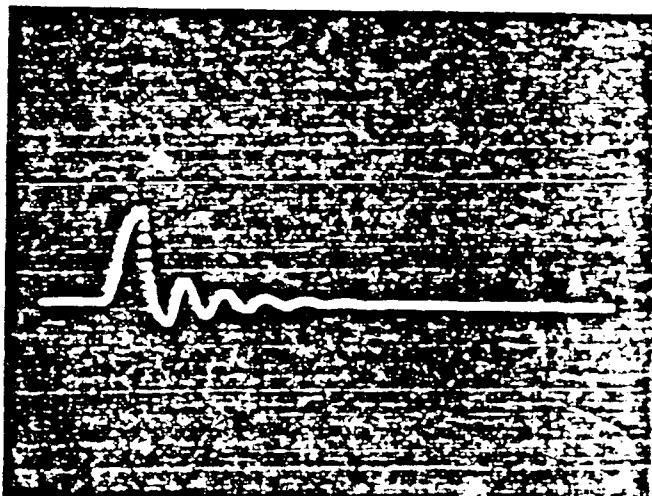
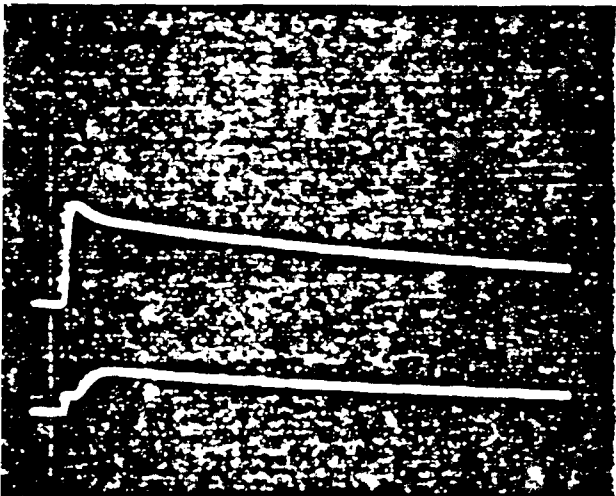
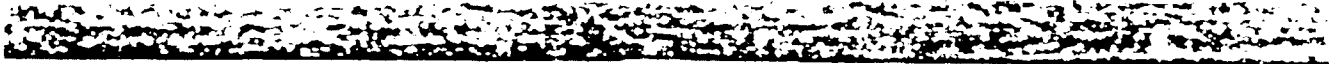

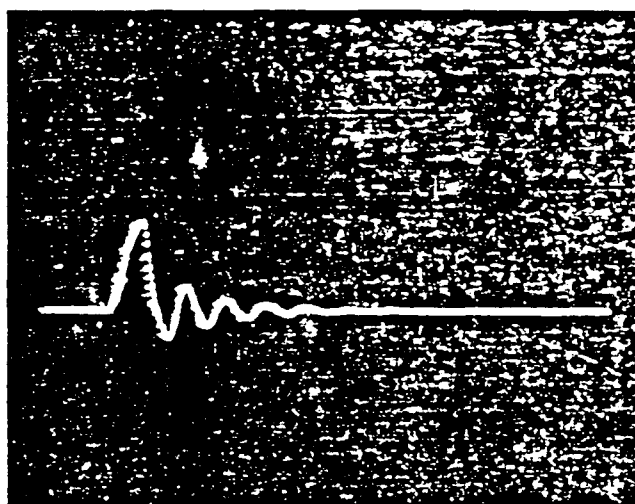
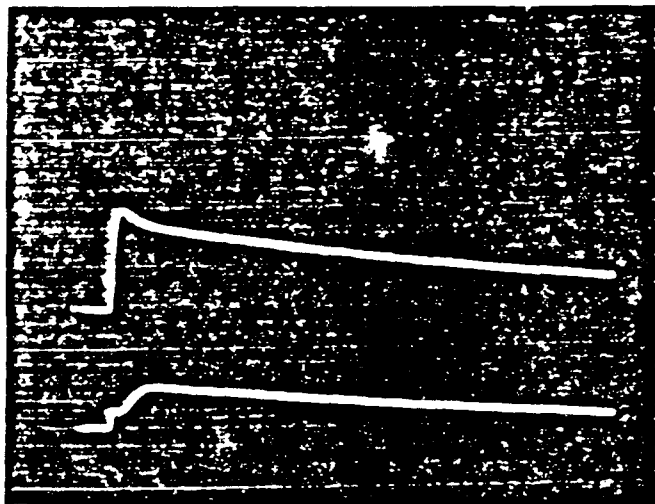

ECG tracing showing a regular rhythm with a narrow QRS complex and a prominent ST segment depression.

ECG tracing showing a regular rhythm with a narrow QRS complex and a prominent ST segment depression.

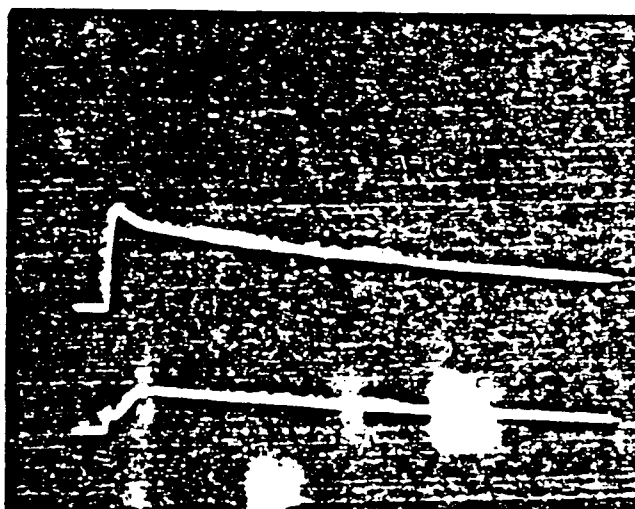
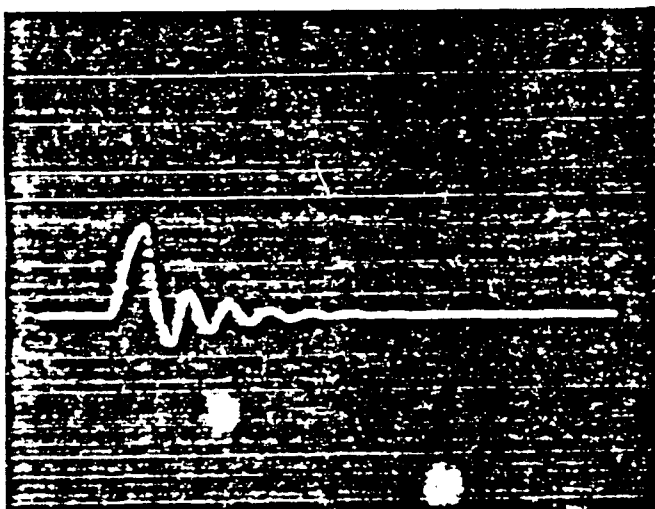

ECG tracing showing a regular rhythm with a narrow QRS complex and a prominent ST segment depression.

ECG tracing showing a regular rhythm with a narrow QRS complex and a prominent ST segment depression.

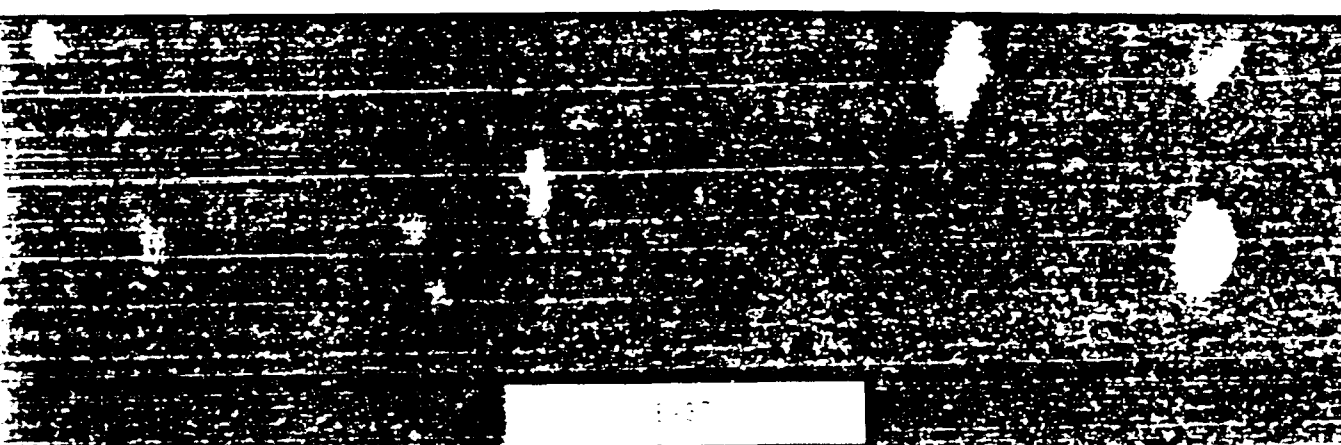

ECG tracing showing a regular rhythm with a narrow QRS complex and a prominent ST segment depression.

EB NATIONAL INDUSTRI

2520 58th Street
Hampton, Virginia 23661

Telephone
(804) 838-8080

Telex
82-3646

Telefax
(804) 838-8905

TRANSMITTAL LETTER

FOR

CERTIFIED TEST REPORT

RE: ABB SERVICE CO.
2382 E. ARTESIA BLVD.
LONG BEACH, CA 90805

DATE: OCT 16 1990

SHOP ORDER NO: 28980

ATTENTION: ROGER RATICAN

JOB NAME: TBA

CUSTOMER: ABB SERVICE CO

P.O.NO: LS-0 6-C

We are transmitting herewith four (4) copies of the Certified Test Report for your records.

If you have any questions, please do not hesitate to contact me.

Sincerely,

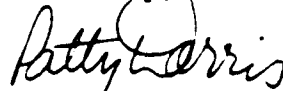

Patty Dorris
Admin. Assist. Mkt.

ABB
A SEA BROWN BOVERI GROUP

E-38

EB CORPORATION - A MEMBER OF THE ASEA BROWN BOVERI GROUP

PARTIAL DISCHARGE TEST DATA

SHOP ORDER 02898-1
STYLE NO. 810300B001
KVA 300
TEST DATE OCTOBER 8, 1990

```
*****  
* TOP * % VOLTAGE * COIL 1 * COIL 2 * COIL 3 *  
*****  
* * * * *  
*INCEPTION * 150 * 32 pc * 35 pc * 32 pc *  
*****
```

```
*****  
* BOTTOM * % VOLTAGE * COIL 1 * COIL 2 * COIL 3 *  
*****  
* * * * *  
*INCEPTION * 150 * 35 pc * 35 pc * 31 pc *  
*****
```

TRANSFORMER IMPULSE TEST REPORT

Purchaser W. H. Service Co.

Date of Test 10/15/79 Purchaser's Order No. LS-1001-C Mfr's. Ref. 21520-11

Type CAST/CAST Phase 3 Hertz 60 Insulating Fluid _____
 H Winding 300 KVA X Winding 300 KVA Y Winding _____ KVA
480 DELTA Volts 208-220/120 Volts _____ Volts
30 kV 9IL 30 kV 9IL _____ 9IL

Serial No.	Terminal Surged	Test	Crust Voltage KV	Wave Shape or Rate of Rise	Time to Reinover	Oscillogram Number	Sweep Time or Timing Wave Freq. 4 Sec.	Cor. or N. T. er	
02598-1	H-1	RFW	15	1.50/47 μ s		1	10	Grow 400	
		RFWC				1c	10	Cur 500	
		CW	30		1.55 μ s	2	2		
		CW	30		1.35 μ s	3	2		
		FW	30	1.50/47 μ s		4	10		
		FWC				4c	10		
	H-2	RFW	15	1.50/47 μ s			5	10	
		RFWC					5c	10	
		CW	30		1.65 μ s		6	2	
		CW	30		1.4 μ s		7	2	
		FW	30	1.50/47 μ s			8	10	
		FWC					8c	10	
H-3	RFW	15	1.50/47 μ s			9	10		
	RFWC					9c	10		
	CW	30		1.50 μ s		10	2		
	CW	30		1.4 μ s		11	2		
	FW	30	1.50/47 μ s			12	10		
	FWC					12c	10		

• RFWV Reduced Full-Wave Voltage. RFWC Reduced Full-Wave Current. FWV Full-Wave Voltage. FWC Full-Wave Current. CWV Chopped-Wave Voltage. FCWV Front of Wave Voltage.
 GRD Terminals grounded. ARR Terminals connected to arresters. RES Terminals connected to ground through line resistance.

Tests Witnessed by Scott McRae

I hereby certify that this is a true report based on factory tests made in accordance with USA Standard Test Code for Distribution, Power and Regulating Transformers, C57.12 or latest revision thereof; and that each transformer withstood the above tests.

Signed [Signature] Date 10/15/79 [Signature]

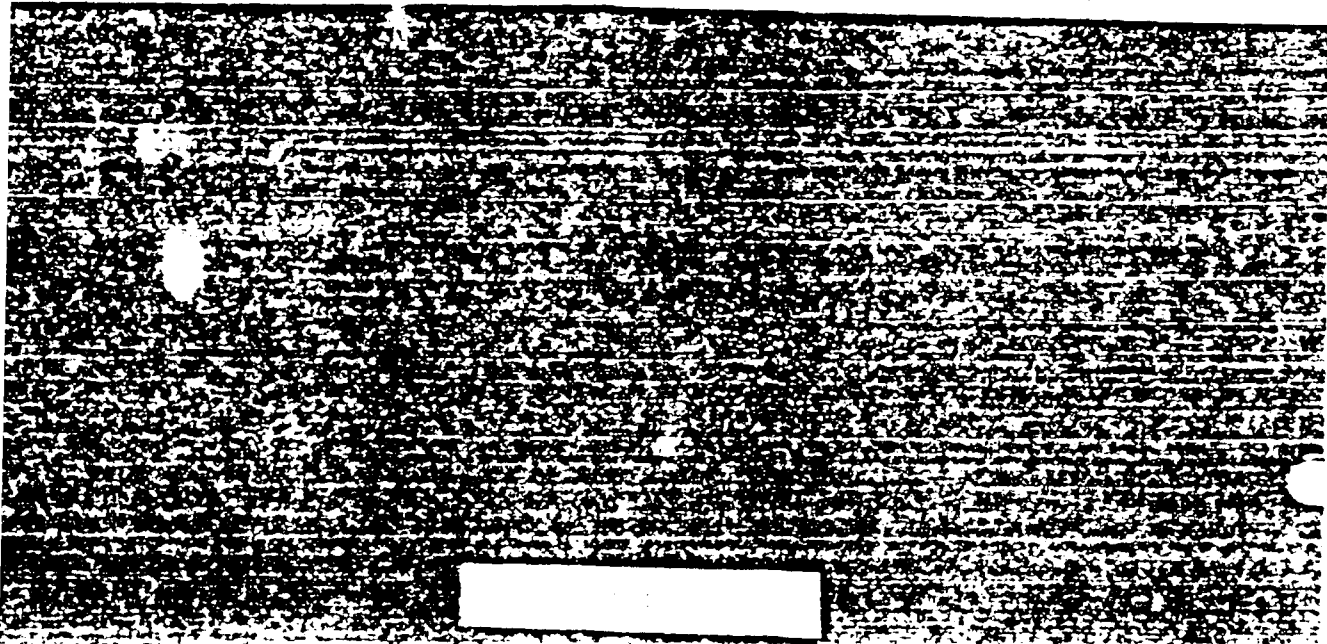
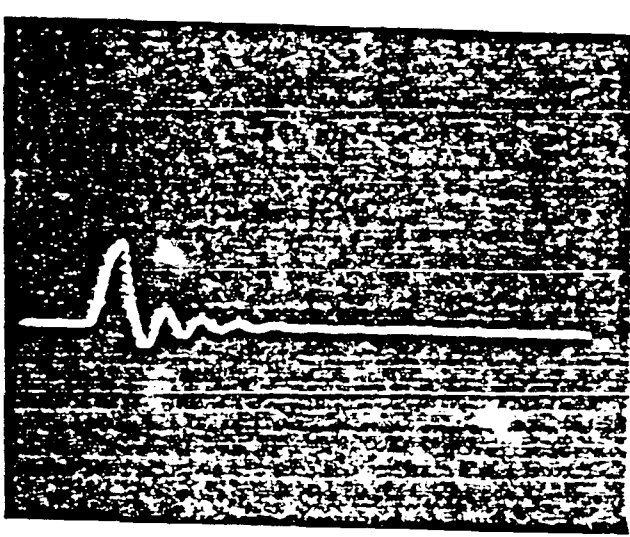
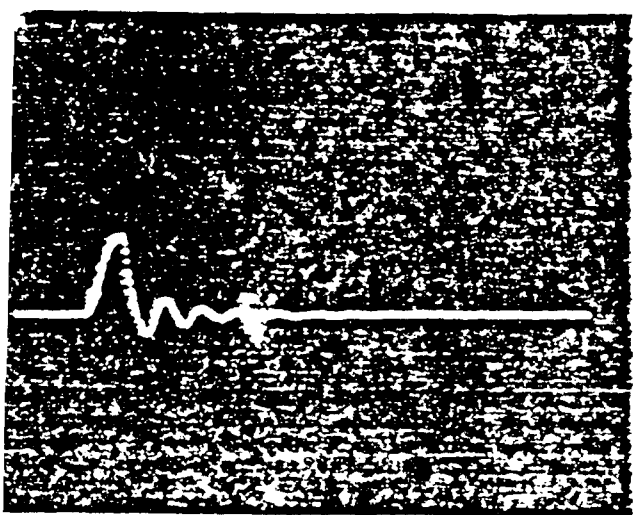
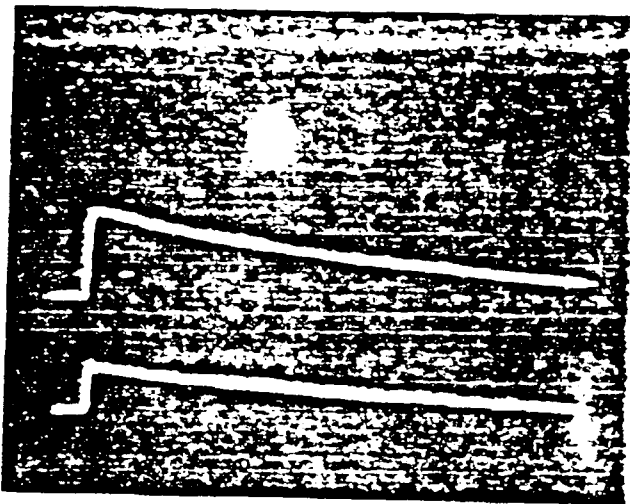
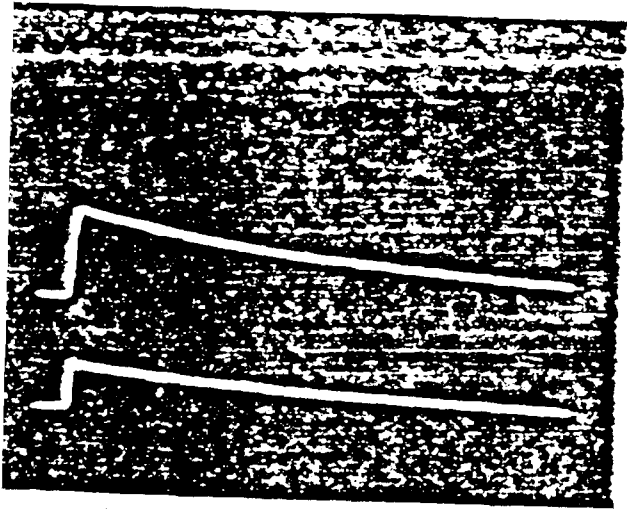

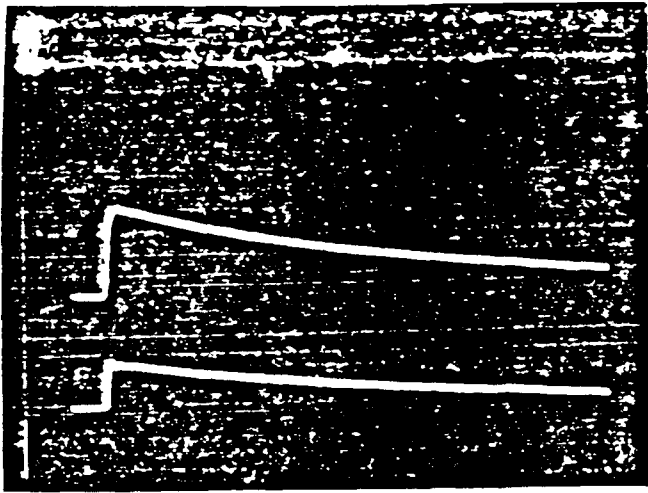

ECG tracing showing a regular rhythm with a narrow QRS complex and a T wave.

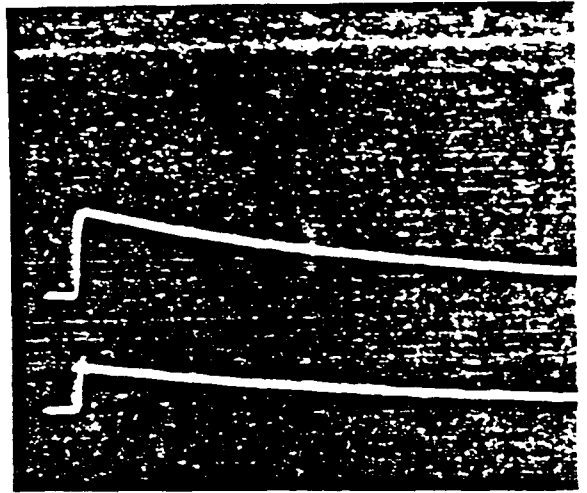

ECG tracing showing a regular rhythm with a narrow QRS complex and a T wave.

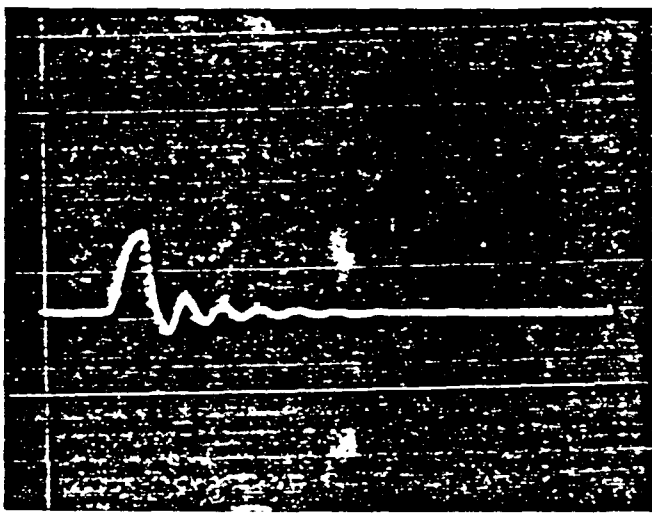

ECG tracing showing a regular rhythm with a narrow QRS complex and a T wave.

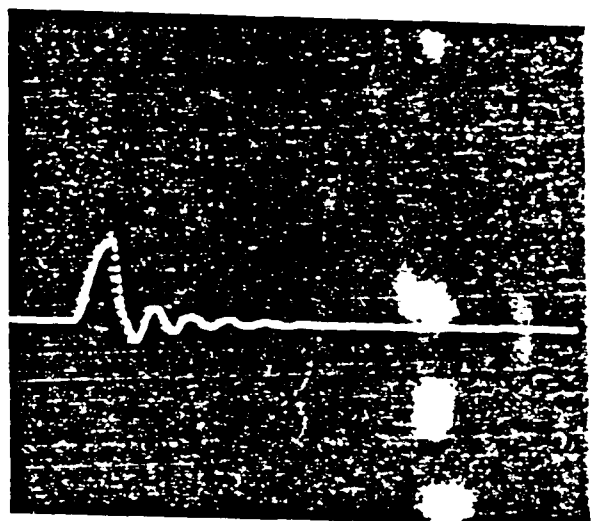

ECG tracing showing a regular rhythm with a narrow QRS complex and a T wave.

ECG tracing showing a regular rhythm with a narrow QRS complex and a T wave.

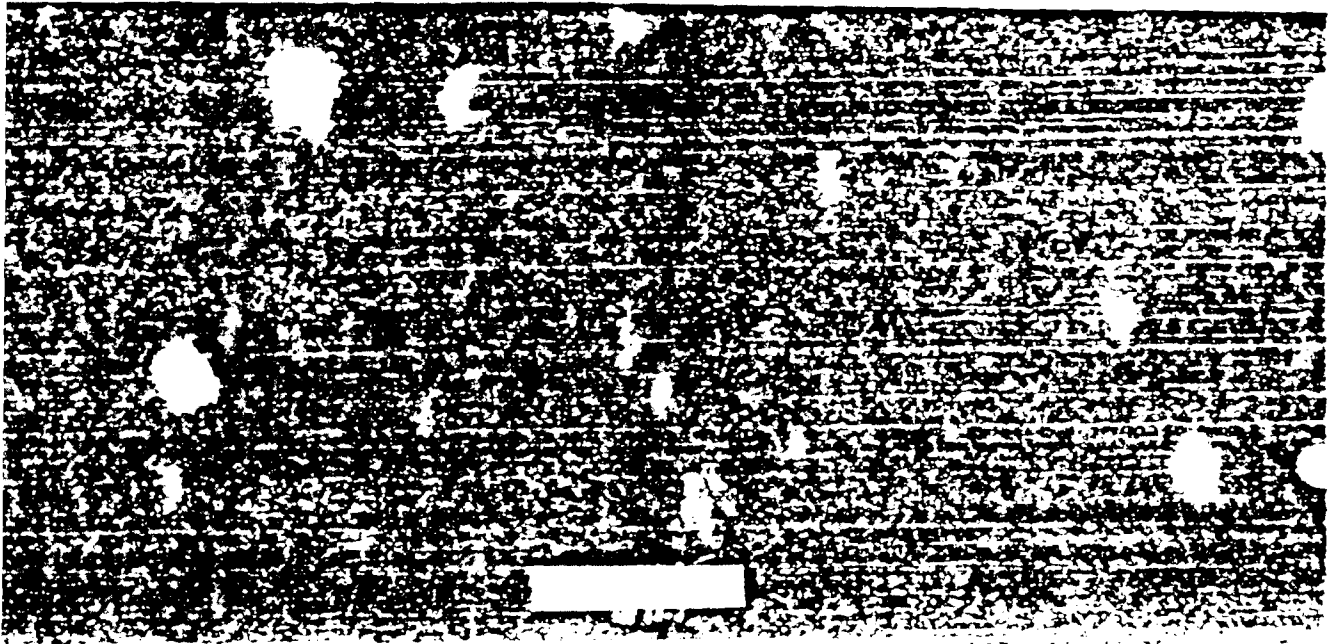
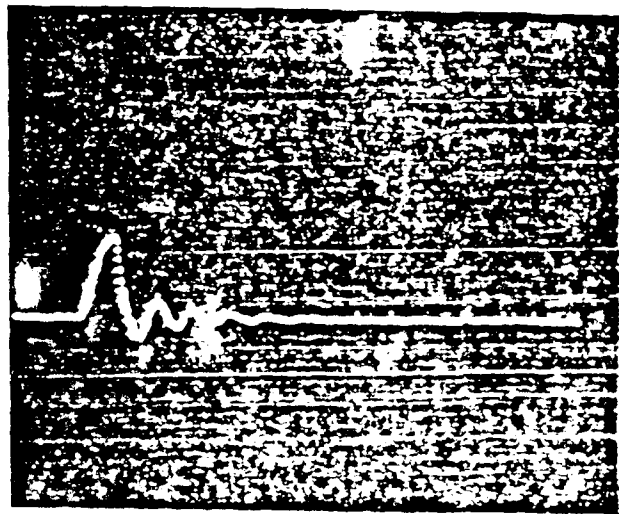
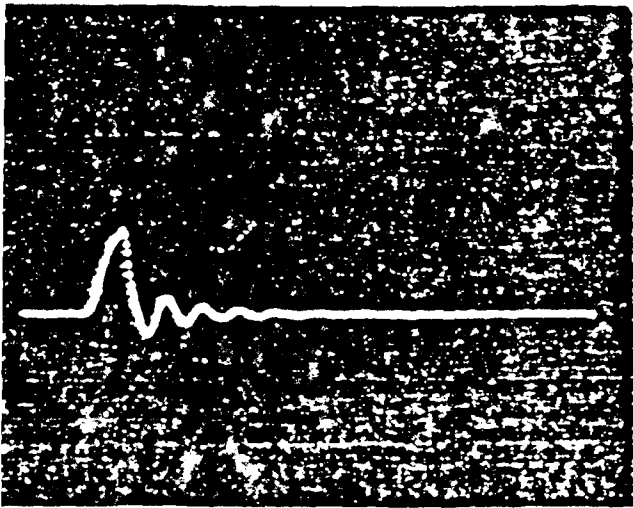
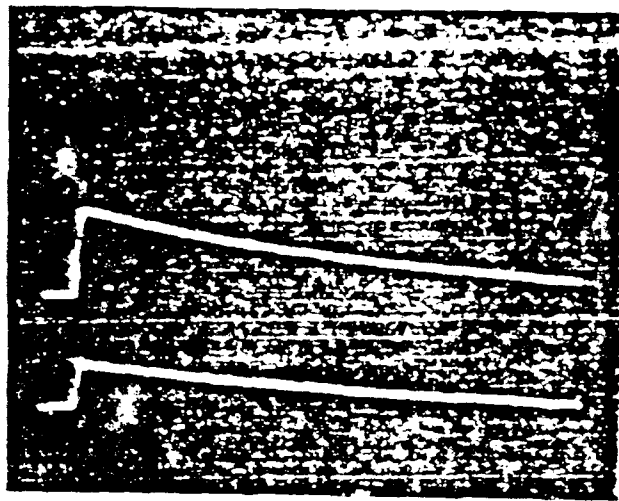
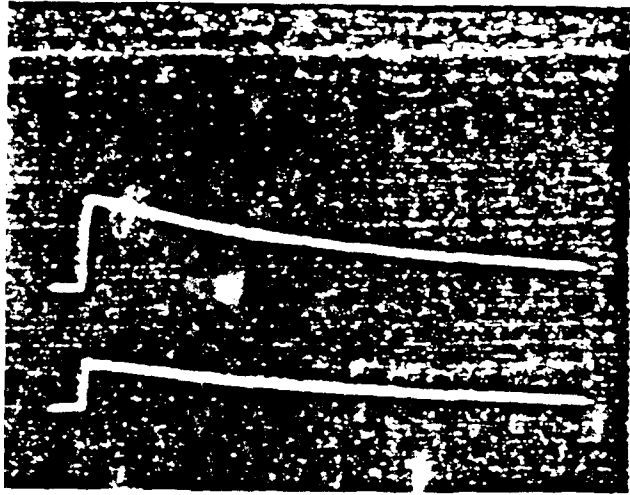

EB NATIONAL INDUSTRI

2520 58th Street
Hampton, Virginia 23661

Telephone
(804) 838-8080

Telex
82-3646

Telefax
(804) 838-8905

TRANSMITTAL LETTER
FOR
CERTIFIED TEST REPORT

RE: ABB SERVICE CO.
2382 E. ARTESIA BLVD.
LONG BEACH, CA 90805

DATE: OCT 16 1990
SHOP ORDER NO: 028990

ATTENTION: ROGER RATICAN

JOB NAME: TBA

CUSTOMER: ABB SERVICE CO.

P.O.NO: LS-01446-C

We are transmitting herewith four (4) copies of the Certified Test Report for your records.

If you have any questions, please do not hesitate to contact me.

Sincerely,



Libby Smith
Customer Service Supervisor

ABB
A SEA BROWN BOVERI

B-45

EB CORPORATION - A MEMBER OF THE ASEA BROWN BOVERI GROUP

CERTIFIED TEST REPORT

SHOP ORDER 02899-1 STYLE NO. 840750B056 TEST DATE 10-15-90

NOMINAL VOLTAGE: 12000 Delta / 480 Grd-Wye Three Phase 60 Hertz
 KVA: 750/1000 CLASS: AA/FA AVG WDG RISE: 75 DEG.C
 INSULATION RATED AT 185 DEGREE C BIL (kv): HV- 95 LV- 30

CUSTOMER: ABB SERVICE CO. PO# LS-01446-C
 LONG BEACH, CA 90805

KVA	NO LOAD	TAP	LOAD	TOTAL SERIES
LOSSES	% I _{ex}	LOSSES	% Z	RESISTANCE @ 95 C
22 C	22 C	95 C	95 C	PRIMARY SECONDARY
(watts)	(volts)	(watts)	(ohms)	(ohms)
750	2022	0.647	12000	5159
				5.41
				6.02399
				0.002718

APPLIED VOLTAGE	INDUCED VOLTAGE	NOMINAL RATIO
HV LV	400 Hz, 18 SEC.	
(kv) (kv)	(volts)	
34 4	960	A/B 43.271
		C/A 43.259
		B/C 43.260

ANSI STANDARD IMPULSE TEST PERFORMED AT 95 KV BIL.

AA MEASURED TEMPERATURE RISE (C): HV - 63.6 LV - 63.2

FA MEASURED TEMPERATURE RISE (C): HV - 56.9 LV - 50.2

IMPEDANCE AND LOAD LOSSES AT TAPS:

(1-2) = 5.33% AND 5020 WATTS, (5-6) = 5.52% AND 5340 WATTS.

PARTIAL DISCHARGE TEST PERFORMED, SEE ATTACHED FOR TEST RESULTS.

POWER FACTOR TEST PERFORMED AT 2.5 KV:

H-G = .805, L-G = .495 AND H-L = .182

CERTIFICATION:

TEST TECHNICIAN

[Signature]

ENGINEER

[Signature]

NATIONAL INDUSTRI TRANSFORMERS, INC.
 HAMPTON, VA. 23661



PARTIAL DISCHARGE TEST DATA

SHOP ORDER C2899-1
 STYLE NO. 840750B056
 FVA 750
 TEST DATE OCTOBER 15, 1990

```
*****
* TOP * % VOLTAGE * COIL 1 * COIL 2 * COIL 3 *
*****
* * * * *
* INCEPTION * 150 * 5 pc * 3 pc * 5 pc *
*****
* * * * *
* EXTINCTION * 110 * 0 pc * 0 pc * 0 pc *
*****
```

```
*****
* BOTTOM * % VOLTAGE * COIL 1 * COIL 2 * COIL 3 *
*****
* * * * *
* INCEPTION * 150 * 5 pc * 3 pc * 3 pc *
*****
* * * * *
* EXTINCTION * 110 * 5 pc * 3 pc * 3 pc *
*****
```



TRANSFORMER IMPULSE TEST REPORT

Purchaser AAA SERVICES
 Date of Test 12/16/90 Purchaser's Order No. LS-01446-C Mfr's. Ref. 84.0750-PO56
 Type 1AT/1AT Phase 3 Hertz 60 Insulating Fluid _____
 H Winding 750 KVA X Winding 750 KVA Y Winding _____ KVA
12000 DFLIA Volts 480-480/277 Volts _____ Volts
95K 3L 30K 3L _____ 3L

Serial No.	Terminal Surged	Test	Crest Voltage kV	Wave Shape of Peak of Peak	Time to Repower	Oscillogram Number	Sweep Time or Timing Wave Freq. 4 Sec.	Comments of JTR or WNC
P-2-1	H-1	RFW	47.5	125/50ns		1	10	Good
		RFWC				10	10	Current
		CVW	95		1.90ps	2	2	
		FWV	95		1.75ps	3	2	
		FVW	95	125/50ns		4	10	
		FVC				40	10	
H-2	H-2	RFW	47.5	125/50ps		5	10	
		RFWC				50	10	
		CVW	95		1.90ps	6	2	
		FWV	95		1.80ps	7	2	
		FVW	95	125/50ns		8	10	
		FVC				80	10	
H-3	H-3	RFW	47.5	125/50ps		9	10	
		RFWC				90	10	
		CVW	95		2.0ps	10	2	
		FWV	95		1.85ps	11	2	
		FVW	95	125/50ps		12	10	
		FVC				120	10	

• RFW Reduced Full-Wave Voltage. RFWC Reduced Full-Wave Current. FWV Full-Wave Voltage. FVC Full-Wave Current. CVW Chopped-Wave Voltage. FWV Front of Wave Voltage.

GRD Terminals grounded. ARR Terminals connected to arresters. RES Terminals connected to ground through linear resistance.

Tests Witnessed by _____
 I hereby certify that this is a true report based on factory tests made in accordance with USA Standard Test Code for Distribution, Power and Regulating Transformers, C57.12 or latest revision thereof, and that each transformer withstood the above tests.

B-48

Signed [Signature] Date 10/16/90 Approved [Signature]

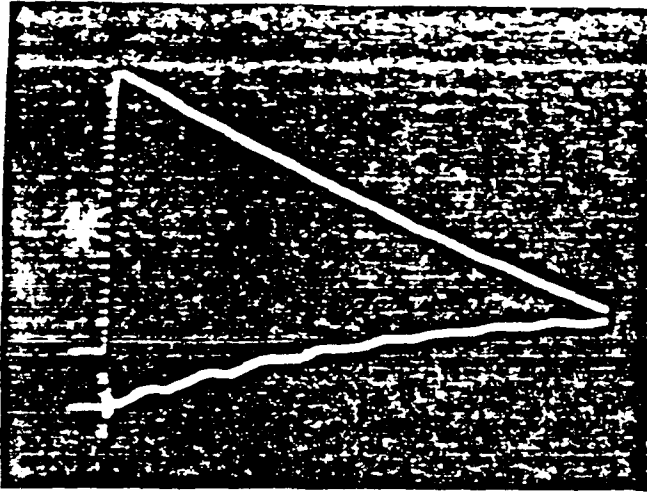

Figure 1 - 10/10/50 - 10/10/50

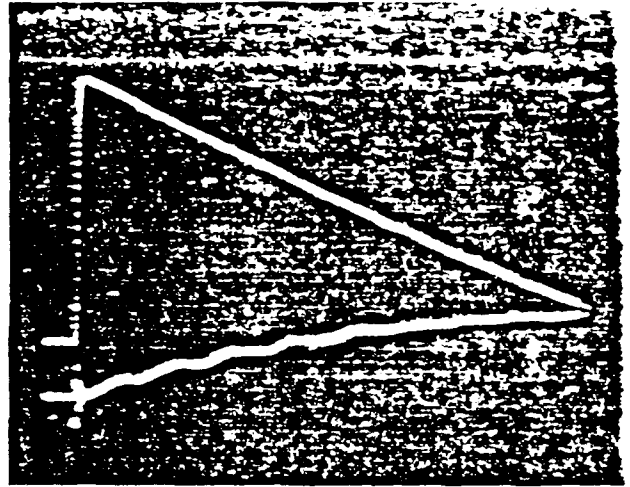

Figure 2 - 10/10/50 - 10/10/50

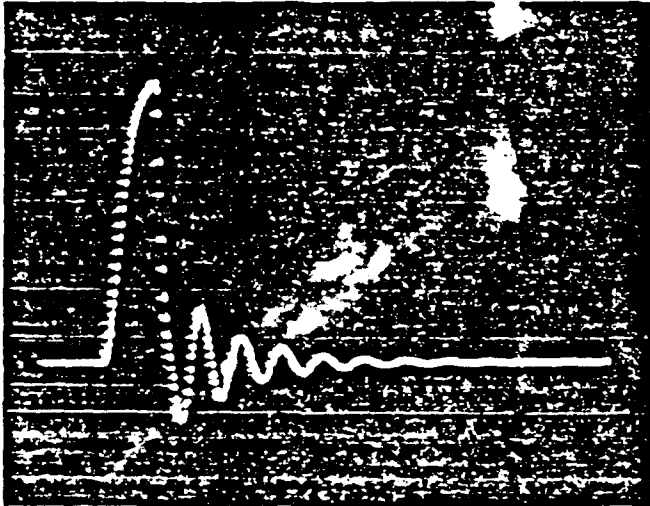

Figure 3 - 10/10/50 - 10/10/50

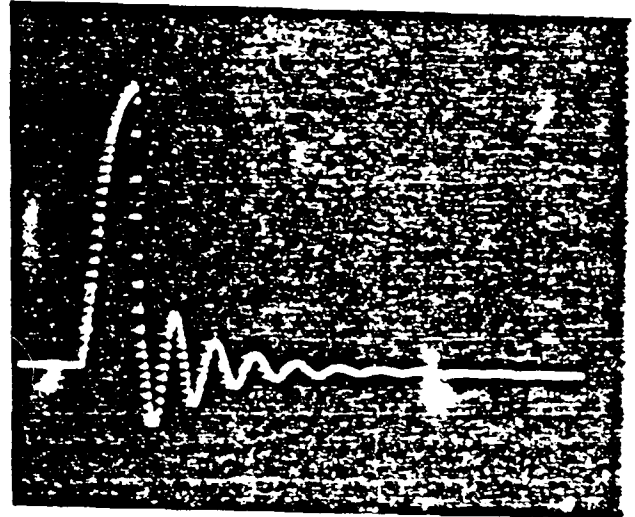
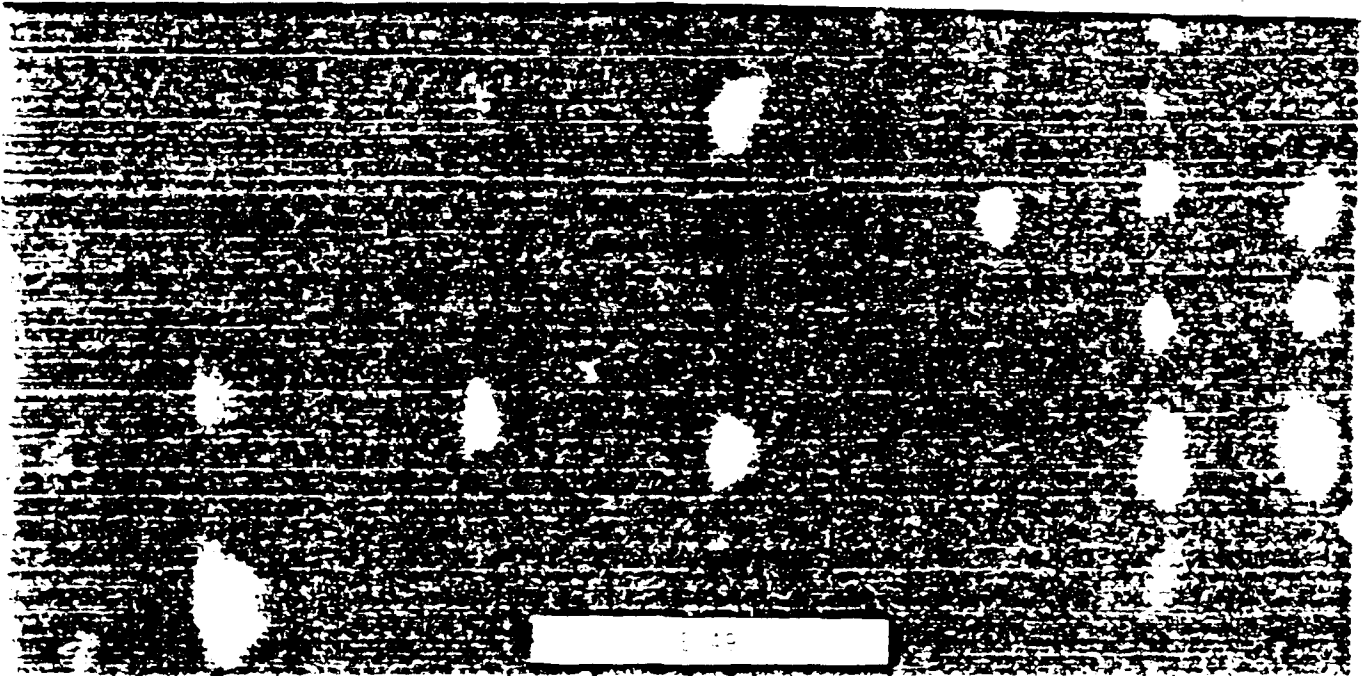
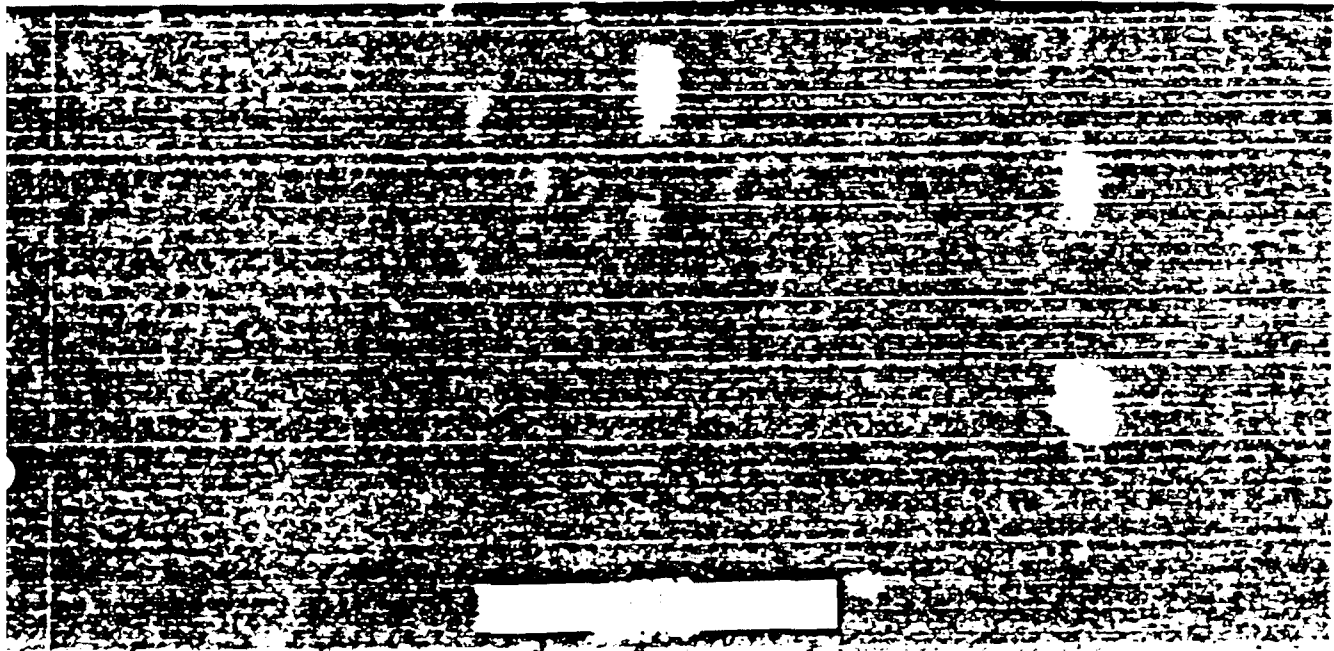
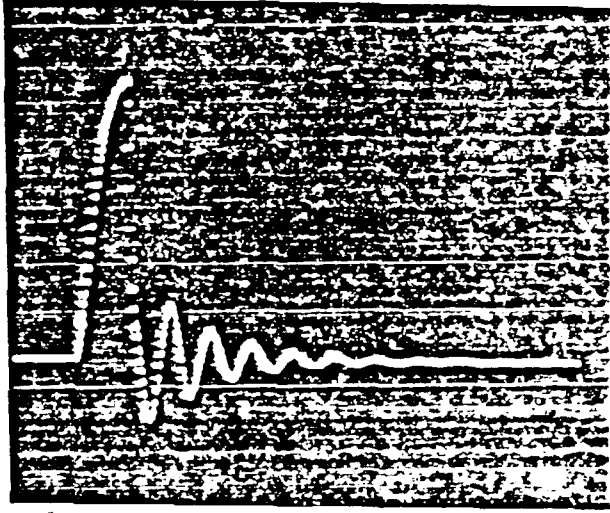
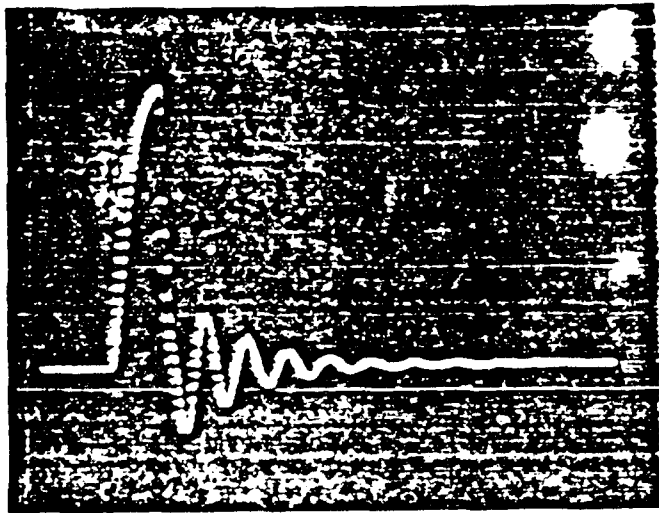
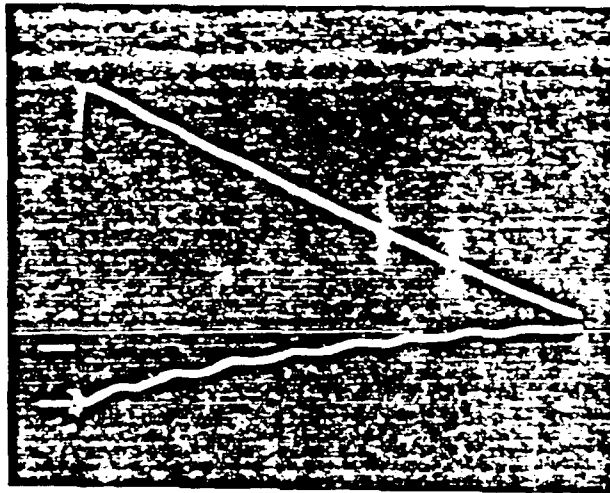
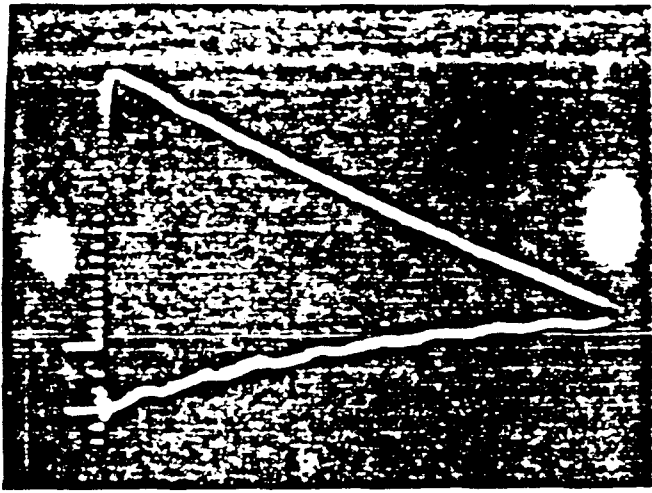
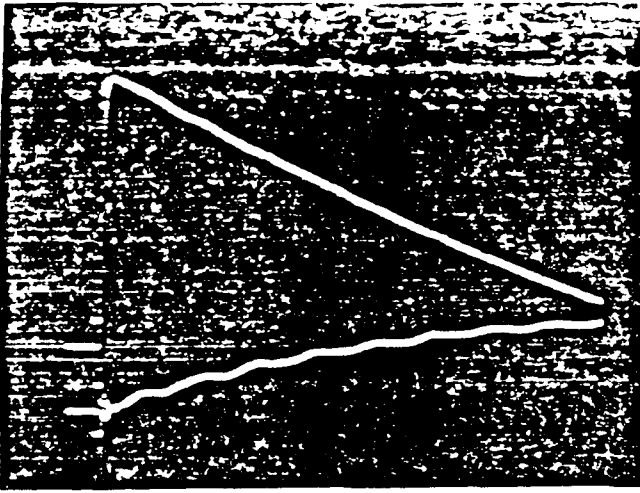

Figure 4 - 10/10/50 - 10/10/50







12-14-59, 12-14-59, 12-14-59, 12-14-59, 12-14-59

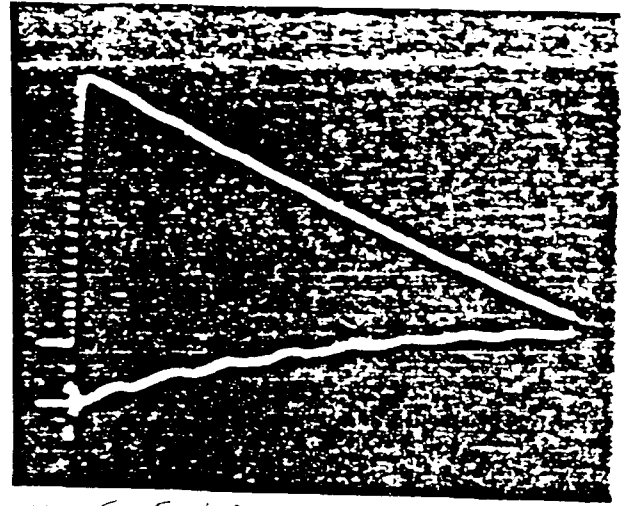

12-14-59, 12-14-59, 12-14-59, 12-14-59, 12-14-59

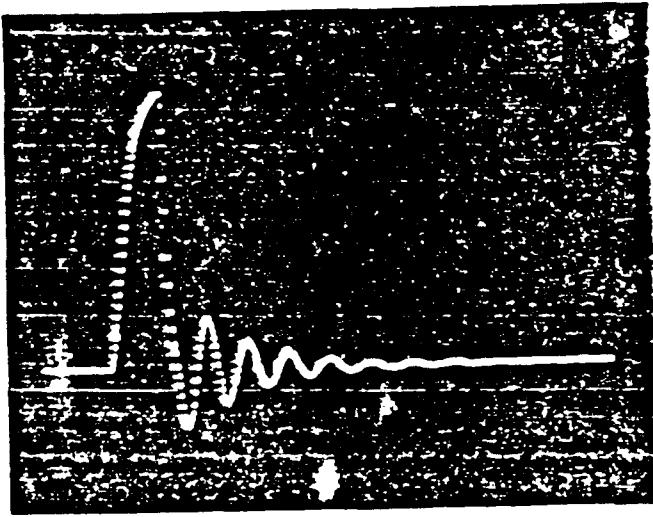

12-14-59, 12-14-59, 12-14-59, 12-14-59, 12-14-59

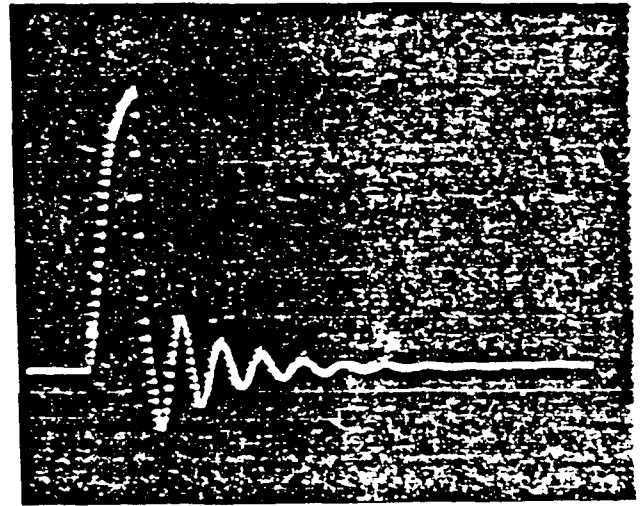

12-14-59, 12-14-59, 12-14-59, 12-14-59, 12-14-59

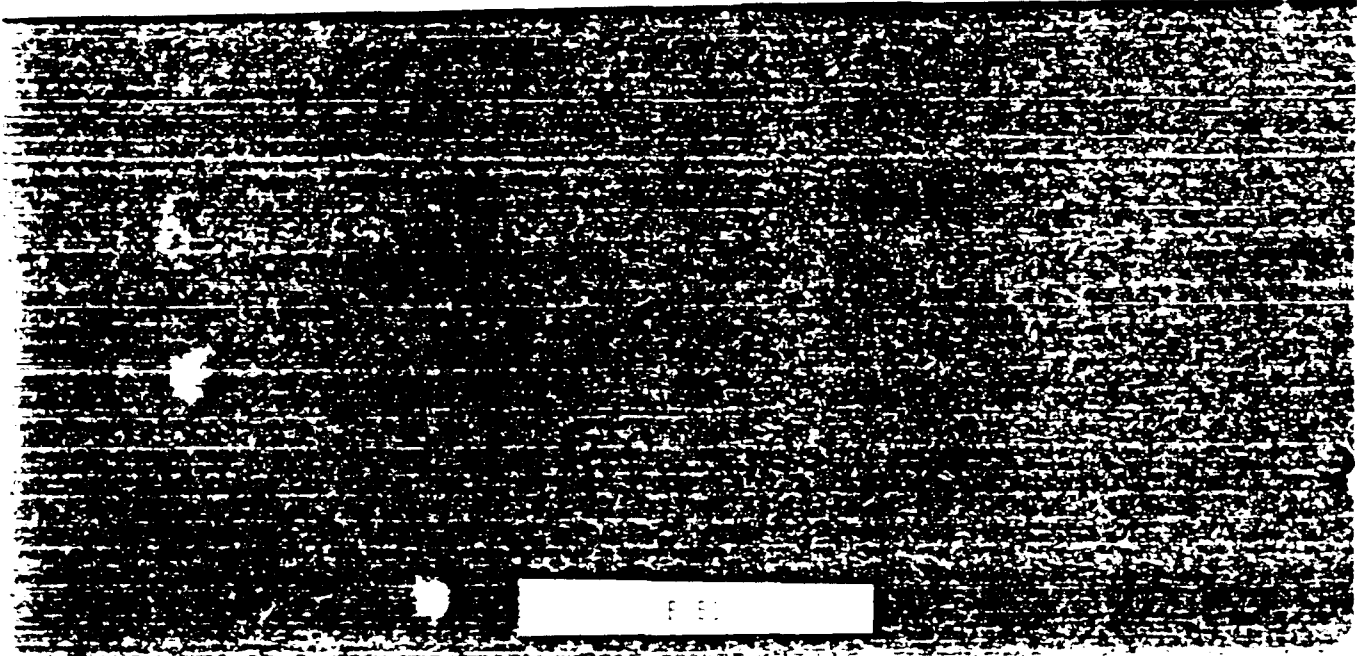

F E I



NATIONAL INDUSTRI

2520 58th Street
Hampton Virginia 23661

Telephone
(804) 838-8080

Telex
82-3646

Telefax
(804) 838-8905

TRANSMITTAL LETTER
FOR
CERTIFIED TEST REPORT

RE: ABB SERVICE CO.
2382 E. ARTESIA BLVD.
LONG BEACH, CA 90805

DATE: OCT 16 1990

SHOP ORDER NO: 029000

ATTENTION: ROGER RATICAN

JOB NAME: TBA

CUSTOMER: ABB SERVICE CO.

P.O.NO: LS-01446-C

We are transmitting herewith four (4) copies of the Certified Test Report for your records.

If you have any questions, please do not hesitate to contact me.

Sincerely,

Libby Smith
Customer Service Supervisor



B-52

EB CORPORATION - A MEMBER OF THE ASEA BROWN BOVERI GROUP

CERTIFIED TEST REPORT

SHOP ORDER 02900-1

STYLE NO. 810500B001

TEST DATE 10-10-90

NOMINAL VOLTAGE: 480 Delta / 208 Grd-Wye
KVA: 500/667
INSULATION RATED AT 185 DEGREE C

Three Phase 60 Hertz
AVG WDG RISE: 75 DEG C.
BIL (kv): HV- 30 LV- 30

CUSTOMER: ABB SERVICE CO.
LONGBEACH, CA 90805

PO# LS-01446-C

KVA	NO LOAD	TAP	LOAD	TOTAL SERIES
LOSSES	% Iex	LOSSES	% Z	RESISTANCE @ 95 C
25 C	25 C	95 C	95 C	PRIMARY SECONDARY
(watts)	(volts)	(watts)	(ohms)	(ohms)
500	1483	0.953	480	6204
				6.22
				0.02384
				0.001183

APPLIED VOLTAGE	INDUCED VOLTAGE	NOMINAL RATIO
HV LV	400 Hz, 18 SEC.	
(kv) (kv)	(volts)	
12 4	416	A/B 3.994
		C/A 3.991
		B/C 3.991

ANSI STANDARD IMPULSE TEST PERFORMED AT 30 KV BIL.

AA MEASURED TEMPERATURE RISE (C): HV - 53.1 LV - 54.5

PARTIAL DISCHARGE TEST PERFORMED, SEE ATTACHED FOR TEST RESULTS.

POWER FACTOR TEST PERFORMED AT 2.5 KV:

H-L = .296, H-G = .605 & L-G = .338

IMPEDANCE AND LOAD LOSSES AT TAPS:

(1-2) = 6.11% AND 6442 WATTS, (5-6) = 6.32% AND 6122 WATTS

CERTIFICATION:

TEST TECHNICIAN

ENGINEER

NATIONAL INDUSTRIES TRANSFORMERS, INC.
HAMPTON, VA. 23661



PARTIAL DISCHARGE TEST DATA

SHOP ORDER 02900-1
STYLE NO. 810500B001
KVA 500
TEST DATE OCTOBER 10, 1990

```
*****  
* TOP * % VOLTAGE * COIL 1 * COIL 2 * COIL 3 *  
*****  
* * * * *  
*INCEPTION * 150 * 30 pc * 35 pc * 30 pc *  
*****
```

```
*****  
* BOTTOM * % VOLTAGE * COIL 1 * COIL 2 * COIL 3 *  
*****  
* * * * *  
*INCEPTION * 150 * 32 pc * 35 pc * 32 pc *  
*****
```

TRANSFORMER IMPULSE TEST REPORT

Purchaser ARR SERVICE CO.
Date of Test 10/10/90 Purchaser's Order No. LS-01446-C Mfr's. Ref. 81-0500-R001
Type CM-10ST Phase 3 Hertz 60 Insulating Fluid _____
H Winding 500 KVA X Winding 500 KVA Y Winding _____ KVA
500 LF17A Volts 208 Grid 4 / 120 Volts _____ Volts
30k 9L 30k 9L _____ 9L

Serial No.	Terminal Surged	Test	Crst Voltage kV	Wave Shape of Rise or Fall	Time to Recover	Oscillogram Number	Stress Time or Timing Wave Prod. 1/4 Sec.	Cnt of 1/4 Sec. Tests	
52900-1	H-1	RFW	15	1.50/47 μ s		1	10	Green Trace	
		RFWC				1c	10	Current Same	
		CMV	30		1.40 μ s	2	2		
		CMV	30		1.60 μ s	3	1		
		FWV	30	1.50/47 μ s		4	10		
		FVVC				4c	10		
	H-2	RFW	15	1.50/47 μ s			5	10	
		RFWC					5c	10	
		CMV	30		1.70 μ s	6	2		
		CMV	30		1.70 μ s	7	2		
		FWV	30	1.50/47 μ s		8	10		
		FVVC				8c	10		
H-3	RFW	15	1.50/47 μ s			9	10		
	RFWC					9c	10		
	CMV	30		1.30 μ s	10	2			
	CMV	30		1.35 μ s	11	2			
	FWV	30	1.50/47 μ s		12	10			
	FVVC				12c	10			

• RFWV Reduced Full-Wave Voltage, RFWC Reduced Full-Wave Current, FWV Full-Wave Voltage, FVVC Full-Wave Current, CMV Chopped-Wave Voltage, FOWV Front of Wave Voltage.

GRD Terminals grounded, ARR Terminals connected to arrestrs, RES Terminals connected to ground through line resistance.

Tests Witnessed by Scott McBride (E446)

I hereby certify that this is a true report based on factory tests made in accordance with USA Standard Test Code for Distribution, Power and Regulating Transformers, CS7.12 or latest revision thereof, and that each transformer withstood the above tests.

B-55

Signed [Signature] Date 10/10/90 Approved M E Huer

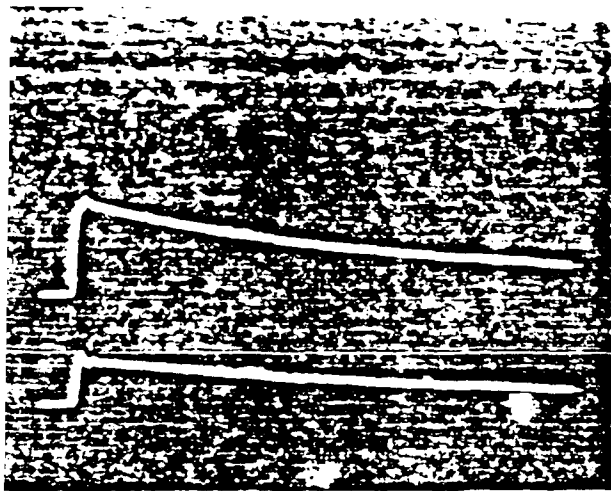

ECG strip showing a regular rhythm with a narrow QRS complex and a T wave.

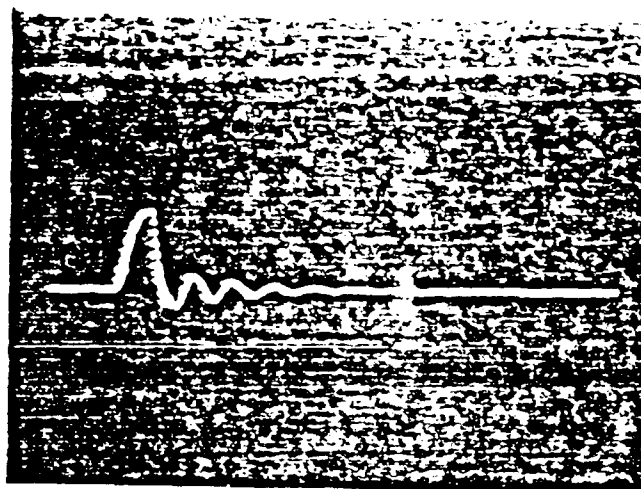

ECG strip showing a regular rhythm with a narrow QRS complex and a T wave.

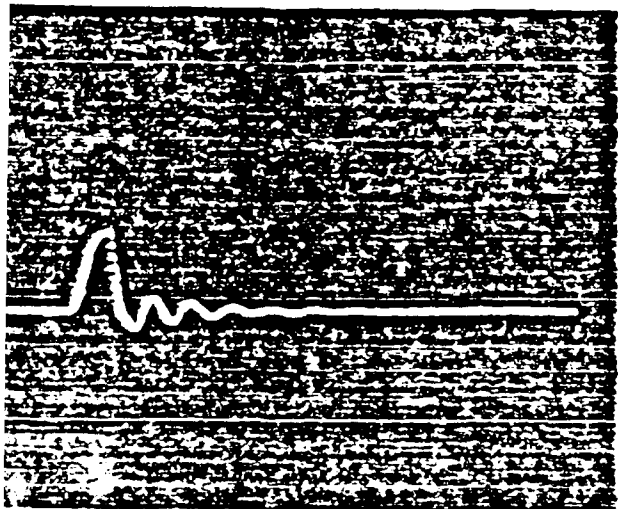

ECG strip showing a regular rhythm with a narrow QRS complex and a T wave.

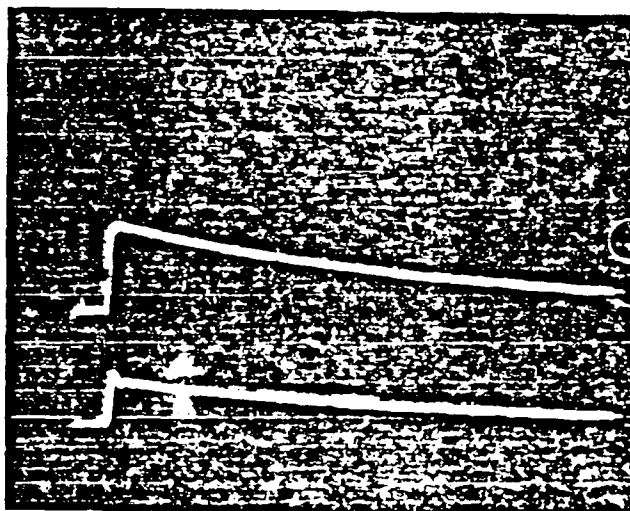

ECG strip showing a regular rhythm with a narrow QRS complex and a T wave.

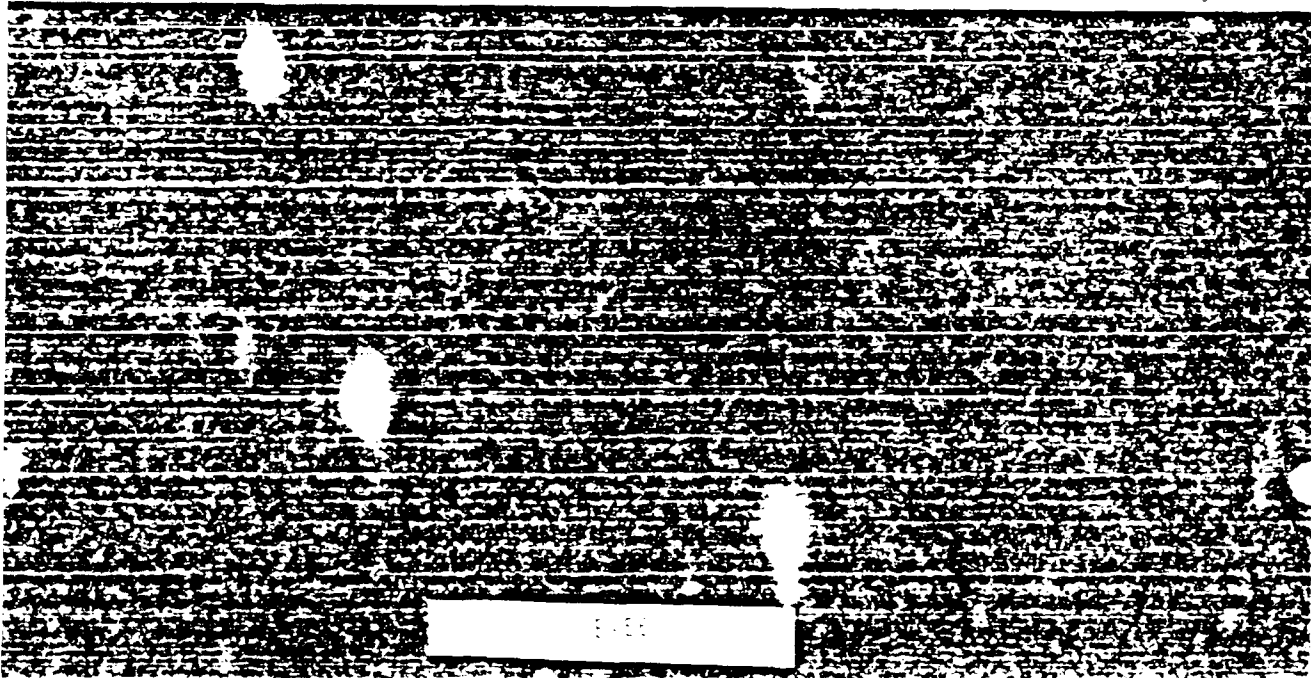

ECG strip showing a regular rhythm with a narrow QRS complex and a T wave.

Vertical text on the left margin, possibly a page number or document identifier.

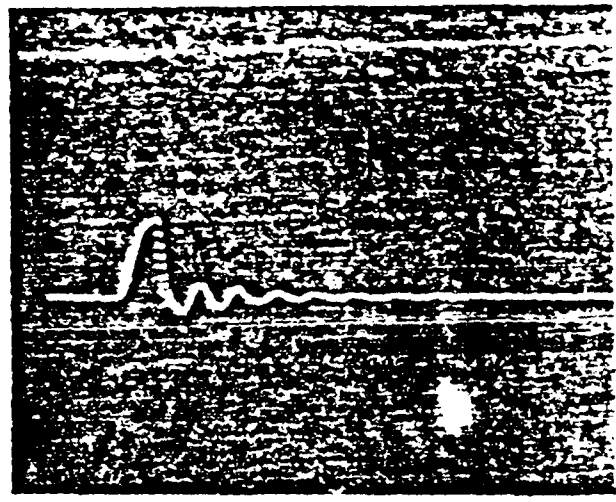
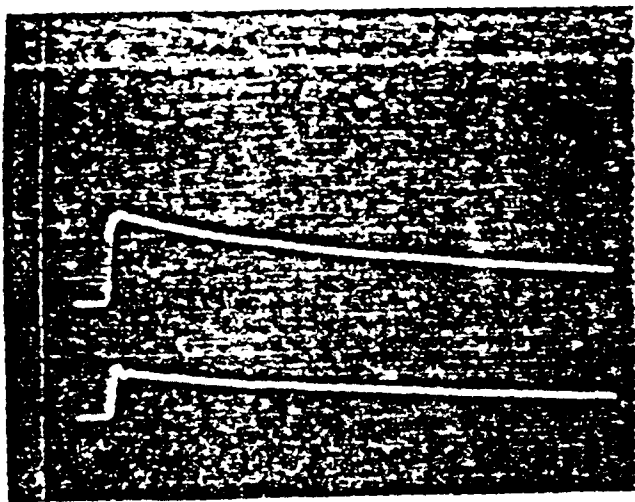

Caption text for the top-left graph, likely describing the signal parameters.

Caption text for the top-right graph, likely describing the signal parameters.

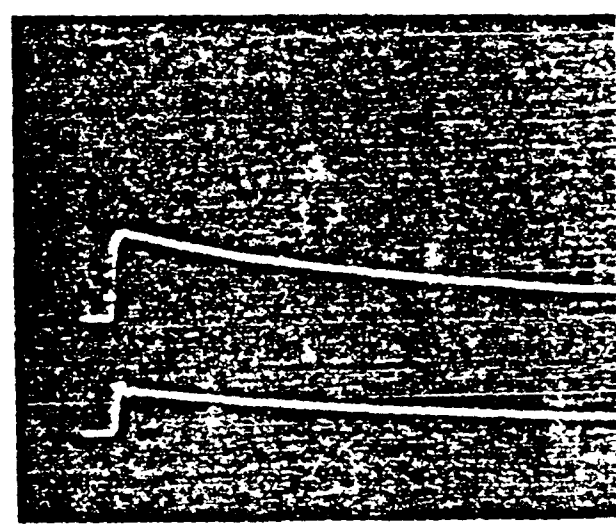
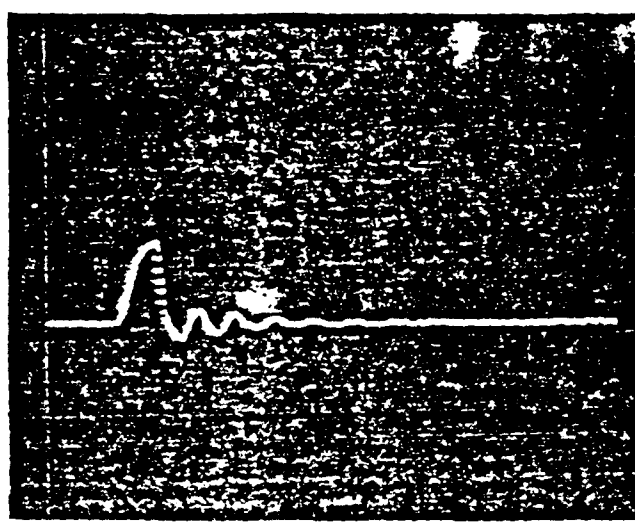

Caption text for the bottom-left graph, likely describing the signal parameters.

Caption text for the bottom-right graph, likely describing the signal parameters.

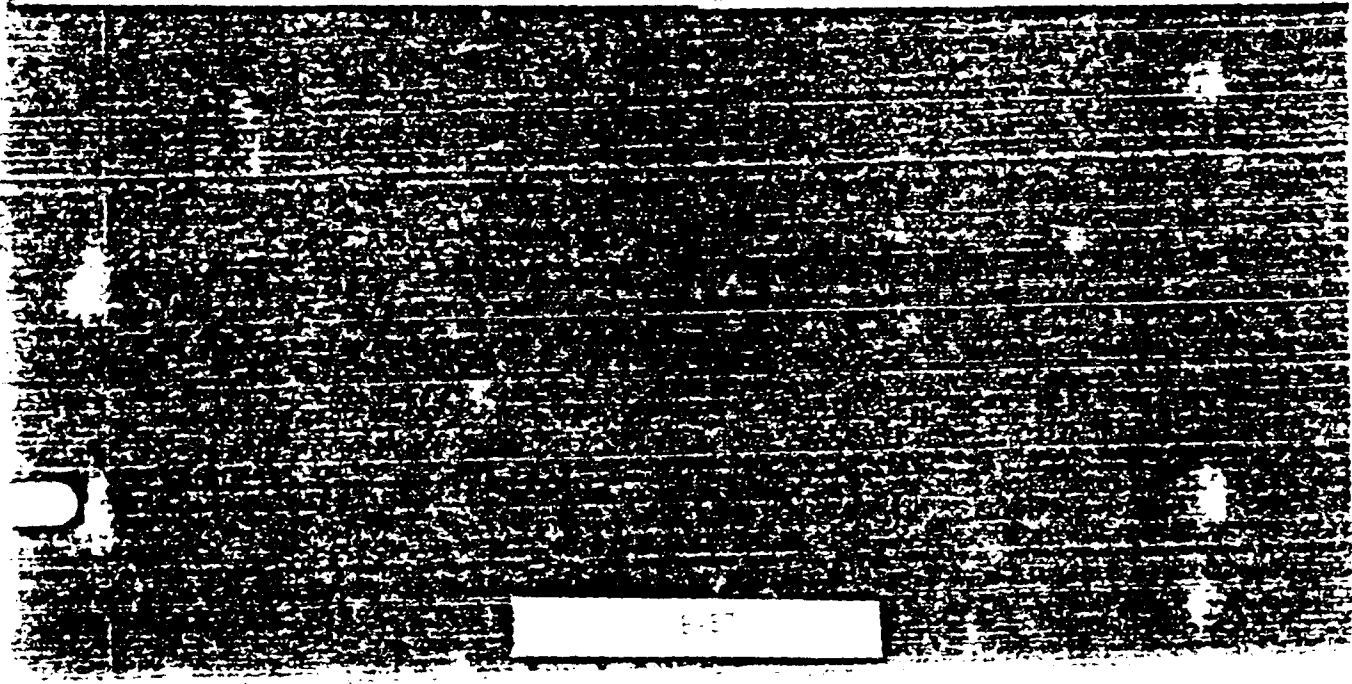

Small white rectangular box at the bottom center containing the number '1-17'.

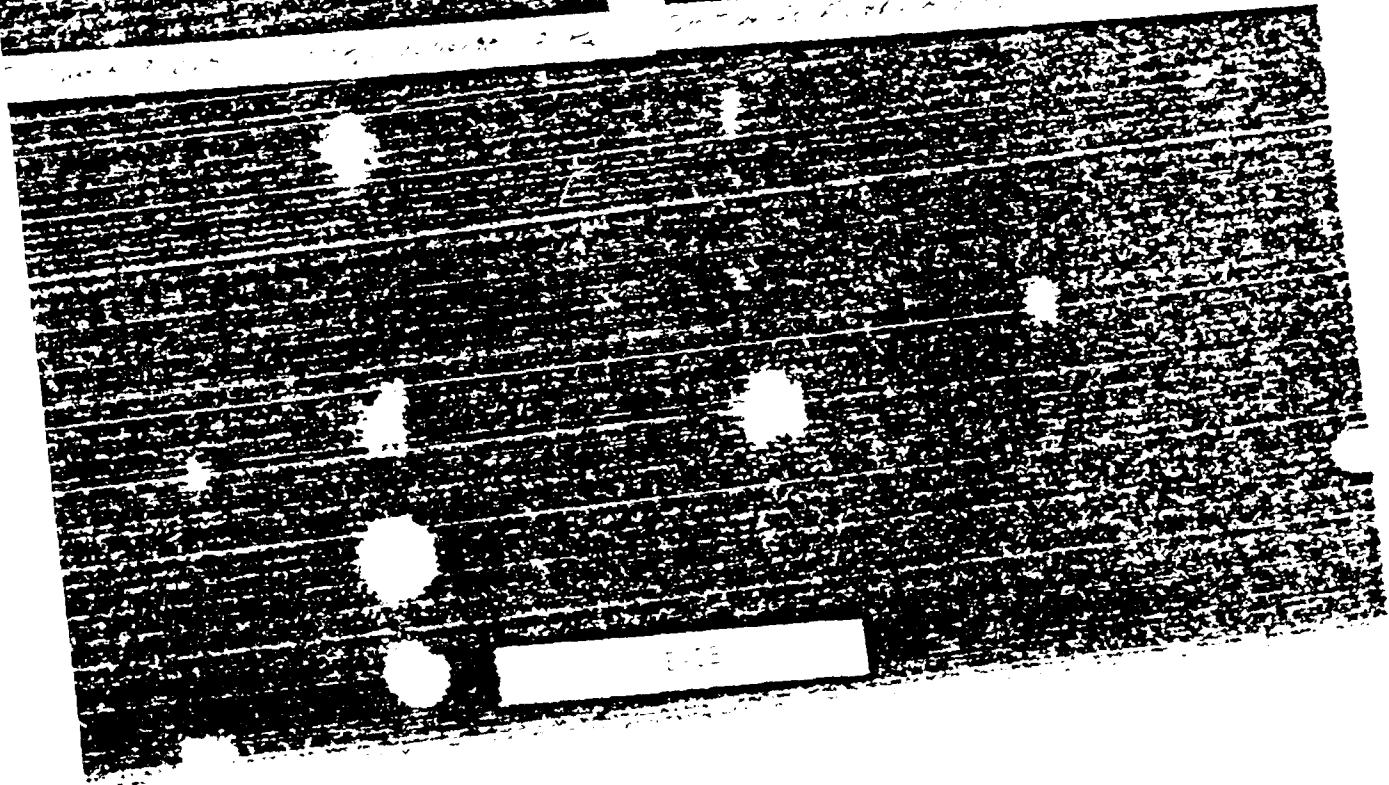
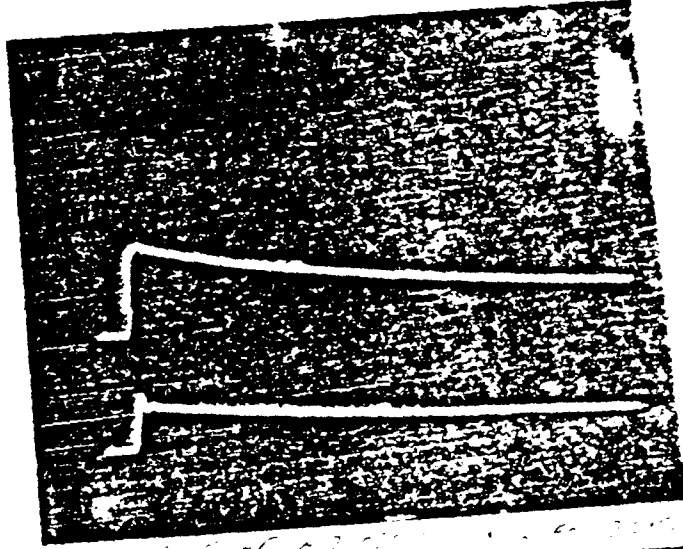
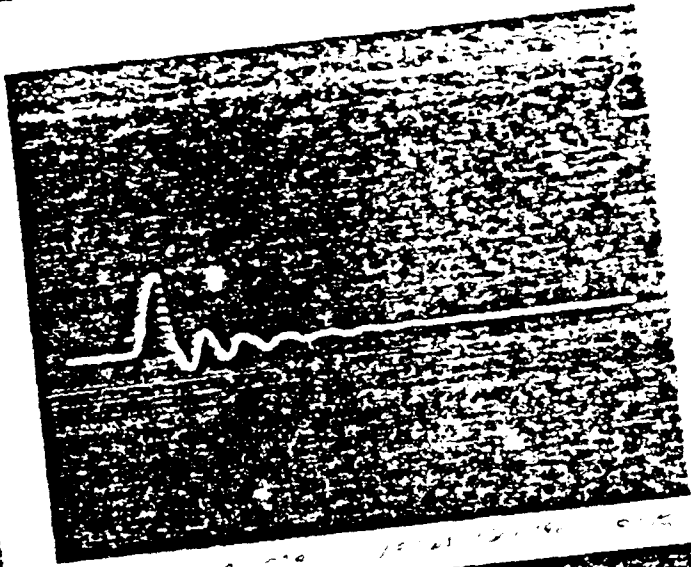
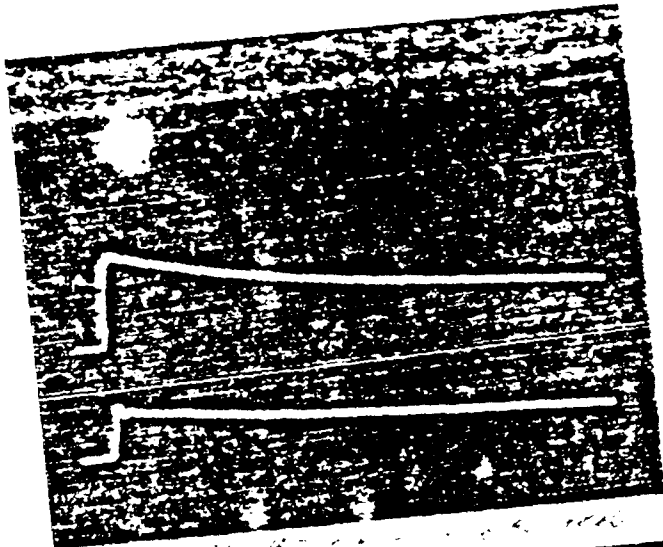

EB NATIONAL INDUSTRI

2520 58th Street
Hampton, Virginia 23661

Telephone
(804) 838-8080

Telex
82-3646

Telefax
(804) 838-8905

TRANSMITTAL LETTER
FOR
CERTIFIED TEST REPORT

RE: ABB SERVICE CO.
1380 E. ARTESIA BLVD.
LONG BEACH, CA 90805

DATE: OCT 16 1990

SHOP ORDER NO: 029012

ATTENTION: ROGER PATICAN

JOB NAME: TEA

CUSTOMER: ABB SERVICE CO.

P.O. NO: LS-01446-C

We are transmitting herewith four (4) copies of the Certified Test Report for your records.

If you have any questions, please do not hesitate to contact me.

Sincerely,



Libby Smith
Customer Service Supervisor



B-59

EB CORPORATION - A MEMBER OF THE ASEA BROWN BOVERI GROUP

CERTIFIED TEST REPORT

SHOP ORDER 02901-1 STYLE NO. 841500B109 TEST DATE 10-08-90

NOMINAL VOLTAGE: 12000 Delta / 480 Grd-Wye Three Phase 60 Hertz
 KVA: 1500/2000 CLASS: AA/FFA AVG WDG RISE: 75 DEG C.
 INSULATION RATED AT 185 DEGREE C BIL (kv): HV- 95 LV- 30

CUSTOMER: ABB SERVICE CO. PO# LS-01446-C
 LONG BEACH, CA 90805

KVA	NO LOAD	TAP	LOAD	TOTAL SERIES			
LOSSES	% I _{ex}	LOSSES	% Z	RESISTANCE @ 95 C			
23 C	23 C	95 C	95 C	PRIMARY SECONDARY			
(watts)	(volts)	(watts)	(ohms)	(ohms)			
1500	3689	0.647	12000	9441	5.60	2.43206	0.001307

APPLIED VOLTAGE	INDUCED VOLTAGE	NOMINAL RATIO
HV LV	400 Hz, 18 SEC.	
(kv) (kv)	(volts)	
34 4	960	A/B 43.285
		C/A 43.255
		B/C 43.265

ANSI STANDARD IMPULSE TEST PERFORMED AT 95 KV BIL.
 MA MEASURED TEMPERATURE RISE (C): HV - 67.4 LV - 64.8

IMPEDANCE AND LOAD LOSSES AT TAPS:
 (1-2) = 5.51% AND 9129 WATTS, (5-6) = 5.77% AND 9794 WATTS.
 PARTIAL DISCHARGE TEST PERFORMED, SEE ATTACHED FOR TEST RESULTS.
 POWER FACTOR TEST PERFORMED AT 2.5 KV:
 H-G = .224, L-G = .501 AND H-L = .196

CERTIFICATION:
 TEST TECHNICIAN *[Signature]* ENGINEER *[Signature]*

NATIONAL INDUSTRIES TRANSFORMERS, INC.
 HAMPTON, VA. 23661



B-60

PARTIAL DISCHARGE TEST DATA

SHOP ORDER 02901-1
 STYLE NO. 841500B109
 KVA 1500
 TEST DATE OCTOBER 8, 1990

```

*****
* TOP * % VOLTAGE * COIL 1 * COIL 2 * COIL 3 *
*****
* INCEPTION * 150 * 30 pc * 5 pc * 20 pc *
*****
* EXTINCTION * 110 * 0 pc * 0 pc * 0 pc *
*****
  
```

```

*****
* BOTTOM * % VOLTAGE * COIL 1 * COIL 2 * COIL 3 *
*****
* INCEPTION * 150 * 30 pc * 3 pc * 25 pc *
*****
* EXTINCTION * 110 * 0 pc * 0 pc * 0 pc *
*****
  
```



NATIONAL INDUSTRIAL

TRANSFORMERS, INC.

— BOSTON OFFICE —

2000 South Street
Hampton, VA 23661
804-808-8080
Telex 82-3646

ISSUED 9/77
REVISED 12/9/80
SECTION B-7

TRANSFORMER IMPULSE TEST REPORT

Purchaser ALB Service Co.

Date of Test 12/1/90 Purchaser's Order No. LS-DX44-C Mfr's. Ref. P4-150-109

Type CAI-1/AT Phase 2 Hertz 60 Insulating Fluid _____
 H Winding _____ KVA X Winding 1500 KVA Y Winding _____ KVA
12000 DFL-A Volts 480620V/277 Volts _____ Volts
95kV BR 30kV BR _____ BR

Test No.	Terminal Surged	Test	Crst Voltage kV	Wave Shape or Rise or Fall	Time to Recover	Cyclogram Number	Swamp Time or Timing Wave Freq. Hz Sec.	Conn. or Lim. or Min. Term.
1-1	H-1	RFW	47.5	125/43 μ s		1	10	Ground
		RFWC				1c	10	Short
		CWV	95		1.90 μ s	2	2	
		CWV	95		1.85 μ s	3	2	
		FWV	95	125/43 μ s		4	10	
		FWC				4c	10	
	H-2	RFW	47.5	125/43 μ s		5	10	
		RFWC				5c	10	
		CWV	95		1.70 μ s	6	2	
		CWV	95		1.9 μ s	7	2	
		FWV	95	125/43 μ s		8	10	
		FWC				8c	10	
	H-3	RFWV	47.5	125/43 μ s		9	10	
		RFWC				9c	10	
		CWV	95		1.85 μ s	10	2	
		CWV	95		1.8 μ s	11	2	
		FWV	95	125/43 μ s		12	10	
		FWC				12c	10	

• RFWV Reduced Full-Wave Voltage. RFWC Reduced Full-Wave Current. FWV Full-Wave Voltage. FWC Full-Wave Current. CWV Chopped-Wave Voltage. FOWV Front of Wave Voltage.

GRD Terminals grounded. ARR Terminals connected to arresters. RES Terminals connected to ground through linear resistance.

Tests Witnessed by Scott McBlade

I hereby certify that this is a true report based on factory tests made in accordance with USA Standard Test Code for Distribution, Power and Regulating Transformers, CS7-12 or latest revision thereof; and that each transformer withstood the above tests.

B-62

Signed [Signature]

Date 10/18/90

[Signature]

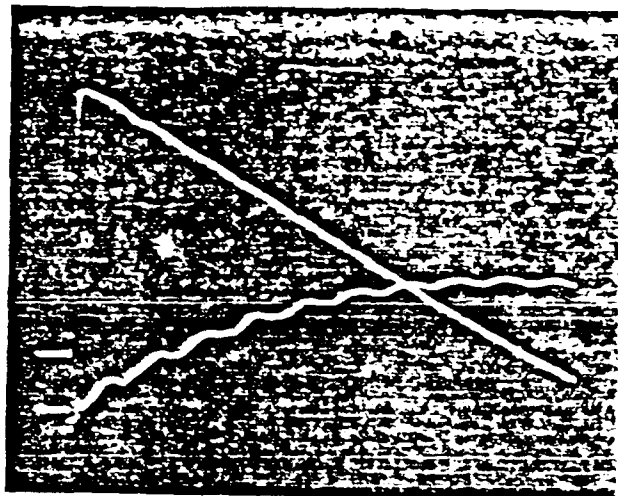
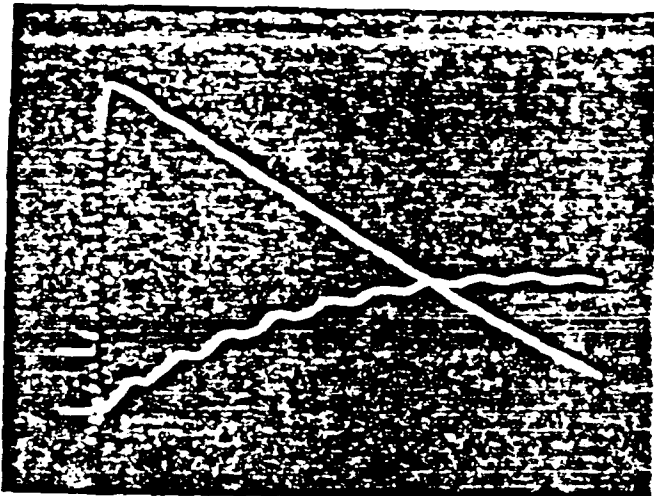

ECG tracing showing a regular rhythm with a narrow QRS complex and a prominent T wave. The rhythm is regular, and the QRS complexes are narrow. The T waves are upright and prominent.

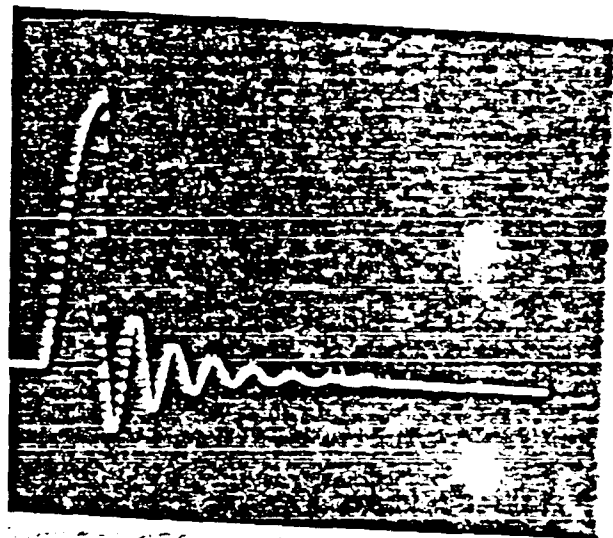
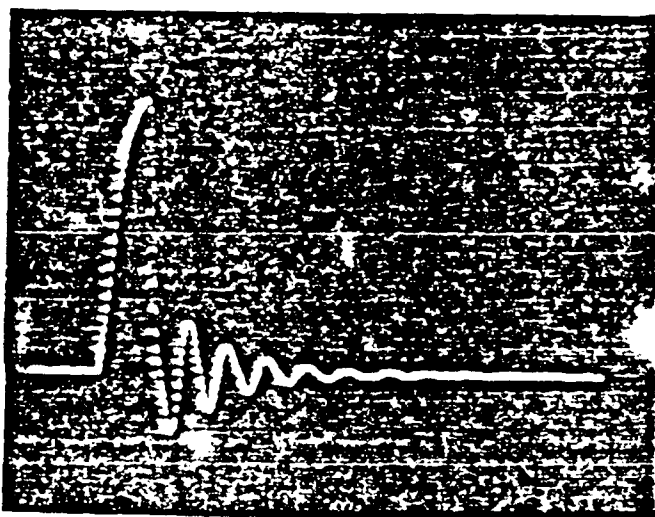

ECG tracing showing a regular rhythm with a narrow QRS complex and a prominent T wave. The rhythm is regular, and the QRS complexes are narrow. The T waves are upright and prominent.

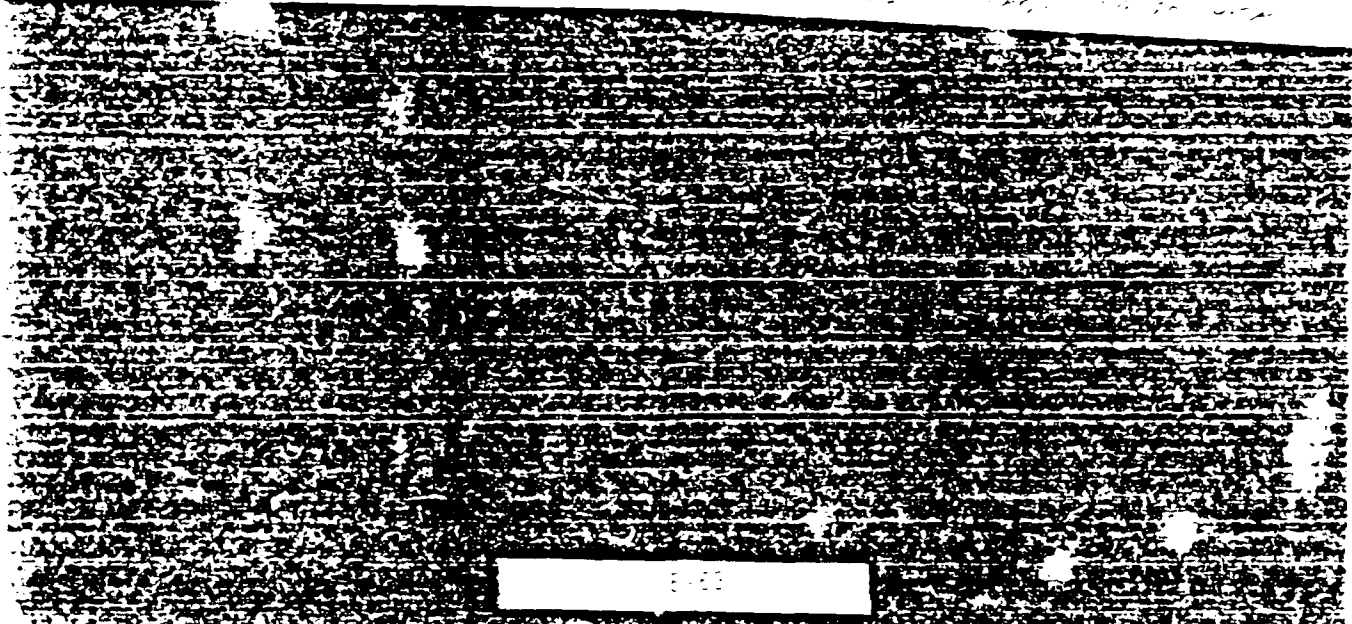

1000

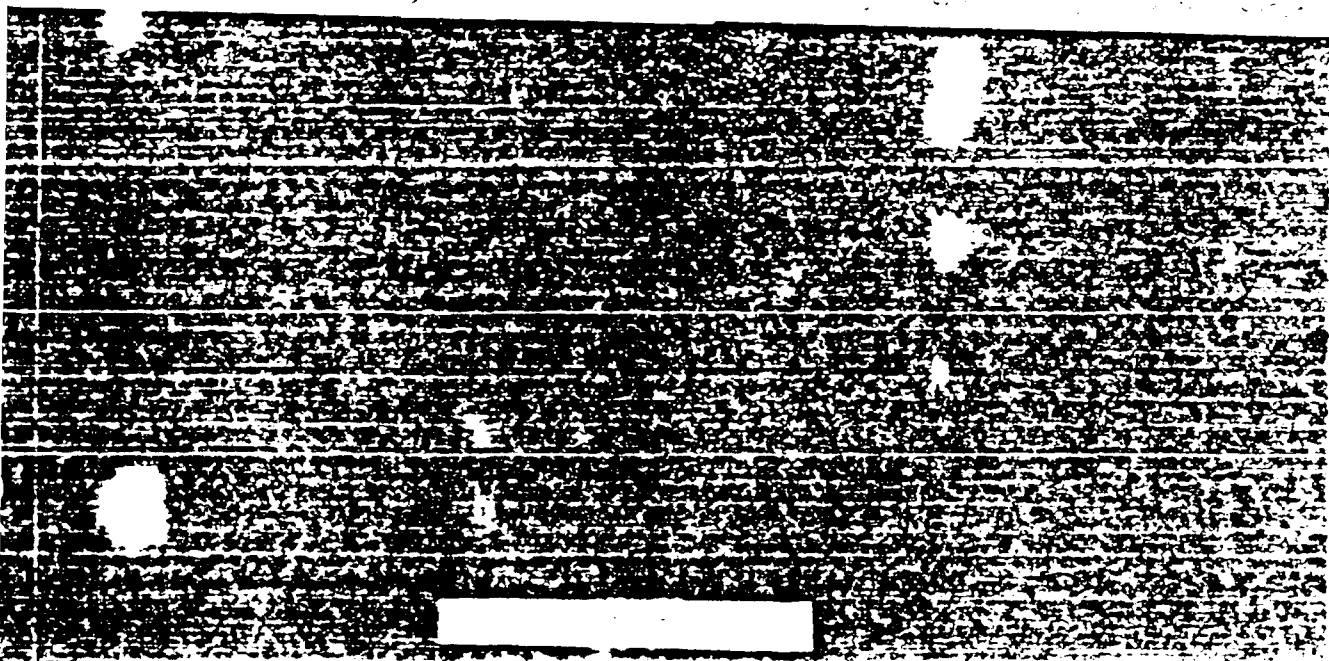
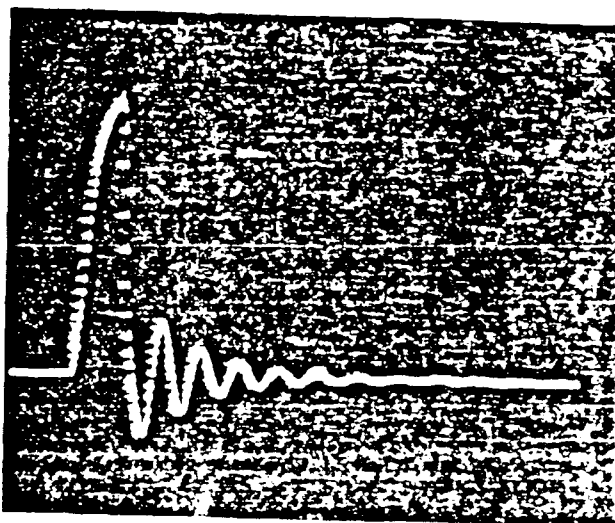
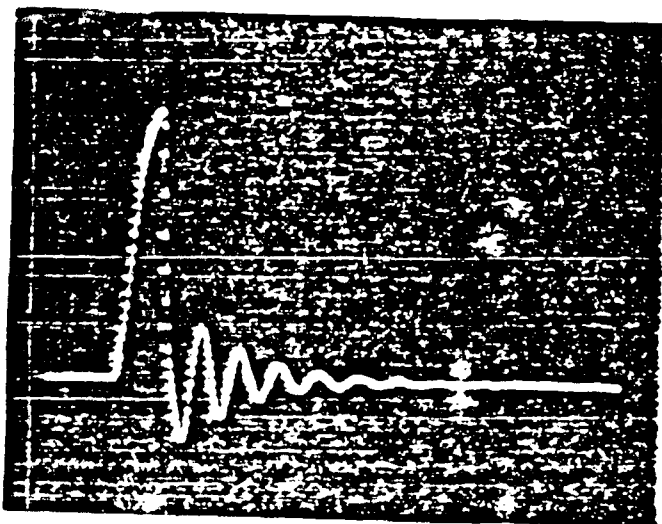
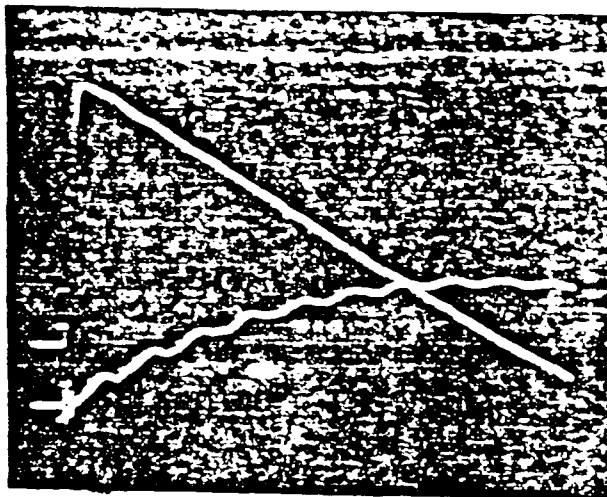
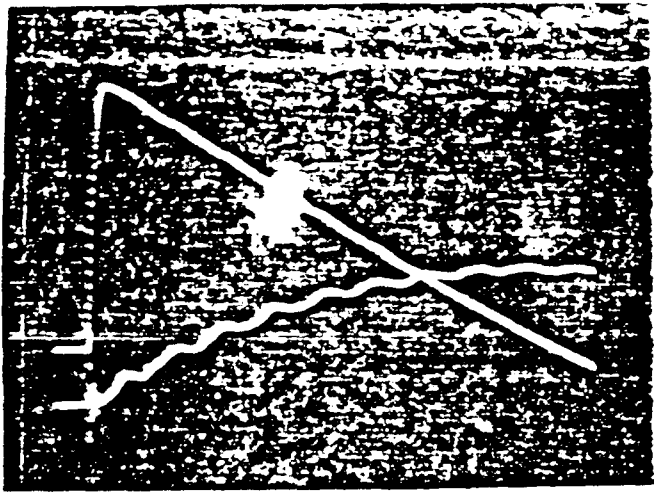

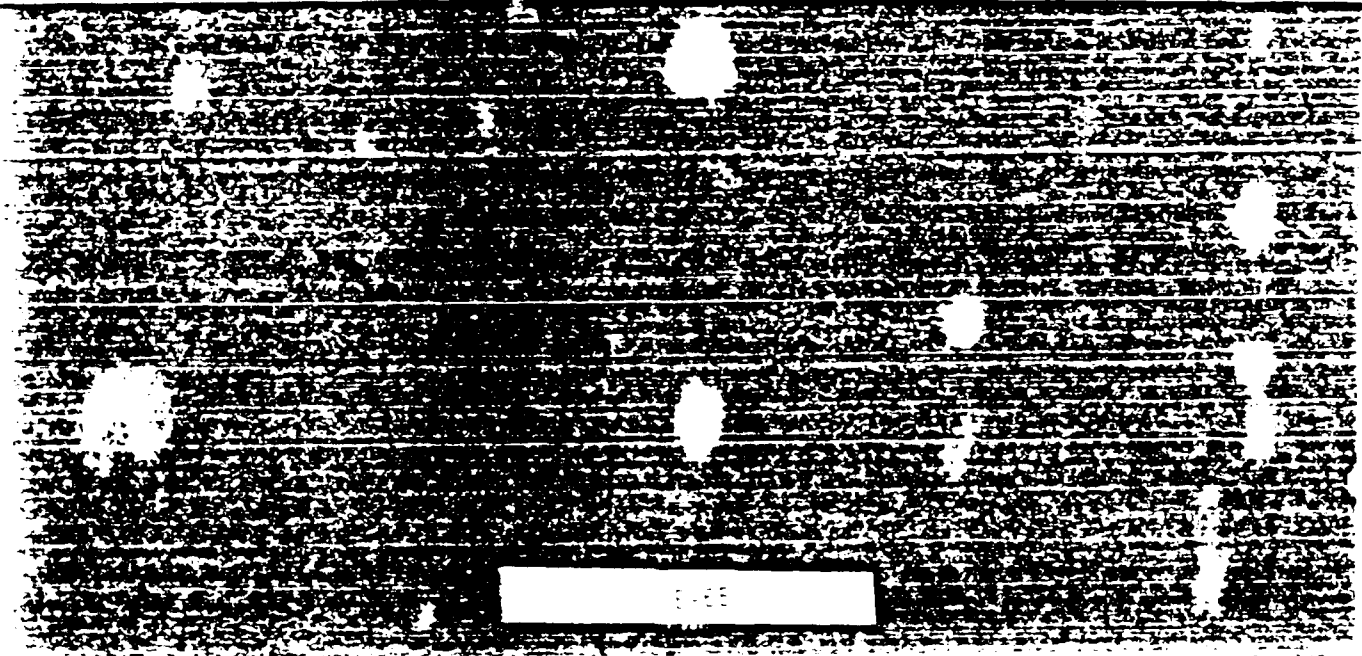
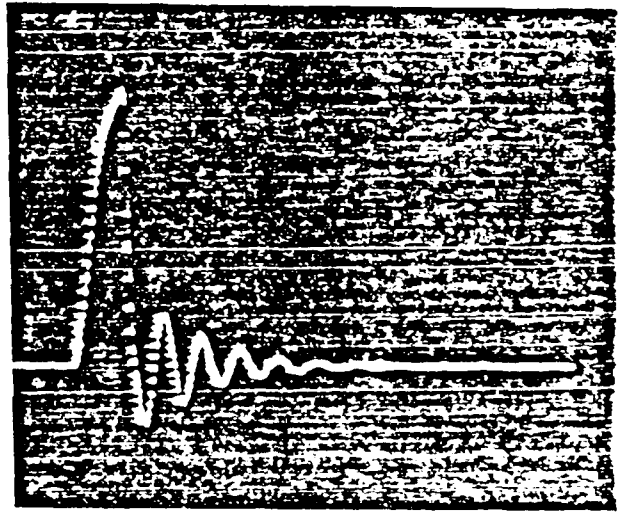
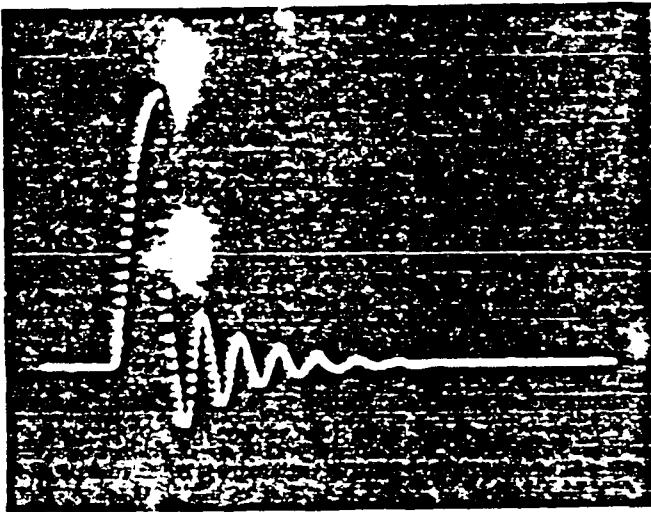
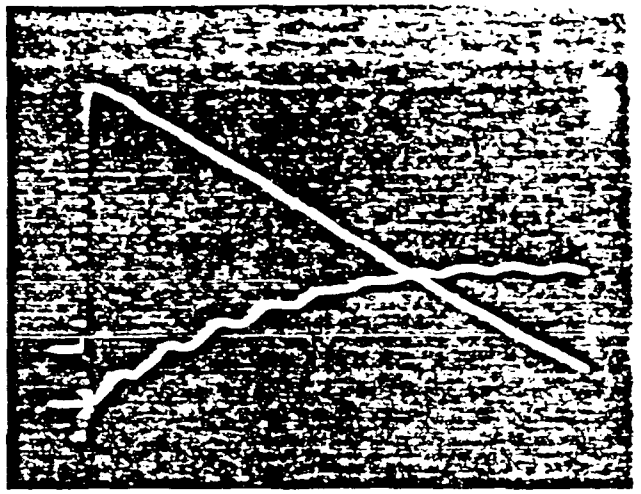
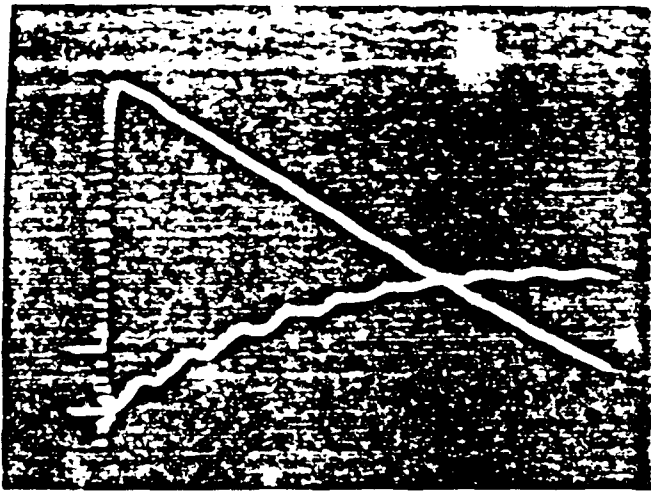

ECG



2520 58th Street
Hampton, Virginia 23661

NATIONAL INDUSTRI

Telephone
(804) 838-8080

Telex
82-3646

Teletax
(804) 838-8905

TRANSMITTAL LETTER

FOR

CERTIFIED TEST REPORT

RE: ABB SERVICE CO.
2382 E. ARTESIA BLVD.
LONG BEACH, CA 90805

DATE: OCT 16 1990

SHOP ORDER NO: 29020

ATTENTION: ROGER RATICAN

JOB NAME: TBA

CUSTOMER: ABB SERVICE CO

P.O.NO: LS-01446-C

We are transmitting herewith four (4) copies of the Certified Test Report for your records.

If you have any questions, please do not hesitate to contact me.

Sincerely,

Patty Dorris
Admin. Assist. Mkt.



B-66

ABB CORPORATION - A MEMBER OF THE ASEA BROWN BOVERI GROUP

CERTIFIED TEST REPORT

SHOP ORDER 02902-1 STYLE NO. 841500B110 TEST DATE 10-09-90

NOMINAL VOLTAGE: 12000 Delta / 480 Grd-Wye Three Phase 60 Her
 KVA: 1500/2000 CLASS: AA/FFA AVG WDG RISE: 75 DEG C.
 INSULATION RATED AT 185 DEGREE C BIL (kv): HV- 95 LV-

CUSTOMER: ABB SERVICE CO. PO# LS-01446-C
 LONG BEACH, CA 90805

```

*****
*      *      *      *      *      *      *      *
*  KVA * NO LOAD *      * TAP * LOAD *      * TOTAL SERIES
*      * LOSSES * % Iex *      * LOSSES * % Z * RESISTANCE @ 95 C
*      * 29 C * 29 C *      * 95 C * 95 C * PRIMARY SECONDAR
*      * (watts) *      * (volts) * (watts) *      * (ohms) (ohms)
*****
*      *      *      *      *      *      *      *
* 1500 * 3759 * 0.746 * 12000 * 9428 * 5.77 * 2.40637 * 0.00131
*      *      *      *      *      *      *      *
*****
    
```

```

*****
*      *      *      *      *      *      *
*  APPLIED VOLTAGE *      * INDUCED VOLTAGE *      * NOMINAL RATIO
*  HV LV *      * 400 Hz, 18 SEC. *      *
*  (kv) (kv) *      * (volts) *      *
*****
*      *      *      *      *      *      *
*      34      4 *      * 960 *      * A/B 43.303
*      *      *      *      *      *      * C/A 43.289
*      *      *      *      *      *      * B/C 43.289
*      *      *      *      *      *      *
*****
    
```

ANSI STANDARD IMPULSE TEST PERFORMED AT 95 KV BIL.

IMPEDANCE AND LOAD LOSSES AT TAPS:
 (1-2) = 5.65% AND 9192 WATTS, (5-6) = 5.91% AND 9872 WATTS
 PARTIAL DISCHARGE TEST PERFORMED, SEE ATTACHED FOR TEST RESULTS.
 POWER FACTOR TEST PERFORMED AT 2.5 KV:
 H-L = .235, H-G = .201 & L-G = .476

CERTIFICATION:

TEST TECHNICIAN *[Signature]* ENGINEER *[Signature]*

NATIONAL INDUSTRI TRANSFORMERS, INC.
 HAMPTON, VA. 23661



PARTIAL DISCHARGE TEST DATA

SHOP ORDER 02902-1
STYLE NO. 841500B110
KVA 1500
TEST DATE OCTOBER 9, 1990

```
*****  
* TOP * % VOLTAGE * COIL 1 * COIL 2 * COIL 3 *  
*****  
* * * * *  
* INCEPTION * 150 * 10 pc * 40 pc * 30 pc *  
*****  
* * * * *  
* EXTINCTION * 110 * 0 pc * 15 pc * 10 pc *  
*****
```

```
*****  
* BOTTOM * % VOLTAGE * COIL 1 * COIL 2 * COIL 3 *  
*****  
* * * * *  
* INCEPTION * 150 * 20 pc * 40 pc * 20 pc *  
*****  
* * * * *  
* EXTINCTION * 110 * 10 pc * 15 pc * 4 pc *  
*****
```

TRANSFORMER IMPULSE TEST REPORT

Purchaser JIP SERVICE CO.
Date of Test 10/10/90 Purchaser's Order No. LS-NV4K-2 Mfg's. Ref. 84-1501-210
Type CAT/CAST Phase 3 Hertz 60 Insulating Fluid _____
H Winding 1500 KVA X Winding 1500 KVA Y Winding _____ KVA
12000 DELTA Volts 480 6004/277 Volts _____ Volts
95k 9L 30k 9L _____ 9L

Serial No.	Terminal Surged	Test	Crst Voltage KV	Wave Shape or Rate of Rise	Time to Reinover	Oscillogram Number	Setup Time or Timing Wave Front, μ Sec.	or μ Sec.
12902-1	H-1	RFW	475	1.25/43 μ s		1	10	Exp. H.
		RFC				1c	2	Cur. 10k
		CWV	95		1.85 μ s	2	2	
		CW	95		2.0 μ s	3	2	
		FVV	95	1.25/43 μ s		4		
	✓	FVC				4c	10	
	H-2	RFW	475	1.25/43 μ s		5	10	
		RFC				5c	10	
		EWV	95		2.15 μ s	6	2	
		FWV	95		1.90 μ s	7	2	
		FVV	95	1.25/43 μ s		8	10	
	✓	FVC				8c	10	
	H-3	RFW	475	1.25/43 μ s		9	10	
		RFC				9c	10	
		CWV	95		1.85 μ s	10	2	
		CW	95		1.70 μ s	11	2	
		FVV	95	1.25/43 μ s		12	10	
✓	✓	FVC				12c	10	

• RFW Reduced Full-Wave Voltage, RFC Reduced Full-Wave Current, FVV Full-Wave Voltage, FVC Full-Wave Current, CWV Chopped-Wave Voltage, FVV Front of Wave Voltage.
GRD Terminals grounded, ARR Terminals connected to arrester, RES Terminals connected to ground through line resistance.

Tests Witnessed by Scott McBride (EG-16)
I hereby certify that this is a true report based on factory tests made in accordance with SA Standard Test Code Distribution, Power and Regulating Transformers, CS7.12 or latest revision thereof, and that each transformer withstood the above tests.
_____ 10/10/90 _____

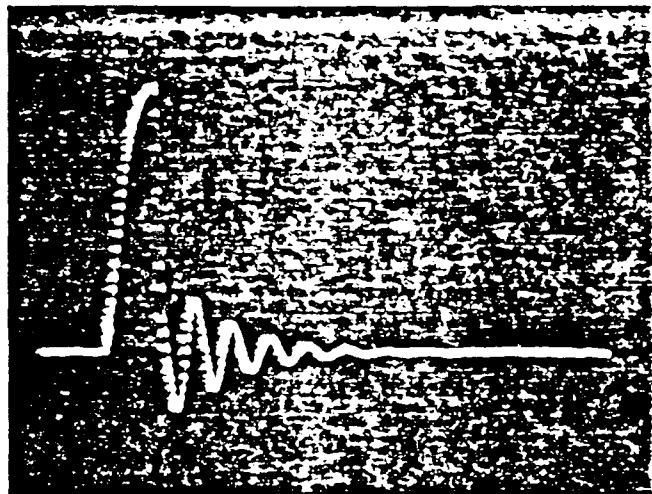
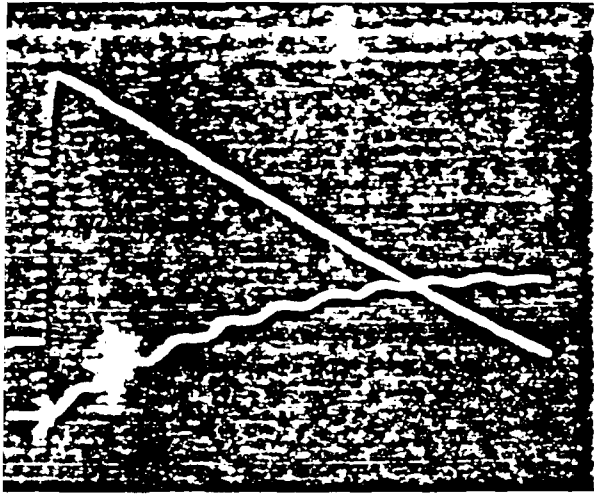

ECG tracing showing a regular rhythm with a prominent ST segment depression, characteristic of a myocardial infarction. The tracing is on a standard grid.

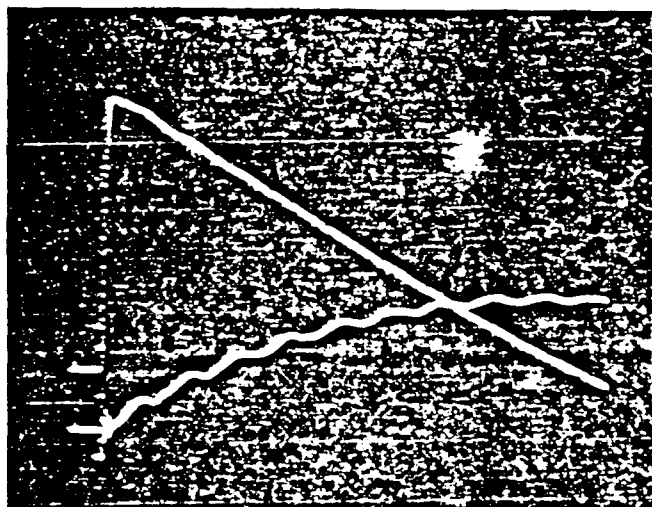
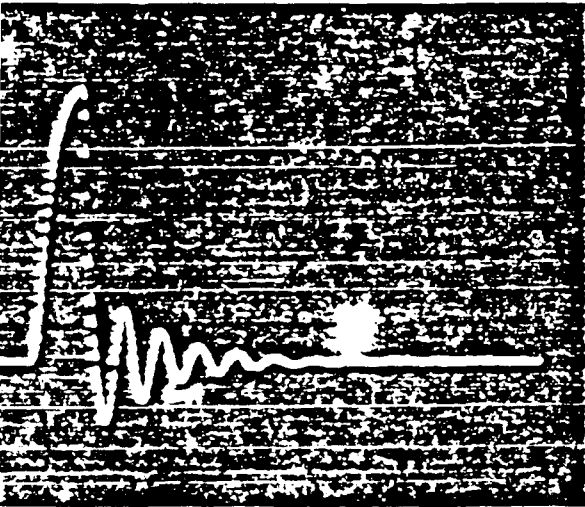

ECG tracing showing a regular rhythm with a prominent ST segment depression, characteristic of a myocardial infarction. The tracing is on a standard grid.

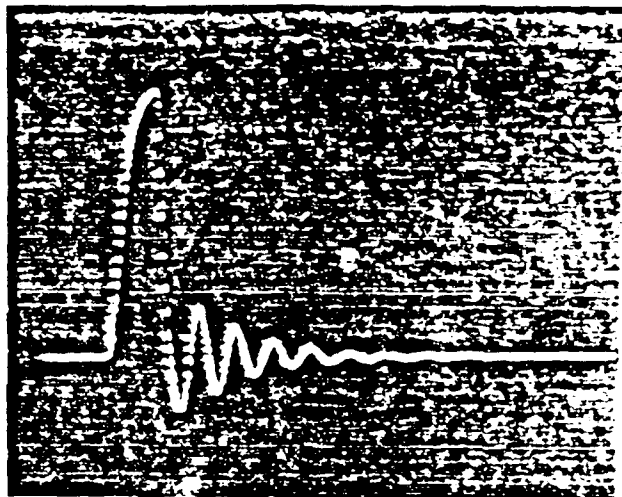
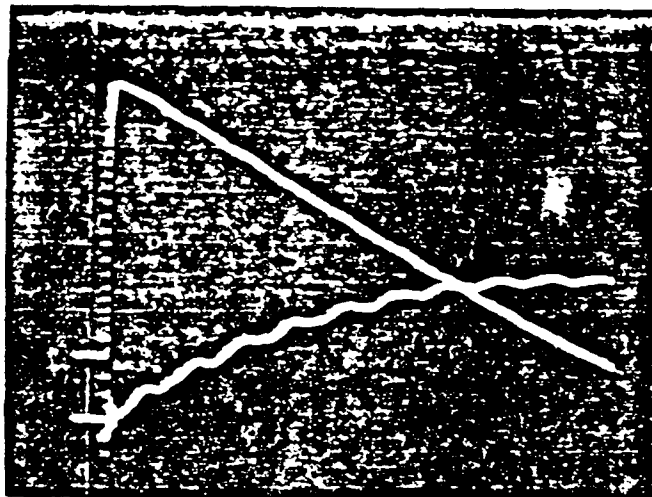

1957-1958 Winter - 1958-1959 Winter - 1959-1960 Winter - 1960-1961 Winter

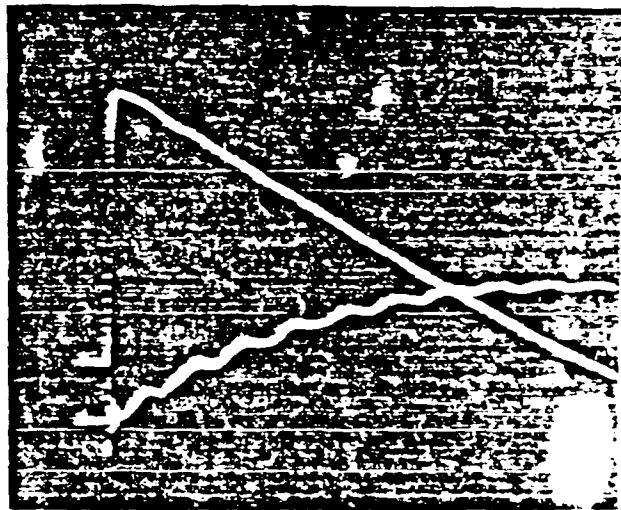
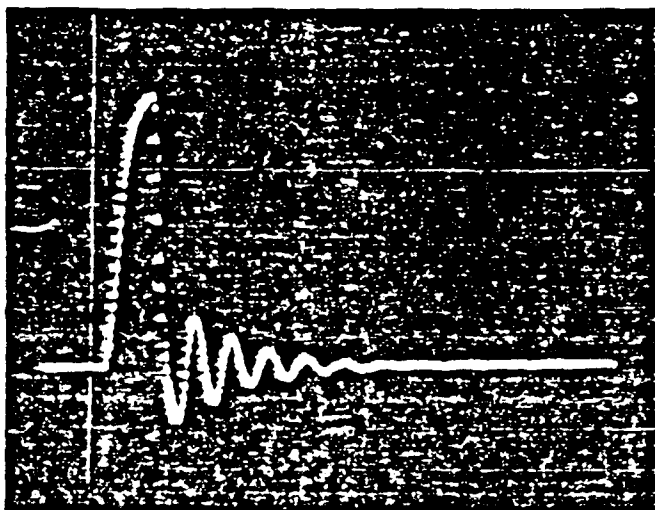

1961-1962 Winter - 1962-1963 Winter - 1963-1964 Winter - 1964-1965 Winter

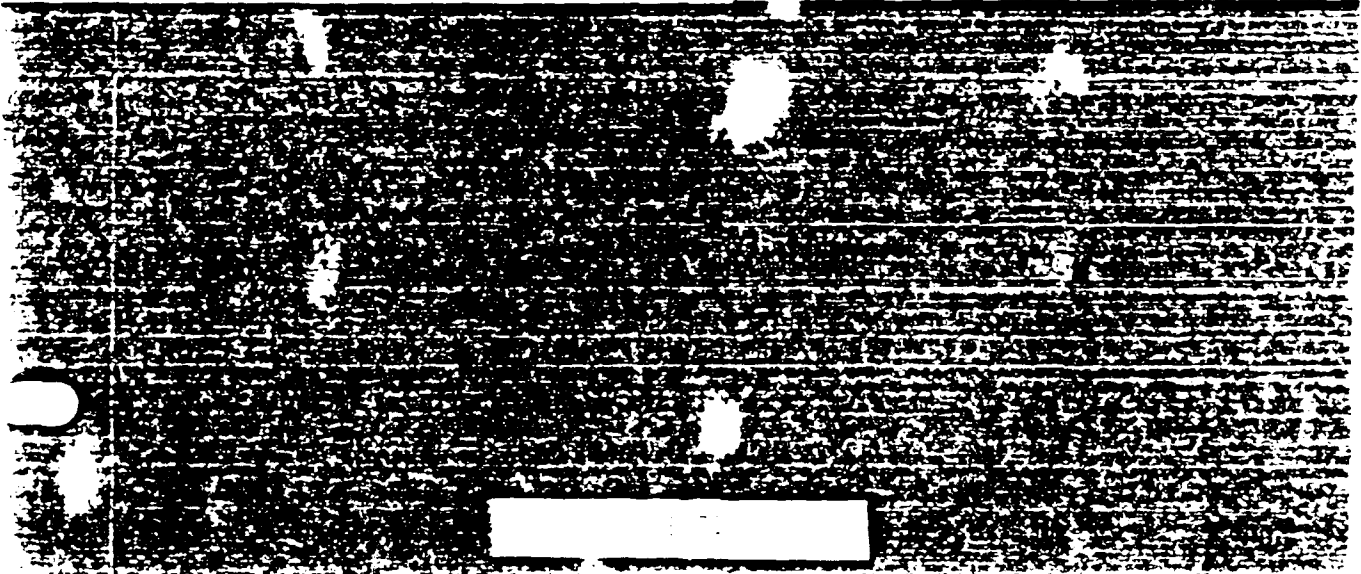

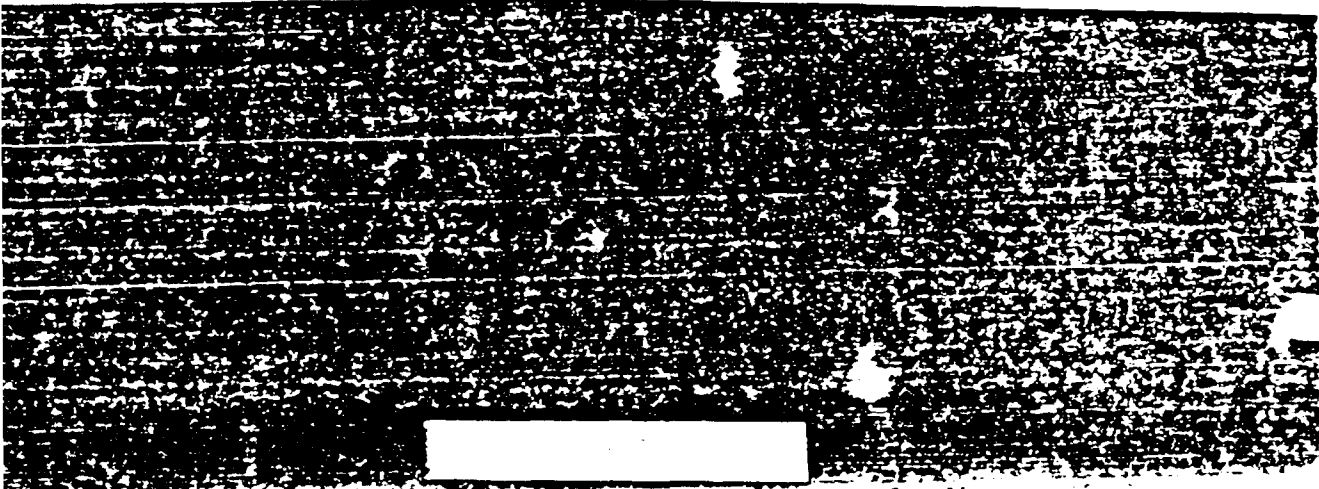
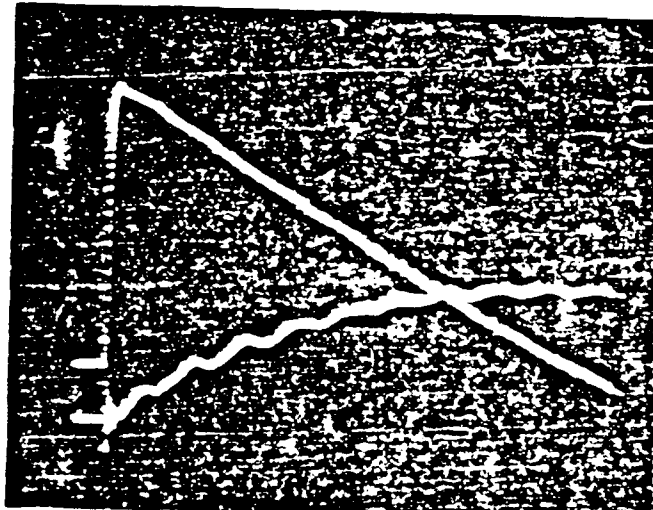
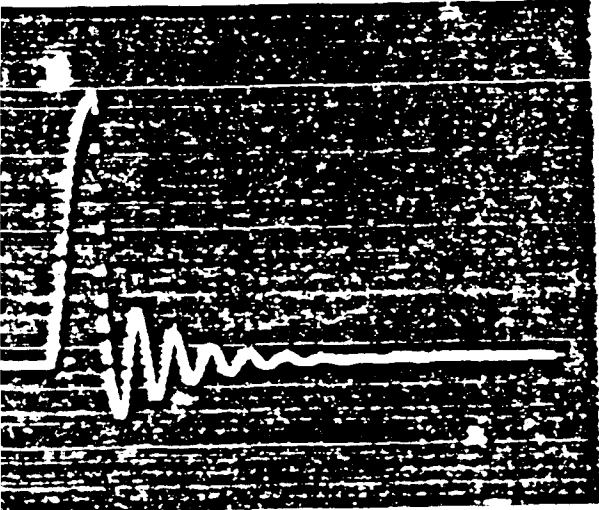
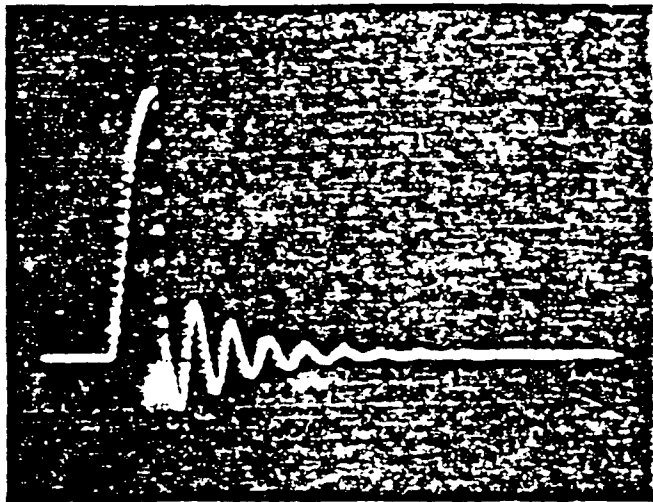
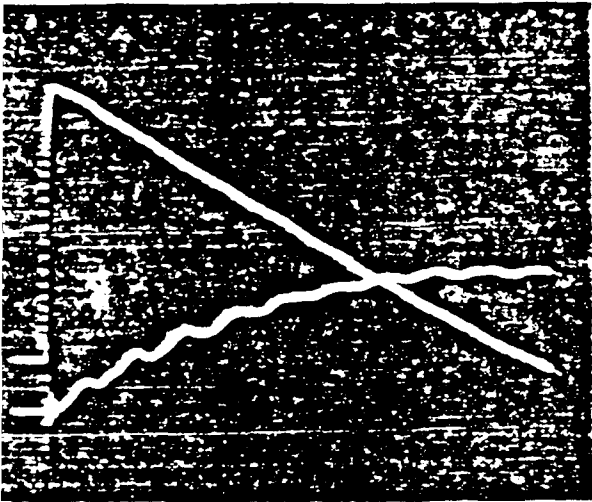

CERTIFIED TEST REPORT

SHOP ORDER 02904-1 STYLE NO. 840500B050 TEST DATE 09-19-90

NOMINAL VOLTAGE: 12000 Delta / 480 Grd-Wye Three Phase 60 Hertz
 KVA: 500/666 CLASS: AA/FFA AVG WDG RISE: 75 DEG C.
 INSULATION RATED AT 185 DEGREE C BIL (kv): HV- 95 LV- 30

CUSTOMER: ABB SERVICE CO. PO# LS-01446-C
 LONG BEACH, CA. 90805

```

*****
*      *      *      *      *      *      *
* KVA * NO LOAD *      * TAP * LOAD *      * TOTAL SERIES
*      * LOSSES * % Iex *      * LOSSES * % Z * RESISTANCE @ 95 C
*      * 26 C * 26 C *      * 95 C * 95 C * PRIMARY SECONDARY
*      * (watts) *      * (volts) * (watts) *      * (ohms) (ohms)
*****
*      *      *      *      *      *      *
* 500 * 2244 * 1.689 * 12000 * 4499 * 5.57 * 13.50484 * 0.004515
*      *      *      *      *      *      *
*****
    
```

```

*****
*      *      *      *      *
* APPLIED VOLTAGE *      * INDUCED VOLTAGE *      * NOMINAL RATIO
* HV LV *      * 400 Hz, 18 SEC. *      *
* (kv) (kv) *      * (volts) *      *
*****
*      *      *      *      *
* 34 4 *      * 960 *      * A/B 43.267
*      *      *      *      *      *      *
*      *      *      *      *      *      *
*      *      *      *      *      *      *
*      *      *      *      *      *      *
*****
    
```

ANSI STANDARD IMPULSE TEST PERFORMED AT 95 KV BIL.

AA MEASURED TEMPERATURE RISE (C): HV - 66.6 LV - 54.0

IMPEDANCE AND LOAD LOSSES AT TAPS:
 (1-2) = 5.51% AND 4344 WATTS, (5-6) = 5.73% = 4638 WATTS

PARTIAL DISCHARGE TEST PERFORMED, SEE ATTACHED FOR TEST RESULTS.

POWER FACTOR TEST PERFORMED AT 2.5 KV:
 H-L = .186, H-G = .182 & L-G = .677

CERTIFICATION:
 TEST TECHNICIAN *[Signature]* ENGINEER *[Signature]*

NATIONAL INDUSTRI TRANSFORMERS, INC.
 HAMPTON, VA. 23661





2520 58th Street
Hampton, Virginia 23661

NATIONAL INDUSTRI

Telephone
(804) 838-8080

Telex
82-3646

Telefax
(804) 838-8905

TRANSMITTAL LETTER

FOR

CERTIFIED TEST REPORT

RE: ABB SERVICE CO.
2382 E. ARTESIA BLVD.
LONG BEACH, CA 90805

DATE: OCT 16 1990

SHOP ORDER NO: 29040

ATTENTION: ROGER RATICAN

JOB NAME: TBA

CUSTOMER: ABB SERVICE CO

P.O.NO: LS-01446-C

We are transmitting herewith four (4) copies of the Certified Test Report for your records.

If you have any questions, please do not hesitate to contact me.

Sincerely,

Patty Dorris
Admin. Assist. Mkt.



B-74

EB CORPORATION - A MEMBER OF THE ASEA BROWN BOVERI GROUP

PARTIAL DISCHARGE TEST DATA

SHOP ORDER 02904-1
STYLE NO. 840500B050
KVA 500
TEST DATE OCTOBER 11, 1990

```
*****  
* TOP * % VOLTAGE * COIL 1 * COIL 2 * COIL 3 *  
*****  
* * * * *  
* INCEPTION * 150 * 3 pc * 5 pc * 15 pc *  
*****  
* * * * *  
* EXTINCTION * 110 * 0 pc * 5 pc * 0 pc *  
*****
```

```
*****  
* BOTTOM * % VOLTAGE * COIL 1 * COIL 2 * COIL 3 *  
*****  
* * * * *  
* INCEPTION * 150 * 3 pc * 5 pc * 15 pc *  
*****  
* * * * *  
* EXTINCTION * 110 * 0 pc * 5 pc * 0 pc *  
*****
```

TRANSFORMER IMPULSE TEST REPORT

Purchaser APP SFEVILLE Co.

Date of Test 12/1/90 Purchaser's Order No. LS-01446-C Mfr's. Ref. 84-1500-B.50

Type CAST/CAST Phase 3 Hertz 60 Insulating Fluid _____
 H Winding 500 KVA X Winding 500 KVA Y Winding _____ KVA
12000 DELTA Volts 480 GRAY/277 Volts _____ Volts
95k 9L 30k 3L _____ 3L

Serial No.	Terminal Surged	Test	Crest Voltage KV	Wave Shape or Rate of Rise	Time to Riseover	Oscillogram Number	Sweep Time or Timing Wave Freq. 4 Sec.	Connect or Limit: Notes - error
204-1	H-1	RFin	475	1.25/50µs		1	10	Grounded
		RFinC				1c	10	Current Limit
		CMV	95		2.05µs	2	2	
		CMV	95		1.95µs	3	2	
		FwV	95	1.25/50µs		4	10	
		FwC				4c	10	
H-2	H-2	RFin	475	1.25/50µs		5	10	
		RFinC				5c	10	
		CMV	95		2.05µs	6	2	
		CMV	95		2.15µs	7	2	
		FwV	95	1.25/50µs		8	10	
		FwC				8c	10	
H-3	H-3	RFin	475	1.25/50µs		9	10	
		RFinC				9c	10	
		CMV	95		2.05µs	10	2	
		CMV	95		1.95µs	11	2	
		FwV	95	1.25/50µs		12	10	
		FwC				12c	10	

• RFWV Reduced Full-Wave Voltage. RFWC Reduced Full-Wave Current. FWV Full-Wave Voltage. FWC Full-Wave Current. CMV Chopped-Wave Voltage. FOWV Front of Wave Voltage.

GRD Terminals grounded. ARR Terminals connected to arresters. RES Terminals connected to ground through linear resistance.

Tests Witnessed by Scott McBride (F646)

I hereby certify that this is a true report based on factory tests made in accordance with USA Standard Test Code for Distribution, Power and Regulating Transformers, C57.12 or latest revision thereof; and that each transformer withstood the above tests.

Signed Tom Johnson B-76 Date 12/1/90

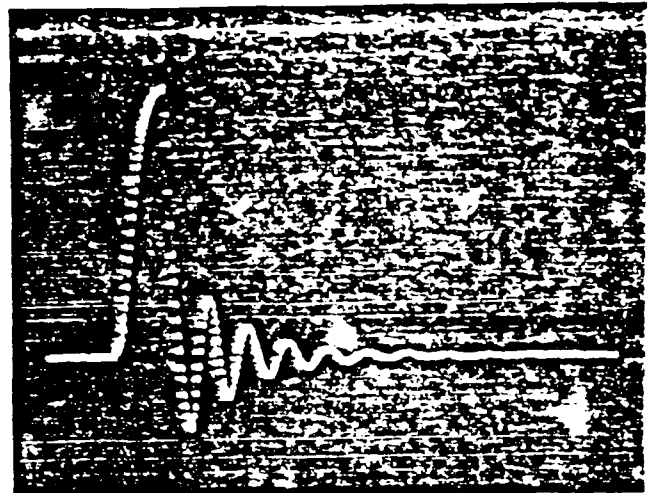
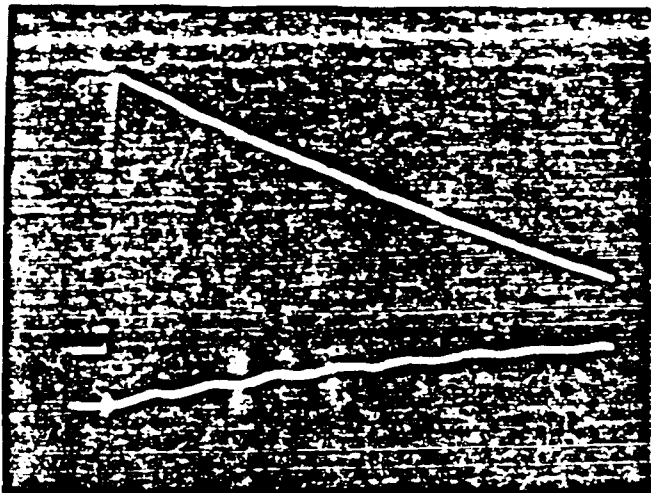

1 - 100 Hz, 100 V, 100 A, 100 W

2 - 100 Hz, 100 V, 100 A, 100 W

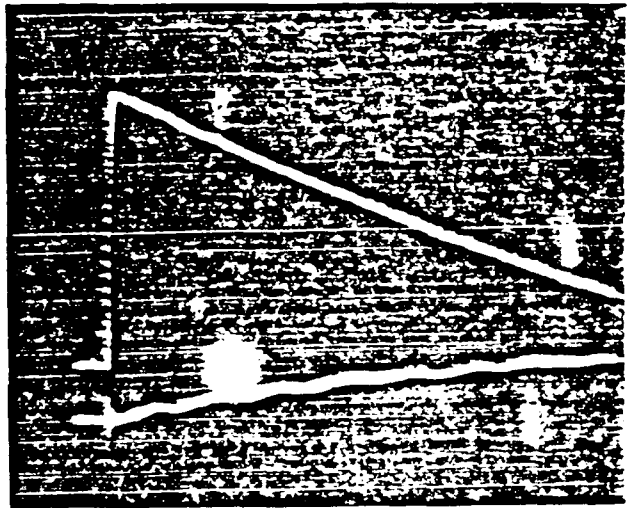
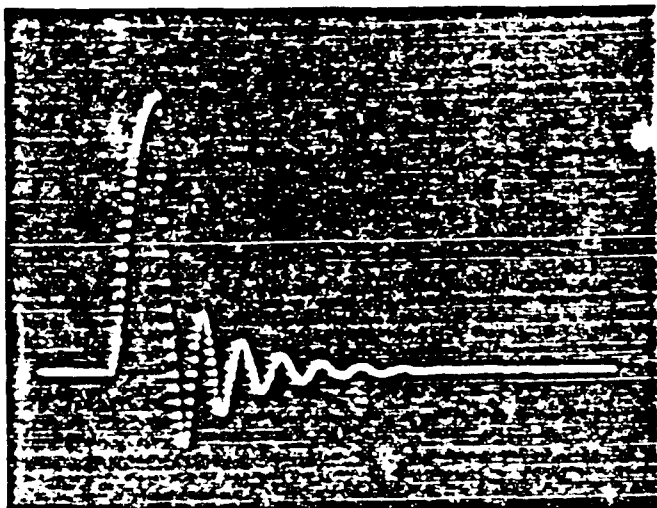

3 - 100 Hz, 100 V, 100 A, 100 W

4 - 100 Hz, 100 V, 100 A, 100 W

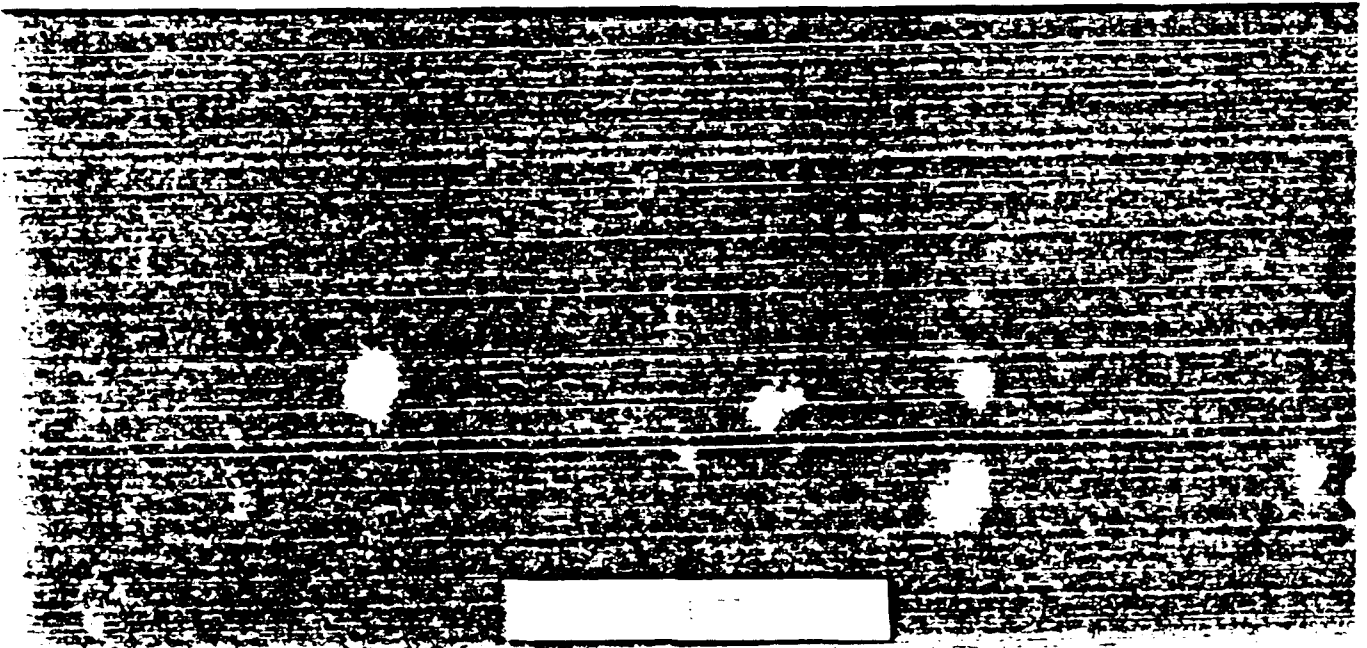

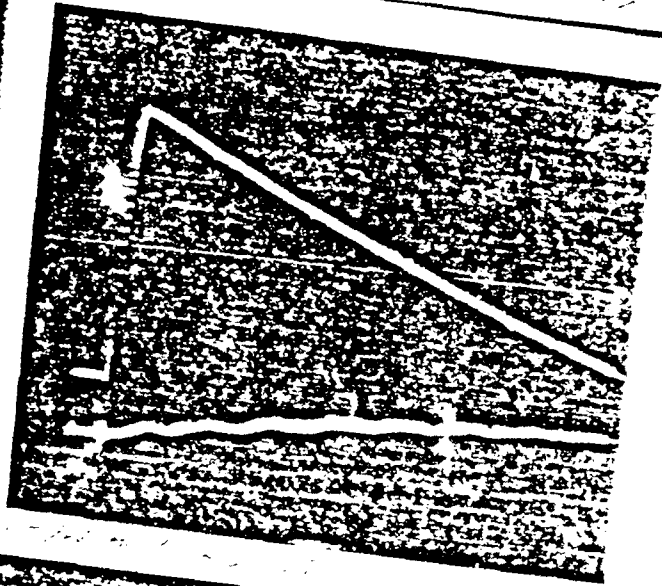
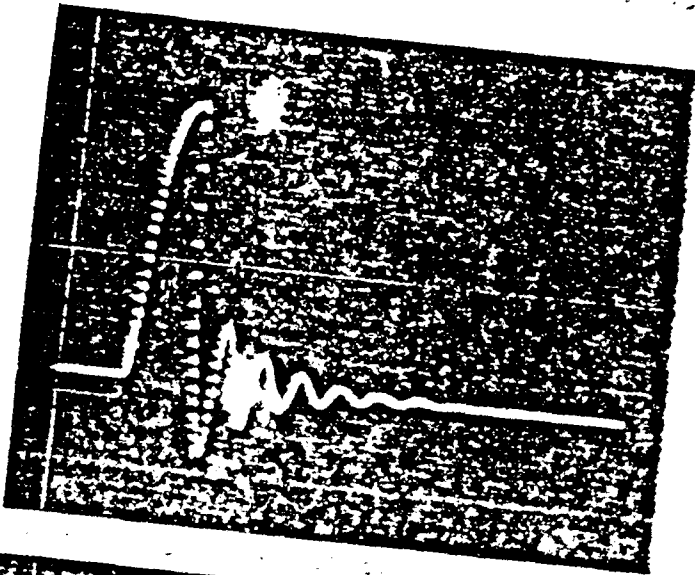
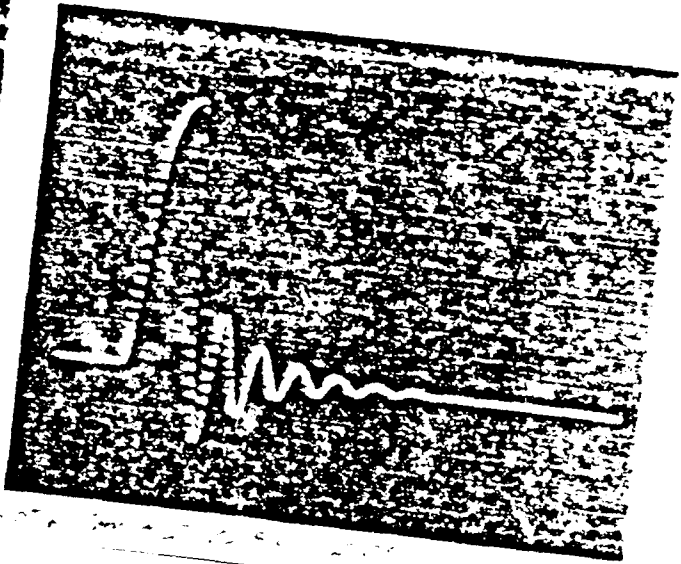
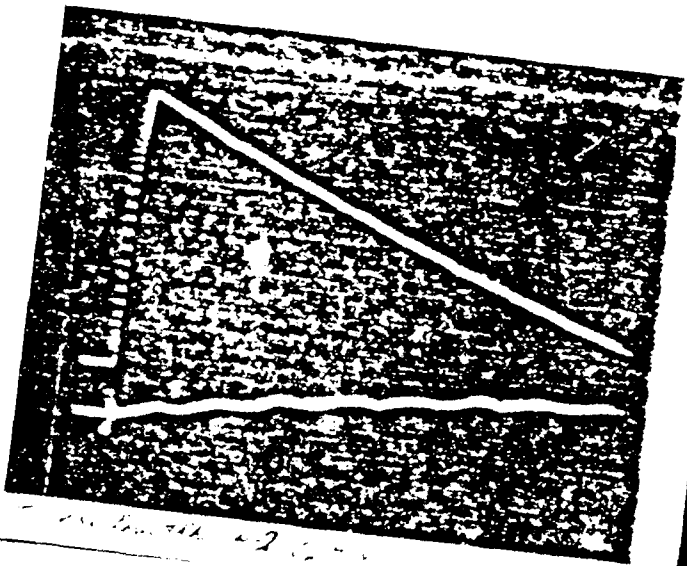

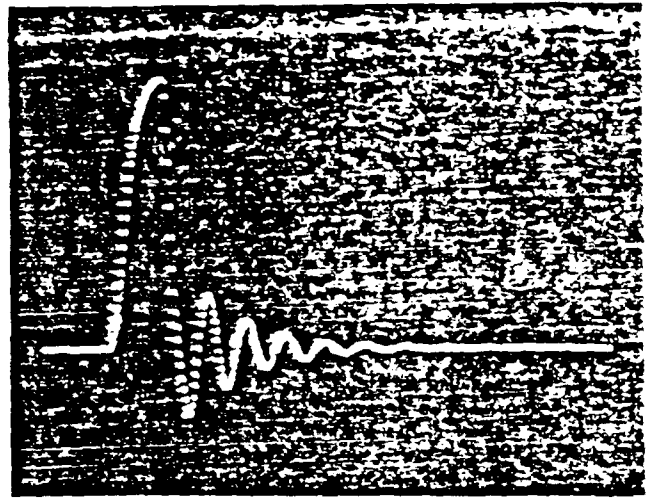
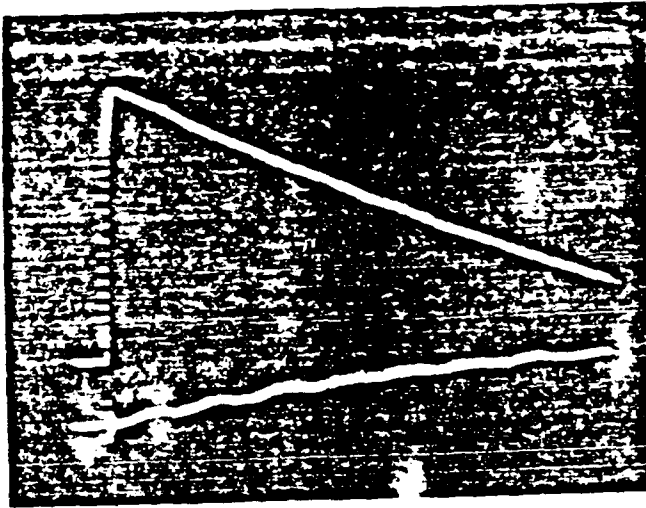

SPT 99, F-3, H-3, K-3, L-3, M-3, N-3, O-3, P-3, Q-3, R-3, S-3, T-3, U-3, V-3, W-3, X-3, Y-3, Z-3

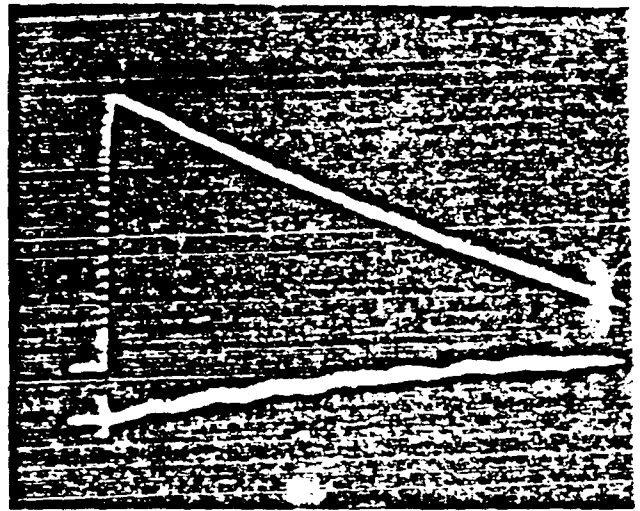
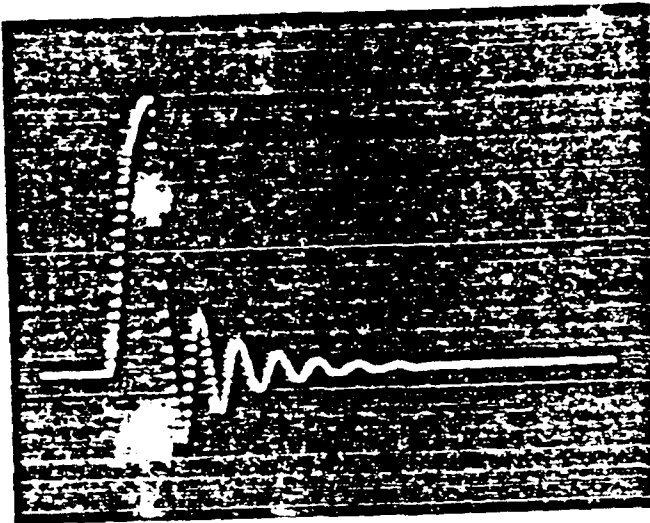

SPT 100, F-4, H-4, K-4, L-4, M-4, N-4, O-4, P-4, Q-4, R-4, S-4, T-4, U-4, V-4, W-4, X-4, Y-4, Z-4

E-73

THREE PHASE
INSULATED TRANSFORMER

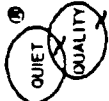

SORGEL[®] TRANSFORMERS
SQUARE D COMPANY

MADE IN U.S.A.



SERIAL NO.: 206105
KVA 300 CLASS AA/FFA
TYPE SHT HERTZ 60
IMPEDANCE %
220 °C INSULATION SYSTEM
FOR 80 °C RISE.
H.V. B.I.L. 60 KV
L.V. B.I.L. 10 KV
APPROX. WEIGHT 4600 LBS.

CONNECTIONS			
2400 DELTA		12000 DELTA	
VOLTS	AMPERES	VOLTS	AMPERES
		12600	13.7
		12300	14.1
2400	72.0	12000	14.4
		11700	14.8
		11400	15.2
LOW VOLTAGE: 480Y/277		AMPERES: 360	
HIGH VOLTAGE TERMINAL BOARD CONNECTIONS			
2400 DELTA			
1 0	10	1 0	10
8 0	09	8 0	09

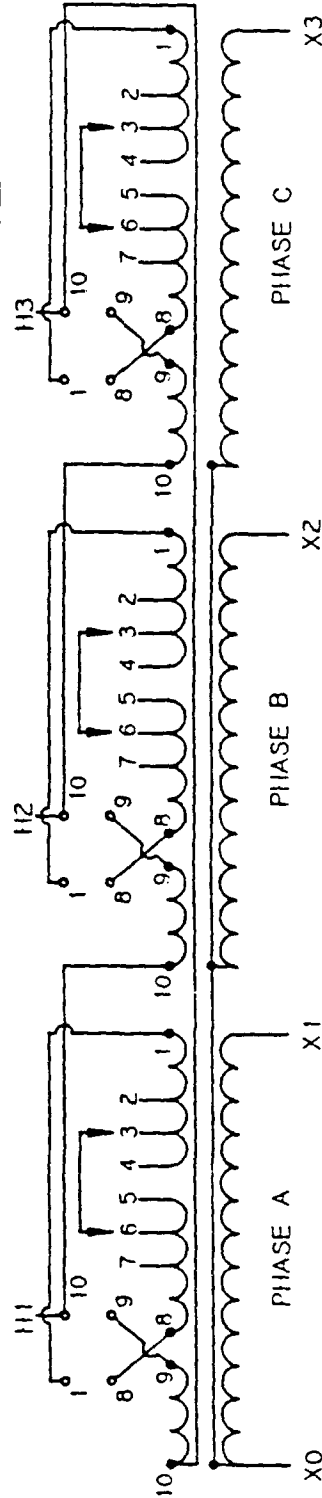
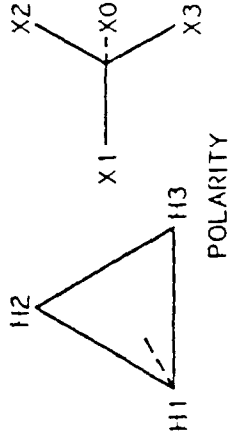

DE-ENERGIZE TRANSFORMER BEFORE CHANGING TAPS.

B-137489

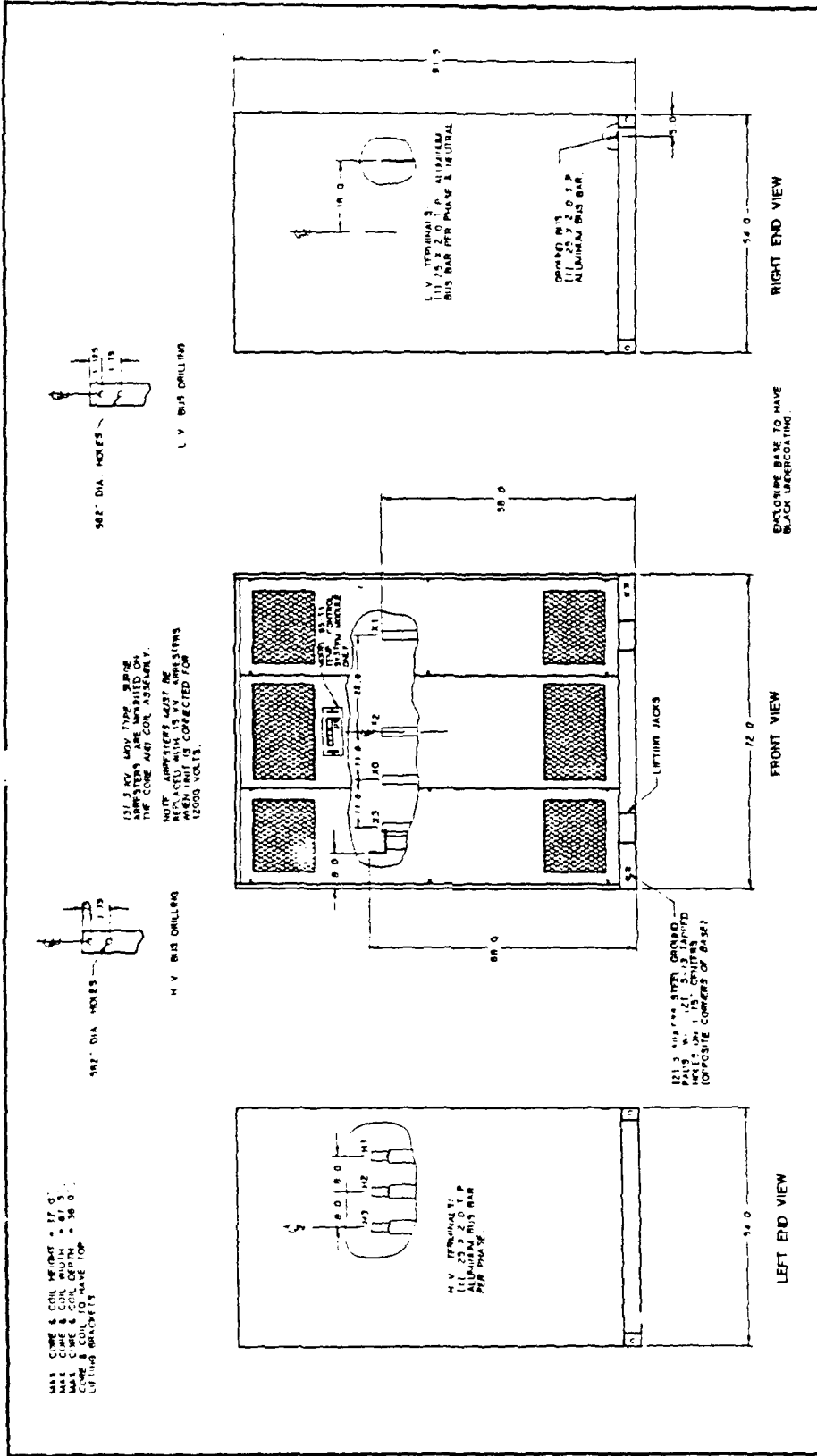

300 KVA 3 PHASE 60 HZ. TYPE SHT
 H.V.: 2400 X 12000 DELTA 60 KV B.I.L.
 L.V.: 480Y/277 10 KV B.I.L.
 TEMPERATURE RISE 80 DEGREES C.

SQUARE D COMPANY
 SQUARE D TRANSFORMERS
 MADE IN U.S.A.

DATE: 10/18/90
 ORDER NO.: 83-2104349 F.O. NO.: 208105

APPROXIMATE WEIGHT: 4800 POUNDS
 FINISH: FED. STD. NO. 595
 DARK FOREST GREEN
 ALUMINUM WINDINGS

REVISIONS	BY	DATE

B-140805

REV	DESCRIPTION	DATE	BY
1	(CHANGED NOTE 3)	AUG 10 90	WHITTE
2	(CHANGED NOTE 81)	AUG 07 90	WHIT

FEATURES

1. STRUCTURAL FRAME, 12 GA AND 14 GA CONSTRUCTION
2. STRUCTURAL STEEL BASE WITH PROVISIONS FOR LIFTING
3. COILS AND BRIDGES
4. COILS FASTENED WITH STD. 5/16 DIA. BOLTS WITH PRIMED PROVISIONS FOR EXTENSION AND LIMITATION FIBERS
5. TOP AREA 2 IN. STAINLESS STEEL GROUND PAINT PROVIDED ON BASE
6. COIL AND COIL ASSEMBLY MOUNTED ON VIBRATION PAWS AND CONNECTED TO EXISTING BASE WITH 1/2" DIA. CABLE PROVISIONS FOR LIFTING OF COIL AND COIL ASSEMBLY (REMOVAL OF TOP ACCESS COVERS REQUIRED)
7. ALUMINUM WOUND COILS, VACUUM CAST FIBER AND REINFORCED
8. ALL WELDED JOINT CONNECTIONS ARE CLEANED AND GROUND
9. TAPS OR FACTS OF COILS ARE ACCESSIBLE BY REMOVAL OF FRONT PANEL OR PANELS
10. FRONT AS NOTED. ALL FRONT AND REAR PANELS ARE REMOVABLE. QUANTITY NOT VARY FROM THAT SHOWN
11. SIMPLE PAINT FINISH TO BE APPLIED TO TOP AND COVERS. 170% PAINT FINISH. ALL PAINT SHALL BE IN ACCORDANCE WITH THE FOLLOWING NOTES. ALL PAINT SHALL BE IN ACCORDANCE WITH THE FOLLOWING UNIFORMS PROVIDED OR NOTED
12. UNIFORMS PROVIDED OR NOTED

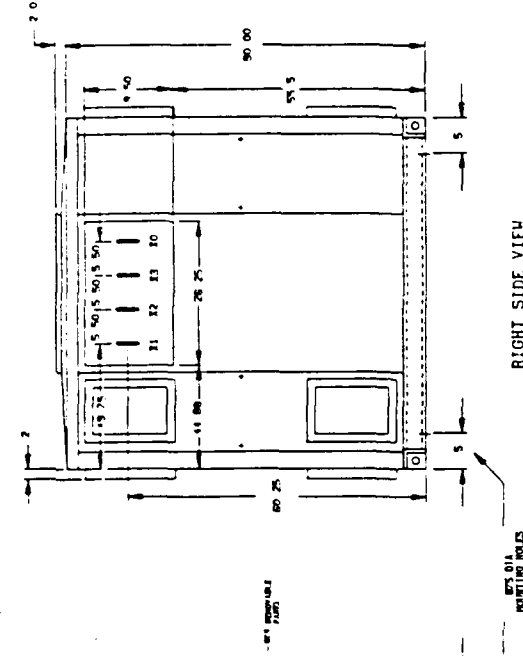
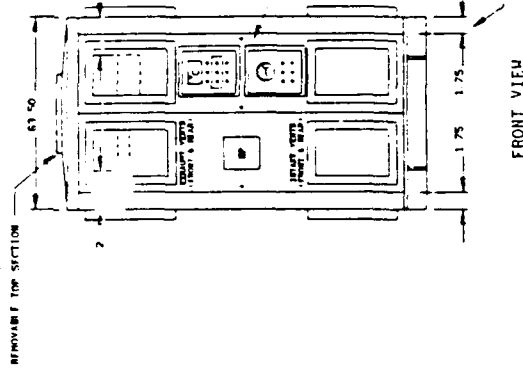
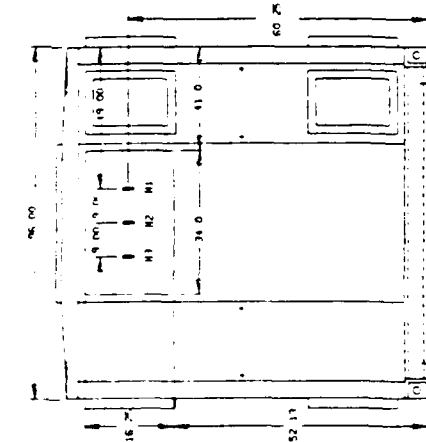
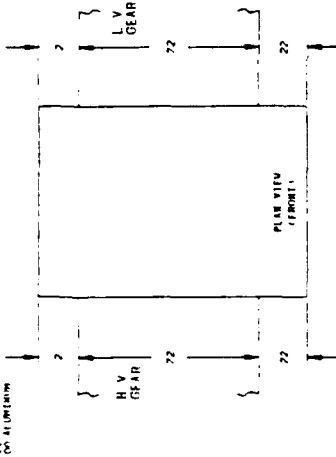
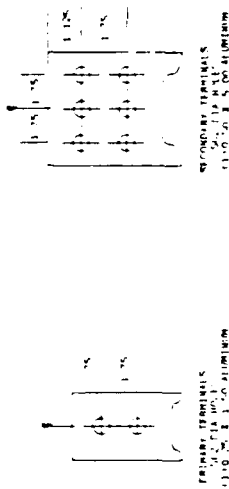

LEFT SIDE VIEW

FRONT VIEW

RIGHT SIDE VIEW

PART UNIT: LITEN 04 - BUDG 472-0245
 OUTDOOR UNIT - 1000 KVA, 33 KV, 1500/2000 KVA, 3. PRIMARY: 3200V DELTA TAPS: 4232.5, 3120V, 1500/2000 KVA, 3. SECONDARY: APPROX 472-0245-0245

REV	DESCRIPTION	DATE	BY
1	ISSUE	AUG 03 90	WHITTE
2	ISSUE	AUG 10 90	WHITTE

SCALE: 1/8" = 1'-0"
 ALL DIMENSIONS UNLESS NOTED OTHERWISE

DESIGNED BY	DATE	ISSUE NO.	ISSUED BY
CONTRACT NO.	AUG 10 90	488 SERVICE CO	WHITTE
PROJECT NO.	10-1	1.6'	WHITTE
DESCRIPTION	10-1	1.6'	WHITTE
ISSUE NO.	10-1	1.6'	WHITTE
ISSUED BY	10-1	1.6'	WHITTE

SAN DIEGO NAVAL FACILITY
 170% PAINT FINISH TO BE APPLIED TO TOP AND COVERS. 170% PAINT FINISH. ALL PAINT SHALL BE IN ACCORDANCE WITH THE FOLLOWING UNIFORMS PROVIDED OR NOTED

ERA NATIONAL INDUSTRIAL
 TRANSFORMERS, INC.
 SAN DIEGO, CALIF.

SPECIAL INSTRUCTIONS:
 A. REFER TO N.E.I. OPERATION AND MAINTENANCE MANUAL
 B. REMOVE ALL RED PAINTED STEEL PARTS BEFORE REMOVING UNIT

STATIONS

- 1 BREAKDOWN ENCLOSURE 12 ON AND 14 ON CONSTRUCTION
- 2 STRUCTURAL STEEL BASE WITH PROVISIONS FOR LIFTING JACKS AND WHEELS
- 3 GEAR / MOTOR ASSEMBLY (SEE STD 5000) WITH PRIMER PROVIDED ON EXTERIOR AND INTERIOR FINISH
- 4 TWO 250A 2 POLE, STAINLESS STEEL, WOUND PAIR PROVIDED ON BASE
- 5 CORE AND COIL ASSEMBLY MOUNTED ON VIBRATION PADS AND PROVIDED TO ENCLOSURE BASE WITH 1/2" GASKET PROVISIONS FOR LIFTING OF CORE AND COIL ASSEMBLY / REMOVAL ON LOW VOLTAGE COVER REQUIRED
- 7 ALUMINUM WOUND COILS, VACUUM CAST PRIMARY AND SECONDARY
- 8 ALL WOUND BUS CONNECTIONS ARE CLEANED AND OILED
- 9 TAPS, ON EACH OF COILS, ARE ACCESSIBLE BY REMOVAL OF FRONT PANEL
- 10 EXCEPT AS NOTED ALL FRONT AND REAR PANELS ARE REMOVABLE. QUANTITY MAY VARY FROM THAT SHOWN
- 11 STEEL FRAME SHALL FORMED AIR COOLING SYSTEM. LEAK TIGHT JOINTS AND ALL THREE PHASE TEMPERATURE MONITORING PROVIDED
- 12 UNDERPARTS PROVIDED ON BASE

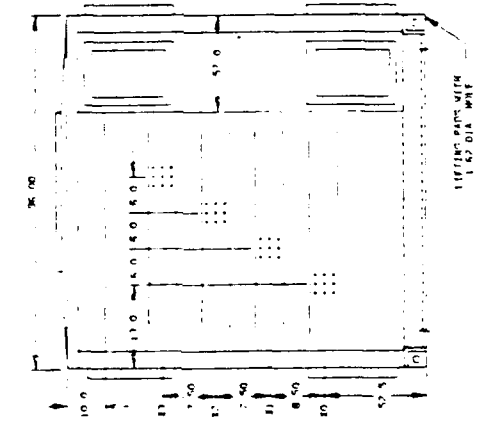
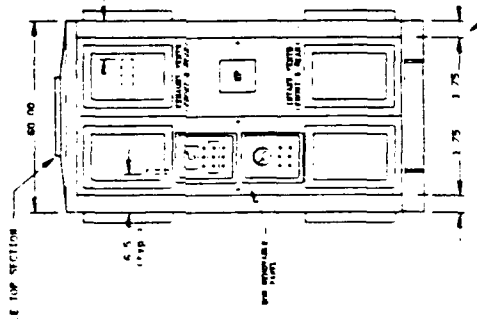
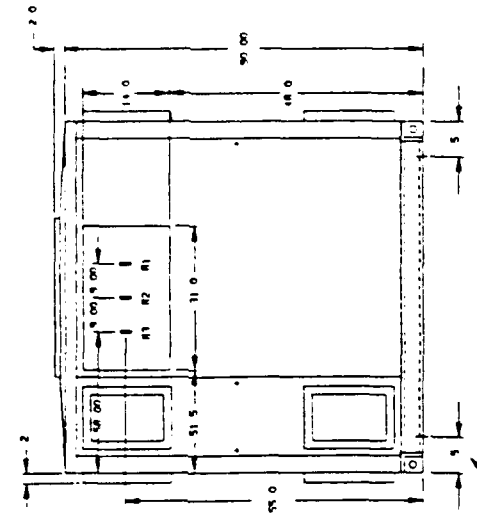
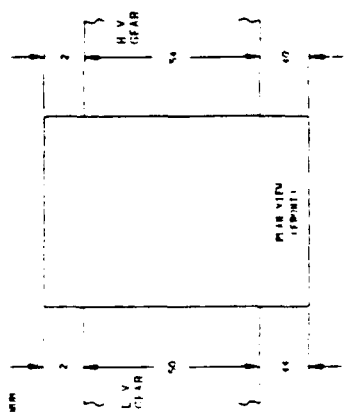
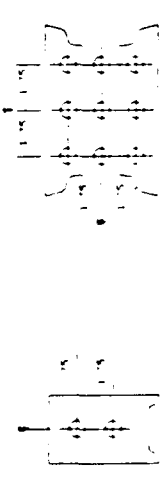

MANUFACTURER'S DATA

UNIT: 11.0 KV, 1.25 KA, 1.25 KA

OUTDOOR, DRY, ALUMINUM FILL TYPE, TRANSFORMER, AZETA CLASS, QUANTITY, 1.

138KV CLASS, 2 PHASE, 60 HZ, 60°C INSULATION, 23°C RISE, 95/20, 1.1 V. BIL

1500/2000 V.A., PRIMARY: 10000 VOLTS, TAPS: 22.5% BEGAN, 22.5% BEGAN, SECONDARY: 10000/22.5% BEGAN, 22.5% BEGAN, APPROX. WT. 12500 LB

FOR NAME AND ADDRESS: SAN DIEGO NAVAL FACILITY

SCALE: 1/4" = 1'-0"

DATE: APR 10 90

PROJECT: C84-1500R110-10.1

DESIGNER: ARB SERVICE CO

DRAWN BY: [Signature]

CHECKED BY: [Signature]

APPROVED BY: [Signature]

DATE: 02/90

SPECIAL INSTRUCTIONS

- 1 REFER TO B 1.1 FOR OBSERVATION AND MAINTENANCE MANUAL
- 2 REMOVE ALL RED PAINTED STEEL PARTS BEFORE ENERGIZING UNIT

NOTES

1. FABRICATED TO DRAWING 1000 T-140-1590-10-1
2. SEE DRAWING 1000 T-140-1590-10-2 FOR DIMENSIONS
3. PAINT FINISH - INTERIOR PARTS: 100% ZINC RICH PRIMER PAINTED ON EXTERIOR AND INTERIOR SURFACES
4. TWO (2) NO. 10-32 STAINLESS STEEL BRACKET FEET PROVIDED ON EACH
5. COIL AND COIL ASSEMBLY MOUNTED ON VIBRATION PAIRS ARE MOUNTED TO BRACKETING BASE WITH 1/2" X 1/4" CAPS
6. PROVISIONS FOR LIFTING OF COIL AND COIL ASSEMBLY REMOVAL OF THE ACCESS COVER REQUIRED.
7. ALUMINUM COILS WITH CAST PRIMARY ARE TO BE USED
8. ALL MOUNTING CONNECTIONS ARE CLEARED AND DRILLED
9. THIS OR PARTS OF COILS, ARE ACCESSIBLE BY REMOVAL OF FRONT BOLT OR PANELS
10. EFFECT AS NOTED: ALL FRONT AND REAR PANELS ARE REMOVABLE. QUANTITY MAY VARY FROM THAT SHOWN
11. SINGLE PHASE AIRING FAN COOLING CONTROL, THREE PHASE MOTORS AND C.T. THREE PHASE TEMPERATURE MONITORING PROVIDED
12. UNDERMOUNTING PROVIDED ON BASE
13. BASE PLATE PROVIDED

PROPERTY IDENTIFICATION
 1000 T-140-1590-10-1
 1000 T-140-1590-10-1

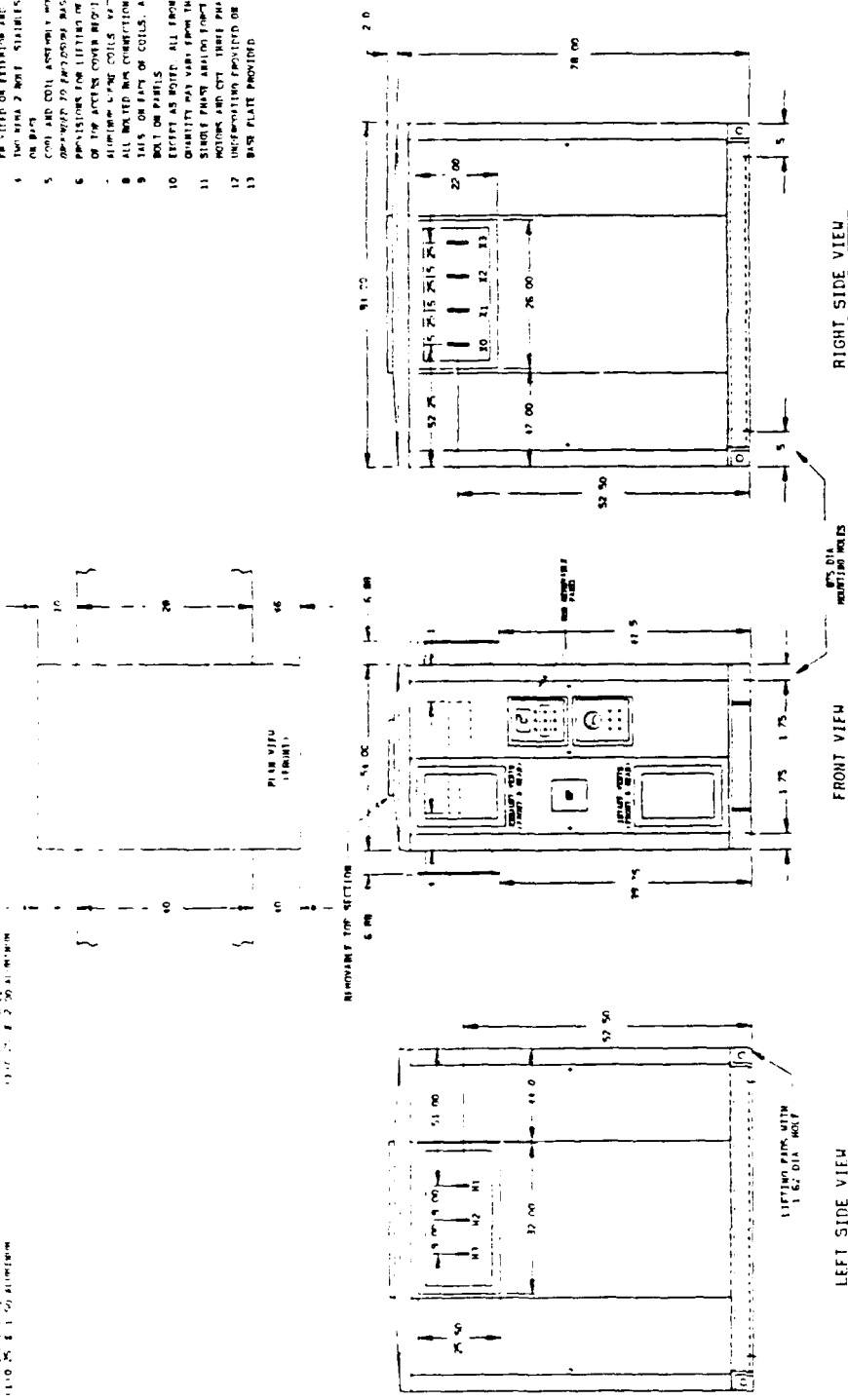

MARK UNIT: ITR 17, INDO 700 & COOL

OUTDOOR, 100% REFRIG. TYPE, TRANSFORMER, 1000 KVA, QUANTITY 1
 15K V. CLASS, 3 PHASE, 60 HZ, 60°C INSULATION, 75°C RISE
 500/600 V V.A., PRIMARY, 10000 BELLA, TAPS, 2.2.5, 2.2.5, 2.2.5, 2.2.5, 2.2.5, 2.2.5
 SECONDARY, 1000/220, 3.75 X 1.75 X 1.75, 1.75 X 1.75, 1.75 X 1.75

ALL DIMENSIONS ARE IN INCHES

SCALE: 1/8" = 1'-0"

DATE	APR 15 90	BY	ARR SERVICE CO
UNIT	1000 T-140-1590-10-1	SCALE	1/8" = 1'-0"
PROJECT	1000 T-140-1590-10-1	DATE	APR 15 90
DESIGNER	SE	SCALE	1/8" = 1'-0"

SPECIAL INSTRUCTIONS

- A REFER TO B I I I OPERATION AND MAINTENANCE MANUAL
- B REMOVE ALL RED PAINTED STEEL PARTS BEFORE ENERGIZING UNIT

1. ALL DIMENSIONS ARE IN INCHES UNLESS OTHERWISE SPECIFIED.

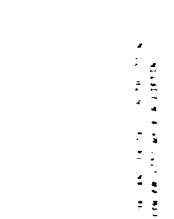

2. ALL DIMENSIONS ARE IN INCHES UNLESS OTHERWISE SPECIFIED.

1. ALL DIMENSIONS ARE IN INCHES UNLESS OTHERWISE SPECIFIED.
2. ALL DIMENSIONS ARE IN INCHES UNLESS OTHERWISE SPECIFIED.
3. ALL DIMENSIONS ARE IN INCHES UNLESS OTHERWISE SPECIFIED.
4. ALL DIMENSIONS ARE IN INCHES UNLESS OTHERWISE SPECIFIED.
5. ALL DIMENSIONS ARE IN INCHES UNLESS OTHERWISE SPECIFIED.
6. ALL DIMENSIONS ARE IN INCHES UNLESS OTHERWISE SPECIFIED.
7. ALL DIMENSIONS ARE IN INCHES UNLESS OTHERWISE SPECIFIED.
8. ALL DIMENSIONS ARE IN INCHES UNLESS OTHERWISE SPECIFIED.
9. ALL DIMENSIONS ARE IN INCHES UNLESS OTHERWISE SPECIFIED.
10. ALL DIMENSIONS ARE IN INCHES UNLESS OTHERWISE SPECIFIED.
11. ALL DIMENSIONS ARE IN INCHES UNLESS OTHERWISE SPECIFIED.
12. ALL DIMENSIONS ARE IN INCHES UNLESS OTHERWISE SPECIFIED.
13. ALL DIMENSIONS ARE IN INCHES UNLESS OTHERWISE SPECIFIED.

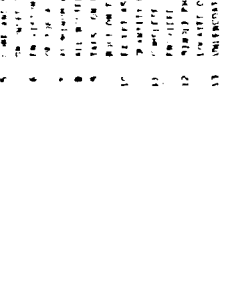

PLAN VIEW (FRONT)

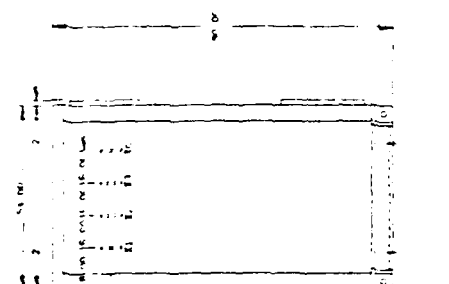

FRONT VIEW

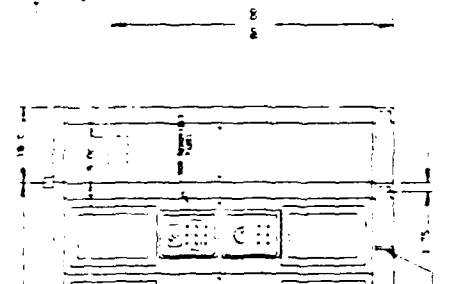

LEFT SIDE VIEW

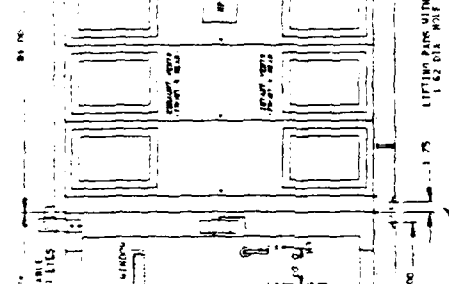

RIGHT SIDE VIEW

OUTDOOR, DRY, SUBSTATION TYPE TRANSFORMER, AREA CLASS, 1500VA, 15K V. CLASS, 2 PHASE, 60 HZ, C. INSULATION, 50°C RISE, 1.5% LOSS, 1.5% RFL. SECONDARY, APPROX. 2.5% TOLERANCE, APPROX. 1.5% LOSS.

EBA NATIONAL PRODUCTS	
TRANSFORMERS IN STOCK	1500VA
TRANSFORMERS IN STOCK	1500VA
TRANSFORMERS IN STOCK	1500VA

WARNING: THIS EQUIPMENT MUST BE FINISHED OR INSTALLED IN A PROPER MANNER AND THE NATIONAL ELECTRIC SAFETY CODE.

SPECIAL INSTRUCTIONS:
1. REFER TO THE INSTRUCTIONS FOR THE UNIT.
2. REFER TO THE INSTRUCTIONS FOR THE UNIT.

Appendix C
Operating and Maintenance Manuals
and Product Information

Instructions for Receiving, Installing Operating and Maintaining **DRY TYPE TRANSFORMERS**

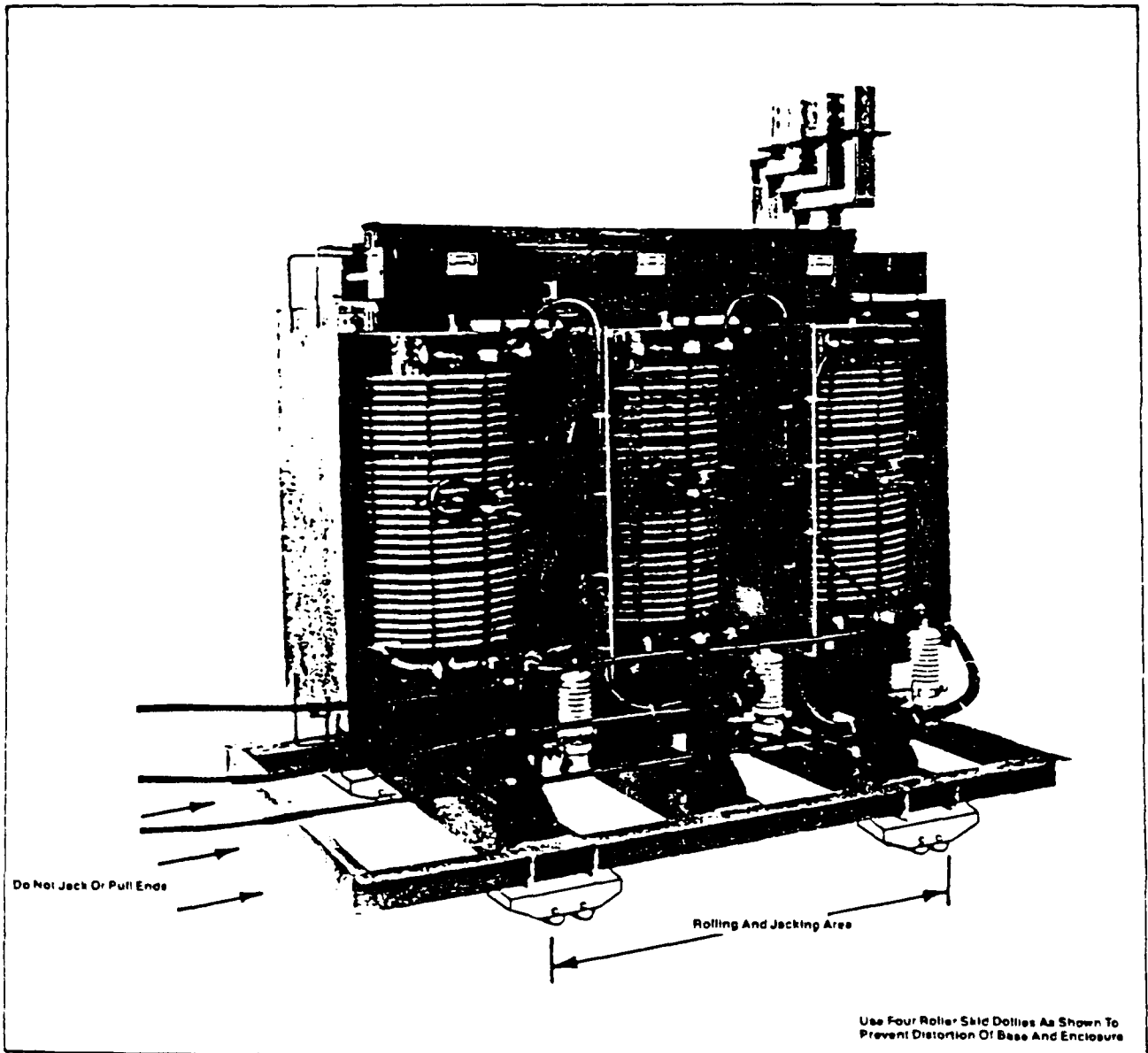

SQUARE D COMPANY

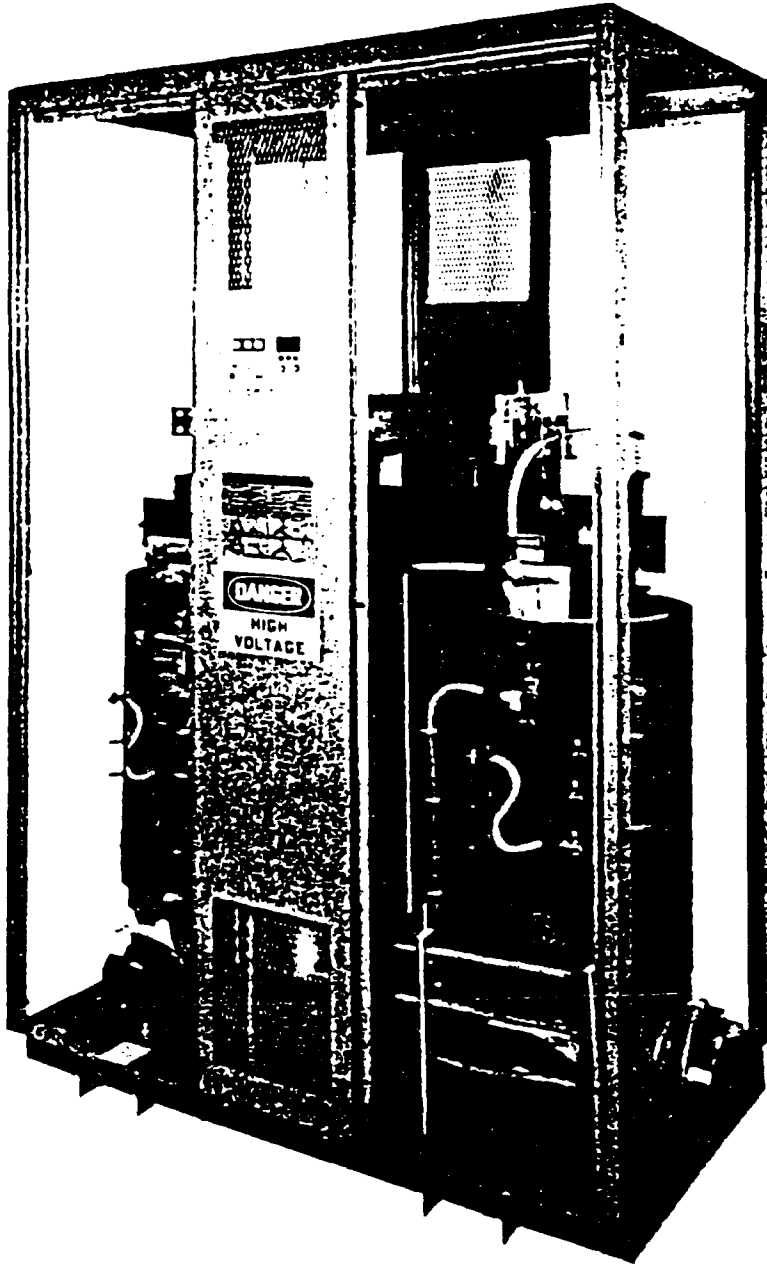

Dry Type Core And Coil Assembly, Compact Type, In 36" Deep, Ventilated Enclosure



Guide For The Operation And Maintenance Of Indoor Ventilated Dry Type Transformers

This instruction manual covers general recommendations for the operation and maintenance of dry type distribution and power transformers.

The successful operation of these transformers is dependent on proper installation, loading and maintenance as well as on proper design and manufacture. As with all electric apparatus, neglect of certain fundamental requirements may lead to serious trouble, if not to the loss of the equipment. For this reason, a wide distribution of information in regard to the care of dry type transformers is important, and these brief instructions are published for that purpose.

In addition to the use of this guide, the factory may be consulted for specific recommendations on special conditions. Also reference may be made to other publications, some of which are listed in the Appendix.

1. INSTALLATION

A. Location

Factors which should be kept clearly in mind in locating dry type transformers are accessibility, ventilation and atmospheric conditions.

Ventilated dry type transformers normally are designed for installation indoors in dry locations. They will operate successfully where the humidity is high but under this condition it may be necessary to take precautions to keep them dry if they are shut down for appreciable periods. This is discussed more fully under "Operation." Locations where there is dripping water should be avoided. If this is not possible, suitable protection should be provided to prevent water from entering the transformer case. Precautions should be taken to guard against accidental entrance of water, such as might occur from an open window, by a break in a water or steam line, or from use of water near the transformers. Adequate ventilation is essential for the proper cooling of transformers. Clean dry air is desirable. Filtered air may reduce maintenance if the location presents a particular problem. When transformers are installed in vaults or other restricted spaces, sufficient ventilation should be provided to hold the air temperature with-

in established limits when measured near the transformer inlets. This usually will require a minimum of 100 cubic feet of air per minute per kilowatt of transformer loss. The area of ventilating openings required depends on the height of the vault, the location of openings, and the maximum loads to be carried by the transformers. For self-cooled transformers, the required effective area should be at least one square foot each of inlet and outlet per 100 KVA of rated transformer capacity, after deduction of the area occupied by screens, gratings or louvers.

Ventilated dry type transformers should be installed in locations free from unusual dust producing mediums or chemical fumes. Transformers should be located at least 12 inches from walls or other obstructions that might prevent free circulation of air through and around each unit. The distance between adjacent transformers should not be less than this value. Also, accessibility for maintenance should be taken into account in locating a transformer. If the transformer is to be located near combustible materials, the minimum separations established by the National Electrical Code should be maintained.

The transformer case is designed to prevent the entrance of most small animals and foreign objects. However, in some locations, it may be necessary to give consideration to additional protection.

In general, a flat, level industrial floor is adequate and no special preparation is necessary because of the base construction used on these transformers which completely eliminates the complicated process of grouting sills into concrete floors.

If noise is a factor in the location and operation of any transformers, special consideration should be given to the installation of the equipment.

The impulse strength of these transformers is less than that of liquid-immersed units of the same voltage class. If there is any likelihood that transformers will be exposed to lightning or severe switching surges, adequate protective equipment should be provided.

Transformers of standard temperature rise are designed to operate at altitudes up to and including 3300 feet. Dry type transformers are dependent upon air for dissipation of their heat losses and consequently the effect of decreased air density due to high altitude is to increase the temperature rise. Standard transformers can be used at altitudes greater than 3300 feet if the load to be carried is reduced below nameplate rating as follows:

1. If the transformer is dry type, self-cooled, Class AA,

reduce the nameplate rating by 0.3% for each 330 feet that the altitude is above 3300 feet.

2. If the transformer is a dry type, forced air cooled, Class AA/FA, reduce the nameplate rating by 0.5% for each 330 feet that the altitude is above 3300 feet.

If the maximum 24 hour average temperature of the cooling air is reduced below design levels, the altitude limitation of 3300 feet can be safely exceeded *without reducing* the nameplate rating of the transformer within the limitations of the table below.

Maximum 24-hour Average Temperature of Cooling Air, Degrees C

Type of Apparatus	Altitude			
	3300 Feet (1000 Meters)	6600 Feet (2000 Meters)	9900 Feet (3000 Meters)	13200 Feet (4000 Meters)
DRY-TYPE CLASS				
AA				
80°C rise	30	26	22	18
115°C rise	30	24	18	12
150°C rise	30	22	15	7
DRY-TYPE CLASS				
AA/FA				
80°C rise	30	22	14	6
115°C rise	30	18	7	-5
150°C rise	30	15	0	-15

B. Inspection

New transformers should be inspected when received for damage during shipment. Examination should be made before removing from cars or trucks and if any injury is evident or any indication of rough handling is visible, a claim should be filed with the carrier at once and the manufacturer should be notified.

Subsequently, covers or panels should be removed and an internal inspection made for injury or displacement of parts, loose or broken connections, cracked porcelain, dirt or foreign material and for the presence of free water or moisture. Corrective measures should be taken where necessary. Slipping braces should be removed if provided.

After a transformer is moved, or if it is stored before installation, this inspection should be repeated before placing the transformer in service.

After making all the necessary primary and secondary connections the equipment should be thoroughly inspected. Before placing in service, the operation of fans, motors, thermal relays and other auxiliary devices should be checked. All bolted connections which may have loosened in shipment must be tightened before energizing. See torque listing below.

Keys nuts must be tightened to the following torque:

- Size 1/4 — 20 torque 4-6 foot pounds
- Size 5/16 — 18 torque 6-12 foot pounds
- Size 3/8 — 16 torque 15-20 foot pounds
- Size 1/2 — 13 torque 25-30 foot pounds

Do not over tighten.

C. Handling

Large dry type transformers are correctly handled as shown below. This method will prevent damage to the sheet metal enclosure using reasonable care. These transformers are constructed on a heavy, rigid base provided with integral lifting devices as seen in the photo. They must be lifted only from the base using proper cable

spreaders to protect the enclosure. If they must be rolled or skidded, use four roller skid dollies, one near each integral lifting device, to prevent tipping and distortion of base and enclosure.

When ventilated transformers are handled or stored outdoors, they must be completely protected against any inclement weather to prevent entrance of rain or snow.

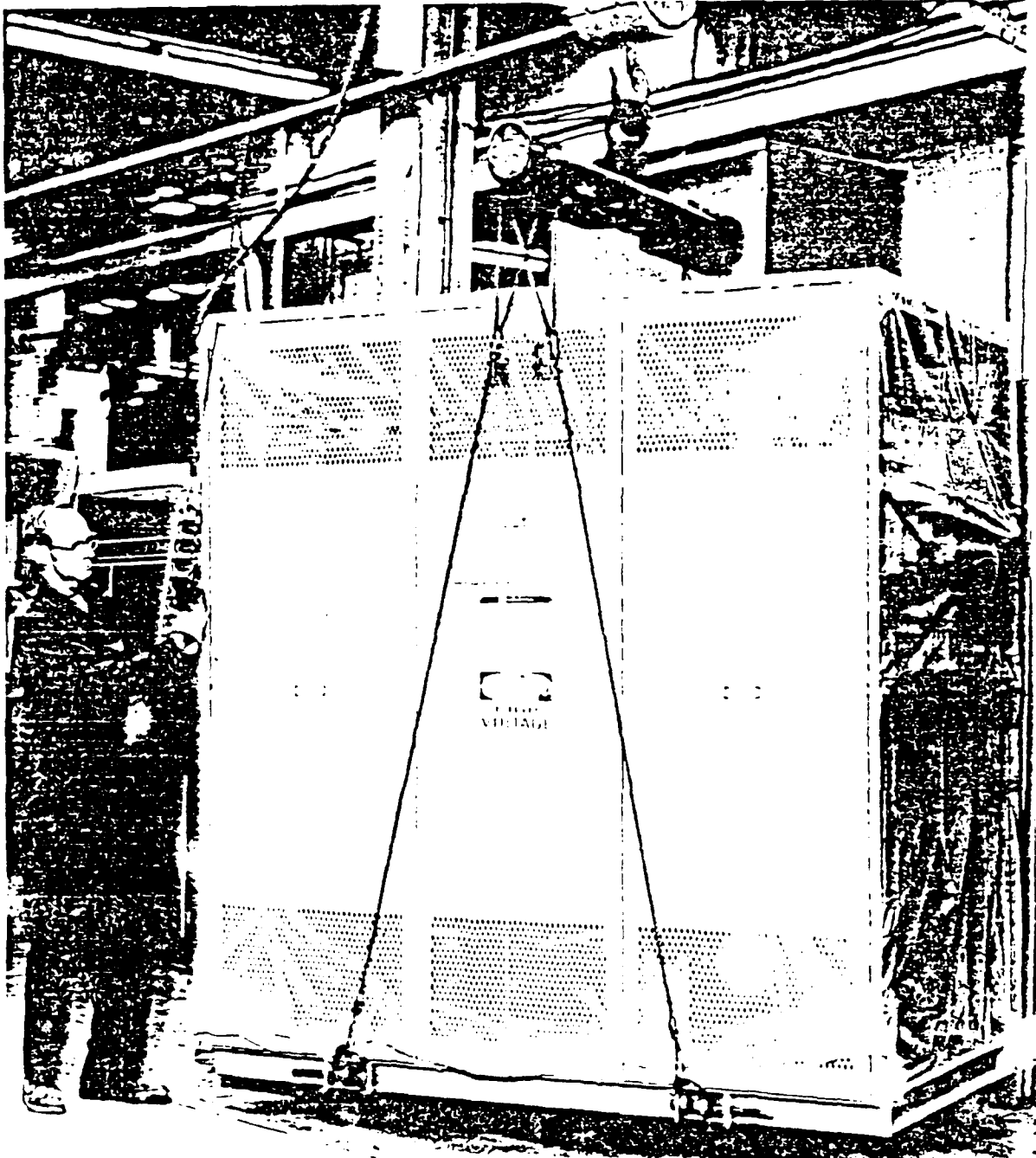

SQUARE D COMPANY

D. Grounding

The case and core assembly of these transformers should be permanently and adequately grounded.

2. TESTING

A. Insulation Resistance – Required

1. GENERAL

The insulation resistance test is of value for future comparative purposes and also for determining the suitability

of the transformer for energizing or application of the high potential test. THE INSULATION RESISTANCE TEST MUST BE SUCCESSFULLY COMPLETED FOR FACTORY WARRANTY TO BE VALID. INSULATION RESISTANCE TEST MUST BE CONDUCTED IMMEDIATELY PRIOR TO ENERGIZING THE TRANSFORMER OR BEGINNING THE DIELECTRIC TEST.

All dry type unit substation transformers are given insulation resistance tests at the factory. These values are recorded on a large megger test tag, facsimile shown below, attached to the transformer.

<p>IMPORTANT READ CAREFULLY</p> <p>FOR TRANSFORMER WARRANTY TO BE VALID, THE FOLLOWING MEGGER TESTS MUST BE MADE, USING A MINIMUM OF A 1000 VOLT MEGGER, IMMEDIATELY PRIOR TO PLACING THIS TRANSFORMER IN SERVICE. BEFORE USING MEGGER BE SURE TO DISCONNECT LIGHTNING ARRESTERS, FAN SYSTEM, METERS, OR ANY LOW VOLTAGE CONTROL SYSTEM THAT IS CONNECTED TO ANY WINDINGS INVOLVED IN THIS TEST. THE TABULATIONS BELOW ARE VALUES OBTAINED ON THE FACTORY TEST FLOOR USING 1000 VOLT INSTRUMENT WITH A 2000 MEGOHM SCALE. IF VALUES OBTAINED IN THE FIELD TESTS ARE LESS THAN 1000 MEGOHM OR ONE-HALF THE FACTORY TEST VALUES LISTED BELOW WHICHEVER IS THE LESSER, THEN THE TRANSFORMER SHOULD NOT BE ENERGIZED UNTIL IT IS DRIED OUT AS DESCRIBED IN THE INSTRUCTION MANUAL FOR DRY TYPE TRANSFORMERS.</p> <p style="text-align: center;">TRANSFORMER SERIAL NO. _____</p> <p>DATE _____ TEMP. ° C. _____ LOW VOLTAGE TO GRD. _____ MEGS. _____</p> <p>L.V. TO H.V. _____ MEGS., H.V. TO GRD. _____ MEGS. BY _____</p> <p style="text-align: right; font-size: small;">43006-081-01</p>

If the test tag is lost or destroyed, refer to the factory where a permanent record of these test results is kept on file.

The field insulation resistance test must be conducted immediately prior to energizing the transformer. These values, CORRECTED TO FACTORY TEST TEMPERA-

TURE in degrees Centigrade, must be either 1,000 megohms or a minimum of one-half or more of the values obtained in the factory test when this value is less than 1,000 megohms. If the corrected field test values are less than the above minimum, the transformer is considered unsafe to energize and must be dried using procedure described under maintenance.

2. TEST PROCEDURE

a. If the transformer is not scheduled to be energized immediately, it is recommended that within one week after receiving, heat be placed under the transformer to insure dryness for megger test.

Six 150 watt lamps placed under the transformer; two lamps under each coil, one on each side of the core should be used for transformers rated 750 KVA and below. Use six 300 watt lamps for transformers rated 751 to 2000 KVA. Heat should be supplied on a continuous 24 hour per day basis. Ventilating openings should be blocked during this period.

b. Make sure transformer is clean using vacuum cleaner to insure removal of all foreign material that may affect insulation resistance test values.

c. Disconnect ALL high voltage, low voltage and neutral connections, as well as lightning arresters, fan system, meters or any low voltage control system that is connected to any windings involved in this test. Do not disconnect ground connection to transformer frame.

CAUTION

TEMPERATURE CONTROL SYSTEM (IF FURNISHED) MUST BE COMPLETELY DISCONNECTED DURING ANY TRANSFORMER TEST SUCH AS MEGGER, DIELECTRIC (HI-POT), DOBLE, ETC., TO PREVENT DESTRUCTION OF TEMPERATURE CONTROL CIRCUITRY.

d. Before beginning megger checks, jumper together all high voltage connections. Make sure jumpers are clear of all steel and grounded parts. Also jumper together all low voltage and neutral connections again making sure jumpers are clear of all steel and grounded parts.

e. Using a megger with a minimum scale of 2,000 megohms and minimum rating of 1,000 volts, make megger checks with the megger connected as follows (Note: Each megger check to be maintained for a period of one minute.)

- (1) High voltage to ground
- (2) Low voltage to ground
- (3) High voltage to low voltage

f. Megger readings should be recorded along with test temperature (°C). If heat has been applied to transformer, determine temperature of transformer at time of test by placing thermometer on top of transformer core and allowing time for thermometer reading to stabilize. Using table on page 6, determine correction multiplier and multiply field test megger readings to obtain temperature corrected field test megger values.

g. If corrected field test megger values are less than one-half of factory test readings, the transformer is not considered safe for energizing or performing dielectric tests. Transformer should be dried as outlined under maintenance section.

h. If the corrected field test values are one-half or more of the factory readings or 1,000 megohms, whichever is less, the transformer is considered safe for conducting the dielectric test or energizing. Transformer connections should be remade and transformer energized immediately after completing insulation resistance test if dielectric test is not to be completed.

B. Dielectric Test — Recommended

1. GENERAL

The dielectric test imposes a stress on the insulation since the dielectric test voltage is higher than the normal operating voltage. The insulation resistance test must be successfully completed immediately before performing the dielectric test to prevent the possibility of transformer failure due to moisture. The dielectric test supplements the megger tests by determining the suitability of the transformer for operation at rated voltage.

Field test voltages should not exceed 75% of factory test values. For routine periodic checks test voltage should be 65% of factory test voltage. The high potential test set must be variable to allow a gradual increase of test voltage from zero and gradual decrease after test is completed.

F A C T O R Y T E S T T E M P E R A T U R E - F

FIELD TEST TEMPERATURE - C		FIELD TEST TEMPERATURE - F																																																																																																																																																																																																																																																																																																																																																																																																																																																																																																																																																																																																																																																																																																																																																																																																																																																																																																																																																																																																																																																																																																																																																																																																																																																																																																																																																																																																																																																																																																																									
1	2	3	4	5	6	7	8	9	10	11	12	13	14	15	16	17	18	19	20	21	22	23	24	25	26	27	28	29	30	31	32	33	34	35	36	37	38	39	40	41	42	43	44	45	46	47	48	49	50	51	52	53	54	55	56	57	58	59	60	61	62	63	64	65	66	67	68	69	70	71	72	73	74	75	76	77	78	79	80	81	82	83	84	85	86	87	88	89	90	91	92	93	94	95	96	97	98	99	100	101	102	103	104	105	106	107	108	109	110	111	112	113	114	115	116	117	118	119	120	121	122	123	124	125	126	127	128	129	130	131	132	133	134	135	136	137	138	139	140	141	142	143	144	145	146	147	148	149	150	151	152	153	154	155	156	157	158	159	160	161	162	163	164	165	166	167	168	169	170	171	172	173	174	175	176	177	178	179	180	181	182	183	184	185	186	187	188	189	190	191	192	193	194	195	196	197	198	199	200	201	202	203	204	205	206	207	208	209	210	211	212	213	214	215	216	217	218	219	220	221	222	223	224	225	226	227	228	229	230	231	232	233	234	235	236	237	238	239	240	241	242	243	244	245	246	247	248	249	250	251	252	253	254	255	256	257	258	259	260	261	262	263	264	265	266	267	268	269	270	271	272	273	274	275	276	277	278	279	280	281	282	283	284	285	286	287	288	289	290	291	292	293	294	295	296	297	298	299	300	301	302	303	304	305	306	307	308	309	310	311	312	313	314	315	316	317	318	319	320	321	322	323	324	325	326	327	328	329	330	331	332	333	334	335	336	337	338	339	340	341	342	343	344	345	346	347	348	349	350	351	352	353	354	355	356	357	358	359	360	361	362	363	364	365	366	367	368	369	370	371	372	373	374	375	376	377	378	379	380	381	382	383	384	385	386	387	388	389	390	391	392	393	394	395	396	397	398	399	400	401	402	403	404	405	406	407	408	409	410	411	412	413	414	415	416	417	418	419	420	421	422	423	424	425	426	427	428	429	430	431	432	433	434	435	436	437	438	439	440	441	442	443	444	445	446	447	448	449	450	451	452	453	454	455	456	457	458	459	460	461	462	463	464	465	466	467	468	469	470	471	472	473	474	475	476	477	478	479	480	481	482	483	484	485	486	487	488	489	490	491	492	493	494	495	496	497	498	499	500	501	502	503	504	505	506	507	508	509	510	511	512	513	514	515	516	517	518	519	520	521	522	523	524	525	526	527	528	529	530	531	532	533	534	535	536	537	538	539	540	541	542	543	544	545	546	547	548	549	550	551	552	553	554	555	556	557	558	559	560	561	562	563	564	565	566	567	568	569	570	571	572	573	574	575	576	577	578	579	580	581	582	583	584	585	586	587	588	589	590	591	592	593	594	595	596	597	598	599	600	601	602	603	604	605	606	607	608	609	610	611	612	613	614	615	616	617	618	619	620	621	622	623	624	625	626	627	628	629	630	631	632	633	634	635	636	637	638	639	640	641	642	643	644	645	646	647	648	649	650	651	652	653	654	655	656	657	658	659	660	661	662	663	664	665	666	667	668	669	670	671	672	673	674	675	676	677	678	679	680	681	682	683	684	685	686	687	688	689	690	691	692	693	694	695	696	697	698	699	700	701	702	703	704	705	706	707	708	709	710	711	712	713	714	715	716	717	718	719	720	721	722	723	724	725	726	727	728	729	730	731	732	733	734	735	736	737	738	739	740	741	742	743	744	745	746	747	748	749	750	751	752	753	754	755	756	757	758	759	760	761	762	763	764	765	766	767	768	769	770	771	772	773	774	775	776	777	778	779	780	781	782	783	784	785	786	787	788	789	790	791	792	793	794	795	796	797	798	799	800	801	802	803	804	805	806	807	808	809	810	811	812	813	814	815	816	817	818	819	820	821	822	823	824	825	826	827	828	829	830	831	832	833	834	835	836	837	838	839	840	841	842	843	844	845	846	847	848	849	850	851	852	853	854	855	856	857	858	859	860	861	862	863	864	865	866	867	868	869	870	871	872	873	874	875	876	877	878	879	880	881	882	883	884	885	886	887	888	889	890	891	892	893	894	895	896	897	898	899	900	901	902	903	904	905	906	907	908	909	910	911	912	913	914	915	916	917	918	919	920	921	922	923	924	925	926	927	928	929	930	931	932	933	934	935	936	937	938	939	940	941	942	943	944	945	946	947	948	949	950	951	952	953	954	955	956	957	958	959	960	961	962	963	964	965	966	967	968	969	970	971	972	973	974	975	976	977	978	979	980	981	982	983	984	985	986	987	988	989	990	991	992	993	994	995	996	997	998	999	1000	1001	1002	1003	1004	1005	1006	1007	1008	1009	1010	1011	1012	1013	1014	1015	1016	1017	1018	1019	1020	1021	1022	1023	1024	1025	1026	1027	1028	1029	1030	1031	1032	1033	1034	1035	1036	1037	1038	1039	1040	1041	1042	1043	1044	1045	1046	1047	1048	1049	1050	1051	1052	1053	1054	1055	1056	1057	1058	1059	1060	1061	1062	1063	1064	1065	1066	1067	1068	1069	1070	1071	1072	1073	1074	1075	1076	1077	1078	1079	1080	1081	1082	1083	1084	1085	1086	1087	1088	1089	1090	1091	1092	1093	1094	1095	1096	1097	1098	1099	1100	1101	1102	1103	1104	1105	1106	1107	1108	1109	1110	1111	1112	1113	1114	1115	1116	1117	1118	1119	1120	1121	1122	1123	1124	1125	1126	1127	1128	1129	1130	1131	1132	1133	1134	1135	1136	1137	1138	1139	1140	1141	1142	1143	1144	1145	1146	1147	1148	1149	1150	1151	1152	1153	1154	1155	1156	1157	1158	1159	1160	1161	1162	1163	1164	1165	1166	1167	1168	1169	1170	1171	1172	1173	1174	1175	1176	1177	1178	1179	1180	1181	1182	1183	1184	1185	1186	1187	1188	1189	1190	1191	1192	1193	1194	1195	1196	1197	1198	1199	1200	1201	1202	1203	1204	1205	1206	1207	1208	1209	1210	1211	1212	1213	1214	1215	1216	1217	1218	1219	1220	1221	1222	1223	1224	1225	1226	1227	1228	1229	1230	1231	1232	1233	1234	1235	1236	1237	1238	1239	1240	1241	1242	1243	1244	1245	1246	1247	1248	1249	1250	1251	1252	1253	1254	1255	1256	1257	1258	1259	1260	1261	1262	1263	1264	1265	1266	1267	1268	1269	1270	1271	1272	1273	1274	1275	1276	1277	1278	1279	1280	1281	1282	1283	1284	1285	1286	1287	1288	1289	1290	1291	1292	1293	1294	1295	1296	1297	1298	1299	1300	1301	1302	1303	1304	1305	1306	1307	1308	1309	1310	1311	1312	1313	1314	1315	1316	1317	1318	1319	1320	1321	1322	1323	1324	1325	1326	1327	1328	1329	1330	1331	1332	1333	1334	1335	1336	1337	1338	1339	1340	1341	1342	1343	1344	1345	1346	1347	1348	1349	1350	1351	1352	1353	1354	1355	1356	1357	1358	1359	1360	1361	1362	1363	1364	1365	1366	1367	1368	1369	1370	1371	1372	1373	1374	1375	1376	1377	1378	1379	1380	1381	1382	1383	1384	1385	1386	1387	1388	1389	1390	1391	1392	1393	1394	1395	1396	1397	1398	1399	1400	1401	1402	1403	1404	1405	1406	1407	1408	1409	1410	1411	1412	1413	1414	1415	1416	1417	1418	1419	1420	1421	1422	1423	1424	1425	1426	1427	1428	1429	1430	1431	1432	1433	1434	1435	1436	1437	1438	1439	1440	1441	1442	1443	1444	1445	1446	1447	1448	1449	1450	1451	1452	1453	1454	1455	1456	1457	1458	1459	1460	1461	1462	1463	1464	1465	1466	1467	1468

Following is a table showing factory dielectric test voltages with recommended field and periodic test voltages relative to the rated voltage of the respective windings.

Transformer Winding Rated A.C. Voltage	Factory Test A.C. Voltage	Recommended Field Test A.C. Voltage (75%)	Recommended Periodic Test A.C. Voltage (65%)
1.2 KV & below	4 KV	3.0 KV	2.6 KV
2.4 KV	10 KV	7.5 KV	6.5 KV
4.16 KV	12 KV	9.0 KV	7.8 KV
4.8 KV	12 KV	9.0 KV	7.8 KV
6.9 KV	19 KV	14.25 KV	12.35 KV
7.2 KV	19 KV	14.25 KV	12.35 KV
8.32 KV	19 KV	14.25 KV	12.35 KV
12.0 KV	31 KV	23.25 KV	20.15 KV
12.47 KV	31 KV	23.25 KV	20.15 KV
13.2 KV	31 KV	23.25 KV	20.15 KV
13.8 KV	31 KV	23.25 KV	20.15 KV

Under some conditions, transformers may be subjected to a periodic insulation test using direct voltage from kenotron sets. In such cases, the test direct voltage should not exceed the original factory test rms alternating voltage; e.g., if the factory test was 31 kilovolts root mean square (kV rms), then the routine test direct voltage should not exceed 31kV.

2. TEST PROCEDURE

- a. Transformer must successfully pass the Insulation Resistance test immediately prior to starting dielectric tests.
- b. Recheck items c, d and e of insulation resistance test to make sure transformer remains completely isolated and jumpers are still connected.
- c. Jumper low voltage windings to ground.
- d. Connect high potential test between high voltage winding and ground. Gradually increase test voltage to desired value. Allow test voltage duration of one minute after which gradually decrease voltage to zero.
- e. Remove low voltage to ground jumper and connect high potential test between low voltage winding and ground. Repeat test using proper test voltage for low voltage winding rated voltage.
- f. If tests in items d and e do not produce failure or breakdowns, transformer is considered satisfactory and ready to be energized.
- g. Remove all jumpers and reconnect primary and secondary connections, lightning arresters, control circuits, etc., that may have been disconnected for test. Energize transformer immediately.

3. STORAGE

Ventilated dry-type transformers preferably should be stored in a warm dry location with uniform temperature. Ventilating openings should be covered to keep out dust. If it is necessary to leave a transformer outdoors it should be thoroughly protected to prevent moisture and foreign material from entering. Condensation and the absorption of moisture can be prevented or greatly reduced by the immediate installation of space heaters or other small electric heaters. If more convenient, incandescent lamps may be substituted for the space heaters. For transformer ratings 750 KVA three phase and below, use six 150 watt lamps, above 750 KVA three phase, use six 300 watt lamps or equivalent. Two lamps should be located under each coil, one on each side of the core. Lamps or heaters should be kept 4 - 6 inches from transformer coils and should never be allowed to come in contact with transformer coil insulation.

4. MAINTENANCE

A. Periodic Inspection and Maintenance

Like other electric equipment, these transformers require maintenance from time to time to assure successful operation. Inspection should be made at regular intervals and corrective measures taken when necessary to assure the most satisfactory service from this equipment.

The frequency at which these transformers should be inspected depends on operating conditions. For clean dry locations an inspection annually, or after a longer period, may be sufficient. However, for other locations, such as may be encountered where the air is contaminated with dust or chemical fumes, an inspection at three or six month intervals may be required. Usually after the first few inspection periods a definite schedule can be set up based on the existing conditions.

With the transformer de-energized, front and rear access panels should be removed. Inspections should be made for dirt, especially accumulations on insulating surfaces or for those which tend to restrict air flow, for loose connections, for the condition of tap changers or terminal boards and for the general condition of the transformer. Observation should be made for signs of overheating and of voltage creepage over insulating surfaces as evidenced by tracking or carbonization.

Evidence of rusting, corrosion and deterioration of the paint should be checked, and corrective measures taken where necessary.

Fans, motors and other auxiliary devices should be inspected and serviced during these inspection periods.

B. Cleaning

If excessive accumulations of dirt are found on the transformer windings or insulators when the transformer is inspected, the dirt should be removed to permit free circulation of air and to guard against the possibility of insulation breakdowns. Particular attention should be given to cleaning top and bottom ends of winding assemblies, and to cleaning out ventilating ducts.

The windings may be cleaned with a vacuum cleaner, a blower, or with compressed air. The use of a vacuum cleaner is preferred as the first step in cleaning followed by the use of compressed air or nitrogen. The compressed air or nitrogen should be clean and dry and should be applied at a relatively low pressure (not over 25 psi). Lead supports, tap changers and terminal boards, bushings and other major insulating surfaces should be brushed or wiped with a dry cloth. The use of liquid cleaners is undesirable because some of them have a solvent or deteriorating effect on most insulating materials.

C. Drying of Core and Coil Assembly

When it is necessary to dry out a transformer before in-

stallation or after an extended shutdown under relatively high humidity conditions, one of the following methods may be used:

- 1) External heat
- 2) Internal heat
- 3) External and internal heat

Before applying any of these methods, free moisture should be blown or wiped off of the windings to reduce the time of the drying period.

1) Drying by External Heat - External heat may be applied to the transformer by one of the following methods:

- a. By directing heated air into the bottom air inlets of the transformer case.
- b. By placing the core and coil assembly in a non-flammable box with openings at the top and bottom through which heated air can be circulated.
- c. By placing the core and coil assembly in a suitably ventilated oven.
- d. By placing incandescent lamps in transformer enclosure. See storage section for details.

It is important that most of the heated air be blown through the winding ducts and not around the sides. Good ventilation is essential in order that condensation will not take place in the transformer itself or inside the case. A sufficient quantity of air should be used to assure approximately equal inlet and outlet temperatures.

When using either of the first two external heating methods, heat may be obtained by the use of resistance grids or space heaters. These may either be located inside the case or box or may be placed outside and the heat blown into the bottom of the case or box. The core and coil assembly should be carefully protected against direct radiation from the heaters.

It is recommended that the air temperature should not exceed 110 °C.

2) Drying by Internal Heat - This method requires voltages and currents which may be difficult to obtain in the field and therefore is not used as frequently as external.

The transformer should be located to allow free circulation of air through the coils from the bottom to the top

of the case. One winding should be short-circuited, and sufficient voltage at normal frequency should be applied to the other winding to circulate approximately normal current.

It is recommended that the winding temperature not be allowed to exceed 100°C, as measured by resistance or by thermometers placed in the ducts between the windings. The thermometers used should be of the spirit type because mercury thermometers give erroneous readings due to the generation of heat in the mercury as a result of induced eddy currents. The end terminals of the windings (and not the taps) must be used in order to circulate current through the entire winding. Proper precaution should be taken to protect the operator from dangerous voltages.

3) Drying by External and Internal Heat — This is a combination of the two methods previously described, and is by far the quickest method. The transformer core and coil assembly should be placed in a nonflammable box, or kept in its own case if suitable, and external heat applied as described in the first method, and current circulated through the windings as described in the second method. The current required will be considerably less than when no external heating is used but should be sufficient to produce the desired temperature of the windings. It is recommended that the temperatures attained not exceed those stated in the foregoing.

D. Use of Insulation Resistance for Determining Drying Time

Drying time depends on the condition of the transformer, size, voltage, amount of moisture absorbed, and the method of drying used.

The measurement of insulation resistance is of value in determining the status of drying. Measurements should be taken before starting the drying process and at two-hour intervals during drying. The initial value, if taken at ordinary temperatures, may be high even though the insulation may not be dry. Because insulation resistance varies inversely with temperature, the transformer temperature should be kept approximately constant during the drying period to obtain comparative readings. As the transformer is heated, the presence of moisture will be evident by the rapid drop in resistance measurement. Following this period the insulation resistance will generally increase gradually until near the end of the drying period when it will increase more rapidly. Sometimes it will rise and fall through a short range before steadying because moisture

in the interior of the insulation is working out through the initially dried portions. A curve with time as abscissa and resistance as ordinate should be plotted and the run should be continued until the resistance levels off and remains relatively constant for three to four hours.

Insulation resistance measurements should be taken for each winding to ground with all windings grounded except the one being tested. Before taking insulation resistance measurements the current should be interrupted and the winding should be short-circuited and grounded for at least one minute to drain off any static charge. All readings should be for the same time of application of the test voltage, preferably one minute.

E. Cautions

Constant attendance during the drying process is desirable. It is advisable to have a suitable fire extinguisher convenient for use in the event of an emergency.

5. OPERATION

A. Removal of Covers over Openings

Covers over openings in the transformer case must not be removed while the transformer is energized.

B. Effect of Humidity

As long as the transformer is energized humidity conditions are relatively unimportant. In the event that a dry type transformer is de-energized and allowed to cool to ambient temperature, consideration must be given to the possible effects of humidity.

If the shutdown period occurs during low humidity conditions no special precautions should be required before energizing the unit.

Experience indicates that if a shutdown exceeding 24 hours occurs during a period of high humidity, particularly if atmospheric conditions are such as to cause condensation within the housing, then precautions should be taken. Small strip heaters may be placed in the bottom of the unit shortly after shutdown to maintain the temperature of the unit a few degrees above that of the outside air. If such precaution has not been taken then the unit should be inspected for evidence of moisture, and insulation resistance should be checked. If there is evidence of moisture or if the insulation resistance is low, the trans-

former should be dried out by one of the methods described.

C Tap Changing

After installation, the output voltage of the transformer should be checked at some safe access point on the load. Never attempt to check the output voltage at the transformer since dangerous high voltage may be present within the transformer enclosure.

When the output or load side voltage requires adjustment either up or down, the percentage tap jumpers found on the front surface of the coils must be changed in all phases. (See photo on front cover of this bulletin for tap appearance.) Consult the transformer diagramatic nameplate for information on what tap must be used to correct for high or low incoming line voltage or for voltage drop in the output or load voltage due to long wiring runs. Note that when the load voltage is low, tap connections below 100% of line voltage must be used to raise the load voltage. If the load voltage is high, tap connections above 100% of line voltage must be used to lower the load voltage.

After the correct tap connection has been determined from the nameplate, this procedure should be followed to change taps:

1. De-energize transformer. Make sure there is no back feed from a low voltage tie breaker.
2. Remove front access panels from transformer enclosure.

3. Change tap jumper on each phase to the correct tap connection. Tap jumper must be on the same tap position on all phases.
4. Tap jumper must be installed on upper side of coil tap with lugs on ends of cable tap jumpers positioned for maximum electrical clearance from ground and other live parts. Be sure bolts are tightened.
5. Replace front access panels.
6. Energize transformer and recheck the output voltage.

APPENDIX

REFERENCES:

1. American Standard for Transformers, Regulators and Reactors, C57.12.01, C57.12.50, C57.12.51 and C57.12.91.
2. Dry-type Transformers for General Applications, NEMA Pub. No. ST20-1972.
3. Commercial, Institutional and Industrial Dry-type Transformers, NEMA Pub. No. TR27-1965.
4. National Electrical Code, NFPA No. 70, ANSI C1-1971.
5. National Electrical Safety Code, ANSI C2-1973.

BOLT TIGHTNESS FOR BUS CONNECTIONS
FOR HARDWARE SHIPPED WITH TRANSFORMER

Bolt Material	Torque in Foot Pounds for Bolt Diameter			
	.25-20	.31-18	.38-16	.50-13
Grade 1 & 2 Heat Treated Steel	4-6	6-12	15-20	25-30

MODEL 85A

FAN CONTROL SYSTEM

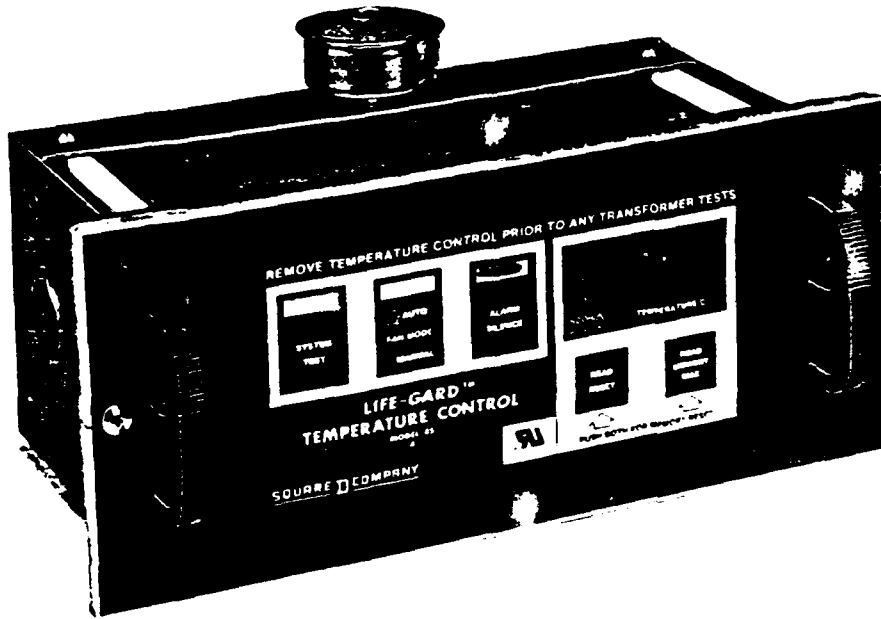

*Keeps Transformers
Running Cooler.
Adds 33 1/3%
Reserve Capacity.*

C-15

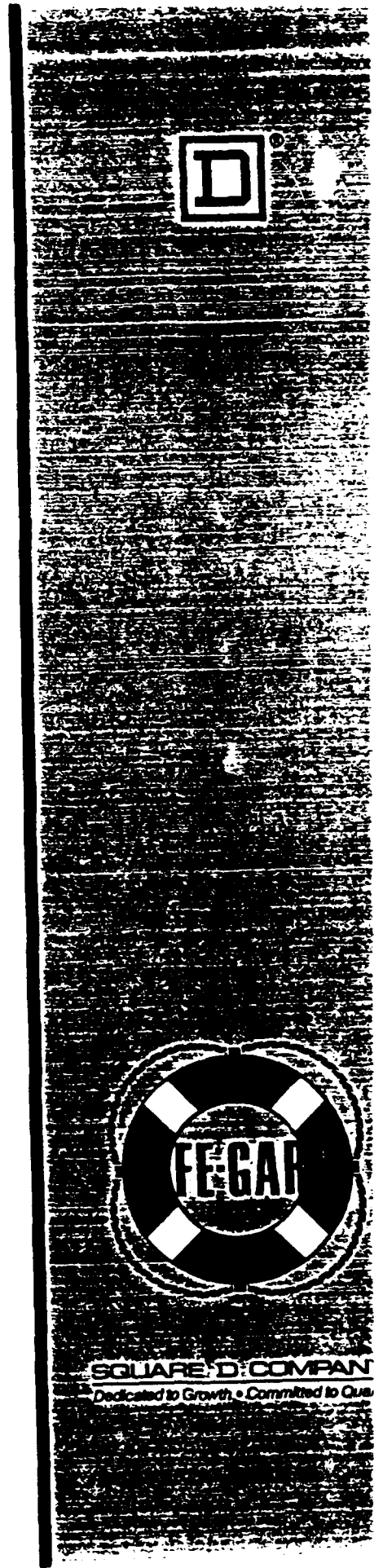

MODEL 85A Control System

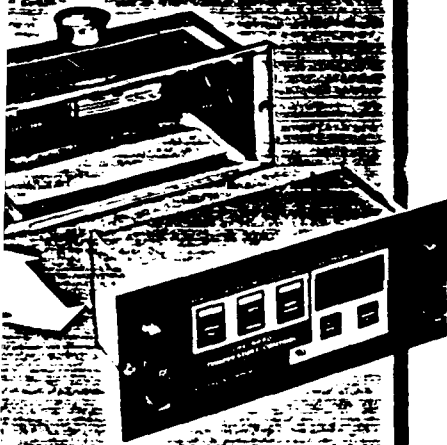

"Pop-out" design permits
removal of control unit without
exposure to high voltages.

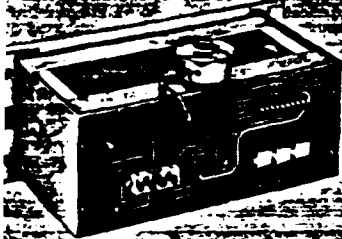

Easily discernible circuit board
removal on rear of control
unit.

The Square D Model 85A "LIFE-GARD" Fan Control System is state-of-the-art instrumentation that protects the transformer and adds up to 33-1/3% reserve capacity.

This system provides precision control through the use of three high accuracy thermistor type temperature sensors, one installed in an air duct of each phase coil of a transformer.

Internal coil temperatures are transmitted by these sensors to a microprocessor which is programmed to provide a digital display of temperature in degrees Celsius and the corresponding coil number.

Digital Display

The digital LED display range is from 24°C to 255°C in 1°C increments. Characters are 0.56" high and clearly legible under all lighting conditions.

The Model 85A provides a choice of either:

- A. Continuous scanning of the three sensors with a three second display period for each coil temperature and corresponding coil number.
- B. Digital display of the temperature and number of the hottest coil only.

For each display mode, two additional options are available:

- 1. Continuous temperature display.
- 2. Display only when the "Read/Reset" or the "Read Memory Max" switch panels are pressed.

For all display modes, the highest temperature reached by any coil in any previous interval will be displayed for three seconds when the "Read Memory Max" switch panel is pressed. This temperature will be cancelled and replaced by the immediate maximum temperature when both "Read/Reset" and "Read Memory Max" switch panels are pressed simultaneously. Thereafter, any succeeding higher temperature will be retained in memory for later recall.

Control Mode Light Panels

Three LED panels are provided to indicate control mode conditions. When the green panel is lighted, it indicates that the control module is energized. Similarly, the lighted yellow panel indicates that the fan circuit is energized. A lighted red panel indicates that one or more coils are above normal temperature and the alarm horn will sound.

If a temperature of 220°C** is detected by one of the sensors, the control will initiate the emergency shutdown mode. Permanent insulation damage will occur above this maximum insulation system temperature. At this

point, the Red LED panel flashes and three dashes replace the temperature numbers.

Actual shutdown or other function can be accomplished by means of an optional, accessory relay.

Fan Mode Control and Indicators

Selection of two modes of fan operation is provided by the "Fan Mode" switch panel. When this switch panel is depressed, the fan mode may be changed from manual to auto or vice versa. In the auto mode, the fans are turned on and off automatically at specified programmed temperature set points. In the manual mode, the fans operate continuously, totally independent of all temperature set points. The selected fan mode is indicated by one of the LEDs in the "Fan Mode" switch panel.

Reference: ANSI Standard C57.12.51

Rated Average Transformer Temperature Rise*	Switch Set Points				Emergency Shutdown	Emergency Shutdown Cast Resin Transformers
	Fans On	Fans Off	Alarm On	Alarm Off		
80°C	110°C	100°C	125°C	125°C	220°C	185°C
115°C	145°C	135°C	160°C	158°C	220°C	185°C
150°C	180°C	170°C	195°C	193°C	220°C	

*Based on NEMA and ANSI Standards of 30°C average and 40°C maximum ambient for any 4-hour period below 2000 ft. altitude.

**Note: The digital temperature displayed is always the TOTAL temperature of AMBIENT + COIL SPOOT temperatures, not the AVERAGE temperature rise. Example: A transformer is rated 150°C average temperature rise when carrying rated load in a 20°C ambient temperature. The thermistor sensors are installed near the theoretical hot spot of the coil. NEMA and ANSI standards permit a 30°C maximum differential between average and hot spot temperatures. Therefore the digital display would indicate approximately 20°C + 30°C + 150°C = 200°C total. Note that the alarm would operate at this point providing ample warning that the transformer is approaching the maximum temperature limit of the insulation system.

High Temperature Alarm

If the operating temperature of the transformer coils increases to the programmed "alarm" set point, the red LED indicator and the alarm horn are activated, thus warning that the maximum designed temperature rise

**185°C for Cast Resin Transformers
© 1988 Square D Company
LIFE-GARD is a Registered Trademark of Square D Company

TYPICAL INSTALLATIONS

has occurred (80 C, 115 C or 150 C). This temperature is within the maximum temperature rating of the insulation system, and the transformer may continue to operate. The alarm horn may be silenced by briefly depressing the "Alarm Silence" switch panel. The red LED panel, however, will remain lighted until the transformer temperature decreases to the programmed "Alarm Off" set point. The LED panel is then de-energized and the silencer relay is automatically reset.

Control Sequence

The Model 85A Fan Control System provides switching at three levels of transformer temperature. This switching is pre-set prior to shipment based on the maximum rating of the insulation system and the designed temperature rise of the transformer (50 C, 115 C or 80 C rise).

At the first switching level, cooling fans are automatically switched on and off at the temperature set points to maintain the winding temperature well within the design limits.

At the second level, the alarm set point temperature is reached and the alarm circuit is energized, operating a visual and audible alarm. This indicates that the transformer has reached a temperature that is not more than 5 C higher than the designed average winding temperature rise based on a 40 C maximum ambient.

If kept within the maximum temperature rating of the insulation system (220 C*), the transformer may continue to operate.

A third level operates when the maximum temperature rating (220 C**) of the insulation system is reached. This energizes the Emergency Shutdown (E.S.) circuit. This circuit can be used for a remote alarm or to automatically drop transformer load and prevent damage to the transformer insulation.

The Model 85A Fan Control System provides two sets of auxiliary Form "C" relay contacts; one set switched by the fan control circuit and one switched by the alarm control circuit. Terminals for these contacts are located on the rear panel of the control.

The output for the emergency shutdown function is 6V D.C. at 300 MA maximum to power an optional external relay. Terminals for this output are also located on the rear panel of the control.

System Test

The Model 85A Fan Control System also incorporates a programmed system test function which is initiated when the "System Test" switch panel is depressed. Each of the various indicators and each segment of the numerical displays are tested in sequence. The upper left segments of the coil and temperature displays are not active and are not lighted during the test sequence.

During the test sequence, the fans operate briefly. The alarm horn is also tested at the end of the sequence and the Emergency Shutdown is not activated.

Remote Indication and Control

In addition to providing control and readout functions when installed in a transformer, the Model 85A Fan Control System has the capability of providing complete readout and control at a remote location. One control module with temperature sensors is mounted in the transformer enclosure and is designated as the "Master". A second identical control without temperature probes is designated as the "Slave" for installation remote from the transformer. By means of an IEEE RS-422 two-wire communication link, the temperature may be monitored and all functions controlled at a remote location.

Similarly, an installation with multiple transformers may be monitored and controlled from a single supervisory station or by a computer.

*IEEE for Cost-Reduction Transformers.
**IEEE is a Registered Trademark of Square D Company.

Fail-Safe Features

The Model 85A Fan Control System is capable of determining a shorted sensor condition. It will also detect a possible open sensor. When two probes read a temperature above 25 C and one reads a temperature of 25 C or less, the latter will be determined open. When either a shorted or open sensor is identified, the temperature display will indicate three dashes (instead of numerals) with the corresponding coil number.

For systems having a Square Model 85A Fan Control System for remote control and monitoring, failure of the Master control at the transformer will cause all coil and temperature readouts of the remote control to be dashes and the alarm LED panel will flash every 20 seconds as the remote control attempts to reset to normal communication with the Master control.

Typical Specifications

Provide a Square D IEEE C422 Model 85A, solid state, Fan Control System with factory pre-set, three level switching to maintain the winding temperature within the design limits during fan-cooled operation. For three phase transformers, the system shall consist of three high accuracy thermistor sensors installed directly in the low voltage air ducts of each transformer coil to continuously monitor the internal coil temperature. The sequence of operations shall be as follows: If the temperature rises to the normal, self-cooled (NA) rating, a relay is activated to start the fans. Should the temperature continue to rise to the next pre-set point, a second relay operates to close the circuit for an audible alarm and a red warning light. If the temperature rises to the maximum rated temperature of the insulation system, a third circuit is activated. It may be used for an emergency shutdown, or remote trouble indication.

The control module shall be a "draw-out" design permitting inspection of the control unit without exposure to high voltages.

The system control module shall have a membrane front panel with switches to provide system tests, fan mode selection and alarm silencing. Function indicators shall be LED bars; Green for "Power On", Amber for "Fans On" and Red for "High Temperature".

The "System Test" switch shall initiate a test sequence which will allow verification that all control functions and numeric readout segments are operational.

The "Fan Mode" switch, with built in LED mode indicators, shall provide selection of manual or automatic fan control modes.

The "Alarm Silence" switch shall silence the sonic alarm, but allow the Red LED bar to remain "On" until the temperature decreases to normal.

The system control module shall provide a digital readout of transformer coil temperature and numeric coil identification.

The system control module shall have a memory mode for retention of the maximum attained temperature during any prior interval with recall to occur when the "Read Memory Max" switch is pressed.

Minimum numerical height shall be 0.5 inch.

The system control module shall be capable of functioning at the transformer (Master Control) or at a remote location (Slave Control), using an RS-422 communication link to provide full control and readout at both locations.

The system control module shall provide Fail-Safe indication of both shorted and open sensors.

Multiple cooling fans are to be installed at the bottom of each coil, front and rear, with a minimum of six for three phase and four for single phase transformers.

NOTE: For ratings over 2500 kVA, a separate LED coil temperature readout is required but this would require an additional compartment.
IEEE C422 is a Registered Trademark of Square D Company.

Operation and Maintenance Manual

Ventilated Dry Type Transformers

Forced Air Cooling System For Ventilated Dry or Cast Coil Transformers

NATIONAL INDUSTRI

Transformers

Ventilated Dry

"THE INFORMATION HEREIN IS BELIEVED TO BE ACCURATE AND RELIABLE. HOWEVER, NATIONAL INDUSTRI ASSUMES NO RESPONSIBILITY FOR ITS USE OR MISUSE AND CAUTIONS THE READER TO EXERCISE CAUTION IN THE INSTALLATION AND MAINTENANCE OF THE PRODUCTS DESCRIBED HEREIN."

General

This manual addresses general considerations for the operation and maintenance of dry-type distribution and power transformers.

The successful operation of these transformers is dependent on proper installation, loading and maintenance, as well as proper design and manufacture. Dry type transformers require little maintenance as compared to other types of transformers, but appropriate attention will ensure their expected service life. Conditions of operation will determine the extent of maintenance required. A periodic inspection program should be established to monitor the effects of the operating conditions on the transformers.

In addition to this guide, the manufacturer should be consulted for recommendations on special conditions.

Portions of the following information are re-printed from ANSI Appendix C57.94 Guide for Installation and Maintenance of Dry-Type Transformers.

Warning: *Lethal Voltages will be present inside all transformer enclosures and at all connection points. Installation and maintenance should be performed only by personnel qualified and experienced in high voltage equipment. De-energize the transformer before performing any maintenance or service work.*

Receiving

Inspection

When received, new transformers should be inspected for damage during shipment.

Examination should be made before removing them from cars or trucks, and, if any injury is evident or any indication of rough handling is visible, a claim should be filed with the carrier at once and the manufacturer notified. Subsequently, covers or panels should be removed and an internal inspection made for damage or displacement of parts, loose or broken connections, dirt or foreign material, and for the presence of water or moisture. If the transformer is moved or if it is stored before installation, this inspection should be repeated before placing the transformer in service.

Handling

National Industri transformers are designed with provisions for lifting, jacking or rolling. These provisions will vary in detail, depending upon the weight, size and mechanical configuration of the unit.

Enclosed transformers with lifting lugs on the enclosure may be lifted with appropriate slings or chains. Larger units will have provisions for lifting from the base frame or from the top core clamps. Units lifted from the top core clamps will usually require that the top cover or part of the cover be removed.

Caution: *Dry type transformers should be maintained in an upright position when being moved. No attempt to handle a transformer in any other position should be made without first contacting the manufacturer.*

Because of their high center of gravity, dry type transformers are subject to tipping over during handling. Reasonable care during handling will prevent equipment damage and/or personnel injury.

When provisions are supplied for lifting larger units from the base frame, lifting slings, chains, or cables should be used with spreaders to avoid damage to the enclosure. The core and coil must also be bolted to the base frame and anti-sway bracing provided.

Core and coil units should be lifted using only the lifting devices provided on the core clamps. Care should be taken to prevent damage to bus work, wiring and termination assemblies during lifting. When lifting, increase tension gradually, do not jerk, jar, or otherwise move the transformer abruptly.

If the transformer cannot be lifted by a crane, it can be skidded or moved on rollers. Care should be taken not to damage the base or tip it over. When rollers are used, skids should be used to distribute the stress over the base.

Large enclosed units with base frame type enclosures, may be jacked using the base frame angles. The transformers should be jacked evenly on all four corners to prevent warping or tipping over.

Care must always be taken to prevent any foreign

Installation

Handling (Continued)

material from falling into or onto the coils. Hardware, connecting parts, tools, or any foreign material should not be allowed on top of the core and coil assembly. Foreign material lodged in a coil duct can cause electrical failure or overheating.

NOTE: All lifting devices and shipping braces painted red must be removed before energizing the transformer.

Installation

Location

Major factors to be considered when locating dry type transformers are *personnel safety*, accessibility, ventilation, atmospheric conditions, and sound level.

When planning the installation, a location should be selected that will comply with all safety codes and will not interfere with the normal movement of personnel, equipment, and material. The location should not expose the transformers to possible damage from cranes, trucks, or moving equipment. It should be remembered that a dent in the enclosure may reduce the insulation clearances to an unsafe level.

As an added safety precaution, thought should be given to the possibility of personnel inserting rods, wire, etc. through the ventilation openings of the enclosure and thus, coming into contact with live parts. Transformer ventilation openings are designed in accordance with NEMA standards which require that a 1/2" diameter rod cannot be inserted through the ventilation openings.

The installation will be simplified if an outline drawing is requested. By studying the overall, mounting, and terminal dimensions, it is possible to plan the installation with an orderly arrangement of connections.

Core and coil units (without case) usually have mounting and terminal dimensions to suit the customer's enclosure. That enclosure should give protection to the coils and have adequate clearances and sufficient ventilation openings. The manufacturer should always be consulted to determine these requirements.

Ventilated dry type transformers can be designed for installation indoors or outdoors. They will operate successfully where the humidity is high, but under this condition it may be necessary to take precautions to keep them dry if they are shut down for extended periods. For locations where severe atmospheric conditions prevail, National Industrial Vacuum Cast Coil transformers are recommended.

Locations where there is dripping water should be avoided. If this is not possible, suitable protection

should be provided to prevent water from entering the transformer case. Precautions should be taken to guard against accidental entrance of water, such as might be obtained from an open window, by a break in a water or steam line, or from use of water near the transformers.

Caution: Adequate ventilation must be provided for Dry Type Air-Cooled Transformers.

Adequate ventilation is essential for the proper cooling of these transformers. Clean dry air is desirable. Filtered air may reduce maintenance if the location presents a particular problem. When transformers are installed in vaults or other restricted spaces, sufficient ventilation should be provided to hold the air temperature within established limits when measured near the transformer inlets. This usually will require approximately 100 cubic feet of air per minute per kilowatt of transformer loss. The area of ventilation openings required depends on the height of the vault, the location of openings, and the maximum loads to be carried by the transformers. For self-cooled transformers, the required effective areas should be at least one square foot each of inlet and outlet per 100 KVA of rated transformer capacity, after deduction of the area occupied by screen, gratings, or louvers.

Ventilated open wound dry type transformers should be installed in locations free from unusual dust or chemical fumes. Transformers should be located at least 12 inches away from walls and other obstructions that might prevent free circulation of air through and around each unit, unless the unit is designed for wall mounting and installed per factory recommendations. The distance between adjacent transformers should be not less than this value. Also, accessibility for maintenance should be taken into account before locating the transformer. If the transformer is to be located near combustible materials, the minimum separations established by the National Electrical Code should be maintained.

The transformer case is designed to prevent the entrance of most small animals and foreign objects. However, in some locations, it may be necessary to give consideration to additional protection.

Sound Level

Special consideration should be given to the installation of any transformer if noise is a factor in its location and operation. Many locations can result in an amplification of the sound level. For example, if the transformer is installed in a quiet hallway, a definite hum will be noticed. If the unit is installed in a location it shares with other equipment such as motors, pumps or compressors, the transformer hum will probably go unnoticed.

Installation

Sound Level (Continued)

The transformer is designed to produce a minimum sound level when the following directions are followed:

- A. Connections to primary and secondary terminals made with flexible connectors
- B. All transit bolts and shipping braces removed so unit will float on rubber isolation pads; these bolts and parts are painted red for easy identification
- C. All enclosure hardware tightened so panels do not vibrate

Inspection

Once the transformer has been located at its permanent site, a thorough final inspection should be made before any necessary assembly is accomplished and the unit is energized.

Careful examination should be made to ensure that all external electrical connections have been made properly and that the correct ratio exists between low voltage and high voltage windings. To test this, apply a low voltage (240V or 480V) to the high voltage winding and measure the output at the low voltage winding.

All control circuits, if any, should be checked for operational ability. Furthermore, they should be able to withstand a 1200 volt applied insulation test for one minute (if the transformer has current transformer circuits, they should be shorted).

The operation of fans, motors, thermal relays, and other auxiliary devices should be checked. Fan rotation should be visually verified as well as by checking any indicator lights. (Reference Fan Control Operation.)

As prescribed by NEMA standards, transformers are shipped with both high and low voltage windings connected for their highest rated voltage (except transformers which have taps above the rated voltage in which case they will be shipped connected for rated voltages). The internal connections should be checked with the diagram on the nameplate to make sure that the connections are correct. The tap setting should also be verified for the proper voltage, and that the setting is the same for all coils.

All windings should be checked for continuity. It is recommended that a megger test be performed to make certain that no windings are grounded which are not intended to be grounded.

See "Testing" for additional tests. Shipping braces should be removed if present. All cable connections

should be checked for proper use of hardware (i.e. Belleville washers on aluminum terminals, proper clearances and proper torque).

Check again to insure that all low voltage and high voltage connections correspond to the connection diagram.

Grounding

The case and core and coil assembly of these transformers should be permanently and adequately grounded.

Grounding is necessary to remove static charges that accumulate. It is also needed as a protection should the transformer windings accidentally come in contact with the core or enclosure. Be sure that the flexible grounding jumper between the core and coil assembly and case is intact, or that the core and coil assembly is directly grounded from the core clamp through a flexible lead. Insure that grounding or bonding meets N.E.C. and local codes.

To insure a solid core ground, transformers have a copper strap embedded in the core laminations and securely connected to the core clamp.

Connections

Make only those connections specified by the nameplate or connection diagram, check all tap jumpers for proper location and tightness, and re-tighten all aluminum cable retaining screws after the first 30 days of service.

This transformer has been designed and built to provide proper electrical connections using either copper or aluminum connecting cable. A protective plating or compound which prevents surface oxidation of the terminals was applied at the factory. This coating should not be removed from tap or line terminals. If in the case of protective compounds it becomes necessary to re-apply it, clean all contact surfaces of oxide and re-coat with a good quality compound, following the manufacturer's instructions. Many kinds are commercially available. Some of them are Fenetrox A, Alnox-UG, and Thomas & Betts 1059. When re-coating, wipe off any excessive compound.

Depending upon KVA rating, this transformer may have flexible leads with bolted type wire terminals, Cu-Al lug connectors, or simply termination pads for mounting of your own crimp type or lug type terminations. The tables below show typical torque values for installing bolted wire connectors and cables in lug type connectors. Check specific recommendations of

Transformers

Ventilated Dry

Grounding

Connections (Continued)

connector or lug manufacturer.

Bolted Wire Connectors		Lug Type Connectors	
Bolt Size	Torque Inch Pounds	Wire Size (Average)	Torque Inch Pounds
1/2 - 20	70	#14 to #8	70
5/16 - 18	120	#6 to #4	100
3/4 - 16	225	#3 to #1	120
1 - 13	480	1'0 to 2'0	150
		3 0 to 200 MCM	210
		250 to 400 MCM	260
		500 to 750 MCM	300

Note: Tighten, wait several seconds, then re-tighten all connecting lugs and bolts.

Where cable terminations are supplied by the user, it is recommended that commercially available, properly sized, UL listed screw type or crimp type connectors be used. These terminations should be attached to the cables as specified by the termination or cable manufacturer. Terminations are readily available from wholesale electrical distributors.

Secure each terminal lug to its proper termination bus bar. Torque all bolts as shown in the bolted wire connector chart above. Do not install washers between the terminal lugs and the termination bus bar as this will cause heating and arcing in that area, resulting in connector failure.

Testing

Tests may be made before placing a transformer in service to determine that it is in satisfactory operating condition and to obtain data for future comparisons.

A. Insulation resistance

B. Dielectric tests in the field in accordance with ANSI C57.12.g1.

The insulation resistance test aids in determining the suitability of the transformer for application of the high-potential test and yields useful data for future comparative purposes. Insulation resistance tests should be made before applying the high-potential test. Variable factors affecting the construction and use of dry-type transformers make it difficult to set limits for this test. Experience indicates that 2 megohms (one minute reading at approximately 25°C) per 1,000 volts of nameplate voltage rating, but in no

case less than 2 megohms total may be a satisfactory value of insulation resistance for the application of the high-potential test.

In addition to the insulation resistance and high-potential dielectric tests, the following tests may be made if desired:

- A. Ratio tests for the full windings and all tap positions
- B. Resistance measurements of windings
- C. Polarity or phase relation

It is preferable that these tests, if planned, be made before applying the dielectric tests.

Operation

Placing in Service

After following the preceding instructions, the transformer may be energized. It is recommended that the unit first be energized at no load if possible, then full load may be applied.

Parallel Operation

When operating transformers in parallel, their rated voltages, impedances, and turn ratios ideally should be the same. Their phasor relationships must be identical. If these parameters are different, circulating current will exist in the circuit loop between these units. The difference in impedance should in no case exceed 10%. The greater the differences in these parameters the larger the magnitude of the circulating current. When specifying a transformer to be operated in parallel with existing units, all of these parameters should be noted.

Loading

The maximum continuous load a transformer may supply is indicated on the nameplate. However, many specially designed units have specific load capabilities designed into them. If there is any question concerning the load capability of the unit, the factory should be consulted. Refer to ANSI Standard C57.96 Guide for Loading Dry-Type Distribution and Power Transformers for general guidelines.

Minimum electrical clearances in the installation of lugs and cables must be per N.E.C. All electrical clearances that are questionable must be insulated.

Overload protection for primary and secondary circuits is covered by the National Electrical Code.

Operation

Shipping Supports

After the transformer has been placed in its permanent location, the hold-down bolts securing the core and coil assembly to the base or case must be removed. Removing these bolts releases the sound isolation pads for maximum effectiveness. Also remove any shipping braces and lifting devices on the core and coil or the enclosure. For easy identification, all of these removable parts will be painted a different color from the remaining assembly parts (usually red).

Should it ever be necessary to move the transformer, replace the hold-down bolts for the moving operation.

Maintenance

Warning: De-energize transformer before any inspection or maintenance!

Periodic Inspection

Like other electrical equipment, all transformers require maintenance from time to time to assure successful operation. Inspection should be made at regular intervals and corrective measures taken when necessary to assure the most satisfactory services from this equipment.

Operating conditions determine the frequency at which these transformers should be inspected. For clean, dry locations, an annual inspection may be sufficient. However, for other locations, such as may be encountered where the air is contaminated with dust or chemical fumes, more frequent inspections may be required. Usually after the first few inspection periods, a definite schedule can be established.

With the transformer de-energized, enclosure panels should be removed. Inspection should be made for dirt, especially accumulations on insulating surfaces where such accumulations could restrict air flow. Inspection should also be made for loose connections for the condition of terminal boards, and for the general condition of the transformer.

Observations should be made for signs of overheating and of voltage creepage over insulating surfaces as evidenced by tracking or carbonization.

Evidence of rusting, corrosion and deterioration of the paint should be looked for and corrective measures should be taken where necessary. Furthermore, fans, motors, and other auxiliary devices should be inspected and serviced during inspection periods.

Jackscrew Assembly Adjustments

Check for loose jackscrew assemblies by attempting to move the coil block from side to side. If they move, tighten the jackscrew assembly following the outlined procedure. (Caution should be observed when

handling nuts, bolts, and washers to prevent dropping them into the coils.)

- A Tighten lower jacking nut while holding jacking bolt until coil block can no longer be moved by hand.
- B Tighten lower jacking nut an additional 1/2 turn.
- C Apply air dry varnish to nut and bolt assembly.
- D Repeat as required on other jackscrew assemblies.

Determining Dryness

The measurement of insulation resistance is of value in determining the status of drying. Measurements should be taken before starting the drying process and at two-hour intervals during drying. The initial value, if taken at ordinary temperatures, may be high even though the insulation may not be dry. Because insulation resistance varies inversely with temperature, the transformer temperature should be kept approximately constant during the drying period to obtain comparative readings. As the transformer is heated, the presence of moisture will be evident by the rapid drop in resistance measurement. Following this period, the insulation resistance will generally increase gradually until near the end of the drying period when it will increase more rapidly. Sometimes it will rise and fall through a short range before steadying, because moisture in the interior of the insulation is working out through the initially-dried portions. A curve, with time as abscissa and resistance as ordinate, should be plotted, and the run should be continued until resistance levels off and remains relatively constant between three and four hours.

Caution: *Insulation resistance measurements should be taken from each winding to ground, with all windings grounded except the one being tested.*

Before taking insulation resistance measurements the winding should be short-circuited and grounded for at least one minute to drain off any static charge.

All readings should be for the same time of application of the test voltage, preferably one minute.

Methods of Drying

General

As long as the transformer remains energized, humidity conditions are of no importance. However, if a dry-type transformer is de-energized and allowed to cool to ambient temperature, consideration must be given to the possible effects of humidity.

If the shutdown period occurs during low humidity conditions, no special precautions should be required before energizing the unit. But, experience indicates that if a shutdown exceeding 24 hours occurs during a period of high humidity, particularly if atmospheric conditions are such that they cause condensation to

Maintenance

Methods of Drying (Continued)

appear within the housing of the transformer, then precautions must be taken. Small strip heaters may be placed in the bottom of the unit shortly after shut-down to maintain the temperature of the transformer a few degrees above that of the outside air. If such a precaution is not taken, the transformer should be inspected for evidence of moisture, and the insulation resistance should be checked. If moisture is present or if the insulation resistance is low, the transformer should be dried out by one of the methods described.

Drying of Core and Coil Assembly

When it is necessary to dry out a transformer before installation or after an extended shutdown under relatively high humidity conditions one of the following methods may be used:

- A. External heat
- B. Internal heat
- C. External and Internal heat

Before applying any of these methods, free moisture should be blown or wiped off of the windings to reduce the time of the drying period.

Drying by External Heat

External heat may be applied to the transformer by one of the following methods:

- A. By directing heated air into the bottom air inlets of the transformer case.
- B. By placing the core and coil assembly in a suitably ventilated oven.

It is important that most of the heated air passes through the winding ducts and not around the sides.

Good ventilation is essential to prevent condensation from taking place within the transformer or inside the case. A sufficient quantity of air should be used to insure approximately equal inlet and outlet temperatures.

When using the first external heating method, heat may be obtained by the use of resistance grids or space heaters. These may be located inside the case or may be placed outside and the heat blown into the bottom of the case. The core and coil assembly should be carefully protected against direct radiation from the heaters.

It is recommended that the air temperature not exceed 110 C.

Drying by Internal Heat

This method is relatively slow and should be used only when the other two methods are unavailable.

The transformer should be located to allow free circulation of air through the coils from the bottom to the top of the case. One winding should be short-circuited, and sufficient voltage at normal frequency should be applied to the other winding to circulate approximately normal current.

It is recommended that the winding temperature not be allowed to exceed 100 C, as measured by resistance, or by thermometers placed in the ducts between the windings. The thermometers used should be the spirit type; mercury thermometers give erroneous readings due to the generation of heat in the mercury resulting from induced eddy currents. The end terminals of the windings (and not the taps) must be used in order to circulate current through the entire winding. **Proper precautions should be taken to protect the operator from dangerous voltage.**

Drying by External and Internal Heat

This is a combination of the two methods previously described and is, by far, the quickest method. The transformer core and coil assembly should be kept in its own case when suitable, and external heat applied (as described in the first method) as current is circulated through the windings (as described in the second method). The current required will be considerably less than when no external heating is used, but should be sufficient to produce the desired temperature of the windings. It is recommended that the temperature attained not exceed those stated in the foregoing paragraphs.

Removal from Service

If a unit is to be off more than 24 hours, provisions should be made to prevent the core and coils from taking on moisture. Refer to "Storage."

If the unit is to be moved, it will be necessary to replace the core and coil hold-down bolts and any shipping braces that might protect the assembly during movement.

Cleaning

If excessive accumulations of dirt are found on the transformer windings or insulators when the transformer is inspected, the dirt should be removed to permit free circulation of air and to guard against the possibility of insulation breakdowns. Particular attention should be given to cleaning the top and bottom ends of the windings assemblies and to cleaning out the ventilating ducts.

The windings may be cleaned with a vacuum cleaner, a blower, or with compressed air. The use of a vacuum

Maintenance

Methods of Drying (Continued)

cleaner is preferred as the first step in cleaning followed by the use of compressed air or nitrogen. The compressed air or nitrogen should be clean and dry and should be applied at a relatively low pressure (not over 25 pounds per square inch). Lead supports, terminal boards, bushings and other major insulation surfaces should be brushed or wiped with a dry cloth. The use of liquid cleaners is discouraged as some of them have a solvent or deteriorating effect on insulating materials.

Renewal Parts

Should a transformer be damaged and new parts needed, write to National Industri giving full nameplate information. Be sure to include the serial number and a description of the part desired. If the proper name of the part is in doubt, a simple sketch or photograph will expedite prompt shipment to you.

Transformers

Ventilated Dry

Trouble Shooting

Transformer failure may occur in either the electric, magnetic or dielectric circuit.

Symptom	Cause
Electric Circuit	
Overheating	Continuous overload — wrong external connections - poor ventilation - high surrounding air temperature. (Rating is based on 30 Degree C average temperature over 24-hour period with peaks not to exceed 40 Degree C.)
Reduced or Zero Voltage	Shorted turns - loose primary tap connections
Excess Secondary Voltage	Input voltage high - improper primary tap connections
High Conductor Loss	Overload - tap connections not on identical tap positions
Coil Distortion	Coils short circuited
Insulation Failure	Continuous overloads - dirt accumulations on coils - mechanical damage in handling - lightning surge.
Breakers or Fuses Opening	Short Circuit - overload.
Excessive Cable Heating	Improper bolted connection.
High Voltage to Ground	Usually a static charge condition.
(using rectifier or VTVM meter)	
Magnetic Circuit	
Vibration and Noise	Low frequency - high input voltage - core clamps loosened in shipment or handling - improper primary tap connection.
Overheating	High input voltage.
High Exciting Current	Low frequency - high input voltage - shorted turns.
High Core Loss	Low frequency - high input voltage.
Insulation Failure	Very high core temperature due to high input voltage or low frequency.
Dielectric Circuit	
Smoke	Insulation failure.
Burned Insulation	Lightning surge - switching or line disturbance - broken bushings, taps, or arrestors - excess dirt or dust on coils.
Overheating	Clogged air ducts or inadequate ventilation.
Breakers or Fuse Open	Insulation failure.

If any of the above symptoms are noticed, the transformer should be removed from service at once. Immediate attention to the problem may save a large repair bill. In many instances, the trouble can be found quickly and the unit returned to service.

If the trouble cannot be definitely corrected, no further use should be made of the transformer until the cause has been found

It may be necessary to remove the core and coils for a closer examination. If no apparent fault can be found

the core and coil may have to be disassembled for a complete inspection. Removal of the coils from the core is a factory or service shop operation. As this will mean replacing many insulation parts when reassembling, it is advised that the trouble be reported to the nearest National Industri representative, before any dismantling takes place. Factory advice may again save a large repair bill. When writing, describe the nature of the trouble, the extent and character of the damage, and list all nameplate information.

Transformers

Forced Air Cooling System

Ventilated Dry and Cast Coil Transformers

Application Data

The forced air cooling system is designed for use with ventilated dry-type and cast coil transformers. Forced air cooling is available on transformers 300 - 3750 KVA to supply an additional 33-1/3% of overload capability to ambient air rating. Consult factory for overload capabilities above 3750 KVA and special applications not mentioned above.

Description

National Industri Transformers, Inc. offers 3 options in forced air cooling equipment. The 3 basic options include the following equipment:

Option A — Future Forced Air Cooling

1. Insulated tube well in low voltage winding for future addition of temperature sensing device
2. Properly sized bus for increased capacity of transformer
3. A control box with a hinged blank door

Option B — Provision For Future Forced Air Cooling

4. All items described under Option A
5. A hinged door with dial type temperature indicator with 3 SPDT adjustable alarm contacts and a maximum temperature indicating pointer with reset

Option C — Complete Forced Air Cooling

6. Fan mounting brackets for maximum cooling efficiency
7. All items described under Option B
8. Automatic control panel equipped with indicating lights and alarm bell
9. Fan motors and blades
10. 120 VAC power source supplied if specified at time of order entry

Ordering Information

To order forced air cooling equipment select from the description above, Option A, B, or C and so state that selection on order.

Control Power

Control power should be supplied by customer from any available 120 VAC supply. The amount of power required for operation of the Fan cooling system will vary with size of transformer being supplied. General requirements for transformers up to 3000 KVA (ambient air rating) 1500 VA. Consult factory for larger transformers. If 120 VAC control power is not available, control power may be furnished by factory from the secondary of the main transformer if specified at time of order entry. In cases where control

power is to be supplied by the factory, the customer's order should be written, e.g. 1500 2000 AA FA Option C Forced Air Cooling with control power.

3 coil sensing is available as a separate package - consult factory.

Future Addition of Forced Air Equipment

Forced air equipment may be added in the field to transformers that were equipped by the factory with Future Forced Air or Provision For Future Forced Air Cooling (Option A and B). Most units that require the addition of a fan cooling system can be readily modified in the field. Some of the units which have been in service for longer periods of time may require a more extensive conversion process. When ordering equipment for completion of forced air cooling, the serial number of the unit on which fans are being added must be supplied with the order.

National Industri reserves the right to alter any of the equipment described in this information.

Forced Air Cooling Equipment

KVA	(1) No. of Motors	(2) Fan Blade Diameter
300	6	7"
301-500	6	8"
501-750	6	9"
751-1250	6	10"
1251-2000	12	9"
2001-3000	12	10"
Above 3000	(3)	(3)

Table 1

Notes:

- (1) Fan motors are 1550 RPM, 120 Volt, 0.7 Amp, 1/83 H.P. each
- (2) Fan blades are uncoated aluminum
- (3) Consult factory

Transformers

Forced Air Cooling System

Ventilated Dry and Cast Coil Transformers

Thermostat

The control circuit elements are actuated by thermometer contacts in the Qualitrol model 104-075-01 temperature indicator assembly

The thermostat is of the bourdon-tube type and is connected with capillary tubing to a bulb installed directly in the air duct of the center transformer coil, where it transmits the winding hot-spot temperature

Forced Air Cooling Equipment Contact Settings

Contacts				(1) 220° C Max Total Temp erature	(2) 185° C Max Total Temp erature	(3) 150° C Max Total Temp erature
	Contact Position	Recom- mended Circuits	Dead Band			
T	Left	Fan Control	17 °C	180° C	145° C	110° C
T	Center	Alarm	5° C	210° C	175° C	140° C
T	Right	Auxiliary	5° C	220° C	185° C	150° C

Table 2

- (1) Standard settings for conventional Open-Wound Transformer Forced Air Cooling System. Used on 80° C, 100° C, 115° C, and 150° C Rise Transformers unless specified otherwise
- (2) Standard settings for Cast-Coil Transformer Forced Air Cooling System. Used on 80° C, 100° C, and 115° C Rise Transformers unless specified otherwise.
- (3) Optional Settings for Cast-Coil and Open-Wound Transformers Forced Air Cooling System. Used when 80° C is to be maintained at Forced Air Cooling Rating

Field Conversion from Option A — Provisions for Forced Air Cooling to Option B — Future Forced Air Cooling.

A tube-well in the center coil of the transformer will normally be provided for most installations. If no tube-well exists in older units, consult factory for details

The temperature sensing bulb of the temperature indicator should be fully inserted into the tube-well as shown on Fig. 4

Proper air clearances must be maintained from any transformer live part to capillary tubing and temperature indicator. General guidelines for such clearances are: up to 5 KV — 2½", up to 15 KV — 6".

Replace hinged blank door over cutout in transformer enclosure with temperature indicator panel with indicator and terminal block attached. Indicator contacts are available on this terminal block for connection to remote devices, see Fig. 1.

Field Conversion from Option B — Future Forced Air Cooling to Option C — Complete Forced Air Cooling

Fan mounting brackets, if not already installed, should be mounted as per Fig. 6. Use existing bolts in bottom flange of bottom transformer clamping channel if available and if in appropriate position. Otherwise weld brackets to the bottom flange.

Remove hinged indicator panel from cutout in transformer enclosure and replace with FAC control panel. Connect contact wires to terminal block on rear of control panel per terminal numbers as shown on Fig. 7.

Fan motors should be mounted on the mounting brackets using lock washers on all screws. Fan blades and rubber sound/vibration reducing washer should be installed on locating pins, and secured with lock washer and nut.

Wire six fan motors in parallel and connect to terminal points 1 and 2 on terminal block on rear of FAC control panel. If 12 motors are required, wire the remaining six motors in parallel and connect to points 3 and 4. Connect 120 VAC to terminal points 11 and 12 on same terminal block

Transformers

Forced Air Cooling System

Ventilated Dry and Cast Coil Transformers

If CPT is required, mount unit and fuses in a suitable location and connect as per Fig. 9

For digital units see separate instruction manual

Proper air clearances must be maintained between all transformer live parts and fan motors, blades and all control wiring

Temperature Indicator Contact Wiring

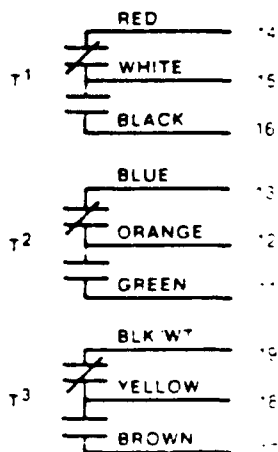

- 1 The temperature indicator is equipped with 3-SPDT contacts, each independently adjustable over a broad temperature range.
- 2 Contact Rating: 10 Amp @ 125-250 VAC
.5 Amp @ 125 VDC (Non-inductive)
.25 Amp @ 250 VDC (Non-inductive)
- 3 Contacts are wired to control elements in FAC panel in Option C, or to customer termination points for connection to remote devices in Option B.
- 4 Contact settings are normally factory preset. For possible field adjustments refer to Table 2.

Fig. 1

Transformers

Forced Air Cooling System

Dry and Cast Coil Transformers

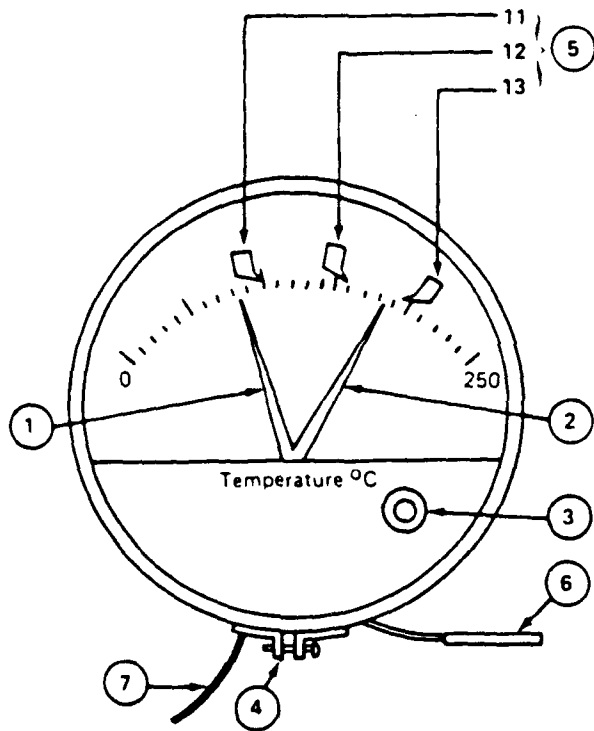

Fig. 2

Temperature Indicator

1. Black temperature indicating pointer.
2. Red maximum temperature pointer.
3. Maximum temperature pointer reset button.
4. Removable bezel ring for access to contact settings.
5. Three adjustable contacts for connection to remote controls and alarm.
6. Temperature sensing bulb.
7. Contact leads.

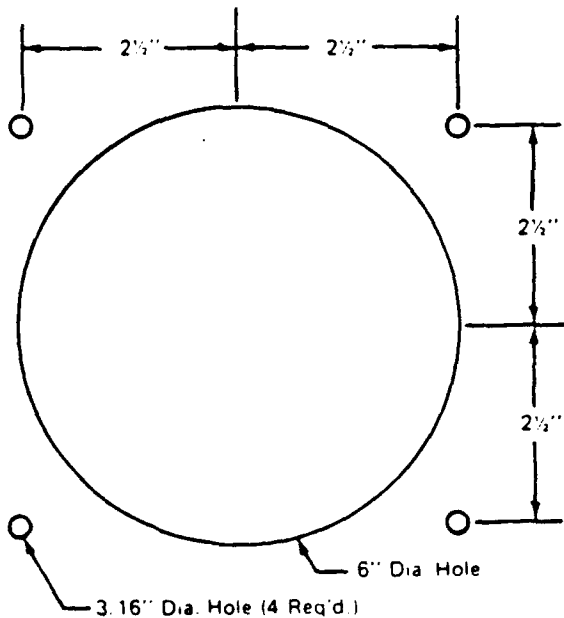

Fig. 3

Field Installation of Temperature Indicator

1. When indicator is supplied for field installation in an enclosure which does not have provision for mounting of device, the cutout and drilling shown at left will be required.
2. Cutout should be made in non-removable panel.
3. Mount indicator with flange inside of panel.
4. Cutout should be in a location that provides adequate clearance to transformer live parts. Indicator extends 3 1/2" inside of panel.

Transformers

Forced Air Cooling System

Dry and Cast Coil Transformers

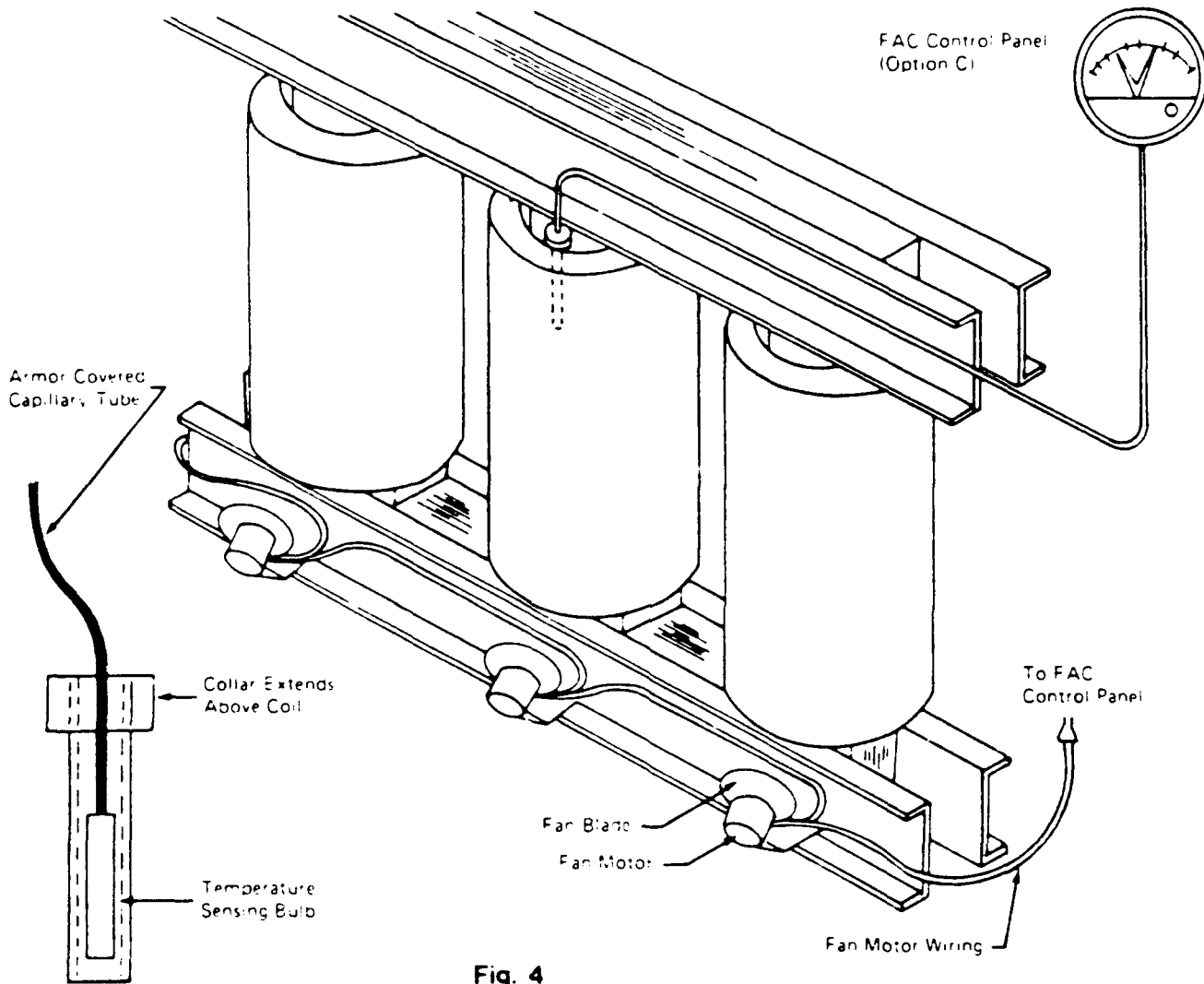

Fig. 4

Data of Insulated We

- Notes:
1. Install indicator such that adequate clearance to live parts is maintained for indicator and capillary tubing.
 2. Exercise care not to crush sensing bulb and not to make sharp bends in capillary tube. Coil excess length of capillary tube and support to prevent damage to tube.
 3. Route fan motor wiring to maintain adequate clearance to transformer live parts.

Transformers

Forced Air Cooling System

Dry and Cast Coil Transformers

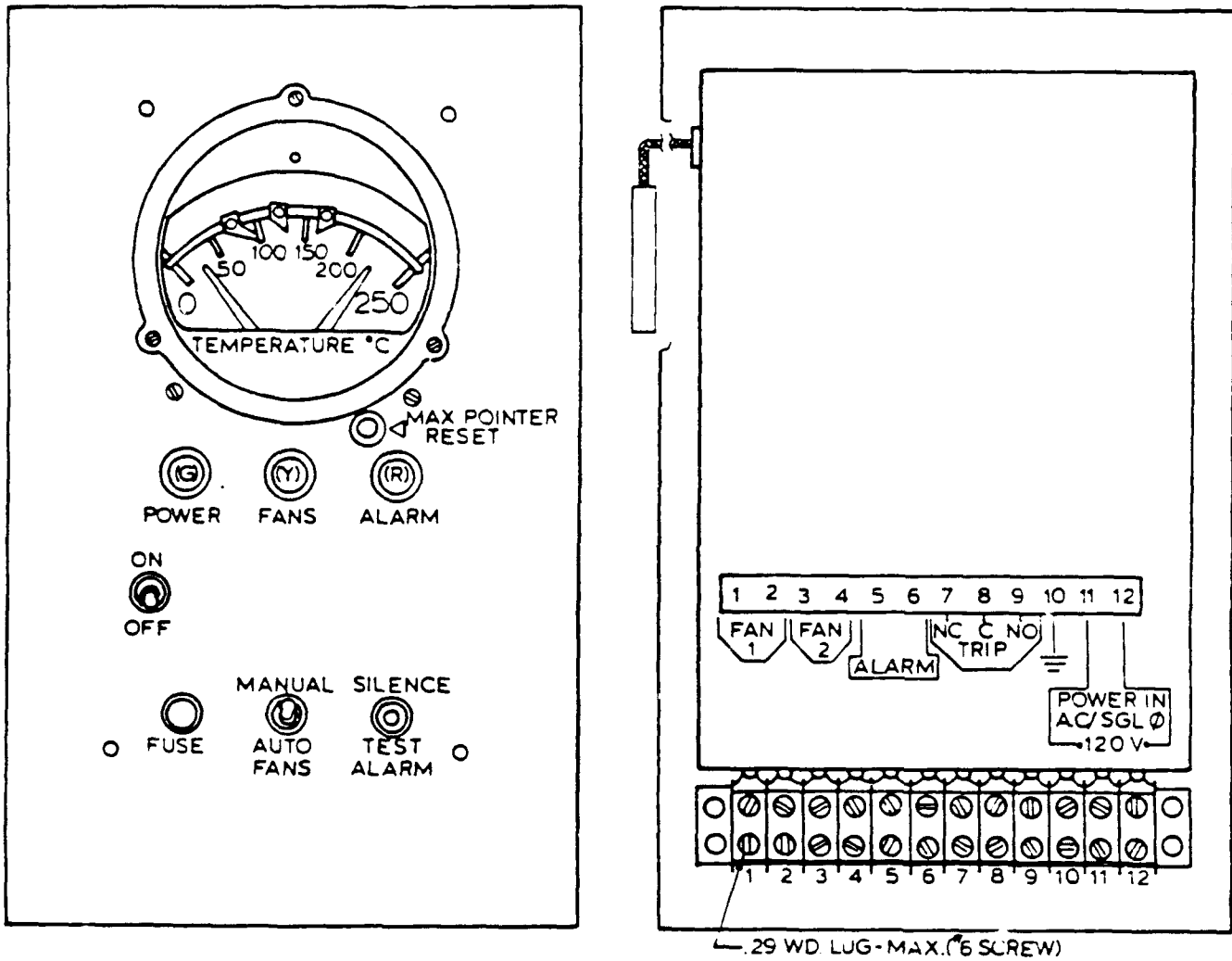

Fig. 5

Transformers

Forced Air Cooling System

Dry and Cast Coil Transformers

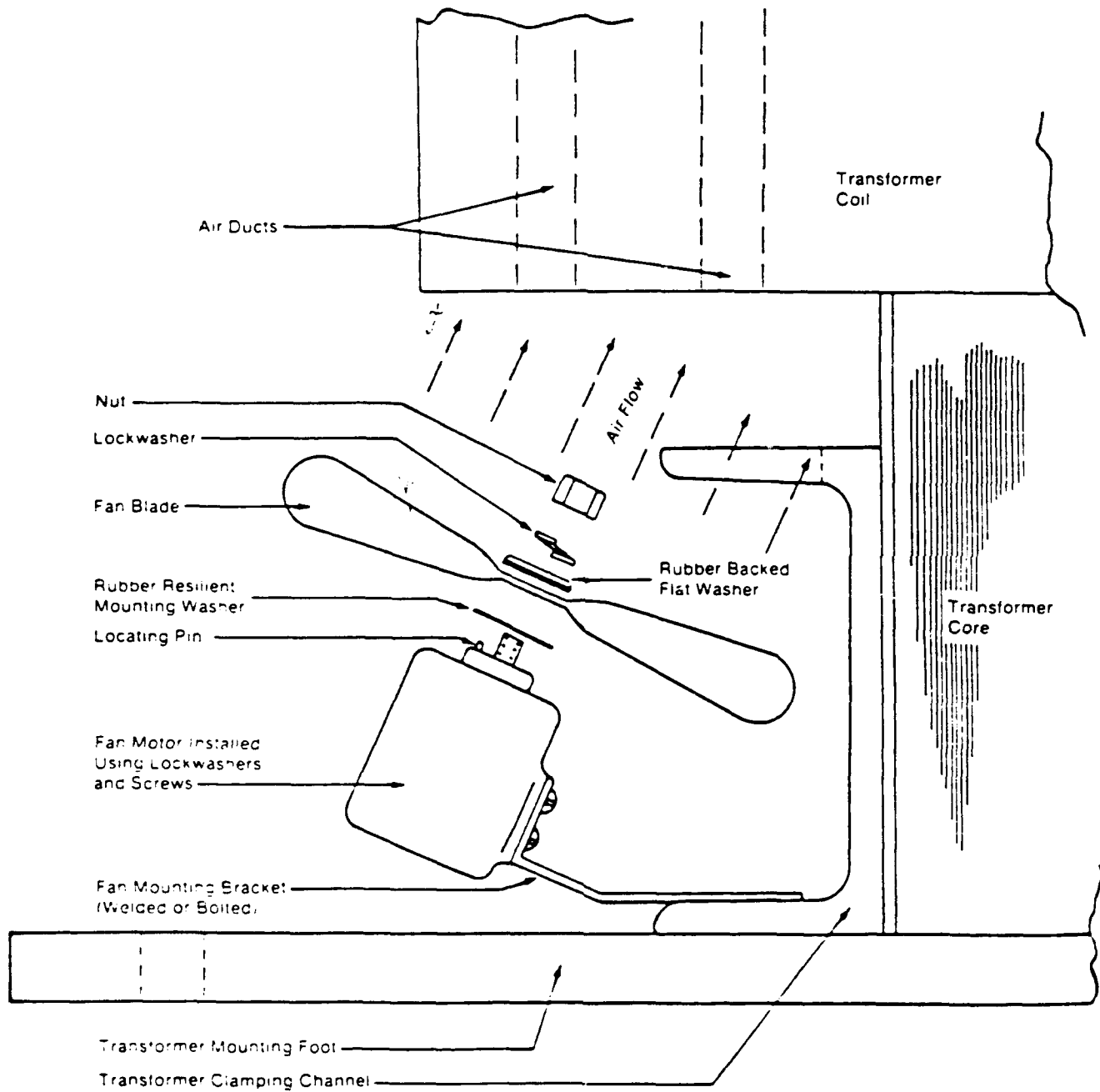

Fig. 6

Transformers

Forced Air Cooling System

Dry and Cast Coil Transformers

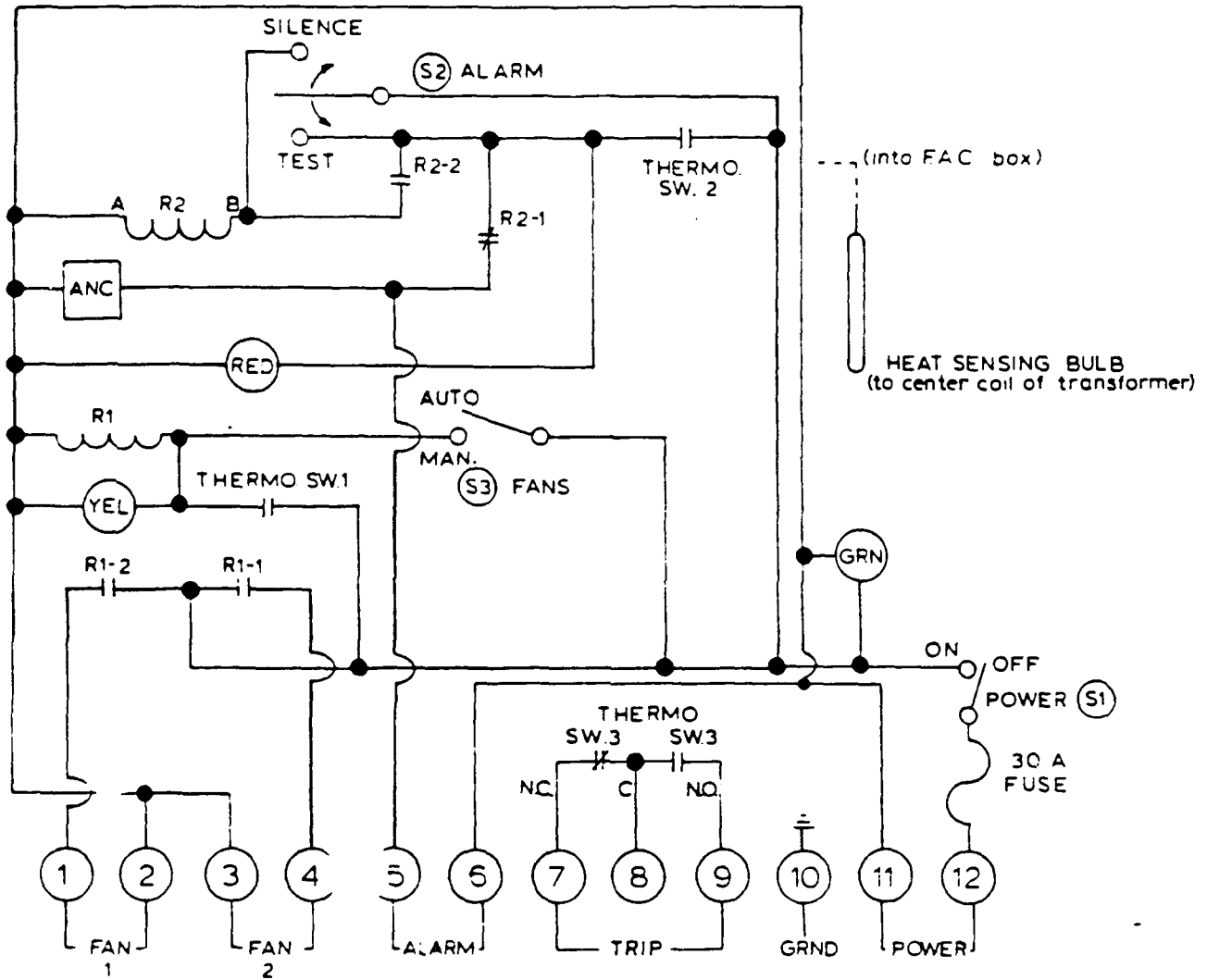

Fig. 7

Transformers

Forced Air Cooling System

Dry and Cast Coil Transformers

FAC Instructions

- 1 Supply of 120 volts - 60 Hz or 100 volts - 50 Hz to points 11 and 12 of control panel
- 2 Panel is de-energized with main switch in "OFF" position
- 3 With circuit breakers in "ON" position the green "POWER" pilot light indicates that panel is energized. Transformer may be operated at its forced air rating only if this light is on
- 4A Move "FANS" switch to "AUTO" position. This is the normal position for operating fan controller. When the temperature of T1 contact is reached, contact T1 closes, the amber "FANS" light is energized, fan motors operate. The fan motors and the "FANS" light will continue to operate until the temperature falls 15-20° C below T1 contact setting
- 4B Move "FANS" switch to "MANUAL" position. This function by-passes the automatic controls and operates fan continuously. This position should be used only for emergency operation or testing of fan motors
- 5 If temperature continues to rise above T1 contact setting and T2 contact setting is reached, contact T2 closes, energizing the red "ALARM" light, the local annunciator, and the remote "ALARM" contacts on the rear terminal board. The local annunciator and the remote "ALARM" contacts may be de-energized by momentarily moving the "ALARM" switch to "SILENCE" position, while overload condition is being adjusted. The red "ALARM" light will remain lighted until temperature falls 5-10° C below T2 contact setting. The "ALARM" circuit also resets itself at this point
- 6 Move "ALARM" switch to "TEST" position to test operation of the "ALARM" light, local annunciator, and remote "ALARM" relay operation. The red "ALARM" light, local annunciator, and remote "ALARM" relay will all remain actuated as long as the "ALARM" switch is held in the "TEST" position.
- 7A Auxiliary circuit for remote "ALARM" connections are provided at points 5 and 6. Device should be rated maximum 120 vac, 3 amps. Power is provided from fan control panel
- 7B Auxiliary circuit for remote "TRIP" connections are provided at points 7, 8 and 9. Device should not exceed 3 amps 125/250 vac and should include its own source of supply power.

Transformers

Forced Air Cooling System

Dry and Cast Coil Transformers

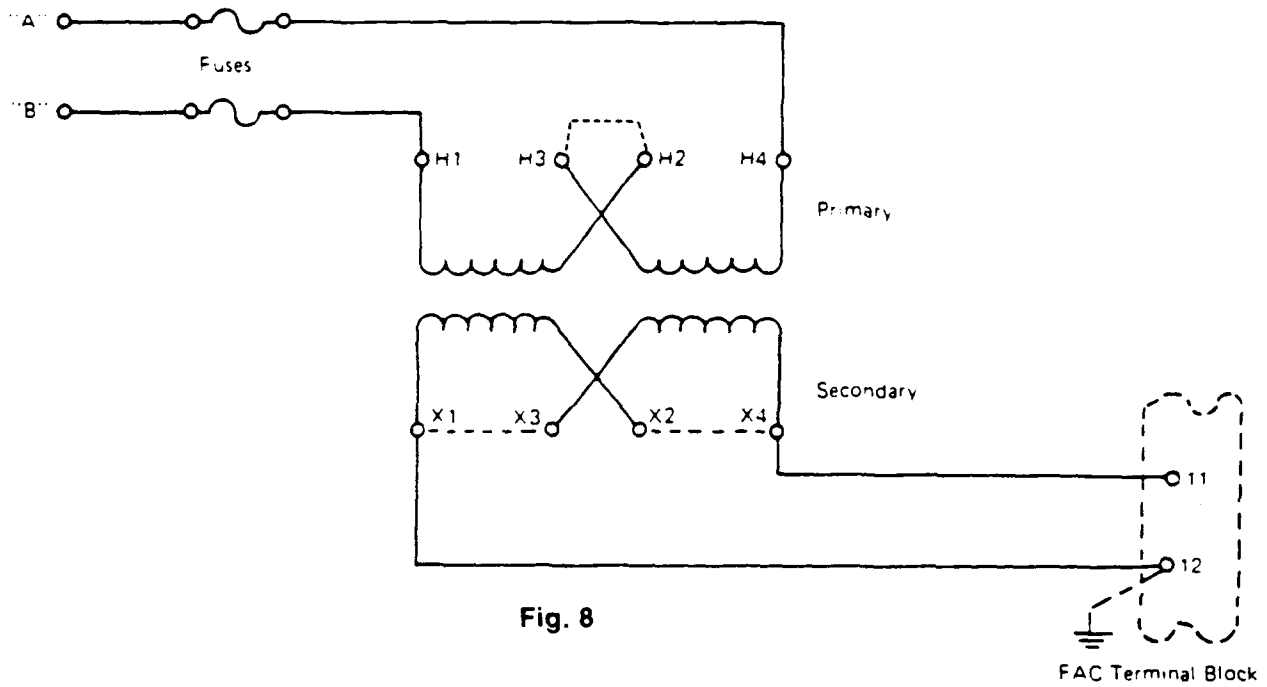

Fig. 8

- Notes
- 1 Points A and B connected to 240 or 480 volt supply
 - 2 Fuses — see table below
 - 3 Connect primary of CPT for correct input voltage. See CPT nameplate for proper connection.
 - 4 Connect secondary of CPT as shown by dotted lines
 - 5 Output of CPT connected to terminal points 11 and 12 of FAC panel. See Fig. 7

Main Transformer	Input Voltage to CPT	Fuse Size Required
Up to 3000 KVA	240V 480 V	250V - 9A 600V - 5A
Above 3000 KVA	480V	600V 9A

Table 3

NOTES

Cimco Series 50XL

**Winding Temperature Indicator &
Controller for Dry-Type
Transformers**

Cimco Electronics, Inc.
P.O. BOX 248 • 104 MAIN ST.
West Middlesex, PA 16159
(412) 528-9558

Cimco's Series 50 XL instruments provide hot spot temperature measurement, fan on-off control, alarm indication, audio alarm, trip indication, and trip and alarm switches for dry-type transformers. These instruments will also measure and remember the maximum temperature that is experienced by the three transformer coils.

OPERATION

As the temperature of the transformer hot spot changes, the ambient compensated circuit provides accurate indication of the highest temperature which the 3 thermocouples sense. This highest temperature is used to drive the control logic. The set points for the switch and light operation are energized from the same circuit which drives the indicator on the face of the panel. The alarm and trip relays have a 5°C hysteresis to maintain alarm and trip information. The fan control has a 25°C hysteresis to help extend the life of the fans and the fan relay contacts. The power light is green, the fan-on light is yellow, the alarm light is red, and the trip light is red.

THERMOCOUPLES

These instruments use Type "E" thermocouples. Type "E" thermocouples are used to reduce the introduction of errors that can occur if thermocouples are used that contain magnetic materials. The specially constructed Cimco thermocouples can be imbedded into the 1.2 KV dry-type coils to sense the hot-spot temperature directly without concern for thermal gradients within the coils.

FAIL SAFE FEATURES

- With loss of power, Alarm turns on
- With loss of any thermocouple, Alarm and Fan relays turn on while the trip circuit does not turn on under either of the above conditions.
- If fan control switch is in off position or if fan control logic is inoperative, the trip function will turn on fans.

INSTALLATION

- Complete instructions are printed on the back side of the instrument next to the terminals.
- As relays are included in the instrument.
- 120 / 240 VAC input power selection
- Panel mounted
- One piece installation
- Verify accuracy by reading ambient at start.
- Set points are adjustable by transformer manufacturer
- Verify set points with self-test feature
- Use Type "E" thermocouples
- The red thermocouple lead is "negative".

CONSTRUCTION

All of the necessary circuitry and relays are enclosed. An attractive face plate covers the small cabinet and is used to mount the instrument in the dry-type transformer sheet metal enclosure. All connecting terminal points are located on the back of the instrument and are clearly labeled to help reduce error during installation.

AUGUST 1989

Cineo Series 58XL

**Winding temperature Indicator &
Controller for Dry-Type
Transformers**

**Cineco Electronics, Inc.
P. O. BOX 248 • 104 MAIN ST.
West Middlesex, PA 16158
(412) 528-9558**

OPERATIONAL CONTROLS

• FAN CONTROL SWITCH

The fan control switch can be in the automatic, manual, or off position. In automatic, fans turn on and off at the previously set fans on-and-off temperature. In the manual position, fans will be turned on at all times. In the off position, fan power is not available to the fans.

• ALARM

The operator can silence the local alarm located on the front panel of the instrument. The remote alarm continues until the alarm condition clears. The complete alarm circuit is tested by using the self test feature.

• SELF TEST

The self test feature provides the operator with the ability to test all set points without the need for additional instrumentation. The push and hold control energizes the test circuit. The make and break set points are checked by changing the turn to check control and comparing the on-off action of the fans on, alarm, and trip lights with the indication on the read-out. The fans, local and remote alarms, and trip lights are turned on by the self test feature. The trip relay is not energized during self test.

The self test feature can also be used to change the set points. Contact the transformer manufacturer before attempting to change set-points. The set-points are established to protect the insulation system as well as the electrical operating system.

The self test feature can also be used to test the entire electrical control scheme and fans. The trip circuit will not energize when using the self test feature.

• MAXIMUM TEMPERATURE MEMORY

The maximum temperature memory is displayed on the meter by pressing the push to read control. The maximum memory is erased by pressing the push to reset control. The maximum temperature memory is retained in the electronics for 30 days or more if the power to the instrument is lost. A battery is not used to retain memory.

• THREE THERMOCOUPLE SELECTOR

The three thermocouple selector feature operates automatically to select the hottest phase to be used in the control logic. To read the temperature of the other phases, press the corresponding control button. Three lights indicate which phase is the hottest and is being used in the control logic.

• FUSE

The front mounted fuse or breaker is to protect the fans. The instrument is not fused in order to provide maximum protection for the transformer.

Cineo Series 58XL
Winding Temperature Indicator
& Controller for Dry-Type
Transformers

Cineo Electronics, Inc.
P. O. BOX 248 • 104 MAIN ST.
West Middlesex, PA 16159
(412) 520-9559

FEATURES

- **SELF-TEST**
 - ALL ON-OFF SET-POINTS CAN BE CHECKED BY USING FRONT PANEL CONTROLS.
 - ALL OF SET-POINTS CAN BE CHANGED USING THE FRONT PANEL CONTROLS AND THE SCREW DRIVER ADJUSTMENTS. (DEAD BAND IS FIXED)
 - MAXIMUM MEMORY IS NOT AFFECTED BY SELF-TEST
 - EXTERNAL TRIP CIRCUIT IS NOT AFFECTED
 - LOCAL ALARM CAN BE TESTED
 - FANS AND REMOTE ALARM CAN BE TESTED
 - FANS ON, ALARM, AND TRIP LIGHTS CAN BE TESTED
- **FAIL-SAFE**
 - FOR ANY OPEN THERMOCOUPLE
 - METER WILL READ FULL SCALE
 - MAXIMUM MEMORY READS FULL SCALE
 - FAN, ALARM, AND TRIP LIGHTS TURN ON
 - ALARM RELAYS OPERATE
 - LOCAL SONIC ALARM OPERATES
 - TRIP RELAY DOES NOT OPERATE
 - FOR LOSS OF POWER TO INSTRUMENT
 - ALL LIGHTS TURN OFF
 - ALARM RELAYS TURN ON
 - MAXIMUM TEMPERATURE IS STORED
 - RETAINED AT LEAST FOR 30 DAYS
 - NO LOSS OF ACCURACY
 - NO BATTERY POWER
- **INSTALLATION INSTRUCTIONS**
 - COMPLETE INSTRUCTIONS ON BACK PLATE
 - TERMINALS CLEARLY MARKED
 - FUNCTIONAL DESCRIPTION INCLUDED
 - THERMOCOUPLE CONNECTING INSTRUCTIONS
 - 120 / 240 VAC INPUT SELECTION
 - 30 AMPS OF FAN POWER
 - TWO SETS OF FAN POWER TERMINALS

• OPERATING INSTRUCTIONS

- SINGLE FUNCTION CONTROLS -- ALL OF THE FRONT PANEL CONTROLS PERFORM ONE FUNCTION ONLY.
- INSTRUCTIONS FOR EACH CONTROL ARE PRINTED ON THE FRONT PANEL NEXT TO THE CONTROL
- EXPERIENCED CONTROL ROOM OPERATORS USUALLY DO NOT REQUIRE ANY TRAINING TO OPERATE THIS INSTRUMENT.

OPERATING INSTRUCTIONS FOR MAXIMUM TEMPERATURE MEMORY

- AT START-UP
 - PRESS "PUSH TO READ"
 - PRESS "PUSH TO RESET" IF RESET IS DESIRED
 - NORMAL OPERATION
 - PRESS "PUSH TO READ" TO DETERMINE MAXIMUM TEMPERATURE SINCE LAST RESET
 - PRESS "PUSH TO RESET" TO CLEAR THE MAXIMUM TEMPERATURE VALUE IN MEMORY

OPERATING INSTRUCTIONS FOR SELF-TEST FEATURE

- SET FAN MODE CONTROL TO AUTOMATIC
- ROTATE SELF-TEST CONTROL COUNTER-CLOCK WISE
- PRESS "PUSH AND HOLD" SWITCH
- SLOWLY ROTATE SELF-TEST CONTROL CLOCK WISE
- RECORD THE TEMPERATURE INDICATION ON THE METER AS EACH OF THE CONTROL LIGHTS TURNS ON.
- SLOWLY ROTATE THE SELF-TEST CONTROL COUNTER CLOCKWISE. (OK TO SILENCE ALARM DURING CHECK)
- RECORD THE TEMPERATURE INDICATION ON THE METER AS EACH OF THE CONTROL LIGHTS TURNS OFF

Cimco Series 50XL
 Winding Temperature Indicator
 & Controller for Dry-Type
 Transformers

Cimco Electronics, Inc.
 P. O. BOX 248 • 104 MAIN ST.
 West Middlesex, PA 16158
 (412) 528-9558

GENERAL SPECIFICATIONS

FEATURE	STANDARD	OPTIONAL
SCALE RANGE	0-250°C	
SCALE TYPE	DIGITAL	
ACCURACY	± 1 % OF FULL SCALE	
CURRENT LOOP		4-20 MILLI AMP
SET POINT RANGE	FULL SCALE	
DEAD BAND		
FANS	25°C	>10°C <50°C
ALARM AND TRIP	5°C	>5°C <20°C
FAN CONTROL	AUTO-OFF-MANUAL	AUTO-MANUAL
FAN RELAY RATINGS		
FANS 1 (SPST)	1 HP AT 120 VAC 1-1/2 HP AT 240 VAC	
FANS 2 (SPST)	1 HP AT 120 VAC 1-1/2 HP AT 240 VAC	
ALARM AND TRIP RELAY RATING	10 AMPS AT 120 VAC 8 AMPS AT 240 VAC AT PF = 1.0 1.5 AMPS AT 125 VDC 0.7 AMPS AT 240 VDC	
THERMOCOUPLE TYPE*E*	3 REQUIRED	
SUPPLY POWER	120 OR 240 VAC	
MAXIMUM LOAD	30 AMPS	
PROTECTION	20 AMP FUSE	SINGLE POLE BREAKER ON FAN CIRCUIT
SONIC ALARM	FRONT PANEL MOUNT 90db - INTERMITTENT SIREN	
PANEL CUT-OUT	6.75" WIDE BY 13.875"	CONTACT CIMCO
HI-POT TEST*	1500 VAC, 60HZ, 60 SEC.	

***TEST NOTES**

- DURING HI-POT TEST; DO NOT INCLUDE THE THERMOCOUPLE TERMINALS IN THE TEST.
- DURING IMPULSE TEST; DO NOT CONNECT THERMOCOUPLE TERMINALS TO GROUND.

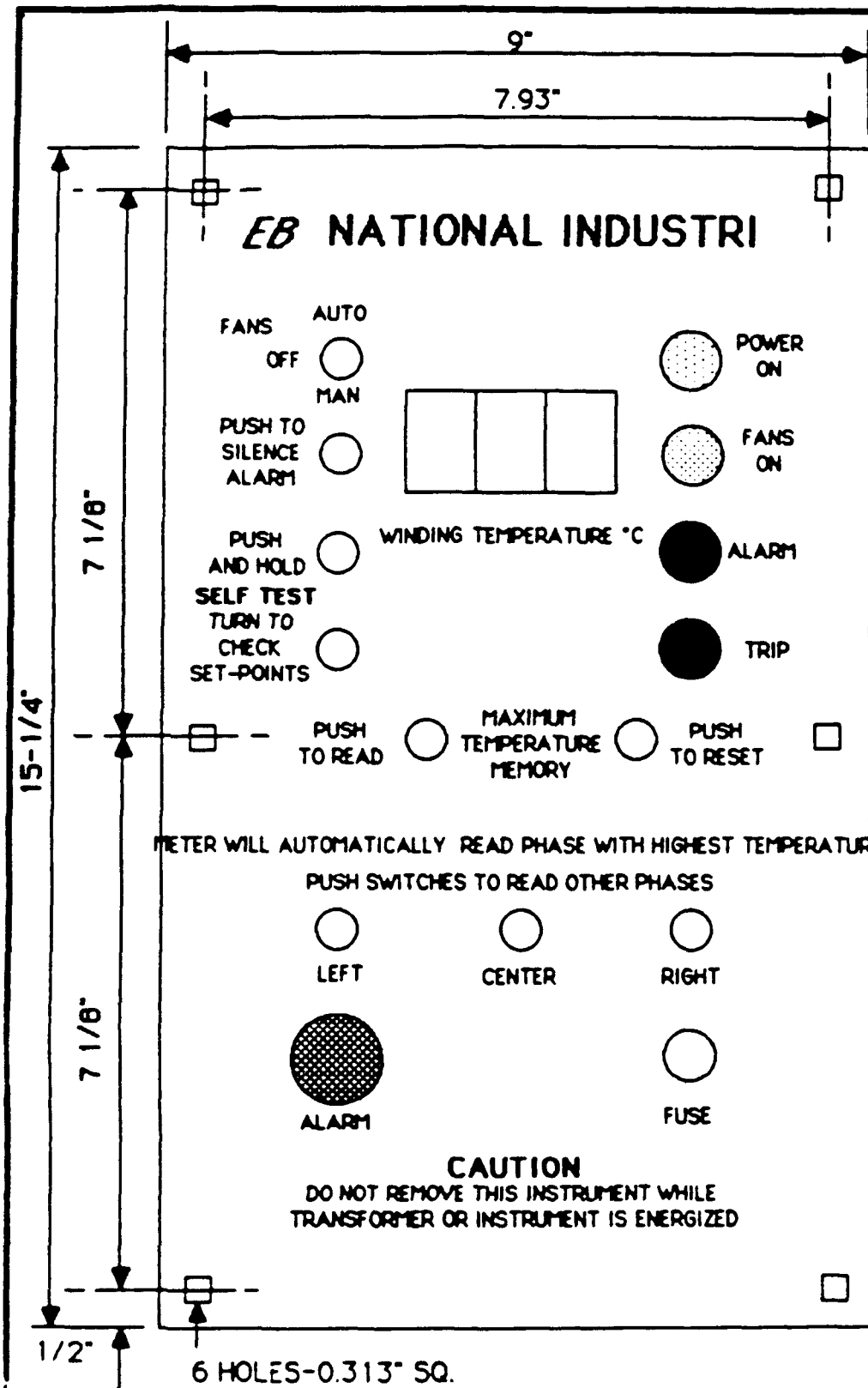

NOTES

1. FACE PLATE IS 0.60" BRUSHED ALUMINUM.
2. LETTERING IS SLIGHTLY SMALLER IN SCALE THAN SHOWN.
3. BOX IS 4" DEEP.
4. BOX IS 6-1/2" X 11-
5. TYPE "E" THERMOCOUP IS STANDARD.
6. FUSE DOES NOT INTERRUPT POWER TO INSTRUMENT.
7. ALARM EMITS AN INTERMITTENT HIGH PITCHED SIREN TYPE OF SOUND RATED AT 90 db.
8. ALL LIGHTS ARE LED'S
9. DIGITAL METER IS LED

**SERIES 50 XL
NATIONAL INDUSTRI**

CIMCO ELECTRONICS, INC.
WEST MIDDLESEX, PA 161
(412) 528-9559

SUB 1
1-10-89

SCALE = 1/2

DEC. 3, 1

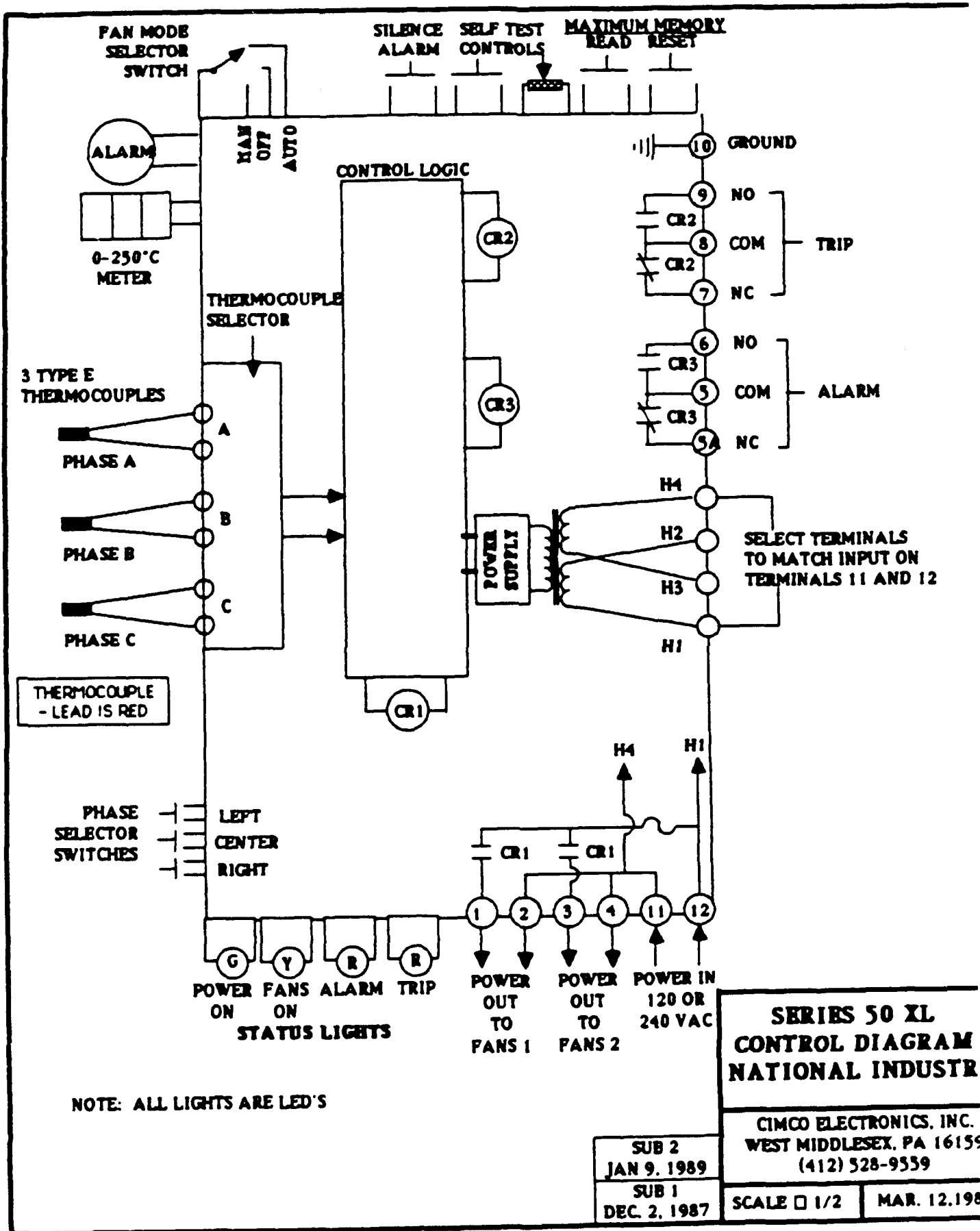

**SERIES 50 XL
CONTROL DIAGRAM
NATIONAL INDUSTRIAL**

CIMCO ELECTRONICS, INC.
WEST MIDDLESEX, PA 16155
(412) 528-9559

SUB 2
JAN 9, 1989

SUB 1
DEC. 2, 1987

SCALE □ 1/2

MAR. 12, 1988



ABB Power T&D Company Inc.
Underground Distribution Transformers
Jefferson City, MO 65101

Instruction Booklet
I.B. 46-060-1, Section D

Effective May 1991
Supersedes I.B. 46-060-1
Section D, dated June 1985

Instructions for Oil-Immersed Distribution Transformers

Section D: Padmounted, 75-2500 KVA, Three-Phase

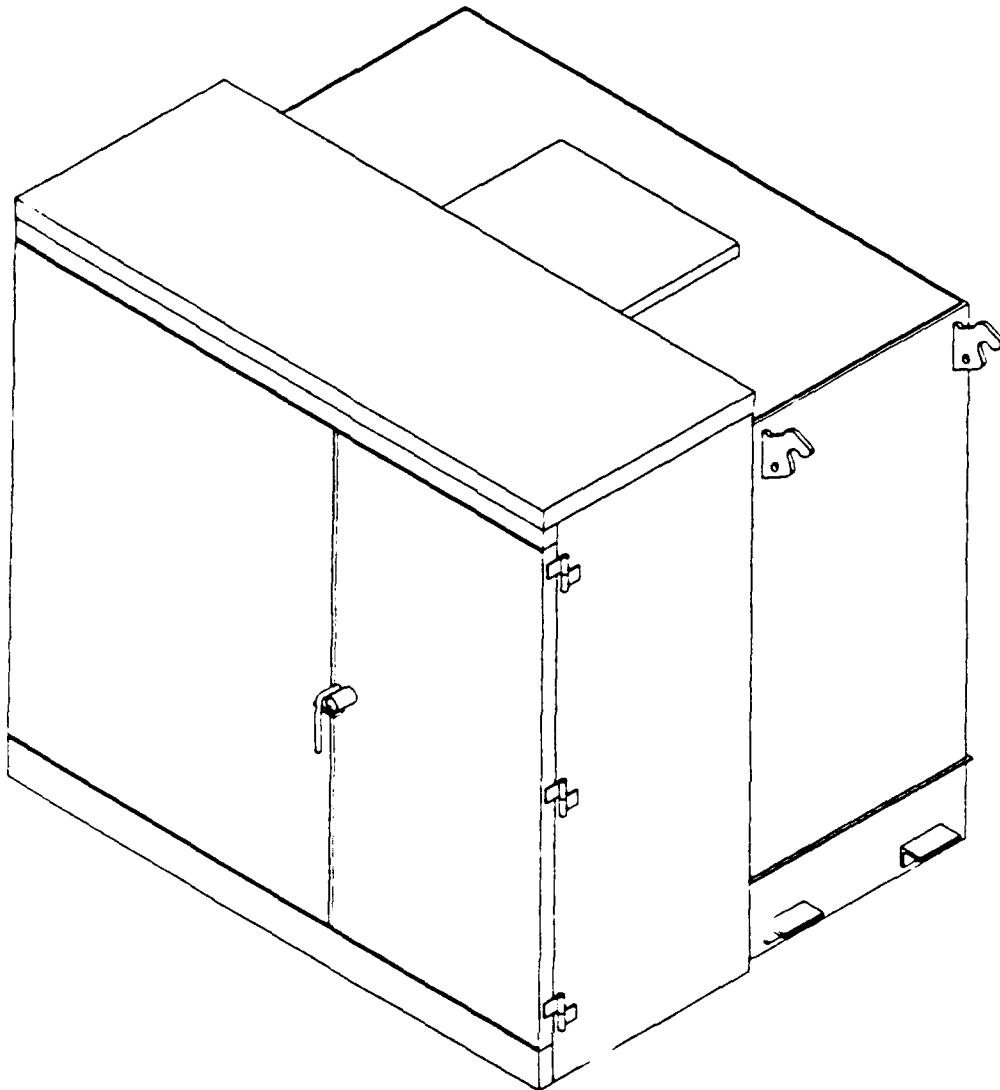

C-45

1.0 INTRODUCTION

The three phase padmounted distribution transformer is designed to provide electrical service on underground distribution systems. The transformer is designed for outdoor mounting on a pad. Primary and secondary cables enter the transformer compartment from below through openings in the pad. All exposed live parts are completely enclosed in tamper-resistant cabinets with provisions for padlocking.

The transformers described herein are designed for the conditions normally encountered on electric utility power distribution systems. As such, they are suitable for use under the "usual service conditions" described in ANSI C57.12.00 (General Requirements for Liquid-immersed Distribution, Power and Regulating Transformers). All other conditions are considered unusual service and should be avoided.

2.0 SAFETY

WARNING: READ THIS INSTRUCTION BOOK CAREFULLY BEFORE ATTEMPTING TO INSTALL, MAINTAIN, OPERATE OR SERVICE THE TRANSFORMER. FAILURE TO FOLLOW INSTRUCTIONS CAN CAUSE SEVERE INJURY, DEATH, OR PROPERTY DAMAGE.

Keep this Instruction Book available to those responsible for the installation, maintenance, operation, and service of the transformer. Safety as defined in this Instruction Book involves two conditions:

- 1. Personal injury
- 2. Product or property damage

SEE IMPORTANT "DISCLAIMER OF WARRANTIES AND LIMITATION OF LIABILITY" ON PAGE 12

Safety notations, intended to alert personnel of possible personal injury, death or property damage have been inserted in the instructional text prior to the step in which the condition is cited. These safety notations are headed by one of three hazard intensity levels which are defined as follows:



2. WARNING — Hazard or unsafe practice which can cause severe personal injury, death or substantial property damage.

3. CAUTION — Hazard or unsafe practice which will or can cause minor personal injury or minor property damage.

The transformer should be operated and serviced only by competent personnel familiar with good safety practices. These instructions are written for such personnel and are not intended as a substitute for adequate training and experience in the use of this equipment. Should clarification or further information be required, or should problems arise which are not covered sufficiently for the user's purpose, refer the matter to the ABB Power T&D Company Inc. When communicating with ABB regarding the product covered by this Instruction Book, ways include the following items of information from the transformer's nameplate: Serial number, style number, KVA rating, high voltage and low voltage ratings.

Additionally, all applicable safety procedures such as OSHA requirements, regional and local safety requirements, safe working practices and good judgement must be used by such personnel.

3.0 RECEIVING

WARNING: DO NOT LIFT THE TRANSFORMER BY USING CRANES OR JACKS ON ANY PART OF THE TRANSFORMER OTHER THAN THE LIFTING HOOKS OR JACKING PADS PROVIDED FOR THIS PURPOSE. IMPROPER LIFTING OR JACKING CAN CAUSE SEVERE INJURY AND PROPERTY DAMAGE.

The transformers are normally shipped completely assembled and ready to install. Each transformer should be carefully inspected upon receipt and the transportation company notified of any damage that has been incurred. The shipping list should be checked for possible shortages.

Three-phase transformers are normally shipped on a pallet. Palletized transformers in these ratings may be moved readily by a lift truck, crane, or car. The lifting hooks supplied on the sides of the transformer enable it to be lifted by crane.

Be sure the device chosen has the capacity to lift or move the complete unit. (Weight is shown on the nameplate.)

Lift the transformer utilizing all the hooks and use proper spreaders to obtain a vertical lift.

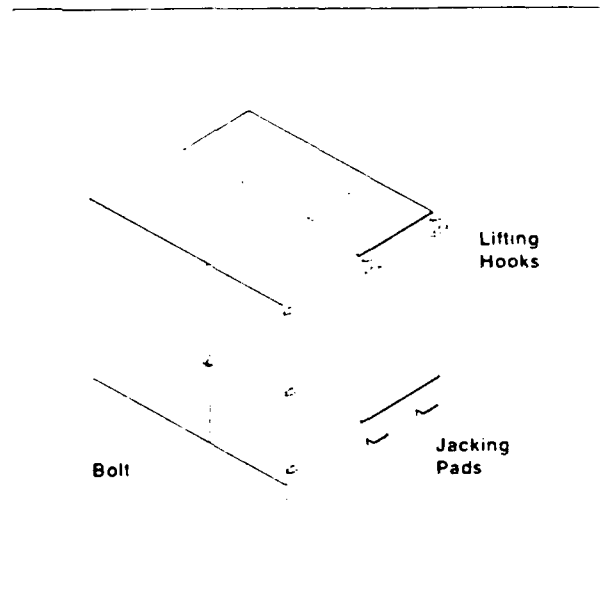

Fig. 1

This transformer has been furnished with a "penta-head" locking bolt that must be loosened to open the compartment. This bolt can be turned with a standard pentahead socket (wrench), as used widely in the utility industry. Sockets can be obtained from the Snap-On Company (tool #B2191), or equivalent.

4.0 EXTERNAL INSPECTION

WARNING: THE OIL MUST BE AT THE PROPER LEVEL BEFORE VOLTAGE IS APPLIED TO THE TRANSFORMER. FAILURE TO MAINTAIN THE PROPER OIL LEVEL CAN CAUSE SEVERE PERSONAL INJURY, DEATH OR SUBSTANTIAL PROPERTY DAMAGE.

The oil level should be checked by removing the oil level plug located at the 25 °C level. Any unit which does not have the proper oil level should be checked for leaks and refilled through the vent plug before placing in service. Use only quality oil per ASTM D3487 when adding oil to the transformer. The transformer was filled or processed at the factory with non-PCB dielectric fluid in accordance with Federal Polychlorinated Bi-phenyl (PCB) Regulations 40 CFR 761, et seq. The non-PCB fluid contained less than 1ppm at time of processing or filling. The owner should take the necessary precautions so that PCB contamination is not introduced during field filling or maintenance of the transformer (refer to Fig. 2).

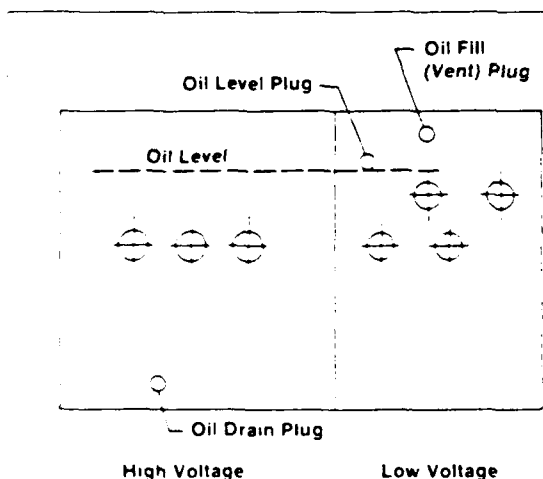

Fig. 2

5.0 INTERNAL TANK INSPECTION

WARNING: ALWAYS VENT THE TRANSFORMER BY FOLLOWING THE INSTRUCTIONS IN SECTION 7.3. FAILURE TO DO SO CAN CAUSE SEVERE PERSONAL INJURY, DEATH OR SUBSTANTIAL PROPERTY DAMAGE.

CAUTION: WHEN A TRANSFORMER IS OPENED, USE CARE TO PREVENT ENTRANCE OF MOISTURE OR FOREIGN OBJECTS. MOISTURE, DIRT OR FOREIGN OBJECTS CAN WEAKEN THE INSULATION OF A TRANSFORMER AND GREATLY SHORTEN ITS LIFE.

The transformer covered by this instruction is shipped ready for installation and does not require internal inspection. However, if the transformer must be opened, prevent the entrance of moisture or other foreign material.

6.0 STORAGE

The transformer should be stored completely assembled (tank sealed and cabinet closed) as though it were energized and at its permanent location. Transformers should not be stacked on top of one another, and care must be exercised to prevent submersion in water. The transformer should be stored on a solid level foundation.

In the event a transformer is to be held in storage for a period in excess of one (1) year, it is recommended the space above the oil be pressurized with dry air to two (2) to three (3) psig. This will prevent moisture ingress due to negative pressure.

The transformer will be ready for service at any time provided it has received the inspections outlined in Sections 4.0 and Section 7.0 thru 7.7.

7.0 INSTALLATION

Installation should comply with the latest edition of the National Electrical Code.

7.1 Mounting

WARNING: FAILURE TO PROPERLY MOUNT THE TRANSFORMER CAN CAUSE SEVERE INJURY, DEATH OR PROPERTY DAMAGE.

The transformers should be mounted on a flat level pad strong enough to support the weight of the transformer. The unit should not be tilted in any direction greater than 1.5 degrees, as a greater tilt will cause deviations in liquid level near fuses, pressure relief devices, or other accessories specifically located at or near the 25 degree C liquid level.

CAUTION: DEVIATIONS IN OIL LEVEL CAN INCREASE THE POSSIBILITY OF A DISRUPTIVE FAILURE.

When supplied, hold down cleats or brackets should be used to bolt the transformer securely to the pad (refer to Fig. 3).

The transformer cabinet should sit flush on the pad allowing no gaps which would compromise the tamper-resistance of the transformer.

7.2 Location

Since these transformers contain a flammable insulating fluid (mineral oil), transformer failure can cause fire and/or explosion. This possibility should be considered when locating these transformers in close proximity to buildings or public thoroughfares. Refer to the latest edition of the National Electrical Code.

7.3 Venting

Vent the transformer by manually operating the pressure relief device normally provided, or by removing the vent plug. The transformer should be vented before it is energized if it has been pressurized for leak test or if the unit has been opened and resealed.

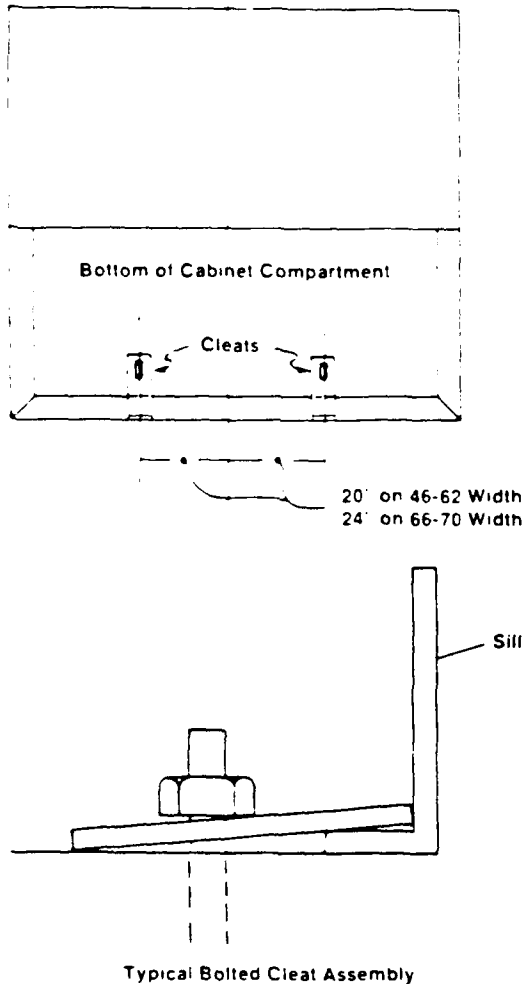

Fig. 3

7.4 Grounding

WARNING: THE TRANSFORMER MUST BE PROPERLY GROUNDED PRIOR TO ENERGIZING. FAILURE TO PROPERLY GROUND CAN CAUSE SEVERE INJURY OR DEATH.

A good, permanent, low impedance ground connection must be made to the tank by using the ground pads, provided near the bottom of the tank for this purpose.

Transformers which are designed for use on a grounded wye system, that is, one having a solidly grounded neutral, must have the tank and other available neutrals permanently and solidly grounded to the common neutral of the system before the transformer is energized.

7.5 Connections

During installation, the recommended sequence of connections is to first make all ground connections, then the low voltage connections, and finally the high voltage connections. The transformer should be removed from service by reversing the above sequence of connections. Carefully check the transformer nameplate for its rating and the connections that can be made to it. Avoid excessive strain on the

bushing terminals or insulators. This could loosen the contact joints or damage the insulators.

7.6 Liquid Level

WARNING: ENERGIZATION OR OPERATION OF THE TRANSFORMER WITH THE INSULATING LIQUID LOWER THAN 1/2 INCH BELOW THE 25°C LEVEL (1/2 INCH BELOW THE BOTTOM EDGE OF THE LIQUID LEVEL PLUG) CAN CAUSE SEVERE INJURY, DEATH OR PROPERTY DAMAGE.

Never operate or apply voltage to transformer if the liquid level is below the 25 degree C liquid level plug more than 1/2 inch. Check the liquid level before the transformer is energized to ensure the proper liquid level.

NOTE: Cold temperatures can cause the liquid level to drop, through contraction, by more than 1/2 inch. When this happens, the liquid should be heated to allow for expansion to the proper liquid level, or additional liquid is to be added to bring the liquid level up to within 1/2 inch of the liquid level plug. This liquid will then have to be removed when the unit has reached normal operating temperature. Follow the maintenance information in Section 10.0 when adding and removing any liquid.

7.7 Cabinet Security

WARNING: FAILURE TO PROPERLY SECURE THE CABINET MAY ALLOW ACCESS BY UNAUTHORIZED PERSONNEL WHICH CAN CAUSE SEVERE INJURY, DEATH, OR PROPERTY DAMAGE.

Before leaving the site of an energized transformer, make sure that any protective or insulating barriers are in place, the cabinet is completely closed, and all locking provisions are properly installed.

The following procedure should be used to assure cabinet security:

- A. Close the high voltage (left) door and secure it in place with the captive bolts supplied (pentahed or hexhead).
- B. Close the low voltage (right) door and secure it in place by rotating the handle in a clockwise direction until seated (handle should then be in a vertical orientation).
- C. Tighten the safety bolt (pentahed or hexhead) located in the locking tube until fully seated.
- D. Install a padlock through the door handle and locking tube and secure.
- E. Check both the high and low voltage doors for proper fit and security.

8.0 OPERATION

This transformer was built and tested in accordance with the latest version of the following standards of American National Standards Institute:

ANSI C57.12.00 — General Requirements for Liquid-Immersed Distribution, Power and Regulating Transformers

ANSI C57.12.90 — Test Code for Liquid-Immersed Distribution, Power and Regulating Transformers, and Guide for Short-Circuit Testing of Distribution and Power Transformers

The paper-oiled transformer is an integral part of the distribution system and its operation must be given the proper protection from system disturbances. Protection from excessive voltage transients and severe overcurrents must be provided. To allow proper operation of overcurrent protection, it must be supplied with the transformer coordinated with system overcurrent protection must be achieved.

9.0 ACCESSORIES AND COMPONENTS

9.1 Bushings

CAUTION REMOVE ALL DIRT AND FOREIGN MATERIAL FROM ALL BUSHINGS BEFORE PLACING TRANSFORMER IN SERVICE. READ AND FOLLOW THE MANUFACTURER'S INSTRUCTIONS FOR INSTALLING SEPARABLE-INSULATED HIGH VOLTAGE CONNECTORS. DO NOT ENERGIZE THE TRANSFORMER WITH THE SHIPPING CAPS ON THE BUSHINGS OR INSERTS. DO NOT OPERATE THE TRANSFORMER BEYOND THE MANUFACTURER'S RATING. FAILURE TO DO SO CAN CAUSE MINOR PERSONAL INJURY OR PROPERTY DAMAGE.

9.1.1 Separable Insulated Connectors

Separable insulated connectors may be universal bushing wells, integral bushings or bushing wells with inserts installed. They may be either loadbreak or non-loadbreak. All connectors must be dry and clear of any contamination before installation. Unused terminals should be properly terminated to prevent possible contamination. Follow the manufacturer's instructions and warnings on the use of these terminations.

9.1.2 Porcelain Bushings

High voltage porcelain bushings (when provided) are externally clamped, gasketed bushings with eyebolt-type terminals. The primary cables enter the compartment from below and attach to the bushing terminals. The eyebolt-type terminals will accommodate No. 6 through 250 kcmil cable.

9.2 Fuses

WARNING: OPERATION OF A FUSE MAY INDICATE A FAULTED TRANSFORMER. DO NOT REPLACE THE FUSE UNLESS THE CAUSE OF THE FUSE OPERATION IS POSITIVELY IDENTIFIED AND CORRECTED. IF THE CAUSE OF THE FUSE OPERATION CANNOT BE POSITIVELY IDENTIFIED AND CORRECTED, THE TRANSFORMER SHOULD BE REPLACED OR RE-ENERGIZED FROM A REMOTE LOCATION. FAILURE TO DO SO CAN CAUSE SEVERE INJURY, DEATH OR PROPERTY DAMAGE.

WARNING: FUSES SHOULD BE OPERATED WITHIN THEIR RATINGS AND REPLACED WITH FUSES HAVING EQUIVALENT VOLTAGE AND TIME-CURRENT CHARACTERISTICS. FAILURE TO DO SO CAN CAUSE SEVERE INJURY, DEATH OR PROPERTY DAMAGE.

9.2.1 Protective Link

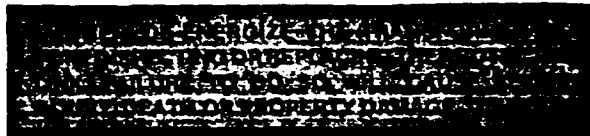

WARNING: VENT THE TRANSFORMER BEFORE DISTURBING THE TANK SEAL. FAILURE TO DO SO CAN CAUSE SEVERE INJURY, DEATH OR PROPERTY DAMAGE.

The protective link is an oil-immersed high voltage expulsion fuse designed to isolate the transformer from the distribution system in the event of a transformer fault inside the tank on the load side of the link. It is not designed to provide overload or secondary fault current protection for the transformer.

When inspecting or replacing protective links, always vent the transformer before disturbing the tank seal as outlined in section 7.3. Care should be taken to prevent the entrance of moisture or foreign material.

For further technical information, refer to ABB TPL 44-636.

9.2.2 Bayonet Oil Fuse

WARNING: VENT THE TRANSFORMER BEFORE OPERATING THE BAYONET FUSEHOLDER. FAILURE TO DO SO CAN CAUSE SEVERE INJURY, DEATH OR PROPERTY DAMAGE.

The bayonet oil fuse is a device which permits replacement of an under-oil expulsion fuse in the field and has loadbreak capability, allowing it to energize and de-energize a transformer.

To operate or replace the fuse, follow the instructions in Fig. 4.

For further technical information, refer to ABB TPL 44-635.

9.2.3 Loadbreak Drawout Fuseholder

This device combines the high interrupting capability of a primary purpose current-limiting fuse with a drawout fuseholder. The loadbreak drawout utilizes the rod and bolt principle to accomplish safe break and loadmake within the fuseholder.

To operate or replace the fuse, follow the instructions shown in Figs. 5 and 6.

For further technical information, refer to ABB TPL 44-637.

9.2.4 Deadbreak Drawout Fuseholder

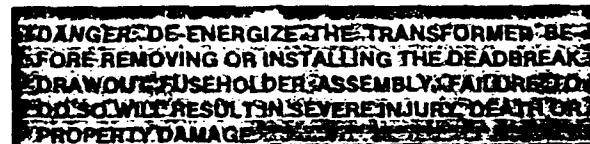

DANGER: DE-ENERGIZE THE TRANSFORMER BEFORE REMOVING OR INSTALLING THE DEADBREAK DRAWOUT FUSEHOLDER ASSEMBLY. FAILURE TO DO SO WILL RESULT IN SEVERE INJURY, DEATH OR PROPERTY DAMAGE.

To operate the bayonet Loadbreak Fuseholders, it is necessary to raise the Hinged Weathercover (Flip-top):

With both cabinet doors fully open (over 90 degrees), push upward on the front edge of the cover assembly. Tilt the hinged cover backward until the supporting arm, con-

nected to the high-low barrier, can be securely latched in place on the inside of the cover.

Proceed with the operating instructions for the Bayonet Loadbreak Fuseholder (below):

BAYONET LOADBREAK FUSEHOLDER

WARNING: OPERATE THE FUSEHOLDER PER THESE INSTRUCTIONS. FAILURE TO DO SO CAN RESULT IN SEVERE INJURY, DEATH OR PROPERTY DAMAGE.

OPERATING INSTRUCTIONS

①

WARNING: VENT THE TRANSFORMER BEFORE OPERATING THE BAYONET FUSE HOLDER. FAILURE TO DO SO CAN CAUSE SEVERE INJURY, DEATH OR PROPERTY DAMAGE.

VENT THE TRANSFORMER AS OUTLINED IN SECTION 7.3

②

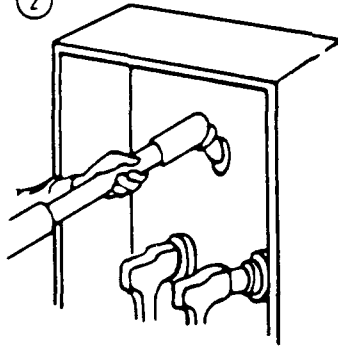

ATTACH HOT-LINE TOOL TO HANDLE EYE. STAND TO ONE SIDE AND UNLOCK THE HANDLE.

③

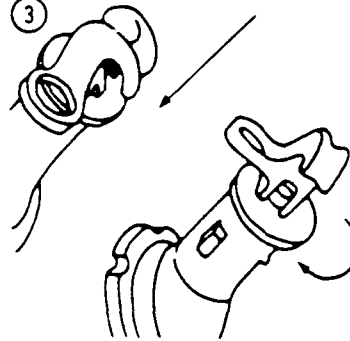

PUSH DOWN AND ROTATE THE HANDLE 90° CLOCKWISE IN THE HOUSING TO BREAK ANY ADHESION BETWEEN THE GASKET AND THE HOUSING.

④

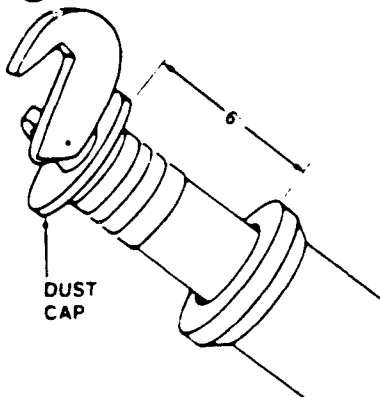

JERK THE FUSEHOLDER OUT APPROXIMATELY 6" TO OPEN THE CIRCUIT. WAIT A FEW SECONDS FOR OIL TO DRAIN BACK INTO THE TANK. THEN COMPLETELY WITHDRAW FUSEHOLDER.

⑤

TO REPLACE FUSE
INSTRUCTIONS FOR REPLACING FUSE ELEMENT ARE PACKED WITH EACH REPLACEMENT FUSE. FOLLOW THE FUSE MANUFACTURER'S INSTRUCTIONS.

⑥

TO REINSTALL FUSEHOLDER
ATTACH HOT-LINE TOOL TO HANDLE EYE. STAND TO ONE SIDE AND PLACE THE FUSEHOLDER END JUST INSIDE THE HOUSING.
RAPIDLY PUSH THE FUSEHOLDER IN UNTIL DUST CAP SEATS AGAINST HOUSING.
PUSH DOWN AND ROTATE THE LOCKING HANDLE, HOOKING IT OVER THE SHOULDER OF THE HOUSING.

When the bayonet operations are completed, release the latch on the Hinged Weathercover by tilting the cover slightly backwards. Lower the cover, making sure it is all the way

down. (The upper high-voltage door bolt should engage THROUGH the hole in the Hinged Weathercover.)

Fig. 4

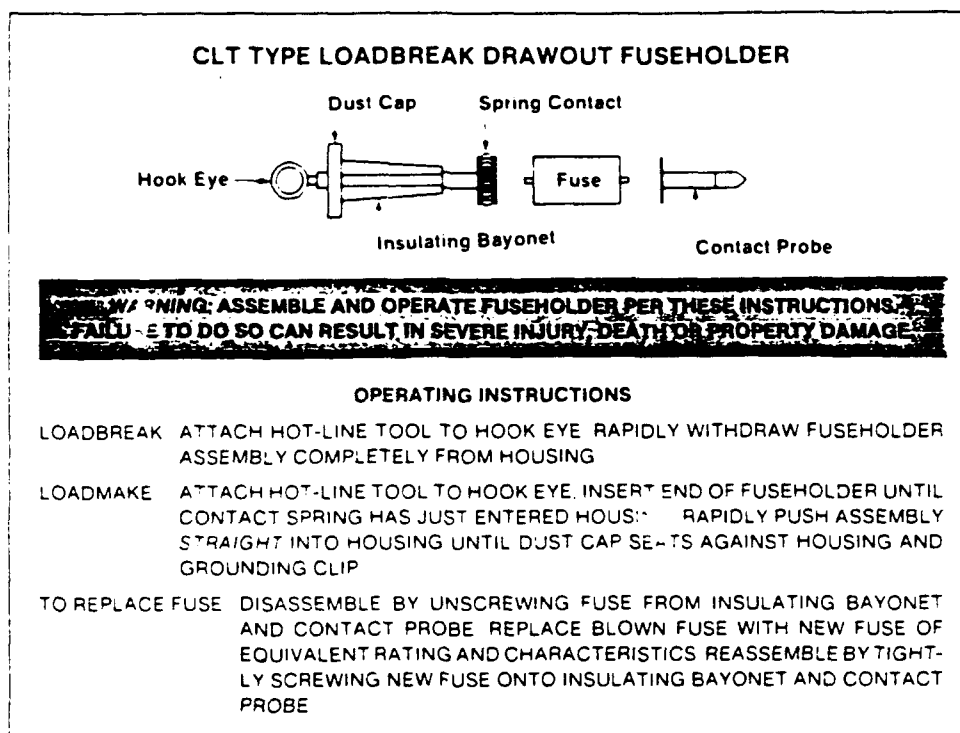

FIG. 5

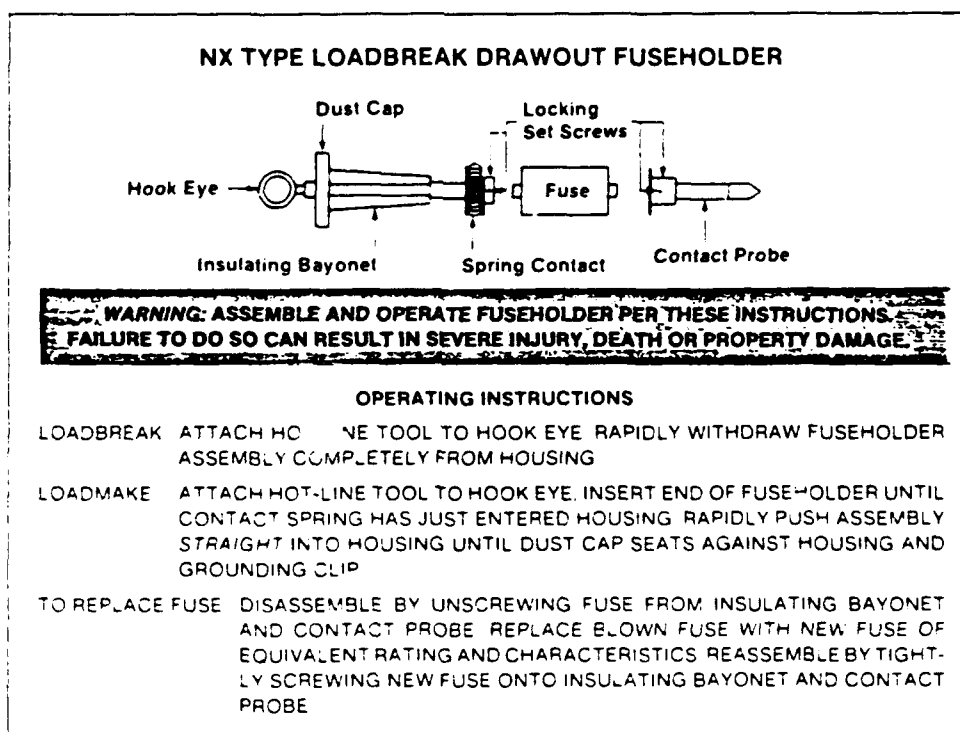
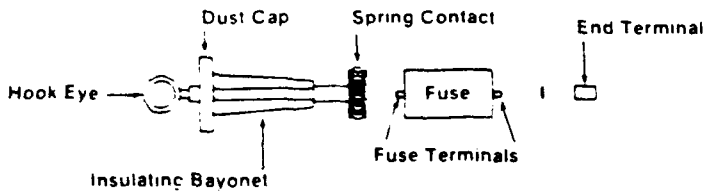

FIG. 6

CLT TYPE DEADBREAK DRAWOUT FUSEHOLDER

DE-ENERGIZED OPERATION ONLY



DANGER: DE-ENERGIZE THE TRANSFORMER BEFORE REMOVING OR INSTALLING THE DEADBREAK DRAWOUT FUSEHOLDER ASSEMBLY. FAILURE TO DO SO WILL RESULT IN SEVERE INJURY, DEATH OR PROPERTY DAMAGE.

WARNING: ASSEMBLE AND INSTALL FUSE AND FUSEHOLDER PER THESE INSTRUCTIONS. FAILURE TO DO SO CAN RESULT IN SEVERE INJURY, DEATH OR PROPERTY DAMAGE.

- TO REMOVE FUSE ATTACH HOT-LINE TOOL TO HOOK EYE AND WITHDRAW FUSE HOLDER STRAIGHT OUT FROM HOUSING
- TO REPLACE FUSE DISASSEMBLE BY UNSCREWING THE FUSE FROM THE INSULATING BAYONET. REPLACE THE BLOWN FUSE WITH A NEW FUSE OF EQUIVALENT RATING AND CHARACTERISTICS. REASSEMBLE BY TIGHTLY SCREWING FUSE ONTO THE INSULATING BAYONET.
- TO INSTALL FUSE ATTACH HOT-LINE TOOL TO HOOK EYE AND PLACE FUSEHOLDER INTO HOUSING. PUSH FUSEHOLDER IN FIRMLY UNTIL DUST CAP IS SEATED AGAINST HOUSING AND GROUND CLIP.

Fig. 7

NX TYPE DEADBREAK DRAWOUT FUSEHOLDER

DE-ENERGIZED OPERATION ONLY

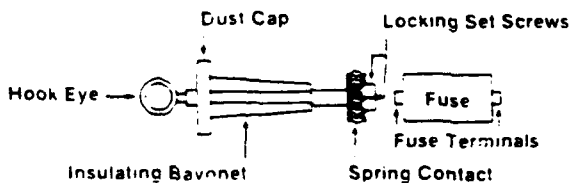

DANGER: DE-ENERGIZE THE TRANSFORMER BEFORE REMOVING OR INSTALLING THE DEADBREAK DRAWOUT FUSEHOLDER ASSEMBLY. FAILURE TO DO SO WILL RESULT IN SEVERE INJURY, DEATH OR PROPERTY DAMAGE.

WARNING: ASSEMBLE AND INSTALL FUSE AND FUSEHOLDER PER THESE INSTRUCTIONS. FAILURE TO DO SO CAN RESULT IN SEVERE INJURY, DEATH OR PROPERTY DAMAGE.

- TO REMOVE FUSE ATTACH HOT-LINE TOOL TO HOOK EYE AND WITHDRAW FUSE HOLDER STRAIGHT OUT FROM HOUSING
- TO REPLACE FUSE DISASSEMBLE BY UNSCREWING THE FUSE FROM THE INSULATING BAYONET. REPLACE THE BLOWN FUSE WITH A NEW FUSE OF EQUIVALENT RATING AND CHARACTERISTICS. REASSEMBLE BY TIGHTLY SCREWING FUSE ONTO THE INSULATING BAYONET.
- TO INSTALL FUSE ATTACH HOT-LINE TOOL TO HOOK EYE AND PLACE FUSEHOLDER INTO HOUSING. PUSH FUSEHOLDER IN FIRMLY UNTIL DUST CAP IS SEATED AGAINST HOUSING AND GROUND CLIP.

Fig. 8

EFD LOADBREAK DRAWOUT FUSEHOLDER

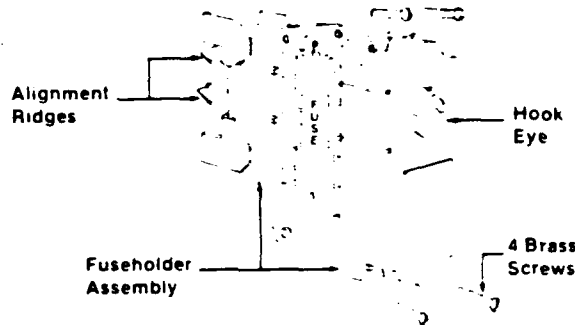

WARNING: ASSEMBLE AND OPERATE FUSEHOLDER PER THESE INSTRUCTIONS. FAILURE TO DO SO CAN RESULT IN SEVERE INJURY, DEATH OR PROPERTY DAMAGE.

OPERATING INSTRUCTIONS

- LOADBREAK ATTACH HOT-LINE TOOL TO HOOK EYE. RAPIDLY WITHDRAW FUSEHOLDER ASSEMBLY COMPLETELY FROM HOUSING.
- LOADMAKE ATTACH HOT-LINE TOOL TO HOOK EYE. CAREFULLY POSITION ALIGNMENT RIDGES IN THE CORRESPONDING GROOVES OF THE HOUSING. RAPIDLY PUSH THE ASSEMBLY INTO THE HOUSING UNTIL BASE OF HOOK EYE IS FLUSH WITH HOUSING.
- TO REPLACE FUSE ONLY REPLACE FUSE WITH FUSEHOLDER WITHDRAWN FROM HOUSING. DISASSEMBLE BY REMOVING THE 4 BRASS SCREWS AND SHROUD. REPLACE BLOWN FUSE WITH A NEW FUSE OF EQUAL RATING AND CHARACTERISTICS. REASSEMBLE WITH PARTS ORIENTED AS SHOWN. RETIGHTEN THE 4 BRASS SCREWS.

Fig. 9

This device combines the high interrupting capabilities of a general purpose current-limiting fuse with a dry-well fuseholder. The deadbreak drawout is normally mechanically interlocked with a loadbreak switch. Once the transformer is de-energized by operation of the loadbreak switch, the safety baffle may be slid to the side, permitting access to the fuseholder.

To replace the fuse, follow the instructions shown in Figs. 7 and 8.

For further technical information, refer to ABB TPL 44-837.

9.2.5 Internal Partial Range Current-Limiting Fuse

The internal partial range current-limiting fuse is used in series with a low current interrupting device, such as a protective link or bayonet. The partial range fuse is designed to clear low impedance (high-current) faults with the expulsion fuse clearing any high impedance faults or overloads. When properly applied, the partial range fuse will only operate for internal transformer faults. Upon operation of a partial range fuse, it is recommended the unit be removed from service and returned to the ABB Power T&D Company Inc. for repair.

9.3 High Voltage Switches

WARNING: WHEN DE-ENERGIZING THE TRANSFORMER, DO NOT RELY ON SWITCH POSITION OR OTHER VISUAL INDICATORS. ALWAYS ASSUME THAT TERMINALS ARE ENERGIZED UNLESS CHECKED AND GROUNDED. CONTACT WITH AN UNGROUNDED TERMINAL CAN CAUSE ELECTRICAL SHOCK, BURN OR DEATH.

9.3.1 EFD Switch

The EFD (Externally Fused Disconnect) is an air insulated loadbreak switch available for radial feed (single pole). A general purpose current limiting fuse or a solid blade is provided in the transformer connecting pole. The switch contacts are opened by drawing out the connecting pole so that they are completely free of the switch housing, leaving a visible disconnect.

To operate or replace the fuse, follow the instructions shown in Fig. 9.

9.3.2 LBOR Switch

The ABB LBOR is a gang-operated, two position rotary oil switch. The switch is operated by attaching a hot-line tool to the external hook eye handle and rotating to either the "open" or "closed" position (refer to Fig. 10). Circuit connections are shown on the transformer nameplate.

For further technical information, refer to ABB TPL 44-834.

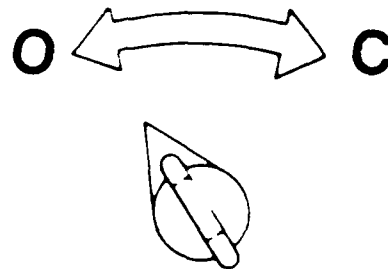

Fig. 10

9.3.3 Tap Changer (Hookstick-operable)

WARNING: DE-ENERGIZE THE TRANSFORMER BEFORE OPERATING THE TAP CHANGER. FAILURE TO DO SO CAN CAUSE SEVERE INJURY, DEATH OR PROPERTY DAMAGE.

The tap changer provides a means of changing the voltage ratio of a transformer. The transformers are normally supplied with an externally operated high voltage tap changer, located near the high voltage bushing. To change taps proceed as follows (refer to Fig. 11):

- A De-energize the transformer
- B Back out the locking screw until it is clear of the locking hole
- C Turn the handle to the desired tap position
- D Tighten the locking screw to minimize the possibility of unintentional movement

Some large-size units are furnished with a power-transformer tap changer drive which requires pulling of a locking pin and a full turn of the handle for each change in tap position

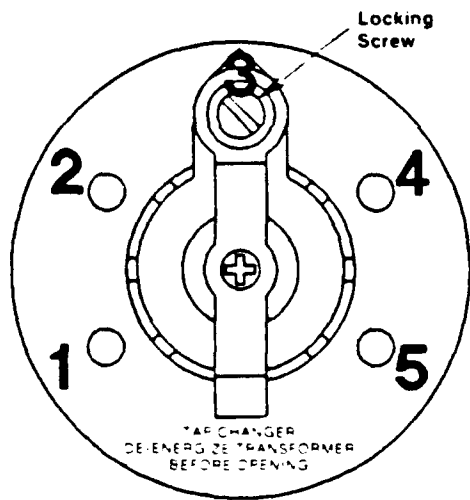

Fig. 11

9.3.4 Dual Voltage Switch (Hookstick-operable)

WARNING: DE-ENERGIZE THE TRANSFORMER BEFORE OPERATING THE DUAL-VOLTAGE SWITCH. FAILURE TO DO SO CAN CAUSE SEVERE INJURY, DEATH OR PROPERTY DAMAGE.

WARNING: WHEN CHANGING VOLTAGE POSITION, FUSES MAY HAVE TO BE REPLACED WITH THOSE OF THE PROPER RATINGS. THE USE OF AN IMPROPERLY RATED FUSE CAN CAUSE SEVERE INJURY, DEATH OR PROPERTY DAMAGE.

On a dual voltage switch Position 1 is the low or multiple connected position while position 2 is the high or series connected position. To change the voltage position, proceed as follows (refer to Figure 12):

- A De-energize the transformer
- B Back out the locking screw until it is clear of the locking hole
- C Pull out on the handle until it will rotate
- D Rotate the handle to the new position
- E Release the handle
- F Tighten the locking screw to minimize the possibility of unintentional movement

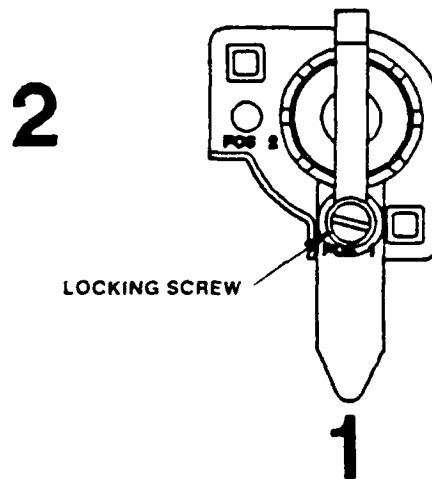

Fig. 12

9.3.5 Arc-Strangler Fused Switch

Arc-Strangler fused switch is mounted in the high voltage compartment. The fused disconnect(s) will have NX current-limiting fuses. Follow the McGraw Edison (Cooper Industries) instructions for operating these devices.

9.3.6 S & C Fused Switch

WARNING: USE THE S & C LOADBUSTER TOOL TO OPERATE THE DISCONNECT. FAILURE TO DO SO CAN CAUSE SEVERE INJURY, DEATH OR PROPERTY DAMAGE.

When an S & C fused switch is used, follow the manufacturer's instructions for operating this equipment. When operated with the S & C loadbuster tool, this disconnect functions as a loadbreak switch.

9.3.7 Surge Arresters

The function of a surge arrester is to intercept and divert to ground various overvoltage transients (such as lightning surges) which occur on the distribution system.

The arresters must be disconnected whenever high potential or induced potential tests are made on transformers with arresters.

For further technical information, refer to ABB PL 44-921

9.4 Low Voltage Oil-Immersed Circuit Breaker

The low voltage oil-immersed circuit breaker is designed to open the low voltage circuit on secondary faults or excessive overloads. The low voltage breaker is not intended to protect secondary (low voltage) circuits and connected apparatus (meters, service entrance equipment, etc.) from thermal and magnetic effects due to short circuit and overloads. The breaker is primarily a protective device designed for only occasional switching operations, as such it is not intended for frequent (weekly or daily) switching duty. The handle is located in the low voltage compartment and should be operated with a hot-line tool.

CAUTION: WITH THE SECONDARY CIRCUIT OPEN, THERE MAY BE SUFFICIENT COUPLING TO THE WINDING TO CAUSE SHOCK FROM THE SECONDARY TERMINALS. GROUND THE OPEN SECONDARY TERMINALS BEFORE WORKING ON THE SECONDARY SERVICE.

Prior to transformer installation, reset the breaker by opening and closing it as follows (refer to Fig. 13):

- To open the breaker manually, rotate the handle so that the pointer moves from the closed to the open position.
- To close the breaker, rotate the handle past the open position (to reset the breaker), then back through the open position to the closed position.

If a fault or excessive overload exists, the breaker will trip out even though the handle is held in the closed position.

Following a breaker tripout due to a long term overload, the transformer oil may not have had time to cool sufficiently to allow the breaker latch to be set, making it impossible to reclose the breaker immediately.

CAUTION: AN EMERGENCY CONTROL HANDLE IS PROVIDED TO RECALIBRATE THE BREAKER TO A HIGHER TRIP TEMPERATURE. THIS HANDLE SHOULD BE USED ONLY WHEN ABSOLUTELY NECESSARY AND FOR AS SHORT A DURATION AS POSSIBLE, BECAUSE ITS USE CAN CAUSE A SIGNIFICANT REDUCTION IN TRANSFORMER LIFE.

The breaker can be recalibrated to the emergency position by removing the meter seal and rotating the emergency control handle clockwise. To reset the breaker to its previous setting, return the emergency control handle to the original position. It is recommended that a new seal be applied to the handle when it is returned to the normal position to avoid inadvertent operation of the emergency control.

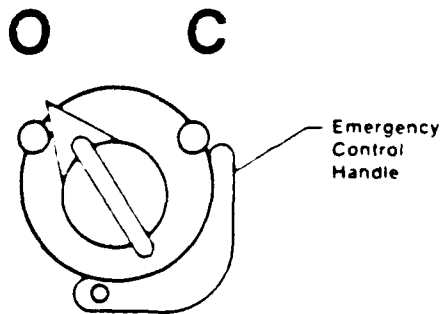

Fig. 13

9.5 Pressure Relief Device

The standard pressure relief device, located on the tank above the liquid level, relieves excessive internal tank pressure and reseals at a lower positive pressure. The pressure relief device is manually operated by grasping the end-cap (or ring, if provided), and slowly pulling the cap away from the tank until pressure is relieved.

9.6 Thermometer

When supplied, a thermometer indicates the liquid temperature near the top of the tank. The temperature sensitive element is mounted in a leakproof well, permitting removal of the thermometer without lowering the liquid level. The device is furnished with an additional pointer, red in color, to show the highest temperature attained since last reset.

9.7 Liquid Level Gauge

When supplied, a liquid level gauge is located in the low voltage compartment to indicate the variation from the 25 degree C liquid level.

9.8 Pressure-Vacuum Gauge

When supplied, a pressure gauge is located in the low voltage compartment above the bushings in the air space. The gauge indicates whether the gas space in the tank is under positive or negative pressure.

9.9 Nameplate

A nameplate is supplied on each transformer according to ANSI standard C57.12.00-1963, Section 5.12. Refer to the nameplate for transformer ratings and for proper connections of the transformer to the system. No internal connections should be made inside the transformer other than those shown on the nameplate.

10.0 MAINTENANCE

A periodic visual inspection of the transformer is recommended. At such times, the general condition of the following should be noted:

- A. High voltage bushings
- B. Low voltage bushings
- C. Arresters (if provided)
- D. Enclosure integrity (hinges, locking provisions, corrosion, etc.)
- E. Evidence of oil leakage
- F. Ground connections
- G. Accessories
- H. Safety labels
- I. Transformer tilt

WARNING: WHEN BROKEN PARTS, LEAKING OIL OR OTHER POTENTIALLY HAZARDOUS CONDITIONS ARE OBSERVED, REMOVE THE TRANSFORMER FROM SERVICE UNTIL REPAIRS CAN BE COMPLETED. FAILURE TO DO SO CAN CAUSE SEVERE INJURY, DEATH OR PROPERTY DAMAGE.

Where tanks show evidence of rusting or deterioration of the finish, they may be cleaned and then retouched with paint available for that purpose. When bare metal is exposed, a primer should initially be applied, then retouching paint applied.

A periodic check of the load should be made to ensure that the transformer is not being subjected to excessive overload. Planned overloading should be in accordance with the ANSI Loading Guide (C57.9).

When adding oil to the transformer, the owner should take the necessary precautions so that PCB contamination is not introduced.

WARNING: OIL SAMPLES SHOULD BE TAKEN FROM THE TRANSFORMER ONLY AFTER DE-ENERGIZING AND MANUALLY VENTING THE TRANSFORMER. FAILURE TO DO SO CAN CAUSE SEVERE INJURY, DEATH OR PROPERTY DAMAGE.

Whenever replacement parts or information regarding existing transformers are required, COMPLETE NAME-PLATE data including KVA rating, STYLE NUMBER, SERIAL NUMBER, and a DESCRIPTION of the part should be given to ABB.

11.0 REPAIR

WARNING: BEFORE ATTEMPTING REPAIRS, DE-ENERGIZE AND VENT THE TRANSFORMER. FAILURE TO DO SO CAN CAUSE SEVERE INJURY, DEATH, OR PROPERTY DAMAGE.

It is the responsibility of the owner to inspect, maintain and keep the transformer in good repair.

Report all failures during the warranty period to your ABB Sales Office. All warranty repairs must be made by ABB or an approved service facility.

To assure proper operation, use only ABB approved replacement parts.

It is recommended that the owner limit repairs to replacing broken parts unless the owner has well-trained repair personnel.

Some internal parts can be replaced without completely draining the tank. In such cases, only the fluid necessary to expose the part should be drained. There may also be occasions when complete draining of the transformer tank will be necessary.

The core and coil assembly can be repaired or replaced by ABB personnel at either the factory or at an authorized repair facility. Refer to Service Policy 46-315 for details or contact the ABB Power T&D Company Inc.

DISCLAIMER OF WARRANTIES AND LIMITATION OF LIABILITY

THERE ARE NO UNDERSTANDINGS, AGREEMENTS, REPRESENTATIONS OR WARRANTIES, EXPRESS OR IMPLIED, INCLUDING WARRANTIES OF MERCHANTABILITY OR FITNESS FOR A PARTICULAR PURPOSE, OTHER THAN THOSE SPECIFICALLY SET OUT BY ANY EXISTING CONTRACT BETWEEN THE PARTIES. ANY SUCH CONTRACT STATES THE ENTIRE OBLIGATION OF SELLER. THE CONTENTS OF THIS DOCUMENT SHALL NOT BECOME PART OF OR MODIFY ANY PRIOR OR EXISTING AGREEMENT, COMMITMENT OR RELATIONSHIP.

The information, recommendations, descriptions and safety notations in this document are based on ABB's experience and judgment with respect to transformers. THIS INFORMATION SHOULD NOT BE CONSIDERED TO BE ALL INCLUSIVE OR COVERING ALL CONTINGENCIES.

NO WARRANTIES, EXPRESS OR IMPLIED, INCLUDING WARRANTIES OF FITNESS FOR A PARTICULAR PURPOSE OR MERCHANTABILITY, OR WARRANTIES ARISING FROM COURSE OF DEALING OR USAGE OF TRADE, ARE MADE REGARDING THE INFORMATION, RECOMMENDATIONS, DESCRIPTIONS AND SAFETY NOTATIONS CONTAINED HEREIN. In no event will ABB be responsible to the user in contract, in tort (including negligence), strict liability or otherwise for any special, indirect, incidental or consequential damage or loss whatsoever including but not limited to damage to or loss of use of equipment, plant or power system, cost of capital, loss of profits or revenues, cost of replacement power, additional expenses in the use of existing power facilities, or claims against the user by its customers resulting from the use of the information, recommendations, descriptions and safety notations contained herein.

DISTRIBUTION LIST

1SG/CEEE / LT MARSH, LANGLEY AFB, VA
92 CES / DEEE, FAIRCHILD AFB, WA
A. TEICHERT & SON, INC / B.T. JOHNSON, SACRAMENTO, CA
ACEC RESEARCH / A.J. WILLMAN, WASHINGTON, DC
ADMINSUPU / PWO, BAHRAIN, FPO AE
AF / AFSC/DEEE, WASHINGTON, DC
AF / MO ANG, 231 CEF/DE (SCHMEDAKE), BRIDGETON, MO
AFB / 82ND ABG/DEMCA, WILLIAMS AFB, AZ
AFIT / DET, WRIGHT PATTERSON AFB, OH
AFIT / DEV, WRIGHT-PATTERSON AFB, OH
AMERICAN SYS ENGRG CORP / M. VIOLANTE, VIRGINIA BEACH, VA
ANTARCTIC / STAFFO, ALEXANDRIA, VA
ARMSTRONG, W. / MYSTIC, CT
ARMY / ENGR CEN, ATSE-DAC-LC, FORT LEONARD WOOD, MO
AR / KWAJALEIN ATOLL, CSSD-IA-LT, APO AP
AR / POJED-O, APO AP
ARMY / QMSCH, ASTM-CDM (JANCZEWSKI), FORT LEE, VA
ARMY CECOM R&D TECH LIBRARY / ASNC-ELC-1-T, FORT MONMOUTH, NJ
ARMY CERL / LIB, CHAMPAIGN, IL
ARMY CRREL / ISKANDAR, HANOVER, NH
ARMY DEPOT / LETTERKENNY, SDSLE-EN, CHAMBERSBURG, PA
ARMY DEPOT / SDSNC-T-MOD-E, NEW CUMBERLAND, PA
ARMY EHA / HSE-RP-HG, ABERDEEN PROVING GROUND, MD
ARMY EHA / HSHB-EA-S, ABERDEEN PROVING GROUND, MD
ARMY EHA / W630, ABERDEEN PROVING GROUND, MD
ARMY ENGRG DIST / SAMEN-DS/DAVIS, MOBILE, AL
ARMY ENGRG DIV / ED-SY (LOYD), HUNTSVILLE, AL
ARMY EWES / LIB, VICKSBURG, MS
ASSOCIATED SCIENTISTS / MCCOY, WOODS HOLE, MA
AU REG HOSP/SGPB / GARG, MAXWELL AFB, AL
BATTELLE NEW ENGLAND MARINE RSCH LAB / LIB, DUXBURY, MA
BECHTEL CIVIL, INC / K. MARK, SAN FRANCISCO, CA
BELV R&DC / COLONEL NEWMAN, FT BELVOIR, VA
BRIT. EMBASSY / SCI & TECH DEPT (WILKINS), WASHINGTON, DC
BUREAU OF RECLAMATION / D-1512 (GS DEPUY), DENVER, CO
CALIFORNIA / FISH & GAME DEPT, LONG BEACH, CA
CALIFORNIA / NAV & OCEAN DEV (ARMSTRONG), SACRAMENTO, CA
CBC / CODE 430, GULFPORT, MS
CBC / CODE 84, PORT HUENEME, CA
CBC / PWO (CODE 400), GULFPORT, MS
CECOS / CODE C35, PORT HUENEME, CA
CHEE, WINSTON / GRETNA, LA
CHEM RP / DEARBORN CHEM DIV LIB, LAKE ZURICH, IL
CITY OF EAST LANSING / N. KING, EAST LANSING, MI
COGUARD / SUPERINTENDENT, NEW LONDON, CT
COLLEGE OF ENGINEERING / CE DEPT (AKINMUSURU), SOUTHFIELD, MI
COM GEN FMF / PAC, SCIAD (G5), CAMP M SMITH, HI
COMDT COGUARD / G-ECV, WASHINGTON, DC
COMNAVLOGPAC / CODE 4318, PEARL HARBOR, HI
COMSUBPAC / CODE 541, SCE, PEARL HARBOR, HI

CONSOER TOWNSEND & ASSOC / DEBIAK, CHICAGO, IL
CONSTRUCTION TECH LABS, INC / G. CORLEY, SKOKIE, IL
DAMES & MOORE / LIB, LOS ANGELES, CA
DEFENSE DEPOT / STRAND, OGDEN, UT
DELAWARE / PUBLIC SAFETY DEPT, DELAWARE CITY, DE
DFSC / F, ALEXANDRIA, VA
DTRCEN / CODE 284, ANNAPOLIS, MD
DTRCEN / CODE 4111, BETHESDA, MD
DTRCEN / CODE 42, BETHESDA, MD
ESSM / WHSE 12 (BOWMAN), WILLIAMSBURG, VA
FACILITIES DEPT / FACILITIES OFFICER, FPO AP
FCTC / LANT, CODE 182, VIRGINIA BEACH, VA
FLORIDA INST OF TECH / CE DEPT (KALAJIAN), MELBOURNE, FL
GARD INC / L B HOLMES, NILES, IL
GEI CONSULTANTS, INC. / T.C. DUNN, WINCHESTER, MA
GEOTECHNICAL ENGRS, INC / MURDOCK, WINCHESTER, MA
GLIDDEN CO / RSCH LIB, STRONGSVILLE, OH
GOLDER ASSOC / BRUMUND, ATLANTA, GA
HARBOR BRANCH OCEANOGRAPHIS INSTITUTION / WANG, FORT PIERCE, FL
HARTER, J.V. / METAIRIE, LA
KAISER PERMANENTE MEDICIAL CARE PROGRAM / OAKLAND, CA
KATSURA CONSULTING ENGRS / Y. KATSURA, VENTURA, CA
KLIJGER, PAUL / CE, NORTHBROOK, IL
LEHIGH UNIV / CE DEPT, HYDRAULICS LAB, BETHLEHAM, PA
MARCORBASE / BASE MAINT DEPT, CAMP LEJEUNE, NC
MARCORBASE / CODE 405, CAMP LEJEUNE, NC
MARCORBASE / CODE 406, CAMP LEJEUNE, NC
MARCORBASE / FACILITIES COORDINATOR, CAMP PENDLETON, CA
MARITECH ENGRG / DONOGHUE, AUSTIN, TX
MARITIME ADMIN / MMA, LIB, KINGS POINT, NY
MATRECON, INC / H. HAXO, ALAMEDA, CA
MC CLELLAND ENGRS, INC / LIB, HOUSTON, TX
MCAF / CODE C144, QUANTICO, VA
MCLB / CODE 506, ALBANY, GA
MCLB / CODE 555, ALBANY, GA
MCRDAC / M & L DIV, QUANTICO, VA
MIT / R.V. WHITMAN, CAMBRIDGE, MA
NAF / PWO, FPO AP
NAF / SO, EL CENTRO, CA
NALF / OIC, SAN DIEGO, CA
NAS / CODE 110, FPO AP
NAS / CODE 163, KEFLAVIK, ICELAND, FPO AP
NAS / CODE 421, SAN DIEGO, CA
NAS / CODE 504, SAN DIEGO, CA
NAS / CODE 6201 (CORRIGAN), POINT MUGU, CA
NAS / CODE 721, NEW ORLEANS, LA
NAS / CODE 83, PATUXENT RIVER, MD
NAS / KOBAYASHI, CODE 703, LONG BEACH, CA
NAS / MIRAMAR, SAN DIEGO, CA
NAS / MIRAMAR, PWO, SAN DIEGO, CA
NAS / P&E SUPR, FPO AP
NAS / PW ENGRG, PATUXENT RIVER, MD
NAS / PWD MAINT DIV, NEW ORLEANS, LA

NAS / PWO, MOFFETT FIELD, CA
NAS / PWO, MERIDIAN, MS
NAS / SCE, FPO AP
NAS / SCE, NORFOLK, VA
NAS / TREASURE ISLAND, CODE 84, SAN FRANCISCO, CA
NAS / WHITING FLD, PWO, MILTON, FL
NAS / WPNS OFFR, ALAMEDA, CA
NAS MEMPHIS / CODE N-81, MILLINGTON, TN
NAS NPWC / CODE 102 (J. ARESTO), SAN DIEGO, CA
NAS PENSACOLA / FAC MGMT OFFICER, PENSACOLA, FL
NATL ACADEMY OF ENGRY / ALEXANDRIA, VA
NAVAIRDEVCEN / CODE 832, WARMINSTER, PA
NAVAIRPROPCEN / CODE PW-3, TRENTON, NJ
NAVAL ED & TRAIN CEN / UTIL DIR, NEWPORT, RI
NAVAUDSVCHQ / DIR, FALLS CHURCH, VA
NAVAVIDEPOT / CODE 904, NORFOLK, VA
NAVAVIONICEN / PWO, INDIANAPOLIS, IN
NAVAVNDEPOT / CODE 011, NORFOLK, VA
NAVAVNDEPOT / CODE 61000, CHERRY POINT, NC
NAVCAMS / WESTPAC, SCE, FPO AP
NAVCOASTSYSCEN / CODE 423, PANAMA CITY, FL
NAVCOMMSTA / PWO, THURSO, UK, FPO AE
NAVCONSTRACEN / CODE D2A, PORT HUENEME, CA
NAVDIVESALVTRACEN / CO, PANAMA CITY, FL
NAVENVIRHLTHCEN / CODE 42, NORFOLK, VA
NAVFAC / N62, ARGENTINA, NF, FPO AE
NAVFAC CENTERVILLE BEACH / FERNDALE, CA
NAVFACENGCOM / CODE 04A3, ALEXANDRIA, VA
NAVFACENGCOM / CODE 04A4E, ALEXANDRIA, VA
NAVFACENGCOM / CODE 051A, ALEXANDRIA, VA
NAVFACENGCOM / CODE 083, ALEXANDRIA, VA
NAVFACENGCOM / CODE 183 (GERHART), ALEXANDRIA, VA
NAVFACENGCOM CHESDIV / CODE 04, WASHINGTON, DC
NAVFACENGCOM CHESDIV / CODE 114.1, WASHINGTON, DC
NAVFACENGCOM CHESDIV / YACHNIS, WASHINGTON, DC
NAVFACENGCOM CONTRACTS / ROICC, POINT MUGU, CA
NAVFACENGCOM CONTRACTS / ROICC, SANTA ANA, CA
NAVFACENGCOM LANTDIV / CODE 405, NORFOLK, VA
NAVFACENGCOM NORTHDIV / CO, PHILADELPHIA, PA
NAVFACENGCOM NORTHDIV / CODE 202.2, PHILADELPHIA, PA
NAVFACENGCOM SOUTHDIV / CODE 04A, CHARLESTON, SC
NAVFACENGCOM SOUTHWESTDIV / CODE 101.1, SAN DIEGO, CA
NAVFACENGCOM SOUTHWESTDIV / CODE 1812, SAN DIEGO, CA
NAVFACENGCOM WESTDIV / CODE 102, SAN BRUNO, CA
NAVFACENGCOM WESTDIV / CODE 1833, SAN BRUNO, CA
NAVFACENGCOM WESTDIV / PAC NW BR OFFC, CODE C/42, SILVERDALE, WA
NAVFACENGCOM WESTDIV / ROICC, SILVERDALE, WA
NAVFACENGCOM WESTDIV / VALDEMORO, SAN BRUNO, CA
NAVFUEL DET / OIC, FPO AP
NAVMAG / CODE 09, LUAIUALEI, HI
NAVMAG / SCE, FPO AP
NAVMEDCLINIC / HEAD, INDUST HYGIENE DIV, PEARL HARBOR, HI
NAVMEDCOM / NWREG, FAC ENGR, PWD, OAKLAND, CA

NAVMEDRSCHINSTITUTE / CODE 47, BETHESDA, MD
NAVOCEANO / LIB, NSTL, MS
NAVORDMISTESTSTA / CODE 40, WHITE SANDS MISSILE RANGE, NM
NAVORDSTA / INDIAN HEAD DET, MCALESTER, OK
NAVORDSTA / PWO, LOUISVILLE, KY
NAVPEOFF / SEC OFFR (CODE 20), ALEXANDRIA, VA
NAVPGSCOL / E. THORNTON, MONTEREY, CA
NAVPMC / TAYLOR, PENSACOLA, FL
NAVSCSCOL / PWO, ATHENS, GA
NAVSEACENPAC / CODE 420, SAN DIEGO, CA
NAVSEASYSOM / CODE 51412, WASHINGTON, DC
NAVSECGRU / CODE G43, WASHINGTON, DC
NAVSECGRUACT / CODE 31 PWO, FPO AA
NAVSECGRUACT / PWO (CODE 40), EDZELL, SCOTLAND, FPO AE
NAVSECGRUACT / PWO, CHESAPEAKE, VA
NAVSECSTA / CODE 60, WASHINGTON, DC
NAVSECSTA / CODE N70, WASHINGTON, DC
NAVSHIPPREPAC / SCE, FPO AP
NAVSHIPYARD / CODE 383.4, PORTSMOUTH, VA
NAVSHIPYD / CODE 106.4 STARYNSKI, PHILADELPHIA, PA
NAVSHIPYD / CODE 202.5 LIB, BREMERTON, WA
NAVSHIPYD / CODE 308.3, PEARL HARBOR, HI
NAVSHIPYD / CODE 450, BREMERTON, WA
NAVSHIPYD / MARE IS, CODE 440, VALLEJO, CA
NAVSHIPYD / SCE (CODE 308.2), PEARL HARBOR, HI
NAVSHIPYD / TECH LIB, PORTSMOUTH, NH
NAVSTA / CBU-422, WASHINGTON, DC
NAVSTA / CODE ODA2, SAN DIEGO, CA
NAVSTA / DIR, ENGR DIV, PWD, GUANTANAMO BAY, CUBA, FPO AE
NAVSTA / ENVIR, STATEN ISLAND, NY
NAVSTA / PWO, ROTA, SPAIN, FPO AE
NAVSTA / TREASURE IS, SO, SAN FRANCISCO, CA
NAVSTA / UTIL ENGRG OFFR, ROTA, SPAIN, FPO AE
NAVSTA PUGET SOUND / CODE 922, EVERETT, WA
NAVSUPCEN / CODE 700A.1, NORFOLK, VA
NAVSUPPACT / PWO, NAPLES, ITALY, FPO AE
NAVSUPPO / SEC OFFR, LA MAD LENA, ITALY, FPO AE
NAVSWC / CODE C83, DAHLGREN, VA
NAVSWC / CODE W42 (GS HAGA), DAHLGREN, VA
NAVSWC / DET, WHITE OAK LAB, CODE W50, SILVER SPRING, MD
NAVSWC / DET, WHITE OAK LAB, PWO, SILVER SPRING, MD
NAVSWC / PWO, DAHLGREN, VA
NAVTECHTRACEN / UPSON, PENSACOLA, FL
NAVTRASTA / PWO, ORLANDO, FL
NAVWPNCEN / CODE 2405, CHINA LAKE, CA
NAVWPNCEN / CODE 2637, CHINA LAKE, CA
NAVWPNSTA / CODE 092, CONCORD, CA
NAVWPNSTA / CODE 092, SEAL BEACH, CA
NAVWPNSTA / PWO, YORKTOWN, VA
NAVWPNSTA EARLE / CODE 092, COLTS NECK, NJ
NCR / 20, CODE R70, GULFPORT, MS
NEESA / CODE 113M, PORT HUENEME, CA
NIEDORODA, AW / GAINESVILLE, FL

NIST / BLDG TECH, MCKNIGHT, GAITHERSBURG, MD
NOAA / DIR, PAC MARINE CEN, SEATTLE, WA
NORDA / CODE 352, NSTL, MS
NORTHDIV CONTRACTS OFFICE / ROICC, PORTSMOUTH, NH
NOSC / CODE 94, SAN DIEGO, CA
NRL / CODE 2530.1, WASHINGTON, DC
NRL / CODE 6123, WASHINGTON, DC
NSC / CODE 02, PEARL HARBOR, HI
NSC / CODE 43, OAKLAND, CA
NSC / CODE 70, OAKLAND, CA
NUSC DET / CODE 0261, NEW LONDON, CT
NUSC DET / CODE 52, NEW LONDON, CT
NUSC DET / CODE 5202 (SCHADY), NEW LONDON, CT
OAS / MCCONAHY, ARLINGTON, VA
PACIFIC MARINE TECH / M. WAGNER, DUVALI, WA
PAULI, DC / SILVER SPRING, MD
PILE BUCK, INC / SMOOT, JUPITER, FL
PODELL, H.I. / NEW ROCHELLE, NY
PWC / CODE 101, GREAT LAKES, IL
PWC / CODE 1013, OAKLAND, CA
PWC / CODE 110, OAKLAND, CA
PWC / CODE 420, OAKLAND, CA
PWC / CODE 421 (KIMURA), PEARL HARBOR, HI
PWC / CODE 500, SAN DIEGO, CA
PWD / ENGR DIRECTOR, CORPUS CHRISTI, TX
SARGENT & HERKES, INC / JP PIERCE, JR, NEW ORLEANS, LA
SEATTLE PORT / DAVE VAN VLEET, SEATTLE, WA
SHANNON & WILSON, INC / LIB, SEATTLE, WA
SPCC / CODE 082, MECHANICSBURG, PA
STATE UNIV OF NEW YORK / CE DEPT, BUFFALO, NY
SUBASE / SCE, PEARL HARBOR, HI
SURFACE COMBUSTION / V.R. DAIGAN, MAUMEE, OH
TEXAS A&M UNIV / CE DEPT (HERBICH), COLLEGE STATION, TX
TEXAS A&M UNIV / CE DEPT (SNOW), COLLEGE STATION, TX
TEXAS A&M UNIV / ENERGY TRNG DIV (DONALDSON), HOUSTON, TX
TEXAS A&M UNIV / OCEAN ENGR PROJ, COLLEGE STATION, TX
THE KLING-LINDQUIST, INC / RADWAN, PHILADELPHIA, PA
TRIDENT TRAINING FAC / ANDERSON, KINGS BAY, GA
UNITED TECHNOLOGIES / LIB, WINDSOR LOCKS, CT
UNIV OF NEW MEXICO / NMERI (FALK), ALBUQUERQUE, NM
UNIV OF PENNSYLVANIA / INST ENVIRON MEDICINE, PHILADELPHIA, PA
UNIV OF RHODE ISLAND / DR. VEYERA, KINGSTON, RI
UNIV OF WASHINGTON / ENGRG COL (CARLSON), SEATTLE, WA
US DEPT OF HHS / FDA (FISHERY RSCH BR), DAUPHIN ISLAND, AL
US DEPT OF INTERIOR / BLM, ENGRG DIV (330), WASHINGTON, DC
US GEOLOGICAL SURVEY / J BALES, RALEIGH, NC
US GEOLOGICAL SURVEY / MARINE GEOLOGICAL OFFC, RESTON, VA
USACOE / CESP-CD-EQ, SAN FRANCISCO, CA
USDA / FOR SVC, EQUIP DEV CEN, SAN DIMAS, CA
USN / CAPT COLIN M JONES, HONOLULU, HI
USNA / SYS ENGRG, ANNAPOLIS, MD
VEDA / SUTTON, OAKLAND, CA
VENTURA COUNTY / PWA (BROWNIE), VENTURA, CA

VIATEUR DE CHAMPLAIN / INST OF MARITIME ENGRG, MATANE, QUEBEC
VSE / OCEAN ENGRG GROUP (MURTON), ALEXANDRIA, VA
WASTE-TECH SVCS / ENVIRON DIR (COOPER), GOLDEN, CO
WESTERN ARCHEOLOGICAL CEN / LIB, TUCSON, AZ
WESTINGHOUSE ELECTRIC CORP / LJB, PITTSBURG, PA
WOODWARD-CLYDE CONSULTANTS / R. CROSS, OAKLAND, CA

DISTRIBUTION QUESTIONNAIRE

The Naval Civil Engineering Laboratory is revising its primary distribution lists.

SUBJECT CATEGORIES

1 SHORE FACILITIES

- 1A Construction methods and materials (including corrosion control, coatings)
- 1B Waterfront structures (maintenance/deterioration control)
- 1C Utilities (including power conditioning)
- 1D Explosives safety
- 1E Aviation Engineering Test Facilities
- 1F Fire prevention and control
- 1G Antenna technology
- 1H Structural analysis and design (including numerical and computer techniques)
- 1J Protective construction (including hardened shelters, shock and vibration studies)
- 1K Soil/rock mechanics
- 1L Airfields and pavements
- 1M Physical security

2 ADVANCED BASE AND AMPHIBIOUS FACILITIES

- 2A Base facilities (including shelters, power generation, water supplies)
- 2B Expedient roads/airfields/bridges
- 2C Over-the-beach operations (including breakwaters, wave forces)
- 2D POL storage, transfer, and distribution
- 2E Polar engineering

3 ENERGY/POWER GENERATION

- 3A Thermal conservation (thermal engineering of buildings, HVAC systems, energy loss measurement, power generation)
- 3B Controls and electrical conservation (electrical systems, energy monitoring and control systems)
- 3C Fuel flexibility (liquid fuels, coal utilization, energy from solid waste)

- 3D Alternate energy source (geothermal power, photovoltaic power systems, solar systems, wind systems, energy storage systems)

- 3E Site data and systems integration (energy resource data, integrating energy systems)

- 3F EMCS design

4 ENVIRONMENTAL PROTECTION

- 4A Solid waste management
- 4B Hazardous/toxic materials management
- 4C Waterwaste management and sanitary engineering
- 4D Oil pollution removal and recovery
- 4E Air pollution
- 4F Noise abatement

5 OCEAN ENGINEERING

- 5A Seafloor soils and foundations
- 5B Seafloor construction systems and operations (including diver and manipulator tools)
- 5C Undersea structures and materials
- 5D Anchors and moorings
- 5E Undersea power systems, electromechanical cables, and connectors
- 5F Pressure vessel facilities
- 5G Physical environment (including site surveying)
- 5H Ocean-based concrete structures
- 5J Hyperbaric chambers
- 5K Undersea cable dynamics

ARMY FEAP

- BDG Shore Facilities
- NRG Energy
- ENV Environmental/Natural Responses
- MGT Management
- PRR Pavements/Railroads

TYPES OF DOCUMENTS

D - Techdata Sheets; R - Technical Reports and Technical Notes; G - NCEL Guides and Abstracts; I - Index to TDS; U - User Guides; None - remove my name

Old Address:

Telephone No.: _____

New Address:

Telephone No.: _____

INSTRUCTIONS

The Naval Civil Engineering Laboratory has revised its primary distribution lists. To help us verify our records and update our data base, please do the following:

- Add - circle number on list
- Remove my name from all your lists - check box on list.
- Change my address - line out incorrect line and write in correction **(DO NOT REMOVE LABEL)**.
- Number of copies should be entered after the title of the subject categories you select.
- Are we sending you the correct type of document? If not, circle the type(s) of document(s) you want to receive listed on the back of this card.

Fold on line, staple, and drop in mail.

DEPARTMENT OF THE NAVY
Naval Civil Engineering Laboratory
560 Laboratory Drive
Port Hueneme CA 93043-4328

Official Business
Penalty for Private Use, \$300



BUSINESS REPLY CARD

FIRST CLASS PERMIT NO. 12503 WASH D.C.

POSTAGE WILL BE PAID BY ADDRESSEE

NO POSTAGE
NECESSARY
IF MAILED
IN THE
UNITED STATES

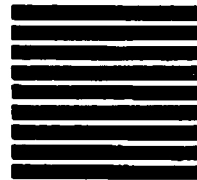

**COMMANDING OFFICER
CODE L34
560 LABORATORY DRIVE
NAVAL CIVIL ENGINEERING LABORATORY
PORT HUENEME CA 93043-4328**

NCEL DOCUMENT EVALUATION

You are number one with us; how do we rate with you?

We at NCEL want to provide you our customer the best possible reports but we need your help. Therefore, I ask you to please take the time from your busy schedule to fill out this questionnaire. Your response will assist us in providing the best reports possible for our users. I wish to thank you in advance for your assistance. I assure you that the information you provide will help us to be more responsive to your future needs.

R. N. Storer

R. N. STORER, Ph.D, P.E.
Technical Director

DOCUMENT NO. _____ TITLE OF DOCUMENT: _____

Date: _____ Respondent Organization : _____

Name: _____ Activity Code: _____
 Phone: _____ Grade/Rank: _____

Category (please check):

Sponsor _____ User _____ Proponent _____ Other (Specify) _____

Please answer on your behalf only; not on your organization's. Please check (use an X) only the block that most closely describes your attitude or feeling toward that statement:

SA Strongly Agree A Agree O Neutral D Disagree SD Strongly Disagree

- | | SA | A | N | D | SD |
|------------------------------------------------------------------------------------------------------------|-----|-----|-----|-----|-----|
| 1. The technical quality of the report is comparable to most of my other sources of technical information. | () | () | () | () | () |
| 2. The report will make significant improvements in the cost and or performance of my operation. | () | () | () | () | () |
| 3. The report acknowledges related work accomplished by others. | () | () | () | () | () |
| 4. The report is well formatted. | () | () | () | () | () |
| 5. The report is clearly written. | () | () | () | () | () |

- | | SA | A | N | D | SD |
|--------------------------------------------------------------------------------------------------------|-----|-----|-----|-----|-----|
| 6. The conclusions and recommendations are clear and directly supported by the contents of the report. | () | () | () | () | () |
| 7. The graphics, tables, and photographs are well done. | () | () | () | () | () |

Do you wish to continue getting NCEL reports? <input style="margin-left: 100px;" type="checkbox"/> YES <input style="margin-left: 20px;" type="checkbox"/> NO

Please add any comments (e.g., in what ways can we improve the quality of our reports?) on the back of this form.

Comments:

Fold on line, staple, and drop in mail.

DEPARTMENT OF THE NAVY
Naval Civil Engineering Laboratory
560 Laboratory Drive
Port Hueneme CA 93043-4328

Official Business
Penalty for Private Use, \$300



BUSINESS REPLY CARD

FIRST CLASS PERMIT NO. 12503 WASH D.C.

POSTAGE WILL BE PAID BY ADDRESSEE

NO POSTAGE
NECESSARY
IF MAILED
IN THE
UNITED STATES



COMMANDING OFFICER
CODE L03
560 LABORATORY DRIVE
NAVAL CIVIL ENGINEERING LABORATORY
PORT HUENEME CA 93043-4328