

AD-A243 115

2



NAVAL POSTGRADUATE SCHOOL

Monterey, California

DTIC
ELECTE
DEC 7 1991
S C D



THESIS

ARMY JTIDS: A C³ CASE STUDY

by

Richard E. Volz, Jr

March, 1991

Thesis Advisor:

Donald A. Lacer

Approved for public release; distribution is unlimited

91-17183



91 12 5 06T

REPORT DOCUMENTATION PAGE			
1a. REPORT SECURITY CLASSIFICATION UNCLASSIFIED		1b. RESTRICTIVE MARKINGS	
2a. SECURITY CLASSIFICATION AUTHORITY		3. DISTRIBUTION/AVAILABILITY OF REPORT Approved for public release; distribution is unlimited.	
2b. DECLASSIFICATION/DOWNGRADING SCHEDULE			
4. PERFORMING ORGANIZATION REPORT NUMBER(S)		5. MONITORING ORGANIZATION REPORT NUMBER(S)	
6a. NAME OF PERFORMING ORGANIZATION Naval Postgraduate School	6b. OFFICE SYMBOL (If applicable) CC	7a. NAME OF MONITORING ORGANIZATION Naval Postgraduate School	
6c. ADDRESS (City, State, and ZIP Code) Monterey, CA 93943-5000		7b. ADDRESS (City, State, and ZIP Code) Monterey, CA 93943-5000	
8a. NAME OF FUNDING/SPONSORING ORGANIZATION	8b. OFFICE SYMBOL (If applicable)	9. PROCUREMENT INSTRUMENT IDENTIFICATION NUMBER	
8c. ADDRESS (City, State, and ZIP Code)		10. SOURCE OF FUNDING NUMBERS	
		Program Element No.	Project No.
		Task No.	Work Unit Accession Number
11. TITLE (Include Security Classification) ARMY JTIDS: A C ² CASE STUDY, UNCLASSIFIED			
12. PERSONAL AUTHOR(S) Volz, Richard E. Jr.			
13a. TYPE OF REPORT Master's Thesis	13b. TIME COVERED From To	14. DATE OF REPORT (year, month, day) March, 1991	15. PAGE COUNT 142
16. SUPPLEMENTARY NOTATION The views expressed in this thesis are those of the author and do not reflect the official policy or position of the Department of Defense or the U.S. Government.			
17. COSATI CODES		18. SUBJECT TERMS (continue on reverse if necessary and identify by block number)	
FIELD	GROUP	SUBGROUP	
		JTIDS, Command, Control, Communications, ATCCS, JSTARS	
19. ABSTRACT (continue on reverse if necessary and identify by block number)			
<p>The author examines the Army command, control, and communications aspects of the Joint Tactical Information Distribution System (JTIDS). The developmental history of JTIDS as a secure, jam-resistant, data distribution system is discussed with emphasis placed on the acquisition process. An overview of the system, highlighting the key components, is also presented. Particular emphasis is placed on management of the network and the current joint concept of operations. The potential of JTIDS to pass other forms of surveillance information is examined. In particular, the Joint Surveillance Target Attack Radar System (JSTARS) produces a wealth of information for all Army C² elements. JTIDS can provide the means to transmit JSTARS ground surveillance data to the Army Tactical Command and Control System (ATCCS), making this information available to users that would not ordinarily receive it. Total Battlefield Automated System integration is the key component for full exploitation of this information.</p>			
20. DISTRIBUTION/AVAILABILITY OF ABSTRACT <input checked="" type="checkbox"/> UNCLASSIFIED/UNLIMITED <input type="checkbox"/> SAME AS REPORT <input type="checkbox"/> DTIC USERS		21. ABSTRACT SECURITY CLASSIFICATION Unclassified	
22a. NAME OF RESPONSIBLE INDIVIDUAL Professor Donald A Lacer		22b. TELEPHONE (Include Area code) (408) 646-2772	22c. OFFICE SYMBOL CC

Approved for public release; distribution is unlimited.

Army JTIDS: A C3 Case Study

by

Richard E. Volz, Jr.
Captain, United States Army
B.S., Siena College, 1983

Submitted in partial fulfillment
of the requirements for the degree of

MASTER OF SCIENCE IN SYSTEMS TECHNOLOGY
(JOINT COMMAND, CONTROL, AND COMMUNICATIONS)

from the

NAVAL POSTGRADUATE SCHOOL

March 1991

Author:

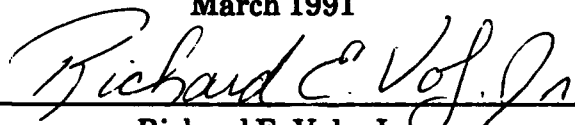
Richard E. Volz, Jr.

Approved by:

Donald A. Lacer, Thesis Advisor,

Michael G. Sovereign, Second Reader

Carl R. Jones, Chairman

Joint Command, Control, and Communications Academic Group

ABSTRACT

The author examines Army command, control, and communications aspects of the Joint Tactical Information Distribution System (JTIDS). The developmental history of JTIDS as a secure, jam-resistant, data distribution system is discussed with emphasis placed on the acquisition process. An overview of the system, highlighting the key components, is also presented. Particular emphasis is placed on management of the network and the current joint concept of operations. The potential of JTIDS to pass other forms of surveillance information is examined. In particular, the Joint Surveillance Target Attack Radar System (JSTARS) produces a wealth of information for all Army C² elements. JTIDS can provide the means to transmit JSTARS ground surveillance data to the Army Tactical Command and Control System (ATCCS), making this information available to users that would not ordinarily receive it. Total Battlefield Automated System integration is the key component to full exploitation of this information.



Accession For	
NTIS GRA&I	<input checked="" type="checkbox"/>
DTIC TAB	<input type="checkbox"/>
Unannounced	<input type="checkbox"/>
Justification	
By _____	
Distribution/	
Availability Codes	
Dist	Avail and/or Special
A-1	

TABLE OF CONTENTS

CHAPTER I. HISTORICAL EVOLUTION	1
A. INTRODUCTION	1
1. Purpose	1
2. Definition	1
3. Scope	1
4. Background	2
5. Joint Concept of Operations	5
B. PROGRAM HISTORY	6
1. Phase Development	6
a. Phase I	7
b. Phase II	9
2. Congressional Review	10
3. Multifunctional Information Distribution System (MIDS)	11
C. SYSTEM EVALUATION	13
1. Technology Risk	13
2. Program Cost	15
3. Schedule/Milestones	18
4. JTIDS and NATO	20
5. Test and Evaluation	21
CHAPTER II. SYSTEM OVERVIEW	25

A.	SYSTEM DESCRIPTION	25
B.	SYSTEM TECHNOLOGY	26
C.	MESSAGE STRUCTURE	29
D.	INFORMATION DISTRIBUTION	31
E.	RELAY FUNCTION	33
	1. Paired Slot Relay	33
	2. Repromulgation Relay	34
F.	ACCESS MODES	34
	1. Dedicated Access	34
	2. Contention Access	35
	3. Distributed Reservation Access	35
G.	VOICE	36
H.	POSITION LOCATION	37
I.	IDENTIFICATION	38
J.	CLASSES OF TERMINALS	38
	1. Class 1 Terminal	39
	2. Class 2 Full Scale Development Terminal	39
	3. Class 2M Terminal	41
	4. Class 2H Terminal	43
	5. Class LV Terminal	43
CHAPTER III. NETWORK MANAGEMENT		46
A.	DEFINITION	46
B.	NETWORK MANAGEMENT OVERVIEW	46
	1. Class 1 Terminal Network	47
	2. Class 1 and 2 Terminal Networks	51

C.	NETWORK DESIGN FOR JTIDS JTAO	58
D.	ARMY NET MANAGEMENT	60
	1. Means of Employment	60
	2. Army JTIDS Network Employment	63
CHAPTER IV. CONCEPT OF OPERATIONS		66
A.	JCS JOINT CONCEPT OF OPERATIONS	66
	1. Current Joint Tactical Air Operations	66
	2. Information Exchange (Non-JTIDS)	69
	a. Track and Track Management	70
	b. C ² Unit Status	71
	c. C ² Coordination	71
	d. Special Information Transfer	72
	e. Summary	73
	3. JTIDS Equipped Joint Tactical Air Operations	73
	a. Position and Status Reporting	78
	b. Surveillance	78
	c. Target Selection and Coordination	79
	d. Navigation	79
	e. Digital Voice	79
B.	ARMY CONCEPT OF OPERATIONS	80
	1. Introduction	80
	2. Airland Battle Doctrine	80
	3. Army Command and Control Systems	82
	4. Three Pillared Architecture	83
	a. Area Common User System	84

b. Combat Net Radio	85
c. Army Data Distribution System	86
5. Army JTIDS/EPLRS Employment	88

CHAPTER V. PROPOSED APPLICATIONS FOR JTIDS INFORMATION

DISTRIBUTION	91
A. INTRODUCTION	91
B. AIRLAND BATTLE - FUTURE	91
1. Projected Doctrine	91
2. Communications Support	94
C. JTIDS - A VITAL LINK FOR ALB-F	95
1. Joint Surveillance Target Attack Radar System	95
2. JTIDS - A Gateway to the Sigma Star	98
D. A PROPOSED JTIDS ALTERNATIVE	99
1. Maneuver Control	101
2. Air Defense Artillery	103
3. Fire Support	104
4. Intelligence/Electronic Warfare	105
5. Combat Service Support	106
E. HURDLES TO OVERCOME	109
1. Data Fusion	109
2. Decision Support Algorithms	110
3. Multilevel Security	111
4. Doctrine	112
5. Summary	114

CHAPTER VI. CONCLUSIONS AND RECOMMENDATIONS	115
A. SUMMARY	115
B. CONCLUSIONS	115
C. RECOMMENDATIONS	116
1. Timely Fielding	116
2. Continued JTIDS Development	116
3. NCS-J - The Joint Management Tool	117
4. JTIDS Transmission of JSTARS Information	117
LIST OF REFERENCES	119
INITIAL DISTRIBUTION LIST	123

LIST OF TABLES

TABLE 1	System Requirements for Each Phase	8
TABLE 2	JTIDS Family of Terminals	12
TABLE 3	Projected JTIDS Program Development Costs	18
TABLE 4	Projected Milestones	20
TABLE 5	JTIDS Class 2 Cost Estimates as of February 1990	24
TABLE 6	JTIDS Operational Requirements	25
TABLE 7	JTIDS Terminal Capabilities	45

LIST OF FIGURES

Figure 1	Planned JTIDS Users	7
Figure 2	JTIDS System Technology	11
Figure 3	JTIDS Signal Structure	26
Figure 4	JTIDS Time Slot Structures	28
Figure 5	IJMS Message Structure	31
Figure 6	TADIL J Message Structure	32
Figure 7	JTIDS Voice	37
Figure 8	JTIDS Multi-Purpose Color Display	42
Figure 9	JTIDS Single Net Operations	48
Figure 10	JTIDS Multinet Operations	54
Figure 11	Terminal Initialization Load Generation	57
Figure 12	Army JTIDS Communication System	62
Figure 13	Division JTIDS Network Management	65
Figure 14	Current Joint Air Operations	67
Figure 15	JTIDS Concept of Operations	75
Figure 16	The Army Command and Control System	83
Figure 17	The Three Pillared Communication Architecture	84
Figure 18	Deployment of Army Communication Systems	88
Figure 19	The PLRS/JTIDS Hybrid System	89
Figure 20	Airland Battle - Future Concept	93
Figure 21	Communications on the Non-Linear Battlefield	96
Figure 22	The JSTARS Radar Platform	98

Figure 23	The JTIDS Alternative	100
Figure 24	Integrated Information Flow	108
Figure 25	Potential ATCCS Management	113

TABLE OF ABBREVIATIONS

ABMOC	Air Battle Management Operations Center
ACCS	Army Command and Control System
ACUS	Area Common User System
ADA	Air Defense Artillery
ADDS	Army Data Distribution System
ADSO	Assistant Division Signal Officer
AFATDS	Advanced Field Artillery Tactical Data System
AFP	Assault Fire Platoon
ALB	Airland Battle
ALB-F	Airland Battle-Future
ASAS	All Source Analysis System
ASIT	Adaptable Surface Interface Terminal
ATCCS	Army Tactical Command and Control System
ATDL-1	Army Tactical Data Link-1
AWACS	Airborne Warning And Control System
BAS	Battlefield Automated System
BDEFDC	Brigade Fire Direction Center
BIT	Built-in-Test
BFA	Battlefield Functional Area
BNFDC	Battalion Fire Direction Center
CAC	Combined Arms Center
C ²	Command and Control
CCSK	Cyclic Code Shift Keying

CIP	Communication Improvement Program
CNR	Combat Net Radio
CONOPS	Concept of Operations
CONUS	Continental United States
CPSM	Continuous Phase Shift Modulation
CRC	Control and Reporting Center
CRP	Control and Reporting Post
CSS	Combat Service Support
CSSCS	Combat Service Support Control System
CVSD	Continuous Variable Slope Delta
DAB	Defense Acquisition Board
DCA	Defensive Counterair
DJRU	Dedicated JTIDS Relay Unit
DME	Distance Measuring Equipment
DTDMA	Distributed Time Division Multiple Access
DTM	Data Transfer Module
EAC	Echelons Above Corps
ECM	Electronic Counter Measures
EPLRS	Enhanced Position Reporting Location System
EPUU	EPLRS User Unit
EW	Electronic Warfare
FAAD	Forward Area Air Defense
FACP	Forward Area Control Post
FAADC ² I	FAAD Command, Control, and Intelligence
FM	Field Manual

FS	Fire Support
FSD	Full Scale Development
GAO	Government Accounting Office
GSM	Ground Station Module
HF	High Frequency
HIC	High Intensity Conflict
HIMAD	High to Medium Air Defense
HIU	Host Interface Unit
ICP	Interface Control Panel
IEW	Intelligence/Electronic Warfare
IHFR	Improved High Frequency Radio
IJMS	Interim JTIDS Message Specification
ITNS	Integrated Tactical Navigation System
JCS	Joint Chiefs of Staff
JINTACCS	Joint Interoperability Program for Tactical Command and Control Systems
JMSWG	JTIDS Message Standards Working Group
JOPM	JTIDS Operational Performance Model
JOR	Joint Operating Requirement
JPO	Joint Program Office
JSTARS	Joint Surveillance Target Attack Radar System
JTAO	Joint Tactical Air Operations
JTIDS	Joint Tactical Information Distribution System
Kbs	Kilobits per Second

LIC	Low Intensity Conflict
LNO	Liaison Officer
LRIP	Low Rate Initial Production
MCS	Maneuver Control System
MIC	Medium Intensity Conflict
MIDS	Multinational Information Distribution System
MLS	Multilevel Security
MPC	Message Processing Center
MPCD	Multi-Purpose Color Display
MSE	Mobile Subscriber Equipment
MSRT	Mobile Subscriber Radio Telephone
NATO	North Atlantic Treaty Organization
NCS	Net Control Station
NCS-J	Net Control Station-JTIDS
O&C	Operations and Control
OSD	Office of the Secretary Of Defense
PCDP	Pilot Control and Display Panel
PJHI	PLRS-JTIDS Hybrid Interface
PLRS	Position Location Reporting System
PPLI	Precise Position Location Identification
PT	Enhanced PLRS Terminal
RATT	Radio Teletype
RL	Rapid Load
RSC	Radio Set Control
SACP	Stand Alone Control Panel

SAM	Surface to Air Missile
SDS	Software Development Station
SINCGARS	Single Channel Ground and Airborne Radio System
SYSCON	System Control
TACAN	Tactical Air Navigation
TACS	Tactical Air Control System
TADIL	Tactical Data Information Link
TADIL J	Tactical Data Information Link JTIDS
TCT	Tactical Computer Terminal
TDMA	Time Division Multiple Access
TRADOC	Training and Doctrine Command
TRI-TAC	Tri-service Tactical Communications
URO	User Readout
WAN	Wide Area Network

ACKNOWLEDGMENTS

The author wishes to express his appreciation to Colonel William Guerra, Director of Combat Developments, United States Army Signal Center, Fort Gordon for his sponsorship. Professor Donald A. Lacer and Professor Michael G. Sovereign provided invaluable support and advise throughout the development of this thesis. Special thanks are provided to Captain James Kohlman, Captain David S. Velasquez, and Captain David J. Sacha for their invaluable assistance in researching this thesis.

CHAPTER I. HISTORICAL EVOLUTION

A. INTRODUCTION

1. Purpose

This chapter presents an introduction to the Joint Tactical Information Distribution System (JTIDS). It will examine JTIDS's mission requirements and its history of development to meet those needs. The system's procurement history and current procurement status will be discussed.

2. Definition

JTIDS is a secure, jam-resistant data and voice communications system. The system enables the exchange of real-time tactical information between joint forces concerning friend and foe alike. The information exchange includes force identification, location, and command and control data. [Ref. 1:p 11]

3. Scope

This thesis will present JTIDS under its command and control aspects. An examination of JTIDS potential applications for information distribution on future battlefields will also be performed. Chapter I examines the history of JTIDS development as a data distribution system for joint air operations. Chapter II presents an overview of JTIDS and highlights key components in the system. The

components will include the major terminals and their interfaces with various platforms. Chapter III reviews current concepts to plan and manage a JTIDS network. Chapter IV discusses the current Joint CONOPS for JTIDS employment. The communication architecture planned by the U.S. Army will also be presented. Chapter V presents potential JTIDS interfaces into the ATCCS. A number of proposals are developed for use of JTIDS provided information. Primary among the information sources is the U.S. Air Force JSTARS ground surveillance aircraft. The last portion of the chapter is devoted to the problems inherent in the integration of automation devices on the battlefield.

4. Background

The war in Vietnam, particularly the air war, demonstrated U.S. forces' inability to effectively employ combat power. Much of this ineffectiveness was due to inadequate command and control (C²) capabilities. Aircraft and weapon systems have dramatically increased both their capabilities and lethality, while C² has lagged behind. The air war over North Vietnam is a case in point. [Ref. 2:p 25]

In 1972 the U.S. was withdrawing it's land forces from the Asian land mass. The North Vietnamese viewed this as an opportunity to capture South Vietnam with limited U.S. opposition. It was decided by then-President Richard Nixon to commit U.S. air power over North Vietnam to stem the flow of

arms to the South. The ensuing air war over North Vietnam clearly displayed our command and control weaknesses.

North Vietnam was divided into geographical areas of responsibility that were under the control of only one service, namely the Navy or Air Force. This was done to eliminate confusion due to incompatible C² systems. Each service had its own surveillance capability and intelligence reports. Lack of interoperability of the command and control systems prevented information sharing and all source information processing. Invaluable information was not shared, though both services could have benefitted from it. In addition, aircraft from different services could not communicate with each other. Frequencies, call signs and radio procedures differed for each service. Navigation and position reporting were also extremely difficult and differed between the services. Hanoi was often used as a central reference point. Each pilot had to be aware of his location with reference to Hanoi. Any hostile aircraft detected were referenced in the same manner. In a combat situation, the pilots often became confused and misoriented. It became clear that some form of data distribution system would be required to fuse this data. The requirement to share information throughout the theater of operation, as a joint network was self-evident. [Ref. 2:p 13]

The 1973 Mideast War between Israel and Egypt pointed out, in a rather dramatic manner, a major weakness in U.S.

communication systems. Israeli intelligence reported that Egyptian forces used Soviet-developed jammers during the conflict that virtually blocked all inter-aircraft communications. This threat was viewed in it's implications for a land war in Central Europe, and a need for jam-resistant communications was given a greater priority. [Ref. 3:p 25]

In 1974, the Joint Chiefs of Staff issued a service-wide directive that outlined the potential threat to U.S. forces. It also directed that a new command and control system be developed. This system was to be jam resistant with a method for the distribution of shared data to all participants. [Ref. 4:p 3]

The Air Force and Navy were both directly affected by the JCS directive. Fortunately, both had previously begun development of tactical information distribution systems. The Navy was developing the Integrated Tactical Navigation System (ITNS) that was a distributed form of Time Division Multiple Access (TDMA). The Air Force was concurrently working on a position, location, reporting and control system, known as PLRACTA. This system later evolved into the SEEK BUS system. The SEEK BUS placed it's emphasis on incorporating many subscribers into a single network. Both developmental efforts were pursued in order to evaluate technical requirements and potential concepts of operation.

The Office of the Secretary of Defense (OSD) combined both efforts in 1974 by selecting the Air Force as the lead

service. DTDMA and TDMA technologies were each viewed as having potential. The Navy was to continue its efforts under DTDMA technology with new requirements for security and jam-resistance. Their system was designed for use over existing Tactical Data Information Links (TADIL) links. The Air Force continued its development of the already proven potential of TDMA. [Ref. 4:p 3]

In 1976, a Joint Operating Requirement (JOR) was published. It further outlined the development of a secure, anti-jam, digital data distribution system. It also separated further development into two phases, with different requirements. The phases, as determined by the Under Secretary of Defense for Research and Engineering, differed under the criteria of system capacity, multiple netting, and the number of voice channels per net. [Ref. 4:p 4]

5. Joint Concept of Operations

Joint operations are the norm today rather than the exception. An integrated data distribution system is vital to command and control of air, ground, and sea assets in the Airland Battle. The JTIDS system incorporates all air and ground sensor information into a coherent picture that can then be filtered to meet unique user requirements.

Sensors, such as the Air Force E-3A AWACS and the Navy E-2C Hawkeye, with other air and ground sensors, can create an integrated air picture. This snapshot of the air battle is

sent to all the net participants in near real-time. One of the primary recipients is the Air Force Control and Reporting Center (CRC). The CRC is responsible for the conduct of air defense and air space control over the area designated by the Joint Force Commander. The CRC will perform a management function over subordinate Control and Reporting Posts (CRPs) and U.S. and NATO E-3As. When Army surface-to-air missiles (SAMs) are assigned to operate in a joint air defense environment, the CRC provides operational control over the SAM employment. The CRC establishes an air picture of its area of responsibility. This is accomplished through local radar and the cross telling of track information among all the elements having track data in the designated air space. Figure 1 depicts planned JTIDS users. [Ref. 5:p 24]

In the past, these vital command and control functions were performed manually between systems. The JTIDS network automates this process providing near real-time distribution of surveillance and C2 information to all users. A fully deployed JTIDS network will greatly enhance combat effectiveness in the air battle. [Ref. 5:p 26]

B. PROGRAM HISTORY

1. Phase Development

The Joint Operating Requirement (JOR) for a data distribution system set the goals for future development. The phased development of the system was designed to meet short

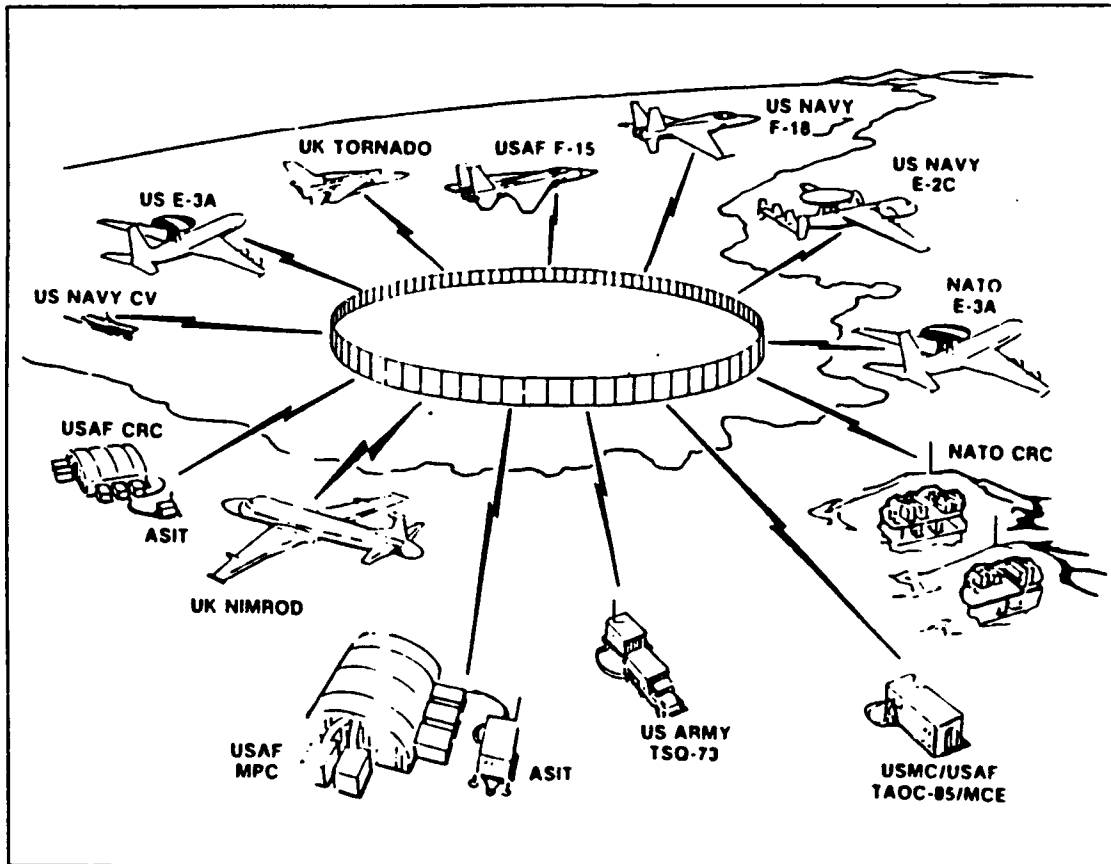

Figure 1 Planned JTIDS Users

and long term goals. Phase I established minimum essential requirements to meet the Air Force's desperate need for a data link between the E-3A AWACS and ground C² centers. Phase II was to produce a terminal with a greatly enhanced data capacity and netting capability. Table 1 depicts the specific digital requirements for each phase.

a. Phase I

The first priority for the Air Force was to develop a data distribution terminal for the E-3A AWACS and NATO E-3As. The Hughes Aircraft CO., under a \$20 million contract,

TABLE 1 System Requirements for Each Phase

	Phase I	Phase II
Data Rate	20 kbs	300 kbs
Netting Capability	4 nets	15 nets
Voice Channels per Net	3 voice	7 voice

developed the Class 1 terminal. This first generation JTIDS terminal met the anti-jam requirement under the JOR. The Class 1 JTIDS terminal could be used in both versions of the E-3A AWACS aircraft, but its weight and size requirements made it incapable of use in any Air Force fighter aircraft. The Class 1 terminal had a limited capacity, which lacked flexibility, and could employ limited netting. Additionally, an agreed upon standard message format had not yet been developed [Ref. 6:p 54]. The interim JTIDS Message Specification (IJMS) was developed to meet the needs of the Class 1 terminal until a final message format could be approved. [Ref. 7:p 3]

The Advanced Surface Interface Terminal (ASIT) was developed to meet the need to communicate with ground systems. The ASIT enabled communications with Air Force ground command and control centers and Army air defense assets with the primary function of translating the IJMS message format into TADIL B. In 1987, the Class 1 terminal successfully passed its operational test. [Ref. 1:p 57]

b. Phase II

The development of the first generation JTIDS terminal (Class 1) established the operational capability of the TDMA technology. The Class 1 terminal was too large and heavy and had limited capabilities to be used in tactical aircraft. Phase II development began well before Phase I requirements were met. It focused on reduction in terminal size, weight, and greatly enhanced data capability. The Air Force and Army continued with development of TDMA technology. The Navy was allowed to continue development of DTDMA technology providing it was compatible with the Air Force program. With the understanding that TADIL J was to be the joint message format standard, both technologies were funded for Full Scale Development (FSD) in 1981. [Ref. 8:p 7]

The Class 2 terminal was developed through TDMA technological advances. The terminal developed was smaller, had a much greater data capability, and an improved capacity for netting; however, it also had its share of problems. The Class 2 terminal was still too large to fit into smaller tactical aircraft such as the Air Force F-16. The Army had difficulty interfacing the Class 2 terminal with its Position, Location, and Reporting System (PLRS). A single type of terminal would not be able to perform all the assigned missions; therefore, several different versions were developed

to meet specific requirements of individual services. [Ref. 1:p 87]

One version was the Army's Class 2M terminal. This terminal was designed to meet the needs of the Army Air Defense community. The Class 2M terminal differed in that it had a data-only capability. Voice capability was determined to be unnecessary and its elimination would reduce the terminal's size. The Army opted for the trade-off of capability for size. [Ref 9:p 7]

A high power version of the Class 2 terminal, the 2H is under development to meet a system requirement for greater range. This new requirement was established to meet the needs of:

- The Marine Corps Tactical Air Operations Module.
- Air Force Modular Control Equipment.
- Navy E-2C surveillance aircraft.
- Class 1 terminal upgrades for E-3A AWACS. [Ref. 4:p 19]

2. Congressional Review

The JTIDS program came under Congressional review in August of 1985. A joint meeting of both the Senate and House Armed Services Committees directed then-Secretary of Defense Casper Weinberger to select one system that would meet the needs of all services. The evaluation by OSD determined that the Naval development of DTDMA technology was yielding a product that was too complex and required costly unique micro-

circuitry. The Secretary of the Navy, John Lehman, canceled all DTDMA development in October 1985. He directed that all future naval fighters were to use the Class 2 terminals. [Ref. 8:p 3] The selected system technology is depicted in Figure 2.

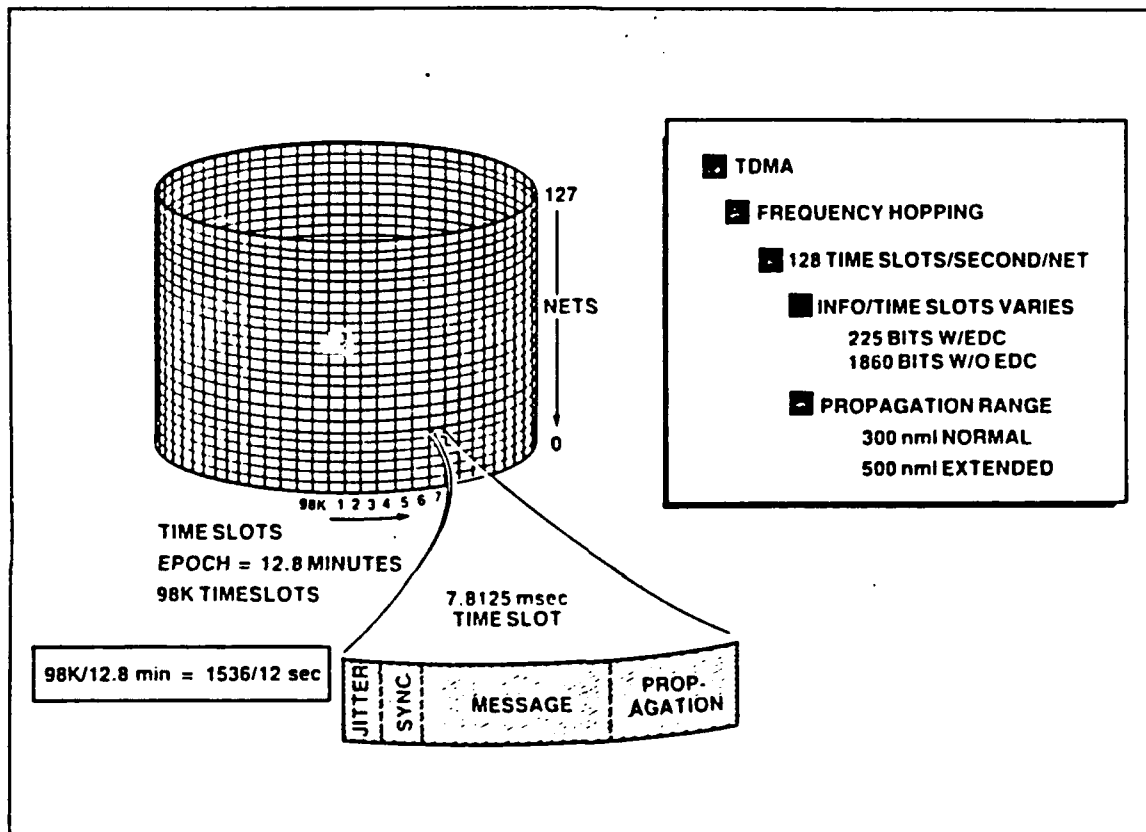

Figure 2 JTIDS System Technology

3. Multifunctional Information Distribution System (MIDS)

A team of experts were brought together by NATO allies in 1979. Their purpose was to recommend to the NATO alliance current technologies available for development of a secure, anti-jam, data distribution system. This system had to meet mission needs for all aspects of the NATO battle plan. The

team recommended that TDMA technology developed under the JTIDS program had the greatest potential to meet those mission needs; hence the MIDS program was established.

The MIDS program is currently in the concept development phase. U.S. services are working concurrently with their NATO counterparts to develop JTIDS-type terminals that would be adaptable to a variety of NATO aircraft. The Air Force hopes to develop a terminal that will fit into the cockpit of their smaller tactical aircraft (i.e., F-16 and F-18). The Navy as the lead service represents the United States in the MIDS program. [Ref. 1:p 129-132] The family of JTIDS terminals are depicted in Table 2.

TABLE 2 JTIDS Family of Terminals

	CLASS 1	CLASS 2	CLASS 3
POTENTIAL APPLICATIONS	C2 CENTERS * E-3A * AF TACS * NATO C2 * ARMY TSQ-73	SMALL PLATFORMS * F-15 * F-16 * HAWK * ARMY AIR DEFENSE * ARMY C2	VERY SMALL PLATFORMS * TRANSPONDER * RPV * MISSILE * MANPACK
PERFORMANCE MULTINET CAPACITY AJ PROTECTION POWER OUTPUT REL NAV RELAY INTEGRATE CNI VOICE	* Yes * 30/60 kb/s * High * 200W & 1000W * References Only * Yes * No * Yes	* Yes * 30/238 kb/s * High * 200W * Yes * Yes * TACAN * Yes	TO BE DEFINED
CHARACTERISTICS WEIGHT SIZE	* 400 lb * 6.4 ft ³	* 125 lb * 1.7 ft ³	TO BE DEFINED

C. SYSTEM EVALUATION

1. Technology Risk

The development of a JTIDS system to meet the mission requirements for a secure, anti-jam, data distribution system made large assumptions about available and potential technologies. A comprehensive assessment of the risks to the program with a common baseline for the level of technology was never performed. The technological risk was compounded due to the number of new technologies required to implement the JTIDS program.

The need for a data distribution system was the driving force behind JTIDS development. In the early stages of the program, the Air Force and Navy had developed two different technologies to meet the data distribution requirement. The Air Force was developing TDMA and the Navy was developing DTDMA. The development of these two technologies created two levels of risk for the program. There was a great deal of duplication in the research and development involved with the two approaches. Congressional review of the program resulted in the cancellation of DTDMA development. Naval development of DTDMA only lasted as long as it did because of the potential savings in the long term goal of using existing TADIL B links. [Ref. 10:p 36]

The JCS requirement for an anti-jam capability added technical risk to the program. In 1974 this technology was in

its infancy. Two methods under development to overcome potential Soviet jamming were frequency hopping and spread spectrum technology. Frequency hopping involves signal transmission on a randomly selected frequency within a predetermined frequency band. Spread spectrum technology entails spreading the message signal over a broad frequency band. This would ensure that enough of the message signal is received at the receiver to be accurately reproduced. Additionally, both anti-jamming technologies added greater risk to the program. The frequency hopping technique was selected for incorporation into the Class 1 and Class 2 terminals. [Ref. 5:p 44]

The final technical risk is one that was never adequately assessed. Software development for the JTIDS terminals has continually lagged behind hardware. Over one million lines of code have been written for eight versions of the terminal. A standard message format for the system was still undecided during initial testing of the Class 1 terminal. The Air Force directed the development of an interim message format known as Interim JTIDS Message Specification (IJMS). This format evolved in order to continue development of the JTIDS system. IJMS was incapable of directly interfacing with existing service command and control centers that currently use TADIL B data links (i.e. Air Force CRCs and MPCs). The development of the Adaptable Surface Interface Terminal (ASIT) was driven by the IJMS,

enabling ground users to translate message formats. [Ref. 1:p 21]

The TADIL J message format was developed by the JTIDS Message Standards Working Group (JMSWG) of the Joint Interoperability Program for Tactical Command and Control Systems (JINTACCS). This message format has been accepted by each service for employment in the JTIDS systems. The TADIL J format was employed in all JTIDS terminals in the late 1980s. JTIDS message formats will be described in detail in Chapter II. [Ref 7:p 6]

2. Program Cost

Program cost estimates have continually risen since JTIDS's conceptual development. Initial life cycle cost estimates in 1974 varied between \$3 billion and \$4 billion to meet data distribution needs for the U.S. in NATO. The Joint Program Office (JPO) increased this estimate in 1979 to \$7 billion. This new life cycle cost estimate had defects. The JPO did not perform a separate cost estimate based upon the entire joint program; rather, it totalled all the services' individual cost estimates to determine the joint program figure. Further investigation reveals that the Air Force based their estimate on current and anticipated TDMA technology. The Air Force also included a cost escalation factor to account for anticipated inflation rates. The Navy based it's cost estimate on DTDMA technology under their

development. Naval program managers also didn't include an inflation factor, basing their estimate solely on 1978 dollars. The Army's estimate was based on fielding the Class 2 terminal with their PLRS system in command posts only. This estimate did not include any figure for advanced third generation terminals to be employed with ground units. It is also important to note here that as of 1979 the Army still lacked approval of a mission need for JTIDS within their service. [Ref 8:p 7]

No common baseline upon which to determine system costs was established. In 1979, the JTIDS program was joint in name only. Each service was maintaining its own program and cost estimates were based on vastly different sets of criteria. Thus, there was no basis for an accurate estimate of the cost of the program from cradle to grave. Current estimates call for the procurement of 1700 terminals through the year 1997. The cost of production of these terminals is approximately \$1.7 billion. [Ref. 8:p 5]

The lead-follow contract method was employed in low rate initial production of the Class 2 terminal. It was hoped that this method of contracting would enhance competition and help drive down unit cost. The lead contractor for Air Force procurement of the Class 2 terminal is Plessey Electronics System Corporation. The Plessey Corporation was awarded a LRIP contract worth \$90 million dollars for 47 Class 2 terminals. The first 20 terminals were designated for

installation in Air Force F-15 tactical fighters. The additional 27 Class 2 terminals will be installed into Navy F-14s and several command and control vessels. The follow contract for low rate initial production was awarded to Rockwell Collins, Inc. at \$42 million dollars. The Class 2 terminals produced under this contract will be installed solely on Air Force F-15s. [Ref. 9:p 10]

Current cost figures for each Class 2 terminal is approximately \$800,000 to \$1 million. This estimate includes the cost of production and initial logistical support. Contractors, in conjunction with the JPO estimate the per unit cost could possibly be reduced by as much as one half. A cost reduction to \$400,000 per terminal could be achieved through experience gained on the production line and competition between Plessey and Rockwell Collins. The cost of investment in test equipment and tooling may be recouped by the contractor by 1992. Unit cost reductions should then follow. The JPO has a number of product improvement programs to aid in life cycle cost reduction. These are as follows:

1. State of the art off-the-shelf mini processors.
2. Increase reliability of the system.
3. Bulk purchase of replacement parts.

In summary, the original developmental estimate of \$3 to \$4 billion was highly optimistic. Software development was not estimated nor was the cost of having to develop two message formats included. JTIDS software development

dramatically contributed to the already exceeded developmental cost, currently over \$2 billion. [Ref. 3:p 47] Recent budget information is found in Table 3.

TABLE 3 Projected JTIDS Program Development Costs

BUDGET (000)	FY 1988	FY 1989	FY 1990	FY 1991	FY 1992	PGM TOT (TO COMPL)
MAJOR CONTRACT	78,603	61,120	87,130	87,808	72,317	TBD

(\$\$\$ in Thousands)

3. Schedule/Milestones

Program managers are required to submit an acquisition strategy within ninety days of appointment in accordance with the Defense Management Review. This was never done for JTIDS acquisition. The Air Force, as the lead service, established few milestones, which were regularly pushed back due to a lack of results in technological development.

Forces outside the JPO also contributed to delays in the developmental process. The Class 1 terminal experienced delays for several reasons. Congressional review of the JTIDS program discovered the services were developing systems that were not frequency compatible nor did they incorporate TACAN frequencies. Congress then mandated that the JTIDS system must be interoperable and TACAN frequency compatible before further development. Additionally, the developmental phase was extended two years, based on the Hughes Aircraft Co.'s recommendation that added development time would enable them

to substantially reduce unit cost of first generation terminals. [Ref. 8:p 5]

Development of the Class 2 terminal also suffered from delays. Singer Kearfott and Rockwell Collins had developed newer micro computer chips that would process data at a much higher rate. Incorporation of these chips into the Class 2 terminal design would greatly reduce the size of the terminal. Based on the inherent advantage in size reduction and increased capability, OSD approved a 14 month delay in awarding a production contract. [Ref. 8:p 15]

Development of the third generation of JTIDS terminals has been repeatedly delayed. The Class 3 terminals were to be designed to meet the needs of Army air defense units and smaller fighter aircraft. This generation of terminals has experienced many delays due to repeated lowering of its priority through the Defense budgeting process. There has been continued lack of service support, due to the large cost involved, for JTIDS development and no clear definition of mission requirements. At this time, the future of the Class 3 terminal is uncertain. Current schedule information is found in the Table 4.

Current estimates show that the first low rate initial production Class 2 terminals will be delivered to the Navy in December 1991. Delivery of low rate initial production terminals to the Air Force will occur in April 1992. The Army's Class 2M terminal is still in the developmental stage,

TABLE 4 Projected Milestones

Schedule	1988	1989	1990	1991	1992	To Complete
Program MS		IIIA 9/89 F-15 CLS2		IIIA 2/91 Navy CLS2	IOC F-15	IOC Army/ Navy
Engr MS	Rel. Verif			Army Terminal Integr.		Navy Terminal Integr.
T&E MS	DT-II F-15	Pre DAB Test	OT F-15	OT-II Navy 9/91		DT/OT Eval.
Contract MS	BLK 1 Navy		BLK II Navy	F-15 Prod Unit		Prod. Unit Army/Navy

due to an Army-unique data only requirement. The Class 2M terminal is expected to undergo Defense Acquisition Board (DAB) Milestone IIIA review in October 1991. [Ref. 9:p 45]

4. JTIDS and NATO

The NATO MIDS program selected JTIDS technology for its development in Europe. Cooperative agreements with the United States, the United Kingdom, and France are planned to purchase JTIDS terminals for each countries' own E-3A AWACS aircraft. The terminals will be bilingual and fully interoperable with existing Class 1 terminals. Memorandums of Understanding with the U.K. and France were signed by the Air Force in 1989. The Plessey Corp. will deliver 20 Class 2H, high power terminals to the U.K. and ten Class 2H terminals to France in 1990. Plessey is the lead contractor of all NATO contractors involved in MIDS development. Other NATO member nations involved in the program are Germany, Spain, and Italy. [Ref. 11:p 89]

5. Test and Evaluation

Testing and evaluation of the JTIDS system has been on-going throughout the developmental phases of the program. The Air Force conducted the first operational test on the Class 1 terminal in April 1973 on board an E-3A AWACS aircraft. The operational test concluded that the Class 1 terminal did not meet defined requirements. As late as 1978, the Class 1 terminal still fell short of established requirements. At this time, the Class 1 terminal is the only terminal undergoing operational tests. The Air Force's assessment of the terminal's operational capability is that some requirements are being met by the system, (anti-jam and data rate), and others were not (multi-netting). The criteria used by the Air Force are outlined in the Joint Operating Requirement (JOR) for JTIDS published by the JCS in March 1976, under Phase 1 developmental requirements. The first full scale development model test of the Class 2 terminal took place in 1979. This test was to include an operational assessment of the terminal's ability to enhance command and control functions between the E-3A aircraft and ground support C2 centers. At the time of the evaluation, the ASIT was the only ground terminal used in the test. A true ground environmental test of the system, including C² elements, was delayed until the mid 1980s. [Ref. 9:p 20-21]

In 1980, two reviews of JTIDS procurement were conducted. The first of these reviews was the Welsh Study,

conducted by the JCS. The second review was known as the Critical Evaluation Study under the direction of the Air Force. Both studies concluded that employment of the JTIDS system would significantly increase the combat effectiveness of both tactical fighter and surveillance aircraft. In 1983, Boeing Aerospace was awarded a contract to upgrade command, control and communication elements of the E-3A AWACS, including the Class 1 terminal in the upgrade. [Ref. 4:p 46]

A Class 2 terminal installed in a F-15 tactical fighter was tested in 1985. The test included three communication terminals: two ground and one airborne. The test was conducted by the Air Force Electronics Systems Division. A second test was conducted in 1986. This test evaluated the JTIDS system within a combat scenario. Five F-15s with Class 2 terminals, 1 E-3A AWACS with a Class 1 terminal, and Army Air Defense Artillery (ADA) units, also with Class 2 terminals, were involved in the test. Both tests were viewed as highly successful by all services involved. [Ref. 6:p 62-63]

Independent evaluations of the system were conducted by McDonnell-Douglas Astronautic Co. in 1979 and 1986. Both studies concluded that combat effectiveness was increased for both fighter and surveillance aircraft. The Plessey Corp. conducted a reliability verification demonstration in August 1988. Five hundred fifty sorties were flown with JTIDS equipped aircraft under a variety of climatic conditions. The

mean time between failure of the terminals tested was 316 hours. The report stressed that none of the failures effected the combat mission. [Ref. 9:p 51]

Computer simulations have also been used to determine combat effectiveness. The JTIDS Operational Performance Model (JOPM) was developed to assess the operational performance in the F-15 theater defensive counterair mission (DCA). The assessment was performed by the DOD JOPM Supervisory Working Group and Teledyne Brown Engineering. The report, published in November 1988, concluded that one JTIDS-equipped F-15 is worth 1.35 non-JTIDS F-15s in the DCA role. The report further stated that JTIDS dramatically enhances F-15 defensive counterair combat effectiveness against a hostile force heavily superior in numbers. [Ref. 12:p 4-11]

A GAO report to Congress in February 1990 stated that although the Class 2 terminal is currently below its laboratory and field reliability requirements, it has achieved at least the threshold values for other performance requirements established by the 1981 Secretary of Defense Decision Memorandum. Nevertheless, in October 1989 the Under Secretary of Defense for Acquisition approved low rate initial production (LRIP) for the Class 2 and 2H terminals. Approval of low rate initial production for the Army Class 2M terminal is scheduled for Defense Acquisition Board (DAB) review in October 1991. The Under Secretary had segmented Class 2 and 2H LRIP into three consecutive annual production lots.

However, the Under Secretary has identified specific criteria, such as reliability improvements that must be satisfied before the final two production contracts are awarded. [Ref. 9:p 55]

The GAO report also stated that the services and DOD will continue to share the \$2 billion cost of developing the Class 2 terminal. The JPO estimates that development will continue through 1995. The services will purchase production terminals with their own funds. As of February 1990, total program costs through production are estimated at \$3.9 billion. [Ref. 9:p 56] A breakdown of JTIDS Class 2 cost estimates from the 1990 GAO report are listed in Table 5.

TABLE 5 JTIDS Class 2 Cost Estimates as of February 1990 Escalated Dollars in Millions

Funding Category	Cost
Development	\$2,032.1
Procurement	\$1,861.6
Total	\$3,893.7

CHAPTER II. SYSTEM OVERVIEW

A. SYSTEM DESCRIPTION

The Joint Tactical Information Distribution System (JTIDS) is an advanced radio system which provides a wide range of information distribution, position location and identification. The system can distribute information at a high rate in a manner that is both secure and jam resistant in a hostile EW environment. JTIDS links together dispersed users and sensors yielding a position grid, position location with a common reference point, and provides a unique identification capability. [Ref. 1:p 11] Operational requirements are summarized in Table 6.

TABLE 6 JTIDS Operational Requirements

<p style="text-align: center;">JTIDS Joint Operational Requirements</p> <p style="text-align: center;">1. INFORMATION DISTRIBUTION Broadcast and Point-to-point Jam Protection Non-Nodal Secure High Capacity</p> <p style="text-align: center;">2. POSITION LOCATION Common Grid (Relative & Geodetic) High Accuracy</p> <p style="text-align: center;">3. IDENTIFICATION Direct Indirect</p>
--

B. SYSTEM TECHNOLOGY

JTIDS utilizes a bit oriented message form of information which enables the use of extremely efficient digital message structure as in TADIL J, digital voice, or character oriented messages. The system operates within the 960 to 1215 MHz radio frequency band. This insures compatibility with civil Distance Measuring Equipment (DME), Military Tactical Air Navigation equipment (TACAN). JTIDS uses Time Division Multiple Access (TDMA) technology to meet integrated operational requirements. [Ref. 1:p 11] The structure of TDMA design is depicted in Figure 3.

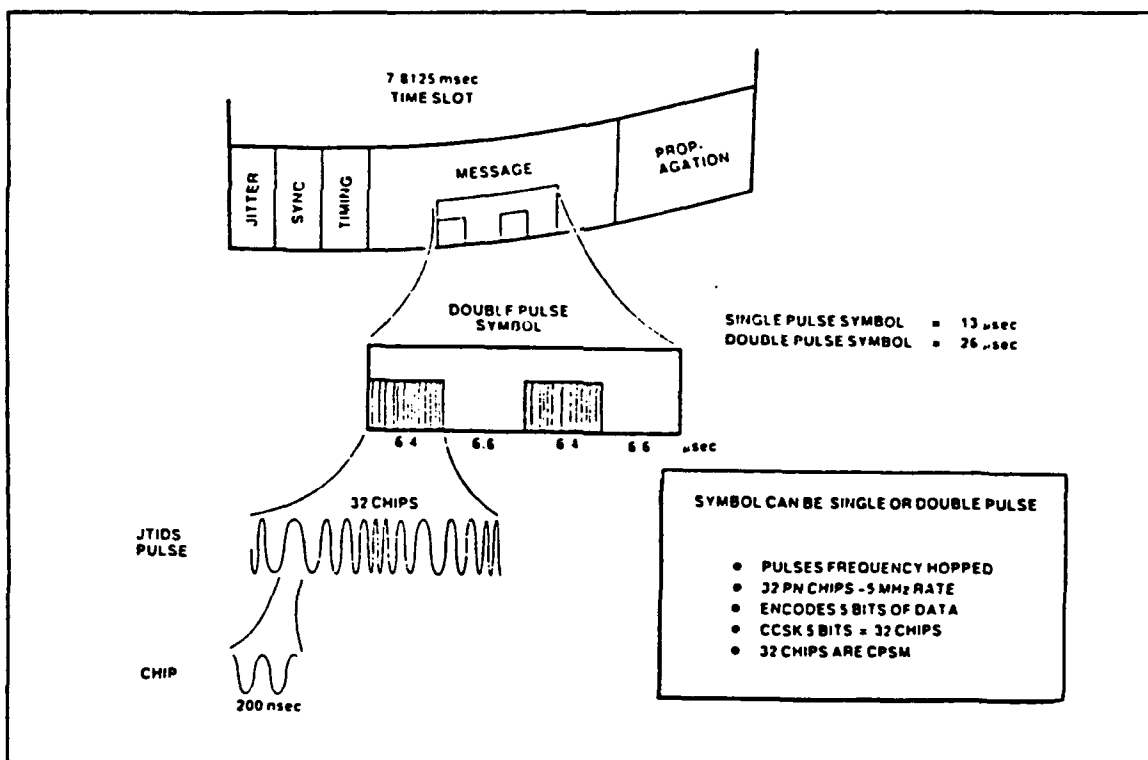

Figure 3 JTIDS Signal Structure

TDMA technology is used to produce a time slot multinet structure. A 12.8 minute epoch is divided in 7.8125 millisecond time slots, yielding 128 time slots/second/net. The 7.8125 millisecond time slot is divided into a variable time slot (jitter), a synchronization preamble, the information transmitted, and a propagation time period. The propagation time allows a maximum transmission range of 300 nautical miles or 500 nautical miles in the extended relay mode. The extended range is achieved by decreasing the size of the jitter in order to increase propagation time. Time slot nets may then be stacked using frequency hopping pattern of code division techniques. A total of 128 separate nets with 98,304 time slots/net can then be achieved within a single geographic area of operations. [Ref. 1:p 16] Figure 4 depicts the time slot structure.

A time reference for all nets or individual nets is made by designating one terminal as the Net Time Reference. This is determined based on the user's operational requirements. The selected Net Time Reference terminal will maintain alignment of the time slots within each net. Up to 200 fully assigned nets can exist in one geographic area before mutual interference seriously degrades the network. The same number of nets can be employed in non-overlapping geographic areas. [Ref. 1:p 16]

The JTIDS signal, within a single time slot, consists of a train of pulses organized into symbols. One pulse consists

		INFORMATION BITS PER SLOT [TERMINAL CAPACITY = Kb/s]	
		WITH EDC	W/O EDC
STANDARD DOUBLE PULSE		$\frac{225}{[28.8]}$	$\frac{465}{[59.5]}$
PACKED 2 SINGLE PULSE		$\frac{450}{[57.6]}$	$\frac{930}{[119.0]}$
PACKED 2 DOUBLE PULSE		$\frac{450}{[57.6]}$	$\frac{930}{[119.0]}$
PACKED 4 SINGLE PULSE		$\frac{900}{[115.2]}$	$\frac{1860}{[238.0]}$

S = SYNC J = JITTER
 H = HEADER P = PROPAGATION
 D = DATA EDC = ERROR DETECTION AND CORRECTION

Figure 4 JTIDS Time Slot Structures

of 5 bits of data in one 6.4 microsecond unit of time in a 13 microsecond symbol or 2 pulses in each 26 microsecond symbol. The latter method still contains 5 bits of data within the two pulses. Each pulse containing the 5 bits are represented by a 32-chip Cyclic Code Shift Keying (CCSK) pattern. The resulting pulse is then Continuous Phase Shift Modulated (CPSM) at a rate of 5MHz. The resultant signal symbols are then interleaved on transmission. Employment of the frequency hopping mode (Mode 1) dictates that each successive pulse is randomly transmitted using one of the 51 available frequencies. In the non-frequency hopping mode (Modes 2, 3 and 4) all pulses are transmitted on 969 MHz. [Ref. 13:p 6]

C. MESSAGE STRUCTURE

Different information capacities are obtained through the use of differing message structures. The differing information capacities can then be matched to the type of information desired for transmission. The standard is the double pulse structure which is the most rugged for operational performance. Some structures enable the time slot to be packed with two or four messages through the use of the single pulse structure or deletion of the jitter or both. Error detection and correction is accomplished through use of the Reed-Solomon method. The error and correction portion of the transmission may be deleted if considered unnecessary, thereby providing additional bits for operational information.

[Ref. 1:p 17]

JTIDS currently uses two message formats. The Interim JTIDS Message Specification (IJMS) and TADIL J message were developed by the JTIDS Message Standards Working Group (JMSWG) of the Joint Interoperability Program for Tactical Command and Control Systems (JINTACCS). Both message formats provide fixed format and free text messages. Additionally, TADIL J provides a variable message format structure. Reed-Solomon data code words are used to embed information for both message specifications. A shortened Reed-Solomon code word is incorporated into the header yielding a 35 bit information header. The header includes the type of message, the source

address of the originator, and security information to decode the transmission. [Ref. 7:p 3]

The IJMS message contains 225 bits within a standard time slot. Message labelling provides 128 possible message formats, only 36 of which have been defined. These messages include position reports, track reports, strobes, special reports and command and control messages. There are a limited number of net management messages available. The entire menu of messages available are based on the JCS Publication 10 set of messages. The data field portion of the message corresponds directly to the JCS Publication 10 data fields, but have been expanded to allow future use. There are only two major exceptions here. The first is the position reference which uses longitude and latitude rather than the rectanglinear coordinate system. The second exception is the basic reference number which is 5 octal digits rather than 4. [Ref. 13:p 8] Figure 5 contains a breakdown of the IJMS Structure.

TADIL J messages consist of one or more 75 bit message words. Four error detection bits, 70 information bits and 1 spare bit are contained in one word. This composition provides a modular message structure allowing single or multiple messages to be transmitted in one time slot. Messages include position reports, track reports, special reports, strobes, weapons control and command and control messages. Message labelling permits 256 message types

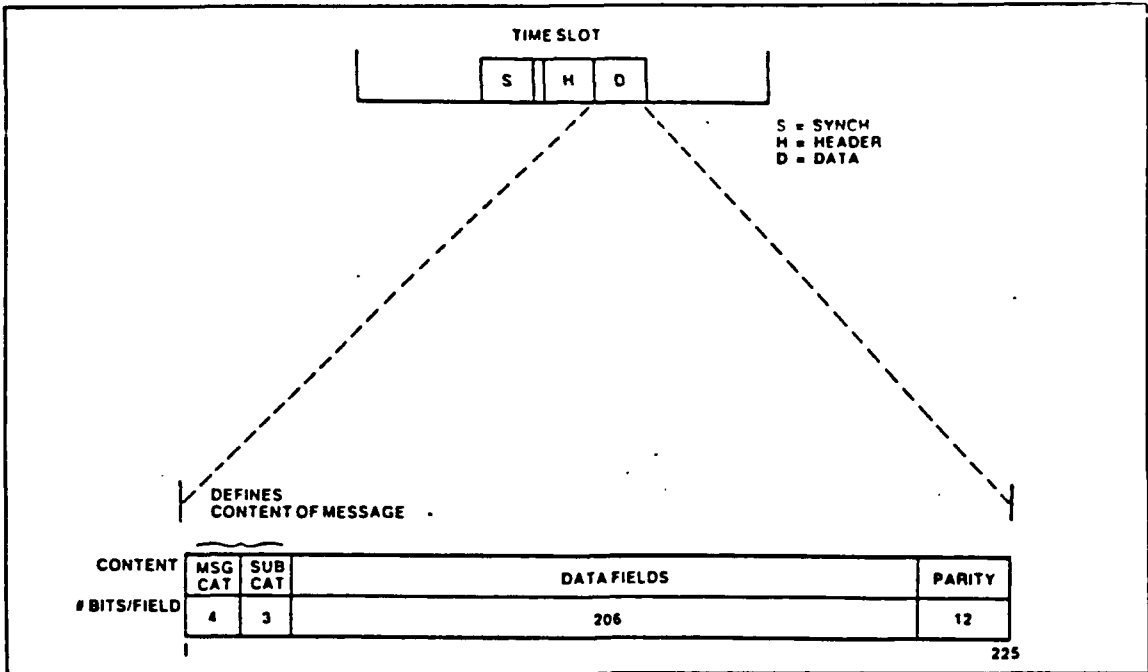

Figure 5 IJMS Message Structure

including a full set of net management messages. The JCS Publication 10 is also the model for TADIL J messages. There is also a variable message format which allows the user to compose messages of varied content and format. [Ref. 7:p 8] Figure 6 contains a breakdown of the TADIL J message format. Interoperability of the two message formats is achieved through a bilingual capability for all Class 2 terminals.

D. INFORMATION DISTRIBUTION

JTIDS' unique architecture and signal structure provide a large number of information distribution techniques which can be designed to meet specific user requirements. Participation groups are formed by pooling time slots. Nets are created by assigning these groups various net access and relay modes.

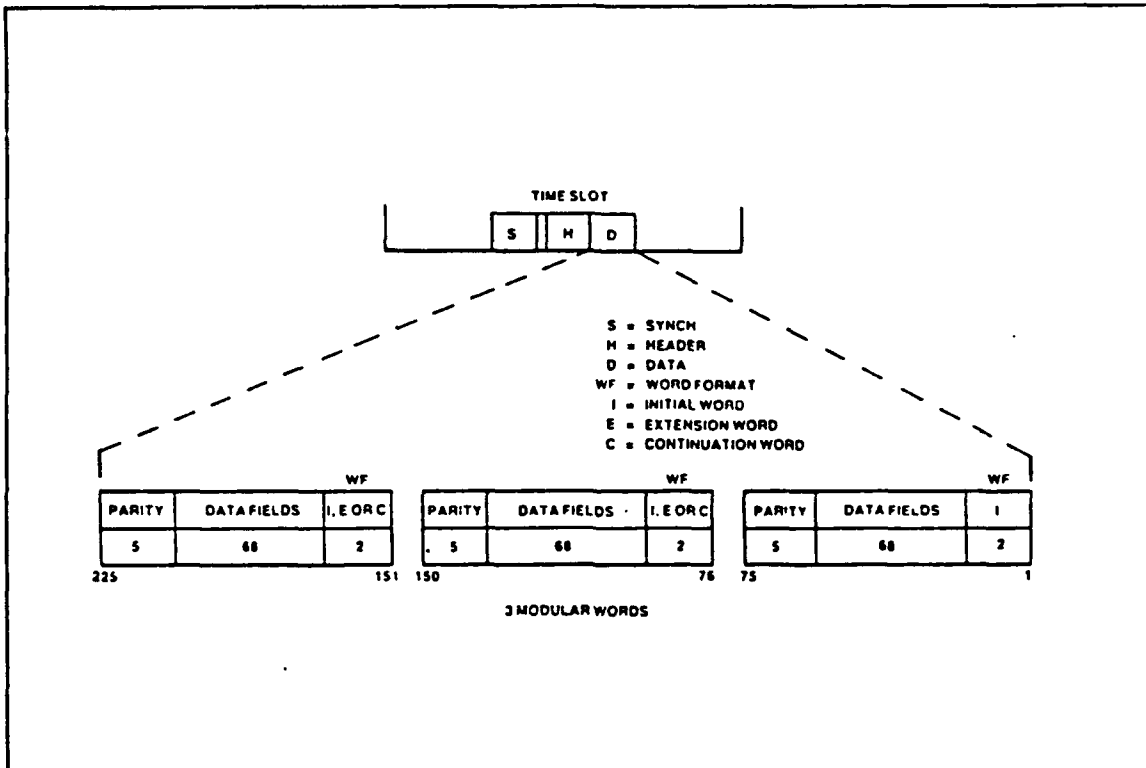

Figure 6 TADIL J Message Structure

Information is thereby distributed to users in the portion required. Information transfer needs are met by creating blocks of 2^n time slots. Various combinations of these structures are designed to meet specific needs.

The system is based on a broadcast receiver oriented structure or a circuit oriented structure. The broadcast receiver oriented structure transmits information without a specific address. Users then listen to all time slots and select only the desired portion of information required. The circuit oriented structure provides a link between two users over specified time slots. These time slots then function as a virtual circuit. The number of time slots employed must

match the desired bit rate of the virtual circuit. [Ref. 1:p 24]

E. RELAY FUNCTION

Basic coverage of the JTIDS network can be extended from 300 nautical miles to a maximum range of 500 nautical miles by retransmitting the message content of the time slots. This is accomplished by retransmitting messages received in one time slot into another specific time slot. This function, when selected, is automatic and is transparent to the user. Two relay techniques may be employed to extend the range of the network. The two methods are paired slot relay and repromulgation relay. [Ref. 1:p 25]

1. Paired Slot Relay

In this relay method one or more sets of time slots are designated as blocks. These blocks are then paired with other blocks of the same size for retransmission. Additional blocks can be linked together when more than one relay hop is desired. Each terminal so assigned can then relay on a conditional or unconditional basis. In the unconditional mode, the designated terminal relays continuously in the designated time slots. In the conditional mode, the terminal relays messages received in the slots designated to be relayed only if that terminal has the best coverage. If there is another terminal with better net coverage, it will serve as the relay terminal. [Ref. 13:p 12]

2. Repromulgation Relay

The originator of the message determines how often the particular message will be relayed and the pattern of time slots that will be used in the repromulgation method. All other designated receivers will be assigned to listen to the pool of slots designated for transmission. The number of successive relay hops is then determined by the receiver. If the designated number of hops has not been reached, the receiving terminal will retransmit the message in the appropriate time slot. If the last hop has been attained, the receiving terminal stops transmission. Within three time slots, the originator can transmit over the same sequence of time slots. Messages transmitted over a given sequence of time slots may be stacked one immediately following another.

[Ref. 13:p 13]

F. ACCESS MODES

A variety of access modes are provided for the JTIDS system. These modes define which terminal can transmit in a given time slot. Access modes are designed to match predetermined information distribution needs. There are three access modes available to network planners.

1. Dedicated Access

In this access mode, specific users are assigned specific time slots for transmission of messages. The time slot remains vacant when the designated user is not

transmitting. The number of slots assigned to a given user will depend upon that user's particular needs. These designated time slots may only be reused in a different geographical area.

2. Contention Access

A block of time slots is designated, in this method, to be shared by a number of users. Each user randomly selects a time slot from the block for transmission. All users within the group listen to the entire block of time slots when not transmitting. The amount of information to be transmitted or the rate at which the information is to be transmitted will determine the number of time slots utilized.

3. Distributed Reservation Access

The final access mode again determines a block of time slots to be shared by a group of users. Sequentially, the users determine how many time slots they will need in the future. Reservation messages are used to identify each user's future requirements. These messages are transmitted in the dedicated access mode. The previous reservation is used to determine the number of time slots remaining for use within the block. In turn, the remaining users transmit their reservation message to the reservation group. This is a cyclic, ongoing process and provides the opportunity for all users to adjust reservations based on changing needs. [Ref. 1:p 27]

G. VOICE

Digitized voice data transmission is incorporated as a function of the JTIDS system. The audio signal is digitized into a bit stream which is then divided into time intervals which correspond to time slot lengths. Transmission then occurs in periodic time slots. The periodic time slots are received at the designated receivers and are recombined into the digitized voice bit stream. A voice digitizer in the terminal returns the audio signal. The use of JTIDS error detection and correction will depend upon the error correction function that is present in the voice digitizer.

Time slot blocks are designated as voice channels and can be placed in parallel on a multinet or single net configuration. Voice channels are defined by the particular net and block of time slots selected. Voice may then be relayed beyond line-of-sight transmission in the same manner as digital data [Ref. 13:p 29]. Figure 7 contains a representation of JTIDS voice transmission.

Voice channels can be operated under half duplex or full duplex protocols. In half duplex, the user utilizes the listen before talk (push-to-talk) method. All members of the net are assigned to the same block of time slots. Transmission is controlled by the user initiating communications only when no one else is talking. Receivers will receive only the nearest terminal when more than one terminal transmits at the same time. In the full duplex mode,

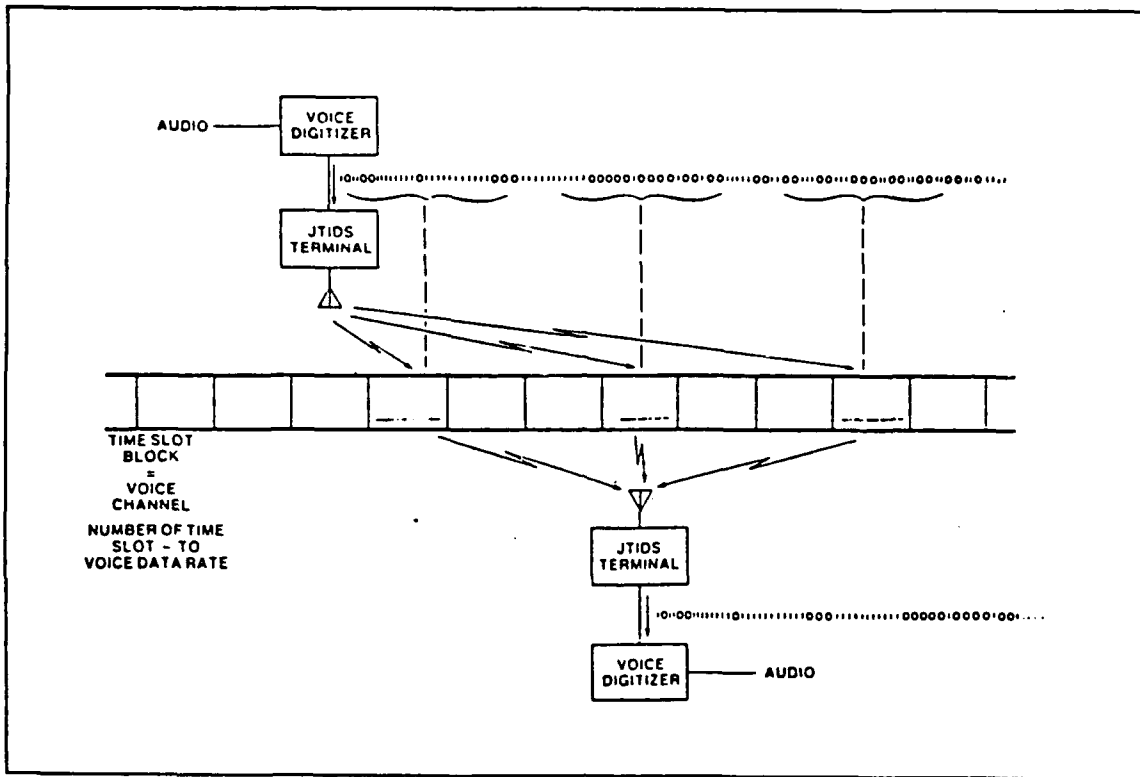

Figure 7 JTIDS Voice

two blocks of time slots are designated; one for transmission and one for reception. [Ref. 1:p 33]

H. POSITION LOCATION

The JTIDS system provides the capability for position location. This capability enables a JTIDS equipped platform to locate itself with a high degree of accuracy. Measuring the time of arrival of position reports from other JTIDS participants determines a platform's position location. A given terminal synchronizes with the system time. The terminal then determines position location based on the propagation time of position messages between the transmitter

and itself. The propagation time and the transmitter's reported position permits the terminal to determine its range from the transmitter. Similar measurements are taken from other transmitters or subsequent transmissions from the first transmitter. These measurements are used to triangulate the terminal's position. Once the terminal's position location has been accurately determined, it will periodically transmit position reports for other platforms to use. [Ref. 1:p 35]

I. IDENTIFICATION

Periodic secure position and identification messages are transmitted to provide direct identification among all platforms equipped with JTIDS. Position location and command and control functions are also supported with these messages. JTIDS position and identification messages that are received can be verified against radar tracks and/or intelligence information. The periodicity of reporting can be varied to coincide with the needs of the platform. An aircraft will be required to broadcast its identification and position much more often than a ground station. [Ref. 1:p 37]

J. CLASSES OF TERMINALS

There are three classes of terminals that are each designed to meet the requirements of a general grouping of users:

- **Command and Control Users.** The Class 1 Terminal is designed for use in large airborne and ground based command and control elements.
- **Small Platform Users.** The Class 2 Terminal is designed for use in small command and control elements and some tactical aircraft.
- **Missile and Manpack Users.** The Class 3 Terminal is being designed for use with very small units including manpacks, missiles and voice-only uses. [Ref. 1:p 41]

1. Class 1 Terminal

The Class 1 command and control terminal is designed for use in U.S. and NATO E-3As, NATO air defense C² systems and in the JTIDS Adaptable Surface Interface Terminal (ASIT). The terminal can operate in all four JTIDS modes. It processes only the standard JTIDS message format. Both the normal and extended range modes may be employed. The Class 1 terminal can operate as a Net Time Reference station, but does not have a position location function. It may function as a position reference station with an external position data source. The terminal can transmit in only one net and can receive on a maximum of three different nets. The message format used is the Interim JTIDS Message Standard (IJMS). The unit weighs 400 pounds and occupies 6.5 cubic feet of space. It is rack mounted to enable employment with the various users it supports. [Ref. 14]

2. Class 2 Full Scale Development Terminal

The Class 2 (FSD) terminal is designed for small platform users. The terminal contains an Interface Unit (IU)

which allows integration with a large number of diversified platforms. Versions are currently available for the F-14 and F-15 tactical aircraft and some Army elements.

The Class 2 terminal can operate in TDMA modes 1,2 and 4. Mode 3 is not operationally required for the terminal. It processes the TADIL J message structure and can process either the single or double pulse waveforms. Normal and extended range modes can be employed. The terminal can transmit and receive on any JTIDS net. The terminal also has a position location capability and a Continuous Variable Slope Delta (CVSD) voice capability. An analog-digital conversion may be employed outside the terminal to accommodate other voice rates. Incorporation of a TACAN function into the Class 2 terminal eliminates the need for separate aircraft TACAN equipment.

A bilingual capability allows the Class 2 terminal to communicate with all Class 1 terminals which employ the IJMS message standard. All IJMS messages that are sent by existing IJMS terminals can be received and transmitted by the Class 2 terminal. Software in the Subscriber Interface Computer Program translates IJMS messages into TADIL J message for use by the Class 2 user. It also translates TADIL J into IJMS for transmission into the net. Users of Class 2 terminals can determine which messages that are received will be translated and whether IJMS, TADIL J or both message standards will be used for transmission. [Ref. 14]

JTIDS information is displayed on the Multi-Purpose Color Display (MPCD), a five inch, four color graphic screen located in the combat aircraft's cockpit. The unit presents JTIDS data, armament data, and Built-in-Test (BIT) information based on the pilot's selection. A graphic air situation is presented with a choice of six display options (net, subnet, identification, hostile SAM, corridor and route). Any combination of options may be selected. JTIDS displays are in color to identify the data presented. Green represents friendly objects, white represents text, red represents hostile objects, and yellow indicates points and paths. A typical display consists of friendly and hostile tracks with a range scale determined by the pilot. [Ref. 1:p 104-110] Figure 8 depicts the MPCD.

3. Class 2M Terminal

The Class 2M terminal is being designed to meet specific requirements of the Army's air defense C² elements. The terminal will replace the TADIL B link between the Control and Reporting Center (CRC) and the Brigade Fire Direction Center (BDEFDC). This terminal will also replace all ATDL-1 data links between Army air defense C² units.

The Class 2M terminal is bilingual and processes both the IJMS and TADIL J message protocols. It has an automatic relay capability, relative navigation feature and an over-the-air rekeying capability. The terminal generates 200 watts of

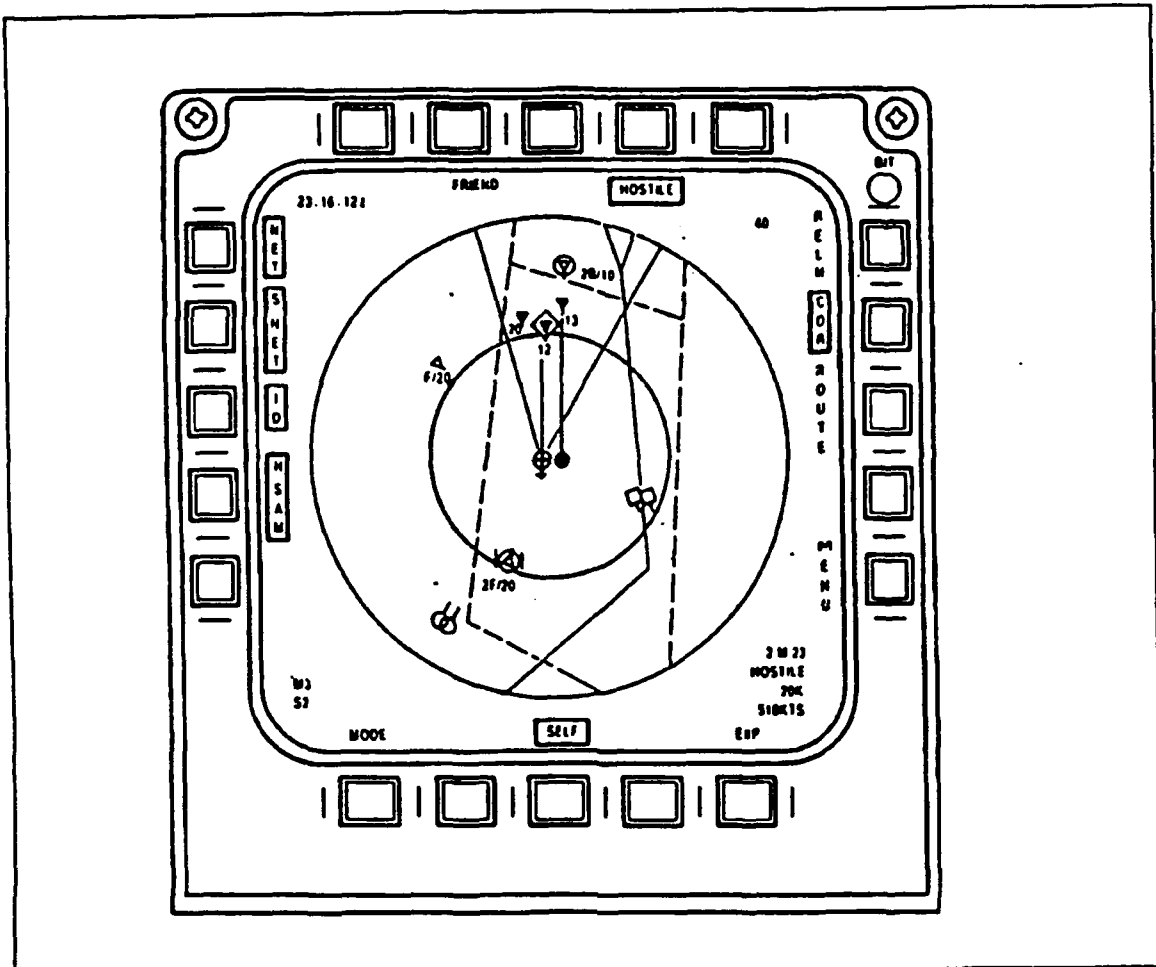

Figure 8 JTIDS Multi-Purpose Color Display

output power, has a volume of 1.3 cubic feet and weighs 93 pounds.

This version of the JTIDS Class 2 terminal has a number of unique characteristics. The Class 2M terminal utilizes the X.25 protocol to control all input and output interfaces. A broadcast connect status indicator is also unique to the 2M terminal. The TACAN function was eliminated from the terminal as the Army had no requirement for this function. The most significant difference associated with the

Class 2M terminal is its lack of the digital voice capability. The terminal has no ability to participate on the digital voice channel of the JTIDS net to which it is assigned. [Ref. 15]

4. Class 2H Terminal

The Class 2H terminal is under development to meet the needs of the Navy E-2C and C² elements. It will also replace Class 1 terminals previously fielded to Air Force E-3A AWACS aircraft. The terminal was approved to meet requirements for extended transmission range.

The 2H terminal has a transmission output power of 1000 watts. This increased power capability greatly extends the terminal's range of transmission. The terminal processes both message protocols. It has an automatic relay capability and relative navigation feature. The navigation feature provides a new capability to the E-3A AWACS. The terminal has a TACAN capability and over-the-air rekey function. It's volume is 5.2 cubic feet and weighs 340 pounds. [Ref. 15]

5. Class LV Terminal

The Low Volume terminal is currently in the concept development stage. It is being designed to meet requirements under the third phase of JTIDS development. This terminal is to be employed with manpacks, missiles and very small C² elements.

The LV terminal has the same basic capabilities as the Class 2 series of terminals. These capabilities include 200 watts of output power, bilingual message protocol processing, automatic relaying, digital voice, TACAN and over-the-air rekeying. The major difference in this terminal is its size. The LV terminal's volume is 0.6 cubic feet and weighs 64 pounds. It also has a lower data processing capability. [Ref. 15] Table 7 contains a summary of terminal capabilities.

TABLE 7 JTIDS Terminal Capabilities

CHARACTERISTIC	TERMINAL CLASS DESIGNATOR				
	1	2	2H	2M	LV
VOLUME (Cu. ft.)	6.5	1.6	5.2	1.3	0.6
WEIGHT (lbs)	400	130	340	93	64
OUTPUT POWER (watts)	200 & 1000	200	1000	200	200
BIT RATE (kbps)	30/60/11 5	115/238	115/238	115/238	115/238
MESSAGE PROTOCOL	IJMS ONLY	IJMS & TADIL J	IJMS & TADIL J	IJMS & TADIL J	IJMS & TADIL J
I/O INTERFACE	1553A	1553B	1553B	X.25	1553 & OTHERS
BROADCAST CONNECT STATUS	No	No	No	Yes	No
AUTO RELAY CAPABILITY	Yes	Yes	Yes	Yes	Yes
INTEGRATED VOICE	Yes	Yes	Yes	No	Yes
RELATIVE NAVIGATION	No	Yes	Yes	Yes	Yes
TACAN CAPABILITY	Yes	Yes	Yes	No	Yes
KEY VARIABLE QUANTITY	4	8	8	8/64	TBD
KG INSTALLATION	External	External	External	Internal	Internal
OVER-THE-AIR INITIALIZATION	TSA	TSA	TSA	FULL	TSA
OTAR CAPABILITY	Yes	Yes	Yes	Yes	Yes
PACKAGING	3 BOX	2 BOX	3 BOX	1 BOX	1 BOX

CHAPTER III. NETWORK MANAGEMENT

A. DEFINITION

Network management of JTIDS is the process of directing the use of specific terminal capabilities and net configurations to meet mission requirements. Appropriate terminal parameters are selected for each member terminal. Transmission requirements for each platform are met through assignment of appropriate time slots. Compatible initialization parameters are determined to ensure terminal communications. In addition, network support functions must be assigned (i.e. Terminals designated to serve as Net Time References). This broad scope of activities is referred to as Network Management. [Ref. 1:p 33]

B. NETWORK MANAGEMENT OVERVIEW

The required exchange of information among network participants is met through the development of network designs, by the JTIDS system manager. These network designs can range from simple Class 1 terminal networks to more complex networks containing both Class 1 and 2 terminals. A network involving only Class 1 terminals is described, followed by a description of network management of a more complex system incorporating both terminal types.

1. Class 1 Terminal Network

Current implementation of Class 1 JTIDS networks involve E-3A AWACS and Control and Reporting Centers (CRCs). The operation of a JTIDS network can be conceptualized as a "data bus in the sky." This analogy represents the technology of Time Division Multiple Access (TDMA). Under TDMA, each user is assigned specific time slots in which to transmit. Computers, internal to each terminal, receive their time slot assignments through the loading of software parameters. The software directs time slots that will be used for transmission by the terminal. Every time slot contains a series of pulses, each of which can encode 225 bits of formatted data or 465 bits of free text information. 128 time slots are available every second to users in a JTIDS net. All terminals listen to the net when they are not transmitting. This reception occurs automatically and is the default condition of the Class 1 terminal. The JTIDS Class 1 network is a receiver oriented communications system. Each terminal receives all transmitted information on the network. The individual user then filter the information as necessary to meet their requirements.

[Ref. 1:p 16]

A Class 1 terminal only network contains a single net. It is not capable of participating in networks where multiple nets are operating simultaneously. Multiple nets are developed through the use of frequency division multiplexing. All members of a Class 1 network operate on a single

frequency, therefore multiple nets are not possible. [Ref. 5:p 2] Figure 9 represents JTIDS single net operations.

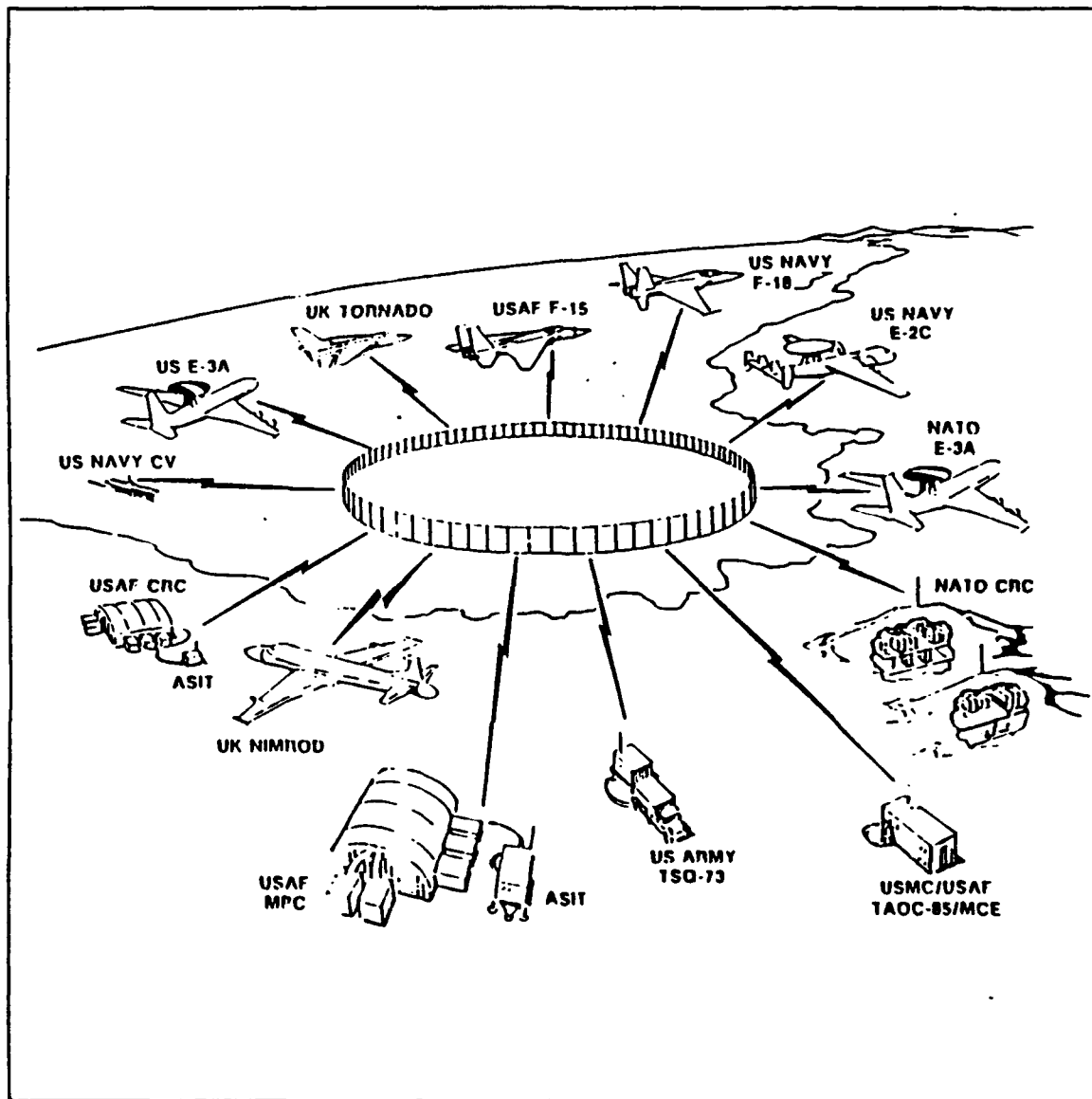

Figure 9 JTIDS Single Net Operations

The Class 1 network makes use of a cryptovisible pair. This is the normal mode of operation, although any terminal may operate without encrypting transmitted messages.

All messages are encrypted for transmission and decrypted for reception through use of the current cryptovvariable. The transmission frequency appears to be a random series of pulses to any receiver not possessing the cryptovvariable. Class 1 terminals are loaded with only two cryptovvariables. The first cryptovvariable is used for the first day of operation. At the end of the 24 hour period, the first variable is destroyed by the terminal and the second variable is selected for the next day's use. The terminal is loaded with a new pair of cryptovvariables upon completion of the second day. There is no confusion on the Class 1 net as to which variable is in use during any given time period. [Ref. 5:p 3]

Messages are segregated by the transmitting Class 1 terminal. Only three classes of messages exist for this purpose. The message classes are P messages which carry the transmitter's identity, status and position, all other data messages, and voice messages. Each class of message is designated for transmission in specific time slots. Any receiver in the net can select a specific class of messages and ignore the rest. The terminal must listen to all incoming messages and then screen them for the desired information. [Ref. 13:p 12]

Time slots are assigned to a specific Class 1 terminal in groups called time slot blocks. The number of time slots contained in a time slot block must be an integral power of two. A terminal can be allotted a time slot block which may

contain one time slot, two slots, four slots, eight slots, etc. For example, if a terminal requires 24 time slots per 12 second JTIDS frame for data transmissions it would be assigned one time slot block of 16 time slots and one block of 8 time slots. A terminal may be assigned a total number of time slots not equal to a power of two by assigning several time blocks whose sum of time slots is greater than or equal to the desired number of slots. Terminals requiring 22 time slots per frame, which is not a power of two, would be assigned the same blocks of time slots as above. This would result in two extra slots per frame. Class 1 terminals may be assigned a total of four time slot blocks, one is for P messages and the remaining three for data transmission. Additionally, the terminal can be assigned one block for digital voice and as many as six pairs of smaller blocks for transmission relay. Each time slot block requires only four initialization parameters. The first three parameters identify a specific time slot block. The final parameter identifies the class of message that will be transmitted in that block. [Ref. 1:p 43]

Class 1 terminals have relatively few features which need to be enabled or disabled during initialization. Selection of normal or extended range mode is an example of one of these features. The net manager may select the extended range mode which would reduce that terminal's anti-jam capability due to a reduction in the anti-jam provision of the transmitted signal. This assignment of terminal

capabilities requires that choices be made by the network manager of initialization parameters that will result in the desired JTIDS network. The default condition of the Class 1 terminal is "receive only." This condition reduces the workload for the network manager because each time slot not specifically assigned will automatically default to the receive conditions. There are only 15-20 parameters that must be selected to implement this network. [Ref. 5:p 13]

In summary, the network manager's tasks to implement a Class 1 network are as follows:

- Allocation of time slots to terminals.
- Selection of implemented features.
- Assignment of initialization parameters.

The network manager must ensure that all parameters are distributed to terminal operators, that they are properly loaded and validated, and that the network performs properly during operation. Any changes are made on the ground by the network manager and are loaded into individual terminals as the users return to base or are couriered to other ground units. These responsibilities will remain consistent for multiple nets involving Class 1 and 2 terminals.

2. Class 1 and 2 Terminal Networks

A Class 1 terminal only network provides increased capabilities to air battle participants over non-JTIDS equipped participants. The network is receiver oriented and

is therefore highly flexible. This network configuration allows significantly reduced preplanning regarding design of a JTIDS network. Data distribution requirements at the theater level have dramatically increased the demand for JTIDS communication capabilities. Numerous capabilities have been incorporated into the Class 2 series of terminals to meet these increased requirements. The complexity of network design has increased with each new capability. [Ref. 5:p 5]

Employment of Class 2 terminals in a JTIDS network meets the required increase in network capacity. A JTIDS terminal is assigned specific time slots in which to transmit. Narrow band jamming is defeated by pseudo-randomly selecting a new frequency for each pulse transmitted. The process of selecting frequencies is part of the encryption process, preventing the enemy from ascertaining the pattern of frequency hopping. Selection of different frequency hopping patterns allows the simultaneous operation of multiple JTIDS nets. [Ref. 1:p 16]

Multiple nets are produced by assigning unique time slots to each terminal with a unique frequency hopping pattern. A terminal transmits data pulses during its assigned time slots under its frequency hopping pattern. A second terminal transmits its data pulses over a second frequency hopping pattern. Any terminals desiring receipt of the first terminal's transmission are set to the first terminal's frequency hopping pattern. The same requirement exists for

those terminals wanting to receive the second terminal's transmission. Each frequency hopping pattern is referred to as a net. Class 2 terminals can select up to 128 different nets (0-127) for transmission or reception. Net 127 is usually designated for network management. [Ref. 13:p 32]

Class 2 terminals are capable of transmission or reception on any net in any time slot. However, the terminal can only be on one net during one time slot at any given period in time. It is therefore imperative that network managers ensure that no terminal needs to be on two nets during the same time slot. In this event, network designers will determine which data on the network is of interest to small groups of users. If more than one such information exchange requirement exists, different nets will be established during those same time slots. For example, separate nets will be established for surveillance, Army ADA track status, aircraft engagement status, etc. [Ref. 4:p 21]

Design of multi-net operations makes it vital for Class 2 terminals to have the same frequency hopping pattern. The terminals must therefore be initialized with the same net number for the desired time slot and the same cryptovvariable to be used in that time slot. The cryptovvariable key randomizes the frequency hopping pattern so that when terminals select the same net but are using different cryptovvariables the terminals will be following a different pattern for frequency hopping. The network designer can then

assign a specific terminal to operate on a particular net during time slots in which information is available that the host platform can utilize. The terminal can then operate on other nets during the remaining time slots. [Ref. 1:p 43] Figure 10 represents multiple net operations.

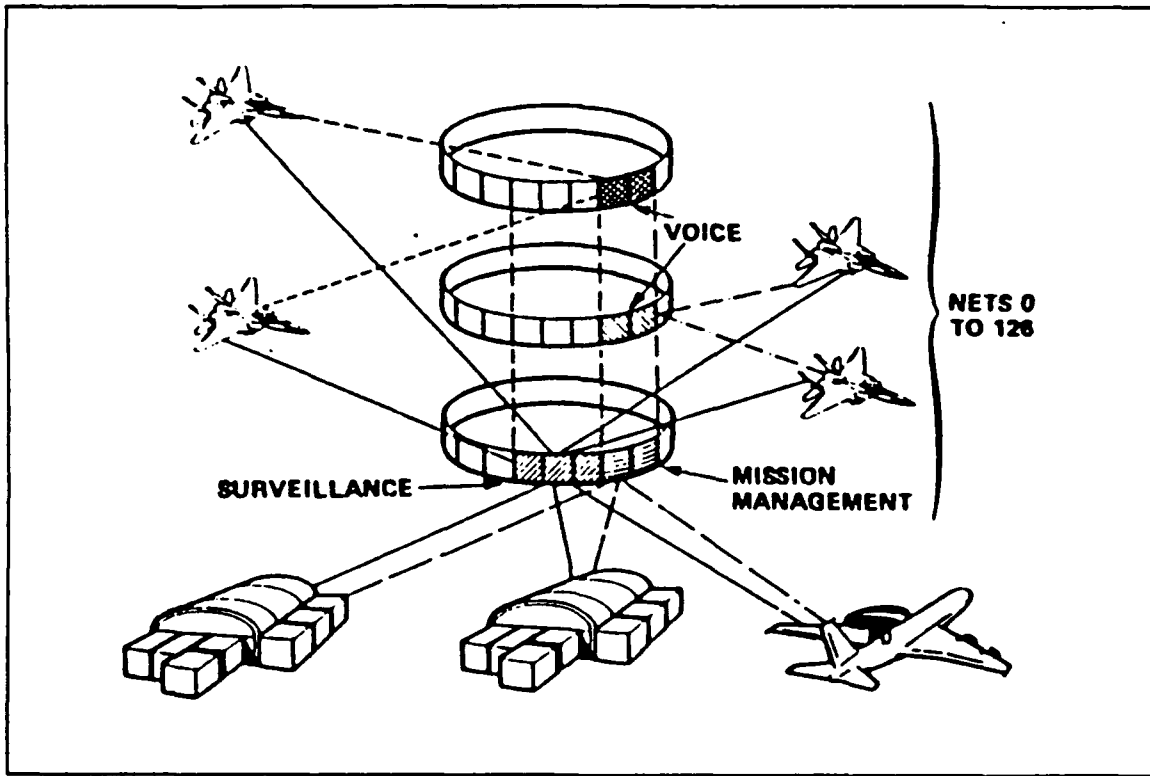

Figure 10 JTIDS Multinet Operations

It is important to note that Class 1 terminals transmit all of their data during blocks of time slots. The Class 1 terminal will transmit messages, regardless of their type, during the next available time slot block. These message categories can include surveillance, control and mission management messages. Any user requiring only a

specific category of messages would have to listen to all Class 1 transmissions to ensure reception of the desired information. This limitation was eliminated in the Class 2 series terminal design by having each message category assigned to a specific time slot. [Ref. 5:p 6]

Eighteen different subject categories were designed into the Class 2 terminal to overcome Class 1 limitations. The subject categories are referred to as Network Participation Groups. There are also 480 categories of potential message distributions, known as Needline Participation Groups. The Class 2 terminal initialization process directs time slots to be selected specifically for each category of messages to be transmitted. For example, surveillance information is directed to be transmitted in specific time slots on net 0 and control messages are to be transmitted on net 5 during a different set of time slots. Any terminal requiring receipt of this surveillance information must be directed to listen to net 0 during the appropriate set of time slots. All terminals that are required to transmit surveillance information are assigned time slots on net 0 for this purpose. All JTIDS members that require surveillance information will be assigned to listen to all time slots on net 0 which contains surveillance information. These time slots will coincide with the set of time slots assigned for surveillance transmission.

Transmitting terminals will also be directed to listen to all other surveillance transmissions on net 0. [Ref. 5:p 7]

This design process continues for the development of subsequent nets. It is the network designer's responsibility to ensure that each JTIDS participant is able to transmit and receive all assigned information in time slots that are mutually exclusive. This higher level network is no longer receiver oriented. Each terminal must know when it is to transmit and on which net. The terminal must also be told when and where it is to listen. [Ref. 13:p 29]

The Class 1 terminal is of a simpler design and only uses one cryptovisible pair for transmission. Multiple cryptovisibles are available on the Class 2 terminal during any given time slot. Therefore the Class 2 terminal must know which cryptovisible is to be used in which time slot. In addition, the Class 2 terminal has a great many more features than the Class 1 terminal. The Class 1 terminal's default condition has widespread utilization in a Class 1 terminal only network. The Class 2 terminal's default condition has very limited utilization in the mixed terminal network. [Ref. 13:p 55]

The increased number of features on the Class 2 terminal facilitates more initialization parameters. The parameters enable the terminal to determine which function is to be performed in any given time slot. Initialization parameters will assign appropriate time slots for

transmission, preset selected Class 2 features and establish self-test functions. [Ref. 13:p 9-2]

The parameters are divided into three categories based on the support group that is responsible for their implementation. Working parameters involve feature selection and selection of options available to the network designer. They are the only parameters under the control of the network designer/manager. Test parameters tell the terminal which test data is to be collect during operation and where it is to be stored. The third category consists of fixed parameters. Fixed parameters are associated with a particular host platform and are predetermined by the development community. [Ref. 5:p 8] Figure 11 displays the process of initialization parameter generation.

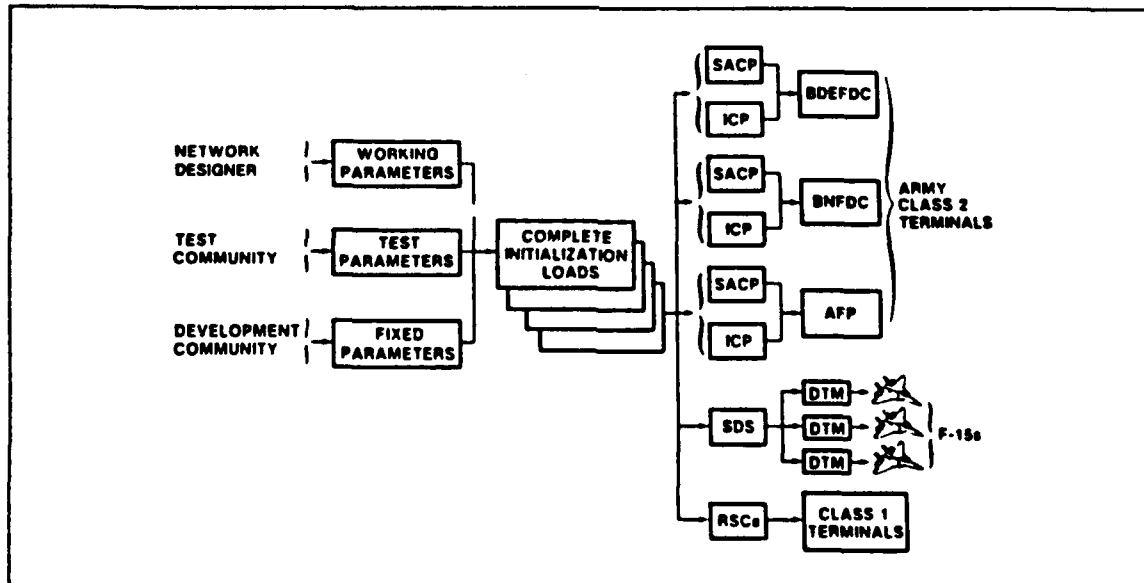

Figure 11 Terminal Initialization Load Generation

Numerous devices are used to load initialization parameters into each of the terminals. The Stand Alone Control Panel (SACP) and the Interface Control Panel (ICP) are used to load the Army's Class 2M terminal. The Software Development Station (SDS) is used to set initialization parameters which are loaded into a number of Data Transfer Modules (DTMs). The DTMs have battery powered memories which store the designated parameters. Tactical aircraft pilots carry the DTM to their aircraft and load the parameters into the aircraft's control panel. The Class 1 terminal is loaded through operator entries on the Radio Set Control (RSC) panel. [Ref. 5:p 8-9]

Multiple net operations are now possible with the introduction of the Class 2 terminal. A great deal of flexibility in network design has also been achieved, but this has been accomplished at the cost of greatly increased complexity of design. The network designer must understand the information requirements of the users he is supporting. The designer must also know who must communicate with whom and what type of information is to be exchanged. Correct network design choices will ensure all appropriate communication channels are established.

C. NETWORK DESIGN FOR JTIDS JTAO

A JTIDS network is designed to support the tactical communication requirements of the joint air defense system,

known as the Joint Tactical Air Operations (JTAO) system. Air Force command and control elements receive JTIDS service through Class 1 terminals located in Adaptable Surface Interface Terminals (ASITs). The ASIT can be deployed directly to a Command and Reporting Center (CRC) or to a Message Processing Center (MPC) which services the CRC via a TADIL B data link. The E-3A AWACS also contains a Class 1 terminal, but the ASIT is not required. The Army C² portion of the JTAO is the HAWK Brigade Fire Direction Center (BDEFDC). These C² elements employ the Class 2M terminal to direct accomplishment of the defensive counterair (DCA) mission. The Air Force CRC is the primary player in joint tactical air operations. The CRC generates and receives surveillance data, assigns engagement missions to organic aircraft, and coordinates with Army HAWK missile elements. The E-3A aircraft provides surveillance information and may act as the CRC when the situation warrants. The BDEFDC assigns engagement missions to its Assault Fire Platoons (AFPs) via the Battalion Fire Direction Center (BNFDC) (This will be discussed in detail in Chapter IV). [Ref. 14]

The JTIDS Main Net, designated as net 0, is the medium for exchange of surveillance information. Since Air Force C² elements are equipped with Class 1 terminals, IJMS is the message format used on the Main Net. Tactical aircraft monitor the Main Net to establish an air situation picture. All JTIDS members transmit P messages into the Main Net.

Control messages, status reports and assignment acknowledgements are also exchanged on the Main Net. A subnet is established for tactical aircraft to exchange organic data track data and to provide digital voice. [Ref. 13:p 11-2]

Information exchange can occur between tactical aircraft and Army air defense elements. The TADIL J message format can now be used because a subnet can be established without Class 1 terminal participants. Use of TADIL J permits the expansion of multinet operations. [Ref. 13:p 11-7]

D. ARMY NET MANAGEMENT

1. Means of Employment

Army development of JTIDS surfaced a unique deployment difficulty that was not encountered by other services. JTIDS communication means require line of sight transmission. This factor was not a significant problem to airborne platforms. However, ground army air defense units often encounter terrain that requires precise engineering to ensure a proper signal to noise ratio (i.e. Europe and Korea). The Army has developed two automated tools to meet engineering requirements. These tools will enable network managers to surpass anti-jam margins, site relays for maximum effectiveness and manage cryptovvariable keys. [Ref. 15]

The Net Control Station JTIDS (NCS-J) was designed to provide automated net management and technical control. The NCS-J generates initialization data and cryptovvariables for

automatic over the air initialization and rekeying. It can implement alternate routing schemes and can support physical distribution of either initialization or cryptovvariable data. The NCS-J will provide an interface to its parent System Control (Syscon) organic to the division signal battalion. [Ref. 16:p 6]

The second net management tool developed by the Army is the Dedicated JTIDS Relay Unit (DJRU). The DJRU was specifically developed to enhance network connectivity in difficult terrain. It relays JTIDS line of sight transmissions between Army Class 2M terminal users. It acts as the interface to the Army air defense host system via the PLRS-JTIDS Hybrid Interface (PJHI). The Army's Position Location and Reporting System (PLRS) will be discussed in Chapter IV. The DJRU can function as an NCS-J with the addition of a cryptographic keying device. The Host System is the Army Air Defense Artillery's (ADA) Class 2M terminal platform. It provides a high data rate, high anti-jam and low probability of intercept data link. It can accept full terminal initialization over the air from the NCS-J. The system also provides host status information to the NCS-J. [Ref. 16:p 22] Figure 12 depicts the two Army net management tools and the ADA's Host System.

MAJOR COMPONENTS

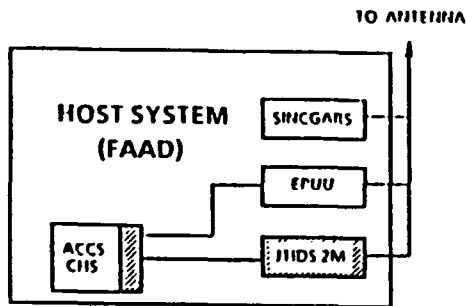
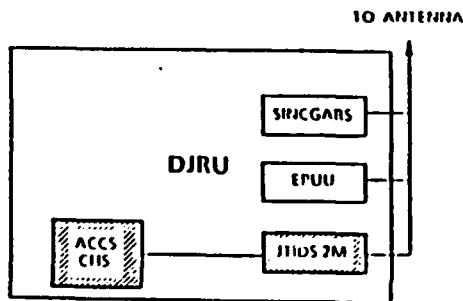
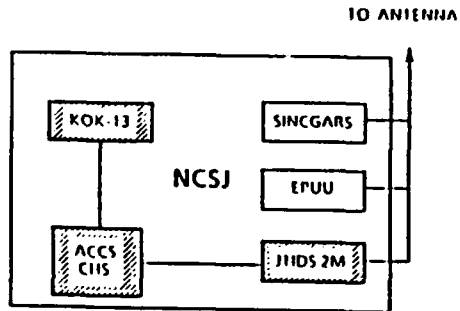

ACRONYMS

Army Command and Control System (ACCS CHS)

Enhanced PLRS User Unit (EPUU)

CAPABILITIES

Net Control Station JTIDS (NCSJ)

- Overall system control and monitoring of the JTIDS communication system
- Provides over-the-air rekey of cryptovariables
- Provides over-the-air initialization of all network members
- Verifies receive signal strength on all network links
- Can assume control over existing net

Dedicated JTIDS Relay Unit (DJRU)

- Enhances network connectivity in rugged terrain
- provides remote interface (up to 1 km) to Host System via PJ111 (X.25)

Host System (JTIDS Communication Portion Only)

- Provides high data rate, high anti-jam and low probability of intercept data link
- Accepts full initialization over the air from NCSJ or locally from ACCS CHS
- Provides host status information to the NCSJ

Figure 12 Army JTIDS Communication System

2. Army JTIDS Network Employment

All of the Army's network design and management of JTIDS is centered around the NCS-J. The NCS-J develops the initial network design off line; either while it is in garrison or prior to its establishment within the net. The station makes use of preplanned Rapid Load (RL) files to create an overall mission file. The RL files are organized under a menu driven database. This database contains a standard set of initialization parameters for all JTIDS users, tailored to specific units (i.e. Heavy, Light, Airborne, HIMAD (HAWK or PATRIOT), etc.). The stored parameters include all 64 initialization blocks which can be updated over the air by the NCS-J. The NCS-J then validates the employment plan and resolves any conflicts. Mission unique RL files are generated and distributed to all network members. [Ref. 13:p 11-9]

The NCS-J's next task is to plan for an area grid system deployment. A terrain analysis is performed for the unit's area of operation. Line-of-sight signal path profiles are made to ensure network connectivity. Precise path engineering is necessary to guarantee that the anti-jam margin is met. Once initial locations are determined, the terminals are deployed throughout the area of operations. [Ref. 13:p 11-10]

Once deployment is accomplished, the NCS-J transmits initialization parameters to all Class 2M terminals in the

net. It performs link anti-jam margin verifications and evaluates the results. Links that are determined to be susceptible to jamming are corrected. The NCS-J continues to monitor and maintain the network. The station repeatedly performs network design tasks to redeploy network assets due to significant changes in the air battle. [Ref. 13:p 11-11]

All NCS-J functions are controlled by the Division Signal Battalion System Control (Syscon). The Syscon coordinates with the Air Battle Management Operations Center (ABMOC) of the Forward Area Air Defense (FAAD) Battalion S-3. The Division G-3 staff plans the battle based on the Division Commander's concept of the operation. The Division G-3 tasks subordinate units as required. The air defense portion of the battle is tasked through the ADA Liaison Officer (LNO) to the ABMOC. Communication requirements are tasked through the Assistant Division Signal Officer (ADSO) to the Division Signal Battalion. At Corps level and above the NCS-J and DJRUs are organic assets of the air defense community and are controlled directly by the ADA. [Ref. 16:p 31] Figure 13 depicts Division JTIDS network management.

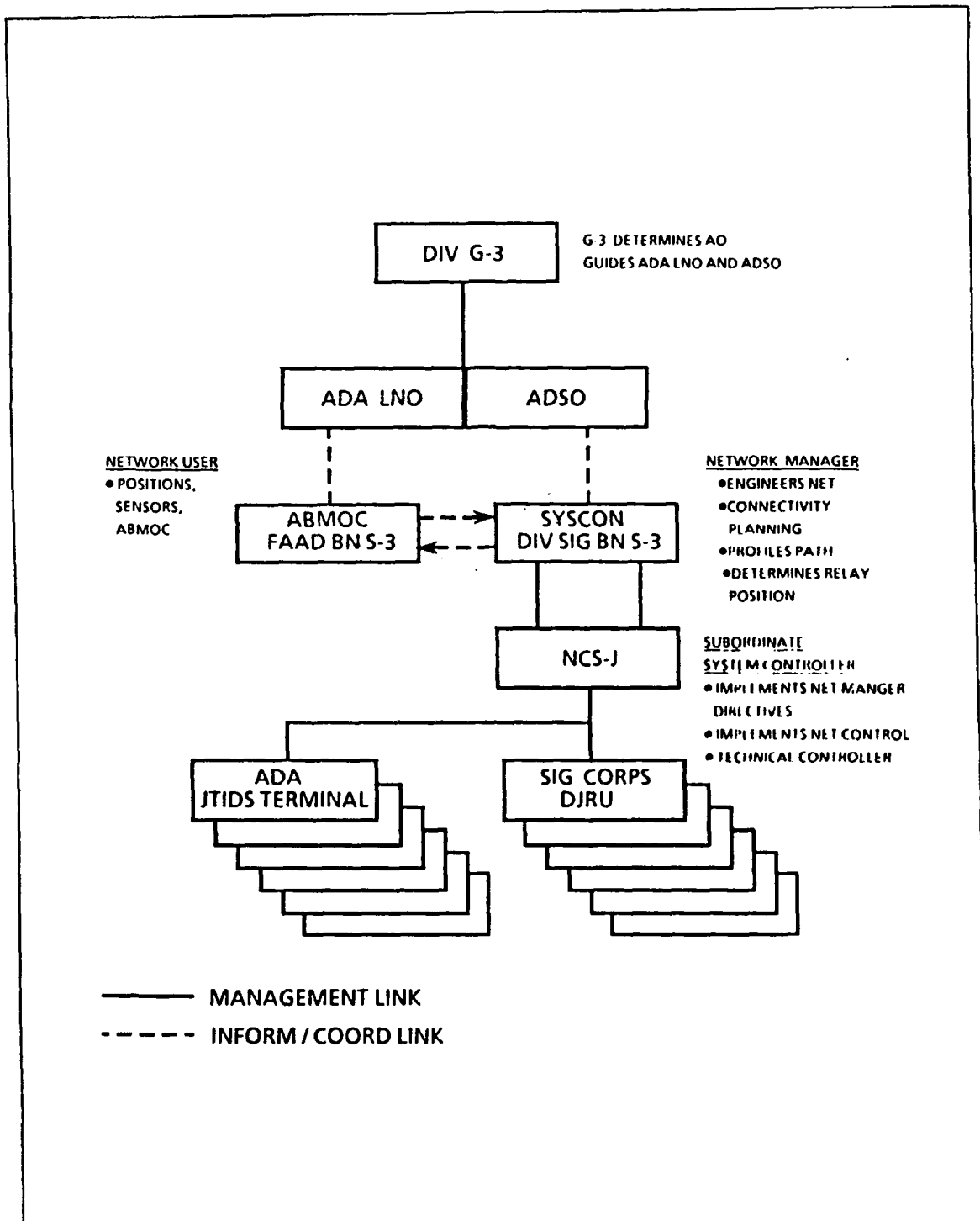

Figure 13 Division JTIDS Network Management

CHAPTER IV. CONCEPT OF OPERATIONS

A. JCS JOINT CONCEPT OF OPERATIONS

1. Current Joint Tactical Air Operations

Discussion of information exchange in current Joint Tactical Air Operations (JTAO) is essential to understand the improvement derived from the incorporation of JTIDS into our air defense systems. The system used by the Air Force to perform tactical air operations is the Tactical Air Control System (TACS). This system is a transportable command and control system which can be employed world wide. It is used to plan, direct and control U.S. air forces and to coordinate air activities with sister services and our NATO allies. [Ref. 5:p 3]

The TACS consists of a number of automated control elements. These elements include the Control and Reporting Centers (CRCs), Message processing Centers (MPCs), Control and Reporting Posts (CRPs) and the E-3A surveillance aircraft. Additional surveillance data is provided by Forward Air Control Posts (FACPs) and input to the CRC/CRP. The connections existing currently between these elements are depicted in Figure 14. A JTIDS capability will be provided to the CRCs, CRPs, MPCs and E-3As in the initial fielding. [Ref. 5:p 4]

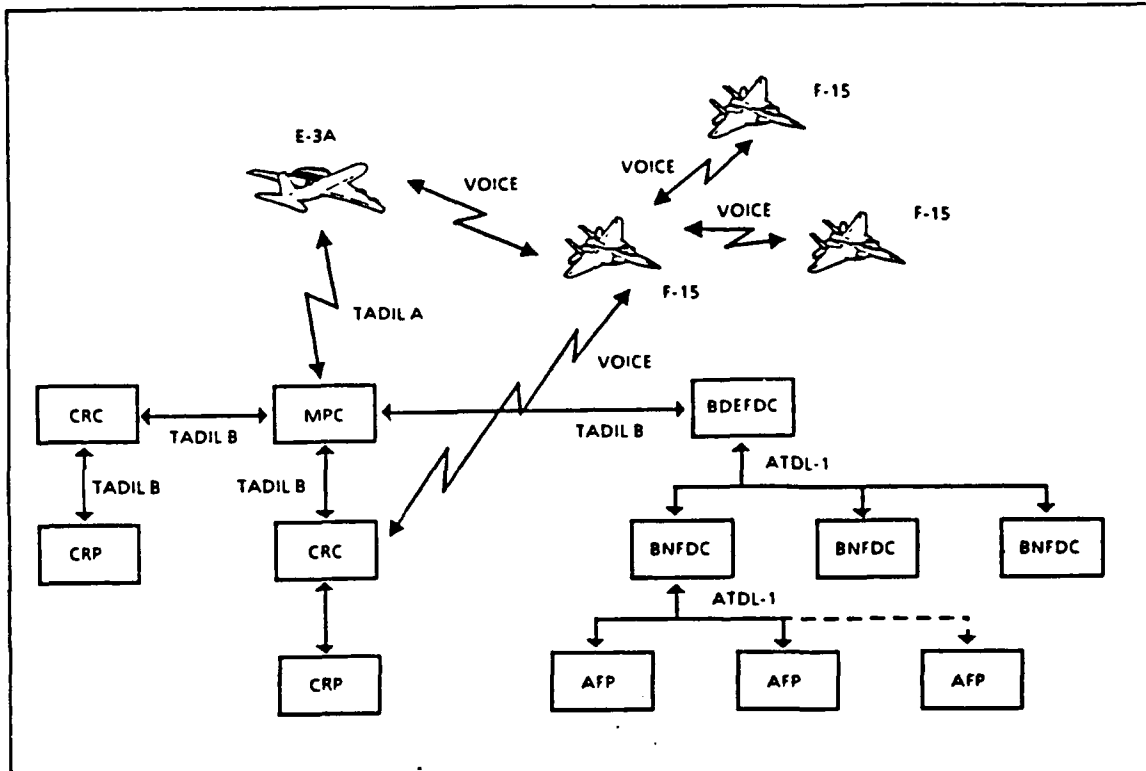

Figure 14 Current Joint Air Operations

The Joint Force Commander designates the area over which the CRC will be responsible for air defense and air space control. The CRC is also responsible for management of its subordinate CRPs and E-3A aircraft. The CRC may exercise operational control over Army surface to air missiles (SAMs) when a joint air defense environment exists. Input of local sensor data and tracks produced by all elements within the assigned air space enables the CRC to produce an air picture of its area of responsibility. [Ref. 5:p 4]

The CRP is one level below, and subordinate to the CRC. It performs weapons control and radar surveillance within its area of responsibility. The post performs air

defense and airspace control under the direction of the CRC. The CRP has the same information processing capability as the CRC and can assume the responsibilities of the CRC in the event the CRC is unable to function. [Ref. 4:p 22]

Interface control functions are performed by the MPCs for all elements within the TACS, Army air defense centers, intelligence assets and any other elements which require access to the TACS network. Information exchange between C² elements is coordinated by the MPC. Data forwarding schemes are used to direct routing of information among elements which interface with the TACS. Filters are employed to match the information flow with the communication capacities of the C² centers. The MPC can be directed to support Air Force TACC operations. [Ref. 5:p 4]

The U.S. Air Force E-3A is an airborne C² platform. It is subordinate to the CRC. The aircraft provides radar surveillance and weapons control over a large geographic area, although its primary delegated control function is surveillance. It may also perform weapons control as designated by the CRC. The E-3A can assume the role of the CRC in the event of its loss. [Ref. 5:p 5]

Army High to Medium Air Defense (HIMAD) consists of HAWK and Patriot missile systems with their associated surveillance and command and control elements. The Brigade Fire Direction Center (BDEFDC), the Battalion Fire Direction Center (BNFDC) and Assault Fire Platoons (AFPs) are the C²

elements for the HAWK system. Track information is exchanged over Army Tactical Data Links-1 (ATDL-1) between internal elements. Information is exchanged between HAWK and Air Force elements, via the BDEFDC, over a TADIL B link to an Air Force CRC through the appropriate MPC. Patriot brigades utilize similar command, control and coordination channels. [Ref. 17:p 3]

Actual direction of the air defense battle occurs in the BNFDC. Functions inherent in the BNFDC are target detection, target tracking and command and control of firing units. A BNFDC may function as the BDEFDC in the event that the BDEFDC is inoperable. Responsibilities assumed by the BNFDC will include coordination with the Air Force if a joint operation is in progress. [Ref. 17:p 27]

HAWK AFPs provide radar surveillance and C² functions for their organic launch platforms. Maintenance of communications with its higher headquarters, the BNFDC, is essential for command and control and track information exchange. The AFPs also process information from surveillance data and IFF equipment. [Ref. 17:p 28]

2. Information Exchange (Non-JTIDS)

The TADIL B digital data link is the primary communication means between ground C² elements. Point-to-point communications are provided for the TADIL B link. An information processor is located at each C² element. Each

processor contains a number of data ports, with each port associated with a particular source and destination. Host processors are capable of forwarding data between elements lacking a direct TADIL B link. The host is provided with a list of users that are directly connected to the host via a particular port. Those units to which data may be passed indirectly through a forwarding unit are also identified with a particular port. This routing list is provided to the host processor during the initialization procedure. [Ref. 5:p 5]

TADIL B data links were developed to exchange information over point-to-point channels. Tropospheric scatter radio is a common example of the communications means utilized to pass this information. The data passed over the network may be described within the scope of four categories:

a. Track and Track Management

Exchange of surveillance information among C² elements is the primary function of track management. Track messages provide location, identification and other pertinent information on possible airborne targets. A protocol has been developed that ensures that the best track on any given target is reported only by that unit having that track. Other units on the TADIL B network with inferior tracks on the same target will not transmit their track information. The other units may determine, at a later period in time, that their track has become superior. In that event, the unit with the superior

track will transmit its information. The superior track report must propagate through the network link by link because TADIL B is a point-to-point communications network. Each host processor compares its local track with the track report received over its TADIL B links. The best track is selected and then broadcast over all of the host's TADIL B links except the one on which the superior track was received. All other host processors then stop transmitting track reports on the same target upon receipt of the superior track. Dual track numbers are assigned by different C² units to resolve discrepancies. Track management messages and link protocols ensure consistent track numbering, reporting unit identification and position referencing. [Ref. 5:p 6]

b. C² Unit Status

All C² units regularly broadcast unit status information over the link. Status reports contain information on the unit's assets (i.e. aircraft), the status of targets those assets are assigned to engage. Status reports may contain other information that is relevant to the combat effectiveness of the unit. [Ref. 5:p 6]

c. C² Coordination

Coordination between C² units is accomplished through transmission of formatted TADIL B messages. These messages are designed to enable one C² unit to direct another to assign assets against a particular target. These messages

can also be used to transfer control of assets between Air Force C² units. [Ref. 5:p 6]

d. Special Information Transfer

Message formats are available within the TADIL B system to provide information to another C² element regarding special points of interest or in the event of an emergency. Intelligence information is also passed in this manner.

The E-3A is not directly involved in the TADIL B network. It participates in the network via a TADIL A link to the MPC. The MPC is the interface between the TADIL A and TADIL B links. The E-3A is thereby able to participate in the exchange of information across the network. [Ref. 5:p 6]

The BDEFDC participates in the network over a direct TADIL B link. Subordinate HAWK units communicate with the BDEFDC via the ATDL-1 link. Information exchange over the ATDL-1 link is similar to TADIL B. Track handling, multiple track deconfliction and engagement status are processed in a manner very similar to TADIL B. The major difference between the data links is that ATDL-1 is strictly hierarchical. There is no lateral crossteling of tracks, handover of assets, or asset status reporting. There is also no facility to forward messages because each host processor port is designated for a single data port. [Ref. 17:p 29]

e. Summary

It is important to note that currently there is no digital data link between Air Force fighter aircraft and the network. The only information exchange that takes place is accomplished over a voice channel. Voice channels are established between the pilot and his CRC and/or an E-3A. The fighter pilot has no need for the majority of information available over the digital network. A filtered portion of this information, tailored to the pilot's needs, would greatly enhance the pilot's air situation picture. Currently, information on incoming hostiles that have previously been targeted by friendly SAMs or other fighter formations is not available. This information could influence the flight leader's target assignments.

The fighter control function is accomplished solely by voice communications. Mission assignment, engagement status, mission results and aircraft status are all communicated over a voice channel. Handovers between C² units in which fighters participate and surveillance information passed to the pilot are also accomplished over a voice link. Critical information may not be available to the fighter pilot when it is needed. [Ref. 5:p 7]

3. JTIDS Equipped Joint Tactical Air Operations

JTIDS can be incorporated into the JTAO environment as a one for one replacement for existing digital data links.

This concept is extremely limited and does not utilize the full potential of a JTIDS communications network. JTIDS is capable of much more than copying a simple point-to-point data communications network. A fundamental principle of JTIDS is that any terminal is capable of communicating with any other terminal or group of terminals.

Some restrictions are inherently embedded in the system such as terminal capacity and limitations due to line-of-sight requirements. The line-of-sight limitation can be overcome by placement of relays at proper positions throughout the network. Figure 15 contains a representation of the JTIDS Concept of Operations. [Ref. 18:p 13]

JTIDS service is provided to the CRC by connecting an Adaptable Surface Interface Terminal (ASIT), with a Class 1 terminal, to the CRC. A translator processor within the ASIT provides the interface between the Class 1 terminal and the CRC. This interface appears to the CRC as a TADIL B link. JTIDS is therefore transparent to the CRC which continues to process TADIL B information. The Class 1 terminal transmits CRC messages into a Main Net which includes all Class 1 terminals. The CRC messages may then be received by all JTIDS terminals in the net, to include tactical aircraft. Surveillance information can then be exchanged in a common pool. Additionally, each JTIDS terminal will broadcast to the net P messages which provide position, identification and status of the host platform. The ASIT converts the P messages

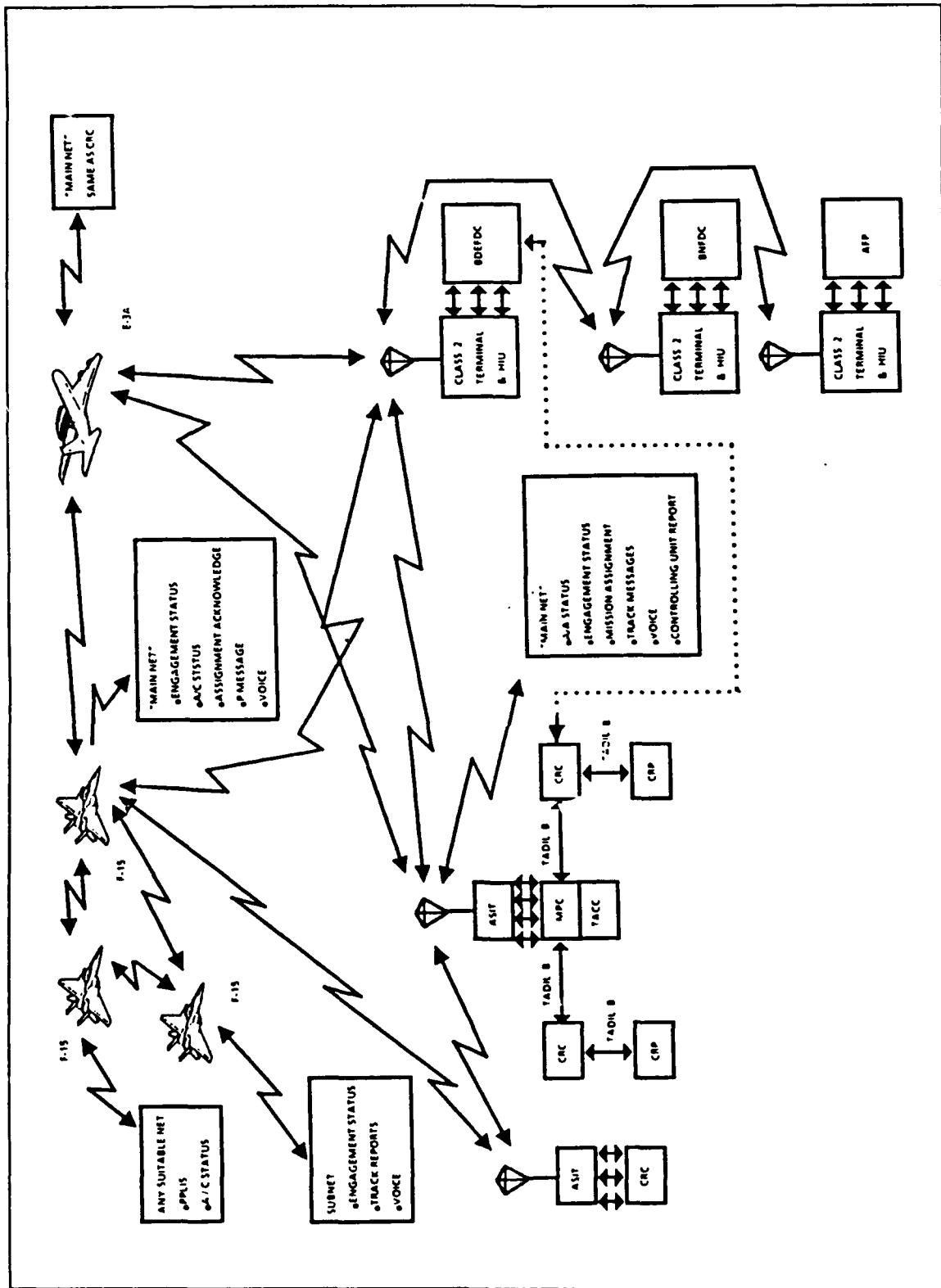

Figure 15 JTIDS Concept of Operations

into TADIL B track reports for use by the CRC. Status, C² coordination and other categories of TADIL B information are broadcast on the Class 1 Main Net. Class 2 terminals can translate IJMS messages available on the Class 1 Main Net since they are bilingual. A direct digital data link between the CRC and E-3A over the Main Net replaces the TADIL A link via the MPC. Finally, CRC command instructions can be made, through the cockpit display, to tactical aircraft. [Ref. 1:p 87-132]

The interservice connection between the CRC and the BDEFDC is also replaced by JTIDS. The BDEFDC, using a Class 2M terminal, is a full participant in the Main Net. It must therefore listen to all potential track sources as each source will transmit only superior tracks. This will result in an air situation picture that contains only superior tracks. Links between the BDEFDC, BNFDc and AFPs will also be over JTIDS. ATDL-1 messages are embedded in JTIDS message transmissions. The Host Interface Unit (HIU), which acts in the same manner as the ASIT, makes JTIDS transparent to Army air defense host processors. [Ref. 5:p 7]

There are two new features which are added under the JTIDS network. First, high quality position, status and identification information, formatted as Precise Position Location Identification (PPLI) messages, can be directly received from tactical aircraft by the BDEFDC and Master BNFDcs. Autonomous AFPs are also capable of receiving this

information directly when they are not receiving data from their parent BNFDC. These PPLI messages transmitted by tactical aircraft will be in addition to the standard IJMS P messages the aircraft regularly transmit into the Main Net. Both message types will add to the air situation picture. This view of the air battle is filtered to meet individual requirements of Army air defense units. [Ref. 13:p 5-13]

The second feature JTIDS adds to the HIMAD mission is that all tactical aircraft in the net will directly receive AFP engagement status. Pilots will immediately be aware of hostile tracks that have been previously targeted by friendly ground air defense assets. The flight leader can then assign his aircraft to targets not previously engaged. [Ref. 18:p 22]

The role the E-3A plays in the air battle is essentially unchanged, with one notable exception. The E-3A directly communicates with all net members. It no longer transmits and receives information via the MPC. Tactical aircraft position, status and identification information is directly available to the E-3A. The E-3A can also directly transmit mission assignments to the aircraft under its control. Mission assignments are presented on the tactical aircraft cockpit display. Acknowledgement of receipt will then be transmitted directly to the E-3A. Due to line of sight communications limitations, the E-3A's unique position

allows it to function as a communication relay for all JTIDS participants. [Ref. 1:p 89]

JTIDS provides tactical aircraft with a number of greatly enhanced capabilities:

a. Position and Status Reporting

Tactical aircraft will transmit their position and status under both the IJMS and TADIL J message format. The Main Net contains those platforms which are equipped with Class 1 terminals (i.e. CRC and E-3A). Tactical aircraft transmit IJMS P messages once every 12 seconds to update the Main Net. Airborne radar track data are exchanged among tactical aircraft, as well as position, status and identification. TADIL J PPLI reports are therefore transmitted once every 3 seconds to aircraft in the net equipped with Class 2 terminals. [Ref. 6:p 55]

b. Surveillance

Currently, tactical aircraft have only their onboard radar as a source of tracks. All other track information that is available from ground C² units can only be transmitted over a voice channel. Equipped with the JTIDS Class 2 terminal, the pilot can select track information from the Main Net, the air group's subnet or a combination of the two nets. The number of potential targets can be limited by the pilot selecting a specific set of criteria. These

criteria may include track source or target range divided by range rate. [Ref. 5:p 7]

c. Target Selection and Coordination

C² elements transmit mission assignments to assigned aircraft. This information will be represented on the pilot's cockpit display. The pilot WILCOs the assignment and the target is displayed as engaged. An engagement status report is then transmitted into both the Main Net and the air group's subnet. The situation may warrant the flight leader assigning targets to aircraft without the direction of C² elements. In this event, engagement status is transmitted over both the IJMS Main Net and the TADIL J air group subnet. Radar lock-on by individual tactical aircraft is also transmitted in both message formats and presented on the cockpit displays of all JTIDS participants. [Ref. 5:p 7]

d. Navigation

Tactical aircraft that are equipped with JTIDS may update their inertial navigation system. The terminal performs this update based on ranging to ground stations whose position are precisely known. [Ref. 5:p 7]

e. Digital Voice

One final capability available to most JTIDS users is digital voice. Only the Army's Class 2M terminal lacks this capability. JTIDS provided digital voice will serve as a backup to current voice communications means. Digital voice

will be implemented on the Class 1 Main Net. Tactical aircraft pilots will have the option to select digital voice on a subnet unique to that pilots air group. Use of digital voice on a subnet eliminates participation on the voice portion of the Main Net. [Ref. 13:p 8-21]

B. ARMY CONCEPT OF OPERATIONS

1. Introduction

Technical innovations have drastically altered the conduct of war. Today's weapon systems are increasingly more sophisticated and lethal. The tactics employed by the various military services have been forcibly changed due to technical advances. Tactics that are designed to complement these weapon systems ensure a reasonable chance of success on the modern battlefield. Effective command, control, and communications (C³) is essential to efficiently employ modern tactics. The United States Army developed FM 100-5, the Operations Field Manual, to establish doctrine based on current tactics.

FM 100-5 is the cornerstone of Airland Battle doctrinal literature on how the Army forces plan to conduct warfighting operations. It furnishes the authoritative foundation for subordinate doctrine, force design, material acquisition, professional education, and individual and unit training. [Ref. 19:p i]

2. Airland Battle Doctrine

Airland battle doctrine states that a qualitatively superior force can defeat a quantitatively superior force.

This doctrine, first published in 1982, incorporated many intangibles of war such as leadership, training, and surprise. Airland battle doctrine returns to more offensive operations and incorporates new views.

The first doctrinal concept is the deep battle which implies that fighting in the enemy's rear area will slow his forces and disrupt follow-on echelon forces. The second concept focuses on the importance of individual initiative in battle. The third concept highlights decentralization of C³, which enables combat commanders to seize and maintain the initiative. The fourth concept emphasizes maneuver to increase effective firepower. The fifth concept is the addition of the operational level of combat between the tactical and strategic levels. Finally, The last major concept places a much greater emphasis on combined and joint operations. [Ref. 19:p 179]

FM 100-5 was updated in 1986 to place a lesser emphasis on NATO and provide a more general view of combat around the world. The goal of the 1986 version is to prepare U.S. forces to fight in a full spectrum of scenarios. Central to this version are the four Airland battle tenants.

The basic tenants of Airland Battle doctrine - initiative, agility, depth and synchronization are reemphasized. Initiative means to set or change the terms of battle by action. Agility is the ability of friendly forces to act faster than the enemy. Depth is the extension of operations in space, time, and resources. Synchronization is the arrangement of battlefield activities in time, space, and purpose to produce maximum relative combat power at the decisive point. [Ref. 19:p 14-18]

Successful execution of Airland battle doctrine depends heavily on proper employment of these four tenants. These tenants can only be executed with a highly reliable and flexible command and control system. A command and control system is the facilities, equipment, communications, procedures, and personnel essential to a commander for planning, directing, and controlling operations of assigned forces pursuant to the missions assigned. [Ref. 20:p 77]

3. Army Command and Control Systems

The United States Army has invested a great deal of time and resources into their development and deployment of increasingly more effective command and control systems. In an attempt to unify these diverse systems the Army Command and Control System (ACCS) was established. ACCS, also known as the Sigma Star, consists of five Battlefield Functional Areas (BFAs). The functional areas are maneuver, air defense (AD), fire support (FS), combat service support (CSS), and intelligence/electronic warfare (IEW). Figure 16 depicts the Army Command and Control System.

The Army Tactical Command and Control System (ATCCS) designates the specific automated systems associated with each functional area. The five automated systems are the Maneuver Control System (MCS), the Forward Area Air Defense Command, Control, and Intelligence System (FAADC²I), the Advanced Field Artillery Tactical Data System (AFATDS), the Combat Service

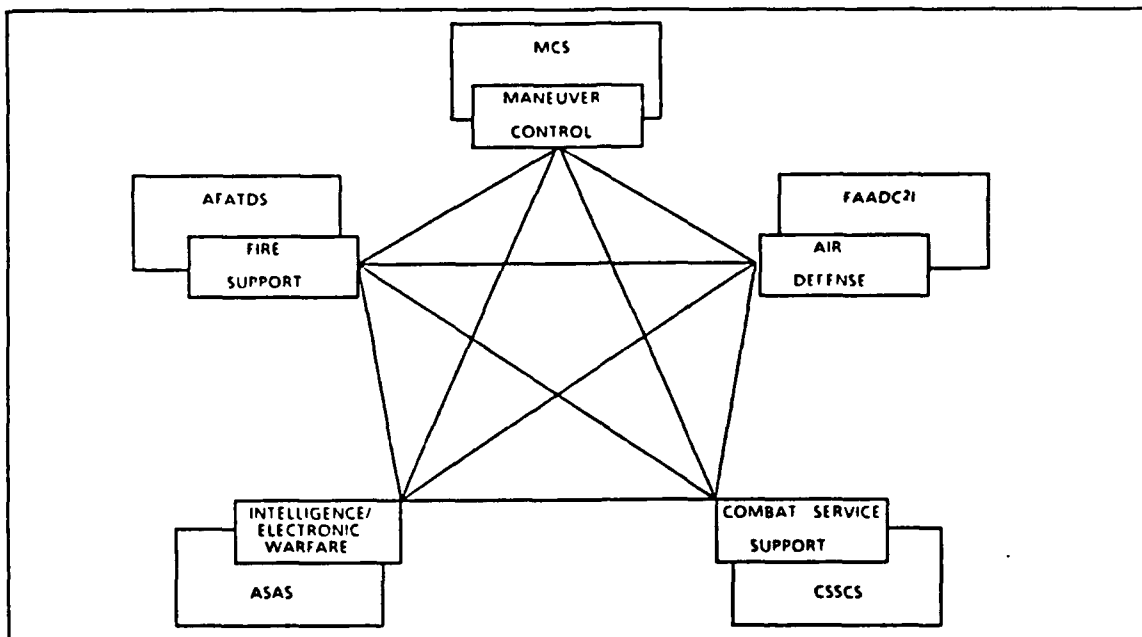

Figure 16 The Army Command and Control System

Support Control System (CSSCS), and the All Source Analysis System (ASAS). The air defense portion of the Sigma Star is of extreme importance as it is the interface between information available on the JTIDS network and the Army's BFAs. [Ref. 21:p 67-69]

4. Three Pillared Architecture

Proper employment of Airland battle doctrine require a highly reliable and flexible command and control system. The U.S. Army Signal Corps has developed a three pillared communications architecture to meet both voice and data requirements. The three elements of this architecture are the Area Common User System (ACUS), Combat Net Radio (CNR), and the Army Data Distribution System (ADDS). Figure 17 represents this architecture. [Ref. 22:p 31]

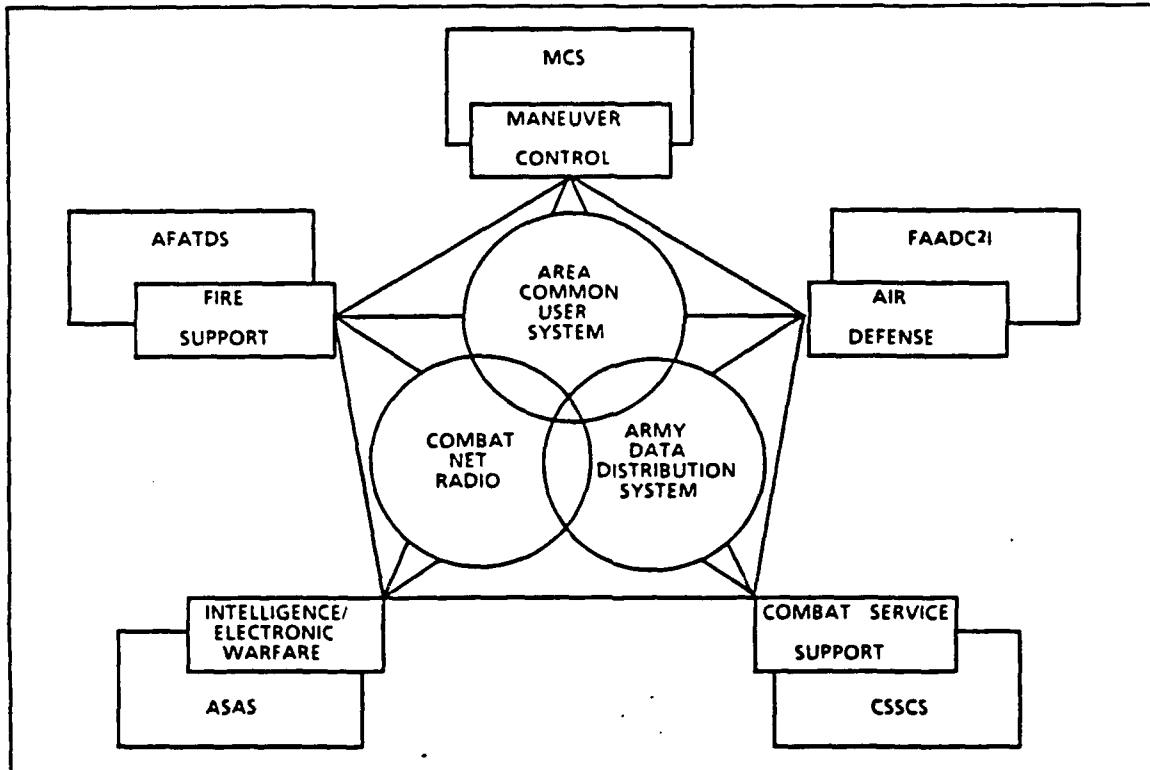

Figure 17 The Three Pillared Communication Architecture

a. Area Common User System

The ACUS consists of two components. At corps level and below Mobile Subscriber Equipment (MSE) comprises the ACUS. MSE provides telephone and mobile radio telephone service to users of a five division corps deployed over a geographical area of approximately 37,500 square kilometers. The system is a digital, secure, nodal network composed of 42 nodes that are interconnected by line-of-sight multichannel radio which forms the backbone of the network. Telephone and data terminal users are provided connectivity to the network through large and small extension node switches. Seven system control centers are deployed throughout the corps to centrally

manage the network. [Ref. 23:p 8-14] A recent technical insertion program has upgraded the system to a packet switched network following X.25 protocol. MSE is interoperable with combat net radios such as SINCGARS through its radio net interface. It is also interoperable with satellite terminals and can be linked with NATO analog, digital, and facsimile equipment. [Ref. 24:p 42]

The Echelons Above Corps Communications Improvement Program (EAC CIP) is the second component of the ACUS. The EAC CIP provides both voice and data communications to Army echelons above the corps level. The system provides an integrated theater area communications system by overlapping mobile subscriber capabilities on the existing EAC common user digital network. The system was originally designed according to the tri-service tactical communications (TRI-TAC) Block II architecture. The EAC CIP provides expanded service via an increased number of circuit switching nodes. Communications support to theater army command headquarters has been streamlined. Designated EAC users will receive mobile subscriber service. [Ref. 25:p 17]

b. Combat Net Radio

CNR consists of the Single Channel Ground and Airborne Radio System (SINCGARS) and the Improved High Frequency Radio (IHFR). SINCGARS is a frequency hopping radio system designed to provide secure voice and data

communications in a hostile Electronic Warfare (EW) environment. This family of radios is replacing the AN/VRC-12, AN/PRC-77, and AN/ARC-54/131 series of tactical radios. The system can operate in both the frequency hopping and single channel modes. SINCGARS is planned to be fielded throughout corps and divisions to include individual tank, infantry fighting vehicle, helicopter, howitzer, and any small unit (platoon, section, or squad). [Ref. 26:p 61-65]

The Army is currently deploying the IHFR to replace the AN/GRC-106 and PRC-74 voice high frequency (HF) radios. The IHFR is a reliable, user friendly HF radio system. The system includes the manpacked version, PRC-104A; the GRC-193, high power vehicle mounted version; and the GRC-213, the vehicle version of the PRC-104A. IHFR will replace current HF manpack and vehicular radios. It will not replace the HF radio teletype (RATT) systems. The IHFR has several operational modes including upper and lower side band, voice, data, and continuous wave. [Ref. 27:p 17]

c. Army Data Distribution System

The ADDS is comprised of the Enhanced Position Location and Reporting System (EPLRS) and the Joint Tactical Information Distribution System (JTIDS). EPLRS is designed to support Army data distribution requirements and support existing and developing C² systems and battlefield automated systems (BAS). EPLRS provides responsive data communications,

accurate position, navigation, and identification on the Airland battlefield.

The principal components of the system are the Enhanced PLRS Terminal (PT) and the Net Control Station (NCS). The PT consists of an Enhanced PLRS User Unit (EPUU), a User Readout (URO) device or a Pilot Control and Display Panel (PCDP). The EPUU can support host systems via an X.25 interface or by a Frequency Shift Keying Interface. The terminal can support a data rate of 1200 bps. The URO device is for handheld use with the manpack, vehicular, or ground relay PT. Requests are manually entered on the URO for position and identification purposes and to send free text messages. The PCDP, airborne configuration, is designed for remote operation of the EPUU by the pilot. It is connected to the aircraft instrument system providing bearing and altitude information. [Ref. 28:p 1-0]

Under the control of the NCS, the PT provides a position and navigation service and a limited free text capability. Interface configurations permit data exchange with many BASs. The system can be configured in either a manpack, vehicular, or airborne version. Each NCS controls 150-250 PTs, or approximately a brigade size deployment. Four NCSs are assigned to a division and fall under the control of the Division Signal Battalion Syscon. [Ref. 29:p 30] Figure 18 depicts the projected deployment of Army communication systems.

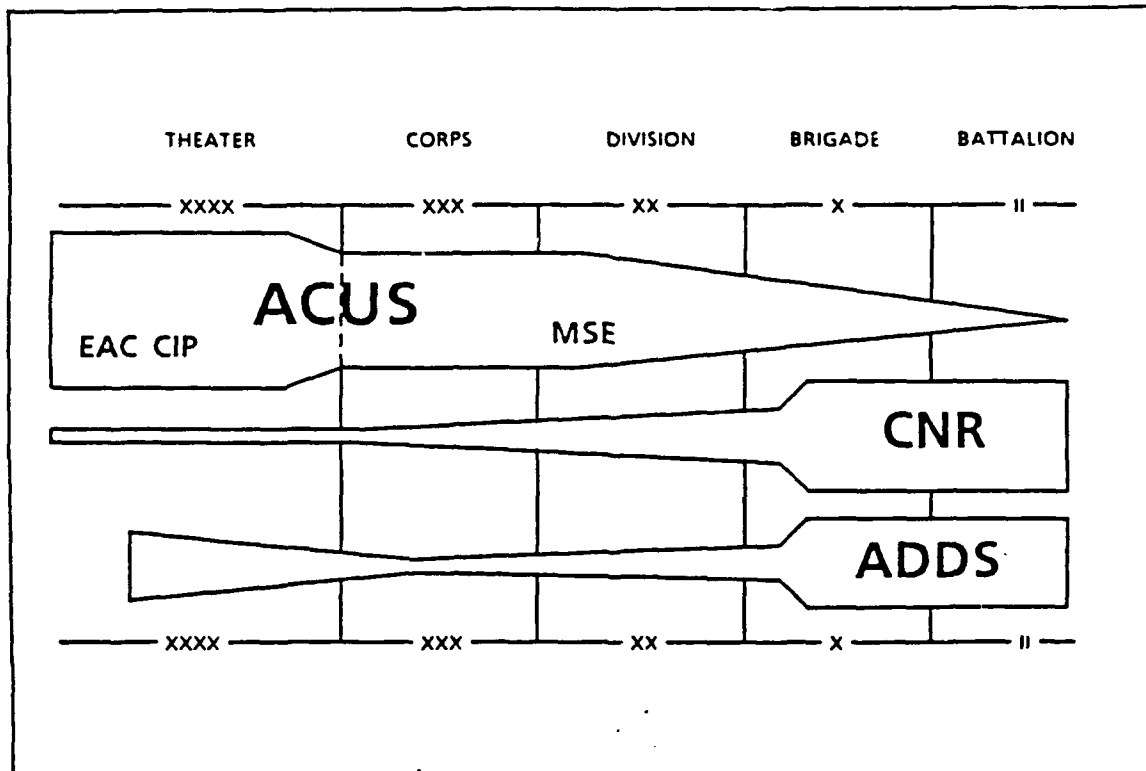

Figure 18 Deployment of Army Communication Systems

5. Army JTIDS/EPLRS Employment

The U.S. Army plans to use JTIDS in conjunction with EPLRS to form a PLRS JTIDS Hybrid (PJH) System to provide a unified data distribution and position location capability which will support the Army's BAS of the 1990's. Increased development of the BASs demands greater digital communication capacities among the five mission areas. The PJH System depicted in Figure 19 is designed to meet these requirements. [Ref. 13:p 8-7]

The MIMAD brigade is organized according to strict hierarchical control structures. The highest organizational authority is the BDEFDC. JTIDS provides communication

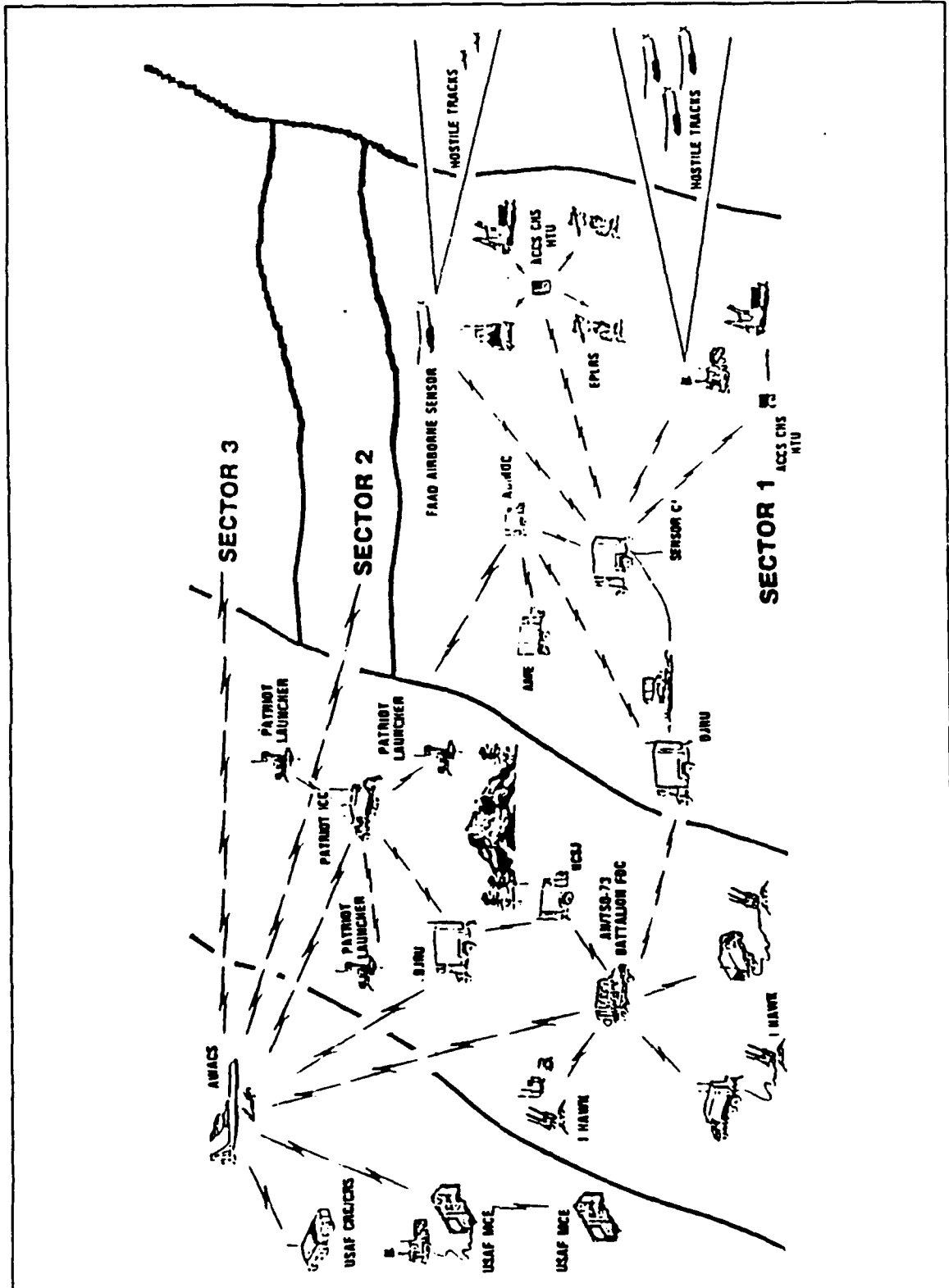

Figure 19 The PLRS/JTIDS Hybrid System

circuits between the HIMAD units and between the BDEFDC and the C² elements of other services.

The Army Class 2M terminal and the Host Interface Unit (HIU) is the primary JTIDS interface to the HIMAD units. The HIU communicates with a host terminal via TADIL B or ATDL-1. The AN/TSQ-73 Missile Minder is the host system at the BDEFDC and the BNFDC. The HAWK Missile System is the host system at the AFP. The HIU has the capability to translate fixed format TADIL J messages into TADIL B and vice versa. The data that is provide passes to the host system via a single TADIL B channel. The HIU can also embed ATDL-1 messages into TADIL J Variable Message Format (VMF) messages and extract ATDL-1 messages from TADIL J VMF messages. Precise Participant Location and Identification (PPLI) messages form JTIDS equipped airborne platforms are translated into ATDL-1 messages for Army air defense elements. The HAWK HIU will translate PPLI messages only when operating autonomously; normally translation is performed at the controlling BNFDC. Embedding ATDL-1 messages into TADIL J VMF messages allows Class 2M equipped platforms to communicate beyond line-of-sight through a Class 1 terminal acting as a relay. [Ref. 5:p 38]

**CHAPTER V. PROPOSED APPLICATIONS FOR JTIDS INFORMATION
DISTRIBUTION**

A. INTRODUCTION

The U.S. Army's view of modern warfare has changed somewhat since the conceptualization of Airland battle. The Army recognizes the need for the capacity to respond to a broad spectrum of conflict. This spectrum ranges from Low Intensity Conflict (LIC) through Mid and High Intensity Conflict (MIC/HIC), anywhere in the world. The pace of warfare has also dramatically increased, requiring commanders to be able to assess current battlefield information and act accordingly. This directly implies the introduction and integration of automated tools into all Battlefield Functional Areas (BFAs). This chapter will discuss potential applications for distribution of JTIDS provided information.

B. AIRLAND BATTLE - FUTURE

1. Projected Doctrine

The Airland Battle-Future (ALB-F) study was produced by the Combined Arms Center at Ft. Leavenworth, Kansas under the direction of the Training and Doctrine (TRADOC) Commander. The purpose of this study was to transition the 1986 Airland battle doctrine to better prepare the Army to fight future wars. The objective was to move the Army towards a more

strategic projection orientation. The study focused on the total Army over the next 5 - 15 years. Joint and combined operations at the tactical and operational level were reviewed with a less NATO and more global perspective. The TRADOC Commander's generic guidance to the CAC was three-fold. First, combat support and combat service support elements would be moved from the division level to either maneuver brigades or the corps level. The division would become a tactical headquarters only. Second, the Army would fight on a non-linear battlefield, where traditional unit boundaries become obscure. The Army will fight with fewer soldiers and smarter, more lethal weapons. Third, that military power is to be projected from the Continental United States (CONUS) contingency based force rather than from a forward deployed presence. [Ref. 30:p 3]

The CAC study developed the concept of operation for ALB-F. ALB-F can be summarized into four phases. The first phase consists of intelligence and battle preparation. The Army's prediction is that modern surveillance devices will enable commanders to know, with a high degree of certainty, the location of significant enemy forces at any point in time. The second phase is the establishment of conditions for decisive operations. The purpose of this phase is to attrit the enemy with long range smart/brilliant weapons. The third phase is decisive operations. Army units will maneuver with highly agile and lethal forces to quickly destroy the enemy.

A battle of attrition is to be avoided. The fourth phase is reconstitution. Combat forces will be rearmed, refitted, and refueled during this phase. Surveillance will be on going and battle damage assessment will take place. Units will also prepare for the next battle of the operation. The Airland battle tenets described in Chapter IV remain valid, but units must be more agile with precise synchronization to execute ALB-F. [Ref. 30:p 4] Figure 20 depicts the planned execution of ALB-F.

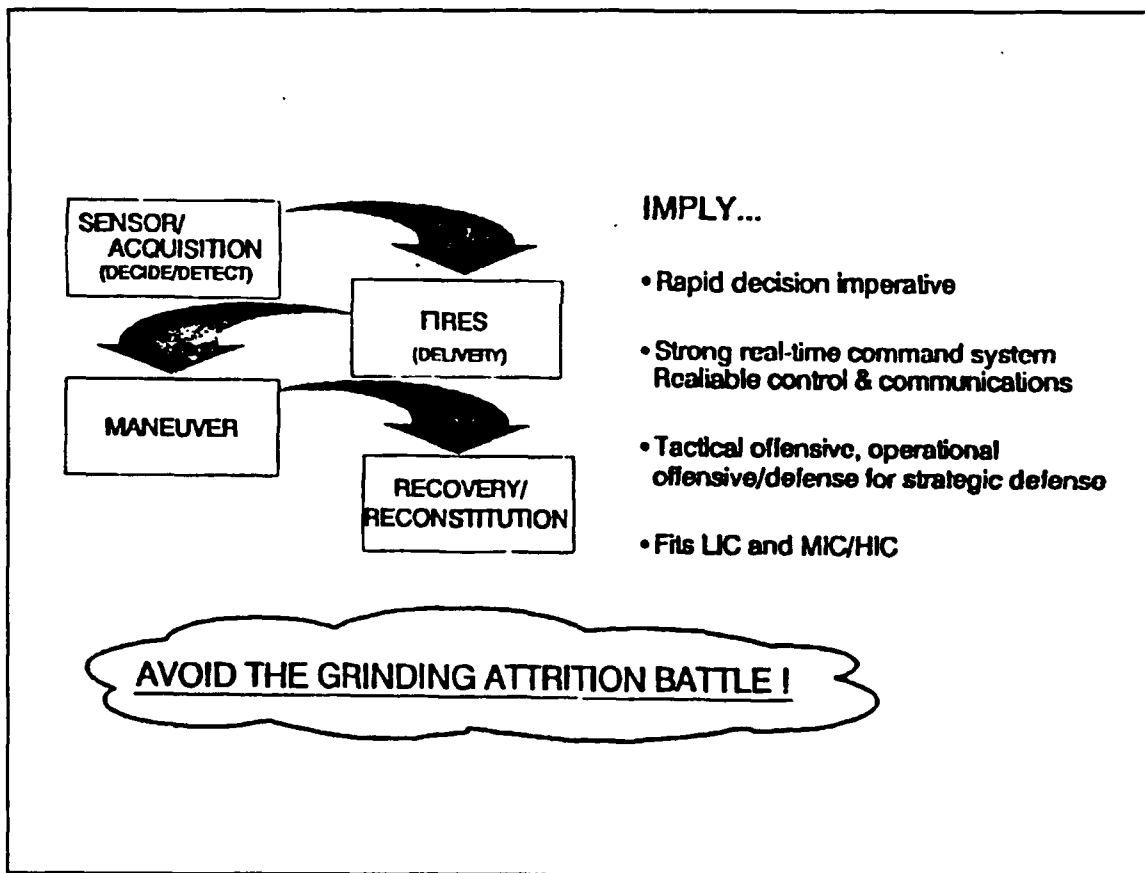

Figure 20 Airland Battle - Future Concept

2. Communications Support

ALB-F, in order to be successfully accomplished, implies a number of tasks that must be completed. The U.S. Army Signal Corps is tasked to integrate sensors, weapons, commanders, forces, sustainment, and transportation elements. The Signal Corps must provide and manage a network which will tie these elements together and be transparent to the user.

Effective command and control is essential to ALB-F. Integrated, automated systems must be provided to commanders and staffs to produce a common picture of the battle. The non-linear battlefield, where unit boundaries are blurred, will require dispersed communication networks. The range of communications must be extended to link these dispersed elements on the battlefield. Under the Airland battle concept, communicators support users on a linear battlefield. This system was adequate in its support of heavy forces in central Europe providing grid-area coverage on a mobile battlefield. The system's enhanced C² capabilities offer a redundant, robust, and survivable network with an increased data capacity. Communications support on the non-linear battlefield must support low to high intensity conflicts over a dispersed battlefield. Extension of the range of communications will increase the systems flexibility. Strategic and tactical communication assets will be relied upon to help increase range. The focus of the communicator

will be more on operations and less on terrain. [Ref. 31:p 7]
Figure 21 depicts these two communication architectures.

C. JTIDS - A VITAL LINK FOR ALB-F

The ALB-F concept depends heavily on the commander's anticipated ability to see through the "fog of war". Advances in battlefield sensors and improved information processing capabilities will enable the commander to know to a large extent the disposition of friendly and enemy forces. New systems incorporating advanced technology are currently under development to meet this requirement.

1. Joint Surveillance Target Attack Radar System

The requirement for knowing the enemy's capabilities, intentions, disposition and actions has been well defined by all military services. U.S. Air Force and Army C² architectures are built around command and control of a complex, fast moving battlefield. Integral to this architecture is the ability to detect and target troop and armored vehicles in the combat area and deep within enemy territory. The E-3A AWACS aircraft met the early detection airborne requirement and has been fully integrated into Joint-Combined Counterair operations. Wide area ground surveillance of slow moving targets has been especially difficult. Traditional radar systems had problems distinguishing ground targets from background clutter. This capability has been achieved in recent years. [Ref. 31:p 33]

SIGNAL SUPPORT FOR THE LINEAR BATTLEFIELD

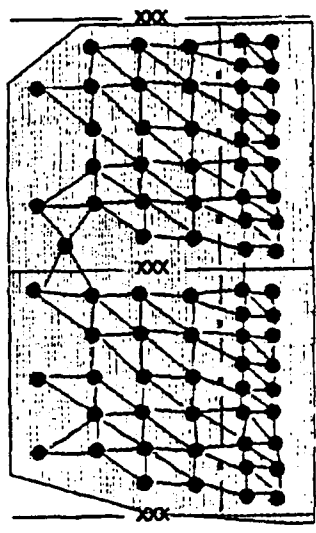

SUPPORTS

- Heavy/Light Forces
- Central Europe scenario
- Grid area coverage
- Mobile Battlefield

PRIMARY ATTRIBUTES

- Enhances Command and Control
- Supports tenets of ALB
- Large pipes
- Greater access
- Redundant, Robust, Survivable
- Area Oriented

SIGNAL SUPPORT FOR THE NON-LINEAR BATTLEFIELD

SUPPORTS

- Entire spectrum of conflict
- Dispersed Battlefield
- Coverage of selected zones

ATTRIBUTES

- Greater flexibility with range extension
- Blurs traditional boundaries
- Increased reliance on Strategic assets
- Greater use of all area resources
- Focus is on Operations vice Terrain

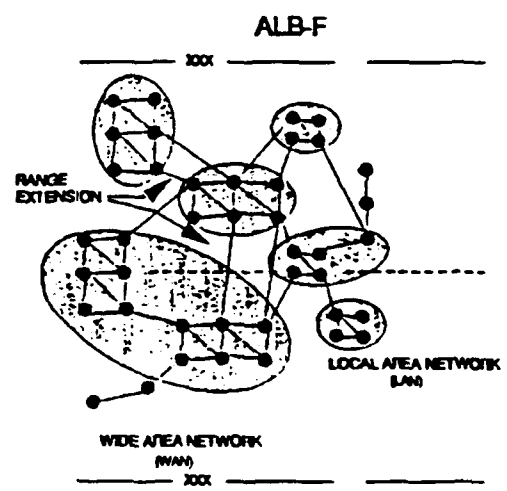

Figure 21 Communications on the Non-Linear Battlefield

Advances in radar technology and information processing have made ground battlefield surveillance possible. The Joint Surveillance Target Attack Radar System (JSTARS) is an airborne and ground based system with the ability to identify and track aircraft, missiles, artillery, and maneuver forces in all weather conditions. JSTARS' primary mission is to detect non-emitting mobile targets. Priority is given to those enemy forces in imminent contact with friendly ground elements. The system simultaneously covers enemy second echelon forces permitting those elements to be targeted and destroyed. [Ref. 32:p 33] Figure 22 depicts the JSTARS radar system.

The U.S. Air Force Electronic Systems Command and the U.S. Army Communications-Electronics Command are developing a multinode radar for the E-8A (a modified Boeing 707) aircraft. Radar surveillance data will be processed on board the aircraft. Radar display and control capabilities will be available on board and to ground based C² elements. Surveillance data is further processed on board the aircraft by Operations and Control (O&C) Air Force personnel and by Ground Station Modules (GSMs). The GSMs communicate to the radar via a surveillance and control data link. The data is evaluated by Air Force surveillance operators and weapon controllers and passed as track data, under the TADIL J message format, to Air Force C² elements. GSMs are planned to be deployed to Army division and corps levels providing input

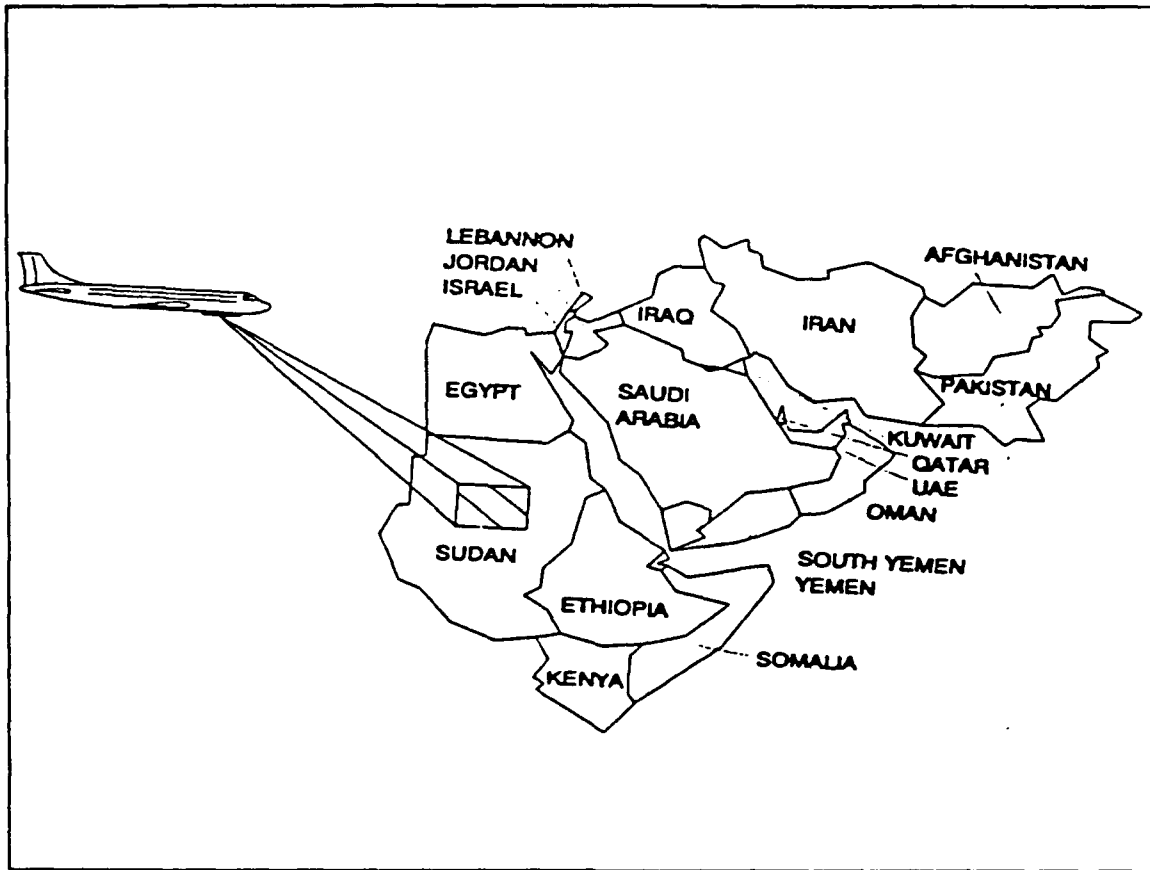

Figure 22 The JSTARS Radar Platform

data to Army fire support, intelligence, and maneuver control systems. Army connectivity with JSTARS is via a surveillance control data link to the GSM and to Army C² nodes via cable or other ground based communications. [Ref. 33:p 41-44]

2. JTIDS - A Gateway to the Sigma Star

The JTIDS Class 2M terminal was developed to meet the ADA's requirement for high throughput data distribution. The information available on the 2M terminal provides a secure, jam-resistant means of developing a joint picture of the air battle. Surveillance information from the U.S. Air Force E-3A

AWACS aircraft will be available to all ADA users with a JTIDS capability. The surveillance data collected by the E-8A JSTARS aircraft will be invaluable to ground combat commanders. The problems inherent in the practical use of this information are two-fold. The first problem is that the information received must be processed into a useable form in the most practical C² facility. Currently, the GSM is designed to process JSTARS surveillance data for use by the Army. GSMs will be deployed to C² centers across the battlefield to enhance ground commanders capabilities. The second and most difficult problem is to provide this useable information to all battlefield functional areas in near real time. This can only be achieved through total integration of all five battlefield automated systems (BASs).

D. A PROPOSED JTIDS ALTERNATIVE

The JTIDS network provides a survivable data distribution communication system linking Air Force E-3A surveillance and engagement data with Army air defense assets. JTIDS could also be employed to link JSTARS produced ground surveillance data with all ground BFAs. This integration would yield a truly joint combat force. Figure 23 represents the potential flow of information into the Sigma Star.

In order for JTIDS to be effective in carrying the information available from JSTARS, the surveillance data received by the E-8A aircraft would have to be processed on

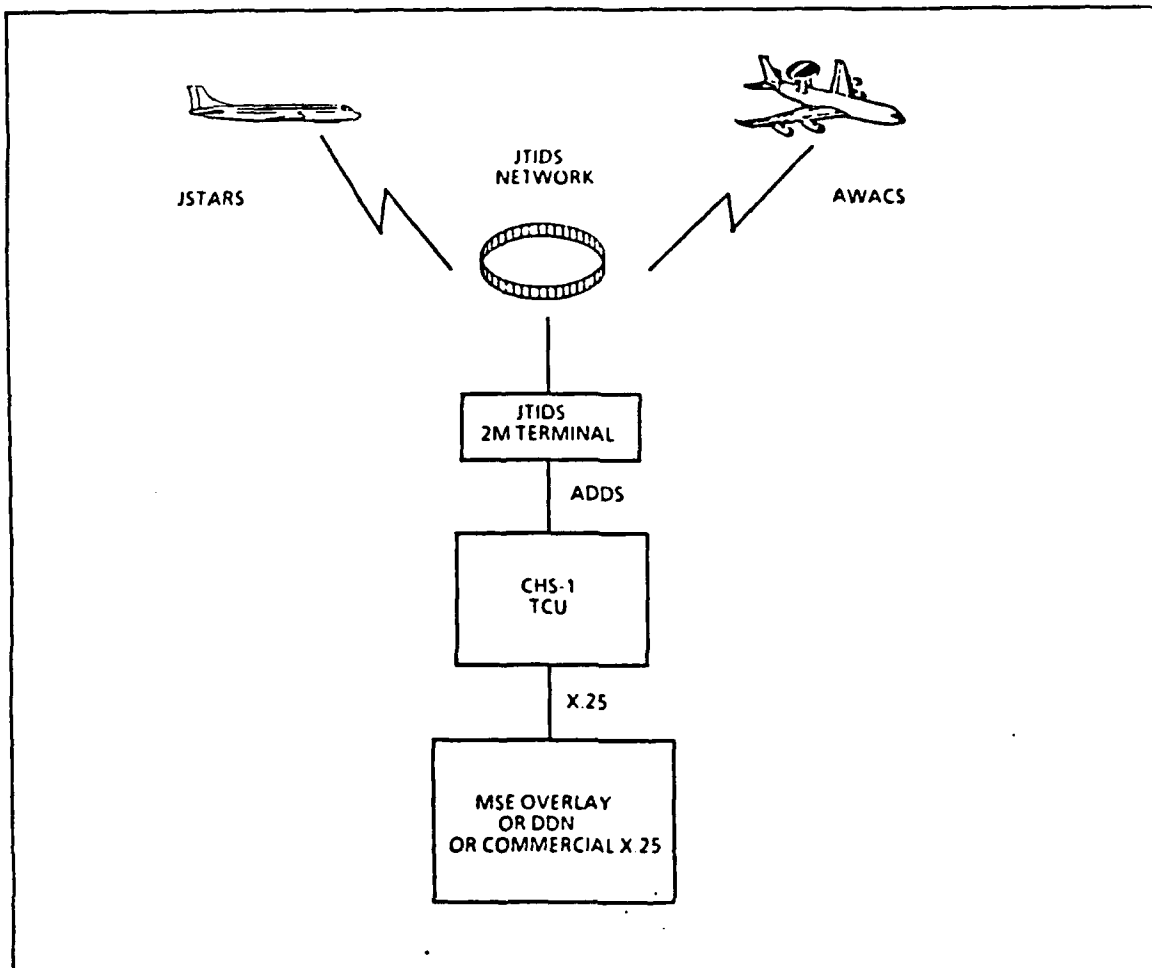

Figure 23 The JTIDS Alternative

board the aircraft prior to transmission. Army intelligence analysts would have to be assigned to the JSTARS platform to insure that the surveillance data is processed in a manner that is most useful to Army C² elements. This processed surveillance information could then be transmitted over a JTIDS network as the AWACS information is currently transmitted. Army Class 2M terminals would then act as gateways to the Area Common User System (ACUS).

The Army's product improvement program is providing a packet switch capability to the MSE portion of the ACUS. It is anticipated that packet switching will also be provided to EAC communications. Once this is accomplished, the information available on JTIDS can be transferred to all functional areas of the ATCCS. JTIDS furnished information presents a wide range of potential applications to Army users. [Ref. 25:p 15]

1. Maneuver Control

The near real time picture of enemy ground dispositions would be invaluable to maneuver commanders. The Maneuver Control System (MCS) currently enables commanders to monitor the dispositions of friendly forces in a given theater of operations. JSTARS surveillance data of enemy positions would have to be made compatible with the MCS Tactical Computer Terminal (TCT). The MCS would be able to provide maneuver commanders with a picture of the battlefield that accurately depicts the disposition of forces. The "fog of war" would be lifted to a large extent. [Ref. 21:p 68]

This integrated picture of the battlefield must be available to commanders at all times, not only in the maneuver unit's C² element. The MSE network provides specified users with a Mobile Subscriber Radio Telephone (MSRT). The MSRT is capable of secure voice and data transmission. Data communication is possible due to the incorporation of a 16Kbs data port in the MSRT. [Ref. 23:p 12]

Providing MSRT users with a packet switch capable laptop computer permits access to an integrated picture of the battle, anywhere on the battlefield. The limited data rate of the MSRT would drive the development of software tools which would free the information available on the MCS yet still provide a useable picture of the battle. A user's request for more detailed information could be requested either by secure voice or by a key stroke operation on the laptop computer provided. The laptop computer would conform to the Common Hardware and Software (CHS) program to ensure full integration. [Ref. 21:p 69]

JSTARS surveillance information transmitted over a JTIDS network could eventually provide track and targeting information to maneuver units at the lowest levels. Individual armored vehicles could be provided with a JTIDS type visual display terminal similar to that being tested in Air Force F-15 combat aircraft. A JTIDS network could be established at the battalion level to pass this traffic. This network would necessarily have to be tied to the JSTARS surveillance network. An individual tank crew would have an accurate picture of the enemy armored vehicles it is facing. Enemy vehicles could be engaged without visual confirmation by friendly forces. Terrain would become a less significant factor in favor of the operation itself.

Lighter units, such as infantry platoons, could employ EPLRS to a similar purpose. Ground surveillance data

available on JTIDS could interface EPLRS through CHS. Software development would be necessary to format this data into a package that would be useful on a hand-held device; the EPUU/URO (See Chapter IV). Engagements could also be reported back into the system for integration on the MCS.

2. Air Defense Artillery

The use of JTIDS as the method of data distribution for air defense has been well defined. AWACS surveillance data transmitted over JTIDS to HIMAD and FAAD units permits air defense weapon systems to engage enemy aircraft not previously targeted by either ground or air assets. The ADAC² System is a data processor which correlates JTIDS provided track information with ground based sensors. The processor will assign fire missions to weapon systems based on a decision support algorithm. A data link to the MSE network makes any of this information available to all users of integrated BASs. [Ref. 13:p 11-9]

Smaller ADA units, such as Stinger teams, receive fire missions over EPLRS. This information is passed over JTIDS through CHS. Once the team has fired at the target, confirmation of the mission could be transmitted back into the network. The BDEFDC would then be able to track aircraft kills and missile expenditures.

The ground surveillance data available on the network would also be invaluable to ADA commanders and staffs for

planning purposes. The battlefield could be evaluated to determine the optimum plan for deployment of air defense assets. Updates to the ground surveillance picture would enable planners to determine which locations are in potential jeopardy and relocate assets accordingly.

3. Fire Support

The Advanced Field Artillery Tactical Data System (AFATDS) is under development by the U.S. Army Field Artillery. It is designed to efficiently manage the use of indirect fire support on the battlefield. Indirect fire support can be divided into two categories. Preparatory fire is used to prepare a geographic area with artillery fire in concurrence with a planned operation. Call for fire is artillery support provided on request by supported units on targets of opportunity. Targets of opportunity are identified and fire support is requested over tactical combat net radio/EPLRS by forward observers or maneuver units. [Ref. 21:p 68]

The JTIDS link could again provide specific ground surveillance data to AFATDS. This view of potential targets would allow field artillery C² elements to better prioritize fire missions as part of an overall battle plan. The call for fire mission only identifies targets visible to forward units and may not provide an accurate assessment of the greater portion of the threat. Potential targets would be identified

at the AFATDS. Automated tools would select artillery batteries best able to meet specific fire missions. Firing batteries could also be provided EPLRS' EPUUs down to individual gun emplacements for interface to their BFA. Automated fire missions could be designated at the AFATDS, assets selected to meet those missions, and the target destroyed in a matter of seconds. Status of ammunition, fuel, and spare parts could then be reported automatically back up the chain of command.

4. Intelligence/Electronic Warfare

The IEW functional area of the Sigma Star is responsible to evaluate battlefield information from all sources and develop an intelligence estimate of the battlefield and advise the commander accordingly. Elements in this functional area also develop plans for Electronic Counter Measures (ECM) to support the commander's battle plan. [Ref. 34:p 1-1]

Real time ground surveillance data received through JTIDS provides the same picture of enemy dispositions to all elements. The All Source Analysis System (ASAS), under development, would then be used to make more accurate assessments of probable enemy actions based on the much more complete picture of the battlefield. These intelligence products would be broadcast back into the ATCCS for use by all participants. [Ref. 35:p 25-30]

The potential increase in the detection of enemy emitters would add greatly to existing EW operations. Battlefield sensors that have confirmed the location of either ground or airborne enemy EW emitters could pass this information back into the system. AFATDS would then have targeting information on the location of these emitters and be able to respond to the threat with indirect artillery fire within seconds.

5. Combat Service Support

Combat Service Support (CSS) is vital to any combat operation. Food, ammunition, fuel, medical supplies, and maintenance support must be produced in the Continental United States (CONUS) and transported to the theater of operations where it is needed. The Combat Service Support Control System (CSSCS) is under development to manage the vast quantity of supplies required by an army in combat. The CSSCS will provide an automated tool to logistical managers to accomplish this mission. The fielding of JTIDS/EPLRS could greatly enhance resupply. [Ref. 22:p 31]

JTIDS/EPLRS users could use the terminals to report status of food, fuel, ammunition, etc. back to higher headquarters. A sensor on the vehicle could monitor the status of these crucial supplies and automatically transmit a status report up the chain of command. This information could be stored in computer memory of any BAS at the brigade or

battalion level. Once resupply requests reach a predetermined level, a requisition would be automatically generated and transmitted over the communications network to be received at a logistical supply point. Software packages available to the CSSCS would make supply decisions concerning where the requisition must go and what assets are available to transport then to the requesting unit. The time required to resupply a unit would be dramatically reduced. Network connectivity to CONUS would allow logistical managers to pass requests for resupply back to CONUS for any items not available within the theater of operations. This automated system of resupply would permit CSS commanders to provide an "intelligent push" of supplies to the forward areas of the battle where they are needed.

Modern warfare dictates that combat service support elements must be prepared to fight the rear battle. The information available due to a JTIDS interface would be invaluable. CSS commanders could manage unit deployments and direct the effort of the rear battle much more efficiently with the picture of the battlefield potentially resident on the MCS. Projections of enemy future operations by the IEW functional area would allow rear area commanders to better plan locations for future logistical resupply points. Greatly improved plans could be developed anticipating movements of supported units in future operations. Figure 24 represents potential information flow under this proposal.

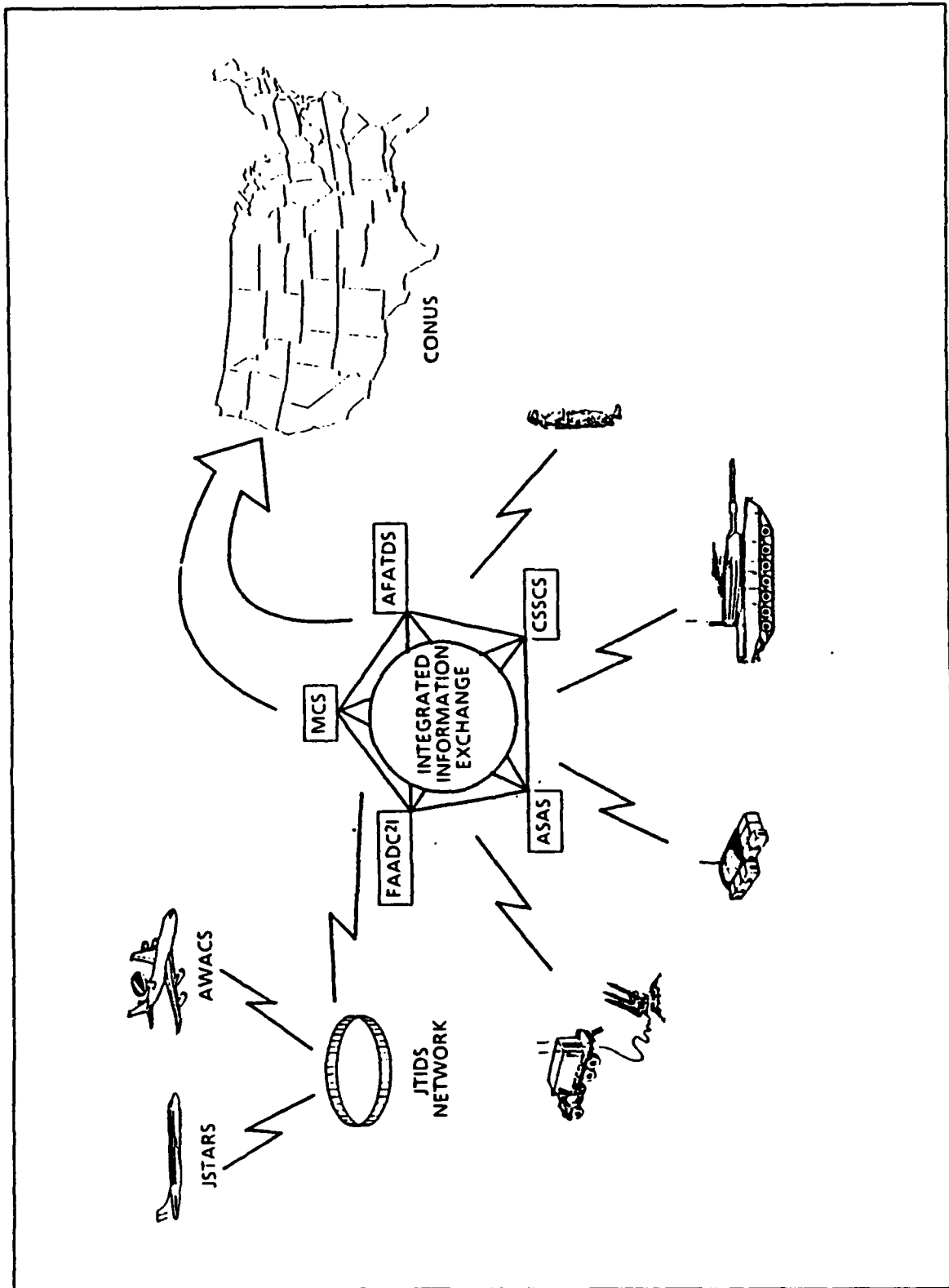

Figure 24 Integrated Information Flow

E. HURDLES TO OVERCOME

The proper management of information on the battlefield will enable unit commanders to successfully accomplish the combat mission. The dramatic increase in the capabilities of weapon systems and sensors continually drive the need for better tools to effectively manage these assets. The U.S. Army has taken the first tentative steps towards this goal in its development of automated tools for use by the unit commander. The challenge that faces the Army today is the integration of these automated systems. The problems associated with system integration are numerous and must be tackled one by one.

1. Data Fusion

Modern battlefield sensors produce a vast quantity of raw data. This data, in its raw form, is of little use to commanders and their staffs. The data must be processed in such a way that it becomes manageable information. This process must be performed for each sensor on the battlefield. Systems, such as the GSM, are currently under development to process raw sensor data. The greatest challenge lies in the incorporation of the data produced by the vast array of sensors on the battlefield. [Ref. 36:p 41]

System integrators must develop computer software algorithms that will fuse the data available from all sources into a coherent picture of the battlefield. The battle

picture developed through data fusion must be available to all users. In order for this to occur the data capacities of all users must be determined along with user information requirements. A user with a 16Kbs data capability cannot process all of the information available on the network. An automated system would be needed to package the information in a format readily available to the user which conforms to predetermined requirements.

2. Decision Support Algorithms

The pace of modern warfare has increased dramatically over the past two decades. Smarter weapons, with increased range and lethality, are the norm. Combat commanders can no longer rely on manual systems to command and control their forces. Automated tools must be provided for commanders to employ their forces in a manner that will achieve maximum results.

ALB-F requires a high degree of agility with precise synchronization of forces. This can only be achieved with the development and incorporation of decision support software tools or algorithms. Military software developers must remember that processing and displaying combat information is only one half of the problem. The second half of the problem is managing the decision making process based on the ever increasing amount of available information. Commanders are becoming swamped with information. The commander's ability to

assess the situation and determine a course of action is hindered by the vast amount of information available. The demand for software across all of DOD is increasing at an alarming rate. Greater emphasis must be placed on common software development. Common software must become the standard if total system integration is to be achieved. A number of programs have been instituted with this goal in mind. Selecting Ada as the standard computer language and the institution of the CHS program are important steps towards integration. [Ref. 22:p 31]

3. Multilevel Security

A fully integrated automation system does not imply equal access for all users. The capability to enter and/or access data must be controlled. Not all users of an Automated Information System (AIS) possess the required security clearance for all of the data being processed by the AIS. A Multilevel Security (MLS) system must be put in place. Access control to the information available can be accomplished in many ways that are transparent to the user.

The effective use of Communications Security (COMSEC) devices will assist in denying data access and analysis during transmission. The devices will secure the data only while it is in the network. COMSEC devices will be essential to protect information traffic passing over the Wide Area Network (WAN).

A system of passwords must be established for battlefield system users. Particular passwords will grant access to particular portions of the information base. Passwords will define the user's access capability. The system will know what information the user will be permitted to read and what information the user may edit. Inherent in this system is a dependance on trusted software. All available information must be present in the network, but not all users should have full access to it.

4. Doctrine

U.S. Army doctrine for the foreseeable future is stated in ALB-F. This doctrine explains how Army units are to fight in future conflicts. Other doctrine must be developed which will tell ATCCS users how the system will be employed. Management of the network and the information available on it must be established and procedures determined.

The explosion of information on the battlefield will require personnel that can manage this information and act as system integrators. BFA managers will necessarily be required to manage the information that will continually flow between C² elements. The increased use of portable computers by the military in the field will require soldiers with specialized skills in system integration on the hardware level. [Ref. 37:p 12] Figure 25 represents future ATCCS management.

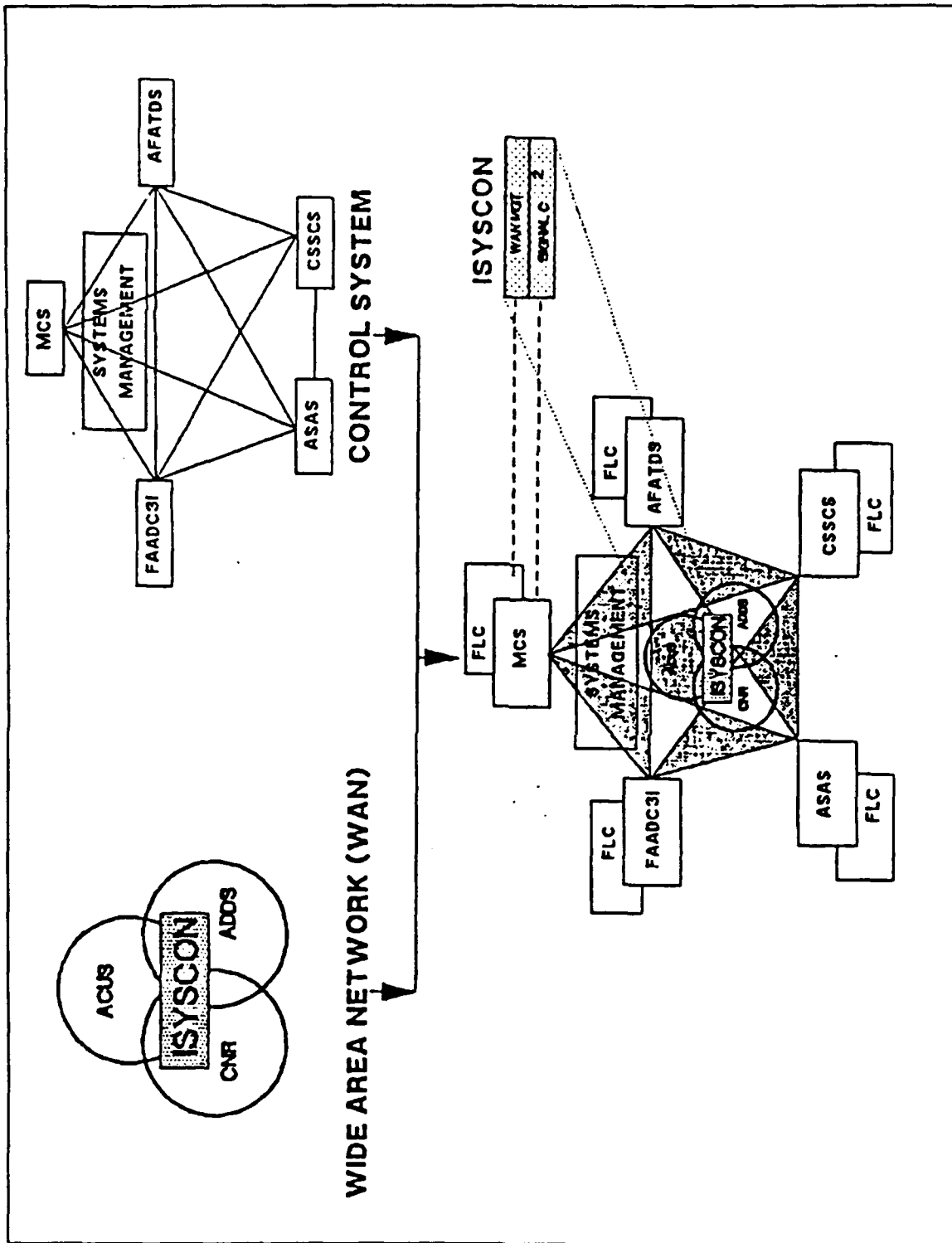

Figure 25 Potential ATCCS Management

5. Summary

This conceptualization of the potential capabilities of JTIDS provided information is by no means complete. Further investigation of these proposals is essential to determine their feasibility. They are the author's proposed viewed and do not necessarily represent current trends in system development.

CHAPTER VI. CONCLUSIONS AND RECOMMENDATIONS

A. SUMMARY

This thesis has presented JTIDS under its command and control aspects. An examination of JTIDS potential applications was also performed. A number of proposals were developed for the use of JTIDS provided information. The primary information source examined was the U.S. Air Force JSTARS ground surveillance aircraft. The use of JSTARS information, transmitted over JTIDS, on the ATCCS was also discussed.

B. CONCLUSIONS

The need for a secure , jam-resistant, data distribution system has been well documented. Numerous communities of all the services have approved operational requirements for such a system. JTIDS, in conjunction with EPLRS, will meet this requirement for the Army. The JSTARS ground surveillance aircraft can generate a wealth of information pertaining to enemy mobile targets. This information is invaluable to all Army commanders. Efforts should be directed towards making this information available to Army C² elements at all echelons. Due to future decreases in resources, the current Army communication architecture must be adapted to pass this traffic.

Airland Battle-Future doctrine is the future of the U.S. Army. Successful employment of this doctrine requires the complete integration of the ATCCS. JTIDS will be an integral part of the system. JTIDS should be fielded in the near future, if its full potential is to be realized. There is no other system in development which will meet the Army's data distribution needs.

C. RECOMMENDATIONS

1. Timely Fielding

The development of a secure, jam-resistant, data distribution system has been ongoing since the early 1970's. The result of this development effort is JTIDS. Studies have shown that the potential of JTIDS to meet established requirements is near fruition. JTIDS must be fielded soon if it is ever to become the joint system it was designed to be.

2. Continued JTIDS Development

Efforts in two areas of JTIDS development must continue. First, the MIDS program, under its initial conceptualization, should take advantage of newer technology to reduce the size of the JTIDS terminals. Complete integration of the air battle will never occur until the terminal can be incorporated into the smaller combat aircraft of the U.S. and our allies. Second, efforts need to continue on all JTIDS interfaces. All JTIDS terminals should be adapted to interact with the platforms planned for JTIDS

augmentation. Technology development will aid in the reduction of interface devices and increase the system's potential uses.

3. NCS-J - The Joint Management Tool

The Army's development of the NCS-J displays the difficulties encountered in managing an extremely complex JTIDS network. The NCS-J is a key start point towards reliable network management. Each service that plans to field JTIDS should examine its potential to manage the network closely. JTIDS is far too complex to manage manually and any reconfiguration of the network would be almost impossible to handle. The services can adapt the NCS-J to meet their specific needs, but the basic framework of the system should remain the same for all users.

4. JTIDS Transmission of JSTARS Information

The potential applications for JSTARS provided information are enormous. JTIDS should be examined as the means to transmit JSTARS information to all users. Full exploitation of JSTARS can occur if JTIDS is incorporated into a fully integrated ATCCS. Once it is available to ATCCS users, applications of this information can be adapted to specific BFA users. This facilitates the development of software which will assist commanders in evaluating all available information and make the best command decision

possible. The complete integration of information systems will act as a strong force multiplier.

LIST OF REFERENCES

1. Mitre Corporation, *Overview Description, TDMA JTIDS*, Revision 1, May 1984.
2. Cushman, John H., LtGen USA, "Joint Command and Control," *Military Review*, July 1990.
3. Ethell, Jeffrey and Price, Alfred, *One Day in a Long War*, Random House, Inc., 1989.
4. Air Force System Command, *Joint Program Management Plan, Joint Tactical Information Distribution System*, August 1990.
5. Air Force System Command, *JTIDS System Operations Manual, IOT&E Version*, Volume 1, Revision 1, July 1986.
6. Jaszka, Paul R., "JTIDS - A Primary Data Link," *Defense Electronics*, February 1989.
7. Naval Ocean Systems Center, *Support Analysis for the TADIL J Test System*, July 1987.
8. Comptroller General of the United States, "The Joint Tactical Information Distribution System - How Important Is It?", *Report to the Congress of the United States*, PSAD-80-22, 30 January 1980.
9. Comptroller General of the United States, "Joint Tactical Information Distribution System Class 2 Terminal," *Report to the Congress of the United States*, PSAD-90-159, 10 February 1990.
10. Kirkpatrick, Kenneth A., "Cutting the Gordian Knot: The New Air Force Architecture for Anti-Jam Communications," *Signal*, November 1984.
11. "JTIDS Joint Program Planning Office Focuses on Reliability, Lower Unit Cost," *Aviation Week and Space Technology*, June 1990.

12. DOD JOPM Supervisory Working Group, "Joint Tactical Information Distribution System (JTIDS) Operational Performance in the F-15 Theater Defensive Counterair Mission," *JTIDS Operational Performance Model (JOPM)*, November 1988.
13. Mitre Corporation, *Army System Operations Training Course*, October/November 1989.
14. Ellingson, Carl E., *System Engineering at Mitre: A Case History of JTIDS*, Video Tape, Session 2, 1988.
15. Telephone conversation between David S. Velasquez, CPT, USA, JTIDS Material Management, Directorate of Combat Developments, U.S. Army Signal Center, Ft. Gordon, GA, and the author 16 January 1991.
16. JTIDS Material Management, Directorate of Combat Development, *What Rides On What?*, U.S. Army Signal Center, Ft. Gordon, GA, March 1989.
17. Headquarters, Department of the Army, *Field Manual 44-1, U.S. Army Air Defense Artillery Employment*, Government Printing Office, Washington, DC, 1984.
18. Headquarters, Department of the Army, *JTIDS Joint Concept of Operations Manual*, Government Printing Office, Washington, DC, 1989.
19. Headquarters, Department of the Army, *Field Manual 100-5, Operations*, Government Printing Office, Washington, DC, 1986.
20. Joint Chiefs of Staff, Department of Defense, *Dictionary of Military and Associated Terms*, Government Printing Office, Washington, DC, 1987.
21. Dacunto, Lawrence J., Col (Ret.), USA, "Army Command and Control Initiatives," *Signal*, November 1988.
22. Wagner, Louis C., Gen, USA, "Modernizing the Army's C³I," *Signal*, January 1989.

23. Headquarters, Department of the Army, *Field Manual 11-30, MSE Corps/Division Signal Unit Operations (Coordinating Draft)*, Government Printing Office, Washington, DC, 1987.
24. Castro, Christine, "Tactical Voice Communications Become User Friendly," *Defense Electronics*, June 1990.
25. Whigham, John A., Col, USA, "Tactical Communications at Echelons Above Corps," *Signal*, September 1988.
26. Rawles, James W., "SINCGARS Second Source: Several Suppliers Seek Selection," *Defense Electronics*, January 1988.
27. Whigham, John A., Col, USA, "Improved High Frequency Radio," *Signal*, September 1988.
28. Hughes Ground Systems Group, *Enhanced Position Location Reporting System (EPLRS) Technical Description*, Fullerton, CA, May 1988.
29. Hughes Ground Systems Group, *Enhanced Position Location Reporting System*, Fullerton, CA, June 1989.
30. Directorate of Combat Developments, *Adapting Signal Support for Airland Battle-Future*, Fort Gordon, GA, January 1991.
31. Colligan, John J., Col, USAF, "JSTARS - The Deep Look," *Signal*, January, 1988.
32. Haystead, John, "JSTARS - Real Time Warning and Control for Surface Warfare," *Defense Electronics*, July 1990.
33. Rawles, James W., "Part II JSTARS: The Ground Stations," *Defense Electronics*, August 1990.
34. Headquarters, Department of the Army, *Field Manual 34-1, Intelligence and Electronic Warfare Operations*, Government Printing Office, Washington, DC, July 1987.

35. Harmon, William E., BGen USA and Webb, Richard B., Col USA, "Evolution and Progress: The All Source Analysis System/ Enemy Situation Correlation Element," *Signal*, December 1987.
36. Desbois, Michel, "Multisensor Tracking," *Signal*, November 1988.
37. Directorate of Combat Developments, *Multilevel Security (MLS)*, Fort Gordon, GA, January 1991.

INITIAL DISTRIBUTION LIST

1. Defense Technical Information Center 2
Cameron Station
Alexandria, Virginia 22304-6145
2. Library, Code 52 2
Naval Postgraduate School
Monterey, California 93943-5000
3. Director for Command, Control and 1
Communications Systems, Joint Staff
Washington, DC 20318-6000
4. C3 Academic Group, Code CC 1
Naval Postgraduate School
Monterey, California 93943-5000
5. BG David J. Kelley 1
U.S. Army Signal Center and Fort Gordon
ATTN: ATZH-DC
Fort Gordon, Georgia 30905
6. Director of Combat Developments 2
U.S. Army Signal Center and Fort Gordon
ATTN: ATZH-CD (CPT David S. Velasquez)
Fort Gordon, Georgia 30905
7. TRADOC System Manager-ADDS 1
U.S. Army Signal Center and Fort Gordon
ATTN: ATZH-AD
Fort Gordon, Georgia 30905
8. Professor Donald A. Lacer, Code CC 1
Naval Postgraduate School
Monterey, California 93943-5000
9. Professor Michael G. Sovereign, Code OR 1
Naval Postgraduate School
Monterey, California 93943-5000
10. CPT Richard E. Volz, Jr. 1
2009 Pine Log Road
Aiken, South Carolina 29801