

2

UNCLASSIFIED  
SECURITY CLASSIFICATION OF THIS PAGE

REPORT DOCUMENTATION

AD-A232 450

Approved  
B No. 0704-0188

1a. REPORT SECURITY CLASSIFICATION Unclassified		3. DISTRIBUTION/AVAILABILITY OF REPORT	
2a. SECURITY CLASSIFICATION AUTHORITY		5. MONITORING ORGANIZATION REPORT NUMBER(S)	
2b. DECLASSIFICATION/DOWNGRADING SCHEDULE		7a. NAME OF MONITORING ORGANIZATION DTIC ELECTE MAR 15 1991 S G D	
4. PERFORMING ORGANIZATION REPORT NUMBER(S) USAFSAM-JA-88-43		7b. ADDRESS (City, State, and ZIP Code)	
6a. NAME OF PERFORMING ORGANIZATION USAF School of Aerospace Medicine	6b. OFFICE SYMBOL (If applicable) USAFSAM/VNB	9. PROCUREMENT INSTRUMENT IDENTIFICATION NUMBER	
6c. ADDRESS (City, State, and ZIP Code) Human Systems Division (AFSC) Brooks AFB, TX 78235-5301		10. SOURCE OF FUNDING NUMBERS	
8a. NAME OF FUNDING/SPONSORING ORGANIZATION USAF School of Aerospace Medicine	8b. OFFICE SYMBOL (If applicable) USAFSAM/VNB	PROGRAM ELEMENT NO. 62202F	PROJECT NO. 7930
8c. ADDRESS (City, State, and ZIP Code) Human Systems Division (AFSC) Brooks AFB, TX 78235-5301		TASK NO. 20	WORK UNIT ACCESSION NO. 01
11. TITLE (Include Security Classification) Functional Specialization in the Lower and Upper Visual Fields in Humans: Its Ecological Origins and Neurophysiological Implications			
12. PERSONAL AUTHOR(S) Fred H. Previc			
13a. TYPE OF REPORT Interim	13b. TIME COVERED FROM 9/84 TO 9/90	14. DATE OF REPORT (Year, Month, Day) September 90	15. PAGE COUNT 76
16. SUPPLEMENTARY NOTATION			
17. COSATI CODES		18. SUBJECT TERMS (Continue on reverse if necessary and identify by block number)	
FIELD	GROUP	Evolution; Magno/parvocellular; Near/far; Primate	
	05	Space perception; Visual association cortex; Visual attention	
	08		
19. ABSTRACT (Continue on reverse if necessary and identify by block number)			
Functional specialization in the lower and upper visual fields in humans is analyzed in relation to the origins of the primate visual system. Processing differences between the vertical hemifields are related to the distinction between near (peripersonal) and far (extrapersonal) space, which are biased toward the lower and upper visual fields, respectively. Nonlinear/global processing is required in the lower visual field in order to perceive the optically degraded and diplopic images in near vision, whereas objects in far vision are searched for and recognized primarily using linear/local perceptual mechanisms. The functional differences between near and far visual space are correlated with their disproportionate representations in the dorsal and ventral divisions of visual association cortex, respectively, and in the magnocellular and parvocellular pathways that project to them. Advances in far visual capabilities and forelimb manipulatory skills may have led to a significant enhancement of these functional specializations.			
20. DISTRIBUTION/AVAILABILITY OF ABSTRACT <input checked="" type="checkbox"/> UNCLASSIFIED/UNLIMITED <input type="checkbox"/> SAME AS RPT. <input type="checkbox"/> DTIC USERS		21. ABSTRACT SECURITY CLASSIFICATION Unclassified	
22a. NAME OF RESPONSIBLE INDIVIDUAL Fred H. Previc, PhD		22b. TELEPHONE (Include Area Code) (512) 536-3521	22c. OFFICE SYMBOL VNB

Accession For	
NTIS CRA&I	<input checked="" type="checkbox"/>
DTIC TAB	<input type="checkbox"/>
Unannounced	<input type="checkbox"/>
Justification .....	
By .....	
Distribution /	
Availability Codes	
Dist	Avail and/or Special
A-1	20

# Functional specialization in the lower and upper visual fields in humans: Its ecological origins and neurophysiological implications



**Fred H. Previc**

Crew Technology Division, USAF School of Aerospace Medicine, Brooks AFB, TX 78235-5301

Electronic mail: [previc%apache.decnat@hqhhsd.brooks.af.mil](mailto:previc%apache.decnat@hqhhsd.brooks.af.mil)

**Abstract:** Functional specialization in the lower and upper visual fields in humans is analyzed in relation to the origins of the primate visual system. Processing differences between the vertical hemifields are related to the distinction between *near* (peripersonal) and *far* (extrapersonal) space, which are biased toward the lower and upper visual fields, respectively. *Non-linear/global* processing is required in the lower visual field in order to perceive the optically degraded and diplopic images in near vision, whereas objects in far vision are searched for and recognized primarily using *linear/local* perceptual mechanisms. The functional differences between near and far visual space are correlated with their disproportionate representations in the *dorsal* and *ventral* divisions of visual association cortex, respectively, and in the *magnocellular* and *parvocellular* pathways that project to them. Advances in far visual capabilities and forelimb manipulatory skills may have led to a significant enhancement of these functional specializations.

**Keywords:** evolution, magno/parvocellular, near/far vision, primate, space perception, visual association cortex, visual attention, visual fields

## 1. Introduction

One of the little-known and poorly understood features of the human visual system is how it processes information in its lower and upper visual fields (hereafter referred to as the LVF and UVF). In this theoretical review, I hypothesize that increased functional specialization in the LVF and UVF in primates was promoted by advances in *near* (peripersonal) visuomotor manipulatory skills and *far* (extrapersonal) visual capabilities, respectively. Processing in the LVF is believed to be more *non-linear/global* because of its involvement in reaching and other manipulations performed in peripersonal space, whereas processing in the UVF is primarily *linear/local* and linked to visual search and recognition mechanisms directed toward extrapersonal space. Finally, the enhanced segregation of near versus far visual space may explain many unique neurophysiological aspects of the primate visual system, especially regarding the specialization of its *dorsal* and *ventral* cortical divisions.

### 1.1. The distinction between near and far vision in the primate

I first discuss how important changes in the visual environment of primates dramatically increased the segregation of near and far visual space. There are four advances of particular importance to far vision: (a) the tremendous increase in the optical resolution of the primate eye (Polyak 1957), (b) the greater reliance on colored fruits as a food source, made possible by the evolution of spectrally selective cone pigments (Polyak 1957; Snodderly 1979); (c) the use of the face as an important instrument of emotional expression and other social communication (Allman 1977), and (d) the emergence of a voluntary saccadic system independent of head movements. Conversely, two major developments greatly expanded the visuomotor skills used in peripersonal space. First, the increased body size and the assumption of a sitting or partially erect posture resulted in an elevation of the eyes relative to the rest of the body and

facilitated the use of the hands and arms for primarily manipulative behaviors rather than postural support (Osman Hill 1972). Second, changes in the shape of the hand led to sophisticated reaching behavior in the higher primates (Bishop 1962).

The quartet of far visual developments presumably operated synergistically, in that: (a) the dramatic improvement in optical quality made the emphasis on far vision possible; (b) the frugivorous diet and enhanced role of facial expression provided the functional impetus for scanning, recognition, and memory functions directed toward distal space; and (c) the emergence of an independent saccadic eye movement system provided an efficient mechanism for exploring extrapersonal space. The improvement in optical quality paralleled the emergence of a well-defined fovea in diurnal primates, although the enhanced exploration of the extrapersonal visual environment would extend considerably beyond the boundary of the fovea. The contribution of color vision is evidenced in (a) the red-green and yellow-blue spectral opponency of the primate geniculostriate pathways (useful for perceiving the longer-wavelength colors in fruits against a blue-green forest background), (b) powerful color-specific attentional capabilities (instrumental in searching for and locating fruits), and (c) mechanisms for achieving color constancy (valuable in detecting fruits under different spectral illuminations). The importance of increased facial expression – facilitated by the evolution of a mobile upper lip (Allman 1977) – is reflected in the extensive and sophisticated facial processing performed by neurons in the anterior temporal lobe of rhesus monkeys (Perrett et al. 1984). Finally, the freeing of saccadic eye movements from head movements – not found in nonprimate mammals such as the cat (Guitton et al. 1984) – resulted in an enormous expansion of the output of the saccadic system (culminating in more than 100,000 saccades per day, according to Schiller 1986). Although the increased emphasis on far vision may have led to the advances in saccadic eye movement control and, in turn, to the marked expansion of prefrontal brain areas engaged in saccadic scanning (Goldman-Rakic 1987), it is also possible that the reverse scenario occurred.

Meanwhile, the expanded use of the arms and hands in retrieving and ingesting fruits and other food objects promoted specialized mechanisms for operating in, and switching to, the near visual environment. One such mechanism is the “near reflex,” involving a triad of ocular responses (accommodation, convergence, and pupillary constriction) designed to focus on nearby objects. This reflex, along with the related capability of pursuit tracking, is a phylogenetically recent phenomenon largely confined to primates (Jampel 1959). Other specialized perceptual capabilities would prove more valuable in reaching and related activities. One of these is a contralateral spatial attentional system that allows the hand to be accurately guided from the visual periphery to the fixated object, even though it cannot be directly viewed. A second capability, termed “global perception,” also assists in monitoring the reaching hand despite the distortions and reduced contrast caused by its rapid motion as well as the diplopia and defocus resulting from the more distal fixation (Figure 1).

It is important to note that visible peripersonal space is almost exclusively contained in the LVF in primates, so

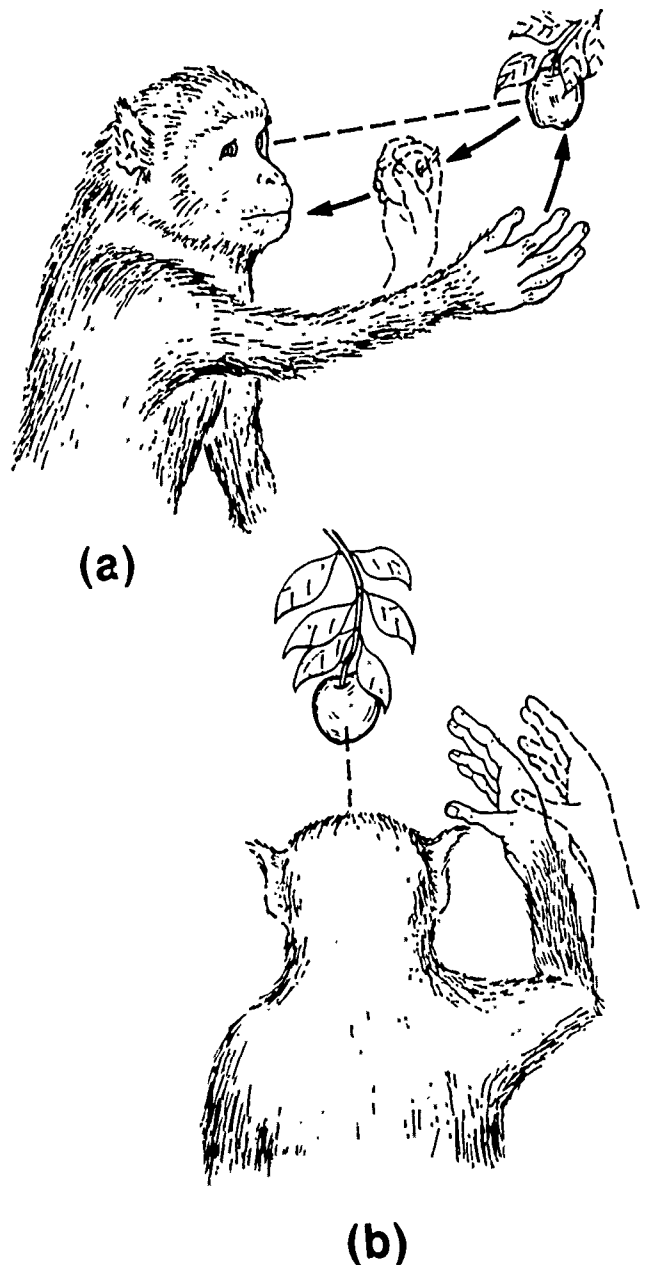

Figure 1. An illustration of the relationship between the lower visual field (LVF) and primate reaching behavior. The lateral view (a) shows that both reaching for objects and transporting them toward the mouth are normally accomplished in the LVF. The rear view (b) depicts the substantial diplopia in the proximal LVF as the hand approaches the object.

the above aspects of near vision apply to the LVF as well. Consequently, the LVF is functionally linked to (a) ocular movements (i.e., pursuit and convergence) associated with tracking an object as it is brought to the mouth, which is located inferior to the eyes, (b) an attentional system capable of monitoring the motion of the contralateral hand from the lower visual quadrants, and (c) global perceptual capabilities that can overcome the visual degradations produced by the rapid, diplopic motion of the upper limbs in peripersonal space. Other ecological pressures generated by the greater motion flow beneath the horizon during forward locomotion and the heightened

shadowing found close to the ground could also contribute to the LVF's greater relative sensitivity to motion and luminance (see Gibson 1966). The influence of these factors is reflected in the greater forward vection (self-motion) elicited by optical flow in the LVF as compared to the UVF (Young & Oman 1974), and by the importance of vertical luminance gradients in judging the direction of earth's gravity (Barbour & Coss 1988). These features cannot account, however, for those LVF advantages that are unique to primates, as they are also present in the visual environments of many other mammals. Nor do they relate to the major functional specializations of those cortical visual areas in which the LVF is predominantly represented, as will become evident in later sections.

In contrast to the link between the LVF and peripersonal space, the relationship between far vision and the UVF is not nearly as exclusive, as both vertical hemifields represent the extrapersonal portion of visual space. Indeed, it will be shown that virtually no UVF advantages exist in *sensory processing per se*. Nevertheless, a functional link between far vision and the UVF clearly exists, based on the relationship between height in the visual field and perceived distance (see Sedgwick 1986). During binocular viewing, objects in the UVF generally appear more distant than those in the LVF, a phenomenon that has been related to the greater strength of uncrossed-versus crossed-disparity mechanisms in the UVF and LVF, respectively (Breitmeyer et al. 1977). A further link between vergence distance and height in the field has recently been demonstrated, with divergence accompanying elevation of the head or eyes into the UVF and convergence accompanying their descent into the LVF (Heuer et al. 1988). It is not surprising, therefore, that visual search and saccadic scanning in far visual space are more efficiently performed in the UVF.

Processing differences between the LVF and UVF will be reviewed and interpreted in the framework of the near-far dichotomy. Although the LVF-near and UVF-far links are far from absolute, the differences between the vertical hemifields will serve as basic "markers" for less extensively studied peripersonal and extrapersonal differences. The distinction between near and far vision will remain the overriding theme of this paper, however, and will be directly addressed whenever relevant evidence exists.

### 1.2. The relationship between the dorsal and ventral systems and near and far vision

The enhanced split of near and far vision ultimately led to important transformations in the primate visual system. Perhaps the most important of these involved the increased functional segregation of the dorsal (occipito-parietal) and ventral (occipito-temporal) visual cortical pathways. Many different dichotomies have been proposed to characterize the visual specializations of these pathways, including *spatial/peripheral versus object/central* vision (Ungerleider & Mishkin 1982), *motion versus color-form* processing (Maunsell & Newsome 1987; Van Essen & Maunsell 1983), and *global (movement/depth) processing versus object identification* (Livingstone & Hubel 1988a).

Although all of these distinctions have merit, there are several reasons why none of them is altogether satisfacto-

ry. First, the proposed functional specializations are far from absolute and are subject to many counterexamples. Indeed, with the possible exception of color recognition, neither human clinical data (Martin 1988) nor animal neurophysiological evidence (DeYoe & Van Essen 1988) support a strict allocation of individual perceptual functions to one system or the other. Not only is this consistent with the extensive anatomical connections between the two systems (DeYoe & Van Essen 1988), but it suggests that the dorsal and ventral pathways differ more in their processing strategies in different regions of visual space than in the particular types of information they process. Second, a host of dorsal-ventral differences to be discussed in later sections have not been addressed by previous dichotomies. These include differences in binocular disparity tuning, visual field representation, visuomotor outputs, and visual attention.

The following examples illustrate the first of the above objections: (a) counter to the central/peripheral distinction, most neuronal fields in parietal cortex overlap the foveal region and/or are influenced by foveal fixation and pursuit (Andersen 1987; Sakata et al. 1985), whereas inferotemporal fields average 25 degrees in diameter (Desimone et al. 1985); moreover, the retinal distributions of the magnocellular and parvocellular pathways (which dominate the dorsal and ventral systems, respectively) exhibit considerably more overlap than previously believed (Livingstone & Hubel 1988b); (b) counter to the spatial/object dichotomy, the perception of certain types of objects (e.g., fragmented or foreshortened ones) is impaired by parietal lesions (Warrington & Taylor 1973; Vaina 1989), whereas memory for the topographical relationships among objects in extrapersonal space can be disrupted by temporal lesions in humans (Goldstein et al. 1989); and (c) the assignment of depth and motion processing to the dorsal system conflicts with evidence that certain motion and depth percepts (e.g., short-range motion; local stereopsis) clearly remain unimpaired following dorsal system damage in humans (Rothstein & Sacks 1972; Zihl et al. 1983).

A more general challenge to the functional parcellations contained in previous dorsal-ventral schemes is the *teleological* one. Why, for instance, should the processing of the features of an object be divorced from the processing of its relation to other objects? Or, why, when focusing on an object in front of us, should we attend to its shape with one part of our brain and its motion and depth with another? Such divisions are contradicted by the unity of our phenomenological experience, by the importance of motion and depth in shape processing (DeYoe & Van Essen 1988), and by the fact that objects and places can be perceived only as a particular spatial configuration of individual features or elements. Moreover, a gross division of the brain according to the particular information processed ignores the fact that primates are better able to attend to broad regions of space than to particular stimulus attributes within limited spatial regions (Nakayama & Silverman 1986). Given that the shaping of the higher visual pathways depends on those visual experiences that are actively attended (Singer 1985), functional specialization in the primate brain should above all correspond to the three-dimensional structure of visual space and the powerful attentional mechanisms associated with it.<sup>1</sup>

The hypothesis that specialization in the dorsal and ventral cortical pathways is linked to the different perceptual requirements of near and far visual space offers several advantages over previous schemes. For example, it can explain most of the dorsal-ventral differences (e.g., eye movements and visual field representational biases) neglected by previous theories (see sections 3.2 and 3.3). The near-far distinction can also account for the fact that functional differences between the dorsal and ventral systems are only relative, not absolute; after all, motion, depth, and form perception must be carried out in both near and far space, although not necessarily in identical ways in the two sectors. Perhaps most important, the near-far dichotomy has a clear *ecological* basis that is reflected neurologically in the separate neuronal pools tuned to near versus far disparities (Poggio & Poggio 1984) and in the clinical illusions (e.g., teleopsia and macropsia) that the entire world is either closer or farther away (Critchley 1953; Penfield & Rasmussen 1950). Moreover, selective impairments of the crossed- or uncrossed-disparity systems (Mustillo 1985; Richards & Lieberman 1985) or peripersonal as opposed to extrapersonal visual functions in various developmental disorders suggest how near and far visual perception are neurodevelopmentally shaped into the dorsal and ventral pathways (see section 4.1).

Despite its relative advantages, the near-far dichotomy is by no means incompatible with previous dorsal-ventral schemes. It can, for example, account for the specialization of the dorsal system for most motion and depth operations, since they are more frequently performed in peripersonal space (where motion is most rapid and convergence and disparity information most useful). Conversely, the specialization of the ventral system for color and object recognition can be attributed to the greater importance of these processes in distal space (i.e., color is of little importance in monitoring the position of the limbs during reaching and objects rarely enter peripersonal space unless already recognized). In addition, the central/peripheral differences can be incorporated into the near-far dichotomy, in that most far visual processes are confined to the central 30 degrees because of the poor spatial resolution of the peripheral retina (see section 2.5), whereas peripheral visual inputs must be attended and processed during reaching and other peripersonal activities (see section 3.2.1).

The near-far distinction has recently been emphasized in the neurophysiological literature (e.g., Rizzolatti et al. 1985), although the affinity between the occipito-parietal pathways and near vision has long been recognized (see Mountcastle 1976). No direct theoretical link has yet been made between the occipito-temporal pathways and far vision, however. In Rizzolatti et al.'s (1985) scheme, for instance, far visual functions reside in area 8 of prefrontal cortex and the superior colliculus. Yet neither of these structures contains neurons capable of performing the extensive computations required of complex form recognition in extrapersonal space (see Bruce 1988; Goldberg & Robinson 1978), so they may be more properly considered part of the far visual system's *output* pathways.

It must be conceded that the near-far dichotomy also falls short as a complete explanatory scheme. Perhaps its most significant weakness lies in the fact that the bound-

ary of peripersonal and extrapersonal space is easier to define physically (i.e., at the edge of arm's reach) than functionally. It is obvious that visual scanning and local perceptual analyses typically directed toward extrapersonal space can also be performed on objects within reach, just as the body-centered spatial coordinate system ordinarily used in peripersonal visuomotor activities (see sections 2.5 and 3.2) can project beyond the reach of the animal. A secondary objection is that dorsal-ventral specialization may be created by neurodevelopmental shaping forces (e.g., the proximity of vestibular cortical areas to the dorsal pathways) that relate to, but do not explicitly distinguish between, near and far visual space (see section 4.1). Neither of these criticisms undermines the basic tenet, however, that functional specialization in the higher visual pathways conforms largely to the fundamental division of the primate visual world into near and far visual space.

### 1.3. Local versus global visual perception

Before reviewing the functional differences between LVF and UVF processing, I will briefly discuss the distinction between linear/local and nonlinear/global perception. This is arguably the most important perceptual dichotomy referred to in this paper, and serves as a cornerstone of many other perceptual and neurophysiological theories.

"Linear" and "nonlinear" will be defined in accordance with their neurophysiological usage (Enroth-Cugell & Robson 1966). For example, a "linear" neuron responds to the precise spatial profile of a luminance gradient in its receptive field and will, in the proper phase, display a "null" response. The majority of such neurons also respond in a fairly linear fashion to increments in the contrast of the image, and do not show response saturation at high contrasts (Shapley & Perry 1986). By comparison, nonlinear cells respond to luminance gradients in many regions of their receptive field and summate in such a way that no spatial phase produces a null response. They also exhibit temporal nonlinearity (transient responsiveness) and saturate at contrast levels well below those of linear neurons, despite their greater luminance sensitivity. Accordingly, a linear perceptual system would transmit precise spatiotemporal phase information and thereby mediate "local" perceptual processes, whereas a nonlinear perceptual mechanism would be more adept at processing transient, low-contrast information in a spatially distributed ("global") fashion.

The difference between local and global processing is illustrated in Figure 2. For example, the small E's in Figure 2a, the corners of the equilateral triangle in 2b, and the individual motions in Figure 2c are perceived using contour-dependent local processing. In contrast, the large S in Figure 2a, the illusory triangle in Figure 2b, and the group motion in Figure 2c require global perceptual processing - i.e., correspondence-matching among elements rather than contour-extraction.

The difference between local and global processing is also illustrated by the perceptual properties of the chromatic system, which is generally considered a spatiotemporally linear system. Many aspects of global perception either weaken or collapse entirely with stimuli composed only of equiluminant color contrast (Livingstone & Hubel

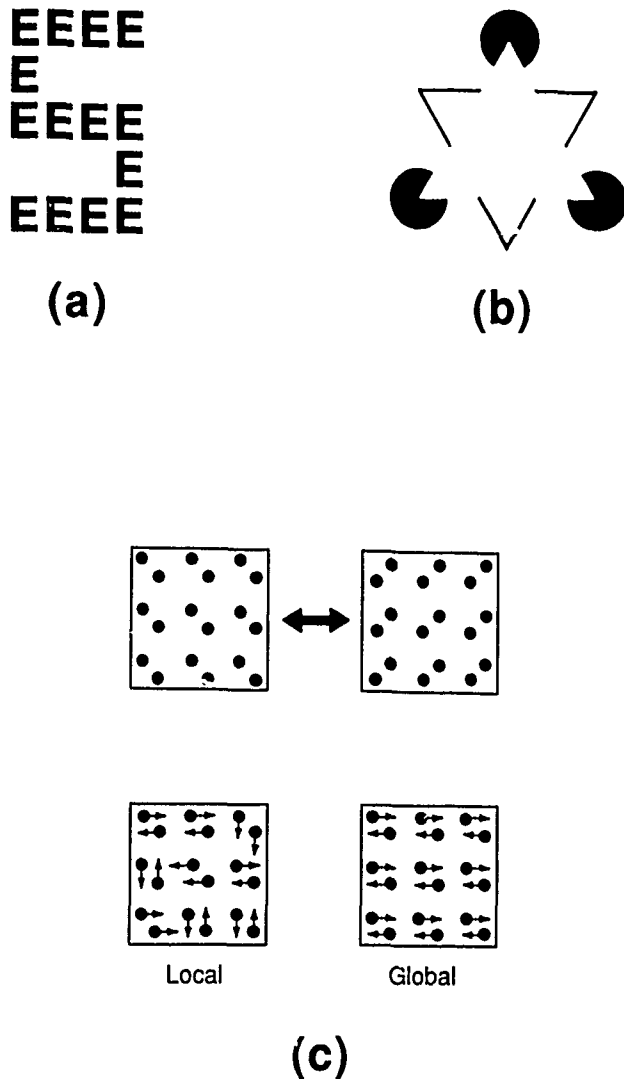

Figure 2. Illustrations of the difference between "local" and "global" perception: (a) local (small Es) vs. global (large S) letters; (b) local (disks and lines) vs. global (illusory triangle) forms; and (c) local (individual element) vs. global (group) motion percepts for alternating frames of dots.

1988a), such as: (a) global form perception (Gregory 1977), including the perception of the illusory triangle shown in Figure 2a; (b) global motion analysis (Cavanagh et al. 1985), including the group motion shown in Figure 2c; and (c) global depth perception (Lu & Fender 1972), as in random-dot stereograms. Although Livingstone and Hubel (1988a) also claim that local motion and depth perception are impaired at equiluminance, their argument is contradicted by numerous perceptual studies (including the above-mentioned ones) and by clinical dissociations between local and global motion and depth perception (De Hamsher 1978; Rothstein & Sacks 1972; Zihl et al. 1983).

Motion perception also illustrates the differences between linear and nonlinear processing. For example, a distinction is often made between short-range (local) and long-range (global) motion perception (see Anstis 1978). As illustrated in Figure 2c, long-range motion can be

perceived even over large spatial excursions, whereas short-range motion perception depends more on an analysis of local positional displacements. A truly linear motion system cannot perform a "speed-invariant" analysis – i.e., it cannot code the velocity of a moving grating independent of its spatial frequency (Maunsell & Newsome 1987) – nor can it properly signal overall image motion when the linear sum of individual motions is ambiguous, as exemplified by the aperture problem (Movshon et al. 1985). These and other distinctions between local and global motion analysis will be more extensively treated in connection with the dorsal system's role in reaching behavior (see section 3.2.1).

Of course, some global percepts may be achieved via higher-order transformations of linear outputs, especially when features are integrated into recognizable faces and objects. Nevertheless, most global perceptual processes – and especially those not highly dependent on contour and contrast boundaries – will be shown to utilize the nonlinear pathways of the visual system, which ultimately project into the highest levels of the dorsal system.

## 2. The functional specializations of the LVF and UVF

Having briefly presented the conceptual background of this theory, I now review LVF/UVF (near/far) perceptual asymmetries in the following major areas: reaction-time (RT) performance, eye movements, visual thresholds, motion perception, and visual attention. Data from human visual evoked potential (VEP) studies will also be examined in conjunction with the behavioral evidence. Subsequent sections will then review and integrate animal neurophysiological and human neuropsychological findings from the standpoint of these functional specializations. Much of the evidence discussed in this section was cited in a recent review by Skrandies (1987), who concluded that perception in the LVF is generally superior to that in the UVF. I, too, will highlight LVF advantages in many basic visual functions, emphasizing in addition the relatively greater role of UVF processing in many aspects of far vision.

### 2.1. Reaction-time performance

One of the best-studied and most reliable functional differences between the LVF and UVF is in reaction times. It was already recognized more than a century ago (Hall & Von Kreis 1879, cited in Woodworth 1938) that the latency of RTs to most stimuli is shorter in the LVF. In a widely cited study, Payne (1967) showed that the mean latency advantage of the LVF is approximately 8–10 msec at the vertical meridian but increases to more than 20 msec in the nasal hemiretinae. Recent studies (Gawryzowski et al. 1987; Rizzolatti et al. 1987) confirm the LVF latency advantage, at least under valid or neutral attentional cueing. One RT study (Cocito et al. 1977), however, reported that the LVF RT advantage may be limited to gratings in the low spatial frequency range.

The basis for the RT latency advantage is not entirely clear, but two possibilities suggest themselves. First, it may reflect a basic sensitivity difference between the LVF and UVF (Skrandies 1987), in accordance with the

greater receptor density in the upper hemiretina, which processes LVF input (Osterberg 1935; Perry et al. 1984; Van Buren 1963). The asymmetrical receptor density, illustrated in Figure 3, parallels that found in primary visual cortex (Tootell et al. 1988b; Van Essen et al. 1984) and may underlie the LVF advantage in luminance and contrast threshold sensitivities (see section 2.3). A second possibility is that the RT differences are produced during sensorimotor integration stages, since saccadic eye movement latencies to similar targets generally exhibit an opposite asymmetry (Heywood & Churcher 1980). Indeed, the manual RT advantage in the LVF is highly predictable from the previously described perceptual relationship between the LVF and peripersonal space (in which the arm and hands exclusively operate) and parallels the shorter manual RTs to crossed- versus uncrossed-disparity targets (Gawryszewski et al. 1987).

## 2.2. Eye movements

Vertical asymmetries in eye movements are highly dependent on the type of movement executed. For example, Tychsen and Lisberger (1986a) reported a striking asymmetry in eye movement accelerations to pursuit targets in the two hemifields, with greater accelerations in the LVF for both upward and downward target motion. Their results contrast, however, with those for saccadic eye movements to static targets. As reviewed by Heywood and Churcher (1980), the majority of saccade studies have shown a UVF advantage (particularly beyond 10 degrees eccentricity), with no study showing a significant opposite trend.

The most plausible explanation of the LVF specialization for processing and pursuing moving targets is that tracking of objects as they are brought into peripersonal space for ingestion or manipulation usually involves an initial descent into the LVF. This is especially true of food brought to the mouth, which is below the eyes. In fact, to track approaching objects calls for a combination of (a) stereomotion detection (to discern the object's course),

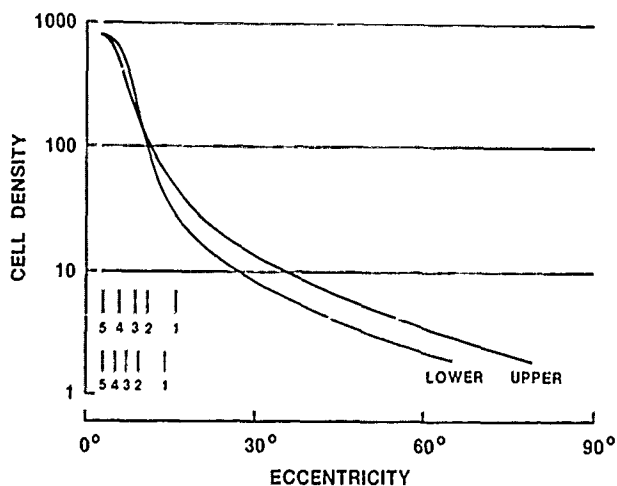

Figure 3. Ganglion cell distribution in the human retina along the vertical meridian. Data are from Van Buren (1963), as redrawn by Skrandies (1987), with permission from Springer-Verlag and Dr. W. Skrandies.

(b) vergence movements (to fixate in the same depth plane as the approaching object), and (c) pursuit movements (to adjust to the lateral slips that occur as the object is brought toward the body). Not surprisingly, the pursuit and vergence systems are 'nearly additive' (Miller et al. 1980), exhibit similar temporal frequency responses (Hine & Thorn 1987), and, along with stereomotion detection, are biased toward the LVF (see section 2.4). Furthermore, pursuit, vergence, and stereomotion deficits are commonly observed together after damage to the dorsal system (Girotti et al. 1982; Zihl et al. 1983). That the pursuit system is primarily an instrument of near vision is also supported by evidence that the most effective stimuli for the ocular following system are substantial retinal slips (more likely in peripersonal space because of motion parallax) and large targets (see Miles & Kawano 1987).

The LVF superiority in pursuit initiation is paralleled by the greater slow-phase gain of horizontal optokinetic nystagmus (OKN) in the LVF (Murasugi & Howard 1989). Even though pursuit and OKN drive the eyes in opposite directions while following an object against a moving background, their neurophysiological substrates are closely entwined in that both kinds of movements are impaired by vestibulo-cerebellar damage (Magnusson et al. 1986; Zee et al. 1981) and damage to the dorsal visual system (see section 3.2.1). The vestibular system may be involved because of its important role in signalling the head movements that typically accompany these ocular movements. The lowpass spatial tuning and high temporal resolution of OKN (Schor & Narayan 1981) indicate that it is probably mediated by the magnocellular pathways, which project into the higher stages of the dorsal visual system and are biased toward the LVF (see section 3.1).

The closer link between the saccadic system and the UVF may arise from the importance of saccades in object scanning and visual search in extrapersonal space. As noted earlier, the two major neural components of the voluntary saccade system – the superior colliculus and frontal eye fields – have been assigned to the far visual system (Rizzolatti et al. 1985). The control of saccadic eye movements is clearly dissociable from pursuit control, as evidenced by the differential effects of vestibular lesions on the two movements (Magnusson et al. 1986) and the numerous clinical reports of cortically damaged patients with pursuit deficits but normal scanning of scenes and objects (Girotti et al. 1982; Pierrot-Deseilligny et al. 1986) and vice versa (Luria et al. 1963). That vestibular lesions fail to disrupt saccadic eye movements is consistent with the fact that most saccades are placed within the foveal attentional field (approximately 15 degrees surrounding the fixation point), whereas most head movements only accompany saccades that extend beyond this point (Bahill et al. 1975).

In summary, the reverse vertical asymmetry of different types of eye movements contrasts markedly with the reliable LVF advantage for manual RTs. This difference makes sense from an ecological standpoint in that the oculomotor system subserves at least two major functions – locking onto and following a target moving in peripersonal space versus saccadic scanning in extrapersonal space – whereas arm and hand movements *always occur within the confines of peripersonal space*.

### 2.3. Visual thresholds

The next body of evidence to be reviewed pertains to threshold data in the areas of luminance sensitivity, contrast sensitivity, temporal resolution, stereoacuity, and color perception.

The distribution of luminance thresholds across the retina largely parallels the receptor density distribution. Hence, most normal subjects can detect dim targets much further into the LVF periphery, especially in the nasal hemifield (see Riopelle & Bevan 1953; Sloan 1947). This, of course, is why the typical perimetry exam shows such a pronounced skewing toward the lower nasal field. Sloan's data, however, clearly suggest that the vertical asymmetry in luminance thresholds is much greater for larger targets, which may relate to the contrast sensitivity and acuity findings described below.

Data from several contrast threshold studies have established that there is a greater LVF sensitivity in the low-to-moderate spatial frequency range (Lundh et al. 1983; Murray et al. 1983; Rijdsdijk et al. 1980; Skrandies 1985a). On the other hand, the LVF superiority at medium-to-high spatial frequencies appears to be substantially reduced, if it is present at all (Lundh et al. 1983; Rijdsdijk et al. 1980). This is consistent with the absence of vertical asymmetry in fias (Cocito et al. 1977) and luminance thresholds (Sloan 1947) when high spatial frequencies or small targets are used and may account for the muddled picture regarding visual acuity differences. Although some studies have reported better acuity in the LVF (Finke & Kosslyn 1980; Low 1943; Millodot & Lamont 1974), others have shown UVF superiorities (Julesz et al. 1976; Weymouth et al. 1928). A considerable overlap of the UVF and LVF visual acuity distributions undoubtedly exists, based on Low's (1943) data from 100 subjects.

A number of studies have investigated differences in temporal resolution across the retina (Hylkema 1942; Phillips 1933; Skrandies 1985b; Tyler 1987; Yasuma et al. 1986). All used the critical flicker fusion technique and all but Yasuma et al. (1986) showed a greater flicker resolution in the LVF.<sup>2</sup> For example, 13 of 20 subjects in Hylkema's study had a higher fusion limit in the LVF, while only two subjects showed the opposite trend. Using the somewhat more difficult double-flash resolution technique, Skrandies (1985b) also found superior LVF temporal resolution but, once again, Yasuma et al. (1986) reported no differences between the hemifields. It should be noted that the LVF superiority observed by Murray et al. (1983) in both pattern and motion detection at all spatial frequencies tested may actually have reflected a LVF superiority in transient processing, as a relatively high (15-Hz) flicker rate was used in that study.

Like visual acuity, stereoacuity appears to be roughly isotropic across the vertical hemifields (Richards & Regan 1973). It has also been shown, however, that the ability to detect random-dot stereograms - in which global correspondences determine the percept - is faster in the LVF for convergent (near) disparities but faster in the UVF for divergent (far) ones (Breitmeyer et al. 1975; Fox 1982; Julesz et al. 1976). This finding is especially intriguing since a truly vertical line should be seen at a crossed disparity in the UVF and at an uncrossed disparity in the LVF during a distant fixation, because of the substantial tilt of the vertical horopter toward the base of the ob-

server (Cogan 1979). Of course, the tilt of the vertical horopter is less relevant during movement indoors, and a person's fixation may occasionally be directed to some intermediate distance along the ground in front. Based on subjective experience, however, the images most frequently and reliably encountered at large crossed disparities in the LVF are those contained in elevated peripersonal space (e.g., the arms and hands).

At least one psychophysical study (Manning et al. 1987) has reported a crossed-disparity advantage in both the LVF and the UVF, in accordance with the results of an earlier VEP study (Fenelon et al. 1986). In addressing the discrepancy with previous research, Manning et al. noted the failure of earlier studies to align the fixation point and stimulus frame in the same depth plane. An alternative explanation is that the vertical differences may interact with an overall perceptual advantage for crossed-disparity random-dot stereograms (Grabowska 1983; Harwerth & Boltz 1979; Lasley et al. 1984; Mustillo 1985), derived from the basic link between global stereopsis and near vision discussed in section 2.7.

Finally, thresholds for colored stimuli appear to be asymmetric in the nasal portions of the two hemifields, with sensitivity to red, green, blue, and yellow lights all slightly greater in the LVF (Carlow et al. 1976; Hurvich 1982). These asymmetries probably relate more to the distribution of luminance thresholds than to color per se, since it is necessary to detect a target before its hue can be identified. Indeed, recent evidence indicates that equiluminant red-green color sensitivity does not differ between the LVF and UVF (Anderson et al. 1989). One researcher (Pennal 1977) claims to have found better color matching in the lower left visual quadrant in normals, but the methodology and data interpretation in his study can be challenged.<sup>3</sup>

In summary, luminance and contrast thresholds for low-spatial and high-temporal frequency stimulation may be lower in the LVF. Vertical asymmetries in visual acuity, stereoacuity, color discrimination, and threshold sensitivity outside the above ranges appear to be much less reliable, however.

### 2.4. Motion perception

Vertical asymmetries in motion perception also depend on the type of processing required. Two perimetric studies have investigated frontal-plane motion thresholds using small targets moving at low velocities (McColgin 1960; Regan & Beverley 1983). In the latter study, most subjects were reported to have exhibited vertical symmetry for both in-phase and antiphase motion, although the authors did not display their group data quantitatively. McColgin's (1960) findings present a somewhat more complicated picture in that movement thresholds exhibited overall vertical symmetry, despite a slight interaction involving horizontal and vertical motion detection (lower vertical thresholds in the LVF; lower horizontal ones in the UVF). In more recent studies using low grating velocities, no UVF/LVF differences have been reported in either detecting or perceiving the direction or velocity of drifting/counterphasing gratings (Anderson et al. 1989; Smith & Hammond 1986).

Because all of the above studies arguably investigated "short-range" motion perception, it may be concluded



that little vertical asymmetry exists for this type of percept. In contrast, several studies suggest that global motion perception – especially that involving “motion-in-depth” – is better performed in the LVF. For example, Regan et al. (1986) demonstrated that motion-in-depth perception occurs over a larger region of the LVF than the UVF. This was true for all five subjects tested and confirmed a previous finding for a single subject (Richards & Regan 1973).<sup>4</sup> Regan and colleagues argue that stereomotion perception differs from the perception of both static depth and frontal plane motion. (Indeed, stereomotion detection can be completely absent in UVF regions in which static disparities are readily detected.) Since visually guided reaching in peripersonal space is arguably the most frequently encountered movement-in-depth, it is not surprising that stereomotion is better perceived in the LVF. Given that the image of the reaching hand is optically degraded and diplopic during fixation on the reached-for object, its motion-in-depth must be detected via more *global* mechanisms than could be used to detect static disparities. Thus, stereomotion can be perceived over large disparity ranges (Cynader & Regan 1982), whereas local stereopsis requires small disparities and point-to-point correspondences. It further appears that the closely related vergence system is likewise stimulated by global perceptual mechanisms (Jones & Kerr 1972; Julesz 1978) and suffers from “blind spots” that are closely aligned with regions of poor stereomotion perception (Regan et al. 1986).

No research has specifically addressed whether other “long-range” motion percepts are vertically asymmetric, although they would be predicted to be on the basis of clinical evidence that links the long-range process to stereomotion detection (e.g., Zihl et al. 1983). The ability to extract an object’s shape from the pure motion information generated by its three-dimensional rotation may be less readily achieved, however, at uncrossed disparities and by individuals who lack a crossed-disparity mechanism (Richards & Lieberman 1985). The link between near vision and this long-range percept (termed “structure-from-motion”) makes intuitive sense in that rotation-in-depth frequently occurs during many visuomotor manipulations in peripersonal space (e.g., the rotation of a food object as it is brought to the mouth), and may, at least in the case of object foreshortening, be rarely encountered *except* in peripersonal space. The detection of structure-from-motion accordingly depends on the integrity of middle temporal cortex (Andersen 1988), an important dorsal brain structure involved in near vision and biased toward the LVF (see section 3.2.1).<sup>5</sup>

It can tentatively be concluded, therefore, that whereas short-range motion is perceived equally well in both the UVF and LVF, stereomotion detection and other global motion percepts may be biased toward near vision and/or the LVF.

## 2.5. Visual attention

In this section, vertical asymmetries in visual attention are examined with reference to two countervailing systems: a *body-centered* one for monitoring visuomotor activities in peripersonal space and a *retinotopic* one for visual search and scanning in extrapersonal space.

The former system is probably synonymous with the

visuospatial attentional mechanisms investigated in recent studies that have required manual RT responses (Gawryszewski et al. 1987; Hughes & Zimba 1987; Rizzolatti et al. 1987). Gawryszewski et al.’s results, in particular, suggest a three-dimensional cubic framework for visuospatial attention, with fundamental divisions occurring along the lateral (left-right), vertical (up-down), and depth (near-far) axes. Preliminary evidence indicates that this attentional structure may in most subjects be biased toward the proximal LVF, based on the greater “cost” of attending to near/LVF space when far/UVF stimuli are presented than vice versa (Gawryszewski et al. 1987; D. L. Robinson, personal communication). The basic structure of the visuospatial attentional system, along with its alleged proximal LVF bias, points to a relationship between it and the visuomotor coordination required in peripersonal space. Obviously, an ability to attend specifically to the contralateral, proximal LVF would allow the trajectory of the reaching hand to be more accurately monitored.

The proximal LVF bias of the visuospatial attention system is reflected in the vertical asymmetry associated with the “neglect” syndrome. This attentional disorder is typically produced by right parietal lobe damage and is generally more pronounced in the contralateral LVF (Bender & Furlow 1945; Butter et al. 1989; Morris et al. 1986; Nathan 1946; Rapcsak et al. 1988; Rubens 1985). Examples of the LVF bias, which is particularly evident during the immediate recovery period, are illustrated in Figure 4. These LVF deficits are attributable to atten-

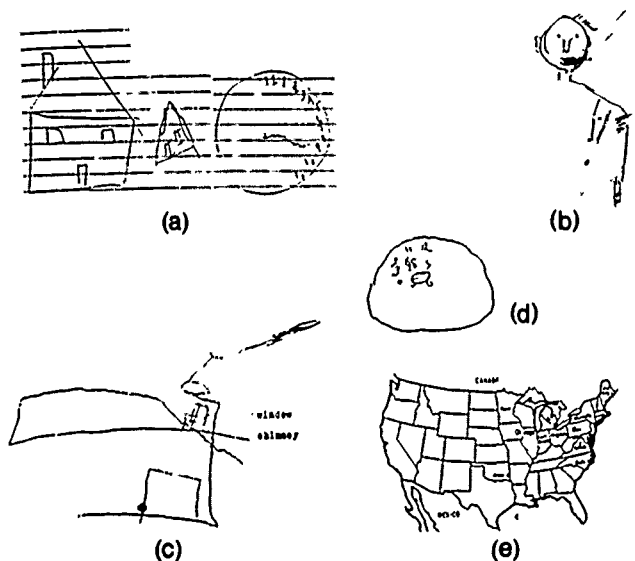

Figure 4. Examples of the LVF bias in drawings of patients suffering from the “neglect” syndrome. Note how the neglect of the contralateral visual field is more pronounced in the lower quadrant, with the LVF neglect even crossing the vertical meridian into the ipsilateral quadrant in some cases. Figure 4a is reproduced from Mountcastle (1976, Figure 3), with permission from MIT Press and Dr. V. B. Mountcastle; Figure 4b is from Weinstein (1980, Figure 2), with permission from Cambridge University Press and Dr. E. A. Weinstein; Figures 4c and 4d are from Critchley (1953, Figures 104 & 108), with permission from MacMillan Publishing Co., Figure 4e is from Benton, Levin and Van Allen (1974, Figure 1), with permission from Pergamon Press and Dr. A. L. Benton.

tional factors because (a) they can occur in the absence of visual field loss per se, (b) they frequently reappear during simultaneous left-right visual field testing, and (c) they can be alleviated by unilateral vestibular activation (see section 4.1). Indeed, all 18 patients in Rubens's (1985) study exhibited LVF neglect (in 13 of them the neglect was limited to the LVF), even though actual visual defects were reported in only eight of them. Evidence of an additional proximal bias is based on the observation that parietal (area 7b) "neglect" in monkeys is biased toward peripersonal space, whereas damage to the arcuate region of prefrontal cortex (containing the frontal eye fields) leads to a greater neglect of extrapersonal space (Rizzolatti et al. 1985). This coincides with evidence in humans that parietal neglect – along with many other visual lateralization phenomena – appears to be framed more in terms of body-centered rather than retinotopic coordinates (Bradshaw, Nettleton et al. 1987; Gazzaniga & Ladavas 1987; Kooistra & Heilman 1989).

In contrast to the proximal bias of the body-centered visuospatial coordinate system, the extrapersonal attentional system is associated more with the search for and recognition of objects in the extrapersonal visual environment. This type of attention can serve as the "glue" whereby color and form cues are properly integrated into the feature conjunctions that define an object (Treisman & Schmidt 1982), but it also has an important prior stage known as "feature selection," which occurs approximately 150–250 msec after the stimulus (Previc & Harter 1982). Feature selection is generally performed in parallel across the central visual field and greatly increases the efficiency of visual search, since only those objects that have a reasonable probability of being the ones actually searched for (i.e., those sharing one or more features with it) serve as targets for subsequent saccadic eye movements (Williams 1966). Thus, it may be assumed that, like the saccadic system, visual search is tied to a retinotopic (as opposed to body-centered) spatial coordinate system. Although the exact diameter of the feature search field depends on the nature of the target and background information, feature attention generally falls off rapidly beyond 15 degrees from fixation (see Haber & Hershenson 1973, Fig. 9.7). This distance also represents the maximum radius of most naturally occurring saccades, as well as those unaccompanied by head movements (Bahill et al. 1975). Since shape detection (Engel 1971) and saccadic accuracy (Jeannerod & Biguer 1987) both decrease beyond this point, the size of the extrapersonal attentional field is probably ultimately limited by the poor spatial resolution of the retina beyond the central 30 degrees. [See Tsotsos: "Analyzing Vision at the Complexity Level" *BBS* 13(3) 1990.]

The proposed relationship between visual search and extrapersonal space is further supported by the former's bias toward the UVF. For example, visual search usually commences in the UVF (especially the upper left quadrant) and proceeds from left to right (Chedru et al. 1973; Jeannerod et al. 1968), which may account for why UVF targets are more frequently identified in briefly presented displays (Chaiken et al. 1962). Furthermore, the duration of search in the UVF is typically greater than in the LVF (Chedru et al. 1973), which parallels the finding that, while performing a search of a visual display in memory, subjects typically elevate their eyes (Kins-

bourne 1972). Because oculomotor biases are believed to reflect heightened activation of those brain regions that ordinarily direct eye movements to the same region of space, the cortical areas most responsible for UVF saccades – that is, the more ventral regions of visual cortex and the frontal eye fields (Bender 1980; Wagman 1964) – are presumably more active during the search for objects in extrapersonal space.

The recognition of visual forms may also utilize attentional mechanisms that are biased toward the UVF. One of the first researchers to note this was Piaget (1969), who performed several experiments related to the classic illusion in which a vertical line intersecting a horizontal one appears shorter in the UVF ( $\perp$ ) than in the LVF ( $\top$ ). Piaget argued that subjects' "centrations" (attentional foci) are shifted toward the UVF in this task and are paralleled by a bias in their ocular fixations. Although alternative explanations for this illusion exist, Piaget's interpretation is supported by recent evidence from line bisection tasks in which most subjects bisect a vertical line above the midpoint (Scarbrick et al. 1987). Since patients suffering from the "neglect" syndrome bisect lines in the direction of the unneglected field or quadrant (see Morris et al. 1986), the bisection findings in normals arguably reflect an "attentional shift" toward the UVF.

The relationship between form recognition and the UVF is somewhat attenuated by the tendency to fixate near the effective center of a form (Kaufman & Richards 1969), at least if its diameter subtends less than 10 degrees. This central tendency would be expected, of course, given that critical components of objects and scenes may be located in any sector of the fixated image. UVF facial features (e.g., the eyes and bridge of the nose) appear to be more critical, however, in facial recognition (see Gloning & Quatember 1966; Hines et al. 1987), which cannot be attributed merely to physical salience because the largest single facial feature is the mouth, located in the LVF. Also, Schwartz and Kirsner (1982) demonstrated a significant UVF RT advantage of approximately 20 msec when both name-matching and physical-matching of letter pairs was required, but no attempt to replicate this study has apparently been made. In other letter and shape recognition studies, no consistent vertical hemifield differences have been reported (Engel 1971; Ikeda & Takeuchi 1975).

In conclusion, various evidence points to a UVF-linked attentional system in humans that aids in visual search and object recognition in extrapersonal space. This system presumably opposes a peripersonal visual attentional system that is directed toward the proximal LVF so as to prevent serious attentional and fixational imbalances from occurring. In fact, the LVF neglect that follows parietal damage is mirrored by a UVF neglect created by damage to structures that apparently mediate attention to extrapersonal space (see section 4.2).

## 2.6. Visual evoked potentials

The final group of studies to be reviewed in this section are those that have recorded VEPs from the scalp of humans in response to UVF and LVF stimulation. The transient VEP to pattern-reversal stimulation is composed of three primary components, the two earliest of which (N1 and P1) are maximally recorded over the

posterior scalp at  $O_z$  and are apparently generated in primary visual cortex (Previc 1988). It has been reported by many researchers that, at least for gratings,  $N_1$  is generated by UVF stimulation whereas  $P_1$  is generated by LVF stimulation (Kriss & Halliday 1980; Michael & Halliday 1971; Previc 1988). One widely accepted explanation for the opposite polarities of  $N_1$  and  $P_1$  relates to the inverted orientations of their UVF and LVF dipole generators, located on opposite sides of the calcarine fissure (Michael & Halliday 1971). What is significant about the relationship between  $N_1$  and  $P_1$  and the UVF and LVF, respectively, is the strikingly different functional characteristics of these components. Based on the results of many studies – including those of Plant et al. (1983), Previc (1988), Ristanovic and Hajdukovic (1981), and Strucl et al. (1982) – a recent study (Previc 1988) concluded that  $N_1$  and  $P_1$  probably reflect the outputs of the parvocellular and magnocellular pathways of the visual system, respectively. This conclusion was based on the fact that  $N_1$ 's response is spatially linear and limited to medium-to-high spatial frequencies and contrasts, whereas  $P_1$  is sensitive to motion transients and predominates at low spatial frequencies, high temporal frequencies, and low contrasts. Because  $P_1$  is also prominent at high contrasts and spatial frequencies (see Figure 5), however, it could alternatively manifest both magnocellular and parvocellular processing. Translated into visual fields, this would mean that both the magnocellular and parvocellular pathways process LVF inputs, whereas only the latter processes UVF inputs (see section 3.1).

The shorter latency of  $N_1$  is difficult to explain if it truly represents a UVF version of  $P_1$ , given the faster RTs in the LVF. The onset of  $P_1$ , however, may be reflected in an early positive potential frequently masked by  $N_1$ . In fact, VEP studies have generally revealed that comparable components are recorded at shorter latencies when elicited by LVF stimulation (see Skrandies 1987), and that the LVF latency advantage (10–20 msec) approximates that for manual RTs. Another parallel between

VEPs (particularly  $P_1$ ) and RTs involves the similar monotonic latency increase as a function of spatial frequency (Lupp et al. 1976; Parker & Salzen 1977; Vassilev & Strashimirov 1979). Such lowpass tuning resembles the spatial contrast sensitivity function at high temporal frequencies (Kelly 1977), as well as the spatial tuning of the magnocellular system. Thus, both  $P_1$  and manual RT latencies may be dominated by transient mechanisms in the visual system (Lupp et al. 1976; Parker & Salzen 1977).

In conclusion, VEP evidence suggests that LVF processing is specialized for a nonlinear analysis of rapidly moving (transient) visual inputs in the low spatial frequency and low contrast ranges, whereas UVF processing is more restricted to a linear analysis of higher spatial frequencies and contrasts.

## 2.7. Conclusions

Based on the preceding review, the specializations of the UVF and LVF in man are summarized in Table 1. These specializations should be considered only relative, as even the most extreme differences between the two vertical hemifields cannot overshadow the extensive processing that they have in common. Nevertheless, the very existence of these vertical anisotropies provides important clues as to the origin and function of various visual perceptual mechanisms in man and other primates.

Perhaps the most pronounced asymmetries involve the LVF superiorities in the low spatial and high temporal frequency ranges. Certain types of nonlinear (global) processing – especially those related to transient motion perception – accordingly appear to be performed better in the LVF. Crossed (near) disparities are detected more readily in the LVF, consistent with the fact that the LVF appears closer to us. There further exist LVF advantages in the execution of manual RTs and pursuit, vergence, and optokinetic eye movements, as well as a LVF bias in the peripersonal attentional system impaired by parietal lobe damage. Conversely, the UVF is more closely tied to far vision, and uncrossed (far) disparities may be better processed in it. Moreover, the latency of saccadic eye movements is shorter when they are directed toward the UVF, in accordance with the link between the UVF and an extrapersonal attentional mechanism that facilitates object search and recognition.

The above summary clearly indicates that whereas many of the LVF specializations lie within the realm of *sensory* processing (e.g., low spatial/high temporal frequency analysis), the UVF specializations are more of an *attentional/perceptual* nature. Not surprisingly, clinical patients with altitudinal hemianopia suffer much more severe functional impairment when LVF vision is disrupted (Berkley & Bussey 1950), at least if the hemianopia does not originate from cortical damage. The above difference is predictable given the almost exclusive confinement of peripersonal space to the LVF as opposed to the much more vertically isotropic expanse of far vision. Despite the LVF advantage in certain areas, however, most "local" perceptual processes (e.g., visual acuity, stereoacuity, color vision, short-range motion detection) are performed equally well above and below the horizontal meridian. This observation conflicts with Skrandies's (1987) view that the greater receptor density

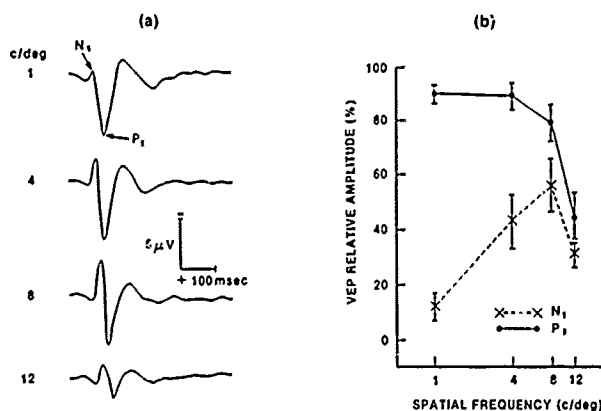

Figure 5. The spatial tuning of the  $N_1$  and  $P_1$  components of the visual evoked potential (VEP) across four spatial frequencies. The "raw" VEPs illustrating the  $N_1$  and  $P_1$  components are shown in (a), while the same data are plotted in (b) as relative  $N_1$  and  $P_1$  amplitudes, referenced to the largest component amplitude (usually that of  $P_1$ ) for a given subject across all experimental conditions. Reproduced from Previc (1988, Figure 1), with permission from Pergamon Press.

Table 1. *Functional specializations of the LVF and UVF*

Function	LVF	UVF
Depth perception	crossed-disparities (appears closer)	uncrossed-disparities (appears farther away)
Motor output	oculomotor (pursuit, vergence, OKN); RTs	saccadic eye movements
Attention	peripersonal (body-centered)	extrapersonal (visual search)
Spatial vision	more sensitive in low frequency range	
Temporal vision	more sensitive in high frequency range	
Perception	more global (e.g., stereomotion)	more local (e.g., object perception)

in the upper hemiretina is associated with a general LVF processing superiority. Rather, I argue that the LVF processing edge (and the corresponding upper hemiretinal representational bias) is limited to the transient, low spatial frequency, and low contrast information typically encountered in peripersonal space.

The above statement clearly accounts for the many LVF specializations that can be linked to processing in peripersonal space but do not require local disparity and contour processing, including pursuit and vergence movements, stereomotion perception, and crossed-disparity detection (Bridgeman 1989; Cynader & Regan 1982; Jones & Kerr 1972; Julesz 1978; Steinbach 1976). It may be speculated, therefore, that *the primary function of global form and motion perception in the primate visual system is to facilitate visuomotor coordination in peripersonal space*. With few exceptions, global percepts are achieved better at crossed disparities, including structure-from-motion (Richards & Lieberman 1985), random-dot stereograms (Grabowska 1983; Harwerth & Boltz 1979; Lasley et al. 1984; Manning et al. 1987; Mustillo 1985), and various illusions and masking phenomena (Fox 1982; Fox & Patterson 1981). Moreover, the perception of illusory forms such as the triangle in Figure 2b almost always requires that the form occlude the background. In addition, global depth, form, and motion percepts may all be mediated by the low spatial frequency, "transient" channels in the visual system (Bonnet 1987; Ginsburg 1986; Julesz 1978; Nakayama 1983; Ramachandran & Cavanagh 1987; Rogers & Graham 1982; Shulman et al. 1986; Tynan & Sekuler 1975), which is reflected in the well-documented resistance of these percepts to optical blurring. Finally, the inhibition of local perception by the global system (Navon 1977) closely parallels the inhibition exerted by the crossed-disparity and transient systems over the uncrossed and sustained ones, respectively (Breitmeyer 1980; Richards 1972).

To date, no satisfactory explanation has been provided for what Fox and Patterson (1981) describe as the "front" (near) effect in visual perception, but the important ability of a global/nonlinear system to operate under degraded optical conditions would be of greatest benefit

in peripersonal space. By contrast, such mechanisms would hardly seem necessary in far visual space, for two principal reasons: First, the greater distance of far objects ensures that they are typically smaller and slower moving, which together renders them more amenable to local perceptual analysis; and second, we generally attend to far visual space only when we are fixating in the same depth plane, so relevant visual information in extrapersonal space generally occurs at or near zero disparity (see section 3.3.1). By contrast, biologically important visual processing in near space must be monitored even when it is located at a considerable crossed disparity relative to the fixation point.

The link between near vision and global perception has repeatedly been illustrated by the act of reaching during fixation on a more distant object. But the global processing superiority in peripersonal space is unlikely to be an exclusive consequence of reaching and the rapid image motion that it entails, for several reasons. For one, although visual guidance may be critical in the development of reaching (McDonnell 1975), only subtle reaching decrements are produced when peripheral vision is occluded in adults (Paillard 1982; Perenin & Vighetto 1983). Second, illusory contour perception evidently occurs in young infants (Ghim & Eimas 1988) as well as cats (Bravo et al. 1988), both of whom rely on near vision yet engage in reaching patterns that are vastly inferior to those of the adult human. Third, virtually all adult humans engage in similar types of reaching, yet only those with good crossed-disparity systems appear to be highly proficient at extracting structure-from-motion and related percepts. Finally, the differences between the cerebral hemispheres in global versus local perception (see section 4.1) cannot easily be explained by their differential involvement in reaching, since the vast majority of humans reach with the right hand (controlled by the left hemisphere), whereas the right hemisphere is apparently more adept at performing global perceptual computations. Thus, global perception may ultimately be linked to near vision and the LVF because of the *nonlinear perceptual analyses required at crossed disparities in peripersonal space*, regardless of the specific visuomotor activity.

### 3. Neural correlates of near and far vision

This section focuses on the differences between the two major streams of processing in the geniculostriate system of primates as they are manifested at both the subcortical (magnocellular/parvocellular) and the cortical (dorsal vs. ventral) level. The functions of these divisions will be examined with special reference to: (a) the biased representations of the magnocellular and parvocellular systems in the two cortical divisions; (b) LVF-UVF anisotropies in the visual field maps at various stages within these neural streams; and (c) the different functional requirements in peripersonal and extrapersonal space and their role in shaping the unique characteristics of the two visual systems.

#### 3.1. Magnocellular and parvocellular pathways

The geniculostriate portion of the primate visual system exhibits a considerable segregation of its two major divisions, extending all the way from the retina to the highest cortical centers. At early stages, these two divisions are referred to as magnocellular and parvocellular, hereafter termed *magno* and *parvo*. Compared to other mammals, other visual pathways (such as the W-cell and the accessory optic) are substantially reduced in importance, while the functional segregation of the parvo and magno pathways is much more pronounced (Guillery 1979). For example, cells with very different functional properties (X-cells and Y-cells) are highly intermixed in the lateral geniculate nucleus (LGN) of the cat, whereas cells in the four dorsal (parvo) and two ventral (magno) layers of the monkey geniculate are anatomically and functionally distinct.

It has been established that the segregation of the magno and parvo pathways extends into primary visual cortex (area 17, or area V1) and the higher cortical visual areas beyond. The major projection of the parvo pathways is to layers 4A and 4C $\beta$  of area 17, whereas the major magno projection is to layer 4C $\alpha$ , and, in turn, 4B (Blasdel & Fitzpatrick 1984; Blasdel & Lund 1983). Using various staining techniques, it has been further established that the magno system largely projects dorsally to areas V2, V3, V4, MT (middle temporal cortex), MST (middle superior temporal cortex), and, ultimately, area 7a (posterior parietal cortex), whereas the parvo system is directed more ventrally toward V2, VP (ventral posterior cortex), V4, and, ultimately, IT (inferotemporal cortex) (see DeYoe & Van Essen 1988; Maunsell 1987; Maunsell & Newsome 1987). For reference purposes, the major visual cortical regions and their connections are mapped and diagrammed in Figures 6 and 7.

Much of what is known about the functional specializations of the magno and parvo systems is derived from physiological recordings in the LGN. The fundamental distinctions between the two systems – based on a consensus of many reports and reviews (Blakemore & Vital-Durand 1986; Derrington & Lennie 1984; Derrington et al. 1984; Dreher et al. 1976; Kaplan & Shapley 1982; Marrocco et al. 1982; Schiller 1986; Schiller & Malpeli 1978; Shapley & Perry 1986) – are summarized in Table 2. Cells in the magno layers tend to have (a) larger receptive fields, (b) good contrast and luminance sensitivities, (c) lowpass spatial tuning, (d) greater non-

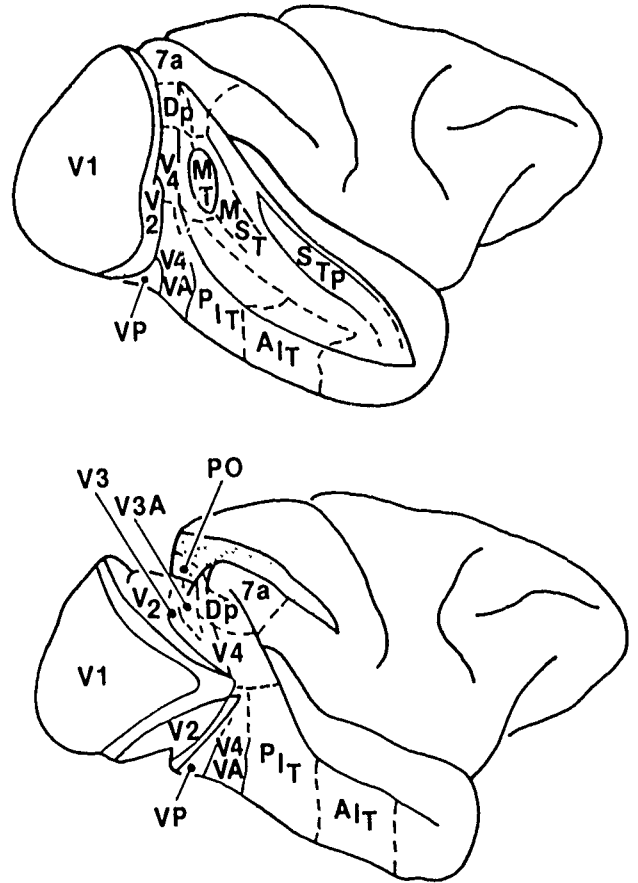

Figure 6. Two views of the visual areas of the macaque monkey (from Maunsell & Newsome 1987, Figure 2). The abbreviations are the same as those used in the text. Reproduced, with permission, from the *Annual Review of Neuroscience*, vol. 10, 1987, by Annual Reviews Inc. and Dr. J. H. R. Maunsell.

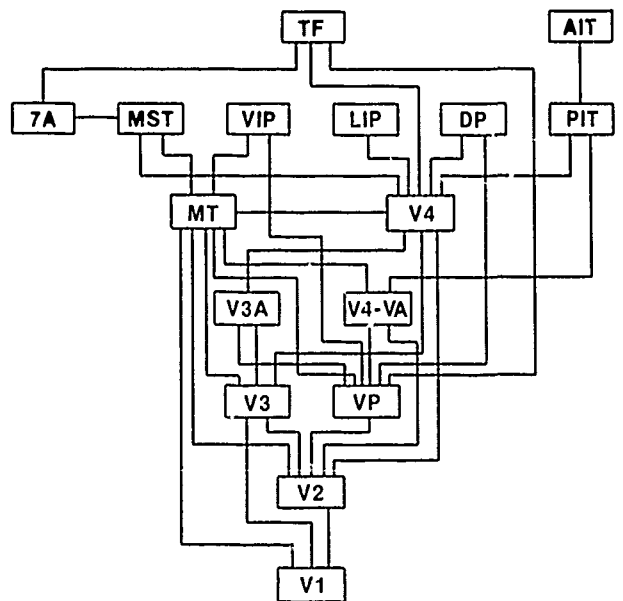

Figure 7. A diagram of the hierarchy and connections of macaque cortical areas (from Maunsell & Newsome 1987, Figure 4). Reproduced, with permission, from the *Annual Review of Neuroscience*, vol. 10, 1987, by Annual Reviews Inc. and Dr. J. H. R. Maunsell.

Table 2. Differences between magno and parvo cells

Function	Magno	Parvo
Spatial vision	lowpass tuning; more nonlinear	bandpass tuning; more linear; high resolution
Temporal vision	transient; high flicker resolution	sustained, lowpass tuning
Contrast response	high sensitivity; saturation at high contrasts	low sensitivity; no saturation at high contrasts
Color vision	broadband	opponent (e.g. red-green)

linearity (i.e., relatively fewer "null" responses), (e) greater responsiveness to transient or high temporal frequency stimulation, and (f) a preference for broadband as opposed to colored stimuli. By contrast, parvo neurons are more likely (a) to have smaller receptive fields, (b) to exhibit a greater degree of spatial linearity, (c) to respond best at intermediate-to-high spatial frequencies and high contrasts, and (d) to exhibit a greater preference for chromatic (opponent) stimulation. It should be emphasized that the above differences are far from absolute, as many cells with "mixed" properties (e.g., lowpass but linear spatial responsiveness) exist near the boundary of the parvo and magno layers and in the magno layers themselves. Some magno units certainly respond to pure color-contrast and show better spatial acuity and linearity than many of their parvo counterparts. Nevertheless, magno units are clearly distinguished by their greater ability to respond to "transient" stimulation presented at low spatial frequencies and contrasts, rendering them clearly nonlinear in a general sense. Conversely, parvo units are ideally suited to performing a linear analysis of luminance and color contours in relatively static images, which is arguably their major function (Marrocco et al. 1982; Shapley & Perry 1986).

The physiological characterization of the parvo system has largely been confirmed by recent studies in which parvo neurons were selectively destroyed by injecting the retina with acrylamide (Merigan 1989; Merigan & Eskin 1986) or, on a more local basis, with ibotenic acid (Schiller et al. 1989). Following parvo damage, chromatic vision, local stereopsis, and contrast sensitivity at low temporal and high spatial frequencies are severely disrupted, but gross form perception and sensitivity at high temporal frequencies remain largely intact. Although it has not been specifically investigated, the loss of the sustained parvo system should also impair the ability to retain images long enough to place them into a long-term memory store. Indeed, the response of MT neurons largely ceases within 50 msec following the onset of the stimulus (Maunsell 1987), which is far too short to complete feature integration and other memory encoding and recognition processes (see Coltheart 1983, Previc & Harter 1982). Whether this factor underlies the pattern recognition impairments that have been observed after damage to the parvo-rich inferior temporal lobe is presently unknown.

It has been more difficult to delineate the perceptual consequences of a loss of the magno system, but the belief that these outputs are neutralized at equiluminance led Livingstone and Hubel (1988a) to perform a series of perceptual experiments using equiluminant color-contrast stimuli. On the basis of their findings, Livingstone and Hubel inferred that the magno system is responsible for the perception of depth and movement, as well as a whole host of global cues including perspective, texture gradients, and motion parallax. The ability of Livingstone and Hubel's studies to isolate the role of the magno system in visual perception may be challenged on three major grounds, however. First, the exclusive ability of the parvo system to operate at equiluminance is still controversial (Derrington et al. 1984; Schiller & Colby 1983; Schiller et al. 1989), so it cannot be definitely concluded that all magno inputs were silenced in those experiments. Second, other factors besides a loss of magno input may contribute to the difficulties in perceiving images at equiluminance; these include the poor overall contrast sensitivity for red-green gratings, especially at mid-to-high spatial frequencies (Mullen 1985), and the "unnaturalness" of most equiluminant stimuli. Indeed, we never encounter real-world scene layouts at equiluminance, which is significant in view of the perceptual learning required to utilize many monocular depth cues (Deregowski 1989). Moreover, the degradation of visual perception at isoluminance evidently also extends to facial perception (Perrett et al. 1984), which is generally believed to be performed by the ventral system and its parvo inputs. Third, the failure at equiluminance to perceive local stereopsis and short-range motion – along with the Ponzo, corridor, and other "spatial organizational" illusions – may be questioned on the basis of both perceptual (Cavanagh et al. 1985; Gregory 1977; Lu & Fender 1972) and neurophysiological evidence (Schiller et al. 1989).<sup>6</sup> In fact, neurons in parvo projection area VP do respond well to positional displacements although they are generally not highly direction-selective in their motion responses (Felleman & Van Essen 1987), and most are narrowly tuned for disparity, thereby indicating that they are clearly capable of mediating local stereopsis.

In contrast to Livingstone and Hubel's approach, the present one will infer the functions of the magno system from the specializations of two regions in which it is disproportionately represented – the higher dorsal cortical areas and the LVF. It is proposed that the magno system, like the LVF and the dorsal system, is *critically linked to the visual control of reaching and other manipulations in veripersonal visual space*. This is reflected in its greater ability to perform a nonlinear analysis of transient and/or low-contrast inputs in the low-spatial/high-temporal frequency range, which parallels the superiority of the LVF (Table 1). Conversely, those functions not required of visuomotor coordination in peripersonal space (e.g., color processing) are poorly represented in both the magno system and the dorsal visual system. Of course, the need for transient processing during visual search and scanning – in which images must be rapidly erased so succeeding ones can be processed (see Breitmeyer 1980) – mandates that at least some magno cells (especially those with spatially linear but transient properties) be located in brain areas dealing with extrapersonal space. It is obvious, however, that the

functional properties of the parvo system (sustained, linear, color-opponent responding within relatively small receptive field boundaries) are better suited to the *search for and recognition of objects in extrapersonal space*.

Before I review the functional specializations of the higher cortical streams into which the magno and parvo pathways feed, several important anatomical differences between these systems will be presented. The biased representations of the LVF and magno system in the higher dorsal pathways have already been briefly discussed and will be touched on again. Additional differences relate to the extent of myelination and the topographical precision of the callosal representation (Burkhalter et al. 1986).

It is not clear exactly where the dominance of the LVF in the magno and dorsal systems first appears, but there is currently no evidence of such a bias in the projections from the retina to the LGN, despite the greater overall LVF representation in them. Following a re-analysis of data from Malpeli and Baker (1975), Connolly and Van Essen (1984) noted a possible LVF representational bias in the magno layers of the LGN, but difficulties in anatomical mapping of the geniculate (see Livingstone & Hubel 1988b) make the magnitude of this alleged anisotropy difficult to ascertain. Upon leaving the LGN, the LVF and UVF radiations enter the dorsal and ventral regions of primary visual cortex (V1), respectively, and remain isolated along this axis at least as far as the next three cortical visual stages (V2, V3, and V4). An overall LVF bias in the spatial map of V1 appears to replicate that found in the retina (Tootell, Switkes et al. 1988; Van Essen et al. 1984), but whether this bias is greater for the magno-recipient zones is not known. Evidently, however, a uniform distribution of 2-deoxyglucose uptake occurs within the cortical representation of the central eight degrees after pure color stimulation, which preferentially activates the parvo system (Tootell, Silverman et al. 1988).

It is in V1's output to the higher visual cortical areas that a pronounced LVF bias in the magno system first emerges. For example, magno layer 4B projects directly to dorsal (LVF) area V3 and to LVF-dominated MT, but not to V3's ventral (UVF) counterpart (Maunsell 1987; Maunsell & Newsome 1987). The role of MT in various near vision activities has already been alluded to, but many of the same functional specializations are evidenced in dorsal V3; indeed, the neuronal response properties in the LVF and UVF representations of V3 differ so substantially that a separate label (VP) has been bestowed on the latter (Burkhalter et al. 1986). Since little vertical specialization is observed in the second cortical tier (V2), whose LVF/dorsal and UVF/ventral regions both receive direct inputs from V1, the exclusive output of layer 4B to the higher dorsal regions apparently represents the first major functional divergence of LVF and UVF processing in the primate visual system. It may be speculated that the purpose of the direct dorsal pathways is to avoid costly transmission delays in processing the rapidly moving information in peripersonal space. Indeed, latency delays are considerable along the multisynaptic path from V1 to V4, but are quite negligible en route to MT (Maunsell 1987).

Evidence for a biased representation of the parvo system in its projections to dorsal versus ventral cortex is

more equivocal. Although the response properties of VP (ventral V3) suggest that this area receives a greater parvo contribution than does dorsal V3 (Burkhalter et al. 1986), this may be true only in a relative sense (i.e., the actual size of the parvo representation may be as large in V3, but the presence of additional magno-type cells could lead to a smaller percentage of parvo-type neurons being recorded in the latter's samples). In fact, a balanced parvo contribution to the LVF and UVF representations would be predicted on the basis of (a) the full vertical extent of far (as opposed to near) space, (b) the vertical symmetry shown in many parvo-type perceptual functions (see section 2.7), and (c) the full vertical representation of the visual field in parvo-rich inferotemporal cortex (Desimone et al. 1985; Gross et al. 1985).

In addition to the hemifield and neuronal biases, the dorsal and ventral pathways are also distinguished by their myelination and callosal representation patterns. The dorsal regions surpass the ventral ones in the extent of myelination, based on a comparison of V3 and VP (Burkhalter et al. 1986). This is consonant with the rapid conduction from V1 to MT and other dorsal areas. Conversely, the ventral regions may exhibit greater topographical precision in their callosal representation of the region surrounding the vertical meridian, as again reflected in the differences between V3 and VP (Burkhalter et al. 1986). Although greater topographical precision would be expected of the more linear ventral system, this precision may also contribute to the callosal mediation of local stereopsis in the naso-temporal overlap region surrounding the vertical meridian (Mitchell & Blakemore 1970).

In summary, the dorsal cortical system's unique neuroanatomical features, including its domination by magno inputs, indicates an involvement in the processing of transient, nonlinear inputs during reaching and other near vision behaviors. By contrast, the ventral system is largely fed by parvo inputs and exhibits the greater topographical precision required of far visual perception, along with the expected full vertical representation of the visual world. The next sections review the functional specializations of the dorsal and ventral regions and point out their important relationships to near and far vision, respectively. Relevant findings from both the animal neurophysiological and human neuropsychological literatures will be used to support the proposed functional specializations.

### 3.2. The dorsal cortical visual system

**3.2.1. Neurophysiological findings.** This review focuses on areas 7a and MT, the two most widely studied regions of the dorsal system. Although some controversy has arisen concerning the major specialization of the former region – for example, command functions in personal space (Mountcastle 1976) versus visual perception/attention (Robinson et al. 1978) – a unified perspective on both areas 7a and MT may be obtained if one views them as primarily devoted to the perceptual needs of near vision.

The following represent some of the most distinguishing visual properties of area 7a neurons. First, their receptive fields are typically quite large and are biased toward the lower contralateral quadrant (Figure 9). Although the fovea is adequately represented! (Andersen

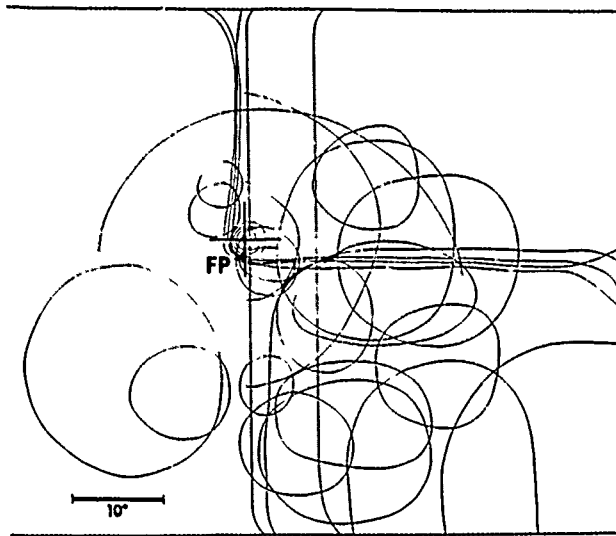

Figure 8. The receptive field map of area 7a, illustrating the bias toward the contralateral LVF. Reproduced from Robinson et al. (1978, Figure 12), with permission from the American Physiological Society and Dr. D. L. Robinson.

1987), as many as 40% of 7a's neurons do not include this region (Motter et al. 1987). Perhaps even more intriguing, many posterior parietal neurons appear to code visual space in terms of head-centered coordinates (Andersen et al. 1985), so that their receptive fields remain stationary relative to the animal's head rather than its fixation. As mentioned by Andersen et al. (1985), this property would be especially useful in visuomotor coordination, and thereby indicates an emphasis on near vision.<sup>7</sup> Generally, area 7a cells are not fastidious about stimulus properties such as shape, orientation or color, but are highly sensitive to various motion parameters. Many cells are responsive to movement-in-depth, predominantly away from the animal (Steinmetz et al. 1987) and are excited by the "opponent-vector" stimulation (i.e., opposite motion in different meridians) that naturally occurs during such motion. They also appear to be sensitive to the rotation of an object in depth (Sakata et al. 1985).

Area 7a neurons are also influenced by various extraretinal inputs, particularly those from "body" senses (somatosensory, proprioceptive, and vestibular) whose recipient areas also reside in parietal cortex (Hyvarinen 1982). Many neurons are sensitive to where the animal is fixating (Sakata et al. 1985) and may be either excited or inhibited by foveal fixation. Approximately half of the fixation neurons in the experiments of Sakata et al. signalled the distance of the fixation in depth, with two-thirds of them preferring near fixations. It appears that a small minority of area 7a neurons responds prior to saccadic gaze shifts (see Andersen 1987), but this relationship may largely reflect visual attentional influences since the saccade-related firing rarely occurs in the dark (Lynch et al. 1977; Robinson et al. 1978). Many neurons are also active during pursuit eye movements (Lynch et al. 1977) and can distinguish self-induced motion of the environment during pursuit from actual background motion during steady fixation (Sakata et al. 1985). A significant percentage of area 7a neurons also responds to

reaching movements, but primarily when the reaching is visually guided and intended to obtain biological reinforcement (Lynch et al. 1977; Robinson et al. 1978). Finally, these neurons can be influenced by pure attentional shifts, in the absence of eye movements per se (Bushnell et al. 1981). [See also, Näätänen: "The Role of Attention in Auditory Information Processing as Revealed by Event-related Potentials and Other Brain Measures of Cognitive Function" *BBS* 13(2) 1990.]

Many of the above-mentioned properties are also exhibited by neurons in MT, which serves as an important indirect source of input to the posterior parietal cortex (see Andersen 1987; 1988; Maunsell & Newsome 1987). MT neurons, however, are more restricted to processing stimulus motion per se, as their responses do not reflect area 7a's many higher-order perceptual and motivational influences. Although MT receptive fields are generally smaller, they also exhibit a strong bias toward the inferior contralateral quadrant (Gattass & Gross 1981; Maunsell & Van Essen 1983a; 1983b; 1987; Van Essen et al. 1981). MT neurons are capable of detecting high rates of stimulus motion and exhibit the transient, short-latency responsiveness characteristic of the magno system, which projects heavily to this area (Maunsell 1987). They are involved in many global aspects of motion processing, including: (a) detecting whole-pattern, as opposed to local-component, motion (Movshon et al. 1985; Newsome & Wurtz 1988); (b) coding the stimulus' speed as opposed to its displacement velocity (Maunsell & Newsome 1987); (c) enhanced responding to antagonistic motion of the background relative to the direction of motion in the classical receptive field (Allman et al. 1985); and (d) sensitivity to changing-size contours (Saito et al. 1986), an important aspect of stereomotion perception. Area MT also appears to be involved in pursuit tracking, primarily in its initiation (Newsome & Wurtz 1988), and in the perception of "structure-from-motion" (Andersen 1988). Finally, MT neurons exhibit fairly broad disparity tuning and, like those in MST (Komatsu et al. 1988), prefer crossed-disparity stimulation (Maunsell & Van Essen 1983b). It should be noted in conjunction with MT's purported proximal bias that the complete triad of behaviors comprising the "near reflex" has been elicited via cortical stimulation only in the posterior superior temporal sulcal region (Jampel 1959) containing what are now known as MT and MST.

In accordance with the theory presented here, Maunsell and Van Essen (1987) recently hypothesized that the bias of MT neuronal fields toward the inferior contralateral quadrant and crossed disparities is related to the control of the contralateral hand during reaching. These authors further support their argument by citing the progressively slower speed preferences of MT neurons in moving from the lateral periphery to the vertical meridian (Maunsell & Van Essen 1983a), which would correspond to the decreasing visual angle traversed by the arm as it moves further in depth toward the fixated object. This propensity could also explain the underrepresentation in MT of cells that prefer downward, oblique target motion toward the vertical meridian (Maunsell & Van Essen 1983a), given that the reaching arm rarely moves toward the fixated object from a higher position in the visual field.

The purported role of MT in visually guided reaching



behavior may also account for much of its ability to process global motion. Paillard (1982), for example, distinguishes between visual channels responsible for high-velocity (global) motion analysis and positional (local) displacement analysis, with the former responsible for guiding the arm and hand from the lower periphery to the central target area and the latter enabling the hand to grasp the fixated object in central vision. MT's global processing may also be important, however, in other types of visuomotor coordination in peripersonal space. For example, the sensitivity to shearing produced by opposite movement in the cell's center versus surround area would be useful in triggering the ocular following during object pursuit (Miles & Kawano 1987), whereas sensitivity to rotation-in-depth would be useful in object manipulation (see section 2.4).

Comparative evidence also points to the major role of reaching behavior in determining the functional properties of the middle temporal region, as illustrated by the striking transformation in the visual map of MT that emerged with the higher primates. Whereas the MT map in the rhesus monkey is severely biased toward the inferior contralateral quadrant, the visual representations in the nocturnal prosimian *galago* (bushbaby) and the nocturnal owl monkey are basically symmetrical about the horizontal axis (Allman 1988; Maunsell & Van Essen 1987). This difference may be attributed to the fact that prosimians (and, to a lesser extent, the owl monkey) engage in more ballistic and stereotyped reaching behaviors than do rhesus monkeys (Bishop 1962). For example, the bushbaby is primarily an insectivore that typically places its hand within a few centimeters of the insect before striking, in marked contrast to the LVF trajectory of the hand during object reaching in diurnal primates. An even more primitive and vertically symmetric tendency displayed by many nonprimate mammals (including prosimians such as the lemur) is to pick up the food object directly with the mouth. [See also: MacNeilage et al.: "Primate Handedness Reconsidered" *BBS* 10(2) 1987.]

Although the above findings illustrate the tremendous importance of reaching and other peripersonal behaviors in dorsal system function, other researchers have suggested that a sensitivity to high movement velocities, motion shearing, and opponent-vector motion demonstrate an additional involvement of area 7a and MT in the processing of optical flow information during locomotion through the environment (e.g. Allman et al. 1985; Steinmetz et al. 1987). Although such a role is consistent with the disproportionate LVF representation in these regions, five major observations weigh against it. First, the most rapid flow rates during locomotion are found in the extreme LVF periphery, whereas most MT and area 7a receptive fields are located within, or at least overlap, the central 20 degrees of the visual field. Second, optical flow patterns during locomotion are almost exclusively expanding (because we almost never move backwards), whereas the majority of area 7a neurons respond to motion *away* from the animal (Steinmetz et al. 1987). Third, opposite motion in neighboring visual regions is never produced by egomotion through the environment, so the preference of dorsal neurons for antagonistic motion in the center versus surround must be related to other factors. Fourth, the preference of dorsal neurons for near disparities and/or near fixations is inconsistent

with the fact that most ground objects during locomotion lie near the null-disparity region surrounding the vertical horopter, which slants along the ground from the base of the animal to the horizon. Finally, it is difficult from an ecological standpoint to understand why brain areas so obviously involved in reaching and eye movement control should perform an optical flow analysis whose chief value would be to maintain *postural* (i.e., leg) control. It may be concluded, therefore, that the global motion analyses performed by area 7a and MT are primarily related to the control of reaching, pursuit eye movements and other peripersonal behaviors, whereas flow patterns during locomotion are more likely to be analyzed by dorsomedial parietal areas that receive projections from the extreme visual periphery (Allman 1977).

In summary, most of the above-cited properties of neurons in the higher dorsal structures can be related either directly or indirectly to near vision. While dorsal neurons are not particularly involved in color or shape processing, they do perform important visual analyses (e.g., global motion perception) that are crucial to the visuomotor behaviors carried out in peripersonal space. Even the involvement of some area 7a neurons with saccadic eye movements does not contradict the proposed relationship between the dorsal system and near vision, as many saccades obviously occur within the confines of peripersonal space, often in conjunction with smooth eye movements. Indeed, the poor spatial resolution of most posterior parietal neurons renders them incapable of signalling the precise location of objects in space (Motter et al. 1987), so they would be of marginal value in the visual scanning of extrapersonal space.

**3.2.2. Neuropsychological findings.** A large number of human clinical studies have attempted to define the role of the posterior parietal area in vision; thus, I provide only a summary depiction here. Unfortunately, most clinical investigations inherently lack the precise stimulus control and anatomical localization characteristic of the neurophysiological literature. Furthermore, the close anatomical proximity of the dorsal and ventral systems at some stages (e.g., V4's adjacency to area MT, as shown in Figure 6) almost guarantees that both systems are at least partially damaged in a high percentage of clinical cases. Finally, the posterior parietal area itself is not a unitary structure, as it contains areas such as LIP (Andersen 1987; 1988) that receive substantial input from V4 and may therefore be more closely aligned with the ventral system (see Figure 7). Despite these reservations, neuropsychological evidence generally confirms the important role of the posterior parietal area in the perceptual functions of peripersonal space.

Two of the most prominent symptoms of posterior parietal damage are a disturbance of visually guided reaching and a constellation of oculomotor impairments, both evident in a classic parietal disorder known as Balint's syndrome. Many studies have documented the reaching difficulties (see Damasio & Benton 1979; Perenin & Vighetto 1983), which also constitute one of the cardinal symptoms of posterior parietal lobe damage in monkeys (Lynch 1980). As for the oculomotor impairments, the literature review of Girotti et al. (1982) indicates that pursuit and vergence movements are much more likely to be disturbed than are voluntary and spon-

taneous saccades, a distinction also noted by Pierrot-Deseilligny et al. (1986). Optokinetic and vestibulo-ocular (VOR) reflexes are also frequently impaired by parietal damage (Lynch 1980, Ventre & Faugier-Grimaud 1986).

A number of perceptual disturbances have also been frequently observed following posterior parietal damage, especially on the right side. These include global perceptual deficits, visual perseveration, and contralateral neglect. Included among the global deficits are (a) an inability to perceive objects in unfamiliar (including three-dimensional) rotations (Warrington & Taylor 1973), (b) poor recognition of fragmented visual forms and random-dot stereograms (Rothstein & Sacks 1972, Vaina 1989, Warrington & James 1967), (c) loss of stereomotion and other global motion sensitivities (Vaina 1989, Zihl et al. 1983), and (d) deficits in overall topographical visual orientation (Benton et al. 1974; Girotti et al. 1982, Levine et al. 1985). Global perceptual and visuomotor impairments often accompany each other, as illustrated by the fact that reaching disturbances were found in all 26 patients suffering from topographical disorientation (without memory loss) in the literature reviewed by Levine et al. (1985).

As noted by Vaina (1989), the basis of the global perceptual deficits exhibited by right parietal patients is the inability to solve the *correspondence problem* - i.e., the ability to construct a global form from spatially distributed local elements. This capability involves a fundamentally nonlinear set of computations that involve the magno/transient pathways to a relatively greater extent (Bonnet 1987; Peterhans & Von Der Heydt 1989a). By contrast, object, face, and color recognition are preserved in parietal patients (Levine et al. 1985; Warrington & James 1967), along with local stereopsis (Rothstein & Sacks 1972). Zihl et al. (1983) reported an interesting case of a patient who apparently lost only the long-range component of the motion system after presumed damage to the middle temporal and/or occipito-parietal regions. Stereomotion, pursuit tracking, and RT deficits also characterized this patient's syndrome, although saccadic eye movements were unimpaired.

Another parietal disorder that appears to directly relate to the LVF and/or near vision specializations is visual perseveration (palinopsia). Both Critchley (1953) and Bender et al. (1968) concluded that perseveration is most likely to occur after damage to the occipito-parietal areas, especially on the right side. While many different types of palinopsia have been reported, perhaps the most common type involves the mere prolongation of images, suggesting a disorder of the transient visual pathways. In normals, the transient (magno) system is believed to reduce visual persistence by inhibiting the sustained (parvo) system (Breitmeyer 1980), which may explain why crossed-disparity and global stimuli (also predominantly processed by the magno system) exert important inhibitory influences over uncrossed/local ones (Navon 1977; Richards 1972).

As mentioned in section 2.5, one of the most prominent parietal symptoms is a disturbance of visual attention that is especially evident in the hemispace contralateral to the lesion site. This neglect syndrome has been exhaustively investigated, but its origins and manifestations are still the subject of wide debate. Recent evidence has established that parietal neglect is framed primarily in body-

centered coordinates (Gazzaniga & Ladavas 1987, Kooistra & Heilman 1989)<sup>8</sup> and biased toward the LVF, both of which imply the disruption of a peripersonal attentional mechanism. It is conceivable that the spatial confusions and neglect stemming from the loss of a body-centered attentional system also lead to the topographical disorientation manifested by so many parietal patients (Levine et al. 1985). Although the body-centered coordinate system may be intimately tied to the behaviors performed in peripersonal space, it can also extend into extrapersonal space, as would be expected given that information contained in far vision is important in maintaining posture and regulating egolocomotion (Brandt et al. 1975). The saccadic exploration of extrapersonal space - necessarily tied to retinotopic coordinates - appears, however, to be much less affected by parieto-occipital damage than by frontal lesions, for example (Holmes 1938; Karpov et al. 1968). Thus, parietal damage interferes not with extrapersonal visual functioning per se, but rather its representation in a body-centered coordinate frame.

In summary, neuropsychological evidence reinforces the view that the posterior parietal region engages mainly in the visual control over peripersonal space. A dramatic illustration of this involvement is reflected in a symptom known as teleopsia, which is usually associated with occipito-parietal damage. Teleopsia refers to the illusion of objects and persons as being farther away than they actually are (Critchley 1953) and may be a natural perceptual consequence of the loss of a near vision attentional system. Although considered somewhat rare, it was also reported by Newman et al. (1984) and in several patients of Bender et al. (1968), and may turn out upon careful investigation to be more common than previously believed.

### 3.3. The ventral cortical visual system

**3.3.1. Neurophysiological findings.** It has long been recognized that neurons in the ventral (occipito-temporal) pathways engage in substantially different processing than their dorsal counterparts. The following review - focusing primarily on the neurophysiology of IT and area V4 - will attempt to show how the ventral system is specialized for the scanning and recognition of objects in extrapersonal space.

Consistent with several decades of monkey lesion evidence (Mishkin 1972; Sahgal & Iversen 1978; Ungerleider & Mishkin 1982), IT neurons appear to be highly involved in object recognition and visual memory. Most of these neurons have large receptive fields (averaging 25 degrees in diameter) that virtually always include the fovea, even though they may be biased toward the contralateral hemifield. In contrast to the response of many dorsal neurons, IT neuronal activity is clearly tied to the animal's gaze rather than to a head- or body-centered coordinate system (Gross et al. 1979). Inferotemporal neurons often prefer highly complex shapes or objects, including faces, and can respond to them in any portion of their receptive field. Despite this "global" capability, IT neurons are highly sensitive to slight changes in the local contours of objects and shapes (Desimone et al. 1985, Gross et al. 1985), although they are not "linear" responders in a strict sense. Like their parvo

projection neurons, they also tend to respond in a sustained fashion, for as long as several hundred milliseconds in some cases (Gross et al. 1974), which may account for their involvement in long-term memory encoding (Miyashita 1988).

Although the above properties are consistent with the ventral system's proposed emphasis on extrapersonal space, a more specific illustration of this link is provided by recent analyses of "face-specific" neurons in the fundus of the superior temporal sulcus (Perrett et al. 1984), which receives important input from the inferior temporal lobe. Such neurons are highly responsive to ecologically valid spatial transformations in extrapersonal space (e.g., a left facial profile along with a diverted gaze and leftward movement), but are relatively unresponsive to perceptually rare transformations (e.g., facial inversions). Approximately 90% of the movement-in-depth neurons in this area prefer movement toward the animal (Jeeves et al. 1983), which makes sense in that receding motion (stemming from backwards locomotion) is rarely encountered in extrapersonal space.

Lesion evidence has consistently pointed to a major role of inferotemporal cortex in visual attention in primates (Butter 1969; Soper et al. 1975, Wilson et al. 1977), not surprisingly, therefore, the average size of IT receptive fields closely approximates the extent of the extrapersonal attentional field. The involvement of IT neurons in visual attention is illustrated by the finding that stimuli passing through their receptive fields do not elicit a strong response unless the animal is actually fixating and attending to them (Gross et al. 1979). Indeed, many neurons are more influenced by task-related cues and sequencing than by the actual physical profile of the stimulus (Fuster & Jervey 1982; Gross et al. 1979). As mentioned earlier, a major purpose of the far attentional system is to "glue" features into integrated wholes, so as to ensure that forms composed of identical features in different arrangements are not confused. Temporal neurons accordingly seem to be very sensitive to the overall spatial arrangement of individual features (Perrett et al. 1984).

Posterior portions of the occipito-temporal pathways contain neurons that are extensively involved in processing form and color information (Burkhalter et al. 1986, Burkhalter & Van Essen 1986; Desimone & Schein 1987; Desimone et al. 1985; Felleman & Van Essen 1987; Moran & Desimone 1985). Most disparity-sensitive neurons in these areas are narrowly tuned, with their peak response occurring when the stimulus is in the plane of fixation (Burkhalter & Van Essen 1986). As discussed earlier, this property would be expected of neurons involved in far vision and contrasts markedly with the crossed-disparity preference of MT and MST neurons. Besides their involvement in analyzing stimulus features, these regions also appear to mediate the *selection* of individual features (Braitman 1984; Gross et al. 1971; Haenny & Schiller 1988; Manning 1971; Wilson et al. 1977). Feature selection requires that the anatomical substrate of each feature "channel" be somewhat independent, as is confirmed by the pattern of cytochrome oxidase (CO) staining in area V2. Cells that signal color (e.g., double-opponent neurons) are more coarsely tuned to thinly stained CO regions, whereas nonchromatic (e.g.,

orientation-selective) neurons are to a greater extent found in nonstained regions (DeYoe & Van Essen 1988; Livingstone & Hubel 1988a). The greater staining for double-opponent neurons may reflect the leading role that color plays in visual object search (Williams 1966), since such staining reflects a high degree of metabolic activity.

A particularly well-studied posterior region predominantly associated with the ventral system is area V4, the major source of input to IT. V4 is clearly involved in form perception, as many of its neurons exhibit spatial frequency, color, and orientation selectivity and prefer that the stimulus presented in their extensive background field differ in some attribute (e.g., color or spatial frequency) from the stimulus presented in the center of the receptive field (Desimone & Schein 1987; Desimone et al. 1985). Area V4 has been the subject of some controversy among neurophysiologists, who are divided over whether it is involved primarily in color constancy (Zeki 1980) or in a preliminary analysis and/or selection of visual forms (Desimone & Schein 1987; Moran & Desimone 1985). The fact that many V4 neurons do not respond well to color (Schein et al. 1982) conflicts with the claim that their major purpose is to maintain color constancy. On the other hand, it would be useful for at least some visual search neurons to have this ability, to ensure the detectability of fruit and other colored objects despite cyclical fluctuations in spectral illumination. Otherwise, visual search would prove much less efficient, particularly when noncolor form cues are compromised by shading and large egocentric distances.

V4's role in visual search is also reflected in the spatially selective attentional enhancement exhibited by its neurons (Moran & Desimone 1985), which enables the spatial coordinates of searched-for stimuli to be precisely defined. The enhancement of V4 neuronal activity can extend as far as 15 degrees from the fixation point (Fischer & Boch 1981), which, as mentioned earlier, corresponds roughly to the limits of effective visual search in humans. Neurons in V4 are probably more involved in the preparation for (rather than the execution of) saccades during visual search, as the attentional enhancement to relevant targets does not appear to require the execution of a subsequent saccade to the target (Fischer & Boch 1985). The actual programming of saccadic eye movements during visual search is more likely to be controlled by other areas to which V4 projects directly, such as the frontal eye fields (Van Essen & Maunsell 1983). The involvement of V4 in visual search may explain why it also receives some magno input, since it must engage in nonlinear (transient) response processing during rapid scanning yet still perform at least a rudimentary form analysis. The thinly stained CO pathways that project to V4 are ideal for this purpose, since many of their inputs originate in the interlaminar regions surrounding the magno layers of the LGN (DeYoe & Van Essen 1988; Hendrickson 1985).

Based on the above neurophysiological review, it may be concluded that the major function of the ventral system is to engage in scanning and recognition of objects in extrapersonal space. Posterior areas such as V4 appear to be more involved in visual search and feature selection, whereas IT and other anterior areas evidently perform

the feature integration and memory search required for object recognition. No neurophysiological evidence directly links the higher stages of the ventral system with the UVF, but then again neither has any single-neuronal study to date specifically addressed the proposed hypothesis that far attention, rather than far sensory processing per se, is biased toward the UVF.

**3.3.2. Neuropsychological findings.** Although the visual deficits produced by ventral damage in humans are rarely as precise as those exhibited in monkey lesion studies, clinical evidence generally supports the view of the ventral system outlined above. A listing of those symptoms specifically produced by damage to the occipito-temporal pathways in humans includes the following disorders: alexia (reading loss), color agnosia, visual object agnosia, prosopagnosia (impaired facial recognition), and topographical memory loss (see Albert et al. 1979; Cummings et al. 1983; Damasio & Damasio 1983; Damasio et al. 1982; Larrabee et al. 1985; Levine et al. 1985; Meadows 1974a; 1974b). Recent evidence (Robertson et al. 1988) also suggests that temporal lobe damage in humans specifically produces a disorder of local perception (e.g., the inability to perceive the small E's in Figure 2a). Most of the above disorders tend to correlate well among themselves, and may be linked to more basic impairments. For example, prosopagnosia has been attributed to a general disturbance of visual memory (Damasio et al. 1982; Hecaen & Albert 1978), while defective visual search and scanning mechanisms may underlie object agnosia (Bender & Feldman 1972; Kinsbourne & Warrington 1962).

Rarely do the above symptoms accompany those resulting from parietal lobe damage. For example, prosopagnosia correlates poorly with deficits in reaching, visuospatial orientation, and global form perception (Levine et al. 1985; Wasserstein et al. 1987), as illustrated by the fact that not one of the 28 prosopagnosics in Levine et al.'s (1985) review showed a reaching defect. Although disorientation in relation to one's surrounding environment may occur after either occipito-parietal or occipito-temporal damage, the latter is more typically followed by a loss of topographical memory and the former by the loss of a spatial coordinate system in which to place the remembered landmarks (Levine et al. 1985). Yet, the parietal patient may be able to describe the place to be visited without being able to describe how to get there, so some spatial memory obviously remains intact. In fact, temporal lobe involvement in spatial memory is supported by recent studies of patients with anterior temporal lobe damage (Goldstein, et al. 1989; Jones-Gotman 1986), although the integrity of the hippocampus (also damaged in these studies) is considered more critical for the nonegocentric representation of visual space (Jones-Gotman 1986). Given, however, that the hippocampus receives heavy projections from the temporal lobe and that the visual component of the hippocampal amnesic syndrome can be almost completely duplicated by bilateral destruction of the temporal lobes (Horel 1978), it may be presumed that an extrapersonal spatial representation is also contained in the temporal visual areas, as would be required of an area so intimately involved in visual search and scanning.

It is particularly relevant to the present theory that the above impairments are almost always associated with disturbed vision in one or both UVF quadrants (Damasio & Damasio 1983; Meadows 1974a). The link between occipito-temporal damage and the UVF is invariably attributed to damage to adjacent inferior striate and prestriate occipital areas (representing the UVF) or to damage to the UVF radiations that course beneath the temporal lobe on their way from the LGN to V1, via what is known as Meyer's loop. Several factors suggest, however, that the link between the temporal lobe specializations and the UVF may also arise from the UVF bias of the far attentional system (see section 2.7). For one, excisions limited to the temporal pole (well away from the radiation fibers) can result in transient UVF deficits (Van Buren & Baldwin 1958), reminiscent of the transient LVF attentional deficits that occur after parietal damage. Second, most temporal lobe patients are not even aware of their UVF defects (Jensen & Seedorff 1976; Van Buren & Baldwin 1958), which suggests that they have a field-specific attentional deficit in addition to the actual sensory loss.<sup>9</sup> Third, UVF-specific memory loss and/or neglect can occur after damage to prefrontal visual areas and can be unaccompanied by actual sensory loss (see section 4.2.3). Fourth, recent cerebral blood flow experiments in humans have revealed that the inferior temporal and inferior (UVF) occipital regions compose a unified system that is activated during visual imagery tasks (Goldenberg et al. 1989). Finally, it has been reported that pattern-sensitive epilepsy – presumably associated with temporal lobe dysfunction – is much more easily elicited by UVF than LVF stimulation (Soso et al. 1980).

The most plausible reason why no extrapersonal analogue of the parietal neglect syndrome has been reported after damage to the temporal lobe (or, for that matter, any other area) in humans is that neuropsychological testing generally permits free eye movements under continuous viewing, effectively precluding a *retinotopically* mediated neglect from revealing itself. By comparison, those animal studies demonstrating UVF and/or extrapersonal neglect have maintained precise fixational control. Nevertheless, the poor recognition of upper facial features in prosopagnosia (Gloning & Quatember 1966) and other indications of distorted or absent upper-half form perception (see Levine et al., Figure 2) point to a UVF attentional neglect in many temporal lobe patients.

In summary, the neuropsychological literature confirms that the ventral portion of the primate visual system is involved in the scanning and recognition of objects, faces, and other images in extrapersonal space, but not in the reaching, oculomotor, and global perceptual functions performed by the dorsal system. In contrast to the latter's LVF representational bias, the anterior temporal visual areas may be linked to the UVF only via higher-order attentional mechanisms. It is not known whether ventral damage leads to an exaggerated emphasis on near vision, mirroring the teleopsia associated with parietal damage. Although Penfield and Rasmussen (1950) reported that distance illusions in either direction were common after temporal lobe stimulation, a map of their stimulation sites clearly indicates that some must have been located in the middle and superior temporal areas, which are hypothesized to subservise near vision.

#### 4. The origins of the near and far visual systems in the primate

As argued previously, a major limitation of previous dorsal-ventral theories is their failure to put forth plausible ontogenetic and/or phylogenetic scenarios to explain the origins of these specializations. Consequently, the final major section of this paper briefly explores the roles of near and far vision in shaping the primate visual system.

It is now widely accepted that visual experience plays a critical role in the development of the visual system. Of course, some genetic influences may directly guide the formation of at least crude topographical representations and specializations, whereas others (such as those described in section 1.1) may determine the specific milieu wherein the neurodevelopmental shaping of the primate visual system occurs. Yet it is clear that visual experience exerts a profound influence over the formation of higher cortical visual maps and specializations (see Hyvarinen 1982; Maunsell & Van Essen 1987; Von Der Malsburg & Singer 1988) and can even alter the visual representations at subcortical and retinal levels (Shatz & Stretavan 1986; Von Der Malsburg & Singer 1988). Furthermore, the experiential shaping of the visual system depends not only on what is "seen," but also on what is "attended" (Singer 1985).

Thus, it is likely that differential experiences in the near and far visual realms shape the primate visual system. Even the most basic manifestation of the functional link between the LVF and near vision – namely, the greater ganglion density in the LVF, present in most mammals (Skrandies 1987) – may be subject to experiential shaping, because it is not evidenced in the visual perimetry maps of human infants (Schwartz et al. 1987). Likewise, the parvo representation in the LGN can be reduced by refractive error during development (Von Noorden et al. 1983), which limits access to the far visual environment. In the following sections, it will be shown how one developmental influence – the vestibular system's role in reaching and oculomotor integration – may contribute greatly to the development of near vision and the dorsal visual system. Conversely, important transformations of the primate LGN and its ventral projection areas, the superior colliculus, and the frontal visual areas can all be traced to the emergence of far vision.

##### 4.1. Near vision and the vestibular system

As noted by Ornitz (1970), the vestibular system provides one of the most important sources of information about the position of the body in space. Although it is by no means exclusively concerned with peripersonal space, the vestibular system does provide critical inputs for many near vision functions, including pursuit eye movements (Lammam et al. 1978, Magnusson et al. 1986) and limb control (Fukuda 1959, Jeannerod & Biguer 1987).

Despite decades of controversy, the most definitive evidence to date has localized the major cortical vestibular projection to the posterior bank of the superior temporal gyrus (Friebert et al. 1985), in accordance with Penfield's (1957) proposed locus based on cortical stimulation data. Although the efferents from this region have not been precisely mapped, a major vestibular projection stream apparently courses dorsally into the posterior parietal lobe (see Hyvarinen 1982), in close proximity to

areas MT and MST. The involvement of the vestibular system in parietal function has long been recognized, and the deficits of the parietally lesioned patient are analogous to those of labyrinth-defective individuals (Barlow 1970). Parietal symptoms such as the loss of a body-centered coordinate system, spatial disorientation, oculomotor (pursuit, OKN, and VOR) deficits, limb biases, and contralateral neglect all resemble the symptoms of unilateral or bilateral vestibular damage. Indeed, vestibular destruction itself can produce unilateral neglect (Jeannerod & Biguer 1987), whereas unilateral vestibular stimulation can alleviate the symptoms of parietal neglect (Cappa et al. 1987; Rubens 1985).

The justification for assigning the vestibular system an important role in the development of the dorsal system is based on three principal factors. First, the vestibular system is an ontogenetically precocious system, with many vestibulo-ocular reflexes well-established by birth (Eviatar et al. 1979), so it is quite capable of influencing the postnatal development of the higher visual pathways. Second, it has been hypothesized that left-right vestibular asymmetry may be responsible for a further subdivision of near versus far visual perception into the left and right hemispheres of most humans (see Previc, in preparation). Finally, disruption of dorsal visual functioning has been hypothesized to occur in at least two disorders linked to vestibular dysfunction: strabismic amblyopia and visuospatial dyslexia (Previc, in preparation).

Regarding the second argument cited above, I recently theorized that the existence of left vestibular dominance in most humans leads to a greater involvement of the right parietal lobe in vestibular processing (see also Penfield 1957). The specialization for vestibular functions may, in turn, promote the right parietal area's greater emphasis on near vision, based on two principal observations. First, recent neuropsychological studies have convincingly established a dissociation between the hemispheres in terms of global versus local processing (Delis et al. 1986; Vaina 1989), with the right hemisphere superior in global perception (e.g., the large S in Figure 2a) and the left in local perception (e.g., the small E's in Figure 2a). Second, the right hemisphere is believed to possess a more bilateral attentional system, whereas the left appears to be more exclusively concerned with the right side of space (Heilman & Van Den Abell 1980). This is reflected in both the neglect of the left side of space following right-parietal damage and the left-right confusions following left-parietal damage (McFie & Zangwill 1960). The bilateral attentional system of the right hemisphere can be related to its putative emphasis on near vision because the guidance of proximal arm movements is more bilateral than is that of distal movements (Haaxma & Kuypers 1975).

An important contribution of the vestibular system to the development of the dorsal system is also suggested by its alleged role in strabismic amblyopia and visuospatial dyslexia, both linked to possible magno dysfunction. Regarding the former disorder, it appears that low-contrast and low-luminance (i.e., magno) visual performance is impaired in the amblyopic eye of strabismics, whereas spatial resolution and suprathreshold (i.e., parvo) vision are left relatively intact (Barbeito et al. 1987, Flom & Bedell 1985, Hess & Bradley 1980). The putative magno loss coincides with the deficits exhibited by strabismics in

velocity discrimination, contrast sensitivity, RTs, and pursuit eye movements (Hamasaki & Flynn 1981, Hilz et al. 1977; Tychsen & Lisberger 1986b), including the failure to show the normal LVF advantage in pursuit tracking. In general, impaired global spatial percept. on the face of preserved pattern vision and acuity characterizes the strabismic amblyopia deficit, whereas the reverse may be true for the refractive amblyopias and other "far" visual disorders (see Barbeito et al. 1987, Flom & Bedell 1985, Hilz et al. 1977). Although a peripheral labyrinthine defect in most cases of strabismus is unlikely, various "vestibular" symptoms are frequently observed in this disorder, including an abnormal VOR (Hoyt 1982; Schor & Westall 1984), abnormal caloric and postrotary nystagmus (Salman & Von Noorden 1970; Slavik 1982), and atypical postural biases (Niederlandova & Litvinenkova 1973). It is not known whether the strabismic perceptual deficits are caused by the oculomotor imbalances also manifested in this disorder or vice versa, but recent evidence indicates that relatives of strabismics who do not actually show the oculomotor deviations may nonetheless exhibit many of the "magno" perceptual deficits (Tychsen 1989).

More convincing evidence links impaired vestibular processing with visuospatial dyslexia (see Previc, in preparation). For example, many reading-disabled individuals suffer from vestibulo-cerebellar oculomotor symptoms (Levinson 1988) and manifest severe postural problems when relying exclusively on vestibular inputs (Horak et al. 1988). Moreover, all postmortem analyses to date have indicated prominent neuroanomalies in the posterior superior temporal gyral region of dyslexic brains (Galaburda et al. 1985). It has also been suggested that visuospatial dyslexics suffer from a specific disorder of the transient (magno) pathways (Martin & Lovegrove 1984), based on evidence of increased visual persistence and reduced low spatial frequency sensitivity (Badcock & Lovegrove 1981, Martin & Lovegrove 1984). Consistent with this hypothesis are the many reports (e.g., Adler-Grinberg & Stark 1978, Bogacz et al. 1974, Pavlidis 1981) of pursuit deficits among dyslexics, although this finding has not always been replicated (see Brown et al. 1983).

The vestibular hypothesis is not the only one that may be invoked to account for the posterior parietal lobe's bias toward near vision and the LVF, but alternative explanations do not suffice as easily. For example, the dorsal location of the LVF projection in primary visual cortex could promote a near vision bias throughout the entire dorsal brain because of the confinement of peripersonal space to the LVF. This scenario is contradicted, however, by the enormous crossover of LVF and UVF projections from V1 to the highest stages of the dorsal and ventral systems, which suggests that higher-order visual field biases depend more on the establishment of other specializations than on the location of primary visual cortical representations. Second, the proximity of somatosensory cortex to the posterior parietal area may influence the latter's specialization for reaching, eye movements, etc. Area 7a is only circuitously linked with somatosensory cortex (Pandya & Seltzer 1980), however, and it is less evident that somatosensory disturbances can account for the gross reaching biases, disorientation, and inattention to peripersonal space manifested in the parietal neglect syndrome.

In summary, the pre-eminent factor responsible for the dorsal visual system's emphasis on peripersonal space may be its anatomical relationship with the cortical vestibular pathways. The contribution of vestibular inputs to the specialization of MT and other dorsal areas for motion processing and visuomotor coordination is obviously not limited to primates, however, as these phylogenetically older areas engage in similar functions in nonprimates (Schiller 1986; Tusa et al. 1989). Rather, the unique behavioral interactions performed in peripersonal space (see section 3.2.1) ultimately determine the specific LVF biases of the dorsal visual system in primates.

#### 4.2. The emergence of far vision and its neural consequences

Although the emergence of far vision gave rise to widespread transformations in the primate brain, the organizing factors governing the neurodevelopmental shaping of the far visual system are more obscure than in the case of the near system. One possibility is that the ventral location of far vision may also be determined largely by nonvisual influences. Perhaps the most important of these are the close proximity of primary auditory cortex (since the auditory system is also concerned with extrapersonal space) and the limbic system (whose involvement in emotional associations, cognitive maps, etc., implies an emphasis on the extrapersonal environment). Far visual structures such as the superior colliculus and the frontal eye fields are not closely linked anatomically with the limbic region, however, and their auditory responses are more influenced by visual factors (i.e., gaze direction) than their visual responses are influenced by auditory factors (see Bruce 1988). A second possibility is that far visual functions are assigned by default, and reside only in those regions that have not already become entwined with near vision. This hypothesis is somewhat consistent with developmental evidence, in that the crossed-disparity system does appear to develop first (Mustillo 1985) although the magno system may take longer to mature (Hickey 1977). The growth of the far visual system was not accomplished merely by enlarging those areas already outside the near visual system's sphere of influence, however, its development also entailed the *active transformation* of structures such as the LGN and superior colliculus that once served mainly in a near visual capacity (see below).

In contrast to its somewhat shrouded ontogeny, the far visual system's phylogenetic origins can be more clearly traced to the ecological developments described in section 1.1. This is particularly true of the profound transformations wrought in three important visual regions: the LGN and its parvo-projection areas, the superior colliculus, and the visual areas of the prefrontal cortex.

**4.2.1. The lateral geniculate nucleus and the ventral system.** The primate LGN differs in two important respects from that of other mammalian species. First, functionally distinct cell classes are much more segregated anatomically, and second, the size of the parvo system is markedly increased (see Guillery 1979). Both of these trends are also observed within the primate order itself. Compared to the LGN of diurnal monkeys, for instance, that of the prosimian *galago* contains additional laminae besides the

magno and parvo ones, exhibits much less striking functional segregation among laminae, and does not include as great a parvo representation (Norton & Casagrande 1982).

Many features of the LGN are formed during prenatal development, but the final distribution of laminae and cell types depends on experience. Much of the postnatal shaping is brought about by binocular competitive interactions, but attentional factors may also play a role (Singer 1985) since a cortifugal attentional gating is believed to operate at the level of the geniculate (Singer 1977). Thus, the tremendous expansion of the parvo system in the higher primates might have been influenced by the increased attention to far vision. This may also be true for the "mixed" cells in the magno layers, which have many properties in common with parvo units. In the cat, a small percentage of neurons possess both X-like and Y-like properties, which apparently reflects the synapsing of geniculate X-cells onto Y-cell axons (Garraghty 1985). Evidently, the percentage of such "mixed" cells substantially increases after disruption of the Y-cell pathways by monocular deprivation (Freidlander et al. 1982), suggesting an increased competitive advantage for the linear X-cells under these circumstances. It may be speculated that the emphasis on far vision in the primate produces a similar bias against transient, nonlinear Y-cells, thereby increasing the tenacity (and survival rate) of parvo neurons in anatomically defined magno space. Although the greater laminar segregation is believed to decrease many of the competitive interactions between cell types in the primate geniculate (Guillery 1979), it has nevertheless been shown that a disruption of far vision can indeed selectively reduce the percentage of parvo units (Von Noorden et al. 1983).

It can be predicted, then, that parvo units should largely be confined to the visual search field (i.e., the central 30 degrees), whereas cells with nonlinear receptive field properties should predominate in the more peripheral LVF regions in which visually guided reaching and other more global processing occur. Parvo and magno cells do, in fact, disproportionately represent the central and peripheral portions of the visual field, respectively (Connolly & Van Essen 1984, Derrington & Lennie 1984), although these biases may be smaller than previously believed (Livingstone & Hubel 1988b). The magno representation may also be slightly biased toward the LVF (Connolly & Van Essen 1984), but a definitive confirmation of this anisotropy may be precluded by current anatomical mapping limitations.

The major expansion of the LGN parvo system in primates is paralleled by a large increase in the size of the temporal lobe, in which it predominantly terminates. In fact, Diamond and Hall (1969) argued that the expansion of the temporal visual areas represents one of the most salient features of primate evolution. Although it has since been shown that at least some rudimentary parallels exist between cats and monkeys (Campbell 1978), other researchers continue to doubt whether a clearcut homologue of the primate inferotemporal areas is found in this species (Tusa & Palmer 1980). The primate occipito-temporal pathways, however, are distinguished not only by their anatomical expansion but also by their unique functional specializations. For example, VP (the UVF portion of V3) appears to be much more involved in color,

shape, and other far visual analyses in the diurnal rhesus than in the nocturnal owl monkey (see Burkhalter et al. 1986). Also, the presence of large numbers of "face-sensitive" neurons in the inferior and anterior temporal regions has apparently not been reported in any species other than the rhesus monkey, as is consistent with the enhanced role of facial expression as a means of social communication in the higher primates.

It is difficult to account for the major expansion of the parvo/ventral pathways in primates if they merely subserve object perception, since there is no indication that cats and other mammals cannot learn object discriminations quite well. Rather, what differentiates primates from most other mammals is the significant enlargement of extrapersonal space, the striking increase in the ability to scan it, and the remarkable visuospatial memory for objects in it (Menzel 1973).

**4.2.2. The superior colliculus.** Another subcortical visual structure that has been radically altered by the emergence of far vision in the primate is the superior colliculus. This structure plays an important role in visual search, saccadic eye movement initiation, and orientation toward visual and other stimuli. It has accordingly been assigned to the far visual system in primates (Rizzolatti et al. 1985; Rizzolatti & Camarda 1987).

Perhaps the most distinct feature of the primate colliculus is its adoption of a binocular visual coordinate system relative to the animal's fixation. Unlike the colliculi of other mammals, which receive inputs that emanate almost exclusively from the contralateral retina, the primate colliculus receives a substantial input from the *ipsilateral* retina in initiating saccades confined to the contralateral visual field (Allman 1977; Goldberg & Robinson 1978; Sprague et al. 1973). This transformation has been attributed to the evolution of frontally directed eyes and good binocular vision (Allman 1977), but cats also have a largely contralateral retinal projection, despite their good binocular vision. It is more likely that this change represents an adaptation to the increased emphasis on far vision, in which binocular input limited to the contralateral visual field would be important in targeting saccades. By contrast, off-axis images of near objects that are not directly fixated (and therefore the target of potential fixation) are so disparate that only one eye's input is useful in directing saccades to the contralateral hemifield. Ordinarily, this would be the input from the contralateral eye, which is dominant in that same hemifield (Miles 1954).

The above interpretation is consistent with the results of recent perceptual studies that have investigated the ability to use eye-of-origin (utrocular) information. Utricular discriminations are only possible for the transient, low spatial frequency stimuli that predominate in peripersonal space (Martens et al. 1981), whereas eye-of-origin information cannot be used during target search (Wolfe & Franzel 1988), which entails a binocular scanning of extrapersonal space. The putative link between utrocular processing and peripersonal space is also consistent with the role of area MT - a near vision region - in ocular rivalry, discrimination, and dominance (Logothetis & Schall 1989; Previc, in preparation).

The binocular representation of the contralateral hemifield in the primate colliculus may be largely dependent upon the descending efferents from primary visual cor-

tex. Indeed, cortical cooling has been shown to abolish almost all visual responses in the intermediate and deeper layers of the primate colliculus (Schiller et al. 1974). Although the corticotectal projection emanates largely from the magno pathways (Schiller et al. 1979), its disproportionate representation of the central visual field (Wilson & Toyne 1970) indicates that these magno inputs probably mediate the transient processing required in the scanning of extrapersonal space.

Other indications that the superior colliculus has been transformed into a far visual structure are the lack of directional sensitivity in the vast majority of its cells and the inability to elicit combined head and eye movements upon stimulation (see Goldberg & Robinson 1978). Both of these properties contrast strikingly with the properties of the cat colliculus, in which a high degree of directional selectivity is found and head movements are readily elicited. Such a difference is expected, of course, given that cats rarely move their eyes without a concomitant head movement (Guitton et al. 1984) whereas primates only make combined eye-head movements when the distance to the target exceeds the 15 degree radius of the visual search field (Bahill et al. 1975).

It is intriguing to note in connection with the proposed collicular link with far vision that neglect of the UVF has been shown to accompany collicular damage in many species (see Sprague et al. 1973). Some researchers have argued that damage to the colliculus itself is not crucial for the production of this syndrome, but that the critical locus may be the pretectum (Pasik et al. 1969) or intertectal commissures (Matelli et al. 1983). UVF receptive field biases do, in fact, exist in the superior colliculi of many mammals (Drager & Hubel 1976, Sprague et al. 1973, Figure 9), just as stimulation of the colliculus (along with a host of other midbrain structures) results in a preponderance of upward, divergent eye movements (Sprague et al. 1973). Ironically, no clear vertical anisotropy has been reported in the primate colliculus, although previous topographical mapping studies have used only anesthetized animals.

Despite the negative topographical results in primates, it is tempting to speculate that *the role of the primate colliculus in far vision is somehow linked to its involvement in a midbrain system oriented toward the UVF*. In fact, an excess of convergence accompanies the UVF neglect produced by pretectal lesions in monkeys (Pasik et al. 1969), in striking opposition to the impaired convergence and LVF neglect produced by parietal lesions (see section 3.2.2). The greater convergence associated with UVF neglect also parallels the increased convergence produced by descent of the eyes in humans (see section 1.1).

**4.2.3. The prefrontal visual areas.** It is now believed that the dorsal-ventral division of the primate visual pathways continues into the frontal lobes, with the parietal and temporal visual areas maintaining extensive and reciprocal connections with the superior and inferior frontal regions, respectively (Bruce 1988, Goldman-Rakic 1987). As with the temporal visual areas, the frontal lobe has undergone a tremendous expansion in primates (Goldman-Rakic 1987), but this expansion may not merely reflect an enhanced emphasis on extrapersonal space (which would have led primarily to an expansion of the

inferior regions). Rather, the general importance of the prefrontal areas in attention and behavioral control – as well as their strategic ability to monitor processing in near and far visual space – may mean that they play a pivotal role in regulating the balance between the two posterior visual systems. Perhaps the extensive interconnections between the superior and inferior frontal regions (Goldman-Rakic 1987) serve as the force that ultimately integrates the primate's perceptual interactions within its three-dimensional visual world.

The specialization of the inferior frontal lobe for object recognition and memory parallels that of the inferior temporal lobe, whereas the adjacent dorsal region surrounding the principal sulcus may duplicate many of the specializations of the posterior parietal area (Bruce 1988, Goldman-Rakic 1987). These differences may correlate with the different eye movements elicited in the superior versus inferior portions of the frontal eye fields (areas 8 and 45, respectively). Whereas saccades elicited from the superior portion are large in amplitude (extending well beyond the typical distance traversed during visual search), the much smaller amplitude of inferior saccades indicates that they are instrumental in scanning closer to the fovea (Bruce 1988). Furthermore, eye movements elicited from the superior and inferior fields may be relatively biased toward the LVF and UVF, respectively (Bender 1980, Wagman 1964), despite the presence of multiple oculomotor maps in each region (Bruce et al. 1985).

It has yet to be firmly established whether the UVF neglect noted by Goldman-Rakic (1987, Figure 3) arises from a more ventral location in prefrontal cortex than does LVF neglect, or whether it corresponds to the locus of the IT projection area. Nor is it clear whether the prefrontal UVF neglect is related to the extrapersonal neglect noted by Rizzolatti et al. (1985), as these authors have not distinguished between the role of the superior and inferior arcuate regions in attending to extrapersonal space. In producing the far visual neglect in their monkeys, however, Rizzolatti et al. (1985) appear to have damaged primarily the *ventral* arcuate region. Perhaps this is also why Lattin and Cowey (1971) observed a deviation of the eyes into the ipsilateral LVF following unilateral damage to the frontal eye fields.

As knowledge concerning the functional specializations of prefrontal cortex continues to grow, the above issues will undoubtedly be settled. For now, it can at least be hypothesized that the ventral arcuate and midbrain UVF attentional systems work together in directing attention to the realm of extrapersonal space, paralleling their critical combined role in the initiation of voluntary saccadic eye movements (Schiller 1986).

## 5. Conclusions

The foregoing theoretical review of the specializations of the LVF and UVF and their respective neural systems indicates that both were greatly enhanced by the increased segregation of near and far visual space that occurred during primate evolution. The LVF has been shown to be more important in the perceptual processes required of visuomotor coordination in peripersonal space (largely performed by the dorsal pathways of the



primate visual system), whereas the UVF has been linked with the visual search and recognition mechanisms directed toward extrapersonal space (primarily controlled by the ventral system). In contrast to previous theories, this one has adopted an *ecological perspective* in relating neural functioning to the perceptual processes required for successfully operating in the greatly expanded three-dimensional visual world of the primate. It has also emphasized the role of *experiential* rather than genetic factors in the actual shaping of the higher visual areas of the primate brain.

The comprehensive theoretical perspective put forth in this paper offers the possibility of unifying a wealth of diverse and previously unexplained findings regarding the nature and origins of human visual perception. Almost all of these findings have been, or could be, the subject of individual review and debate. Regrettably, it must be conceded that many important points of discussion were necessarily glossed over in the attempt to present as comprehensive a theory as possible. There is undoubtedly danger in such a decision, which Martin (1988) has described as going "a bridge too far." Indeed, Martin's argument is supported by the revelation that a largely neglected set of findings concerning differences between the LVF and UVF may provide an important clue in piecing together the origins of the primate visual system. The intent of this theory, however, is not to constrain the interpretation of existing data, but to expand the scope of future research. Its essential message to future visual research is that the primate visual system can only be understood in relation to a richly three-dimensional visual world and the behavioral interactions engendered therein.

#### ACKNOWLEDGMENTS

I would like to acknowledge the contributions of: (a) those individuals who reviewed early drafts of this manuscript (Preston Garraghty, Fran Greene, John Maunsell, Lawrence Tychsen, and Denise Varner); (b) the BBS reviewers who contributed important suggestions and criticisms; and (c) the many other researchers who provided preprints and correspondence during the course of this endeavor. Also, thanks are given to the many technical contributions provided by personnel at the USAF School of Aerospace Medicine, especially those of Joseph Franzello (computer literature searches), Raymond Blancarte (illustrations), and Janet Trueblood (technical editing). The writing of this manuscript was supported in part by a grant from the Air Force Office of Scientific Research.

#### NOTES

1. The projection of the visual fields to opposite hemispheres is certainly consistent with the basic left-right division of the visual world. It has also been proposed that a weaker subcortical dorsal-ventral brain axis mirrors the up-down split of the visual world (Bender 1980), but the related near-far axis has evidently superseded the primordial vertical one in determining the structure of the primate higher visual cortical pathways.

2. It is not clear why Yasuma et al. did not find a visual field effect, but the relatively small stimulus (34) compared to those used in the other studies could have been a factor.

3. One potentially serious flaw, for example, involved the use of extremely brief (30-msec) stimulus presentations that probably prevented the more sluggish color-opponent channels from being activated (King-Smith & Carden 1976).

4. At the time of this paper's acceptance, Hong and Regan (1989) published additional findings concerning the visual field

representation of motion-in-depth perception. Although UVF-LVF differences were not mentioned by these authors, it still appears that the LVF may predominate in stereomotion detection for most subjects (D. Regan, personal communication), particularly those who possess no major stereomotion scotomas.

5. It should be noted that Richards and Lieberman's finding was challenged by Bradshaw, Frisby et al. (1987), who found no near-far asymmetry in the ability of their subjects to detect structure-from-motion. Two factors may underlie the discrepancy between the two results. First, the tasks in the respective studies were different (volume estimation vs. shape discrimination), with the shape discrimination task in Bradshaw et al.'s study yielding extremely high overall correct detections (90%), thereby raising the possibility that a ceiling effect was introduced. Second, the stimuli in Bradshaw et al.'s study were presented in the UVF only, a potentially serious flaw in view of the purported UVF bias against crossed disparities.

6. I personally have failed to observe an elimination of the corridor and Ponzo illusions at equiluminance in my own laboratory.

7. Since the monkey's head was restrained in Andersen et al.'s study, it is possible that their "head-centered" cells actually signal spatial location in a body-centered frame of reference, which would arguably be more useful in monitoring the position of the limbs during reaching. Since Gazzaniga and Ladavas (1987) demonstrated that parietal neglect is *not* framed in a head-centered coordinate system, a body-centered explanation seems more plausible. (See also DiZio & Lackner 1989)

8. Gazzaniga and Ladavas (1987) actually suggest that parietal neglect may be framed in gravitational coordinates, but the corporeal and gravitational axes were aligned in their experiments. It is difficult to understand why visual control of the motor system - which is organized corporeally (i.e., the left and right hemispheres control the right and left sides of the body, respectively) - would be framed in nonegocentric gravitational coordinates.

9. Critchley (1953) noted the much greater awareness of visual field defects after anterior (e.g., optic tract) as opposed to cortical damage. Since visual attention operates even at the level of primary visual cortex (Haenny & Schiller 1988), it may be assumed that all posterior cortical damage is accompanied by some degree of attentional impairment.

## Open Peer Commentary

*Commentaries submitted by the qualified professional readership of this journal will be considered for publication in a later issue as Continuing Commentary on this article. Integrative overviews and syntheses are especially encouraged.*

### Does visual-field specialization really have implications for coordinated visuai-motor behavior?

Richard A. Abrams

Department of Psychology, Washington University, St. Louis, MO 63130  
Electronic mail: c39823 ra@wuvmd.bitnet

Given the importance of visual-motor coordination, it is not surprising that distinct brain mechanisms might underlie the processing of visual information related to reaching in peripersonal space (lower visual field) and the visual information needed to search for and evaluate objects in extrapersonal space

(upper visual field). What is fascinating about Previc's analysis is that there exists considerable evidence from a variety of domains in support of this possibility. Indeed, his theory integrates a wide range of seemingly disparate neurophysiological and psychological findings into a cohesive framework. Nevertheless, despite all that it has to recommend it, the theory falls somewhat short because it is incomplete. In particular, it is not at all clear what the implications of this perceptual specialization are for the control of actual reaching behaviors.

Previc's analysis rests on the premise that visual specialization arose, in part, from the evolution of visuomotor manipulatory skills (i.e., "eye-hand coordination"). He shows, quite convincingly, that the visual functions that are presumably needed to monitor such limb movements are best performed by parts of the visual system that work best in the lower visual field, and the visual functions needed to perform scanning, visual search, and object recognition are best performed by parts of the brain that are linked to the upper visual field. While considerable evidence is presented to support this *perceptual* specialization, the link to actual motor behavior is somewhat tenuous. The problem can be stated as follows: The fact that the visual-field specialization seems to be just what is needed to accomplish reaching and scanning in the world does not in itself constitute evidence that this is why the specialization exists, or that this is why the specialization evolved as it did.

Unfortunately, little evidence is offered to indicate that the control of reaching depends on visual-field specialization at all. For example, Previc argues that "an ability to attend specifically to the contralateral, proximal LVF would allow the trajectory of the reaching hand to be more accurately monitored" (sect. 2.5, para. 2). This may indeed be true, but what is the evidence that it is true? What is needed to complete the theory is an analysis of the extent to which principles of motor control are consistent with the properties of the mechanisms that Previc assumes are involved in that control.

Although it is not completely understood precisely what kinds of visual analyses are actually performed on images of moving limbs, or how people might actually *use* visual information to prepare and produce limb movements, there has been considerable work on these issues. Unfortunately this research is not addressed in the target article. In what follows, I outline a few such issues that may inform, or be informed by Previc's theory.

Perhaps one of the most relevant results is the finding that a person's ability to localize an object in space depends to a great extent on the nature of the response the person must produce. Subjects often make large errors when providing *perceptual* judgments about the locations of objects, but they can accurately localize the object if a *motor* response is required (Bridgeman et al. 1979, Hansen & Skavenski 1977, Honda 1985, Matin et al. 1969). These results suggest that brain mechanisms responsible for the production of reaching movements have access to information about the environment that is unavailable to the perceptual/cognitive system. This is essentially what Previc has proposed: special mechanisms evolved specifically for the purpose of coordinating visual input with motor output. Some insight into the nature of these differences is provided by a recent study by Abrams & Landgraf (in press), who concluded that the apparent difference between perceptual and motor systems might be explained in part by a difference in the type of visual/spatial information used to produce the two types of responses. Such differences may be the result of specialization in the visual system that causes different brain structures to be sensitive to different types of visual information, much as Previc suggests.

An alternative approach researchers have taken to learn about details of motor behavior has been to evaluate the movements themselves to gain some insight into the information used to produce those movements. This approach has revealed the operation of two very different types of control processes that underlie the production of reaching movements. First, some

researchers have characterized eye and limb movements as consisting of preprogrammed bursts of activity in agonist muscles with well-defined force-time relationships (Abrams et al. 1989, Abrams et al. in press, Meyer et al. 1988, Meyer et al. 1982, Schmidt et al. 1979). According to these views, movements may be programmed on the basis of the perceived *distance* required of the movement. Other workers have emphasized the position-seeking aspects of eye and limb movements. In some situations, commands to the muscles may directly specify the final desired *location* of the movement (Abrams et al. in press, Mays & Sparks 1980, Polit & Bizzi 1979). These alternative views of motor programming and production are not necessarily inconsistent with each other (Abrams et al. in press), and may reflect the operation of specialized mechanisms sensitive to different types of visual information.

Previc's theory presents a considerable challenge - raising as many new questions as it has answered. The task that remains is to extend the theory and link perceptual specialization with the control of motor behavior. The theory provides a good framework in which to accomplish that goal.

## Seeing double: Dichotomizing the visual system

R. Martyn Bracewell

Department of Brain & Cognitive Sciences, Massachusetts Institute of Technology, Cambridge, MA 02139

Electronic mail: bracewell@mitwccf.bitnet

Previc has put forward a bold hypothesis, drawing on an impressive array of experimental data. Many of his ideas are interesting. Unfortunately, I feel that the attempted synthesis is in places inconsistent and is ultimately unconvincing. In this commentary I wish to deal with three topics: the question of specialisation within the visual cortex, the use of the terms "linear" and "nonlinear," and some of the evidence cited, both behavioural and neurophysiological.

**Cortical maps.** Previc surveys the parcellation of function in the visual cortex and discusses some of the problems of the strict "isolationist" position (e.g., MT "does" motion, V4 "does" colour) well. However, he goes on to ask "Why, for instance, should the processing of the features of an object be divorced from the processing of its relation to other objects?" (sect. 1.2, para. 4). He appears to find "such divisions . . . contradicted by the unity of our phenomenological experience" (sect. 1.2, para. 4). Why then do primates (and other mammals) have more than one visual cortical field at all? It has been argued that functional parcellation is an efficient way of organizing neuronal hardware for the complex operations involved in visual information processing (e.g., Barlow 1986). Moreover, such parcellation is not necessarily at odds with the perceptual unity we experience (Covey, 1981). [See also Ebbesson, "Evolution and Ontogeny of Neural Circuits" *BBS* 7(3) 1984, Precht & Powley, "B-afferents. A Fundamental Division of the Nervous System Mediating Homeostasis?" *BBS* 13:2 1990]

And yet Previc himself clearly believes in parcellation of function. The dorsal/ventral dichotomy is at the heart of his paper.

**Local/linear versus global/nonlinear visual perception.** Previc defines "linear" and "nonlinear" "in accordance with their neurophysiological usage (E. Ruth-Cugell & Robson 1966)" (sect. 1.3, para. 2). The dorsal pathway is supposed to be characterized by nonlinear mechanisms and the ventral pathway by linear ones. It seems clear, however, that the majority of cortical visual neurons, especially beyond the striate cortex, are nonlinear according to the criteria of Enroth-Cugell and Robson. In what sense are "face selective" neurons in the temporal lobes representative of a linear system?

Previc equates local with linear processing and global with nonlinear processing. It is not clear to me how he defines "local" and "global." The Barlow & Levick (1965) model of directional selectivity posits a *nonlinear* mechanism, at what one might well consider a "local" level (the receptive field of a single retinal ganglion cell).

Fig. 2a illustrates Previc's confusion over this issue (or perhaps his confusion over his view). The small E's are supposedly "perceived using contour-dependent local processing", whereas the large S "require[s] global perceptual processing" (sect. 1.3, para. 3). But the detection of an "E" - the extraction of a feature - is a *nonlinear* process.

**Two attentional systems?** It is clear that there are differences between the upper and lower visual fields (UVF and LVF). However, I must confess that I do not find that the evidence marshalled compels me to accept Previc's hypothesis. For example, let us consider the suggestion that there are two countervailing attentional systems, one mediating body-centred, peripersonal attention (which favours the LVF) and another mediating retinotopic, extrapersonal attention (which favours the UVF). Damage to the parietal lobe produces neglect, which is more pronounced in the LVF and the peripersonal space. This neglect "appears to be framed largely in terms of body-centered rather than retinotopic coordinates" (sect. 2.5, para. 3). However, evidence from patients with neglect syndrome and normal subjects suggests that attention may be tied to one of several frames (e.g., gravitational, retinotopic, head-centered, see Jeannerod 1987). Moreover, the work of Bisiach and colleagues suggests that parietal neglect may be manifest at a purely ideational level (Bisiach & Luzzatti 1978, Bisiach et al. 1979).

Previc also contends that there is a UVF advantage in attending to retinotopic, extrapersonal space. He cites the work of Scarisbrick et al. (1987), which showed that most normals bisect a vertical line above the midpoint. Yet might one not interpret line bisection as an example of a task carried out in peri-, not extra-, personal space?

**Neurophysiological evidence.** In his discussion of the M and P pathways in monkey visual cortex, Previc makes a number of equivocal claims and raises several points I wish to address:

1. Previc states that "the ventral system . . . exhibits the greater topographical precision required of far visual perception" (sect. 3.1, para. 12). This does not appear to be true in the higher ventral areas such as V4 and the inferior temporal cortex, where visual receptive fields are large and topography is disorderly (see van Essen 1985).

2. Work from this laboratory on the posterior parietal cortex has *not* shown that "receptive fields remain stationary relative to the animal's head" (sect. 3.2.1, para. 2). Anderson et al. (1985) in fact demonstrated that receptive fields of area 7a cells remains retinotopic, although the strength of responses depends on the orbital position of the eye. It is on the *population* level that such cells may code space in head-centred coordinates. We (Andersen et al., in press) have recently confirmed and extended this result to another field of the posterior parietal cortex, the lateral intraparietal area (LIP).

Previc suggests, reasonably enough, that a head-centred representation would be "especially useful in visuomotor coordination" but he goes on to state that this "indicates an emphasis on near vision" (sect. 3.2.1, para. 2). We have shown that although presaccadic cells are rare in area 7a, they are common in area LIP, and they *are* active for saccades in the dark (Bracewell et al. 1989, Gnadt & Andersen 1988). Moreover, presaccadic activity is modulated by eye position in a fashion similar to that of the visual activity of area 7a cells (Andersen et al., in press). It is possible that such eye position modulation of presaccadic activity underlies a head-centred representation for saccades (see Robinson 1975). Thus the presence of a head-centred representation *per se* should not be taken as evidence

for peripersonal spatial representation (since, as Previc points out, saccades are frequently directed to targets in extrapersonal space).

3. Previc states that "the poor spatial resolution of most posterior parietal neurons renders them incapable of signalling the precise location of objects in space" (sect. 3.2.1, para. 9). Computational studies have revealed that it is perfectly possible for a population of neurons with broad but overlapping tuning curves to represent spatial location quite precisely (Hinton et al. 1986). The notion of coarse coding is gaining increasing prominence in neuroscience (e.g., Sejnowski 1988). Also, it would indeed be strange if parietal neurons - at least in ensembles - were incapable of accurate spatial localisation, given the clear deficits in such functions that follow parietal lesions (Critchley 1953).

4. Previc stresses the role of MT in visually-guided reaching behavior. He cites Paillard's (1982) suggestion that global motion analysis supports the ability of monkeys to guide the hand from the LVF to an object in foveal vision. Local analysis (presumably mediated by Previc's ventral system) then allows manipulation of the object. And yet surely manipulation is *par excellence* a peripersonal activity?

5. Kendrick & Baldwin (1987) reported that 40/561 neurons recorded in the temporal cortex of sheep respond preferentially to faces. This percentage is similar to those reported for monkey temporal cortex (e.g., 8-9%, Perrett et al. 1985). Previc should perhaps be more cautious in claiming "unique functional specializations" (sect. 4.2.1, para. 4) for the primate ventral pathway.

**Summary.** I have raised these issues not as points to carp over, but rather to illustrate the difficulties and dangers in making such a sweeping hypothesis. Previc has attempted a bold synthesis of many experimental findings. It is pleasing to see an ecological perspective being taken. Certainly, some of the evidence may be taken to support the hypothesis, but I feel that much of it is equivocal. The proposed dichotomy in functional specialization is not strongly supported.

ACKNOWLEDGMENTS

It is a pleasure to thank the Whitaker Health Sciences Fund for its support and Robert J. Snowden and Catherine Cooper for comments on an earlier draft of this commentary.

The benefits and constraints of visual processing dichotomies

Julie R. Brannan

Departments of Neurobiology and Neurology, Mount Sinai School of Medicine, New York, NY 10029

Electronic mail: jrbms@cunyvm.bitnet

Visual science has a long history of creating processing dichotomies (X/Y, sustained/transient, "what"/"where," parvo/magno) which, although ultimately not truly independent, stimulate a great deal of productive research. Previc's upper/lower dichotomy is equally problematic, but may be equally fruitful in providing an alternate framework for directing research. I will point out some potential difficulties for this newest dichotomy, however.

**Do the data suggest any real division?** Previc notes (sect. 1.2) that previous dichotomies are not absolute and are subject to many counterexamples. Unfortunately, this also applies to the upper/lower dichotomy. As Previc points out, the functional specializations of upper and lower hemifields overlap more than they differ. In temporal and spatial resolution, for example, the magno/parvo dichotomy shows a clearer division than the upper/lower one does. More troubling, in section 1.3 Previc states

that short-range motion is a local process. However, even in short-range motion it is often necessary to solve the correspondence problem (Chang & Julesz 1984), which requires global processing (see sect. 3.2.2). Perceptual phenomena are often difficult to dichotomize along a local/global axis. A further example is that contrast thresholds are determined by local spatial inhomogeneities (Wilson & Giese 1977), yet they also depend on a global process of spatial probability summation (Robson & Graham 1978). Finally, in section 2.5 Previc suggests that retinotopic attention associated with visual search is biased toward the upper visual field. But in a recent visual search task, Krose and Julesz (1988; 1989) found that performance was better along the horizontal dimension, diminishing when targets were in either the upper or lower visual fields. These counterexamples illustrate that the upper/lower and local/global dichotomies are less than distinct.

**Can this theory explain the reading process?** The reading process, taking place in near, peripersonal space, is somewhat difficult to reconcile with Previc's near/far dichotomy. Although reading requires some global, transient activity (which Previc ties to near vision), it is primarily local. In particular, reading rate increases with field size only up to 4 degrees, and is limited by a window only below 4 characters (Legge et al. 1985). Other aspects of reading contradict perceptual processes which are supposed to take place in near vision. For example, attenuating high spatial frequency content by blurring below a bandwidth of 2 cycles/character reduces reading rate (Legge et al. 1985); Previc suggests that low spatial frequencies dominate near vision. Reading rate falls off sharply below 10% contrast (Legge et al. 1987), which is more consistent with parvo processing (tied by Previc to far vision). Although Previc states (sect. 3.2.1) that near vision involves visual pursuit while far vision uses voluntary eye movements, it is well known that voluntary saccades are an important part of the reading process (Rayner & McConkie 1976; Rayner & Pollatsek 1981). Finally, Williams & Brannan (1986) found that children who were poor readers were much slower than good readers in reaction time to the local information in Navon's (1977) global precedence task. Differences were negligible in judging the global aspect. Together, these data suggest that local processing is crucial to the reading process – which takes place in near, peripersonal space.

A look at the reading process leads one to question whether any dichotomy is relevant when complex, real-world perceptual events take place. Although local information is fundamental, global information in the form of attentional activity which preprocesses parafoveal information is also necessary for efficient reading skill (Brannan & Williams 1987).

**Conclusions.** Previc's upper/lower visual field dichotomy may not explain visual processing any better than existing dichotomies. However, it is always interesting to speculate on the possible evolutionary benefit of any apparent parallel processing in the human visual system. Recently Brannan and Camp (1987) noted that many of the visual changes associated with the aging process (e.g., reduced temporal sensitivity) result in a reliance on more sustained information. This is consistent with certain cognitive capabilities, such as "wisdom," that are associated with aged people. We suggested that it would be beneficial to the human species to have two types of processors: younger, quicker ones as well as older, slower, "wiser" ones. Given older adults' tendency to develop presbyopia ("farsightedness") perhaps this theory is not inconsistent with Previc's notion.

## Ups and downs of the visual field: Manipulation and locomotion

Bruno G. Breitmeyer

Department of Psychology, University of Houston, Houston, TX 77204-5341  
Electronic mail: [psycm9@uhupvm1.bitnet](mailto:psycm9@uhupvm1.bitnet)

The hypothesis that the lower and upper visual fields in humans are functionally specialized for near and far vision, respectively, is attractive and allows a conceptual integration of a wide range of diverse findings. However, as with unitary explanations of most complex behaviors, Previc's version of the hypothesis either leaves out some cogent findings or appropriates findings which could be explained equally well by alternate schemes. For example, in his discussion of the relationship between visual search and extrapersonal space, Previc correctly states that visual search in humans typically begins in the upper visual field (and preferably from left to right). However, this alone cannot be taken as evidence supporting the author's thesis of functional specialization in the upper hemifield for far vision and visual search. After all, in subjects living in literate cultures such scanning strategies could be acquired from extensive exposure to structured textual material which, by convention, places spatial and temporal sequential constraints on how they scan visual displays. What is required here is a convincing argument that such culturally biased scanning strategies are based on, rather than the basis for, functional differences between upper and lower visual field scanning performances. The fact that lower animals also tend to initiate scanning in the upper part of the visual stimulus (Hebb 1949) would lend credence to Previc's hypothesis.

Previc's unitary hypothesis further requires eliminating alternate explanations for functional differences between upper and lower hemifields. Previc's hypothesis of specialization of the lower field for function in near peripersonal space is based on reasonable considerations of reaching and manipulative behavior serving the largely frugivorous diet of primates such as the monkey. Human evolution, however, did not get hung up in trees or bushes. Besides evolving into gatherers of fruits, berries, nuts, and so forth, humans also evolved the capacity to explore and move across terrain in order to hunt animals for food and other needs. As with other predators, this relies of course on locomotion on a largely horizontal terrain. Except in early infancy, locomotion by humans is usually performed bipedally, with upright posture. As noted by Breitmeyer et al. (1977), such locomotion or posture on a horizontal terrain already provides a basis for establishing biases for crossed and uncrossed disparities, that is, for near and far vision, in the lower and upper hemifields, respectively. Previc's thesis that preferences for crossed and uncrossed disparities in these respective hemifields are related to reaching and manipulating in near space and to exploration of far space is not contradicted by this explanation; rather it is complemented.

Moreover, searching, hunting, and other locomotor behavior also rely heavily on postural control guided not only by the vestibular system but also by visual kinesthesia (Gibson 1958). To support his particular thesis, Previc would like to establish a close link between near vision and the vestibular system. Indeed, while the vestibular system does provide input to near visual functions such as visual pursuit, it also provides a clear input to the control of locomotion through the environment (Diegans & Brandt 1978). Visually guided locomotion depends on centrifugal optical flow patterns (Regan & Beverly 1979), because humans as well as other ground dwelling creatures most frequently move forward rather than backward. Recently, Rauschecker et al. (1987) found a centrifugal organization of directional preferences in the motion sensitive units of the lateral suprasylvian cortex of the cat. Moreover, these authors suggest that homologous areas in the monkey ought to be found

in or near area MT. Such areas are part of the dorsal cortical pathway whose function, according to Previc, is to serve near vision as opposed to visually guided locomotion.

The upshot seems to be that an inclusive explanatory scheme which incorporates not only Previc's hypothesis based on near/far visual function but also one based on locomotion through the environment is more valuable to fully explain the functional differences between the lower and upper hemifields and the corresponding specializations of the dorsal and ventral cortical streams of visual processing. In fact, the presence of visual structures supporting locomotion on a horizontal surface may be a general feature of most land-dwelling mammals. These structures would already be in place prior to the evolution of bipedalism and the consequent freeing of the upper limbs for reaching and for manipulating objects. Hence, functional differences between the upper and lower hemifields supporting near/far vision as envisaged by Previc may in some measure already have been established on the basis of prior needs for ground-based locomotion.

### Response field biases in parietal, temporal, and frontal lobe visual areas

Charles J. Bruce and Martha G. MacAvoy

Section of Neuroanatomy, Yale University School of Medicine, New Haven, CT 06510

Electronic mail: bruce@yalemed.bitnet

A functional dichotomy of "two visual systems" was originally proposed by Trevarthen (1968) and Schneider (1969), and has been refined over the past two decades. One visual system, originally termed "ambient" by Trevarthen, has also been given adjectives such as spatial and motion-sensitive, and is associated with processing coarse peripheral visual field information. The other system is specialized for pattern and form recognition, color discrimination, and foveal/central field processing of fine detail, and was termed "focal" by Trevarthen. In the primate, both systems depend critically upon visual information relayed through V1;<sup>1</sup> beyond V1 the primate's dorsally situated parietal lobe areas are generally most important for ambient/spatial vision whereas ventral/temporal lobe areas subservise focal/pattern vision. This dichotomy has been extended back towards the visual periphery, to the metabolic activity patterns in V1 and V2, to the parvocellular-magnocellular layer specializations of the geniculate, and to the X-Y distinction of retinal ganglion cells.

Here, Previc makes a strong case for differences in visual processing abilities in the upper and lower visual hemifields (UVF & LVF). In general, the differences he cites reflect a relative specialization of UVF for the focal (form-color-central-parvocellular-X) set of functions and of LVF for the ambient (spatial-motion-peripheral-magnocellular-Y) set.<sup>2</sup> However, it would be a mistake to supplant the more traditional functional dichotomy with these postulated specializations of the upper and lower visual fields or the far/near terminology, in part because these UVF/LVF specializations are relative or statistical rather than functional and in part because some of the evidence is disputable. We will review physiological evidence from visual association cortex, behavioral evidence concerning eye movements, and also new data regarding the representation of eye movements in the frontal eye fields.

First, consider the status of the UVF/LVF thesis with respect to neurophysiology of the monkey's visual association cortex. Parietal lobe visual areas, especially the posterior parietal lobule (PP or 7a), are strongly aligned with the ambient vision grouping, and temporal lobe visual areas, particularly inferotemporal cortex (IT) with the focal vision grouping. The relative importance of the UVF and LVF for IT and PP neurons has not been

quantified, however, the issue is necessarily a statistical one because each area represents both the UVF and the LVF even though neither has a simple visuotopic map. Previc's target article may prompt such a quantitative analysis, but his review of the extant neurophysiological literature is somewhat slanted, both in evaluating evidence regarding the UVF/LVF thesis and also in discounting the central/peripheral distinctiveness of IT and PP visual responses. With respect to the UVF/LVF hypothesis for IT and PP, the evidence simply is not there. The figure of Robinson et al. (1978) that was reproduced (Fig. 8) seems to show a preponderance of LVF representation for its sample of ~30 PP receptive fields (RFs), however, one tends not to notice some of the upper right quadrant RFs because their far borders apparently exceeded the screen border and hence were not drawn. The published figure showing the *most* PP data pertinent to the UVF/LVF issue may be Figure 9 of Mountcastle et al. 1984. Of the 90 quantitatively analyzed "asymmetrical radial" types of PP cells comprising this figure the slight preponderance, if any, is of cells with stronger responses from the UVF. Similarly, the published figure showing the most IT RFs is probably Figure 4 of Desimone & Gross (1979), and the vast majority of the ~100 IT RFs shown therein are comprised of comparable portions of UVF and LVF. In summary, the hypothesis of an enhanced LVF representation in PP cortex and enhanced UVF representation in IT cortex is simply not supported by the neurophysiological literature.

Second, Previc reasons that because most visual RFs in both IT and PP are "large," a foveal versus peripheral distinction is absent. However, in reaching this conclusion he neglects important aspects of IT and PP visual responses. Not only do nearly all IT RFs include the center of gaze, but even IT cells with very large RFs invariably respond most intensely to foveated visual stimuli. In striking contrast, many "light-sensitive" PP neurons have "foveal sparing" or even foveal inhibition while giving strong excitatory responses to movements in all parts of the far visual periphery (e.g., Mountcastle et al. 1984).<sup>4</sup> These foveal/peripheral distinctions point to function and have been emphasized by many researchers. They are both stronger and more abundant effects than a possible statistical preponderance of LVF representation in PP cortex, or of UVF representation in IT cortex.

Previc aligns the smooth pursuit and saccadic classes of eye movement with the ambient/LVF and focal/UVF groupings, respectively. We disagree with associating the smooth pursuit (SP) type of eye movement with the ambient half of the visual dichotomy or with the LVF. (We think the near-far distinction does not apply either, as saccades and SP can both serve to trace far and near stimuli.) Previc repeatedly associates SP with the vestibular ocular reflex and the optokinetic reflex, however, SP is not another mechanism to reduce overall retinal image slippage. Instead, SP subserves the primate's desire to *foveate* particular, often small, moving visual stimuli. To support a SP-LVF connection, he cites Tychsen & Lisberger's (1986a) finding that in the step-ramp/Rashbass paradigm human SP accelerates faster in response to peripheral LVF motion than to peripheral UVF motion. However, this study also found that the retinal eccentricity of stimulus motion was critical, with the fastest accelerations to motion being in the central visual field, which supports a focal vision interpretation of SP. Moreover, Lisberger & Pavelko (1989) concluded that in the *monkey* "target motion in the superior and inferior visual hemifields is equally effective for the initiation of pursuit." Thus, although there exists some LVF superiority for peripheral *motion analysis*, presumably based in part on the large LVF representation in area MT, the SP eye movement system is concerned with continued foveation of moving stimuli and does not necessarily parallel all aspects of the brain's motion analysis system.

Finally, do the primate's Frontal Eye Fields (FEF) belong in the focal/UVF/far vision grouping? Previc places FEF in this

grouping primarily because of its traditional association with saccadic eye movements; however, recent data indicate that SP eye movements are also represented in the monkey FEF: Microstimulation ventral to the small saccade representation of FEF elicits smooth eye movements at thresholds as low as 10  $\mu$ A, and obtaining velocities as high as 25-50°/sec (MacAvoy et al. 1988). Neurons in this area respond in association with stimulus motion and SP eye movements, agreeing in preferred direction with the elicited movements (Gottlieb et al. 1989); deficits in SP eye movements follow removal of this ventral FEF region (Keating et al. 1985, Lynch 1987; MacAvoy & Bruce 1989). The FEF can still be viewed as a primary cortical mechanism for foveation, and thus as an "output" module of the focal visual system, if one accepts our functional characterization of SP.

However, we hesitate to further categorize the FEF as an UVF structure because the FEF receives visual information, dynamic and static, from the entire visual field and represents downward, as well as upward, saccades and SP. Some UVF dominance in FEF is possible, and in this regard we note that 14 of the 16 cells comprising the scatter plot of Figure 4 of Bruce et al. 1985 have obliquely upward response fields and elicited movements. On the other hand, Figures 8 and 9 of the same paper show both upward and downward elicited saccadic movements. As is the case for other visual association cortex, the issue of an asymmetrical UVF/LVF representation in FEF awaits quantitative neurophysiological analysis.

#### NOTES

1. Although striate cortex is extremely critical in the primate, it is also clear that the primate superior colliculus is the primary structure responsible for the considerable visual abilities (collectively termed "blindsight") that survive lesions of striate cortex (Feinberg et al. 1978), especially the remaining oculomotor abilities (Mohler & Wurtz 1977). [See also Campion et al.: "Is Blindsight an Effect of Scattered Light, Spared Cortex, and Near-threshold Vision?" *BBS* 6(3) 1983.] Moreover, the visual activity in both the superior temporal polysensory cortex (Bruce et al. 1986) and in area MT (Rodman et al. 1986) that survives striate lesions critically depends on the superior colliculus. Although cortical cooling abolishes some collicular visual responses, as stated in the target article, the retinotectal projection evidently maintains enough visual activation to support visual responses elsewhere and some visual behavior, including visually guided saccades.

2. Origins of the dorsal and ventral systems: Even though relative, Previc's hypothesis, together with the visual topography of striate cortex, could still help explain the overall dorsal-ventral grouping of extrastriate visual specializations anterior to V1/V2 in the primate brain: The UVF representation of V1 (and of V2) lies in the ventral occipital lobe whereas the LVF representations are in the dorsal occipital lobe. Perhaps early in primate evolution the relatively greater importance of the LVF for spatial/motion/ambient functions dictated specializing dorsal cortex closer to the LVF representation of V1/V2 for these functions, and, conversely, specializing ventral extrastriate cortex for form/color/focal types of functions where the UVF was of equal or greater importance.

3. We omitted the linear versus nonlinear distinction because it hardly applies beyond simple cells in the visual cortex and probably no higher order visual area, regardless of visual field or function, is linear in the original, operational sense applied to the retinal ganglion cells. As used in the target article, linear/nonlinear is suspect jargon and suggests associations like "linear thinking."

4. The visual receptive fields of Area 7a (or PP) neurons do not "remain stationary relative to the animal's head rather than its fixation." Even though area 7a responses are modulated by direction of gaze, the neurons still have retinotopic RFs and thus possess neither head-centered nor body-centered coordinates. Unfortunately, Previc is not alone in confusing neural-network modeling hypotheses with physiological data.

## Twisting the world by 90°

M. P. Bryden<sup>a</sup> and Geoffrey Underwood<sup>b</sup>

<sup>a</sup>Department of Psychology, University of Waterloo, Waterloo, Ontario N2L 3G1, Canada, and <sup>b</sup>Department of Psychology, University of Nottingham, Nottingham NG7 2RD, England

Electronic mail: <sup>a</sup>mpbryden@watcgl.uwaterloo.edu and <sup>b</sup>gju@heig.not.ac.uk

Previc has argued for functional distinctions between LVF and UVF on the basis of very limited data. His Table 1 lists a number of distinctions between upper and lower visual fields that are poorly supported, in particular those involving differences between crossed and uncrossed disparities, saccadic eye movements, and global and local processing. We would agree that these distinctions are premature and poorly grounded.

Previc's Table 1 shows some remarkable similarities to other summaries of the differential functions of the two cerebral hemispheres, as manifested by differences between the left and right visual fields (cf. Bryden 1982; Sergent 1983a; Underwood 1976). In particular, the distinction between local and global processing (or analytic and holistic processing) has often been applied to visual laterality studies, with the left hemisphere (or right visual field) being seen as better at detecting local features and the right hemisphere (or left visual field) better at more holistic processing (Semmes 1968; Bradshaw & Sherlock 1982; Martin 1979). Likewise, Sergent (1983a; 1983b) has proposed that the left cerebral hemisphere is better at making use of relatively high spatial frequencies, as demonstrated in her studies of laterality effects in face recognition. Previc has twisted this by 90°, and given us some elegant evolutionary and physiological arguments for making functional distinctions between the lower and upper visual fields. By his logic, one might expect to find many visual laterality effects to be replicated in the upper and lower visual fields.

The left-right differences are now clearly established. It is not clear whether or not Previc would see upper-lower differences as independent of hemispheric asymmetries and additive to them. Should one expect to see left VF global effects exaggerated in the lower visual field and attenuated in the upper visual field? If so, then the ordering of effects should move diagonally from LL to UR.

For example, if the sequence of processing proceeds from global to local, then Previc should argue that scanning eye movements begin in the lower left and move to the upper right. In fact, eye movement studies suggest that the pattern is generally orthogonal to this, proceeding from upper left to lower right (Brandt 1945).

Despite the plethora of research on visual field effects, very few researchers have paid much attention to possible top-bottom differences. It is true that one of the earliest visual field studies, that of Mishkin and Forgays (1952) found not only a right visual field superiority for the identification of words, but also a lower visual field superiority. If word recognition involves more analytic or local processes, this finding is counter to that predicted by Previc's model, for this sees the upper visual field as being more "local." Unfortunately, very few researchers using visual field paradigms have paid much attention to top-bottom differences: Liederman et al. (1985) and Liederman and Meehan (1986), for instance, have presented words at different corners of an imaginary square, but they collapsed data across different conditions so that top-bottom differences cannot be ascertained. Previc's target article certainly opens the door for the replication of a wide variety of visual laterality studies as comparisons of UVF and LVF; whether or not such studies will be fruitful remains a matter of conjecture.

Previc also suggests that low spatial frequencies are more frequently encountered in peripersonal space. It is true that bringing an object closer reduces the spatial frequencies of the major contours. However, in peripersonal space it is the details

that become relevant, while in extrapersonal space it is the more global contours. We need to discriminate whether that onrushing object is friend or foe, but in peripersonal space we pick out the fine details of the fabric or the specific characteristics of the text. In many ways, then, peripersonal space is local and analytic, while extrapersonal space is global and holistic.

Although Previc also sees differences between UVF and LVF in disparity detection, this has not proved to be a consistent finding. Manning et al. (1987), for instance, failed to find any significant top-bottom differences for the detection of either crossed or uncrossed disparities using dynamic random dot stereograms.

A further source of evidence for the functional specialization of the upper and lower visual fields involves a UVF advantage for saccadic movements, but there are problems with this view. Most important, the data do not give good support for such a conclusion. The paper by Heywood and Churcher (1980), which is cited in support of a UVF saccadic movement advantage, reviews four earlier studies of up-down movements. Only two of these found an advantage for upward saccades, although the experiment reported in the Heywood and Churcher paper also found that saccadic latencies to targets in the UVF were shorter than those to LVF targets. Targets were single point sources of light which were displayed for 2 sec while the subject maintained fixation on a central point. When the target brightness was incremented, the subject made a saccade to it. The latency of this saccadic movement was 31 msec longer for LVF targets than for UVF targets. The fact that subjects knew the location of the target before the onset of the signal which triggered the movement suggests that the difference is a function of saccadic programming or control, rather than target detection. This provides some support for the UVF/LVF distinction, but Heywood and Churcher reported no effects of target distance and there is no evidence of differences between UVF and LVF movements in accuracy of fixation following a saccadic movement.

Further evidence in support of a distinction comes from visual search tasks in which eye movements are monitored. Hall (1985), for example, found preferences for initial inspections in the UVF when subjects searched for a target picture in a set of three UVF and three LVF pictures. Not all the available measures support the asymmetry, however. Findlay and Harris (1984) monitored the movement from a central fixation point to one of eight "clockface" locations and then to either of the two adjoining locations. They found no directional differences in saccadic amplitude. Thus, the evidence is at best equivocal for any UVF/LVF difference in the control of saccadic eye movements.

Rather than a general principle of "UVF advantages for saccadic eye movements" we need more analysis of the aspects of saccadic movements which show differences and those which do not. There are differences in preferences for the direction of search, an effect of saccadic latency (which is not unequivocal), and no effect of saccadic amplitude. Perhaps the preference for UVF searches is simply an indication of learned probabilities of the locations of objects for which we are likely to have to search. The kinds of objects in the LVF are not those we have to search for, and perhaps most of the things that require inspection of the environment (principally objects in extrapersonal space) are likely to be in the UVF. This would not be to say that there is functional specialization of the two visual fields, so much as there are different probabilities of occurrence of objects in our visual field and that these probabilities will be learned over time. Saccadic onset latencies, which also varied according to some reports for upward and downward movements, would then also be a function of practice.

A more general problem with the argument concerning functional specialization of saccadic movements is that at the stages of evolution at which saccadic movements were developing, Previc also sees UVF/LVF differences emerging. Now, if we are

developing the ability to move our eyes rapidly to bring the power of the retina to bear upon the available light then why should we need to develop new asymmetries in neurophysiological processing? The very ability to search and inspect finely would obviate the necessity for specialization.

Previc has adopted a position free of the encumbrances of data to support the distinction between UVF/LVF processing specialization, and it is surprising to see such an argument prior to seeing the collection of data. Previc seems to have lost his overall, global view of visual field asymmetries, as well as his focal, local view of the importance of the relationship between theory and data.

#### ACKNOWLEDGMENT

This commentary was prepared while MPB held a Bilateral Exchange Grant from the Natural Sciences and Engineering Research Council of Canada and The Royal Society of London, at the University of Nottingham.

### Functional specialization in the visual system: Retinotopic or body centered?

Charles M. Butter

Department of Psychology, University of Michigan, Ann Arbor, MI 48104-1687

Electronic mail: charles\_butter@ub.cc.umich.edu

In the exposition and defense of his view concerning the nature of functional specialization in the dorsal and ventral cortical visual pathways, Previc draws on a large number of findings from a wide range of fields, including neurophysiology, neuropsychology, psychophysics, and the evolution and ontogeny of the nervous system. Although, as he admits, there are clearly problems in fitting all the findings he discusses into the mold required by his hypothesis, there is indeed an impressive sweep to his theorizing.

My main reservation about accepting Previc's view is that he has not considered the possibility that near and far vision may not be related so much to visual field differences as to differences in body-centered visual space. One reason for entertaining this possibility is that when the eyes are directed to objects of interest, whether one is scanning them in far space or manipulating them in peripersonal space, it seems unlikely that in either of these situations the objects of interest are preferentially located in upper or lower fields. Furthermore, in many of the studies the author cites in which the eyes are centered, retinotopic location is confounded with upper and lower visual space. On the other hand, if the eyes are free to move, as in the examples given above and in some of the visual search studies Previc mentions, it is likely that any differences in performance with stimuli located at different heights are attributable to their location in body-centered space.

Two recent experiments Previc refers to that deal with altitudinal neglect (Butter et al. 1989, Rapcsak et al. 1988) make this point. In both studies, the patients, who had bilateral lesions of the parietal cortex (a cortical region that in Previc's view preferentially processes lower field stimuli), neglected the lower halves of vertically oriented rods, when asked to bisect these rods visually, they pointed too high. Fixation was not controlled, furthermore, as the patients were required to point to the top and bottom of the rod before pointing to the center, it seems unlikely that differences in upper and lower visual field processing accounted for their abnormal bisections. These patients also pointed too high when bisecting rods using only tactile/kinesthetic cues and, in one case when bisecting the perceived distance between two sounds, one located above the head, the other below the head. Thus, their neglect is clearly not retinotopically based, rather, it is more likely to be related to body-centered space.

Another procedure that can be used to disentangle the effects of retinotopic and body-centered location in the vertical dimension is to require subjects to direct their gaze to points above and below the centered eye position while they perform tasks in which stimuli are presented in upper and lower visual fields (perhaps using the chin or neck as the dividing line between the two halves of space). A similar procedure, involving lateral fixation of gaze, was used in a recent study to show that what appeared to be a hemianopia in a patient with a unilateral lesion was actually hemispacial (lateralized) inattention (Kooistra & Heilman 1989). Thus, the separate contribution of field and space factors needs to be investigated more thoroughly before one can with confidence attribute the functional difference between dorsal and ventral visual pathways to one or the other of these factors.

### Visual information in the upper and lower visual fields may be processed differently, but how and why remains to be established

Leo M. Chalupa and Cheryl A. White

*Department of Psychology and the Neurobiology and Physiology Graduate Groups, University of California, Davis, CA 95616*

Even casual inspection of a flat-mounted mammalian retina reveals a nonuniform distribution of cells. The nonuniformity is relatively modest in rodents (animals with poorly developed focal vision), quite pronounced in cats (more visual animals), and striking in primates (the most visual of all mammals). In addition to the variations in overall cell density across a retina, there are differences in the distribution patterns of specific cell types. Perhaps the best known example is the pronounced dissimilarity in the distribution of cones and rods in the photoreceptor layer.

The functional significance of such retinal regional variations has been investigated by psychophysicists for more than a century. Most of these studies have been concerned with relating the sensory/perceptual capabilities of the visual system to retinal eccentricity (i.e., central-to-peripheral regional variations). The reason for such an emphasis seems obvious. The nonuniformity in the density of retinal cells, particularly ganglion cells, is most pronounced when the central region of the retina is compared with the periphery. For instance, in the adult cat the density of ganglion cells in the area centralis is about 80 times greater than at the margins of the retina. In the human retina, the central-to-peripheral difference is even more striking; ganglion cells around the fovea are several hundredfold more dense than in the far periphery (Stone 1983). With the exception of the nasotemporal decussation pattern, other features of retinal regional specialization have received relatively little attention. Thus, Previc's attempt to explain differences in functional specialization between lower and upper visual fields is certainly quite novel.

Another prevalent theme in the visual sciences has been the attempt to subdivide visual processing into separate components. These functional specializations have usually been related to specific pathways (in modern parlance, "streams") within the central nervous system. For example, an often cited functional subdivision from the 1960's stems from the "two visual systems hypothesis," which advocated that the retino-geniculocortical pathway dealt primarily with answering the question "what is the stimulus," whereas the retino-collicular pathway dealt with answering the question "where is the stimulus" (Schneider 1969). Perhaps the most influential scheme of the 1980s has been that of Livingstone and Hubel (1988), linking global visual processing to the magno system and stimulus identification to the parvo system. Previc finds the functional distinctions proposed by others unsatisfactory. He accordingly

puts forth a near-far dichotomy, which he relates to non-linear/global and linear/local perceptual mechanisms, respectively. The near-far dichotomy is also related to ("biased toward") the lower and upper visual fields, respectively. Hence, the link is made between functional subdivisions of visual processing and specializations within the upper and lower visual fields.

A new improved theory of visual processing would be welcomed by those who spend a substantial portion of the day trying to unravel how the visual system works. The key question is: Does the treatment offered by Previc represent an improvement over what is already available in the literature? An even more basic consideration is: To what degree is his view supported by the evidence?

If there were linear/nonlinear differences in visual information processing between upper and lower fields as Previc postulates, there should be differences in the response properties of cells with receptive fields in the upper and lower visual fields. Specifically, cells with linear attributes should predominate in the upper visual field, whereas cells with nonlinear attributes should predominate in the lower visual field. There is no reason to believe that this is the case. Furthermore, the attempt by Previc to relate upper visual fields to the parvo stream and lower fields to the magno stream is rather tenuous. In the primate lateral geniculate nucleus, for instance, the upper and lower visual fields are represented about equally in the parvo and magno layers. While a case can be made that the "dorsal cortical system" processes different aspects of visual information in comparison to what is processed by the "ventral cortical system," the relevance of this dichotomy to the upper and lower visual fields is obscure. Even where there is evidence for some disproportionate representation of the hemifields in visual cortical areas, the relevance of this inequality for visual information processing is far from straightforward. For instance, there are no clear upper/lower visual field differences on several behavioral tasks involving processing of velocity information, although this attribute is thought to involve the MT visual area, where the lower field has greater representation (see discussion in Murasugi & Howard 1989).

This is not to say that the processing of visual information from upper and lower visual fields is necessarily identical. Recent immunocytochemical studies provide evidence that there is a difference in the organization of the upper and lower retina. White et al. (1988a; 1988b; in press) have shown that there are two types of somatostatin-immunoreactive neurons in the cat retina: a small cell type, thought to be a wide-field amacrine cell, and a large cell type that resembles the alpha class of ganglion cells. Both the small and large cells are found preferentially in the inferior retina, with the small cells in highest concentration at the retinal margin (see Figure 1). Somatostatin-immunoreactive processes, however, are distributed at all eccentricities within the inner plexiform layer of the retina. A similar distribution of somatostatin-immunoreactive cells has also been observed in humans (Sagar & Marshall 1988) and rabbits (Rickman & Brecha 1989; Sagar 1987). The functional significance of the somatostatin-immunoreactive neurons is unknown. However, C. A. White and colleagues suggest that "this peptide could be involved in raising the signal-to-noise ratio in neurons across the retinal surface in response to input from the upper visual field." This speculation is in line with the physiological observation (Zalutsky & Miller 1987; 1988) that infusion of somatostatin in the rabbit eyecup preparation increases visually evoked discharge levels.

As more detailed information becomes available about the functional and morphological organization of the mammalian retina, the intriguing questions raised by Previc will be answered. We suspect, however, that the answers will differ from those provided by Previc.



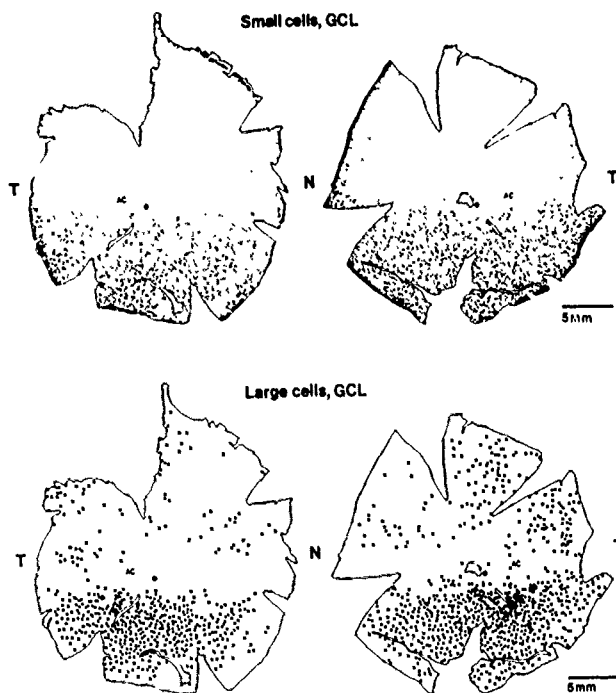

Figure 1 (Chalupa and White). Maps of a pair of adult cat retinas showing the location of every somatostatin-immunoreactive small cell (above) and large cell (below) in the ganglion cell layer (GCL). Some immunoreactive cells of the small type are also found in the inner plexiform and inner nuclear layers, where they are distributed preferentially in the inferior retina (not shown). AC, area centralis; T, temporal; N, nasal. The large, filled circle in each retina represents the optic disk. (Adapted from White et al., in press.)

### The ups and downs of visual fields

David P. Crewther

School of Optometry, University of New South Wales, Kensington, NSW, Australia

Previc has made a brave attempt to combine anatomical, physiological, behavioural, neuropsychological, ecological, and evolutionary information to produce a cohesive explanation for the functional specializations of the lower and upper visual fields of man in particular, and primates in general. I use the word brave because when one gets down to the details of what is known of the "actual" higher functions of visual areas of the brain, at best we rely on speculation. A less courageous approach would first consider objective fact (such as visual field maps, reaction times, receptor densities, spatial and temporal properties of evoked potential traces) separated from the more speculative imputed functional roles (such as associating the function of area 7a with reaching, or ascribing the role of the magnocellular pathway to "near" vision and the parvo pathway to "far" vision), leaving us with a more restricted statement: Certain types of visual field-related functional specializations are exhibited by primates but not by most lower mammals. None of these specializations are, on most measures, highly evident in the retina, the LGN, the superior colliculus, or even the primary visual cortex V1 and the second cortical tier V2. The specializations are present because some of the higher cortical areas, especially in occipito-parietal and occipito-temporal cortex, are restricted to the upper or lower visual field and at the same time have a very different distribution of inputs in terms of LGN magnocellular or parvocellular cell types. The vertical differences in visual performance are seen as biases because it is the combination of

activities in cortical brain areas which causes our overall visual percept. What new dimension does the near-far hypothesis add to this statement?

Previc hypothesizes that the demands of near and far space for a primate are essentially compatible with the lower visual field (LVF) and upper visual field (UVF) respectively, and that this division is in turn supported by specialized magnocellular and parvocellular projections. Perhaps he pushes this hypothesis a little too hard. Whereas a restriction of peripersonal space to LVF is reasonable for the human, at least considering modern lifestyle, it does seem surprising that the peripersonal space for primates should be restricted to LVF – considering that there are many species of frugivorous arboreal monkey whose progress through the trees requires the hands to be elevated above the head most of the time, to pluck fruit as often from UVF as from LVF. The strength of Previc's argument depends to a large extent on the interpretation of the role of the dorsal cortical areas 7a and MT. This requires rejecting the originally postulated role of MT in the processing of optical flow information during locomotion in favour of a role incorporating peripersonal reaching. In arguing against the role of optical flow processing, Previc suggests that the most rapid flow rates would be found in the extreme LVF periphery, a region not well represented in either MT or area 7a. However, in determining the path taken by an animal during visually guided locomotion, which requires attention to the interpretation of obstacles and terrain, peripheral LVF vision would not be important. Second, the role of reaching during locomotion is important for actions such as leaping, incorporating high surround velocities as well as antagonistic centre-surround motion during the grasping of a target. Third, with the neurons (especially those of area 7a) sensitive to change in a large number of different inputs – retinal, somatosensory, vestibular, proprioceptive, and attentional – it is highly likely that the stimulus-space for the neurons of these areas has not been fully elaborated. Thus, while the argument for reaching as a role for dorsal cortical areas is quite compelling, whether it is for the static, peripersonal activities or for reaching during locomotion is less obvious.

The argument for a "far" visual role for the ventral cortical areas also causes some difficulty, notably in the comparison of the properties of areas V3 and VP. While the argument for specialization of the magno projection to the LVF (and hence peripersonal) part of V3 was quite convincing, the evidence presented for a "far" visual role of VP and indeed for the absence of a parvo-generated function in V3 was far less so. Perhaps it is the term "far" vision that provides more problems than the reported evidence. Although the neurons of the ventral system, with their relatively higher proportion of parvo inputs, have disparities fairly narrowly distributed around the fixation plane (cf. the dorsal system with a bias towards crossed disparities) the use of the parvo system during near fixation is basically neglected. While Previc uses the distribution of disparities as an argument for "far" vision, perhaps the term "fixation" vision would be more appropriate. A monkey grooming another (essentially a peripersonal task) would almost certainly call upon the parvo system in the search for and identification of nits.

There is a danger inherent in Previc's inferring the "function of the magno system from the specializations of the two regions in which it is disproportionately represented." The association of the magno system with the visual control of reaching and other peripersonal visual operations may neglect its role in a host of other visual attributes, especially those involved in global visual perception. It also implies that the so-called higher visual cortical areas, such as area 7a, MT, IT, V4 and so on, are the ultimate generators of visual function, causing the reader to relegate regions such as primary visual cortex, V1, to the role of a neural relay station, just as in the past, researchers have described the role of the lateral geniculate nucleus.

In summary, I believe that the case for the near-LVF-magnocellular link has been well argued and should be included in the

distinguishing properties of the dorsal cortical pathway, along with global motion perception, in a description of the dorsal/ventral cortical dichotomy. The far-UVF-parvocellular link is less strong; in particular, I find the idea of far vision less compelling than the concept of the use of the parvo system in object identification in the fixation plane (which of course includes far vision).

## Ecology and functional specialization: The whole is less than the sum of the parts

John M. Findlay

Department of Psychology, University of Durham, South Road, Durham DH1 3LE, England

Electronic mail: j.m.findlay@mts.dur.ac.uk

Previc has performed a useful service in collecting and assembling a diverse literature relating to differences in psychophysical and physiological measures between upper and lower visual fields. He has also presented an admirable survey of some of the different strands of parallel processing known to be present in the visual system. He uses this evidence to support a position of "functional specialization," which suggests that visual material is processed in different ways in the two hemifields. This difference is alleged to have arisen as a consequence of the different visual ecology the two fields encounter. The thrust of the target article is to suggest that these differences have occurred during the course of primate evolution (see e.g., section 5).

The case for functional specialization is made by the accumulation of small pieces of evidence. The critical question seems to be whether this evidence can really support the strong claim for functional specialization as a phylogenetic process, particularly since there may be an alternative ontogenetic explanation for many of the findings. The visual system is sensitive to visual experience during development, as Previc notes in section 4. If the visual system is genetically programmed to have central symmetry and isotropy, we might still expect upper-lower visual field differences to emerge because of the differential ontogenetic experience of the two fields. The difficulty with Previc's thesis is that it has not addressed the question of why differences between the visual fields are generally so small and why, for many measures, isotropy and circular symmetry is in fact so impressive (Rovamo & Virsu 1979).

Turning to detailed evidence, I feel qualified to make only a few comments relating to my area of specialization: saccadic eye movements and visual attention. As Previc notes (sect. 2.1), saccadic eye movements to visual targets in the lower visual field show longer latencies than to targets elsewhere. This has been found in several studies, although as Heywood and Churcher (1980) indicate, there is one counterexample (Miller 1969). A related finding is that when two targets are presented simultaneously in upper and lower visual fields, the tendency to move the eyes to the upper target is very strong (Findlay 1980; Levy-Schoen 1969). No explanation for these differences is known, so Previc's suggestion that they arise because of the importance of the upper visual field for visual scanning cannot be rejected. Nonetheless, this link seems too remote and untestable to form a very satisfying explanation.

Previc places strong emphasis on the distinction between local and global processing (sect. 1.3). Target-elicited saccadic eye movements also demonstrate an interesting form of global processing. When two targets are presented simultaneously in neighbouring positions in the visual field, the first saccade is regularly directed at some "centre of gravity" position (Findlay 1982). Unpublished experiments in our laboratory have shown that this integrative effect is actually less marked in the lower visual field, which, in a sense, runs directly counter to Previc's

thesis. However, the result appears to be a secondary consequence of the latency difference referred to in the previous paragraph since the centre of gravity effect is less marked for saccades with longer latency (Ottes et al. 1985; Findlay 1985). Previc is surely right about the importance he assigns to the local/global distinction. However, attempts to relate this distinction to visual hemifields, whether up/down or left/right, fail because adequate vision demands the integration of both forms of processing throughout the whole visual field.

## Pigeons, primates, and division of labor in the vertebrate visual system

M. A. Goodale<sup>a</sup> and J. A. Graves<sup>b</sup>

<sup>a</sup>Department of Psychology, University of Western Ontario, London, Ontario, Canada N6A 5C2 and <sup>b</sup>Department of Psychology, University of St. Andrews, St. Andrews, Fife, Scotland

Electronic mail: \*goodale@uwo.ca and \*pssjg@sava.st-andrews.ac.uk

Although one might wish to dispute Previc's characterization of the differences between the upper and lower visual fields in primates, it is important to acknowledge that functional specialization of different regions of the retina occurs in a wide variety of nonmammalian vertebrates. Indeed, it would be surprising if the same were not true of primates as well. While the visual system of birds is different from that of primates from the retina on up (Donovan 1978; Hodos 1976), Previc's concentration on primates appears to have led him to ignore the evidence for similar adaptations in other species, even though it would strengthen ecological foundation of the distinction he is trying to establish. In the common pigeon (*Columba livia*), for example, there is plenty of evidence to suggest not only that there are two functionally distinct regions of the visual field, but that the nature of the specialization within these two regions is remarkably similar to that described by Previc in the primate (for review, see Goodale & Graves 1982 and Graves & Goodale 1979).

The visual field of the pigeon, like that of many birds and nonprimate mammals, is largely monocular and panoramic. Only a limited portion of the field immediately in front of and below the bill is binocular (Martinoya et al. 1981; Nye 1973). The retina of the pigeon is quite different from that of the primate or other mammals in that many of the cones contain oil droplets that can be either clear or colored. The binocular portion of the visual field corresponds to a region in the upper temporal quadrant of the retina, the so-called "red area" or "red field", where many of the cones contain large red oil droplets. The remaining portion of the retina consists of the "yellow field" in which few or none of the cones contain the large red oil droplets characteristic of the red field (for review, see Emmerton 1983a and Goodale & Graves 1982). The red area has a relatively high tectal magnification factor and a ganglion cell density comparable to that of the central fovea and visual streak in the monocular yellow field (Clarke & Whitteridge 1976; Galifret 1968; Yazulla 1974), all of which suggest an area specialized for acute vision comparable to the fovea itself (Clarke & Whitteridge 1976). The near point of accommodation for this portion of the visual field, however, is much closer than that of the upper frontal and lateral fields (Nye 1973). Thus, just as Previc has described in the primate, there appear to be two areas of specialization within the visual field of the pigeon: (1) a lateral fovea within the large monocular field of each eye for viewing distant objects, and (2) another area of acute binocular vision, corresponding to the red area of the retina, for viewing stimuli located only a few centimeters away from the bill. This near/far distinction is also supported by a variety of other psychophysical and neurophysiological evidence, including differences in the spectral sensitivity functions of the two fields (for review, see Emmerton 1983b).

Moreover, like the primate, the pigeon appears to use the part of the visual field specialized for near vision, in this case the binocular field, to control grasping movements directed at stimuli in peripersonal space (Goodale 1983a; 1983b). Even though the pigeon uses a beak rather than fingers to pick up objects, the problem it faces is much the same as that facing the monkey – to grasp objects in near space as efficiently as possible. A high-speed cinematic analysis of pecking in the pigeon showed that in both key-pecking for food reward and normal feeding, the decision to peck is made during a brief head fixation that occurs some 80 mm from the surface on which the target is located (Goodale 1983a, 1983b). Once the decision to peck is made, a second and even briefer fixation occurs at a distance of 55 mm, which presumably allows the bird to calculate the size, depth, and location of the target. This behavior is very stereotyped and during both fixations the target falls within the binocular portion of the field corresponding to the red area. Thus, while the actual solution to the problem is different, it would appear that in both the primate and the pigeon particular areas of the visual field are specialized for the control of grasping. In the case of the monkey (and man), the control of grasping involves on-line modulation of the reach trajectory on the basis (in part) of visual information about the position of the moving limb (and sometimes the target itself) that is largely provided by the lower visual field. As Previc points out, that information will consist of “optically-degraded and diplopic images” (particularly if the subject is foveating a more distant aspect of the environment while making the grasping movement). As a consequence, he argues, the primate brain has evolved mechanisms to handle these stimuli – mechanisms that presumably involve the magnocellular pathway – that use specialized “nonlinear/global processing.” Pigeons, whose pecking is largely “visually ballistic,” have solved the problem a somewhat different way by having an area of high visual acuity, the red area, which can provide detailed binocular information about the nature and location of the target to be pecked, while at the same time another two foveae, one in the monocular field of each eye, are available for viewing distant stimuli of potential interest, such as predators.

It is interesting to note that when a pigeon is flying, its head is held so that the bill is oriented well below the horizon with an eye-center to bill-tip angle of around 39° (Erichsen et al. 1989). This posture insures that the ribbon-like visual streak that extends from the lateral visual fields to the upper frontal visual field (as marked by relatively high ganglion cell density) is parallel to the horizon, which, together with the maintenance of a constant orientation of the semicircular canals, may be an important requirement for accurate visual control of flying.

Thus, the pigeon, like Previc's monkey, has specialized visual structures for the control of different behavioral functions, some of which require processing of visual stimuli in near space and others which require processing of visual stimuli in far space. The more we learn about the organization of vertebrate visual systems, the more evident it becomes that the visual system is organized into a number of relatively independent visuomotor “modules”, each of which has a special role to play in the visually control of behavior (Goodale 1983c, Goodale 1988). Previc's thesis, right or wrong, is a commendable attempt to explore this possibility in detail in the primate visual system, and, as such, is a welcome departure from the tendency of many visual scientists to remain fixated on monolithic accounts of visual processing.

## Attention to near and far space: The third dichotomy

✶Kenneth M. Heilman, ✷Dawn Bowers, and ✸Paul Shelton<sup>1</sup>  
*Department of Neurology, University of Florida College of Medicine, Neurology Service, Veterans Affairs Medical Center, Gainesville, FL 32602,<sup>✶✷</sup> and Section of Neurology, University of Manitoba, Winnipeg, Manitoba, Canada<sup>✸</sup>*

Studies of spatial neglect have revealed that the brain is right-left hemispatially organized, and this hemispatial organization is important in the control of behavior. For example, the right hemisphere appears to attend and prepare for movements (intend) in and toward left contralateral egocentric hemispace. Patients with right hemisphere lesions not only bisect lines toward the right but their bisection error is also more severe when a line is placed in left hemispace than when it is placed in right hemispace (Heilman & Valenstein 1979). This right-left dichotomy may be only one of three attention-intention spatial dichotomies, however. Not only horizontal but vertical neglect has been reported. For example Rapsack et al. (1988) reported a patient with biparietal lesions who neglected the lower half of vertically presented lines, and Shelton et al. (1990) reported a patient who had bilateral inferior temporal lobe lesions and neglected the upper part of vertical lines. Brain (1941) posited a third dichotomy when he suggested that the region in extrapersonal space within grasping distance may be of special significance, in this target article Previc proposes that the visual system may be organized so that the lower visual field is specialized to process near stimuli and the upper visual field is specialized to process far stimuli. We have made some observations and reported a patient who provides partial support for a down-near, up-far dichotomy (Shelton et al., 1990).

The patient is a 66-year-old, right-handed man who developed a bilateral inferior temporal lobe infarction that was probably secondary to embolic disease. His clinical picture is complex (for details of his case and experimental procedures used to study him one should refer to our original report). When initially examined he showed a bilateral upper hemivisual field defect with a preserved ability to detect and localize light in the upper fields. This upper field defect eventually improved. He also had a visual agnosia and, as briefly mentioned, vertical neglect. For example, when asked to bisect a vertically oriented line he set his mark below the actual midline. He also demonstrated upper vertical neglect on cancellation and drawing tasks. In addition to testing line bisection in the vertical position (e.g. intersection of the midsagittal and frontal planes), we also tested for radial neglect by having the patient bisect lines presented at the intersection of the transverse and midsagittal planes. Radial lines were presented to this patient and to controls in three locations, with the line adjacent to the body surface (near), with the line approximately 30 cm from the surface of the body (middle), and with the line midpoint 60 cm from the body (far). The patient consistently misbisected radial lines towards his body at all three distances. However, performance in far space was worse than it was in near space. In far space he misbisected radial lines by a mean of 7.10 cm and in near space he erred by a mean of 2.34 cm. His line bisection errors were greater than 4 standard deviations from the mean of the normal controls.

To learn whether this neglect of far space was modality specific we also tested our patient and controls with a tactile radial line bisection task where the blindfolded subjects explored the entire line and attempted to bisect the line. Again the patient misbisected the line toward his body.

There are at least two mechanisms that can induce a systematic error in line bisection tasks: inattention or a directional hypokinesia (hypometria) (Heilman et al. 1985). Extinction to simultaneous stimuli or a failure to detect stimuli cannot be attributed to a directional hypokinesia or hypometria and, in the absence of a primary sensory defect, is thought to represent an attentional deficit. This patient demonstrated a vertical visual

extinction. He was able to detect finger movements in either upper or lower visual fields when presented alone but when upper and lower stimuli were presented simultaneously in the same coronal plane, there was a failure to detect movements of the upper fingers. However, on some occasions an upper field stimulus was no longer extinguished when it was presented 30 cm closer to the subject's face than the simultaneous stimulus in the lower quadrant. Taken together, these observations suggest that this patient's bilateral inferior occipital-ventral temporal lesion induced inattentiveness to far stimuli. Because this inattentiveness was both in the visual and tactile modality, the defect was either polymodal or supermodal. Although one must be cautious about generalizing from one patient to a population or deducing normal function of a brain area based on behavioral deficits associated with destruction of that brain area, our observations of this patient suggest that the inferior occipitotemporal region may be specialized to attend to upper and far stimuli.

Leinonen et al. (1979) and Leinonen and Nyman (1979) recorded from a population of neurons in area 7b of the parietal cortex of monkeys and demonstrated that their activity is enhanced only by visual targets approaching the cutaneous receptive field or by stationary stimuli within 5-10 cm of it. Most of these light-sensitive cells did not respond at all if the target was further than one meter from the monkey. Area 7b projects to the posterior bank of the arcuate sulcus; Rizzolatti et al. (1981a; 1981b) showed that arcuate neurons have properties analogous to those in area 7b, the majority responding to visual stimuli only if less than 10 cm away. Rizzolatti et al. (1981a; 1981b) introduced the term peripersonal space to denote this region of extrapersonal space and showed subsequently that post-arcuate and area 7b ablations induced visual and tactile neglect of contralateral pericutaneous stimuli (Rizzolatti et al. 1985).

Although patients with biparietal lesions have not been studied for the neglect of near peripersonal space and monkeys with inferior temporal lesions have not been studied for the neglect of far peripersonal space, our observations together with those of Rizzolatti and his co-workers would suggest that there is a third dichotomy. Even though the inferior temporal region is important for attending to far space, the parietal areas are important for attending to near space.

#### NOTE

1. Send correspondence to K. M. Heilman, University of Florida College of Medicine, Department of Neurology (J-236), Gainesville, FL 32610

## The role of dorsal/ventral processing dissociation in the economy of the primate brain

Marcel Kinsbourne<sup>a</sup> and Charles J. Duffy<sup>b</sup>

<sup>a</sup>Behavioral Neurology Laboratory, Shriver Center, Waltham, MA 02254,

<sup>b</sup>Laboratory of Sensorimotor Research, National Eye Institute, National Institute of Health, Bethesda, MD 20892

Previc has added a welcome input emphasis to the functional differentiation of the dorsal and ventral extrastriate streams in primates. However, his suggested causal sequence, from altitudinal visual field specialization to differentiation of related extrastriate processors, is perhaps the wrong way around. Differential specialization of UVF and LVF implies a somewhat fixed relationship between the position of the visual fields and extrapersonal spatial coordinates. The reverse is the case for the agile canopy monkey, whose eyes, head, and body are constantly changing position relative to each other, and who is as often hanging upside down as right way up. It is species that can move neither head nor eyes relative to the body (especially fishes) that show fixed differential visual field specialization, not

flexible orientors like monkeys. In any case, any correspondence of magno versus parvo with the LVF versus UVF is quite subordinate to magno correspondence with peripheral and parvo with central vision. In contrast to the Y system, the great majority of cells in the parvo-related X system represent central vision (Kaas 1989).

Why then did the foveal object-related processing stream and the peripheral spatial-relational processing stream (Ungerleider & Mishkin 1982) become anatomically segregated in monkeys? We suggest that these are not, as Previc suggests, alternative modes, but complementary ones. The reason it is not adaptive for monkeys to specialize at a fixed differential visual field is why the two visual systems are separate. Their very mobility complicates the task of placing perceived objects in a spatial framework, necessary as this is for effective foraging. According to the functional cerebral distance principle (FCDP; Kinsbourne & Hicks 1978) parallel disparate but complementary mental operations are best served by keeping their respective neural substrates well separated in functional cerebral space - that is, in the neural network. Dorsal/ventral separation of object and spatial processing presumably minimizes crosstalk between these concurrent complementary processing modes, which establish distinctive objects within a spatial framework. It is precisely when simultaneous functioning is required that neuronal segregation is needed. When it is not, the same neuronal population might be used at different times for different functions (Duffy 1984).

That the near-far dichotomy is of secondary importance compared to the peripheral-central dichotomy is also shown in terms of function by closer delineation of the fundamental neuronal response properties which characterize the two streams. In the dorsal stream, the receptive fields of neurons in area MT are large, being an order of magnitude larger than striate cortical receptive fields (Maunsell & Van Essen 1983a; 1983b). In MST the fields are still larger by another order of magnitude, often more than 100 degrees in diameter (Komatsu & Wurtz 1988). Similarly, large bilateral receptive fields are characteristic of neurons in parietal area 7a (Motter & Mountcastle 1981). Depth preference is relative to the plane of the fixation point. Tuning to binocular disparity has been seen in MT (Maunsell & Van Essen 1983a; 1983b) and in MST (Komatsu et al. 1988). In MST the response to stimuli depends on whether they are nearer or further than the fixation point, with no clear preference for "near" or "far" (Roy & Wurtz 1989). Area 7a neurons are also depth sensitive. Two-thirds prefer close fixations and one-third far fixations (Sakata et al. 1980).

High order response properties of dorsal stream neurons are specific for moving stimuli. The vast majority of MT neurons are movement-selective and strongly direction-sensitive (Dubner & Zeki 1971). In MST specific cell populations respond to complex, rotational, and radial movements (Tanaka & Saito 1989) and are particularly sensitive to computer-generated simulations of optic flow fields (Duffy & Wurtz 1989). Similarly, in area 7a the direction-sensitive neurons demonstrate opponent vector organization suited for flow field analysis (Motter et al. 1987).

In the inferior temporal section of the ventral stream, in awake monkeys during attentive fixation, the receptive fields are small, 5-10 degrees in diameter (Richmond et al. 1983). VA neurons are color, orientation, and shape sensitive (Zeki 1973, 1977). Their strikingly face-selective responses are invariant with changes in the size of the face, contrast reversal of the picture or reduction in the 3-D cues available (Rolls & Baylis 1986). They respond differentially when the face stimulus is rotated from profile to full face (Perrett et al. 1985).

Thus dorsal stream neurons are oriented toward analyzing global visual movement parameters. They may support postural stability, guide locomotion, and encode the three dimensional relationships between features of the environment. Most of these goals may be readily achieved through the analysis of optic

flow fields (Gibson 1986), a task to which these neurons seem ideally adapted. As such, their function is to some extent consistent with near rather than far vision, but it certainly involves the full field rather than just the lower peripheral field.

The response properties of the ventral stream neurons suggest that they extract information about locally cohesive elements (Desimone & Schein 1987). Facility for object recognition, notably of faces, uses multisensory information and memory as integrated in polysensory and limbic temporal cortices (Desimone & Gross 1979). The final discriminations, for example, of faces mediated by the ventral system, occur in near rather than far vision, and at fixation rather than in the UVF.

Why then the altitudinal anisotropies in man? According to the functional cerebral distance principle (FCDP), each visual half field is to some extent under the influence of the processing modes of the more adjacent (more "connected") segment of extrastriate cortex. Just as activating the human left hemisphere favors verbal processing in the right visual field and activating the right hemisphere favors spatial processing in the left visual field, so activating dorsal cortex by posing a spatial problem activates the more connected LVF and vice versa. No additional post hoc adaptive rationalizations for altitudinal visual field anisotropies are needed.

## Why the computations must not be ignored

Chad J. Marsolek

Department of Psychology, Harvard University, Cambridge, MA 02138

Electronic mail: [cjm@wjh12.harvard.edu](mailto:cjm@wjh12.harvard.edu)

In an interesting description of the apparent segregation of primate visual processing in peripersonal and extrapersonal space, Previc hypothesizes that this processing segregation may help to explain why the dorsal and ventral visual streams are functionally separated. In a sense, Previc has added a new dichotomy to the pile, detailing evolutionary interpretations for this new characterization and citing neurophysiological findings consistent with it. The problem, as Previc is aware, is that the previous characterizations of the functions of the two visual streams have also been supported with physiological evidence. More important, not one of these distinctions seems to be incompatible with the others. How do we correctly characterize these functional differences? I propose that a computational approach (Marr 1982) is necessary.

The initial complication is the broad overlap among the different functional descriptions of the dorsal/ventral dichotomy. This overlap makes it hard to generate different predictions to support one or another of the alternatives. Evidence supporting one scheme is likely to support the other.

A computational approach provides additional constraints and suggests nonobvious functional properties of brain systems. If we regard neurons in the parietal lobe (especially in area 7a) and neurons in the inferior temporal lobe (IT) as performing different computations (in terms of a system's neuronal input, an operation performed on this input, and the output produced), a picture different from Previc's emerges.

For example, an adequate description of the different computations being performed by these two systems must account for "stimulus equivalence across retinal translation," the ability of neuronal systems in IT (inferior temporal cortex) to identify an object regardless of where its image strikes the retina (Gross & Mishkin 1977). Given that objects can be identified through processing in the ventral system no matter where they appear in the visual field, or even whether they are in peripersonal or extrapersonal space, IT neurons seem to be performing certain computations (involving object recognition) that are different from those needed to encode the spatial location of objects. These other computations (involving spatial location) must

therefore be performed by some other system. Indeed, Ungerleider and Mishkin (1982) have argued that the parietal lobes are specialized for spatial perception whereas temporal areas are specialized for object perception.

Previc challenges this description of functional specialization in the two visual streams on teleological grounds by asking why the processing of object features should be separated from the processing of spatial relations. Rucekl et al. (1989), using a computational approach, have provided a partial answer. These researchers show that a divided neural network (with one set of hidden nodes processing shape information and another set processing location information) is computationally more efficient than a single, undivided network of the same size in encoding both shape and location information. Thus, it may simply be more efficient for the brain to allocate its resources so that different systems encode these different properties.

To offer physiological evidence inconsistent with the Ungerleider and Mishkin (1982) distinction, Previc also cites findings that parietal lobe receptive fields overlap the foveal region and IT receptive fields are very large, averaging 25 degrees in diameter. At first glance these findings seem inconsistent with the view that spatial perception (using much information from the visual periphery) occurs in the parietal lobes and object perception (using information mostly from central vision) occurs in IT. O'Reilly et al. (in press) used a computational approach to discover nonobvious functional properties of the dorsal system consistent with these receptive field properties and with Ungerleider and Mishkin's (1982) characterization. They first noted that parietal lobe receptive fields are also very large (Andersen et al. 1985; Motter & Mountcastle 1981), which helps to explain why these fields commonly overlap the fovea. To shed light on the different functional properties of these two areas, O'Reilly et al. (in press) next looked for other characteristic differences. They noted that the distribution of receptive field peak locations was different in area 7a (they are more evenly distributed across the field) than IT (they are almost always found on the fovea, Gross et al. 1972; Motter & Mountcastle 1981). To discover possible effects of this variable, O'Reilly et al. (in press) varied the number of off-center receptive field peaks that were "hard-wired" into the receptive fields of input layer nodes of a three-layer neural network. The coordinates of a dot in a matrix were specified far more easily when enough of these receptive field peaks were off-center. In fact, when all the regions of peak response were located on the center, the network could not accomplish the mapping. It never computed the location of the input!

These results indicate that the distribution of receptive field peaks is an important neural characteristic for encoding spatial location, and clearly area 7a neurons are much more suited for this processing than IT neurons. Regarding this functioning, Previc cites the conclusion that since most individual parietal neurons have poor spatial resolution, they cannot process the precise spatial location of objects (Motter et al. 1987). However, when parietal neurons are looked at as a system performing a certain computation, the system as a whole (having neurons with overlapping receptive fields and well distributed peaks covering all of the visual field) can process precise spatial locations, regardless of the spatial resolution of individual cells.

Previc, in a broad attempt to unify many findings under one conceptual roof, fails to take advantage of the computational approach and falls victim to interpreting individual neuronal properties without consideration of the computations being performed by larger systems of neurons. He qualifies this effort by concluding that his intent is not to constrain how physiological data are interpreted, but to call for the expansion of future research. primate vision must be understood in relation to our diverse, three-dimensional environment. Perhaps the message actually communicated is the need for expanding future interpretations of brain system functioning to include the computations being performed by these neuronal systems.

## ACKNOWLEDGMENT

I wish to thank Stephen M. Kosslyn and Christopher J. Azorson for their valuable comments and assistance in preparing this commentary.

## Peripheral lower visual fields: A neglected factor?

Naoyuki Osaka

Department of Psychology, Faculty of Letters, Kyoto University, Kyoto 606, Japan

Electronic mail: b52046%tansel.cc.u-tokyo.junet%UTokyo-relay.csnet@relay.cs.net ; b52046@JPNKUDPC.bitnet

Previc's view on the functional specialization in the LVF and UVF in the human visual system appears quite interesting in connection with magno/parvo (dorsal/ventral) dichotomy and the related neurobiological differences. The hypothesis that near/peripersonal and far/extrapersonal visual space represent functionally distinct systems did not seem clear enough, however.

First, where is the functional boundary between the two types of visual space? Regarding the near/far dichotomy, Previc states that the boundary of peripersonal and extrapersonal space could be specified as within and beyond the edge of an arm's reach, respectively. However, as he pointed, the boundary is not functionally clear enough, even though easy enough to define physically. Thus, he allows for an interdependency between two types of space by saying that the body-centered spatial coordinates used in peripersonal visuomotor activities could also be used beyond the arm's reach, just as local perceptual analyses directed toward extrapersonal space can also be performed on objects within reach. This view clearly weakens the proposed dichotomy.

Second, what kind of factor influences the peripersonal space? If, as Previc argues, the body-centered visual attention system for monitoring visuomotor activities in peripersonal space could be countervailed with a retinotopic attention system for visual search and scanning in far/extrapersonal space, the LVF is therefore critically linked to the visual control of reaching in near/peripersonal space. Visually guided eye-hand coordination in peripersonal space is critical for reaching an object and also critical for monitoring the reaching hand in the peripheral LVF.

The question is whether the observer's peripersonal space could be maintained as it was before when reaching in the peripheral LVF is prevented during visuomotor coordination task. In his "tube study," in which a field of view was restricted to the central 12 degrees by wearing long (33 cm) narrow tubes, Dolezal (1982) found that, in such a restricted peripheral visual field, observers tended to report object shrinking and a reduction of the distance from themselves. Thus, the observer underreached for objects and overreached the ends of the tubes. The observer experienced disorientation, loss of stability, and even difficulty in walking. This evidence from field restriction suggests that peripheral LVF information is important. Peripheral information is critical for monitoring the movement of the hand from LVF, it also allows the hand to be guided from the peripheral LVF to the fixed target, even though it cannot be viewed directly. Consequently, the body part image appearing in the peripheral LVF has a role in keeping and stabilizing near/peripersonal visual space.

Third, how can the central/peripheral distinction be related to the peripersonal/extrapersonal dichotomy? Previc also notes that the central/peripheral differences can be incorporated into the peripersonal/extrapersonal (near/far) dichotomy, in that most far vision is limited to the central 30 degrees because of the poor spatial resolution of the peripheral retina, while peripheral

visual input has to be attended during reaching and other peripersonal activities.

The LVF's advantages (arising from greater sensitivity to motion, luminance, and texture gradient) to the greater optical motion flow below the horizon during forward locomotion would diminish with restriction of the peripheral LVF. Thus, according to Previc's hypothesis, visual space in a restricted field should become increasingly extrapersonal.

This is not what was found by Previc, and many perceptual misjudgments and performance difficulties were experienced in Dolezal's observations; observers judged familiar objects as appearing smaller and nearer to themselves and their perceived point of observation came close to the ground level because of the absence of their seen body image in the peripheral LVF. A similar kind of experience was found among scuba divers and astronauts whenever peripheral LVF information was reduced (Dolezal 1982).

This apparent shrinkage of peripersonal space during field restriction should be taken into consideration in connection with the dynamic functional interdependency between near/peripersonal and far/extrapersonal visual space and the distinction between them.

The last comment is related to manual RT (reaction time) differences between LVF and UVF. I agree that the RT to most stimuli is shorter in the LVF. My own results indicate that the RT to a flashed target is shorter by about 23 ms in the LVF than in the UVF along the vertical meridian; it is even some 10 ms faster in the temporal hemifield (Osaka 1976; 1978). These results would agree with Previc's assumption that the LVF facilitates visuomotor coordination in peripersonal space. It should also be noted that the temporal LVF corresponds to the quadrant where the hand appears in the LVF.

## Properties of neurons in the dorsal visual pathway of the monkey

Ralph M. Siegel

Thomas J. Watson Research Laboratory, International Business Machines, Yorktown Heights, NY 10598

Electronic mail: axon@ibm.com

The target article presents a particularly thorough review of the major differences between the dorsal and ventral visual pathways in the primate. There are still open questions, however, about the electrophysiological support for the functional segregation into upper and lower visual fields that is proposed to coincide with near/far space, or nonlinear/linear processing. This is because there are errors and controversy about some of the deductions in the target article made from the known properties of cortical neurons in the dorsal pathway.

I would first like to point out a misinterpretation of experimental results of Andersen et al. (1985). In the discussion of the dorsal visual system, Previc writes (sect. 3.2.1., para. 2): "Perhaps even more intriguing, many posterior parietal neurons appear to code visual space in terms of head-centered coordinates (Andersen et al. 1985), such that their receptive fields remain stationary relative to the animal's head rather than its fixation."

Our experimental results showed that the receptive field remained stationary relative to retinal coordinates, not the fixed head coordinate system. A change in the animal's gaze angle led to a multiplicative modulation of the amplitude of the response. We suggested that the representation of head coordinates was distributed among a population of neurons which was consistent with the neurological notion that the inferior parietal lobule is the site of the representation of "extrapersonal space" (Critchley 1953).

Two different theoretical approaches (Siegel & Andersen

1987, Zipser & Andersen 1988) indicate that a population of these angle-of-gaze cells could be used to signal the location of an object in head-centered coordinates within 1° in spite of the large receptive field size. Both these studies relied on the summing of the activity of these cells to achieve behaviorally reasonable precision. Thus Previc's suggestion that parietal neurons are "incapable of signaling the precise location in space" is incorrect. The angle-of-gaze cells of parietal cortex could be used to locate an object that is not an immediate "near space" (e.g. a monkey in a tree 10 meters away), which contradicts Previc's thesis.

Previc also argues against "an involvement of area 7a and MT in the processing of optical flow information during locomotion through the environment." (sect. 3.2.1., para. 8) His view is that these regions are used for "reaching and other peripersonal behaviors," and five "major observations" are made to support this view. All of these "observations" are, at the least, subject to dispute. Previc's points (sect. 3.2.1., para. 8) along with relevant comments follow:

"First, the most rapid flow rates . . . are found in the periphery whereas most MT and 7a receptive field are located within . . . the central 20° of the visual field."

Area 7a neurons have quite large visual receptive fields, sometimes up to 40° in size (Andersen et al. 1985). The peripheral MT fields can also be large (Albright & Desimone 1987, Maunsell & Van Essen 1983a). The result that these receptive fields overlap with the center of the visual field does not preclude their use for optical flow analysis in the periphery or across the visual field. Indeed, a model has been proposed (Siegel 1987, 1988) that uses the properties of MT neurons in a parallel processing scheme to extract flow field information.

"Second, optical flow patterns during locomotion are . . . expanding and the majority of area 7a neurons respond to motion away from the animal."

The study cited (Steinmetz et al. 1987) used unnatural stimuli (small moving squares) to test for optical flow properties. Recent physiological studies in the awake behaving monkey (Siegel 1989) using more natural and controlled stimuli (random dot fields) (Siegel & Andersen 1988) to test for optical flow selectivity have found an equal number of cells selective to both expanding and compressing stimuli. Furthermore, this study suggests that there are highly nonlinear interactions between subregions of the receptive field, making it difficult to predict the response to a full field motion stimuli from either local patches of motion or small moving squares. Region MST, pointedly missing in the discussion of the dorsal pathway, also has neurons selective for real optical motion flow (Tanaka et al. 1986, Saito et al. 1986, Duffy & Wurtz 1989). Both the 7a and MST neurons in the dorsal pathway can be used for motion flow field analysis that can occur in both the upper and lower visual field as well as in near or far personal space.

"Third, opposite motion<sup>1</sup> is never produced by egomotion through the environment, so the preference . . . for center vs. surround must be related to other factors."

Center-surround motion cells were first proposed for a number of ethological and physiological reasons by Allman (1977). Center-surround motion can be obtained when an observer moves through an environment, the analysis of such motion is essential for localization in the environment. Thus "never" is clearly an overstatement.

"Fourth, The preference of dorsal neurons for near disparity and/or fixations . . .

Physiological data are not nearly so complete as to permit such a blanket statement for the five or more dorsal visual areas (e.g. MT, MST, FST, LIP, 7a, VIP, etc.) The preference for near disparity is suggested only for area MT (Maunsell & Van Essen 1983b). Some data has been collected for a broadly defined area 7a (Sakata et al. 1980), but there appear to be further complications in the interpretation of such studies in the

subdivision LIP (Gnadt & Mays 1988). MST has disparity tuned cells (Roy & Wurtz 1989), but not enough data is available to determine whether there is a preference for near or far.

"Fifth, it is difficult from an ecological viewpoint to understand why brain areas so obviously involved in reaching and eye movement control should perform an optical flow analysis whose chief value would be to maintain postural control."

The key point in this statement is the assumption that the inferior parietal lobule is involved only in peripersonal behaviors. While it is true that motion flow fields can be used for reaching and eye movement control, they are also useful for a number of other visual-motor tasks (see Ullman 1979, Longuet-Higgins & Prazdny 1980). Some examples are locating the boundaries of objects, determining the three-dimensional structure of an object, locating oneself in a moving environment, as in moving through trees for arboreal primates, and indeed postural control. There is no a priori reason to rule out parietal involvement in these processes, particularly in considering some of the effects of parietal lesions (e.g. disorders of movement, spatial perceptions, etc., in particular, see Critchley 1953, Chap. 5).

In summary, the dorsal visual pathways, which include MT and 7a and a host of other regions (Maunsell & Van Essen 1983c), can indeed be used for visual flow field analyses as well as for determining precise spatial position. I have attempted to describe the controversies that exist for some of the arguments used to support Previc's contentions. Although a weakness in any one supporting proposition does not completely negate the conclusion, the many ostensible shortcomings of the target article suggests that we should exercise some caution before embracing the idea of an upper and lower visual field dichotomy.

NOTE

1. By which I assume the author means "center surround motion."

**Different regions of space or different spaces altogether: What are the dorsal/ventral systems processing?**

Gary W. Strong

College of Information Studies, Drexel University, Philadelphia, PA 19104  
Electronic mail: strong@duvm.bitnet or strong@duvm.ocs.drexel.edu

Previc's target article represents an impressive effort to integrate previous work, but I remain of the opinion expressed in section 1.1 of the target article, that "the LVF-near and UVF-far links are far from absolute." Previc prematurely dismisses as "not altogether satisfactory" Ungerleider and Mishkin's (1982) distinction between spatial/peripheral and object/central perception (section 1.2). However, Ungerleider and Mishkin's placement of spatial/peripheral perception in the parietal, or dorsal, pathway coincides with Kesner et al.'s (1989) identification of the parietal cortex as involved in the processing of allocentric spatial information, that is, information "based on memory for specific stimuli representing places or relations between places that are independent of one's body orientations in space" (p. 956). To the other pathway Ungerleider & Mishkin assigned the function of object/central perception. This is similar to what Mack (1978) calls the "object-relative mode" of perception. This distinction being made, it appears that a more accurate identification of the functional difference between the dorsal and ventral pathways may not be based so much on a partitioning of the regions of space as perceived by the subject (Previc's thesis) as on different spatial coordinate systems. The basic question I wish to pose is whether the dorsal/ventral distinction is based on a differential processing of LVF/UVF "regions of visual space" as Previc suggests, or on the spatial

"types of information they process" (a view Previc dismisses in section 1.2).

The impressive amount of data Previc reviews suggests, at the very least, a distinction between an object-based tracking system for visuomotor coordination in peripersonal space (section 2.7) and a retinotopic visual system. It is one thing to suggest that these two systems must exist, another to say that they correspond to the LVF and the UVF, respectively. Consider, as examples, the acts of tracking a distant motion, such as that of a running animal, and reading a book. The former involves both the UVF and far perception, in opposition to what Previc would suggest, and the latter involves both the LVF and retinotopic, saccadic vision, also in opposition to Previc's thesis.

Furthermore, if parietal patients cannot solve the correspondence problem (as reported in section 3.2.1), then Previc must explain how this relates to or differs from the statement in section 3.3.1 that "a major purpose of the far attentional [temporal] system is to 'glue' features into integrated wholes, so as to ensure that forms composed of identical features in different arrangements are not confused." I hold that both the parietal and the temporal system can play the role of "tag-assignment" and that there is no reason to believe that it can't be done by foveal, saccadic vision (see Strong & Whitehead 1989). What distinguishes one pathway from the other probably depends on whether the so-called "glue" (or tag) is based on spatial location (dorsal/parietal) or object pattern (ventral/temporal). The fact that the hippocampus receives "heavy projections from the temporal lobe" (Section 3.3.2) and does not itself have an obvious global spatial mapping (Eichenbaum et al. 1989) supports the view that the temporal lobe is the site of integration based on something other than space, such as "objecthood."

The reader may suppose that Previc holds his particular thesis in part as a way of making sense of what he calls the "teleological challenge," which is, "Why . . . should the processing of the features of an object be divorced from the processing of its relation to other objects . . . Such divisions are contradicted by the unity of our phenomenological experience . . ." (section 1.2). Current research suggests, however, that there is no reason to suppose that the "unity of experience" is related to the locality of representation in brain tissue. Aiple and Kruger (1989), Eckhorn et al. (1988), Gray et al. (1989) and Gray and Singer (1989) show clearly that perceptual unity is tied to synchrony of activity rather than to locality in the cortex. Unity through synchronization completely changes the way one looks at the brain, in that there is no longer any need to consider that a representation is in one neural site, or that one type of information is processed in one area. Locality arguments now have to be made on other grounds, such as the need for nonspecific pericolumnar inhibition that has been identified between cortical minicolumns, "the most basic units" of the primate cortex (Mountcastle 1979).

The processing distinction between the dorsal and ventral pathways is perhaps that of between-object relationships and within-object relationships, respectively. Between-object relationships are much more dynamic than within-object relationships and probably rely on a different coding method in the brain. Whereas within-object relationships could conceivably be coded by redundant populations of neurons (such as the face-recognizer populations of Rolls et al. 1989), between-object relationships require a more dynamic, constructed representation such as temporary synchrony among a population of nonredundant columns.

In conclusion, I agree with Previc that "It must be conceded that the near-far dichotomy falls short as a complete explanatory scheme" (section 1.2, para. 8). Furthermore, there are probably a large number of simultaneous processing pathways in the brain, some not tied to the ventral/dorsal distinction. For example, Goldman-Rakic (1988) proposes the existence of parallel hand/eye circuits, each involving parietal, temporal, and

frontal cortex as well as other areas. This could even be a more plausible characteristic structure for primate cortex than one based on the UVF/LVF distinction since hand-eye coordination is a distinctive feature of primate behavior.

## The primary visual system does not care about Previc's near-far dichotomy. Why not?

Robert W. Williams

Department of Anatomy and Neurobiology, University of Tennessee, School of Medicine, Memphis, TN 38163

Electronic mail: rwilliams@utmem3.bitnet

Can a major division exist in the processing and representation of upper and lower visual space without a corresponding division in the structure and function of the retina, lateral geniculate nucleus, and striate cortex? An information theorist would say yes (Marr 1982). The program and the processor are separate, and the same processor can run many different programs. But an evolutionary biologist would say no. The program and the processor coevolve, and if Previc's dichotomy is vital - as defined by its effects on fitness - then in the course of several million years of intense selection this dorsal-ventral rift should have left marks along the entire visual system. In other words, a single processor cannot be optimized for two different and very complex tasks. Previc takes this evolutionary-ecological approach and, following in the parallel processing tradition, looks for substrates of the near-far dichotomy in the retina, lateral geniculate, and visual cortex. Here anatomists and physiologists let him down. There is really very little evidence of asymmetry in the representations of upper and lower visual space, particularly in primates.

One counterargument is that structural modifications have not kept pace with changes in the algorithm. This is unlikely. Over a period of merely 25,000 years, the visual system of the cat lineage has undergone wholesale structural change (Williams et al. 1989), and these changes are obvious in the retina and lateral geniculate nucleus. Furthermore, in several species, upper and lower visual space is treated differently by the primary visual system. There can be no more dramatic example than the tropical fish *Anableps* (Walls 1942) with two pupils per eye - one for vision in air and one for vision in water. Vertical asymmetry has also been discovered in a few mammals, but unfortunately for Previc, in all the wrong species (see accompanying commentary by Chalupa & White). For example, retinal ganglion cells are more heavily concentrated along the dorsal vertical meridian in herbivores, dogs, and bush babies (Hughes 1977, Stone 1983), and Hughes argues that in herbivores this vertical streak subserves the grazing field between face and forefeet. But in monkeys and humans almost all we can say at present is that (1) rods are more closely packed in the dorsal hemiretina, forming a rod hot spot about 5 mm above the fovea (Wickler et al. in press), and that (2) somatostatin-immunoreactive cells are located almost exclusively in the ventral hemiretina (Sagar & Marshall 1988). Both of these features are probably related to differences in mean illumination of upper and lower fields, not to near and far vision.

So why doesn't the primary visual system of primates care about Previc's near-far dichotomy? I have three suggestions.

1. Previc is exaggerating the segregation of near and far functions in lower and upper visual space. To some degree, experiments with inverting prisms bear this out (Harris 1965). As a heuristic, a little exaggeration is useful, but here Previc may have gone too far. The near-far dichotomy may actually be a subtle gradient. This would be the simplest explanation for the absence of near-far specialization in the primate primary visual system.



2. Other more important constraints and processes dictate the design of the primate visual system. At most, Previc's dichotomy is a relatively unimportant, although interesting, wrinkle. Since there is minimal evidence for near-far segregation at any level between the photoreceptor mosaic and area 18, we are obliged to accept that other processes have had the dominant role in the evolution and parcellation of the primate visual system (Diamond & Hall 1969; Hassler 1966; Polyak 1957). One of the most interesting recent ideas is that the evolution of stereopsis in primates was driven not by the selective advantage of depth discrimination per se (there are plenty of other cues) but by its utility in revealing well-camouflaged food and foes (Frisby 1980, p. 155).

3. Previc's dichotomy is real and possibly important, but he is looking for structural substrates and functional correlates in the wrong parts of the brain. The visual system provides a wealth of information to disparate systems in parietal, frontal, and temporal neocortex. Each of these external systems requires an interface, and each interface requires custom wetware for filtering, mixing, and re-representing this hybrid information. These interfacing requirements have molded a specialized belt of paraviscual areas that surrounds the relatively uniform visual core. These are the regions in which the split in the visual system, whatever it may mean, is most obvious. If there is a crisp dichotomy between near and far, as Previc argues, then its proximate causes will be found in rostral parts of neocortex and not in the particular design of the retina, geniculate, or visual cortex. Another way of saying 'his is that the near-far dichotomy is not a property of the visual system at all, but simply an outgrowth of diverse requirements of nonvisual neocortex.

## Only half way up

Andrew W. Young

Department of Psychology, University of Durham, Science Laboratories,  
Durham DH1 3LE, England  
Electronic mail: a.w.young@durham.ac.uk

In his insistence on the importance of an ecological perspective for understanding neural functioning, Previc is surely right. We should not consider functional specialisation without any reference to the demands of the world to which the functions have adapted. But the argument can also be misleading if taken to extremes. Every aspect of cerebral organisation does not reflect this type of constraint.

Consider, for instance, the extensively documented involvement of the left cerebral hemisphere in language abilities. Many types of explanation have been offered for this phenomenon, but none of those now taken seriously are in ecological terms. Indeed, it is difficult to see what *ecological* pressures could conceivably result in left rather than right hemisphere specialisation for a particular mental ability. [See also Corballis & Morgan: "On the Biological Basis of Human Laterality." *BBS* 1(2) 1978 and Bradshaw & Nettleton: "The Nature of Hemispheric Specialization in Man." *BBS* 4(1) 1981.] If anything, left cerebral involvement in language must confer the slight disadvantage of making people marginally less able to respond to speech coming from the left. Yet in everyday life we interact without discomfort with people occupying this spatial position (left of us). The underlying pressures ultimately responsible for left cerebral involvement in language, and any overall advantages it confers, would seem to be more realistically sought in internal, organisational factors (such as avoiding unnecessary or complex duplication of function).

One of the consequences of left cerebral specialisation for language is that most right-handed people are better able to recognise words presented in their right visual hemifield (see Bryden 1982; Bradshaw & Nettleton 1983, for reviews). At one

time it was thought that this phenomenon might be in some way related to ecological pressures resulting from the left to right order of reading used by several forms of alphabetic script. It has now been established, however, that right visual hemifield superiority for word recognition is found even in languages that are read from right to left (Carmon et al. 1976), and that the effect is less clearly shown by left-handed people than by right-handed ones (Bradshaw et al. 1981) even though any ecological pressures created by reading direction will be the same for right- and left-handers. Thus it is clear that the primary determinant of visual hemifield differences in word recognition ability is cerebral asymmetry rather than ecological pressures per se (though this is not to deny that these may exert some modifying influence).

Since information processing differences between the left and right visual hemifields do not seem to be primarily determined by ecological pressures, why should we think that matters will be any different with respect to upper (UVF) versus lower (LVF) visual hemifield differences? Convincing arguments are needed. Previc tries to provide two, one of which I find convincing, one unconvincing.

The convincing argument is that because so much visually guided reaching takes place in the LVF, it has become specially adapted for this purpose. Although the literature on upper versus lower visual hemifield differences is not extensive, Previc demonstrates that it is consistent with this idea.

Much less secure is Previc's attempt to argue that the UVF is specialised for object search and recognition in "far" (extrapersonal) visual space. The ecological argument is unconvincing. As I look around me now, I can see plenty of out-of-reach objects that fall either above or below fixation, and once I have identified an object of interest I refixate to bring it into central vision. Similarly, when I am moving around, especially outside the house, new objects of interest are often hidden in small declivities or obscured behind other foreground objects. As they are revealed, these will mostly be found initially in the LVF. Previc in fact concedes this point, and admits that "the relationship between far vision and the UVF is not nearly as exclusive, as both vertical hemifields represent the extrapersonal portion of visual space" (section 1.1, para. 5). Moreover, his review actually demonstrates that "virtually no UVF advantages exist in *sensory processing per se*" (section 1.1, para. 5). Instead, Previc arrives at the conclusion that there is a "link between the UVF and an extrapersonal attention system that facilitates object search and recognition" (section 2.7, para. 2). Evidence for this link, however, is no more than suggestive at present.

Why is Previc so concerned to establish a specific role for the UVF? Why isn't he simply happy with the view that for the reasons he gives the LVF plays a particularly important part in visually guided reaching, whereas search mechanisms involved in locating and identifying objects must operate efficiently in both upper and lower visual fields? Part of the reason seems to be that he wants to develop a theory in line with the widely held (but seldom articulated) dogma of *complementary specialisation*, which holds that if one part of the brain subserves a particular function, then another part of the brain (preferably the opposite part) must subservise the opposite function. This dogma has already generated numerous unhelpful dichotomies in theories of left versus right cerebral hemisphere asymmetries, it would be a shame if it were to be too readily imported into our thinking about the upper and lower visual fields.

# Author's Response

## Visual processing in three-dimensional space: Perceptions and misperceptions

Fred H. Previc

Crew Technology Division, USAF School of Aerospace Medicine, Brooks AFB, TX 78235-5301

Electronic mail: [previc%apache.decnnet@hqhsd.brooks.af.mil](mailto:previc%apache.decnnet@hqhsd.brooks.af.mil)

The BBS treatment of my article generated many diverse commentaries about the proposed relationship between LVF-UVF processing differences and the different perceptual requirements of peripersonal and extrapersonal space. It also unveiled important new or overlooked empirical findings relevant to the various claims of this theory. In the pages that follow, I review the commentators' observations in basically the same order as followed in the target article: I begin with a treatment of some basic conceptual issues before moving on to a discussion of specific behavioral, neurophysiological, and neuropsychological findings, and conclude with a brief mention of those comparative issues that relate to the LVF-UVF and near-far visual processing dichotomies.

### 1. Conceptual issues

#### 1.1. The validity of the near-far distinction

Several commentators (particularly, Young) object to my dichotomization of near and far visual space, while others (e.g., Williams) argue that I exaggerated the interdependencies of vertical (LVF-UVF) and sagittal (near-far) processing. Still others (e.g., Kinsbourne & Duffy) object to the application of the near-far distinction to the specializations of the dorsal and ventral neural pathways. In response, I must first point out the many visual scientists – including Helmholtz and Gibson – who have noted the important ecological links between the UVF and far vision and between the LVF and near vision (see Heuer et al. 1988). Indeed, one would have difficulty in interpreting even the most basic LVF-UVF differences without recourse to these overarching relationships. How, for example, could one fully explain the UVF bias in saccadic eye movements yet ignore the fact that UVF and LVF saccades also lead to greater divergence and convergence, respectively (Enright 1989)? Second, I reiterate that I am by no means the first investigator to argue that the near-far distinction may have a fundamental neurophysiological and neuropsychological basis. Although I cited Rizzolatti et al.'s (1985) near-far theory, the neurophysiological distinction between near and far vision put forth by Pettigrew and Dreher (1987)<sup>1</sup> bears an even closer resemblance to my own, as will be discussed later.

Williams implies that a fundamental ecological relationship between the LVF and near vision and the UVF and far vision is not borne out by inverted prism studies. Yet the perceptual adaptation experiments described by Dolezal (1982) directly contradict his assertion, as the distortion of near and far space and of the size and distances of objects within three-dimensional space actually proved to be the most dramatic perceptual conse-

quence of up-down visual field inversion. According to Dolezal, a perceptual reversal occurred as to "where in the FV [field-of-view] near and far surfaces appeared to be. Specifically, with spectacles, physically distant places appeared at the bottom of my FV, whereas places closer to me appeared closer to the top of the FV" (Dolezal 1982, pp. 246–247).

The target article clearly suggested that the empirical support for the relationship between the dorsal pathways and near vision and the LVF is much stronger than for the relationship between the ventral pathways and far vision and the UVF. Some commentators (e.g., Young and Crewther) accordingly accept only the former's existence. Yet Young's suggestion that the latter link was partially contrived in order to create an aesthetically satisfying dichotomy ignores the fact that attentional and oculomotor imbalances in the direction of far vision are created by parietal damage, which clearly implies the existence of a countervailing far attentional system (see section 3.2.2 of the target article). The existence of two attentional mechanisms that are normally perfectly balanced in the vertical and sagittal dimensions is also congruent with recent evidence by Heuer and colleagues (Heuer & Owens 1989) that resting vergence is close to the edge of peripersonal space (~ one meter) *only when the eyes are vertically centered*. (Otherwise, vergence increases during lowering of the eyes and decreases during ocular elevation.) Moreover, the existence of far visual neglect in Heilman et al.'s bilateral temporal patient clearly demonstrates that a far attentional system does exist in humans. Heilman et al.'s crucial finding belies the claim of Kinsbourne & Duffy that the link between temporal lobe functions (e.g., visual search) and the UVF does not require the postulation of a special relationship between the UVF and far vision, a point to which I will return later.

Although I demonstrated in the target article that the distinction between near and far visual space cannot be easily defined according to the physical extent of the arm, two commentators (Brannan and Strong) nonetheless reiterate the fact that reading – a parvo/ventral function – often takes place within the confines of peripersonal space. Another commentator (Breitmeyer) further notes the difficulty in categorizing the visual processing that mediates our ability to locomote and orient in the environment, since such processing utilizes far visual inputs (Brandt et al. 1975) yet is presumably mediated by the magno/dorsal pathways.

As regards the first counterexample, I argue that reading requires the processing and output mechanisms that are ordinarily applied to information in extrapersonal space, even though it typically occurs within arm's reach. More specifically, reading makes use of a retinotopic scanning system that is (a) largely free of head and limb movements, (b) foveally centered and located within the plane of fixation, and (c) capable of perceiving local contours. This same characterization holds true for related functions such as facial recognition, albeit to a more limited extent. Whether faces are recognized inside the boundary of peripersonal space (e.g., in photographs) or beyond its confines (as is the case for almost all real-life faces that we encounter in our daily existence), they are almost invariably subjected to the visual scanning and local contour analysis that are used in extrapersonal

space. Thus, facial recognition can hardly be considered a "near" perceptual task, as Kinsbourne & Duffy propose. Rather than discarding the concept of a physically well-demarcated near and far visual space, I prefer to view the above counterexamples as supporting a distinction between body-centered space (whose sagittal midline lies at arm's reach) and oculo-centered space (whose sagittal midline lies in the plane of fixation). While the two midpoints occasionally deviate during activities such as reading, a similar divergence of body-centered and oculo-centered space can also occur in the context of left-right vision (Kooistra & Heilman 1989).

The second objection of Breitmeyer can be met by further differentiating between the "far" space used in visual orientation – the "visual background" according to Grusser's (1983) scheme – and that synonymous with the visual search and scanning field. The maintenance of visual orientation, for example, is regarded as an "ambient" process that traverses virtually the entire visual field and does not require visual attention (Post & Leibowitz 1986), as compared to the more limited spatial extent and greater attentional demands of visual search and scanning. (Indeed, it is common practice in vection experiments to instruct the subjects to divert their attention *away* from far vision in order to maximize the orientational effects of large-field image motion.) The far visual background likewise influences convergence state without requiring conscious awareness, as indicated by the "empty-field" myopia that accompanies loss of a textured background field (Whiteside 1952). This phenomenon could explain the greater perceived "nearness" of objects when only central vision is present (see Dolezal 1982, cited by Osaka).<sup>2</sup> It may therefore be concluded that the ambient use of visual background information by parietal regions in maintaining visual orientation and convergence does not invalidate the proposed segregation of peripersonal and extrapersonal *attentional* mechanisms into the parietal and temporal cortices, respectively. This is especially true since visual orientation mechanisms housed in the parietal lobe undoubtedly rely on a body-centered coordinate system that is more closely aligned with peripersonal visual activities than with extrapersonal visual information processing.

In summary, peripersonal and extrapersonal visual space are best viewed as reasonably well-demarcated depth sectors that can be defined according to different coordinate frames, all of which are probably centered near the reach of the arm in the resting state. By recognizing that the division of near and far visual space can be drawn in different coordinate systems that do not always coincide, one can preserve the near-far dichotomy without resorting to a "gradual transition" zone (see Williams) that is uncharacteristic of the other two visuospatial attention dimensions (Hughes & Zimba 1987). One can also dismiss the attempt of Strong and Crewther to dilute the near-far neuropsychological distinction still further by suggesting that the dorsal and ventral systems may be better distinguished by their different processing modes (i.e., the ventral pathway is portrayed as a retinotopic "fixation" system) rather than by their emphases on different regions of space. This is because the parietal lobe does not have only a body- or head-centered system (see section 2.5 of the target article and Bracewell), nor does the temporal lobe maintain an exclusively reti-

notopic coordinate system (given that Heilman et al.'s temporal patient partially manifested far visual neglect in body-centered space – i.e., in a tactile bisection bias).

Before concluding this discussion, I wish to respond to a specific remark concerning the ecological interdependency of vertical (LVF-UVF) and sagittal (near-far) space in arboreal primates. Crewther and Kinsbourne & Duffy speculate that visuomotor and other processing is not confined to a particular vertical hemifield in these species. On the contrary, even in these species the head will virtually always remain dorsal to the proximal limb (e.g., shoulder) joints – as will the eyes relative to the mouth – *along the body axis*. As long as the animal maintains fixation on a more distal food object, therefore, the retrieval and ingestion of it will predominantly occur in the LVF *regardless of the position of the head and/or body relative to the ground*. The major difference between the ecological interactions of arboreal and terrestrial primates would be the latter's relatively infrequent exposure to totally inverted images of extrapersonal space. This would explain why, contrary to Kinsbourne & Duffy's assertion, facial neurons in the anterior temporal lobe of macaques typically respond poorly to inverted faces (see Perrett et al. 1984, Figure 7) and why the perception of human faces is so poor for 180-degree rotations in the frontal plane (Yin 1969).

## 1.2. Local-global perception

Several commentators challenged the dichotomy between linear/local and nonlinear/global perception and its relationship to parvo and magno function, despite the fact that other theories (e.g., Bonnet 1987) have put forth similar distinctions. Bracewell and Bruce & MacAvoy argue that the link between linear neuronal processing and higher-order shape processing is dubious in that all complex shape recognition processes are necessarily nonlinear. While this argument is superficially valid in the sense that a neuron that responds to a face in various portions of the visual field clearly does not exhibit linear responsiveness, it overlooks the fact that the "global" shape recognition carried out by the ventral system is based on the output of parvo (e.g., linear) contour processing and can be impaired by degradation of contour perception (Desimone et al. 1985). It is also true that, as Brannon notes, "local" spatial processing is capable of being space-averaged at a higher stage of processing. But the global shape recognition that is achieved via a hierarchical assemblage of linear outputs is quite unlike the processes involved in the perception of illusory contours and other distributed forms, which are *fundamentally nonlinear* in nature (see Chang & Julesz 1984). An excellent example of such nonlinearity is the response of certain neurons to an illusory contour even when there is absolutely *no luminance contrast* located in their classical receptive field (Peterhans & Von Der Heydt 1989b). As for Bracewell's argument that some nonlinear visual processes also depend on local spatial interactions, his example of directionally selective motion responsiveness is somewhat unfortunate in that direction-selectivity is relatively rare in the parvo-rich ventral (UVF) prestriate areas that clearly process local contour information (Felleman & Van Essen 1987, Figure 17).

It should also be pointed out that Brannon's belief that local motion perception can produce a solution to the

correspondence problem is evidently based on a misinterpretation of Chang and Julesz's (1984) study. Chang and Julesz actually investigated the cooperative processes involved in detecting apparent motion in random-dot cinematograms, a *global* percept. The task used in their experiments is in fact quite similar to one that has recently been shown to require the neuronal output of magno-rich MT (Newsome & Wurtz 1988).

Finally, the assertion by Bryden & Underwood that visual details are more important in near vision than in far vision is without an ecological basis. Precise spatial information is not only unnecessary in performing most visually guided limb movements in peripersonal space; it is probably *nonavailable* as well. The movement of the arm in space is far too rapid (not to mention diplopic) to allow for the perception of local details, as evidenced by the tremendous degradation of high-frequency spatial contrast sensitivity at high temporal velocities (Kelly 1977).

### 1.3. Spatial coordinate systems

Recent evidence from visual neglect and neurophysiological studies indicates that multiple spatial coordinate systems are used by the primate visual system in performing various visuomotor tasks (see section 2.5 of the target article). The exact nature and functions of these different coordinate systems remain unclear, however. I originally argued that egocentric (head- and/or body-centered) systems are used by the dorsal pathways to achieve precise visuomotor coordination in peripersonal space, whereas the ventral system employs an oculocentered (retinotopic) one in its scanning of extrapersonal space. Upper-lower differences could then be expressed in terms of *visual spaces* using the former coordinate system and in terms of *visual fields* using the latter one. This argument attempted to explain why visual neglect – which is at least partially framed in egocentric spatial coordinates since it occurs even when free eye movements are permitted – is most frequently found in the lower as opposed to upper visual quadrants.

Although Strong seems to have accepted this view to some extent, Butter raises the possibility that processing superiorities in both vertical hemifields are framed more in terms of body(hemi) space rather than retinal space. Butter's view is partially confirmed by the deficit found in Heilman et al.'s temporal-lobe patient, who apparently exhibited the classic symptoms of visual neglect in *upper, far* visual space. The presence of a body-centered coordinate system in the temporal lobe could also explain why hemispatial neglect can be expressed ideationally – i.e., in the patient's imaging of extrapersonal space (Bisiach et al. 1979), which involves primarily the ventral cortical pathway (Goldenberg et al. 1989). Conversely, the visual neglect manifested by parietal patients clearly includes both space-specific and field-specific components (Kooistra & Heilman 1989), in line with evidence that both head-centered and oculo-centered coordinate frames may be used by parietal neurons (Andersen et al. 1985).

The best conclusion at this time is that each cortical pathway maintains both types of coordinate frames, although the egocentric one may be weighted more heavily by the dorsal system and the retinotopic one by the ventral pathway. The ease with which the primate brain continuously integrates the outputs of body, head, ocular, and even attentional coordinates (since our atten-

tion is not always yoked to our eye and limb positions) into a unified representation of three-dimensional visual space arguably represents one of its greatest achievements (as well as greatest mysteries!). As Abrams pointed out, much of this integration must lie outside conscious awareness, given the relatively poor visual localization performance of our verbally mediated perceptual system.

## 2. Issues related to LVF-UVF behavioral findings

Most commentators acknowledged that processing in the vertical hemifields is probably not identical. Crewther and Young perhaps reflected the majority opinion in arguing that the data provide more support for specific LVF advantages than for UVF ones. But Findlay raises the more general question as to why LVF-UVF processing differences, even when reliably present, are apparently so slight. The obvious reply is that such differences are minimized by the fact that (a) the vertical hemifields align only partially and asymmetrically with near and far visual space, (b) the segregation of near and far visual space is itself somewhat imperfect, and (c) the visual processing differences in peripersonal and extrapersonal space are offset to a great extent by the large amount of common processing performed in these two sectors.

The proposed specializations of LVF processing remain unchallenged, for the most part. Bryden & Underwood suggest that the case for a LVF global processing advantage could be greatly strengthened if some of the paradigms used to evaluate left-right differences in local versus global perception could also be applied to the investigation of LVF-UVF differences, a point with which I certainly agree. Although Chalupa & White claim that the failure to find differences in velocity judgments between the LVF and UVF casts doubt on the interpretation of other LVF motion superiorities, it is not clear whether the study in question (Smith & Hammond 1986) involved global or local motion processing. Finally, Bruce & MacAvoy claim that the LVF superiority in pursuit initiation has not been found in monkeys, but their interpretation of Lisberger and Pavelko's (1989) study is somewhat incorrect. While the greater ocular acceleration to LVF pursuit targets was less dramatic in monkeys than in humans, Lisberger and Pavelko's results did point to a LVF bias in the late interval of pursuit initiation to targets located *along the vertical meridian*. As stated by the authors, "target motion in the inferior visual field was consistently more effective at initiating pursuit than was motion in the superior visual hemifield." (Lisberger & Pavelko 1989, p. 181) As for Bruce & MacAvoy's claim that the ventral portion of the frontal eye fields is involved in pursuit control, it should be noted that pursuit gains in frontally lesioned monkeys are apparently most reduced for targets moving at low velocities (Lynch 1987, Table 1). This finding points to the specialization of the frontal pursuit system for processing distant (i.e., slower-moving) targets.

One commentator (Osaka) provides further support for the superiority of the LVF in manual RT performance. Osaka not only further documented the LVF RT latency advantage (~ 10–20 msec in his study), but also argued that the additional latency decrement for stimuli presented in the lower temporal visual field relates to the fact that

this region processes information from the monocular region of the LVF periphery, in which the arm commences its motion during reaching. His interpretation would, of course, mesh nicely with that offered in section 2.2 of the target article.

The largest group of comments concerned the proposed specialization of the UVF for visual search and saccadic scanning. Some commentators alluded to negative findings in this regard (e.g., Findlay & Harris 1984 and Mishkin & Forgays 1952, both cited by Bryden & Underwood; and Krose & Julesz 1989, cited by Branman), but such findings must be interpreted with considerable caution. Findlay himself not only acknowledges the UVF saccadic bias in his commentary but cites evidence (Findlay 1980, Levy-Schoen 1969) that further supports it. Also, Krose and Julesz's target recognition experiments used target and distractor stimuli that were subjected to varying amounts of frontal-plane rotation, a situation not normally found in extrapersonal space. Furthermore, Krose and Julesz included only two subjects in their experiments, one of whom actually showed a slight UVF bias in some conditions (see their Figure 2).

I believe it can be tentatively concluded that a UVF saccadic latency advantage does exist. At least four studies have clearly documented such a superiority (Hackman 1940; Heywood & Churcher 1980; Levy-Schoen 1969; Miles 1936), while one researcher (Findlay 1980) found a nonsignificant UVF advantage and another obtained the UVF latency bias in unpublished findings (P. Hallett, personal communication). By contrast, only one published study has reported even a marginally nonsignificant LVF advantage (Miller 1969). Additional small-scale experiments involving a substantial number of subjects and controlling for or manipulating various stimulus parameters (including the size and eccentricity of the target) are clearly mandated, however.

There also appears to be a greater involvement of the UVF in saccadic search and scanning. In addition to the findings cited in the target article, those of Brandt (1945) and Hall (1985) – both cited by Bryden & Underwood – reinforce the conclusion that visual search commences in the upper quadrants, whereas a study that was published after the completion of the target article further documents the UVF bias in target recognition performance (Yund et al. 1990). At least two observations should be made concerning the former tendency. First, its alleged presence in preschool children (Hall 1985) and non-human species (see Breitmeyer) indicates that it is probably not a trivial consequence of the top-to-bottom reading experience in Western cultures. Second, Bryden & Underwood's use of the "global" precedence effect in perception (Navon 1977) to infer the spatial direction of visual search is highly misleading, as I consider visual search to be primarily a "local" process. Bryden & Underwood's position is especially tenuous given that not all findings concerning the lateral pattern of visual search suggest a uniform left → right gradient (and hence a global → local progression). While most research supports the notion that scanning begins in the upper left quadrant and proceeds rightward in the UVF, the scanning direction in the LVF is less agreed upon, compare Brandt (1945) and Chedru et al. (1973). Moreover, Hall's (1985) results question whether even UVF scanning always commences on the left.

In summary, the evidence for a specific role of UVF processing in visual search and scanning continues to mount. Bruce & MacAvoy's reported bias of frontal eye-field saccade neurons toward the UVF – albeit based on the limited sampling of Bruce et al. (1985) – confirms the results of frontal eye-field stimulation experiments in humans (see Godoy et al. 1990) and provides the first glimpse of a possible neuronal correlate of this link.

### 3. Neurophysiological issues

#### 3.1. Retinal LVF-UVF differences

Recent evidence concerning the greater density of somatostatin-stained fibers in the inferior (UVF) retina is cited by both Williams and Chalupa & White. This intriguing finding represents the first evidence of a specific retinal bias favoring the inferior retina, although it does not appear to be limited to primates. The greater somatostatin staining in the ventral retina has been linked to both luminance and color processing (Sagar & Marshall 1988), but the relatively poor luminance sensitivity of the inferior retina and the lack of trichromatic vision in nonprimate species that also show the somatostatin asymmetry render both of these interpretations somewhat problematic.

For unstated reasons, Williams dismisses previous findings of a higher ganglion cell density across the superior retina (Perry et al. 1984; Van Buren 1963) as well as the rod-cone-density asymmetry reported by Osterberg (1935). I find these findings quite convincing, even though their presence in other species makes them difficult to interpret within the context of the origins of primate vision. Since there still exists no evidence of a specific difference between parvo ( $\beta$ ) and magno ( $\alpha$ ) ganglion cells in their vertical distributions, it remains unclear whether the LVF-UVF asymmetries observed at the retinal level in any way relate to those observed in the higher-order visual cortical regions.

#### 3.2. Magno-parvo differences

My synopsis concerning the distinctions between magnocellular and parvocellular processing in the primate LGN received little mention. Kinsbourne & Duffy continue to maintain that the fundamental spatial distinction between the two systems involves the central and peripheral biases of the parvo and magno systems, respectively, yet they offer no new empirical evidence. As I argued in the target article, there probably does exist a slight difference in the mean retinal eccentricity of the two cell types, but the marginally more uniform retinal distribution found in the magno layers cannot justify the postulation of a basic central-peripheral dichotomy.

In the context of the magno-parvo differences, I again note the very similar theoretical analysis put forth by Pettigrew and Dreher (1987). Building upon a previous view of Levick (Levick 1977, cited in Pettigrew & Dreher 1987), these researchers postulated a greater role of the X- and Y-systems of cats in far and near vision, respectively. Since Y-type cells are confined exclusively to the magno layers in primates whereas X-cells are biased toward the parvo layers (see section 3.1 of the target article), an extension of Pettigrew and Dreher's analysis to primates would predict that the magno layers mediate

transient visual processing in both the near and far sectors of visual space, whereas the parvo layers contain neurons involved only in far vision (including the plane of fixation).

### 3.3. Dorsal-ventral differences

This analysis appears to have generated more controversy than any other section of the target article. For the most part, the criticisms concerned the portrayal of neuronal visual processing in the dorsal visual system. At least one minor criticism (noted by **Bracewell, Bruce & MacAvoy, and Siegel**) was valid, as evidence of parietal neuronal involvement in a head-centered coordinate system has indeed been found only at the population level so far (see Andersen et al. 1985). Conversely, two other minor criticisms of my characterization of ventral neuronal functioning were without justification. Contrary to Bruce & MacAvoy's assertion, I clearly stated in the target article (section 3.3.1) that no evidence of an UVF bias among inferotemporal receptive fields has yet been reported. I also noted (section 3.1) that the parvo system probably sends a balanced projection to areas V3 and VP, which runs counter to Crewther's suggestion.

**Bruce & MacAvoy** dispute the evidence that neuronal receptive fields in posterior parietal cortex are biased toward the LVF. They claim that the data contained in Figure 8 of the target article (reprinted from Robinson et al. 1978) do not unequivocally demonstrate the existence of a LVF bias, but it should be emphasized that Robinson et al. themselves mentioned the parietal LVF bias in their article. As regards Bruce & MacAvoy's interpretation of Mountcastle et al.'s (1984) findings about the vertical distribution of PP neuronal fields, Mountcastle himself writes that "we have always had the impression that the lower fields are more intensely represented, but we could never prove it because our equipment . . . is all placed in such a way as to make it difficult to examine the lower fields as extensively as we would like." (V. Mountcastle, personal communication) Finally, a LVF bias in area PP would clearly be expected by virtue of the fact that area MT – whose map is dramatically skewed toward the LVF based on an extensive sampling of almost its entire territory (Maunsell & Van Essen 1987, Figure 8) – provides PP indirectly (via area MST) with its major source of visual input (Maunsell & Newsome 1987).

The putative lack of involvement of dorsal system neurons in spatial localization and saccadic eye movements was challenged by **Bracewell, Marsolek, and Siegel**, who all argued that parietal neurons do exhibit, at least at the population level, the resolution required for saccadic localization in extrapersonal space. Several points can be raised in a rebuttal of their position, however. First, the "one-degree" resolution limit cited by Siegel is based on a theoretically derived population model that has yet to be empirically tested, as Zipser and Andersen (1988) concede. Second, even a one-degree resolution capability is hardly impressive, and more than anything else serves to confirm the tremendous loss of high-frequency spatial vision that follows isolation of the magno system (which projects to area 7a). Third, the major issue should not be whether or not most saccadic movements in extrapersonal space are greater than the one-degree limit but whether or not such resolution is adequate for *processing the details of objects that require scanning in extrapersonal space*. For example, if pri-

mates can only detect a monkey at ten meters with a one-degree resolution (to use Siegel's example), how could the dorsal system detect a particular fruit object or determine its edibility at such a modest distance? Fourth, the entire resolution issue is largely moot in that only a small fraction of area 7a neurons are responsive prior to saccadic eye movements, as Bracewell concedes. Although this is not as true of neurons in area LIP, this latter parietal area is less clearly linked to the "classical" dorsal system leading from MT → MST → 7a (Maunsell & Newsome 1987). Moreover, LIP's involvement in saccadic eye movements does not automatically entitle it to be considered a voluntary extrapersonal scanning center, since many saccadic mechanisms are reflexive or orientational in nature – e.g., the "express" saccade system (see Fischer & Breitmeyer 1987) and the peripheral one located in dorsolateral prefrontal cortex (see Bruce 1988). Rather, the head-centered coordinate system associated with area LIP suggests that it is probably *not* involved in the voluntary scanning of complex scenes, which remains largely intact following parietal damage (Karpov et al. 1968).

Many commentators, (**Breitmeyer, Crewther, Kinsbourne & Duffy, and Siegel**) continue to assign to the dorsal system a role in processing optical flow information. If one views "optical flow" in the generic sense (such as the optical flow fields resulting from a head movement in space), then I agree with Siegel that many neurons in the dorsal system probably engage in some sort of flow analysis. My specific objection is to the frequently espoused view that the classical dorsal system (and especially area 7a) is critically involved in the processing of optical flow information during locomotion, which would obviously conflict with its emphasis on peripersonal space. I originally offered what I considered to be five reasonably compelling arguments as to why the global motion analyses performed by area 7a neurons are probably not related to visually guided locomotion. Although I may have overstated some of the arguments, the basic conclusion remains valid. As but one example, Siegel's observation that a more even distribution of centrifugal and centripetal opponent-vector neurons exists than was found by Steinmetz et al. (1987) remains incompatible with the fact that radial flow patterns during locomotion are *almost exclusively expanding* (i.e., centrifugal). By contrast, a balanced distribution of radial flow processing is exactly what would be expected if such neurons were primarily involved in monitoring the *outward and inward* movement of the arm in peripersonal space.

Some of Siegel's other concerns (e.g., the bias of dorsal neurons toward crossed disparities) are more legitimately based on the dearth of definitive findings on the subject.<sup>3</sup> His criticism of my statement that opponent-motion never occurs during forward locomotion is also partly accurate, in the sense that opposite flow does occur for images that are in front of versus behind the fixation point. Until it can be shown to what extent observers actually maintain a near or intermediate optical focus during terrestrial locomotion, however, I remain convinced that primarily *common image motion* (with relative translation) is experienced as a consequence of forward locomotion. As to whether the maximum extent (~ 40 degrees) of area 7a neuronal fields is sufficient to process optical flow information, the fact that the functional field-of-view for main-

taining visual orientation extends well beyond 100 degrees (Dichgans & Brandt 1978) indicates that area 7a is at least *insufficient* for this purpose. Rather, I continue to hold that dorsomedial posterior parietal cortex – which lies much closer anatomically to the lower limb projection region in somatosensory cortex and whose extremely large receptive fields are ideal for analyzing motion flow across the entire visual field – will eventually be disclosed as the critical processing center for radially expanding flow information resulting from forward locomotion. In the meantime, I await the outcome of a good “ecological” test of the competing positions – namely, the stimulation of area 7a opponent-vector neurons with the image of the animal’s hand and arm during reaching in front of the fixation point versus an equivalently sized optical looming pattern presented at optical infinity.

Finally, I wish to dispute the neurophysiological arguments presented by Bruce & MacAvoy, Kinsbourne & Duffy, and Marsolek in favor of other previous dorsal-ventral dichotomies, especially that of Ungerleider and Mishkin (1982). Although I acknowledged in the target article that the dorsal and ventral systems do differ somewhat along the central/peripheral dimension, such differences are overshadowed by the tremendous overlap of their neuronal receptive field locations in two-dimensional space. Area 7a neuronal fields, for example, rarely extend beyond 40 degrees in diameter (Andersen et al. 1985) and, in most cases, overlap the foveal region.<sup>4</sup> This accords with (a) the well-documented role of the dorsal pathway in foveal pursuit, and (b) the sharp demarcation of the parietal neglect phenomenon, such that even foveal vision in the contralateral visual field is typically affected (see Fig. 4 of the target article). By comparison, the average IT field extends ~ 25 degrees in diameter and is variably centered anywhere from directly on the fovea to *as far as 12 degrees off-center* (Gross et al. 1972, Fig. 3). Thus, the assumption of Marsolek that IT fields are “almost always found on the fovea” is rather misleading, which in turn casts doubt on the validity of the computationally derived support for the notion that the dorsal system is a “spatial” processor and the ventral one an “object” processor.

In fact, the parietal lobe is only a spatial processor to the extent that left-right confusions, inability to perceive object rotation, inattention to certain portions of the visual field, and other symptoms of an impaired egocentric/peripersonal attentional system seriously degrade overall spatial perception (see Crowne et al. 1989). The ability of parietal patients to recall accurately the configuration of *extrapersonal space* often remains remarkably intact, as illustrated by one of Brain’s (1941) patients:

... When she set out for the bathroom she arrived at the lavatory, which was a door on the right, and when she tried to go to the lavatory she made a similar mistake, took a turning to the right and got lost again. Yet when she was asked how she would find her way to the bathroom, the door of which was on the left at right angles outside her bedroom door, she replied. ‘I should go first to the cupboard in which my husband keeps his clothes.’ (This was near the bedroom door.) ‘Then I should open the bedroom door and outside would be where the coats are hung up. I should then look for the electric light switch which is outside the bathroom,

because the Borough Council won’t allow it inside, and I should then find the bathroom and the bath would be in it.’ *Thus she clearly visualized the landmarks of the correct route* (emphasis added). When asked to describe how she would find her way from the tube station to her flat she described this in detail correctly and apparently visualizing the landmarks, but she consistently said right instead of left for the turnings except on one occasion. (Brain 1941, p. 259)

### 3.3. Neuropsychological issues

There were relatively few specific comments that directly disputed the neuropsychological evidence and interpretation presented in the target article. Strong raised the general issue of whether “phenomenological unity” need require a particular type of localization in the brain. If the brain operated strictly in a distributed fashion (i.e., as a “physical mind”), then Strong’s argument would carry more weight. In reality, the brain is a biological organ with an evolutionary history (that aligned both the lower-body somatosensory and LVF representations in the dorsal half of the posterior brain) and physiological constraints (transmission time, noise, etc.). I argue that the basic partitioning of the primate brain, to the extent that it exists, should be related to some primordial attribute of the visual environment that maximizes parallel processing of information located in different sectors of space, different spatiotemporal domains, or different visuomotor coordinate frames. It would be extremely inefficient for the brain to engage in parallel processing of within-object and between-object perception, which occur in the same sector of space (extrapersonal), involve similar types of processing (local contour analysis), and use the same visuomotor coordinate system (oculo-centered). It would be even less efficient to assign neuronal “double-duty” for near and far visual stimuli that occur in different depth regions (whose switching time is at least 100 msec), require antagonistic spatiotemporal processing capabilities (local/sustained vs. global/transient), and are largely framed in different coordinate systems (body- vs. oculo-centric).

A more specific disagreement with Strong relates to his acceptance of the view that parietal processing is oriented more toward “allocentric” than “egocentric” space. The predominant opinion of researchers today is unquestionably that *parietal cortex is critical for the neural representation of egocentric space* (see Stein 1989). As Mountcastle states:

The parietal lobe, together with the distributed system of which it is a central node, generates an internal neural construction of immediately surrounding space, of the location and movements of objects in it in relation to body position, and of the position and movements of the body in relation to that immediately surrounding space. (Butter et al. 1989, p. 145)

In contrast, evidence favoring the involvement of parietal cortex in the representation of allocentric space remains highly equivocal. While some findings involving the “landmark” problem and similar tasks (Ungerleider & Mishkin 1982) provide support for Strong’s notion, there have been several failures to replicate these findings when lesions are limited to the inferior parietal lobe itself (see Lynch 1980). It is not clear, moreover, what effect left-right confusions and other egocentric factors have on

supposedly "allocentric" tasks, since such tasks have traditionally required *manual* responses on the part of the animal.

I also disagree with Strong's suggestion that the parietal lobe is crucial for perceiving feature-conjunctions. His view conflicts with a large body of evidence that points to a role of inferior temporal cortex in such activity (see Harter & Aine 1984). It would be most surprising if the temporal lobe were heavily involved in most aspects of object perception (which almost everyone, including myself, acknowledges) yet not responsible for performing the very processing that is essential for the integration of features into complex form percepts.

The commentaries yielded one new neuropsychological finding - that of Heilman et al., who documented the existence of UVF/far visual neglect following bilateral inferior temporal lobe damage. The importance of this finding for the present theory cannot be overstated, as the postulated relationship between the temporal lobe and far vision and the UVF represented perhaps its weakest link, given that no direct evidence supported it and no previous conceptualization had ever entertained it. Heilman et al.'s finding, though preliminary, provides the first direct empirical support for the role of the inferior temporal lobes in far vision, although it has long been recognized that abnormal temporal-lobe activity in epilepsy and schizophrenia can lead to an aberrant emphasis on far "psychological" space (e.g., hallucinations, grandiose themes and delusions, distorted body-images). Heilman et al.'s finding also counters Kinsbourne & Duffy's claim that the relationship between higher-order ventral processing and the UVF need not require a specific involvement of the temporal lobes in far vision. However, Kinsbourne & Duffy's "distance principle" can be challenged on other grounds as well, in that *anatomical* proximity (i.e., the inferior temporal lobe is closer to the inferior/UVF than the superior/LVF occipital cortex) does not necessarily translate into *neural* proximity (i.e., the inferior temporal lobes apparently receive a balanced projection from the inferior and superior occipital regions).

Finally, I agree with Bryden & Underwood that a general theory of the neuropsychology of human visual perception must ultimately be able to account for differences in the way the two hemispheres process local versus global information. Although I briefly noted in the target article (section 4.1) that hemispheric differences in global and local processing probably exist, a more extensive treatment of this topic is found in a companion theoretical article (Previc, in preparation). The most plausible scheme based on current evidence is that the left temporal lobe and right parietal lobe are most adept at processing local and global information, respectively, while the left parietal and right temporal lobe occupy more intermediate positions along this processing dimension. Partial neuropsychological support for such a notion has recently been provided by Robertson et al. (1988).<sup>5</sup>

#### 4. Comparative Issues

The final set of issues that evoked a large number of commentaries pertained to the differentiation of near-far and LVF-UVF processing in nonprimate species. Judg-

ing from the various commentaries, as well as the findings of Pettigrew and Dreher (1987), the distinction between near and far vision may be useful in understanding the physiology of many, if not most, vertebrate visual systems. It is also clear that certain specializations previously regarded as limited to primates (such as the presence of "face-neurons" in the anterior temporal lobe) can be found in other species (see Bracewell).

Goodale & Graves provide intriguing evidence of a division in the pigeon visual system that resembles that of the primate. While a parallel exists in that the near visual field is biased toward the LVF in both species, there also appear to be certain differences between the partitioning of the two visual systems. For one, the far visual field in primates is clearly binocular, as neurons in the ventral system are precisely tuned to binocular disparity (Felleman & Van Essen 1987). In many respects, therefore, the monocular far field of pigeons may actually resemble more closely the *visual background* field of primates, which I have previously shown to be divorced from the *far attentional* field. Another difference relates to the more important role of monocular information in peripersonal visual functioning in primates. For example, the visual registration of the initial position and motion of the arm during reaching begins in the monocular portion of the peripheral visual field in primates, although binocular vision (and especially crossed-disparity information) is obviously of great importance in primate peripersonal space.

Williams claims that LVF-UVF asymmetries in the early stages of mammalian visual processing may actually be greater in other species than in primates. As noted earlier, however, he unwarrantedly dismisses the clear evidence of ganglion cell density differences put forth by Perry et al. (1984) and Van Buren (1963). A more accurate assessment would probably be that LVF-UVF retinal asymmetries are highly similar across most mammalian species, and probably stem from a factor - possibly evolutionary - that is common to each (e.g., the luminance gradient from sky to ground). On the other hand, I certainly agree with Williams's suggestion (3) that one should expect to find the most striking evidence of primate-specific vertical asymmetries in those areas beyond area 17, since higher cortical regions are much more likely to be influenced by the primate's behavioral experiences in its three-dimensional visual world. This is not to say that magno-parvo vertical asymmetries will not eventually be found in area 17, or even at subcortical levels. After all, the evidence obtained to date can hardly be described as definitive.

In summary, the differentiation of near and far space in the primate somewhat parallels that found in many other species. However, some species (e.g., avians) have excellent far vision but more limited near vision, whereas others (e.g., the nocturnal mammals) may be much more adept in the processing of information found in peripersonal than in far visual space. The remarkable achievement of primate evolution has been to assemble an impressive command of far visual space with an extremely sophisticated peripersonal visuomotor capability.



## 5. A prolegomenon to a future visual science

I conclude that my theory concerning the divergence of near and far vision in the primate and its implications for the partitioning of the higher brain pathways remains quite tenable. This theory has built carefully upon previous neurophysiological and ecological conceptualizations and has marshalled a substantial amount of diverse evidence in its favor, some of which is by now virtually unassailable (e.g., the greater LVF impairment in parietal neglect).<sup>6</sup> At the very least, this theory deserves a status beyond the "premature" one implicitly accorded it by Bryden & Underwood.

In emphasizing the importance of the individual's ecological visuomotor interactions in three-dimensional space, this theory has tried to clarify several emerging lines of thought about how the human brain processes visual information. Many of these conceptual elements – including multiple coordinate systems, three-dimensional attention, altitudinal neglect, disparity pools, etc. – are still in their infancy, as only scattered references have been made to them until recently. Hence, this theory's main contribution is to point out some of the guideposts for future researchers to follow in their efforts to unlock the secrets of three-dimensional visual processing in the human brain. No longer can visual cortical physiology remain in the province of dorsal V1, nor can spatial vision continue to be relegated to processing along the horizontal meridian. Nor can disorders such as teleopsia and pelopsia ("nearness") remain largely neglected by visual neuropsychologists, given that good objective techniques (e.g., tactile bisection and "dark focus") now exist for measuring the sagittal distance of patients' attentional and optical foci. Nor should it be considered proper in the future to refer to a neuron in such nonecological terms as "opponent-vector" when it may respond just as well, if not better, to the reaching movement of the arm in three-dimensional peripersonal space. Nor should researchers continue to see the conservative hand of evolution directing the development of every higher-order perceptual mechanism, when the posterior parietal cortex and other brain areas that house such mechanisms are almost entirely dependent on visual experience for their specific development (Hyvarinen 1982, Chapter XIc).

The maturation of a three-dimensional visual science will inevitably lead to revision or abandonment of many of this theory's specific tenets. As a general theory, however, its legacy will, one hopes, endure much longer.

### NOTES

1. I regret that I was not made aware of Pettigrew and Dreher's article until after the target article was submitted for commentary.

2. As Dolezal points out, the perceived nearness (and associated micropsia) of objects in his experiments was probably also due to the effect of the occluding tube's frame in drawing vergence closer.

3. Dr. G. Poggio recently informed me, however, that a crossed-disparity bias exists among the disparity-sensitive neurons located in the dorsal (LVF) portion of area V1, so a similar crossed-disparity bias in the LVF-dominated higher magno structures remains extremely likely.

4. The claim of Kinsbourne & Duffy that MST fields are "often more than 100 degrees in diameter" is highly overstated. Not only did Komatsu and Wurtz (1988) record only a small

number of MST cells whose diameter exceeded 40 degrees, but their *maximum* visual screen diameter was only 80 × 66 degrees. Furthermore, the average neuronal receptive field diameter in area MT rarely exceeds 20 degrees (Komatsu & Wurtz 1988, Fig. 3; Maunsell & Van Essen 1987, Fig. 2), and is typically centered less than 20 degrees from the midline.

5. See also Yund et al.'s (1990) data concerning target recognition in the four frontal-plane quadrants.

6. Additional findings in support of a LVF neglect bias are presented in a recent paper by Halligan and Marshall (1989) that appeared too late to be included in the target article.

## References

Letters "a" and "r" appearing before authors' initials refer to target article and response respectively.

- Abrams, R. A. & Landgraf, J. Z. (in press) Differential use of distance and location information for spatial localization. *Perception & Psychophysics*. [RAA]
- Abrams, R. A., Meyer, D. E. & Kornblum, S. (1989) Speed and accuracy of saccadic eye movements. Characteristics of impulse variability in the oculomotor system. *Journal of Experimental Psychology: Human Perception and Performance* 15:529–43. [RAA]
- (in press) Eye-hand coordination. Oculomotor control in rapid aimed limb movements. *Journal of Experimental Psychology: Human Perception and Performance*. [RAA]
- Adler-Grinberg, D. & Stark, L. (1978) Eye movements, scanpaths, and dyslexia. *American Journal of Optometry and Physiological Optics* 55:557–70. [aFHP]
- Aiple, F. & Kruger, J. (1989) The brain is an input driven neural network. Connectivity analysis of monkey visual cortex by cross correlating spike trains. In: *Neural networks from models to applications*, ed. L. Personnaz & G. Dreyfus. IDSET. [GWS]
- Albert, M. L., Soffer, D., Silverberg, R. & Reches, A. (1979) The anatomic basis of visual agnosia. *Neurology* 29:876–79. [aFHP]
- Albright, T. D. & Desimone, R. (1987) Local precision of visuotopic organization in the middle temporal area (MT) of the macaque. *Experimental Brain Research* 65:582–92. [RMS]
- Allman, J. (1977) Evolution of the visual system in the early primates. *Progress in Psychobiology and Physiological Psychology* 7:1–53. [aFHP, RMS]
- (1983) Variations in visual cortex organization in primates. In: *Neurobiology of neocortex*, ed. P. Rakic & W. Singer. Wiley & Sons. [aFHP]
- Allman, J., Miezin, F. & McGuinness, E. (1985) Direction- and velocity-specific responses from beyond the classical receptive field in the middle temporal visual area (MT). *Perception* 14:105–26. [aFHP]
- Andersen, R. A. (1987) Inferior parietal lobule function in spatial perception and visuomotor integration. In: *Handbook of physiology*, vol. 5, part 2, ed. V. B. Mountcastle, F. Plum & S. R. Geiger. American Physiological Society. [aFHP]
- (1988) Visual and visual-motor functions of the posterior parietal cortex. In: *Neurobiology of neocortex*, ed. P. Rakic & W. Singer. Wiley & Sons. [aFHP]
- Andersen, R. A., Bracewell, R. M., Barash, S., Fogassi, L. & Ginadt, J. W. (in press) Eye position effects on visual, memory and saccade-related activity in areas LIP and 7a of macaque. *Journal of Neuroscience*. [RMB]
- Andersen, R. A., Essick, G. K. & Siegel, R. M. (1985) Encoding of spatial location by posterior parietal neurons. *Science* 230:456–58. [aFHP, RMB, CJM, RMS]
- Anderson, S. J., Mullen, K. T. & Hess, R. F. (1989) Asymmetry in the retina for motion and colour detection. *Investigative Ophthalmology & Visual Science* 30:53 (Supplement). [aFHP]
- Anstus, S. M. (1978) Apparent movement. In: *Handbook of sensory physiology*, vol. 8, ed. R. Held, H. W. Leibowitz & H.-L. Teuber. Springer-Verlag. [aFHP]
- Badcock, D. & Lovegrove, W. (1981) The effects of contrast, stimulus duration, and spatial frequency on visible persistence in normal and specifically disabled readers. *Journal of Experimental Psychology: Human Perception and Performance* 7:495–505. [aFHP]
- Bahill, A. T., Adler, D. & Stark, L. (1975) Most naturally occurring human saccades have magnitudes of 15 degrees or less. *Investigative Ophthalmology* 14:468–69. [aFHP]
- Barbeito, R., Bedell, H. E., Flom, M. C. & Sumpson, T. L. (1987) Effects of

- luminance on the visual acuity of strabismic and anisometric amblyopes and optically blurred normals. *Vision Research* 27:1543-49. [aFHP]
- Barbour, C. G. & Coss, R. G. (1988) Differential color brightness as a body orientation cue. *Human Factors* 30:713-17. [aFHP]
- Barlow, H. B. (1986) Why have multiple cortical areas? *Vision Research* 26:81-90. [RMB]
- Barlow, H. B. & Levick, W. R. (1965) The neural mechanism of directionally selective units in the rabbit's retina. *Journal of Physiology (London)* 178:477-508. [RMB]
- Barlow, J. S. (1970) Vestibular and non-dominant parietal lobe disorders in man. (Two aspects of spatial disorientation in man.) *Diseases of the Nervous System* 31:667-73. [aFHP]
- Bender, M. B. (1980) Brain control of conjugate horizontal and vertical eye movements. A survey of the structural and functional correlates. *Brain* 103:23-69. [aFHP]
- Bender, M. B. & Feldman, M. (1972) The so-called "visual agnosias." *Brain* 95:173-86. [aFHP]
- Bender, M. B., Feldman, M. & Sobin, A. J. (1968) Palinopsia. *Brain* 91:321-38. [aFHP]
- Bender, M. B. & Furlow, L. T. (1945) Phenomenon of visual extinction in homonymous fields and psychologic principles involved. *Archives of Neurology and Psychiatry* 53:29-33. [aFHP]
- Benton, A. L., Levin, H. S. & Van Allen, M. W. (1974) Geographic orientation in patients with unilateral cerebral disease. *Neuropsychologia* 12:183-91. [aFHP]
- Berkley, W. L. & Bussey, F. R. (1950) Altitudinal hemianopia: Report of two cases. *American Journal of Ophthalmology* 22:593-600. [aFHP]
- Bishop, A. (1962) Control of the hand in lower primates. *Annals of the New York Academy of Sciences* 102:316-37. [aFHP]
- Bisiach, E. & Luzzatti, C. (1978) Unilateral neglect of representational space. *Cortex* 14:129-33. [RMB]
- Bisiach, E., Luzzatti, C. & Perani, D. (1979) Unilateral neglect, representational schema and consciousness. *Brain* 102:609-18. [RMB, rFHP]
- Blakemore, C. & Vital-Durand, F. (1986) Organization and post-natal development of the monkey's lateral geniculate nucleus. *Journal of Physiology* 330:453-91. [aFHP]
- Blasdel, G. G. & Fitzpatrick, D. (1984) Physiological organization of layer 4 in macaque striate cortex. *Journal of Neuroscience* 4:880-95. [aFHP]
- Blasdel, G. G. & Lund, J. S. (1983) Termination of afferent axons in macaque striate cortex. *Journal of Neuroscience* 3:1369-1413. [aFHP]
- Bogacz, J., Mendilaharsu, C. & De Mendilaharsu, S. A. (1974) Electro-oculographic abnormalities during pursuit movements in developmental dyslexia. *Electroencephalography and Clinical Neurophysiology* 36:551-56. [aFHP]
- Bonnet, C. (1987) Les temps de traitement dans la perception visuelle des formes. In: *Psychologie cognitive. Modèles et méthodes*, ed. J. P. Caverni, C. Bastien, P. Mendelsohn & G. Tiberghien. Presses Universitaires de Grenoble. [aFHP]
- Bracewell, R. M., Barash, S., Fogassi, L., Gnadt, J. W. & Andersen, R. A. (1989) Saccade-related activity in the lateral intraparietal cortex of rhesus monkeys. *Perception* 18:514. [RMB]
- Bradshaw, J. L. & Nettleton, N. C. (1983) *Human cerebral asymmetry*. Prentice-Hall. [AWY]
- Bradshaw, J. L., Nettleton, N. C., Pierson, J. M., Wilson, L. E. & Nathan, G. (1987) Coordinates of extracorporeal space. In: *Neurophysical and neuropsychological aspects of spatial neglect*, ed. M. Jeannerod. North-Holland. [aFHP]
- Bradshaw, J. L., Nettleton, N. C. & Taylor, M. J. (1981) Right hemisphere language and cognitive deficit in sinistrals? *Neuropsychologia* 19:113-32. [AWY]
- Bradshaw, J. L. & Sherlock, D. (1982) Bugs and faces in the two visual fields: The analytic/holistic processing dichotomy and task sequencing. *Cortex* 18:211-26. [MPB]
- Bradshaw, M. F., Frisby, J. P. & Mayhew, J. E. W. (1987) The recovery of structure from motion. No evidence for a special link with the convergent disparity mechanism. *Perception* 16:351-57. [aFHP]
- Bran, W. R. (1941) Visual disorientation with special reference to lesions of the right cerebral hemisphere. *Brain* 64:244-72. [KMH, rFHP]
- Braitman, D. J. (1984) Activity of neurons in monkey posterior temporal cortex during multidimensional visual discrimination tasks. *Brain Research* 307:17-28. [aFHP]
- Brandt, H. F. (1945) *The psychology of seeing*. Philosophical Library. [MPB]
- Brandt, T., Wist, E. R. & Dichgans, J. (1975) Foreground and background in dynamic spatial orientation. *Perception & Psychophysics* 17:497-503. [aFHP]
- Brannan, J. R. & Camp, C. J. (1987) Visual processing correlates of adult cognitive development. Paper presented at the Third Beyond Formal Operations Symposium at Harvard. Positive Development During Adolescence and Adulthood, June Cambridge, MA. [JRB]
- Brannan, J. R. & Williams, M. C. (1987) Allocation of visual attention in good and poor readers. *Perception and Psychophysics* 41:23-28. [JRB]
- Bravo, M., Blake, R. & Morrison, S. (1988) Cats see subjective contours. *Vision Research* 28:861-65. [aFHP]
- Breitmeier, B. G. (1980) Unmasking visual masking. A look at the "why" behind the veil of the "how". *Psychological Review* 87:52-69. [aFHP]
- Breitmeier, B., Battaglia, F. & Bridge, J. (1977) Existence and implications of a tilted binocular disparity space. *Perception* 6:161-64. [aFHP, BGB]
- Breitmeier, B., Julesz, B. & Kroffl, W. (1975) Dynamic random-dot stereograms reveal up-down anisotropy and left-right isotropy between cortical hemifields. *Science* 187:269-70. [aFHP]
- Bridgeman, B. (1989) The psychophysics of the pursuit oculomotor system. *Perception & Psychophysics* 46:220-26. [aFHP]
- Bridgeman, B., Lewis, S., Heit, G. & Nagle, M. (1979) Relation between cognitive and motor-oriented systems of visual position perception. *Journal of Experimental Psychology. Human Perception and Performance* 5:692-700. [RAA]
- Brown, B., Haegerstrom-Portnoy, G., Yimghng, C. D., Herron, J., Galin, D. & Marcus, M. (1983) Tracking eye movements are normal in dyslexic children. *American Journal of Optometry and Physiological Optics* 60:376-83. [aFHP]
- Bruce, C. J. (1988) Single neuron activity in the monkey's prefrontal cortex. In: *Neurobiology of neocortex*, ed. P. Rakic & W. Singer. Wiley & Sons. [aFHP]
- Bruce, C. J., Desimone, R. & Gross, C. G. (1986) Both striate cortex and superior colliculus contribute to visual properties of neurons in superior temporal polysensory area of macaque monkey. *Journal of Neurophysiology* 55:1057-75. [CJB]
- Bruce, C. J., Goldberg, M. E., Bushnell, M. C. & Stanton, G. B. (1985) Primate frontal eye fields. II. Physiological and anatomical correlates of electrically evoked eye movements. *Journal of Neurophysiology* 54:714-34. [aFHP, CJB]
- Brvden, M. P. (1982) *Laterality*. Academic Press. [MPB]
- (1982) *Laterality. Functional asymmetry in the intact brain*. Academic Press. [AWY]
- Burkhalter, A., Felleman, D. J., Newsome, W. T. & Van Essen, D. C. (1986) Anatomical and physiological asymmetries related to visual areas V3 and VP in macaque extrastriate cortex. *Vision Research* 26:63-80. [aFHP]
- Burkhalter, A. & Van Essen, D. C. (1986) Processing of color, form and disparity information in visual areas VP and V2 of ventral extrastriate cortex in the macaque monkey. *Journal of Neuroscience* 6:2327-51. [aFHP]
- Bushnell, M. C., Goldberg, M. E. & Robinson, D. L. (1981) Behavioral enhancement of visual responses in monkey cerebral cortex. I. Modulation in posteriorparietal cortex related to selective visual attention. *Journal of Neurophysiology* 46:755-72. [aFHP]
- Butter, C. M. (1969) Impairments in selective attention to visual stimuli in monkeys with inferotemporal and lateral striate lesions. *Brain Research* 12:374-83. [aFHP]
- Butter, C. M., Evans, J., Kirsch, N. & Kewman, D. (1989) Altitudinal neglect following traumatic brain injury. A case report. *Cortex* 25:135-46. [aFHP, CMB]
- Campbell, A., Jr (1978) Deficits in visual learning produced by posterior temporal lesions in cats. *Journal of Comparative and Physiological Psychology* 92:45-57. [aFHP]
- Cappa, S., Sterzi, R., Valla, G. & Bisiach, E. (1987) Remission of hemineglect and anosognosia during vestibular stimulation. *Neuropsychologia* 25:775-82. [aFHP]
- Carlow, T. J., Flynn, J. T. & Shipley, T. (1976) Color perimetry. *Archives of Ophthalmology* 94:1492-96. [aFHP]
- Carron, A., Nachshon, I. & Starinsky, R. (1976) Developmental aspects of visual hemifield differences in perception of verbal material. *Brain and Language* 3:463-69. [AWY]
- Cavanagh, P., Boeglin, J. & Eizner-Favreau, O. (1985) Perception of motion in equilluminous kinematograms. *Perception* 14:151-62. [aFHP]
- Chaikin, J. D., Corbin, H. H. & Volkman, J. (1962) Mapping a field of short-time visual search. *Science* 138:1327-28. [aFHP]
- Chang, J. J. & Julesz, B. (1984) Cooperative phenomena in apparent movement perception of random-dot cinematograms. *Vision Research* 24:1781-88. [JRB, rFHP]
- Chedru, F., Leblanc, M. & Lhermitte, F. (1973) Visual searching in normal and brain-damaged subjects (contribution to the study of unilateral inattention). *Cortex* 9:94-111. [aFHP]
- Clarke, P. G. H. & Whitteridge, D. (1976) The projection of the retina, including the "red area" onto the optic tectum of the pigeon. *Quarterly Journal of Experimental Physiology* 61:351-58. [MAG]

## References/Previc: Visual field specialization

- Cocito, L., Favale, E. & Tartaglione, A. (1977) Asimmetrie funzionali tra emicampo visivo superiore ed inferiore nel soggetto normale. *Bollettino Della Societa Italiana di Biologia Sperimentale* 53:629-33. [aFHP]
- Cogan, A. I. (1979) The relationship between the apparent vertical and the vertical horopter. *Vision Research* 19:655-65. [aFHP]
- Coltheart, M. (1983) Ecological necessity of iconic memory. *Behavioral and Brain Sciences* 6:17-18. [aFHP]
- Connolly, M. & Van Essen, D. C. (1984) The representation of the visual field in parvocellular and magnocellular layers of the lateral geniculate nucleus in the macaque monkey. *Journal of Comparative Neurology* 226:544-64. [aFHP]
- Cowey, A. (1981) Why are there so many visual areas? In: *organization of the cerebral cortex*, ed. F. O. Schmitt. MIT Press. [RMB]
- Critchley, M. (1953) *The parietal lobes*. Hafner. [aFHP, RMB, RMS]
- Crowne, D. P., Dawson, K. A. & Richardson, C. M. (1989) Unilateral periacute and posterior parietal lesions impair conditional position discrimination learning in the monkey. *Neuropsychologia* 27:1119-27. [rFHP]
- Cummings, J. L., Landis, T. & Benson, D. F. (1983) Environmental disorientation: Clinical and radiological findings. *Neurology* 33:103-4. [aFHP]
- Cyander, M. & Regan, D. (1982) Neurons in cat visual cortex tuned to the direction of motion in depth: Effect of positional disparity. *Vision Research* 22:967-82. [aFHP]
- Damasio, A. R. & Benton, A. L. (1979) Impairment of hand movements under visual guidance. *Neurology* 29:170-78. [aFHP]
- Damasio, A. R. & Damasio, H. (1983) The anatomic basis of pure alexia. *Neurology* 33:1573-83. [aFHP]
- Damasio, A. R., Damasio, H. & van Hoesen, G. W. (1982) Prosopagnosia. Anatomic basis and behavioral mechanisms. *Neurology* 32:331-41. [aFHP]
- De Hamsher, K. S. (1978) Stereopsis and unilateral brain disease. *Investigative Ophthalmology & Visual Science* 17:336-43. [aFHP]
- Delis, D. C., Robertson, L. C. & Efron, R. (1986) Hemispheric specialization of memory for visual hierarchical stimuli. *Neuropsychologia* 24:205-14. [aFHP]
- Deregowski, J. B. (1989) Real space and represented space: Cross-cultural perspectives. *Behavioral and Brain Sciences* 12:51-119. [aFHP]
- Derrington, A. M., Krauskopf, J. & Lennie, P. (1984) Chromatic mechanisms in lateral geniculate nucleus of macaque. *Journal of Physiology* 357:241-65. [aFHP]
- Derrington, A. M. & Lennie, P. (1984) Spatial and temporal contrast sensitivities of neurons in lateral geniculate nucleus of macaque. *Journal of Physiology* 357:219-40. [aFHP]
- Desimone, R. & Gross, C. G. (1979) Visual areas in the temporal cortex of the macaque. *Brain Research* 178:363-80. [CJB, MK]
- Desimone, R. & Schein, S. J. (1987) Visual properties of neurons in area V4 of the macaque. Sensitivity to stimulus form. *Journal of Neurophysiology* 57:835-68. [aFHP, MK]
- Desimone, R., Schein, S. J., Moran, J. & Ungerleider, L. G. (1985) Contour, color and shape analysis beyond the striate cortex. *Vision Research* 25:441-52. [aFHP]
- DeYoe, E. A. & Van Essen, D. C. (1988) Concurrent processing streams in monkey visual cortex. *Trends in Neurosciences* 11:219-26. [aFHP]
- Diamond, I. T. & Hall, W. C. (1969) Evolution of neocortex. *Science* 164:251-62. [aFHP, RWW]
- Dichgans, J. & Brandt, T. (1978) Visual-vestibular interaction. Effects on self-motion perception and postural control. In: *Handbook of Sensory Physiology VIII, Perception*, ed. R. Held, H. Leibowitz & H.-L. Teuber. Springer-Verlag [BGB, rFHP]
- DiZio, P. & Lackner, J. R. (1989) Perceived self-motion elicited by postrotary head tilts in a varying gravito-inertial force background. *Perception & Psychophysics* 46:114-18. [aFHP]
- Dolezal, H. (1982) *Living in a world transformed: Perceptual and performatory adaptation to visual distortion*. Academic Press. [NO, rFHP]
- Donovan, W. J. (1978) Structure and function of the pigeon visual system. *Physiological Psychology* 6:403-37. [MAG]
- Drager, U. C. & Hubel, D. H. (1976) Topography of visual and somatosensory projections to mouse superior colliculus. *Journal of Neurophysiology* 39:91-101. [aFHP]
- Drcher, B., Fukada, Y. & Rodieck, R. W. (1976) Identification, classification and anatomical segregation of cells with X-like and Y-like properties in the lateral geniculate nucleus of old-world primates. *Journal of Physiology* 258:433-52. [aFHP]
- Dubner, R. & Zeki, S. M. (1971) Response properties and receptive fields of cells in an anatomically defined region of the superior temporal sulcus in the monkey. *Brain Research* 35:528-32. [MK]
- Duffy, C. J. (1984) The legacy of association cortex. *Neurology* 34:192-97. [MK]
- Duffy, C. J. & Wurtz, R. H. (1989) Radial and axial directionality in cortical visual area MST. *Society for Neuroscience Abstracts* 15:119. [MK, RMS]
- Eckhorn, R., Bauer, R., Jordan, W., Brosch, M., Kruse, W., Munk, M. & Reitboeck, H. J. (1988) Coherent oscillations: A mechanism of feature linking in the visual cortex. *Biological Cybernetics* 60:121-30. [GWS]
- Eichenbaum, H., Wiener, S. I., Shapiro, M. L. & Cohen, N. J. (1989) The organization of spatial coding in the hippocampus: A study of neural ensemble activity. *Journal of Neuroscience* 9:2764-75. [GWS]
- Emmerton, J. (1983a) Functional morphology of the visual system. In: *Physiology and behavior of the pigeon*, ed. M. Abs. Academic Press. [MAG]
- (1983b) Vision. In: *Physiology and behavior of the pigeon*, ed. M. Abs. Academic Press. [MAG]
- Engel, F. L. (1971) Visual conspicuity, directed attention and retinal locus. *Vision Research* 11:563-76. [aFHP]
- Enright, J. T. (1989) Convergence during human vertical saccades. Probable causes and perceptual consequences. *Journal of Physiology* 410:45-65. [rFHP]
- Enroth-Cugell, C. & Robson, J. G. (1966) The contrast sensitivity of retinal ganglion cells of the cat. *Journal of Physiology* 187:517-52. [aFHP, RMB]
- Erichsen, J. T., Hodos, W. R., Evinger, C., Bessette, B. B. & Phillips, S. J. (1989) Head orientation in pigeons: Postural, locomotor, and visual determinants. *Brain, Behavior and Evolution* 33:268-78. [MAG]
- Eviatar, L., Miranda, S., Eviatar, A., Freeman, K. & Borkowski, M. (1979) Development of nystagmus in response to vestibular stimulation in infants. *Annals of Neurology* 5:508-14. [aFHP]
- Feinberg, T. E., Pasik, T. & Pasik, P. (1978) Extrageniculostriate vision in the monkey VI. Visually guided accurate reaching behavior. *Brain Research* 152:422-28. [CJB]
- Felleman, D. J. & Van Essen, D. C. (1987) Receptive field properties of neurons in area V3 of macaque monkey extrastriate cortex. *Journal of Neurophysiology* 57:889-920. [aFHP]
- Fenelon, B., Neill, R. A. & White, C. T. (1986) Evoked potentials to dynamic random dot stereograms in upper, center and lower fields. *Documenta Ophthalmologica* 63:151-56. [aFHP]
- Findlay, J. M. (1980) The visual stimulus for saccadic eye movements in human observers. *Perception* 9:7-21. [JMF, rFHP]
- (1982) Global processing for saccadic eye movements. *Vision Research* 22:1033-45. [JMF]
- (1985) Eye movements and visual cognition. *L'Année Psychologique* 85:101-36. [JMF]
- Findlay, J. M. & Harris, L. R. (1984) Small saccades to double-stepped targets moving in two dimensions. In: *Theoretical and applied aspects of eye movement research*, ed. A. G. Gale & F. Johnson. North-Holland. [MPB, rFHP]
- Finke, R. A. & Kosslyn, S. M. (1980) Mental imagery acuity in the peripheral visual field. *Journal of Experimental Psychology: Human Perception and Performance* 6:126-39. [aFHP]
- Fischer, B. & Boch, R. (1981) Enhanced activation of neurons in prelunate cortex before visually guided saccades of trained rhesus monkeys. *Experimental Brain Research* 44:129-37. [aFHP]
- Fischer, B. & Boch, R. (1985) Peripheral attention versus central fixation. Modulation of the visual activity of prelunate cortical cells of the rhesus monkey. *Brain Research* 345:111-23. [aFHP]
- Fischer, B. & Breitmeyer, B. (1987) Mechanisms of visual attention revealed by saccadic eye movements. *Neuropsychologia* 25:73-83. [rFHP]
- Flom, M. C. & Bedell, H. E. (1985) Identifying amblyopia using associated conditions, acuity, and nonacuity features. *American Journal of Optometry and Physiological Optics* 62:153-60. [aFHP]
- Fox, R. (1982) The effect of depth position on stimulus interaction. In: *Three-dimensional displays: Perceptual research and applications to military systems*, ed. D. J. Getty. National Academy of Sciences. [aFHP]
- Fox, R. & Patterson, R. (1981) Depth separation and lateral interference. *Perception & Psychophysics* 30:513-20. [aFHP]
- Friberg, L., Olsen, T. S., Roland, P. E., Paulson, O. B. & Lassen, N. A. (1985) Focal increase of blood flow in the cerebral cortex of man during vestibular stimulation. *Brain* 108:609-23. [aFHP]
- Friedlander, M. J., Stanford, L. R. & Sherman, S. M. (1982) Effects of monocular deprivation on the structure-function relationship of individual neurons in the cat's lateral geniculate nucleus. *Journal of Neuroscience* 2:321-30. [aFHP]
- Frisby, J. P. (1980) *Seeing, illusion, brain and mind*. Oxford University Press. [RWW]

- Fukuda, T. (1959) Vertical writhing with eyes covered. A new test of vestibulo-spinal reaction. *Acta Oto-laryngologica* 50:26-36. [aFHP]
- Fuster, J. M. & Jervey, J. P. (1982) Neuronal firing in the inferotemporal cortex of the monkey in a visual memory task. *Journal of Neuroscience* 2:361-75. [aFHP]
- Galaburda, A. M., Sherman, G. F., Rosen, G. D., Aboitiz, F. & Geschwind, N. (1985) Developmental dyslexia. Four consecutive cases with cortical anomalies. *Annals of Neurology* 18:222-33. [aFHP]
- Galifret, Y. (1968) Les diverses aires fonctionelles de la retine du pigeon. *Zeitschrift für zellforschung* 86:535-45. [MAG]
- Garraghty, P. E. (1985) Mixed cells in the cat lateral geniculate nucleus. Functional convergence or error in development? *Brain, Behavior and Evolution* 26:58-64. [aFHP]
- Gattass, R. & Gross, C. G. (1981) Visual topography of striate projection zone (MT) in posterior superior temporal sulcus of the macaque. *Journal of Neurophysiology* 46:621-38. [aFHP]
- Gawryszewski, L. G., Riggio, L., Rizzolatti, G. & Umiltà, C. (1987) Movements of attention in the three spatial dimensions and the meaning of "neutral" cues. *Neuropsychologia* 25:19-29 [aFHP]
- Gazzaniga, M. S. & Ladavas, E. (1987) Disturbances in spatial attention following lesion or disconnection of the right parietal lobe. In: *Neurophysiological and neuropsychological aspects of spatial neglect*, ed. M. Jeannerod. North-Holland. [aFHP]
- Glum, H.-R. & Eimas, P. H. (1988) Global and local processing by 3- and 4-month-old infants. *Perception & Psychophysics* 43:165-71. [aFHP]
- Gibson, J. J. (1958) Visually controlled locomotion and visual orientation in animals. *British Journal of Psychology* 49:182-94. [BGB]
- (1966) *The senses considered as perceptual systems*. Houghton-Mifflin. [aFHP]
- (1979) *The ecological approach to visual perception*. Lawrence Erlbaum Associates. [MK]
- Ginsburg, A. P. (1986) Spatial filtering and visual form perception. In: *Handbook of perception and performance*, vol. 2, ed. K. R. Boff, L. Kaufman & J. P. Thomas. Wiley & Sons. [aFHP]
- Girotti, F., Milanese, C., Casazza, M., Allegrezza, A., Corridori, F. & Avanzini, G. (1982) Oculomotor disturbances in Balint's syndrome. Anatomical findings and electrooculographic analysis in a case. *Cortex* 18:603-14. [aFHP]
- Gloning, K. & Quatember, R. (1966) Methodischer Beitrag zur Untersuchung der prosopagnosie. *Neuropsychologia* 4:133-141. [aFHP]
- Gnadt, J. W. & Andersen, R. A. (1988) Memory related planning activity in the posterior parietal cortex of macaque. *Experimental Brain Research* 70:216-20. [RMB]
- Gnadt, J. W. & Mays, L. E. (1989) Posterior parietal cortex. The oculomotor near response and spatial coding in 3-D space. *Society for Neuroscience Abstracts* 15:786. [RMS]
- Godoy, J., Luders, H., Dinner, D. S., Morris, H. H. & Wyllie, E. (1990) Versive eye movement elicited by cortical stimulation of the human brain. *Neurology* 40:296-99. [rFHP]
- Goldberg, M. E. & Robinson, D. L. (1978) Visual system: Superior colliculus. In: *Handbook of behavioral neurobiology*, vol. 1, ed. R. B. Masterton. Plenum. [aFHP]
- Goldenberg, G., Podreka, I., Steiner, M., Willmes, K., Suess, E. & Deecke, L. (1989) Regional cerebral blood flow patterns in visual imagery. *Neuropsychologia* 27:641-664. [aFHP]
- Goldman-Rakic, P. S. (1987) Circuitry of primate prefrontal cortex and regulation of behavior by representational memory. In: *Handbook of physiology*, vol. 5, ed. V. Mountcastle, F. Plum & S. R. Geiger. American Physiological Society. [aFHP]
- (1988) Topography of cognition. Parallel distributed networks in primate association cortex. *Annual Review of Neuroscience* 11:137-56. [GWS]
- Goldstein, L. H., Canavan, A. G. M. & Polkey, C. E. (1989) Cognitive mapping after unilateral temporal lobectomy. *Neuropsychologia* 27:167-77. [aFHP]
- Goodale, M. A. (1983a) Visuomotor organization of pecking in the pigeon. In: *Advances in vertebrate neuroethology*, ed. J.-P. Ewert, R. R. Capranica & D. J. Ingle. Plenum. [MAG]
- (1983b) Visually guided pecking in the pigeon (*Columba livia*). *Brain, Behavior, and Evolution* 22:22-41. [MAG]
- (1983c) Vision as a sensorimotor function. In: *Behavioral approaches to brain research*, ed. T. E. Robinson. Oxford University Press. [MAG]
- (1988) Modularity in visuomotor control. From input to output. In: *Computational processes in human vision. An interdisciplinary perspective*, ed. Z. Pylyshyn. Ablex. [MAG]
- Goodale, M. A. & Graves, J. A. (1982) Interocular transfer in the pigeon. Retinal locus as a factor. In: *Analysis of visual behavior*, ed. D. J. Ingle, M. A. Goodale & R. J. W. Mansfield. MIT Press. [MAG]
- Gottlieb, J. P., MacAvoy, M. G. & Bruce, C. J. (1989) Unit activity related to smooth pursuit eye movements in the rhesus monkey frontal eye fields. *Society for Neuroscience Abstracts* 15:1203. [CJB]
- Grabowska, A. (1983) Lateral differences in the detection of stereoscopic depth. *Neuropsychologia* 21:249-57. [aFHP]
- Graves, J. A. & Goodale, M. A. (1979) Do training conditions affect interocular transfer in the pigeon? In: *Structure and function of the cerebral commissures*, ed. I. Steele Russell, M. van Hof & G. Berlucci. Macmillan. [MAG]
- Gray, C. M., Koenig, P., Engel, A. K. & Singer, W. (1989) Oscillatory responses in cat visual cortex exhibit inter-columnar synchronization which reflects global stimulus properties. *Nature* 338:334-37. [GWS]
- Gray, C. M. & Singer, W. (1989) Stimulus-specific neuronal oscillations in orientation columns of cat visual cortex. *Proceedings of the National Academy of Sciences, USA* 86:1698-1702. [GWS]
- Gregory, R. L. (1977) Vision with isoluminant colour contrast. I. A projection technique and observations. *Perception & Psychophysics* 6:113-19. [aFHP]
- Gross, C. G., Bender, D. B. & Gerstein, G. L. (1979) Activity of inferior temporal neurons in behaving monkeys. *Neuropsychologia* 17:215-29. [aFHP]
- Gross, C. G., Bender, D. B. & Rocha-Miranda, C. E. (1974) Inferotemporal cortex. A single-unit analysis. In: *The neurosciences. Third study program*, ed. F. O. Schmitt & F. G. Worden. MIT Press. [aFHP]
- Gross, C. G., Cowey, A. & Manning, F. J. (1971) Further analysis of visual discrimination deficits following focal prestriate and inferotemporal lesions in rhesus monkeys. *Journal of Comparative and Physiological Psychology* 76:1-7. [aFHP]
- Gross, C. G., Desimone, R., Albright, T. D. & Schwartz, E. L. (1985) Inferior temporal cortex and pattern recognition. In: *Pattern recognition mechanisms*, ed. C. Chagas, R. Gattass & C. Gross. Springer-Verlag. [aFHP]
- Gross, C. G. & Mishkin, M. (1977) The neural basis of stimulus equivalence across retinal translation. In: *Lateralization in the nervous system*, ed. S. Harnad, R. Doty, J. Jaynes, L. Goldstein & G. Krauthamer. Academic Press. [CJM]
- Gross, C. G., Rocha-Miranda, C. E. & Bender, D. B. (1972) Visual properties of neurons in inferotemporal cortex of the macaque. *Journal of Neurophysiology* 35:96-111. [CJM, rFHP]
- Grusser, O.-J. (1983) Multimodal structure of the extrapersonal space. In: *Spatially oriented behavior*, ed. A. Hein & M. Jeannerod. Springer-Verlag. [rFHP]
- Guillery, R. W. (1979) A speculative essay on geniculate lamination and its development. In: *Progress in brain research: Development and chemical specificity of neurons*, vol. 51, ed. M. Cuenod, G. W. Kreutzberg & F. E. Bloom. Elsevier/North-Holland Biomedical Press. [aFHP]
- Guitton, D., Douglas, R. M. & Volle, M. (1984) Eye-head coordination in cats. *Journal of Neurophysiology* 52:1030-50. [aFHP]
- Haaxma, R. & Kuypers, H. G. J. M. (1975) Intrahemispheric cortical connexions and visual guidance of hand and finger movements in the rhesus monkey. *Brain* 98:239-60. [aFHP]
- Haber, R. N. & Hershenson, M. (1973) *The psychology of visual perception*. Holt, Rinehart and Winston. [aFHP]
- Hackman, R. B. (1940) An experimental study of variability in ocular latency. *Journal of Experimental Psychology* 27:546-48.
- Haenny, P. E. & Schiller, P. H. (1988) State dependent activity in monkey visual cortex I. Single cell activity in V1 and V4 on visual tasks. *Experimental Brain Research* 69:225-44. [aFHP]
- Hall, L. C. (1985) Searching high and low. The development of efficient visual search in hearing, deaf and learning disabled children. In: *Eye movements and human information processing*, ed. R. Groner, G. W. McConkie & C. Menz. North-Holland. [MPB, rFHP]
- Halligan, P. W. & Marshall, J. C. (1989) Is neglect (only) lateral? A quadrant analysis of line cancellation. *Journal of Clinical and Experimental Neuropsychology* 11:793-98. [rFHP]
- Hamasaki, D. I. & Flynn, J. T. (1981) Amblyopic eyes have longer reaction times. *Investigative Ophthalmology & Visual Science* 21:846-53. [aFHP]
- Hansen, R. M. & Skavenski, A. A. (1977) Accuracy of eye position information for motor control. *Vision Research* 17:919-26. [RAA]
- Harris, C. S. (1965) Perceptual adaptation to inverted, reversed, and displaced vision. *Psychological Review* 72:419-44. [RWW]
- Harter, M. R. & Aine, C. J. (1984) Brain mechanisms of visual selective attention. In: *Varieties of attention*, ed. R. Parasuraman & D. R. Davies. Academic Press. [rFHP]
- Harwerth, R. S. & Boltz, R. L. (1979) Stereopsis in monkeys using random-dot stereograms. The effect of viewing duration. *Vision Research* 19:985-91. [aFHP]
- Hassler, R. (1966) Comparative anatomy of the central visual system of day-

- and night-active primates. In *Evolution of the forebrain*, ed. R. Hassler & H. Stephan. Thieme. [RWV]
- Hebb, D. O. (1949) *The organization of behavior*. Wiley & Sons. [BGB]
- Hecaen, H. & Albert, M. L. (1978) *Human neuropsychology*. Wiley & Sons. [aFHP]
- Heilman, K. M. & Aalenstein, E. (1979) Mechanisms underlying hemispatial neglect. *Annals of Neurology* 5:166-70. [EMH]
- Heilman, K. M. & van Den Abell, T. (1980) Right hemisphere dominance for attention. The mechanism underlying hemispheric asymmetries of inattention (neglect). *Neurology* 30:327-30. [aFHP]
- Heilman, K. M., Watson, R. T. & Valenstein, E. (1985) Neglect and related disorders. In *Clinical neuropsychology*, 2d ed., ed. K. M. Heilman & E. Valenstein. Oxford University Press. [KMH]
- Hendrickson, A. E. (1985) Dots, stripes and columns in monkey visual cortex. *Trends in Neurosciences* 8:406-10. [aFHP]
- Hess, R. F. & Bradley, A. (1980) Contrast perception above threshold is only minimally impaired in human amblyopia. *Nature* 287:463-64. [aFHP]
- Heuer, H., Dunkel-Abels, G., Bruwer, M., Kroger, H., Romer, T. & Wischmeier, E. (1988) The effects of sustained vertical gaze deviation on the resting state of the vergence system. *Vision Research* 28:1337-44. [aFHP]
- Heuer, H. & Owens, D. A. (1989) Vertical gaze direction and the resting posture of the eyes. *Perception* 18:363-77. [rFHP]
- Heywood, S. & Churcher, J. (1980) Structure of the visual array and saccadic latency: Implications for oculomotor control. *Quarterly Journal of Experimental Psychology* 32:335-41. [aFHP, MPB, JMF]
- Hickey, T. L. (1977) Postnatal development of the human lateral geniculate nucleus: Relationship to a critical period for the visual system. *Science* 198:836-38. [aFHP]
- Hilz, R., Rentschler, I. & Brettel, H. (1977) Myopic and strabismic amblyopia: Substantial differences in human visual development. *Experimental Brain Research* 30:445-46. [aFHP]
- Hine, T. & Thorn, F. (1987) Compensatory eye movements during active head rotation for near targets: Effects of imagination, rapid head oscillation and vergence. *Vision Research* 27:1639-57. [aFHP]
- Hines, D., Jordan-Brown, L. & Juzwin, K. R. (1987) Hemispheric visual processing in face recognition. *Brain and Cognition* 6:91-100. [aFHP]
- Hinton, G. E., McClelland, J. L. & Rumelhart, D. E. (1986) Distributed representations. In: *Parallel distributed processing: Explorations in the microstructure of cognition*, ed. D. E. Rumelhart & J. L. McClelland. MIT Press. [RMB]
- Hodos, W. R. (1976) Vision and the visual system: A bird's-eye view. In: *Progress in psychology and physiological psychology*, ed. J. Sprague & A. N. Epstein. Academic Press. [MAG]
- Holmes, G. (1938) The cerebral integration of the ocular movements. *British Medical Journal* 2:107-12. [aFHP]
- Honda, H. (1985) Spatial localization in saccade and pursuit-eye-movement conditions: A comparison of perceptual and motor measures. *Perception and Psychophysics* 38:41-46. [JMF]
- Hong, X. & Regan, D. (1989) Visual field defects for unidirectional and oscillatory motion in depth. *Vision Research* 29:809-16. [aFHP]
- Horak, F. B., Shumway-Cook, A., Crowe, T. K. & Black, F. O. (1988) Vestibular function and motor proficiency of children with impaired hearing, or with learning disability and motor impairments. *Developmental Medicine and Child Neurology* 30:64-79. [aFHP]
- Horel, J. A. (1978) The neuroanatomy of amnesia. A critique of the hippocampal memory hypothesis. *Brain* 101:403-45. [aFHP]
- Hoyt, C. S. (1982) Abnormalities of the vestibulo-ocular response in congenital esotropia. *American Journal of Ophthalmology* 93:703-8. [aFHP]
- Hughes, A. (1977) The topography of vision in mammals of contrasting lifestyles. Comparative optics and retinal organisation. In *Handbook of sensory physiology*, vol. VII/5, ed. F. Crescitelli. Springer-Verlag. [RWV]
- Hughes, H. C. & Zimba, L. D. (1987) Natural boundaries for the spatial spread of directed visual attention. *Neuropsychologia* 25:5-18. [aFHP]
- Hurvich, L. M. (1981) *Color vision*. Sinauer Associates. [aFHP]
- Hylkema, B. S. (1942) Examination of the visual field by determining the fusion frequency. *Acta Ophthalmologica* 20:181-93. [aFHP]
- Hyvarinen, J. (1982) *The parietal cortex of monkey and man*. Springer-Verlag. [aFHP]
- Ikeda, M. & Takeuchi, T. (1975) Influence of foveal load on the functional visual field. *Perception & Psychophysics* 18:255-60. [aFHP]
- Jampel, R. S. (1959) Representation of the near-response on the cerebral cortex of the macaque. *American Journal of Ophthalmology* 48:573-82. [aFHP]
- Jeannerod, M., ed. (1987) *Neurophysiological and neuropsychological aspects of spatial neglect*. Elsevier. [RMB]
- Jeannerod, M. & Biguer, B. (1987) The directional coding of reaching movements: A visuomotor conception of spatial neglect. In: *Neurophysiological and neuropsychological aspects of spatial neglect*, ed. M. Jeannerod. North-Holland. [aFHP]
- Jeannerod, M., Gerin, P. & Pernier, J. (1968) Déplacements et fixations du regard dans l'exploration libre d'une scène visuelle. *Vision Research* 8:81-97. [aFHP]
- Jeeves, M. A., Milner, A. D., Perrett, D. I. & Smith, P. A. J. (1983) Visual cells responsive to direction of movement and stimulus form in the anterior superior temporal sulcus of the macaque monkey. *Journal of Physiology* 341:80P. [aFHP]
- Jensen, I. & Seedorff, H. H. (1976) Temporal lobe epilepsy and neuro-ophthalmology: Ophthalmological findings in 74 temporal lobe resected patients. *Acta Ophthalmologica* 54:827-41. [aFHP]
- Jones, R. & Kerr, K. E. (1972) Vergence eye movements to pairs of disparity stimuli with shape selection cues. *Vision Research* 12:1425-30. [aFHP]
- Jones-Gotman, M. (1986) Memory for designs. The hippocampal contribution. *Neuropsychologia* 24:193-203. [aFHP]
- Julesz, B. (1978) Global stereopsis. Cooperative phenomena in stereoscopic depth perception. In: *Handbook of sensory physiology*, vol. 8, ed. R. Held, H. W. Leibowitz & H.-L. Teuber. Springer-Verlag. [aFHP]
- Julesz, B., Breitmeyer, B. & Kropff, W. (1976) Binocular-disparity-dependent upper-lower hemifield anisotropy and left-right hemifield isotropy as revealed by dynamic random-dot stereograms. *Perception* 5:129-41. [aFHP]
- Kaas, J. H. (1989) Changing concepts of visual cortex organization in primates. In: *Neuropsychology of visual perception*, ed. J. W. Brown. Lawrence Erlbaum Associates. [MK]
- Kaplan, E. & Shapley, R. M. (1982) X and Y cells in the lateral geniculate nucleus of macaque monkeys. *Journal of Physiology* 330:125-43. [aFHP]
- Karpov, B. A., Luria, A. R. & Yarbuss, A. L. (1968) Disturbances of the structure of active perception in lesions of the posterior and anterior regions of the brain. *Neuropsychologia* 6:157-66. [aFHP]
- Kaufman, L. & Richards, W. (1969) Spontaneous fixation tendencies for visual forms. *Perception & Psychophysics* 5:85-88. [aFHP]
- Keating, E. G., Gooley, S. G. & Kenny, D. V. (1985) Impaired tracking and loss of predictive eye movements after removal of the frontal eye fields. *Society for Neuroscience Abstracts* 11:472. [CJB]
- Kelly, D. H. (1977) Visual contrast sensitivity. *Optica Acta* 24:107-29. [aFHP]
- Kendrick, K. M. & Baldwin, B. A. (1987) Cells in the temporal cortex of conscious sheep respond preferentially to the sight of faces. *Science* 236:448-50. [RMB]
- Kesner, R. P., Farnsworth, G. & DiMattia, B. V. (1989) Double dissociation of egocentric and allocentric space following medial prefrontal and parietal cortex lesions in the rat. *Behavioral Neuroscience* 103:956-61. [GWS]
- King-Smith, P. E. & Caden, D. (1976) Luminance and opponent-color contributions to visual detection and adaptation and to temporal and spatial integration. *Journal of the Optical Society of America* 66:709-17. [aFHP]
- Kinsbourne, M. (1972) Eye and head turning indicates cerebral lateralization. *Science* 176:539-41. [aFHP]
- Kinsbourne, M. & Hicks, R. E. (1978) Functional cerebral space. A model for overflow, transfer and interference effects in human performance. In: *Attention and performance VII*, ed. J. Requin. Lawrence Erlbaum Associates. [MK]
- Kinsbourne, M. & Warrington, E. K. (1962) A disorder of simultaneous form perception. *Brain* 85:461-86. [aFHP]
- Komatsu, H. & Wurtz, R. H. (1988) Relation of cortical areas MT and MST to pursuit eye movements. I. Localization and visual properties of neurons. *Journal of Neurophysiology* 60:580-603. [MK, rFHP]
- Komatsu, H., Roy, J. P. & Wurtz, R. H. (1988) Binocular disparity sensitivity of cells in area MST of the monkey. *Society for Neuroscience Abstracts* 14:202. [aFHP, MK]
- Koosira, C. A. & Heilman, K. M. (1989) Hemispatial visual inattention masquerading as hemianopia. *Neurology* 39:1125-27. [aFHP, CMB]
- Kriss, A. & Halliday, A. M. (1980) A comparison of occipital potentials evoked by pattern onset, offset and reversal by movement. In: *Evoked potentials*, ed. C. Barber. MTP Press. [aFHP]
- Krose, B. J. A. & Julesz, B. (1988) Evidence against rapid voluntary shifts of attention to non-cued target locations in a visual search task. *Investigative Ophthalmology and Visual Science* 29:400. [JRB]
- (1989) The control and speed of shifts of attention. *Vision Research* 29:1607-19. [JRB, rFHP]
- Lanman, J., Bizzi, E. & Allum, J. (1978) The coordination of eye and head movement during smooth pursuit. *Brain Research* 153:39-53. [aFHP]

- Larrabee, G. J., Levin, H. S., Huff, F. J., Kay, M. C. & Guinto, F. C., Jr. (1985) Visual agnosia contrasted with visual-verbal disconnection. *Neuropsychologia* 23:1-12. [aFHP]
- Lasley, D. J., Kivlin, J., Rich, L. & Flynn, J. T. (1984) Stereo-discrimination between diplopic images in clinically normal observers. *Investigative Ophthalmology & Visual Science* 25:1316-20. [aFHP]
- Latto, R. & Cowey, A. (1971) Fixation changes after frontal eye-field lesions in monkeys. *Brain Research* 30:25-36. [aFHP]
- Legge, G. E., Pelli, D. G., Rubin, G. S. & Schleske, M. M. (1985) Psychophysics of reading I. Normal vision. *Vision Research* 25:239-52. [JRB]
- Legge, G. E., Rubin, G. S. & Luebker, A. (1978) Psychophysics of reading V. The role of contrast in normal vision. *Vision Research* 27:1165-77. [JRB]
- Leinonen, L., Hyvarinen, J., Nyman, G. & Linnankoski, I. (1979) Functional properties of neurons in lateral part of association area 7 in awake monkeys, Part 1. *Experimental Brain Research* 34:299-320. [KMH]
- Leinonen, L. & Nyman, G. (1979) Functional properties of cells in anterolateral part of area 7 associative face area of awake monkeys, Part 2. *Experimental Brain Research* 34:321-33. [KMH]
- Levine, D. N., Warach, J. & Farah, M. (1985) Two visual systems in mental imagery: Dissociation of "what" and "where" in imagery disorders due to bilateral posterior cerebral lesions. *Neurology* 35:1010-18. [aFHP]
- Lewinson, H. (1988) The cerebellar-vestibular basis of learning disabilities in children, adolescents and adults. Hypothesis and study. *Perceptual and Motor Skills* 67:993-1006. [aFHP]
- Levy-Schoen, A. (1969) Determination et latence de la réponse oculomotrice à deux stimulus. *L'Année Psychologique* 69:373-92. [JMF, rFHP]
- Liederman, J. & Meehan, P. (1986) When is between-hemisphere division of labor advantageous? *Neuropsychologia* 24:863-74. [MPB]
- Liederman, J., Merola, J. M. & Martinez, S. (1985) Interhemispheric collaboration in response to bilateral input. *Neuropsychologia* 23:673-83. [MPB]
- Lisberger, S. G. & Pavelko, T. A. (1989) Topographic and directional organization of visual motion inputs for the initiation of horizontal and vertical smooth-pursuit eye movements in monkeys. *Journal of Neurophysiology* 61:173-85. [CJB, rFHP]
- Livingstone, M. & Hubel, D. (1988a) Segregation of form, color, movement, and depth: Anatomy, physiology, and perception. *Science* 240:740-49. [aFHP, LMC]
- Livingstone, M. S. & Hubel, D. H. (1988b) Do the relative mapping densities of the magno- and parvocellular systems vary with eccentricity? *Journal of Neuroscience* 8:4334-39. [aFHP]
- Logothetis, N. K. & Schall, J. D. (1989) Neuronal correlates of subjective visual perception. *Science* 245:761-63. [aFHP]
- Longuet-Higgins, H. C. & Prazdny, K. (1980) The interpretation of a moving retinal image. *Proceedings of the Royal Society of London, series B* 208:355-97. [RMS]
- Low, F. N. (1943) The peripheral visual acuity of 100 subjects. *American Journal of Physiology* 140:83-88. [aFHP]
- Lu, C. & Fender, D. H. (1972) The interaction of color and luminance in stereoscopic vision. *Investigative Ophthalmology* 11:482-90. [aFHP]
- Lundh, B. L., Lennerstrand, G. & Derfeldt, G. (1983) Central and peripheral normal contrast sensitivity for static and dynamic sinusoidal gratings. *Acta Ophthalmologica* 61:171-82. [aFHP]
- Lupp, U., Hauske, G. & Wolf, W. (1976) Perceptual latencies to sinusoidal gratings. *Vision Research* 16:969-72. [aFHP]
- Luria, A. R., Pravdina-Vinarskaya, E. N. & Yarbuss, A. L. (1963) Disorders of ocular movement in a case of simultagnosia. *Brain* 86:219-28. [aFHP]
- Lynch, J. C. (1980) The functional organization of posterior parietal association cortex. *Behavioral and Brain Sciences* 3(4):485-534. [aFHP]
- (1987) Frontal eye field lesions in monkeys disrupt visual pursuit. *Experimental Brain Research* 68:437-41. [CJB, rFHP]
- Lynch, J. C., Mountcastle, V. B., Talbot, W. H. & Yin, T. C. T. (1977) Parietal lobe mechanisms for directed visual attention. *Journal of Neurophysiology* 40:369-89. [aFHP]
- MacAvoy, M. C. & Bruce, C. J. (1989) Oculomotor deficits associated with lesions of the frontal eye field area of in macaque monkeys. *Society for Neuroscience Abstracts* 15:1203. [CJB]
- MacAvoy, M. C., Bruce, C. J. & Gottlieb, J. (1988) Smooth eye movements elicited by microstimulation in the frontal eye fields region of alert macaque monkeys. *Society Neuroscience Abstracts* 14:956. [CJB]
- Mack, A. (1978) Three modes of visual perception. In: *Modes of Perceiving and Processing Information*, ed. H. L. Pick, Jr. & E. Saltzman. Wiley & Sons. [GWS]
- Magnusson, M., Pyykko, I. & Norrving, B. (1986) The relationship of optokinetic nystagmus to pursuit eye movements, vestibular nystagmus and to saccades in humans: A clinical study. *Acta Otolaryngologica* 101:361-70. [aFHP]
- Malpeli, J. P. & Baker, F. H. (1975) The representation of the visual field in the lateral geniculate nucleus of *Macaca mulatta*. *Journal of Comparative Neurology* 161:569-94. [aFHP]
- Manning, F. J. (1971) The selective attention "deficit" of monkeys with ablations of foveal prestriate cortex. *Psychonomic Science* 25:291-92. [aFHP]
- Manning, M. L., Finlay, D. C., Neill, R. A. & Frost, B. G. (1987) Detection threshold differences to crossed and uncrossed disparities. *Vision Research* 27:1683-86. [aFHP, MPB]
- Marr, D. (1982) *Vision*. W. H. Freeman. [CJM, RWW]
- Marrocco, R. T., McClurkin, J. W. & Young, R. A. (1982) Spatial summation and conduction latency classification of cells of the lateral geniculate nucleus of macaques. *Journal of Neuroscience* 2:1275-91. [aFHP]
- Martens, W., Blake, R., Sloane, M. & Cormack, R. H. (1981) What masks utricular discrimination. *Perception & Psychophysics* 30:521-32. [aFHP]
- Martin, F. & Lovegrove, W. (1984) The effects of field size and luminance on contrast sensitivity differences between specifically reading disabled and normal children. *Neuropsychological* 22:73-77. [aFHP]
- Martin, K. A. C. (1988) From enzymes to visual perception. A bridge too far? *Trends in Neurosciences* 11:380-87. [aFHP]
- Martin, M. (1979) Hemispheric specialization for local and global processing. *Quarterly Journal of Experimental Psychology* 17:33-40. [MPB]
- Martinoya, G., Rey, J. & Bloch, S. (1981) Limits of the pigeon's binocular field and direction for best binocular viewing. *Vision Research* 21:1197-200. [MAG]
- Matelli, M., Olivieri, M. F., Saccam, A. & Rizzolatti, G. (1983) Upper visual space neglect and motor deficits after section of the midbrain commissures in the cat. *Behavioral Brain Research* 10:263-85 [aFHP]
- Matin, L., Matin, E. & Pearce, D. G. (1969) Visual perception of direction when voluntary saccades occur I. Relation of visual direction of a fixed target extinguished before a saccade to a flash presented during a saccade. *Perception and Psychophysics* 5:65-80. [RAA]
- Maunsell, J. H. R. (1987) Physiological evidence for two visual subsystems. In: *Matters of intelligence. Conceptual structures in cognitive neuroscience*, ed. L. M. Vaina. Reidel Publishing. [aFHP]
- Maunsell, J. H. R. & Newsome, W. T. (1987) Visual processing in monkey extrastriate cortex. *Annual Review of Neuroscience* 10:363-401. [aFHP]
- Maunsell, J. H. R. & Van Essen, D. C. (1983a) Functional properties of neurons in middle temporal visual area of the macaque monkey I. Selectivity for stimulus direction, speed, and orientation. *Journal of Neurophysiology* 49:1127-47. [aFHP, MK, RMS]
- (1983b) Functional properties of neurons in middle temporal visual area of the macaque monkey II. Binocular interactions and the sensitivity to binocular disparity. *Journal of Neurophysiology* 49:1148-67. [aFHP, MK, RMS]
- (1983c) The connections of the middle temporal visual area (MT) and their relationship to a cortical hierarchy in the macaque monkey. *Journal of Neuroscience* 3:2563-86. [RMS]
- (1987) The topographic organization of the middle temporal visual area in the macaque monkey. Representational biases and the relationship to callosal connections and myeloarchitectonic boundaries. *Journal of Comparative Neurology* 266:535-55. [aFHP]
- Mays, L. E. & Sparks, D. L. (1980) Saccades are spatially, not retinotopically coded. *Science* 208:1163-64. [RAA]
- McColgan, F. H. (1960) Movement thresholds in peripheral vision. *Journal of the Optical Society of America* 50:774-79. [aFHP]
- McDonnell, P. M. (1975) The development of visually guided reaching. *Perception & Psychophysics* 18:181-85. [aFHP]
- McFie, J. & Zangwill, O. L. (1960) Visual-constructive disabilities associated with lesions of the left cerebral hemisphere. *Brain* 83:243-60. [aFHP]
- Meadows, J. C. (1974a) Disturbed perception of colours associated with localised cerebral lesions. *Brain* 97:615-32. [aFHP]
- (1974b) The anatomical basis of prosopagnosia. *Journal of Neurology, Neurosurgery, and Psychiatry* 37:489-501. [aFHP]
- Menzel, E. W. (1973) Chimpanzee spatial memory organization. *Science* 182:943-45. [aFHP]
- Merigan, W. H. (1989) Chromatic and achromatic vision of macaques. Role of the P pathway. *Journal of Neuroscience* 9:776-83. [aFHP]
- Merigan, W. H. & Eskin, T. A. (1986) Spatio-temporal vision of macaques with severe loss of P<sub>1</sub> retinal ganglion cells. *Vision Research* 26:1751-61. [aFHP]
- Meyer, D. E., Abrams, R. A., Kornblum, S., Wright, C. E. & Smith, J. E. K. (1988) Optimality in human motor performance. Ideal control of rapid aimed movements. *Psychological Review* 95:340-70. [RAA]

## References/Previc: Visual field specialization

- Meyer, D. E., Smith, J. E. K. & Wright, C. E. (1982) Models for the speed and accuracy of aimed movements. *Psychological Review* 89:449-82. [RAA]
- Michael, W. F. & Halliday, A. M. (1971) Differences between the occipital distribution of upper and lower field pattern-evoked responses in man. *Brain Research* 32:311-24. [aFHP]
- Miles, F. A. & Kawano, K. (1987) Visual stabilization of the eyes. *Trends in Neurosciences* 10:153-58. [aFHP]
- Miles, P. W. (1954) An analysis of depth factors in anisopia and anisodominance. *American Journal of Ophthalmology* 37:98-106. [aFHP]
- Miles, W. R. (1936) The reaction time of the eye. *Psychological Monographs* 47:268-93. [rFHP]
- Miller, J. M., Ono, H. & Steinbach, M. J. (1980) Additivity of fusional vergence and pursuit eye movements. *Vision Research* 20:43-47. [aFHP]
- Miller, L. K. (1969) Eye-movement latency as a function of age, stimulus uncertainty, and position in the visual field. *Perceptual & Motor Skills* 28:631-36. [JMF, rFHP]
- Milodot, M. & Lamont, A. (1974) Peripheral visual acuity in the vertical plane. *Vision Research* 14:1497-98. [aFHP]
- Mishkin, M. (1972) Cortical visual areas and their interactions. In: *The brain and human behavior*, ed. A. Karczmar & J. C. Eccles. Springer-Verlag. [aFHP]
- Mishkin, M. & Forgays, D. G. (1952) Word recognition as function of retinal locus. *Journal of Experimental Psychology* 43:43-48. [MPB, rFHP]
- Mitchell, D. E. & Blakemore, C. (1970) Binocular depth perception and the corpus callosum. *Vision Research* 10:49-54. [aFHP]
- Miyashita, Y. (1988) Neuronal correlate of visual associative long-term memory in the primate temporal cortex. *Nature* 335 817-20. [aFHP]
- Mohler, C. W. & Wurtz, R. H. (1977) Role of striate cortex and superior colliculus in visual guidance of saccadic eye movements in monkeys. *Journal of Neurophysiology* 40:74-94. [CJB]
- Moran, J. & Desimone, R. (1985) Selective attention gates visual processing in the extrastriate cortex. *Science* 229:782-84. [aFHP]
- Morris, R., Mickel, S., Brooks, M., Swavely, S. & Heilman, K. (1986) Recovery from neglect. *Journal of Clinical and Experimental Neuropsychology* 7:609. [aFHP]
- Motter, B. C. & Mountcastle, V. B. (1981) The functional properties of the light-sensitive neurons of the posterior parietal cortex studied in waking monkeys. Foveal sparing and opponent vector organization. *Journal of Neuroscience* 1:3-26. [MK, CJM]
- Motter, B. C., Steinmetz, M. A., Duffy, C. J. & Mountcastle, V. B. (1987) Functional properties of parietal visual neurons: Mechanisms of directionality along a single axis. *Journal of Neuroscience* 7:154-76. [aFHP, MK, CJM]
- Mountcastle, V. B. (1976) The world around us: Neural command functions for selective attention. *Neurosciences Research Program Bulletin* 14:1-47. [aFHP]
- (1979) An organizing principle for cerebral function. The unit module and the distributed system. In: *The neurosciences fourth study program*, ed. F. O. Schmitt & F. G. Worden. MIT Press. [GWS]
- Mountcastle, V. B., Motter, B. C., Steinmetz, M. A. & Duffy, C. J. (1984) Looking and seeing. The visual functions of the parietal lobe. In: *Dynamic aspects of neocortical function*, ed. G. M. Edelman, W. E. Gall & W. M. Cowan. Wiley & Sons. [CJB, rFHP]
- Movshon, J. A., Adelson, E. H., Gizzi, M. S. & Newsome, W. T. (1985) The analysis of moving visual patterns. In: *Pattern recognition mechanisms*, ed. C. Chagas, R. Gattass & C. Gross. Springer-Verlag. [aFHP]
- Mullen, K. T. (1985) The contrast sensitivity of human colour vision to red-green and blue-yellow chromatic gratings. *Journal of Physiology* 339 381-400. [aFHP]
- Murasugi, C. M. & Howard, I. P. (1989) Human horizontal optokinetic nystagmus elicited by the upper versus the lower visual fields. *Visual Neuroscience* 2:73-79. [aFHP, LMC]
- Murray, I., MacCana, F. & Kulikowski, J. J. (1983) Contribution of two movement detecting mechanisms to central and peripheral vision. *Vision Research* 23:151-59. [aFHP]
- Mustillo, P. (1985) Binocular mechanisms mediating crossed and uncrossed stereopsis. *Psychological Bulletin* 97:187-201. [aFHP]
- Nakayama, K. (1983) Motion parallax sensitivity and space perception. In: *Spatially oriented behavior*, ed. A. Hein & M. Jeannerod. Springer-Verlag. [aFHP]
- Nakayama, K. & Silverman, G. H. (1986) Serial and parallel processing of visual feature conjunctions. *Nature* 320:264-65. [aFHP]
- Nathan, P. W. (1946) On simultaneous bilateral stimulation of the body in a lesion of the parietal lobe. *Brain* 69:325-34. [aFHP]
- Navon, D. (1977) Forest before trees. The precedence of global features in visual perception. *Cognitive Psychology* 9:353-83. [aFHP, JRB]
- Newman, R. P., Kinkel, W. R. & Jacobs, L. (1984) Altitudinal hemianopia caused by occipital infarctions. Clinical and computerized tomographic correlations. *Archives of Neurology* 41:413-18. [aFHP]
- Newsome, W. T. & Wurtz, R. H. (1988) Probing visual cortical function with discrete chemical lesions. *Trends in Neurosciences* 11:394-400. [aFHP]
- Niederlandova, Z. & Litvinenkova, V. (1973) Stabilographic findings in strabismus. *Aggressologie* 14D:33-36. [aFHP]
- Norton, T. T. & Casagrande, V. A. (1982) Laminar organization of receptive-field properties in lateral geniculate nucleus of bushy baby (*Galago crassicaudatus*). *Journal of Neurophysiology* 47:715-41. [aFHP]
- Nye, P. W. (1973) On the functional differences between frontal and lateral visual fields of the pigeon. *Vision Research* 13 559-74. [MAG]
- O'Reilly, R. C., Kosslyn, S. M., Marsolek, C. J. & Chabris, C. F. (in press) Receptive field characteristics that allow parietal lobe neurons to encode spatial properties of visual input. A computational analysis. *Journal of Cognitive Neuroscience*. [CJM]
- Ornitz, E. M. (1970) Vestibular dysfunction in schizophrenia and childhood autism. *Comprehensive Psychiatry* 11:159-73. [aFHP]
- Osaka, N. (1976) Reaction time as a function of peripheral retinal locus around fovea. Effect of stimulus size. *Perceptual and Motor Skills* 43:603-6. [NO]
- (1978) Naso-temporal differences in human reaction time in the peripheral visual field. *Neuropsychologia* 16:229-303. [NO]
- Osman Hill, W. C. (1972) *Evolutionary biology of the primates*. Academic Press. [aFHP]
- Osterberg, G. (1935) Topography of the layer of rods and cones in the human retina. *Acta Ophthalmologica* 6:1-102. (Supplement) [aFHP]
- Ottes, F. P., van Gisbergen, J. A. M. & Eggemont, J. J. (1985) Latency dependence of colour-based target vs. nontarget information by the saccadic system. *Vision Research* 25:849-62. [JMF]
- Pavillard, J. (1982) The contribution of peripheral and central vision to visually guided reaching. In: *Analysis of visual behavior*, ed. D. J. Ingle, M. A. Goodale & R. J. W. Mansfield. MIT Press. [aFHP, RMB]
- Pandya, D. N. & Seltzer, B. (1980) Cortical connections and the functional organization of posterior parietal cortex. *Behavioral and Brain Sciences* 3(4):511-13. [aFHP]
- Parker, D. M. & Salzen, E. A. (1977) Latency changes in the human visual evoked response to sinusoidal gratings. *Vision Research* 17:1201-4. [aFHP]
- Pasik, P., Pasik, T. & Bender, M. B. (1969) The pretectal syndrome in monkeys I. Disturbances of gaze and body posture. *Brain* 92:521-34. [aFHP]
- Pavlidis, G. T. (1981) Do eye movements hold the key to dyslexia? *Neuropsychologia* 19:57-64. [aFHP]
- Payne, W. H. (1967) Visual reaction times on a circle about the fovea. *Science* 155:481-82. [aFHP]
- Penfield, W. (1957) Vestibular sensations and the cerebral cortex. *Annals of Otolaryngology and Laryngology* 66:691-93. [aFHP]
- Penfield, W. & Rasmussen, T. (1950) *The cerebral cortex of man*. MacMillan. [aFHP]
- Pennal, B. E. (1977) Human cerebral asymmetry in color discrimination. *Neuropsychologia* 15:563-68. [aFHP]
- Perenn, M. T. & Vighetto, A. (1983) Optic ataxia. A specific disorder in visuomotor coordination. In: *Spatially oriented behavior*, ed. A. Hein & M. Jeannerod. Springer-Verlag. [aFHP]
- Perrett, D. I., Smith, P. A. J., Potter, D. D., Mistlin, A. J., Head, A. S., Milner, A. D. & Jeeves, M. A. (1984) Neurones responsive to faces in the temporal cortex. Studies of functional organization, sensitivity to identity and relation to perception. *Human Neurobiology* 3:197-208. [aFHP]
- (1985) Visual cells in the temporal cortex sensitive to face view and gaze direction. *Proceedings of the Royal Society of London B* 223:293-317 [RMB, MK]
- Perry, V. H., Oehler, R. & Cowey, A. (1984) Retinal cells that project to the dorsal lateral geniculate nucleus in the macaque monkey. *Neuroscience* 12:1101-23. [aFHP]
- Peterhans, E. & von Der Heydt, R. (1989a) Elements of form perception in monkey V2. A correlation with the cytochrome oxidase pattern. *Society for Neuroscience Abstracts* 15:161. [aFHP]
- (1989b) Mechanisms of contour perception in monkey visual cortex II. Contours bridging gaps. *Journal of Neuroscience* 9:1749-63. [rFHP]
- Pettigrew, J. D. & Dreher, B. (1987) Parallel processing of binocular disparity in the cat's retinogeniculocortical pathways. *Proceedings of the Royal Society, series B* 222:297-321. [rFHP]
- Phillips, G. (1933) Perception of flicker in lesions of the visual pathways. *Brain* 56:464-78. [aFHP]

- Piaget, J. (1969) *The mechanisms of perception*. Rutledge & Kegan. [aFHP]
- Pierrot-Descilligny, C., Gray, F. & Brunet, P. (1986) Infarcts of both inferior parietal lobules with impairment of visually guided eye movements, peripheral visual inattention and optic ataxia. *Brain* 109:81-97. [aFHP]
- Plant, G. T., Zimmern, R. L. & Durden, K. (1983) Transient visually evoked potentials to the pattern reversal and onset of sinusoidal gratings. *Electroencephalography and Clinical Neurophysiology* 56:147-58. [aFHP]
- Poggio, G. R. & Poggio, T. (1984) The analysis of stereopsis. *Annual Review of Neuroscience* 7:379-412. [aFHP]
- Polk, A. & Bizzi, E. (1979) Characteristics of motor programs underlying arm movements in monkeys. *Journal of Neurophysiology* 42:183-94. [RAA]
- Polyak, S. (1957) *The vertebrate visual system*. University of Chicago Press. [aFHP, RWW]
- Post, R. B. & Leibowitz, H. W. (1986) Two modes of processing visual information: Implications for assessing visual impairment. *American Journal of Optometry and Physiological Optics* 63:94-96. [rFHP]
- Previc, F. H. (1988) The neurophysiological significance of the N1 and P1 components of the visual evoked potential. *Clinical Vision Sciences* 3:195-202. [aFHP]
- (in preparation) A general theory concerning the prenatal origins of cerebral lateralization in humans. *Psychological Review*. [aFHP]
- Previc, F. H. & Harter, M. R. (1982) Electrophysiological and behavioral indicators of selective attention to multifeature gratings. *Perception & Psychophysics* 32:465-72. [aFHP]
- Ramachandran, V. S. & Cavanagh, P. (1987) Motion capture anisotropy. *Vision Research* 27:97-106. [aFHP]
- Rapesak, S. Z., Camino, C. R. & Heilman, K. M. (1988) Altitudinal neglect. *Neurology* 38:277-81. [aFHP, CMB, KMH]
- Rauschecker, J. P., von Grunau, M. W. & Poulin, C. (1987) Centrifugal organization of direction preferences in the cat's lateral suprasylvian visual cortex and its relation to flow field processing. *Journal of Neuroscience* 7:943-58. [BGB]
- Rayner, K. & McConkie, G. W. (1976) What guides a reader's eye movements? *Vision Research* 16:829-37. [JRB]
- Rayner, K. & Pollatsek, A. (1981) Eye movement control during reading: Evidence for direct control. *Quarterly Journal of Experimental Psychology* 33A:351-73. [JRB]
- Regan, D. & Beverley, K. I. (1979) Visually guided locomotion. Psychophysical evidence for a neural mechanism sensitive to flow patterns. *Science* 205:1-13. [BGB]
- (1983) Visual fields for frontal plane motion and for changing size. *Vision Research* 23:673-76. [aFHP]
- Regan, D., Erkelens, C. J. & Collewijn, H. (1986) Visual field defects for vergence eye movements and for stereomotion perception. *Investigative Ophthalmology & Visual Science* 27:806-19. [aFHP]
- Richards, W. (1972) Disparity masking. *Vision Research* 12:1113-24. [aFHP]
- Richards, W. & Lieberman, H. R. (1985) Correlation between stereo ability and the recovery of structure-from-motion. *American Journal of Optometry and Physiological Optics* 62:111-18. [aFHP]
- Richards, W. & Regan, D. (1973) A stereo field map with implications for disparity processing. *Investigative Ophthalmology* 12:904-9. [aFHP]
- Richmond, B. J., Wurtz, R. H. & Sato, T. (1983) Visual responses of inferior temporal neurons in awake rhesus monkey. *Journal of Neurophysiology* 50:1415-32. [MK]
- Rickman, D. W. & Brecha, N. C. (1989) Morphologies of somatostatin-immunoreactive neurons in the rabbit retina. In: *Neurobiology of the Inner Retina*, ed. R. Weiler & N. N. Osborne. Springer-Verlag. [LMC]
- Rijsdijk, J. P., Kroon, J. N. & van der Wildt, G. J. (1980) Contrast sensitivity as a function of position on the retina. *Vision Research* 20:235-41. [aFHP]
- Riopelle, A. J. & Bevan, W., Jr. (1953) The distribution of scotopic sensitivity in human vision. *American Journal of Psychology* 66:73-80. [aFHP]
- Ristanovic, D. & Hajdukovic, R. (1981) Effects of spatially structured stimulus fields on pattern reversal visual evoked potentials. *Electroencephalography and Clinical Neurophysiology* 51:599-610. [aFHP]
- Rizzolatti, G. & Camarda, R. (1987) Neural circuits for spatial attention and unilateral neglect. In: *Neurophysiological and neuropsychological aspects of spatial neglect*, ed. M. Jeannerod. North-Holland. [aFHP]
- Rizzolatti, G., Gentilucci, M. & Matelli, M. (1985) Selective spatial attention. One center, one circuit, or many circuits? In: *Attention and performance XI*, ed. M. I. Posner & O. S. M. Marin. Lawrence Erlbaum Associates. [aFHP, KMH]
- Rizzolatti, G., Riggio, L., Dascola, I. & Umiltà, C. (1987) Reorienting attention across the horizontal and vertical meridians: Evidence in favor of a premotor theory of attention. *Neuropsychologia* 25:31-40. [aFHP]
- Rizzolatti, G., Scandolara, C., Matelli, M. & Gentilucci, M. (1981a) Afferent properties of periaruate neurons in macaque monkeys I. Somatosensory responses. *Behavioral Brain Research* 2:125-46. [KMH]
- (1981b) Afferent properties of periaruate neurons in macaque monkeys II. Visual responses. *Behavioral Brain Research* 2:147-63. [KMH]
- Robertson, L. C., Lamb, M. R. & Knight, R. T. (1988) Effects of lesions of temporal-parietal junction on perceptual and attentional processing in humans. *Journal of Neuroscience* 8:3757-69. [aFHP]
- Robinson, D. A. (1975) Oculomotor control signals. In: *Basic mechanisms of ocular motility and their clinical implications*, ed. G. Lennerstrand & P. Bach-y-Rita. [RMB]
- Robinson, D. L., Goldberg, M. E. & Stanton, C. B. (1978) Parietal association cortex in the primate. Sensory mechanisms and behavioral modifications. *Journal of Neurophysiology* 41:910-32. [aFHP]
- Robson, J. & Graham, N. (1978) Probability summation and regional variation in sensitivity across the visual field. *Investigative Ophthalmology and Visual Science* 17:221. [JRB]
- Rodman, H. R., Gross, C. G. & Albright, T. A. (1985) Removal of striate cortex does not abolish responsiveness of neurons in visual area MT of the macaque. *Society for Neuroscience Abstracts* 11:1246. [CJB]
- Rodman, H. R., Gross, C. G. & Albright, T. D. (1986) Responses of neurons in visual area MT after removal of the superior colliculus. *Society for Neuroscience Abstracts* 12:1369. [CJB]
- Rogers, B. & Graham, M. (1982) Similarities between motion parallax and stereopsis in human depth perception. *Vision Research* 22:261-70. [aFHP]
- Rolls, E. T. & Baylis, G. C. (1986) Size and contrast have only small effects on the responses to faces of neurons in the cortex of the superior temporal sulcus of the monkey. *Experimental Brain Research* 65:38-48. [MK]
- Rolls, E. T., Baylis, G. C., Hasselmo, M. E. & Nalwa, V. (1989) The effect of learning on the face selective responses of neurons in the cortex in the superior temporal sulcus of the monkey. *Experimental Brain Research* 76:153-64. [GWS]
- Rothstein, T. B. & Sacks, J. G. (1972) Defective stereopsis in lesions of the parietal lobe. *American Journal of Ophthalmology* 73:281-84. [aFHP]
- Rovamo, J. & Virsu, V. (1979) An estimation and application of the cortical magnification factor. *Experimental Brain Research* 37:495-510. [JMF]
- Roy, J. P. & Wurtz, R. H. (1989) Effect of the peripheral visual field on disparity sensitive cells in cortical visual area MST. *Society for Neuroscience Abstracts* 15:119. [MK, RMS]
- Rubens, A. B. (1985) Caloric stimulation and unilateral visual neglect. *Neurology* 35:1019-24. [aFHP]
- Rueckl, J. G., Cave, K. R. & Kosslyn, S. M. (1989) Why are "what" and "where" processed by separate cortical visual systems? A computational investigation. *Journal of Cognitive Neuroscience* 1:171-86. [CJM]
- Sagar, S. M. (1987) Somatostatin-like immunoreactive material in the rabbit retina. Immunohistochemical staining using monoclonal antibodies. *Journal of Comparative Neurology* 266:291-99. [LMC]
- Sagar, S. M. & Marshall, P. E. (1988) Somatostatin-like immunoreactive material in associational ganglion cells of human retina. *Neuroscience* 27:507-16. [LMC, RWW, rFHP]
- Sahgal, A. & Iversen, S. D. (1978) Categorization and retrieval after selective inferotemporal lesions in monkeys. *Brain Research* 146:341-50. [aFHP]
- Sato, H., Yukie, M., Tanaka, K., Hikosaka, K., Fukada, Y. & Iwai, E. (1986) Integration of direction signals of image motion in the superior temporal sulcus of the macaque monkey. *Journal of Neuroscience* 6:145-57. [aFHP, RMS]
- Sakata, H., Shibutani, H. & Kawano, K. (1980) Spatial properties of visual fixation neurons in posterior parietal association cortex of the monkey. *Journal of Neurophysiology* 43:1654-72. [MK, RMS]
- Sakata, H., Shibutani, H., Kawano, K. & Harrington, T. L. (1985) Neural mechanisms of space vision in the parietal association cortex of the monkey. *Vision Research* 25:453-63. [aFHP]
- Salman, S. D. & von Noorden, G. K. (1970) Induced vestibular nystagmus in strabismic patients. *Annals of Otology, Rhinology and Laryngology* 79:352-57. [aFHP]
- Scarisbrick, D. J., Tweedy, J. R. & Kuslansky, G. (1987) Hand preference and performance effects on line bisection. *Neuropsychologia* 25:695-99. [aFHP]
- Schein, S. J., Marrocco, R. T. & De Monasterio, F. M. (1982) Is there a high concentration of color-selective cells in area V4 of monkey visual cortex? *Journal of Neurophysiology* 47:193-213. [aFHP]
- Schiller, P. H. (1986) The central visual system. *Vision Research* 26:1351-86. [aFHP]
- Schiller, P. H. & Colby, C. L. (1983) The responses of single cells in the lateral geniculate nucleus of the rhesus monkey to color and luminance contrast. *Vision Research* 23:1631-41. [aFHP]
- Schiller, P. H., Logothetis, N. K. & Charles, E. R. (1989) The functions of



## References/Previc: Visual field specialization

- the color-opponent (C-O) and broad-band (B-B) channels in perception at luminance. *Investigative Ophthalmology & Visual Science* 30:323. (Supplement) [aFHP]
- Schiller, P. H. & Malpeli, J. G. (1978) Functional specificity of lateral geniculate nucleus laminae of the rhesus monkey. *Journal of Neurophysiology* 41:788-97. [aFHP]
- Schiller, P. H., Malpeli, J. G. & Schein, S. J. (1979) Composition of geniculostriate input to superior colliculus of the rhesus monkey *Journal of Neurophysiology* 42:1124-33. [aFHP]
- Schiller, P. H., Stryker, M., Cynader, M. & Berman, N. (1974) Response characteristics of single cells in the monkey superior colliculus following ablation or cooling of visual cortex. *Journal of Neurophysiology* 37:181-94. [aFHP]
- Schmidt, R. A., Zelaznik, H., Hawkins, B., Frank, J. S. & Quinn, J. T., Jr. (1979) Motor-output variability. A theory for the accuracy of rapid motor acts. *Psychological Review* 86:415-51. [RAA]
- Schneider, G. E. (1969) Two visual systems. *Science* 163:895-902. [CJB, LMC]
- Schor, C. & Narayan, V. (1981) The influence of field size upon the spatial frequency response of optokinetic nystagmus. *Vision Research* 21:985-94. [aFHP]
- Schor, C. M. & Westall, C. (1984) Visual and vestibular sources of fixation instability in amblyopia. *Investigative Ophthalmology & Visual Science* 25:729-38. [aFHP]
- Schwartz, S. & Kirsner, K. (1982) Laterality effects in visual information processing: Hemispheric specialization or the orienting of attention? *Quarterly Journal of Experimental Psychology* 34A:61-77. [aFHP]
- Schwartz, T. L., Dobson, V., Sandstrom, D. J. & van Hof-van Duin, J. (1987) Kinetic perimetry assessment of binocular visual field shape and size in young infants. *Vision Research* 27:2163-75. [aFHP]
- Sedgwick, H. A. (1986) Space perception. In: *Handbook of perception and performance*, vol. 1, ed. K. R. Boff, I. Kaufman & J. P. Thomas. Wiley & Sons. [aFHP]
- Sejnowski, T. J. (1988) Neural populations revealed. *Nature* 332:308. [RMB]
- Semmes, J. (1968) Hemispheric specialization. A possible clue to mechanism. *Neuropsychologia* 6:11-26. [MPB]
- Sergent, J. (1983a) The role of the input in visual hemispheric processing. *Psychological Bulletin* 93:481-512. [MPB]
- (1983b) The effects of sensory limitations on hemispheric processing. *Canadian Journal of Psychology* 37:345-66. [MPB]
- Shapley, R. & Perry, V. H. (1986) Cat and monkey retinal ganglion cells and their visual functional roles. *Trends in Neurosciences* 9:229-35. [aFHP]
- Shatz, C. J. & Stretavan, D. W. (1986) Interactions between retinal ganglion cells during the development of the mammalian visual system. *Annual Review of Neuroscience* 9:171-207. [aFHP]
- Shelton, P. A., Bowers, D. & Heilman, K. M. (1990) Peripersonal and vertical neglect. *Brain* 113:191-205. [KMH]
- Shulman, G. L., Sullivan, M. A., Gish, K. & Sakoda, W. J. (1986) The role of spatial-frequency channels in the perception of local and global structure. *Perception* 15:259-73. [aFHP]
- Siegel, R. M. (1987) Parallel distributed processing that obtains three-dimensional structure from motion. *Society for Neuroscience Abstracts* 13:630. [RMS]
- (1988) Discovery of structure from motion in monkey, man and machine. In: *Neural information processing systems*, ed. D. Z. Anderson. American Institute of Physics. [RMS]
- (1989) Motion analysis in the inferior parietal area 7a of the rhesus monkey. *Society for Neuroscience Abstracts* 15:162. [RMS]
- Siegel, R. M. & Andersen, R. A. (1987) Representation of head-centered visual space in the inferior parietal lobule of macaque monkey. *Neuroscience* 22:1293P (Supplement). [RMS]
- (1988) Perception of three-dimensional structure from two-dimensional motion in monkey and man. *Nature* 331:259-61. [RMS]
- Singer, W. (1977) Control of thalamic transmission by corticofugal and ascending reticular pathways in the visual system. *Physiological Reviews* 57:386-420. [aFHP]
- Singer, W. (1985) Central control of developmental plasticity in the mammalian visual cortex. *Vision Research* 25:389-96. [aFHP]
- (1985a) Human contrast sensitivity. Regional retinal differences. *Human Neurobiology* 4:97-99. [aFHP]
- (1985b) Critical flicker fusion and double flash discrimination in different parts of the visual field. *International Journal of Neuroscience* 25:225-31. [aFHP]
- Skrandies, W. (1987) The upper and lower visual field of man. Electrophysiological and functional differences. In: *Progress in sensory physiology* (vol. 8), eds. H. Autrum et al. Springer-Verlag.
- Slavik, B. A. (1982) Vestibular function in children with nonparalytic strabismus. *The Occupational Therapy Journal of Research* 2:220-33. [aFHP]
- Sloan, L. L. (1947) Rate of dark adaptation and regional threshold gradient of the dark-adapted eye: Physiologic and clinical studies. *American Journal of Ophthalmology* 30:705-20. [aFHP]
- Smith, A. T. & Hammond, P. (1986) Hemifield differences in perceived velocity. *Perception* 15:111-17. [aFHP]
- Snodderly, D. M. (1979) Visual discriminations encountered in food foraging by a neotropical primate: Implications for the evolution of color vision. In: *The behavioral significance of color*, ed. E. Burt G. Garland. [aFHP]
- Soper, H. V., Diamond, I. T. & Wilson, M. (1975) Visual attention and inferotemporal cortex in rhesus monkeys. *Neuropsychologia* 13:409-19. [aFHP]
- Soso, M. J., Lettich, E. & Belgum, J. H. (1980) Pattern-sensitive epilepsy II: Effects of pattern orientation and hemifield stimulation. *Epilepsia* 21:313-23. [aFHP]
- Sprague, J. M., Berlucchi, G. & Rizzolatti, G. (1973) The role of the superior colliculus and pretectum in vision and visually guided behavior. In: *Handbook of sensory physiology*, vol. 7, part 3, ed. R. Jung. Springer-Verlag. [aFHP]
- Stein, J. F. (1989) Representation of egocentric space in the posterior parietal cortex. *Quarterly Journal of Experimental Physiology* 74:583-606. [aFHP]
- Steinbach, M. J. (1976) Pursuing the perceptual rather than the retinal stimulus. *Vision Research* 16:1371-76. [aFHP]
- Steinmetz, M. A., Motter, B. C., Duffy, C. J. & Mountcastle, V. B. (1987) Functional properties of parietal visual neurons: Radial organization of directionalities within the visual field. *Journal of Neuroscience* 7:177-91. [aFHP, RMS]
- Stone, J. (1983) *Parallel processing in the visual system*. Plenum. [LMC, RWW]
- Strong, G. W. & Whitehead, B. A. (1989) A solution to the tag-assignment problem for neural networks. *Behavioral and Brain Sciences* 12:381-433. [GWS]
- Strul, M., Prevec, T. S. & Zidar, I. (1982) Dependence of visual evoked potentials on change of stimulated retinal area associated with different pattern displacements. *Electroencephalography and Clinical Neurophysiology* 53:634-42. [aFHP]
- Tanaka, K., Hikosaka, K., Saito, H., Yukie, M., Fukada, Y. & Iwai, E. (1986) Analysis of local and wide-field movements in the superior temporal visual areas of the macaque monkey. *Journal of Neuroscience* 6:134-44. [RMS]
- Tanaka, K. & Saito, H.-A. (1989) Analysis of motion of the visual field by direction, expansion/contraction, and rotation cells clustered in the dorsal part of the medial superior temporal area of the macaque monkey. *Journal of Neurophysiology* 62:626-41. [MK]
- Tootell, R. B. H., Silverman, M. S., Hamilton, S. L., De Valois, R. L. & Switkes, E. (1988) Functional anatomy of macaque striate cortex III. Color. *Journal of Neuroscience* 8:1569-93. [aFHP]
- Tootell, R. B. H., Switkes, E., Silverman, M. S. & Hamilton, S. L. (1988) Functional anatomy of macaque striate cortex II. Retinotopic organization. *Journal of Neuroscience* 8:1531-68. [aFHP]
- Treisman, A. M. & Schmidt, H. (1982) Illusory conjunctions in the perception of objects. *Cognitive Psychology* 14:107-41. [aFHP]
- Trevarthen, C. B. (1968) Two mechanisms of vision in primates. *Psychologische Forschung* 31:299-337. [CJB]
- Tusa, R. J., Demer, J. L. & Herdman, S. J. (1989) Cortical areas involved in OKN and VOR in cats: Cortical lesions. *Journal of Neuroscience* 9:1163-78. [aFHP]
- Tusa, R. J. & Palmer, L. A. (1980) Retinotopic organization of areas 20 and 21 in the cat. *Journal of Comparative Neurology* 193:147-64. [aFHP]
- Tychsen, L. (1989) Primary maldevelopment of visual motion pathway in humans. *Investigative Ophthalmology & Visual Science* 30:302 (Supplement). [aFHP]
- Tychsen, L. & Lisberger, S. G. (1986a) Visual motion processing for the initiation of smooth-pursuit eye movements in humans. *Journal of Neurophysiology* 56:953-68. [aFHP, CJB]
- (1986b) Maldevelopment of visual motion processing in humans who had strabismus with onset in infancy. *Journal of Neuroscience* 6:2495-2508. [aFHP]
- Tyler, C. W. (1987) Analysis of visual modulation sensitivity III. Meridional variations in peripheral flicker sensitivity. *Journal of the Optical Society of America A*:1612-19. [aFHP]
- Tynan, P. & Sekuler, R. (1975) Moving visual phantoms. A new contour completion effect. *Science* 188:951-52. [aFHP]
- Ullman, S. (1979) *The interpretation of visual motion*. MIT Press. [RMS]
- Underwood, G. (1976) *Attention and memory*. Pergamon. [MPB]

- Ungerleider, L. G. & Mishkin, M. (1982) Two cortical visual systems. In: *Analysis of visual behavior*, ed. D. J. Ingle, M. A. Goodale & R. J. Mansfield. MIT Press. [arFHP, MK, CJM, GWS]
- Vaina, L. M. (1989) Selective impairment of visual motion interpretation following lesions of the right occipito-parietal area in humans. *Biological Cybernetics* 61:347-59. [aFHP]
- Van Buren, J. M. (1963) *The retinal ganglion cell layer*. Thomas. [arFHP]
- Van Buren, J. M. & Baldwin, M. (1958) The architecture of the optic radiation in the temporal lobe of man. *Brain* 81:15-40. [aFHP]
- Van Essen, D. C. (1985) Functional organization of primate visual cortex. In: *Cerebral cortex Vol. 3 Visual cortex*, ed. A. Peters & E. G. Jones. Plenum Press. [RMB]
- Van Essen, D. C. & Maunsell, J. H. R. (1983) Hierarchical organization and functional streams in the visual cortex. *Trends in Neurosciences* 6:370-75. [aFHP]
- Van Essen, D. C., Maunsell, J. H. R. & Bixby, J. L. (1981) The middle temporal visual area in the macaque. Myeloarchitecture, connections, functional properties and topographic organization. *Journal of Comparative Neurology* 199:293-326. [aFHP]
- Van Essen, D. C., Newsome, W. T. & Maunsell, J. H. R. (1984) The visual field representation in striate cortex of the macaque monkey. Asymmetries, anisotropies, and individual variability. *Vision Research* 24:429-48. [aFHP]
- Vassilev, A. & Strashimirov, D. (1979) On the latency of human visually evoked response to sinusoidal gratings. *Vision Research* 19:843-45. [aFHP]
- Ventre, J. & Faugier-Grimaud, S. (1986) Effects of posterior parietal lesions (area 7) on VOR in monkeys. *Experimental Brain Research* 62:654-58. [aFHP]
- Von Der Marlsburg, C. & Singer, W. (1988) Principles of cortical network organization. In: *Neurobiology of neocortex*, ed. P. Rakic & W. Singer. Wiley & Sons. [aFHP]
- Von Noorden, G. K., Crawford, M. L. J. & Levacy, R. A. (1983) The lateral geniculate nucleus in human anisometric amblyopia. *Investigative Ophthalmology & Visual Science* 24:788-90. [aFHP]
- Wagman, I. H. (1964) Eye movements induced by electric stimulation of cerebrum in monkeys and their relationship to bodily movements. In: *The oculomotor system*, ed. M. B. Bender. Harper & Row. [aFHP]
- Walls, G. I. (1942) *The vertebrate eye and its adaptive radiation*. Cranbrook Press. [RWW]
- Warrington, E. K. & James, M. (1967) Disorders of visual perception in patients with localised cerebral lesions. *Neuropsychologia* 5:253-66. [aFHP]
- Warrington, E. K. & Taylor, A. M. (1973) The contribution of the right parietal lobe to object recognition. *Cortex* 9:152-64. [aFHP]
- Wasserstein, J., Zappulla, R., Rosen, J., Gerstman, L. & Rock, D. (1987) In search of closure: Subjective contour illusions, gestalt completion tests, and implications. *Brain and Cognition* 6:1-14. [aFHP]
- Weinstein, E. A. (1980) Clinical features of hemi-inattention. *Behavioral and Brain Sciences* 3:518-20. [aFHP]
- Weymouth, F. W., Hines, D. C., Acres, L. H., Raaf, J. E. & Wheeler, M. C. (1928) Visual acuity within the area centralis and its relation to eye movements and fixation. *American Journal of Ophthalmology* 11:947-60. [aFHP]
- White, C. A., Chalupa, L. M., Johnson, D. & Brecha, N. S. (in press) Somatostatin immunoreactive cells in the adult cat retina. *Journal of Comparative Neurology*. [LMC]
- White, C. A., Johnson, D., Chalupa, L. M. & Brecha, N. C. (1988a) Characterization of somatostatin-like immunoreactive cells in the adult cat retina. *Society of Neuroscience Abstracts* 14:1121. [LMC]
- (1988b) Somatostatin immunoreactivity (SRIF-I) in the adult cat retina. *Investigative Ophthalmology and Visual Science Supplements* 29:196. [LMC]
- Whiteside, T. C. D. (1952) Accommodation of the human eye in a bright and empty visual field. *Journal of Physiology* 118:65P. [rFHP]
- Wickler, K. C., Williams, R. W. & Rakic, P. (in press) The photoreceptor mosaic: Number and distribution of rods and cones in the rhesus monkey retina. *Journal of Comparative Neurology*. [RWV]
- Williams, L. G. (1966) The effect of target specification on objects fixated during visual search. *Perception & Psychophysics* 1:315-18. [aFHP]
- Williams, M. C. & Brannan, J. R. (1986) Global precedence in good and poor readers. Paper presented at the annual meeting of the Psychonomic Society, November, New Orleans, LA. [JRB]
- Williams, R. W., Cavada, C. & Reinoso-Suarez, F. (1989) Evolutionary plasticity in the feline retino-geniculate system. *Society for Neuroscience Abstracts* 15:457. [RWW]
- Wilson, M. E. & Toyne, M. J. (1970) Retino-tectal and cortico-tectal projections in *Macaca mulatta*. *Brain Research* 24:395-406. [aFHP]
- Wilson, H. R. & Giese, S. C. (1977) Threshold visibility of frequency gradient patterns. *Vision Research* 17:1177-90. [JRB]
- Wilson, M., Wilson, W. A., Jr. & Remez, R. (1977) Effects of prestriate, inferotemporal and superior temporal sulcus lesions on attention and gaze shifts in rhesus monkeys. *Journal of Comparative and Physiological Psychology* 91:1261-71. [aFHP]
- Wolfe, J. M. & Franzel, S. L. (1988) Bimodality and visual search. *Perception & Psychophysics* 44:81-93. [aFHP]
- Woodworth, R. S. (1938) *Experimental psychology*. Holt & Co. [aFHP]
- Yasuma, T., Miyakawa, N. & Yamazaki, J. (1986) Clinical application of time-dependent perimetry I. Results in normal subjects. *Japanese Journal of Ophthalmology* 30:330-37. [aFHP]
- Yazulla, S. (1974) Intraretinal differentiation in the synaptic organization of the inner plexiform layer of the pigeon retina. *Journal of Comparative Neurology* 153:309-24. [MAG]
- Yin, R. Z. (1969) Looking at upside-down faces. *Journal of Experimental Psychology* 81:141-45. [rFHP]
- Young, L. R. & Oman, C. M. (1974) Influence of head position and field on visually induced motion effects in three axes of rotation. In: *Proceedings of the Tenth Annual Conference on Manual Control*. Wright-Patterson Air Force Base, OH. [aFHP]
- Yund, E. W., Efron, R. & Nichols, D. R. (1990) Detectability gradients as a function of target location. *Brain and Cognition* 12:1-16. [rFHP]
- Zalutsky, R. A. & Miller, R. F. (1987) The physiology of somatostatin in the rabbit retina. *Society for Neuroscience Abstracts* 13:380. [LMC]
- (1988) Neuropeptide mechanisms in the rabbit retina. *Investigative Ophthalmology and Visual Science Supplements* 29:271. [LMC]
- Zee, D. S., Yamazaki, A., Butler, P. H. & Gucer, G. (1981) Effects of ablation of flocculus and paraflocculus on eye movements in primates. *Journal of Neurophysiology* 46:878-99. [aFHP]
- Zeki, S. (1980) The representation of colours in the cerebral cortex. *Nature* 284:412-18. [aFHP]
- Zeki, S. M. (1973) Colour coding in rhesus monkey prestriate cortex. *Brain Research* 53:422-27. [MK]
- (1977) Colour coding in the superior temporal sulcus of rhesus monkey visual cortex. *Proceedings of the Royal Society, series B* 197:195-223. [MK]
- Zihl, J., von Cramon, D. & Mai, N. (1983) Selective disturbance of movement vision after bilateral brain damage. *Brain* 106:313-40. [aFHP]
- Zipser, D. & Andersen, R. A. (1988) A back-propagation programmed network that simulates response properties of a subset of posterior parietal neurons. *Nature* 331:679-84. [rFHP, RMS]