

2

REPORT NO.

EVT 1-88

FILE

TRANSPORTABILITY TESTING OF LIGHT ARMORED VEHICLE-LOGISTICS (LAV-L)

AD-A215 596

DTIC
ELECTE
DEC 20 1989
S D D

DISSEMINATION STATEMENT A
Approved for public release
Distribution Unlimited

Prepared For:

U.S. Army Tank-Automotive Command
ATTN: AMCPM-LA-E
Warren, MI 48397-5000

Distribution Unlimited

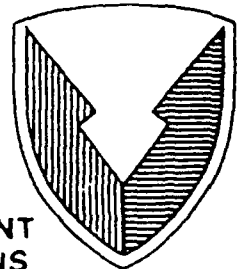

US ARMY
ARMAMENT
MUNITIONS
CHEMICAL COMMAND

US ARMY DEFENSE AMMUNITION
CENTER AND SCHOOL

EVALUATION DIVISION
SAVANNA, ILLINOIS 61074-9639

89 12 10 137

DISCLAIMER NOTICE

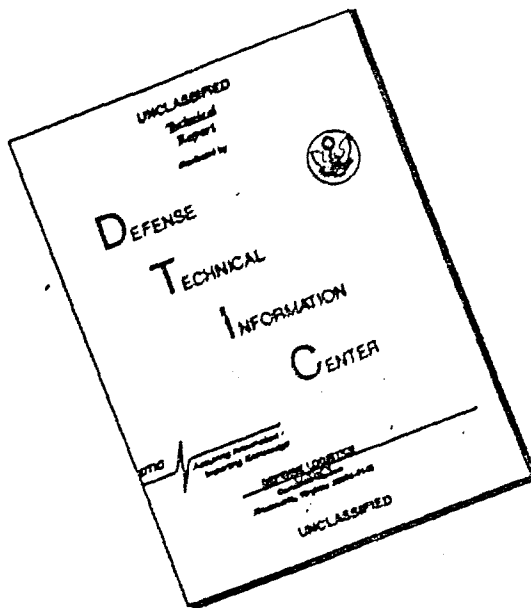

THIS DOCUMENT IS BEST QUALITY AVAILABLE. THE COPY FURNISHED TO DTIC CONTAINED A SIGNIFICANT NUMBER OF PAGES WHICH DO NOT REPRODUCE LEGIBLY.

AVAILABILITY NOTICE

A copy of this report is furnished each attendee on automatic distribution. Additional copies or authority for reprinting may be obtained by written request from Director, U.S. Army Defense Ammunition Center and School. ATTN: SMCAC-DEV, Savanna, IL 61074-9639.

DISTRIBUTION INSTRUCTIONS

Destroy this report when no longer needed. Do not return.

* * *

Citation of trade names in this report does not constitute an official endorsement.

* * *

The information contained herein will not be used for advertising purposes.

UNCLASSIFIED

SECURITY CLASSIFICATION OF THIS PAGE

Form Approved
OMB No. 0704-0188

REPORT DOCUMENTATION PAGE

1a. REPORT SECURITY CLASSIFICATION UNCLASSIFIED			1b. RESTRICTIVE MARKINGS			
2a. SECURITY CLASSIFICATION AUTHORITY			3. DISTRIBUTION/AVAILABILITY OF REPORT			
2b. DECLASSIFICATION/DOWNGRADING SCHEDULE						
4. PERFORMING ORGANIZATION REPORT NUMBER(S) EVT 1-88			5. MONITORING ORGANIZATION REPORT NUMBER(S)			
6a. NAME OF PERFORMING ORGANIZATION U.S. Army Defense Ammunition Center and School		6b. OFFICE SYMBOL (If applicable) SMCAC-DEV	7a. NAME OF MONITORING ORGANIZATION U.S. Army Tank-Automotive Command			
6c. ADDRESS (City, State, and ZIP Code) ATTN: SMCAC-DEV Savanna, IL 61074-9639			7b. ADDRESS (City, State, and ZIP Code) ATTN: AMCPM-LA-E Warren, MI 48397-5000			
8a. NAME OF FUNDING/SPONSORING ORGANIZATION		8b. OFFICE SYMBOL (If applicable)	9. PROCUREMENT INSTRUMENT IDENTIFICATION NUMBER			
8c. ADDRESS (City, State, and ZIP Code)			10. SOURCE OF FUNDING NUMBERS			
			PROGRAM ELEMENT NO.	PROJECT NO.	TASK NO.	WORK UNIT ACCESSION NO.
11. TITLE (Include Security Classification) Transportability Testing of Light Armored Vehicle-Logistics (LAV-L)						
12. PERSONAL AUTHOR(S) J. H. Krohn						
13a. TYPE OF REPORT FINAL		13b. TIME COVERED FROM <u>Nov 87</u> TO <u>Dec 88</u>		14. DATE OF REPORT (Year, Month, Day) 1989 March 14	15. PAGE COUNT 86	
16. SUPPLEMENTARY NOTATION						
17. COSATI CODES			18. SUBJECT TERMS (Continue on reverse if necessary and identify by block number) Rail Impact Road Hazard Course Light Armored Vehicle-Logistics (LAV-L)			
FIELD	GROUP	SUB-GROUP				
19. ABSTRACT (Continue on reverse if necessary and identify by block number) The U.S. Army Defense Ammunition Center and School (USADACS) conducted a transportability test of the U.S. Marine Corps Light Armored Vehicle-Logistics (LAV-L) at the request of the U.S. Army Tank-Automotive Command (TACOM) and to satisfy requirements of the Military Traffic Management Command-Transportation Engineering Agency (MTMC-TEA) and USADACS. The transportability testing evaluates the suitability of the LAV-L for transporting ammunition in the rail and highway mode. The transportability testing of the LAV-L consists of a rail impact and a series of road tests with three types of ammunition considered representative of the ammunition expected to be carried on the LAV-L. The rail impact test was performed with a 4,000-lb pallet of simulated ammunition secured in the cargo area of the LAV-L. During the six mile per hour (mph) rail impact, the pin in the vehicle tiedown clevis on the front curbside of the LAV-L failed. (cont. over)						
20. DISTRIBUTION/AVAILABILITY OF ABSTRACT <input type="checkbox"/> UNCLASSIFIED/UNLIMITED <input checked="" type="checkbox"/> SAME AS RPT <input type="checkbox"/> DTIC USERS			21. ABSTRACT SECURITY CLASSIFICATION UNCLASSIFIED			
22a. NAME OF RESPONSIBLE INDIVIDUAL THOMAS J. MICHELS			22b. TELEPHONE (Include Area Code) AV 585-8080	22c. OFFICE SYMBOL SMCAC-DEV		

DD Form 1473, JUN 86

Previous editions are obsolete

SECURITY CLASSIFICATION OF THIS PAGE

19. ABSTRACT (cont)

In an effort to continue testing, the front cables were applied directly to the vehicle tiedown point without the use of clevises. The vehicle tie-downs completed the rail impact test without incident. The procedure for securing the 4,000-lb LAV-L payload failed.

Prior to the rail impact retest, eight clevises were received and installed in place of the tested clevises. Also prior to the retest, the web straps restraining the inertly loaded pallet were altered to create more securement of the pallet.

The rail impact retest was completed without incident as was the series of road tests with the 4,000-lb pallet load, the Stinger missile load, and the mixed load of various types of ammunition packages. After replacing the clevises, the LAV-L functioned very well during the rail impact test.

PART 1

GENERAL

A. INTRODUCTION. The U.S. Army Defense Ammunition Center and School (USADACS) was requested by the U.S. Army Tank-Automotive Command (TACOM) to conduct transportability testing on the U.S. Marine Corps Light Armored Vehicle-Loaders (LAV-L). The tests on the LAV-L were conducted to evaluate its suitability for transporting a capacity load (4,000 lbs) and other munition loads the vehicle is expected to carry.

Both the rail impact and the road hazard course tests were conducted with the ammunition load being secured using the six web strap tiedown assemblies loaded with the LAV-L.

B. AUTHORITY. The test was accomplished in accordance with mission responsibilities delegated by the U.S. Army Armament, Munitions and Chemical Command (AMCCOM). Reference is made to the following:

1. Change 4, 4 October 1974, to AR 740-1, 23 April 1973, Storage and Supply Activity Operation.

2. AMCCOM-R 10-17, 13 January 1986, Mission and Major Functions of LAV-L.

3. Memorandum, USATACOM, AMCPM-LA-E, 7 August 1987, subject: Test plan for the LAV-L to Transport Ammunition.

C. PURPOSE. The objective of this test was to evaluate and determine if the LAV-L and its requirement system are suitable to transport ammunition.

D. FINDINGS. In the initial rail impact test, a pin in the vehicle tiedown system on the driver's side of the front of the LAV-L failed during the 6 mph rail impact. Two other pins in the tiedown assemblies on the front of the LAV-L were damaged and bent directly into the vehicle front elevis pin during the 6 mph rail impact. The 4, 6, 8, and reverse 8 mph rail

impacts left the web straps securing the pallet very loose and the straps had moved from their original position. The pallet restraint method had failed.

The LAV-L was tested on the USADACS road hazard course with loads representative of the various types of ammunition expected to be carried in the vehicle. The three test loads were restrained with the six web straps issued with the LAV-L. The movement of the various loads was minimal during the test.

A rail impact retest of the LAV-L was performed with a 4,000-lb pallet secured in the cargo area. Prior to this rail impact retest, eight replacement tiedown clevises were received from the Marine Corps at Twentynine Palms, CA. These clevises were placed on the LAV-L prior to the test. The 4,000-lb pallet moved forward and rearward during the rail impacts, but the pallet remained within the confines of the cargo area and no damage resulted.

E. RECOMMENDATIONS.

(1) It is recommended steps be taken to assure that proper vehicle tie-down clevises are used on the LAV-L when the vehicle is cabled to a railroad flatcar. Permanently attaching the proper clevises to the LAV-L is also recommended.

(2) It is recommended that USADACS be tasked to develop a 19-48 series drawing delineating proper restraint and tie down of ammunition in the LAV-L.

F. APPROVAL

Using the securement procedures developed in the transportability testing, the LAV-L is approved for transport of ammunition on/off highway and under load while secured to a railroad flatcar.

PART 2

Light Armored Vehicle-Logistics (LAV-L) and M927A1/M925A1
 Rail Impact Testing, 15-16 December 1987

ATTENDEES

<u>NAME & PHONE NUMBER</u>	<u>ADDRESS</u>
Mr. C. Wayne Crews AV 927-4646	Commander Military Transportation Engineering Agency ATTN: MTT-TRV P.O. Box 6276 Newport News, VA 23606-0276
Mr. John A. Green Com. (202) 639-2357	Assistant Chief Engineer Freight Claim and Damage Prevention Division Association of American Railroads 50 F Street NW Washington, D.C. 20001
Mr. Robert J. Ewoldt Com. (202) 592-5637	Inspector, Hazardous Materiels Association of American Railroads 50 F Street NW Washington, D.C. 20001
Mr. Jim Alexander AV 927-4646	Military Traffic Management Engineering Agency ATTN: MTT-TRU Warwick Blvd., P.O. Box 6276 Newport News, VA 23606
Mr. Pat Brennan AV 952-6854/6848 Com. (619) 368-6854-6848	30 LAV Bn. 7th MAB FMF Twentynine Palms, CA 92272
Mr. John L. Pappin Com. (313) 523-8907	AM General P.O. Box 3330 Levonian, MI 48151
Mr. Max Kahn AV 786-6975 Com. (313) 574-6975	U.S. Army Tank-Automotive Command ATTN: AMCPM-TV-EM Warren, MI 48397-5000
Mr. Jerry Krohn AV 585-8908 Com. (815) 273-8908	Director U.S. Army Defense Ammunition Center and School ATTN: SMCAC-DEV Savanna, IL 61074-9639
Mr. John Simons AV 585-8927 Com. (815) 273-8927	Director U.S. Army Defense Ammunition Center and School ATTN: SMCAC-DEO Savanna, IL 61074-9639

PART 3

TRANSPORTABILITY TESTING PROCEDURES

A. RAIL IMPACT TESTING:

Rail impact testing was accomplished in compliance with previously approved and standardized testing procedures as shown on Page 3-4 and described as follows:

1. The 'Specimen Car' was scheduled to be impacted four times; three times at speeds of 4, 6, and 8 mph in one direction, and one time at 8 mph in the opposite direction. The latter two impacts cited are minimum speed requirements.

2. Impacting was accomplished by striking the test car (specimen car) into a line of five stationary cars (buffer cars). The buffer cars were coupled with all connecting draft gears compressed together to the maximum extent possible under prevailing conditions, with all air brakes in a 'set position.'

3. A locomotive (switch engine) was utilized to start the 'specimen car' rolling in the direction of the buffer cars along an approximate 300-foot segment of level trackage.

4. The 'specimen car' was cut loose from the engine approximately 75 feet from the point of impact and allowed to run freely into the first of the buffer cars.

5. Impacting speeds were determined by the utilization of an electronic counter which measured the time required for the specimen car to traverse an 11-foot distance immediately prior to contact; recorded elapsed time was converted to mph speeds. Additional verification of impacting speeds was accomplished by utilization of an electronic stop clock.

ASSOCIATION OF AMERICAN RAILROADS (AAR)
STANDARD TEST PLAN

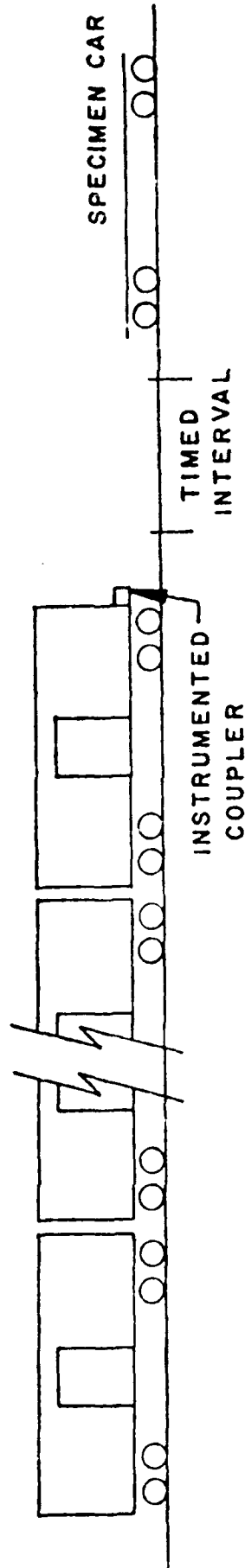
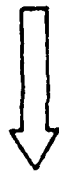

5 BUFFER CARS WITH DRAFT GEAR
COMPRESSED AND AIR BRAKES IN
A SET POSITION

BUFFER CAR TOTAL WT 251,000 LBS (APPROX)

SPECIMEN CAR
IS RELEASED BY
SWITCH ENGINE AT:
IMPACT NO. 1 4 MPH
IMPACT NO. 2 6 MPH
IMPACT NO. 3 8 MPH
THEN CAR IS REVERSED
AND RELEASED AT
IMPACT NO. 4 8 MPH

B. ROAD TESTING PROCEDURES

Five separate road testing steps are required as identified herein:

1. Step No. 1. This step provides for the specimen load to be driven over a 200-foot-long segment of concrete paved road which consists of two series of railroad ties projecting 6 inches above the level of the road surface. This hazard course was traversed two times.

a. The first series of ties are spaced on 8-foot centers and alternately positioned on opposite sides of the road centerline for a distance of 50 feet.

b. Following the first series of ties, a paved roadway of 75 feet separates the first and second series of railroad ties.

c. The second series of ties are alternately positioned similarly to the first, but spaced on 10-foot centers for a distance of 50 feet.

d. The specimen load was driven across the hazard course at speeds that would produce the most violent vertical and side-to-side rolling reaction obtainable in traversing the hazard course (approximately five mph).

2. Step No. 2. This step consist of 30 miles of travel over available rough roads consisting of gravel, concrete and asphalt, curves, cattle gates, and stops and starts.

3. Step No. 3. This step provides for the specimen load to be subjected to three full air brake stops while traveling in the forward direction and one in the reverse direction while traveling down a seven percent grade. The first three stops are at speeds of 5, 10, and 15 mph, while the stop in the reverse direction is of approximately 5 mph.

4. Step No. 4. This step consists of a repeat of that identified in the above

5. Step No. 5. This step provides for the specimen load to be driven over a 300-foot-long segment of concrete paved road which has rails spaced on 26-1/2-inch centers and protruding two inches above the road surface. The specimen load was driven at the speed which will produce the most violent response.

NOTE: Step Nos. 3 and 5 may be deleted at the discretion of the test conductor.

C. INSPECTIONS AND DATA COLLECTION

At selected intervals during testing, thorough inspections of the specimen loads were made by technically proficient personnel to collect data on the specimen load and equipment resulting from above load test steps. This data is recorded in Part 4, following.

US ARMY DEFENSE AMMUNITION CENTER AND SCHOOL

TRANSPORTABILITY ROAD COURSE

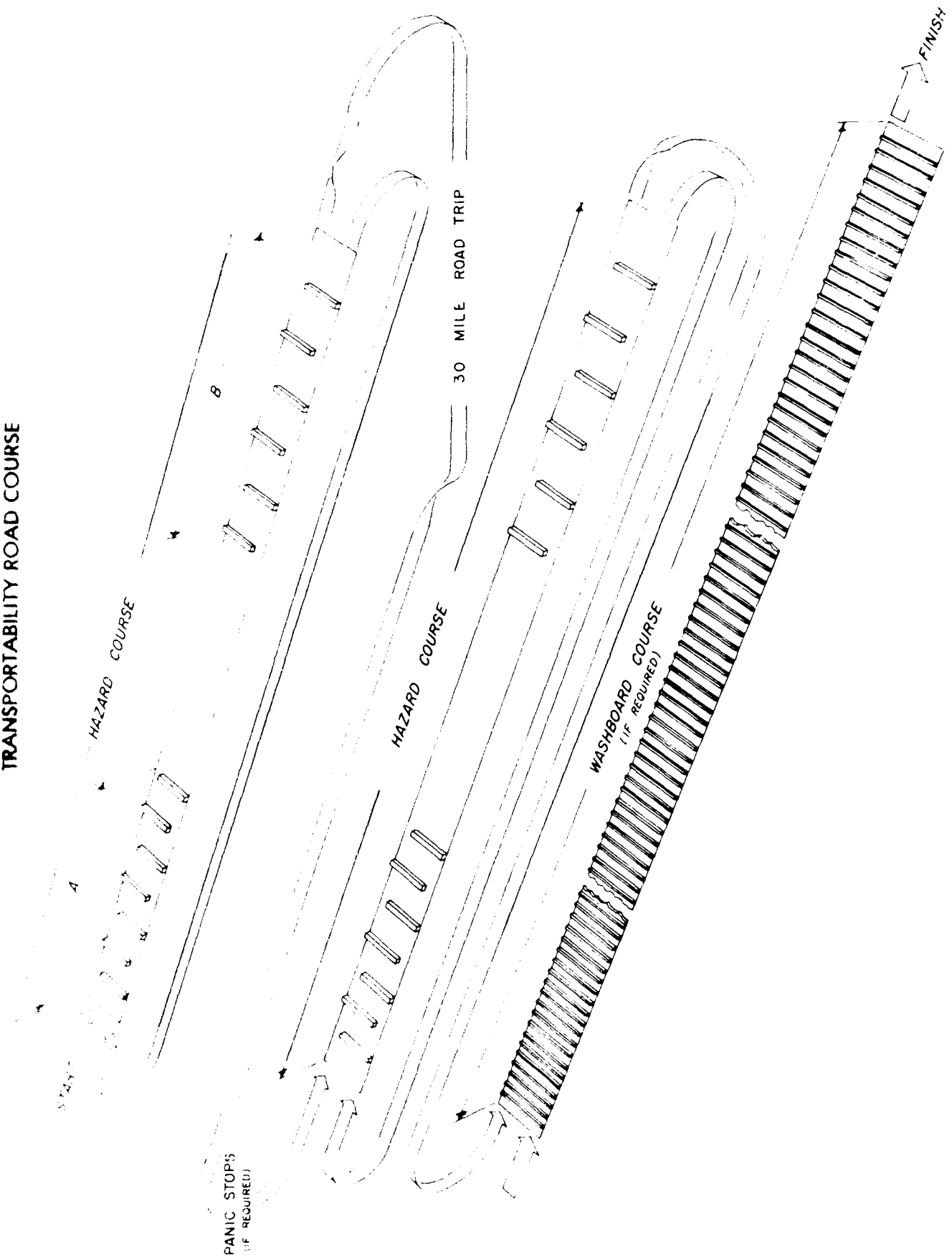

START

HAZARD COURSE

30 MILE ROAD TRIP

HAZARD COURSE

WASHBOARD COURSE
(IF REQUIRED)

FINISH

PANIC STOP
(IF REQUIRED)

PART 4

TEST SPECIMENS AND RESULTS

SYNOPSIS OF RAIL IMPACT TEST

The Light Armored Vehicle Logistics (LAV-L) was secured to railroad flatcar, BN 600371 with a total of eight 5/8-in cables. Two cables were placed through each clevis on the LAV-L and tensioned through the stake pockets on the side of the railroad flatcar.

Within the cargo carrying area of the LAV-L, a pallet of M548 inertly loaded metal cans weighing 4,000 pounds was secured with six web straps issued with the LAV-L. Two web straps extended over the pallet longitudinally, two web straps extended over the pallet laterally and one strap extended around the forward and rear of the pallet just above the pallet base.

During the six mph (6.42 mph actual speed) rail impact, the pin in the vehicle tiedown clevis located on the driver's side on the front of the LAV-L failed. The pin failed through the throat of the first thread from the head side of the pin of the clevis.

RESULTS OF THE HAIL IMPACT TEST
ON THE MARINE VEHICLE
DATE: 18 & 19 NOVEMBER 1987

TAPE CHANNEL 3 : LONG. ACELL. ON SILL

TEST	SPEED MPH	PEAK VALUE G'S	DURATION MILLISECONDS	AREA G'S-SECONDS
IMPACT 1	4.34	**	**	**
IMPACT 2 (FAILURE)	6.42	**	**	**
IMPACT 3	4.18	**	**	**
IMPACT 4	6.30	**	**	**
*IMPACT 5	8.31	-13.33	75.85	1.00
IMPACT 6 (REVERSE)	8.21	2.31	80.16	.11

TAPE CHANNEL 4 : VERT. ACELL. ON SILL

TEST	SPEED MPH	PEAK VALUE G'S	DURATION MILLISECONDS	AREA G'S-SECONDS
IMPACT 1	4.34	**	**	**
IMPACT 2 (FAILURE)	6.42	-1.03	48.89	.01
IMPACT 3	4.18	.43	51.69	.01
IMPACT 4	6.30	.50	51.27	.02
*IMPACT 5	8.31	-22.37	80.27	.99
IMPACT 6 (REVERSE)	8.21	.45	69.21	.02

TAPE CHANNEL 5 : LONG. ACELL. ON AXEL

TEST	SPEED MPH	PEAK VALUE G'S	DURATION MILLISECONDS	AREA G'S-SECONDS
IMPACT 1	4.34	-1.61	96.06	.03
IMPACT 2 (FAILURE)	6.42	-1.77	106.74	.04
IMPACT 3	4.18	-1.57	101.48	.03
IMPACT 4	6.30	-1.74	94.63	.04
*IMPACT 5	8.31	-9.47	79.89	.42
IMPACT 6 (REVERSE)	8.21	1.06	89.12	.06

TAPE CHANNEL 6 : RAIL COUPLER FORCE

TEST	SPEED MPH	PEAK VALUE POUNDS	DURATION MILLISECONDS	AREA POUNDS-SECONDS
IMPACT 1	4.34	150854.09	172.14	10000.03
IMPACT 2 (FAILURE)	6.42	100751.25	115.73	17000.03
IMPACT 3	4.18	181495.34	116.12	20000.45
IMPACT 4	6.30	201856.09	109.16	21000.03
*IMPACT 5	8.31	12019.18	107.83	10000.15
IMPACT 6 (REVERSE)	8.21	117942.51	100.00	10000.00

TAPE CHANNEL 7 : LAT. ACELL. ON AXEL

TEST	SPEED MPH	PEAK VALUE G'S	DURATION MILLISECONDS	AREA G'S-SECONDS
IMPACT 1	4.34	.03	65.87	.00
IMPACT 2 (FAILURE)	6.42	-.16	61.99	.01
IMPACT 3	4.18	-.05	71.26	.00
IMPACT 4	6.30	-.06	60.82	.00
IMPACT 5	8.31	-9.46	87.37	.45
IMPACT 6 (REVERSE)	8.21	-.13	87.10	.01

TAPE CHANNEL 8 : VERT. ACELL. ON AXEL

TEST	SPEED MPH	PEAK VALUE G'S	DURATION MILLISECONDS	AREA G'S-SECONDS
IMPACT 1	4.34	-.22	83.85	.01
IMPACT 2 (FAILURE)	6.42	.36	80.40	.02
IMPACT 3	4.18	-.42	79.86	.02
IMPACT 4	6.30	-.42	88.55	.02
IMPACT 5	8.31	-9.11	81.48	.41
IMPACT 6 (REVERSE)	8.21	.35	72.84	.02

TAPE CHANNEL 9 : LONG. ACELL. ON BODY

TEST	SPEED MPH	PEAK VALUE G'S	DURATION MILLISECONDS	AREA G'S-SECONDS
IMPACT 1	4.34	-.67	96.03	.04
IMPACT 2 (FAILURE)	6.42	-.79	107.30	.05
IMPACT 3	4.18	-.64	98.98	.04
IMPACT 4	6.30	-.82	94.45	.04
IMPACT 5	8.31	-9.43	76.79	.41
IMPACT 6 (REVERSE)	8.21	1.35	89.57	.07

TAPE CHANNEL 10 : LAT. ACELL. ON BODY

TEST	SPEED MPH	PEAK VALUE G'S	DURATION MILLISECONDS	AREA G'S-SECONDS
IMPACT 1	4.34	-.09	77.36	.00
IMPACT 2 (FAILURE)	6.42	-.24	69.93	.01
IMPACT 3	4.18	-.09	65.56	.00
IMPACT 4	6.30	-.13	66.92	.01
IMPACT 5	8.31	-9.39	76.37	.41
IMPACT 6 (REVERSE)	8.21	-.09	56.22	.00

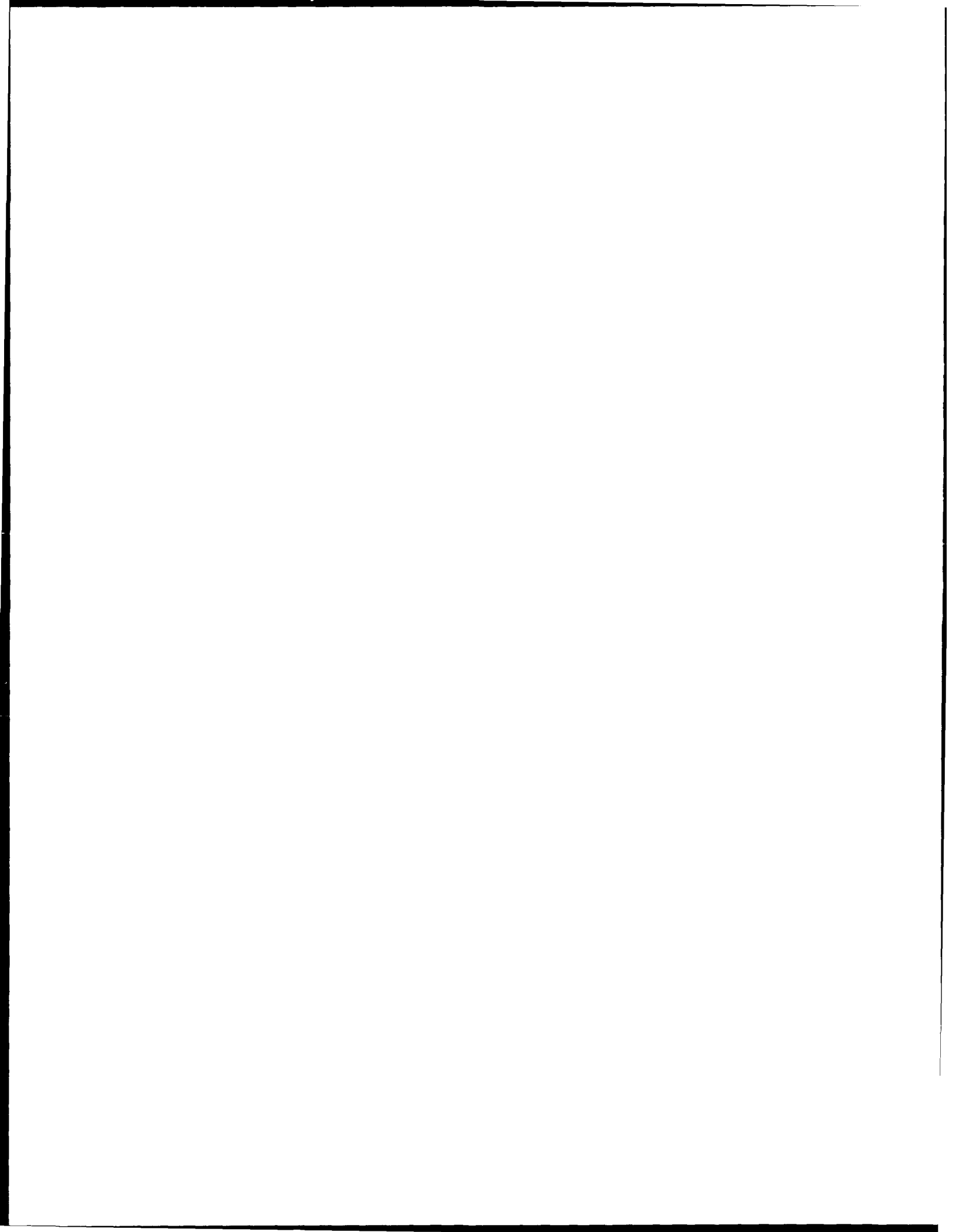

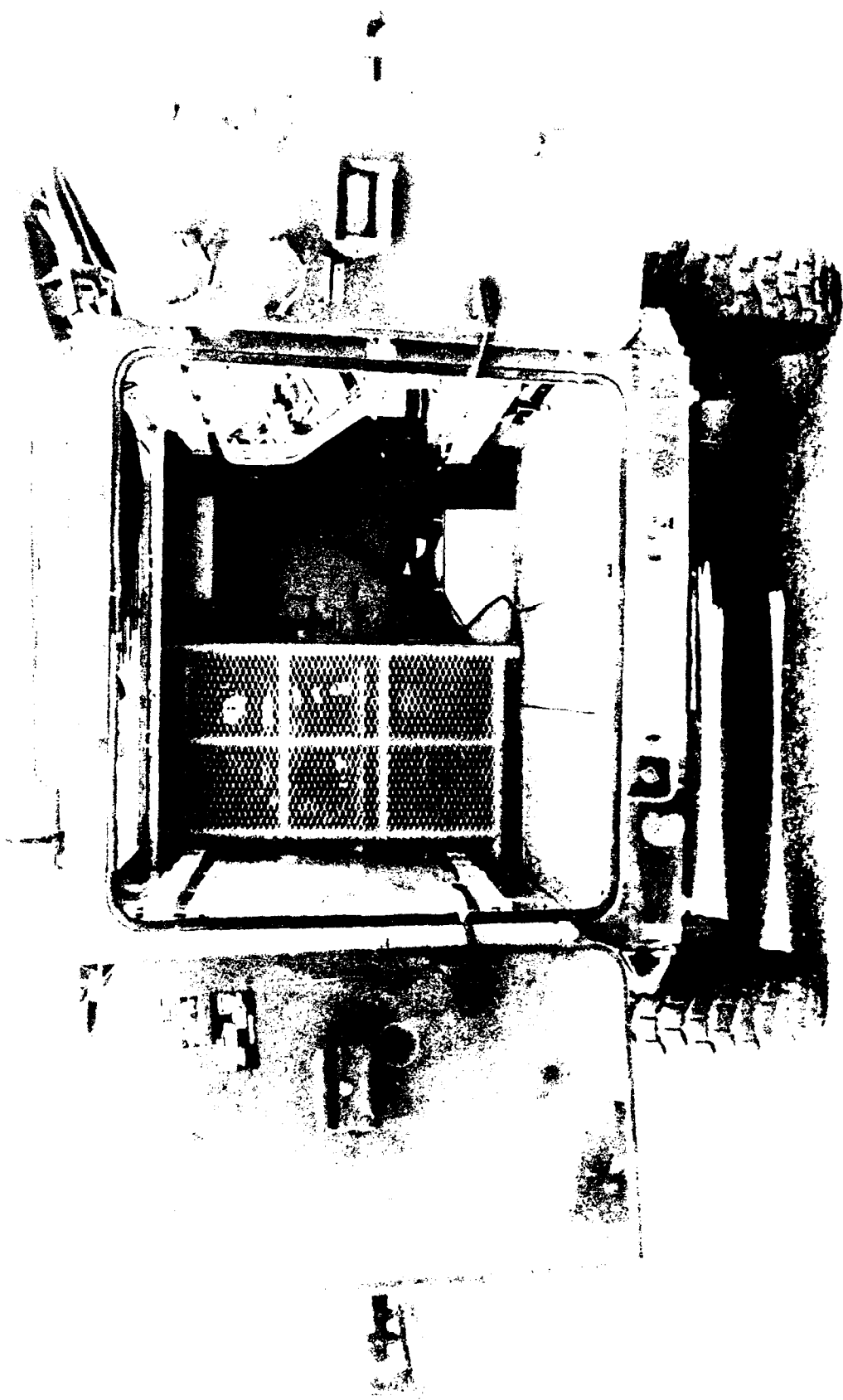

DEFENSE AMMUNITION CENTER AND SCHOOL - SAVANNAH, IL

REPORT OF INVESTIGATION - SEPTEMBER 1954 - 154-104-1

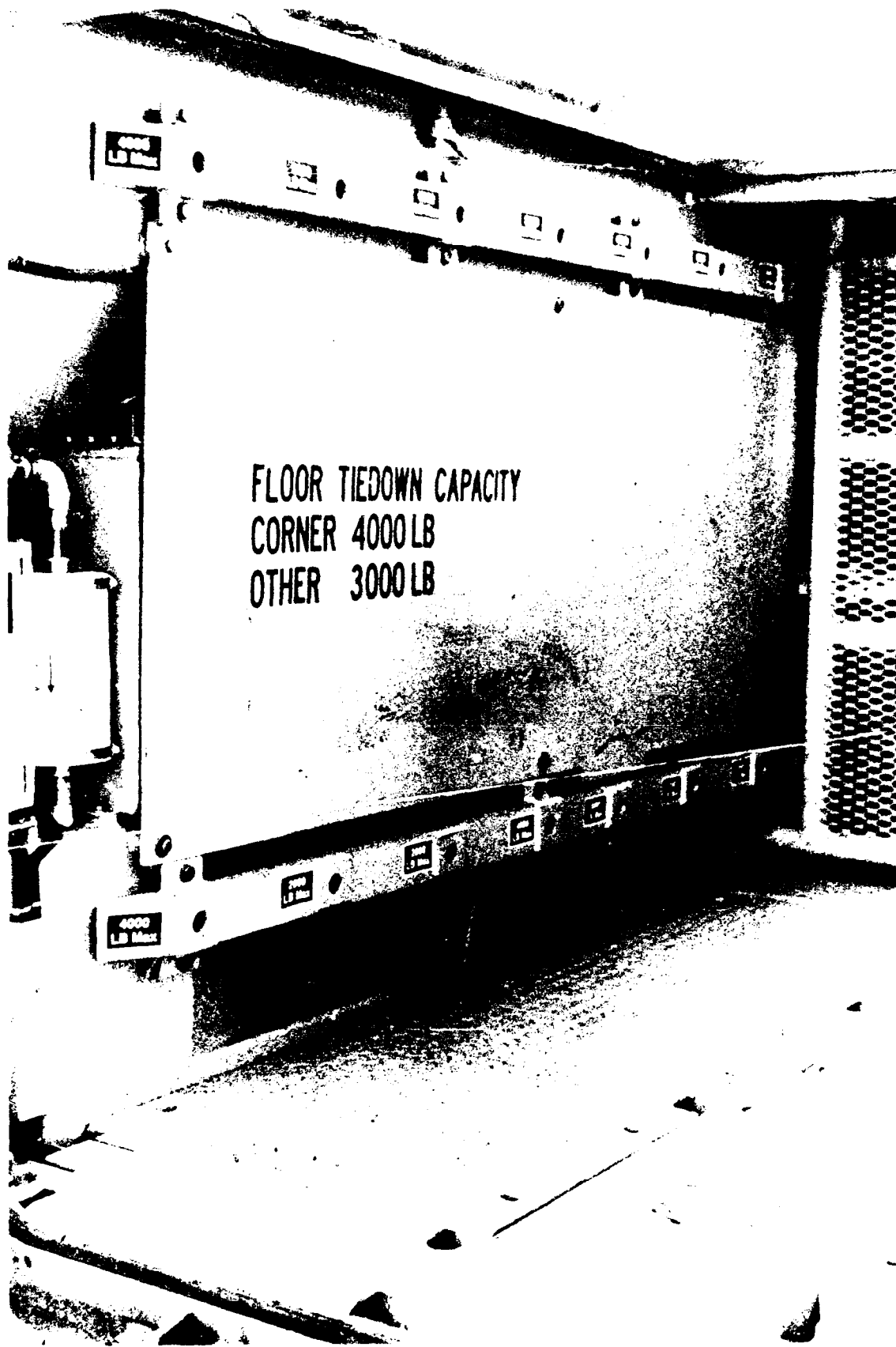

DEFENSE AMMUNITION CENTER AND SCHOOL - SAVANNA, IL

Photo 2. View of cargo carrying compartment of the LAV-L showing the web strap attachment points on floor and wall with the ratings of the various points.



DEFENSE AMMUNITION CENTER AND SCHOOL - SAVANNA, IL

Photo 3. View of the cargo carrying compartment of the LAV-L showing the web strap attachment points on the floor and wall with the ratings of the various points. Note the type of fixture on the ends of the six tiedown straps issued with the LAV-L.

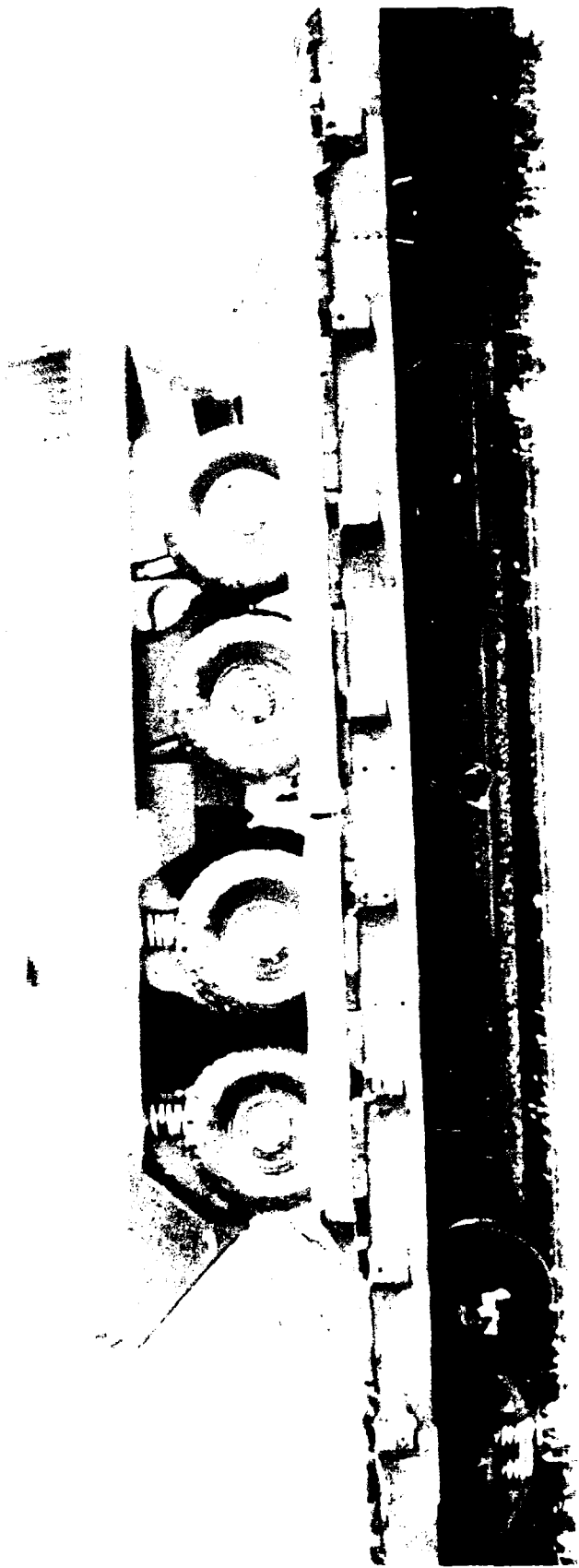

DEFENSE AMMUNITION CENTER AND SCHOOL - SAVANNA, IL

Photo 4. View of the LAV-L secured to the railroad flatcar.



DEFENSE AMMUNITION CENTER AND SCHOOL - SAVANNA, IL

Photo 5. View from the top of the LAV-L cargo compartment showing the position of the web straps securing the pallet in the LAV-L cargo compartment.



DEFENSE AMMUNITION CENTER AND SCHOOL - SAVANNA, IL

Photo 6. View of the failed vehicle tieddown clevis located on the driver's side of the front of the LAV-L.

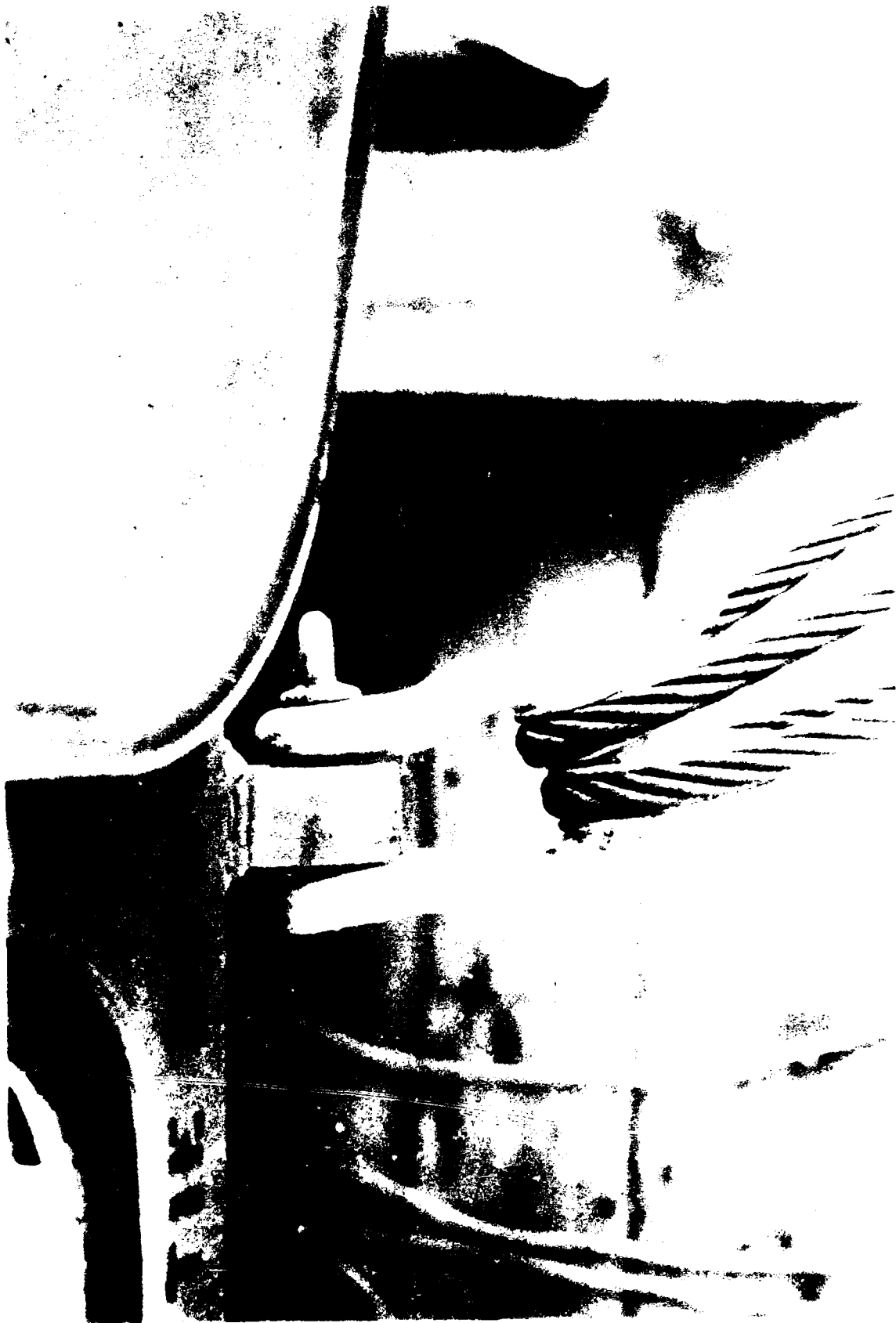

DEFENSE AMMUNITION CENTER AND SCHOOL - SAVANNA, IL

Photo 7. View of a vehicle tiedown clevis located on the curbside at the rear of the vehicle. Note how the cables pull against the side of the clevis putting tension on the clevis pin.



DEFENSE AMMUNITION CENTER AND SCHOOL - SAVANNA, IL

Photo 8. View of an accelerometer positioned on the wheel axle brace.

SYNOPSIS OF RAIL IMPACT RETEST

After failure of the clevis in the six mph rail impact of the LAV-L and with no replacement clevis available, both clevises were removed from the front tiedown provisions of the LAV-L and the two 5/8-inch cables were placed directly through the alternate vehicle front tiedown provisions without the use of a clevis. The rear cabling remained as tested in the previous test.

No problems were experienced with the vehicle tiedown procedure; however, on the reverse impact, the horizontal strap around back of the pallet became slack and dropped to the floor of the LAV-L where it offered no restraint. This cargo tiedown procedure failure requires a retest.

RESULTS OF THE RAIL IMPACT TEST
ON THE MARINE VEHICLE
DATE: 18 & 19 NOVEMBER 1987

TAPE CHANNEL 3 : LONG. ACELL. ON SILL

TEST	SPEED MPH	PEAK VALUE G'S	DURATION MILLISECONDS	AREA G'S-SECONDS
IMPACT 1	4.34	*****	*****	*****
IMPACT 2 (FAILURE)	6.42	*****	*****	*****
IMPACT 3	4.18	*****	*****	*****
IMPACT 4	6.30	*****	*****	*****
IMPACT 5	8.31	-23.33	75.85	1.00
IMPACT 6 (REVERSE)	8.21	2.31	80.16	.11

TAPE CHANNEL 4 : VERT. ACELL. ON SILL

TEST	SPEED MPH	PEAK VALUE G'S	DURATION MILLISECONDS	AREA G'S-SECONDS
IMPACT 1	4.34	*****	*****	*****
IMPACT 2 (FAILURE)	6.42	-.23	48.89	.01
IMPACT 3	4.18	.43	51.69	.01
IMPACT 4	6.30	.53	51.27	.02
IMPACT 5	8.31	-22.37	80.27	.99
IMPACT 6 (REVERSE)	8.21	.45	69.21	.02

TAPE CHANNEL 5 : LONG. ACELL. ON AXEL

TEST	SPEED MPH	PEAK VALUE G'S	DURATION MILLISECONDS	AREA G'S-SECONDS
IMPACT 1	4.34	-.61	96.06	.03
IMPACT 2 (FAILURE)	6.42	-.73	106.74	.04
IMPACT 3	4.18	-.57	101.48	.03
IMPACT 4	6.30	-.74	94.63	.04
IMPACT 5	8.31	-9.42	79.89	.42
IMPACT 6 (REVERSE)	8.21	1.26	89.12	.06

TAPE CHANNEL 6 : RAIL COUPLER FORCE

TEST	SPEED MPH	PEAK VALUE POUNDS	DURATION MILLISECONDS	AREA POUNDS-SECONDS
IMPACT 1	4.34	158854.09	122.18	10751.63
IMPACT 2 (FAILURE)	6.42	200351.28	115.39	13073.83
IMPACT 3	4.18	152495.34	116.12	9896.45
IMPACT 4	6.30	201556.09	108.80	12251.03
IMPACT 5	8.31	222019.28	107.83	13409.15
IMPACT 6 (REVERSE)	8.21	213343.91	120.06	14588.39

TAPE CHANNEL 7 : LAT. ACELL. ON AXEL

TEST	SPEED MPH	PEAK VALUE G'S	DURATION MILLISECONDS	AREA G'S-SECONDS
IMPACT 1	4.34	.03	65.87	.00
IMPACT 2 (FAILURE)	6.42	-.16	61.99	.01
IMPACT 3	4.18	-.05	71.26	.00
IMPACT 4	6.30	-.06	60.82	.00
IMPACT 5	8.31	-9.46	87.37	.45
IMPACT 6 (REVERSE)	8.21	-.13	87.10	.01

TAPE CHANNEL 8 : VERT. ACELL. ON AXEL

TEST	SPEED MPH	PEAK VALUE G'S	DURATION MILLISECONDS	AREA G'S-SECONDS
IMPACT 1	4.34	-.22	83.85	.01
IMPACT 2 (FAILURE)	6.42	.36	80.40	.02
IMPACT 3	4.18	-.42	79.86	.02
IMPACT 4	6.30	-.42	88.55	.02
IMPACT 5	8.31	-9.11	81.48	.41
IMPACT 6 (REVERSE)	8.21	.35	72.84	.02

TAPE CHANNEL 9 : LONG. ACELL. ON BODY

TEST	SPEED MPH	PEAK VALUE G'S	DURATION MILLISECONDS	AREA G'S-SECONDS
IMPACT 1	4.34	-.67	96.03	.04
IMPACT 2 (FAILURE)	6.42	-.79	107.30	.05
IMPACT 3	4.18	-.64	98.98	.04
IMPACT 4	6.30	-.82	94.45	.04
IMPACT 5	8.31	-9.43	76.79	.41
IMPACT 6 (REVERSE)	8.21	1.35	89.57	.07

TAPE CHANNEL 10 : LAT. ACELL. ON BODY

TEST	SPEED MPH	PEAK VALUE G'S	DURATION MILLISECONDS	AREA G'S-SECONDS
IMPACT 1	4.34	-.09	77.36	.00
IMPACT 2 (FAILURE)	6.42	-.24	69.93	.01
IMPACT 3	4.18	-.09	65.56	.00
IMPACT 4	6.30	-.13	66.92	.01
IMPACT 5	8.31	-9.39	76.37	.41
IMPACT 6 (REVERSE)	8.21	-.09	56.22	.00

TAPE CHANNEL 11 : VERT. ACELL. ON BODY

TEST	SPEED MPH	PEAK VALUE G'S	DURATION MILLISECONDS	AREA G'S-SECONDS
IMPACT 1	4.34	-.24	74.45	.01
IMPACT 2 (FAILURE)	6.42	-.14	112.64	.01
IMPACT 3	4.18	-.40	82.17	.02
IMPACT 4	6.30	-.44	85.20	.02
IMPACT 5	8.31	-9.38	74.47	.40
IMPACT 6 (REVERSE)	8.21	.74	115.34	.05

NOTES:

*****: DATA NOT AVAILABLE.

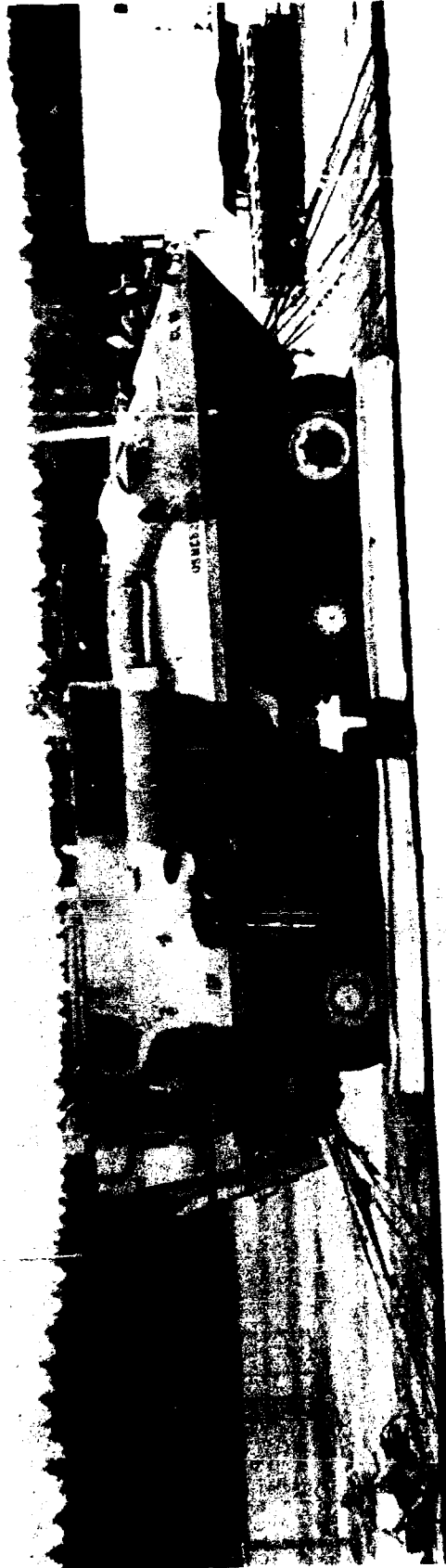

DEFENSE AMMUNITION CENTER AND SCHOOL - SAVANNA, IL

Photo 9. View of LAV-L secured to the railroad flatcar for retest. Note location of cables at front of the LAV-L.



DEFENSE AMMUNITION CENTER AND SCHOOL - SAVANNA, IL

Photo 10. View of LAV-L tiedown provision used in retest. Note the location of the previous test clevis tiedown.

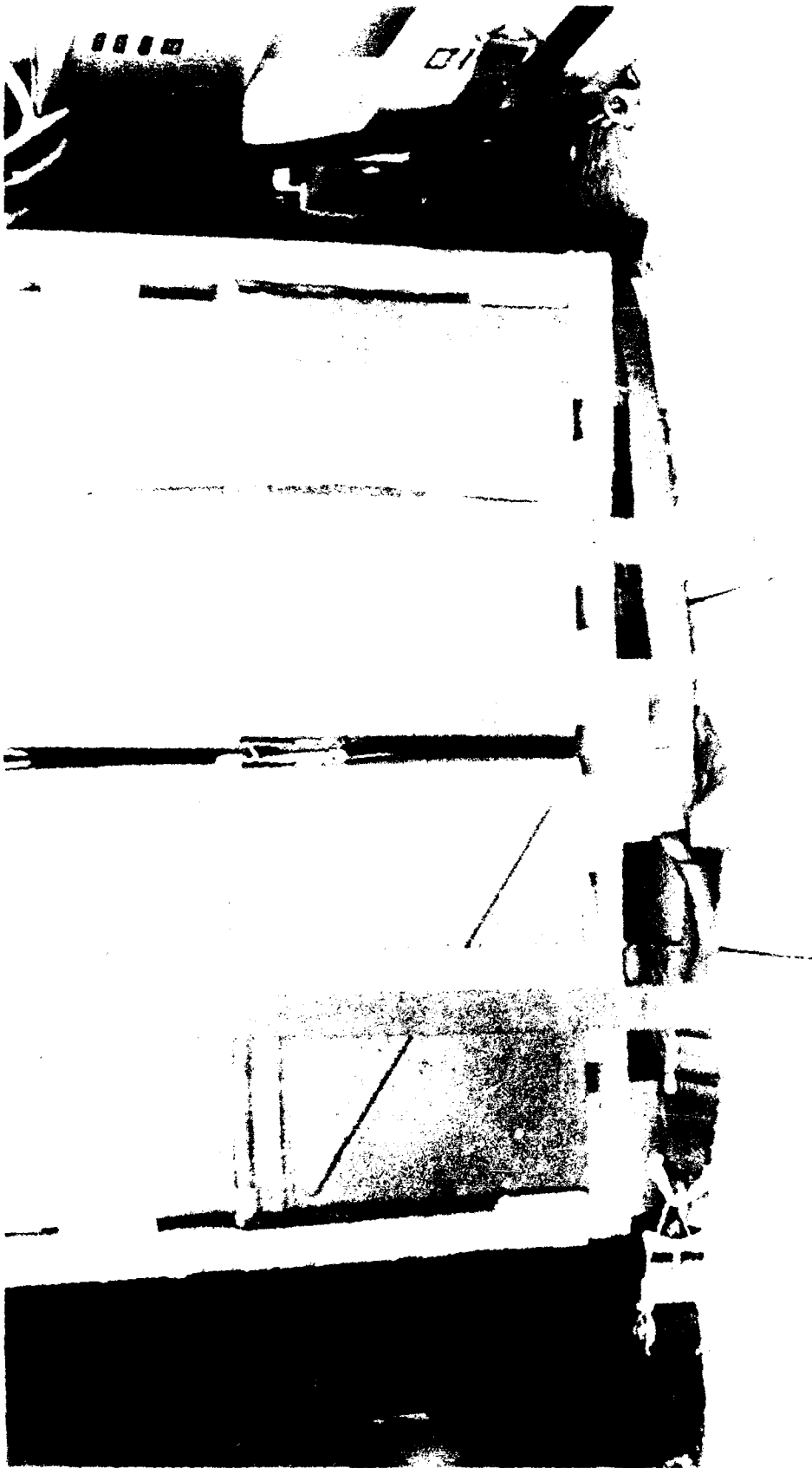

DEFENSE AMMUNITION CENTER AND SCHOOL - SAVANNA, IL

Photo 11. View looking into the LAV-L cargo compartment following completion of the reverse impact. Note the loose web strap on the LAV-L floor which had been positioned around the pallet just above the pallet base.

SYNOPSIS OF ROAD COURSE TEST

In road testing the LAV-L, the 4,000 pound pallet of inert loaded M548 cans was restrained with two web straps laterally over the top of the pallet and one strap around each end of the pallet base to curtail longitudinal movement.

No movement of the pallet was noted during the entire test.

ROAD TEST DATA

TEST NO. 3

DATE 20 November 1987

TEST SPECIMEN: Light Armored Vehicle-Logistics (LAV-L) road tested while loaded with one pallet of M548 inertly loaded metal cans weighing 4,000 pounds.

PASS 1-A OVER FIRST SERIES OF TIES 4.8 SEC 7.10 MPH

PASS 1-B OVER SECOND SERIES OF TIES 4.65 SEC 7.33 MPH

REMARKS: No evidence of change.

PASS 2-A OVER FIRST SERIES OF TIES 5.1 SEC 6.68 MPH

PASS 2-B OVER SECOND SERIES OF TIES 5.1 SEC 6.68 MPH

REMARKS: No evidence of change.

30 MILE ROAD TEST: No evidence of change.

PANIC STOP TEST: Not performed as vehicle was rail impacted.

PASS 3-A OVER FIRST SERIES OF TIES 5.55 SEC 6.14 MPH

PASS 3-B OVER SECOND SERIES OF TIES 5.40 SEC 6.31 MPH

REMARKS: No evidence of movement.

PASS 4-A OVER FIRST SERIES OF TIES 5.85 SEC 5.83 MPH

PASS 4-B OVER SECOND SERIES OF TIES 5.40 SEC 6.31 MPH

REMARKS: No evidence of movement.

WASHBOARD COURSE: No evidence of movement.

SYNOPSIS OF ROAD COURSE TEST

In this test, the LAV-L was loaded with five inertly loaded Stinger containers. The only means of restraint were two laterally placed web straps over top of the five containers.

No significant movement was observed during the entire road test.

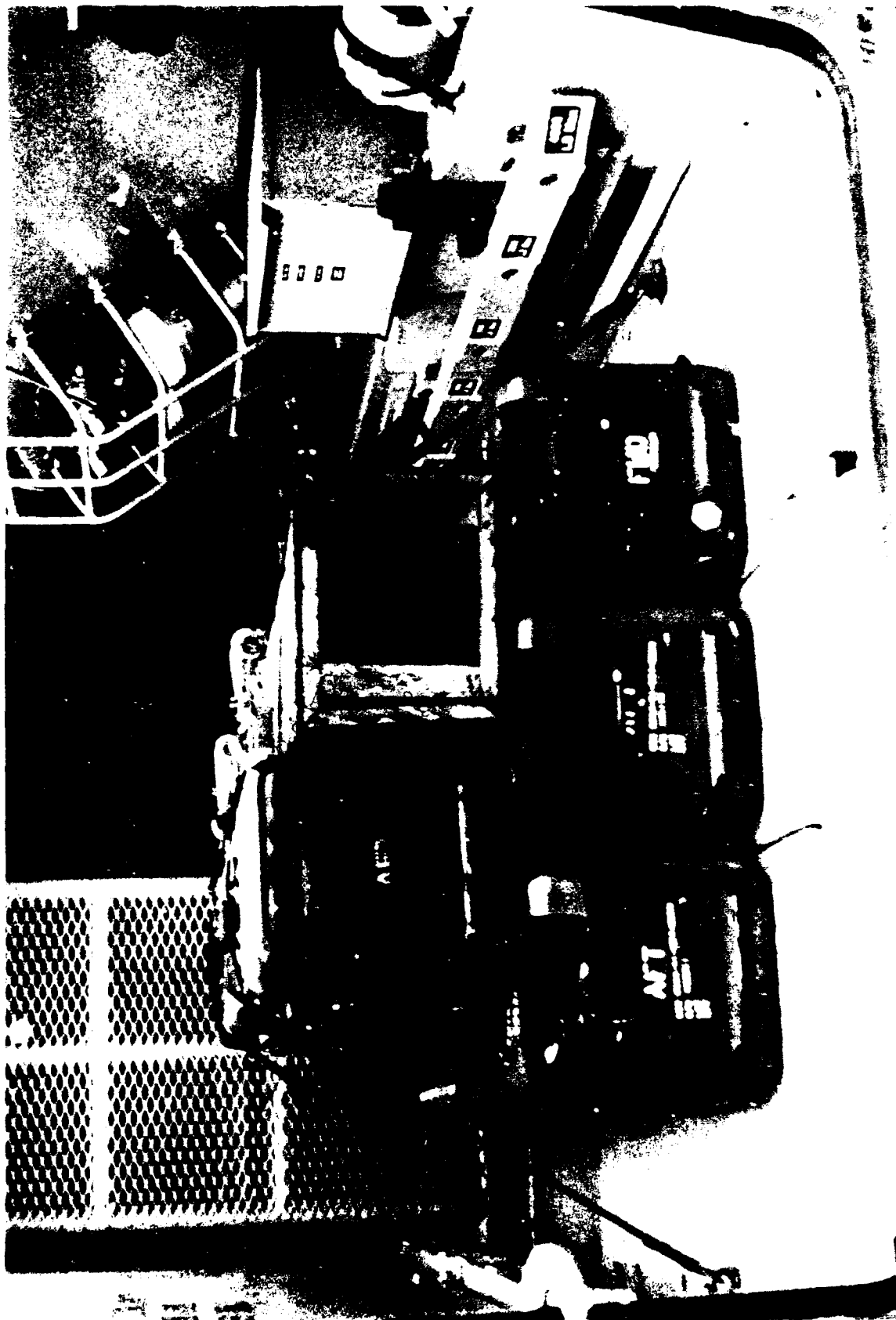

DEFENSE AMMUNITION CENTER AND SCHOOL - SAVANNA, IL

Photo 14. View of the Stinger load in the LAV-L.

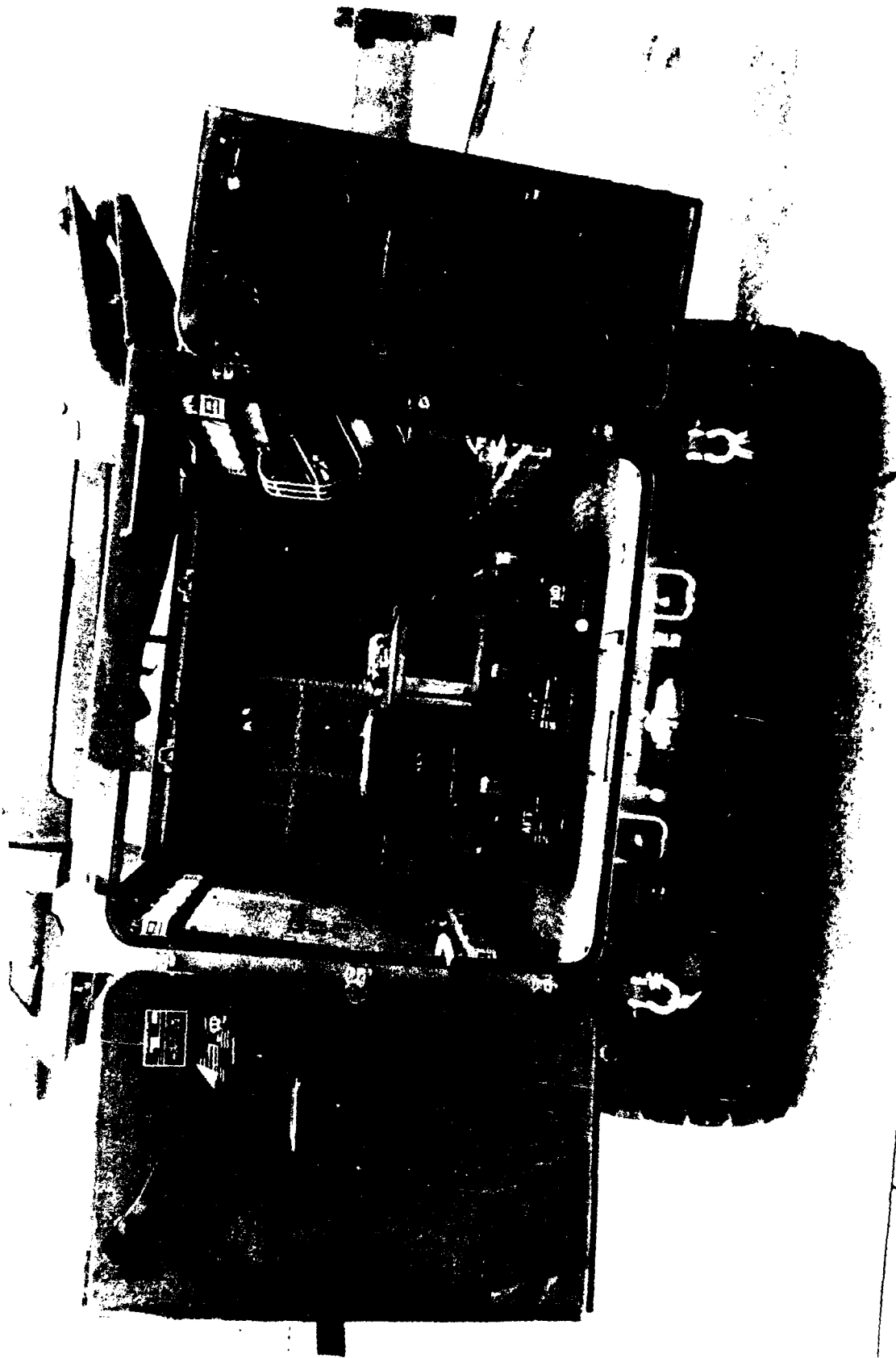

DEFENSE AMMUNITION CENTER AND SCHOOL - SAVANNA, IL

Photo 13. View of the tiedown procedure used to secure the Stinger containers in the LAV-L.

SYNOPSIS OF ROAD COURSE TEST

An inert mixed load consisting of four M548 metal cans, four 50 caliber boxes, four 120mm mortar boxes, and four boxes of fuses, was secured in the cargo area of the LAV-L with three web strap tiedowns placed laterally over the load.

The only movement of this load occurred during the panic stops. However, the load remained secured and no damage occurred to the load or vehicle.

ROAD TEST DATA

TEST NO. 5

DATE: 24 November 1987

TEST SPECIMEN: Light Armored Vehicle-Logistics (LAV-L) road tested while loaded with a mixed load of inertly loaded 120mm mortar boxes, M548 metal cans, 50 caliber cans, and fuse boxes.

PASS 1-A OVER FIRST SERIES OF TIES 5.10 SEC 6.68 MPH

PASS 1-B OVER SECOND SERIES OF TIES 5.40 SEC 6.31 MPH

REMARKS: No evidence of movement

PASS 2-A OVER FIRST SERIES OF TIES 6.75 SEC 5.05 MPH

PASS 2-B OVER SECOND SERIES OF TIES 5.85 SEC 5.83 MPH

REMARKS: No evidence of movement

30 MILE ROAD TEST: No evidence of movement

PANIC STOP TEST: 10 mph panic stop - load moved forward 4-1/2 inches. 15 mph panic stop - load moved forward 1/8 inch. Reverse panic stop - load moved rearward 1 inch.

PASS 3-A OVER FIRST SERIES OF TIES 5.85 SEC 5.83 MPH

PASS 3-B OVER SECOND SERIES OF TIES 5.25 SEC 6.49 MPH

REMARKS: No evidence of movement

PASS 4-A OVER FIRST SERIES OF TIES 5.85 SEC 5.83 MPH

PASS 4-B OVER SECOND SERIES OF TIES 5.40 SEC 6.31 MPH

REMARKS: No evidence of movement

WASHBOARD COURSE: No evidence of movement

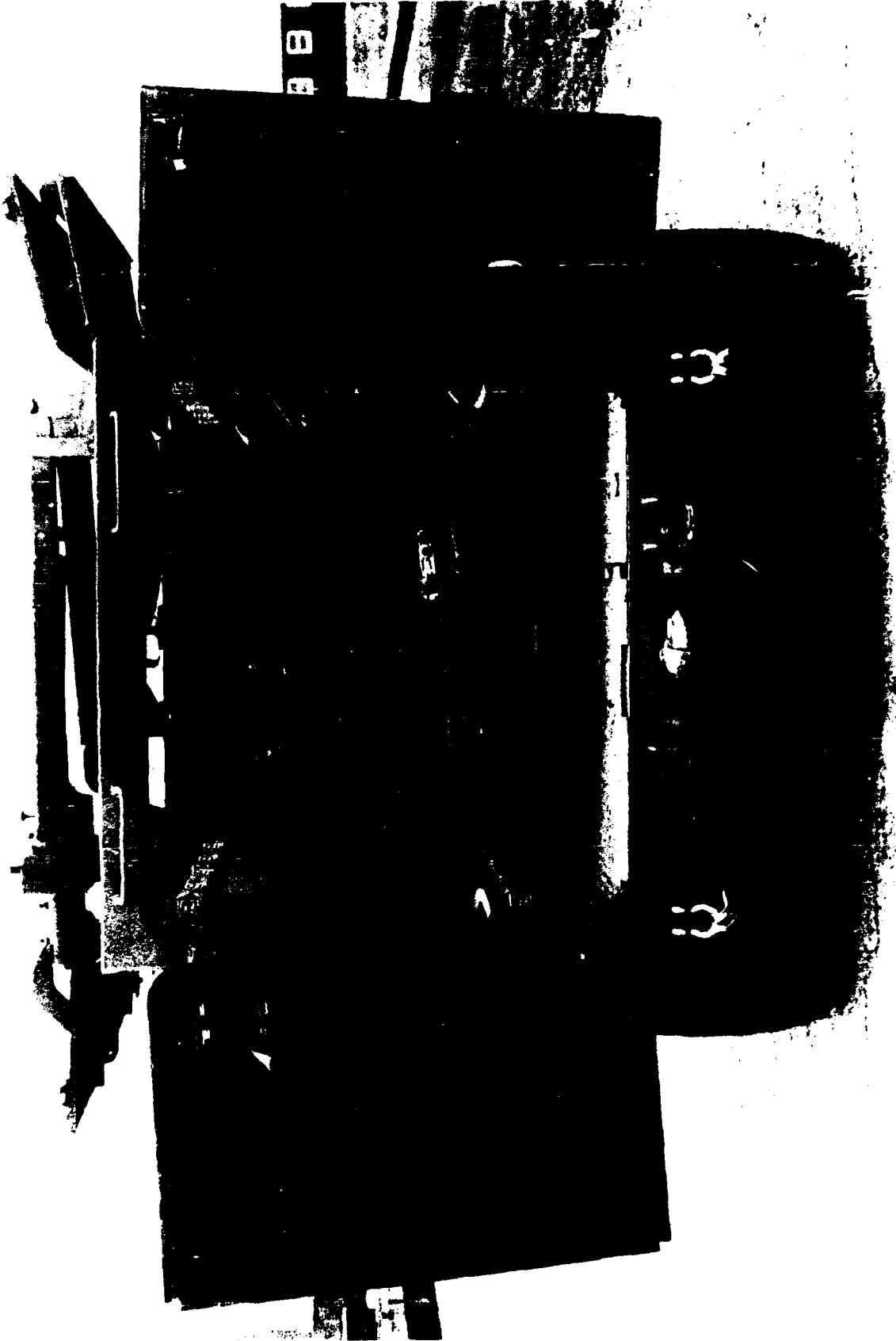

DEFENSE AMMUNITION CENTER AND SCHOOL - SAVANNA, IL

Photo 14. View of the mixed load in the cargo area of the LAV-L.

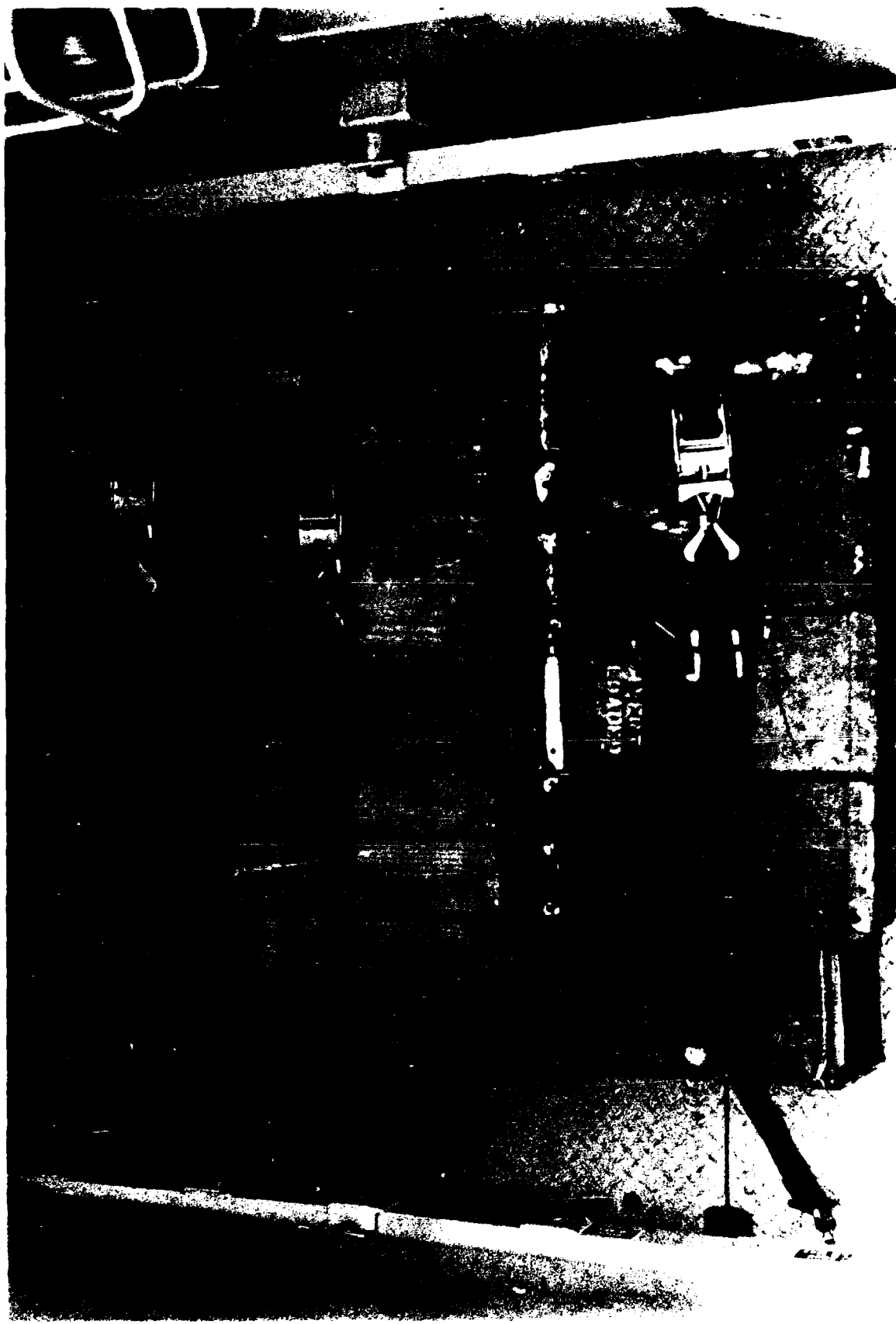

DEFENSE AMMUNITION CENTER AND SCHOOL - SAVANNA, IL

Fig. 15. View from overhead showing the position of the web straps over the mixed load.

SYNOPSIS OF RAIL IMPACT SECOND RETEST

Prior to the LAV-L rail impact second retest, eight clevises were received from the Marine Corps Base, Twentynine Palms, CA. Six of these clevises were installed on the four tiedown provisions on the rear of the LAV-L and on two of the four tiedown provisions on the front of the vehicle.

In an attempt to place less strain on each clevis, the eight required 5/8-inch cables were placed singularly through each of six clevises and two cables were placed through two forward provisions used in the first rail impact.

Using the cable tiedowns as previously detailed, the LAV-L with the 4,000-pound inertly loaded pallet of M548 cans was rail impacted. The vehicle tiedown fixtures performed as expected.

Due to loosening of a spacer block in the pallet base, the pallet moved forward nine inches on the reverse impact. The pallet had received damage from previous testing and movement could not be attributed to this rail impact. The load securement procedure is approved for rail movement.

TEST SPECIMENS AND RESULTS

RAIL IMPACT TEST DATA

Test No. 6 Load No. 1 Date: 15 December 1987

Specimen Load: Light Armored Vehicle-Logistics (LAV-L) loaded on a railroad flatcar. One pallet of M548 inertly loaded metal cans weighing 4,000 pounds secured within the LAV-L with six web straps.

Test Flatcar No. BN60071 Lt. Wt. 47,000 pounds

Reference Load No. 1 Wt. 26,600 pounds

Total Specimen Wt. 73,600 pounds

Buffer Car (5 cars) Wt. 250,000 pounds

<u>IMPACT</u>	<u>END STRUCK</u>	<u>VELOCITY</u>	<u>REMARKS</u>
1	A	4.50	Pallet moved rearward two inches.
2	A	6.07	Pallet moved rearward an additional one inch.
3	A	8.35	Pallet moved rearward an additional four inches. Block on pallet base broke.
4	B	8.33	Pallet moved forward nine inches.

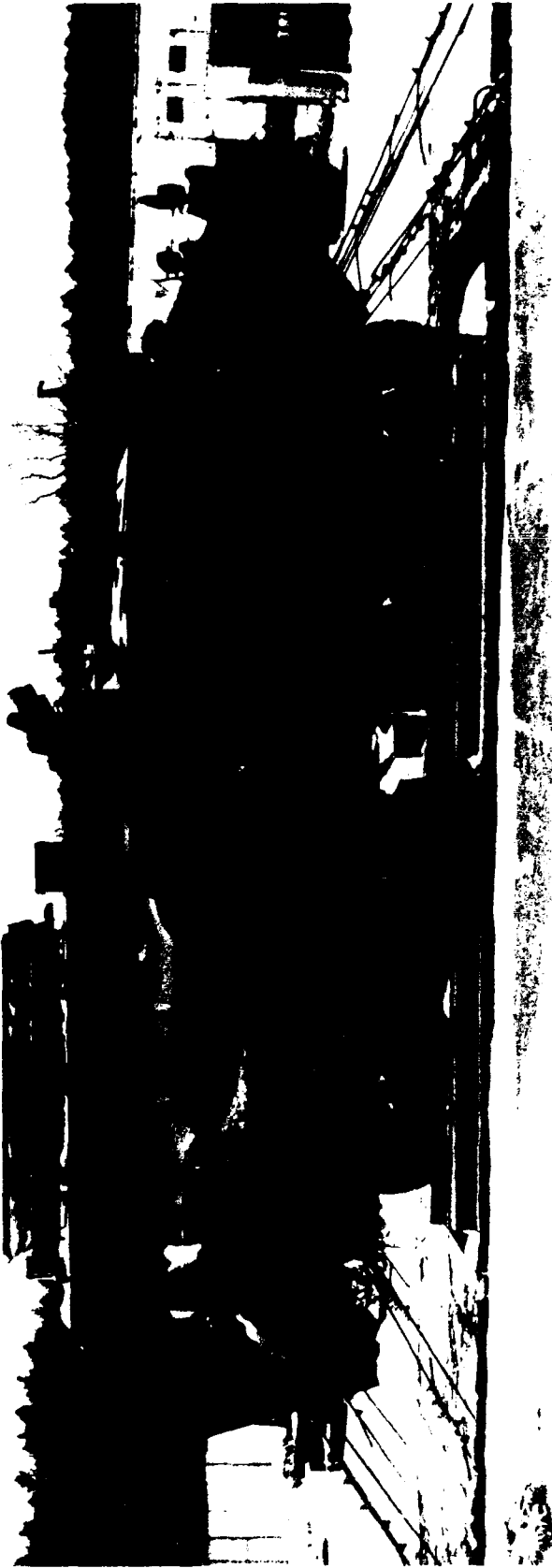

	DEFENSE AMMUNITION CENTER AND SCHOOL - SAVANNA, IL
<p>Photo 16. View of LAV-L secured to the railroad flatcar for retest. Note the locations of all the tiedown cables on the front and rear of the LAV-L.</p>	

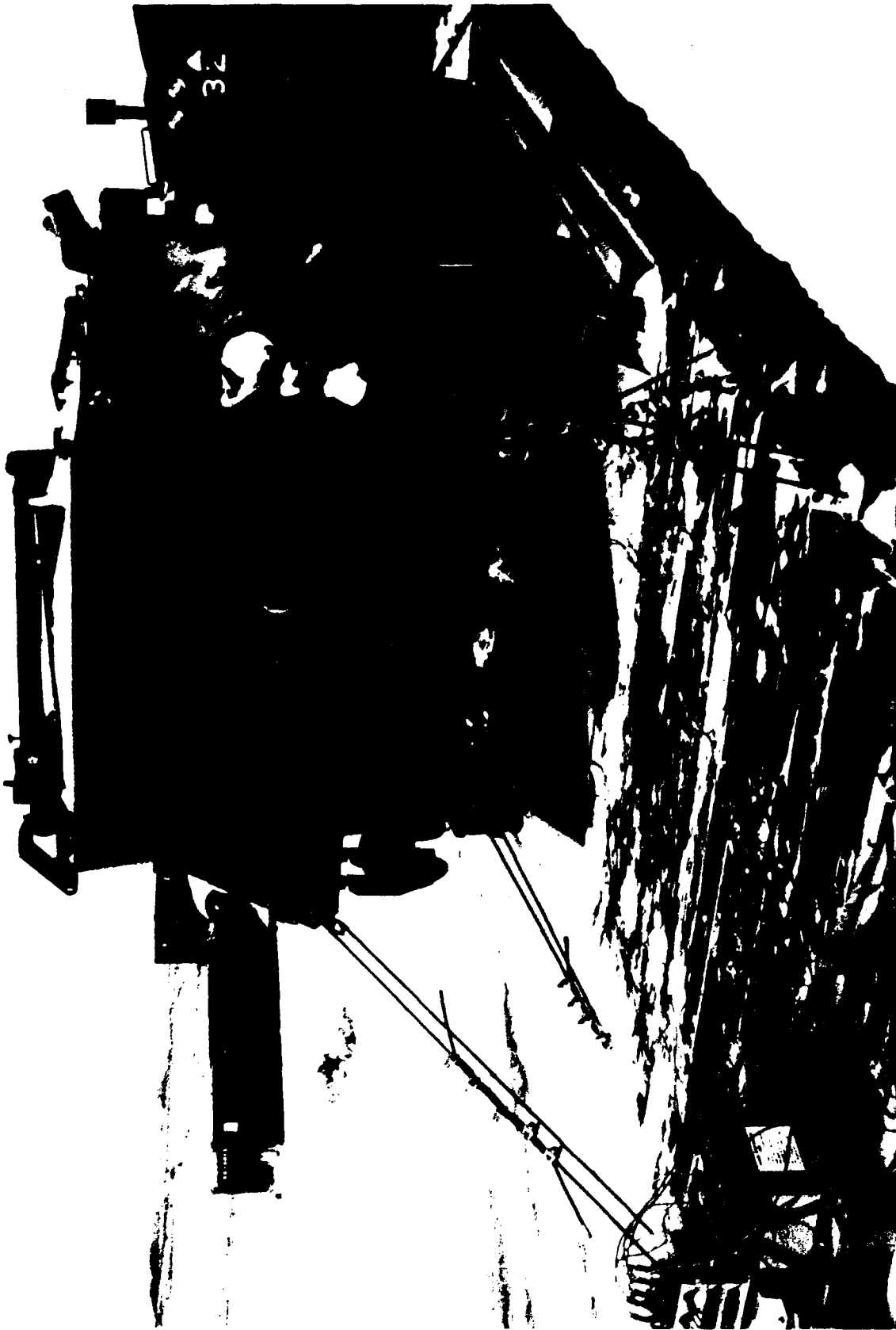

DEFENSE AMMUNITION CENTER AND SCHOOL - SAVANNA, IL

Photo 17. View of tiedown cables on the rear of the LAV-L.



DEFENSE AMMUNITION CENTER AND SCHOOL - SAVANNA, IL

Photo 14 - View of breakdown rubble on the front of the JAV building.

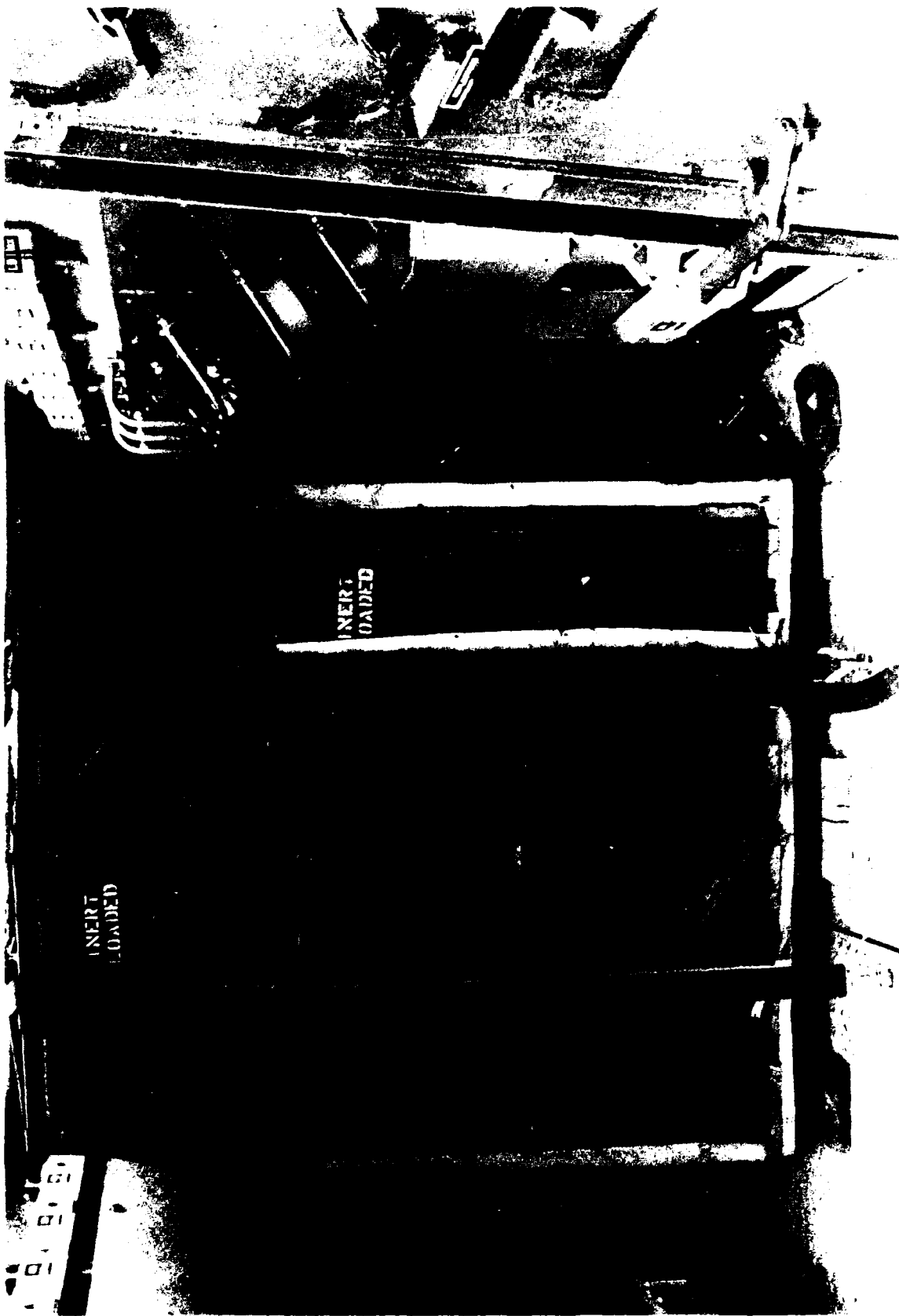

DEFENSE AMMUNITION CENTER AND SCHOOL - SAVANNA, IL

Photo 19. View of the 4,000-pound pallet secured in the cargo area of the LAV-L prior to the rail impact test.

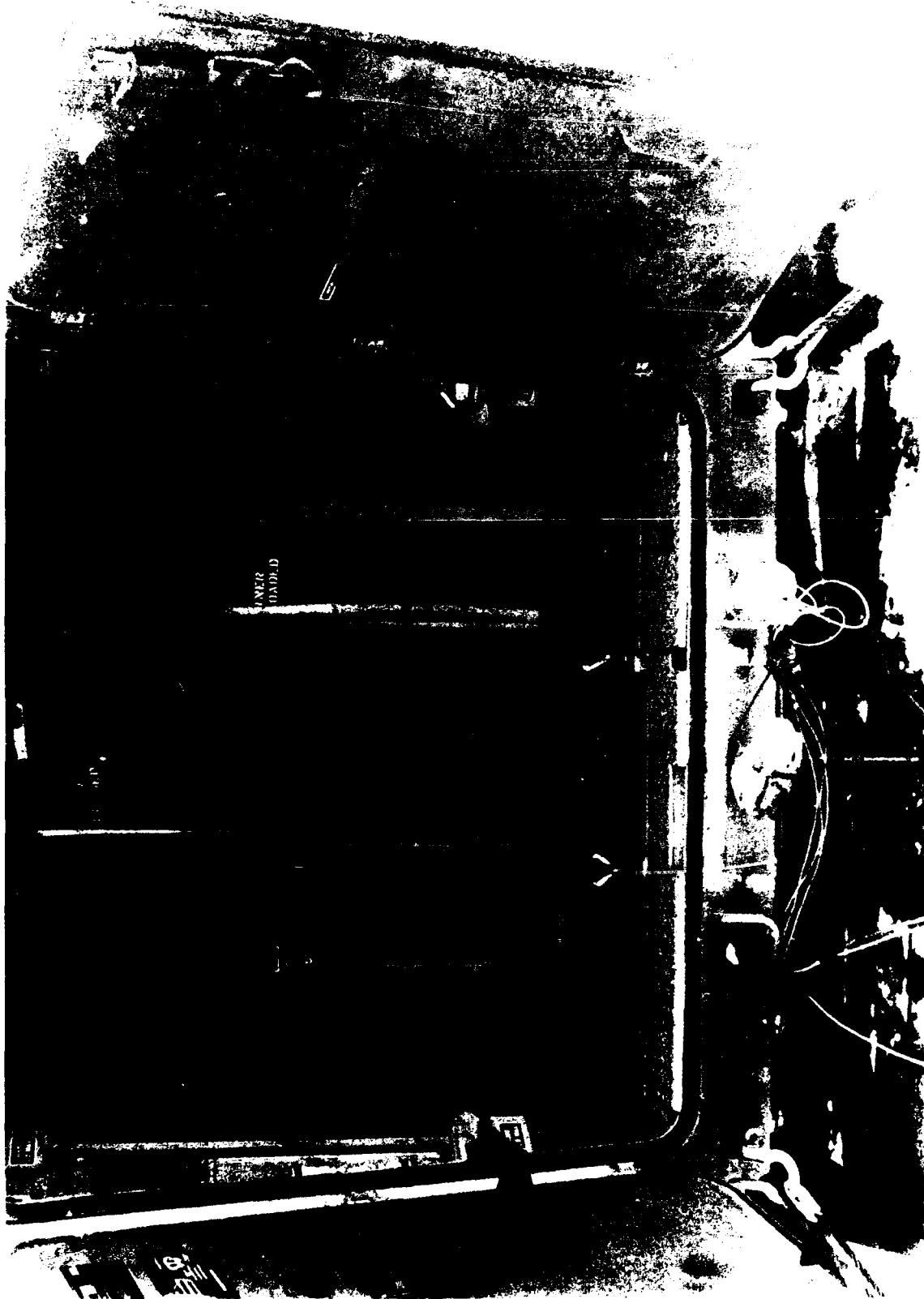

DEFENSE AMMUNITION CENTER AND SCHOOL - SAVANNA, IL

Photo 001. View of the 4,000-pound pallet secured in the cargo area of the LAV-L following completion of the rail impact test. Note the slack cable laying on the floor of the LAV-L.



DEFENSE AMMUNITION CENTER AND SCHOOL - SAVANNA, IL

Photo 21. View of the accelerometer location on the wheel strut of the LAV-L.



	DEFENSE AMMUNITION CENTER AND SCHOOL · SAVANNAH, IL
Photo 22. View of the accelerometer location on the wheel strut of the LAV-1	

RESULTS OF THE RAIL IMPACT TEST ON THE
MARINE LAV
16 DECEMBER 1987

TAPE CHANNEL 3 : LONG. ACELL. ON SILL

TEST	SPEED MPH	PEAK VALUE G'S	DURATION MILLISECONDS	AREA G'S-SECONDS
IMPACT 1	4.50	-1.60	118.21	.04
IMPACT 2	6.07	2.91	65.72	.11
IMPACT 3	8.35	-53.47	95.73	2.77
IMPACT 4 (REVERSE)	8.33	5.64	221.56	.96

TAPE CHANNEL 4 : VERT. ACELL. ON SILL

TEST	SPEED MPH	PEAK VALUE G'S	DURATION MILLISECONDS	AREA G'S-SECONDS
IMPACT 1	4.50	-1.26	70.27	.01
IMPACT 2	6.07	3.74	80.06	.15
IMPACT 3	8.35	-52.12	93.70	2.67
IMPACT 4 (REVERSE)	8.33	.61	80.29	.03

TAPE CHANNEL 5 : LONG. ACELL. ON WHEEL STRUT

TEST	SPEED MPH	PEAK VALUE G'S	DURATION MILLISECONDS	AREA G'S-SECONDS
IMPACT 1	4.50	-1.19	146.97	.09
IMPACT 2	6.07	3.61	60.10	.13
IMPACT 3	8.35	-27.25	100.12	1.51
IMPACT 4 (REVERSE)	8.33	1.67	156.57	.15

TAPE CHANNEL 6 : RAIL COUPLER FORCE

TEST	SPEED MPH	PEAK VALUE POUNDS	DURATION MILLISECONDS	AREA POUNDS-SECONDS
IMPACT 1	4.50	131946.58	130.10	9077.35
IMPACT 2	6.07	116871.13	119.07	8368.96
IMPACT 3	8.35	144190.15	115.44	9864.42
IMPACT 4 (REVERSE)	8.33	144271.73	107.79	8057.06

TAPE CHANNEL 7 : LAT. ACELL. ON WHEEL STRUT

TEST	SPEED MPH	PEAK VALUE G'S	DURATION MILLISECONDS	AREA G'S-SECONDS
IMPACT 1	4.50	-.04	54.62	.00
IMPACT 2	6.07	-.19	82.70	.01
IMPACT 3	8.35	-10.73	106.23	.60
IMPACT 4 (REVERSE)	8.33	.11	62.93	.00

TAPE CHANNEL 8 : VERT. ACELL. ON WHEEL STRUT

TEST	SPEED MPH	PEAK VALUE G'S	DURATION MILLISECONDS	AREA G'S-SECONDS
IMPACT 1	4.50	.32	67.79	.01
IMPACT 2	6.07	2.34	88.09	.10
IMPACT 3	8.35	-26.77	96.75	1.44
IMPACT 4 (REVERSE)	8.33	.55	70.93	.02

TAPE CHANNEL 9 : LONG. ACELL. ON FRAME

TEST	SPEED MPH	PEAK VALUE G'S	DURATION MILLISECONDS	AREA G'S-SECONDS
IMPACT 1	4.50	-.65	144.89	.05
IMPACT 2	6.07	5.35	69.13	.20
IMPACT 3	8.35	-27.63	96.72	1.52
IMPACT 4 (REVERSE)	8.33	.91	155.77	.08

TAPE CHANNEL 10 : LAT. ACELL. ON FRAME

TEST	SPEED MPH	PEAK VALUE G'S	DURATION MILLISECONDS	AREA G'S-SECONDS
IMPACT 1	4.50	-.06	67.21	.00
IMPACT 2	6.07	4.60	78.64	.19
IMPACT 3	8.35	-27.20	95.37	1.44
IMPACT 4 (REVERSE)	8.33	.14	61.25	.01

TAPE CHANNEL 11 : VERT. ACELL. ON FRAME

TEST	SPEED MPH	PEAK VALUE G'S	DURATION MILLISECONDS	AREA G'S-SECONDS
IMPACT 1	4.50	-.42	66.37	.02
IMPACT 2	6.07	5.56	83.01	.23
IMPACT 3	8.35	-26.93	92.43	1.40
IMPACT 4 (REVERSE)	8.33	-.79	72.05	.03

RAIL IMPACT OF THE LAV (12-16-87)

IMPACT 1: 4.13 MPH

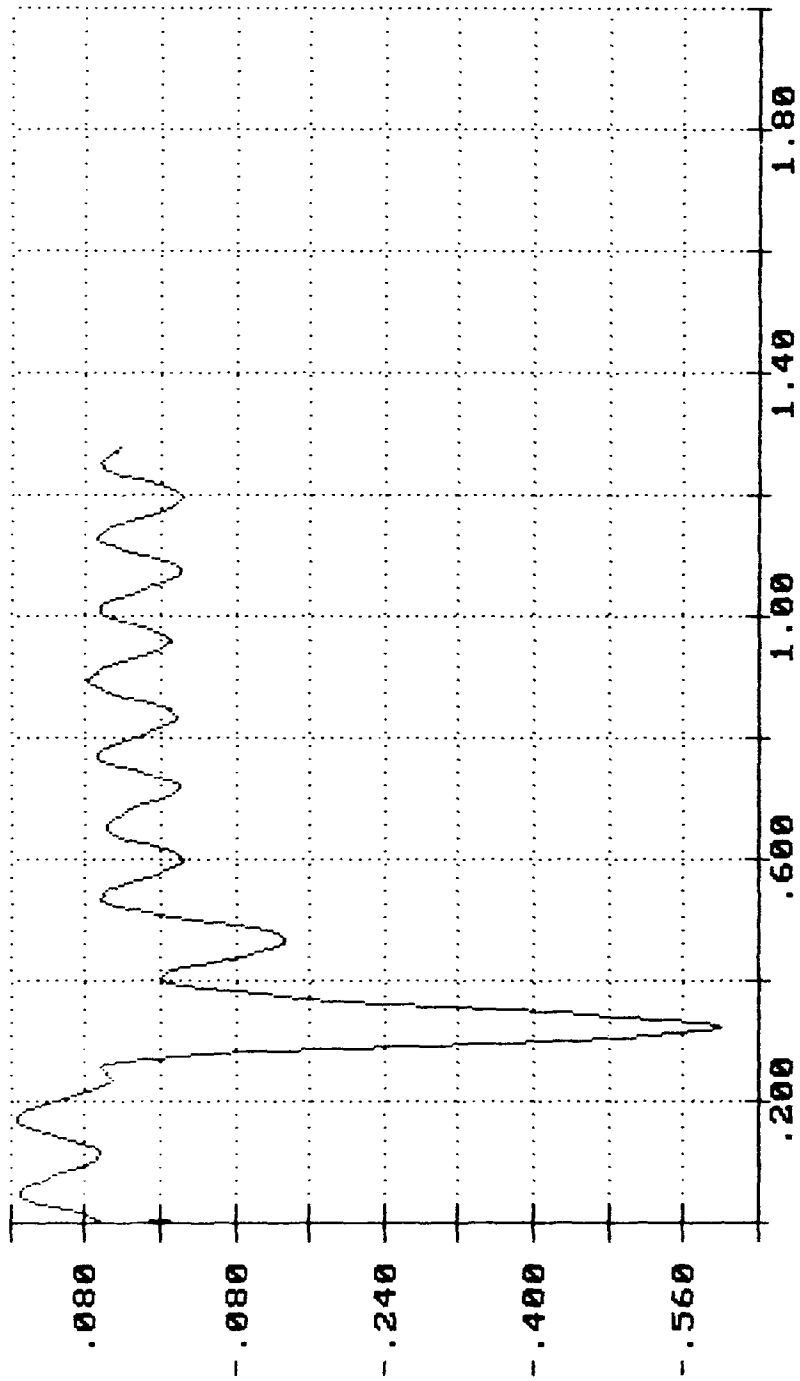

LONG. ACCELL. ON SILL
IN G.S X 1.00

Time in Seconds
X 1.00

RAIL IMPACT OF THE LAU (12-16-87)
IMPACT 1: 4.13 MPH

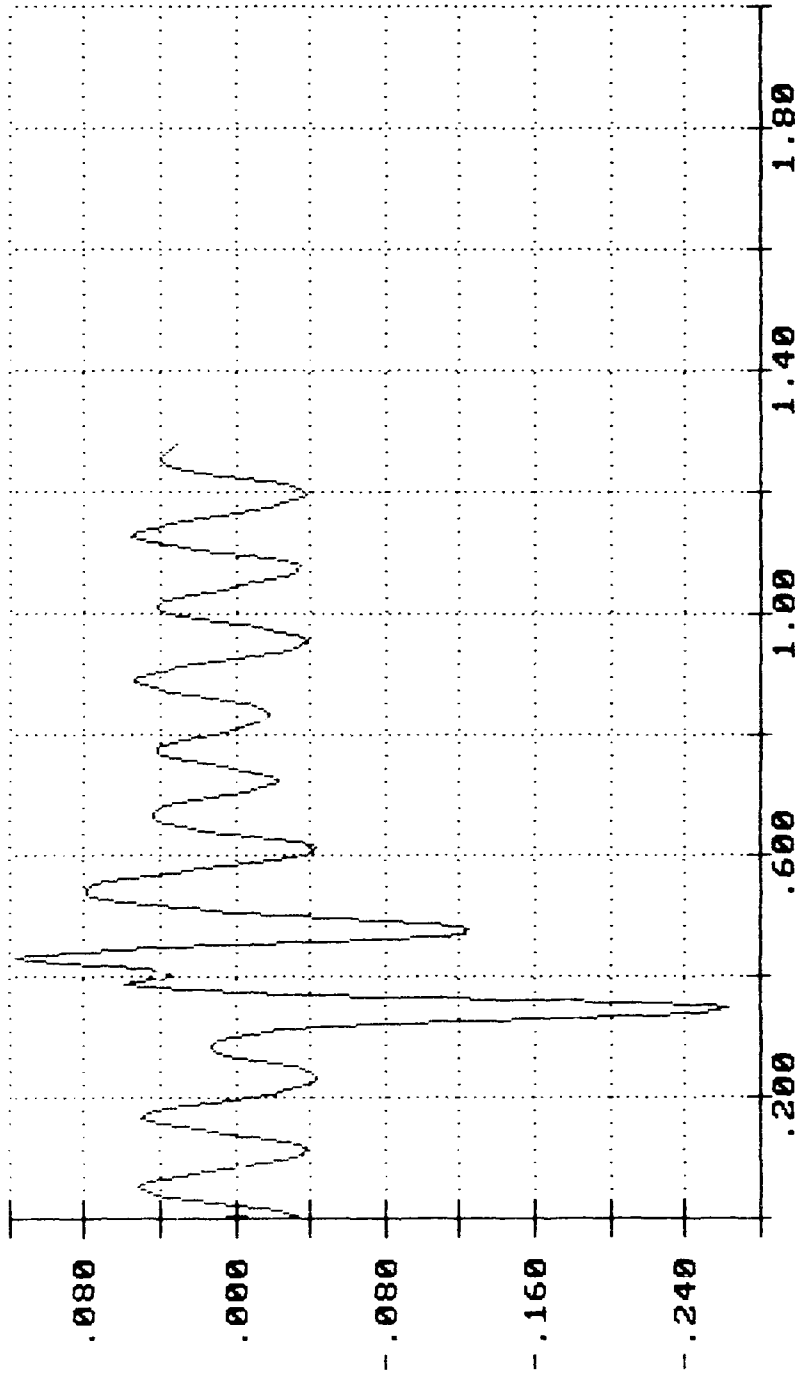

VERT. ACCELL. ON SILL

IN G'S X 1.00

Time in Seconds
X 1.00

RAIL IMPACT OF THE LAV (12-16-87)
IMPACT 1: 4.13 MPH

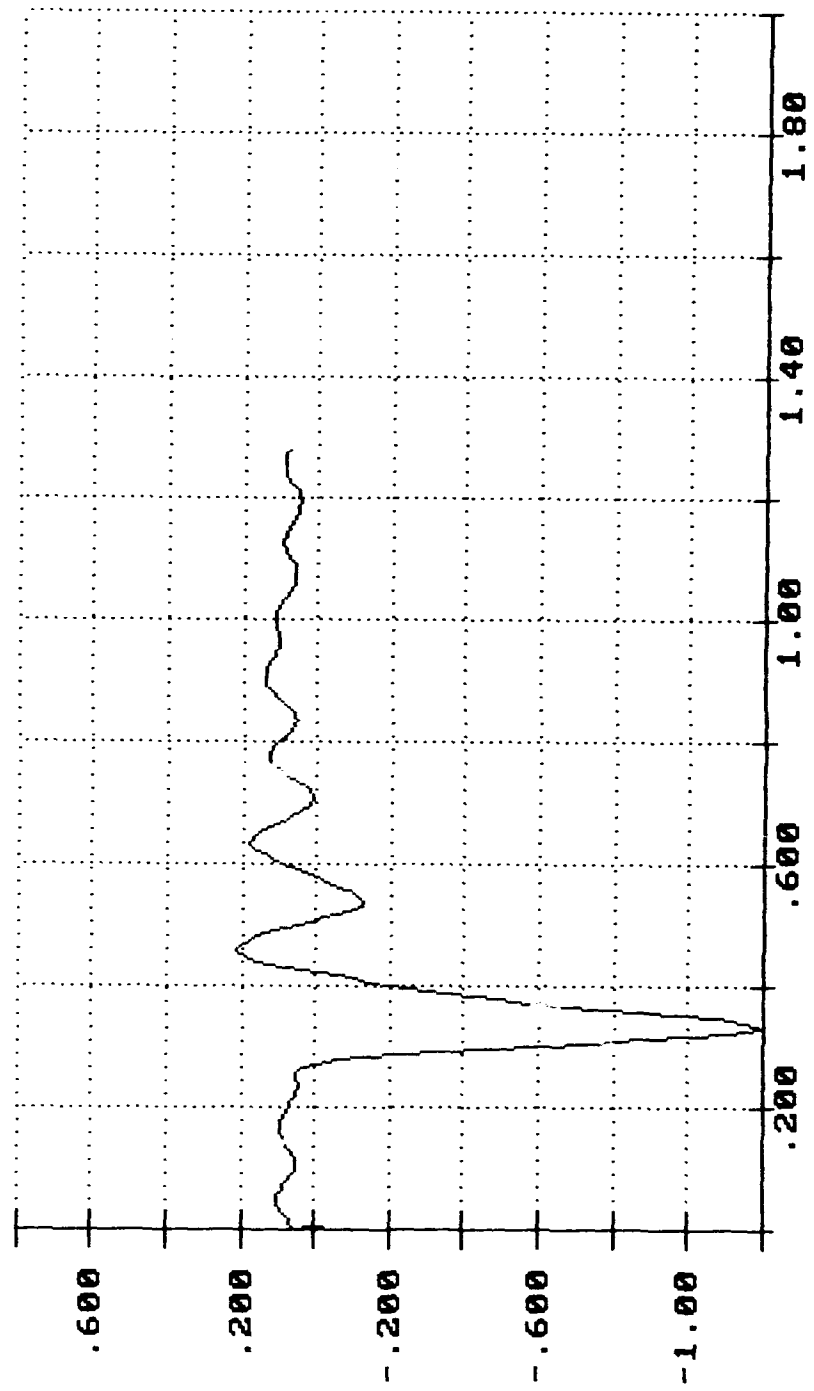

LONG. ACCEL. ON WHEEL STRUT

IN G'S X 1.00

Time in Seconds
X 1.00

RAIL IMPACT OF THE LAV (12-16-87)
IMPACT 1: 4.13 MPH

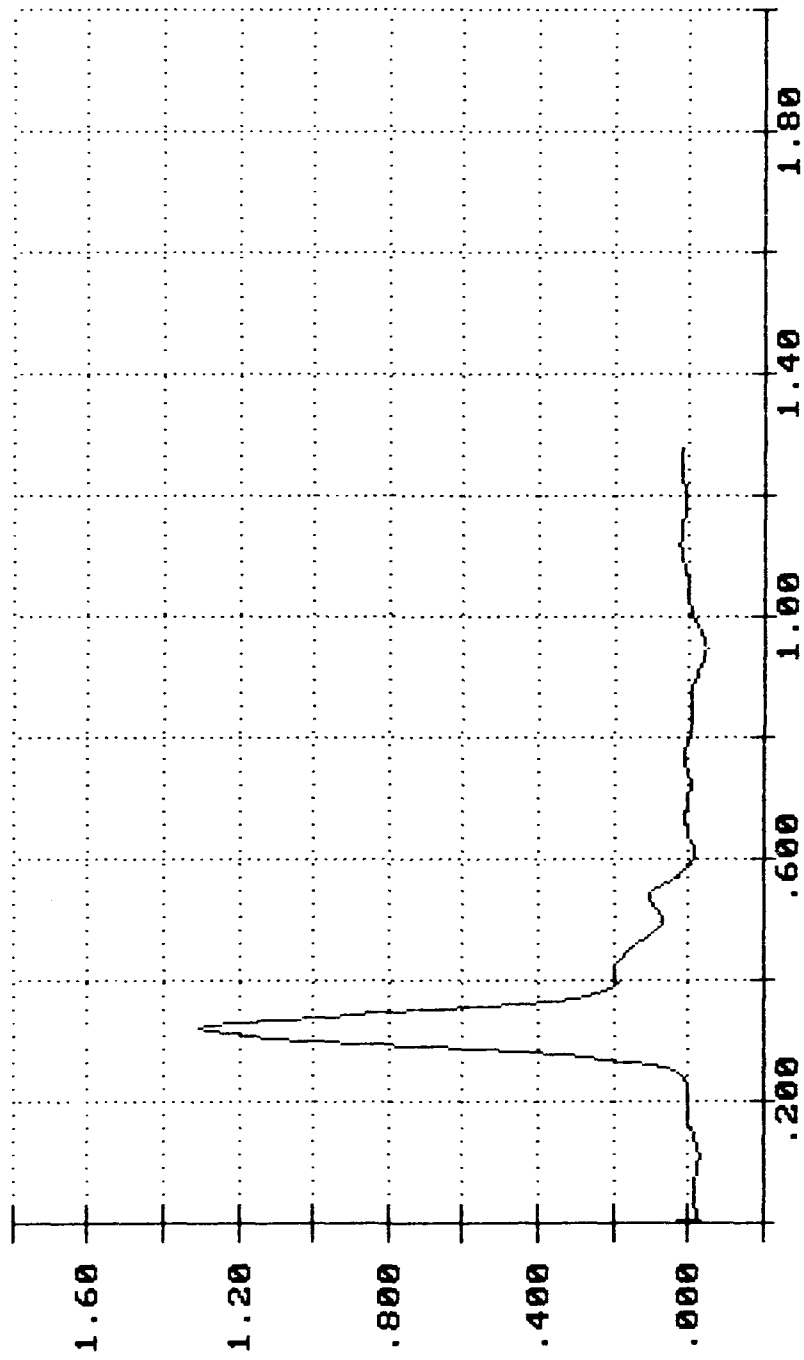

RAIL COUPLER FORCE
IN POUNDS X 100000.00

Time in Seconds
X 1.00

RAIL IMPACT OF THE LAV (12-16-87)
IMPACT 1: 4.13 MPH

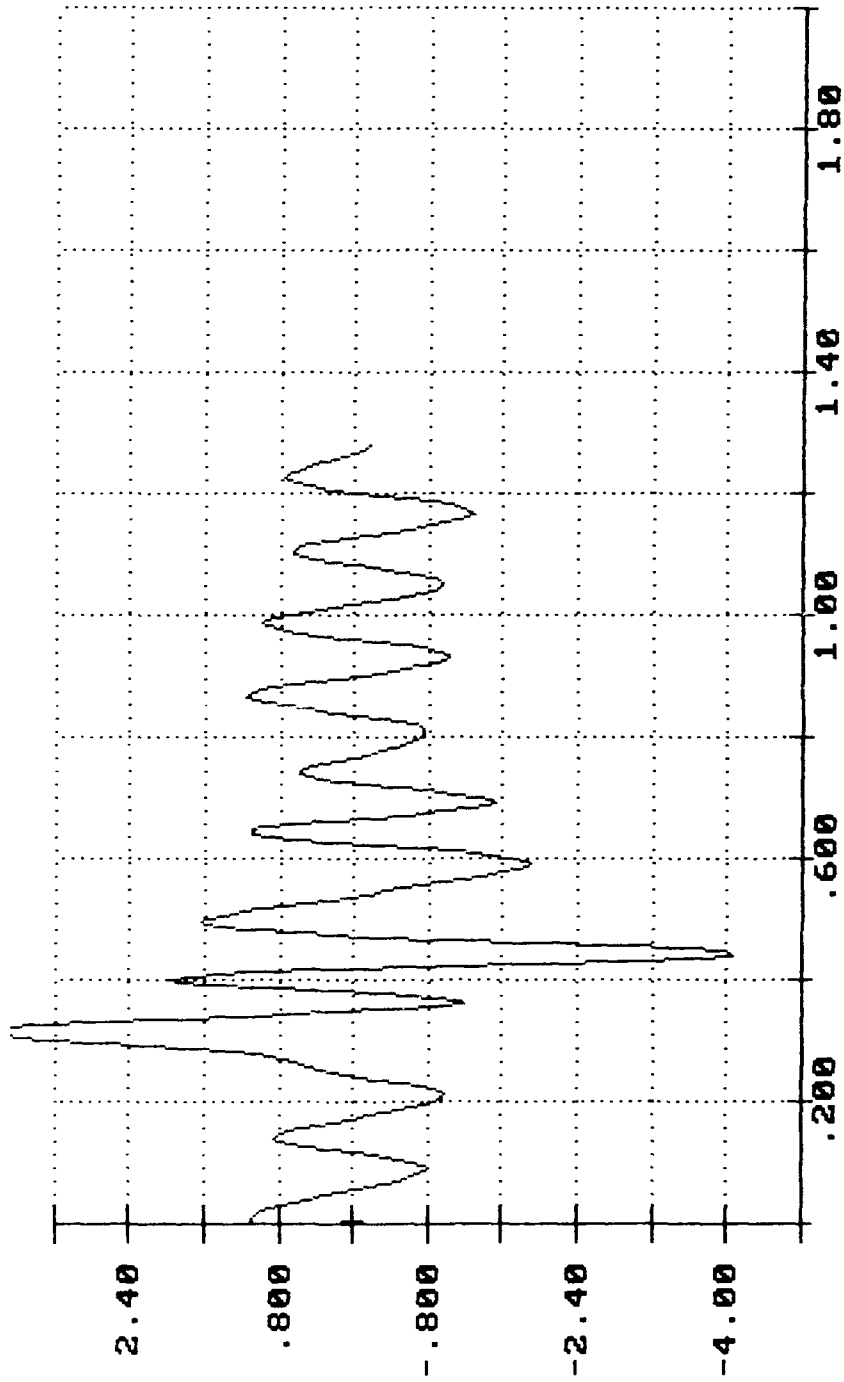

LAT. ACCELL. ON WHEEL STRUT
IN G'S X .01

Time in Seconds
X 1.00

RAIL IMPACT OF THE LAV (12-16-87)
IMPACT 1: 4.13 MPH

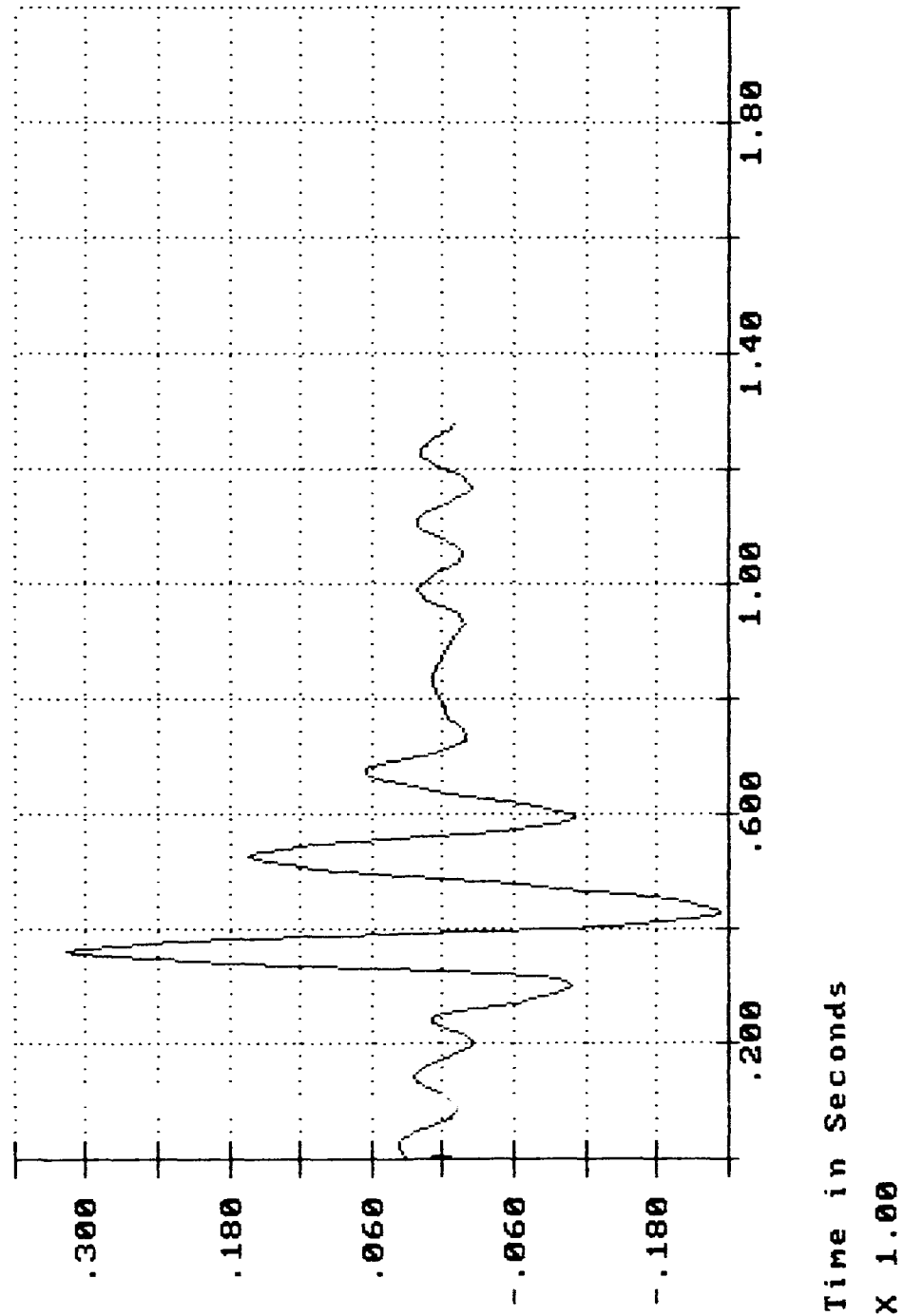

VERT. ACCEL. ON WHEEL STRUT

IN G'S X 1.00

Time in Seconds
X 1.00

RAIL IMPACT OF THE LAV (12-16-87)
IMPACT 1: 4.13 MPH

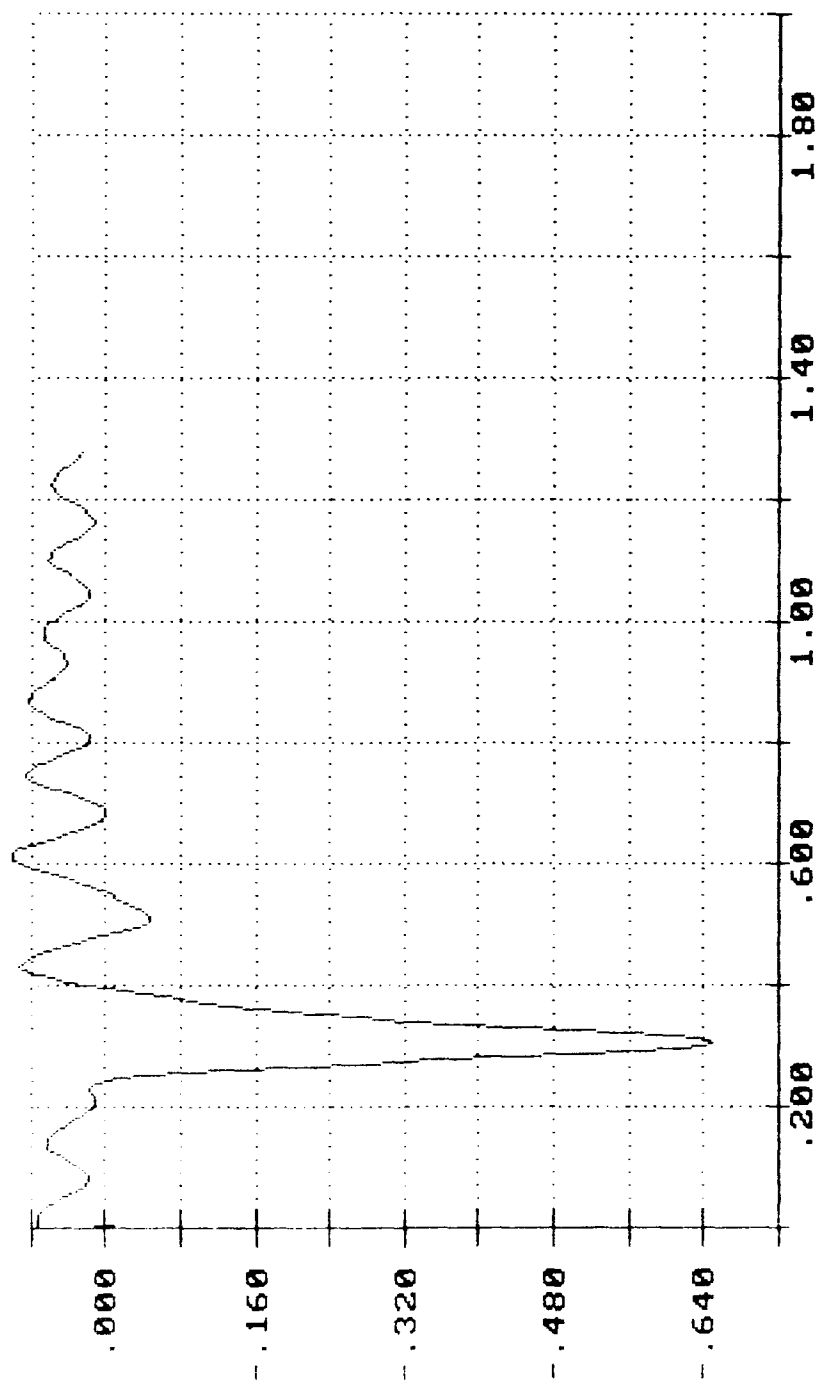

Time in Seconds
X 1.00

LONG. ACCEL. ON FRAME
IN G'S X 1.00

RAIL IMPACT OF THE LAU (12-16-87)
IMPACT 1: 4.13 MPH

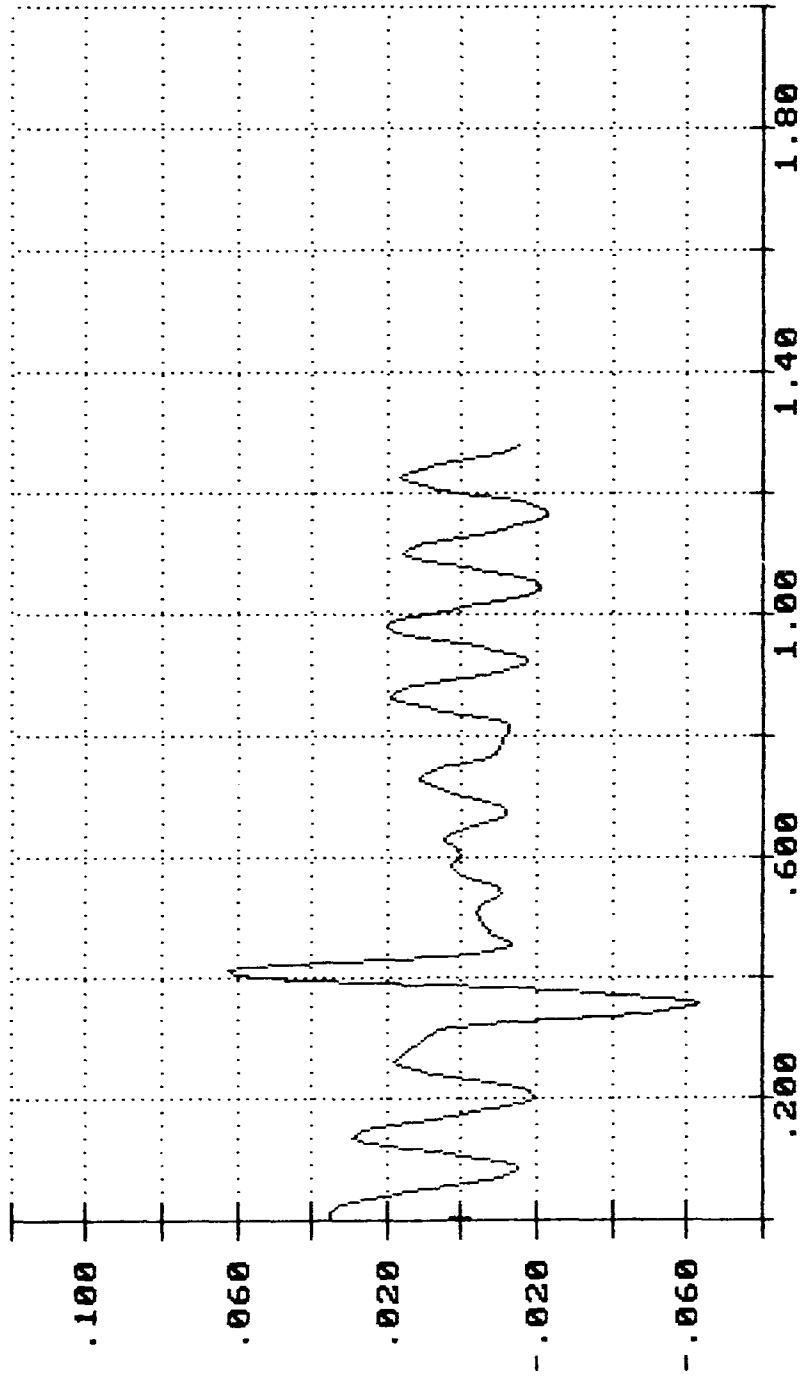

LAT. ACCELL. ON FRAME

IN G'S X 1.00

Time in Seconds
X 1.00

RAIL IMPACT OF THE LAV (12-16-87)
IMPACT 1: 4.13 MPH

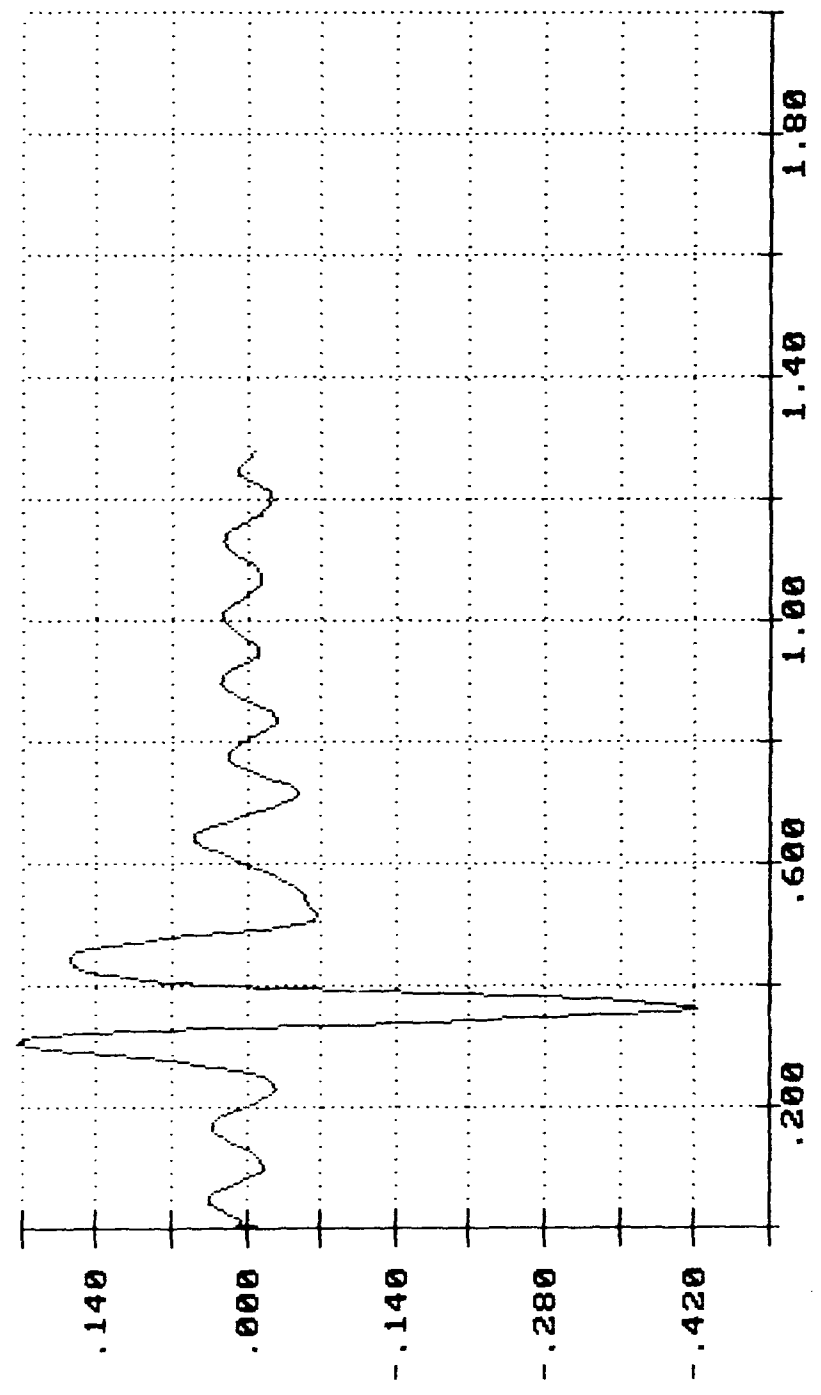

VERT. ACCEL. ON FRAME

IN G'S X 1.00

Time in Seconds
X 1.00

RAIL IMPACT TEST OF THE LAV (12-16-87)
IMPACT 2: 6.07 MPH

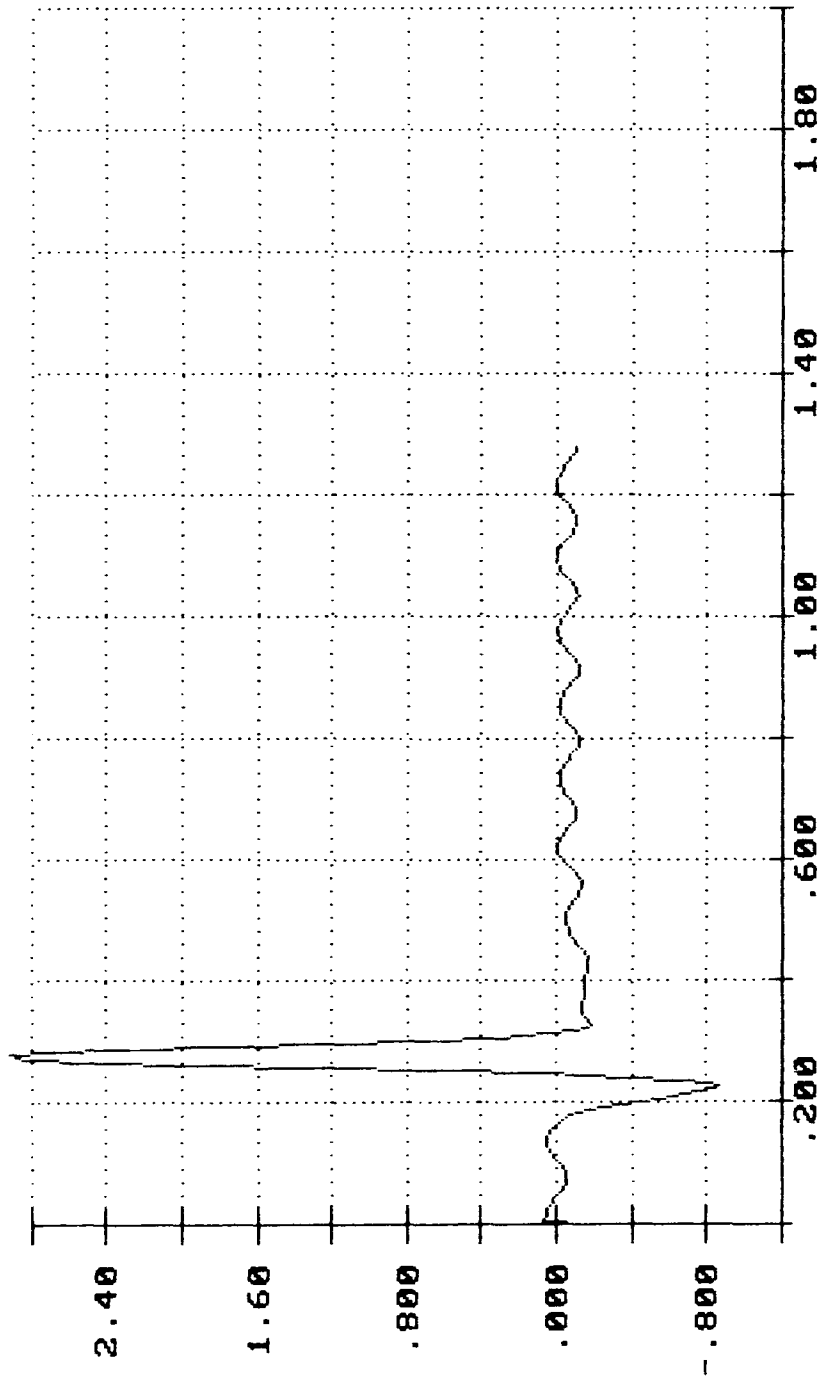

Time in Seconds
X 1.00

IN G'S X 1.00

LONG. ACCEL. ON SILL

RAIL IMPACT TEST OF THE LAV (12-16-87)
IMPACT 2: 6.07 MPH

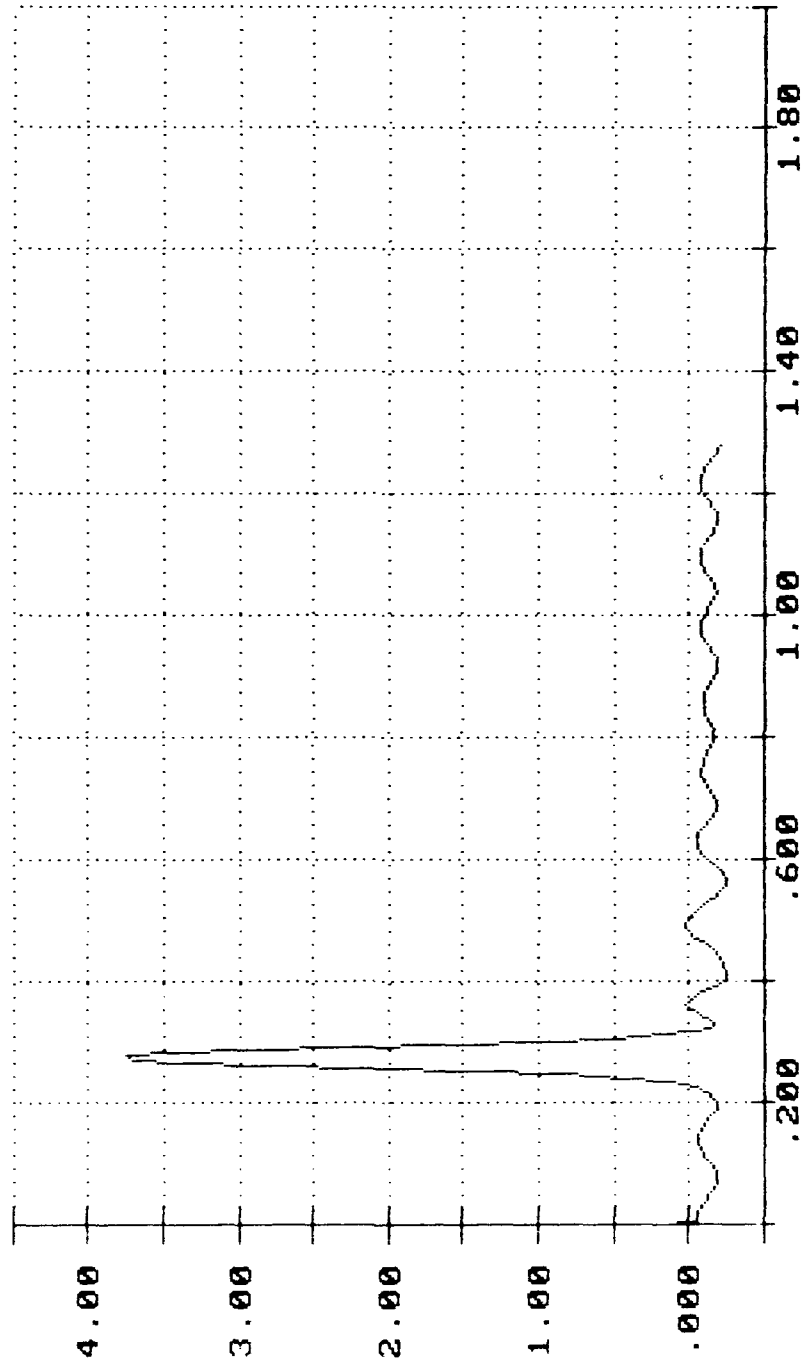

VERT. ACCELL. ON SILL
IN G'S X 1.00
Time in Seconds
X 1.00

RAIL IMPACT TEST OF THE LAV (12-16-87)
IMPACT 2: 6.07 MPH

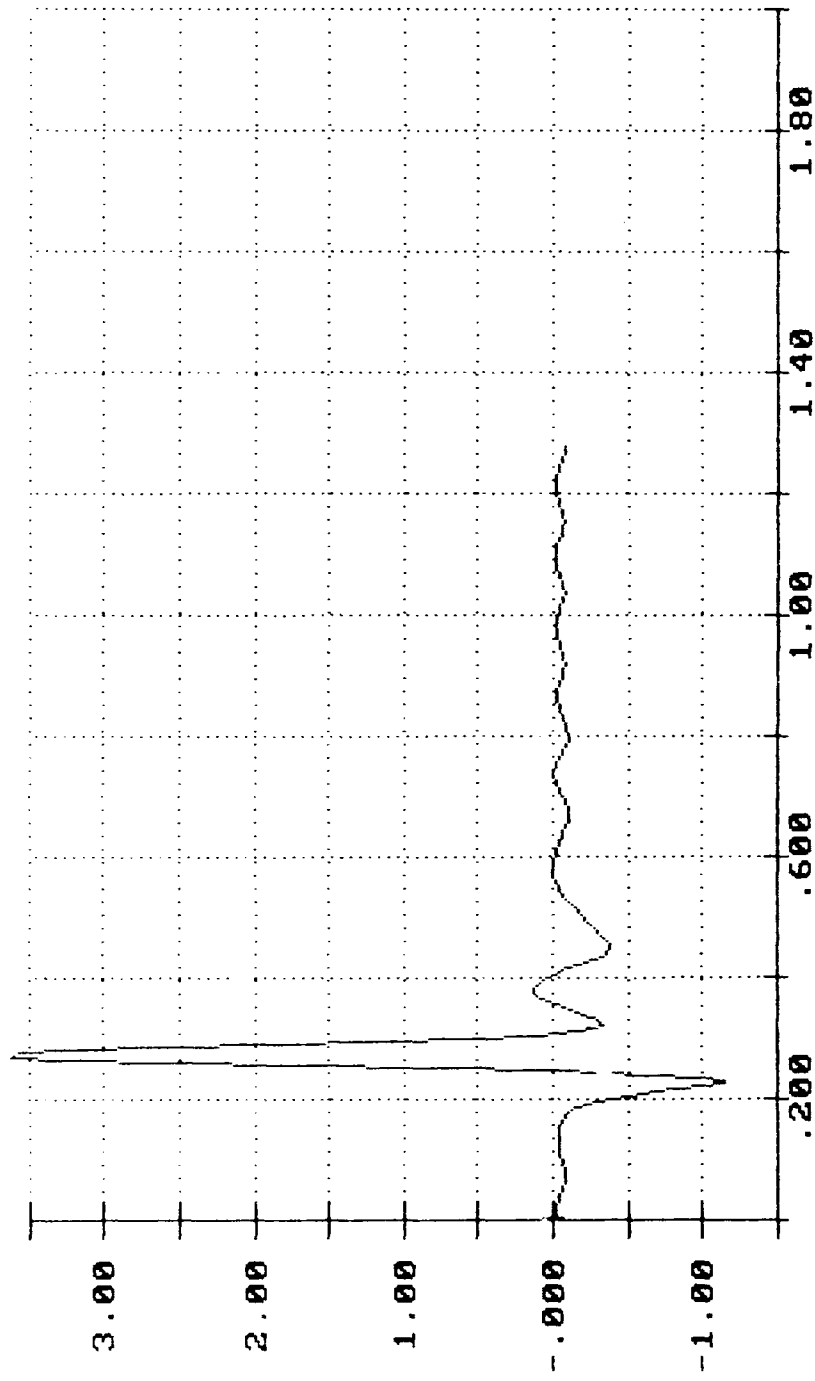

LONG. ACCEL. ON WHEEL STRUT

IN G'S X 1.00

Time in Seconds
X 1.00

RAIL IMPACT TEST OF THE LAV (12-16-87)
IMPACT 2: 6.07 MPH

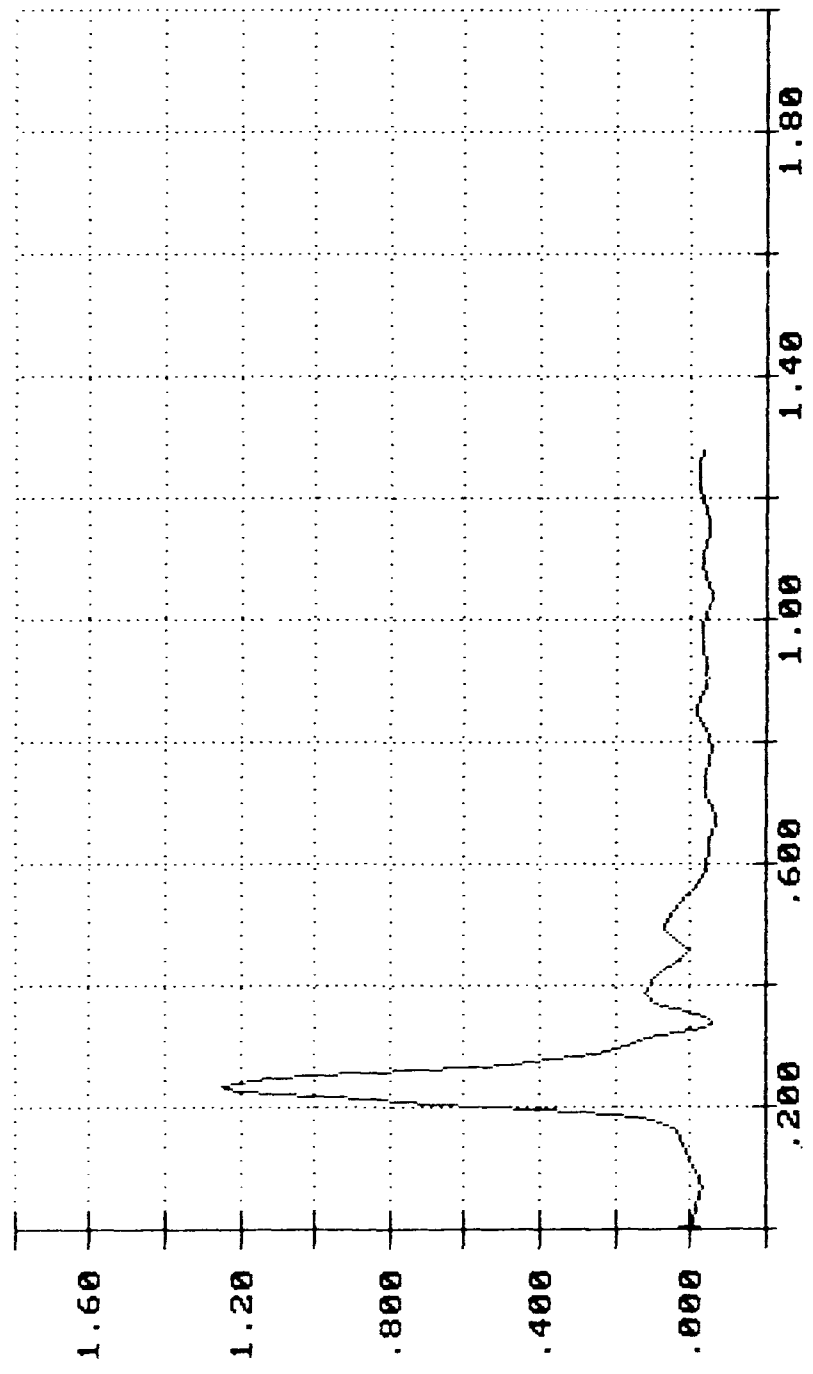

RAIL COUPLER FORCE
IN POUNDS X 100000.00

Time in Seconds
X 1.00

RAIL IMPACT TEST OF THE LAU (12-16-87)
IMPACT 2: 6.07 MPH

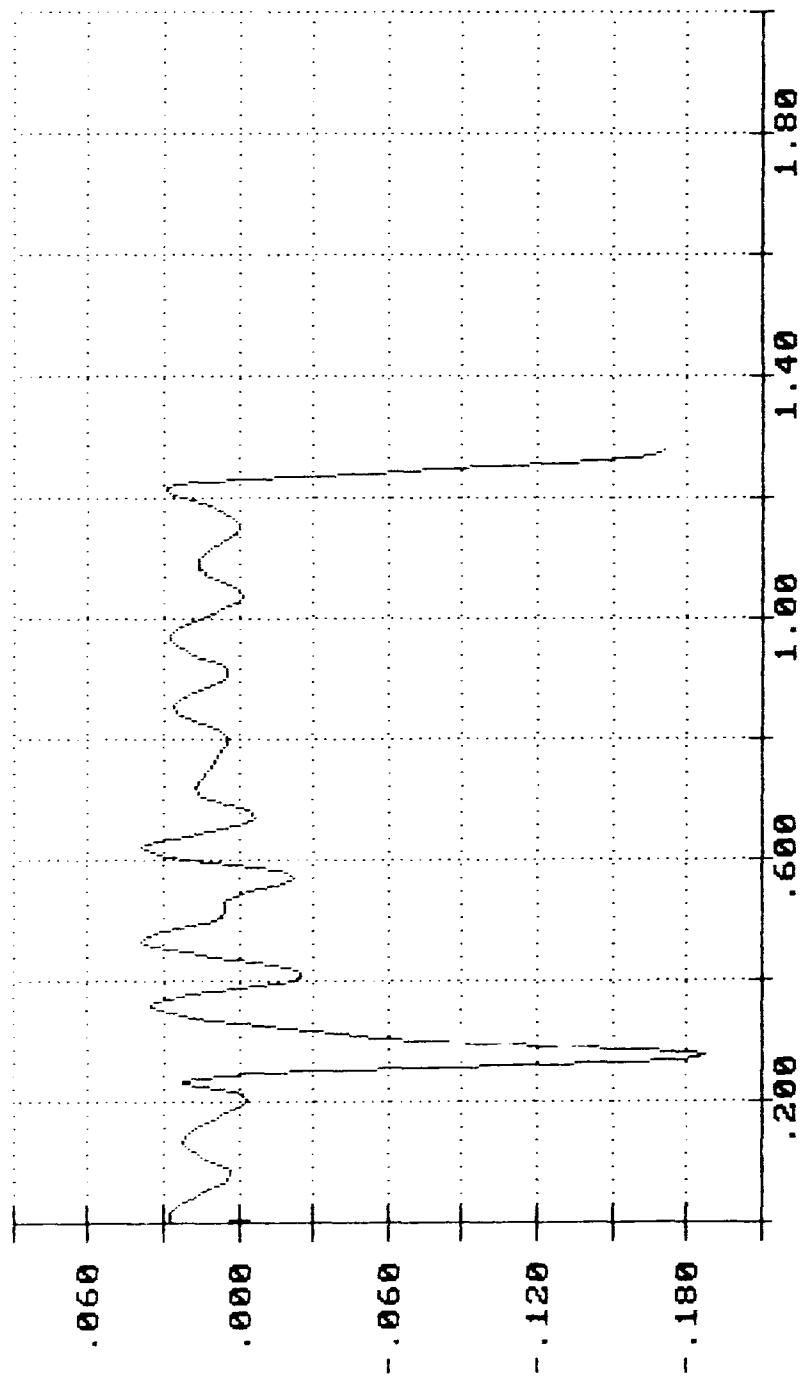

1.00 X 1.00 IN G'S
LAT. ACCEL. ON WHEEL STRUT

RAIL IMPACT TEST OF THE LAV (12-16-87)
IMPACT 2: 6.07 MPH

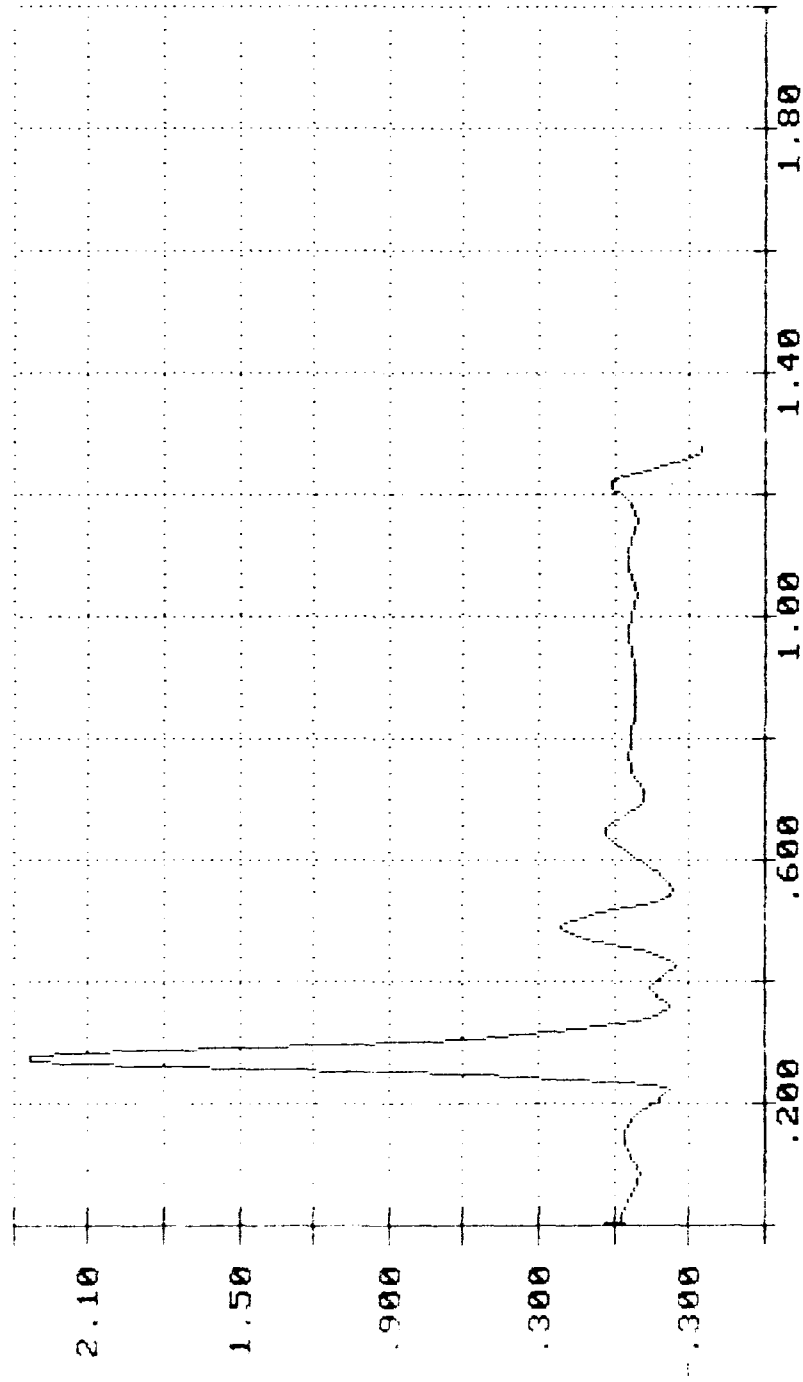

Time in Seconds
X 1.00

12 G'S X 1.00

12 G'S X 1.00

1000 + 1000 = 2000

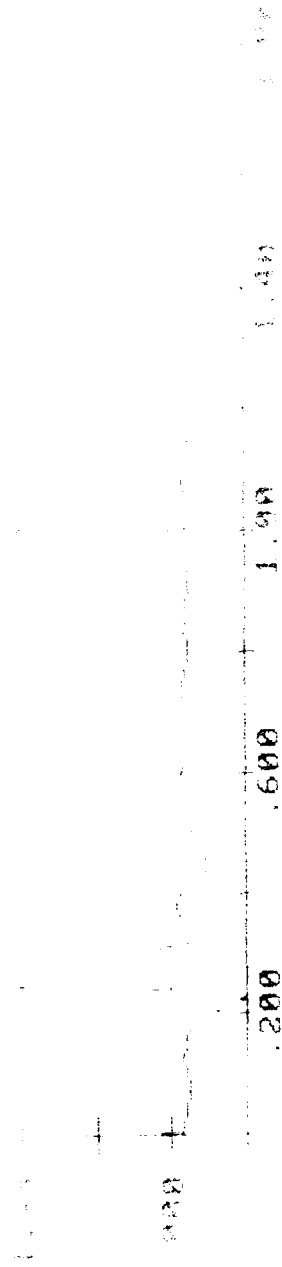

Time in Seconds

RAIL IMPACT TEST OF THE LAV (12-16-87)
IMPACT 2: 6.07 MPH

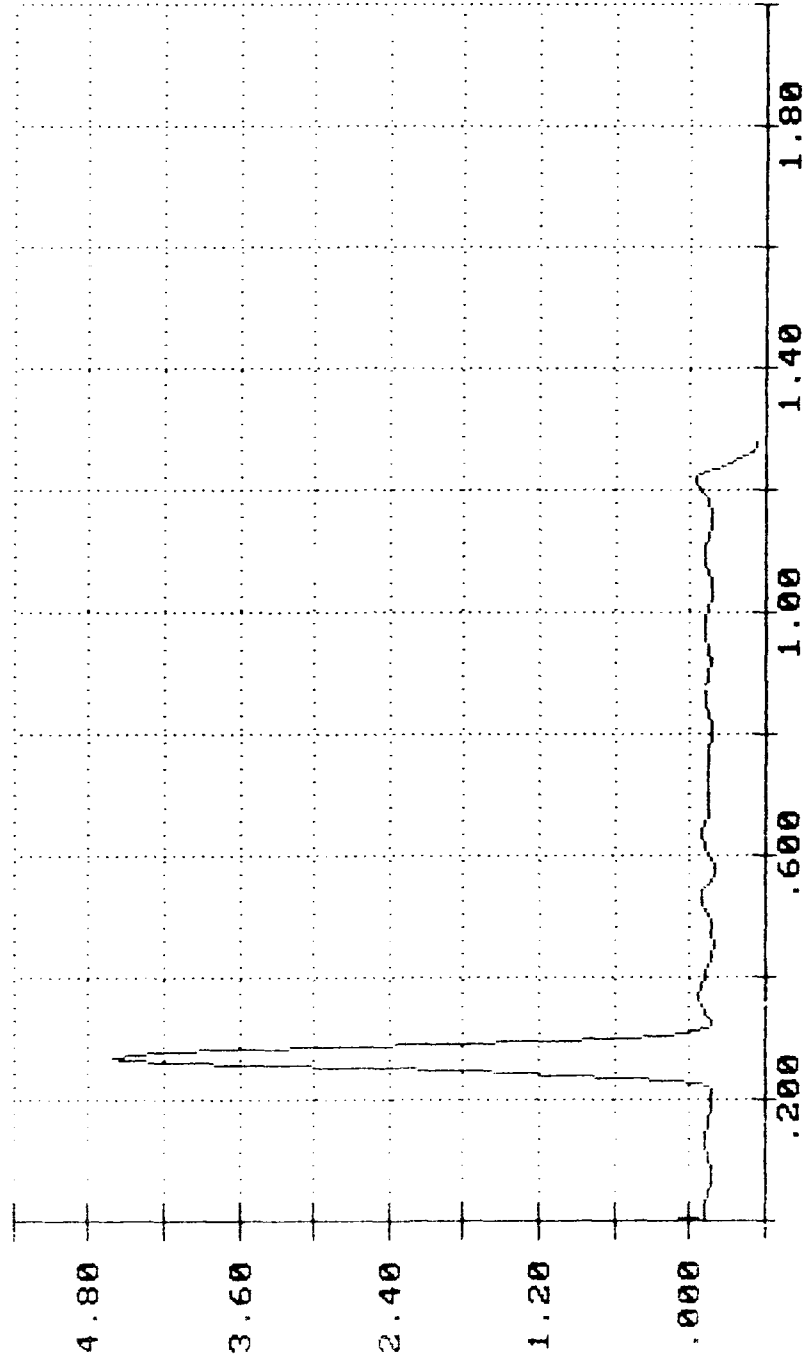

Time in Seconds
X 1.00

12 0.0 X 1.00

RAIL IMPACT TEST OF THE LAV (12-16-87)

RAIL IMPACT TEST OF THE LAV (12-16-87)
IMPACT 2: 6.07 MPH

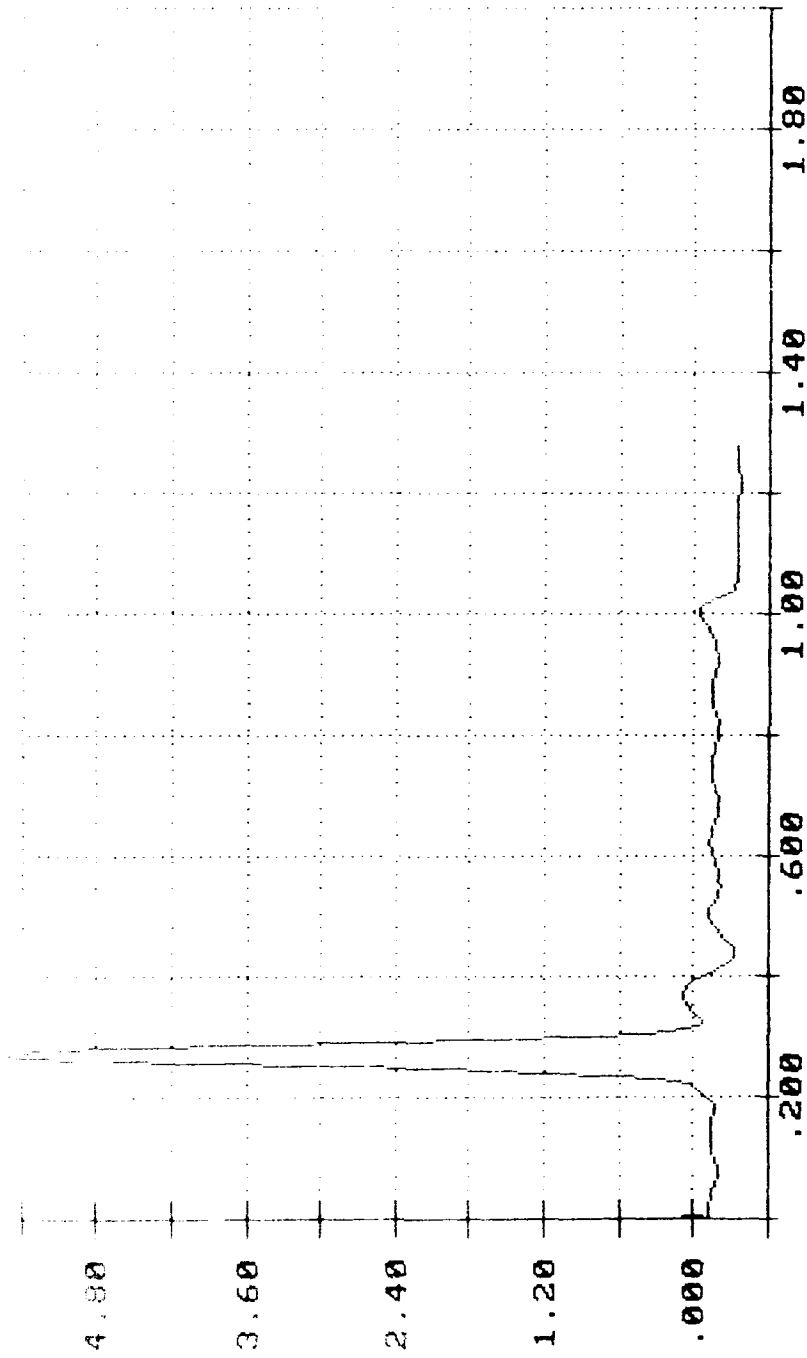

VERT. ACCELL. ON RRAIL

IN G'S X 1.00

Time in Seconds
X 1.00

RAIL IMPACT TEST OF THE LAV (12-16-87)

IMPACT 3: 8.35 MPH

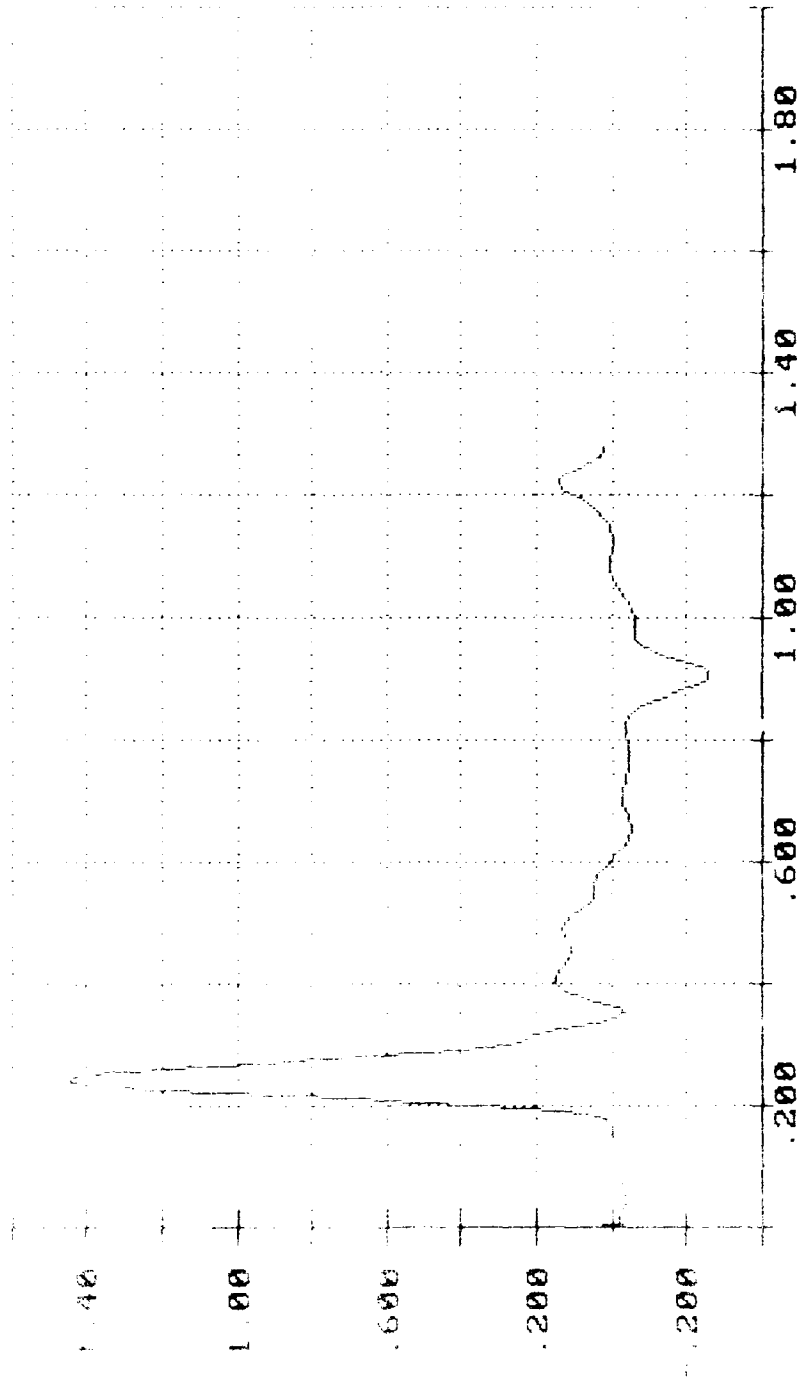

RAIL COUPLER FORCE IN POUNDS X 100000.00

Time in Seconds

X 1.00

RAIL IMPACT OF THE LAV (12-16-87)
IMPACT 4: 8.33 MPH (REVERSE)

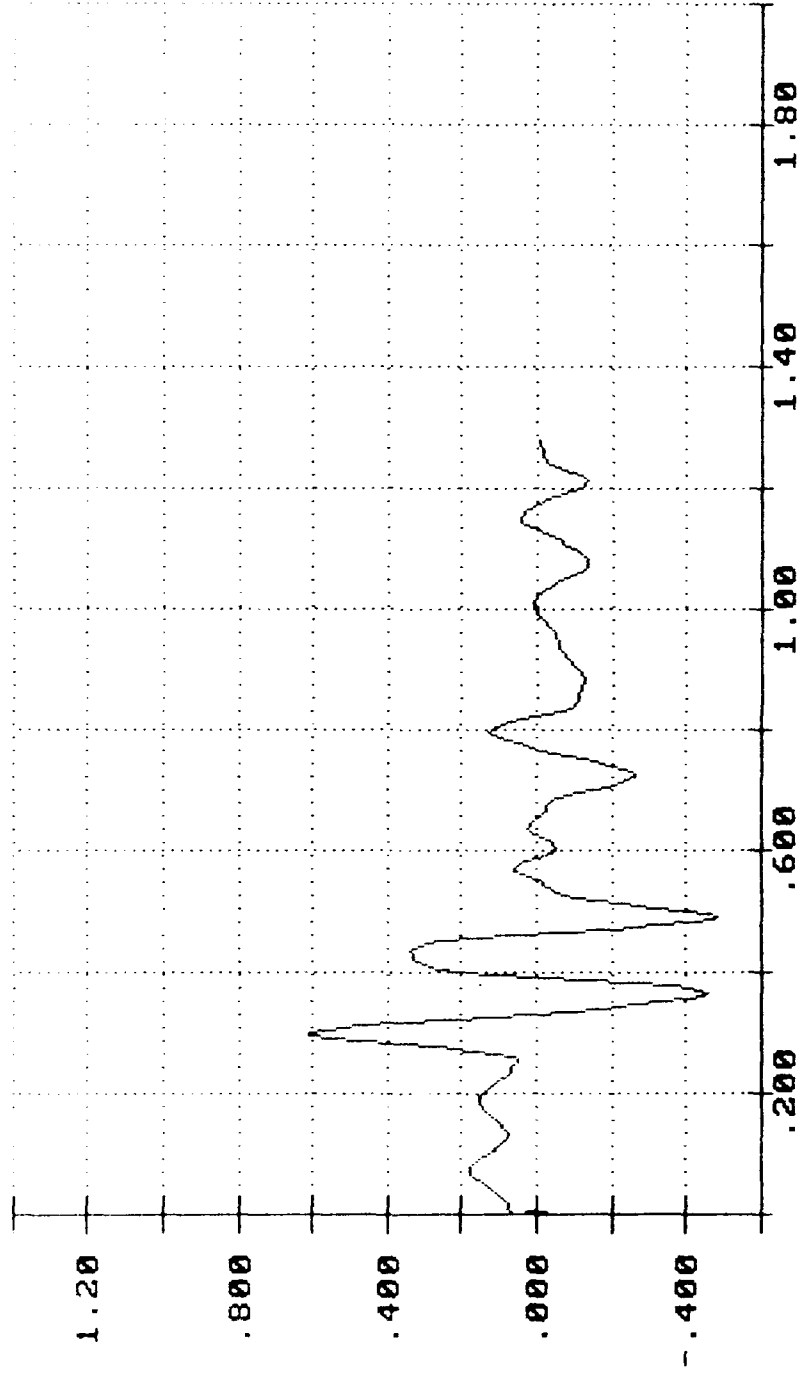

VERT. ACCEL. ON SILL

IN G'S X 1.00

Time in Seconds
X 1.00

RAIL IMPACT OF THE LAV (12-16-87)
 IMPACT 4: 8.33 MPH (REVERSE)

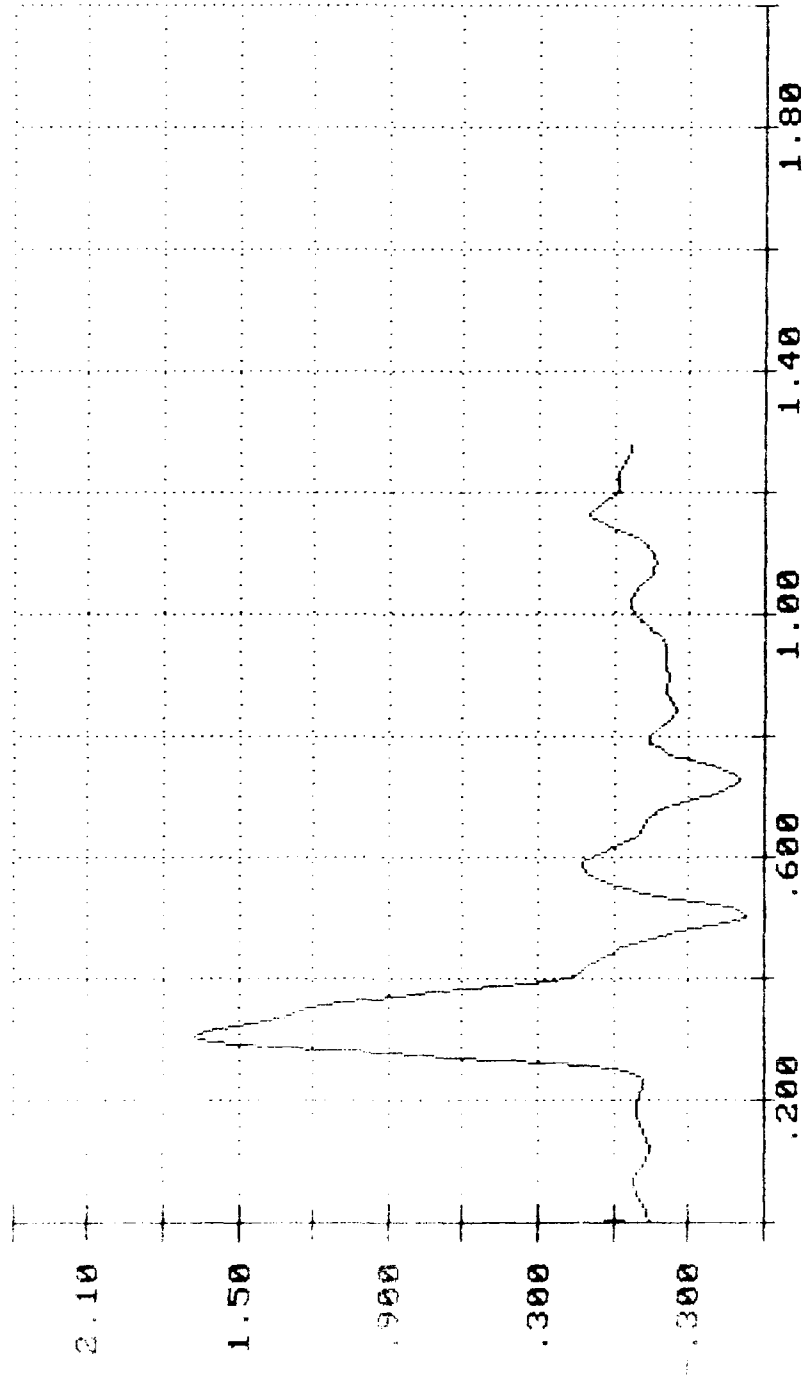

Time in Seconds
 X 1.00

FORCE (POUNDS) ON RAIL

X 1.00

RAIL IMPACT OF THE LAV (12-16-87)
IMPACT 4: 8.33 MPH (REVERSE)

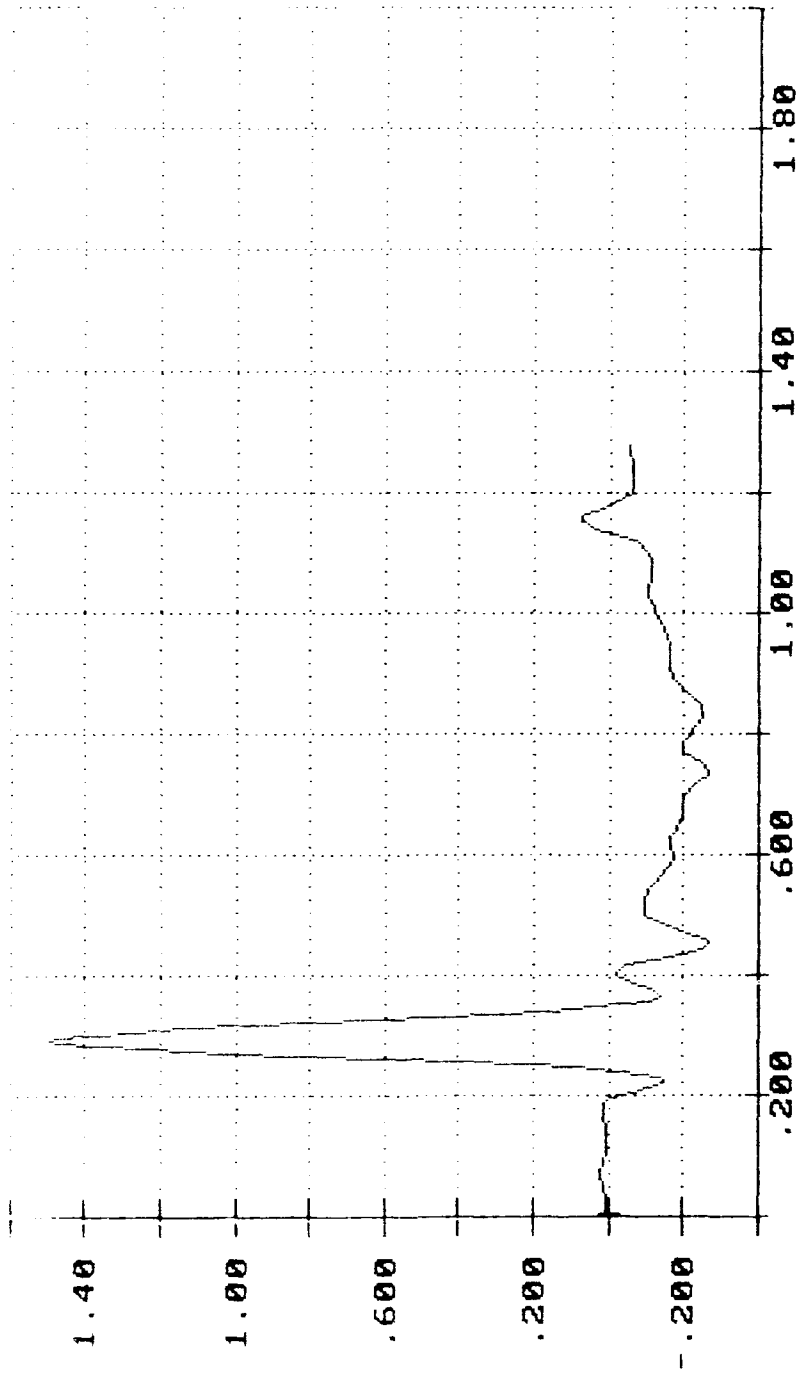

RAIL COUPLER FORCE
IN POUNDS X 10000.00

Time in Seconds
X 1.00

RAIL IMPACT OF THE LAV (12-16-87)
IMPACT 4: 8.33 MPH (REVERSE)

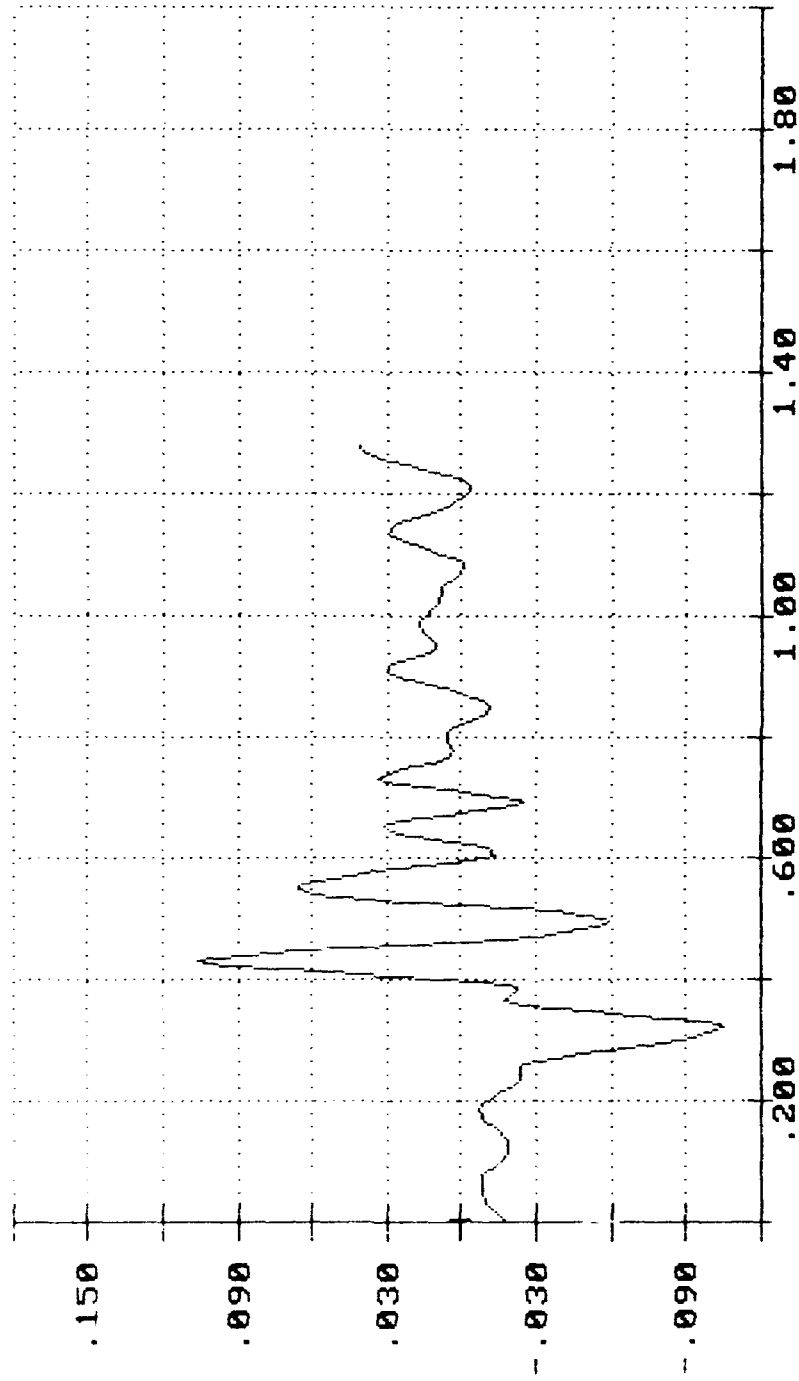

LAT. ACCELL. ON WHEEL STRUT
IN G'S X 1.00

Time in Seconds
X 1.00

VERT. ACCEL. ON WHEEL STRUT

IN G'S X 1.00

RAIL IMPACT OF THE LAV (12-16-87)
IMPACT 4: 8.33 MPH (REVERSE)

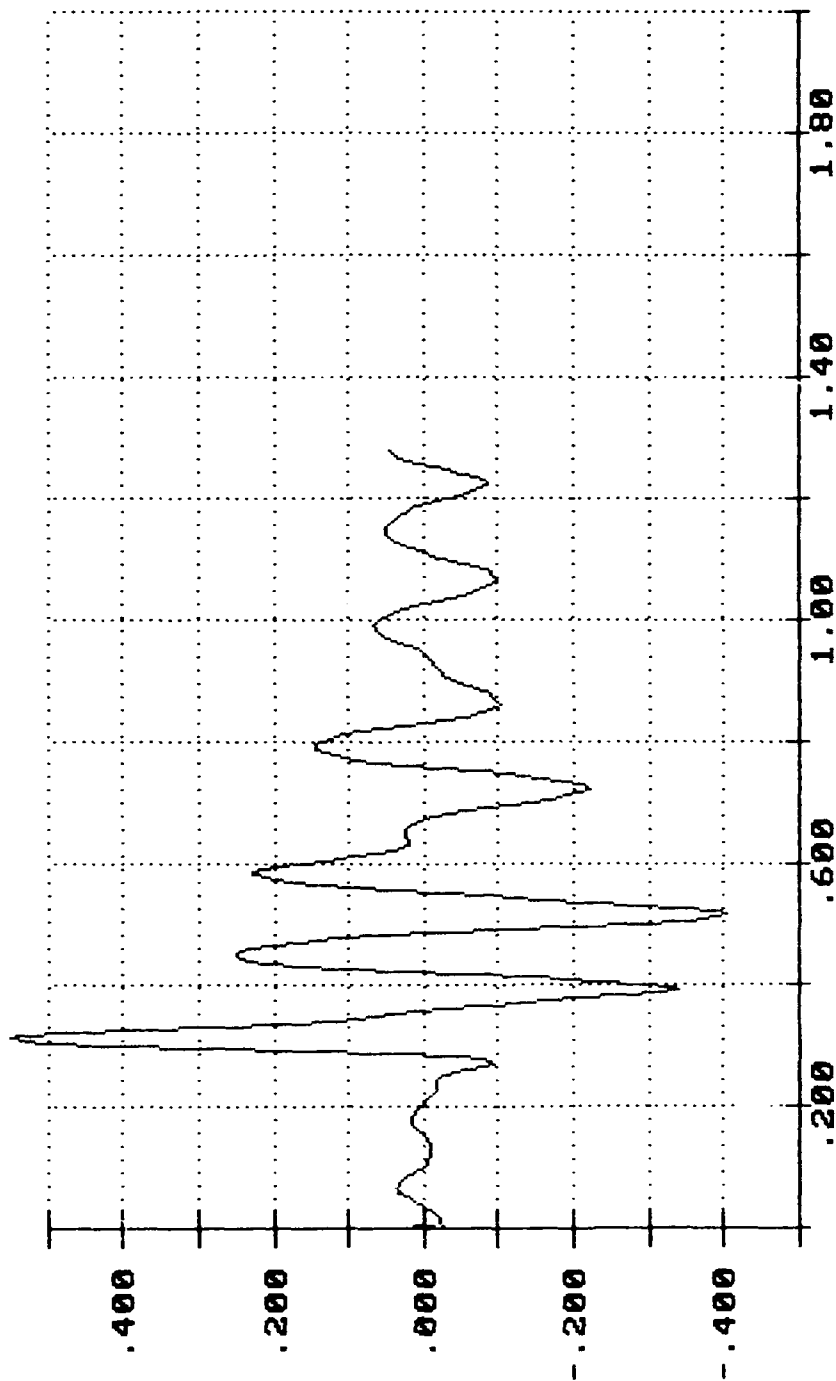

Time in Seconds
X 1.00

RAIL IMPACT OF THE LAV (12-16-87)
IMPACT 4: 8.33 MPH (REVERSE)

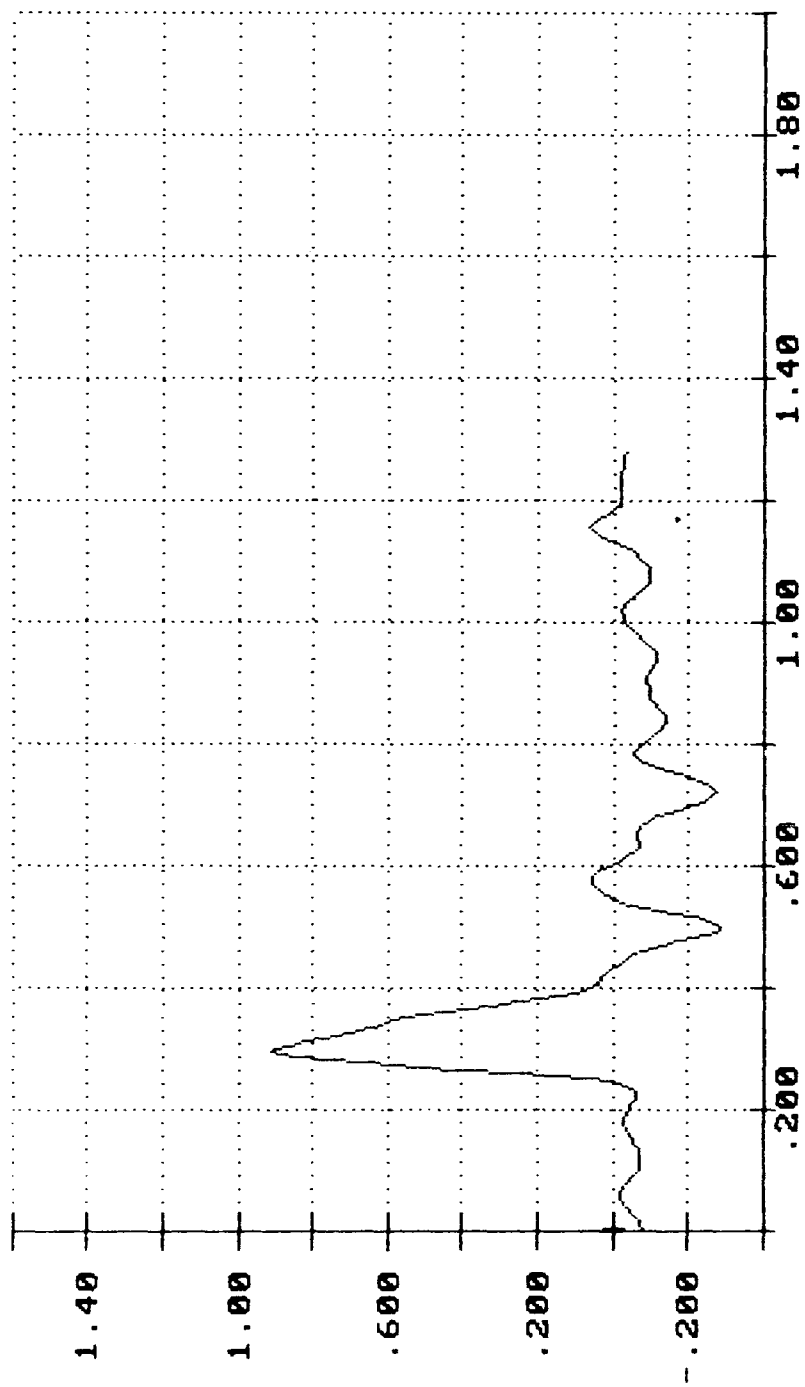

LONG. ACCELL. ON FRAME

8-1

IN G'S X 1.00

Time in Seconds
X 1.00

RAIL IMPACT OF THE LAV (12-16-87)
IMPACT 4: 8.33 MPH (REVERSE)

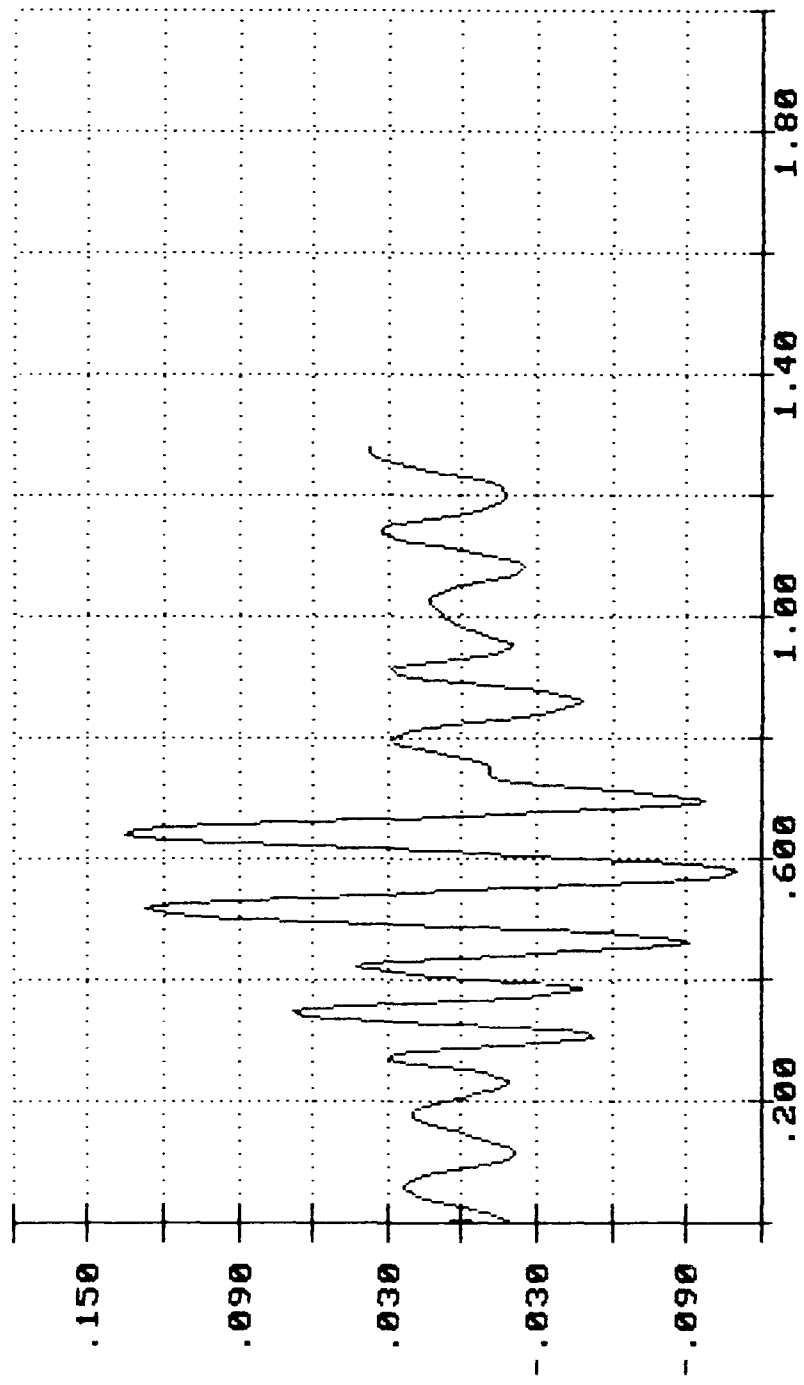

LAT. ACCEL. ON FRAME

IN G'S X 1.00

Time in Seconds
X 1.00

RAIL IMPACT OF THE LAV (12-16-87)
IMPACT 4: 8.33 MPH (REVERSE)

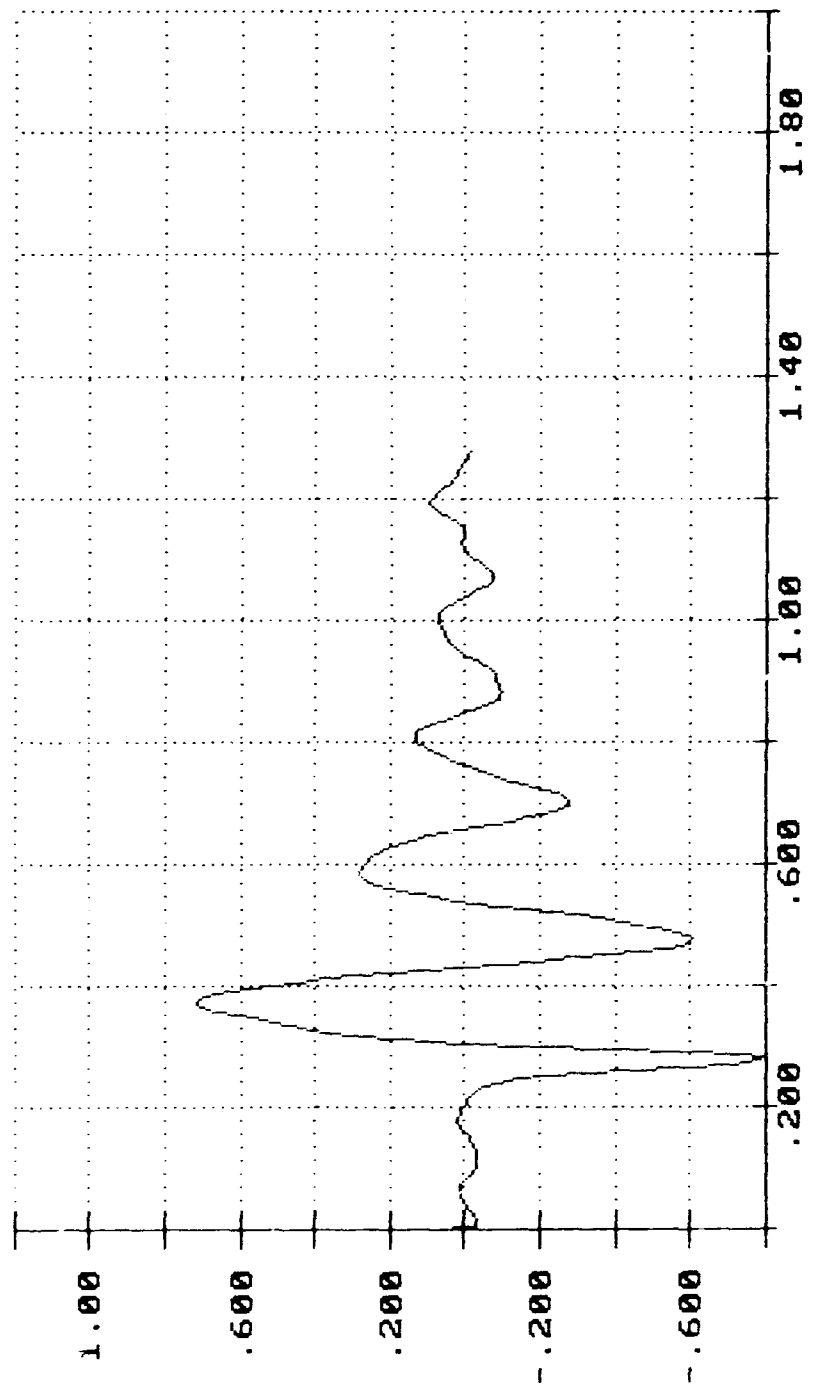

VERT. ACCELL. ON FRAME

IN G'S X 1.00

Time in Seconds
X 1.00

PART 5

TIEDOWN DRAWINGS

Loading and bracing on flatcar of the LA7-L, and tiedown procedures for securement of palletized units and/or loose boxes within the vehicle, for movement by railcar and/or highway or off highway.

LOAD AS SHOWN

ITEM	QUANTITY	WEIGHT (APPROX)
LAV-L	1	28,200 LBS
DUNNAGE		523 LBS
TOTAL WEIGHT		28,723 LBS (APPROX)

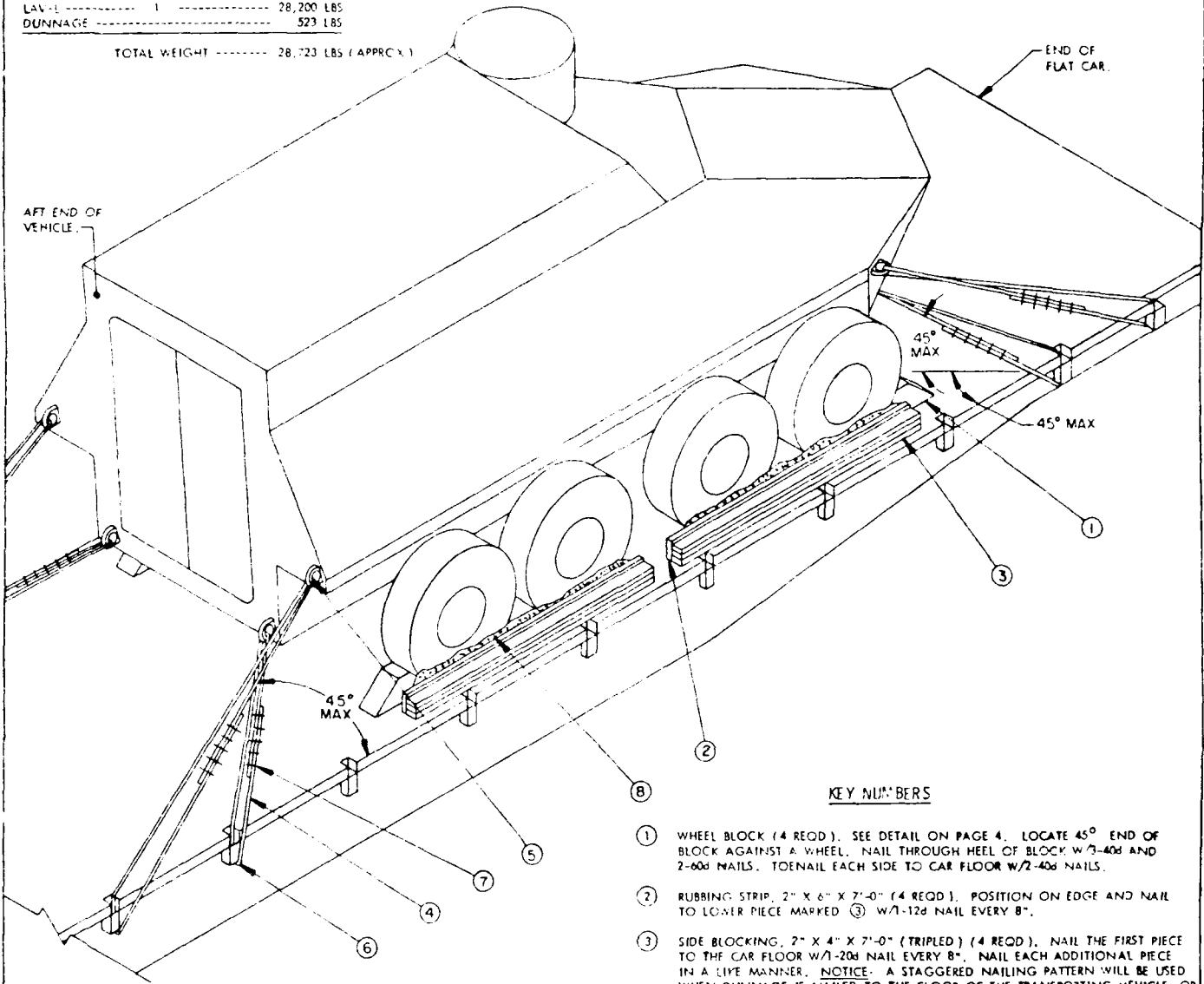

ISOMETRIC VIEW

THE LOAD ABOVE IS SHOWN ON A 52'-0" LONG BY 9'-5" WIDE FLAT CAR HAVING 15 STAKE POCKETS ON EACH SIDE.

BILL OF MATERIAL		
LUMBER	LINEAR FEET	BOARD FEET
2" X 4"	84	56
2" X 5"	28	28
5" X 8"	8	32
NAILS		
	NO. REQD	POUNDS
12d (3-1/4")	42	3/4
20d (4")	126	4-1/4
40d (5")	28	1-3/4
60d (6")	8	3/4
STEEL WIRE ROPE, 5/8" DIA	288 FT	122 LBS
THIMBLE, STANDARD, SIZE 5/8"	14 REQD	5 LBS
CLIP, WIRE ROPE, 5/8"	54 REQD	34 LBS
SHACKLE, 7/8"	6 REQD	24 LBS

KEY NUMBERS

- ① WHEEL BLOCK (4 REQD). SEE DETAIL ON PAGE 4. LOCATE 45° END OF BLOCK AGAINST A WHEEL. NAIL THROUGH HEEL OF BLOCK W/3-40d AND 2-60d NAILS. TOENAIL EACH SIDE TO CAR FLOOR W/2-40d NAILS.
- ② RUBBING STRIP, 2" X 6" X 7'-0" (4 REQD). POSITION ON EDGE AND NAIL TO LOWER PIECE MARKED ③ W/1-12d NAIL EVERY 8".
- ③ SIDE BLOCKING, 2" X 4" X 7'-0" (TRIPLED) (4 REQD). NAIL THE FIRST PIECE TO THE CAR FLOOR W/1-20d NAIL EVERY 8". NAIL EACH ADDITIONAL PIECE IN A LIVE MANNER. NOTICE: A STAGGERED NAILING PATTERN WILL BE USED WHEN LAMINATING DUNNAGE. ADDITIONALLY, THE NAILING PATTERN FOR AN UPPER PIECE OF LAMINATED DUNNAGE WILL BE ADJUSTED AS REQUIRED SO THAT A NAIL FOR THAT PIECE WILL NOT BE DRIVEN THROUGH ONTO OR RIGHT BESIDE A NAIL IN A LOWER PIECE.
- ④ STEEL WIRE ROPE, 5/8" DIA, 17.9 TONS (8 REQD). INSTALL CABLE ANGULARLY AS SHOWN AND TO FORM A COMPLETE LOOP FROM STAKE POCKET ON CAR TO POINT OF ATTACHMENT ON LADING AND BACK TO STAKE POCKET. CAUTION: DO NOT TIE TO LADING LIFTING DEVICES. NOTE: CABLE OF A LARGER SIZE MAY BE USED IF AVAILABLE, WHEN SPECIFIED CABLE IS NOT AVAILABLE. SEE THE "CABLE JOINT" DETAIL ON PAGE 4. NOTE: WIRE ROPE CABLE MUST BE TENSIONED TO CAUSE SLIGHT VEHICLE BODY DEPRESSION. TENSIONING CAN BE ACCOMPLISHED BY EMPLOYING TWO (2) CABLE "GRIPPERS" AND AN APPLICABLE SIZED "COME-A-LONG" TYPE MECHANICAL HOIST.
- ⑤ SHACKLE, SIZE 7/8" (6 REQD). INSTALL ONE EACH ON THE TWO LOWER TIEDOWN FITTINGS ON FRONT OF VEHICLE AND FOUR TIEDOWN FITTINGS ON REAR OF VEHICLE.
- ⑥ THIMBLE, STANDARD, SIZE 5/8" (14 REQD). ONE (1) PER STAKE POCKET AND ONE (1) PER SHACKLE. SECURE TO STEEL WIRE ROPE MARKED ④ W/1-CLIP PER THIMBLE. NOTE THAT AN OPEN TYPE THIMBLE IS RECOMMENDED.
- ⑦ CLIP, WIRE ROPE, SIZE 5/8" (54 REQD). USE FIVE (5) PER CABLE JOINT OF PIECE MARKED ④ AND ONE (1) PER THIMBLE. NOTE: A STANDARD THIMBLE AS SPECIFIED CAN BE SECURED TO A CABLE WITH A 5/8" CLIP. HOWEVER, IF DESIRED, OR IF THE 5/8" THIMBLE BEING USED IS OF A TYPE WHICH CANNOT BE SECURED TO A CABLE WITH A 5/8" CLIP, A 3/4" CLIP MAY BE USED. ALT. NO. 14 GAGE WIRE MAY BE USED IN LIEU OF A CLIP FOR SECUREMENT OF THE THIMBLE TO THE HOLD DOWN CABLE.
- ⑧ WATERPROOF PAPER OF A SUFFICIENT SIZE TO POSITION UNDER AND EXTEND 2' ABOVE PIECE MARKED ②.

SECUREMENT OF THE LIGHT ARMORED VEHICLE ON RAIL CAR

NOTE:

THE PROCEDURES SHOWN ON THIS PAGE ARE FOR MOVEMENT BY RAIL CAR AND/OR HIGHWAY OR OFF HIGHWAY. FOR HIGHWAY AND/OR OFF HIGHWAY MOVEMENT ONLY THE TWO LONGITUDINAL STRAPS MARKED ③ MAY BE OMITTED.

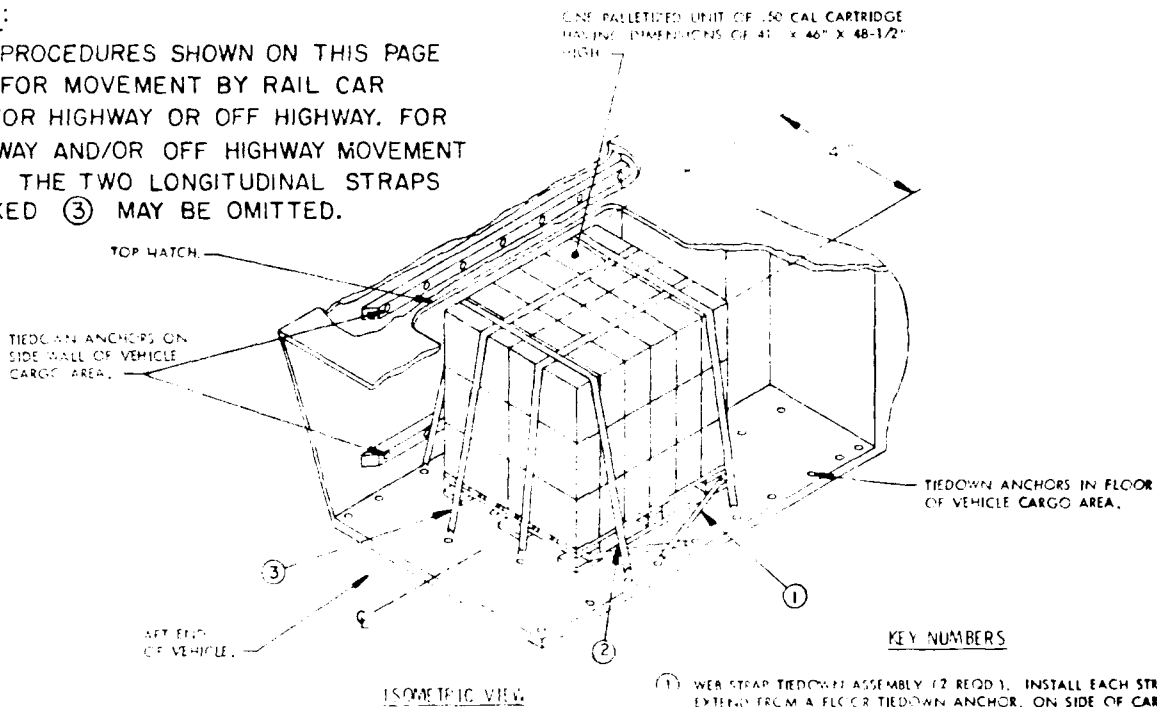

KEY NUMBERS

- ① WEB STRAP TIEDOWN ASSEMBLY (2 REQD). INSTALL EACH STRAP TO EXTEND FROM A FLOOR TIEDOWN ANCHOR, ON SIDE OF CARGO AREA, AROUND END OF PALLET, UNDER THE OVERHANG AND AGAINST THE PALLET POST, AS SHOWN, TO A TIEDOWN ANCHOR ON THE OPPOSITE SIDE OF THE CARGO AREA. TAKE UP EXCESS SLACK IN STRAP AND THEN RATCHET TIGHT.
- ② WEB STRAP TIEDOWN ASSEMBLY (2 REQD). INSTALL EACH STRAP TO EXTEND FROM A FLOOR TIEDOWN ANCHOR ON SIDE OF CARGO AREA, OVER TOP OF PALLETIZED UNIT, TO A FLOOR TIEDOWN ANCHOR ON THE OPPOSITE SIDE OF THE CARGO AREA. TAKE UP EXCESS SLACK IN STRAP AND THEN RATCHET TIGHT.
- ③ WEB STRAP TIEDOWN ASSEMBLY (2 REQD). INSTALL EACH STRAP TO EXTEND FROM A FLOOR TIEDOWN ANCHOR ON REAR OF CARGO AREA, OVER TOP OF PALLETIZED UNIT, TO A FLOOR TIEDOWN ANCHOR ON THE FORWARD END OF CARGO AREA. TAKE UP EXCESS SLACK IN STRAP AND THEN RATCHET TIGHT.

SPECIAL NOTES:

- 1. A TYPICAL LOAD OF ONE PALLETIZED UNIT 50 CAL CARTRIDGE IS SHOWN SECURED TO THE VEHICLE FLOOR. WHEN LOADING PALLETIZED UNITS OF OTHER SIZES AND WEIGHTS, USE THESE SAME PROCEDURES.
- 2. WHEN LOADING, POSITION THE PALLETIZED UNIT IN THE CENTER OF THE VEHICLE WIDTH, AND CENTER LONGITUDINALLY BETWEEN THE FLOOR TIEDOWN ANCHORS AT THE REAR OF THE CARGO AREA, AND THE FLOOR TIEDOWN ANCHOR AT THE FORWARD END OF THE CARGO AREA, TO WHICH STRAPS MARKED ③ WILL BE ATTACHED TO.

LOAD AS SHOWN

ITEM	QUANTITY	WEIGHT (APPROX)
PALLET	1	3,883 LBS

CAUTION:

THE PROCEDURES SHOWN ON THIS PAGE ARE ONLY TO BE USED FOR ON/OFF HIGHWAY MOVEMENT AND ARE NOT TO BE USED FOR MOVEMENT BY RAIL CAR.

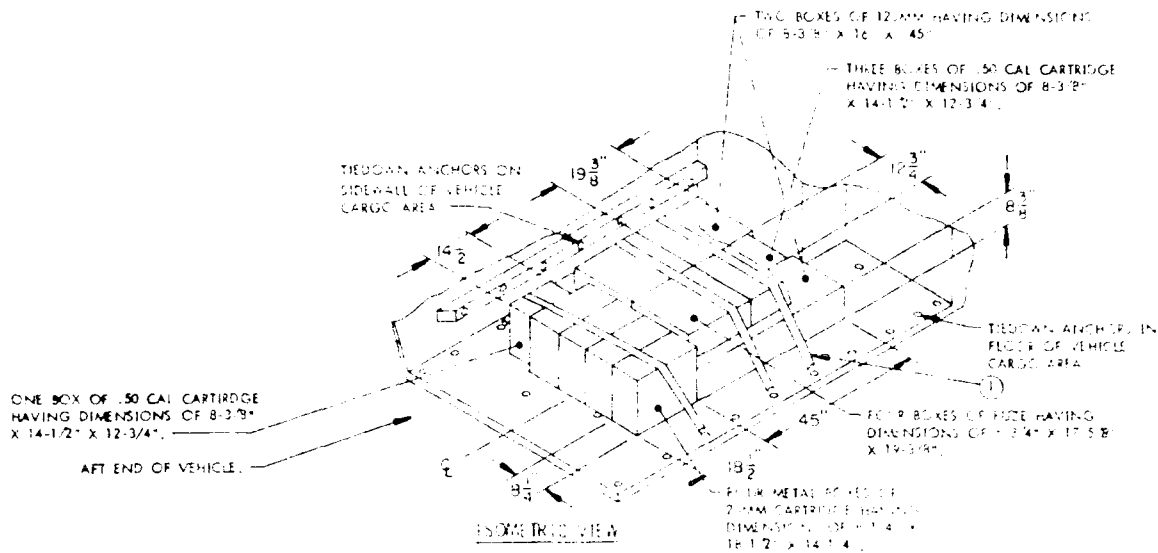

SPECIAL NOTES:

1. A TYPICAL LOAD OF LOOSE BOXES OF VARIOUS SIZES AND WEIGHTS IS SHOWN SECURED TO THE VEHICLE FLOOR.
2. WHEN LOADING LOOSE BOXES POSITION EACH BOX AND OR GROUP OF SAME SIZE BOXES, IN SUCH A MANNER THAT ALL BOXES WITHIN THE LOAD ARE TIGHTLY SECURED BY THE WEB STRAP TIEDOWN ASSEMBLIES.

- KEY NUMBERS
1. WEB STRAP TIEDOWN ASSEMBLY TO BE USED TO INSTALL EACH STRAP TO EXTEND FROM A FLOOR TIEDOWN ANCHOR ON ONE SIDE OF CARGO AREA OVER TOP OF BOXES TO A FLOOR TIEDOWN ANCHOR ON THE OPPOSITE SIDE OF THE VEHICLE. TAKE UP EXCESS SLACK IN STRAP AND THEN RATCHET TIGHT.

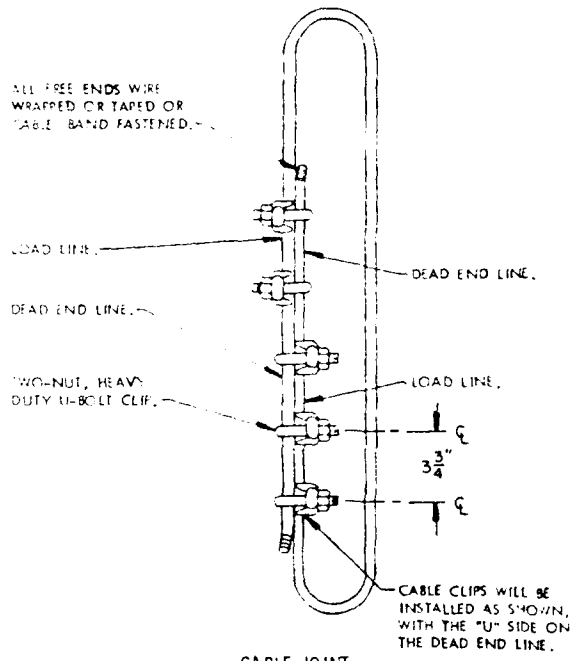

CABLE JOINT

PROPER TIGHTENING OF THE WIRE ROPE CLIP NUTS CAN BE ACCOMPLISHED BY UTILIZING A PROPER SIZED TORQUE WRENCH. AFTER THE NUTS HAVE BEEN INITIALLY TIGHTENED, THE "U" SIDE OF EACH CLIP MUST BE STRUCK SEVERAL TIMES WITH A HAMMER TO INSURE PROPER SEATING INTO THE DEAD END LINE. FINAL TORQUE WILL BE ACQUIRED BY REPEATEDLY AND ALTERNATELY TIGHTENING EACH CLIP NUT. THE NUTS ON 5/8" CLIPS WILL BE TIGHTENED TO A TORQUE OF 135 TO 150 FOOT POUNDS. NOTE: IF A TORQUE WRENCH IS NOT AVAILABLE FOR TIGHTENING CLIP NUTS, THE PROPER TORQUE FOR CLIP NUTS CAN BE ACHIEVED BY USING BOX AND/OR OPEN END OR SOCKET WRENCHES THAT HAVE 24" LONG HANDLES.

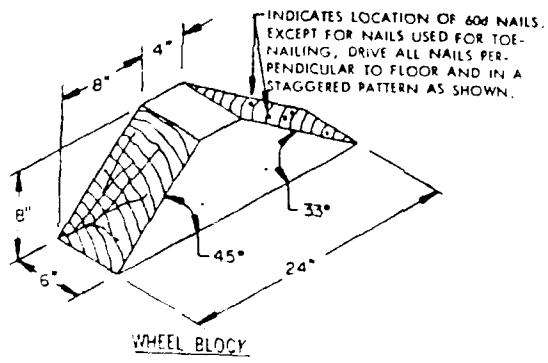

WHEEL BLOCK

MATERIAL SPECIFICATIONS

- LUMBER** --- DOUGLAS FIR OR COMPARABLE LUMBER WITH STRAIGHT GRAIN AND FREE OF MATERIAL DEFECTS. REF: FED SPEC. MM-L-751.
- NAILS** --- COMMON, REF: FED SPEC FF-N-105. ALT: ANNULAR RING TYPE NAIL OF SAME SIZE.
- ROPE** --- STEEL WIRE, PLAIN, PREFORMED, REGULAR LAY 11.5 TONS 6 X 19, FLEXIBLE MRC, MACWHYTE WIRE ROPE CO. (OR EQUAL). REF: FED SPEC RR-W-410.
- CLIPS** --- "U" BOLT, CROSBY, HEAVY DUTY (OR EQUAL)
- TIMBER** --- COMMERCIAL GRADE.
- SHACKLE** --- COMMERCIAL GRADE.