

AD-A212 023

2

THE BATTLE OF ASCHAFFENBURG:
AN EXAMPLE OF LATE WORLD WAR II URBAN COMBAT
IN EUROPE

A thesis presented to the Faculty of the U. S. Army
Command and General Staff College in partial
fulfillment of the requirements for the
degree

MASTER OF MILITARY ART AND SCIENCE

by

QUENTIN W. SCHILLARE, MAJ, USA
B.S., University of Connecticut, 1967
B.A., University of Connecticut, 1974
M.B.A., University of Connecticut, 1977

Fort Leavenworth, Kansas
1989

DTIC
ELECTE
SEP 07 1989
S D
cb

Approved for public release; distribution unlimited.

00

REPORT DOCUMENTATION PAGE				Form Approved OMB No. 0704-0188		
1a. REPORT SECURITY CLASSIFICATION			5. RESTRICTIVE MARKINGS			
2a. SECURITY CLASSIFICATION AUTHORITY			3. DISTRIBUTION AVAILABILITY OF REPORT Approved for public release; distribution unlimited			
2b. DECLASSIFICATION/DOWNGRADING SCHEDULE						
4. PERFORMING ORGANIZATION REPORT NUMBER(S)			5. MONITORING ORGANIZATION REPORT NUMBER(S)			
6a. NAME OF PERFORMING ORGANIZATION U.S. Army Command and General Staff College		6b. OFFICE SYMBOL (if applicable) ATZL-SWD-GD	7a. NAME OF MONITORING ORGANIZATION			
6c. ADDRESS (City, State, and ZIP Code) Attn: ATZL-SWD-GD Fort Leavenworth, Kansas 66027-6900			7b. ADDRESS (City, State, and ZIP Code)			
8a. NAME OF FUNDING / SPONSORING ORGANIZATION		8b. OFFICE SYMBOL (if applicable)	9. PROCUREMENT INSTRUMENT IDENTIFICATION NUMBER			
8c. ADDRESS (City, State, and ZIP Code)			10. SOURCE OF FUNDING NUMBERS			
			PROGRAM ELEMENT NO.	PROJECT NO.	TASK NO.	WORK UNIT ACCESSION NO.
11. TITLE (Include Security Classification) The Battle of Aschaffenburg: An Example of Late World War II Urban Combat in Europe						
12. PERSONAL AUTHOR(S) Major Quentin W. Schillare						
13a. TYPE OF REPORT Master's Thesis		13b. TIME COVERED FROM 8-1988 TO 6-1989		14. DATE OF REPORT (Year, Month, Day) 1989 June 2	15. PAGE COUNT 202	
16. SUPPLEMENTARY NOTATION						
17. COSATI CODES			18. SUBJECT TERMS (Continue on reverse if necessary and identify by block number) Military Operations in Urbanized Terrain, Aschaffenburg, U.S. Army World War II, 4th Armored Division, 45th Infantry Division, Main River, European Theater of Operations			
FIELD	GROUP	SUB-GROUP				
19. ABSTRACT (Continue on reverse if necessary and identify by block number) (See reverse side)						
20. DISTRIBUTION / AVAILABILITY OF ABSTRACT <input checked="" type="checkbox"/> UNCLASSIFIED/UNLIMITED <input type="checkbox"/> SAME AS RPT <input type="checkbox"/> DTIC USERS			21. ABSTRACT SECURITY CLASSIFICATION Unclassified			
22a. NAME OF RESPONSIBLE INDIVIDUAL			22b. TELEPHONE (Include Area Code)		22c. OFFICE SYMBOL	

19. ABSTRACT (CONTINUED)

The Battle of Aschaffenburg examines the fight for the Main River city of Aschaffenburg in the closing weeks of World War II in Europe. It investigates the reasons why it took mobile and well supported elements of the U.S. Army ten days to subdue a defending German military force that was very much militia in character. After setting the battle in the context of Nazi Germany and the Aschaffenburg region just prior to the flight, the study takes the reader through the battle day-by-day describing the struggle and establishing the reasons why it was so prolonged.

The study groups the reasons for the successful German defense into three categories: terrain, operational factors and behavioral determinants. It establishes that the terrain favored the defenders with the town so located across the Main River from the attackers that they were forced into frontal assaults. Granting favorable defensive terrain, it was not until a numerically superior attacking force enveloped the urban defenses, under the cover of massive fire support, that the Americans gained the upper hand. The study further demonstrates the impact of the concept of the will to win on military operations, even in a hopeless cause.

The Battle of Aschaffenburg addresses European urban combat in the context of World War II and concludes that the factors relevant to success then are still applicable. An attacker must carefully plan operations in urbanized terrain, follow doctrine and be physically and mentally prepared for a difficult fight.

THE BATTLE OF ASCHAFFENBURG:
AN EXAMPLE OF LATE WORLD WAR II URBAN COMBAT
IN EUROPE

A thesis presented to the Faculty of the U. S. Army
Command and General Staff College in partial
fulfillment of the requirements for the
degree

MASTER OF MILITARY ART AND SCIENCE

by

QUENTIN W. SCHILLARE, MAJ, USA
B.S., University of Connecticut, 1967
B.A., University of Connecticut, 1974
M.B.A., University of Connecticut, 1977

Fort Leavenworth, Kansas
1989

Approved for public release; distribution unlimited.

MASTER OF MILITARY ART AND SCIENCE

THESIS APPROVAL PAGE

Name of candidate: Major Quentin Wayne Schillare

Title of thesis: The Battle of Aschaffenburg: An
Example of Late World War II Urban
Combat in Europe

Approved by:

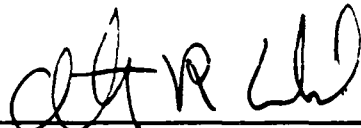
_____, Thesis Committee Chairman
Christopher R. Gabel, Ph.D.

_____, Member, Graduate Faculty
Major Michael W. Hackerson, M.A.

Accepted this 2nd day of June 1989 by:

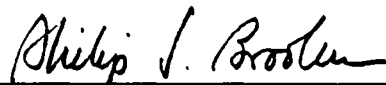
_____, Director, Graduate Degree
Phillip J. Brookes, Ph.D. Programs

The opinions and conclusions expressed herein are those of the student author and do not necessarily represent the views of the U.S. Army Command and General College or any other governmental agency. (References to this study should include the foregoing statement.)

ABSTRACT

THE BATTLE OF ASCHAFFENBURG: AN EXAMPLE OF LATE WORLD WAR II URBAN COMBAT IN EUROPE by Major Quentin W. Schillare, USA, 202 pages.

The Battle of Aschaffenburg examines the fight for the Main River city of Aschaffenburg in the closing weeks of World War II in Europe. It investigates the reasons why it took mobile and well supported elements of the U.S. Army ten days to subdue a defending German military force that was very much militia in character. After setting the battle in the context of Nazi Germany and the Aschaffenburg region just prior to the fight, the study takes the reader through the battle day-by-day describing the struggle and establishing the reasons why it was so prolonged.

The study groups the reasons for the successful German defense into three categories: terrain, operational factors and behavioral determinants. It establishes that the terrain favored the defenders with the town located across the Main River from the attackers so that they were forced into frontal assaults. Granting favorable defensive terrain, it was not until a numerically superior attacking force enveloped the urban defenses, under the cover of massive fire support, that the Americans gained the upper hand. The study further demonstrates the impact of the concept of the will to win on military operations, even in a hopeless cause.

The Battle of Aschaffenburg addresses European urban combat in the context of World War II and concludes that the factors relevant to success then are still applicable. An attacker must carefully plan operations in urbanized terrain, follow doctrine and be physically and mentally prepared for a difficult fight.

Accession For	
NTIS GRA&I	<input checked="" type="checkbox"/>
DTIC TAB	<input type="checkbox"/>
Unannounced	<input type="checkbox"/>
Justification	
By _____	
Distribution/	
Availability Codes	
Dist	Special
A-1	

TABLE OF CONTENTS

Thesis Approval Page	ii
Abstract	iii
Table of Contents	iv
List of Figures	v
Chapter 1 - Introduction	1
Chapter 2 - Aschaffenburg in 1945	14
Chapter 3 - The Eve of the Battle	43
Chapter 4 - The Battle	76
Chapter 5 - Conclusion	152
Appendix 1 - Glossary of Terms	168
Appendix 2 - Chronology	174
Appendix 3 - Order of Battle	184
Appendix 4 - Bibliography	192
Initial Distribution List	202

LIST OF FIGURES

Figure	Title	Page
1	Lower Main Region	16
2	Aschaffenburg and Environs, 1945	19
3	SS Organization for Greater Germany, 1941	25
4	German Military Regions, 1943	27
5	Wetterau-Main-Tauber Line	36
6	Order of Battle Matrix	54
7	Opposing Forces, 26-28 March 1945	58
8	Opening Troop Dispositions, 25 March 1945	78
9	Aschaffenburg, 1945	90
10	Expansion of the American Rhine Bridgehead	91
11	45th Infantry Division Situation Overlay 282400A March 1945	96
12	45th Infantry Division Situation Overlay 292400A March 1945	106
13	45th Infantry Division Drive for Aschaffenburg	112
14	45th Infantry Division Situation Overlay 302400A March 1945	117
15	45th Infantry Division Situation Overlay 312400A March 1945	124
16	45th Infantry Division Situation Overlay 012400A April 1945	131
17	45th Infantry Division Situation Overlay 022400A April 1945	135

CHAPTER 1

INTRODUCTION

The German situation map of the OberKommando der Wehrmacht (OKW) (the German Armed Forces High Command) on 25 March did not present a very encouraging picture. In the east the Soviet Army was advancing with four fronts, in Italy the Allied 15th Army Group was in the foothills of the Alps, and in the west the defenses of the Reich were ruptured and German forces were falling back everywhere.¹ Until the Allied crossing of the Rhine, the German plan had been to aggressively counterattack the Russian threat in the east to slow the drive on Berlin, while simultaneously holding the line in the west.² Now that strategy was in disarray and after six years of war the human, economic and psychological resources of Nazi Germany were nearly depleted.

The Allies in the west were as optimistic as the Germans were pessimistic. The westwall (Siegfried Line) was overwhelmed and the Rhine River crossed. Allied units were advancing steadily all along the front. In mid March the plan for the final destruction of German military forces in the west had been implemented. This plan envisioned the encirclement and destruction of German forces in the Ruhr by the US First and US Ninth Armies, and an all-out drive through the center of Germany to the Leipzig-Dresden area by the US First, Third and Ninth Armies, halting at the Elbe. Simultaneously, the British Second and the

Canadian First Armies, protecting the northern flank, made a northern crossing of the Elbe and were dashing to the Danish border, while the US Sixth Army Group, protecting the southern flank, drove through southern Germany to Austria.³

Within this strategic context the forces of the belligerents fought the daily life and death struggles that make up the fabric of war. The Allies, especially the Americans, had vast superiority in men and materiel over their German adversary who was deficient in the wherewithall to fight a modern war. The von Rundstedt Offensive (The Battle of the Bulge) had depleted the last strategic reserves available to the Wehrmacht. What faced the Allies were remnants of once-powerful Wehrmacht units, with inferior manpower and inadequate equipment. East of the Rhine the Germans had only 60 under-strength divisions to oppose 85 well-equipped Allied divisions supplied by the largest combat service support organization ever known in warfare.⁴ Against this backdrop stands one of the small paradoxes that often occur in war, where a seemingly inferior defender resists a superior attacker.

Beginning on 25 March 1945, elements of four US divisions successively fought for ten days to capture the Main River town of Aschaffenburg, a part of the Wetterau-Main-Tauber Line, an integrated defensive line that ran for 120 kilometers in south-central Germany.⁵ Combat Command Aschaffenburg (KKA from the German Kampfkommando Aschaffenburg) was an eclectic combination of soldiers and civilians drawn from replacement units, convalescing

soldiers, hastily-mustered volkssturm (home guard), police, civil defense and Nazi Party functionaries. Together they resisted battle-tested American infantry supported by tanks, engineers, artillery and fighterbombers for much longer than expected.

The fight for Aschaffenburg was as bitter as it was prolonged. At least in the eyes of the attacker it was unnecessary and many US veterans of the struggle cannot understand why the defenders fought so hard for so long.* The central question of this study will be to answer that question, "Why did it take the Americans ten days to capture the city of Aschaffenburg in March and April 1945?" The study will examine the battle from the perspective of both the attacker and the defender, looking at the environmental, operational and behavioral factors that generated the combat power of each side, and supplied the will to employ it.

The battle and its outcome became relevant in late 1984, as an increased urban terrorist threat in Europe caused US military authorities in Aschaffenburg to investigate how the city could be defended from any threat. Because the area had been heavily defended in World War II, research into how it was done seemed a logical place to start. The results of that investigation led to this thesis.

Recounting the story of the battle is important today beyond its value as a combat narrative of WWII. Aschaffenburg had a wartime population of 38,000, about the size of many urban centers

that the US Army may defend under its NATO commitment to Western Europe. The Battle of Aschaffenburg is significant today as an example of the techniques of military operations in urban terrain (MOUT). Much has changed in military operations in the past forty three years, but it will be the intention of this study to demonstrate that the fighting in the Spring of 1945 is as relevant today as it was when elements of the US Seventh Army faced Combat Command Aschaffenburg. If the US Army is to apply its AirLand Battle doctrine against the threat in Europe it will, very often, have to synchronize combat power in urban terrain to fight and win.

REVIEW OF LITERATURE

The fighting around Aschaffenburg was a very small part of the mosaic that was World War II in March and April 1945. Fighting raged in the Pacific. In the Mediterranean, in eastern Europe, as well as throughout the Western Front.⁷ Rumors abounded of the weakening of the Axis will to resist, and reports of peace feelers made their way to Allied capitals. Because of its limited importance the battle for Aschaffenburg did not command much long term interest.

The struggle was mentioned in contemporary news accounts. Reports of the fighting were a part of the recap of daily operations that appeared in the major newspapers in the United States, Great Britain and elsewhere. Even these brief accounts

comment on the bitter and prolonged nature of the conflict, and they were periodically accompanied by more detailed dispatches from war correspondents writing of the struggle through the eyes of participants. The character of the fighting was such that it made an impression on even those with a broad view of the war.

Secretary of War Stimson made this comment at his weekly news conference on 7 April 1945:

There is a lesson with respect to [fighting to the end] in Aschaffenburg. There Nazi fanatics used the visible threat of two hangings to compel German soldiers and civilians to fight for a week. After a week of fighting, during which the city was reduced to rubble and many Germans lost their lives, the inevitable took place and the Nazi fanatics ran up the white flag and surrendered to our veteran 45th Infantry Division.*

But in the end the fighting in Aschaffenburg was a relatively insignificant part of a long war and its renown short-lived.

Although it lasted for ten days, the Aschaffenburg battle was a relatively small action and is not accorded much space in most accounts of the war. However, adequate documented sources exist to piece together what happened. In addition to the news accounts mentioned above there are other contemporary accounts. The OKW mentioned the fight in several dispatches that appear in war archives. And several documents published by the German defenders still exist, either in the original in the Aschaffenburg city archives or in copy in US and German accounts of the battle.

The daily logs and journals of the units participating in the battle contain much detail of the fight. Because of the state of most German units at the end of the war the combat journals of the Wehrmacht units which fought in the battle are not available. But accounts of the actions of those units are available, at least in part, from the historical narratives compiled by the United States Army Europe Historical Division from 1946 to 1954. The Historical Division encouraged officer prisoners to write of their experiences, and at least something of each German unit division and higher is outlined. These reports contain information on the state of the units and narratives of their day-to-day activities.

The reports of the American units, daily journals, G-2 and G-3 reports and after action reports compiled at the end of the war still exist. A review of the documents of the divisions, corps, armies and army groups involved give an accurate picture of the disposition of forces, their composition and some indication of the actions in which they took part. These war documents are fleshed out, in some cases, by the unofficial unit histories published by most American units immediately after the war. Although they often have small inaccuracies in detail, and show an understandable bias against the former enemy, they contain much valuable information.

For a battle as small as that in Aschaffenburg the Army "Green Books" and other official histories supply limited information. They are, for the most part, compilations from the

sources mentioned above and provide little new information to the researcher who has access to unit histories and logs.

The best source of anecdotal accounts of fighting is always from participants. Although participants usually do not have the broad perspective of an historian, their narratives contain details found nowhere else. In the years since the battle many accounts have appeared. On the German side the best sources are the newspapers and periodicals in Aschaffenburg and the Main-Franken region of Germany. Since the battle was of such significance to the local population, there have been repeated newspaper articles to mark the anniversary throughout the years. Participants are often interviewed and articles written about the Nazi era.

Currently, the most comprehensive account of the battle is by Dr. Alois Stadtmueller, an Aschaffenburg historian. Using both American and German sources Dr. Stadtmueller wrote three works on the war.⁹ All provide valuable information on the conflict from a German perspective.

Another source of information is monographs written by veterans of the fight. In the archives of the US Army Infantry School, the 45th Infantry Division Museum, and various veterans groups lie narratives of the battle as seen from the foxhole level. These flesh out the official histories. There also exist brief accounts in the biographies and autobiographies of Eisenhower, Bradley, Patton and other senior US commanders at the time.

Perhaps the most fascinating accounts of the struggle are personal interviews and letters from the participants. The intervening forty three years have done little to dim their memories of the fight. Whether they are German or American, they remember the way it was and provide texture that is often missing in official and unofficial reports.

RESEARCH METHODOLOGY

The research question is "Why did it take the Americans ten days to capture the city of Aschaffenburg in March and April 1945?" To answer it took two research efforts. The first was a search of literature to provide a narrative of the struggle between 25 March and 3 April 1945. The second was the development of a paradigm to analyze the narrative and discover why it took ten days for a powerful, veteran American infantry force to overcome a seemingly weak combination of military remnants and civilians.

The author was stationed in Aschaffenburg for four years and did much preliminary research during that time. Articles in local newspapers and the histories of the battle by Dr. Stadtmueller provided the foundation for research. In addition to U.S. and German printed sources, the files of the city archives supplied much valuable information. Personal interviews with local participants and with visiting American veterans helped build a working knowledge of the battle.

The primary document source in the United States was the Combined Arms Research Library at Ft. Leavenworth, Kansas. The World War II collections, both U.S. and German, contain a lot in a centralized location. Where holes exist in the literature, the networking with other record depositories, such as the National Archives and the U.S. Military History Institute, was helpful. Several of the U.S. units that participated in the battle either are still active, or have active veteran's associations that maintain records, or keep in contact with veterans of the battle. The 45th Infantry Division Museum in Oklahoma City, and the 4th Armored Division Association provided information.

What German military records still exist from that era are in two places, the U.S. National Archives, Washington, D.C. and the German Bundesarchiv-Militaerarchiv in Freiburg, West Germany. German documents from both repositories are available in the CARL. Basic translation of German language material was done by the author, but valuable assistance with translation was coordinated with both the German Liaison section and the Combat Studies Institute at the Command and General Staff College, Ft. Leavenworth, Kansas.

Building on the literature search, the background for the analysis came from two sources. The first is the quantitative methodology developed by historian Trevor N. Dupuy and detailed in his books Numbers, Prediction and War,¹⁰ and Understanding War,¹¹ Although this study does not use a strictly quantitative approach

to answering the research question, Dupuy's works do provide a structured manner to look at the problem. The other source is a monograph from the U.S. Army Human Engineering Laboratory, Aberdeen Proving Ground, Maryland, dealing with city combat.¹² For most of the battle, Aschaffenburg was city combat and the structure of this study lends itself to the work at hand.

THESIS ORGANIZATION

Chapter Two discusses Aschaffenburg in 1945, its history, its readiness as a fortress city, why it was significant, and why it was an important objective for American forces. The chapter will describe the area, climate, weather, terrain and manmade features that made it worthy of such a determined military action.

Chapter Three focuses on the tactical preparation taken by the combatants to prepare for the battle; the actions taken by the Germans as a part of totalenkrieg to defend this part of the Reich, and those of their adversary to subdue the city. It details the war from the perspective of each side, and tells of the existing situation on that fateful Sunday in March 1945. It describes how the Germans planned to resist with a determined defense of the built up area, supported by a series of outposts to give the city a defense in depth and relates how the initial half-hearted American attempts to overwhelm the defenses had to be followed by a resolute

assault on the "Cassino on the Main." Each side is analyzed in regards to its forces, relative combat power, combat multipliers, logistical support and the behavioral factors that determined the level of combat from the first day. It sets the stage for later analysis detailing the characteristics of urban combat as they apply in general, and as they applied in Aschaffenburg in March and April 1945.

Chapter Four describes the battle itself, the day-to-day struggle from the perspective of both sides. It covers the four phases of the battle: Engagement (25-26 March), Equilibrium (27-28 March), Attrition (28-30 March), Reduction (31 March - 3 April).

The last chapter concludes the thesis by providing a summary of the answer to the research question of why it took so long for a powerful attacker to defeat a weak defender. It focuses on the environmental, operational and behavioral determinants that characterized the battle.

Following the formal portion of the thesis is the appendix which contains a glossary of terms, a chronology of the period covered by the study, order of battle information, and a bibliography.

CHAPTER 1

END NOTES

¹ Mary H. Williams, Chronology, 1941-1945, The United States Army in World War II: Special Studies, Washington D.C.: Office of the Chief of Military History, U.S. Army, 1960, p. 452-3.

² Vincent J. Esposito, A Concise History of World War II, (New York: Frederick A. Praeger, 1964), 102.

³ Omar N. Bradley and Clay Blair, A General's Life (New York: Simon and Schuster, 1983), 419-420. R. Ernest Dupuy and Trevor N. Dupuy in their Encyclopedia of Military History (New York: Harper & Row, 1986) state that, until the unexpected Rhine crossings, Montgomery's 21st Army Group was to be the main effort on the North German Plain.

⁴ R. Ernest Dupuy and Trevor N. Dupuy, The Encyclopedia of Military History: From 3500 B.C. to the Present, 2d rev. ed., (New York: Harper & Row, 1986), 1120.

⁵ Alois Stadtmueller, Aschaffenburg im Zweiten Weltkrieg (Aschaffenburg in the Second World War) (Aschaffenburg: Geschichts- und Kunstverein Aschaffenburg e. V., 1971), 137.

* In reading reports of operations, unofficial histories and in discussions with survivors, all comment on the tenacity of the German defense.

⁷ Williams, Chronology, 1941-1945, 452-3.

⁸ 45th Infantry Division, "The Story of Aschaffenburg" (Public Affairs Office, 1 May 1945), p. 30.

⁹ Dr. Alois Stadtmueller, Aschaffenburg im Zweiten Weltkrieg (Aschaffenburg in the Second World War), (Aschaffenburg: Geschichts- und Kunstverein Aschaffenburg e. V., 1971).

_____, Aschaffenburg nach dem Zweiten Weltkrieg (Aschaffenburg After the Second World War), (Aschaffenburg: Paul Pattloch Verlag, 1973).

_____, Maingebiet und Spessart im Zweiten Weltkrieg (The Main Region and the Spessarts in the Second World War), (Geschichts- und Kunstverein Aschaffenburg e.V., 1983).

¹⁰ Colonel Trevor N. Dupuy, Numbers, Prediction and War: Using History to Evaluate Combat Factors and Predict the Outcome of Battles, (Indianapolis: Bobbs-Merrill, 1978).

¹¹ _____, Understanding War: History and a Theory of Combat, (New York: Paragon House, 1987).

¹² P.D. McLaurin, et. al., "Modern Experience in City Combat", U.S. Army Human Engineering Laboratory Technical Memorandum 5-87, (Aberdeen Proving Ground, Maryland, March 1987).

CHAPTER 2

ASCHAFFENBURG IN 1945

Introduction

For a proper appreciation of the events of the Spring of 1945 an introduction is necessary. This chapter presents an overview of the city, its history, geography, political climate and military significance. The intention is to put the military activity discussed later in context.

Historical Context

Because of its position on one of the major waterways of western Europe, Aschaffenburg has always been of military significance. It has been occupied by many conquerors and colonizers, and around the city it is possible to find ruins of a Celtic fort, a Roman bath, medieval battlements, and more recent examples of military architecture. All bear witness to the rich military history of the city.

As part of the domain of the Prince-Bishop of Mainz, Aschaffenburg suffered repeated attack during the religious wars of the Reformation. In 1547, and again in 1552, it was partially destroyed during the Schmalkaldian War. In the winter of 1631-32 Gustavus Adolphus, one of the developers of modern warfare, forced the capitulation of the town with little difficulty on his way to capture Mainz during the Thirty Years War.¹ In 1743, during the

War of the Austrian Succession, King George II of England left the town to lead his army against the French in the Battle of Dettingen, eight kilometers away.² In 1805, the IInd Corps (Marmont) of Napoleon's Grand Armee passed through the town on its way to the masterful concentration and great strategic victory at Ulm.³ The following year Napoleon himself spent time in the town on his way to sweep the Prussians from the field at the Battle of Jena/Auerstadt.⁴ As members of the Rhine Confederation, Aschaffenburgers fought with Napoleon in Austria and Russia. Later they formed a part of the fleeing Napoleonic army defeated at Hanau in 1813. One of the major wars of German unification, the Austro-Prussian War of 1866, had one of its later battles in the city, when Prussians and their North German Allies defeated the Austrians and troops from their South German supporting states.⁵ From that time until March of 1945 Aschaffenburg did not see an invading enemy, but memorials indicate the part played by Aschaffenburgers in the Franco-Prussian War (1870-71), the Boxer Rebellion of 1900, the First World War (1914-18), and the Spanish Civil War (1936-39). This military history was prologue to the events of the Spring of 1945, and relates something of the martial tradition of the city.

Aschaffenburg sits on the outside of a great bend of the Main River about forty miles upriver from Frankfurt (Figure 1). Called "The Gate to the Spessarts", the town lies on a bluff on the east bank of the river with the forested foothills of the Spessart

LOWER MAIN RIVER REGION

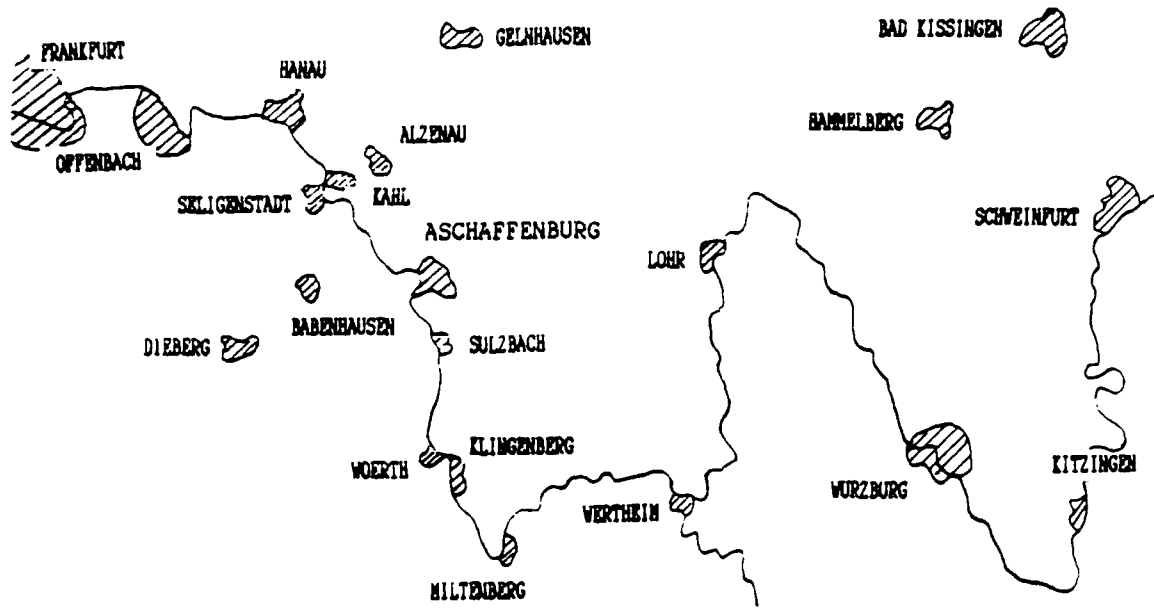

Figure 1

Mountains surrounding the town on the north, east and south. The city is dominated by two man-made objects, the Schloss Johannisburg, an early 17th Century Renaissance palace once a summer home of the Prince-Bishops of Mainz, and the 10th Century Stiftskirche, a Roman Catholic papal basilica sitting on the highest point in the city, the Dahlberg.

In 1936 the city and the surrounding towns in Landkreis Aschaffenburg (Aschaffenburg County) had a population of 36,260, but six years of war had increased it to in excess of 38,000 by the Spring of 1945. The county has 15 towns (Figure 2) on both sides of the river and was an important transportation center. A hub of navigation on the Main River system, the industrial output of the area moved from the harbor area in Leimer. Two major roads met in the center of the city, Reichstrasse 8, the Frankfurt-Nuremberg road, and Reichstrasse 26, the Darmstadt-Bamberg road. Several rail lines of the Reichsbahn connected the city to Frankfurt, Darmstadt, Miltenberg and Wurzburg.

In addition to being a transportation hub, Aschaffenburg was an industrial center, with its chief trade in coal, stone, cellulose, paper, furniture and chemicals.* As with all German cities its size, it boasted several breweries and served as the market town for the southern Spessarts. As will be discussed below, the transportation network and industrial capacity made the area a military target.

Geography

In regards to the military aspects of terrain, Aschaffenburg in 1945 had both strengths and weaknesses as a defensive position. Among its strengths were: its location on the far side of a major river from the most likely enemy avenue of approach, only three bridges across the river near the city, its position as part of an integrated defensive system, its flanks and rear protected by formidable terrain, and good routes to the east to provide resupply, reinforcement and evacuation.⁷ On the negative side major high speed avenues of approach lead directly to the city, the Main River, although not fordable, is only 100 meters wide in some areas, and flat land along the east bank of the river to the south of the city could provide the location for an enemy lodgement. However, granting a strong defense of the river line, viable flanks, and continued access to the east, the terrain in Aschaffenburg favors the defender.

The terrain itself is heterogeneous, ranging from steep, heavily-wooded hills to flat, grass-covered river and stream bottoms.⁸ The county follows a satellite pattern, with the city of Aschaffenburg serving as the central hub, surrounded with smaller, relatively-dependent, built-up areas and rural settlements along the Main and in the Spessarts (Figure 2). With the exception of the Main flood plain, and along the larger streams, the topography is rolling and rises steadily into the Spessarts on the north, east and south. From an elevation of 110 meters near the river to in

ASCHAFFENBURG AND ENVIRONS. 1945

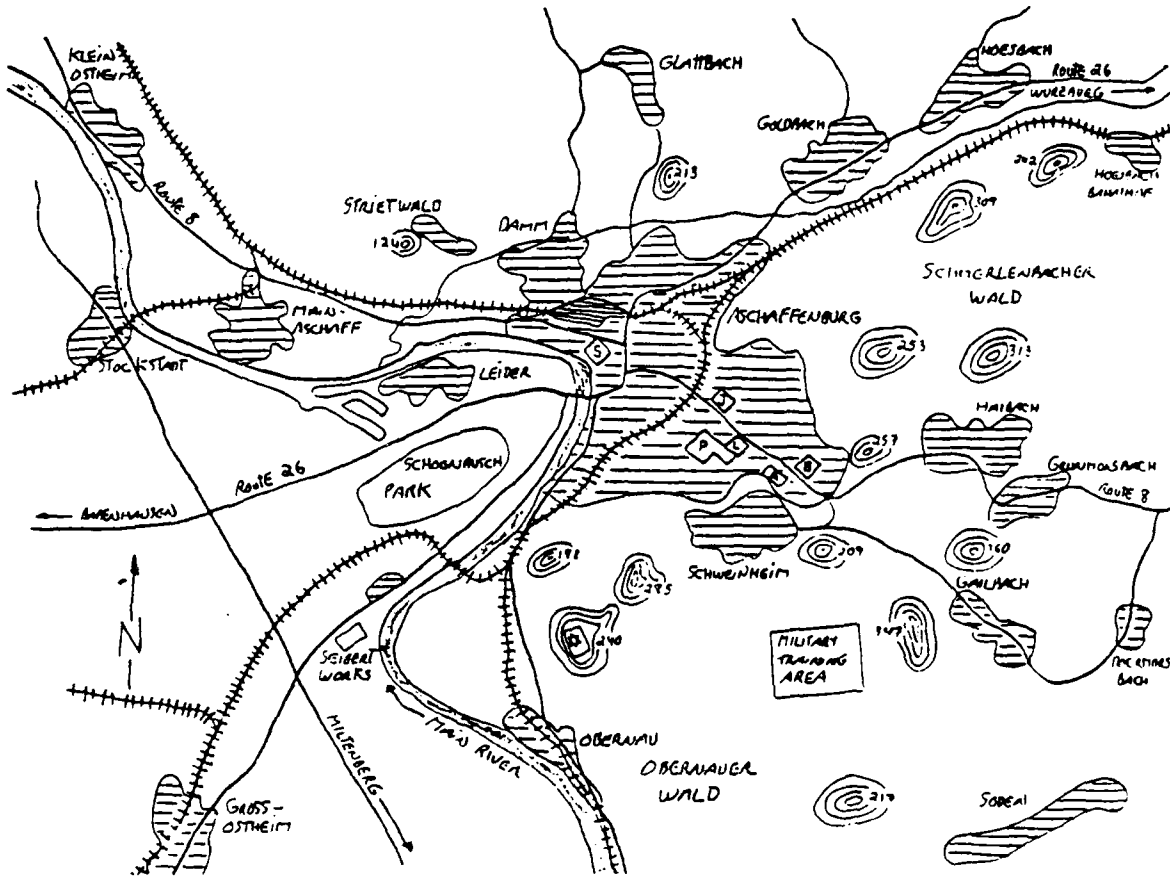

Figure 2

- | | |
|----------------------------------|------------------------|
| Legend: S - Schloss Johannisburg | L - Lagarde Kaserne |
| J - Jaeger Kaserne | A - Artillerie Kaserne |
| P - Pionier Kaserne | B - Bois-Brule Kaserne |

excess of 420 meters to the southeast, the land forms a bowl enclosing the city on three sides.

On the west side of the river the land is flat and open or lightly wooded for several kilometers from the river making good observation and fire possible. The only substantial cover is in the towns, and in Schoenbusch Park at the base of the salient formed by the bend of the river around the Nilkheim-Leider area. Land in that area is agricultural and there are only a few towns on the west bank: Stockstadt, an industrial and rail town in the north; Leider, several score houses along the main street leading to the river port; Nilkheim, a cluster of buildings near an airfield; the Seibert Works, a large steel fabrication complex; Grossostheim, an industrial town in the south. There are few natural obstacles to movement on the west bank. The flat terrain is sparsely wooded and covered with many farm and logging roads which aid movement to the river. The only key terrain features are the towns and Schoenbusch Park, and they are easily bypassed on foot or in vehicles. The main avenues of approach to the city on the west bank are from the west along Route 26 from Darmstadt through Babenhausen, up river from the northwest from Offenbach by way of Seligenstadt, and down river from the Miltenberg area through Obernberg. All three are serviced by good all-weather roads. Militarily, any engagement on the west bank of the Main in this area would favor the attacker. A defender would have to make extensive use of field fortifications, man-made obstacles and

commit large numbers of troops to effectively stop a determined attacker.

The analysis of the terrain on the east side of the river outside the city can be divided into three segments: the area to the north delimited by the river in the west and the Aschaffenburg-Wurzburg rail line in the east; that between the railroad and Route 8 in the east; and that from Route 8 to the river in the south.

In the northern segment the land along the river is flat and open from Kleinostheim through Mainaschaff to the outskirts of the city, offering good observation and fire, but little cover and concealment except in the built up areas. Several small streams and the rail lines hamper movement, but Route 8 provides the best avenue of approach into the city on the east bank of the river. As you leave the river and proceed north, with the exception of the land adjacent to Aschaff Brook, the slope increases and hinders movement. The high ground north of Strietwald, Glattbach and Hoesbach offers good observation of the city, but it is too far from the city for anything except indirect fire. The forests and the folds in the terrain offer excellent cover and concealment in the area directly north of the city. Obstacles in this segment consist of the steep hills, built up areas and the Aschaff. The rail line is at ground level to the west, but is elevated in the east and represents a major obstacle to north-south movement. Secondary avenues of approach into the city center from the north are along the roads into Damm, Goldbach and Hoesbach. Route 26,

the Aschaffenburg-Wurzburg highway which runs on the north side of the river, sits in a major movement corridor from the east. The terrain in this segment favors the defender in that the approach to the city is through narrow valleys and down steep slopes which can be easily interdicted. It favors the attacker in that indirect fire can be placed on the city from well out of direct fire range, and that any attack would initially hold the more easily-defended high ground.

The eastern segment between the rail line and Route 8 is composed of a series of steep hills cut by streams. Although not entirely tree-covered, enough is forest to make observation and fire good only in the area along Route 8, and along logging roads. Much cover and concealment is provided by the folds in the terrain. This is the least populated segment around the city, but the most restricted. The wooded hills and the villages are obstacles. An attacker in this area would want to control the towns of Haibach, Grunmorsbach, and the hills of the Schmerlenbacherwald that dominate the rail line and Route 8. The avenues of approach in this area are along the forest trails south of the rail line, the paths through the woods, and along Route 8, a high-speed vehicular approach. Any advance on the city from this quarter would favor the dismounted attacker, who could move close to the city undetected. However, such an advance would cross the compartments in the terrain, which run north-south. The defender could interdict these avenues, but at great cost in men and materiel.

The southern part from Route 8 to the river offers both the best avenues into the city and the worst. The terrain from Route 8 west to Hill 347 (the Stengerts) and through the Obernauerwald to the river is very rugged and heavily forested. It offers poor observation and fire, but excellent cover and concealment. The towns of Gailbach, Doermorsbach and Soden lie deep within narrow valleys which force movement onto the roads. Vehicular traffic can easily be interdicted and dismounted movement can be hampered as well. The area from the river east through Hill 240 (the Judenberg) and Hill 285 (the Erbig) to Schweinheim offers the best approach into the town. It is flat near the river and, although steep on the saddle between Hill 188 (the Bischberg) to Hill 285, it is open agricultural land and offers excellent observation and fields of fire. It is, however, deficient in cover and concealment. The Aschaffenburg-Miltenberg road is on the same level as the surrounding farmland, but the rail line in the area is elevated in places and presents an obstacle to vehicular movement. The Bischberg and the Erbig are the key terrain in this sector, occupation of them provides observation of the city and the movement corridors into the area. The major avenue of approach in this area is from upriver down the Miltenberg-Aschaffenburg road. An attacker able to secure the Milheim railroad bridge could also approach from the west bank. Military action in this area favors the attacker, as soon as he is able to get to the east bank of the river. There is a wide river frontage that can be assaulted, with many avenues into the forests that are difficult for the defender

to close. Movement into the woods could lead to envelopment of the city and its defenses. Defense of this sector would require the largest investment of men and materiel.

National Socialism and Military Administration

Aschaffenburg was represented in many of the political, military and administrative subdivisions in the Reich. Bavaria had been historically the most conservative of the German states, and Aschaffenburg was no exception. It had early embraced National Socialism and had an active Nazi element before Hitler's rise to power.⁹ The city was a part of the Main-Franken (Main-Franconian) Gau, or Party Region, headquartered in Wurzburg.¹⁰ Dr. Otto Hellmuth became Gauleiter (Party Leader) in 1927 and held the post throughout the war. Aschaffenburg was part of the Aschaffenburg-Alzenau Party District and the local party organization was led by a Kreisleiter (county leader) reporting to Gauleiter Hellmuth. Wilhelm Wohlgemuth held the post and was also the Oberburgermeister (lord mayor) of Aschaffenburg, so that the party administration and general government were centralized in one man.

Represented in the city were all the elements that made up the Nazi regime. The city was in the Fulda-Werra District of the SS (Figure 3), and was a part of similar subdivisions of the SA, Hitler Jugend, and other NAZI organizations.¹¹ The city was a full

SS ORGANIZATION FOR GREATER GERMANY. 1941

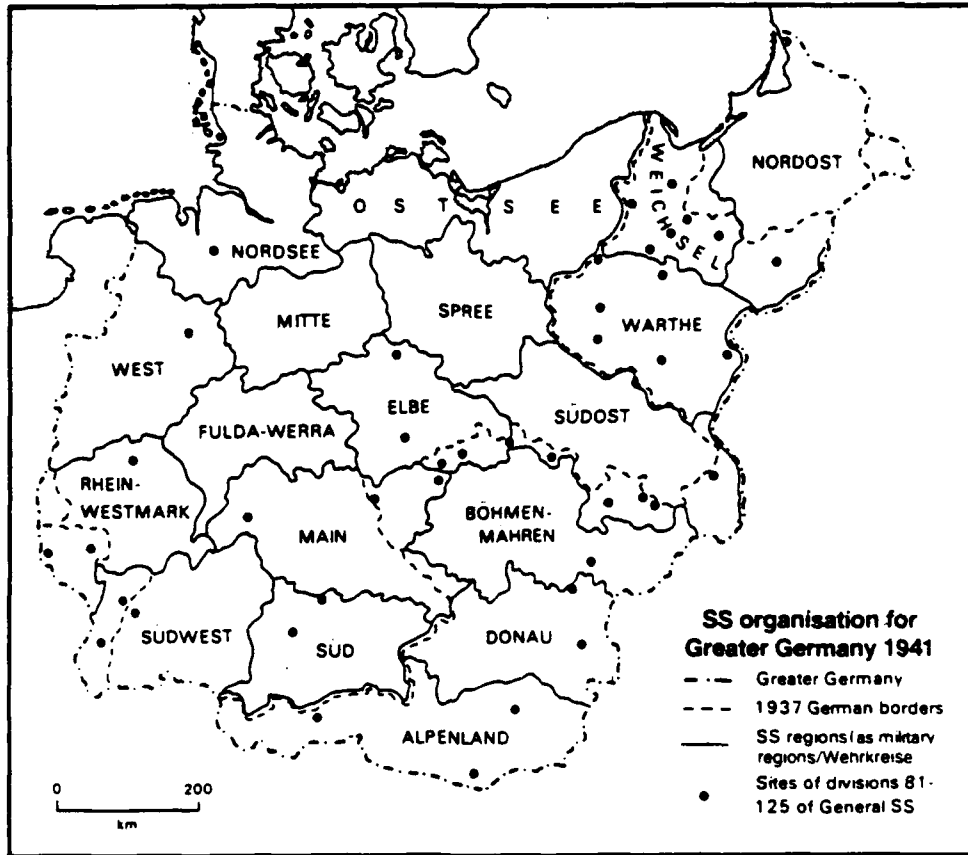

Figure 3

Source: Michael Freeman, Atlas of Nazi Germany, (New York: Macmillan Publishing Company, 1987), 157.

participant in the political life of the period, including the persecution and deportation of the Jews.¹² As is often the case in a dictatorship, power tends to become personal. During the struggle for the city the lord mayor, the combat commander, and the leaders of the various Party organizations would each try to solve the problems of the hour with authoritarian methods through their own organization. It appears that no one was ever totally in charge and this lack of unity contributed to the defeat.

All three principal military services Heer (Army), Kriegsmarine (Navy) and Luftwaffe (Air Force) were part of the Wehrmacht, or Armed Forces. Each service had a high command which theoretically reported to the Oberkommando der Wehrmacht (OKW), the Armed Forces High Command, responsible for all military operations. Administratively, the military organization of Germany centered around the Wehrkreis, or Corps Area (Figure 4). The Reich was divided into nineteen Corps Areas, with fixed responsibilities. The Army itself had two parts, the Feldheer (Field Army) and the Ersatzheer (Replacement Army). The Feldheer conducted active military operations, while the Ersatzheer was responsible for recruitment, training, procurement and administration in the Zone of the Interior.¹³ Each Corps Area supported a corps in the field and there was a formal territorial link between units in combat and their replacement and training base back in Germany. Each Corps Area had a unified command structure with two staffs, one for the active units and one

MILITARY REGIONS OF NAZI GERMANY, 1943



The German Army had its own administrative areas (Wehrkreise), which served as bases for administration, recruitment and training of troops. Each area formed the home of an Army Corps, with the Corps HQ located in one of the major towns. The Wehrkreis boundaries were unrelated to any other administrative boundaries in the Third Reich, with the exception of the SS organisation after 1938.

Figure 4

Source: Michael Freeman. Atlas of Nazi Germany. (New York: Macmillan Publishing Company, 1987). 69.

for the replacement and training units. While the corps commander conducted military operations, the deputy corps commander was the commander of the Corps Area responsible for the replacement and training system in his area. As Corps Area Commander he also exercised three territorial functions: conscription, control of permanent installations in his area, and local defense.¹⁴

All field units left a replacement and training unit in the Corps Area that received, trained and transferred replacements. Soldiers were formed into units before being sent to the front, and all training units had a direct affiliation with a similar unit in the field army. In most cases the training unit was one level down from the combat unit, i.e. an active regiment had a training battalion.¹⁵ For infantry units there was always a direct correlation between units in the field and those back in Germany. All others often had training consolidated on an area basis. Every replacement unit had a mix of reception companies, training companies, convalescent companies and transfer companies all controlled by a local garrison commander supported by a Replacement Division Staff at the Wehrkreis Headquarters.¹⁶

Aschaffenburg was in Wehrkreis IX and the local garrison commander reported, by way of a sub-area commander in Frankfurt, to the training division commander and the Wehrkreis headquarters in Kassel. The city was the home base for the 106th Infantry Regiment of the 15th Infantry Division, and had replacement and training

units for the regiment in addition to an artillery unit and an engineer unit. The units in the city were based in the kasernes (barracks) and conducted individual and collective training in the local area, especially in the truppenubungsplatz (troop training area) to the south of Schweinheim.

In addition to training soldiers and small units, the garrison was also responsible for training reserve officers for its units. After a period of service in a unit, a conscript could undergo an infantry leader's training course and become a reserve officer. These Reserve Offizier Bewerber (ROB) (reserve office aspirants) would be commissioned upon completion of the course¹⁷ and accepted by the officers of the unit in the offizier voll, or officer's vote.¹⁸ In the spring of 1945 ROB Lehrgang (class) 27/28 was undergoing training in Aschaffenburg. These were men born in 1927 and 28, and so were 17 and 18 years old.

Another large group of soldiers in Aschaffenburg in the spring of 1945 were men recovering from illness or wounds in the standort lazarette, or garrison hospitals. Recovered battle casualties are always a valuable group of trained replacements. Once evacuated from a combat zone a soldier was sent to a hospital in his home Wehrkreis to recuperate. The recovering soldiers were organized into convalescent units based on their fitness for duty. Once released for duty the soldier would link up with the replacement unit for his regiment and be sent back to duty in the combat zone. Although not officially controlled by the garrison

commander, until returned to duty, convalescents could be assigned special duty in emergencies.¹⁹ Aschaffenburg County had several lazerettes and an estimated 1800 hospital beds.

The industrial and agricultural segments of the German economy supported the military establishment. The ten million uniformed members of the Wehrmacht placed an enormous strain on all aspects of the national life, especially when combined with the other uniformed "service" organizations of the party, civil defense, police and fire fighters, etc. To offset this drain the Nazi government turned to two non-German sources: prisoners of war and gastarbeiters ("guestworkers", or slave laborers). These two groups added to the human capital available in the Spring of 1945.

Prisoners of war (POWs) were available first. By August 1940 fifty French POWs were working in the Aschaffenburg area,²⁰ with some 215 reported six months later. On 15 August 1942 there were 1549 Poles, Frenchmen, Belgians and Yugoslavs registered in Aschaffenburg and Obernburg Counties employed in agriculture, war production and as day laborers. They lived in special enclosures, or singly with farm families, and based on the few photographs seen by the author, were permitted some freedom and leisure time.

In contrast to the POWs were the gastarbeiter, mostly Czechs and Italians initially, who began slowly arriving in 1941. Foreign workers became a torrent by mid-1942 with the arrival of the ostarbeiter (east workers). Ostarbeiters were Russians, Ukrainians,

West Ruthians and Poles, who were kept separate at work and in special guarded enclosures when not at work. By the spring of 1943 there were 25 Ostarbeiter camps in the area holding 920 men and 128 women. A year later the figure had increased to a total of 1526, and still later an additional 1809 were registered.²¹ In contrast to the POWs, friendly contact with Germans was forbidden, and although there is no evidence of "death camps" as existed elsewhere in the Reich and occupied territory, they were slave laborers. A walk through the Aschaffenburg Main Cemetery today will reveal the graves of several hundred Poles, Ukrainians, Russians and others who died during and after the war in the area. One Aschaffenburg historian states that in June of 1945 there were over 6000 displaced persons from the east in the city.²²

The groups described above all functioned as part of the military structure of Aschaffenburg within the military and political context of the Nazi state. Civilians were controlled by the party's political, labor and social organizations; members of the military by the Wehrmacht through either the field army or the replacement army. As the war got closer defense of the homeland consumed more time and effort, especially after the defeat at Stalingrad in February 1943. As has often been said, before Stalingrad the Nazis never lost, after Stalingrad they never won. But as early as 18 February 1942, Nazi Propaganda Minister Dr. Joseph Goebbels announced a totalenkrieg for Germany. With words more suggestive than declarative he said, "Wollt Ihr den Totalen

Krieg!" ("You want total war!") and announced a program that for the first time put all aspects of the nation on a war footing.²³ Between February 1942 and March 1943 there were 96 public rallies in the Aschaffenburg area to help the people prepare for total war.

Under the direction of the Corps Area commander the senior garrison commander was responsible for local defense, to include air raid protection. When serving as the commander of home defense forces the commander had extraordinary powers over the civilian administration and military personnel. Regardless of affiliation everyone fell under his control.²⁴ However, as with many aspects of life in Nazi Germany, the senior garrison commander had to share responsibility for defense with the Waffen SS (the military arm of the Party), security police, protection police, rural police, the SS, the SA, fire-fighting police, the technical emergency corps, the labor service and others.²⁵ This tension between the army and the Party was a continual problem and would surface during the defense against the Americans.

Exclusive of field army units, the local manpower available for the defense would come from the army garrison, anti-aircraft units, transient military personnel, the volkssturm,²⁶ and special alarm kompanien organized by the SS. They would reinforce units from the field army and any replacement army units engaged in active service. Regardless of the manpower available, however, Aschaffenburg had more reason than most small cities to be confident in its ability to defend itself.

The Urban Area and the Wetterau-Main-Tauber Line

The city itself is a combination of dense, random construction, closed, orderly blocks, military kasernes and semi-urban residential areas. It possesses all the characteristics of an urban area.²⁷ Depending on the location within the built up area, observation and fields of fire are restricted along streets, across spaces between buildings and from the upper floors of buildings. Distance can vary from less than 100 meters in the city center, Innenstadt, to as much as several kilometers on the edge. Concealment is provided by the buildings and cover is provided by strong buildings and the military construction of the kasernes. Obstacles in the city itself were plentiful, both those constructed by the defenders and as the result of damage from aerial bombs, indirect fire and ground combat. The Innenstadt is located on the highest part of the city around the Schloss Johannisburg, and was the most formidable obstacle. The rail line is elevated in places and sunken in others, hence difficult to cross. The area to the north of the main rail yard and in Damm is an old, semi-residential district that presented as many obstacles as the inner city.

In the southeast portion of the city are five military barracks, one constructed in 1894 and the others during the period 1936-38.²⁸ Although not built as forts, the buildings are of heavy masonry construction and were well suited as defensive positions. They also commanded the main roads in their area. Another military area, the Food Supply Depot, is located along the railroad line on

the road to Goldbach, but it contains multi-storied warehouses, well dispersed, and less well suited for defense. An additional obstacle that prevents easy access into the city is a ridge running along the southern edge of the built-up area into Schweinheim. In any fight the built-up area favors the defender fighting along interior lines, having the protection of the buildings and possessing the ability to channelize an attacker into narrow frontages easily flanked and infiltrated. The terrain limits the number of maneuver elements that can be applied against the city and they could be confronted in succession. The natural terrain was enhanced by military construction.

When the Nazis came to power in 1933 one of their stated aims was the remilitarization of Germany. The transformation of the Reichswehr into the Wehrmacht in the mid 1930s was the basis for the offensive capability. The defense of the Reich was accomplished through a mixture of diplomacy, overt military action and fortification construction. In 1936 Germany reoccupied the Rhineland, thereby providing a buffer between the German frontier and the Rhine River. To enhance the ability to trade space for time in a future war, in 1938/39, they built the Westwall (Siegfried Line) to guard the historic invasion routes from the west. Although the construction of the Westwall was an obvious remedy to increase the security of the nation, construction of supporting defenses took more thought.

For the necessary defense in depth, OKW decided to employ the principles of mass and concentration to place combat power where it was most needed. Instead of building additional echelons of Westwall-type fortifications from border-to-border, OKW elected to scatter smaller lines of fortifications along strategic terrain and natural obstacles. One of these interior defense lines was built to connect the Wetter, Main and Tauber river valleys from Giessen to Rothenberg.²⁹

The line was built from 1936 to 1945, but suffered from fluctuating priorities throughout its construction. Planning started with the establishment of a Festungsbaugruppe Aschaffenburg (Fortress Building Group Aschaffenburg) in December 1934. It was responsible for the construction of a 22 kilometer defensive line from Michelbach in the north to Klingenberg in the south (Figure 5).³⁰ Work started in 1935 and continued, together with the construction of the kasernes until 1938 when major construction stopped so that men, materiel and Reichsmarks could support the construction of the Westwall. The line was a collection of bunkers and emplacements that contained infantry fighting positions, machinegun platforms, observation bunkers, defiladed tank positions, observation posts, and troop shelters. They had "hard-wired" communications laterally and back to central command posts. The entire line contained 329 bunkers along its 120 kilometer length concentrated at key locations.³¹

WETTERAU-MAIN-TAUBER LINE

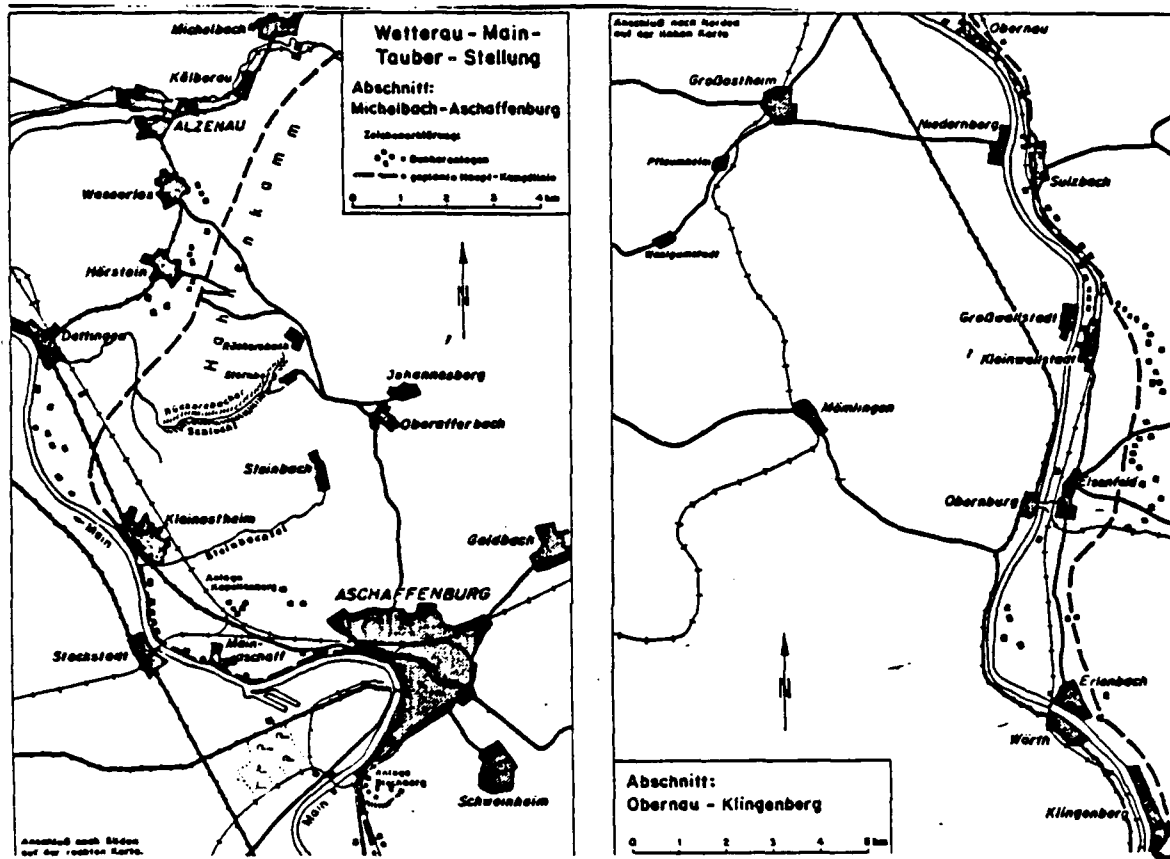

Figure 5

Source: Alois Stadtmueller, Aschaffenburg im Zweiten Weltkrieg, (Aschaffenburg: Geschichts- und Kunstverein Aschaffenburg e. V., 1971), 140-141.

Although the bunkers were substantially completed, the interior equipment was never entirely installed. Starting in 1939 equipment was stripped to equip the Westwall and by 1 November 1940 the line was totally disarmed.²² Construction of the Atlantic Wall on the Dutch, Belgian and French coasts sealed the fate of the line. It also suffered in that the bunker technology of 1934-36 was overmatched by the weapons of 1945. The ability of an attacker to neutralize or destroy a reinforced emplacement had exceeded the ability of the defender to fortify it. The line would play a role in the battle for the city, but only after being partially re-equipped. It would contribute to a "fortress mentality" among the inexperienced soldiers forced to defend the line against the American assaults, and the line would suffer from that bane of many fixed fortifications, insufficient manpower.

The City as a Military Objective

Allied air force planners were the first to target the city in World War II. The transportation network and war production facilities were attacked as early as 1940 and the bombing continued sporadically until late 1944 when there were eight raids from September through November.²³ The largest raid occurred on 21 November 1944 when 274 Lancaster bombers of the British Royal Air Force Bomber Command dropped 1360 tons of explosives, incendiaries and mines on the city. Principal strategic bombing targets in the city were the rail yards and the Seibert-Werk, where armored

vehicles were assembled. As the Allied armies moved closer to the heartland of the Reich the raids increased, with the British and the Americans conducting eight daylight raids from December 1944 to February 1945. As the war approached Aschaffenburg the raids became less strategic and more tactical. In the first months of 1945 fighterbombers were seen for the first time over the city.

As the American Army reached the Rhine River in March 1945 Aschaffenburg became less of a bombing target and more of a military objective on a situation map. It assumed importance as a potential bridgehead over the Main River, as the gateway to south central Germany, and as the location of substantial German forces.

CHAPTER 2

END NOTES

¹ Franz Schaub and Bernd Pattlock, Aschaffenburg: Erlebnis Einer Stadt (Aschaffenburg: Experience a City), (Aschaffenburg: Paul Pattlock Verlag, 1985), 15-22.

² R. Ernest Dupuy and Trevor N. Dupuy, The Encyclopedia of Military History: From 3500 B.C. to the Present, 2d Rev. Ed., (New York: Harper & Row, 1986), 632.

³ David G. Chandler, The Campaigns of Napoleon, (London: Weldenfeld and Nicolson, 1966), 393.

⁴ *Ibid.*, 466.

⁵ Schaub and Pattlock, Aschaffenburg, 26.

⁶ Dr. Alois Stadtmueller, Aschaffenburg im Zweiten Weltkrieg (Aschaffenburg in the Second World War), (Aschaffenburg: Geschichts- und Kunstverein Aschaffenburg e. V., 1971), photo 168.

⁷ U.S. Army, FM 90-10, Military Operations in Urbanized Terrain (MOUT), (Washington D.C.: HQ Dept. of the Army, 15 August 1977), 1:7.

⁸ U.S. Army, Army Map Service, Aschaffenburg, Germany, Sheet 222, AMS Series M741, 1951, (Washington, D.C.: U.S. Army Corps of Engineers), copied from Germany 1:50,000, GSGS, Sheet 222, 1945. This is valuable in that it is an official map of the area at the time of the battle, not just a sketch of the terrain.

⁹ For an indepth treatment of the development of National Socialism in Aschaffenburg see Carsten Pollnick, Die Entwicklung des Nationalsozialismus und Antisemitismus in Aschaffenburg 1919-1933 (The Development of National Socialism and Antisemitism in Aschaffenburg 1919-1933), (Aschaffenburg: Geschichts- und Kunstverein Aschaffenburg e. V., 1984).

¹⁰ U.S. War Department, TM-E 30-451, Handbook on German Military Forces, (Washington, D.C.: U.S. Govt. Printing Office, 15 March 1945), III-27. The Reich was divided into 43 political subdivisions called gaue (regions) led by a Gauleiter, or regional party leader, each with theoretical direct access to Hitler. There was a large party bureaucracy, but for the purposes of this study the Gauleiter supervised a Kreiskeiter, or county leader, responsible for party administration in each county.

¹¹ *Ibid.*, III-10.

¹² Alois Grimm, et al., Vergangen. Nicht Vergessen - Sieben Jahrhunderte Jüdische Gemeinde in Aschaffenburg (Past, Not Forgotten - Seven Centuries of Jewish Community in Aschaffenburg), (Aschaffenburg: Stadt Aschaffenburg, Stock & Koerber, 1984), 10-12. Reichskristallnacht (9-10 November 1938) resulted in the destruction of the synagogue. Between February 1942 and June 1943 300 Jews were sent to concentration camps.

¹³ Victor W. Madej, German Army Order of Battle 1939-1945, 2 vols. (Allentown, PA.: Game Marketing Company, 1981). 1: 49. The Replacement Army performed two functions, conscription/recruiting and replacement/training.

¹⁴ Ibid., 1: 50.

¹⁵ Ibid., 1: 54.

¹⁶ Ibid., 1: 59.

¹⁷ U.S. War Dept., Handbook on German Military Forces, III-29.

¹⁸ Daniel Hughes, "The Officer Corps of the German Army, 1860-1945", (Ft. Leavenworth: S.L.A. Marshall Lecture, 22 November 1988). Unlike the American Army, the German Army had no pre-commissioning educational requirement and gave no commissions before enlistment. According to Dr. Hughes, a soldier entered the army, served for 18 to 30 months in a unit and was selected for officer training. All officers, except specialists, were considered infantry officers and underwent an infantry training course. The course was rigorous and even in the waning days of the Second World War the Wehrmacht considered it better to have no officer than a poor one. ROBs were commissioned reserve officers and could reach the rank of major.

¹⁹ U.S. War Dept., Handbook on German Military Forces, I-48.

²⁰ Alois Stadtmueller, Maingebiet und Spessart im Zweiten Weltkrieg (Main Region and the Spessarts in the Second World War), (Aschaffenburg: Geschichts- und Kunstverein Aschaffenburg e. V., 1983), 62-63.

²¹ Ibid., 64. The term gastarbeiter, or guest worker, was again applied to the mass of imported laborers brought to the Federal Republic in the early 1970s to help sustain the Wirtschaftswunder, or economic miracle. Although their lot was not always a happy one, it was far better than those of the early 1940s.

²² Alois Stadtmueller, Aschaffenburg Nach Dem Zweiten Weltkrieg (Aschaffenburg After the Second World War), (Aschaffenburg: Paul Pattlock Verlag, 1973), 47. Dr. Stadtmueller indicates that Poles made up the largest percentage of the total. Elsewhere he also states that the total number of Displaced Persons in the city was between 15,000 and 20,000 at the end of the war.

²³ Stadtmueller, Maingebiet, 53.

²⁴ Madej, German Army Order of Battle, 1: 54. The only powers to exceed those of the senior garrison commander were those of a "combat commander", which will be discussed in the next chapter.

²⁵ U.S. War Dept., Handbook on German Military Forces, III-29.

²⁶ For a detailed description of the Aschaffenburg volksstrum see Aschaffenburg im Zweiten Weltkrieg, 307-313.

²⁷ FM 90-10, Appendix A.

²⁸ Stadtmueller, Aschaffenburg im Zweiten Weltkrieg, 128-130. Jaeger Kaserne was built in 1894-96 for the 2d Jaeger Battalion of the Bavarian Army. After the city was designated as a "garrison city" in 1934/35 priority of construction for additional barracks led to the building of the others in quick succession: Pionier Kaserne (1936), Lagarde and Bols-Brule Kasernes (1936/37), Artillerie Kaserne (1937/38). The Food Supply Depot was started in 1936 and completed in 1943.

²⁹ Stadtmueller, Aschaffenburg im Zweiten Weltkrieg, 136-142. Other lines in the western part of the Reich included the Schwarzwaldkamm Line, the Neckar-Enz Line, and the Neckar-Riegel Line.

³⁰ Ibid., 146.

³¹ Matthais Schneider, "Biem Kampf vor 40 Jahren Spielten auch Bunker eine Roll, die 1936 Gebaut Wurden" (Built in 1936, the Bunkers Played a Role in the Battle of 40 Years Ago), (Spessart, April 1985), 6. They were of six types: 5-man machinegun bunker, 18-man machinegun bunker, machinegun bunker with an observation turret, steel-reinforced machinegun bunker, 5-man machinegun bunker with an armored turret, underground squad bunker. There were also several special-purpose emplacements.

³² Ibid., 8.

²² For a description of the air war against the city see Dr. Stadtmueller's book Aschaffenburg im Zweiten Weltkrieg referenced above. The first part (115 pages) covers each raid in detail and describes the damage.

CHAPTER 3

THE EVE OF THE BATTLE

Introduction

This chapter narrows the focus of the study. Starting with a brief summary of the strategic situation, it details the specific German preparations, and outlines the order of battle for both sides. A discussion of the combat multipliers available to each belligerent is included to set the stage for the later analysis of tactical operations. Finally, the dispositions of the attackers and the defenders as the battle begins takes the narrative to the start of the battle.

Strategic Overview

Hitler's plan was to stop the Russians at the Polish border, while holding the Western Allies on the Westwall. In the west this took the form of the German Ardennes Offensive, where Hitler hoped to split the Allies and send an armored thrust through to Antwerp, thus crippling supply operations and causing massive disruption in command and control.¹ It was a risky operation, the Germans gambled and lost, and the outcome was fatal to their war effort. The slim Wehrmacht reserves, including seven irreplaceable panzer divisions, were expended with a resulting delay of about six weeks in the Allied time table.²

After Stalingrad, Hitler himself took command of the armed forces by assuming command of OKW, and following the assassination attempt of 20 July 1944 he further consolidated his control over military affairs, putting Heinrich Himmler, head of the Police and the SS, in command of the Replacement Army. Hitler's strategic decision to launch the Ardennes Offensive was followed by another to fight west of the Rhine, a decision that also proved costly to the German war effort. Most of the units engaged were severely attrited and Oberstgruppenfuhrer (Colonel General of the Waffen SS) Paul Hausser, the Army Group G commander, estimated that when withdrawn east of the Rhine they were only 15% effective.³ The Allies' call for unconditional surrender left Hitler little choice, but it seems that at the end of the war OKW was content to trade forces for space and time. Ultimately this strategy only accelerated the Nazi collapse,⁴ and in the opinion of Hausser there was no strategic plan for the defense of central Germany beyond reacting to Allied efforts.⁵ The impact of all this on Aschaffenburg was that the army that faced the Americans across the Main River was largely militia in character.

After the German counteroffensive in the Ardennes the Allies recovered and resumed the general advance. With the realization that the Germans had expended large numbers of reserves in the Ardennes operation, Eisenhower focused all his efforts on the single guiding principle of the destruction of the enemy's forces.⁶ This was in compliance with the directive he had received from the

Combined Chiefs of Staff (CCS) on 14 February 1944 which ordered him to "...undertake operations aimed at the heart of Germany and the destruction of her armed forces."⁷ That Aschaffenburg was not bypassed and left to wither on the vine was a result of the CCS directive and Eisenhower's guiding principle. The objective was not terrain, but the enemy forces. In the final analysis Aschaffenburg represented a concentration of those forces.

German Preparation

As the manpower cost of the Ardennes Offensive became apparent to the Nazi leadership steps were taken by the Wehrmacht to increase the men available for military service. On 3 January 1945 OKW issued regulations implementing a Fuehrer decree dated 10 December 1944 requiring that all personnel of the Wehrmacht, Waffen SS, and police in the Zone of the Interior be re-examined and all found qualified released for duty at the front.⁸ Conditionally-qualified officers, NCOs and over-aged men were made available. These measures affected Aschaffenburg.

Under the arrangements for the defense of the nation, Gauleiter Hellmuth was the Reichs Defense Commissioner for the Main-Franken Gau and the man ultimately responsible for the defense of the gau. He worked through Kreisleiter Wohlgemuth in the Party chain of command, but as a political functionary he had limited real power over the Wehrmacht and such extraordinary Party organizations as the SS, the police and others. This created

problems during the conduct of the defense when the Combat Commander, the Party, the SS, OKW, a special commission from the Fuehrer, troops from three different Corps Areas, and the Seventh (GE) Army all had their hand in the direction of the effort.

Within the political and military framework described in the last chapter Aschaffenburg prepared for the coming assault. Since December of 1942 the Standortaeltesten (Senior Garrison Commander) in Aschaffenburg had been Oberstleutnant (lieutenant colonel) Kurt von Huenersdorff, a regular army officer who was also the Corps Subarea commander.⁹ In June 1944, he received as one of his subordinates Major Emil Lamberth as commander of the 9th Engineer Replacement Battalion in Lagarde Kaserne.¹⁰ Major Lamberth must have quickly made his mark in the city because by the fall he was working as the deputy to the senior garrison commander and on 30 January 1945 replaced Oberstleutnant von Huenersdorff.¹¹

While on the staff of the senior garrison commander, Major Lamberth assisted in the preparation of the plan for the defense of the city. The plan went through several revisions before it was acceptable to the Corps Area commander.¹² In summary, the concept called for the determined defense of the river line, through a defense in depth with the built-up area around the Schloss as the key. The outskirts of the city would be strongpointed with each bastion under the command of an officer or senior NCO. The garrison commander would command from a central bunker. Use would be made of the bunkers of the Wetterau-Main-Tauber Line, and of key terrain

around the city. The main strongpoints: Schweinhelm/Artillerie Kaserne, Haus Carola (the southern approaches to the built up area), Kapellenberg, Mainaschaff, Lumpenmühle (the waterfront), the city center, and the other kasernes each as a separate strongpoint (Figure 2).¹³ Although not indicated in the source literature, it must be assumed that Festung (fortress) Aschaffenburg would be a part of an integrated defensive line tied in with regular army units defending along the Main River.

To OKW at this point in the war the resolute defense of every meter of the Reich was paramount. To strengthen the resolve of a community to defend itself Hitler would personally designate certain areas as festungs to be strongly defended and would appoint a kampfkommandant (combat commander), based on the recommendation of the Corps Area commander.¹⁴ The Wehrmacht used kampfgruppen (battle groups), ad hoc military formations, for specific operations. These units either dissolved after accomplishing their mission, or were destroyed in extended combat. The post-Stalingrad period saw the establishment of combat commands for fixed installations. Perhaps the most famous was that at Breslau where a combat command defended the city against Soviet troops from February until the middle of May (after Nazi Germany had surrendered).¹⁵ The combat commander had extraordinary powers over all aspects of life in the fortress, military and civilian. Hitler would also determine if special regulations were to be put into effect, including the requirement to fight to the last man.¹⁶

General duties were to construct field fortifications, assemble and train all available troops and prepare for the coming attack.¹⁷ In addition to strictly military activities, all municipal services and the feeding of civilians were placed under military control. The combat commander became a virtual dictator. Because a Fuehrer Decree established a fortress it could only be released by his order, something he was unwilling to do at this stage of the war.

As the American and British armies approached the Rhine on 5 March 1945 Aschaffenburg became a combat command. Oberst (Colonel) von Luetzow, the commander of the 409th Replacement and Training Division, administered the oath of office to Major Lamberth in the name of General der Infanterie Zehler, the Corps Area commander.¹⁸ In the oath he promised to defend the city to the last round of ammunition and acknowledged that he was under Hitler's personal command.¹⁹ As a combat commander under orders from the Fuehrer Lamberth set about building a special battle staff that included the subordination of the Kriesleiter and other Party and government officials, including Gauleiter Hellmuth whenever he dealt with Aschaffenburg.²⁰ Under the rule that battlefield efficiency is more important than fairness, Lamberth was probably appointed because he was a battle-tested front line leader, who had shown a toughness of mind and an ability to command. The post was not an honorary one and he earned his pay.

Lamberth had to work closely with the Party functionaries, and especially with the leader of the Hitlerjugend, to organize for

the defense. On 11 March an SS Inspection Commission visited the city to inspect the preparations. The fortress passed muster. The commission is one example of the many different organizations that fragmented the unity of command required for an effective resistance by dabbling in defense matters. After the war, Lamberth indicated that he continually fought interference from the Party in the conduct of the defense.²¹

Among the duties of the combat commander was coordination with other combat commands along the Main River and in the area. The cities of Hanau, Miltenberg, Gelnhausen, Lohr, Marktheidenfeld, Karlstadt, Wurzburg, Hammelburg and Schweinfurt were all designated as combat commands (Figure 1). For the most part the establishment of combat commands was a sign of weakness. There was so little faith in the fighting strength of the Wehrmacht that fortresses were established to provide some resolve to the defense east of the Rhine. This only compounded the problem of unity of command. Wehrmacht units were ordered to fight until told to withdraw, whereas the combat commands were ordered to fight to the last man. Such confusing orders did little to the unity necessary to defeat a determined foe.

Toward the end of the war the German military was little more than a system of improvisations, with units long on combat experience but short on experienced manpower, fighting with local replacement units and thrown-together organizations with only rudimentary military training. From mid-1944 units of the

Replacement Army were engaged in combat and by early 1945 they had become indistinguishable in their employment from Field Army units.²¹ It is under these conditions that Kampfkommando Aschaffenburg (KKA) prepared to fight a modern defensive war. The relationship of KKA to the Seventh (GE) Army will be discussed below, but a review of the forces available within KKA as the battle approached is instructive.

Under Himmler the Replacement Army after November 1944 became a fighting organization. It still retained a training function but supplied more combat units as the war progressed. The regimental and division training staffs were upgraded to field staffs and engaged in active operations. Thus KKA was building up its fighting potential at the same time the Replacement and Training units were filling out their ranks to take the field drawing from the same manpower pool as KKA. Competition was intense and KKA was only able to retain the manpower and equipment it did because the war came to the city before the Wehrmacht could go to meet it. In addition to replacement and training unit personnel, and recuperating soldiers in the convalescent units, the single largest contingent of defenders came from the volkssturm or People's Militia.

The volkssturm was a home guard of over-aged and under-aged men in varying states of physical condition. It had been proposed early in the war but had not been activated because Hitler viewed it as an admission of weakness.²² Its creation is an example of

the desperate measures seen necessary by Nazi Germany near the end of the war. According to some observers, although the volkssturm demonstrated weakness, it also showed a nation's willingness and ability to persist in the face of tremendous odds.²⁴ The acceptance of such a hopeless step by the German people is a tribute to their willingness to defend their nation so late in the war, and also a measure of the degree to which the secret police and the Party had cowed the people. It reminds us that no nation is defeated until its leaders and the people believe as a whole that they are defeated.²⁵

After the 20 July 1944 assassination attempt Hitler had lost all confidence in the army leaders so he entrusted the mustering and training of the volkssturm to the Party. Himmler was responsible for the organization, training, arming and equipping of the force.²⁶ Each gau was to have a volkssturm organization, its size depending on the size of the gau, under the leadership of the gauleiter. Lists were compiled and recruits directed to report, and most did so out of patriotism or fear of the secret police. All unattached men from 16 to 60 were to report for induction. Once mustered the units trained on Sundays to reduce the impact on war production that absence from work would cause during the week. As an over simplification, the volkssturm was under-equipped, inadequately trained, but perhaps most importantly, it was poorly led. "The Volkssturm was being led, from beginning to end, by what

amounted to officials, leadership was not by ability but by Party loyalty."²⁷

The Aschaffenburg Volkssturm was called to the colors on 12 November 1944. Initially all men from year groups 1884-1924 (ages 20-60) were ordered to appear for registration and classification.²⁸ They were organized into seven companies and designated Volkssturm 15/1 (1st Battalion, 15th Volkssturm). Six of the companies were assigned specific areas of the city, with the seventh being a reserve formation. They trained at Bois-Brule Kaserne under the direction of the 106th Replacement and Training Battalion on rifles, machineguns and the panzerfaust ("panzer fist", a shoulder fired anti-tank shape charge). They were under the leadership of Lorenz Junker, the High Inspector of the Finance Administration of Aschaffenburg,²⁹ but were placed under the command of the combat commander on 17 March 1945.

While it may be easy to dismiss the Aschaffenburg Volkssturm as an ineffective organization, it probably contributed several hundred combatants to the battle, and this added significantly to the combat power of KKA. Reports from American units, of armed civilians fighting in defense of Aschaffenburg probably arose from members of the volkssturm justifying the faith placed in them by the Party leadership. But in the end the Party gave the volkssturm too much to do for the resources available, and as a force to save the Reich it failed.

When the battle started KKA consisted of the Replacement Army troops from the 106 Infantry Regiment, the 9th Engineer Battalion, the 15th Artillery Regiment, the convalescent units, Reserve Officer Aspirants, and the volkssturm. These forces were assisted by armed civilians, including Hitlerjugend used in kriegeinsatz ("war employment") non-combatant positions such as lookouts and messengers.²⁰ They had no tanks, few artillery pieces or heavy weapons and in many respects were untrained and unfit for their task, but the 5000 men of KKA possessed combat multipliers that, when used in conjunction with the Field Army units of the Seventh (GE) Army, would stop the American advance cold for over a week.

The Opposing Forces

Throughout the ten days of Aschaffenburg there were four distinct phases, each one with different opposing forces and force ratios (Figure 6). Order of battle information is at Appendix 3, but a recap is necessary to provide a basis for the discussion of relative combat power.

Exclusive of the forces in KKA the German troops belonged to the Seventh Army that was responsible for the defense of south-central Germany. It initially assigned the 413th Replacement Division to defend the Main River front, but soon replaced it with the LXXXII Corps as its senior tactical headquarters in the region. During the seven days that it reinforced KKA on the river, it

ORDER OF BATTLE MATRIX

Phase I - Engagement (25-26 March 1945)

American Units -	ARMY:	Third (LTG Patton)
	CORPS:	XII (MG Eddy)
	DIVISION:	4 Armored Division (BG Hoge)
	OTHER:	Combat Command B, 4 Armored Division (LTC Abrams)
German Units -	ARMY:	Seventh (Gen. der Inf. Felber)
		(Gen. der Inf. Obstfelder, 26 March)
	CORPS:	LXXXII (Gen. der Inf. Hahn) (from 26 March)
	DIVISION:	413 Replacement Division Staff (Genit. von Schacky) (25 March)
		256 Volksgrenadier Division (Genmaj. Franz)
		36 Volksgrenadier Division (Genmaj. Kleikamp) (26 March)
		416 Infantry Division (Genit. Pflieger) (26 March)
	OTHER:	Kampfkommando Aschaffenburg (Maj. Lamberth)

Phase II - Equilibrium (27-28 March 1945)

American Units-	ARMY:	Third (LTG Patton)
	CORPS:	XII (MG Eddy)
	DIVISION:	4 Armored Division (BG Hoge)
	OTHER:	Combat Command B, 4 Armored Division (LTC Abrams)
		1st Bn, 104 Infantry (attached to 4 AD)
German Units -	ARMY:	Seventh (Gen. der Inf. Obstfelder)
	CORPS:	LXXXII (Gen. der Inf. Hahn)
	DIVISION:	256 Volksgrenadier Division (Genmaj. Franz)
		36 Volksgrenadier Division (Genmaj. Kleikamp)
		416 Infantry Division (Genit. Pflieger)
	OTHER:	Kampfkommando Aschaffenburg (Maj. Lamberth)

Phase III - Attrition (28-30 March 1945)

American Units -	ARMY:	Seventh (LTG Patch)
	CORPS:	XV (MG Haislip)
	DIVISION:	44 Infantry Division (MG Dean)
		45 Infantry Division (MG Fredericks)
German Units -	ARMY:	Seventh (Gen. der Inf. Obstfelder)
	CORPS:	LXXXII (Gen. der Inf. Hahn)
	DIVISION:	256 Volksgrenadier Division (Genmaj. Franz)
		36 Volksgrenadier Division (Genmaj. Kleikamp)
		416 Infantry Division (Genit. Pflieger)
	OTHER:	Kampfkommando Aschaffenburg (Maj. Lamberth)

Phase IV - Reduction (31 March - 3 April 1945)

American Units -	ARMY:	Seventh (LTG Patch)
	CORPS:	XV (MG Haislip)
	DIVISION:	44 Infantry Division (MG Dean)
		45 Infantry Division (MG Fredericks)
	OTHER:	157 Infantry (Col O'Brien) (45 Infantry Division)
		324 Infantry (Col Anderson) (44 Infantry Division)
German Units -	ARMY:	Seventh (Gen. der Inf. Obstfelder)
	CORPS:	none
	DIVISION:	none
	OTHER:	Kampfkommando Aschaffenburg (Maj. Lamberth)

Figure 6

controlled four divisions: 413th Replacement, 256th Volksgrenadier, 36th Volksgrenadier, and 416th Infantry. They are treated below in their order of appearance.³¹

The 413th Replacement Division was composed of a replacement division staff with replacement troops assigned. According to its commander it had about 10,000 men but no more than 35% were fit to be soldiers. It had recently become a combat division, its staffs were very weak,³² and was not fit for a defensive mission.³³ On 25 March it was ordered by OKW to move to Aschaffenburg and take over the Main River front; it was subordinated to Army Group G on 26 March and assigned elsewhere.

LXXXII Corps, a veteran headquarters staff, was transferred to Seventh (GE) Army on 25 March.³⁴ It had directed the defense of Fortress Metz in November and December 1944 and therefore had experience in city combat. On 26 March it was directed to take over the defense of the Main River sector NLT 281200 Mar 45.³⁵

The 256 Volksgrenadier Division had a table of organization strength of 10,072 men but it had suffered heavy losses of personnel and equipment in the retreat from the Rhine, and the LXXXII Corps chief of staff, Oberst von Ingelheim, estimated its strength at 50% (about 5000 men). Its replacements were untrained with few heavy weapons and the staffs were strangers to each other. In the opinion of von Ingelheim they were, "...fit for limited [defensive] commitment in favorable terrain only."³⁶ Its mission

was to defend east of the Main River from Hanau to Kleinostheim, so only its left flank regiments opposed the Americans at Aschaffenburg.

The 36 Volksgrenadier Division was organized similar to 256 VGD. It had fought on the Rhine and was ordered to the Michelstadt area just ahead of the advancing Americans, then moved to the Aschaffenburg area because of the weakness of the 413 Replacement Division. It had from 33% to 65% of its authorized strength because of school replacements and fillers from other units (about 6500 men), but only one third were trained and experienced.³⁷ Significantly, it had artillery with one medium and two light battalions at 50% strength. In the opinion of the corps chief of staff it had good officers, adequate NCOs, a fairly complete supply of weapons and two assaults guns. It had limited fitness for attack but was perhaps the best of the Aschaffenburg units.³⁸ Its mission was to defend from Kleinostheim to Kleinwallstadt, with the exception of the area along the Main defended by KKA.

The 416 Infantry Division had a table of organization strength of 12,772, but had fought on the Rhine and was severely depleted. It was assigned two regimental staffs, four infantry battalions and two field artillery battalions from the Replacement Army, and the 506 SS Panzer Grenadier Battalion (6 SS Mountain Division North) was attached to bring its strength to an estimated 7000 men. Having many troops with no combat experience the corps chief of staff rated it as only fit for limited defensive action.³⁹

Its mission was to defend the corps southern front from Kleinwallstadt to Miltenberg, and although not directly involved in the Aschaffenburg fight, it helped maintain the integrity of the Main River line.

During the period that the 413 Replacement Division staff and the LXXXII Corps controlled the front (Figure 7), German strength in and around Aschaffenburg is estimated at 33,500, with some 16,450 directly opposing American forces.⁴⁰

The first American unit to reach the river opposing the LXXXII Corps and KKA was the U.S. 4th Armored Division assigned to the XII Corps (25 March). It was followed by the 45th and 44th Infantry Divisions (28 March and 1 April respectively) of the XV Corps. As a blanket statement, the American units possessed all the Germans were lacking in men and materials.⁴¹ A brief summary of the order of battle follows.

After the Army reorganization of 1943 a corps became a variable combination of divisions and battalions, with a command group and a small staff to direct combat operations and combine combat support and combat service support units to accomplish the mission. The XII Corps arrived overseas in April 1944 and participated in the Northern France, Rhineland and Ardennes-Alsace campaigns before moving to the Main River. Under the command of MG Manton Eddy it was a veteran, experienced combat headquarters. The XV Corps arrived in Europe on 14 December 1943 and had participated

OPPOSING FORCES 26-28 MARCH 1945

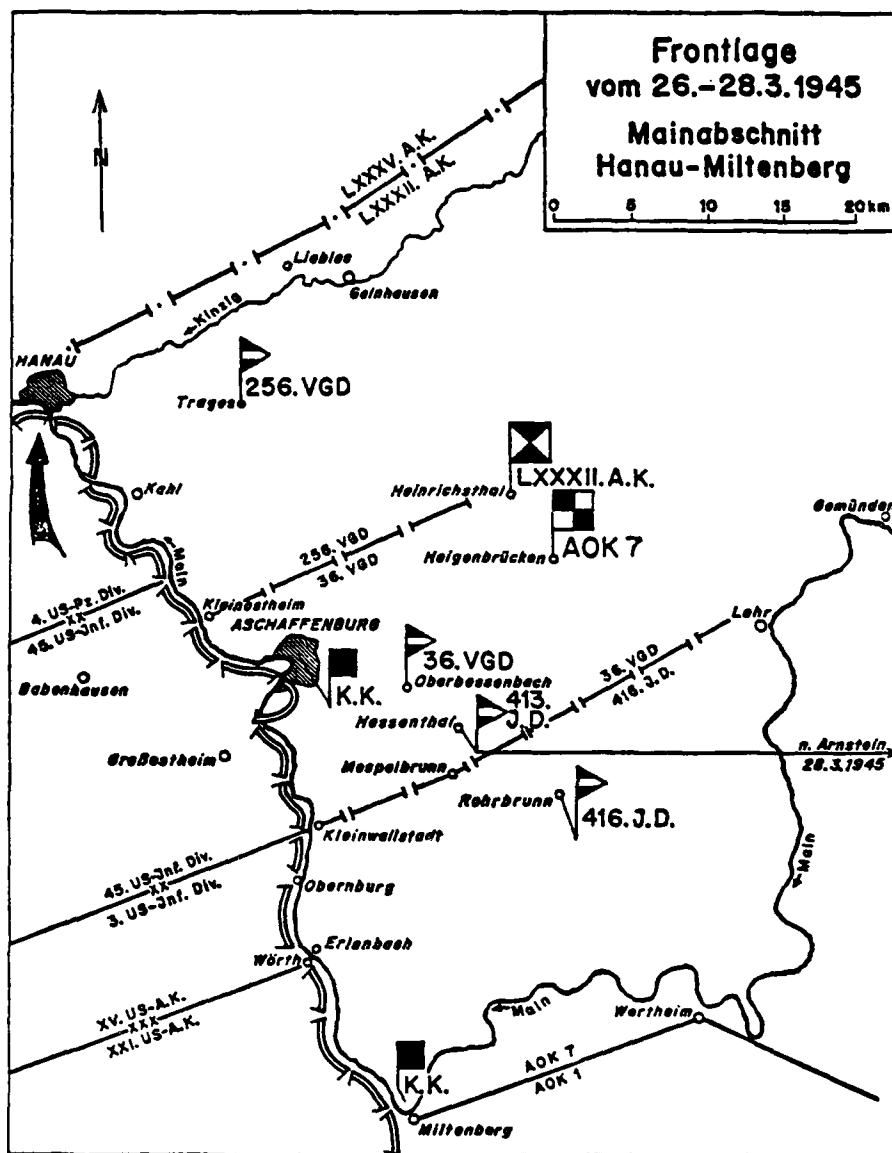

Figure 7

Source: Alois Stadtmueller. Aschaffenburg im Zweiten Weltkrieg. (Aschaffenburg: Geschichts- und Kunstverein Aschaffenburg e. V.. 1971). 235.

in four campaigns. Commanded by MG Wade Haislip, it was also a veteran organization.

Organized under the 1943 TO&E, the 4th Armored Division had a strength of 10,937 formed into three combat commands, each with a tank battalion, armored infantry battalion and an artillery battalion. When it reached the Main River on 25 March it had been on the move in combat since 22 February. Estimated strength was 80% as it reached the Main (about 9300 men).⁴² Its mission was to seize crossings over the Main River and the cities of Hanau and Aschaffenburg. The division's Combat Command B (CCB) was the initial American unit to reach Aschaffenburg with an estimated strength of 2500 men.

The 45th Infantry Division had an organizational strength of 13,688 officers and men, built around three infantry regiments, with artillery, engineers, cavalry, and division services assigned, and tanks, tank destroyer, chemical mortars and other assets attached as required. It was a veteran division with experience in Sicily, Italy, Southern France, Ardennes-Alsace, and the Rhineland before reaching Aschaffenburg. Pulled from the line on 17 February, it re-entered combat on 15 March and was relatively fresh as it approached the Main. It had an estimated strength of 90% (12,300 men). Its mission was to exploit the gains made by the 4th Armored Division along the Main River.

The 44th Infantry Division saw heavy fighting around Aachen in January, occupied evacuated Heidelberg in March, and moved to the west bank of the Main as a corps reserve. It was relatively fresh when it sent the 324th Infantry Regiment across the river to envelop the northern approaches of Aschaffenburg. It was near authorized strength (13,000).⁴²

The 3rd Infantry Division was a veteran infantry division with service in North Africa, Italy, Southern France and Germany. It assaulted the Westwall on 18 March, crossed the Rhine on 26 March and reached the Main on 30 March. It was estimated at 80% strength (12,300 men). Its mission was to breach the Main and drive on south-central Germany.

This information gives some clue as to why the Americans did not immediately overwhelm the Main River front. LXXXII Corps mustered 33,500 men on the 60 kilometers along the Main, whereas US forces, primarily the 4th Armored Division, only numbered 8700 men. Granting that not all German forces were in place, the defenders still had an advantage approaching 3.9 to 1, very poor odds for an attacker regardless of qualitative superiority. Focusing only on Aschaffenburg the ratio was the same, with 16,450 Germans initially defending against the 2500 members of CCB, 4th Armored Division. An attacker does not do well with a 6.6 to 1 advantage in favor of the defender. It is not until the arrival of the 3rd and 44th Infantry Divisions after 30 March that the numbers favor the attacker. By 30 March some 47,600 Americans opposed the remnants

of LXXXII Corps' 23,500 men (less 413 Replacement Division withdrawn on 28 March), a ratio of 2 to 1 in favor of the attacker.

Combat Multipliers

In war numbers alone never tell the story. It is ironic that at the start of the battle for Aschaffenburg the defenders would enjoy a quantitative superiority combined with what some see as the qualitative superiority of German arms in the Second World War.⁴⁴ However, as has been outlined above, the fitness of the German units was far below that of the American units. Given that the Germans enjoyed a numerical superiority for at least the first few days of the battle, what was the effect of other factors at the start of the fight that give some clue to the eventual outcome? The broad categories of environmental, operational and behavioral factors developed by Colonel Trevor N. Dupuy in his books on the analysis of war (End Note 44) offer some guidelines.

As regards the environment, weather and terrain provided some advantage to each side. The weather is the same for both sides, but the defenders had the advantage of fixed facilities in which to hide and fight. Until they captured parts of the city, any attacker would have to fight exposed to the elements. It was late March in south central Germany, the weather was cold, wet and damp. The weather advantage must go to the defender.

Assuming that the Main River line could be held by German forces, the terrain would seem to favor the defender. As is described in Chapter 2, the city sits across the Main River from the most likely avenue of attack. It is not fordable and is some 150 meters wide in most places. The river is not an insurmountable barrier, but would have to be deliberately assaulted. The two conditions necessary for a successful defense would be that flanking units remain in place and that the three bridges in the vicinity, two railroad and one road (Figure 2), could be denied to the enemy. A disadvantage for the defender is the fact that the city is well within indirect fire range from the west bank which would permit fire support for assaulting forces without crossing the river. If the river could be crossed the attacker would gain an advantage, especially if he was able to occupy the high ground around the city. This would afford excellent observation and fire on the city and help to interdict communications and supplies into the built-up area.

Well prepared urban terrain is of advantage to the defender. Aschaffenburg's location in a bowl made a direct assault a necessity until the high ground commanding the city could be secured. The city afforded all the advantages of combat in a built-up area. These include: the cover and concealment of the built-up area providing protection from fire; channelization of the attackers into movement corridors easily swept by fire, where short ranges negate the effect of superior firepower reduce the threat of

mechanized attack; a hostile population to support the defenders and pose security problems for the attackers; defenders who know the terrain; and the high psychological and physiological stress associated with close combat in restricted terrain.⁴⁵ Add these to the fact that the city was a fortress with the bunkers and emplacements of the Wetterau-Main-Tauber Line, and it can be seen that the urban terrain favored the defender.

At first glance the operational factors would seem to favor the Americans. German forces on the Main River were more an armed militia than a field army. The attackers possessed the artillery, air support, armor and other combat support assets not possessed by the defenders, backed up by a functioning logistical system. The German logistics organization was near collapse, for example, the combat commander had 1700 rifles from various countries, only 32 machineguns and a few panzerfausts for a force of 5000 men.⁴⁶ Compare that to the statement of a U.S. Infantry battalion executive officer, "We had an abundance of supporting weapons with plenty of ammo."⁴⁷ The city leadership had stockpiled adequate supplies of food, medical supplies and water, but did not have enough for a long siege.

The defenders did possess some operational advantages. The fortifications would make the Main hard to cross and make an attacker pay for every meter of ground. Although the German forces were short on overall combat experience they did have enough veterans to take advantage of lessons learned throughout a long

war, to include a well-tested doctrine for city combat. They were aware of the fact that an attacker would try to force the city by coup de main and only if it had failed would resort to a deliberate assault. This time gap would allow for reinforcing weak points and for making additional preparation.⁴⁰ Their command, control and communications within KKA was good and they had conducted practice alerts to exercise the system. But the defender's lack of mobility, air superiority, tactical intelligence, heavy weapons, and reinforcements would complicate any effort at long term defense. These deficiencies would force the Germans to fight a positional defense in the rubble of the city and, without reinforcements, lose by attrition.

If the environment favored the defenders and operational factors were somewhat offsetting, what effect would behavioral factors have on a potential struggle? The attackers would be from veteran combat units, with recent experience in city fighting. Even granting new replacements, the leadership of the approaching Americans was battle-tested, although perhaps not to the level of some segments of the Germans forces. Their level of training was good, with recent periods of in-country unit training. Individual replacements had received a full training cycle before assignment to their units.

If there is an area where the Americans were deficient it was in morale. Not in the sense of unit esprit, -- the attacking forces were from successful, highly motivated units, -- but in the

intangibles of combat. The 4th Armored Division knew it would not have to finish the fight and perhaps did not take full advantage of all opportunities. Troops of the 45th Infantry Division were told they were coming to the Main River sector for a rest, because Patton's Third Army had secured the area. The realization that this was not the case must have been a shock and likely reinforced the attitude of all combat soldiers that their lot is always the worst. It was late in the war and the average American soldier could tell the end was near. As one officer put it, "We had special instructions from Allied headquarters to avoid having casualties. If we met resistance to pull back, use the air force, artillery and chemical mortars, then try again." Regardless of whether such instructions were ever actually issued, the thought behind them was plain to the combat veteran who wrote those words.

The German Army possessed several behavioral strengths. It had a solid, well-trained officer corps, that even late in the war worked on the principle that having no officer was better than having a poor officer. The regional-based unit replacement and training system was still functioning somewhat. This system built cohesion even in the face of deterioration because it trained junior leaders to assume command in the absence of their superiors. The training cycle was greatly reduced so that most new recruits were either untrained, or had a few weeks of rudimentary military instruction. The German Army was a thoroughly disciplined force that prided itself on improvisation, a skill needed in city

combat.⁵⁰ The traditions of good leadership would carry the defenders for many days.

Whereas the attackers were weaker in morale, that is the area where the defenders were strongest. The Germans suspected the war was lost but fought until the end. Even as the battle approached, the German soldier fought because he was fighting for his homeland, and because the government promised that the struggle would ultimately benefit Germany. The apparent fanaticism of the defense reflected the skill and efficiency of experienced soldiers hardened in nearly six years of war.⁵¹ This spirit is reflected in a saying current at the time, "Nun volk steh auf und sturm brich los!" (Now the people stand up and the storm break loose!).⁵²

American Prologue

Seventh (US) Army Operation Instruction 110, dated 25 March 1945 informed XV (US) Corps of a boundary change between Third (US) Army and Seventh (US) Army, effective 260001 Mar 45.⁵³ This seemingly insignificant modification in control graphic information changed the entire character of the battle for Aschaffenburg, a fight that would begin later that day. It shifted the boundary between two advancing American armies to the north so that, starting on Monday, 26 March, Aschaffenburg would be the responsibility of the XV (US) Corps' 45th Infantry Division, and not of the XII (US) Corps' 4th Armored Division. An armored force would initiate the fight, but would give way to an infantry unit.

The timing of this message is perhaps as important as its content. Although the record does not reflect it, when the 4th Armored Division started the battle, it knew that it would not finish it and, consciously or subconsciously, that knowledge must have colored the manner in which it conducted the fight. Without passing judgement on the U.S. units that fought at Aschaffenburg, a quick examination of the battle reveals that the 4th Armored Division, after an initial unsuccessful attempt to seize the town by a coupe de main, went over to the tactical defensive and awaited the advanced elements of the 45th Infantry Division. Because the 45th fought most of the battle for Aschaffenburg, this tactical outline will focus on it.

Operation UNDERTONE was the Seventh (US) Army operation to pierce the Westwall and drive to the Rhine River.⁵⁴ It had started on 15 March and according to the official history of the 45th Infantry Division, it was slow, deadly work.⁵⁵ By 19 March the German defenses had been breached and on the 22d the units pushed to the Rhine. The concurrent seizure of the Ludendorff Railroad Bridge by the 9th Armored Division and the rapid establishment of a bridgehead by the First (US) Army on 7 March 1945 had changed the nature of the Rhine crossings for later American units, for in spite of the fact that the crossings were conducted under fire, because they were not the first, the defenders were busy trying to stem the tide at the already-existing bridgeheads. On 26 March the XV (US) Corps began its assault over the river with the 45th

Infantry and 3rd Infantry Divisions spearheading the assault on a fifteen mile wide sector between Gernheim and Mannheim.⁵⁶

The Rhine had been breached and one of the consequences of the German decision to strongly contest the Allies west of the river was that the resistance between the Rhine and the Main River in south-central Germany was weak and unorganized, it was more of a delaying action than of a defense. The Allies recognized this and the race across Germany was started in earnest.

German Final Preparations

As the winter of 1945 faded into spring the Germans knew that the battle for the homeland had begun. On 26 February Obersturuppenfuehrer Paul Hausser, the commanding general of Army Group G sent this message to General der Infanterie Walther Hahm, the commander of LXXXII Corps:

The execution of all measures in the East necessitates a holding of the lines in the West. There is no compromise here either.... He who gives up the fight is not only a coward but he betrays also our women and children.... All soldiers separated from their units who are found loitering on roads, in towns, with the trains, claiming to be stragglers, are to be executed on the spot.⁵⁷

There is no equivocation, the new SS commander of Army Group G is setting the tone for his conduct of operations. The intent of the commander is clear, discipline will be maintained and there will be no compromise in the determination to win.

Ten days later, on 7 March 1945, elements of CCB 9th Armored Division siezed the Ludendorff Bridge over the Rhine River at Remagen and established a small bridgehead. The Americans had their first foothold in the heart of the Reich and they would exploit it over the next few weeks in ever-increasing numbers. Oberstgruppenfuehrer Hausser would have an opportunity to test the will of his troops to continue the struggle.

As the war approached preparation continued in Aschaffenburg. In early 1945 a Festungsdienststelle (Fortress Service Organization) was established to supervise the refurbishment of the Wetterau-Main-Tauber Line. Based on the bunker suitability criteria of 1945, it found 268 of the 329 bunkers not fit for employment.²⁸ With the formal designation as a fortress and the installation of a combat commander on 5 March the work started in earnest.

During the night of 20-21 March the garrison received a teletype message with the code word "Gneisenau" indicating an upgrade to full alert. The alert was executed over the next few days and by 0730 hours on 23 March the measures had been implemented. The next day Major Lamberth, the combat commander, went to Michaelstadt to Seventh Army headquarters to give a personal report and the garrison was placed under the army's control.²⁹ Simultaneously, the U.S. 4th Armored Division was crossing the Rhine River at Worms for a drive to the Main River,

which it reached at 1200 hours the next day. The battle of
Aschaffenburg was about to begin.

CHAPTER 3

END NOTES

¹ R. Ernest Dupuy and Trevor N. Dupuy, The Encyclopedia of Military History: From 3500 B.C. to the Present, 2d rev. ed. (New York: Harper & Row, 1986), 1112.

² Ibid., 1114.

³ U.S. Army, Seventh Army, G-2 Reports, 1-31 March 1945. CARL, 1. During interrogation after his capture Hausser said that the refusal to withdraw east of the Rhine and Mosel Rivers, combined with the policy of fighting to the last man was ruinous for his army group. According to the Seventh Army report in speaking of Hitler Hausser expressed the highest esteem for him as a strategist, except that he was usually too late in ordering withdrawals.

⁴ Generalmajor Carl Wagener, "The Battle of Army Group B on the Rhein Up to its Dissolution (22 March - 17 April 1945)," USAREUR Historical Division, 1945, CARL, 65. General Wagener also was of the opinion that Hitler's strategic measures always seemed of advantage to the enemy (p. 60).

⁵ Oberstgruppenfuehrer Paul Hausser, "Central Europe. Fighting of Heeresgruppe 'G' From 22 March - 4 April 1945," USAREUR Historical Division, 6 May 1946, CARL, 58.

⁶ Dwight D. Eisenhower, Crusade in Europe, (Garden City, N.Y.: Doubleday, 1948), 225.

⁷ Forrest C. Pogue, The Supreme Command. The United States Army in World War II: European Theater of Operations, (Washington D.C.: Office of the Chief of Military History, U.S. Army, 1954), 53.

⁸ Dr. Percy Ernst Schram, "The German Wehrmacht in the Last Days of the War (1 January - 7 May 1945)," World War II German Military Studies, (New York: Garland Publishing Inc., 1979), 11: 35.

⁹ Dr. Alois Stadtmueller, Aschaffenburg im Zweiten Weltkrieg (Aschaffenburg in the Second World War), (Aschaffenburg: Geschichts- und Kunstverein Aschaffenburg e. V., 1971), 133-34.

¹⁰ Ibid., 134. Emil Lamberth (or Lambert) was a reserve officer who had served for four years in the First World War and after the war became a teacher (and organist for the local Catholic Church) in Erbach in the Odenwald. In 1937 he joined the NSDAP and

later the Wehrmacht. By 1940 he was a captain, and in 1942 he was a major and a battalion commander in Russia. Next came service in France, Holland and finally Aschaffenburg.

¹¹ Ibid., 134. Much was made in the immediate post-war American literature about the fact that Lamberth was only a major and was outranked by several officers in the city. Dr. Daniel Hughes, the Combined Arms Center Historian, states that the answer probably lies in the fact that the Germans prized efficiency over fairness. He was most likely selected by the Corps Area commander because he was the best man for the job.

¹² Emil Lamberth, "Der Bericht des Kampfkommandanten" (The Report of the Combat Commander), Main Echo, 25 March 1955, 70:. Lamberth says that the initial plan manning only strongpoints and bunkers was rejected by the Corps Area commander. In this article written ten years after the war he says that his plan was to avoid destruction of the Schloss and the old town, but that General Zehler and his Chief of Staff, General Uckermann, rejected it as not tough enough, and reinforced the point by ordering Lamberth to move his headquarters from Lagarde Kaserne to the Schloss.

¹³ Stadtmueller, Aschaffenburg im Zweiten Weltkrieg, 155.

¹⁴ Schram, The German Wehrmacht, 43.

¹⁵ Hans von Ahlen, "The Fighting of Fortress Breslau," Military Review, September 1956, 90. The city had been declared a fortress in August 1944, but no action occurred until January 1945. At a cost of 6000 dead the Germans tied down 100,000 in the Soviet rear and inflicted between 30,000 and 40,000 casualties.

¹⁶ Schram, The German Wehrmacht, 43.

¹⁷ Oberst (Graf) i. G. Ludwig von Ingelheim. "LXXXII AK Interrogation," USAREUR Historical Division, 4 August 1946, CARL, 1.

¹⁸ Stadtmueller, Aschaffenburg im Zweiten Weltkrieg, 157.

¹⁹ Lamberth, "Der Bericht", 70:. Lamberth says that one of the requirements was the publishing of a document announcing to the city that he was the combat commander so that everyone would know that he had the authority of the Fuehrer.

²⁰ von Ingelheim, LXXXII AK Interrogation, 1.

²¹ Lamberth, "Der Bericht", 70:. Lamberth states that at one point he was ordered by the Corps Area commander to establish better relations with the Party.

²² Victor W. Madej, German Army Order of Battle 1939-1945, 2 vols. (Allentown, PA: Game Marketing Company, 1970), I:67.

²³ Burton Wright III, Army of Despair: The German Volkssturm 1944-1945, Ph.D. Diss., The Florida State University, 1982 (Ann Arbor, MI: UMI, 1982), v.

²⁴ Ibid., 5.

²⁵ Ibid., 5.

²⁶ Alois Stadtmueller, Maingebiet und Spessart im Zweiten Weltkrieg (Main Region and the Spessarts in the Second World War), (Aschaffenburg: Geschichts- und Kunstverein Aschaffenburg e. V., 1983), 105.

²⁷ Wright, Army of Despair, 134.

²⁸ Stadtmueller, Maingebiet, 104. A summons was spread throughout the area directing each man to report to a location specified in the Aschaffenburger Zeitung (Aschaffenburg Newspaper). At the bottom of the summons was a coupon calling for vital information that had to be completed and taken to the registration location.

²⁹ Stadtmueller, Aschaffenburg im Zweiten Weltkrieg, 309. The fact that the local leader was in the Finance Administration may speak volumes of the actual readiness of the volkssturm as a military formation in the city.

³⁰ In a number of discussions with the author, Manfred Baunach, at the end of the war a 15 year old Hitlerjugend, told of digging anti-tank ditches, serving as an observer in the towers of the Schloss, and working as a motorcycle messenger.

³¹ General information for German order of battle from Ian V. Hogg, German Order of Battle 1944, (London: Arms and Armour Press, 1975), and Victor W. Madej, German Army Order of Battle 1939-1945, End Note 22 above.

³² Freiherr Siegmund von Schacky, "Report of 413th Replacement Division's Activities Between Area Wurzburg to the Thuringian Forest," USAREUR Historical Division, 18 March 1946. CARL, 15.

³³ Oberst i. G. Horst Wilutzki, "Army Group G (22 March - 6 May 1945)," USAREUR Historical Division, 25 March 1946, CARL, 16.

³⁴ Ibid., 16.

³⁵ Oberst (Graf) i. G. Ludwig von Ingelheim, "LXXXII Corps, 27 March - 6 May 1945," USAREUR Historical Division, 6 May 1946, CARL, 5. Graf (Count) von Ingelheim was the chief of staff of the corps. He was also a member of the family whose ancestral home is Schloss Mespelbrunn a well known tourist attraction in the Spessart Mountains not far from Aschaffenburg.

³⁶ Ibid., 8.

³⁷ Generalmajor Helmut Kleikamp, "36th Volks Grenadier Division (28 March - 3 May 1945)," USAREUR Historical Division, 1945, CARL, [no page numbers].

³⁸ von Ingelheim, LXXXII Corps, 9.

³⁹ Ibid., 9.

⁴⁰ A recap: KKA: 5000
 413 ID: 10000
 256 VGD: 5000
 36 VGD: 6500
 416 ID: 7000
 33,500 along the entire Corps front.

KKA: 5000
 413 ID: 3300 (1/3 of 10,000)
 256 VGD: 1650 (1/3 of 5000)
 36 VGD: 6500
 16,450 on the Aschaffenburg front.

⁴¹ General order of battle information is from Shelby L. Stanton, Order of Battle US Army World War II, (Novato, CA: Presidio Press, 1984).

⁴² U.S. Army, 4 Armored Division, "After Action Report for the Period 1 March - 31 March 1945," 6 July 1945, CARL, 5.

⁴³ U.S. Army, XV Corps, Actions Against Enemy, Reports After, 1-31 March 1945, CARL, 70.

⁴⁴ Colonel Trevor N. Dupuy is a leading proponent of the idea that man-for-man the German soldier, and by extension, the Wehrmacht was most effective in WW II. His two books, Numbers, Prediction and War (Indianapolis: Bobbs-Merrill, 1978), and Understanding War (New York: Paragon House, 1987) develop his case.

⁴⁵ U.S. War Army, FM 90-10, Military Operations in Urbanized Terrain (MOUT), (Washington, D.C.: HQ Dept. of the Army, 15 August 1977), 1-10, and U.S. War Department, FM 31-50, Attack on a

Fortified Position and Combat in Towns, (Washington, D.C.: United States Government Printing Office, 31 January 1944), 61.

⁴⁶ Stadtmueller, Aschaffenburg im Zweiten Weltkrieg, 153.

⁴⁷ Leland Woods, letter to author, 4 January 1987.

⁴⁸ LTC Peter A. Igel, "Defense of Villages: a German Army 'How To Fight' Guide From 1944," Monograph M-22-83, (Cologne, GE: U.S. Army Training and Doctrine Command Liaison Office Federal Republic of Germany, no date [1983?]), 2.

⁴⁹ Leland Woods, letter to author, 4 January 1987.

⁵⁰ Daniel Hughes, "The Officer Corps of the German Army, 1860-1945," (Ft. Leavenworth: S.L.A. Marshall Lecture, 22 November 1988).

⁵¹ Madej, German Army Order of Battle, 30.

⁵² Stadtmueller, Maingebiet, 53.

⁵³ XV Corps, Actions Against Enemy, 70.

⁵⁴ Guy Nelson, Thunderbird. A History of the 45th Infantry Division, (Oklahoma City, OK: The Oklahoma Publishing Company, 1970), 91.

⁵⁵ Ibid., 94.

⁵⁶ Ibid., 96.

⁵⁷ U.S. Army, XII Corps, "G-2 Periodic Reports (1-31 March 1945), 20 Mar 45, CARL, 3. This translation of a captured document dated 20 March appears with the March records.

⁵⁸ Matthais Schneider, "Beim Kampf vor 40 Jahren Spielten auch Bunker eine Rolle, die 1936 Gebaut Wurden' (Built in 1936, the Bunkers Played a Role in the Battle of Forty Years Ago), Spessart, April 1985, 8.

⁵⁹ Lamberth, Der Bericht des Kampfkommandanten, 70:.

CHAPTER 4

THE BATTLE

Introduction

This chapter deals with the battle for the city of Aschaffenburg from 25 March to 3 April 1945, covering the four phases of the struggle: Engagement (25-26 March), Equilibrium (27-28 March), Attrition (28-30 March), Reduction (31 March - 3 April). It is chronological, describing the actions taken by both sides to gain the initiative and secure a tactical advantage.

Setting the Stage

For OKW the news in the west was bad. The Allies had breached the Westwall, siezed the Saar Palatinate and the Rhineland, crossed the Rhine in several places and now were driving, almost unopposed, towards the heart of the Reich. In south central Germany remnants of Wehrmacht units were streaming back to the next echelon of defensive positions along the Wetter, Main and Tauber River systems. Their fitness for combat was poor and any effort at defense resembled more of an armed delay. Pushing them were two strong American armies, the Third and the Seventh, both with as much combat experience as any American units.

The Third Army spearhead was the 4th Armored Division racing across the flat country between the Rhine and the Main through Darmstadt. The operation was aided by the German Seventh Army

commander's decision to abandon the defense of Darmstadt, a city already substantially destroyed by aerial bombing.¹ In the 38° weather of the Bavarian spring morning LTC Creighton W. Abrams' Combat Command B (CCB), a strong force of 2500 men, raced to the Main River in Aschaffenburg following a report of a road bridge still undamaged over the river.

Awaiting them on this Palm Sunday were the five thousand combatants of Kampfkommando Aschaffenburg (KKA) and German troops under the control of the 413 Replacement Division staff, hastily ordered by OKW to control all forces along the Main River front from Hanau to Miltenberg.² Most of the division's 10,000 partially-trained troops were concentrated in the major towns along its 60 kilometer front. However, at the start of the battle Aschaffenburg was an isolated defensive stronghold with few other troops for support.³ KKA positioned its forces as seen at Figure 8 with an initial echelon of troops on the west bank of the river in the Nilkheim salient and the second echelon arrayed in strongpoints from west to east on high ground, or in fortified positions in front of the urban area of the city. A weakly held area was the open ground south of the city in the vicinity of the Nilkheim railroad bridge.

OPENING TROOP DISPOSITIONS. 25 MARCH 1945

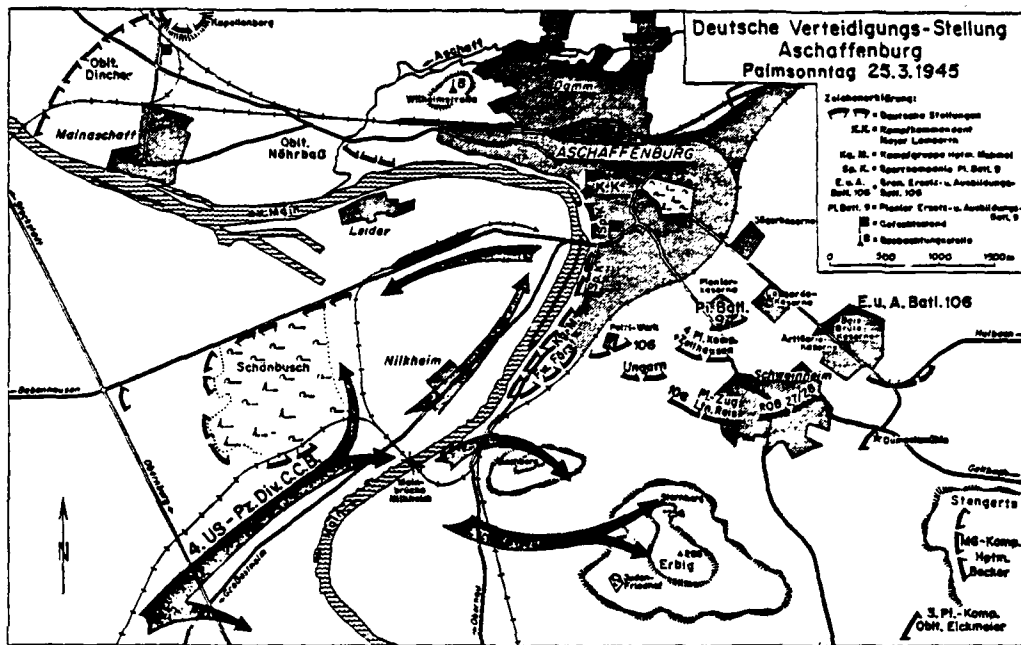

Figure 8

Source: Alois Stadtmueller. Aschaffenburg im Zweiten Weltkrieg. (Aschaffenburg: Geschichts- und Kunstverein e. V. Aschaffenburg, 1971). 177.

Day 1 - 25 March 1945

At 0900 hours the German command at Babenhausen, nine miles to the west, called Aschaffenburg to report that the town was under attack by strong American armored forces. This information went out to all strongpoints and Major Lamberth, the Combat Commander, ordered the burning of all secret documents. At noon sentries in the towers of the Schloss Johannisburg reported the approach of the Americans along Darmstaedter Strasse, the road from Babenhausen. The members of CCB, 4th Armored Division were driving for the Mainbrücke over the Main at the apex of the Nilkheim salient.⁴ They reached the bridge and tried to push their way across under intense small arms fire. As the first Sherman tank tried to force its way across it exploded with a flash from multiple hits from antitank rockets, antitank shells, mortars and small arms fire.⁵ This caused the Americans to withdraw from the nose of the salient. Simultaneously German defenders in the Schloss saw American men and armored vehicles crossing the undamaged railroad bridge three kilometers upriver (south) from the road bridge.

As the lead American units were pulling back from the road bridge, LTC Harold Cohen, commander of the 10th Armored Infantry, received a radio call telling him of the railroad bridge. He directed the battalion recon platoon to take the bridge and all available vehicles to provide fire support. In rapid succession, under intense small arms fire, the scouts swarmed across the

one-track-wide iron girder structure, cutting wires, pushing aerial bombs rigged for demolition into the river. Once on the other side some men dove in the water to swim to the center support to cut away additional bombs.* When reasonably assured that the bridge would not blow up in their faces, three companies of infantry went across on foot, followed by their halftracks and some tanks from the 37th Tank Battalion.† By 1230 hours the Americans had moved away from the river and were fighting their way up the slopes of the Bischberg and the Erbig against light resistance. Realizing the importance of the bridgehead, LTC Abrams moved as much combat power over the bridge as he dared.

The American approach to the city had occurred so fast that the plans for the destruction of the bridges were not executed. Oberleutnant Paul Keil, the railroad bridge commander, was awaiting demolitions which did not arrive in time.‡ When this was reported to the combat commander he ordered immediate counterattacks, but the Americans had built up such strong forces that the attacks failed. While the defenders were trying to stop the hemorrhage at the railroad bridge, they did succeed in blowing up the Mainbrücke sending two spans into the muddy water. By mid-afternoon, despite repeated ground counterattacks and sorties by ME-109 fighters, the Americans had opened an eight square kilometer lodgement on the east bank of the Main. The Nilkheimer railroad bridge was the only intact bridge across the Main River from Frankfurt to Miltenberg: the Wetterau-Main-Tauber Line had been compromised. In the

afternoon the German Seventh Army commander, General der Infanterie (major general) Felber visited the city to assess the situation. Having the recent example of the Remagen railroad bridge, he was especially aware of the importance of containing the American penetration.² He directed that all available units be sent to the Main front at Aschaffenburg.

In mid-afternoon the Americans attempted to capitalize on the bridgehead by trying to seize the town of Schweinheim by a coup de main. A strong force of tanks and infantry, supported by artillery, attacked the town along the flat rolling farmland, but pulled back to positions on the Erblg, the Sternberg and the Bischberg after losing several tanks and engaging in hand-to-hand fighting.¹⁰ Before nightfall US units had moved north along the river to the southern approaches to Aschaffenburg. The elements not engaged in the bridgehead mounted assaults to eliminate isolated German defensive positions in Schoenbusch Park and in Leider (Figure 8).

Thus, on the first day of the battle of Aschaffenburg the Americans had gained a foothold across the Main River, but at a cost of four tanks put out of action and several men killed or wounded. Although a bridgehead was firmly established they had missed an important opportunity. The area south of the city was initially lightly defended, but in the words of LTC Cohen, "the Wehrmacht moved in and built up a crust." A massing of forces in the Aschaffenburg area could have provided a quick entrance into

the Spessart Mountains and the Franconian heartland beyond. The Germans saw the possibility and the Aschaffenburg area became a schwerpunkt drawing forces from the entire area. Yet, they were too late to erase the bridgehead and had committed a tactical blunder similar to that made at Remagen.

Destruction of bridges was an engineer function that was centralized in engineer channels. According to Major Lamberth, the destruction of the Main bridges (one road and two rail bridges in the KKA sector) was not a part of the defensive plan developed in the fall of 1944. In an article written after the war he states that the plan for the bridges came to the city, without comment, on 23 March from Wehrkreis XII in Wiesbaden.¹¹ Bridges were such a strategic asset that OKW probably chose to centralize their control to avoid their destruction by inexperienced, or at least not fully-informed, commanders.

The Americans seized the initiative at the bridge and then let it slip away when they did not follow up against defenders so feeble that both the commander of the 413 Replacement Division's home Wehrkreis and the chief of staff of Seventh Army were painfully aware of the inferior quality of its men and equipment.¹² There are several possible reasons why the Americans did not press the attack. They were at the end of a lengthening supply line, were the only force across the Main River and did not know if they were being drawn into a trap where they could be hit in the flank and destroyed. Also, because of its position in a bowl formed by

the Spessart Mountains and the Main River. the city could not be bypassed. The reduction of a defended city is always a costly, time-consuming operation, especially for an armored formation. It was the habit of the US Army in Europe in the Second World War to attach additional infantry to armored combat commands to give them added protection and make them more suited for combat in restrictive terrain. The 4th Armored Division had received the 328th Infantry Regiment from the 26th Infantry Division on 24 March, but CCB had not yet been reinforced.¹⁻² But perhaps the most important reason CCB did not press the attack was that, effective 260001 Mar 45, an army boundary change would make Aschaffenburg officially the responsibility of the US Seventh Army. On order, CCB would cross the Main at Hanau and join the rest of the 4th Armored Division in a push north towards Giessen. So the initiative gained by the seizure of the bridgehead was allowed to pass to the Germans, who were rushing reinforcements into the area by rail.

Day 2 - 26 March 1945

As an indication of the seriousness with which the American penetration was viewed by the Germans, a two-person special commission was dispatched from OKW. SS Obersturmbannfuehrer (SS-lieutenant colonel) Wegener, an OKW staff officer, and Stabsapotheker (staff pharmacist) Stumpf, a district judge from the Berlin area, arrived in the city on the 25th with credentials signed by OKW chief Field Marshal Wilhelm Keitel. They were

empowered to direct operations in the city if necessary. It was plain that Kampfkommandanten Lamberth was going to have plenty of help in his defense of the city.¹⁴

As the Seventh Army rushed reinforcements to the Main front, the Americans maintained pressure on the bridgehead. To outflank the American bulge on the east bank the defenders reinforced the positions in Schweinheim and Stengerts Hill to the east of the nose of the penetration. While the defenders kept up a stream of small arms and mortar fire on the bulge, the elements of CCB in the bulge received word to disengage. They were to make no further penetration, but just withdraw and hold the bridge.¹⁵ As they complied, the Wehrmacht was making organizational changes in the defending forces.

In the early morning hours of 26 March OKW placed the 413 Replacement Division under the command of the Seventh Army. There was still no intermediate headquarters, but the German High Command felt it had to achieve some operational control of the Main River front.¹⁶ It can be argued that in the face of the near total breakdown in the command and control apparatus of the German forces at this stage of the war, assigning any higher controlling staff above corps level was wishful thinking, but OKW must have felt this necessary. Certainly the influence of Army Group G and Seventh Army became less as the battle progressed. Army Group G, especially, had no reserves, no intelligence system, no adequate

command facilities, and almost no right to make independent decisions in its zone of action.

To reinforce KKA the 36 Volksgrenadier Division (VGD) was ordered from north of Michelstadt to the area south of the penetration to block any American breakout to the south. They were accompanied by the 416 Infantry Division directed to occupy the area to the south of the 36 VGD,¹⁷ and elements of the XIII SS Corps which entered the line along with the 256 VGD on the city's right flank.¹⁸ In an attempt to improve coordination on its flanks KKA established liaison with the combat commands in Klingenberg on its left and Hanau on its right. Hanau, like Aschaffenburg, was under orders to fight to the end, although it was still quiet in most of the city.¹⁹

On the tactical side the situation was approaching equilibrium. The Americans did not want to attack and the Germans were not yet strong enough to do so. CCB mounted limited assaults toward the Obernauer Kolonie section on the southern end of city,²⁰ and along Bischberger Strasse in the direction of Schweinheim. Both attacks extended the US lines and gave them a toehold in the suburbs of the city.

It is in this context that the events of the "Hammelburg Raid" unfold. US Third Army commander Lieutenant General George S. Patton directed the use of the Aschaffenburg bridgehead to launch an armored thrust towards the German POW camp at the Wehrmacht

infantry training area at Hammelburg, forty miles northeast of the city. The object was to free the American officer prisoners held there and bring them back to American lines. Among those prisoners was Patton's son-in-law, LTC John Waters. The decision was staffed during the day and Patton himself came to the Aschaffenburg area to discuss the mission with the leaders involved. The troops for the mission would come from CCB.²¹

During the night of 25-26 March, Major Stiller, Patton's aide, came to Aschaffenburg and told LTC Cohen to "prepare for a dangerous mission."²² After several hours of discussion on its size, and whether it should go at all, a task force of 53 vehicles (Jeeps, light and medium tanks, halftracks and assault guns) and 294 men under the command of CPT Abraham Baum was assembled, equipped and briefed during the daylight hours of 26 March. The plan called for the Task Force Baum to punch through Schweinheim, get on the main road towards Haibach and follow routes 8 and 26 to Hammelburg. Starting with a thirty minute artillery preparation at 2030 hours the infantrymen, engineers and tankers of CCB fought into Schweinheim and cleared a path through the town. The Germans put up a determined defense and it was not until midnight that TF Baum push through and reached the main road in the vicinity of Artillerie Kaserne in the southeastern part of Aschaffenburg. Once on the main road they drove rapidly to the northeast encountering light resistance.

The immediate reaction on the part of the Germans was one of confusion. Outposts along the route reported the presence of a mechanized column in the German rear, and a number of trains moving troops and supplies west along the Main River valley were engaged and damaged.²³ Upon reaching OKW these reports contributed to the impression that the Main River front was in jeopardy, and contributed to the strengthening of the front at Aschaffenburg by convincing the German High Command that a leak must be plugged. At the same time, General der Infanterie Weisenberger, the commander of Wenckries XIII, took steps to stop the penetration which eventually succeeded on the morning of the 28th when the force was surrounded and captured.²⁴ While the raid contributed directly to the reinforcement of the Aschaffenburg area, it also indirectly contributed to the long term weakening of the front. The Wenrmacht realized the necessity of holding at least some forces in reserve.

After the departure of Task Force Baum, CCB pulled back to its positions on the high ground overlooking the city. The hard fought toehold in Schweinheim was relinquished as it prepared for another mission. The battle of Aschaffenburg was about to enter another phase. The Germans had lost the bridge, but, with the exception of TF Baum, they were able to contain the penetration. Meanwhile, the Americans were retrenching.

Day 3 - 27 March 1945

To enhance the control on the Main River the staff of the 416 Infantry Division was ordered by the German Seventh Army to take over control of the defense of the area from the 413 Replacement Division.²⁵ Even though better equipped, and with a more experienced staff, the 416 ID struggled to receive, organize and properly distribute the many small independent units that were arriving on the front. They were mostly training units of the Replacement Army, with inadequate training and equipment. During the day Aschaffenburg received a grenadier training battalion, a light artillery training section, a medium artillery training unit, a Flak training battalion and an engineer training company.²⁶ Facing the Americans was a collection of various replacement and training units.²⁷ Notably absent in the forces available were adequate infantry units. However, we should not make too much of the lack of infantry units, for during the Battle of the Bulge the U.S. Army rushed men not assigned to infantry units to the front and many fought well. As will be seen below, regardless of their apparent quality, the replacement units fought vigorously.

On the American side, CCB was pulling across the Main into assembly area prior to moving towards Hanau to rejoin the rest of the division. Its place in the Nilkheim bridgehead was taken by the 1st Battalion, 104th Infantry (26th Infantry Division), then attached to the 4th Armored Division. In the early morning hours

the battalion, reinforced with a company of medium tanks from the 778th Tank Battalion, moved to the Aschaffenburg front and relieved OCB.²⁻ While the 1/104th IR cautiously approached Schweinheim (Figure 9) other American units were beginning to learn about Aschaffenburg.

The boundary change that had become effective the preceeding day gave the Seventh Army's XV Corps responsibility for Aschaffenburg and it in turn directed its left flank unit, the 45th Infantry Division, to move into the area. The 45th ID was moving east against light resistance with three regiments abreast (See Figure 10). MG Fredericks, the division commander, gave the 157th Infantry Regiment, moving on his right flank the mission of seizing the town. In the morning of the 27th, LTC Felix Sparks, the commander of the 3rd Battalion, 157th Infantry, was ordered to drive rapidly to the Main at Aschaffenburg and seize the high ground immediately beyond the river. According to LTC Sparks he was informed that the town had been cleared by the Third Army. he was not told of Task Force Baum operating beyond the river. although he was told not to fire on any American tanks he might find to his front.²⁻ Leaving its assembly area at 1200 hours the 3/157 IR arrived at the Nilkheim railroad bridge at 1400 hours. The lead elements of the battalion discovered the bridge planked over to facilitate vehicle movement, but found no friendly troops. A platoon, and then a company, was sent across the bridge, and

ASCHAFFENBURG, 1945

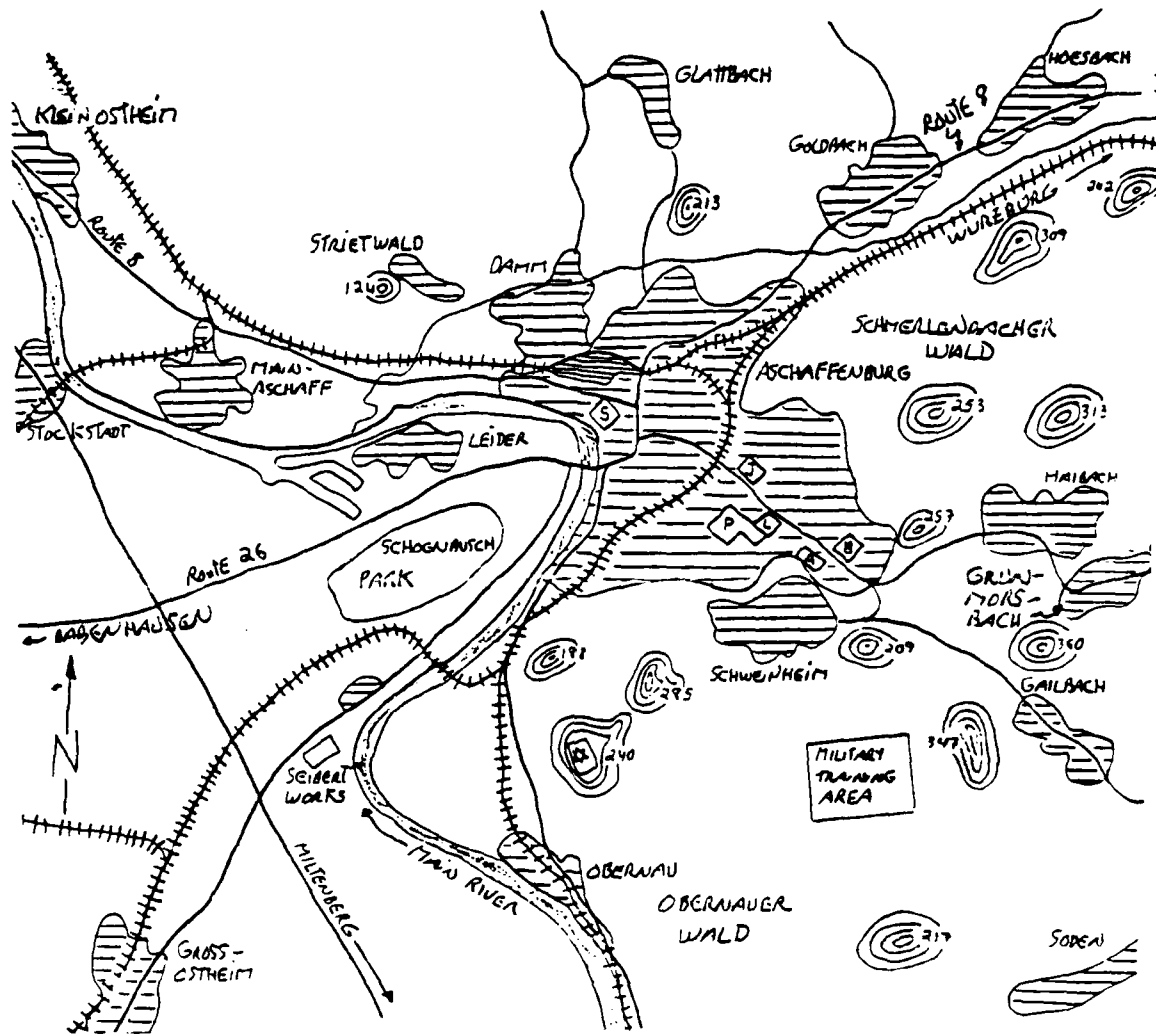

Figure 9

- | | |
|----------------------------------|------------------------|
| Legend: S - Schloss Johannisburg | L - Lagarde Kaserne |
| J - Jaeger Kaserne | A - Artillerie Kaserne |
| P - Pionier Kaserne | B - Bois-Brule Kaserne |

EXPANSION OF THE AMERICAN RHINE BRIDGEHEAD

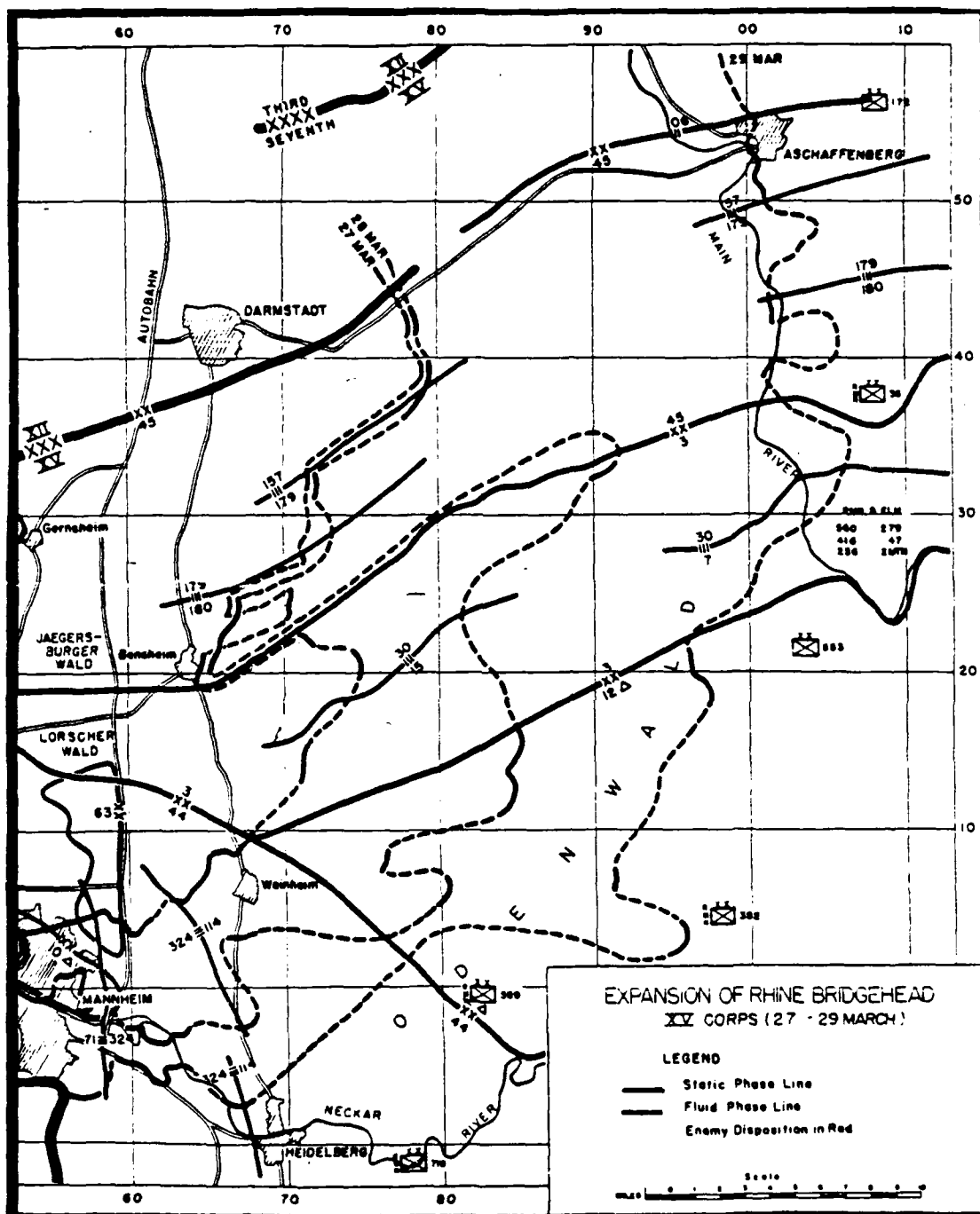

Figure 10

Source: U.S. Army, The Seventh United States Army in France and Germany, 1944-1945: Report of Operations, (Heidelberg, Germany: A. Graf, 1946), V.3, 750.

while being engaged with mortars and small arms fire, it met the American troops holding the bridgehead.²⁰

The 3/157 IR took up defensive positions on the west bank of the Main while the leaders coordinated the relief in place. LTC Sparks met with the captain commanding the bridgehead who said that his orders were to hold the bridge "until relieved." He also told Sparks that the town was not cleared.²¹ After relieving the recon troop, the 3/157 IR moved across the bridge and took up defensive positions. At 1400 hours and again at 1600 hours the Americans repulsed two strong counterattacks by the defenders in Schweinheim. They also received mortar and small arms fire from the high ground east of the town, but by 1640 hours the relief in place was complete; the battle was theirs²² Immediately two rifle companies supported by artillery and tank destroyers made a coordinated assault on the town. A small toehold was siezed on the east side and fifteen prisoners captured²³. The period of equilibrium in the battle of Aschaffenburg was over.

The stiff resistance at the Main River line was unexpected. The 45th ID had met determined resistance at the Westwall and while crossing the Rhine, but the forty kilometers between the Rhine and the Main had been lightly defended. The division had encountered more civilians with white flags than soldiers with assault rifles. It must have seemed as if the end was finally in sight and German resistance was crumbling at last. In the words of LTC Sparks, "The resistance in the Aschaffenburg area came as a great surprise to my

regiment and division."³⁴ The news that the regiment had an enemy force several thousand strong to overcome was not welcome, and as the fighting progressed, led to increased bitterness on the part of the attackers. The soldiers of the 45th ID felt they had been lied to by the 4th AD.³⁵

As the 3/157 IR settled into the bridgehead the Germans were consolidating their positions to block any breakout. The 36 VGD occupied positions on the right flank of KKA in the military training area on the south side of Schweinheim, and in the hills beyond. To increase the level of control on the front Seventh Army alerted the LXXXII Corps to take over the defense of the Main River line by 1200 hours the next day.³⁶ In addition to its own weak units it would have KKA with its collection of some 15 various replacement and convalescent units to defend the river line.³⁷

Day 4 - 28 March 1945

KKA still held. The 36 VGD was weakly outposting the southern end of the city and the 256 VGD had troops in contact with the western strongpoint in Mainaschaff. The American penetration had been sealed off, and German forces were strong enough that the only safe US crossing sites were still around the railroad bridge. As the strongest of the German units facing the Americans, the 36 VGD was selected to conduct a counterattack to eliminate what the Germans called the "Oberrau Bridgehead." Before dawn the 87th and 165th Infantry Regiments, along with two light and one medium

artillery battalions, were in place to the south.³⁹ Throughout the day the leaders conducted reconnaissance and rehearsed the plan, which called for the 165 Grenadier Regiment (GR) to hit the right flank of the American bulge in the vicinity of the Erbig, while the 87 GR pushed to the river at Obernau. The division's other regiment, the 118th was still moving up from the Michelstadt area. The town of Gailbach served as the assembly area.

On the American side, beginning at 0730 hours the rest of the 157th IR, and its supporting arms and services, motored to the Main River near Aschaffenburg and started to cross the railroad bridge, which was under enemy air attack by ME-109s for part of the day.⁴⁰ All elements of the 3/157 IR were in position in the bridgehead by 1200 hours, those not in the line occupied an assembly area near the river east of the Erbig preparing to attack into Schweinheim. The 2/157 IR followed, crossed into the bridgehead and made preparations for an attack to the north along the river. The 1/157 IR crossed the railroad bridge at 1530 hours and occupied an assembly area preparing to attack between its sister battalions.⁴⁰

At approximately 1530 hours the regiment began a general attack supported by the 158th Field Artillery Battalion, set up in Schoenbusch Park three kilometers west of the town.⁴¹ Company A, 191st Tank Battalion, Company B, 645th Tank Destroyer Battalion and Company B, 2nd Chemical Mortar Battalion. The 2/157 IR attacked into the Oepnauer Kolonie on the regimental left flank in a column

of companies with Company F leading. The company met strong small arms, machinegun and anti-tank grenade fire, and inched its way forward to a position two kilometers northeast of the railroad bridge where it remained overnight (Figure 11). The 3/157 IR attacked into the eastern end of Schweinheim encountering very stiff resistance with Company I on the left, Company K on the right and Company L in reserve. Although supported by tactical air and artillery, it failed to pass beyond the outskirts of the town because of determined German resistance, which included officer aspirants from the Wehrkreis officer training school in the town. The 1/157 IR the regimental reserve, sent Company C north into the gap between the 2nd and 3rd Battalions against heavy sniper fire. The attack halted at dark as companies tied in to the flanking units for the night.

While the attack within the bridgehead was in progress, other soldiers of the regiment cleared the last resistance in the Nilkheim salient in the town of Lelder.⁴² With the salient cleared, Company A, 120th Engineer Combat Battalion repaired the approaches and the planking on the floor of the railroad bridge to improve the trafficability. An interesting find during the day was the discovery of a warehouse full of liquor, which was distributed throughout the division.⁴³

Meanwhile the rest of the 45th Division was moving to the river. The division CP became operational at 1545 hours in the town of Gross Ostheim, where it was joined by the CPs of the

45TH INFANTRY DIVISION SITUATION OVERLAY
282400A MARCH 1945

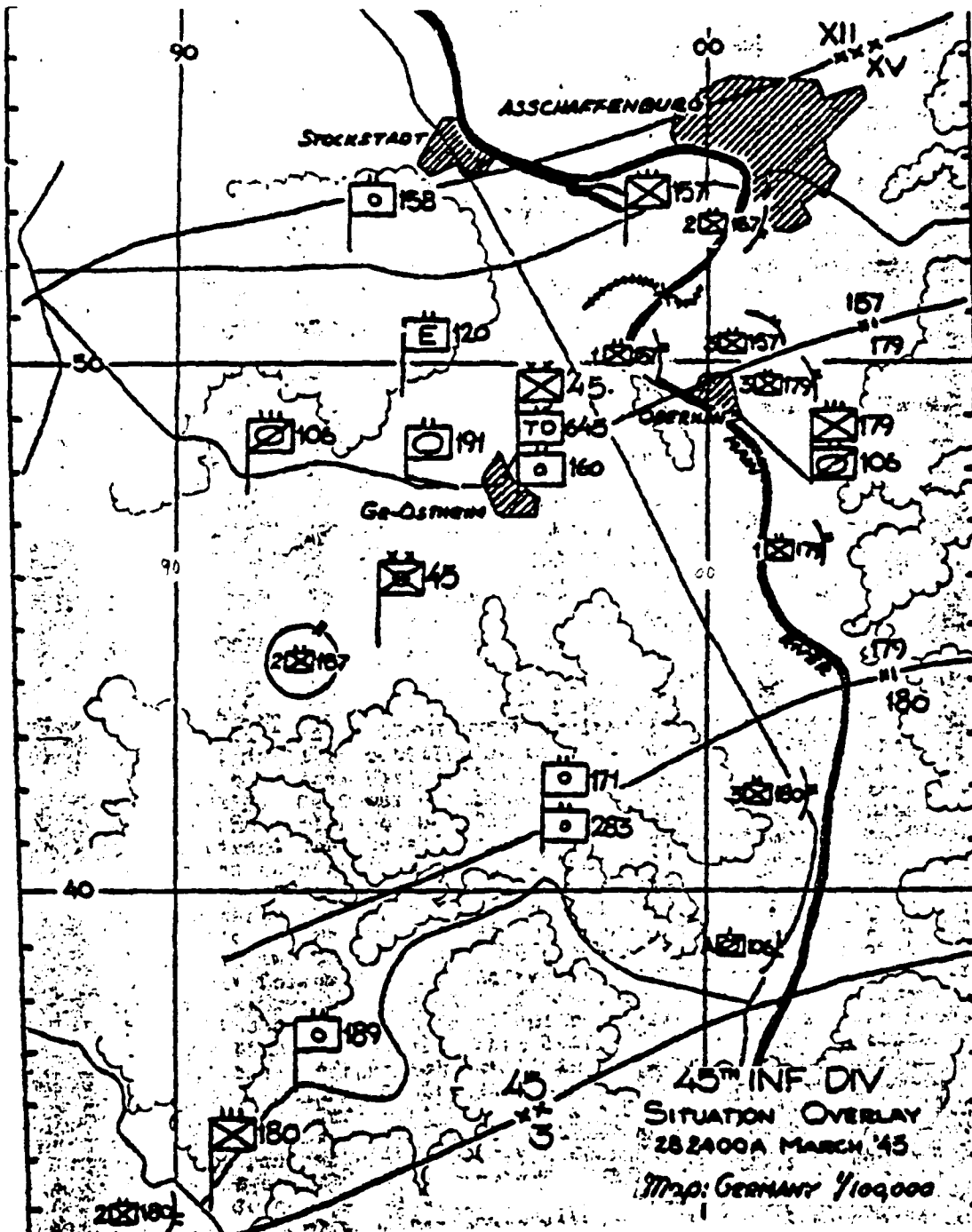

Figure 11

Source: U.S. Army, 45th Infantry Division, G-3 Report, 280001-282400A March 1945. CARL.

division artillery and the 645th TD Bn (Figure 11).⁴⁴ The other infantry regiments of the 45th ID moved to the Main River. The 179th IR arrived first and sent 3/179 IR and then the 1/179 IR across the railroad bridge to clear Obernau and occupy the high ground to the east of the river tying in with the 157th.

As the 45th ID consolidated on the Main River the Germans were increasing their investment of men and materiel in the defense of Aschaffenburg. By 1200 hours the LXXXII Corps reported to Seventh Army that it had positive contact with the 256 VGD, KKA, 36 VGD and the 416 ID.⁴⁵ Although the Germans were rapidly becoming outnumbered, they still had some 5000 combatants defending in a city that was increasingly becoming rubble by artillery, aerial bombing and ground attack.

While the defenders fought resolutely against the 157th IR, the military and political leadership of KKA took steps to clarify the role of every person in the fortress. To remove any doubt as to what lay in store for the city two proclamations were issued, one by the Kreisleiter (County Leader) and one by the Kampfkommandant. That published by Kreisleiter Wohlgemuth, no doubt with the concurrence of Gauleiter Hellmuth in Wurzburg, ordered mothers, the very young, the very old, and the sick out of the town. It said in part:

Whoever remains in the city belongs to a
battlegroup which will not know any selfishness,
but will know only unlimited hatred for this
cursed enemy of ours. They will know only

complete sacrifice for the Fuehrer and the nation. Day and night we will work. We will commit all our power to do the enemy the greatest possible damage because we know that Germany will live if we are prepared to give our lives."⁴⁶

There had been scattered reports of civilians fighting with the Wehrmacht along the Main River front, and it is the attitude expressed in this proclamation that explains the increased use of civilians in the defense.⁴⁷ At this point of the war the term civilian can really only be applied to the very young, very old and females, because virtually everyone else was either in the army or in some quasi-military organization of the Nazi Party deputized for the defense of the Fatherland. With the official sanction of the Party those who were able started moving out of the city to small towns and the farming villages in the Spessart Mountains.⁴⁸ Local Aschaffenburg historian Dr. Alois Stadtmueller relates that of a pre-war population of 38,000, only some 3500 civilians lived in the cellars of the destroyed city throughout the battle.⁴⁹

Major Lambertn, the Kampfkommandant, also issued a proclamation addressed to "Soldiers, Men of the Volkssturm, Comrades":

The fortress of Aschaffenburg will be defended to the last man. As long as the enemy gives us time we will prepare and employ our troops to our best advantage. This means fight, build barriers, erect dugouts, get supplies! As of today, everyone is to give his [sic] to the last. I order no one shall rest more than three hours out of twenty four. I forbid any sitting around or loafing. Our belief is that it is our mission to give the cursed enemy the greatest

resistance and to send as many as possible of them to the devil.⁵⁰

As a veteran combat leader Lamberth was aware of the sense of Napoleon's aphorism that in war the moral is to the physical as three is to one. He was removing all doubt as to the fate of the garrison. Whether they fought for their homes, for the fatherland or out of fear of the SS and the Party, the defenders of Aschaffenburg would fight. As if to reinforce the point, during the night he received a teletype message from OKW ordering Festung Aschaffenburg to "fight to the last cartridge."⁵¹

During the night the opposing sides traded mortar fire, small arms fire, and probed each other's lines. In activities elsewhere affecting the battle, the 16th ID southern flank was threatened by crossings of the Main by the 3rd Infantry Division in the vicinity of Obernberg and Klingenberg, and the fall of Hanau to the 26th Infantry Division jeopardized the right flank of XXX by driving back the 256 VGD.⁵²

Preliminary Analysis

As in all analysis an appreciation of the situation depends on perspective. On the American side, the commanders of the Seventh Army and XV Corps were pleased. Two days after breaking out from the Rhine bridgehead the next significant barrier was breached. Two divisions, the 45th ID and the 3rd ID, held bridgeneads on the east bank of the Main River and were advancing.

although resistance was stiffening. The German's Seventh Army and LXXXII Corps commanders were less sanguine. They had stopped the hemorrhaging of the front, but could not be optimistic about the future.

What does a closer look at the situation reveal? The American fight now belonged to the 45th Infantry, a veteran division participating in its fifth campaign. The mission was clear, Aschaffenburg was to be invested and reduced. As the Allies drove east for a link-up with the Russians the objective now became the Wehrmacht, and any other concentrations of Nazi power. It became apparent that Aschaffenburg was both a military and a political objective, military because of its garrison, political as a seat of Nazi power resisting American military might. After the failure of a bold attempt at a coup de main during their first full day at the city, the veteran leadership of the division saw the necessity for a reduction in detail as time-consuming and costly.

The Americans had material superiority, but a case can be made for the superiority of will of the Germans. At this point both sides could see that the war was almost over, and the Americans resented the stubborn resistance of the defenders of Aschaffenburg. A press release from this time captures the mood.

Our own troops have never been more bitter about a single action, despite their participation in five campaigns. Thunderbird troops, realizing the futility of German defense, were never so anxious to clear a town as they were to wipe out

this garrison that has cost them so many casualties.⁵³

Even granting that the correspondent was overstating the case to get his dispatch printed, the passage above indicates a reticence to close with the enemy, while at the same time an acceptance of the necessity of doing so. This attitude hardened as the battle progressed.

Compare this mindset with the "fight-to-the-last-cartridge" attitude of the Germans. A Fuehrer directive making the city a combat command, an order to fight to the last man, and proclamations exhorting the population to greater efforts were having their effect. The Germans were capitalizing on the only real strength they possessed, their will.

But often will is not enough. With superiority of armor, artillery and air support on the side of the enemy, the defenders did have strengths. They had a sophisticated defense, terrain that forced the attacker into frontal assault, troops who knew the terrain, the support of the population, a resupply and replacement link to the interior of the Reich, a well-tested city combat doctrine, and an effective messenger system linking strongpoint to strongpoint.

However, in the final analysis, as they started the fifth day of the desperate fight for the city, the Germans were at a disadvantage. The problems are summarized by the commander of the 413 Replacement Division who explained poor Wehrmacht performance

as the result of: constant revision of orders which overtaxed staffs and confused commanders; primitive command and control mechanisms because of the lack of communications which enabled the enemy to gain local tactical advantages; tactical inferiority stemming from inferior forces, poor staffs and poor leaders; a lack of reserves which eliminated tactical flexibility; enemy air superiority which stopped daytime resupply and reinforcement; and inadequate supporting arms for the infantry.³⁴ The German concept of Auftragstaktik, or mission-type orders, only works well when both the leaders and the led are trained to a standard with a common frame of reference. The level of training was so uneven along the Main front that Auftragstaktik would not work.

Day 5 - 29 March 1945

With US units in control of the high ground to the south of Aschaffenburg the KKA strategy was to reinforce the southern approaches. Elements of the garrison deployed on a line running through Schweinheim west towards the river. The tactical plan was to keep the enemy off the high ground of Schweinheim Hill which separates the town from Aschaffenburg proper. Schweinheim was becoming rubble, but the defenders capitalized on the destruction by constructing nasty fighting positions in the destroyed buildings. The defense of Schweinheim was becoming the responsibility of officer candidates from the Reserve Officers Candidate School in Bois-Brule Kaserne.³⁵ The defenses of

Schweinheim were also tied to the 36 VGD in the local training area running east through Hill 209 to Hill 347.

Despite the pressure of repeated local counterattacks in Schweinheim, by 0730 hours the Americans resumed their attacks: the 2/157 IR north along the river and the 3/157 IR east into Schweinheim. The 2nd Battalion attack immediately bogged down and it called for the medium tanks of B/191 TB to help clear out enemy resistance with main gun and machinegun fire. Each house had to be reduced against a resolute defense.⁵⁴ In the Schweinheim sector the 3/157 IR, with Company C from the 1/157 IR on its left flank, attacked with two companies up and one back, reached the first street by 0830 hours against the same determined resistance. The fighting was house-to-house with reports of civilians fighting alongside the Wehrmacht soldiers.⁵⁷ In Schweinheim the fighting was so intense that Company L, attacking on the right across the open fields into the town, lost all its officers and 100 men of 180 in five minutes.⁵⁸ Once the attack stalled the Americans dug in and held on while artillery and mortars softened up the town.

Because of the strength of the resistance Colonel O'Brien, the regimental commander, decided to commit his reserve battalion, and following a ten minute artillery preparation by the 105mm howitzers of the 158 FA Bn, the 1/157 IR attacked in the gap between the 2nd and 3rd Battalions. The division G-3 Reports for the period indicate that the fighting was difficult and the progress was very slow throughout the day due to fanatical German

resistance.³⁷ As an indicator of the serious nature of the day's engagements, the clearing station of the 120th Medical Battalion supporting the 157 IR recorded its largest daily casualty count of the battle on 29 March.³⁸ To add weight to the assault, all available guns were used to fire on the town, including the M36 tank destroyers of the 645th TD Bn. With one platoon of Company B attached to each battalion of infantry, they fired harrassing fire into Schweinheim, including 25 rounds at the steeple of the Catholic Church in the center of the town which was being used as an observation post.³⁹

Because of the character of the German defense the Americans had to clear each house and barn individually. As veterans of house-to-house fighting in Italy and southern France the 157 IR was proficient in the use of direct fire from heavy caliber weapons, such as the 76mm gun on the M4A3 tank or the 90mm gun on the new M36 tank destroyer, to suppress the defenders which could then be rushed by a squad of infantry. It was tough, bloody fighting on both sides. Not only were personnel casualties high, but A/191 TB lost two tanks because of panzerfaust and artillery fire during the day.⁴⁰

As the 157 IR was locked in the struggle for Schweinheim the rest of the 45th ID was preparing to conduct further operations. Company A, 120th Engineer Combat Battalion was busy at the river guarding the railroad bridge and preparing the banks for the empiacement of a treadway bridge and the use of boats and rafts to

expedite crossing the rest of the division over the Main. For that purpose the 831 and 832 DUKW Truck Companies were attached to the division.²³ The 179 IR continued its attacks against heavy opposition from the 36 VGD in the area south of Schweinheim, while the 180 IR moved across the river on the railroad bridge and took up positions on the 179th right flank for the start of the division general attack planned for the next day.²⁴ The final American positions are seen in Figure 12.

The 29th was the second of the two days specified by Kreisleiter Wollgemuth for non-combatants to leave the city, and many did so. The city administration worked to get all those left into air raid shelters where they could be supplied with bread and water. The streets were deserted as American artillery shells continued to rain down on the town. Civilian wounded and dead were now adding to the medical and sanitation problems in the city.²⁵ It was on this day that Kampfkommandant Lamberth demonstrated his will to fight to the last man. In front of a wine shop in the center of town he hung a Wehrmacht lieutenant who had been convicted of fannenflucht (fleeing the flag), i.e. desertion. The officer's body was left to hang with a sign warning death to all traitors.²⁶ Such harsh treatment of a potential defender illustrates the lengths to which Lamberth was willing to go to prosecute the fight. His decision was encouraged by the officers of the SS Special Commission supervising the defense. It now became apparent to the defenders that their leadership would stop

45TH INFANTRY DIVISION SITUATION OVERLAY
292400A MARCH 1945

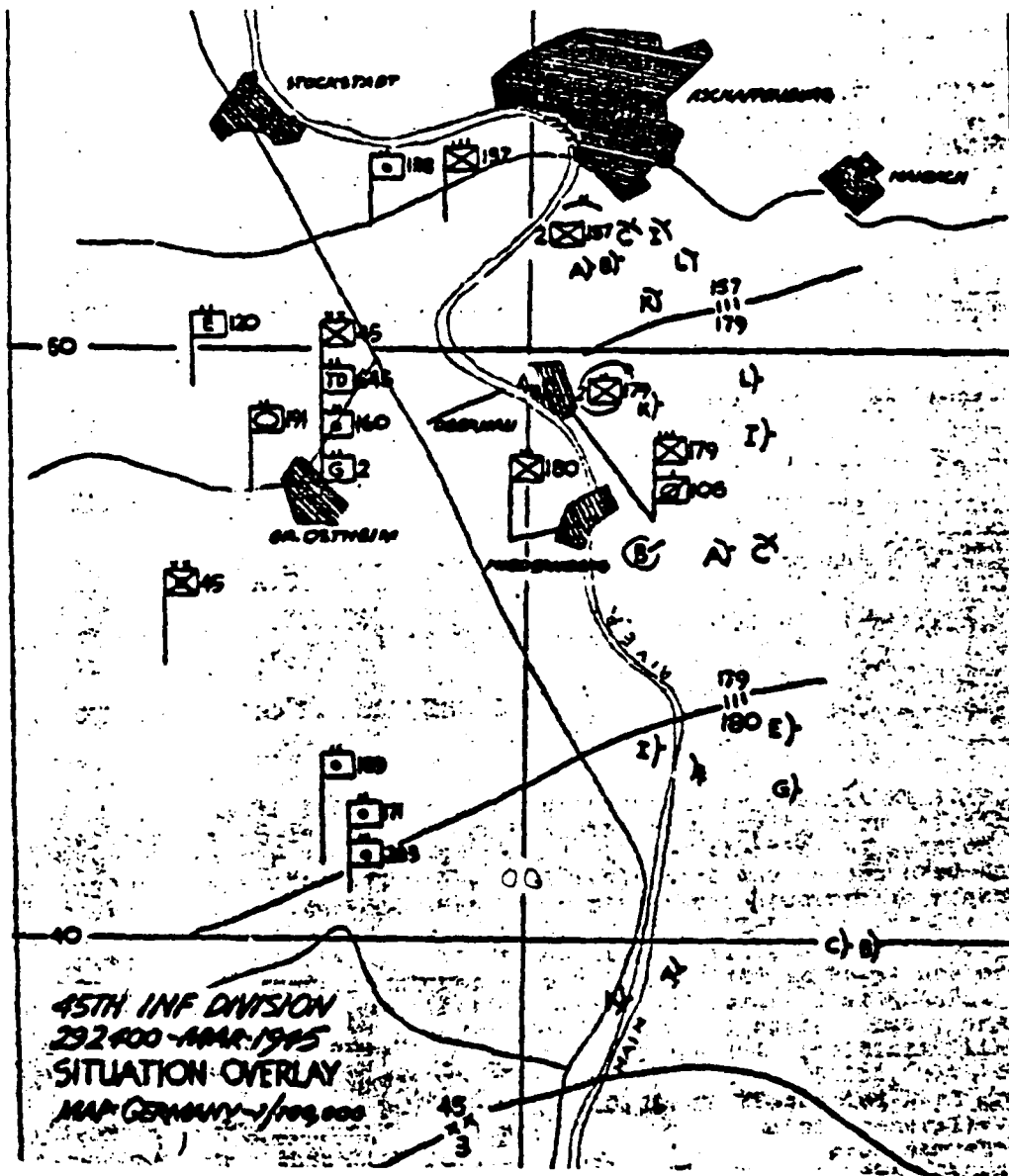

Figure 12

Source: U.S. Army, 45th Infantry Division, G-3 Report, 290001-292400A March 1945, CARL.

at nothing to defend the city.² During the day another order was received from OKW directing the city to fight to the last cartridge, further clarifying the situation for the city.

Other events served to indicate the increasingly hopeless situation of KKA. During the day the American 324th Infantry Regiment of the 44th Infantry Division crossed the Main near Kahl and Kleinostheim, not far downstream from Aschaffenburg. Having already been pushed back from the Main near Hanau, the 256 VGD now had an American penetration in the center of its sector. As a precaution the LXXXII Corps set up a radio station in Aschaffenburg to keep communications if the garrison was surrounded.³ While the LXXXII Corps commander struggled to counter the American attrition tactics, he saw that he might have to pull back from the river, thereby leaving the city's garrison isolated.

Day 6 - 30 March 1945

The terrain most coveted by the Germans at this point was the high ground to the south of the city which dominated the American bridgehead and the bulge. Capture of the wooded Erbig would permit them to control the saddle between the Bischberg and the Erbig that was the US avenue of approach into Schweinheim. In German hands it would make Schweinheim untenable. The capture of the Erbig would also split the seam between the 157 IR and the 179 IR, and isolate the 179 IR from its line of communication over the

railroad bridge. Success in this endeavor was crucial to the LXXXII Corps efforts to stabilize the Main River front.

At 0001 hours two battlegroups, based on the headquarters of the 165 GR and the 87 GR, launched an infiltration attack. The 165 GR was to seize the Erbig and then the Bischberg, while the 87 GR would regain Obernau. The 165 GR immediately fell on the soldiers of K/3/157 IR in their night defensive position, pinning them down and bypassing them enroute up the hill. The 87 GR broke through American lines and made the woods east of Obernau. Once the shock of the attack passed the American response was heavy and direct. Elements of 1/157 IR, 3/157 IR and 3/179 IR counterattacked the German penetration supported by tanks and heavy mortar and artillery fire. The Germans continued the attack in several rushes at 0100 and 0320 hours, and by 0400 hours had a foothold on the Erbig and were pushing across the saddle between the Erbig and the Bischberg. The 165 GR fought hard, but under attack by armor and artillery eventually had to withdraw to the Erbig by 0830 hours. The 87 GR enjoyed limited success, but, it also had to withdraw. Under tank-supported counterattacks both German regiments were driven back to their jumping off points by 1200 hours with heavy losses.

It was apparent to General Hahm of the LXXXII Corps that his situation was becoming untenable and that orders would have to be issued to pull back from the Main River line. Reports were received during the day of the fall of the combat commands south of

Aschaffenburg at Klingenberg and Miltenberg. Of four combat commands in his zone of action along the Main (Hanau, Aschaffenburg, Klingenberg, Miltenberg) only Aschaffenburg was still resisting.⁷⁴ Small packets of reinforcements from anti-aircraft, artillery and service units were still arriving on the front, but they were not enough. The three divisions of the corps were all being slowly driven back from the river. The 256 VGD was tenuously holding on to positions west of Hanau, but under constant attack. The 36 VGD was consolidating its positions in the forests and villages to the south of Aschaffenburg, but was being steadily pushed back by the advancing American infantrymen. The 416 ID in the south was also pushed back and at the end of the day was eight kilometers from the river.

Throughout the day, as the 179 IR and the 180 IR continued attacks to the east to flank the city, the 157th inched forward. The Germans launched at least five company-sized counterattacks that were repulsed with moderate American losses, but with substantial German casualties. As the day progressed the counterattacks became less determined. The Germans were rapidly approaching the limit of their ability to take even local offensive action. The 2/157 IR continued its attack into the southern part of Aschaffenburg, with fighting so close that the defenders were dropping hand grenades on the attackers from second story windows.⁷⁵ The 3/157 IR continued its push into Schweinheim and, against stiff resistance, reached the far side of the town on

ground level with the edge of Artillerie Kaserne in Aschaffenburg proper.⁷³ By nightfall the infantrymen of the 3/157 IR had split the town in two, but continual German infiltration behind previously cleared positions made holding the ground difficult. In the early afternoon, in an effort to envelop the defenses of KKA, the 1/157 IR was ordered to attack on the right flank of the 3/157 IR to seize high ground to the south of Schweinheim. It did so with only two companies because Company C was pinned down by mortar and small arms fire in its positions between the 2nd and 3rd Battalions. The battalion gained a thousand yards against effective resistance.⁷⁴

We can see in these latest dispositions a recognition by the Americans that the battle of attrition based on frontal assaults was not working, and that the city was not going to be easily taken by direct assault. Conditions were now right for an envelopment of the city. The 179th and 180th Infantry Regiments were outflanking the city to the south, driving back the Germans holding the southern sector of KKA. Moving the 1/157 IR from the middle of the US line to the southern flank shows an appreciation for the need to use the indirect approach of envelopment. This course of action gave the Americans a chance to fight in wooded instead of urban terrain, and the opportunity to seize high ground dominating the kasernes on Wurzburger Strasse. The fighting in Schweinheim foretold what combat would be like in Aschaffenburg itself. To reduce the city without massive use of American life would take the

proper use of the available combat multipliers. The American leadership did not take long to use them.

On the German side, the failure to capture and hold the Erbig represented the last concerted German effort to prevent a tactical envelopment of Aschaffenburg. The LXXXII Corps had gambled and lost. Its most combat-worthy unit had failed to break the American hold on the east bank of the Main River. With the German units to the south of the city weakened, the 45th ID was in a position to execute the plan seen at Figure 13, where the 179th and the 180th Infantry Regiments would sweep around the southern flank of the city and envelop the defenses, thereby cutting off the city from its life lines to the east.

For the Americans Aschaffenburg was difficult house-to-house fighting. To improve the fire support available to the infantrymen organizational changes were necessary. At 0700 hours LTC Doivin, the commander of the 191st Tank Battalion, ordered three platoons of light tanks of Company D to mass in Schweinheim to support the 3/157 IR. The 37mm guns and machineguns of the M5 tanks gave excellent mobile firepower for infantry support.¹⁵ These tanks, combined with the M4A3 Shermans of A/191 TB and the M36 tank destroyers of 3/B/645 TD Bn already in support, made the breakthrough possible. While D/191 TB stayed with the 2/157 IR in Aschaffenburg, A/191 TB accompanied the 1/157 IR in its mission to gain the high ground to the south and east of Schweinheim.

45TH INFANTRY DIVISION DRIVE FOR ASCHAFFENBURG

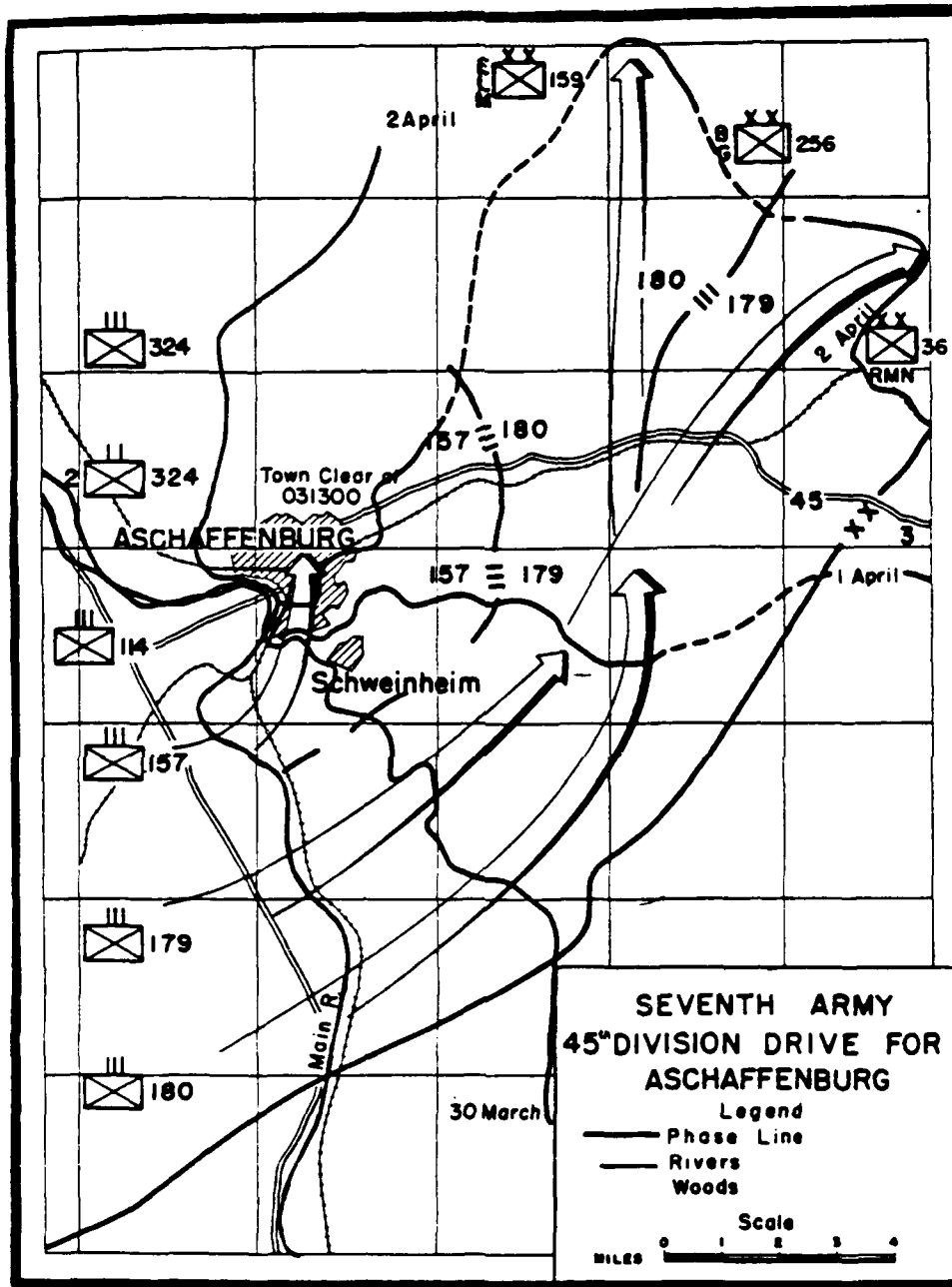

Figure 13

Source: U.S. Army, The Seventh United States Army in France and Germany, 1944-1945: Report of Operations, (Heidelberg, Germany: A. Graf, 1946), V.3, 766.

The division took steps to increase the number of artillery tubes available to provide suppressive and harrassing fire. To augment the fires of the 45th ID Divarty (three battalions of 105mm and one of 155mm) the division artillery of the 44th Infantry Division, moving up in a quiet sector on the left flank, was attached to the 45th ID. In addition, the 194th Field Artillery Group (three heavy battalions) and the 173rd Field Artillery Group (two battalions) were placed in general support.⁷⁶ For the rest of the battle up to thirteen battalions (90 tubes of artillery) fired in support of the Americans at Aschaffenburg. To this was added the weight of the 2nd Chemical Mortar Battalion (4.2") attached to the 157th Infantry throughout the fight. For KKA massed indirect fire, in the words of a city administrator, "...played death and destruction on the city."⁷⁷ The American artillery fire was so heavy that some German participants of the battle called it as rapid as machinegun fire. The result of the incessant pounding was the gradual destruction of the city, with a concurrent reduction of the will of the defenders to fight.

Most of this Good Friday of 1945 was rainy and overcast, so much so that the U.S. Army Air Forces could not fly in support of operations. However, by 1800 hours the weather cleared and the P-47 Thunderbolts of the 64th Fighter Wing, flying from bases just inside France, flew eight sorties over the city dropping bombs and firing rockets on the city center.⁷⁸ But because of the closeness of the belligerents to each other, most of the effect of these

missions did not directly affect the tactical fight. The P-47s could only fire .50 caliber machineguns in direct support of the engaged troops because the front lines were so close to each other.

In the afternoon after consultation with the Seventh Army commander, General Hahn gave the order for a general withdrawal of the LXXXII Corps from the Main River line.⁷⁷ This decision recognized the reality of the situation because at the time no corps units remained on the river. It permitted a somewhat orderly withdrawal to positions further to the east. Kampfkommandant Lamberth was informed of this decision and that from this point on he would be fighting as a true combat command with no physical contact with other German units. His mission was still to hold out as long as possible. This is an excellent illustration of how the fighting strength of a military organization breaks down when units are under two different headquarters with different missions. LXXXII Corps was subordinate to Seventh Army with a mission to defend in this part of the Reich. KKA, although located in the Seventh Army zone, as a combat command was under the direct orders of OKW with a mission to fight to the end. When LXXXII Corps troops pulled back KKA was isolated but not yet surrounded. Its only contact with Wehrmacht units was by phone and radio. This lack of unity of command left no doubt about the eventual fate of Festung Aschaffenburg.

Though he was being abandoned by the LXXXII Corps Lamberth was still busy directing operations against the enemy. He

continued to capitalize on his real strength, the will of the defenders, and published a newsletter with the assistance of his Nationalsozialistischer Fuehrungsoffizier (National Socialist Guidance Officer) (NSFO), the political commissar attached to the command.³⁰ In addition to reprinting the OKW war bulletin for 28 March, the Aschaffener Soldatenzeitung began with a quote from Hitler on the necessity of continuing the struggle, but then included an extraordinary editorial from the Mainfränkische Zeitung entitled "Ruhig Blut!" (literally "Calm Blood") meaning "Keep Calm." The editorial called for calm and gave ways in which the population could assist in defeating the enemy, but then made an unusual admission. Saying that it would be silly to deny that the situation was grave, the author wrote that it was now time for Main-Franconia to pay the high price demanded of it. That Major Lamberth published this virtual admission of defeat is unusual and indicated a desire to prepare the population for the eventual outcome. That it was done with the help of the Nazi Party shows that even some elements of the Party saw life after Hitler.

Major Lamberth's time was also occupied with more military activities. With the withdrawal of the 36 VGD the southern flank had to be reinforced and elements of Pionier Bataillon 9 were sent to the high ground to the south of Schweinheim. The Germans still held out hope that the crossing site at the railroad bridge could be interdicted. With the present American positions the bridge was at the extreme range of the indirect fire weapons available to the

defenders. Repeated ground attacks towards the bridge had failed, as had several aerial attempts, including a try by a flight of two ME-262 jet fighters. The most bizarre action was conducted by a team of Kriegsmarine frogmen who attempted to place a torpedo against the sandstone center support of the bridge and bring it down. Attempts during the nights of 29-30 March and 30-31 March both failed.²¹

As German resistance diminished more soldiers and civilians surrendered to the 45th ID. Among the 465 captured by the division on this date were many 16 and 17 year olds who were surly and defiant.²² The Hungarian POWs said that Major Lamberth brought in 50 SS troops to enforce discipline and that the SS were to shoot those who tried to escape to the American lines.²³ By the end of the day the Americans had firm control of most of Schweinheim, were pressing into southern Aschaffenburg, and held high ground on the southwest of the city. They had suffered ten killed and over 30 wounded. American unit dispositions at the end of the day are seen at Figure 14.

During the day the 45th Infantry Division's parent unit, the XV Corps, consolidated its hold on the Main River Line from the boundary with the Third Army's XII Corps near Kahl. In the Aschaffenburg sector the 106th Cavalry Reconnaissance Squadron relieved the last element of the Third Army on the western side of Aschaffenburg. It reported no German forces on the western flank of KKA. Elements of the 114 IR (44th ID) held the left flank of

45TH INFANTRY DIVISION SITUATION OVERLAY
302400A MARCH 1945

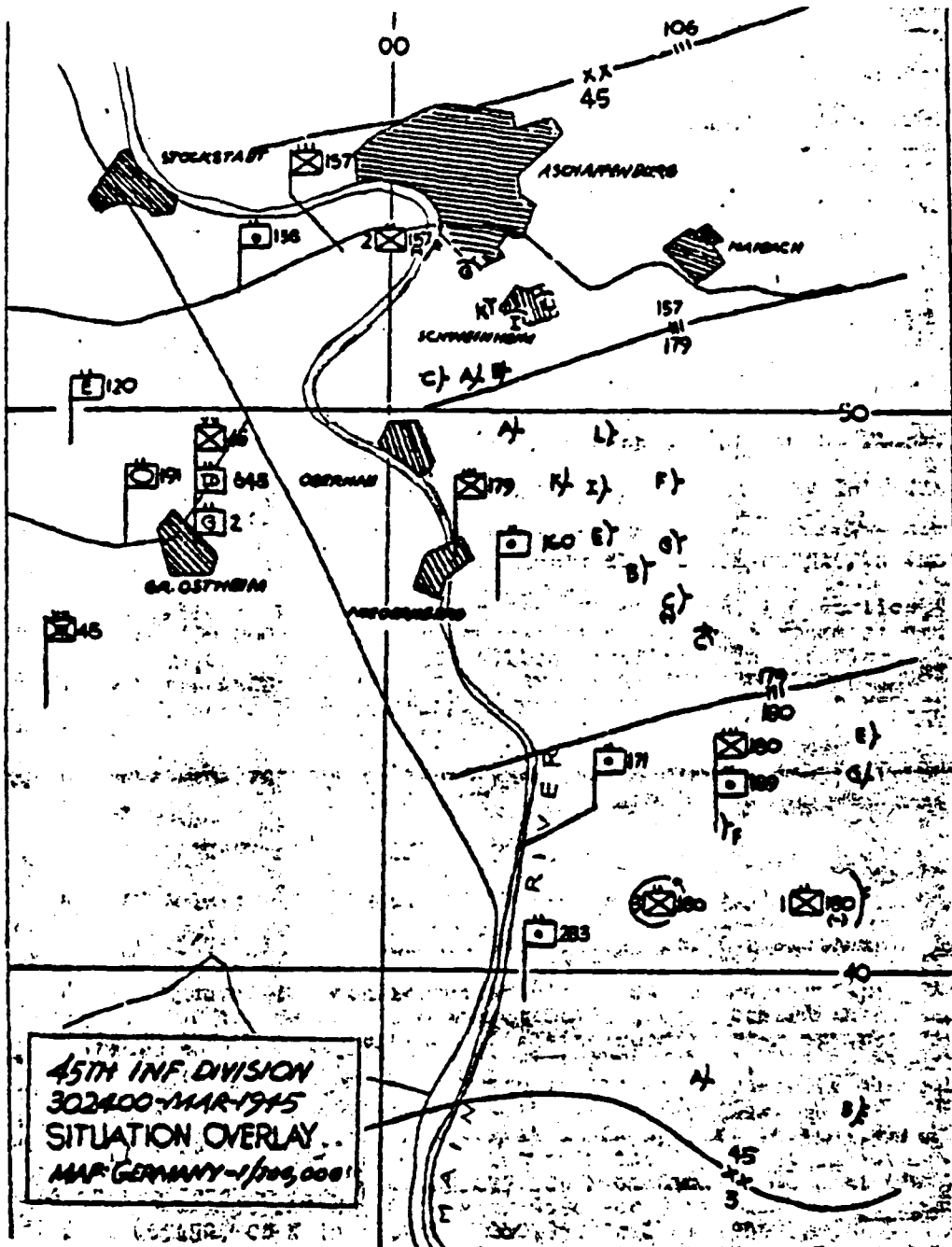

Figure 14

Source: U.S. Army, 45th Infantry Division, G-3 Report, 300001-302400A March 1945, CARL.

the 45th ID on the west side of the river. The Main River was secure for ten kilometers on each side of Aschaffenburg.²⁵

Day 7 - 31 March 1945

The seventh day of the battle was a time of transition for both sides. For KKA it was one of accommodation with the fact that they were on their own, and that the fight "to the last man" had begun. The LXXXII Corps was withdrawing to the east and had lost all contact with the forces in Aschaffenburg. KKA still controlled a small part of Schweinheim, Gailbach to the southeast, Haibach to the east, Hoesbach and Goldbach to the northeast, Damm on the northern rim of the city, and Mainaschaff to the west. Within these confines the battle would be fought to a conclusion in the next four days. The Germans would fight resolutely for each meter of ground inside an ever decreasing perimeter. They would be hit with all the weapons of modern war that the Americans could muster, but on balance, they would give as much as they received.

For the Americans it was a time of a gradual shift from attrition to maneuver warfare. Throughout the rest of the fight the 2/157 IR. in its battleground in the southern approaches to the city center, remained as the anvil upon which all other tactical movement compressed the enemy. It would never have the opportunity to maneuver, only to slug it out toe-to-toe with the defenders. The 3/157 IR. after clearing Schweinheim and moving on the kasernes, would conduct a sweep around the eastern part of the city

pushing back the defenders into the center. To the 1/157 IR fell the role of the hammer sweeping around the city from the south and east to capture the outlying towns and drive the defenders against the 2nd Battalion anvil. The 157 IR would be assisted by the 324 IR attacking the city from the west. However, the events just described would only occur gradually over the next four days.

The 157th bridgehead was a busy place as DUKWs, ferries and small boats were in use to supplement the railroad bridge.²⁶ Starting at 0630 hours the 157 IR attack continued. The 1/157 IR moved around the right flank of the regiment in a column of companies. It slowly moved up the slopes of Hill 347, its efforts supported by the 3/179 IR also attacking in that area towards the town of Gailbach, which sits in a deep, narrow valley north of Hill 347. The 2/157 IR continued its assault into the industrial area near the Sudbahnhof (South Railroad Station), while the 3/157 IR with D/191 TB in support continued to mop up in Schweinheim, which was cleared by 1700 hours.

All US ground combat actions during the day were supported by the 64th Fighter Wing which flew 176 sorties in the division zone. According to division records the air force dropped 100 tons of bombs, launched 300 4.5" rockets and fired over 200,000 rounds of .50 caliber ammunition on Aschaffenburg, Gailbach, Haibach, Goldbach and other targets in the area.²⁷ The intense artillery shelling of the town continued. In addition to calls for fire in direct support of the attacks, twice during the day the massed

American artillery executed fire plans sending 400 rounds per battalion on selected targets in the city.²² The artillery was accompanied in its destruction by the new 105mm assault guns of the 191 TB which fired 120 rounds in direct support of the infantry.²³

Until this day the city had sustained only moderate war damage, but the combined effects of the artillery, the white phosphorus shell of the 4.2" mortars and the air force fighter-bombers increasingly turned the city into a heap of rubble. The Schloss Johannisburg received an especially severe pounding as it was an easily identifiable landmark in the city.

The defenders did not take the "Ami" efforts lying down.²⁴ According to American counts, between 1000 and 1500 rounds of mortar fire landed in Schweinheim during the day in support of local counterattacks, including 200 rounds in one fifteen-minute period. At one point in the late afternoon two tanks rolled out to engage the Americans in Schweinheim. The tanks, one German Mark VI and an American M4 operated by the Germans, were destroyed.²⁵ In the air four ME-262 made brief passes over the city. The Germans defended the city room-by-room, conducting heavy infiltration behind American lines, sniping at the attackers and forcing them to secure again and again areas previously cleared. They took excellent advantage of their knowledge of the city to move freely about the rubble to resupply, reinforce and generally meet the American challenge.

On the 31st both sides resorted to the written word in the prosecution of the struggle. At noon the commander of the 157th Infantry dispatched Captain Anse Spears, the regimental adjutant, in an L-19 spotter plane to drop an ultimatum on the German headquarters in the Schloss.⁹² The purpose of the note, written in German and addressed to the commandant of the City of Aschaffenburg, is plain:

Your situation is hopeless. Our superiority in men and material is overpowering. You are offered herewith the opportunity, by accepting unconditional surrender, to save lives and property of countless civilians. The conditions of the Geneva Convention are assured to you and to your garrison.

The following is requested immediately upon receipt of this message:

1. The raising of the white flag on the Engineer Barracks.
2. The sending of a delegation under a white flag to the south end of the city, which will be authorized to negotiate for the conclusion of the capitulation of Aschaffenburg.

Should you refuse to accept these conditions, we shall be forced to level Aschaffenburg.

The fate of Aschaffenburg is in your hands.

The commander of the Allied Troops.⁹³

Major Lamberth ignored the ultimatum and the fighting continued. The Americans also dropped leaflets on the city addressed to the German soldiers specifying the conditions under which they would be kept prisoner if they surrendered.⁹⁴ Although it may have been coincidental, as the battle progressed the number of prisoners did increase.

The defenders were continuing their own campaign to maintain the will of their soldiers. During the day copies of the Aschaffenburg Frontzeitung began to appear. Published by the Party instead of the Kampfkommandant, it was similar in content to the Aschaffenburg Soldatenzeitung and also included references to life after Hitler. But it stated "Nevertheless! We Believe! We Fight! We Work!"²⁵ In it we can see the attempts to apply political pressure on the soldiers to fight on in spite of the dreadful conditions they saw around them. Still, as the Germans read the words they continued to fight.

Late in the afternoon 3/157 IR had cleared Schweinheim and gotten on the high ground along Wurzbürger Strasse. The first obstacles in their path were Artillerie Kaserne on the south side of the street, and Bois-Brule Kaserne across the street on slightly higher ground. The kasernes were not built as fortresses per se but they had been turned into formidable defensive positions by the defenders. At about 1730 hours K/3/157 IR attacked Artillerie Kaserne attempting to take it by coup de main. The attack quickly bogged down and the infantrymen pulled back while artillery, aviation and tanks softened up the area. The attackers were only able to gain a small foothold on the kaserne before nightfall.

At the end of the day's fighting the Americans had cleared Schweinheim, although continued infiltration was still a problem requiring repeated mopping up. The 1/157 IR was still fighting its way up the steep slopes of Hill 347 above Gailbach against stiff

resistance. while on the other end of the American lines the 2/157 IR continued to slug it out with the defenders along the river. The Germans still held all the kasernes and most of the city itself but had lost 680 prisoners during the day to the Americans.²⁰ The plan to envelop Aschaffenburg was not yet a reality. On the city's western flank the 324th IR was in the process of relieving the 106th Cav Recon Group west of the Main. The unit that would envelop the city from the left was moving into place, leaving its 1st Bn on the west side of the Main while the 2nd and 3rd Bns crossed it to occupy forward assembly areas on the east bank.²¹ Figure 15 has the 45 ID dispositons at the end of the period.

Day 8 - 1 April 1945

On this Easter Sunday there was no joyous religious celebration in Aschaffenburg. In the center of the city a Jesuit priest said mass in the Maelzerkeller, one of the shelters being used by the defenders.²² American chaplains also held services in honor of the Prince of Peace, however the symbolism was lost on most parishoners.

During the day the Americans finally achieved some measure of freedom of maneuver and continued the envelopment of the city. According to the commander of D/191 TB, this was to be done through the use of field artillery, tanks and air power, to reduce American losses.²³ A German officer observed that the American infantry simply walked behind tanks and field artillery, and that the

45TH INFANTRY DIVISION SITUATION OVERLAY
312400A MARCH 1945

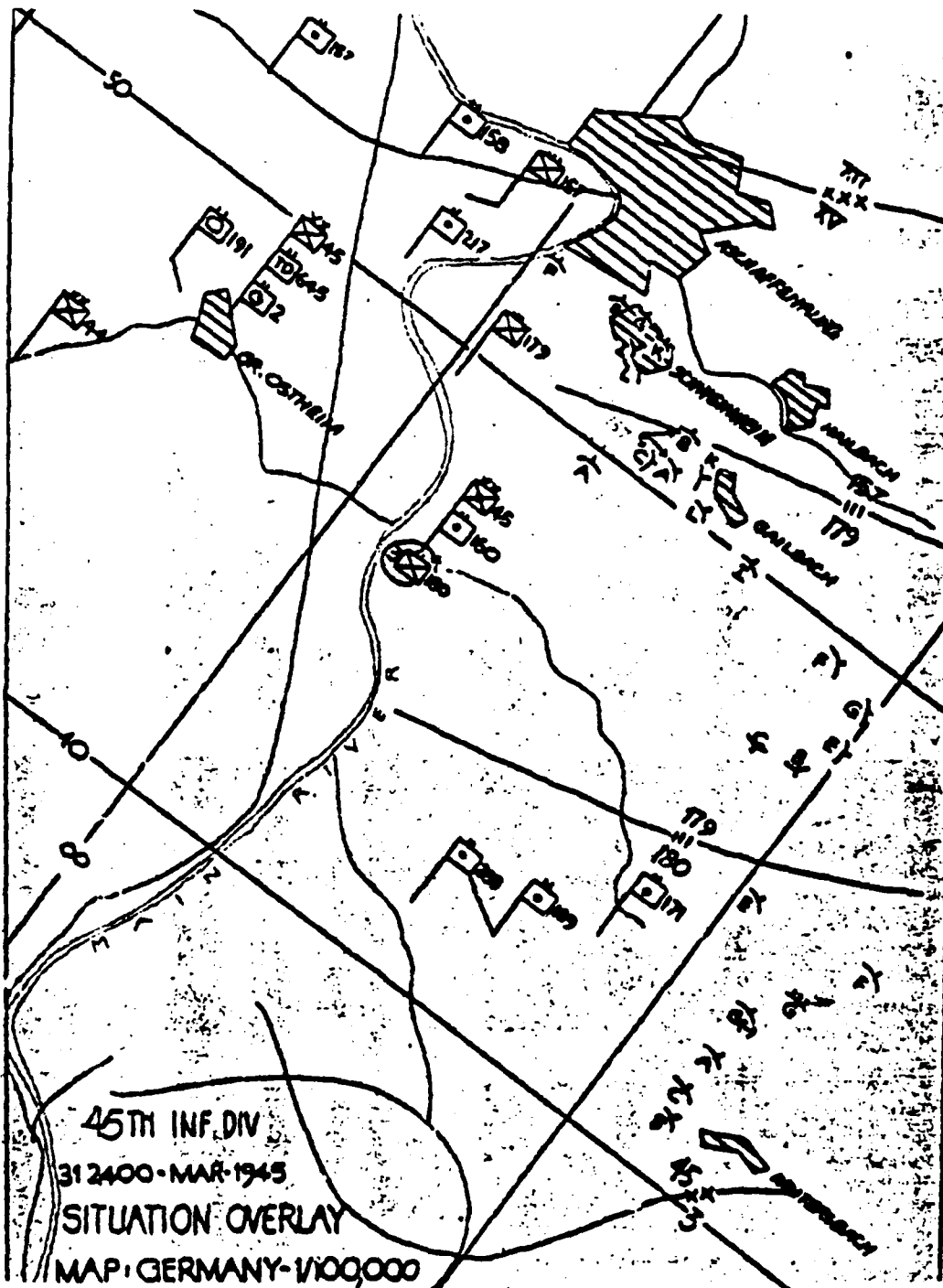

Figure 15

Source: U.S. Army, 45th Infantry Division, G-3 Report,
310001-312400A March 1945, CARL.

infantry was invisible.¹⁰⁰ The American infantry did not feel invisible but realized that such tactics took best advantage of the overwhelming American superiority of artillery, armor, and automatic weapons.

The key to the encirclement was the capture of the town of Haibach on high ground to the east of Aschaffenburg. In the morning the 3/179 IR cleared the northern end of Gallbach thereby isolating that town from Aschaffenburg. It was through this gap that 1/157 IR attacked across the rugged wooded hills and fields towards Haibach, which it cleared against light opposition. It then occupied Hill 313 to the north.¹⁰¹ With an opportunity to advance against light resistance the battalion continued the attack. The battalion commander, LTC Ralph Krieger, ordered Company B to attack in the direction of Goldbach, Company A towards Hoesbach and Company C to follow and support.¹⁰² The mission was to capture the two towns and link up with 179 IR units sweeping in a wider arch around the city. Moving steadily the battalion cut the main rail and road links to Wurzburg and began the reduction of the twin towns. Both were resolutely defended and the battalion would not clear them until 1500 hours the next day. For the Germans the damage had been done, the last line of communication to the east was cut.

Before other American combat elements could take advantage of the open flank to the east of the city the kasernes had to be taken. The 3/157 IR which had secured a tenuous hold within

Artillerie Kaserne the previous night prepared for the attack. Starting at 0700 hours artillery fire was directed at the kaserne. At 1300 hours Company K attacked but was driven back by heavy machinegun and rifle fire. A second attack carried the buildings after tanks had fired white phosphorous shells into the basement windows to suppress the defenders. The attackers had to fight room-to-room to eliminate all resistance. They found that the defenders were some 100 men from three convalescent companies.¹⁰³ The same process was repeated for Bois-Brule Kaserne across the street and by 1700 hours all resistance had ceased. There had been heavy losses on both sides, every one of the defenders captured in Bois-Brule Kaserne being wounded. With the two eastern-most kasernes in American hands the other kasernes along Wurzburger Strasse were in jeopardy. LTC Sparks, the 3rd Battalion commander, now sent troops to the north clearing the high ground on the eastern fringes of the city, flanking Lagarde and Jaeger Kasernes. After four days of fighting fanatical defenders they were now advancing against light opposition.¹⁰⁴

The key to success in the 2/157 IR sector was Pionier Kaserne, the home of Pionier (Engineer) Bataillon 9. The kaserne dominates Schweinheimer Strasse, the main road from Schweinheim to Aschaffenburg. It had to be taken to permit an assault on the southeastern section of the city. Just as in Artillerie and Bois-Brule Kasernes, the defenders built strongpoints among the thick-walled barracks and sighted machineguns to sweep the road and

the fields to the east. Its Achilles heel was the height of Schweinheimer Hohe, Schweinhelm Hill, overlooking the kaserne from the south.

The 2/157 IR had the mission of seizing the kaserne and the unit moved on it across open fields from the east and from high ground on the south. Having learned in the assaults on the first kasernes along Wurzburger Strasse, the attackers planned in advance for adequate fire support. In addition to adjusted fire on enemy concentrations, two M12 155mm "Long Tom" howltzers were driven up Schweinheimer Hohe and sited to fire over open sights down on the kaserne. As the infantry slowly fought their way into the barracks and workshops of the kaserne area the "Long Toms" fired 100 rounds in support.¹⁰⁵ Pionier Kaserne is much larger than any kaserne in Aschaffenburg with more buildings. The Germans fortified each one and the attackers made very slow progress. By 1500 hours only half the kaserne was in American hands.¹⁰⁶

As on the previous day good weather brought the air force in support of tactical operations. Eighty-two sorties were flown in support of the 157th. Directed very close to friendly troops, aircraft of the XII Tactical Air Force dropped 45 tons of bombs, launched 200 rockets and fired 100,000 rounds of .50 caliber machinegun ammunition on the Germans.¹⁰⁷ The aircraft were directed to their targets by ground liaison officers and by field artillery that fired marking rounds.¹⁰⁸ There was still plenty of artillery available to the regiment. The 158 FA had four

battalions reinforcing its fires and two more in general support. Between noon and 1700 hours the massed artillery fired fifteen "time on target" missions on Aschaffenburg.¹⁰⁵

The effect of this firepower was starting to make an impact. Prisoners surrendered in ever-increasing numbers. During the day the regiment would accept the surrender of 1037 enemy soldiers.¹¹⁰ Still, the artillery was at times ineffective because the defenders went underground in the rubble, but the incessant pounding made it impossible for the defenders to get any rest. Living in such an environment undoubtedly affected the mental attitude of the Germans and reduced their desire to resist. Food, water and ammunition were in very short supply as the American ground troops battled their way into the kasernes. The results of the American efforts occasionally were seen in concrete ways. At about 1500 hours in the 2/157 IR sector the resistance seemed to break and an estimated 300 prisoners surrendered. Many more were taken during the rest of the day.¹¹¹

The hopelessness of the situation was apparent to a group of German officers in Pionier Kaserne who went to their commander saying that the city was lost and the kaserne ought to be abandoned.¹¹² Still willing to resist, the commander reported the incident to Major Lamberth who "sentenced" them to service in the front lines - just what they had been doing. This indicates a change in the Kampfkommandant's attitude about the struggle. On the 29th he executed an officer for desertion, but three days later

the situation had changed sufficiently for him simply to tell the men to go back to work.

Although the level of resistance was decreasing, it was still strong enough merit specific comment in American accounts of the battle. The soldiers of the 157th characterized the fighting as the toughest many of them had seen. A veteran soldier was quoted in a United Press story as saying that he, "...fought in Sicily, Salerno, Anzio and the Riviera, but the hills near Cassino is the only place they handed it to us like this."¹¹² Even this late in the struggle some prisoners were reported as frenzied, sullen and arrogant, still voicing a determination to fight to the last man.¹¹⁴

As the 157th Infantry struggled in Aschaffenburg and to the east, elements of the 44th Infantry Division were moving into position on the western side of KKA. By 0510 hours the rest of the 324th Infantry had crossed the Main at Seligenstadt and relieved the 106th Cav Recon Group on the left flank of the 157 IR sector.¹¹⁵ At 0530 hours the 3rd Battalion, 114th Infantry moved to the river in the vicinity of Stockstadt/Mainaschaff, securing a ferry crossing site and relieving elements of the 45th ID Recon Troop on the west side of the Main.¹¹⁶ With the ferry crossing secure the 1/324 IR moved northeast from the river and by nightfall had taken up a blocking position northwest of Aschaffenburg, thereby cutting off the city on that side for the first time. From

that time until the city surrendered two days later it cut off infiltration and exfiltration on the west and northwest.¹¹⁷ Screened by the 1/324 IR on its left, the 2/324 IR attacked north and then west towards Aschaff Creek. By nightfall the infantrymen were battling the German troops in the western strongpoints of KKA.¹¹⁸ For the first time the city had American troops closing in from the west.

The day ended with the attackers in control of two kasernes, in partial control of one more, and with troops fighting in Goldbach, Hoesbach and Mainaschaff. The Americans had experienced their first full day of maneuver and the only part of KKA not encircled was the area to the north of the city. As the Americans prepared for the next day's attack from the positions seen on Figure 16 there were an estimated 800 Germans still resisting in the city.¹¹⁹

Day 9 - 2 April 1945

As Easter Monday dawned in the beleaguered garrison of Aschaffenburg KKA was still resisting, but it was becoming more difficult to put up an organized defense. As the Americans seized more of the city its combat leadership became casualties or were captured. Considering the quality of the troops available to Major Lamberth, a cadre of trained leaders was essential for continued organized defense. With the attackers isolating and eliminating pockets of resistance the defense was becoming more disorganized.

45TH INFANTRY DIVISION SITUATION OVERLAY
012400A APRIL 1945

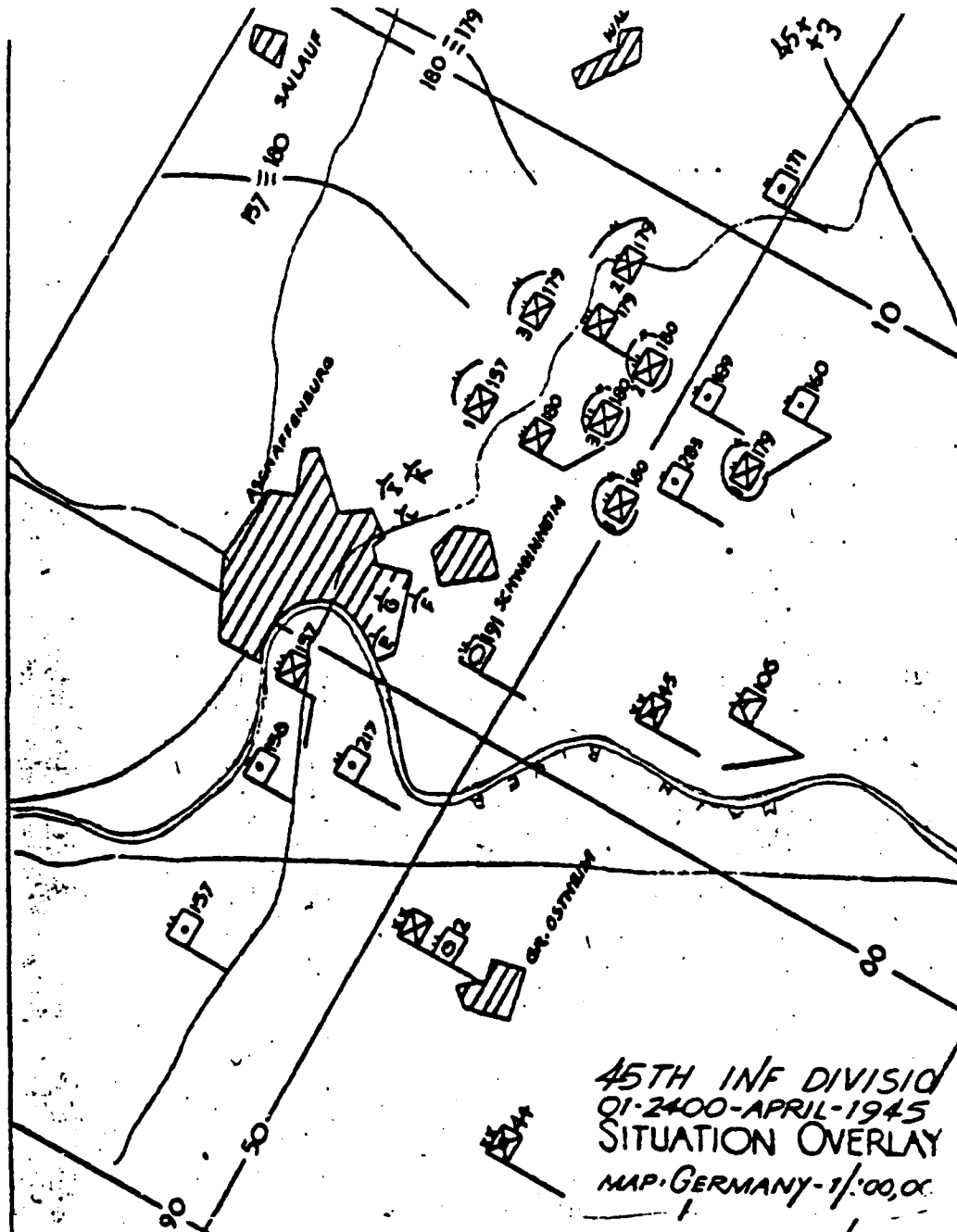

Figure 16

Source: U.S. Army, 45th Infantry Division, G-3 Report, 010001-012400A April 1945, CARL.

On this ninth day the defense became less a centrally-controlled and unified military effort and more a contest by an armed rabble with each man desperately fighting for his life. The hopeless nature of the German position was reinforced when at about 1100 hours it became generally known that the political leadership of the city had fled.¹²⁰

Early on this Monday morning the two sister regiments of the 157th, the 179th and the 180th, started operations to assist in the reduction of the fortress by clearing the eastern approaches to the city. The previous day XV Corps Field Order #24 directed the division to shift its axis of advance from east to northeast. The division implemented this by directing two regiments to the northeast while the 157 IR continued to reduce Aschaffenburg.¹²¹ As a result the 180 IR exchanged places with the 179 IR and briefly became the division reserve. At 0320 hours on 2 April 1945 it occupied Gailbach, then attacked at dawn establishing roadblocks on all roads from Aschaffenburg to the east. This further sealed the city.¹²²

In the face of crumbling resistance the Americans continued to execute the envelopment and reduction of the city.¹²³ Beginning with a thirty minute artillery preparation the attackers jumped off at 0630 hours.¹²⁴ With Company C occupying Haibach, the rest of the 1/157 IR mopped up resistance in Goldbach and Haibach. In the afternoon the battalion swung to the west cutting the roads to the north of the city and linking up with Co. A, 1st Bn, 324th Infantry

at 1700 hours.¹²⁵ While the linkup of American forces was occurring the reinforced 2/324 IR attacked Mainaschaff, scattering moderate resistance and taking 120 prisoners. By 1850 hours the town was cleared.¹²⁶ The city was physically surrounded, but resistance continued to be strong.¹²⁷

The reduction of the rest of Pionier Kaserne continued. The estimated 400 remaining defenders were under constant attack including 155mm rounds fired in direct fire at enemy strongpoints.¹²⁸ The situation became critical for the defenders and between 1000-1100 hours a large group of defenders exfiltrated from the kaserne.¹²⁹ At about 1530 hours the last strongpoint fell and the Americans were in control of this vital installation. With the capture of Pionier Kaserne the backbone of the defense in the southern section of the city was broken. In the words of one regimental history of the battle, the 2/157 IR was now able to conduct a "...slaughter of the retreating Germans."¹³⁰ By nightfall the battalion was able to make its way into the center of the city in bitter room-to-room fighting. Late in the day they were assisted by Companies I and L from the 3rd Battalion.

The 3/157 IR took Lagarde and Jaeger Kasernes during the day in hard fighting while capturing many prisoners. Its Company K flanked the eastern suburban area and established nighttime positions in the Fasanerie, a wooded park reaching into the heart of the city.¹³¹ On the city's western front the 2/324 IR continued its attack and by 1900 hours the bunker complex on Hill 214, the

Kappellenberg, between Mainaschaff and the western fringe of the city, was in American hands.¹³²

After holding out for nine days the Germans were paying a high price for their defense of Fortress Aschaffenburg. They withstood another day of incessant artillery and aerial bombardment (48 sorties flown) and were still putting up a determined resistance, but they lost vital defensive ground and the confines of KKA was reduced to the area around the Schloss in the center of the city. The Americans captured 1117 prisoners during the day bringing the total taken from the city to over 3000.¹³³ By the end of the day the American troop dispositions were as seen at Figure 17.

Day 10 - 3 April 1945

The Americans sensed the battle for Aschaffenburg was almost over and planned for its culmination. The previous day, to expedite the traffic over the river, A/120 Eng Cbt Bn had constructed a Class 30 Stringer Bridge a kilometer down river from the railroad bridge.¹³⁴ This provided for two-way traffic, and many units, including several headquarters, crossed the Main.

Following a short artillery preparation the 157 IR began its attacks for the day between 0630 and 0700 hours. However, at 0720 hours the units were directed to hold in place as surrender negotiations took place.¹³⁵ Major Lamberth had been in contact

45TH INFANTRY DIVISION SITUATION OVERLAY
022400A APRIL 1945

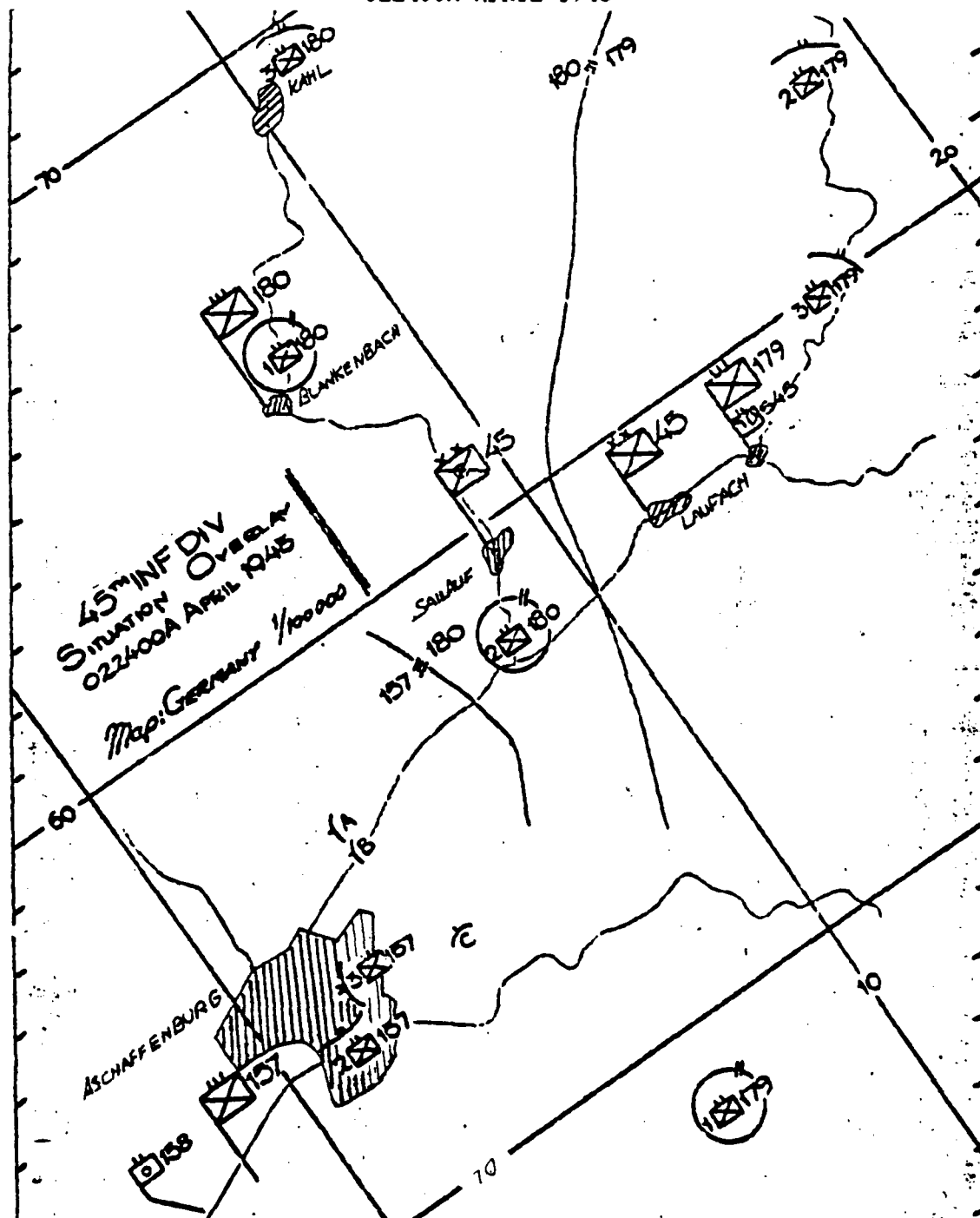

Figure 17

Source: U.S. Army, 45th Infantry Division, G-3 Report, 020001-022400A April 1945, CARL.

with Gauleiter Hellmuth, the Reichs Defense Commissioner in Wurzburg, and other civilian and Party leaders about conditions in the city. Lamberth told Hellmuth during the night of 2-3 April of the impending American takeover of the city.¹²⁴

At 0700 hours Lamberth sent the leader of his 7th Volkssturm Company escorted by an American captured on Easter Sunday to the American lines requesting surrender terms. Colonel O'Brien, the 157th Infantry Regimental commander, rejected negotiations and directed the emissary to tell his commander to hang white flags from the towers of the Schloss by 0800 hours or the attacks would continue.¹²⁵ To insure the message got through and to assist with any details, Colonel O'Brien sent two German-speaking POW Interrogation Officers (IPWs) back with the delegation. They were to bring Major Lamberth back to regimental headquarters where he would surrender.

Upon reaching the Schloss Lamberth informed the Americans that he would surrender, but not to officers of inferior rank (both of the American IPWs were lieutenants). Colonel O'Brien directed LTC Sparks, the nearest battalion commander, to go to the Schloss and accept the surrender. At 0900 hours Major Lamberth surrendered his command to LTC Sparks. For the next few hours, escorted by the IPWs, he travelled around the city to the various remaining strongpoints supervising their surrender. Finally he was taken to regimental headquarters to surrender again to Colonel O'Brien and go into captivity.

At 1300 hours on 3 April 1945 the city of Aschaffenburg was declared cleared by the 157th Infantry and by nightfall the unit was assembled in the towns of Goldbach and Hoesbach awaiting further orders.

The Oberkommandos des Heeres (Army High Command) daily announcement for 3 April 1945 included the statement:

Aschaffenburg ging verloren.
(Aschaffenburg is given up for lost.)¹³⁸

After The Battle

Following the battle the civilian administration was kept in place until the US Military Government could begin dismantling the Nazi regime and start the de-Nazification program. By 7 April the provisional military administration was replaced, and US Military Government Detachment HIA3 took over the city from the National Socialist government. On 14 April Jean Stock, the leader of the Social Democratic Party in pre-Nazi Aschaffenburg was installed as the Oberburgermeister (Lord Mayor).¹³⁹

The post-war period is beyond the scope of this study, but some basic information illustrates the character of the struggle. During the battle the city was 70% destroyed, with military casualties estimated in one German source at 1600 killed or wounded and 3500 POWs.¹⁴⁰ Of the estimated 8500 German military and civilian participants present in the city during the battle this represents a 60% casualty rate. American casualties are also

difficult to estimate, but probably exceed twenty killed and 300 wounded. The impact on the Americans who fought in Aschaffenburg is best summarized by a sentence that appeared in the 45th Infantry Division's Operations Summary for April 1945:

If a chart were composed representing resistance in Aschaffenburg at 100 percent, by analogy Bamberg would be assigned 25 percent, Nuernberg 75 percent and Munich 10 percent.¹⁴¹

CHAPTER 4

END NOTES

¹ Charles B. MacDonald. The Last Offensive. The United States Army in World War II: European Theater of Operations, (Washington, D.C.: Office of the Chief of Military History, U.S. Army, 1984). 279.

² Oberst i. G. Horst Wilutzki. "Army Group G (22 Mar-6 May 1945)." USAREUR Historical Division, 12 November 1947. CARL. 16. Originally from Wehrkreis XIII (Nuremberg) the 413 Replacement Division. was commanded by Genlt. von Schacky auf Schoenfeld.

³ Generalleutnant (Freiherr) Siegmund von Schacky, "Report of the 413th Replacement Division's Activities Between Area Wurzburg to the Thuringian Forests," USAREUR Historical Division, 18 March 1946, CARL. 7.

⁴ CCB's major units for this operation consisted of the 37th Tank Battalion, 10th Armored Infantry, 22nd Armored Field Artillery, and a troop of the 25th Cavalry Reconnaissance Squadron. LTC Abrams (promoted to colonel in April) had been in command for about a week.

⁵ This differs from the report of the bridge commander, Oberleutnant Keil, who wrote after the war that no explosives were on the bridge. The account appears in Dr. Alois Stadtmueller, Aschaffenburg im Zweiten Weltkrieg, (Aschaffenburg: 1971). 172.

⁶ Manfred Baunach. discussion with author 15 March 1985. Herr Baunach was on duty in the pre-Renaissance, middle tower, of the schloss at the time.

⁷ Harold Cohen. discussion with author on 11 November 1985.

⁸ Dr. Alois Stadtmueller, Aschaffenburg im Zweiten Weltkrieg. (Aschaffenburg: Geschichts- und Kunstverein Aschaffenburg e. V., 1971). 172-173.

⁹ Ibid., 174.

¹⁰ U.S. Army, 4 Armored Division. "After-Action Report for the Period 1-31 March 1945," 9 May 1945. CARL, entry for 25 Mar 45.

¹¹ Emil Lamberth. "Der Bericht des Kampfkommandanten" (The Report of the Combat Commander), Main Echo, 25 March 1955, 70:.

¹² Stadtmueller, Aschaffenburg im Zweiten Weltkrieg, 233. Gen. d. Inf. Karl Weisenberger, the Deputy Commander of Wehrkreis

XIII. and Genm. (Freiher) von Gernsdorff. Chief of Staff of Seventh Army, felt the division was only 35% effective.

¹³ U.S. Army, XII Corps, Report of Operations (1-31 Mar 45), 15 April 1945, CARL, entry for 24 Mar.

¹⁴ Stadtmueller, Aschaffenburg im Zweiten Weltkrieg, 196.

¹⁵ Cohen. discussion with author.

¹⁶ Wilutzki, "Army Group G", 6.

¹⁷ Ibid.. 18.

¹⁸ Dr. Percy E. Schram, "The German Wehrmacht in the Last Days of the War (1 Jan - 7 May 45)," World War II German Military Studies, vol 11. (New York: Garland Publishing Inc., 1979), 242.

¹⁹ Stadtmueller, Aschaffenburg im Zweiten Weltkrieg, 237.

²⁰ The Obernauer Kolonie even today is called "Ami-berg", or "American Town", by those oldtime Aschaffenburg citizens who remember that it was the first part of the city to put out white flags to announce surrender to the Americans.

²¹ The story of the raid itself is beyond the scope of this paper, however the details are interesting to provide background for a later discussion on its effect on German Army reinforcements into the Aschaffenburg area. Briefly, CCB sent a task force commanded by CPT Abraham Baum with 53 vehicles and 294 men to liberate the American POWs. Although they got to the camp after a harrowing 12 hour journey, they were eventually overpowered and captured. At a cost of 9 KIA, 32 WIA, 16 missing and 232 captured the mission failed. LTC Waters was in the camp but was wounded in its capture by the Americans and hospitalized. The camp was liberated nine days later by the 14 Armored Division.

There are several possible reasons why Patton sent the raid: 1) to match the exploits of the US Sixth Army in the Philippines which had rescued POWs from Cabanatuan Camp on 28 January, from Santo Tomas University in Manila on 3 February and from Los Banos Camp on 23 February; 2) to rescue his son-in-law; 3) to confuse the Germans with a deep thrust. Perhaps he wanted to do all three. LTC Cohen, who supplied most of the men felt strongly that Patton did it to confuse the enemy, but in a discussion with the author he said that his good friends Creighton Abrams and Abe Baum feel that Patton did it to rescue his son-in-law.

There are several books and articles on the Hammelburg Raid, one of the best is Dr. Alois Stadtmueller, "Die Waghalsige Operation der Task Force Baum" ("The Daring Operation of Task Force Baum"). Spessart: Monatsschrift des Spessartbundes, March 1985, 3-8.

²² LTC Cohen. discussion with author.

²³ Sheldon L. Thompson, "The Operation of Task Force Baum (4th Armored Division) Between Aschaffenburg and Hammelburg, Germany. 27-28 March 1945." Ft. Benning, GA: Academic Department, The Infantry School, 1949, CARL, 5. Thompson, one of the officers on the raid, makes the point that troops destined for the Main River front at Aschaffenburg and Hanau were kept in the Gemunden area to search for and destroy TF Baum.

²⁴ Stadtmueller, Aschaffenburg im Zweiten Weltkrieg, 222-3.

²⁵ Major Kurt Hold, "Operations Conducted by the 416th Infantry Division From 16 February until 6 May 1945," USAREUR Historical Division, 30 August 1946, CARL, 35.

²⁶ Stadtmueller, Aschaffenburg im Zweiten Weltkrieg, 232.

²⁷ Ibid., 237.

²⁸ U.S. Army, 104th Infantry, "S-3 Journal, 262400-272400 March 1945." Record Group 407, National Archives.

²⁹ BG (ret.) Felix L. Sparks, "The Aschaffenburg Battle," Lakewood, CO: 157th Infantry Association, 22 July 1982, 2.

³⁰ Ibid., 3. General Sparks, in a letter to the author dated 14 July 1987, writes that the troops his soldiers found were from a recon troop of the 4th Armored Division commanded by a captain. The record is unclear at this point. An entry in the S-3 Journal of the 104th Infantry for 1400 hours on 27 March records the order to 1/104 IR to assemble in the vicinity of Stockstadt when relieved by the 157th IR, seeming to indicate that relief was imminent. Whether they were from the 1/104th IR as reported in Note 28, or from the 4th AD, the basic fact remains, a very small force was left to hold the bridghead.

³¹ Sparks, "The Aschaffenburg Battle," 3.

³² XII Corps, "Report of Operations, 1-31 March 1945," 35, and 104th Infantry, "S-3 Journal," Entry #20 for 27 March 1945.

³³ U.S. Army, 157th Infantry Regiment, "Transmittal of Unit History, March 1945," 16 April 1945, 45 ID Museum, 12. One of the greatest dangers when close to the defenses was mortar fire. The history of the 645th TD Bn mentions eight wounded near the bridge on the 28th.

³⁴ Felix L. Sparks, letter to author, 14 July 1987.

³⁵ The "creative tension" that always exists between infantry and armored units was not helped by an article that appeared in Stars and Stripes on 29 March 1945 that said the Third Army had cleared the Main River towns of Hanau and Aschaffenburg.

³⁶ Oberst (Graf) i. G. Ludwig von Ingelheim, "LXXXII Corps, 27 March - 6 May 1945." USAREUR Historical Division, 6 May 1946. CARL. 5.

³⁷ Stadtmueller, Aschaffenburg im Zweiten Weltkrieg, 237.

³⁸ Generalmajor Helmut Kleikamp, "36th Volk Grenadier Division (28 March - 3 May 1945)." USAREUR Historical Division, 4 August 1946. CARL. no page numbers.

³⁹ William Sanders (former Corporal, M/3/157th IR). conversation with author June 1985.

⁴⁰ U.S. Army, 45th Infantry Division. "Operations of the 45th Infantry Division, Germany, 1-31 March 1945," CARL. 17-18. The narrative for the 28th was taken from this source, other official records of the division, and the histories of the supporting tank, tank destroyer and artillery battallions. In describing an afternoon attack on the 28th the record is at variance with an account written by General Sparks ("The Aschaffenburg Battle," Note 29, page 3), which indicates a morning assault. Since his is the only account of a morning fight on the 28th, in all probability General Sparks meant the 29th.

⁴¹ U.S. Army, 45th Infantry Division, "Historical Record, 158th FA Bn. March 1945." 24 April 1945, 45th ID Museum, 4.

⁴² U.S. Army, 45th Infantry Division, "War Room Journal (21-31 March 1945)." 45th ID Museum, 14.

⁴³ History of the 157th Infantry Regiment. (Baton Rouge: Army & Navy Publishing Company, 1946). 150. There are many accounts of the capture of the liquor warehouse, including one in the official Transmittal of the Unit History of the 157th for the month of March submitted to the 45th ID. The warehouse contained liquors confiscated in various Western European countries occupied by the Nazis. After the discoverers took their share the rest was turned over to regiment for further distribution. At least one account includes a recipe for a "157th Zombie" containing portions of Cognac, Benedictine and Cointreau, with a champagne censer (Dr. Howard A. Buechner, Dachau: The Hour of the Avenger, Metairie, LA: Thunderbird Press, Inc., 1986). It is probable that on the 28th and the following days many men of the 157th IR fought fortified with the contents of the warehouse, but it is impossible to tell if this improved or hindered their performance of duty.

42 "Operations of 45th ID." 17.

43 von Ingelheim. "LXXXII Corps," 7.

44 The Fighting Forty-Fifth: The Combat Report of an Infantry Division, (Baton Rouge: Army & Navy Publishing Company, 1946), 146. This work contains an English translation. A German version is in Stadtmueller. Aschaffenburg im Zweiten Weltkrieg, on pages 239-40.

47 Dr. Stadtmueller in his history of the war in the Main region (Maingebiet und Spessart im Zweiten Weltkrieg, Aschaffenburg: 1983) on page 586, makes the point that there was no general civilian participation in the battle, and that no organized Hitlerjugend or young girls fought. But he acknowledges that the Americans thought so, and that the Nazi daily newspaper, the Voelkische Beobachter, mentions civilian participation in Aschaffenburg in its 3 April 1945 edition. Civilians, or those who were civilians by the loose definition of the day, probably fought for home and country, either directly as combatants, or indirectly by providing food, carrying supplies and running messages between the battle positions.

48 Manfred Baunach, discussion with author, 15 March 1985.

49 Dr. Alois Stadtmueller, Aschaffenburg nach dem Zweiten Weltkrieg (Aschaffenburg After the Second World War). (Aschaffenburg: Paul Pattloch Verlag, 1973), 19.

50 U.S. Army, 45th Infantry Division, "The Story of Aschaffenburg," 1 May 1945, 11. This is a compilation of news stories, radio reports and press releases about the battle, published and given to the troops to send home. A German version of the proclamation appears in Stadtmueller. Aschaffenburg im Zweiten Weltkrieg, Photo 164.

51 Emil Lamberth. "Der Bericht des Kampfkommendanten" (The Report of the Combat Commander), Main Echo, 70 (25 March 1955).

52 Mary H. Williams, Chronology 1941-1945, The United States Army in World War II: Special Studies, Washington, D.C.: Office of the Chief of Military History, U.S. Army, 1960, 459.

53 45 ID. "The Story of Aschaffenburg," 10.

54 von Schacky, "Report of the 413th Replacement Division." 10.

55 Unlike American officer candidates, who were very often men without substantial military experience who met basic educational requirements, German reserve officer candidates were soldiers who had served from 12 to 30 months in a unit before selection. The

school was basically an infantry training course which reinforced the practical learning already conducted at the front. Although they may have been young, German officer candidates were seasoned combat veterans.

=- Harold B. Henderly, "The Operations of Company D, 191st Tank Battalion at Aschaffenburg, Germany, 28 March - 3 April 1945: Personal Experience of a Company Commander," Fort Benning, GA: Academic Department, The Infantry School, 1949, CARL, 8. The 191st had supported the 45 ID several times during the war, starting at Anzio and in the opinion of CPT Henderly there was great mutual respect between the tank battalion and the Thunderbirds because of friendships, long association and shared hardship.

=- U.S. Army, 45th Infantry Division, "G-3 Report, 29 March 1945," 30 March 1945, CARL, 1.

=- William Sanders, conversation with author, June 1985.

=- 45 ID, "G-3 Report," 1.

=- U.S. Army, 120th Medical Battalion, "Transmittal of Unit History," 19 April 1945, 45 ID Museum, 1. On 29 March A/120 Med Bn processed 57 wounded, 4 injured and 21 diseased, while the regimental statistical recap identifies 3 killed and 4 missing.

=- U.S. Army, 645th Tank Destroyer Battalion, "Battle Report (March 1945)," 12 April 1945, 45 ID Museum, 3.

=- U.S. Army, 191st Tank Battalion, "Transmittal of Unit History, 1-31 March 1945," 13 April 1945, 45 ID Museum, 4.

=- 45 ID, "War Room Journal," 29.

=- 45 ID, "Operations," 19.

=- Main Echo, "Hundert Geschuetze waren auf Aschaffenburg gerichtet" (A Hundred Guns Were Reported [firing] at Aschaffenburg), 69 (3 May 1952). In this article by Stadtammann (City Administrator) Franz Geiger telling of the fighting, he indicated that only 3000 non-combatants remained in the city by the morning of 30 March.

=- Main Post, "Der Tod des Leutnants Heymann" (The Death of Lieutenant Heymann), 144 (19 November 1949). Called in this account "the dark chapter in the defense of Aschaffenburg." Lt. Heymann was a decorated infantry officer recuperating from wounds received on the Eastern Front. At the start of the battle on the 26th he was stopped by a security patrol and told to register with the Kampfkommandant so that he could participate in the defense of the city. Later in the day he was found to have not done so by the

same patrol. Accused of cowardice, and of also making an English sign that was found in a basement in Schweinheim, he was arrested. A garrison court sentenced him to death on the two charges and he was hung on the 29th. At his trial for manslaughter after the war, Lamberth said that because Heymann put up no defense to the charges he considered him guilty. Found guilty and sentenced to four years in prison, the term was reduced because the judge felt that he acted under the influence of the Party leaders and the SS Special Commission present in the city at that time.

*7 Main Echo, "Zwei SS-Offiziere schrieen lauthal herum. Lamberth sass recht deprimiert da und sagte kein Wort" ([With] Two SS Officers yelling loudly, Lamberth was depressed and did not say a word), 76 (30 March 1985). In this article a soldier who worked in the garrison headquarters writes that Lamberth was berated by the SS and the Party whenever he had to make a decision. In an article in the 5 December 1949 Main Echo about the hanging there is also a statement that Lamberth was drunk at the time he made the decision, probably not unrealistic considering the pressure under which he was operating at the time.

*8 von Ingelheim, "LXXXII Corps," 11.

*9 Kleikamp, "36th Volks Grenadier division," np.

*10 von Ingelheim, "LXXXII Corps," 12.

*11 Dr. Alois Stadtmueller, Maingebiet und Spessart im Zweiten Weltkrieg, (Aschaffenburg: Geschichts- und Kunstverien Aschaffenburg e. V., 1983), 363. The designation of Kampfkommando did not add much to the will to resist as those in the Main-Franken region fell in succession, Hanau (28 March), Miltenberg and Klingenberg (30 March), Geinhausen (1 April), Marktheidenfeld (2 April), Lohr and Aschaffenburg (3 April), Wurzburg (5 April), Karlstadt and Hammelburg (6 April). Of these only Hanau, Wurzburg and Aschaffenburg, the largest cities, fought for more than a day.

*12 45 ID, "Operations," 20.

*13 History of the 157th Infantry Regiment, 152. There are five kasernes (barracks) in Aschaffenburg: Pionier Kaserne along Schweinheimer Strasse, the main street from Schweinheim to Aschaffenburg, and Artillerie, Bois-Brule, Lagarde and Jaeger Kasernes from southeast to northwest along Wurzbürger Strasse, the main street into the heart of the city.

*14 45 ID, "Operations," 20.

*15 Henderly, "Operations of Company D," The movement of armored vehicles behind the lines was possible because of the undulating terrain and the German's lack of anti-tank guns.

⁷⁰ U.S. Army, 45th Infantry Division Artillery, "After Action Report, March-April 1945," CARL, entry for 30 March. The 158th FA Bn was in direct support to the 157 IR, from the 44th ID Divarty they got the 217th FA Bn and the 156th FA Bn (both 105mm), the 220th FA Bn and the 157th FA Bn (both 155mm), the 194th FA Group supplied the 697th FA Bn (240mm howitzer), 989th FA Bn (155mm guns) and the 999th FA Bn (8" howitzer, a colored unit), the 182nd FA Bn and the 961st FA Bn (both 105mm) from the 173rd FA Group. At times, starting on 30 March, up to thirteen battalions of artillery of all calibers fired in support of the 157 IR operations.

⁷⁷ Main Echo, "Hundert Geschuetze." In this article Stadtammann Geiger tells of the struggle to maintain city services in support of the few civilians left in the city and their military defenders.

⁷⁸ Henderly, "Operations of Company D," 12. According to Air Force Combat Units of World War II (M. Maurer, ed. Washington: Govt. Printing Office, 1961) the elements of the 64th Fighter Wing were stationed near Nancy, France, until 31 March and then moved to Endenkoben, Germany, on 1 April.

⁷⁹ Stadtmueller, Aschaffenburg im Zweiten Weltkrieg, 268.

⁸⁰ Aschaffenburger Soldatenzeitung, Folge (edition) 2, Freitag, den 30 Marz 1945. Stadt- und Stiftsarchiv Aschaffenburg. This two-page newsletter was typewritten and mimeographed for distribution to the troops.

⁸¹ Hans Reinthaler, "Der Kampf um Aschaffenburg. Das Unternehmen der Kampfschwimmer" (The Battle Around Aschaffenburg. The Undertaking of the Battle Swimmers), Main Echo, Freitag, 1 April 1955, 4. The Germans tried to repeat earlier success. A similar team had blown up a sea lock at Antwerp and delayed Allied use of the port. They had tried at Remagen and failed, but would try again. A team of four frogmen, led by a holder of the Knight's Cross, using an explosive-filled torpedo, planned to swim upstream to the bridge with the device. On the first night they could not get the torpedo over the wreckage of the Mainbrücke across the river in the center of town. On the second night they were spotted by the Americans, mortar fire was brought down on the party which detonated the torpedo. The swimmers were killed.

⁸² 45 ID, "Operations," 20. The 157 IR captured 30 POWs in Schweinheim.

⁸³ The Fighting Forty-Fifth, 165. Troops of the XIII SS Corps were fighting on the KKA left flank in Mainaschaff, and this is perhaps where these soldiers came from. Among the many foreign nationals in Aschaffenburg were some fifty Hungarian soldiers who probably served in SS formations.

¹⁷ 157 IR. "Transmittal of Unit History," 45 ID Museum, 12.

¹⁸ U.S. Army, XV Corps. "Actions Against Enemy. Reports After, 1-31 March 1945." 1 June 1945, CARL, 88.

¹⁹ 45 ID, "G-3 Reports, March," 32. A/120 Eng Cbt Bn was busy guarding the bridge, improving the roads in the area, sweeping for mines, clearing booby traps, removing roadblocks and other engineer support tasks.

²⁰ Ibid., 31.

²¹ 45 ID, "Historical record, 158th FA Bn," 4.

²² Ibid., 4. These were M4A3 tanks mounting 105mm guns, there were six in the battalion.

²³ "Ami" is a slightly derogatory German slang term for Americans.

²⁴ U.S. Army, Seventh Army, "G-2 History, Part Eight (1-31 March 1945)." CARL, 31 March, 1. Several sources mention the tanks, which apparently appeared around 1500 hours and were destroyed by 1630 hours. According to Henderly the German tank had no oil in the crankcase and apparently was operated by untrained personnel. The Sherman (a picture appears in Photo 151 of Aschaffenburg im Zweiten Weltkrieg) was probably captured from the 4th Armored Division in Schweinheim early in the battle. To distinguish it as a German tank it had iron crosses painted on the sides. It was knocked out by a tank destroyer from 2/B/645 TD Bn.

²⁵ 45 ID, "Operations," 21.

²⁶ Copy of the original in the author's possession. The original is in the Stadt und Stiftsarchiv in Aschaffenburg.

²⁷ Stadtmueller, Aschaffenburg im Zweiten Weltkrieg, 274 and Photo 157. Entitled Die Nuechterne Wahrheit ueber Kriegsgefangenschaft (The Sensible Truth About [being] a Prisoner of War), it describes in detail the conditions under which prisoners are held, stressing the Geneva Convention, the ability to write four letters and four postcards a month, medical treatment, and other benefits of surrendering. For soldiers fighting in the wet, cold March of 1945, being an American POW may have had its attractions.

²⁸ Aschaffenburger Frontzeitung (Aschaffenburger Front Newspaper), no date, but probably 31 March 1945. Stadt und Stiftsarchiv Aschaffenburg. This remarkable two-page paper was published by Kreisleiter Wohlgermuth. It is a much more professional job than the Soldatenzeitung published by the Army.

It was typeset in gothic script in the format of a newspaper and printed on a press. Its political commentary is just as astounding as the Soldatenzeitung, mentioning that the Soviets and the Americans have the superiority of men and materials, and that rivers are not the barriers the Germans thought they were. While discussing the destruction to the city it relates, "In spite of that there will be life again in beautiful Aschaffenburg. We will rebuild."

96 45 ID, "Operations," 21.

97 U.S. Army, 324th Infantry Regiment, "Narrative Report. 324th Infantry for Month of March 1945," Record Group 407, National Archives, 10.

98 Main Echo, "Hundert Geschuetze." City Administrator Geiger was busy supplying bread and water. Because of the heavy bombardment supplies could not be replenished and water had to be rationed.

99 Henderly, "Operations of Company D," 14.

100 von Schacky, "Report of the 413th Replacement Division," 11. Genlt. von Schacky felt that the lack of adequate American reconnaissance permitted the Germans to break through US lines repeatedly. He states that this is an example of lack of initiative.

101 45 ID, "G-3 Report, 1 April 1945," 1.

102 Stadtmueller, Maingebiet und Spessart, 578.

103 Stadtmueller, Aschaffenburg im Zweiten Weltkrieg, 276.

104 Ibid., 277.

105 45 ID, "Historical Record, 158th FA Bn," 4.

106 History of the 157th, 153.

107 45 ID, "G-3 Report, 1 April 1945," 1.

108 U.S. Army, 158th Field Artillery Battalion, "Historical Record, April 1945, 45 ID Museum, entry for 1 April.

¹⁰⁷ Ibid. The TOTs were eight battery 155s, three battery 240s and four battery 8"s. Twenty-two more missions were fired during the night.

¹¹⁰ U.S. Army, 45th Infantry Division, "Operations of the 45th Infantry Division, 1-30 April 1945," 28 May 1945, CARL, 2.

¹¹¹ 45 ID. "G-3 Report," 1.

¹¹² Main Echo, "Die Rebellion in der Pionierkaserne," 74 (1 April 1970). In the late afternoon Colonel O'Brien, the American regimental commander, sent a note into the kaserne carried by a German soldier under a white flag, establishing a truce from 1800-1830 hours. During this time any German soldiers who wanted to could approach American lines and surrender. There were no takers (Stadtmueller, Aschaffenburg im Zweiten Weltkrieg, 282-4).

¹¹³ 45 ID. "The Story of Aschaffenburg," 8. The quote appears in a digest of cabled or broadcast news items sent to the US on 3 April 1945. The United Press dispatch quotes a PFC Melvin Prigg, and although it does not specify, PFC Prigg probably is responsible for the portion of the quote that begins "but in the hills...."

¹¹⁴ Ibid., 4. The stories in this digest of news reports undoubtedly reflect the situation during the battle, but they also reflect an understandable bias toward the enemy and seem to be very overwritten.

¹¹⁵ Combat History of the 324th Infantry Regiment, (Baton Rouge, LA: Army & Navy Publishing Company, 1946), 101.

¹¹⁶ U.S. Army, 114th Infantry Regiment, "Regimental History, 114th Infantry, April 1945," 1 May 1945, Record Group 407, National Archives, 2.

¹¹⁷ Combat History of the 324th. 101.

¹¹⁸ Stadtmueller, Maingebiet und Spessart. 387.

¹¹⁹ 45 ID, "The Story of Aschaffenburg," 6.

¹²⁰ Main Echo, "Hundert Geshuetze." At the same time in order to prepare for the end the city administration hung a white flag and the Red Cross flag outside the cellar where it was located to announce to the Americans the non-combatant nature of the business in its particular cellar.

¹²¹ 45 ID, "Operations." 2.

¹²² George A. Fisher, The Story of the 180th Infantry Regiment, (San Angelo, TX: Newsfoto Publishing Co. 147), Chapter 10, 15.

¹²³ XV Corps, "Actions Against Enemy," 5. This was especially noticeable in the reduction in the number of mortar and nebelwerfer rounds fired at the Americans.

¹²⁴ 158th FA Bn, "Historical Record," entry for 2 April. From 0900-1200 hours the 158th, reinforcing and general support units fired 500 rounds in TOTs and observed fire missions. Several thousand rounds of artillery of all calibers from 105mm to 240mm were fired at Aschaffenburg. A witness to the artillery operations, now a barber for the US Army in Aschaffenburg, but then a small boy, told the author that he saw the Americans bring up a train full of artillery rounds and, to his amazement, fire it all up.

¹²⁵ U.S. Army, 324th Infantry Regiment, "Narrative Report, 324th Infantry, Month of April 1945," 9 May 1945, Record Group 407, National Archives. 2.

¹²⁶ *Ibid.*, 2.

¹²⁷ 45 ID, "G-3 Report, 2 April 1945." 1.

¹²⁸ 45 ID. "Operations." 3.

¹²⁹ Stadtmueller, Aschaffenburg im Zweiten Weltkrieg, 287.

¹³⁰ History of the 157th, 154.

¹³¹ 45 ID, "Operations," 3.

¹³² Stadtmueller, Aschaffenburg im Zweiten Weltkrieg, 291.

¹³³ 45 ID, "Operations." 2. The total division POW count for the day was 1222. These 45 ID figures do not include those taken by the 44th ID on the west. The unofficial history of the 114th Infantry Regiment, With the 114th in the ETO states on page 105 that the prisoners taken at Aschaffenburg "reached staggering heights." The book also comments on the polyglot nature of the German soldiers and civilians captured.

¹³⁴ 45 ID, "G-3 Reports," 2.

¹³⁵ U.S. Army, 1st Battalion, 157th Infantry, "Unit Jopurnal, 1-7 April 1945," Record Group 407, National Archives. Additional information for the account is taken from a copy of letter dated 31 March 1987 about the surrender sent to the author by General

Sparks, and from Dr. Stadtmueller's book on the city during the war which is based on interviews with German participants.

¹³⁶ Stadtmueller, Aschaffenburg im Zweiten Weltkrieg, 300.

¹³⁷ Ibid., 300-1.

¹³⁸ Ibid., 269.

¹³⁹ Ibid., 351. Stock spent most of the war in a concentration camp in western Germany. The Military Government Detachment was commanded by a major with a first lieutenant deputy. The first occupation troops came from the 2nd Battalion, 393rd Infantry, 99th Infantry Division (Stadtmueller, Aschaffenburg nach dem Zweiten Weltkrieg, Aschnaffenburg: 1973, 20).

¹⁴⁰ Main Echo, "Um 9 Uhr kapitulierte Aschaffenburg," 76 (3 April 1970). The author of the article admits that the numbers are imprecise. The 45th ID Operations Summary estimates: 1500 killed and wounded, 2941 prisoners, 39 prisoners evacuated through the 45th ID clearing stations, 202 wounded prisoners in hospitals in the city, for a total of 4682. An article in the Main Echo on 20 January 1948 gives the totals then known for the entire war:

Dead	1250
Missing	1700
Prisoners of war	1700
Victims of Allied bombing	900
Deported Jews	450
Displaced persons in the city	4000
Evacuated	26800 (20000 have returned)

¹⁴¹ 45 ID, "Operations," 1.

CHAPTER FIVE

CONCLUSION

General

This study describes the struggle for the Main River city of Aschaffenburg in March and April 1945 at the close of World War II, and provides an answer to the question, "Why did it take the Americans ten days to capture the city?" It suggests that the answer to the question lies in German political and military organizational advantages on the one hand, and certain initial American operational shortcomings on the other. In summary the Germans came to fight and the Americans did not. This chapter will examine why this was so.

Before the thesis question can be answered a preliminary point must be addressed. Was ten days exceptional? Yes it was. When compared to other Main River cities, the ten days it took the Americans to reduce Aschaffenburg stands out. With a similar ratio of forces engaged it took four days to take Hanau (slightly smaller than Aschaffenburg), and five days to subdue Frankfurt (twelve times as large). Therefore by comparison Aschaffenburg resisted much harder than its neighbors.⁴

Another fundamental question is "Who Won?" Clearly the Americans achieved tactical victory, but in one sense the Germans also won. By holding up the American juggernaut for ten days

Kampfkommando Aschaffenburg (KKA) may have served its purpose in the eyes of OKW. Surely a force of 5000 men deployed in any other manner would not have inflicted an equal number of casualties or slowed the American timetable of conquest as well.² The attacker won, but at a high cost in casualties, resources and time. In spite of being destroyed in prolonged combat, KKA accomplished its mission of delay.

Aschaffenburg represents the last half year of the war in Europe in microcosm. In the course of the war things had come full circle and the Germans, like the Poles and French in 1939 and 1940, were fighting from fixed positions against overwhelming mechanized power.³ But the Germans, unlike the Poles and the French, put up a spirited defense assisted by the accumulated combat experience of six years of war.

Environmental Factors

The environment at Aschaffenburg favored the defending Germans. They were behind a river barrier with the city cradled in hilly terrain so that the attacker initially was forced into frontal assaults. Thus the terrain was partially responsible for a costly battle of attrition. Even the American's incredible luck in capturing a bridge over the Main did not immediately doom the Germans because of the necessity of rooting out an entrenched enemy in urban combat. A case can even be made that the capture of the bridge hurt the American efforts because its location so close to

the city begged for an immediate attempt at a frontal assault. Erection of tactical bridging further upriver would have made an indirect approach more attractive. So the river location, the city's position at the foothills to the Spessart Mountains, and the urban character of most of the defended terrain increased the time required for the Americans to take the city.

Other factors also contributed to the character of the struggle. They can be grouped into operational determinants, those dealing with the techniques of employment of military forces, and behavioral determinants, those dealing with the ways of sustaining combat power during employment.

Operational Determinants

In the operational arena, several factors relating to force strength and composition contributed to the excessive length of the battle. At the beginning of the battle the attacking Americans were outnumbered by the defending Germans, and considering that the defenders were in prepared defensive positions, it is understandable why the attackers did not seize the city by a coup de main. It was not until the German LXXXII Corps withdrew from the Main River on the seventh day of the battle that the Americans achieved superiority of forces at Aschaffenburg. The composition of the forces initially favored the defenders. The Americans reached the Main with armored and mechanized forces ill-suited for an assault on a stoutly-defended city. The Germans, as light

infantry forces equipped with automatic weapons, regardless of deficiencies in other categories of fire support, were able to hold the American mechanized formations at bay. The militia-like character of the German forces initially assisted them in their defense because everyone was employable for close combat. It was not until the American infantrymen of the veteran 157th Infantry Regiment, with massive fire support, took over the fight on day three that the force composition favored the attackers. Even though the quality differential was with the Americans from the start, it was not sufficient to overcome the inherent strengths of the defender and greatly shorten the fight. It has been said that the German Army in World War II, especially its infantry, was accustomed to fighting short of men, material and equipment. The circumstances at Aschaffenburg, while certainly dire, were not unprecedented.*

The manner of force employment had a direct affect on the outcome of the struggle for Aschaffenburg. Before the battle the Germans fell back to the defensible terrain of the Main River. Especially around Aschaffenburg, the existence of a "combat command" flanked by two volksgrenadier divisions made the defensive dispositions strong. Even taking into account the inherent operational weaknesses of the understrength LXXXII Corps, to defeat the Germans along the Main Front from Hanau to Miltenberg required more combat power than the Americans had available early in the battle. For the Americans, although the Aschaffenburg bridgehead

was important tactically as an entre into the Spessarts and beyond. It was not operationally important. On the second day of the battle crossings were secured over the Main at Hanau and Frankfurt, and others would be made later. By 1 April the Americans had several ways to cross the river, so the part played by the Nilkheim railroad bridge was less important in light of more promising opportunities elsewhere. A case can be made that bypassing the city, cutting it off from reinforcement and replenishment, and letting it wither on the vine would have been a viable option for the Americans. But the Americans did attack.

The first American efforts at Aschaffenburg were half-hearted, and for three days no determined effort was made to capture the city. This can be explained in several ways. As the Americans reached the Main on 25 March the boundary between Bradley's 12th Army Group and Dever's 6th Army Group split the city. Military units are reticent to encroach on each other's territory, particularly if such an action will require a difficult fight. The 4th Armored Division, the first American unit to reach the Main, knew that the boundary would change at 260001 March and that Aschaffenburg would belong to another unit. By that time they also knew that the easiest way across the Main lay at Hanau and not Aschaffenburg. It is understandable that after they launched the Hammeiberg Raid during the night of 26-27 March the 4th AD retrenched and prepared for a change of mission. This American

false start at the city gave the Germans additional time to prepare, and therefore lengthened the fight.

The initial American forces available also added to the length of the fight. The suburbs of Obernauer Kolonie and Schweinheim were heavily garrisoned strongpoints. With the river on the American left flank and the defended foothills of the Spessarts on their right flank, a frontal assault was the only course open to the attackers. This course of action was hampered by insufficient strength to take the strongpoints by frontal assault. It was not until the seventh day of the battle that the Americans had enough forces to fix the defenders and maneuver to flank the city. This finally was accomplished by elements of four regiments, the 324th Infantry on the west and northwest, the 179th Infantry and the 180th Infantry on the east and northeast, and a battalion of the 157th Infantry in the north.

Regardless of the other operational factors that prolonged the struggle, the primary reason why the fight lasted ten days was the variables of urban combat. The battle of Aschattensburg demonstrates that a well planned defense, even if cut off and lacking air, armor and artillery, can consume inordinate amounts of an attacker's time.² From the first day the need to pry the defenders from their positions made for slow going, and even after the city was cut off from resupply and reinforcement, the house-to-house fighting demonstrated the difficulty of urban combat. A review of several of the variables of urban combat as

they affected Aschaffenburg further serves to illustrate why the battle took ten days.

Several things helped the Germans in their mission. The city was a part of a prepared defensive line, and although the line was in disrepair, the defenders of KKA had been working on improvements to the city's defensive posture since the previous November. These physical preparations were enhanced by the initial lack of American aggressiveness. Several other variables further contributed to the initial success of the defense.- The city was big enough to force the attacker to take it a little bit at a time. The heavy stone and brick construction of the buildings in the city center facilitated the defense, resisting destruction from both direct and indirect fire. The American superiority in fire power was mitigated somewhat by the ability of the old, closely packed buildings to absorb punishment. To a point, the more the attackers rumbled the city, the more places were created for the defenders to hide.

The physical arrangement of the buildings served to nullify much of the American force advantage. Regardless of the size of the force the attackers brought to bear, the layout of streets and buildings often dictated that only a small portion of that force could be in contact with the enemy at any one time. This inability to bring all of its force into play neutralized the American numerical superiority and slowed U.S. efforts. The German cause was further assisted by the civilian population. During the

closing stages of the fight there were less than 3000 non-combatants left in the city. They aided the soldiers and, while it is unclear whether they took up arms against the attackers (some certainly did), their presence inhibited the American efforts as they tried not to harm unarmed civilians.

The tactics employed by the Americans were effective, but city combat is time consuming. The need to isolate an area, secure a foothold and systematically clear it, combined with the demands of handling wounded, POWs and civilians, slowed military operations. Even the use of heavy caliber direct fire weapons did not substantially eliminate the need for infantry in detailed house-to-house fighting. The Germans employed a strongpoint defense and prepared their positions with enough care to make a fight for each house, and in many cases each room, necessary. The German tactic of re-entering "cleared" buildings was particularly troublesome for the Americans. Especially in Schweinheim, the inability to eliminate all resistance until 1 April postponed further American operations on the city from that direction. This probably added a full day to the fight. The direct fire battle was only one facet of the fight.

Throughout the battle the indirect fire edge went to the Americans, who at one point had ninety tubes of artillery, plus additional 4.2", 81mm and 60mm mortars, in support. This massive weight of fire power demoralized and harassed the defenders, as well as interdicted movement within the city. The German inability

to adequately resupply, reinforce and evacuate grew more important as the battle progressed. However, the defenders also used indirect fire, expending in excess of three thousand rounds of mortar and nebelwerfer (multi-barrelled grenade launcher) ammunition. In the absence of heavier fire support this fire reduced American effectiveness by slowing attacks and hindering the repositioning of forces. The Americans had vast superiority in air support, but air power had only a moderate impact on the fight. Because of the close proximity of the belligerents to each other it was often difficult to direct air support with the telling accuracy required. A student of the battle is left with the impression that unless directed to a more appropriate target, U.S. air forces automatically and persistently attacked the Schloss Johannisburg.

Behavioral Determinants

The fight for Aschaffenburg is another validation of Napoleon's aphorism that in war the moral is to the material as three is to one. The Germans made up with moral force what they lacked in material force. Three components of that moral force are examined here: will, leadership and morale.

The battle for Aschaffenburg provides evidence that the Wehrmacht disintegrated from the top down and not the bottom up. Compared to the forces that overwhelmed France in 1940, the individual German soldiers and their immediate superiors were still cohesive and willing to fight when the military and political

actions above them were in disarray. The reasons for this strength of will are complex but Aschaffenburg offers some explanation.

On the highest plane the will to continue the fight can be attributed to a sense of duty, a conviction that as a German fighting man each soldier was bound to defend the Fatherland against an alien enemy. This basic conviction was reinforced by a faith in Hitler. It is difficult in our time to understand the affinity for the Fuehrer felt then by most Germans. The moral bankruptcy of the Nazi ideology and its state policy were apparent to the soldiers of Aschaffenburg, yet the need to believe in something strengthened the defender's will to resist. Whether it was a desire to fight for Hitler, or a realization that there was nothing else to lose, the result was the same. A longstanding Teutonic martial tradition undoubtedly assisted in strengthening the collective will to resist. Any analysis of the events of 1945 are colored by our knowledge of the result, in that fateful Spring the defenders of Kampfkommando Aschaffenburg (KKA) did not yet know the outcome and from all evidence still believed in victory of some sort.

This belief in the innate superiority of German arms was brutally reinforced by the Nazi political system that taught that "only unquestioning optimism, silent obedience and passive faith were considered right." The typical German soldier in Aschaffenburg was fighting for self preservation tempered by

political indoctrination in National Socialist ideology, enforced by a repressive, and all-pervasive, political system. This is hardly a formula for the early end to any fight.

The foregoing attitude bred a certain contempt for the American adversary, not just a xenophobic view that foreigners were not the equal to Germans, but a belief that the individual American was the antithesis of the "master race".⁹ This attitude undoubtedly was further reinforced by the preceding nine months of combat against the American Army that, in the minds of many Wehrmacht leaders, showed the GI to be inferior in the infantry fighting that is the crux of ground combat. In the words of one observer, "The American soldier, trained for battles of materiel, appears to rely exclusively on his material superiority and can therefore easily become victim of a surprise move and the flexible fighting power of a bold adversary."⁹ This attitude, common among the German Army leadership, was certainly communicated to the troops and helped steel the will of the defenders of Aschaffenburg. It must have come as a surprise to the German defenders when the Americans they discounted as unequal fought with a ferocity and skill to match their own.¹⁰

In war, the will to win, though vital, is often not enough. An important determinant of victory is proper leadership. As a general statement, the leadership on both sides at Aschaffenburg was good. There is insufficient material available to the author for in-depth biographical research of the opposing leaders, but

some points can be made. The tactical leaders (officer and NCO) on both sides were not professional soldiers. On the German side, because of six years of war a professional soldier (i.e. pre-1935 service) was hard to find at unit level. Those not killed or disabled were promoted to higher levels. This was true in Aschaffenburg. The American story was much the same, with few leaders with more than four years service.¹¹ However, lack of long service did not mean a lack of tactical acumen or an inability to command soldiers. Within the units involved, certain key leaders had months of hard combat experience that was apparent in the ferociousness of the close combat, especially the house-to-house fighting in Schweinhein and the center of Aschaffenburg. Leadership superiority can compensate for numerical inferiority, but only up to a point. At Aschaffenburg though both sides possessed effective leadership, when the Americans gained numerical superiority they also gained the upper hand.

For the Germans, tactical military leadership was affected by the political leadership. The Nazi Party, from the top down, took every opportunity to influence the course of the struggle. Hitler's order directing Aschaffenburg to become a combat command and to fight to the last man set the tone for tactical operations at the start. As the battle began the arrival of a Special Commission from OKW, headed by an SS lieutenant colonel, reinforced the Party's ability to control events locally. Finally, the local Party apparatus contributed to the dilution of army control when

the Gauleiter in his role as Reichs Defense Commissioner took steps to ensure politically correct tactical decisions. It is unclear how much direct interference there was in the daily tactical conduct of the German defense, but the Party, with its broader view of the war, undoubtedly directed continued resistance long after it made military sense.

Napoleon is quoted above on the superiority of the moral over the material in war, referring to the will of the commander. But the morale of the fighting force, its collective will, is also important. In Aschaffenburg there was a difference between the belligerents with regards to morale. The Americans came to the city with high morale, sure in the knowledge that the war was almost over and that the Germans were beaten. The realization that this view was not held by the Germans must have been a great disappointment. It is this author's analysis that until that overoptimism could be overcome by positive leadership the attackers did not perform up to their potential. Conversely, on the German side there is ample evidence that the morale of the defenders remained high throughout the battle. It was not until the eighth day that large groups of Germans surrendered without a fight. Surely this is testimony of the ability of the German leaders to sustain the will to fight under extremely difficult conditions.

Whatever the cause, unit cohesion, National Socialist indoctrination, or because of a desire to fight for the homeland, the facts are not in dispute. The defenders of Aschaffenburg held

out against the accumulated might of veteran American military formations for ten days in difficult urban combat. If war ever comes again to Europe, the U.S. Army should hope to defend with the same resolute courage of Combat Command Aschaffenburg, and attack with the determined ferocity of the American troops at Aschaffenburg. Any less will not bring victory.

CHAPTER FIVE

End Notes

¹ Mary H. Williams, Chronology 1941-1945, The United States Army in World War II: Special Studies. (Washington D.C.: Office of the Chief of Military History, U.S. Army, 1960), 461. Population comparisons are taken from The MacMillian World Gazetteer and Geographical Dictionary (New York: MacMillian, 1955).

² It was a march of conquest. According to Harold Cohen, the commander of the 10th Armored Infantry Battalion in the battle. a phrase current at the time was "We came as conquerors, not liberators!"

³ H.M. Cole. The Lorraine Campaign, The United States Army in World War II, (Washington, D.C.: Office of the Chief of Military History, U.S. Army, 1950), 604-5.

⁴ Dr. S.J. Lewis in his Forgotten Legions, German Army Infantry Policy 1918-1941 (New York: Praeger, 1985) relates how the almost uncontrolled expansion of the German Army from 1938 onward combined with battle losses to make fighting a deathrattle a way of life, and that leaders learned to cope.

⁵ P.D. McLaurin, et. al. "Modern Experience in City Combat." Technical Memorandum 5-87, Aberdeen Proving Ground, MD: U.S. Army Human Engineering Laboratory, March 1987, 3. This study contains a wealth of information about urban combat from World War II to the present, using 22 case studies to analyze the nature of military operations in urbanized terrain.

⁶ Ibid., 21-34.

⁷ Generalmajor Carl Wagener. "The Battle of Army Group B on the Rhein to its Dissolution (22 March - 17 April 1945)." USAREUR Historical Division, 1945, CARL. 64.

⁸ As the Germans were marched back to POW cages it must have been a shock to some to find that among the victors was a "colored" artillery unit (the 999th FA Bn). The polyglot nature of America was also reinforced during the post-war occupation when, since the segregated American Army garrisoned German towns by race. Babenhausen (fifteen kilometers away) was a "colored" town, and that black soldiers occasionally came to Aschaffenburg.

⁹ Wagener. "The Battle of Army Group B", 68.

¹⁰ The ongoing debate on the superiority of the Wehrmacht is beyond the scope of this study. An interesting critique in opposition to the proposition favoring the Germans is "Colonel Trevor N. Dupuy and the Mythos of Wehrmacht Superiority: A Reconsideration" (Military Affairs, Vol I, June 1986, 16-20) by historian John Sloan Brown. Colonel Dupuy's rebuttal and Lieutenant Colonel Brown's counter-rebuttal follow in subsequent issues.

¹¹ As an example on the German side, Major Lamberth, the Combat Commander, although a WWI veteran was a reserve officer and a former school teacher. For the Americans to cite an extreme example, LTC Cohen, the commander of the 4th Armored Division's 10th Armored Infantry Battalion, went from second lieutenant to lieutenant colonel in two and a half years.

APPENDIX 1

APPENDIX 1

GLOSSARY OF TERMS AND ACRONYMS

A

Alarm Kompanien - ad hoc formations under the supervision of the Nazi Party that were raised as a last effort at defense at the end of the war.

Artillerie Kaserne - Artillery Barracks located on Wurzburger Strasse, constructed during 1937/38. Today called Ready Barracks.

B

Blitzkrieg - a descriptive term meaning lightning war; combined arms surprise attack against an enemy weak point. It was never formally used in German doctrinal literature.

Bois-Brule Kaserne - kaserne located on Wurzburger Strasse, constructed during 1936/37. Today called Graves Barracks.

E

Ersatz - replacement, reserve; the Ersatz Heer was the replacement and training arm of the Wehrmacht.

F

Feldarmee - the field army that conducted active military operations outside of Germany.

Festung - fortress, fortification.

Festung Europa - Fortress of Europe, a propaganda concept.

Front - offices of the NSDAP, i.e., Arbeitsfront (labor office).

Fuehrer - leader, used in SS ranks, i.e. Sturmabfuhrer (assault group leader); used primarily to refer to Hitler, one of whose official titles was Fuehrer und Reichskanzler (Leader and Reichs Chancellor).

G

Gastarbeiter - foreign worker; term used for the foreigners working in Germany, either voluntarily or by force; they later were called slave laborers by the Allies.

Gau - one of 43 regional divisions of the NSDAP, 42 were in Germany and the conquered territories, and one existed for ethnic Germans living overseas.

Gauleiter - regional leader; Party appointed post responsible for government of one of the 43 Party Regions, with theoretical direct access to Hitler.

Gebiet - district.

Geheimstaatspolizei - State Secret Police, the GESTAPO.

Generalmajor - "one-star" general, US equivalent is brigadier general.

General der Infanterie (Artillerie, etc.) - "two-star" general, US equivalent is major general.

H

Hitler Jugend - NSDAP youth organization composed of several divisions: Hitlerjugend for boys 14-16 years old, Deutsches Jungvolk for boys 10-14 years old, Bund Deutscher Maedel for girls 14-18 years old and the Bund der Jungmaedel for girls 10-14 years old. Membership was compulsory.

I

Ia - the "Eins A" or first general staff officer, a member of the German General Staff Corps who was chief of staff/operations officer of military formations of division level and higher.

J

Jaeger Kaserne - oldest kaserne in Aschaffenburg, built for the Bavarian Army in 1894-96.

K

Kaserne - military barracks.

KKA - Kampfkommmando Aschaffenburg, Combat Command Aschaffenburg. A formal military-political designation announced by Hitler requiring a fight to the "last cartridge."

Kriegseinsatz - war utilization, used to describe the use of Hitlerjugend and others in work directly related to the war effort.

Kreisleiter - county leader, a Party appointed post reporting to the Gauleiter.

L

Lagarde Kaserne - kaserne on Wurzburger Strasse, built during 1936/37. Today called Smith Barracks.

Landser - infantry man, equivalent to "GI."

Lazarette - military hospital, several of which were located in Aschaffenburg and surrounding communities with over 1800 total beds.

Luftwaffe - the air arm of the German Armed Forces. In addition to those functions normally performed by an air force, the Luftwaffe also had anti-aircraft troops, paratroopers and infantry.

N

NSDAP - Nationalsozialistische Deutsche Arbeiterpartei. National Socialist German Workers Party, the Nazi Party; controlled all aspects of German life.

NSFO - Nationalsozialistischer Führungsoffizier, political commissar assigned to military units

Nepelwerfer - multi-barrelled grenade launcher.

O

Oberbürgermeister - the Lord Mayor, or senior political official under the traditional German municipal government system.

OKH - Oberkommando des Heer, Army High Command.

OKW - Oberkommando der Wehrmacht, Armed Forces High Command

Ostarbeiter - workers imported into the Reich from Eastern Europe and the Balkans for the German war industry, often termed slave laborers.

P

Panzer - tank, or armored formation.

Panzerfaust - shoulder fired antitank weapon with a shape charge warhead.

Pionier - combat engineer, abbreviated Pl.

Pionier Kaserne - Engineer Kaserne located on Schweinheimer Strasse, built in 1936. Largest kaserne in Aschaffenburg. Today called Fiori Barracks.

R

Reich - Nazi Germany and all incorporated territories.

Reserve Offizier Bewerber (ROB) - Officer candidates undergoing an infantry training course prior to commissioning as reserve officers in the Wehrmacht.

S

Schutzstaffel - the SS; composed of the Allgemeine SS or General SS. Party members available to be the muscle of the Party, and the Waffen-SS, a full-fledged army with recruitment, command and training separate from the Wehrmacht.

Schwerpunkt - concentration or thrust point of an attack; the main effort. Used more often in a strategic or operational sense than tactically.

Seigfried Linie - Seigfried Line. line of fortification between the Rhine River and the western border of Germany; called the Westwall.

T

Totalenkrieg - total mobilization of the German nation for war after the defeat at Stalingrad (February 1943).

V

Versorgungs Depot - the food supply warehouse complex on Goldbacher Strasse, constructed from 1936/43. Today called Taylor Barracks or the Recreation Services Depot.

Volkssturm - home guard, raised from old men, men unfit for military service and boys too young for the army late in the war and trained by the Nazi Party; poorly armed, trained and led.

W

Waffen-SS - elite military formations of the SS. or Party military arm.

Wehrkreis - Corps Area or Military District. One of nineteen military divisions of the German Reich on which the Wehrmacht was based. Commanded by a deputy corps commander. Aschaffenburg was in Wehrkreis IX with headquarters in Kassel.

Wehrmacht - German Armed Forces, all military, naval and air forces except those belonging to the Party.

Westwall - the Siegfried Line. the line of military fortifications running along the western border of the Reich on the west bank of the Rhine.

Wetterau-Main-Tauber Linie - the line of military fortifications running for 120km along the Wetter, Main and Tauber river valleys.

APPENDIX 2

APPENDIX 2

BATTLE OF ASCHAFFENBURG - CHRONOLOGY

PRE-1939

1927

Dr. Otto Hellmuth appointed Gauleiter (regional leader) of Main-Franken Party Region.

1932

Wilhelm Wohlgenuth appointed Kreisleiter (county leader) of Aschaffenburg.

1933

Wilhelm Wohlgenuth becomes Oberbürgermeister (lord mayor) upon Nazi rise to power.

1934

Aschaffenburg designated a "garrison city", a "Festungsbaugruppe" (Fortress Building Group) established.

1935

Construction starts on the bunkers of the Wetterau-Main-Tauber Line.

Establishment of Festungsinspektion VI Aschaffenburg (Fortress Inspection Section VI).

1936

Conversion of Festungsbaugruppe Aschaffenburg to Festungs-Pionier-Staff 14 (Fortress Engineering Staff 14).

Pionier Kaserne constructed, Pionierbataillon 15 (Engineer Battalion 15) moves in.

Infanterieregiments 88 (Infantry Regiment 88, later 106IR) established.

Versorgungs Depot (Food Supply Depot) construction started (completed in 1943).

1937

Lagarde and Bois-Brule Kasernes constructed.

1938

Construction of Artillerie Kaserne, Artillerieregiments 15/1 (1st Bn. Artillery Regiment 15) moves into the kaserne.

Festungs-Pionier-Stub 14 takes over the work of Festungsinspektion VI Aschaffenburg.

Reichskristalnacht activities on 9-10 November lead to the burning of the Jewish synagogue and destruction to Jewish property.

1939

Establishment of Reserve Lazarett Aschaffenburg (Reserve Military Hospital Complex Aschaffenburg).

Establishment of Replacement Army organizations in Aschaffenburg.

Departure of the 106th Infantry Regiment, 15th and 9th Engineer Battalions and the 1st Battalion, 15th Artillery Regiment for combat in France, Russia and Holland (through 1944).

1940-44

1940

First air raid warning (June) and first air raid on the city (September).

1943

Germany moves from the strategic offensive to the strategic defensive. the beginning of "total mobilization."

1944

Allied Combined Chiefs of Staff issue directive to aim for heart of Germany and destroy all German armed forces (14 Feb).

Attempt on Hitler's life (20 Jul), Himmler takes command of Replacement Army.

Major Emil Lambert assumes command of 9th Engineer Replacement Battalion (26 Jul).

Eight air attacks on the city (Sep-Nov).

Aschaffenburg attacked by 274 British bombers in largest raid of war (21 Nov).

City upgraded to a "fortress city" (Nov).

Aschaffenburger Volksstrum mustered to the colors (Dec).

January - March 1945

OKW (Armed Forces High Command) issues regulation implementing Fuehrer Decree of 10 Dec 44 providing all available men for combat duty.

Major Lambert assigned as the Military District Commander (30 Jan).

Aschaffenburg Volksstrum organized as Volksstrum Battalion 15/1 with seven companies (Feb).

Major Lambert sworn in as the Aschaffenburg Combat Commander (5 Mar).

SS commission inspects city defenses: they pass (11 Mar).

Code Word "Ghiesenau" received from Wehrkreis (Corps Area) IX, city to go on alert (20-21 Mar), occupation completed by 23 March.

Set up and occupation of outlying defenses in Schoenbusch Park, Mainaschaft and on the Kapellenberg (20-25 Mar).

Plan for destruction of the city Main bridges received from Wehrkreis IX, Major Lambert goes to Seventh Army HQ to give a personal report on defensive preparations.

Kampfkommmando Aschaffenburg (KKA) (Combat Command Aschaffenburg) on full alert (24 Mar).

25 March - 3 April 1945

25 March 1945

Staff of 413th Replacement Division is ordered to control German forces on the Main River around Aschaffenburg.

256th Volksgrenadier Division given mission to defend Main from Hanau to Aschaffenburg.

Proces of CCB 4th (US) Armored Division reach city and capture railroad bridge at Milckheim; establish small bridgehead (1230hrs). take high ground overlooking bridge.

Defenders blow up Mainbrucke road bridge (1326hrs). Ground assault on railroad bridge by 9/2 Pioneer Battallon fails. Fifteen ME 109 sorties attack bridge with little result.

Commander of Seventh (GE) Army visits city to inspect.

Americans report armed civilian resistance.

26 March 1945

US boundry change effective, 0001hrs, moves Aschaffenburg from Third (US) Army to Seventh (US) Army zone, XV Corps responsibility.

Darmstadt capitulates.

OKW orders 413th Replacement Division Staff subordinated to Army Group G with mission to secure Main front. 36th VGD and 416th Infantry Division ordered from Michelstadt and Miltenberg area north to Aschaffenburg area.

KKA sends 106 IR troops to Haibach to link up with 36 VGD.

CCB 4th AD fights to enlarge bridgehead against strong opposition. launches Task Force Baum (2030hrs).

Attacks by elements of CCB on the Obernauer Kolonie.

27 March 1945

German 416 ID takes over command of the defense of the Main. Remnants of XIII SS Corps reinforce KKA.

1/104th Inf (26th ID, attached to 4th AD) relieves CCB 4AD near Schweinheim.

American forces repulse two German counterattacks on bridgehead at 1400 and 1600hrs.

3/157th Inf (45th ID) links up with elements of 4th AD (recon troop from 1/104 Inf) at Main.

28 March 1945

416 ID subordinated to LXXXII Corps.

Effective 1200hrs LXXXII Corps takes over Main front from Hanau to Miltenberg, has positive control of 36 VGD, 256 VGD and 416 ID and KKA in sector.

36 VGD in place to south of city with two infantry regiments, two light artillery and one heavy artillery battallions.

1/104 Inf relieved by 157th Infantry Regiment. 2/157 IR and 3/157 IR cross RR bridge and move on town.

157th IR consolidates on high ground south of town, 3/157 IR moves on Schweinheim at 1900 hrs.

KKA seals off town. 36 VGD seals off southern egress out of bridgehead.

1/3/157 IR attacks Schweinheim and gains a small foothold after sustaining heavy casualties in fight with KKA elements.

By 1530hrs 1/157 IR crosses bridge: all 157 IR elements are on the east bank of the Main.

Kreisleiter Wohlgenuth publishes a proclamation directing women, children, the sick and the elderly to leave on the 28th and 29th of March.

Teletype arrives from OKW ordering KKA to "fight to the last cartridge."

36 VGD conducts reconnaissance and prepares to assault bridgehead.

US 179th IR captures Obernberg and Sulzbach.

416 ID's southern flank is threatened by US assault crossings of the Main at Obernberg and Klingenberg by 3rd ID.

Hanau falls to Americans jepordizing KKA right flank.

The last German resistance on west bank of Main in Aschaffenburg area, at Leider, cleared by 157 IR.

179th IR crosses RR bridge and moves into line to south of 157 IR.

29 March 1945

At 1030hrs C/1/157 IR and I and L/3/157 IR attack Schweinheim with support of A/191 Tank Battalion and 2/B/645 TD Bn. Limited success as far as Catholic church.

OKW again transmits teletype order for KKA to fight "to the last cartridge."

LXXXII Corps ordered to maintain radio liaison with KKA in the event of a pull back.

A number of Luftwaffe infantry join 256 VGD in Mainaschaff sector.

Stars & Stripes newspaper reports that Patton's Third Army has cleared the Main River cities of Frankfurt, Hanau and Aschaffenburg.

KKA defenders from 106 IR and 9 Pionier Battalion training units occupy main defensive line from river east to Schweinheim. Cadets from local Reserve Officer Candidate School reinforce in Schweinheim.

Lieutenant Heymann hung for "fahnenflucht", "fleeing the flag", desertion.

German navy frogman team makes an attempt to blow center support of RR bridge with an aluminum torpedo; they fail.

30 March 1945

Two regiments of the 36 VGD attack American bridgehead at 0001hrs. overrun K/3/157 IR, by 0400 hrs reach to within one kilometer of bridge before being driven back. Back at start points by 0800hrs.

KKA elements counterattack in Schweinheim at 0320hrs.

3/157 IR attacks on right (south) in Schweinheim. 2/157 IR attacks through Obernauer Kolonie north along river. Both met with heavy resistance. L/3/157 IR loses 100 men in five minutes during assault.

44th ID Divarty attached to 45th ID Divarty. A total of 13 battalions, 90 tubes of artillery available to 157th Infantry Regiment. C/2 Chemical Mortar Bn DS to 157 IR.

1/ and 3/157 IR in house-to-house fighting in Schweinheim by midday.

Main River front flanked on north at Hanau and south at Kiingenberg. LXXXII Corps begins withdrawal from river. 36 VGD withdraws under fire from south of Schweinheim. KKA sends 9/3 Pi Bn to occupy positions vacated by 36 VGD on south of Schweinheim.

Navy frogmen final attempt to blow bridge fails when US mortar round detonates torpedo.

2/157 IR attack at 1730 hrs into southern part of Aschaffenburg is called off at 1900 hrs after heavy losses.

Skies clear at 1800hrs and eight fighterbomber sorties flow against city.

Recon troop from US 106 Cav Group clears railroad bridge at Mainaschaff. KKA now has direct pressure on south and north.

31 March 1945

2/157 IR bogged down in attack on northwest of battle lines.

3/157 IR makes good progress in Schweinheim. Co. K attacks and occupies part of Artillerie Kaserne.

1/157 IR jumps off in an attack on Haibach at 0630hrs.

3/179 IR attacks and captures Gailbach and Stengert hill.

Fifteen fighterbomber missions are flown in support of 157 IR dropping 100,000lbs of aerial bombs. A/ and D/191 TK BN support 157 IR.

Regimental Adjutant of 157 IR. in an artillery spotter plane, drops an ultimatum calling for surrender on German Headquarters. No response.

German-operated US Sherman tank takes advancing Americans under fire from Schweinheim Hill: destroyed by 2/B/645th TD Bn. Over 1000 mortar rounds are fired at the Americans in Schweinheim.

Four ME-262 German jet fighterbombers appear over the battlefield.

LXXXII Corps orders the 36 VGD to withdraw to the vicinity of Lohr. 256 VGD previously withdrawn. KKA isolated.

OKW publishes a report stating that Aschaffenburg is surrounded and the situation is hopeless.

1 April 1945

179 IR attacks through local training area to clear German artillery from high ground overlooking city on southeast.

1/157 IR attacks to clear Gailbach and Haibach. City is now flanked on southeast.

2/157 IR attacks down river (north), by 1500hrs resistance along river is broken.

3/157 IR, with F/2/157 IR attached, clears Schweinheim. K/3/157 IR clears Artillerie Kaserne, and attacks Bols-Brule Kaserne, by 1500hrs the kaserne falls after room-to-room fighting with heavy casualties on both sides. Parts of Pionier Kaserne occupied by Americans in the evening.

Loss of two southeastern kasernes and Haibach open route to encircle the city from the east.

Ten American fighterbomber missions (82 sorties) drop over 90,000lbs of bombs on battle area.

157 IR takes 1000 prisoners during day.

Elements of 324th Infantry Regiment cross Main and occupy blocking positions on northwest of Aschaffenburg. 1/324 IR screens while 2/324 IR attacks towards Mainaschaff.

2 April 1945

CG, 45th ID directs 157 IR to reduce city, while 179th and 180th IRs bypass and press to the east.

A/120 Engineer Combat Battalion constructs a Class 30 Spanner Bridge one kilometer downriver from the RR bridge.

Americans attach a platoon of M36 tank destroyers (90mm gun) to each battalion.

1/157 IR cuts road to east (Route 26) from city, takes Hoespach and Goldbach, and swings to west toward Mainaschaff. By 1700 hrs the city is physically surrounded when A/1/324 IR links up with 1/157 IR.

Lagarde and Jaeger Kasernes fall to 2/157 IR and 3/157 IR respectively.

2/157 IR with Cos. I and L from 3/157 IR attack the center of the city near the City Hospital. Pionier Kaserne strongpoints are reduced with direct fire 155mm artillery and heavy ground assaults. It falls at 1530 hrs.

3/157 IR (-) clears the northeast residential part of the city and occupies part of Fasantarie Park.

At 1850 hours 2/324 IR captures Mainaschaff, secures Kappellenberg at 1900 hours.

German defenses now uncoordinated and isolated, being defeated in detail.

German defenses now consist of only the center of the city around the castle and north of the rail line from the Sudbahnhof.

3 April 1945

Germans request surrender terms from Americans. Response is unconditional surrender, Germans comply.

City surrenders at 0900 hours. Two US liaison officers accompany Major Lambert as he personally directs the surrender of isolated outposts. Four hundred prisoners collected.

Smoke is rising 1000 ft into the air from the destruction cause by the fighterbombers and artillery.

HQ & Serv/120 Eng CBT BN has fire fight with exfiltrating KKA soldiers.

By 1840 hours the 157 IR is assembled near Hoesbach awaiting orders.

US military government detachment H1A3 arrives to take over city administration. The battle of Aschaffenburg is over.

APPENDIX 3

APPENDIX 3
ORDER OF BATTLE

American Forces:

1. Order of Battle. 25 March - 3 April 1945
2. Armored Division
3. Infantry Division

German Forces:

1. Order of Battle. 25 March - 3 April 1945
2. Infantry Division
3. Volksgrenadier Division

ORDER OF BATTLE AMERICAN FORCES 25 MAR - 3 APR 45

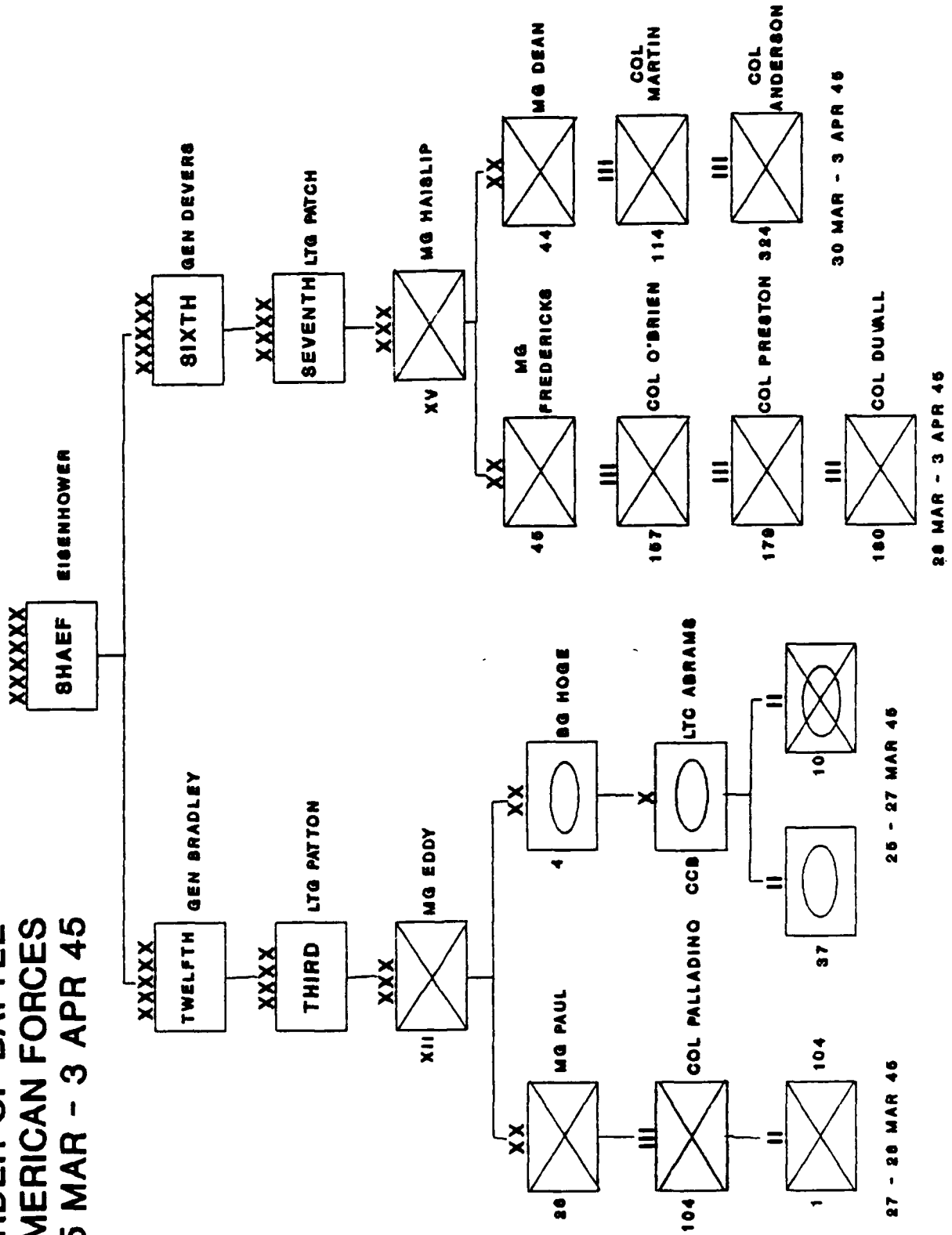

**U.S. ARMORED DIVISION WITH ATTACHMENTS
1945**

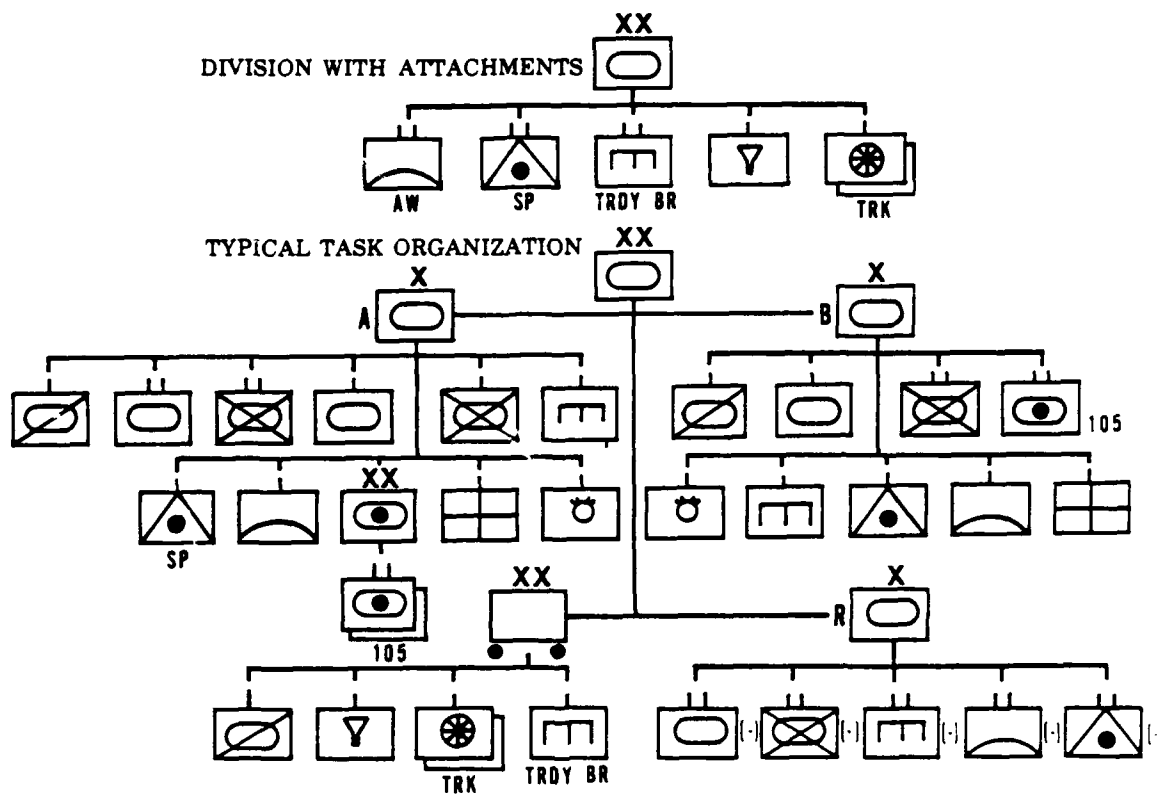

Source: Dr. Christopher R. Gabel, The Lorraine Campaign: An Overview, September-December 1944, (Fort Leavenworth, KS: Combat Studies Institute, U.S. Army Command and General Staff College, February 1985), 13.

**U.S. INFANTRY DIVISION WITH ATTACHMENTS
1945**

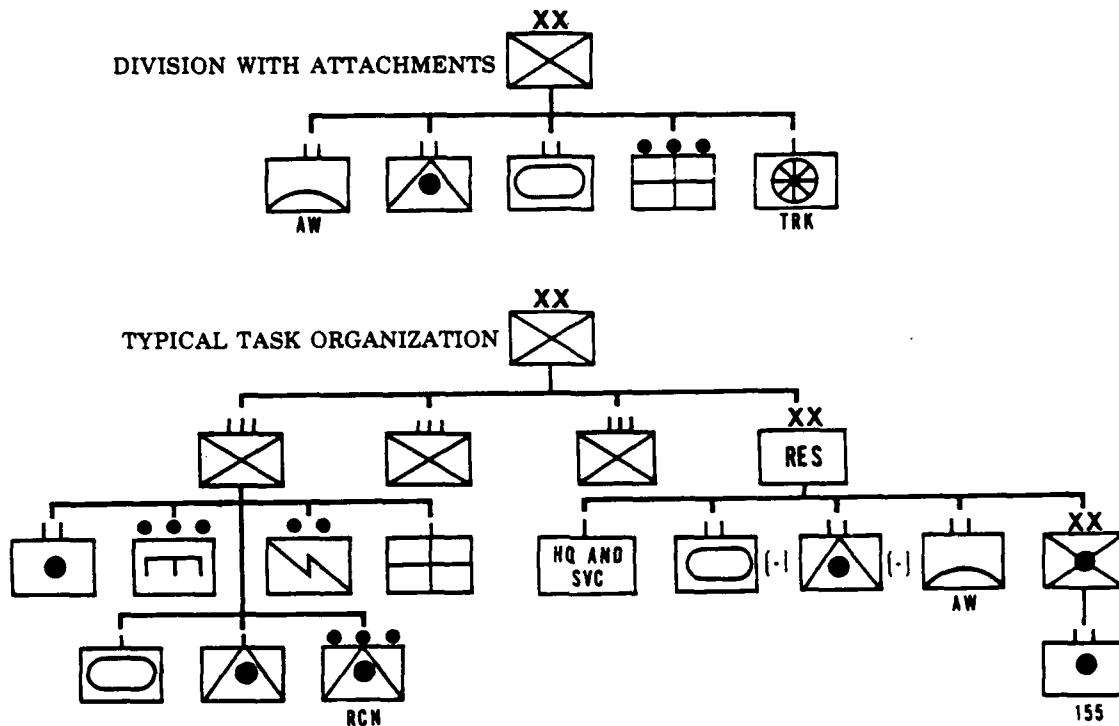

Source: Dr. Christopher K. Gabel, The Lorraine Campaign: An Overview, September-December 1944, (Fort Leavenworth, KS: Combat Studies Institute, U.S. Army Command and General Staff College, February 1985), 12.

ORDER OF BATTLE GERMAN FORCES

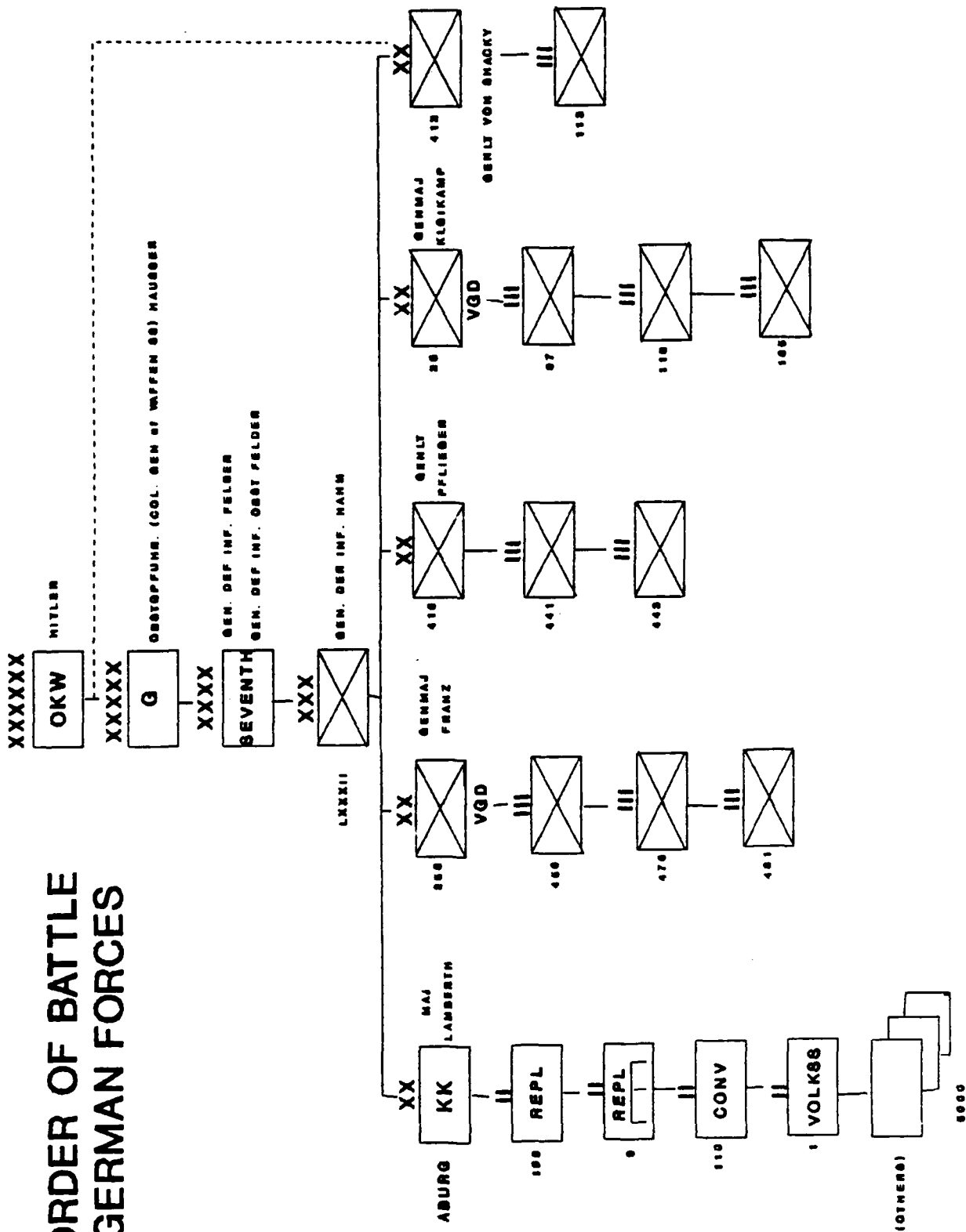

GERMAN, 1944

XX

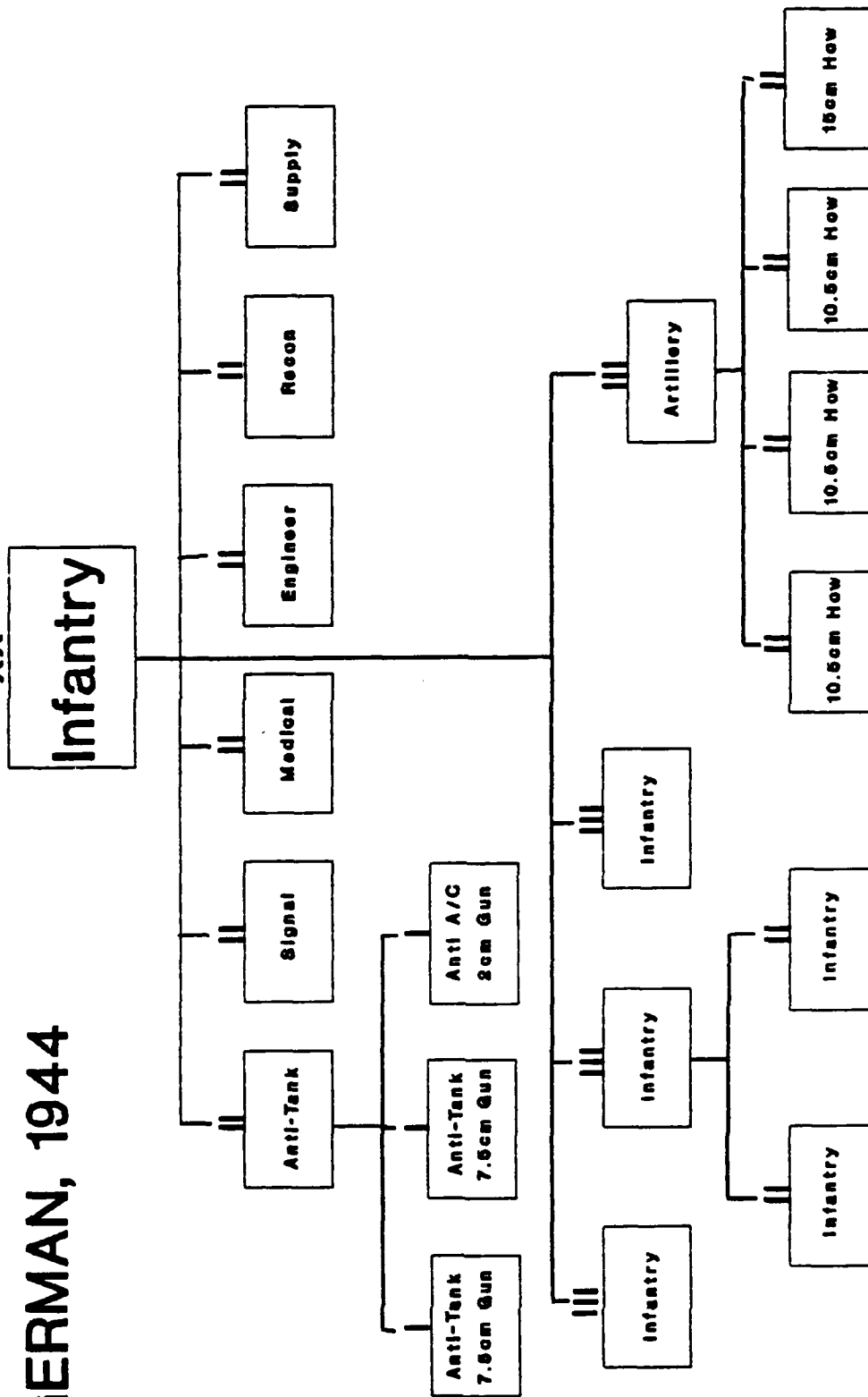

GERMAN VOLKSGRENADIER DIVISION, 1944

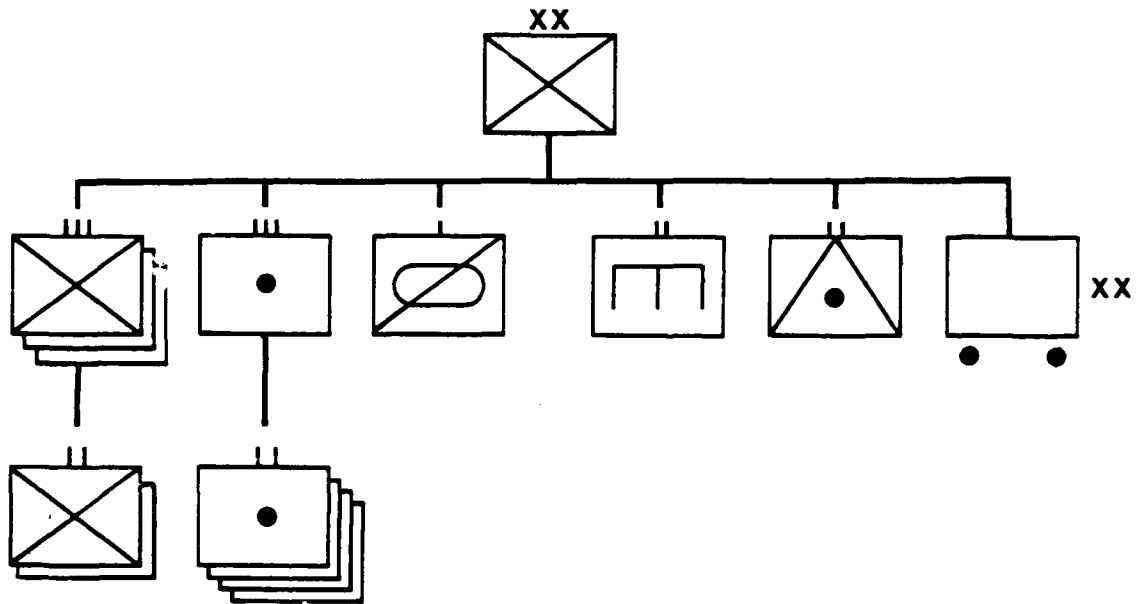

Source: Dr. Christopher R. Gabel, The Lorraine Campaign: An Overview, September-December 1944, (Fort Leavenworth, KS: Combat Studies Institute, U.S. Army Command and General Staff College, February 1985), 8.

APPENDIX 4

APPENDIX 4

Bibliography

Bibliographic sources examined for this study are organized under four broad headings: documents (published and unpublished); interviews, letters and lectures; articles; books. They are not further divided into primary and secondary sources because, in my view, the classification would have been artificial and not have truly reflected their value in the research effort. The principle sources used to tell the story from the American side come from unit histories, daily reports and summaries of operations. They were found in the Combined Arms Research Library (CARL), U.S. Army Command and General Staff College, Fort Leavenworth, KS, the 45th Infantry Division Museum (45 ID Museum), Oklahoma City, OK, and the Military Reference Branch of the National Archives and Records Administration, Washington, D.C. (NARA). These sources were supplemented with letters, newspaper and journal articles and discussions with participants. The principle sources for the German side come from CARL in the form of the post-war history studies done by former German officers for the United States Army Europe Historical Division, from the records of the Stadt- und Stiftsarchiv Aschaffenburg (SSA), and from letters, articles and discussions with participants. An especially valuable source are the local histories of Dr. Alois Stadtmueller, who has written three books and numerous articles on World War II.

DOCUMENTS:

Unpublished-

- Franz, Gerard. "Report on the Operations of the 256 VG Div., Mid Nov. 44 - 8 Apr 45." USAREUR Historical Division, 1946. CARL.
- Hausser, Paul. "Central Europe. Fighting of Heeresgruppe "G" From 22 Mar-4 Apr 45." USAREUR Historical Division, 1947. CARL
- Henderly, Harold B. "The Operation of Company D, 191st Tank Battalion at Aschaffenburg, Germany, 28 March-3 April 1945: Personal Experience of a Company Commander." Fort Benning, Ga: Academic Department, The Infantry School, 1949.
- Hold, Kurt, Maj. "Operations Conducted by the 416ID From 16 Feb Until 6 May 45." USAREUR Historical Division, 30 August 1946. CARL.

- Idei, LTC Peter A. "Defense of Villages: a German Army 'How To Fight' Guide From 1944." Monograph M-22-83. Cologne, GE: US Army Training and Doctrine Command Liaison Office Federal Republic of Germany. no date (1983?).
- von Ingelheim, Oberst (Graf) i. G. Ludwig. "LXXXII Corps. 27 Mar - 6 May 1945." USAREUR Historical Division. 6 May 1946. CARL.
- _____. "LXXXII AK - Interrogation." USAREUR Historical Division. 4 August 1946. CARL.
- Kleikamp, Generalmajor Helmut. "36th Volks Grenadier Division (28 Mar - 3 May 45)." USAREUR Historical Division. undated. CARL.
- Reichneim, Oberst i. G. Guenther. "Report on Activity of Colonel (GSC) Reichneim." USAREUR Historical Division. 1945. CARL.
- von Schnacky, Siegmund (Freiherr). "Report of 413th Replacement Division's Activities Between Area Wurzburg to the Thuringian Forests." USAREUR Historical Division. 18 March 1946. CARL.
- Sparks, Felix L. "The Aschaffenburg Battle." Lakewood, Co: 157th Infantry Association. 22 July 1982.
- Thompson, Sheldon L. "The Operation of Task Force Baum (4th Armored Division) Between Aschaffenburg and Hammelburg, Germany. 27-28 March 1945." Ft. Benning, GA: Academic Department, The Infantry School. 1949.
- U.S. Army Ground Forces Board Report. "Employment of FA Group HQ & HQ Batteries." 20 April 1945. CARL.
- U.S. Army. European Theater of Operations. 45th Divarty After Action Report. Mar-Apr 45. CARL.
- U.S. Army. 4th Armored Division. After Action Report for the Period 1 March - 31 March 1945. 6 July 1945. CARL.
- U.S. Army. 45th Infantry Division. G-3 Reports. 28 Mar - 3 Apr 45. CARL.
- U.S. Army. 45th Infantry Division. Transmittal of Unit History: Report of the 106th AAA AW Bn. 1-30 Apr 45. 45 ID museum.
- U.S. Army. 45th Infantry Division. Transmittal of Unit History: 158th Field Artillery Bn. 1-31 Mar 45. 24 April 1945. 45 ID museum.
- U.S. Army. 45th Infantry Division. Transmittal of Unit History: 158th Field Artillery Bn. 1-30 Apr 45. 12 May 1945. 45 ID Museum.

- U.S. Army. 45th Infantry Division. Transmittal of Unit History: 120th Medical Bn. March 1945. 19 April 1945. 45 ID Museum.
- U.S. Army. 45th Infantry Division. Transmittal of Unit History: 157th Infantry Regiment. March 1945. 16 April 1945. 45 ID Museum.
- U.S. Army. 1st Battalion. 157th Infantry Regiment. Unit Journal. 26 March - 3 April 1945. Record Group 407. NARA.
- U.S. Army. 2nd Battalion. 157th Infantry Regiment. Unit Journal. 26 March - 3 April 1945. Record Group 407. NARA.
- U.S. Army. 3rd Battalion. 157th Infantry Regiment. Unit Journal. 26 March - 3 April 1945. Record Group 407. NARA.
- U.S. Army. 45th Infantry Division. Transmittal of Unit History: 191st Tank Bn. 1-31 Mar 45 and 1-30 Apr 45. 45 ID Museum.
- U.S. Army. 45th Infantry Division. Battle Report (Mar 45): 645th Tank Destroyer Bn. 12 April 1945. 45 ID Museum.
- U.S. Army. 45th Infantry Division. War Room Journal (21-31 Mar 45). 45 ID Museum.
- U.S. Army. 45th Infantry Division. "The Story of Aschnaffenburg." PAO Office. 1 May 1945. Copy in author's possession.
- U.S. Army. 45th Infantry Division. Operations of the 45th Infantry Division. 28 Mar - 3 Apr 45. CARL.
- U.S. Army. 104th Infantry Regiment. S-3 Journal. 24-29 March 1945. Record Group 407. NARA.
- U.S. Army. 114th Infantry Regiment. Regimental History. March - April 1945. Record Group 407. NARA.
- U.S. Army. 324th Infantry Regiment. Narrative Report for the Months of March and April 1945. Record Group 407. NARA.
- U.S. Army. XII Corps. G-2 Periodic Reports (1-31 Mar 45). 29 March 1945. CARL.
- U.S. Army. XII Corps. Report of Operations (1-31 Mar 1945). 15 April 1945. CARL.
- U.S. Army. XV Corps. Action Against Enemy. Reports After. 1-31 Mar and 1-30 Apr 1945. 1 June 1945. CARL.
- U.S. Army. Seventh Army. G-2 History. Part Eight (1-31 Mar 1945). CARL.

U.S. Army. Seventh Army. G-2 Reports (1-31 Mar 45). CARL.

U.S. Army. 6th Army Group. G-2 Estimate of the Enemy Situation. 19 April 1945. CARL.

Wagener. Generalmajor Carl. "The Battle of Army Group B on the Rhein Up To Its Dissolution (22 Mar- 17 Apr 45)." USAREUR Historical Division. 25 March 1946. CARL.

War Department Observers Board. "Organization and Operations of XV Corps Artillery." 30 June 1945.

Wlutzki. Oberst i. G. Horst. "Army Group G (22 Mar - 6 May 45)." USAREUR Historical Division. 1947. CARL.

Published-

- McLaurin, P.D. and Paul A. Jureidini, David S. McDonald, Kurt Sellers. "Modern Experience in City Combat." Aberdeen Proving Ground, Md: US Army Human Engineering Laboratory Technical Memorandum 5-87. March 1987.
- Schram, Dr. Percy Ernst, Major der Reserve. "The German Wehrmacht in the Last Days of the War (1 Jan - 7 May 45)." World War II German Military Studies, vol II. New York: Garland Publishing Inc. 1979.
- U.S. Army. Army Map Service. Aschaffenburg, Germany, Sheet 222. AMS Series M741. 1951. copied from Germany 1:50,000. GSGS. Sheet 222. 1945. Washington, D.C.: U. S. Army Corps of Engineers.
- U.S. Army. European Theater of Operations. "Order of Battle of the United States Army. World War II. Paris: Office of the Theater Historian. December 1945. CARL.
- U.S. Army. FM 31-50. Attack on a Fortified Position and Combat in Towns. Washington, D.C.: U.S. Government Printing Office. 31 January 1944.
- U.S. Army. FM 90-10. Military Operations in Urbanized Terrain (MOU). Washington, D.C.: HQ Dept. of the Army. 15 August 1977.
- U.S. Army. XX Corps. "The Reduction of Fortress Metz. 1 September - 6 December 1944: An Operational Report." Carlisle, PA: US Military History Institute. March 1983.
- U.S. War Department. TM-E 30-451. "Handbook on German Military Forces." Washington: U.S. Govt. Printing Office. 15 March 1945.
- Wright, Burton III. Army of Despair: The German Volkssturm 1944-1945. Ph.D. Diss. The Florida State University. 1982. Ann Arbor, MI: UMI. 1982.

INTERVIEWS, LETTERS AND LECTURES:

Baunach, Manfred. Interview with author on 15 March 1985.

Conen, Harold. Interview with author on 11 November 1985.

Hugnes, Daniel. Ph.D. "Officer Corps of the German Army, 1860-1945." Fort Leavenworth, KS: S.L.A. Marshall Lecture. 22 November 1988.

Sanders, William (former corporal, M/3/157th Infantry Regiment). Interview with author. June 1985.

Sparks, BG (ret.) Felix L. Letter to author 31 March 1987.

_____. Letter to author 14 July 1987.

Woods, Maj (ret.) Leland. Letter to author 4 January 1987.

ARTICLES:

- von Anlen, Hans. "The Fighting of Fortress Breslau." Military Review. September 1956. p. 90-97.
- Aschaffenburg Frontzeitung (Aschaffenburg Front Newspaper). 30 Marz 1945. 2 pages. SSA.
- Aschaffenburg Soldatenzeitung. Folge 2, Freitag den 30 Marz 1945. 2 pages. SSA
- Brown, John S. "Colonel Trevor N. Dupuy and the Mythos of Wehrmacht Superiority: a Reconsideration." Military Affairs. January 1985. 16-20.
- "Der Bericht des Kampfkommandanten" (The Report of the Combat Commander). Main Echo. 70 (25 March 1955).
- "Hundert Geschuetze waren auf Aschaffenburg gerichtet" (A Hundred Guns Were Reported [Firing] At Aschaffenburg). Main Echo. 69 (3 May 1952).
- "Die Rebellion in der Pionierkaserne" (The Rebellion in Pioneer Barracks). Main Echo. 74 (1 April 1970).
- Reinthal, Hans. "Der Kampf um Aschaffenburg, Das Unternehmen der Kampfschwimmer" (The Battle Around Aschaffenburg, The Undertaking of the Combat Swimmers). Main Echo. (1 April 1955). 4.
- Schneider, Matthais. "Beim Kampf vor 40 Jahren Spielten auch Bunker eine Rolle, die 1936 Gebaut Wurden" (Built in 1936, the Bunkers Played a Role in the Battle of Forty Years Ago). Spessart. (April 1985). 3-9.
- "Der Tod des Leutnants Heymann" (The Death of Lieutenant Heymann). Main Post. 144 (19 November 1949).
- "Um 9 Uhr kapitulierte Aschaffenburg" (Aschaffenburg Capitulated At 9 AM). Main Echo. 76 (3 April 1970).
- "Zwei SS-Offiziere schrieen lauthals herum" (Two SS-Officers Yelling Loudly). Main Echo. 76 (30 March 1985).

BOOKS:

- Bradley, Omar N. A General's Life. New York: Simon and Schuster, 1983.
- Chandler, David G. The Campaigns of Napoleon. London: Weidenfeld and Nicolson, 1966.
- Combat History of the 44th Infantry Division 1944-1945. Atlanta, GA: Albert Love Enterprises, 1946.
- Combat History of the 324th Infantry Regiment. Baton Rouge, LA: Army and Navy Publishing Company, 1946.
- Dupuy, R. Ernest and Trevor N. Dupuy. The Encyclopedia of Military History. New York: Harper & Row, 1986.
- Dupuy, Trevor N. Numbers, Prediction and War: Using History to Evaluate Combat Factors and Predict the Outcome of Battles. Indianapolis: Bobbs-Merrill, 1978.
- Understanding War: History and a Theory of Combat. New York: Paragon House, 1987.
- Eisenhower, Dwight D. Crusade in Europe. Garden City, NY: Doubleday, 1948.
- The Fighting Forty-Fifth: The Combat Report of an Infantry Division. Baton Rouge, LA: Army and Navy Publishing Company, 1946.
- Fisher, George A. The Story of the 180th Infantry Regiment. San Angelo, TX: Newfoto Publishing Co. 1947.
- Grimm, Alois, et al. Vergangen, Nicht Vergessen - Sieben Jahrhunderte Jüdische Gemeinde in Aschaffenburg (Past, Not Forgotten - Seven Centuries of Jewish Community in Aschaffenburg). Aschaffenburg: Stadt Aschaffenburg, Stock & Koerber, 1984.
- Hasson, Joseph S. With the 114th in the ETO: a Combat History. Baton Rouge, LA: Army and Navy Publishing Company, 1945.
- History of the 157th Infantry Regiment. Baton Rouge: Army & Navy Publishing Company, 1946.
- Hogg, Ian V. German Army Order of Battle 1944. London: Arms and Armor Press, 1975.
- Madaj, W. Victor. German Army Order of Battle 1939-1945. 2 vols. plus supplement. Allentown, PA: Game Marketing Company, 1981.

- MacDonald, Charles B. The Last Offensive. The United States Army in World War II: European Theater of Operations. Washington, D.C.: Office of the Chief of Military History, U.S. Army, 1984.
- Nelson, Guy. Thunderbird, A history of the 45th Infantry Division. Oklanoma City, OK: The Oklahoma Publishing Company, 1970.
- Paecnter, Heinz. NAZI-Deutsch: a Glossary of Contemporary German Usage. New York: Fredrick Ungar Publishing Co. 1945.
- Pogue, Forrest C. The Supreme Command. The United States Army in World War II: European Theater of Operations. Washington, D.C.: Office of the Chief of Military History, U.S. Army, 1954.
- Polinick, Carsten. Die Entwicklung des Nationalsozialismus und Antisemitismus in Aschaffenburg 1919-1933 (The Development of National Socialism and Antisemitism in Aschnattenburg 1919-1933). Aschaffenburg: Geschichts- und Kunstverein Aschaffenburg e. V., 1984.
- Schwaub, Franz, and Bernd Pattloch. Aschaffenburg: Erlebnis Einer Stadt (Aschaffenburg: Experience a City). Aschaffenburg: Paul Pattloch Verlag, 1985.
- Stadtmueller, Alois. Aschaffenburg im Zweiten Weltkrieg (Aschaffenburg in the Second World War). Aschaffenburg: Geschichts- und Kunstverein Aschaffenburg e. V., 1971.
- _____. Aschaffenburg nach dem Zweiten Weltkrieg (Aschaffenburg After the Second World War). Aschaffenburg: Paul Pattloch Verlag, 1973.
- _____. Maingebiet und Spessart im Zweiten Weltkrieg (Main Region and the Spessarts in the Second World War). Aschnattenburg: Geschichts- und Kunstverein Aschaffenburg e. V., 1983.
- Stanton, Shelby L. Order of Battle US Army World War II. Novato, CA: Presidio Press, 1984.
- U.S. Army. The Seventh United States Army in France and Germany, 1944-1945: Report of Operations. Heidelberg, Germany: A. Graf, 1946.
- Williams, Mary H. Chronology, 1941-1945. The United States Army in World War II: Special Studies. Washington, D.C.: Office of the Chief of Military History, U.S. Army, 1960.

INITIAL DISTRIBUTION LIST

1. Combined Arms Research Library
U.S. Army Command and General Staff College
Fort Leavenworth, Kansas 66027
2. Defense Technical Information Center
Cameron Station
Alexandria, Virginia 22314
3. Lieutenant Colonel John S. Brown
2nd Battalion, 66th Armor
APO New York 09355
4. Colonel Burnet R. Quick
3rd Brigade, 3rd Infantry Division
APO New York 09162
5. 3rd Infantry Division Museum
APO New York 09036
6. Stadt- und Stiftsarchiv
Schoenborner Hof
8750 Aschaffenburg
Federal Republic of Germany
7. The 45th Infantry Division Museum
2145 N.E. 36th Street
Oklahoma City, Oklahoma 73111
8. Doctor Christopher R. Gabel
Combat Studies Institute
Command and General Staff College
Fort Leavenworth, Kansas 66027
9. Major Michael W. Hackerson
Center for Army Tactics
Command and General Staff College
Fort Leavenworth, Kansas 66027
10. Doctor Samuel J. Lewis
Combat Studies Institute
Command and General Staff College
Fort Leavenworth, Kansas 66027