

AD-A181 322

Close Support Artillery for the  
U.S. Light Infantry Division

by  
Major Michael D. Starry  
Field Artillery

DTIC  
SELECTE  
JUN 08 1987  
S D

School of Advanced Military Studies  
U.S. Army Command and General Staff College  
Fort Leavenworth, Kansas

15 December 1986

Approved for public release, distribution unlimited

# DISCLAIMER NOTICE

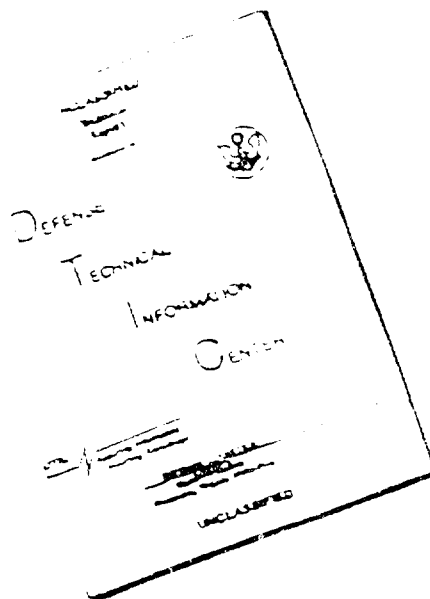

THIS DOCUMENT IS BEST  
QUALITY AVAILABLE. THE COPY  
FURNISHED TO DTIC CONTAINED  
A SIGNIFICANT NUMBER OF  
PAGES WHICH DO NOT  
REPRODUCE LEGIBLY.

REPRODUCED FROM  
BEST AVAILABLE COPY

THIS DOCUMENT CONTAINED  
BLANK PAGES THAT HAVE  
BEEN DELETED

## REPORT DOCUMENTATION PAGE

Form Approved  
OMB No 0704-0188  
Exp. Date: Jun 30, 1986

1a REPORT SECURITY CLASSIFICATION Unclassified		1b RESTRICTIVE MARKINGS	
2a SECURITY CLASSIFICATION AUTHORITY		3 DISTRIBUTION/AVAILABILITY OF REPORT Approved for public release; distribution unlimited.	
2b DECLASSIFICATION/DOWNGRADING SCHEDULE		4 PERFORMING ORGANIZATION REPORT NUMBER(S)	
4 PERFORMING ORGANIZATION REPORT NUMBER(S)		5 MONITORING ORGANIZATION REPORT NUMBER(S)	
6a. NAME OF PERFORMING ORGANIZATION School of Advanced Military Studies USAC&GSC	6b. OFFICE SYMBOL (If applicable) ATZI-SWV	7a. NAME OF MONITORING ORGANIZATION	
6c. ADDRESS (City, State, and ZIP Code) Ft. Leavenworth, Kansas 66027-6900		7b. ADDRESS (City, State, and ZIP Code)	
8a. NAME OF FUNDING/SPONSORING ORGANIZATION	8b. OFFICE SYMBOL (If applicable)	9. PROCUREMENT INSTRUMENT IDENTIFICATION NUMBER	
8c. ADDRESS (City, State, and ZIP Code)		10. SOURCE OF FUNDING NUMBERS	
		PROGRAM ELEMENT NO.	PROJECT NO.
		TASK NO.	WORK UNIT ACCESSION NO.
11. TITLE (Include Security Classification) Close Support Artillery for the U.S. Light Infantry Division (U)			
12. PERSONAL AUTHOR(S) Major Michael D. Starry, USA			
13a. TYPE OF REPORT Monograph	13b. TIME COVERED FROM _____ TO _____	14. DATE OF REPORT (Year, Month, Day) 86/12/15	15. PAGE COUNT 46
16. SUPPLEMENTARY NOTATION			
17. COSATI CODES		18. SUBJECT TERMS (Continue on reverse if necessary and identify by block number)	
FIELD	GROUP	SUB-GROUP	
19 ABSTRACT (Continue on reverse if necessary and identify by block number) This study is an analysis of the close support artillery battalion in the Light Infantry Division (LID) and it's relationship with the maneuver brigade. There is currently a debate over whether the maneuver brigade should have an organic artillery battalion or the traditional direct support artillery battalion. Recent studies such as ARMY 21 and MOC 96 (Maneuver Oriented Corps) suggest organic artillery battalions are the best organization for the future battlefield. In addition recent experience at the National Training Center indicates in general that maneuver-fire support team relationships have some serious weaknesses. One solution in correcting these problems and organizing units for the future battlefield is organic artillery battalions in the maneuver brigades to include the brigades of the LID. (continued on the other side)			
20 DISTRIBUTION/AVAILABILITY OF ABSTRACT <input type="checkbox"/> UNCLASSIFIED/UNLIMITED <input type="checkbox"/> SAME AS RPT <input type="checkbox"/> DTIC USERS		21 ABSTRACT SECURITY CLASSIFICATION Unclassified	
22a NAME OF RESPONSIBLE INDIVIDUAL MAJ Michael D. Starry		22b TELEPHONE (Include Area Code) (913) 684-2138	22c OFFICE SYMBOL ATZI-SWV

In order to determine if the maneuver brigades should have organic artillery battalions in the LID this paper examines the LID, its unique missions, capabilities and limitations, and its unique light infantry characteristics. Also considered are historical examples of U.S. and German light divisions in WWII, U.S. infantry divisions in Vietnam and the contemporary British light contingency force. The analysis includes an examination of the employment of close support artillery in these historical examples using the fire support doctrinal tenets of adequacy, flexibility and continuity. Technological improvements in field artillery systems are also considered as they relate to a potential need for a change in the artillery battalion-maneuver brigade relationship. Finally the organic and direct support options are examined using four principles of war: offense, mass, economy of force and unity of effort.

The study concludes that the close support artillery battalions of the LID should not be organic to the maneuver brigades. The LID is designed to combine arms at the division level and the division cannot synchronize firepower for the division battle if the artillery battalions are organic to the maneuver brigades. Some organic artillery in the maneuver brigades appears to be an effective, efficient option although the brigades would be unable to rely on these small units of artillery for all their close support needs. The best relationship for now and into the 1990's remains the direct support mission which gives the division commander flexibility in employing scarce artillery assets as he synchronizes the division fight.

Close Support Artillery for the  
U.S. Light Infantry Division

by  
Major Michael D. Starry  
Field Artillery

School of Advanced Military Studies  
U.S. Army Command and General Staff College  
Fort Leavenworth, Kansas



15 December 1986

Approved for public release, distribution unlimited

Acquisition For	
NTIS CRA&I	<input checked="" type="checkbox"/>
DTIC TAB	<input type="checkbox"/>
Unannounced Justification	<input type="checkbox"/>
By Distribution/	
Availability Codes	
Dist	Avail and/or Special
A-1	

School of Advanced Military Studies

Monograph Approval

Name of Student: Major Michael D. Starry

Title of Monograph: Close Support Artillery for the U.S. Light Infantry Division

Approved by:

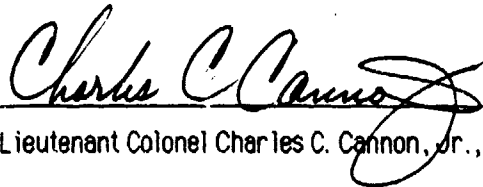
  
Lieutenant Colonel Charles C. Cannon, Jr., M.S.

Monograph Director

  
Colonel Richard Hart Sinnreich, M.A.

Director, School of  
Advanced Military Studies

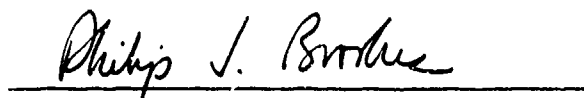
  
Philip J. Brookes, Ph.D.

Director, Graduate Degree  
Program

Accepted this 15<sup>th</sup> day of December 1986.

## ABSTRACT

CLOSE SUPPORT ARTILLERY FOR THE U.S. LIGHT INFANTRY DIVISION by MAJ. Michael D. Starry, USA., 46 pages

This study is an analysis of the close support artillery battalion in the Light Infantry Division (LID) and its relationship with the maneuver brigade. There is currently a debate over whether the maneuver brigade should have an organic artillery battalion or the traditional direct support artillery battalion. Recent studies such as ARMY 21 and MOC 96 (Maneuver Oriented Corps) suggest organic artillery battalions are the best organization for the future battlefield. In addition recent experience at the National Training Center indicate in general that maneuver-fire support team relationships have some serious weaknesses. One solution in correcting these problems and organizing units for the future battlefield is organic artillery battalions in the maneuver brigades to include the brigades of the LID.

In order to determine if the maneuver brigades should have organic artillery battalions in the LID this paper examines the LID, its unique missions, capabilities and limitations, and its unique light infantry characteristics. Also considered are historical examples of U.S. and German light divisions in WWII, U.S. infantry divisions in Vietnam and the contemporary British light contingency force. The analysis includes an examination of the employment of close support artillery in these historical examples using the fire support doctrinal tenets of adequacy, flexibility and continuity. Technological improvements in field artillery systems are also considered as they relate to a potential need for a change in the artillery battalion-maneuver brigade relationship. Finally, the organic and direct support options are examined using four principles of war: offense, mass, economy of force and unity of effort.

The study concludes that the close support artillery battalions of the LID should not be organic to the maneuver brigades. The LID is designed to combine arms at the division level and the division cannot synchronize firepower for the division battle if the artillery battalions are organic to the maneuver brigades. Some organic artillery in the maneuver brigades appears to be an effective, efficient option although the brigades would be unable to rely on these small units of artillery for all their close support needs. The best relationship for now and into the 1990's remains the direct support mission which gives the division commander flexibility in employing scarce artillery assets as he synchronizes the division fight.

## Table of Contents

	Page
Introduction	1
Definitions	4
The Light Infantry Divisions (LID)	5
Field Artillery Support	7
An Historical Perspective	9
The 10th Mountain Division (WWII)	9
The German Mountain Division (WWII)	11
The U.S. Infantry Division (Vietnam)	12
The United Kingdom Expeditionary Forces (UKEF)	14
Analysis and Implications	15
Field Artillery Support for the LID	15
Future Conflict	18
Four Principles of War	21
Conclusions	27
Appendices:	
1. Inherent Responsibilities of Artillery Units	30
2. The Light Infantry Division	31
3. The 10th Mountain Division	32
4. Regimental Cannon Companies	33
5. The German Mountain Division	34
6. The German Mountain Division (Organic Artillery)	35
7. U.S. Infantry Division Artillery-1965	36
8. The United Kingdom Expeditionary Force	37
Endnotes	38
Bibliography	42



## Introduction:

The key to success on the modern battlefield is the ability to create superior combat power by combining maneuver, firepower, protection and leadership in combat action.<sup>1</sup> This unique integration of material assets and military maxim has come to be known as "combined arms". Its value has been recognized by professional soldiers since the days of Frederick the Great. Simply stated, this "combined arms concept" is the basic idea that different arms and weapons systems must be used in concert to maximize the survival and combat effectiveness of each other. The strengths of one system must be used to compensate for the weaknesses of the others, so as to gain a collective effect greater than that of the individual parts.<sup>2</sup> If this contemporary description of combined arms is accepted, then it is essential that the strength of the given combat arm be organized so as to maximize this potential.

Although there are numerous factors that contribute to accomplishing the synergy that produces effective combat power, there are two essential elements. The first of these is doctrine. Doctrine describes the actual roles performed and techniques applied by the different weapons and arms once they have been integrated into the combined arms team. Doctrine also reflects an army's assessment of the battlefield and its expectations of what combat will be like. The second element is the combined arms organization itself, which reflects doctrine in its structure and design. Based on the tactics and operations envisioned for the battlefield, companies, battalions, and brigades are structured in order to maximize their combat power by combining arms at various tactical levels. Different arms and weapons are brought together in these organizations by either fixed tables of organization and equipment, or by "ad hoc" task organized combinations.

Exactly which arms and weapons are combined varies greatly. Different armies have done it differently throughout history. Today, however, the basic list of arms that are routinely combined includes infantry (all types), armor, artillery, engineers, cavalry, helicopters, signal, air defense, close air support and combat service support. A second point of variance, and one of considerable controversy, is that of the level of organization. Which arms or weapons to combine at the various levels of command has been a focal point of debate from the Napoleonic Corps system to the Army of Excellence (AOE), and is reflected in the variety of force structures in armies around the world. One such debate today centers on the direct support field artillery battalions of the Light Infantry Division and their relationship with maneuver brigades. The fundamental question is how should modern American field artillery be structured to meet the Airland Battle doctrinal challenge? In order to answer this question, especially in the context

of the light division, several issues must be addressed.

The current light division organization has a division artillery (Divarty) that includes three artillery "close support" battalions, one for each maneuver brigade. (The term close support is used to differentiate between a unit and a mission assigned to a unit such as direct support or reinforcing). The artillery battalions remain under the command of the Divarty and the support relationships are established based on the tactical situation. This centralized, pooling of artillery units at the division level has been the rule in U. S. artillery organization since WWI. Three wars and almost seventy years later, there are a number of indicators that suggest this traditional approach to task organizing field artillery for direct support needs to be re-examined. Perhaps a more effective decentralized or even an organic relationship in force design should be adopted. In the context of the U.S. Army Light Infantry Division a series of trends and indicators exist that require its artillery organization to be critically analyzed to insure it is getting its proverbial "best bang for the buck."

The first indicator is the trend in combined arms warfare toward a more decentralized apportionment of arms and weapons in order to achieve a more effective balance of combat power. As one Army historian points out: ".....major armies have tended to integrate more and more arms and services at progressively lower levels of organization, in order to combine different capabilities of mobility, protection, and firepower while posing more complicated threats to enemy units." <sup>3</sup> A review of the changes in force structure of the world's leading armies in the 20th Century clearly reflects this trend.

A second indicator involves a look toward the future. FM100-5, OPERATIONS, describes tomorrow's battlefield as three-dimensional, non-linear, fluid, and highly lethal with advanced technology aiding leaders as well as soldiers at all levels. <sup>4</sup> In predicting the battlefield of 1996, a recent National Defense University study uses a similar description of the battlefield. It also builds on the Airland Battle tenets of agility, initiative, depth and synchronization. The study suggests a reorganization of the U.S. Army corps, focusing on self-contained, mobile regimental combat teams (including an organic field artillery battalion) with the corps, not the division, providing the necessary additional combat support and combat service support assets. <sup>5</sup> Another study, Army 21, also addresses reorganization by providing the conceptual framework to guide new developments in force structure, doctrine and training well into the 21st Century. That document provides a deeper look into the future, characterizing future combat as ever more decentralized and increasingly fought by smaller more self-contained units than today. Similar to the 1996 study, the fire support concepts in ARMY 21 envision organic field artillery battalions at the maneuver regiment level much like the howitzer battalion in today's armored

cavalry regiments or separate brigades.<sup>6</sup>

Yet another factor that argues for a review of traditional artillery organization and support relationships is the unique missions of the Light Infantry Division(s). The division is a strategically deployable force with requirements to respond to crisis virtually anywhere in the world. In a 1984 White Paper, the Chief of Staff of the Army indicated that while the Light Infantry Division is primarily a force to be employed in a low intensity combat environment, it must also be capable of deployment to and operations in a high intensity environment.<sup>7</sup> Therefore, given the scope of employment possibilities and variety of missions, it is obvious that the light division will need great flexibility in organization and doctrine. It must be a highly trained, closely knit combined arms team that seeks to maximize its strength through superior organization, weapons and tactics.

In view of these facts it appears that a thorough analysis of artillery support in the Light Infantry Division is overdue. This monograph will focus on the close support battalions normally assigned the traditional mission of direct support to the maneuver brigades, concentrating on how these artillery battalions are combined with maneuver forces, in order to answer a vital organizational question: Should the direct support artillery battalions be organic to the maneuver brigades in the Light Infantry Division?

To answer this question I will first establish the definitions of organic support and direct support highlighting the differences between the two relationships. In order to establish the field artillery support requirements of the LID, I will also examine its various missions, capabilities and its unique light infantry characteristics. This background discussion will also include the current field artillery organization and doctrine in the LID. The current artillery organization and doctrine will be the basis for comparison with historical examples of light infantry divisions in WWII, Vietnam and the Falklands. This comparison will be used in the analysis to determine which is the best relationship for the close support artillery battalion: organic or direct support. The analysis will also include an assessment of future conflict to determine if the current LID artillery organization and doctrine is adequate to support the division on tomorrow's battlefield. The monograph will conclude with an examination of the adequacy of the direct support and organic relationships, using the principles of the offense, mass, economy of force and unity of effort as tools for the analysis.

## Definitions

Before proceeding, it is important to insure a common understanding of some essential terms. First, what is meant by the term organic? Current Army doctrine defines it as "Assigned to and forming an essential part of a military organization; an element normally shown in the unit's table of organization and equipment (TOE)".<sup>8</sup> More specifically, when applied to an organic field artillery battalion of a maneuver brigade, organic means: an artillery battalion assigned to the brigade and shown on the brigade table of organization and equipment. Such a battalion is primarily concerned with the field artillery support needs of only that brigade. The artillery commander serves as the brigade fire support coordinator (FSCoord) and insures fires are planned and coordinated with the brigade scheme of maneuver. The organic field artillery (FA) battalion is positioned by its commander with the approval of brigade. It trains and deploys the brigade's fire support teams (FIST) and fire support sections (FSS) from company to brigade level. The FA battalion commander is also responsible to the brigade commander for the overall training and readiness of his unit. As with other organic elements supply, maintenance and administrative support are the responsibility of the brigade.

For artillery, direct support describes the current relationship between the artillery battalion and the maneuver brigade. Current doctrine defines it as: "Artillery whose primary task is to provide fire requested by the supported units".<sup>9</sup> A cannon battalion assigned the mission of direct support is primarily concerned with the field artillery support needs of the supported brigade only. The artillery battalion commander is the brigade FSCoord. Fires are planned and coordinated by the FSCoord with the brigade scheme of maneuver. The battalion is positioned on the battlefield by the battalion commander or as directed by force FA headquarters. The battalion answers calls for fire from the brigade and from the force FA HQ. The artillery battalion trains and deploys FIST and FSS from company to brigade level. The battalion commander is responsible to the force FA HQ for the overall training and readiness of the unit. Supply, maintenance and administrative support are provided by the force FA HQ.<sup>10</sup>

Several essential distinctions between organic and direct support need to be reiterated briefly. (See Appendix I) The organic unit has no inherent responsibility to respond to "force artillery headquarters," i.e. Divarty in calls for fire or positioning, whereas the direct support (DS) unit is responsive to Divarty control. That means the division cannot rely on the organic FA battalion in the brigade for additional firepower when massing division fires or when firing counterfire or interdiction. In addition the organic unit cannot be assigned either of three other field artillery tactical missions (reinforcing, general support reinforcing or

general support), or an "on order" mission when its parent unit is not committed or is in reserve. That is to say they cannot support other field artillery units or division requirements for fires. In addition the organic unit could be held in reserve (when its parent brigade is in reserve).

In order to determine if the close support artillery battalions should be organic to the brigades, one has to look first at the Light Infantry Division and its missions, including the basic characteristics and capabilities of light infantry in general. These two factors will provide a focus for the discussion of doctrinal requirements and force design needs of the division in the context of artillery support.

### The Light Infantry Divisions (LID)

Today's Army faces a variety of challenges. It may have to fight in a mid to high intensity environment on a sophisticated Airland battlefield against a well-equipped heavy force or in a low intensity environment against enemy forces that range from insurgent guerillas to Soviet surrogates. The LID has been developed to provide a flexible combat ready force capable of deterring aggression, and should deterrence fail, defeating an enemy in low to mid intensity combat scenarios. It is optimized for employment against light forces in a low to mid intensity conflict. Depending on the situation the division can be employed as a complete division or as separate brigades and battalions. Without additional augmentation the LID is extremely vulnerable to enemy air, artillery and nuclear or chemical attack. Whether the division is operating in a contingency area or as a reinforcement to a forward deployed corps, it is augmented by or integrated into the operating and supporting structure of a larger force.<sup>11</sup>

Tactical operations conducted by the LID capitalize on the unique capabilities of light infantry. Although their tactics and techniques in a specific environment are based on the factors of METT-T, the division is capable of operating in virtually all types of terrain and weather. It is ideally suited for fighting at night or in periods of reduced visibility. The division fights in and moves through forests, jungles, mountains or urban areas.<sup>12</sup>

Colonel Huba Wass de Czege provides some insight to these LID distinctions in his description of light infantry. "Light infantry is specialized for rapid air transportability, clandestine insertion, very rugged terrain, night operations, infiltration, raids and ambushes; it gives off only a small tactical signature."<sup>13</sup>

Edward N. Luttwak also describes light infantry and points up some essential differences between it and other kinds of infantry:

The salient differences between the 'light' and regular infantry lies in their respective modes of warfare rather than in their equipment.

.....regular infantry fights predominantly in a linear-front mode as part of a wider array of forces, both serving and being served by the extra-divisional artillery, armor and other elements with which it must cooperate at the tactical level;

.....light infantry, on the other hand, normally fights in a non-linear and tactically independent manner, even if its actions are coordinated with those of other elements at the operational level. <sup>14</sup>

Steven L. Canby in his study "Classic Light Infantry and New Technology" highlights still more characteristics of light infantry that are important to this discussion, especially as they relate to the size of the force employed and also to its firepower needs. Frequently, the light infantry will not employ an artillery preparation prior to an attack. This aids the force in achieving surprise and gaining the initiative. The force emphasizes a quick attack supported by timely volume fire. The critical factor is not mass but rather timely accurate concentrations. In regards to the debate over fire or maneuver for the light infantry force in the attack or the defense, maneuver not firepower is employed. Protection is achieved not as much from firepower as through night operations, camouflage and simply digging-in. The light infantry relies mostly on its organic infantry weapons which capitalizes on opportunity gained in decentralized, small unit operations like ambushes, patrolling or squad through platoon sized attacks. Best suited for close terrain, light infantry formations have historically been most often employed in brigade or smaller size elements in close terrain environments. <sup>15</sup>

In summary, as a part of the combined arms team (the field artillery) has a unique challenge as the principal indirect fire support means in the LID. To accomplish its mission the field artillery organization and doctrine must be highly flexible. The artillery must provide adequate support to any size unit deployed for combat whether it is the entire division, a brigade or a battalion. Support is also required in a variety of environmental conditions ranging from the open terrain of the mountains to the jungles. The restrictions of terrain and tactical mobility as well as strategic mobility considerations will limit the size of artillery weapons (weight and caliber). These mobility factors will also limit the size of the artillery units to be employed

The demand for responsive, accurate fires is a universal requirement of the maneuver commander regardless of the environment (high or low intensity) or type of force (heavy or light). But in the light infantry environment of close combat, decentralized operations and offensive maneuver, the artillery must capitalize on flexibility in doctrine and organization to provide the best support possible. To better understand how the artillery will meet this challenge a review of the current LID artillery organization and doctrine is necessary.

### Field Artillery Support

The division's field artillery organization provides the LID with artillery fires and establishes the command, control and coordination (C3) network needed to integrate all other available fire support. Divarty is organic to the division and (See Appendix 2) has three 105mm battalions (one for each brigade) to provide close support and one general support 155mm battery providing support to the division as a whole. Each close support battalion has a countermortar radar (Q36) for target acquisition. For additional fire support the division will receive augmentation from a supporting force (echelons above division) in the areas of target acquisition, counter fire and indirect fire for deep attack (long range cannons and rocket systems).<sup>16</sup>

Current doctrine specifies that the Divarty will provide support in three primary areas: close support, counterfire and interdiction. Close Support is immediately responsive close and continuous fires that are coordinated with and integrated into the scheme of maneuver. Close support enables commanders rapidly to multiply combat power and shift fires quickly around the battlefield expanding the battlefield depth, damaging enemy forces and positions and inflicting damage beyond direct fire range. Logically maneuver commanders value close support over other field artillery roles because of the clearly visible effects on the outcome of the battle as it occurs along the FLOT. This is the primary mission of the close support battalion.<sup>17</sup>

Counterfire on the other hand is the attack of enemy artillery, mortars and air defense. Enemy observation posts and command posts are also counterfire targets. Counterfire will normally be planned by Divarty. It will be executed by artillery battalions with either general support, general support reinforcing or reinforcing missions or by "other" fire support means augmenting the division (naval gunfire, helicopters or close air support).<sup>18</sup>

Interdiction disrupts, delays or destroys enemy forces not yet in contact and in doing so adds depth to the battlefield. Correspondingly it allows the commander to shape portions of the battlefield while enhancing his force's increased freedom of maneuver. Interdiction fires are

normally planned and executed in the same manner as counterfire. Because of the limited range of the 105mm howitzer the LID will rely heavily on naval gunfire, close air support and attack helicopters for interdiction fires. <sup>19</sup>

Doctrine also provides the rules and procedures that guide the action and employment of the artillery as a part of the combined arms team. Let us look briefly at current doctrine for employment of the LID artillery. The artillery organizes for combat in order to provide responsive, effective fires, and to coordinate all fire support. To accomplish these tasks the field artillery uses four standard tactical missions: direct support (DS), reinforcing (R), general support reinforcing (GSR) and general support (GS). When the division commander organizes his Divarty for combat, he meets his own needs for artillery fires as well as the needs of the maneuver brigades. He must provide assets for close support (DS,R) of the brigades and keep enough assets under his immediate control (GSR, GS) to influence the close battle and deep battle at critical times and places. These fires under the division commander's control (GSR, GS) include close support fires, but will focus largely on interdiction and counterfire. In order to provide these responsive, effective fires, current doctrine focuses on three fundamentals clearly stated in the Army's capstone doctrinal manual FM100-5, Operations: "In integrating fire support into operations, the most important considerations are adequacy, flexibility and continuity". <sup>20</sup>

Minimum adequate support for units in contact will always be an important issue in combining arms, and ultimately, in winning battles. Current U.S. Army doctrine considers one FA battalion in support of each committed brigade as minimum adequate support. Tied to the question of adequacy is the related issue of responsiveness. Essentially it is a question of timely fires, but it is also a question of mass. Massing at the right place and at the right time has become the hallmark of the U.S. Army artillery and the means by which adequacy and responsiveness are measured. Not only in massed fire missions, but in other battery and battalion fire missions, the unit in contact expects fires quickly and at the right place, otherwise the support is not adequate regardless of the number of fire units supporting the brigade. Assignment of standard field artillery tactical missions to battalions in the Divarty allows the division commander to provide adequate fires at the right place, the right time and in sufficient quantity. <sup>21</sup>

Flexibility in our current doctrine is largely a function of centralized control. Control is centralized at the highest level possible consistent with fire support capabilities and mission requirements. Flexibility in organizational design also allows the system to establish and rapidly to shift priorities as the operation unfolds. In doing so it provides the necessary weight



to support the main effort in the offense while also being capable of strengthening the vulnerable areas in the defense. Flexibility is gained largely through positioning and assignment of tactical missions versus organic or fixed organizational association. <sup>22</sup>

In order to provide continuity of support field artillery must be prepared in the face of either planned or unforeseen events to insure smooth transitions from one phase of an operation to another. In order to accomplish this the artillery units are assigned standard tactical missions. They can also be assigned on-order as well as non-standard missions. Continuity is further enhanced by positioning, movement of units, and allocation of ammunition. In order to provide continuous effective fire support throughout an operation, the fire support planning and coordination process must mirror the operations planning effort. Fire planning is a continuous and simultaneous process conducted at all levels of command. Finally, continuous support also refers to the "grass roots" sustainability of the system, ie weapons system maintenance and ammunition resupply. <sup>23</sup>

### An Historical Perspective

It is appropriate at this point to look at historical and contemporary examples of light infantry divisions and their field artillery organizations and doctrine. In each example the armies organized their artillery to provide adequate, flexible and continuous support. In order to accomplish these three fundamentals each army had to chose between organic artillery in the infantry brigades or centralized control at the division level and the subsequent direct support relationship. These historical examples will examine light infantry divisions and how effective they were in terms of providing adequate, flexible and continuous support to determine which is the best relationship-organic or DS.

#### The 10th Mountain Division (WWII)

The 10th Mountain Division was the only U.S. Army light division to see combat in WWII. The division was specifically designed and trained to fight in the mountains of northern Italy and deployed to that theater in December 1944 under a modified light division TOE which closely resembled the regular infantry division. (See Appendix 3) The unit fought with distinction in medium mountain terrain at Riva Ridge and in the Po Valley. Improvisation in task organizing

units, small unit actions and individual initiative characterized the division's successful operations.<sup>24</sup>

The division's field artillery was organized with only three battalions of 75mm howitzers organic to the Divarty. Also, the division was organized without the cannon companies normally found in the infantry regiments; however, companies and battalions had 60mm and 81mm mortars respectively. In addition the Divarty was made even weaker with the decision to delete the 105mm general support battalion from the original TOE.<sup>25</sup> The division had to overcome these weaknesses and it was able to do it, largely through application of sound doctrinal principles. First, adequate support was provided to the regiments not through organic artillery but by maintaining centralized control of the artillery at division level and by assigning artillery battalions direct support and other missions. Doctrine also required the division to synchronize the supporting fires of the corps and army artillery units. The Divarty effectively allocated and prioritized the augmenting fires of these units to support the entire division which included massed fires when necessary. This centralized control at the Division level also gave the Divarty the flexibility to attach artillery units to regiments when necessary. At Tarbole during the Riva Ridge operation, 75mm artillery platoons (four howitzers each) were attached to units well forward to provide direct and indirect fires to assault troops, river crossings, ambushes, patrols, "bunker-busting", and clearing tunnels and roadways.<sup>26</sup> Adequacy of support was provided assigning DS missions and giving priority of fires to the critical point in the battle. In addition massing of artillery fires controlled by the Divarty was decisive in the battle at Tarbole. The Divarty provided continuity in this battle by attaching artillery units, assigning missions (DS, R, GS) and employing all the artillery available, holding none in reserve.<sup>27</sup>

It is difficult to ascertain whether or not the field artillery support of the infantry regiments would have been different if the close support artillery battalion was organic rather than DS. However, one thing is clear - the 10th Division Artillery would have had difficulty providing adequate, flexible and continuous support if the battalions were organic. Without modifying the organic relationship, the division would not have been able to call on the DS battalion to mass fires with the division. In addition the brigade in reserve would have kept its organic artillery battalion also in reserve, limiting the division commander's ability to anticipate future operations and weight the main attack or strengthen the defense. In the experience of the 10th Mountain Division there was nothing to be gained by having organic close support battalions in the infantry regiments. Their current system provided them adequate,

flexible and continuous fires. A similar situation can be found in the German Mountain Division.

### The German Mountain Division (WWII)

Another example of artillery support for a light infantry force is found in the German Mountain Division of WWII, the 10th Division's "Wehrmacht" equivalent. German light divisions were employed in a variety of environments under a wide range of conditions but they were designed primarily for combat in mountainous and highly compartmented terrain. These divisions fought in every theater in Europe from Norway to Crete and from low to mid intensity combat environs. German light division tactical doctrine was characterized by agility, speed and initiative with the focus on small unit actions.<sup>28</sup> Indirect fire support in these divisions included a variety of both mortars and howitzers. (See appendix 5) Companies and battalions had 50mm and 80mm mortars respectively, as well as 75mm howitzer platoons of two guns (Hausbatterien) organic to the heavy weapons company. The division had an artillery regiment (U.S. Divarty equivalent) with two 75mm howitzer battalions and 150mm howitzer battalion.<sup>29</sup>

As in the 10th Mountain Division, artillery doctrine in the German mountain division also maintained flexibility through centralized control at the division level. Artillery was task organized based on mission, mobility, range, amount of ammunition, trajectory, sectors of fire and availability of firing positions. All of these factors were considered by the regiment in providing adequate support to the division. The end result was close cooperation, timely concentration of fires and quick response to calls for fire. The artillery support for the attack of the 46th Infantry Division at Maratuki in the western Caucasus provides a good example. Adequate support was provided by dividing up the artillery available from the Division and the Corps. Missions were assigned (DS, GS) and priorities established for the artillery units based on support required for the main and supporting attacks. In addition mobility of the guns was considered (they had self-propelled and towed howitzers), along with range of the guns, ammunition available and position areas available. Continuity was gained by proper positioning of the guns to support the maneuver units. In addition no artillery was kept in reserve. Instead, ammunition was carefully allocated and priorities established for resupply of the critical units. The overall flexibility of artillery support was maintained through centralized control at division level.<sup>30</sup>

In general terms the Germans believed artillery support should be far enough forward to influence the battle at the decisive time and place. They had small units of organic artillery in

the Infantry regiments and in many cases artillery units from battalion size to single gun were "attached" in order to provide this decisive firepower. But they relied on the concept of direct support battalion or attached battalions to provide close support to their regiments. The doctrinal rule was to maintain control at the division level and support the regiments by assigning missions or attaching the field artillery units.<sup>31</sup> Organic artillery battalions in the infantry regiments would have inhibited the flexibility and adequacy of artillery support in an operation such as Maratuki. Artillery would have been held in reserve or fully committed to regimental priorities. The organic battalion would not have been available to support critical areas of the battlefield or mass fires beyond its regimental zone of action. In a division that had only three artillery battalions in its Divarty, holding guns in reserve was not an option. There was nothing to be gained by having organic artillery battalions and then modifying that command relationship to fit the factors of METT-T. Their system of centralized control gave the German Mountain Division the flexibility to task organize and adapt to any situation.

#### U.S. Infantry Division (Vietnam)

The war in Vietnam can be characterized by shifting intensities of conflict from early "pacification" operations to variations of conventional war in its later stages. Tactical operations were predominantly offensive in nature and focused on "finding, fixing and destroying the enemy". Units were scattered widely in order to control large areas and consequently the battlefield was non-linear and multidirectional. The majority of fighting was based upon non-conventional, guerrilla or semiguerrilla tactics. Although there were a number of large unit operations, tactical operations by brigades, battalions and companies comprised the bulk of the U.S. effort throughout the war.<sup>32</sup>

Firepower was a dominant characteristic of the Vietnam war where artillery battalions of the infantry divisions played an important and often decisive role. In the U.S. ROAD division organic artillery was held at the division level. (See Appendix 7) Divarty had three direct support battalions (105mm) for close support fires and one composite general support battalion of 155mm and 8 inch howitzers to provide augmenting fires (GS, GSR, R). Infantry companies and battalions had organic 81mm mortars and 107mm mortars respectively. Once again flexibility was gained by retaining control of the artillery at the division level. The artillery was organized to provide support by assigning standard tactical missions to battalions and by coordinating the employment of all available assets to include artillery support from

outside the division as well as air support and naval gunfire.<sup>33</sup>

The artillery, however, had to modify established operational procedures to adapt to the unconventional battlefield. The wide dispersal of maneuver units and the decentralized fighting (company-battalion-brigade) required these changes and adaptations. In general the brigade direct support battalions could not mass the fires of all three batteries. To meet the demands of adequacy in fire support it was necessary to "attach" to each infantry battalion a "direct support" battery in order to provide effective, responsive fires. In most cases these batteries were isolated from their parent battalions and became "habitually associated" on a relatively permanent basis with the supported unit.<sup>34</sup> In a fire base configuration adequacy was also provided by reinforcing the direct support batteries and battalions with mutually supporting indirect fires from other artillery units within range. In virtually every situation the Divarty also enhanced adequacy of fires throughout the division by controlling the fires of long range artillery provided by Corps Artillery and Field Force Artillery units. Continuity of support was maintained by holding no artillery in reserve and by careful positioning of units to provide close support for the maneuver commander as well as mutual support for other artillery units.

Operation LAM SON 216 (April 1968) provides an example of how the U.S. artillery applied its doctrine in combat.<sup>35</sup> The 1st Cavalry Divarty provided adequacy in support by assigning a DS mission and reinforcing missions to the artillery battalions. In addition the Divarty controlled the fires of two heavy artillery battalions and an aerial field artillery battalion in general support (GS) of the division. The massed fires of these units and their responsive answers to calls for fire were decisive in the battle. Continuity of support became a problem because of the terrain and bad weather which hampered airmobile operations and limited the mobility of the guns and resupply of ammunition. The tempo of the operation was not disrupted, however, because of the number of guns available, their ranges, and careful ammunition management. The division was able to provide adequate support in this operation as well as many others because of the flexibility inherent in centralized control at the division level. They could provide timely and accurate artillery in a relatively conventional situation like LAM SON 216.

On the other hand U.S. artillery was also highly successful in decentralized unconventional situations typified by fire base operations. The situation especially early in the war required artillery units to spread out in decentralized operations supporting maneuver units in large areas of jungle, mountains or river delta. The decentralized execution of artillery support is reflected by the fact that many artillery units were attached to maneuver units from battery to

battalion level. These attachments were modified direct support missions. Therefore, Divarty still maintained command and control of these units and could still position them and call on their fires in an emergency. This doctrine of maximum feasible centralized control gave the Division great flexibility and provided adequate fires throughout the Division area of operations. An organic command relationship would have limited this versatility and adaptability.

#### United Kingdom Expeditionary Forces (UKEF)

The UKEF provides a unique example of a light infantry force that does contain organic artillery battalions in its brigades. Although it is not a "light division" it is the only contemporary examples of a large light infantry force using organic artillery in support of brigades. Therefore it will provide a useful perspective for evaluation of organic artillery. The UKEF is made up of two differently organized brigades, the 3d Commando Brigade (3CDB) and the 5th Infantry Brigade. (See Enclosure 8) Similar to the U.S. LID, the UKEF is a small, light, deployable force used for strategic contingency missions. The 5th Infantry Bde is best suited for fighting in close terrain against a light infantry or lightly armored infantry threat. It is envisioned that the brigade would rarely be employed alone. Consequently it would reinforce a forward deployed unit or be augmented by other units once in theatre. The 3CDB is a very light force with no armor. It is best suited for operations against light infantry and special operation. Both units rely on close air support, naval gunfire, armed helicopters and field artillery for fire support; however, they both have organic artillery battalions (105mm). The maneuver companies and battalions have "light company mortars" and 81mm mortars respectively. Similar to all light divisions their tactical doctrine focuses on small unit combat, agile maneuver and individual initiative.<sup>36</sup>

Historically as well as in current doctrine, the British adhere to the maxim of one artillery battalion per maneuver brigade in order to provide close support fires. When fighting as division sized formations these artillery battalions are in direct support instead of organic. The current British doctrine parallels that of the previous historical examples.<sup>37</sup> It emphasizes centralized control at the division in order to provide adequate, flexible and continuous support for the division. In this situation, however, both the brigades maintained command and control of their own artillery. Neither the expeditionary force headquarters nor the land force commander ever established any centralized control. The assessment of fire support following the war indicated that the infantry needed greater indirect firepower.<sup>38</sup>

This parallels the battlefield assessment of the Goose Green battle by the ground force commander, Brigadier Thompson, when he commented that the battle for Goose Green would have been incomparably easier had 2PARA possessed more artillery support.<sup>39</sup> Also, one could conjecture that the engagements from 11-14 June on Port Stanley might have had fewer British casualties and more enemy casualties if there had been some sort of coordinated effort between the two organic artillery battalions. A coordinated effort might have allowed for better positioning of the guns and massed fires of the two battalions. In addition a cooperative effort would have made more guns available to shift fires around the battlefield to critical points. There is no doubt that many of the difficulties the artillery had in providing adequate support were beyond the control of the two organic battalions, especially at Goose Green. Lack of mobility resulted from the lack of helicopters and poor flying weather. These same limitations hindered ammunition resupply. Consequently continuity of support was weak but that is predictable in a contingency operation of this nature.

By all accounts the Royal Artillery provided superb support under these difficult conditions and it is not my intent to revise history. But given the facts and the circumstances there is a reasonable doubt that organic field artillery battalions was the best possible option for the UKEF in the Falklands War.

### Analysis and Implications

#### Field Artillery Support for the Light Infantry Division

In the examples used in this paper, (except for the UKEF in its unique situation), as well as others considered by the author, there is no army that has opted for organic close support artillery battalions with their maneuver brigades in light divisions. No doubt each nation faced the same dilemma of providing adequate responsive field artillery support on a close terrain battlefield characterized by decentralized small unit action, initiative and surprise. In each example, Americans and Germans in WWII, Vietnam and the Falklands, the requirement was for immediately available close fire support for infantry units in contact whether it be a platoon or brigade. In addition each division considered the needs of the force as a whole, which gave the division the ability to influence the battlefield where necessary, allocate resources considering the entire battlefield (deep, close, rear), and fight the current battle as well as anticipate future requirements. Lower echelons (ie brigade) often cannot see the proverbial "forest for

the trees" in terms of the total tactical situation. Therefore, it is division control that established the necessary flexibility to provide adequate support using the DS mission to support maneuver brigades, not organic artillery battalions.

One can see that in order to accomplish this delicate "fine tuned" combined arms balance between firepower and maneuver, different armies have used different organizational solutions. In the case of the German Mountain Division, the infantry brigades/regiments each had some organic artillery, and in several instances organic guns were found at maneuver battalion level. The U.S. Army approach in WWII, after the elimination of the organic regimental cannon companies, was "attachment" of artillery units to maneuver units. The U.S. continued that trend in Vietnam using highly decentralized direct support missions (at battery level), by "attachment" and even by operational control (OPCON). The mission of these small organic units was immediate and close-in fires for the supported maneuver unit. In many battles organic or "attached" DS field artillery units were up front and engaged by the enemy along with the maneuver units. Fighting in the mountains and forests of the Caucasus in 1942, the Germans routinely used their organic "Hausbatterien" well forward with their advanced guard and to accompany reinforcing infantry battalions in order to build up combat power at the decisive point.<sup>40</sup> Strikingly similar missions were given to the 616th FA battalion and 605th FA battalion of the 10th Mountain Division in Italy during the Riva Ridge operation.<sup>41</sup> In Vietnam the familiar fire base was established, complete with artillery units from platoon to battalion size. The primary concern of that artillery was defense of the fire base concurrent with support of operations outside the fire base.<sup>42</sup>

In each of these situations the organic or attached artillery worked for the maneuver commander and was not involved in other artillery fires in the immediate sector let alone over the rest of the division front. For additional fires, either interdiction, counterfire or close support, the maneuver units as well as the division relied on the fires of the division, corps or army artillery. The 10th Division reported that at Tarbole, Italy, "the reinforcing artillery once again saved the day".<sup>43</sup> The Germans in the western Caucasus (Maratuki) had support from division and corps artillery units that allowed for concentration, quick response, and close cooperation in their successful attack.<sup>44</sup>

Another factor limiting the size and scope of organic or attached units is mobility. Not only does close difficult terrain limit the movement of single guns (and their ammunition) but it also makes impractical units any larger than battery, platoon or single gun. High alpine terrain, thick forests and loamy or extreme rocky soil limited the use and resupply of artillery



pieces by German mountain units. The U.S. Army in Vietnam experienced the same difficulty in the rice patties of the MeKong Delta and the mountains of the Central Highlands. More recently British artillery in the Falklands was limited by both bog-like terrain and limited helicopter assets to move the guns in support of the attacks on Goose Green and Telegraph Ridge. The 2d PARA at Goose Green was initially supported by only three guns. These units remain small because of the effects of terrain on the mobility of the guns the space available in close, compartmented, untrafficable terrain and the difficulty of resupplying a larger (battalion-sized) unit. In addition strategic mobility considerations were a factor in WWII just as they are today for the LID. The organic regimental cannon companies were eliminated in 10th Mountain Division to save shipping space. Similar considerations effect the LID force design effort as well as planning for actual mission deployment.

At this point one can conclude that small quantities of organic or attached artillery have contributed to the success of close combat in the three divisional units considered. Most important, however, is the fact that these units were not assigned (as organic) or task organized (attached) in order to meet all the firepower needs of their maneuver units in the close battle. Their mission was a limited one, providing direct fires, assault fires and some counterfire and interdiction in the local area of operations. It is interesting to note that the original design concepts for the artillery support in the LID generally corroborate these conclusions. These concepts included organic artillery in the infantry brigades (one battery, 105mm X 9 guns, per brigade). Army Material System Analysis Activity (AMSAA) did the analysis using the Artillery Force Simulation Model (AFSM). The comparison was conducted with the base case (three battalions 105mm, 3 X 6 organic to division) and twelve alternatives, one of which was the organic alternative. The analysis concluded it was an effective, efficient option and in fact it was one of the preferred options. However, it was rejected because it was not the best option for low intensity conflict force design; it did not provide enough howitzers for the close support mission requirements; and the maneuver brigade would have difficulty employing supporting artillery units.<sup>45</sup>

The LID could find itself in many of the same situations depicted in these historical examples: in the Hohe Rhone, the Zagros Mountains or the jungles of Nicaragua. Each of these situations poses different levels of conflict from high to low intensity and different levels of organizational commitment from "battalion packets" to independent division operations. Just as it was for the WWII U.S. and German divisions and the U.S. Vietnam division, the key to success

for the LID is flexibility in its force design. Organic artillery at the division level gives the LID the flexibility to task organize successfully and adapt to any of these missions. In addition artillery organized at the division level (Divarty) provides the C3 node necessary effectively to employ augmentation "plugs" received by the LID (artillery, target acquisition assets, NGF, CAS) from outside the division just as it did in Italy for the 10th Mountain Division and U.S. divisions in Vietnam. The Divarty becomes the clearing house and distribution point for fire planning, fire coordination and allocation of fires to the brigades. Once on the ground attached artillery would provide support in much the same manner described in the Vietnam war with the Divarty "overwatching" the artillery organization for combat, and making changes and adjustments in tactical missions, positioning and ammunition allocation in order to provide adequate and continuous support to subordinate units and the division as a whole. It is this "pooling" of assets coupled with the broad view of the entire situation or battlefield at the division level that enables the proper balance of artillery firepower and maneuver.

In all the historical examples considered as well as the recent LID design efforts, the organic (or attached) units could not provide sufficient support to satisfy all the close support needs of the brigades. The only possible exception might be the UKEF. The bulk of the artillery support for the close in fight, as well as fires for the remainder of the battlefield, came from divisional and non-divisional units under the centralized control of the division headquarters. In short, if the divisions controlled the battle or were responsible for task organizing the artillery and maneuver units sent into the fight, then centralized control at division level was the most effective, efficient method of organizing the field artillery. Those are some of the lessons of the past. What about the future battlefield?

#### Future Conflict

This look toward the future battlefield will consider the tactical environment of tomorrow as well as the influence of technological change. Current LID organization and doctrine will be assessed in light of these factors to determine if organic artillery in the brigades would be more effective than the current DS mission in future LID organizations.

The Army 21 concept and the MOC96 study orient largely on the conventional battlefield. They do not offer a great deal of information on the future of low intensity conflict and the strategy and type of force the U.S. might use in a low intensity conflict situation. However,

there is research available focusing specifically on the future low intensity battlefield. This research suggests that at the tactical level the battlefield will retain many of the characteristics that have been evolving since WWII:

- Most weapons will be improved, but not essentially different, except that they will be increasingly automated. No single weapon is expected to dominate the battlefield.

- Because of increased lethality there will be an increased requirement to locate the enemy and monitor his activities. The increased requirement to monitor the battlefield will require tactical information processing centers to integrate diverse sources of information.

- Problems with rapid augmentation, deployment and resupply will remain.

- Well-trained soldiers with the ability to operate effectively within a broad spectrum of conflict will continue to be at a premium.

- An integration of many systems, arms and services will be required for success.<sup>46</sup>

This brief assessment of the conflict environment does not suggest any major force design or organization changes are needed as far as current LID artillery organization is concerned. New technology will expand close battle space with longer range, lighter cannons and mortars, more lethal ammunition, improved propellants, more sophisticated C3 systems, and light weight mobility platforms for soldiers, cannons and mortars. The helicopter is the greatest single technological change currently effecting low intensity combat. It significantly increases the mobility of the force. But the LID is still a footmobile force once on the ground. The U.S. airmobile experience in Vietnam argues strongly against organic artillery in such situations. The experience of the 1st Cavalry Division in the Pleiku Campaign (October 1965) revealed that centralized control allowed the division to task organize and tailor the artillery support to match mission, terrain and transport availability in a highly mobile operation dispersed over an ever expanding jungle battlefield.<sup>47</sup> Longer range cannons and more lethal ammunition will give the sparse artillery support in the LID increased combat power. Centralized control of the artillery battalions with this enhanced range and lethality give the division commander even more firepower when concentrating fires and forces especially in the deep battle. An organic association of artillery and brigades only disperses that lethality and gives the division an additional headquarters to go through when concentrating division fires. Some would say the requirement for massed fires has diminished as technology has transformed artillery from an area fire weapon to a more precision killer. On the contrary, the ability to see and kill more discretely allows the force structure to stay light while multiplying the division's lethality.

Ultimately division still needs to control all of its precious few guns, especially so in the LID.

Another argument for organic artillery support to the brigades in the future suggests that C3, the "brain" of the system, will improve tactical and technical actions necessary to attack targets with greater speed and accuracy. A highly mobile conventional environment calls for high volume, sustained fire across the front and in depth. It also needs a highly integrated system of sensor nets and real-time intelligence processing in order to see the enemy and effect the battlefield. As the historical examples of the light division in the mountains and jungles suggest, combat for the light infantry is decentralized on a noncontinuous front. The pace of combat in many cases is slower than a conventional battle and it is characterized by surges of activity versus sustained combat. Targets are fewer and ammunition is carefully managed. These "characteristics" of light infantry combat reduce the need for extensive fire control and data processing systems like TACFIRE. The Germans in the Caucasus found that a good C3 system was critical. The best system was simply one that was well planned, reliable and complete.<sup>48</sup> Technological enhancements in C3 will no doubt improve the speed and security of communications. It will also speed technical artillery gunnery computations and enable the unit to process large volumes of information. However, the ability to enhance adequacy of artillery support at any level is very speculative at this point. Therefore, there is not a convincing technological argument for a change in the organization of the field artillery.

What technology may do is make possible small units of artillery organic to the brigades to supplement close indirect fires from mortars and other artillery units. These would be small, light weight guns that use a lighter weight projectile and propellant. The AMSAA analysis cited previously suggests such an option as efficient and effective. In other words, we might see a return to the cannon companies of American divisions in WWII or the "Hausbatterien" of the German mountain divisions. Additionally, technology will enhance the capabilities of organic mortars in the maneuver units giving them increased range and wider variety of ammunition with greater lethality. Because of its lighter weight (weapon and ammunition) smaller size, greater maneuverability, and trajectory, the mortar is in many cases the weapon of choice (or necessity) for the light infantry in close terrain. For operating in the high Alpines the Germans relied heavily on mortars for close-in fires.<sup>49</sup> The 2d PARA in the Falklands also found mortars indispensable. At Goose Green the 2 PARA was initially supported by only three artillery pieces. At daybreak when weather made air support difficult and naval gunfire was not available, they would normally have turned to their mortars. But they had left the mortars in the rear because

of space and weight limitations on the helicopters and in the rucksacks. In criticizing their own performance, commanders stated that it was a mistake to leave their mortars behind--they would never do that again.<sup>50</sup> Mortars are becoming more popular in lighter, smaller and more specialized light infantry formations such as the Israeli Paratroop Brigade and the German Mountain Brigade. In fact both units are organized with 120mm mortars as their organic indirect fire weapons.<sup>51</sup> They are taking advantage of improvements in mortar construction, increased range and enhanced ammunition capability. The cheaper, lighter weight, highly lethal and effective mortar could be an ideal organic indirect fire weapon for the maneuver brigade. This would preclude organic tube artillery which could be had only at the expense of the division firepower base.

It is clear that technological improvements will increase depth, width and vertical distance on an expanding three dimensional battlefield. Nevertheless, the tactical requirements of the LID remain focused on a footmobile force, operating in close terrain, emphasizing small unit and individual initiative to close with and destroy the enemy. Regardless of range, improvements in lethality, or enhanced communications capability the artillery will best support subordinate units and the division as a whole only if control remains at the division level. All of these factors enhance the division's ability to provide responsive, continuous support across the entire battlefield, a capability that would be dispersed and diluted if the artillery battalions were organic to the brigades.

#### Four Principles of War

To examine further the advantages and disadvantages of organic artillery versus DS artillery it is useful to look at the underlying principles of traditional field artillery doctrine. The natural tendency toward decentralized organizations and operations in the light infantry reflects the self reliant, offensive-minded character of those units. Wallace Franz points out that organic firepower gives infantry not only united killing power but confidence. Good infantry inflicts heavy damage on the enemy with organic weapons. In the light infantry especially, organic weapons are the "weapons of choice".<sup>52</sup> These comments are made with traditional infantry weapons in mind like machine-guns, grenade launchers and anti-tank weapons. But it raises the question of whether the artillery should also be organic. In the mind of the infantryman the most responsive firepower comes from weapons that in fact as well as in

essence "belong" to the organization. Although this is a tempting conclusion the facts drawn from the historical examples do not support it. Responsiveness has been best gained and maintained through a flexible system of centralized control. An examination of the principles of offense, mass, economy of force and unity of effort best illustrates this point.<sup>53</sup>

Centralization of control first of all establishes the overall offensive character of the artillery support in light infantry organizations. When the U.S. Army advisors first arrived in South Vietnam they found the artillery of the Vietnamese Army (ARVN) being employed ineffectively. Units were employed in fixed defensive positions, parceled out in single gun, platoon or battery sized elements to reinforce strong points. The artillery lacked mobility as it remained static in position for months at a time. Artillery not deployed on the battlefield was placed in holding areas in the rear, more often for protection of the artillery pieces than for the benefit of future operations. There was no centralized control whatever in assigning missions, nor was there a technical capability to mass fires.

In situations where infantry regiments had artillery, under the direct control of a maneuver commander, the regimental commander actually commanded the artillery unit. The Vietnamese ground maneuver commander tended to over-involve himself with artillery tactics and employment with negative results. To make matters worse the artillery units could not fire without permission of the maneuver chain of command which often precluded massing of the division fires. This micro management of artillery hampered the flexibility of the division commander to influence other parts of the battlefield. Fortunately U.S. Army advisors were able to break the restrictive, reactive and highly defensive orientation by centralizing control at the division level. They also improved communications and technical fire direction capabilities. ARVN units were then able to mass and respond to calls for fire according to mission assignments and the priorities established by the division. All artillery units were given tactical missions and artillery was not held in reserve. Although Vietnamese artillery improved greatly it continued to have problems breaking with the past and continued to have technical difficulties. Ultimately ARVN units still required extensive U.S. artillery support (advice as well as fires) but their performance did improve throughout the war.<sup>54</sup>

During the same war the 25th Infantry Division conducted an appraisal of its fire support bases in late 1968. It was determined that a defensive mindset, or "fire base psychosis", was limiting the success of their operations as maneuver units huddled close to the overwhelming firepower available to them on the fire base. Once units moved out from these strong points on

local offensive operations they were supported by a system of deep, simultaneous and continuous fires coordinated with the divisional and non-divisional artillery, as well as close air support and armed helicopters. Subsequent 25th division experience showed that ultimately offensive maneuver when combined with the offensive use of artillery coordinated and controlled at Division level resolved the defensive mindset.<sup>55</sup>

If the artillery battalions are organic to the brigades, the division would be limited in its ability aggressively and offensively to influence the battle massing fires and shifting fires to critical points. Although in the UKEF the organic artillery units successfully provided support to their brigades, indications are that more adequate support could have been provided by a coordinated centralized effort by the artillery units. Given these three examples (ARVN, 25th Div, UKEF) it is evident that while providing adequate support to the brigades the organic relationship tends to stifle the overall offensive capability of the division.

The ability to mass, or concentrate, is the capability to deliver fires that are necessary or tactically significant. Although light infantry relies on decisive maneuver, firepower is critical for effective concentration of combat power and protection of the force. Artillery fires in support of the light force come not only from their organic, attached or DS artillery, but from all other resources available to the division. As one looks across any battlefield there will be critical or decisive engagements at certain places. But seldom if ever will there be decisive engagements across the entire battlefield. Examples of massed fires in the 10th Mountain and the U.S. divisions in Vietnam illustrate the decisive effect of coordinated and massed division and non-divisional artillery. Those guns were available because division had control of them even though they were attached or DS. On the other hand the South Vietnamese early experiences in the Vietnam war illustrates the debilitating effect decentralized control can have on the ability to mass fires. Artillery can maneuver across the battlefield, technically, using deflection and quadrant. This tremendous versatility allows the artillery in the division to respond to more than one unit and more than one priority. Most importantly it allows the division commander to respond to the enemy en masse when necessary. The 7th LID emphasizes this capability to mass fires using a "Gold Target System". When a critical target is located or a unit is at a decisive point in the battle this system allows the division to mass the fires of all its artillery, DS and GS.<sup>56</sup> If the artillery battalions were organic this capability to concentrate would be constrained. Therefore it can be seen that responsive and adequate (tactically significant) fire support is not so much a matter of "belonging" as it is a matter of mission responsibilities or

priorities assigned by the division.

Economy of force is the partner of concentration. It allows one to make full use of all resources, theoretically striking a balance between too much and too little. From the standpoint of centralized control it allows the artillery to use all available guns, leaving none standing idle in reserve. The axiom of "artillery is never in reserve" has particular significance in the case of the LID. The current U.S. LID has the same inherent limitations in artillery support as its WWII counterpart, the 10th Mountain Division. This paucity of artillery available makes it imperative that all available guns play a role on the battlefield. If field artillery battalions were organic to the LID infantry brigades, the artillery of a brigade in reserve would conceivably also be in reserve unless the organic relationship were modified and in fact violated. The flexibility in a centralized system, however, compensates for that situation by assigning standard tactical missions, on-order missions, and by establishing ammunition expenditure priorities thru controlled supply rates (CSR). The overall effects of artillery not actively engaged in supporting the battle are evident in the experience of the South Vietnamese Army. An additional concern related to economy of force is the actual commitment of artillery in close combat along with the supported infantry units. Organic and "attached" units in many cases quickly get involved in the confusion and destruction of the close-in fight. Killing the enemy with assault or direct fires supporting small unit maneuver and basic survival requirements dominate the action. The artillery unit involved in close combat or the imminent threat of such an engagement is unable to support any other requirements from the brigade or the division in other parts of the battlefield (deep or rear). The division or brigade is effectively robbed of that firepower for any other purpose. The German and American experience in WWII as well as more recent experience in Vietnam suggests that organic or attached artillery has a tendency to get directly involved in close combat along with its maneuver unit. In many cases the artillery was employed as assault guns or in defense of a fire base, for example. These same examples also illustrate that close combat could put the guns at risk. Physical destruction of the already sparse numbers of artillery pieces available is danger a light force, such as the U.S. LID, can ill afford. Given the vagaries of close combat, organic artillery battalions are not the best option for the maneuver brigades in the LID.

A final principle to examine is unity of effort. Another very attractive assumption in the argument for organic artillery is team-building and cohesion. A command relationship backed up by a close day to day working relationships and frequent combined arms training



opportunities would produce a more cohesive combined arms team, the end result being better teamwork but most importantly better artillery support for the infantry. The fact that maneuver and artillery must cooperate is a given and the argument has merit. But it is a questionable assumption that a command relationship will enhance cooperation and improve the quality of artillery support. One example used frequently to support this contention is the howitzer battery assigned to the armored cavalry squadron. In Vietnam, artillery training became such a problem that the 11th Armored Cavalry Regiment turned to a nearby division artillery for help to keep their howitzer batteries proficient.<sup>56</sup> However, a counter to that example is the 173rd Airborne Brigade and the 2d Brigade of the 1st Infantry Division in Vietnam (June-1965). Both units operated as separate brigades with their own "organic" field artillery close support battalions. Both brigades performed well during the early build-up of U.S. troops in Vietnam and there is no record of training or proficiency problems either in the combined arms effort or the technical proficiency of the artillery close support battalions.<sup>57</sup> The difference between the two examples is the difference between a captain and a lieutenant colonel. The captain commanding the howitzer battery does not have the training, experience or staff to assist him in establishing and enforcing standards of training and performance. On the other hand the lieutenant colonel commanding the artillery battalion of the 173d Brigade or the 2d Brigade (1st Infantry Division) had years of accumulated experience and a complete staff to insure the proficiency of his command.<sup>58</sup> There is a logical argument here that says, if an artillery unit is having difficulty executing its responsibilities as a part of the combined arms team, it is a function of leadership and training and not a matter of command relationships. However, experience at the National Training Center (NTC) has surfaced training problems and there is still speculation that deficiencies could be resolved if the artillery "belonged" to the brigade.

A recent summary of observations by the U.S. Army Field Artillery School (USAFAS) reveals that the artillery in general is having some difficulties at the National Training Center. In addition results of the 7th Infantry Division Celtic Cross exercises (CCIII, CCIV) indicate that division is having similar difficulties although not to the same extent indicated in the USAFAS report. Some of the problem areas are:

- Insufficient doctrine to properly prepare a fire support plan.
- Weak or haphazard staff interaction and coordination in all phases of operations (between artillery FSO's and maneuver S3, S2, Engineers)

- Insufficient procedures for FSO's to prepare fire plans in a time constrained environment.
- Insufficient doctrinal guidance on where commanders and FSO's should locate (ie separately or together)<sup>59</sup>

Additional observations include:

- Captains are needed as FIST; Lieutenants are simply too inexperienced.
- FIST do not understand maneuver tactics, techniques.
- FIST/FSO are poor fire planners.
- FIST/FSO do not "see" the battlefield well.
- Battalion commanders are too concerned with the artillery and not enough with FSCOORD duties.<sup>60</sup>

The NTC report goes on to evaluate each finding and make recommendations. In virtually every case solutions can be found in the service school system or in unit training. The report recommends the Field Artillery School review and rewrite doctrine, for instance, in the case of the poor fire plans and weak fire planners. Recommendations are also made that include better unit training plans and better training execution in combined arms exercises. In sum the NTC observations report views the problems as a matter for doctrinal refinement, better unit training and a more focused effort by all artillerymen to do a better job in the critical business of combined arms training. The problems highlighted in the NTC report and in the Celtic Cross reports are not a unique problem in a peacetime army.

The observations in the NTC report and its enclosures are a general indictment implying that the field artillery and maneuver are losing their focus on the combined arms effort. There are similar trends experienced in British artillery between WWI and WWII. After WWI the British established the School of Artillery at Larkhill where it ultimately became the artillery "Mecca," because of the influence of the Imperial General Staff. Gunnery instructors, as well as the subjects they taught, became God and Gospel. However, the fault with the system lay in this close-knit artillery community's conservative approach which focused narrowly on technical artillery (ie gunnery, meteorology, tactics) subjects while the army, better yet warfare itself, was going through the armored revolution. "There was a tragic failure to build a bridge between the old arm and the new".<sup>61</sup> For a variety of reasons during this time of peace the artillery lost sight of its tactical responsibility to the maneuver arm. It was not focusing on and cooperating with the armored force and the traditional infantry arm. Larkhill instead was mainly concerned

with artillery...speed, time and accuracy. At the same time the maneuver arms failed to concern themselves with artillery support and failed to agree on what it should be or how it could be improved with a resulting lack of critical developments in doctrine, training and equipment improvements. Shelford Bidwell sums up the results:

"The legacy of all this folly was that no attempt was made before the war broke out to work out a common doctrine for co-operation between tanks and field guns and equally important, tanks and antitank guns. This was to cost us much more than the lack of a selfpropelled gun".<sup>62</sup>

In the campaign of 1940 the Royal Artillery failed successfully to support the infantry and armor and it was largely a question of doctrine and training: they simply had not spent enough time in the maneuvers of 1939-1940 doing combined arms training and maneuver.<sup>63</sup> The British Artillery was later successful in adapting to the battlefield. They did that by developing better combined arms doctrine, better equipment, and conducting more intense "all arms" training. The solution was not found in an organic command relationship. Centralized control of the artillery and the DS mission relationship provided satisfactory support. The only additional requirement was good training and a combined arms focus.

Application of these four principles to the argument for organic versus DS artillery favors the DS relationship. The basic characteristics of the LID are offense and initiative, and the field artillery organization needs to mirror that image. "Fighting economically" is another characteristic of the LID. It goes into the fight very lean and with a minimum of combat support assets. Consequently, it is imperative that the limited artillery available be used efficiently to provide responsive, continuous fires, and massed fires when necessary. Unity of effort is of paramount importance when building the combined arms team. Intelligent leadership and sound training will prepare an effective "all arms team" for tomorrow's battlefield. This brief review of four basic principles of war as they relate to this argument confirms that there is no significant benefit to be gained from assigning artillery battalions organic to the maneuver brigades of the LID.

### Conclusions

In order to determine whether the maneuver brigades should have organic artillery battalions in the Light Infantry Division this paper has examined the LID, its unique missions,

capabilities and limitations, and its unique light infantry characteristics. Also considered were historical examples of light divisions in WWII, infantry divisions "fighting light" in Vietnam and the contemporary British light contingency force. The analysis included an examination of the use of organic close support artillery in these historical examples. The future battlefield and its potential requirements for a change in the artillery battalion- maneuver brigade relationship was also considered. Finally, the organic and direct support options were examined using four principles of war: offense, mass, economy of force, and unity of effort. The following conclusions can be drawn:

- The close support artillery battalions of the LID should not be organic to the maneuver brigades.

- The LID is designed to combine arms at the division level. Division cannot synchronize its field artillery battalions to support the division battle if those battalions are organic to the maneuver brigades.

- The doctrinal tenets of adequacy, flexibility and continuity, as they are applied in current artillery force design and organization, provide a sufficient doctrinal foundation on which to build an effective fighting force capable of winning on the Airland battlefield.

- Conditions on the battlefield of the 1990's do not require a change to the current artillery organization.

- Technological innovation into the 1990's supports the current artillery organization.

- Technological improvements in mortars (caliber, range and ammunition) will offer greater indirect firepower to maneuver brigades. Mortars are potentially an alternative to organic artillery battalions as the primary indirect fire support means for the brigades of the Light Infantry Division.

- Some organic artillery in the maneuver brigades appears to be an efficient, effective option, although the brigade would be unable to rely on these small units of artillery for all of its close support needs.

- Combined arms training and cooperation with maneuver units continues to be a challenge for the current artillery system. Peacetime training practices and doctrinal development generally lag behind the realities of combat. Imaginative leadership and aggressive combined arms training will reduce this gap, rather than an organic relationship between artillery battalions and maneuver brigades.

Before a final conclusion can be reached in this argument, several subjects need more

complete analysis. Assigning organic artillery battalions to the brigades of the LID would have a profound impact on the LID Divarty. A thorough examination of the impact on the Divarty and its role in the division fire support system will be required. There will also be significant effects on current artillery doctrine requiring fundamental changes to the current system. Maneuver doctrine will also be affected although not to the same extent. This "joint" effect on the doctrine and organizations of the armor, infantry and artillery needs careful consideration before a decision is made. Finally, many logistics questions remain to be answered. Especially important are the supply of Class 5,7 and 9 in both peacetime and in wartime. All these questions notwithstanding, at this point we can conclude that the fire support structure that exists in the LID today works. It has been proven in combat and the artillery is recognized as an essential member of the combined arms team. This analysis has provided no clear reason or advantage to changing the artillery relationship with the infantry brigades from direct support to organic.

### Inherent Responsibility for Field Artillery Units

	<u>DS</u>	<u>Organic</u>
Answers calls for fire in priority from	Supported units Own Observers Force FA HQ	Supported unit Own Observers
Has as its zone of fire	Zone of action Supported unit	Zone of action Supported unit
Furnishes FIST & FSO	Supported unit	Supported unit
Furnishes LNO	No requirement	No requirement
Establishes Commo with	FIST, FSO and Supported unit HQ	FIST, FSO and Supported unit HQ
Positioned by	DS FA unit cdr or as directed by higher FA HQ	Organic FA unit cdr (or as directed by brigade cdr)
Fire Plans	Develops own fire plans	Develops own fire plans

64  
**ARMY OF EXCELLENCE**  
**LIGHT INFANTRY DIVISION**

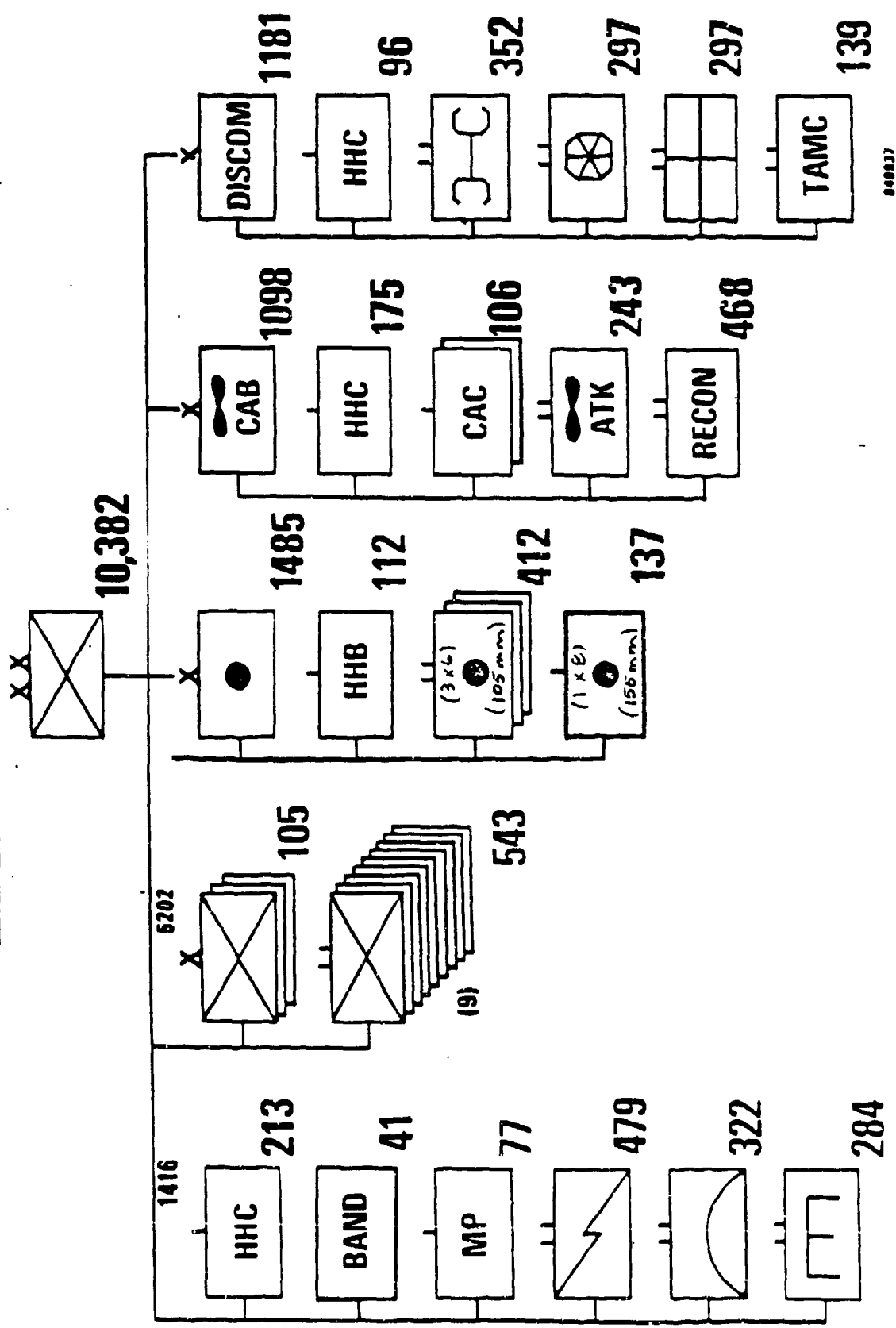

1945  
USA  
14,101

10th MOUNT DIV

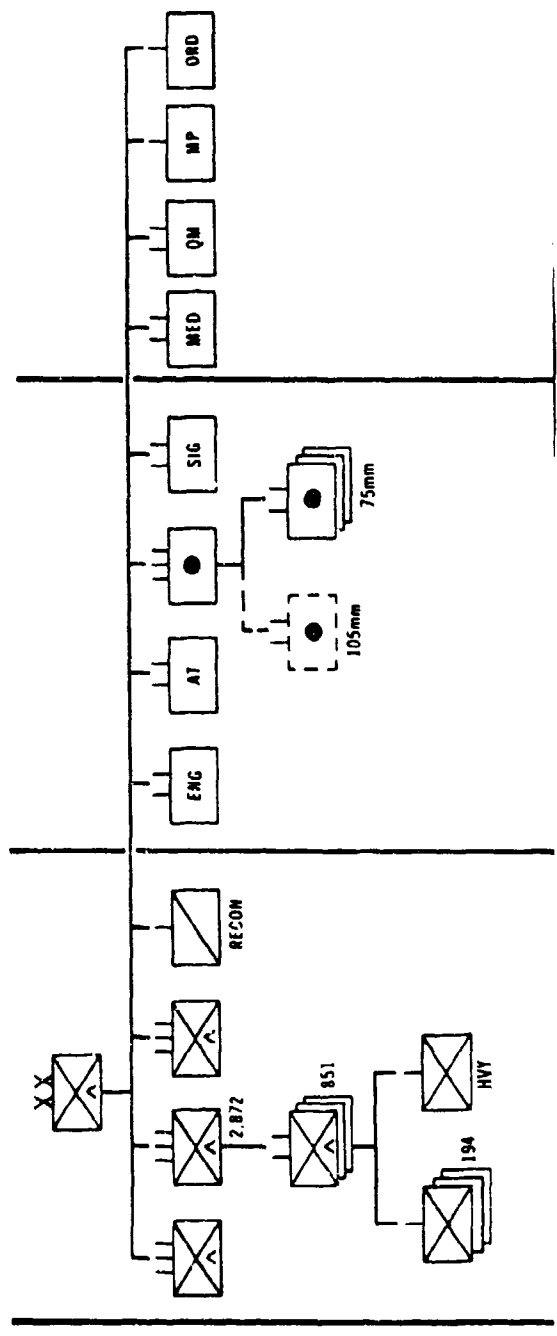

Source: See Endnote 65



Regimental Cannon Company<sup>66</sup>

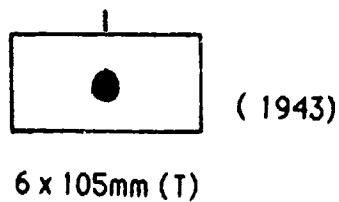
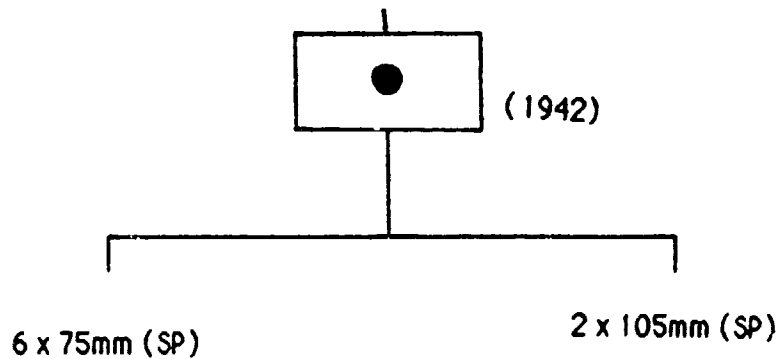

Strategic mobility and tactical considerations made the self-propelled howitzers impractical (1942). The towed howitzer replaced the self-propelled howitzer in 1943. Due to the subsequent loss of mobility and maneuverability commanders in Theatre reported the cannon companies could not be used to accompany armored and infantry formations. Not only could the towed howitzer not keep up they could not survive well forward. Cannon companies more frequently tied in with divisional artillery direct support (DS) units and became a "fourth battery" in these units.

1939  
GERMANY  
2d & 3d MOUNT  
DIVISIONS

17,188

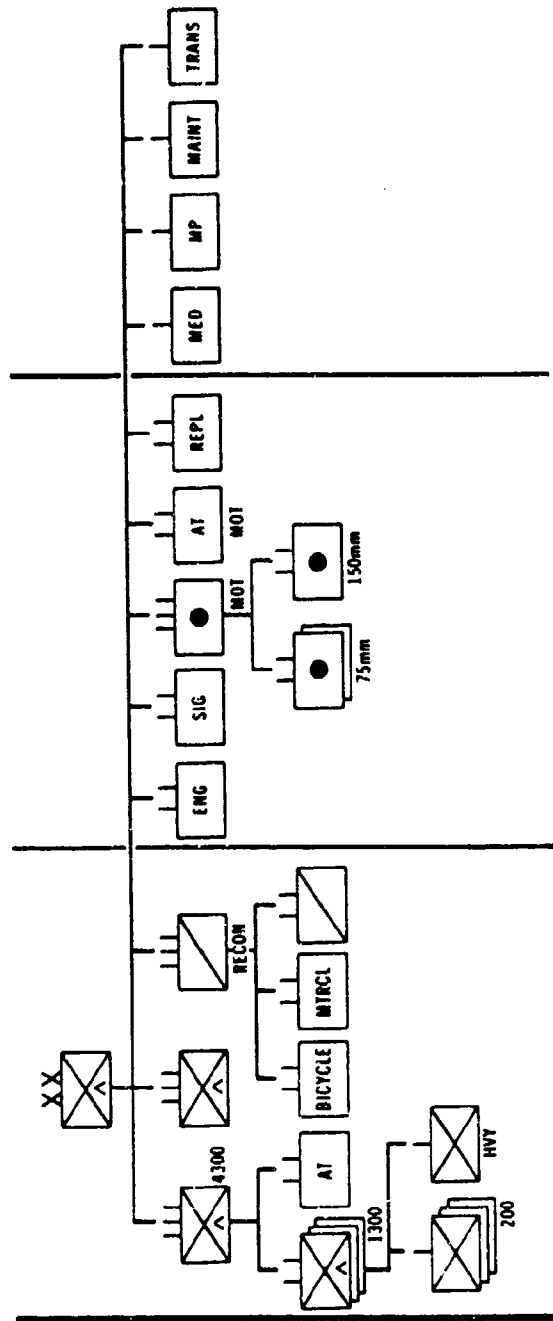

Source: See Enchote 67

German Mountain Division 68  
Regimental and Battalion Organic Artillery  
(Hausbatterien)

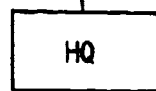
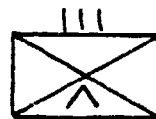

Heavy Howitzer Platoon

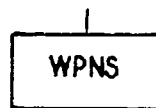
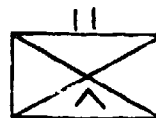

Light Howitzer Platoon

These organic howitzer platoons varied in size and type weapon throughout the war depending on the terrain and the mission. They were generally 105mm or 75mm howitzers and 75mm mountain howitzers.

U.S. Infantry Division Artillery (1965)<sup>69</sup>

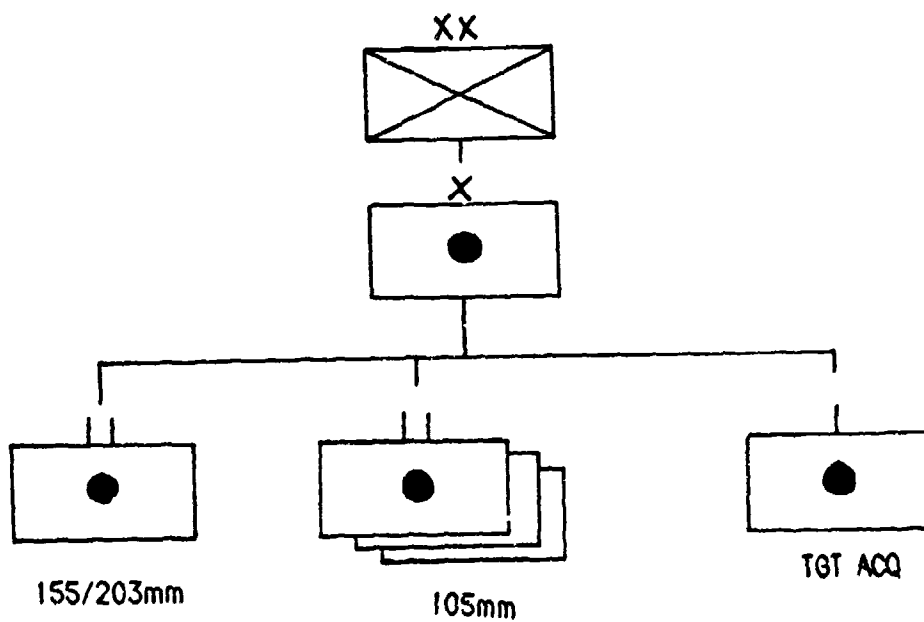

1983  
UK  
EXPEDITIONARY  
FORCES

APPROX  
4,500

5TH INFANTRY BRIGADE (WORLDWIDE TASKS)

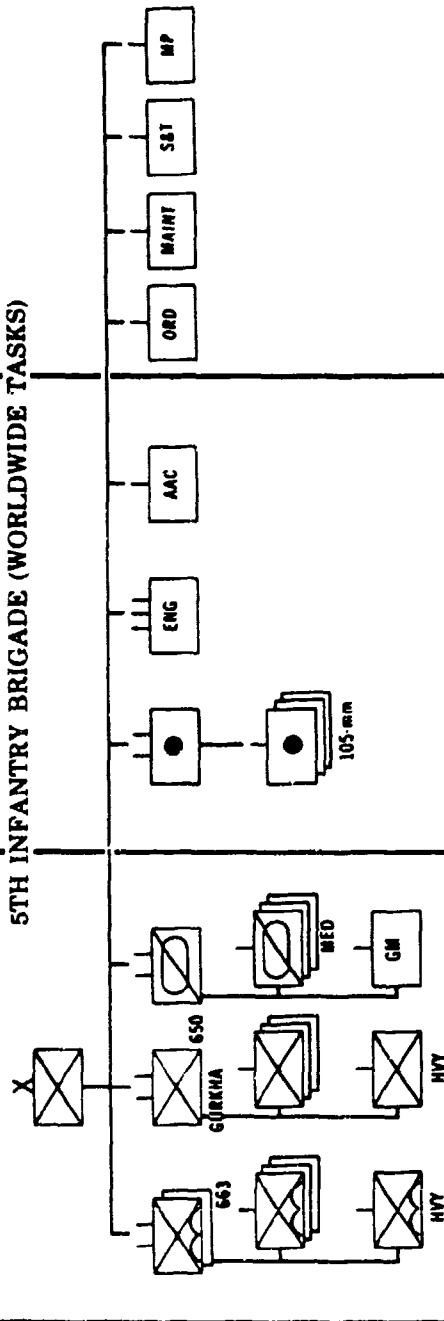

3D COMMANDO BRIGADE — ROYAL MARINES

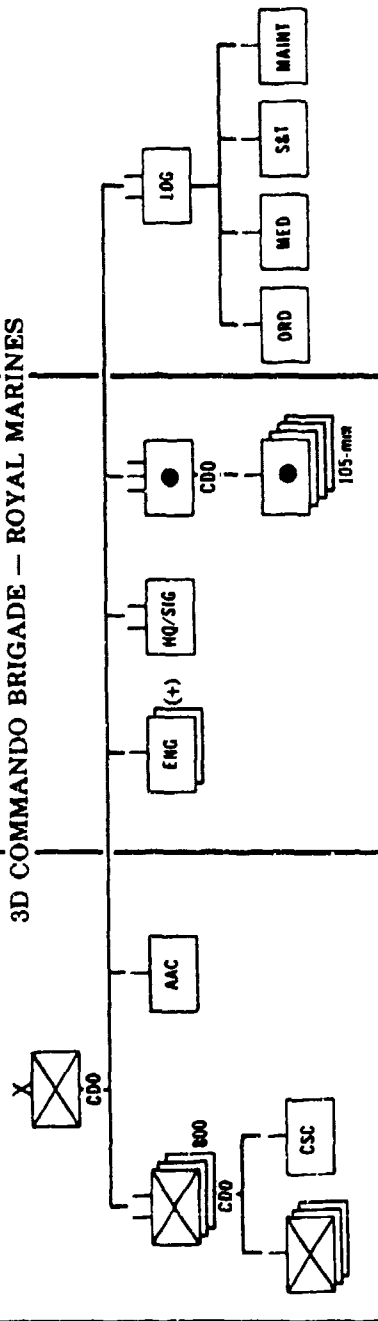

4,442

Source: See Endnote 70

## Endnotes

1. U.S. Army Field Manual 100-5, Operations (Washington, D.C.: HQDA, May 1986), p.4.
2. House, Jonathan M., Towards Combined Arms Warfare: A Survey of 20th Century Tactics, Doctrine and Organization (Combat Studies Institute, Fort Leavenworth, Kansas, August 1984), p. 2.
3. Ibid, p. 188.
4. U.S. Army Field Manual 100-5, p. 3.
5. National Defense University, "The Maneuver Oriented Corps- 1996 (MOC96)." (National Defense University: Washington, D.C. 1986), pp. 14-19.
6. U.S. Army Training and Doctrine Command, Army 21, (Fort Monroe, Virginia: HQUSATRADOC, June 1985), Fire Support Concept.
7. Wickham, GEN John A. Jr. "Light Infantry Divisions," CSA White Paper 1984 (Washington, D.C.: HQDA, April 1984) p. 1.
8. U.S. Army Field Manual 101-5-1, Operational Terms and Symbols (Washington, D.C.: HQDA, January 1985) p. 91.
9. Ibid, pp. 1-43.
10. U.S. Army Field Manual 6-20-1, Field Artillery Cannon Battalion (Washington, D.C.: HQDA, December 1983), chapter two gives a complete description of the direct support cannon battalion and its responsibilities and requirements.
11. U.S. Army Operational Concept, The Light Infantry Division. (Fort Leavenworth, Kansas: USCADA, March 1984) p.1.
12. Ibid, paragraphs 2,3, and 4 layout the purpose, limitations and concept for employment of the light divisions.
13. Wass de Czege, Huba. "Three Kinds of Infantry," Infantry (Fort Benning, Georgia: HQDA, July-August, 1985) p. 22.
14. Luttwak, Edward N. Strategic Utility of U.S. Light Divisions. A Systematic Evaluation (Fort Monroe, Virginia: HQUSATRADOC, 1985) p. 1.
15. Canby, Steven L. "Classic Light Infantry and New Technology" (DARPA Contract No. MDA 903-81-C-0207, December 1982), this general description is taken from the Executive Summary and from chapters 1-4.
16. U.S. Army Field Circular 71-101, Light Infantry Division Operations (Fort Leavenworth, Kansas: USACGSC, July 1984), this description was taken from Chapter 4, Fire Support.

17. U.S. Army Field Manual 6-20, Fire Support in Combined Operations (Washington, D.C.: HQDA, December 1984), pp.1-10.
18. Ibid, pp. 1-10.
19. Ibid, pp. 1-10.
20. U.S. Army Field Manual 100-5, p. 44.
21. U.S. Army Field Manual 6-20, pp. 1-3, 4 and pp. 1-15, 16. See also FM 100-5, pp.43-45. Adequacy, flexibility and continuity are discussed in both manuals. The definitions presented here are the authors interpretation of both manuals.
22. Ibid.
23. Ibid.
24. Luttwak, Edward N. Historical Analysis and Projection for the Army 2000 (Fort Monroe, Virginia: HQSATRADOC, March 1983) pp. 1-49.
25. Ibid, pp. 1-49.
26. Headquarters, Army Ground Forces, "10th Mountain Division Artillery as Assault Guns" (Washington, D.C.: AGF Report No. A473 June, 1945) pp. 1-12.
27. Luttwak, Historical Analysis and Projection, pp. 1-49.
28. War Department, Military Intelligence Division, German Mountain Warfare, Special Series No. 21 (Washington, D.C.: War Department, February 1944) pp. 1-10.
29. Lucas, James. Alpine Elite (New York, New York: Jane's Publishing, Inc., 1980) p. 192.
30. U.S. Army Chief of Military History, "Mountain Warfare" No. 11, Volume 1 and 2, MS No. P-304 (Washington, D.C.: Office of the Chief of Military History, February, 1950) pp. 204-227.
31. Ibid, pp. 204-227.
32. Ott, David E. Vietnam Studies: Field Artillery, 1954-1973 (Washington, D.C.: U.S. Government Printing Office, 1975) pp. 29-34.
33. Ibid, pp. 38-42.
34. Ibid, pp. 42-47.
35. Ibid, pp. 157-160.

36. McMichael, Scott R. "Light Infantry Forces," Bibliography No. 2 (Fort Leavenworth, Kansas: Combat Studies Institute, USAACGSC, 1984), the attached foldout entitled "Light Infantry and Close Combat Forces in Perspective" is an excellent overview of organizations and characteristics in a wall chart format.
37. Bidwell, Shelford. Gunners at War (London: Arrow Books, LTD, 1972) pp. 78-82.
38. Secretary of State for Defense, Great Britain, "The Falklands Campaign: The Lessons" (London: Her Majesty's Stationery Office, October, 1983) pp. 305, 319.
39. Hastings, Max and Jenkins, Simon. The Battle for the Falklands (New York: W.W. Norton and Company, 1983), chapters 13 and 16 describe the battles at Goose Green and Wireless Ridge.
40. U.S. Army, Chief of Military History, "Mountain warfare," pp. 205-246.
41. "10th Mountain Division Artillery as Assault Guns," p.2.
42. Ott, pp. 55-72.
43. "10th Mountain Division Artillery as Assault Guns," p. 6.
44. U.S. Army, Chief of Military History, "Mountain warfare," pp. 161-246.
46. Ibid, pp. 161-167.
45. U.S. Army Field Artillery School, "Division Artillery Force Design," CSA Decision Briefing, July 1984. This information came from copies of slides from the above decision brief to the CSA by the USAFAS. The copies of slides were obtained from the Concepts Division, Combat Development Directorate, USAFAS.
46. Su, Poon Ghee. "Equipping the Infantry Division (Light) in the 1990," MMAS Thesis (Fort Leavenworth, Kansas: USACGSC June 1986) p. 41.
47. Ott, p. 87.
48. U.S. Army Chief of Military History, "Mountain Warfare," pp. 233-239.
49. Ibid, p. 205.
50. Hastings and Jenkins, p. 242.
51. Luttwak. Historical Projection and Analysis. Paper No. 14 (p.29) describes the West German Mountain Brigade and Paper No. 16 (p.13) describes the Israeli Paratroop Brigade.
52. Franz Wallace R. "Infantry the American Way" included in Boeing Corporation, "Report of Proceeding: Light Infantry Conference 1985" (Seattle, Washington: the Boeing Corporation, September 1985) pp. 78-82.



53. Bidwell, pp. 78-82.
54. Ott, pp. 21-37.
55. Ott, p. 161.
56. Seventh Infantry Division (Light), "Division FTX Celtic Cross III," After Action Reports. 7th Infantry Division (Light) AC of S, G3, 18 October 1985, pp. 10-9.
57. Ott, p. 86.
58. U.S. Army Command and General Staff College, Memorandum for Record, Subject: "Division Artillery." This is a memorandum for the Deputy Commandant prepared by the Director, School for Advanced Military Studies, USACGSC on 10 February 1986.
59. U.S. Army Field Artillery School letter, Subject: "Field Artillery Focused Rotation, NTC 86-5." This is a report prepared for the Commandant, USAFAS by the "Fire Support Assessment Team" 28 February 1986. The report was obtained from the Doctrine Division, Directorate of Training and Doctrine, USAFAS, p. 2.
60. Ibid, Inclosure 1.
61. Bidwell, p. 58.
62. Bidwell, p. 75.
63. Bidwell, p. 134.
64. U.S. Army Field Artillery School, "Division Artillery Force Design," unnumbered slide copy.
65. McMichael, Bibliography No. 2, Foldout.
66. Greenfield, Kent R.; Palmer, Robert A. and Wiley, Bell I. The Army Forces: The Organization of Ground Combat Forces (Washington, D.C.: HQ DA, 1947) p. 302.
67. McMichael, Bibliography No. 2, Foldout.
68. Lucas, p. 192.
69. House, p. 158.
70. McMichael, Bibliography No. 2, Foldout.

## BIBLIOGRAPHY

### BOOKS

- Bidwell, Shelford. Gunners at War, Arrow Books, LTD, London. 1972.
- Danysh, Romana and Mahon, John K. Infantry, Part 1: The Regular Army. Office of the Chief of Military History, Washington D.C., 1972.
- Greenfield, Kent R., Palmer, Robert R. and Wiley, Bell I. The Army Ground Forces: The Organization of Ground Combat Forces. United States Army in World War II, Washington, 1947.
- Hastings, Max and Jenkins, Simon. The Battle for the Falklands. W.W. Norton and Company, New York, 1983.
- The International Institute for Strategic Studies. Strategic Survey 1985-1986. The International Institute for Strategic Studies, London, Spring, 1986.
- The International Institute for Strategic Studies. The Military Balance 1985-1986. The International Institute for Strategic Studies, London, Autumn, 1985.
- Lucas, James. Alpine Elite. Jane's Publishing, Inc. New York, New York, 1980.
- Milner, Samuel. Victory in Papua. United States World War II, Office of the Chief of Military History, U.S. Government Printing Office, Washington D.C., 1957.
- McClellan, Donald B. Japanese Artillery. Normount Technical Publications, Wickenburg, Arizona, 1973.
- Ott, David E. Vietnam Studies. Field Artillery, 1954-1973. Department of the Army, U.S. Government Printing Office, Washington D.C., 1975.
- Watson, Bruce W. and Dunn Peter M. Military Lessons of the Falkland Islands War. Westview Press, Boulder, Colorado, 1984.

### PERIODICALS

- Adams, John A. "Heavy versus Light Forces: A Middle Ground." Military Review, October, 1986, pp. 65-73.
- Canby, Steven L. "Light Infantry in Perspectives." Infantry, July-August 1984, pp. 78-81.

- Cheney, Richard B. and Harvey Thomas N. "Strategic Underpinnings of a Future Force." Military Review, October 1986, pp. 4-13.
- Deputy, William E. "Light Infantry: Modern Battle's Essential Arm." Army, June 1985, pp. 26-41.
- Donnelly, C.N. "The Wind of Change in Soviet Artillery," International Defense Review, No. 6 1982, pp. 737-744.
- Doughty, Robert A. "The Evolution of U.S. Army Tactical Doctrine, 1946-76." Leavenworth Papers, Combat Studies Institute, U.S. Army Command and General Staff College, Fort Leavenworth, Kansas, 1974.
- Garnier, A.P. "The German Artillery in Combat," Field Artillery Journal, Jan-Feb., 1939, pp. 29-40.
- House, Jonathan M. Towards Combined Arms Warfare: A Survey of 20th Century Tactics, Doctrine and Organization, Combat Studies Institute, U.S. Army Command and General Staff College, Fort Leavenworth, Kansas, August 1984.
- Huddleston, Louis D. "Light Infantry Division: Azimuth Check." Military Review, September 1985.
- McMichael, Scott R. "Light Infantry Forces." CSI Historical Bibliography No. 2, Combat Studies Institute, U.S. Army Command and General Staff College, Fort Leavenworth, Kansas, 1984.
- McMichael, Scott R. "Proverbs of the Light Infantry." Military Review, September 1985, pp. 22-28.
- McMichael, Scott R. "Urgent Fury: Looking Back and Forward." Field Artillery Journal, March-April 1985, pp. 8-16.
- Olson, William J. "The Light Force Initiative." Military Review, June 1985, pp. 3-9.
- Peters, Ralph. "Kinds of War." Military Review, October 1986, pp. 15-31.
- Spiller, Roger J. "Not War But Like War: The American Intervention in Lebanon." Leavenworth Papers, Combat Studies Institute, U.S. Army Command and General Staff College, Fort Leavenworth, Kansas, January 1981.
- Wass de Czege, Huba. "Three Kinds of Infantry." Infantry, July-August 1985, pp. 19-22.

## DOCUMENTS

- Boeing Corporation. "Report of Proceedings: Light Infantry Conference 1985." 17-20 September 1985, Seattle, Washington.
- Canby, Steven L. "Classic Light Infantry and New Technology." Darpa Contract No. MDA 903-81-C-0207, December 1982.
- Foreign Broadcast Information Service, USSR Report, "The Artillery Battalion in Combat," JPRS Publication, JPRS UMA-85-012-L, 1 May 1985.
- Greenberg, Lawrence M. "United States Army Unilateral and Coalition Operations in the 1965 Dominican Republic Intervention." (Final Draft), U.S. Army Center of Military History, Washington D.C., 1985.
- Headquarters, Army Ground Forces. "10th Mountain Division Artillery as Assault Guns." Army Ground Forces Report #A473, Washington D.C., 14 June 1945.
- Luttwak, Edward N. Historical Analysis and Projection for Army 2000, the U.S. Army of the Second World War: The Light Division, TRADOC Contract #DABT 58-82-C-0055, March 1983.
- Luttwak, Edward N. Historical Analysis and Projection for Army 2000, The U.S. Army of the Second World War: The 10th Mountain Division, TRADOC Contract # DABT-58-82-C-0055, March 1983.
- Luttwak, Edward N. Strategic Utility of U.S. Light Divisions, A Systematic Evaluation, Contract #DDBT-60-34-C-0099, 1 August, 1985.
- Luttwak, Edward N. Historical Analysis and Projection for Army 2000, Part One, TRADOC Contract DABT-58-82-C-0055, 1 March 1983.
- National Defense University. "The Maneuver Oriented Corps-1996 (MOC-96)." Student Research Project, National Defense University, July 1986.
- Scales, Robert H. Jr. "Do We Need a Division Artillery?" (Unpublished paper) U.S. Army Field Artillery School, Fort Sill, Oklahoma, July 1986, pp.1-19.
- Secretary of State for Defense, Great Britain. "The Falklands Campaign: The Lessons." Her Majesty's Stationary Office, London, October, 1983.
- Seventh Infantry Division (Light), Division FTX Celtic Cross III After Action Reports. 7th Infantry Division (Light) ACofS, G3, 18 October 1985.

- Su, Poon Ghee, "Equipping the Infantry Division (Light) in the 1990's" MMAS Thesis, U.S. Army Command and General Staff College, Fort Leavenworth, Kansas, 1986.
- U.S. Army, Chief of Military History. "Mountain Warfare," No. 11, Vol. 1 and II, MS #P-034, 24 February 1950.
- U.S. Army, Chief of Staff White Paper 1984. "Light Infantry Divisions," 16 April 1984.
- U.S. Army Command and General Staff College, Department of Joint and Combined Operations, "Operation Urgent Fury," unpublished briefing, Fort Leavenworth, Kansas, October 1986.
- U.S. Army Command and General Staff College, Memorandum for Record, Subj: "Division Artillery." Memorandum For the Deputy Commandant from the Director, School of Advanced Military Studies, Fort Leavenworth, Kansas, 10 February 1986.
- U.S. Army Field Circular 71-101, Light Infantry Division Operations, July 1984.
- U.S. Army Field Circular 100-20, Low Intensity Conflict, 16 July 1986.
- U.S. Army Field Manual 100-15, Corps Operations (Final Draft), U.S. Army Command and General Staff College, Fort Leavenworth, Kansas, 20 February 1985.
- U.S. Army Field Manual FM 6-20-1, Field Artillery Cannon Battalion, December 1983.
- U.S. Army Field Manual 6-20, Fire Support in Combined Operations, 31 December 1984.
- U.S. Army Field Manual 100-5, Operations, May 1986.
- U.S. Army Field Manual FM 101-5-1, Operational Terms and Symbols, January 1985.
- United States Field Artillery School, "Field Artillery Force Design for the Alaska Theatre Defense Division (ATDD)." Action officer briefing, Fort Sill, Oklahoma, 21 May 1985.
- United States Field Artillery School. Tactical Employment of Field Artillery, 1934 Edition, Fort Sill, Oklahoma.
- U.S. Army Field Artillery School letter, "Field Artillery Focused Rotation, NTC 86-5" (Fire Support Assessment Team Report), Fort Sill, Oklahoma, 28 February 1986.
- U.S. Army Field Artillery School, "Division Artillery Force Design," CSA Decision Briefing, July 1984.

J.S. Army Training and Doctrine Command, Army 21, Interim Operational Concept (First Edition). Fort Monroe, Virginia: HQ, USATRAPOC, June 1985.

U.S. Army Training and Doctrine Command Liaison Office, French War College, "French Light Forces" Rpt. no. 01-84, 15 February 1984.

U.S. Army Operational Concept, The Light Infantry Division. U.S. Army Combined Arms Development Activity, Fort Leavenworth, Kansas, 15 March 1984.

War Department, Military Intelligence Division, German Mountain Warfare, Special Series, no.21, 29 February 1944.

Wass de Czege, Huba, "Understanding and Developing Combat Power." School of Advanced Military Studies, Course Special, U.S. Army Command and General Staff College, Fort Leavenworth, Kansas, 10 February 1984.