

AD-A179 863

ARO 20953.20-CH

DTIC FILE COPY

(2)

RESEARCH IN INORGANIC FLUORINE CHEMISTRY

FINAL REPORT

ROCKETDYNE DIVISION
ROCKWELL INTERNATIONAL
6633 CANOGA AVENUE
CANOGA PARK, CA 91303

AUTHOR: K. O. Christe

DTIC
ELECTE
APR 28 1987
S D

1 MARCH 1987

Final Report for Period 1 March 1984 - 28 February 1987

Approved for public release; distribution unlimited.
Reproduction in whole or in part is permitted for
any purpose of the United States Government.

Prepared for

U.S. ARMY RESEARCH OFFICE
RESEARCH TRIANGLE PARK, NC 27709

A Report on Work Sponsored by the U.S. Army Research Office,
under Contract DAAG29-84-C-0001.

87 4 27 028

UNCLASSIFIED

A179863

SECURITY CLASSIFICATION OF THIS PAGE

REPORT DOCUMENTATION PAGE

1a. REPORT SECURITY CLASSIFICATION UNCLASSIFIED		1b. RESTRICTIVE MARKINGS	
2a. SECURITY CLASSIFICATION AUTHORITY		3. DISTRIBUTION/AVAILABILITY OF REPORT Approved for public release; distribution unlimited.	
2b. DECLASSIFICATION/DOWNGRADING SCHEDULE		5. MONITORING ORGANIZATION REPORT NUMBER(S) ARO 20953.20-CH	
4. PERFORMING ORGANIZATION REPORT NUMBER(S)		7a. NAME OF MONITORING ORGANIZATION U.S. Army Research Office	
6a. NAME OF PERFORMING ORGANIZATION Rocketdyne Division Rockwell International	6b. OFFICE SYMBOL (If applicable)	7b. ADDRESS (City, State and ZIP Code) P.O. Box 12211 Research Triangle Park, NC 27709	
6c. ADDRESS (City, State and ZIP Code) 6633 Canoga Avenue Canoga Park, CA 91303		9. PROCUREMENT INSTRUMENT IDENTIFICATION NUMBER DAAG29-84-C-0001	
8a. NAME OF FUNDING/SPONSORING ORGANIZATION U. S. Army Research Office	8b. OFFICE SYMBOL (If applicable)	10. SOURCE OF FUNDING NOS.	
8c. ADDRESS (City, State and ZIP Code) P.O. Box 12211 Research Triangle Park, NC 27709		PROGRAM ELEMENT NO.	PROJECT NO.
11. TITLE (Include Security Classification) Research in Inorganic Fluorine Chemistry		TASK NO.	WORK UNIT NO.
12. PERSONAL AUTHOR(S) Karl O. Christe		TETRAFLUORO AMMONIUM HEXAFLUORO BROMIDE	
13a. TYPE OF REPORT	13b. TIME COVERED FROM Mar 84 to 28 Feb 87	14. DATE OF REPORT (Yr., Mo., Day) 1987 March 1	15. PAGE COUNT
16. SUPPLEMENTARY NOTATION The view, opinions, and/or findings contained in this report are those of the author and should not be construed as an official Department of the Army position, policy, or decision, unless so designated by other documentation.			
17. COSATI CODES		18. SUBJECT TERMS (Continue on reverse if necessary and identify by block number)	
FIELD	GROUP	SUB. GR.	
		Synthesis, Novel Oxidizers, Chemical Synthesis of Fluorine, Solid Propellant Fluorine Generators, Perfluoroammonium Salts, Difluoramine, Bromine Nitrates, Dinitrogen Pentoxide,	
19. ABSTRACT (Continue on reverse if necessary and identify by block number)			
A basic research program was carried out in the area of inorganic fluorine chemistry. Major achievements accomplished during this program include: The first purely chemical synthesis of elemental fluorine was realized. Solid propellant based pure fluorine gas generators were developed. The first examples of NF_4 salts containing halogen fluoride counterions were prepared and characterized. Also NF_4GrF_6 was synthesized and characterized. The bond length in NF_4 was estimated from its General Valence Force Field and was verified by a crystal structure determination of NF_4Br_2 . Difluoramine and DNF_2 were prepared, characterized, and their alkali metal fluoride adducts were studied. These adducts were shown to contain $[F \cdot \cdot HNF_2]^-$ anions. The nature of the association in solid HNF_2 was explored. The interaction of difluoroamino compounds with Lewis acids was studied. The reaction chemistry of NF_4 and CrF_4 was studied and several new compounds were prepared and characterized. The nitrate anion was found to be an excellent and readily available reagent for accomplishing fluorine-oxygen exchange in certain halogen fluorides.			
20. DISTRIBUTION/AVAILABILITY OF ABSTRACT UNCLASSIFIED/UNLIMITED <input checked="" type="checkbox"/> SAME AS RPT <input type="checkbox"/> DTIC USERS <input type="checkbox"/>		21. ABSTRACT SECURITY CLASSIFICATION UNCLASSIFIED	
22a. NAME OF RESPONSIBLE INDIVIDUAL Dr. KARL O. Christe		22b. TELEPHONE NUMBER (Include Area Code) (818) 710-3268	22c. OFFICE SYMBOL

19. Key Words (Continued)

Chromium Fluorides, Bromine Trifluoride Oxide, Tetrafluorobromine Oxide Anion, Krypton Fluorides, Platinum Hexafluoride Oxonium Salts, Chlorine Oxyfluorides, Trifluoromethyl Azide, Nickel (II) Hexafluoroantimonate.

20. Abstract (Continued)

This work resulted in new, simplified syntheses for compounds such as BrF_3O , BrF_4O^- salts, BrNO_3 and N_2O_5 . Based on its Raman spectra, solid N_2O_5 was shown to contain nonlinear NO_2^+ cations. The salts $\text{Cs}[\text{Br}(\text{NO}_3)_2]$ and $\text{NO}_2[\text{Br}(\text{NO}_3)_2]$ were prepared and characterized. It was shown that the previously reported $\text{Br}(\text{NO}_3)_3$ actually is $\text{NO}_2[\text{Br}(\text{NO}_3)_2]$. A total of 33 papers, manuscripts and patents are included in the Appendix.

CONTENTS

	PAGE
INTRODUCTION	2
PUBLICATIONS AND PATENTS GENERATED UNDER THIS PROGRAM . .	3
PUBLICATIONS	3
PAPERS IN PRESS	5
PAPERS PRESENTED AT MEETINGS	6
INVITED LECTURES	7
PATENTS ISSUED	8
PATENT DISCLOSURES	8
AWARDS	9
RESULTS AND DISCUSSIONS	10
CHEMICAL SYNTHESIS OF ELEMENTAL FLUORINE	10
SOLID PROPELLANT PURE FLUORINE GAS GENERATORS	12
NF_4^+ CHEMISTRY	13
NF_2 CHEMISTRY	13
CHROMIUM FLUORIDE CHEMISTRY	14
OXYGEN-FLUORINE EXCHANGE REACTIONS	14
CONCLUSION	15/16
APPENDICES	A
TECHNICAL PAPERS	THROUGH Y
PATENTS	AA THROUGH GG

PREFACE

The research reported herein was supported by the U.S. Army Research Office with Dr. B. Spielvogel as Scientific Officer. Other support of this work was provided by the Office of Naval Research with Dr. H. Guard as Scientific Officer. This report covers the period 1 March 1984 through 28 February 1987. The program has been directed by Dr. K. O. Christe. The scientific effort was carried out mainly by Drs. K. O. Christe, W. W. Wilson and C. J. Schack and Mr. R. D. Wilson. Other contributors to these research efforts, at no cost to the contract, were Drs. R. Bougon, P. Charpin and E. Soulie (French Atomic Energy Commission), Prof. J. Fawcett (University of Leicester, U.K.), Profs. H. Oberhammer and D. Christen (Universitat Tubingen, W-Germany), Profs. G. Olah and R. Bau (University of Southern California), Dr. M. D. Lind (Science Center of Rockwell International) and Prof. N. Thorup (University of Lingby, Denmark). The program was administered by Dr. L. Grant and after his resignation by Dr. J. Flanagan.



Accession For	
NTIS CRA&I	<input checked="" type="checkbox"/>
ERIC TAB	<input type="checkbox"/>
Unannounced	<input type="checkbox"/>
Justification	
By	
Distribution /	
Availability Codes	
Dist	Availability for Special
A-1	

INTRODUCTION

This is the final report of a research program carried out at Rocketdyne between 1 March 1984 and 28 February 1987. The purpose of this program was to explore the synthesis and properties of energetic inorganic halogen oxidizers. Although the program was directed toward basic research, applications of the results were continuously considered.

Only completed items of research, which have been summarized in manuscript form, are included in this report. A total of 18 technical papers were published and 8 papers are in press in major scientific journals. In addition, 10 papers were presented at international and national conferences, and 14 invited lectures were given in the US and abroad. A further testimony to the creativity of this program is the fact that it resulted in 7 US patents and 3 patent disclosures. The technical papers and issued patents are given as Appendices A through Y and AA through GG, respectively.

During 1985, the author served as a member on the Committee on Energetic Materials Science and Technology appointed by the Board on Army Science and Technology. Rocketdyne's outstanding contributions to fluorine chemistry were also recognized by the American Chemical Society with its 1986 Award for Creative Work in Fluorine Chemistry.

PUBLICATIONS AND PATENTS GENERATED UNDER THIS PROGRAM

PUBLICATIONS

1. "Coordinatively Saturated Fluoro Cations. Oxidative Fluorination Reactions with KrF^+ Salts and PtF_6 ," by K. O. Christe, W. W. Wilson and R. D. Wilson, Inorg. Chem., 23, 2058 (1984).
2. "Some Interesting Observations in Chlorine Oxyfluoride Chemistry," by K. O. Christe and W. W. Wilson, J. Fluorine Chem., 26, 257 (1984).
3. "Structure and Vibrational Spectra of Oxonium Hexafluoro-Arsenates (V) and -Antimonates (V)," by K. O. Christe, P. Charpin, E. Soulie, R. Bougon and J. Fawcett, Inorg. Chem., 23, 3756 (1984).
4. "The Gas Phase Structure of CF_3N_3 . An Electron Diffraction, Microwave Spectroscopy and Normal Coordinate Analysis," by K. O. Christe, D. Christen, H. Oberhammer, and C. J. Schack, Inorg. Chem., 23, 4283 (1984).
5. "Positive Fluorine - Reality or Misconcept?," by K. O. Christe, J. Fluorine Chem., 25, 269 (1984).
6. "Synthesis and Characterization of Bis[difluoroxychlorine (V)] Hexafluoronickelate (IV), $(\text{ClF}_2\text{O})_2\text{NiF}_6$," by W. W. Wilson and K. O. Christe, Inorg. Chem., 23, 3261 (1984).
7. "Lewis Acid Induced Intramolecular Redox Reactions of Difluoramino Compounds," by K. O. Christe, W. W. Wilson, C. J. Schack, and R. D. Wilson, Inorg. Chem., 24, 303 (1985).

8. "Synthesis and Characterization of NF_4CrF_6 and Reaction Chemistry of CrF_5 ," by R. Bougon, W. W. Wilson and K. O. Christe, Inorg. Chem., 24, 2286 (1985).
9. "Cyanation and Nitration of Toluene with Cyanamide and Nitramide Through Intermediate Cyano- and Nitrodiazonium Ions. Attempted Fluorination of Aromatics with Fluorodiazonium Ion," by G. A. Olah, K. Laali, M. Farnia, J. Shih, B. P. Singh, C. J. Schack, and K. O. Christe, J. Org. Chem., 50, 1339 (1985).
10. "Synthesis and Characterization of $\text{NF}_4^+\text{BrF}_4^-$ and $\text{NF}_4^+\text{BrF}_4\text{O}^-$," by K. O. Christe and W. W. Wilson, Inorg. Chem., 25, 1904 (1986).
11. "Tetrafluoroammonium Salts," by K. O. Christe, W. W. Wilson, C. J. Schack and R. D. Wilson, Inorg. Synth., 24, 39 (1986).
12. "Tungsten Oxide Tetrafluoride," by W. W. Wilson and K. O. Christe, Inorg. Synth., 24, 37 (1986).
13. "Cesium Hexafluoromanganate (IV)," by W. W. Wilson and K. O. Christe, Inorg. Synth., 24, 3 (1986).
14. "Chloryl Fluoride," by K. O. Christe, R. D. Wilson and C. J. Schack, Inorg. Synth., 24, 3 (1986).
15. "Synthesis and Characterization of CrF_4O , $\text{KrF}_2\cdot\text{CrF}_4\text{O}$, and $\text{NO}^+\text{CrF}_5\text{O}^-$," by K. O. Christe, W. W. Wilson, and R. A. Bougon, Inorg. Chem., 25, 2163 (1986).
16. "Estimation of the N-F Bond Distance in NF_4^+ from its General Valence Force Field," by K. O. Christe, Spectrochim. Acta, 42A, 939 (1986).

17. "Chemical Synthesis of Elemental Fluorine," by K. O. Christe, Inorg. Chem., 25, 3721 (1986).
18. "Preparation and Characterization of $\text{Ni}(\text{SbF}_6)_2$," by K. O. Christe, W. W. Wilson, R. A. Bougon and P. Charpin, J. Fluorine Chem., 34, 287 (1986).

PAPERS IN PRESS

19. "On the Condensed Phases of Difluoramine and its Alkali Metal Fluoride Adducts," by K. O. Christe and R. D. Wilson, Inorg. Chem.
20. "New, One Step Syntheses of BrF_3O and BrF_4O^- Salts and the Preparation and Characterization of RbBrF_4O and NaBrF_4O ," by W. W. Wilson and K. O. Christe, Inorg. Chem.
21. "Dinitrogen Pentoxide. New Synthesis and Laser Raman Spectrum," by W. W. Wilson and K. O. Christe, Inorg. Chem.
22. "Bromine Nitrates," by W. W. Wilson and K. O. Christe, Inorg. Chem.
23. "Solid Propellant Based Pure Fluorine Gas Generators," by K. O. Christe and R. D. Wilson, Inorg. Chem.
24. "Preparation of Halogen Oxyfluorides," by K. O. Christe, contributed chapter to Volume 3 of Inorganic Reactions and Methods.
25. "On the Existence of $\text{CrF}_4\text{O}\cdot\text{SbF}_5$ Adduct," by W. W. Wilson and K. O. Christe, J. Fluorine Chem.
26. "Self-Association in HOF and HNF_2 . Which Atoms are the Better Proton Acceptors, Fluorine, Oxygen or Nitrogen?" by K. O. Christe, J. Fluorine Chem.

PAPERS PRESENTED AT MEETINGS

27. "Synthesis and Characterization of NF_4CrF_6 and some Chemistry of CrF_5 ," by W. W. Wilson, R. A. Bougon, and K. O. Christe, 39th ACS Northwest Regional Meeting, Moscow, Idaho, June 1984.
28. "Lewis Acid Induced Intramolecular Redox Reaction of Difluoramino Compounds," by K. O. Christe, W. W. Wilson, C. J. Schack and R. D. Wilson, presented at the 1984 International Chemical Congress of Pacific Basin Societies, Honolulu, Hawaii, December 1984.
29. " CrF_5 Chemistry and Synthesis of NF_4CrF_6 ," by R. A. Bougon, W. W. Wilson, and K. O. Christe, presented at the Seventh Winter Fluorine Conference, Orlando, Florida.
30. "High Energy Fluorine Compounds," by K. O. Christe, State of the Art Symposium - Fluorine Chemistry: One Hundred Years and Beyond. Future Trends in Fluorine Chemistry, paper presented at 191st National ACS Meeting, April 13-18, 1986, New York City.
31. "Synthesis and Characterization of CrF_4O , $\text{KrF}_2 \cdot \text{CrF}_4\text{O}$ and $\text{NO}^+\text{CrF}_5\text{O}^-$," by W. W. Wilson, R. A. Bougon and K. O. Christe paper presented at 191st National ACS Meeting, April 13-18, 1986, New York City.
32. "Chemical Generation of Elemental Fluorine," by K. O. Christe, Invited Lecture, Centenary of the Discovery of Fluorine, August 25-29, Paris, France.
33. "Reactions of Oxo Anions with Halogen and Noble Gas Fluorides," by W. W. Wilson and K. O. Christe, Centenary of the Discovery of Fluorine, August 25-29, 1986, Paris, France.

34. "Some New Results in Nitrogen-Fluorine Chemistry," by K. O. Christe, R. D. Wilson, M. D. Lind and N. Thorup, Eighth Winter Fluorine Conference, January 25-30, 1987, St. Petersburg, Florida.
35. "Reactions of BrF_5 with the Nitrate Anion," by W. W. Wilson and K. O. Christe, Eighth Winter Fluorine Conference, January 25-30, 1987, St. Petersburg, Florida.
36. "Preparation and Characterization of $\text{Ni}(\text{SbF}_6)_2$ and $\text{Ni}(\text{BiF}_6)_2$," by R. Bougon, P. Charpin, J. Isabey, M. Lance, K. O. Christe, and W. W. Wilson, Eighth Winter Fluorine Conference, January 25-30, 1987, St. Petersburg, Florida.

INVITED LECTURES

Invited lectures on work done under this contract were given at:

37. University of Utah, Salt Lake City
38. University of British Columbia, Canada
39. University of California, Santa Barbara
40. Universitat Dortmund, W-Germany
41. Ruhr-Universitat Bochum, W-Germany
42. Freie Universitat Berlin, W-Germany
43. Technische Universitat Stuttgart, W-Germany
44. Universitat Ulm, W-Germany
45. Phillips Universitat Marburg, W-Germany •
46. Universitat Hannover, W-Germany
47. Universitat Gottingen, W-Germany
48. University of Alabama, Tuscaloosa
49. Clemson University, South Carolina
50. Stanford University, Stanford, CA

PATENTS ISSUED

51. "NF₃-F₂ Gas Generator Compositions," by K. O. Christe and W. W. Wilson, U.S. Pat. 4,410,377 (October 1983).
52. "NF₄⁺WF₆⁻ and NF₄⁺UF₇⁻ and Methods of Preparation," by W. W. Wilson and K. O. Christe, U.S. Pat. 4,421,727 (December, 1983).
53. "Method for Introducing Fluorine into an Aromatic Ring," by K. O. Christe and C. J. Schack, U.S. Pat. 4,423,260 (December, 1983).
54. "Perfluoroammonium Salt of Heptafluoroxenon Anion," by K. O. Christe and W. W. Wilson, U.S. Pat. 4,428,913 (January 1984).
55. "Perfluoroammonium Salts Fluoroxenon Anions," by K. O. Christe and W. W. Wilson, U.S. Pat. 4,447,407 (May 1984).
56. "Synthesis of Pentafluorotellurium Hypofluorite," by C. J. Schack, W. W. Wilson and K. O. Christe, U.S. Pat. 4,462,975 (July 1984).
57. "Method for Introducing Fluorine into an Aromatic Ring," by K. O. Christe and C. J. Schack, U.S. Pat. 4,476,337 (October 1984).

PATENT DISCLOSURES

58. "Improved Process for the Production of BrF₃O, Its Alkali Metal Fluoride Salts and FNO₂," by W. W. Wilson and K. O. Christe.

59. "Chemical Synthesis of Elemental Fluorine," by K. O. Christe.

60. "Improved Process for the Preparation of Pure N_2O_5 ," by
K. O. Christe and W. W. Wilson.

AWARDS

61. "Award for Creative Work in Fluorine Chemistry," by the
Fluorine Division of the American Chemical Society,
presented to K. O. Christe at the 191st National ACS
Meeting in New York, April 1986.

RESULTS AND DISCUSSION

In view of the vast amount of data generated under this program, this discussion will be limited to a highlight of some of the major achievements. For more detail, the interested reader is referred to the manuscripts given in the Appendices.

CHEMICAL SYNTHESIS OF ELEMENTAL FLUORINE

The chemical synthesis of elemental fluorine had been pursued for at least 173 years by many notable chemists, including Davy, Fremy, Moissan, and Ruff. All their attempts had failed, and the only known practical synthesis of F_2 was Moissan's electrochemical process, which had been discovered 100 years ago.

Although in principle the thermal decomposition of any fluoride is bound to yield fluorine, the required reaction temperatures and conditions are so extreme that rapid reaction of the evolved fluorine with the hot reactor walls preempts the isolation of significant amounts of fluorine. Thus, even in the well-publicized case of K_3PbF_7 , only trace amounts of fluorine were isolated.

These failures, combined with the fact that fluorine is the most electronegative element and generally exhibits the highest single bond energies in its combinations with other elements, had led to the widely accepted belief that it was impossible to generate fluorine by purely chemical means.

The Centenary of the Discovery of Fluorine by Moissan which was held in August 1986 in Paris prompted us to study the possibility of a purely chemical synthesis of fluorine. This goal was achieved within two weeks, just in time for presentation at the Moissan Centenary. Our chemical synthesis of F_2 was based on

the fact that thermodynamically unstable high-oxidation-state transition-metal fluorides can be stabilized by anion formation. Thus, unstable NiF_4 , CuF_4 , or MnF_4 can be stabilized in the form of their corresponding MF_6^{2-} anions. Furthermore, it was well-known that a weaker Lewis acid, such as MF_4 , can be displaced from its salts by a stronger Lewis acid, such as SbF_5 .

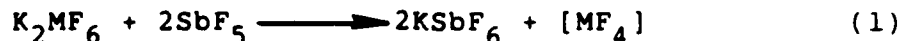

If the liberated MF_4 is thermodynamically unstable, it will spontaneously decompose to a lower fluoride, such as MF_3 or MF_2 , with simultaneous evolution of elemental fluorine.

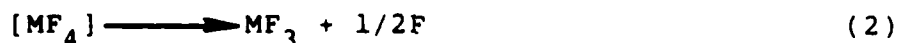

Since a reversal of (2) is thermodynamically not favored, fluorine can be generated even at relatively high pressures.

Consequently, the chemical generation of elemental fluorine was accomplished by a very simple displacement reaction and by selecting a suitable complex fluoro anion which can be prepared without the use of elemental fluorine and is derived from a thermodynamically unstable parent molecule. The salt selected for this study was K_2MnF_6 . It had been known since 1899 and is best prepared from aqueous HF solution.

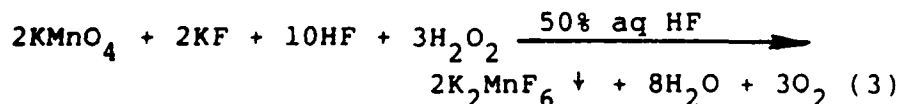

The other starting material, SbF_5 , was prepared in high yield from SbCl_5 and HF.



Since both starting materials, K_2MnF_6 and SbF_5 , can be readily prepared without the use of F_2 from HF solutions, the reaction



represents a truly chemical synthesis of elemental fluorine.

The displacement reaction between K_2MnF_6 and SbF_5 was carried out in a passivated Teflon-stainless-steel reactor at $150^\circ C$ for 1 h. The gas, volatile at $-196^\circ C$, was measured by PVT and shown by its reaction with mercury and its characteristic odor to be fluorine. The yield of fluorine based on (5) was found to be reproducible and in excess of 40%. Fluorine pressures of more than 1 atm were generated in this manner.

Our successful chemical synthesis of fluorine received much attention and was published within one month in *Inorganic Chemistry* (Appendix Q). It was also highlighted in journals such as *Chemical and Engineering News*, *Chem Matters*, and the *Yearbook of Science and the Future* for *Encyclopaedia Britannica*.

Solid Propellant Pure Fluorine Gas Generators

The principle outlined above for the chemical synthesis of elemental fluorine can also be applied to solid propellant pure fluorine gas generators by a simple replacement of the volatile Lewis acid SbF_5 by a nonvolatile solid Lewis acid such as BiF_5 or TiF_4 . This concept was successfully demonstrated (Appendix W) for the K_2NiF_6 - BiF_5 , Cs_2CuF_6 - BiF_5 , Cs_2MnF_6 - BiF_5 , K_2NiF_6 - TiF_4 , and K_2NiF_6 - TiF_4 - BiF_5 systems. This type of generator holds great potential for applications such as pulsed DF chemical lasers using a gas recirculating system.

NF₄⁺ Chemistry

In view of the fact that the NF₄⁺ cation is the most useful and most stable highly energetic cationic oxidizer presently known, the chemistry of NF₄⁺ was further explored.

The first examples of NF₄⁺ salts with halogen fluoride anions were synthesized and characterized. These salts are NF₄BrF₄ and NF₄BrF₄O and are described in Appendix J. Similarly, the synthesis and characterization of NF₄CrF₆ is described in Appendix H.

The bond length in NF₄⁺ has been estimated from its General Valence Force Field as 1.31Å (see Appendix P). Experimental verification of this value has finally been achieved by a x-ray single crystal structure determination of NF₄BF₄ which resulted in a value of 1.30Å. These results will be reported on in a future publication. A review of synthetic procedures for the preparation of NF₄⁺ salts was published in Inorganic Syntheses (see Appendix M).

NF₂ Chemistry

Since difluoramine is an important intermediate in the preparation of other oxidizers such as N₂F₄, a better knowledge of this poorly characterized material was desired. This work was complicated by the fact that HNF₂ is a vicious explosive. Samples of HNF₂ and pure DNF₂ were prepared and studied in both the liquid and the solid phase (Appendix S). It was shown that, surprisingly, association in the condensed phases occurs through N-H--bridges and not through N-H--F bridges (Appendix Y). The structures of the alkali metal fluoride ·HNF₂ adducts were studied and it was shown that the different alkali metal adducts all contain the [F···HNF₂]⁻

anion (Appendix S). Evidence was obtained for two different adducts which do not differ by nature but only by the relative strength of their F...H-N bridge. The more strongly bridged adducts might account for the explosive nature of some of the adducts.

It was also found that certain difluoramino compounds are unstable towards Lewis acids and readily undergo intramolecular redox reactions (see Appendix G).

CHROMIUM FLUORIDE CHEMISTRY

Since CrF_6 is expected to be a very powerful oxidizer (CrF_5 can already oxidize O_2 to O_2^+), we became interested in chromium fluoride chemistry. Although the synthesis of CrF_6 in bulk quantities has so far proven elusive, the reaction chemistry of CrF_5 (Appendix H) and CrF_4O (Appendices O and X) was studied and several new adducts such as $\text{KrF}_2 \cdot \text{CrF}_4\text{O}$, $\text{NO}^+ \text{CrF}_5\text{O}^-$ and $\text{CrF}_4\text{O} \cdot \text{SbF}_5$ were synthesized and characterized. It was shown that some of these adducts are extremely powerful oxidizers.

OXYGEN-FLUORINE EXCHANGE REACTIONS

The nitrate anion was found to be a very versatile, cheap and readily available reagent for achieving fluorine-oxygen exchange in many cases. For example, the previously rather inaccessible BrF_3O molecule and its BrF_4O^- salts can now be prepared with great ease in quantitative yields (see Appendix T):

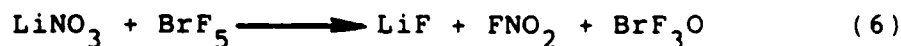

The latter type reaction was used to synthesize and characterize the novel salts NaBrF_4O and RbBrF_4O . By using an excess of MNO_3 in these reactions, it was found that BrONO_2 and N_2O_5 became the major products. Since BrONO_2 had previously been only poorly characterized, this compound and its reaction chemistry were studied in more detail (Appendix V). It was found that N_2O_5 forms with BrONO_2 the ionic adduct $\text{NO}_2^+[\text{Br}(\text{ONO}_2)_3]^-$. Furthermore, it was shown that the previously reported compound $\text{Br}(\text{ONO}_2)_3$ is identical to $\text{NO}_2^+[\text{Br}(\text{ONO}_2)_2]^-$ and had been incorrectly identified.

In connection with this study we have also discovered a new synthesis of N_2O_5 according to



This synthesis offers the advantage of eliminating the need for an ozone generator required for the previously used methods. The laser Raman spectrum of N_2O_5 was also recorded and it was shown that solid N_2O_5 which has the ionic structure $\text{NO}_2^+\text{NO}_3^-$ cannot contain completely linear NO_2^+ cations. The latter result is in contrast to previous, low-precision x-ray diffraction data (Appendix U).

Extension of this work to other fluorides and oxoanions is under progress.

CONCLUSION

The work during this contract period has again been extremely fruitful. The first chemical synthesis of elemental fluorine not only represented a major breakthrough in basic chemistry, but also resulted in useful applications such as a solid propellant pure fluorine gas generator for high-power, pulsed DF lasers. Another example is the class of oxygen-fluorine exchange reactions using nitrates which resulted in an improved synthesis of pure N_2O_5 . These and the other examples highlighted above demonstrate again the benefits which can be expected from well-planned, goal-oriented basic research and program continuity.

APPENDIX A

Reprinted from *Inorganic Chemistry*, 1984, 23, 2058
Copyright © 1984 by the American Chemical Society and reprinted by permission of the copyright owner.

Contribution from Rocketdyne, A Division of
Rockwell International, Canoga Park, California 91304

Coordinationally Saturated Fluoro Cations. Oxidative Fluorination Reactions with KrF^+ Salts and PtF_6

KARL O. CHRISTE,* WILLIAM W. WILSON, and RICHARD D. WILSON

Received August 24, 1983

The usefulness of KrF^+ salts and PtF_6 as oxidative fluorinators for the syntheses of the coordinationally saturated complex fluoro cations NF_4^+ , ClF_4^+ , and BrF_4^+ was studied. The syntheses of NF_4SbF_6 , NF_4AsF_6 , NF_4BF_6 , and $NF_4TiF_6 \cdot nTiF_6$ from KrF^+ -Lewis acid adducts and NF_3 were investigated under different reaction conditions. The fluorination of NF_3 by $KrF^+SbF_6^-$ in HF solution was found to proceed quantitatively at temperatures as low as $-31^\circ C$, indicating an ionic two-electron oxidation mechanism. An improved synthesis of $KrF^+MF_6^-$ ($M = As, Sb$), Raman data and solubilities in HF, and the existence of a $Kr_2F_3^+ \cdot nKrF_2BF_4^-$ adduct in HF at $-40^\circ C$ are reported. Attempts to fluorinate OF_2 , CF_3NF_2 , and ClF_3O with KrF^+ salts were unsuccessful. Whereas KrF^+ is capable of oxidizing NF_3 , ClF_3 , and BrF_3 to the corresponding complex fluoro cations, PtF_6 was shown to be capable of oxidizing only NF_3 and ClF_3 . Since the yield and purity of the NF_4^+ fluoroplatinate salts obtained in this manner were low, NF_4PtF_6 was also prepared from NF_3 , F_2 , and PtF_6 at elevated temperature and pressure. General aspects of the formation mechanisms of coordinationally saturated complex fluoro cations are discussed briefly.

Introduction

The preparation of coordinationally saturated complex fluoro cations presents a great challenge to the synthetic chemist. The nonexistence of the corresponding parent molecules preempts the normally facile cation formation by a simple F^- abstraction from a parent molecule, and an F^+ addition to a lower fluoride is ruled out by the fact that fluorine is the most electronegative element and therefore F^+ cannot be generated by chemical means.¹ In view of these difficulties it is not surprising that at the present time only three coordinationally saturated fluoro cations, NF_4^+ ,^{2,3} ClF_4^+ ,^{4,5} and BrF_4^+ ,⁶ are known to exist. In addition to their challenge to the synthetic chemist, the formation mechanism of these cations represents an intriguing and as yet unsolved puzzle.⁷

These problems were complicated by the facts that each of the three known coordinationally saturated fluoro cations had been prepared by a different method²⁻⁶ and that these methods could not readily be transferred from one cation to another. The purpose of this study was to examine whether the synthesis of each coordinationally saturated fluoro cation is indeed limited to a specific method and whether these methods possess any commonalities.

Experimental Section

Apparatus. Volatile materials used in this work were handled in a stainless steel-Teflon FEP vacuum line. The line and other hardware used were well passivated with ClF_3 and, if HF was to be used, with HF. Nonvolatile materials were handled in the dry-nitrogen atmosphere of a glovebox. Metathetical reactions and solubility measurements were carried out in HF solution with use of an apparatus consisting of two FEP U-traps interconnected through a coupling containing a porous Teflon filter.⁸

Infrared spectra were recorded in the range $4000-200\text{ cm}^{-1}$ on a Perkin-Elmer Model 283 spectrophotometer. Spectra of solids were obtained by using dry powders pressed between $AgCl$ windows in an

- (1) Christe, K. O.; Wilson, W. W.; Curtis, E. C. *Inorg. Chem.* 1983, 22, 3056.
- (2) Christe, K. O.; Guertin, J. P.; Pavlath, A. E. *Inorg. Nucl. Chem. Lett.* 1966, 2, 83.
- (3) Tolberg, W. E.; Rewick, R. T.; Stringham, R. S.; Hill, M. E. *Inorg. Nucl. Chem. Lett.* 1966, 2, 79.
- (4) Roberto, F. O. *Inorg. Nucl. Chem. Lett.* 1972, 8, 737.
- (5) Christe, K. O. *Inorg. Nucl. Chem. Lett.* 1972, 8, 741.
- (6) Gillespie, R. J.; Schrobilgen, G. J. *J. Chem. Soc., Chem. Commun.* 1974, 90; *Inorg. Chem.* 1974, 13, 1230.

- (7) Christe, K. O.; Wilson, R. D.; Goldberg, I. B. *Inorg. Chem.* 1979, 18, 2572 and references cited therein.
- (8) Christe, K. O.; Scheck, C. J.; Wilson, R. D. *Inorg. Chem.* 1977, 16, 849.

Econo press (Barnes Engineering Co.). Spectra of gases were obtained by using a Teflon cell of 5-cm length equipped with AgCl windows.

Raman spectra were recorded on a Cary Model 83 spectrophotometer using the 4880-Å exciting line of an Ar ion laser and Claassen filter⁹ for the elimination of plasma lines. Sealed glass, Teflon FEP, or Kel-F tubes were used as sample containers in the transverse-viewing-transverse-excitation mode. Lines due to the Teflon or Kel-F sample tubes were suppressed by the use of a metal mask.

Materials. Literature methods were used for the preparation of PtF₆,¹⁰ KrF₂,¹¹ CF₃NF₂,¹² ClF₃O,¹³ ClF₃,¹⁴ and FNO¹⁵ and for the drying of HF.¹⁶ Nitrogen trifluoride (Rockodyne), F₂ (Air Products), OF₂ (Allied Chemical), BrF₃ and BF₃ (Matheson), and AsF₅, SbF₅, and TiF₄ (Ozark Mahoning) were commercially available. Their purity was checked by vibrational spectroscopy prior to use and, where necessary, improved by fractional condensation or distillation.

Preparation of KrFSbF₆. Antimony pentafluoride (21.7 mmol) was syringed in the drybox into a prepassivated Teflon FEP U-tube equipped with two stainless steel valves. The tube was connected to the vacuum line, and dry HF (5 mL of liquid) was distilled into the tube. The HF and SbF₅ were allowed to homogenize at ambient temperature, and a preweighed amount of KrF₂ (22.9 mmol) was transferred under a dynamic vacuum into the U-tube at -196 °C. The mixture was warmed toward room temperature until a slight effervescence was noted. At this point the tube was cooled again, and the warmup procedure was repeated. After a total of three warmup cycles, all volatile material was pumped off at -22 °C, leaving behind pure KrFSbF₆ (21.5 mmol = 99% yield based on SbF₅). KrFAsF₆ was prepared in an analogous manner, except the AsF₅ was loaded into the tube on the vacuum line.

Reaction of NF₃ with KrF₂ and AsF₅. A prepassivated (with ClF₃) 10-mL stainless steel Hoke cylinder equipped with a 1/8 in. Whitey stainless steel valve was loaded on the vacuum line at -196 °C with KrF₂ (6.15 mmol), AsF₅ (3.07 mmol), and NF₃ (21.9 mmol). The cylinder was placed in a liquid-N₂-dry-ice slush bath and allowed to warm slowly to room temperature over a 30-h time period and then was kept in an oven at 53 °C for 4 days. The cylinder was cooled to -210 °C (N₂ slush bath, prepared by pumping on liquid N₂), and the volatile products were separated during warmup of the cylinder by fractional condensation through traps kept at -156 °C (nothing) and -210 °C (24.9 mmol of NF₃ and Kr). The white solid residue (827.6 mg = 2.97 mmol) was identified by infrared and Raman spectroscopy as pure NF₄AsF₆¹⁷ (96.7% yield based on AsF₅).

Reaction of NF₃ with KrF₂ and BF₃. The reaction was carried out as described above for the corresponding AsF₅ system, except for a 40% reduction in the amount of starting materials used. The yield of solid NF₄BF₄ was 30.6% based on BF₃.

Reaction of Solid KrFSbF₆ with NF₃. KrFSbF₆ (2.42 mmol) was added in the drybox to a prepassivated Teflon PFA U-tube (59 mL volume) equipped with Teflon PFA valves. The tube was connected to the vacuum line, and NF₃ (2.43 mmol) was added at -196 °C. After 3 h at 22 °C, the volatile products were removed. Analyses of the volatile material and of the solid residue showed that 12.7% of the KrFSbF₆ had been converted to an NF₄⁺ salt.

When the reaction was repeated with 2.32 mmol of KrFSbF₆ and 6.84 mmol of NF₃ at 30 °C for 3.5 h, the conversion of KrFSbF₆ to NF₄⁺ salts was 43.8%. An additional treatment of the solid mixture of NF₄⁺ salts and unreacted KrFSbF₆ with more NF₃ for 4 h at 30 °C resulted in little further conversion to NF₄⁺ salts. Vibrational spectra of the white solid product showed the presence of the NF₄⁺,¹⁷ KrF⁺,¹⁸ SbF₆⁻,¹⁹ and Sb₂F₁₁⁻¹⁷ ions.

Table I. Oxidative Fluorination of NF₃ to NF₄SbF₆ by KrFSbF₆ in HF Solution

reacn temp, °C	reacn of KrFSbF ₆ :NF ₃	reacn time, h	conversion of KrFSbF ₆ , %	products (composition, %)
25	1:1	3	100	NF ₄ Sb ₂ F ₁₁ (91), NF ₄ SbF ₆ (9)
-31	1:1	3	37	NF ₄ SbF ₆ (37), KrFSbF ₆ (63)
-31	large excess of NF ₃ , P _{NF₃} = 1000 mm	1	100	NF ₄ SbF ₆ (100)
-45	1:1	3	23	NF ₄ SbF ₆ (23), KrFSbF ₆ (77)
-78	1:1	3	0	KrFSbF ₆ (100)

Reactions of KrFSbF₆ with NF₃ in HF Solution. General Procedure. KrFSbF₆ (~3 mmol) was weighed in the drybox into a prepassivated 0.5 in. o.d. Teflon PFA U-tube (58 mL volume) equipped with two Teflon PFA valves. The tube was connected to the vacuum line, and anhydrous HF (~1.25 g) and NF₃ were added at -196 °C. The contents of the tube were warmed for a specified time period to the desired reaction temperature. The reaction was stopped by quickly pumping off the NF₃, followed by removal of the HF solvent. The material balances were obtained by separating the volatile products via fractional condensation through traps kept at -126 and -210 °C, by PVT measurements and infrared analysis of each fraction, and by the weight change of the solid phase and its Raman and infrared spectra, which were compared against those of mixtures of known composition. When stoichiometric amounts of KrFSbF₆ and NF₃ were used, the NF₃ was condensed into the U-tube and the valves were closed. When a large excess of NF₃ was used, the NF₃ pressure was kept constant at 1000 mm by the use of a large ballast volume and a pressure regulator. The results of these reactions are summarized in Table I.

Reaction of PtF₆ with NF₃ in HF. A prepassivated Teflon FEP U-trap (119 mL volume) was loaded at -196 °C with HF (5 mL liquid) and equimolar amounts (4.88 mmol each) of PtF₆, NF₃, and F₂. The contents of the trap were kept at 25 °C for 14 h. All volatile material was pumped off at 25 °C, leaving behind 828 mg of a dark red tacky solid, which based on its infrared spectrum was an NF₄⁺ salt (1158 vs cm⁻¹, ν₃(F₂)) of PtF₆⁻ and/or a fluoroplatinate polyanion (665 vs, 625 s, 560 vs cm⁻¹). Attempts were unsuccessful to purify the sample by extraction with anhydrous HF.

UV Photoanalysis of NF₃-PtF₆. A prepassivated 0.5 in. o.d. sapphire reactor¹ (26 mL volume) was loaded at -196 °C with PtF₆ (1.22 mmol) and NF₃ (1.31 mmol). The mixture was irradiated for 2 days at ambient temperature with a Hanovia Model 616A high-pressure quartz mercury vapor arc lamp. All volatile material was pumped off at 25 °C, leaving behind a red-brown solid (116 mg), which based on its infrared spectrum contained the NF₄⁺ cation (2000 w cm⁻¹, ν₁ + ν₂(F₂); 1218 mw cm⁻¹, 2ν₄(A₁ + E + F₂); 1159 vs cm⁻¹, ν₃(F₂); 607 m cm⁻¹, ν₄(F₂)¹⁷ and a fluoroplatinate polyanion (690 vs, 659 vs, 636 s, 535 vs, br cm⁻¹).

Synthesis of NF₄PtF₆. Into a prepassivated Monel cylinder (100 mL volume) were loaded PtF₆ (2.22 mmol), NF₃ (211.8 mmol), and F₂ (216.7 mmol) at -196 °C. The cylinder was heated to 125 °C for 7 days, followed by removal of all material volatile at 25 °C. The residue consisted of 802 mg of a dark red solid (weight calcd for 2.22 mmol of NF₄PtF₆ = 884 mg), which on the basis of its infrared and Raman spectra consisted mainly of NF₄PtF₆.^{15,17,20} IR (cm⁻¹): NF₄⁺, 2305 vw (2ν₃), 1995 w (ν₁ + ν₂), 1758 vw (ν₃ + ν₄), 1452 w (ν₁ + ν₄), 1220 mw (2ν₄), 1180 sh, 1158 vs, 1145 sh (ν₃), 1049 w (ν₂ + ν₄) 606 m (ν₄); PtF₆⁻, 1320, 1300, 1280 w (ν₁ + ν₃), 1220 (ν₂ + ν₃), 675 sh, 650 vs, 625 sh (ν₃), 570 s, tr (ν₂). Raman (cm⁻¹): NF₄⁺, 850 mw (ν₁); PtF₆⁻, 641 vs (ν₁), 580 mw (ν₂), 239 m (ν₃), 194 w (ν₆).

Reaction of PtF₆ with ClF₃ in HF. A prepassivated 0.75 in. o.d. Teflon FEP ampule (49-mL volume) was loaded at -196 °C with PtF₆ (2.10 mmol), HF (2 mL liquid), and ClF₃ (4.20 mmol). The mixture was allowed to slowly warm to ambient temperature in an empty cold Dewar. After the ampule was kept for 2 days at ambient temperature, the brown PtF₆ color had disappeared. The volatile material was

- (9) Claassen, H. H.; Selig, H.; Shamir, J. *J. Appl. Spectrosc.* 1969, 23, 8.
- (10) Weinstock, B.; Claassen, H. H.; Malm, J. G. *J. Am. Chem. Soc.* 1957, 79, 5832. Weinstock, B.; Malm, J. G.; Weaver, E. E. *Ibid.* 1961, 83, 4310.
- (11) Christe, K. O.; Wilson, R. D. *Inorg. Chem.* 1975, 14, 694.
- (12) Schack, C. J. *J. Fluorine Chem.* 1981, 18, 583.
- (13) Pilipovich, D.; Lindahl, C. B.; Schack, C. J.; Wilson, R. D.; Christe, K. O. *Inorg. Chem.* 1972, 11, 2189.
- (14) Pilipovich, D.; Maya, W.; Lawton, E. A.; Bauer, H. F.; Sheehan, D. F.; Ogamachi, N. N.; Wilson, R. D.; Gunderloy, F. C.; Bedwell, V. E. *Inorg. Chem.* 1967, 6, 1918.
- (15) Christe, K. O. *Inorg. Chem.* 1973, 12, 1580.
- (16) Christe, K. O.; Wilson, W. W.; Schack, C. J. *J. Fluorine Chem.* 1978, 11, 71.
- (17) Christe, K. O.; Schack, C. J.; Wilson, R. D. *Inorg. Chem.* 1976, 15, 1275.
- (18) Gillespie, R. J.; Schrobilgen, G. *J. Inorg. Chem.* 1976, 15, 22.

- (19) Christe, K. O.; Wilson, R. D.; Schack, C. J. *Inorg. Chem.* 1977, 16, 937.
- (20) Tolberg, W. E., et al., unpublished results.

removed in vacuo at room temperature and separated by fractional condensation. It consisted of the HF solvent and ClF_3 (2.1 mmol). The orange-yellow solid residue (0.91 g) was shown by infrared and Raman spectroscopy to be an about equimolar mixture of ClF_4PtF_6 and ClF_4PtF_5 ¹⁵ (weight calculated for a mixture of 1.05 mmol of ClF_4PtF_6 and 1.05 mmol of $\text{ClF}_4\text{PtF}_5 = 0.923$ g).

When the reaction was repeated under the same conditions, except for use of BrF_3 in place of ClF_3 , no evidence for the formation of a stable BrF_4^+ salt was obtained.

Results

Syntheses and Some Properties of KrF_2 -Lewis Acid Adducts. Although the synthesis of $\text{KrF}^+\text{MF}_6^-$ ($M = \text{As}, \text{Sb}$) salts is well-known,^{6,18,21,22} the reported direct combination of KrF_2 with the Lewis acids can result in a spontaneous exothermic decomposition of KrF_2 accompanied by a bright flash and gas evolution.¹⁸ In this study this problem was avoided by dissolving the Lewis acid in a large excess of anhydrous HF before adding a stoichiometric amount of KrF_2 . This procedure resulted in an easily controllable, scalable, and quantitative synthesis of the desired KrF_2 -Lewis acid adducts.

Since the Raman spectra of solid $\text{KrF}^+\text{MF}_6^-$ salts show many more bands than expected for an isolated diatomic cation and an octahedral anion,¹⁸ we have recorded the Raman spectrum of $\text{KrF}^+\text{SbF}_6^-$ in HF solution at -5°C . The total number of bands was reduced to four, as expected for a diatomic KrF^+ (610 cm^{-1}) and octahedral SbF_6^- ($\nu_1(\text{A}_{1g}) = 656$, $\nu_2(\text{E}_g) = 576$, $\nu_3(\text{F}_{2g}) = 278\text{ cm}^{-1}$), thus confirming that the additional bands observed for solid $\text{KrF}^+\text{SbF}_6^-$ ¹⁸ are indeed due to solid-state effects. The solubility of $\text{KrF}^+\text{SbF}_6^-$ in anhydrous HF at -31°C was also measured as 43.9 mg/g of HF by the use of a previously described method.¹⁶

Since mixtures of KrF_2 and BF_3 in anhydrous HF are capable of oxidizing NF_3 to NF_4^+ (see below), it was interesting to establish whether BF_3 forms an adduct with KrF_2 under these conditions. Raman spectra of an equimolar mixture of KrF_2 and BF_3 in anhydrous HF at -40°C showed bands (597 (10), 561 (2), 462 (7.5), 334 (1), 179 (1.7) cm^{-1}) characteristic for $\text{Kr}_2\text{F}_3^+ \cdot x\text{KrF}_2$ ¹⁸ and a weak band at 879 cm^{-1} due to $\nu_1(\text{A}_1)$ of BF_3 .²³ The bands expected for BF_4^- were difficult to observe under the given conditions due to their low relative intensity and the low signal to noise ratio. Removal of volatile material under a dynamic vacuum at -78°C resulted in a white solid residue which, on the basis of its Raman spectrum (461 cm^{-1}) at -110°C , consisted of KrF_2 .²⁴ These results clearly show that KrF_2 does not form a stable solid adduct with BF_3 at temperatures as low as -78°C but that in HF solution, even at temperatures as high as -40°C , ionization to $[\text{Kr}_2\text{F}_3^+ \cdot x\text{KrF}_2][\text{BF}_4^-]$ occurs. The observation of free BF_3 is readily accounted for by the formation of krypton fluoride polycations, which leaves most of the BF_3 uncomplexed. Whether any free KrF_2 is also present in the HF solution is difficult to say because the KrF_2 band coincides with the 462- cm^{-1} band of $\text{Kr}_2\text{F}_3^+ \cdot x\text{KrF}_2$.¹⁸

Fluorination Reactions with KrF^+ Salts. The oxidative fluorination of NF_3 to NF_4^+ by KrF^+ salts was first discovered²⁵ by Artyukhov and Khoroshev and independently rediscovered in our laboratory. In our study, mixtures of NF_3 , KrF_2 , and either AsF_5 or BF_3 in mole ratios of 7:2:1 were allowed to warm in stainless steel cylinders from -196 to $+50^\circ\text{C}$ under autogenous pressures of about 75 atm. In 2 days NF_4AsF_6 and NF_4BF_4 had formed in 97 and 30% yield, respectively, based on the limiting reagents AsF_5 and BF_3 ,

agreement with the equations



In the Russian study the reactions were carried out at room temperature either with solid $\text{KrF}^+\text{SbF}_6^-$ and 1 atm of NF_3 or in HF solution with stoichiometric amounts of KrF_2 , NF_3 , and one of the Lewis acids SbF_5 , NbF_5 , PF_5 , TiF_4 , and BF_3 at total pressures of 3–4 atm and with reaction times of 1–3 h. On the basis of elemental analyses and vibrational spectra their products were assigned to NF_4^+ salts of SbF_6^- , NbF_6^- , PF_6^- , TiF_6^{2-} , and BF_4^- , respectively.²⁵ We have repeated some of these reactions in our laboratory because for $(\text{NF}_4)_2\text{TiF}_6$ and NF_4SbF_6 the reported vibrational spectra were those of polyanions,^{17,19,26} and no yields and concentration or temperature dependences were given that would help to shed some light on the possible mechanism of these reactions.

Our results for the reaction of solid KrFSbF_6 with NF_3 showed that indeed the NF_4^+ cation is formed but that under the reported conditions²⁵ the reaction is incomplete and that the NF_4^+ salt is mainly $\text{NF}_4\text{Sb}_2\text{F}_{11}$ and not NF_4SbF_6 .

When the reaction of KrF_2 - SbF_5 mixtures or of preformed KrFSbF_6 with stoichiometric amounts of NF_3 was carried out, as previously reported,²⁵ in HF solution at ambient temperature, the reaction was complete in less than 3 h. However, contrary to the previously reported elemental analysis but in agreement with the listed vibrational spectra,²⁵ the solid product consisted mainly of $\text{NF}_4\text{Sb}_2\text{F}_{11}$ (~90%) and not NF_4SbF_6 . The formation of mainly $\text{NF}_4\text{Sb}_2\text{F}_{11}$ suggests that under these conditions the oxidation of NF_3 by KrFSbF_6 is not quantitative and that some KrFSbF_6 decomposes to Kr , F_2 , and SbF_5 with the latter combining with NF_4SbF_6 to form $\text{NF}_4\text{Sb}_2\text{F}_{11}$. By lowering the reaction temperature, we succeeded in completely suppressing the formation of $\text{NF}_4\text{Sb}_2\text{F}_{11}$, and NF_4SbF_6 was obtained as the only product, contaminated by large amounts of unreacted KrFSbF_6 . However, a quantitative oxidation of NF_3 by KrFSbF_6 according to



was accomplished by the use of a sufficient excess of NF_3 . Since the concentration of NF_3 in the HF solution is proportional to the NF_3 pressure above the solution,²⁷ the excess of NF_3 required for a complete reaction can be minimized by using a small ullage in the reactor. This results in a high NF_3 pressure and consequently in a high concentration of NF_3 in the HF solution. The results of a series of runs are summarized in Table I and demonstrate that, for example at -31°C in HF solution at an NF_3 pressure of 1000 mm, NF_3 can quantitatively be oxidized by KrFSbF_6 to NF_4SbF_6 in less than 1 h.

In the absence of yield data in the previous report,²⁵ it was of interest to examine whether NF_4BF_4 can also be formed quantitatively under similar conditions. We found that an equimolar mixture of KrF_2 , NF_3 , and BF_3 in anhydrous HF, when allowed to warm slowly from -196 to $+25^\circ\text{C}$ and kept at 25°C for 3 h, resulted in only a 28.1% yield of pure NF_4BF_4 . When the reaction was carried out at -78°C for 3 h, the yield of NF_4BF_4 (7.1%) was, contrary to the NF_3 - KrFSbF_6 system, still appreciable. Without the use of HF as a solvent and at ambient pressure, no detectable amounts of NF_4BF_4 were obtained after 3 h at 25°C . However, as stated above, the use of a sevenfold excess of NF_3 at 45 atm pressure and gentle heating to 53°C for 4 days resulted in a 31% yield of NF_4BF_4 .

In view of the known tendency of TiF_4 to form polyanion salts with $(\text{NF}_4)_2\text{TiF}_6$ ²⁶ and the fact that the vibrational bands

(21) Fricc, B.; Holloway, J. H.; *Inorg. Chem.* 1976, 15, 1263; *J. Chem. Soc., Chem. Commun.* 1974, 89.

(22) Selig, H.; Peacock, R. D. *J. Am. Chem. Soc.* 1964, 86, 3895.

(23) Lindeman, L. P.; Wilson, M. K. *J. Chem. Phys.* 1956, 24, 242.

(24) Claassen, H. H.; Goodman, G. L.; Malm, J. G.; Schreiner, F. *J. Chem. Phys.* 1965, 42, 1229.

(25) Artyukhov, A. A.; Khoroshev, S. S. *Koord. Khim.* 1977, 3, 1478.

(26) Christe, K. O.; Schack, C. J. *Inorg. Chem.* 1977, 16, 353.

(27) Rewick, R. T.; Tolberg, W. E.; Hill, M. E. *J. Chem. Eng. Data* 1970, 15, 527.

attributed in the Russian study²⁵ to TiF_6^{2-} resemble those of a polyanion,²⁶ we have also repeated the reaction of NF_3 with KrF_2 and TiF_4 in the same 2:2:1 mole ratio in HF solution at room temperature for 3 h. On the basis of the observed material balance, our solid product had the average composition $\text{NF}_4\text{TiF}_5 \cdot 2.25\text{TiF}_4$. The presence of only polytitanate anions and of no TiF_6^{2-} was confirmed by vibrational spectroscopy (strongest Raman bands at 795 and 755 cm^{-1}). On the basis of our above results for NF_4SbF_6 , it appears safe to predict that the use of a large excess of NF_3 and particularly of an increase in the NF_3 pressure and concentration should also decrease the extent of polyanion formation in the NF_3 - KrF_2 - TiF_4 system.

Attempts to prepare the unknown $\text{OF}_3^+\text{AsF}_6^-$ and $\text{OF}_3^+\text{SbF}_6^-$ salts by the above methods (reaction of OF_2 with KrFMF_6 in either HF solution at temperatures as low as -31°C or neat in a nickel cylinder under 25 atm of OF_2 pressure) produced no evidence for the existence of these salts.

We have also attempted to oxidatively fluorinate CF_3NF_2 with KrF^+ salts to CF_3NF_3^+ salts. A mixture of KrF_2 , AsF_5 , and CF_3NF_2 in a mole ratio of 1.86:1:5.62, when slowly warmed in a nickel reactor from -196 to $+50^\circ\text{C}$, produced NF_3 and CF_4 as the main products, with the excess of CF_3NF_2 being decomposed to give CF_4 and *cis*- and *trans*- N_2F_2 . *cis*- N_2F_2 reacted with AsF_5 to form solid $\text{N}_2\text{F}^+\text{AsF}_6^-$.²⁸ Attempts to moderate this reaction by using preformed KrFSbF_6 and HF as a solvent resulted again in an oxidative fluorination of the C-N bond with CF_4 , NF_3 , and some *trans*- N_2F_2 as the main products. However, in this case the white solid product consisted mainly of $\text{NF}_4\text{SbF}_6 \cdot x\text{SbF}_5$.

An attempt was also made to oxidize the ClF_4O^- anion^{29,30} with preformed KrFSbF_6 in anhydrous HF solution at -78°C . The reaction



was observed. This result is not surprising since CsClF_4O was shown to readily undergo solvolysis in HF



and because the ClF_2O^+ cation is difficult to oxidize.¹⁵ Reaction of solid KrFSbF_6 with CsClF_4O and of liquid ClF_3O with KrF_2 also did not result in oxidation of the ClF_4O^- anion.

Fluorination Reactions with PtF_6 . Since gaseous PtF_6 does not react with gaseous NF_3 at ambient temperature to any significant extent,²⁰ we have studied this reaction in HF solution without irradiation and in the gas phase under the influence of unfiltered UV irradiation. In both cases, the vibrational spectra of the solid reaction products demonstrated the formation of some NF_4^+ salts. The anions in these salts were not very well defined due to the simultaneous formation of PtF_5 and possibly lower platinum fluorides and their interaction with PtF_6^- to form polyanions. Attempts to purify the products by extraction with anhydrous HF were unsuccessful.

To obtain a better defined sample of an NF_4^+ fluoroplatinate salt for comparison, we have prepared NF_4PtF_6 by a known, but unpublished, method.²⁰ When a large excess of F_2 and NF_3 was used and the reaction was carried out at 125°C under an autogenous pressure of about 140 atm, NF_4PtF_6 was obtained in high yield according to



The NF_4PtF_6 salt is a stable solid that shows spectra characteristic for tetrahedral NF_4^+ ¹⁷ and octahedral PtF_6^- .¹⁵

It was shown that the known oxidative fluorination of ClF_3 to ClF_6^+ with PtF_6 ^{4,5,15} can also be carried out at room temperature in HF solution without requiring UV irradiation:



However, attempts to prepare $\text{BrF}_6^+\text{PtF}_6^-$ in an analogous manner from BrF_3 and PtF_6 were unsuccessful.

Discussion

Syntheses of Coordinatively Saturated Fluoro Cations. At present, only three coordinatively saturated fluoro cations, i.e. NF_4^+ , ClF_6^+ , and BrF_6^+ , are known to exist. They can be prepared from the corresponding lower fluorides by one or more of the following three methods: (1) oxidation of KrF^+ salts; (2) oxidation by PtF_6 ; (3) oxidation by F_2 in the presence of a strong Lewis acid and an activation energy source.

One of the goals of this study was to examine the scope of these methods. A priori one would expect that the ease of preparing a given coordinatively saturated fluoro cation should increase with increasing oxidizing power of the fluorinating agent and with decreasing oxidation potential of the desired coordinatively saturated fluoro cation. Although the oxidation potentials of the three coordinatively saturated fluoro cations are unknown, a comparison with those of either the isoelectronic fluorides CF_4 , SF_6 , and SeF_6 or the corresponding oxo anions in the same oxidation states, i.e. NO_3^- , ClO_4^- , and BrO_4^- , suggests that the oxidation potentials should increase in the order $\text{NF}_4^+ < \text{ClF}_6^+ < \text{BrF}_6^+$. As far as the order of oxidizing power of KrF^+ , PtF_6 , and F_2 -Lewis acid combinations is concerned, Sokolov et al. have shown that KrF^+ can oxidize PtF_6^- to PtF_6^+ ³¹ and both KrF^+ and PtF_6 are expected to be stronger oxidizers than mixtures of F_2 with Lewis acids. Therefore, the oxidizer strength should increase in the order F_2 -Lewis acid $< \text{PtF}_6 < \text{KrF}^+$.

The results of this study are in accord with these predictions. Thus, KrF^+ , the most powerful oxidizer, is capable of oxidizing all three substrates, NF_3 , ClF_3 , and BrF_3 . The second strongest oxidizer, PtF_6 , can still fluorinate NF_3 and ClF_3 , whereas the weakest oxidizer, the Lewis acid- F_2 mixtures, can oxidize only NF_3 . These results show that the preparative methods are transferable from one coordinatively saturated fluoro cation to another, provided that the oxidant is powerful enough to oxidize the substrate. Obviously, secondary effects such as the possibility of high activation energy barriers and competitive side reactions might also be important. For example, the activation energy sources used in the F_2 -Lewis acid method can cause breakdown of ClF_3 and BrF_3 to F_2 and lower fluorides with the latter being continuously removed from the equilibrium by rapid complexing with the Lewis acid. For NF_3 , such a side reaction is not effective, and the F_2 -Lewis acid method is therefore well suited for the preparation of NF_4^+ salts.

Formation Mechanisms of Coordinatively Saturated Fluoro Cations. Previous reports⁷ have been concerned almost exclusively with the formation and decomposition mechanisms of NF_4^+ salts, and several different mechanisms have been proposed. These include the heterolytic fission of fluorine^{2,32} (mechanism I), the dissociation of NF_4AsF_6 to yield unstable



(28) Christie, K. O.; Wilson, R. D.; Sawodny, W. *J. Mol. Struct.* 1971, 8, 245.

(29) Christie, K. O.; Schack, C. J.; Pilipovich, D. *Inorg. Chem.* 1972, 11, 2205.

(30) Christie, K. O.; Curtis, E. C. *Inorg. Chem.* 1972, 11, 2209.

(31) Sokolov, V. B.; Drobyshevskii, Yu. V.; Prusakov, V. N.; Ryzhkov, A. V.; Khoroashev, S. S. *Dokl. Akad. Nauk SSSR* 1976, 229, 641.

(32) Christie, K. O.; Guertin, J. P.; Pavlath, A. E. US Patent 3503719, 1970.

NF_3^{33} (mechanism II), the formation of an intermediate mechanism II

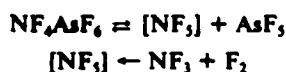

strongly oxidizing Lewis acid-F radical³⁴ (mechanism III), mechanism III

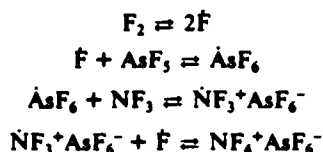

the formation of an intermediate NF_4 radical⁷ (mechanism IV), and the absorption and ionization of NF_3 on a $\text{KrF}^+\text{MF}_6^-$ mechanism IV

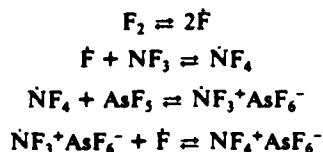

surface²⁵ (mechanism V). For the formation of NF_4^+ salts mechanism V

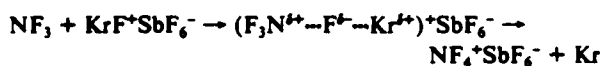

from NF_3 , F_2 , and Lewis acids, the importance of the F_2 dissociation step and of NF_3^+ formation has previously been experimentally confirmed,^{34,35} thus rendering mechanisms III and IV most likely. Of these two mechanisms, mechanism III has previously been preferred by us because the formation and decomposition of NF_4^+ salts were assumed to follow the same mechanism, and the decomposition of NF_4AsF_6 is suppressed more strongly by AsF_5 than by NF_3 .⁷ However, recent ab initio molecular orbital calculations³⁶ have provided evidence for NF_4 being energetically unfavorable, and the formation and decomposition of NF_4^+ salts do not necessarily proceed by the same mechanism. These considerations prompted us to reconsider our previous preference.

The results of the present study confirm that NF_4^+ salts can be formed from NF_3 and F_2 -Lewis acid mixtures, KrF^+ salts, or PtF_6 . Furthermore, the fact that the reaction of KrF^+ with NF_3 not only proceeds quantitatively but also proceeds at temperatures (-31 to -45 °C) at which $\text{KrF}^+\text{SbF}_6^-$ is completely stable rules out a free-radical mechanism based on the decomposition of KrF_2 to Kr and F atoms and supports an ionic mechanism for the KrF^+-NF_3 reaction. In such an ionic mechanism, NF_3 is oxidized either to an intermediate NF_3^+ radical cation or directly to NF_4^+ . In view of the quantitative yields of NF_4^+ salts and our failure to obtain evidence for an intermediate NF_3^+ radical cation in these KrF^+ reactions by ESR spectroscopy, the direct fluorination to NF_4^+ is preferred. One can easily envision an intermediate activated complex between the electrophilic KrF^+ cation and the, albeit weak, electron donor NF_3 , which could readily decompose to NF_4^+ with Kr elimination.

For the reactions of NF_3 with F_2 -Lewis acid mixtures the requirement for an activation energy source capable of dis-

sociating F_2 ,³⁴ the ESR evidence for the intermediate formation of the NF_3^+ radical cation,³⁵ and the unlikely formation of an NF_4 radical³⁶ favor free-radical mechanism III. For the thermal decomposition of NF_4^+ salts which are derived from stable Lewis acids, mechanism H is preferred because it best explains the observed strong rate suppression by the Lewis acids.⁷

Even in the absence of experimental data it appears rather safe to propose for the PtF_6 oxidation reactions a one-electron transfer leading to $\text{NF}_3^+\text{PtF}_6^-$ as an intermediate, which is then further fluorinated by a second PtF_6 molecule to NF_4^+ . Such a mechanism is in accord with the rather low yields of NF_4^+ salts obtained for the NF_3 - PtF_6 system and has previously also been proposed for the ClF_3 - PtF_6 system.¹⁵

Considering all the experimental evidence presently available for the formation mechanisms of coordinatively saturated complex fluoro cations, it appears that all reactions exhibit a certain commonality. The crucial step in all systems appears to be the reaction of a powerful one-electron (PtF_6 or Lewis acid-F) or two-electron (KrF^+) oxidizer with the substrate (NF_3 , ClF_3 , or BrF_3) resulting in an electron transfer from the substrate to the oxidant, with a simultaneous (in the case of KrF^+) or subsequent (in the case of PtF_6 and Lewis acid-F) fluorination of the intermediate radical cation (NF_3^+ , ClF_3^+ , BrF_3^+) to give the final product (NF_4^+ , ClF_6^+ , BrF_6^+). Thus, the mechanisms of the three presently known methods for the syntheses of NF_4^+ salts might be written

Lewis acid- F_2 system

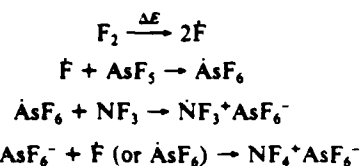

PtF_6 system

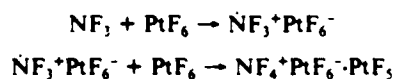

KrF^+ system

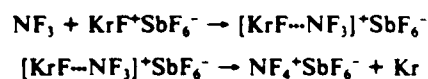

As can be seen from these equations, an ionic oxidant (KrF^+) results in an ionic mechanism and a radical oxidant (LAF or PtF_6) in a radical mechanism.

If in the Lewis acid- F_2 reactions the hard base NF_3 is replaced by a soft base, such as Xe, the reaction can proceed even in the absence of an activation energy source, as was demonstrated by Stein for the $\text{Xe}-\text{F}_2$ - SbF_5 system.³⁷ Although XeF^+ is not a coordinatively saturated cation, this reaction is most interesting. Contrary to the NF_3 - F_2 -Lewis acid reactions, it probably proceeds as a two-electron oxidation reaction by F_2 and therefore might be considered as the only presently known example of an actual heterolytic fission of fluorine by a Lewis acid and a Lewis base.³²



The lower activation energy required for fluorinating Xe, compared to that for NF_3 , is attributed mainly to its increased polarizability (i.e., it is a softer base) and to a lesser degree to the difference in their ionization potentials ($\text{IP}_{\text{NF}_3} = 13.0$ eV, $\text{IP}_{\text{Xe}} = 12.13$ eV), because the hard base O_2 has an even lower IP of 12.06 eV but does not react with fluorine and a

(33) Solomon, I. J.; Keith, J. N.; Snelson, A. *J. Fluorine Chem.* 1972, 2, 129

(34) Christe, K. O.; Wilson, R. D.; Axworthy, A. E. *Inorg. Chem.* 1973, 12, 2478

(35) Goldberg, I. B.; Crowe, H. R.; Christe, K. O. *Inorg. Chem.* 1978, 17, 3189

(36) Peters, N. J. S.; Allen, L. C.; De Frees, D. J.; Pople, J. A., to be submitted for publication

(37) Stein, L. *J. Fluorine Chem.* 1982, 20, 65.

Lewis acid in the absence of an activation energy source.

Conclusion. Although the present study has provided us with more insight into the formation reactions of coordinatively saturated complex fluoro cations, and particularly into those involving the use of KrF^+ salts as an oxidant, there is a definite need for more experimental and theoretical work in this field to further establish the mechanisms of these interesting reactions.

Acknowledgment. We are indebted to Drs. C. J. Schack and

L. R. Grant for helpful discussions, to Drs. I. B. Goldberg and T. McKinney for ESR measurements, and to the Army Research Office and the Office of Naval Research for financial support of this work.

Registry No. $KrFSbF_6$, 52708-44-8; SbF_5 , 7783-70-2; NF_3 , 7783-54-2; NF_4AsF_6 , 16871-75-3; BF_3 , 7637-07-2; NF_4BF_4 , 15640-93-4; $NF_4Sb_2F_{11}$, 58702-89-9; PtF_6 , 13693-05-5; NF_4PtF_6 , 90025-87-9; CIF_3 , 13637-63-3; F_2 , 7782-41-4; CIF_4PtF_6 , 38123-69-2; CIF_6PtF_6 , 36609-91-3; BrF_5 , 7789-30-2; AsF_5 , 7784-36-3.

Received: February 27, 1984; accepted: March 10, 1984

SOME INTERESTING OBSERVATIONS IN CHLORINE OXYFLUORIDE CHEMISTRY

KARL O. CHRISSTE AND WILLIAM W. WILSON

Rocketdyne, A Division of Rockwell International Corporation,
Canoga Park, California 91304 (U.S.A.)

SUMMARY

A new synthesis of FOClO_3 was discovered involving the fluorination of ClO_4^- with ClF_6^+ . An unexpected oxygen abstraction from ClF_4O^- was observed when CsClF_4O was reacted with FOSO_2F .

INTRODUCTION

We would like to report two interesting reactions observed during our studies in the area of chlorine oxyfluorides. The first reaction involved the low-temperature metathesis of ClF_6AsF_6 with CsClO_4 in anhydrous HF solution. In view of the known NF_4^+ reaction [1]

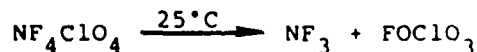

it was interesting to study whether ClF_6^+ is also capable of oxidizing ClO_4^- to FOClO_3 . The thermal stability of ClF_6ClO_4 was found to be lower than that of NF_4ClO_4 [1] and did not permit the isolation of solid ClF_6ClO_4 even at temperatures as low as -45°C . However, the corresponding decomposition products, FOClO_3 and ClF_5 , were observed in good yield.

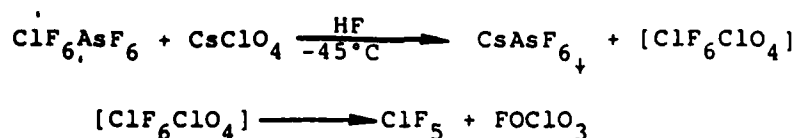

Although this presents an alternative synthetic path to FOClO_3 , the NF_4^+ reaction is preferred from a synthetic point of view since the NF_4SbF_6 starting material is more readily accessible [2].

The second reaction involved CsClF_4O and FOSO_2F . Fluorine fluorosulfate is known to be a useful reagent for the synthesis of hypofluorites [3], such as

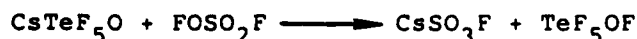

For CsClF_4O , however, the major reaction was not the formation of either the unknown ClF_4OF or its expected decomposition products, but oxygen abstraction accompanied by SO_2F_2 elimination according to the following reaction.



This unexpected reaction path might be rationalized in terms of an addition of FOSO_2F to the $\text{Cl}=\text{O}$ bond in one of the favored resonance structures of ClF_4O^- [4], followed by an intramolecular nucleophilic substitution (S_N^1) reaction accompanied by O_2 and SO_2F_2 elimination:

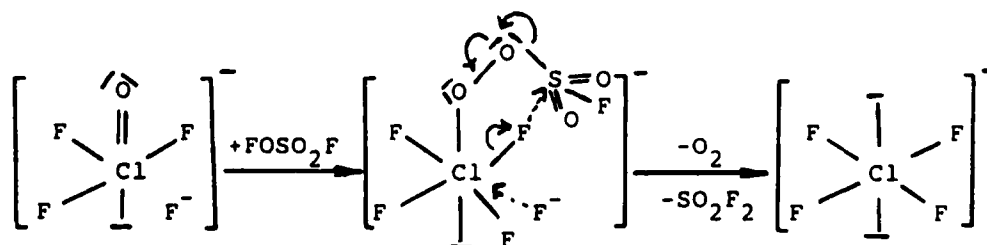

To our knowledge, this is the first example of a reaction in which FOSO_2F acts as a deoxygenating agent.

EXPERIMENTAL

Apparatus Volatile materials were handled in a stainless steel-Teflon FEP vacuum line [5]. The line and other hardware used were well passivated with ClF_3 and, if HF was to be used, with HF. Nonvolatile materials were handled in the dry nitrogen atmosphere of a glovebox. Metathetical reactions were carried out in HF solution using a previously described apparatus [6].

Infrared spectra were recorded on a Perkin Elmer Model 283 spectrophotometer. Spectra of solids were obtained using dry powders pressed between AgCl windows. Spectra of gases were obtained by using a Teflon cell of 5 cm path length equipped with AgCl windows. Raman spectra were recorded on a Cary Model 83 spectrophotometer using the 4880-Å exciting line of an Ar-ion laser.

Materials Literature methods were used for the syntheses of ClF_6AsF_6 [7], CsClF_4O [8] and FOSO_2F [9] and for the drying of the HF solvent [10]. The CsClO_4 (ROC/RIC) was used as received.

Reaction of ClF_6AsF_6 with CsClO_4 . In the drybox ClF_6AsF_6 (0.318 mmol) and CsClO_4 (0.304 mmol) were placed into the bottom U-tube of the metathesis apparatus [6]. On the vacuum line, dry HF (1.1 ml of liquid) was added at -78°C . The resulting mixture was agitated at -45°C for 1.5 hr and then filtered at -78°C through a porous Teflon filter while the filtrate was collected at -45°C . All material volatile at -45° was pumped off for 2.5 hr and separated by fractional condensation through a series of traps kept at -126 , -142 and -196°C . The -126° trap contained the HF solvent and a small amount of FClO_2 , the -142° trap contained a mixture of FOClO_3 and ClF_5 (0.445 mmol), and the -196° trap contained FClO_3 (0.128 mmol). Essentially no filtrate residue was left behind. The white solid filter cake (106 mg, weight calcd for 0.304 mmol of CsAsF_6 , 98 mg) was identified by infrared and Raman spectroscopy as CsAsF_6 . The FClO_3 formed in the above reaction is attributed to decomposition of a small amount of FOClO_3 . For a larger scale reaction, the percentage of FClO_3 in the product is expected to decrease significantly.

Caution! Fluorine perchlorate is highly shock sensitive [11] and proper safety precautions must be taken when working with this material.

Reaction of CsClF₄O with FOSO₂F In the dry box CsClF₄O (2.24 mmol) was placed into a 10 ml stainless steel cylinder. On the vacuum line FOSO₂F (4.97 mmol) was added to the cylinder at -196°C. The cylinder was kept at 0°C for 3 days, then cooled to -196°C. Oxygen (2.23 mmol) was pumped off at -196°C, and all material volatile at ambient temperature was separated by fractional condensation through traps kept at -112, -142, and -196°C. The -112° trap contained small amounts of ClF₃O, FClO₂ and ClF₃. The -142° trap contained FOSO₂F (2.6 mmol) and SO₂F₂ (1.7 mmol), and the -196° trap showed SO₂F₂ (0.52 mmol). The white solid residue showed a weight loss of 39 mg (calcd weight loss for 1.12 mmol of O₂ 36 mg) and was identified by infrared and Raman spectroscopy as CsClF₄ [12] containing a small amount of CsSO₃F.

ACKNOWLEDGEMENTS

The authors are grateful to Drs. C. J. Schack and L. R. Grant and Mr. R. D. Wilson for their help and to the Army Research Office and the Office of Naval Research for financial support.

REFERENCES

- 1 K. O. CHRISTE, W. W. WILSON, and R. D. WILSON, *Inorg. Chem.*, 19, 1494 (1980).
- 2 K. O. CHRISTE, C. J. SCHACK, and R. D. WILSON, *J. Fluorine Chem.*, 8, 541 (1976).
- 3 C. J. SCHACK, W. W. WILSON, and K. O. CHRISTE, *Inorg. Chem.*, 22, 18 (1983).
- 4 K. O. CHRISTE and E. C. CURTIS, *Inorg. Chem.*, 11, 2209 (1972).
- 5 K. O. CHRISTE, R. D. WILSON, and C. J. SCHACK, *Inorg. Synth.*, in press.
- 6 K. O. CHRISTE, W. W. WILSON, C. J. SCHACK, and R. D. WILSON, *Inorg. Synth.*, in press.

- 7 K. O. CHRISTE, W. W. WILSON, and E. C. CURTIS, *Inorg. Chem.*, 22, 3056 (1983).
- 8 K. O. CHRISTE, C. J. SCHACK, and D. PILIPOVICH, *Inorg. Chem.*, 11, 2205 (1972).
- 9 F. B. DUDLEY, G. H. CADY, and D. F. EGGERS, *J. Am. Chem. Soc.*, 78, 290 (1956).
- 10 K. O. CHRISTE, W. W. WILSON, and C. J. SCHACK, *J. Fluorine Chem.*, 11, 71 (1978).
- 11 K. O. CHRISTE and C. J. SCHACK, *Adv. Inorg. Chem. Radiochem.*, 18, 319 (1976).
- 12 K. O. CHRISTE and D. NAUMANN, *Inorg. Chem.*, 12, 59 (1973).

Contribution from Rocketdyne, A Division of Rockwell International, Canoga Park, California 91304,
 the Centre d'Etudes Nucleaires de Saclay, 91191 Gif-sur-Yvette Cedex, France,
 and the Department of Chemistry, University of Leicester, Leicester LE1 7RH, U.K.

Structure and Vibrational Spectra of Oxonium Hexafluoroarsenates(V) and -antimonates(V)

K. O. CHRISTE,¹ P. CHARPIN,² E. SOULIE,² R. BOUGON,² J. FAWCETT,³ and D. R. RUSSELL³

Received February 28, 1984

The salts $\text{OD}_3^+\text{AsF}_6^-$, $\text{OD}_3^+\text{SbF}_6^-$, and partially deuterated $\text{OH}_3^+\text{SbF}_6^-$ were prepared and characterized by X-ray and neutron diffraction techniques, DSC measurements, and vibrational spectroscopy. At room temperature, $\text{OH}_3^+\text{AsF}_6^-$ exists in a plastic phase where ions, centered on the atomic positions of the NaCl structure, are in motion or oscillation. No valuable information on atomic distances or angles in $\text{OH}_3^+\text{AsF}_6^-$ could be obtained due to these dynamic structural disorder problems. For $\text{OH}_3^+\text{SbF}_6^-$ the phase transition from an ordered to a disordered phase was shown to occur above room temperature. The room-temperature phase can be described by an ordered hydrogen-bonded model based on a CsCl type structure. Vibrational spectra were recorded for these oxonium salts and confirm the presence of the different phases and phase transitions. Improved assignments are given for the OH_3^+ and OD_3^+ cations, and the OH-FM bridge stretching mode and some of the bands characteristic for OD_2H^+ and ODH_2^+ were identified. A modified valence force field was calculated for OH_3^+ , which is in good agreement with the known general valence force field of isoelectronic NH_3 and values obtained by ab initio calculations. From the OH-FM stretching mode, the hydrogen-bridge bond strength was found to be 1.77 kcal mol⁻¹.

Introduction

Although the existence of oxonium salts at low temperature had been well known for many years, the synthesis of surprisingly stable OH_3^+ salts containing the AsF_6^- and SbF_6^- anions has been reported⁴ only in 1975. Since then, numerous papers have been published on other OH_3^+ salts containing complex fluoro anions such as UF_6^- ,⁵ BiF_6^- ,⁶ IrF_6^- , PtF_6^- , RuF_6^- ,^{7,8} TiF_3^- ,⁹ or BF_4^- .¹⁰ In these oxonium salts the cations and anions are strongly hydrogen bonded, as shown by the short O-F distances of 2.51–2.61 Å found by X-ray diffraction studies.^{9,10} Since the nature of these hydrogen bridges is strongly temperature dependent, these oxonium salts show phase transitions and present interesting structural problems. In this paper we report unpublished results accumulated during the past 8 years in our laboratories for these oxonium salts.

Experimental Section

Materials and Apparatus. Volatile materials used in this work were manipulated in a well-passivated (with ClF_3 and HF or DF) Monel Teflon FEP vacuum system.¹¹ Nonvolatile materials were handled in the dry-nitrogen atmosphere of a glovebox. Hydrogen fluoride (Matheson Co.) was dried by storage over BiF_3 ,⁶ SbF_3 and AsF_3 (Ozark Mahoning Co.) were purified by distillation and fractional condensation, respectively, and DF (Ozark Mahoning Co.) and D_2O (99.6%, Volk) were used as received. Literature methods were used for the preparation of O_2AsF_6 ,¹² OH_3SbF_6 , and OH_3AsF_6 .⁴

Infrared spectra were recorded on a Perkin-Elmer Model 283 spectrometer, which was calibrated by comparison with standard gas calibration points.^{13,14} Spectra of solids were obtained by using dry powders pressed between AgCl or AgBr windows in an Econo press (Barnes Engineering Co.). For low-temperature spectra, the pressed

silver halide disks were placed in a copper block cooled to -196°C with liquid N_2 and mounted in an evacuated 10-cm path length cell equipped with CsI windows.

Raman spectra were recorded on a Cary Model 83 spectrophotometer using the 4880-Å exciting line and a Claassen filter¹⁵ for the elimination of plasma lines. Sealed quartz tubes were used as sample containers in the transverse-viewing, transverse-excitation technique. The low-temperature spectra were recorded with a previously described¹⁶ device.

A Perkin-Elmer differential-scanning calorimeter, Model DSC-1B, equipped with a liquid- N_2 -cooled low-temperature assembly, was used to measure phase transitions above -90°C . The sample was crimp sealed in aluminum pans, and a heating rate of $5^\circ/\text{min}$ in N_2 was used. The instrument was calibrated with the known melting points of *n*-octane, water, and indium.

The neutron powder diffraction patterns of $\text{OH}_3^+\text{AsF}_6^-$, $\text{OD}_3^+\text{AsF}_6^-$, and $\text{O}_2^+\text{AsF}_6^-$ were measured at Saclay on the research reactor EL3 with $\lambda = 1.140$ Å for 2θ ranging from 6 to 44° . The data for $\text{OD}_3^+\text{SbF}_6^-$ were recorded at ILL Grenoble with $\lambda = 1.2778$ Å for 2θ ranging from 12 to 92° with 400 measured values of intensity separated by 0.10° .

The X-ray powder diffraction patterns were obtained from samples sealed in 0.3-mm Lindemann capillaries with a 114.6-mm diameter Philips camera using Ni-filtered $\text{Cu K}\alpha$ radiation. Low-temperature diagrams were measured with a jet of cold N_2 to cool the sample and a Meric MV3000 regulator.

The single crystal of $\text{OH}_3^+\text{SbF}_6^-$ was isolated as a side product from the reaction of MoF_6O and SbF_3 in a thin-walled Teflon FEP reactor with H_2O slowly diffusing through the reactor wall.

Preparation of $\text{OD}_3^+\text{AsF}_6^-$. A sample of D_2O (987.5 mg, 49.30 mmol) was syringed in the drybox into a $3/4$ -in. Teflon FEP ampule equipped with a Teflon-coated magnetic stirring bar and a stainless-steel valve. The ampule was connected to a Monel Teflon vacuum line, cooled to -196°C , and evacuated, and DF (10 g) was added. The mixture was homogenized at room temperature, and AsF_5 (57.7 mmol) was added at -196°C . The mixture was warmed to -78°C and then to ambient temperature for 1 h with agitation. All material volatile at ambient temperature was pumped off for 2 h, leaving behind a white solid residue (10.408 g; weight calculated for 49.30 mmol of $\text{OD}_3^+\text{AsF}_6^-$ 10.402 g) identified by IR spectroscopy as mainly $\text{OD}_3^+\text{AsF}_6^-$ containing a small amount (less than 1%) of $\text{OD}_2\text{H}^+\text{AsF}_6^-$ as impurity.

Preparation of $\text{OD}_3^+\text{SbF}_6^-$. Antimony pentafluoride (18.448 g, 85.11 mmol) was added in the drybox to a $3/4$ -in. Teflon FEP ampule equipped with a Teflon-coated magnetic stirring bar and a stainless-steel valve. The ampule was connected to the vacuum line, cooled to -78°C , and evacuated, and DF (23.1 g) was added. The mixture was homogenized at room temperature. The ampule was cooled inside the drybox to -196°C , and D_2O (1.6951 g, 84.63 mmol) was added

- (1) Rocketdyne.
- (2) CEN Saclay.
- (3) University of Leicester.
- (4) Christie, K. O.; Schack, C. J.; Wilson, R. D. *Inorg. Chem.* 1975, 14, 2224.
- (5) Mason, J. P.; Desmoulin, J. P.; Charpin, P.; Bougon, R. *Inorg. Chem.* 1976, 15, 2529.
- (6) Christie, K. O.; Wilson, W. W.; Schack, C. J. *J. Fluorine Chem.* 1978, 11, 71.
- (7) Selig, H.; Sunder, W. A.; Disalvo, F. A.; Falconer, W. E. *J. Fluorine Chem.* 1978, 11, 39.
- (8) Selig, H.; Sunder, W. A.; Schilling, F. C.; Falconer, W. E. *J. Fluorine Chem.* 1978, 11, 629.
- (9) Coben, S.; Selig, H.; Gut, R. *J. Fluorine Chem.* 1982, 20, 349.
- (10) Mootz, D.; Steffen, M. Z. *Anorg. Allg. Chem.* 1981, 482, 193.
- (11) Christie, K. O.; Wilson, R. D.; Schack, C. J. *Inorg. Synth.*, in press.
- (12) Shamir, J.; Binenboym, J. *Inorg. Chim. Acta* 1968, 2, 37.
- (13) Plyler, E. K.; Danti, A.; Blaine, L. R.; Tidwell, E. D. *J. Res. Natl. Bur. Stand., Sect. A* 1960, 64, 841.
- (14) International Union of Pure and Applied Chemistry. "Tables of Wavenumbers for the Calibration of Infrared Spectrometers"; Butterworths: Washington, D.C., 1961.

- (15) Claassen, H. H.; Selig, H.; Shamir, J. *J. Appl. Spectrosc.* 1969, 23, 8.
- (16) Miller, F. A.; Harney, B. M. *J. Appl. Spectrosc.* 1970, 24, 271.

with a syringe. The mixture was agitated for several hours at 25 °C, and all material volatile at 45 °C was pumped off for 14 h. The white solid residue (21.987 g; weight calculated for 84.63 mmol of $\text{OD}_3^+\text{SbF}_6^-$, 21.813 g) was identified by spectroscopic methods as mainly $\text{OD}_3^+\text{SbF}_6^-$ containing a small amount (less than 1%) of $\text{OD}_2\text{H}^+\text{SbF}_6^-$.

Preparation of Partially Deuterated Oxonium Salts. A sample of $\text{OH}_3^+\text{SbF}_6^-$ (2.0016 g, 7.857 mmol) was dissolved in liquid DF (2.012 g, 95.81 mmol) in a Teflon ampule for 1 h. All volatile material was pumped off at 45 °C for 3 h, leaving behind a white solid residue (2.020 g, weight calculated for 7.857 mmol of $\text{OD}_3^+\text{SbF}_6^-$, 2.0252 g) that on the basis of its vibrational spectra showed about equimolar amounts of OD_3^+ and OD_2H^+ and smaller amounts of $\text{ODH}_2^+\text{SbF}_6^-$ (calculated statistical product distribution for 19.74% H and 80.26% D (mol %): OD_3^+ , 51.68; OD_2H^+ , 38.16; ODH_2^+ , 9.33; OH_3^+ , 0.77).

Results and Discussion

Syntheses and Properties of Deuterated Oxonium Salts. The OD_3^+ salts were prepared by the same method as previously reported⁴ for the corresponding OH_3^+ salts, except for replacing H_2O and HF by D_2O and DF, respectively.



The yields are quantitative, and the samples were almost completely deuterated. The small amounts of OD_2H^+ observed in the infrared spectra and to a lesser degree in the Raman spectra of the products (see below) are attributed to small amounts (0.6%) of H_2O in the D_2O starting material and to exchange with traces of moisture during the preparation of the IR samples. A partially deuterated sample of $\text{OH}_3^+\text{SbF}_6^-$ was prepared by treating solid $\text{OH}_3^+\text{SbF}_6^-$ with an excess of DF.



The exchange appeared to be fast, and the product exhibited the correct statistical OD_3^+ , OD_2H^+ , ODH_2^+ , and OH_3^+ distribution based on the H:D ratio of the starting materials. As expected, the physical properties of the deuterated oxonium salts were practically identical with those⁴ of the corresponding OH_3^+ salts.

DSC Data. Since the neutron and X-ray diffraction data suggested (see below) that at room temperature OH_3SbF_6 is ordered whereas OH_3AsF_6 exists in a plastic phase, low-temperature DSC data were recorded to locate the corresponding phase changes for each compound.

The OD_3AsF_6 salt exhibited on warm-up from -90 °C a large endothermic phase change at 2.5 °C that was shown to be reversible, occurring at -7.5 °C on cooling. For OH_3AsF_6 this phase change was observed at practically the same temperatures. No other endotherms or exotherms were observed between -90 °C and the onset of irreversible decomposition. The observed phase-change temperatures are in excellent agreement with those found by low-temperature Raman spectroscopy (see below).

For OH_3SbF_6 three small endotherms at 20, 49, and 81 °C and a large endothermic phase change at 100 °C were observed on warming. All of these were reversible, occurring at 19, 42, 77, and 96 °C, respectively, on cooling. For OD_3SbF_6 the corresponding changes were observed at 20, 48, 82, and 100 °C on warming and 20, 43, 74, and 76 °C on cooling. Again no other heat effects were observed in this temperature range. The temperature differences observed for phase changes between the heating and cooling data are attributed to hysteresis, which normally is a problem in salts of this type.¹⁷ The smaller heat effects observed for OH_3SbF_6 below the major order-disorder phase transition may be attributed to damping of rotational motions of the ions, similar to those found for O_2AsF_6 .¹⁷

Table I. X-ray Diffraction Powder Pattern of OH_3AsF_6 at -153 °C^a

d_{obsd} , Å	intens	d_{obcd} , Å	intens
6.35	vw	2.024	ms
4.95	s	2.010	m
4.72	s	1.942	m
4.12	w	1.913	vw
3.87	w	1.877	ms
3.749	ms	1.871	w
3.730	ms	1.802	vw
3.473	m	1.775	vw
3.225	m	1.769	vw
3.163	m	1.739	vw
3.029	mw	1.712	w
2.845	m	1.695	w
2.837	m	1.659	vw
2.596	w	1.648	mw
2.530	vw	1.612	w
2.362	vw	1.585	mw
2.139	w	1.581	vw
2.061	m		
2.055	m		

^a Cu K α radiation and Ni filter.

Table II. Neutron Diffraction Powder Patterns of the Face-Centered Cubic, Room-Temperature Phases of OH_3AsF_6 , OD_3AsF_6 , and O_2AsF_6 ^a

hkl	OH_3AsF_6		OD_3AsF_6	O_2AsF_6
	calcd intens	obsd intens	obsd intens	obsd intens
111	1100	1127	12	200
200	177	174	1033	1000
220	11		177	215
311	5		137	210
222	0		19	45
400	2		12	20
331	5			
420	66	71	38	90
422	100	92	26	100
511/333	5		16	35

^a Intensities in arbitrary units.

For OH_3BiF_6 no phase transitions were observed between -90 °C and the onset of decomposition.

Structural Studies

OH_3AsF_6 . As previously reported,⁴ this compound is cubic at room temperature, and a cell parameter of 8.043 (8) Å was found in this study from X-ray powder data. It exhibits only one phase transition at -2 ± 5 °C (based on DSC and Raman data) in the temperature range from -90 °C to its decomposition point. The X-ray powder pattern at -153 °C is given in Table I and indicates a lowering of the symmetry in agreement with the low-temperature vibrational spectra (see below). Attempts to index the pattern were unsuccessful.

It is interesting to compare X-ray powder diffraction patterns of OH_3AsF_6 and O_2AsF_6 . Whereas their room-temperature patterns^{4,12,18} and cell parameters are for practical purposes identical, their low-temperature patterns (Table I and ref 19) are very distinct due to different ion motion freezing. Since OH_3^+ , OD_3^+ , and O_2^+ are weak X-ray scatterers, but contribute strongly to the neutron scattering, neutron diffraction powder patterns were also recorded at room temperature for their AsF_6^- salts (see Table II). As expected, the cell dimensions were for practical purposes identical, but the observed relative intensities were very different.

Attempts were made to obtain structural information from the room-temperature neutron diffraction powder patterns of

(18) Young, A. R.; Hirata, T.; Morrow, S. I. *J. Am. Chem. Soc.* 1964, 86, 20.

(19) Naulin, C.; Bougon, R. *J. Chem. Phys.* 1976, 64, 4155

(17) Griffiths, J. E.; Sunder, W. A. *J. Chem. Phys.* 1982, 77, 1087.

OH_3AsF_6 and OD_3AsF_6 . It was shown that the unit cell is indeed face-centered cubic and that an alternate solution,⁴ a primitive cubic CsPF_6 structure, can be ruled out for both compounds. The number of observed peaks is rather small, but the respective intensities due to the substitution of hydrogen by deuterium (scattering lengths $b_{\text{H}} = -0.374$ and $b_{\text{D}} = 0.667$) are very different (Table II). The rapid vanishing of intensities at large diffraction angles and the presence of a bump in the background level implying a short distance order are characteristic of plastic phases with ions in motion. The only models that could be tested to describe such a motion have been tried successively.

The first one is a disordered model with statistical occupancy factors for fluorine atoms and hydrogen atoms in the $Fm\bar{3}$ symmetry group. This corresponds to four equivalent positions of the octahedra around the fourfold axes, and to eight positions for the OH_3^+ ion. With use of the intensities observed for OH_3AsF_6 , the solution refines to $R = 0.047$ but is not considered acceptable because the resulting distances As-F = 1.58 Å and O-H = 0.82 Å are too short when compared to As-F = 1.719 (3) Å in KAsF_6 ²⁰ and O-H = 1.011 (8) Å in $\text{OH}_3^+p\text{-CH}_3\text{C}_6\text{H}_4\text{SO}_3^-$.²¹

The second one is a rotating model that places As at the 0, 0, 0 position connected to fluorines by a complex term

$$b_{\text{As}} + 6b_{\text{F}}[(\sin x)/x] \quad x = 4\pi r_{\text{F}}(\sin \theta)/\lambda$$

and O at the $1/2, 1/2, 1/2$ position connected to H atoms by

$$b_{\text{O}} + 3b_{\text{H}}[(\sin x)/x] \quad x = 4\pi r_{\text{H}}(\sin \theta)/\lambda$$

where b_{As} , b_{F} , b_{O} , and b_{H} are the scattering lengths of As, F, O, and H, respectively. The As-F distance, r_{F} , and the O-H distance, r_{H} , are the only unknowns with the scale factor of the structure.²² The best results ($R = 0.059$) are obtained with the combination As-F = 1.59 Å and O-H = 0.81 Å, not so different indeed from the first model.

For OD_3AsF_6 , the second model gives more plausible distances, As-F = 1.65 Å and O-D = 1.01 Å with $R = 0.054$, if the intensity of the 200 reflections is arbitrarily lowered by 20%, with the excessive intensity being assumed to be due to preferential orientation.

On the basis of the short distances found for OH_3AsF_6 , we can consider that the real structure is probably not properly accounted for by either one of the models, due to the motion of the ions, which is not correctly simulated as for other plastic phases.

OH_3SbF_6 . On the basis of the DSC data (see above), the transition from an ordered to a disordered phase occurs at 88 ± 12 °C. The existence of an ordered phase at room temperature for OH_3SbF_6 and its deuterated analogues was confirmed by the diffraction studies. The X-ray powder diffraction pattern, which originally had been read backwards due to very intense back-reflections and indexed incorrectly as tetragonal,⁴ is listed in Table III. By analogy with a large class of other MF_6^- compounds such as O_2PtF_6 ²³ and O_2SbF_6 ,²⁴ the OH_3SbF_6 pattern can be indexed for a cubic unit cell with $a = 10.143$ (3) Å (CEN) data or 10.090 Å (Rocketdyne data). The cell dimensions were confirmed by a single-crystal X-ray study at Leicester (see below) that resulted in $a = 10.130$ (8) Å. Although all of the observed X-ray reflections obey the conditions ($h + k + l = 2n$ and $0kl$ where $k, l = 2n$) for space group $Ia\bar{3}$, the neutron diffraction data (see below) suggest a lower symmetry subgroup such as $I2_13$. In the following

Table III. Room-Temperature X-ray Powder Data for OH_3SbF_6 .^a

d_{obsd} , Å	d_{calcd} , Å	intens	h	k	l
5.04	5.04	vs	2	0	0
3.56	3.57	vs	2	2	0
2.909	2.912	mw	2	2	2
2.691	2.696	w	3	2	1
2.519	2.522	mw	4	0	0
2.374	2.378	w	4	1	1
2.254	2.256	m	4	2	0
2.149	2.151	mw	3	3	2
2.060	2.059	s	4	2	2
1.979	1.978	w	4	3	1
1.784	1.783	ms	4	4	0
1.682	1.681	ms	6	0	0 4 4 2
1.637	1.636	vw	5	3	2
1.596	1.595	ms	6	2	0
1.519	1.521	ms	6	2	2
1.456	1.456	w	4	4	4
1.398	1.399	ms	6	4	0
1.372	1.373	vw	6	3	3
1.349	1.348	ms	6	4	2
1.282	1.281	vw	7	3	2 6 5 1
1.262	1.261	vw	8	0	0
1.225	1.223	m	8	2	0 6 4 4
1.189	1.189	m	8	2	2 6 6 0
1.159	1.157	w	6	6	2
1.129	1.128	m	8	4	0
1.103	1.101	m	8	4	2

^a Cubic, $a = 10.09$ Å, $V = 1027.2$ Å³, $Z = 8$, $\rho_{\text{calcd}} = 3.296$ g cm⁻³, Cu K α radiation, Ni filter

paragraphs the results obtained for the ordered cubic, room-temperature phase of OH_3SbF_6 are discussed in more detail.

Single-Crystal X-ray Study. The OH_3SbF_6 single crystal had the approximate dimensions $0.46 \times 0.35 \times 0.22$ mm and was sealed in a Pyrex capillary. Preliminary cell dimensions were obtained from Weissenberg and precession photographs. The final value for the unit cell parameter was determined from the optimized counterangles for zero-layer reflections on a Stoe Weissenberg diffractometer. The data were collected for layers $0kl$ to $6kl$ of the aligned pseudotetragonal cell, using the Stoe Stadi-2 diffractometer, in the four quadrants $h, \pm k, \pm l$ and an ω -scan technique with graphite-monochromated Mo K α radiation. The intensities of reflections with $0.086 \leq (\sin \theta)/\lambda \leq 0.702$ Å⁻¹ were collected and a total of 719 reflections obtained with $I/\sigma(I) \geq 3$. Check reflections were monitored during the data collection of each layer, and no deterioration of the crystal was indicated. Lorentz and polarization corrections were made to the data set.

The program system SHELX²⁵ was used to solve the structure. Neutral scattering factors were used with anomalous dispersion coefficients. Three cycles of least-squares refinement with antimony at $(1/2, 1/2, 1/2)$ in the space group $Ia\bar{3}$ gave an R factor of 0.27. The Fourier difference map located a $9 e \text{ \AA}^{-3}$ peak, assumed to be oxygen, on the position $(1/2, 1/2, 1/2)$, with two sets of possible fluorine octahedra each at 1.90 Å from Sb. Three cycles of refinement with the oxygen atom included reduced the R factor to 0.22. The inclusion of either of the sets of F atoms about Sb, with all atoms refining isotropically, resulted in a reduced R factor of 0.13; however, the refinement cycles moved the F atoms to >2.0 Å from Sb. The inclusion of fluorine atoms also resulted in a more complex difference Fourier map, with several peaks $\approx 3 e \text{ \AA}^{-3}$ remaining. The alternate fluorine atom positions indicated were refined in partially occupied sites, initially adjusting the site occupation factors and then their temperature factors. The resultant R factor of 0.12 was not significantly less than with either ordered structure; one of the partial fluorine atoms refined to a position

(20) Gafner, G.; Kruger, G. J. *Acta Crystallogr., Sect. B: Struct. Crystallogr. Cryst. Chem.* 1974, B30, 250.

(21) Lundgren, J. O.; Williams, J. M. J. *J. Chem. Phys.* 1973, 58, 788.

(22) APL program written by G. Langlet.

(23) Ibers, J. A.; Hamilton, W. C. *J. Chem. Phys.* 1966, 44, 1748.

(24) McKee, D. E.; Bartlett, N. *Inorg. Chem.* 1973, 12, 2738.

(25) Sheldrick, G. M. "SHELX, A Program for Structure Determination"; University of Cambridge: Cambridge, England, 1976.

Oxonium Hexafluoroarsenates(V) and -antimonates(V)

Table IV. Final Atomic Positional and Thermal Parameters (with Esd's in Parentheses) for OH_3SbF_6 from X-ray Data

atom	x	y	z	U_{11}	U_{22}	U_{33}
Sb	0.5	0.5	0.5	0.0205 (18)		
O	0.25	0.25	0.25	0.043 (17)		
F	0.4334 (33)	0.6444 (34)	0.6021 (22)	0.059 (20)	0.158 (35)	0.003 (12)
H	not located					

	dist. Å	angle, deg
Sb-F	1.891 (19)	F-Sb-F 180
Sb-O	4.386	F-Sb-F 89.5 (1.0)
O-F	2.63	F-Sb-F 90.5 (1.0)
F-F	2.68/2.71	

Table V. X-ray and Neutron Powder Patterns of OD_3SbF_6 at Room Temperature

<i>hkl</i>	X-ray	neutron	<i>hkl</i>	X-ray	neutron
200	100	6	710/550/543	...	1
211	...	2	640	11	8
220	70	100	721/633/552	1	8
222	13	8	642	21	9
321	3	30	730	...	3
400	7	2	732/651	2	18
411/330	6	13	800	4	...
420	17	17	811/741/554	...	7
332	4	22	820/644	11	9
422	36	18	653	...	3
431/510	3	13	822/660	10	2
440	19	14	831/750/743	...	4
433/530	21	3	662	4	...
442/600	2	7	752	...	3
611/532	2	9	840	6	2
620	21	3			
541	1	14			
622	12	5			
631	...	2			
444	4	4			

2.2 Å from Sb, and further possible fluorine sites appeared in the Fourier map. Refinement of various models with either ordered fluorine atoms or disordered atoms constrained to be 1.86 (3) Å from antimony did not improve the *R* factor or the residual Fourier map. Accordingly, the F atom parameters given in Table IV represent an ordered solution in *Ia3*; the actual F atom chosen was that which remained at the expected distance from antimony during the various trial refinements. This represents an incomplete solution, as there are residual peaks at Sb-F distances in the final Fourier difference map. This is reflected in the structure factors, where agreement between $|F_o|$ and $|F_c|$ is good for even, even, even reflections with dominant contributions by the antimony and oxygen atoms but poor for odd, odd, even reflections, which are dependent only upon the fluorine (and hydrogen) atom parameters. Final residual indices for 155 unique reflections are *R* = 0.119 and *R*_w = 0.131.

Neutron Powder Diffraction Study. For OD_3SbF_6 , 46 reflections were observed (see Figure 1) out of which 4 could not be indexed on the basis of the cubic cell and are attributed to an unidentified impurity (mainly lines at 3.269, 2.235, and 2.225 Å). The list of observed reflections is given in Table V in comparison with X-ray data. The cell parameter is 10.116 (6) Å.

The Rietveld program for profile refinement²⁶ was used to solve the structure. The first refinement was attempted in the *Ia3* space group starting from the X-ray values for Sb, O, and F and adding approximate values for D, with the OD_3^+ ion

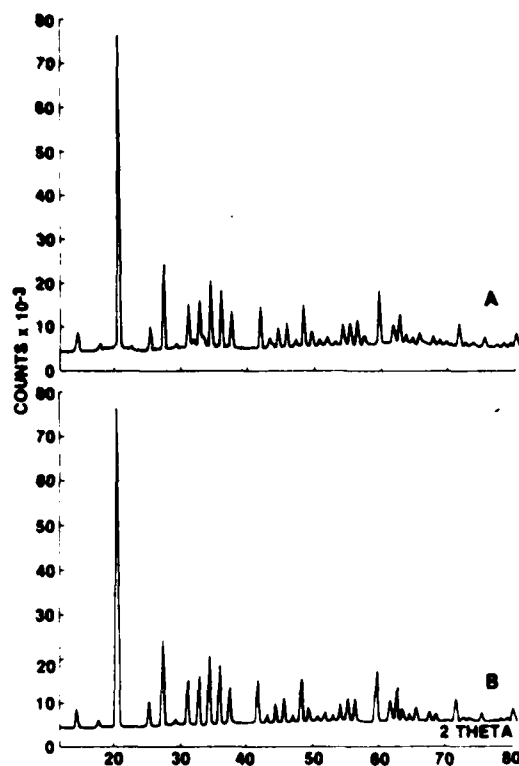
Figure 1. Neutron powder diffraction diagram of OD_3SbF_6 at ambient temperature; traces A and B, observed and calculated profiles, respectively.

being disordered on two equivalent positions (occupancy factor $1/2$ of general positions *x, y, z*). The system refined to *R* = 0.135 with the following parameters:

atom	x	y	z	<i>B</i> , Å ²
Sb	0.5	0.5	0.5	0.94 (25)
O	0.25	0.25	0.25	4.87 (41)
F	0.441 (6)	0.604 (6)	0.641 (7)	2.88 (13)
D	0.300 (1)	0.317 (1)	0.204 (1)	2.98 (27)

The *y* and *z* coordinates of the fluorine atom have been permuted, probably due to the choice of the coordinates of deuterium. The atomic distances and angles are then

	dist. Å	dist. Å	angle, deg
Sb-F	1.87	O-D 0.96	DOD 108
O-F	2.67	D-D 1.56	

which compare relatively well with the X-ray values of Table IV. At this stage, our attention was drawn to the presence of a weak but well-isolated line at an angle θ high enough not to be attributed to the impurity. This line corresponded to a 730 reflection, a forbidden reflection in the space group *Ia3* (*hk0*; *h, k = 2n*). In view of a similar observation for the cubic phase of KSbF_6 (II) (in this case the 310 reflection),²⁷ the trouble with locating the fluorine atoms by difference X-ray syntheses, and mainly the incompatibility of the group *Ia3* with the observed Raman and IR spectra (see below), we considered the possibility of an ordered structure in a subgroup of the *Ia3* space group, first the noncentrosymmetric *I2_13* space group (No. 199).

Since the symmetry center does not exist anymore, the local symmetry of the Sb and O atoms is then only a threefold axis. The structure has to be described with two sets of fluorine atoms *F*₁ and *F*₂, and the oxonium ion is ordered with a full

(26) Rietveld, H. M. *J. Appl. Crystallogr.* 1969, 2, 65.(27) Heyns, A. M.; Pistorius, C. W. F. T. *Spectrochim. Acta, Part A* 1976, 32A, 535.

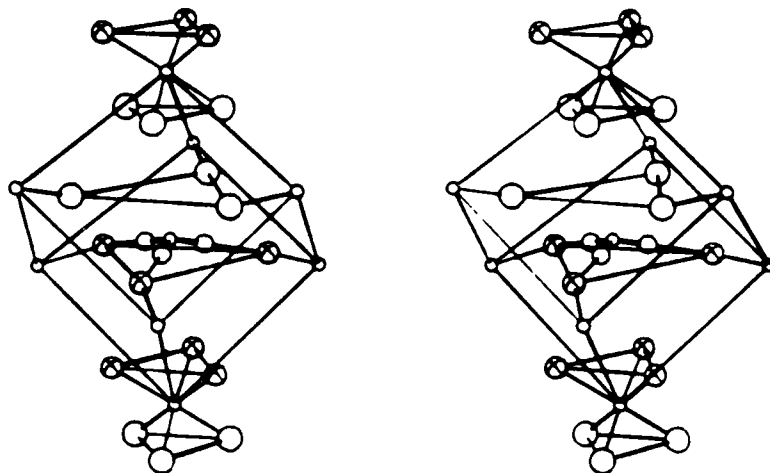

Figure 2. ORTEP stereoview of the structure of OD_3SbF_6 . The bridging F_2 atoms are differentiated from the nonbridging F_1 atoms by smaller circles marked by traces.

occupation of deuterium atoms on the general positions. The Sb and O atoms are also allowed to move along the threefold axes from their ideal positions $(0, 0, 0; \frac{1}{2}, \frac{1}{2}, \frac{1}{2})$.

This hypothesis was tested and led to a better R factor (0.106) with the following parameters:

atom	x	y	z	$B, \text{\AA}^2$
Sb	-0.012 (1)	-0.012 (1)	-0.012 (1)	0.13 (0.38)
O	0.238 (3)	0.238 (3)	0.238 (3)	3.50 (0.75)
F_1	0.044 (1)	-0.118 (1)	-0.143 (2)	1.26 (0.42)
F_2	-0.75 (2)	0.091 (1)	0.137 (2)	1.89 (0.45)
D	0.199 (2)	0.184 (1)	0.299 (1)	3.40 (0.30)

Figure 1 gives the resulting profile of observed and calculated neutron diffraction diagrams and shows satisfactory agreement.

The Sb and O atoms are displaced from their ideal positions by 0.21 \AA , and the environment of the Sb atom has 3 F_1 atoms at 1.80 \AA and 3 F_2 atoms at 1.94 \AA , which seems to be compatible with the Raman and IR spectra.

The F_2 atoms are closer to the oxygen atom of the oxonium group than the F_1 atoms with $\text{F}_2\text{-O} = 2.60$ \AA and $\text{F}_1\text{-O} = 2.79$ \AA . The $\text{F}_2\text{-O}$ distance is within the correct range for a strong $\text{OD}\cdots\text{F}$ hydrogen bridge bond (2.51–2.56 \AA in OH_3TiF_6 ⁹ and 2.58–2.61 \AA in OH_3BF_4 ¹⁰).

The deuterium atoms are located at 0.91 \AA from the oxygen atom (with a D–D distance of 1.54 \AA and a DOD angle of 116°) on the line $\text{O}-\text{F}_2$ ($\text{OD} + \text{DF}_2 = 0.91 + 1.69 = 2.60$ \AA). This confirms, in the precision of our results, the quasi-linearity of the $\text{O}-\text{D}\cdots\text{F}$ bond in this compound. The geometry of the OD_3^+ cation itself is a flat pyramid with C_3 symmetry. The oxygen atom lies 0.18 \AA out of the plane of the three deuterium atoms.

Figure 2 illustrates the environment around the oxonium ion, with the F_2 atoms being differentiated from the F_1 atoms by traces of the ellipses. The two SbF_6^- octahedra fully represented are approximately located at $0, 0, 0$ and $\frac{1}{2}, \frac{1}{2}, \frac{1}{2}$ along the $[1, 1, 1]$ direction and bring the environment to an icosahedron. The distinction between F_1 and F_2 implies a small displacement of the fluorine atoms from their average positions obtained in the $Ia\bar{3}$ space group ($\text{F}-\text{F}_1$ or $\text{F}-\text{F}_2$ distances are about 0.20 \AA), but the angular distortion of the octahedron is small, one side being flattened and the other one being elongated. To obtain a refinement in the $I2_13$ symmetry group, we had to allow the existence of antiphase domains without local symmetry centers, but which are images of each other.

The interesting point of this structure is the existence of an ordered solution for all atoms with a scheme of hydrogen bonding that prevents at room temperature the existence of

a plastic phase. Such a phase may however exist at higher temperatures and explains the phase changes observed before the decomposition point. To obtain more information on the motions of the ions in the different phases, additional experimental data such as second moment and relaxation time NMR measurements are required.

As far as the exact geometry of the OD_3^+ cation is concerned, it must be pointed out that the precision of the results obtained from the powder diffraction data is not very high and that the final values depend on the starting points used for the different refinements. Thus, the $\text{O}-\text{D}$ distance was found to vary from 0.91 to 1.05 \AA , with the ODO angle varying from 116 to 92°. The correct values certainly lie between these extreme values. This is also reflected by the higher thermal parameters found for the deuterium and oxygen positions (see above), indicating high thermal motion of the OD_3^+ cation itself. For the $\text{O}-\text{H}$ bond length in OH_3^+ , a lower limit of 0.97 \AA appears more realistic for the following reasons: The bond length in free OH_2 is already 0.96 \AA , and both the hydrogen–fluorine bridging and the increased O^+-H^{++} polarity of the $\text{O}-\text{H}$ bond in OH_3SbF_6 are expected to increase the $\text{O}-\text{H}$ bond length. This bond weakening in OH_3^+ when compared to free OH_2 is also supported by the force constant calculations given below. The most likely range of the $\text{O}-\text{H}$ bond length in these OH_3MF_6 salts is therefore 0.98–1.05 \AA , which is in excellent agreement with the values of 1.013 (8), 1.020 (3), and 0.994 (5) \AA previously found for $\text{OH}_3^+\text{CH}_3\text{C}_6\text{H}_4\text{SO}_3^-$,²¹ $\text{OD}_3^+\text{CH}_3\text{C}_6\text{H}_4\text{SO}_3^-$,²⁸ and $\text{OH}_3^+\text{CF}_3\text{SO}_3^-$,²⁹ respectively, by neutron diffraction and values of 1.01–1.04 \AA for $\text{OH}_3^+\text{NO}_3^-$ and $\text{OH}_3^+\text{ClO}_4^-$, derived from wide-line NMR measurements.³⁰

The value of 1.19 \AA , previously reported⁹ for the $\text{O}-\text{H}$ bond length in $\text{OH}_3^+\text{BF}_4^-$, is based on X-ray data and therefore is deemed unreliable. It should be pointed out that the $\text{OH}\cdots\text{F}$ distances in $\text{OH}_3^+\text{BF}_4^-$ and $\text{OD}_3^+\text{AsF}_6^-$ are practically identical (2.60 \AA). This suggests that $r_{\text{O-H}}$ and $r_{\text{O-D}}$ in these two compounds should also be similar.

The neutron model was tested against the X-ray data for OH_3SbF_6 , but there was no improvement in the refinement or the appearance of the Fourier difference map.

Vibrational Spectra. Although many papers have been published on the vibrational spectra and force field of the

(28) Finholt, J. E.; Williams, J. M. *J. Chem. Phys.* 1973, 59, 5114.

(29) Lundgren, J. O.; Tellgren, R.; Olovsson, I. *Acta Crystallogr. Sect. B Struct. Crystallogr. Cryst. Chem.* 1978, B34, 2945.

(30) Herzog-Cance, M. H.; Potier, J.; Potier, A. *Adv. Mol. Relaxation Interact. Processes* 1979, 14, 245.

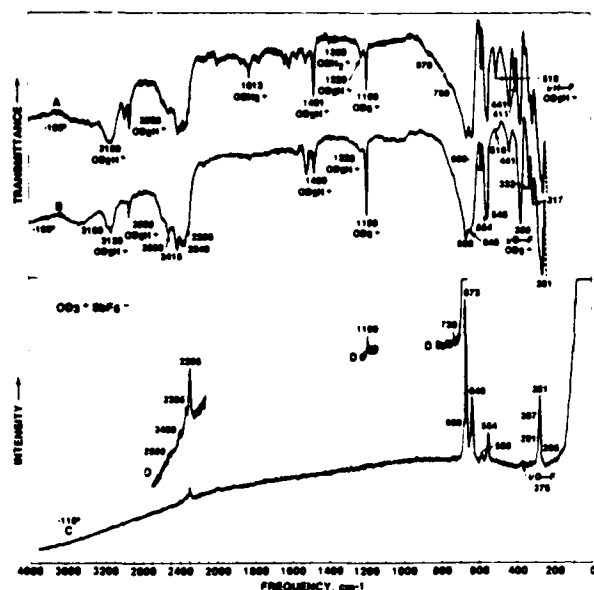

Figure 7. Vibrational spectra of solid OD_3SbF_6 and partially deuterated OH_3SbF_6 at low temperature: traces A and B, infrared spectra of partially deuterated OH_3SbF_6 and of OD_3SbF_6 , respectively, between AgBr windows; traces C and D, Raman spectra recorded at two different sensitivities.

general confusion. As a consequence, there is still considerable ambiguity⁴ whether the antisymmetric or the symmetric OH_3^+ stretching mode has the higher frequency. Furthermore, the symmetric OH_3^+ deformation mode is generally very difficult to locate due to the great line width of the band.⁴⁶ Although vibrational spectra have previously been reported for OD_3^+ ^{32,34,38} they have been of little help to strengthen the vibrational assignments for the oxonium cation. Consequently, it was interesting to record the vibrational spectra of deuterated and partially deuterated OH_3^+ in salts containing well-defined discrete oxonium cations. We hoped to verify the above described phase changes and to compare the experimentally observed spectra with the results from recent theoretical calculations⁴⁷⁻⁴⁹ and with those of the isoelectronic ammonia analogues.⁵⁰⁻⁵⁴

The observed infrared and Raman spectra and the more important frequencies are given in Figures 3-7 and Table VI.

Room-Temperature Spectra of OD_3AsF_6 . Figure 3 shows the room-temperature spectra of solid OD_3AsF_6 . As can be seen, the bands are broad and show no splittings or asymmetry as expected for ions undergoing rapid motion in a plastic phase.^{4,17,19} On the basis of their relative infrared and Raman intensities, the band at about 2450 cm^{-1} can be assigned with confidence to the antisymmetric OD_3^+ stretching mode $\nu_3(\text{E})$ and the band at about 2300 cm^{-1} to the symmetric OD_3^+ stretching mode $\nu_1(\text{A}_1)$. This assignment of $\nu_3 > \nu_1$ is further supported by all the other spectra recorded in this study (see

below). Also, their frequency separation of about 150 cm^{-1} is very similar to that of 144 cm^{-1} found for isoelectronic ND_3 .⁵⁰ Furthermore, a recent ab initio calculation for OD_3^+ also arrived (after applying the suggested -12.3% correction to all frequencies) at ν_3 being 165 cm^{-1} higher than ν_1 (see Table VII).⁴⁹ This finding that in a strongly hydrogen-bridged oxonium salt ν_3 is higher than ν_1 disagrees with the previous suggestion that the order of the OH_3^+ stretching frequencies should invert when $r_{\text{X-Y}}$ in X-H-Y becomes shorter than the van der Waals radius sum.³⁸

The assignment of the 1192-cm^{-1} infrared and the 1178-cm^{-1} Raman band to the antisymmetric OD_3^+ deformation $\nu_4(\text{E})$ is straightforward and again is in excellent agreement with the frequency values of 1191 and 1161 cm^{-1} , found for isoelectronic ND_3 ,⁵⁰ and calculated for OD_3^+ by ab initio methods,⁴⁹ respectively (see Table VII).

The assignment of the last yet unassigned fundamental of OD_3^+ , the symmetric deformation mode $\nu_2(\text{A}_1)$, is more difficult. On the basis of an analogy with ND_3 , this mode should occur at about 750 cm^{-1} , and indeed the Raman spectrum of OD_3AsF_6 exhibits a band at 770 cm^{-1} of about the right intensity. The failure to observe a well-defined infrared counterpart could possibly be due to its great line width. The ab initio calculations for $\nu_2(\text{A}_1)$ of OD_3^+ predict an intense infrared band at 549 cm^{-1} . Indeed the infrared spectrum of OD_3AsF_6 (trace A, Figure 3) shows a medium-strong band at 580 cm^{-1} . However, we prefer to assign this band to $\nu_2(\text{E}_g)$ of AsF_6^- for the following reasons: This mode frequently becomes infrared active in many AsF_6^- salts. Furthermore, it has also been observed in OH_3AsF_6 ,⁴ if it were due to OD_3^+ , it would have been shifted in OH_3AsF_6 to a significantly higher frequency. This assignment to ν_2 of AsF_6^- is also supported by the low-temperature infrared spectra of OH_3AsF_6 and OD_3AsF_6 (Figure 4), both of which show two sharp bands of almost identical intensities and frequencies at about 580 and 560 cm^{-1} .

The remaining bands due to AsF_6^- in OD_3AsF_6 are in excellent agreement with those previously observed for OH_3AsF_6 and can be assigned accordingly.⁴ IR: $\nu_3(\text{F}_{1u})$, 700 ; $\nu_4(\text{F}_{1u})$, 389 cm^{-1} . Raman: $\nu_1(\text{A}_{1g})$, 682 ; $\nu_2(\text{E}_g)$, 560 ; $\nu_3(\text{F}_{2g})$, 363 cm^{-1} . Several weak bands in the spectrum of OD_3AsF_6 are marked by an asterisk. These are due to a small amount of OD_2H^+ and will be discussed below.

Low-Temperature Spectra of OD_3AsF_6 . Figure 4 shows the low-temperature spectra of OD_3AsF_6 . The most prominent changes from the room-temperature spectra are the pronounced sharpening of all bands accompanied by splittings. As discussed above, these changes are caused by freezing of the ion motions. The change from a plastic phase to an ordered one, occurring on the basis of DSC measurements in the -7 to $+2\text{ }^\circ\text{C}$ temperature range, was confirmed by Raman spectroscopy. As can be seen from Figure 5, the freezing out of the ion motion occurs indeed within the very narrow temperature range.

Compared to the room-temperature spectra, the low-temperature spectra do not provide much additional information on the fundamental vibrations of OD_3^+ . The $\nu_1(\text{A}_1)$ fundamental is shown to occur at a lower frequency than $\nu_3(\text{E})$, and $\nu_4(\text{E})$ shows a splitting into two components in the infrared spectrum. The $\nu_2(\text{A}_1)$ deformation mode is again difficult to locate but clearly cannot be attributed to the 582-cm^{-1} infrared band for the above given reasons.

From the AsF_6^- part of the spectra some conclusions concerning the possible site symmetry of AsF_6^- might be reached. All degeneracies appear to be lifted for the fundamentals, and the bands are not mutually exclusive. This eliminates all centrosymmetric space groups and site symmetries such as O_h , T_h , or C_{3i} . The highest possible site symmetry appears to be

- (46) Giguere, P. A.; Guillot, J. G. *J. Phys. Chem.* **1982**, *86*, 3231.
 (47) Allavena, M.; Le Clech, E. *J. Mol. Struct.* **1974**, *22*, 265.
 (48) Bunker, P. R.; Kraemer, W. P.; Spirko, V. *J. Mol. Spectrosc.* **1983**, *101*, 180.
 (49) Colvin, M. E.; Raine, G. P.; Schaefer, H. F.; Dupuis, M. *J. Chem. Phys.* **1983**, *79*, 1551.
 (50) Shimanouchi, T. *Natl. Stand. Ref. Data Ser. (U.S., Natl. Bur. Stand.)* **1972**, *39*, 15.
 (51) Whitmer, J. C. *J. Chem. Phys.* **1972**, *56*, 1050.
 (52) Wolff, H.; Rollar, H. G.; Wolff, E. *J. Chem. Phys.* **1971**, *55*, 1373.
 (53) Reding, F. P.; Hornig, D. F. *J. Chem. Phys.* **1951**, *19*, 594; **1955**, *23*, 1053.
 (54) Thornton, C.; Khatkale, M. S.; Devlin, J. P. *J. Chem. Phys.* **1981**, *75*, 5609.

Table VII. Frequencies (cm^{-1}), Frequency Shifts on Deuteration, and Relative Infrared Intensities of OD_3^+ and OH_3^+ Compared to Those of Gaseous ND_3 and NH_3 ,^a and to the Results from ab Initio Calculations^b

assign for point group C_{3v}	approx descrpn of mode	OD_3^+ obsd	OH_3^+ obsd	$\nu(\text{OH}_3^+)$: $\nu(\text{OD}_3^+)$	ND_3	NH_3	$\nu(\text{NH}_3)$: $\nu(\text{ND}_3)$	OD_3^+ calcd	OH_3^+ calcd	$\nu(\text{OH}_3^+)$: $\nu(\text{OD}_3^+)$ calcd
$\nu_1(\text{A}_1)$	$\nu_2(\text{XY}_2)$	2300 m	3150 m	1.37	2420	3336	1.38	2424 (0.6)	3411 (1.0)	1.41
$\nu_2(\text{A}_1)$	$\delta_2(\text{XY}_2)$	715	900 m, br	1.26	748	950	1.27	549 (6.6)	725 (13.9)	1.32
$\nu_3(\text{E})$	$\nu_{\text{as}}(\text{XY}_2)$	2450 vs	3300 vs	1.35	2564	3444	1.34	2589 (7.0)	3516 (13.5)	1.36
$\nu_4(\text{E})$	$\delta_{\text{as}}(\text{XY}_2)$	1182 ms	1620 ms	1.37	1191	1626	1.37	1161 (1.3)	1598 (3.2)	1.38

^a Data from ref 50. ^b Data from ref 49 after application of the suggested -12.3% frequency correction.**Table VIII.** Frequencies (cm^{-1}) and Relative Infrared Intensities of OD_2H^+ and ODH_2^+ Compared to Those of Solid ND_2H and NHD_2 ,^a and to the Results of ab Initio Calculations^b

assign for point group C_2	approx descrpn of mode for XY_2Z	OD_2H^+ calcd	OD_2H^+ c obsd	ND_2H obsd	ODH_2^+ calcd	ODH_2^+ c obsd	NHD_2 obsd
$\nu_1(\text{A}')$	XZ str	3484 (9.9)	3150 vs	3329 s	2532 (4.4)		2447 s
$\nu_2(\text{A}')$	sym XY_2 str	2476 (2.1)		2392 m	3450 (5.8)		3300 m
$\nu_3(\text{A}')$	sym deformn	1447 (2.7)	1481 mw	1476 mw	1344 (1.7)	1398 w	1393 w
$\nu_4(\text{A}')$	sym deformn	611 (9.0)		905 vs	671 (11.5)		992 vs
$\nu_5(\text{A}')$	sym XY_2 str	2589 (7.2)		2501 vs	3516 (13.5)		3359 vs
$\nu_6(\text{A}')$	asym deformn	1186 (1.2)	1229 w	1254 w	1580 (3.4)	1613 mw	1602 mw

^a Data from ref 52. ^b Data from ref 49 after application of the suggested -12.3% frequency correction. ^c Frequency values taken from the low-temperature IR spectra of the SbF_6^- salts.

C_3 , in agreement with our triply hydrogen-bonded model possessing AsF_6^- ions with three shorter and three longer As-F bonds. Since that unit cell contains more than one molecule, additional splittings are possible due to in-phase out-of-phase coupling effects within the unit cell.

The low-temperature spectra of OD_3AsF_6 show a medium-strong IR band at 341 cm^{-1} and a Raman band at 329 cm^{-1} . These bands cannot be assigned to AsF_6^- because their frequencies are too low for ν_4 and also they were not observed in the low-temperature spectra of OH_3AsF_6 .⁴ In OH_3AsF_6 , however, two corresponding bands were observed at 467 cm^{-1} (IR) and 480 cm^{-1} (Raman).⁴ Since their average frequency value, 335 and 474 cm^{-1} , respectively, are exactly in a ratio of $1:2^{1/2}$, these bands must involve the hydrogen atoms and therefore are assigned to the D-F and H-F stretching modes, respectively. As expected, these bands due to H-F stretching are not observed in the plastic-phase, room-temperature spectra due to rapid motion of the ions.

From a simple diatomic model and the average observed frequency values ($\nu_{\text{H-F}} = 474$ and $\nu_{\text{D-F}} = 335 \text{ cm}^{-1}$), the corresponding force constants are $f_{\text{HF}} = 0.1258 \text{ mdyne/\AA}$ and $f_{\text{DF}} = 0.1204 \text{ mdyne/\AA}$, respectively. Their averaged value (0.1231 mdyne/\AA) corresponds to a hydrogen bridge bond energy of $1.77 \text{ kcal mol}^{-1}$, indicative of a weak hydrogen bond.

Spectra of OD_2SbF_6 , OH_2SbF_6 , and Partially Deuterated OH_3SbF_6 . Figure 6 shows the room-temperature vibrational spectra of OD_2SbF_6 , OH_2SbF_6 , and partially deuterated OH_3SbF_6 . Although the Raman lines due to SbF_6^- (670 , 590 , 555 , and 282 cm^{-1} in trace E) are broadened, the 670-cm^{-1} line had a pronounced shoulder at 644 cm^{-1} , the $\nu_2(\text{E}_g)$ mode is split into its two degenerate components (see Figure 5), and the D-F stretching mode at 355 cm^{-1} (trace E of Figure 6) and H-F stretching mode at 487 cm^{-1} (trace A of Figure 6) are observed. All these features clearly indicate that OD_2SbF_6 and OH_2SbF_6 are ordered at room temperature, thus confirming the above given DSC and neutron diffraction data.

The assignments for OD_2^+ in its SbF_6^- salt can be made by complete analogy to those given above for OD_3AsF_6 . The increased splitting of the 2430 - and 2330-cm^{-1} bands and their relative infrared intensities⁴⁹ (trace D of Figure 6) lend further support to the $\nu_3 > \nu_1$ assignment for the oxonium salts. On cooling (see Figure 7), all the important spectral features are retained, but become more evident due to better resolution caused by the narrow line widths. Thus, the D-F stretching

vibrations at 380 cm^{-1} become very prominent in the infrared spectra.

An analysis of the bands attributable to SbF_6^- (IR: 668 , 645 , 590 , 554 , 548 , 285 sh, 270 sh, 261 cm^{-1} . Raman: 680 sh, 673 , 650 sh, 640 , 586 , 554 , 291 sh, 287 sh, 281 , 265 sh cm^{-1} .) shows again that the site symmetry can be at best C_3 . Thus, the vibrational spectra appear to be compatible with a space group such as $I2_3$, which was chosen for the above given neutron diffraction structure analysis.

Assignments for OD_2H^+ and ODH_2^+ . The vibrational spectra of the OD_2^+ salts showed bands at about 3160 , 2920 , and 1470 cm^{-1} , marked by an asterisk in Figure 3, which could not readily be attributed to combination bands of OD_2^+ . Assignment of the 1470-cm^{-1} infrared band to the antisymmetric stretching mode of HF_2^- is also unsatisfactory, because the band was also observed in the Raman spectrum, which in turn did not show the expected symmetric HF_2^- stretching mode at 600 cm^{-1} . Furthermore, $\text{OD}_2^+\text{SbF}_6^-$ should result in the formation of DF_2^- and not of HF_2^- . Consequently, we have examined the possibility of these bands being due to small amounts of incompletely deuterated oxonium ions by recording the spectra of partially deuterated OH_2SbF_6 . As can be seen from trace B of Figure 6, the intensity of the band at about 3160 , 2920 , and 1470 cm^{-1} has increased strongly for the partially deuterated sample, and therefore these bands are assigned to the OD_2H^+ cation. The observed frequencies closely correspond to those of isoelectronic $\text{ND}_2\text{H}^{51-54}$ and the ab initio calculated OD_2H^+ values⁴⁹ (see Table VIII). Consequently the 3160 - and 1470-cm^{-1} bands are assigned to the OH stretching mode and the antisymmetric (A') OD_2H deformation mode, respectively, of OD_2H^+ . The 2920-cm^{-1} band can readily be assigned to the first overtone of the 1470-cm^{-1} band being in Fermi resonance with the OH stretching mode. The antisymmetric and symmetric OD_2 stretching modes of OD_2H^+ are expected to have frequencies of about 2400 and 2300 cm^{-1} ,^{49,51-54} respectively, and therefore are hidden underneath the intense OD_2^+ stretching modes. The antisymmetric (A'') OD_2H^+ deformation mode is expected^{49,51-54} to have a frequency between 1190 and 1250 cm^{-1} and therefore can be assigned to the infrared band at 1220 cm^{-1} observed in trace B of Figure 6.

In addition to the bands attributed to OD_2^+ and OD_2H^+ , the infrared spectrum of the partially deuterated OH_2SbF_6 sample (calculated product distribution (mol %): OD_2^+ , 51.68;

Table IX. Symmetry and Internal Force Constants^a of OD₃⁺ Compared to Those of OH₃⁺, NH₃, and ND₃^b

	force field ^c	DFF	OD ₃ ⁺		OH ₃ ⁺		NH ₃ -ND ₃ GVFF
			F ₁₂ and F ₄₄ ≡ min	NH ₃ TR	F ₁₂ and F ₄₄ ≡ min		
A ₁	F ₁₁ = f _r + 2f _{rr}	6.030	6.0440	6.085	5.7783	6.4540	
	F ₂₂ = f _α + 2f _{αα}	0.4868	0.4866	0.4997	0.4382	0.4049	
E	F ₁₂ = f _{rα} + f _{αr}	0	0.0527	0.3244	0.0242	0.3244	
	F ₃₃ = f _r - f _{rr}	6.0595	6.1194	6.133	5.9696	6.4732	
	F ₄₄ = f _α - f _{αα}	0.6041	0.6010	0.6011	0.5934	0.6161	
	F ₃₄ = f _{rα} + f _{αr}	0	-0.1228	-0.1622	-0.0654	-0.1622	
	f _r	6.0497	6.0943	6.117	5.9058	6.4668	
	f _{rr}	-0.0098	-0.0251	-0.016	-0.0638	-0.0064	
	f _α	0.5650	0.5629	0.5673	0.5417	0.5457	
	f _{αα}	-0.0391	-0.0381	-0.0338	-0.0517	-0.0704	
	f _{rα}	0	0.0582	0.1622	0.0355	0.1622	
	f _{αr}	0	-0.0646	0	-0.0299	0	

^a Stretching constants in mdyn/Å, deformation constants in mdyn/Årad², and stretch-bend interaction constants in mdyn/rad. The following bond angles and lengths were used: OD₃⁺ and OH₃⁺, 110° and 1.01 Å; NH₃, 107° and 1.01 Å. The bending coordinates were weighted by unit (1-Å) distance. Frequency values: OD₃⁺, ν₁ = 2300, ν₂ = 715, ν₃ = 2450, ν₄ = 1182; OH₃⁺, ν₁ = 3150, ν₂ = 900, ν₃ = 3300, ν₄ = 1620 cm⁻¹. ^b Values from ref 57 with the assumption F₁₂ = -2F₃₄. ^c The potential energy distribution for OD₃⁺ showed all fundamentals to be close to or 100% characteristic, with the largest amount of mixing being observed for ν₄ in the NH₃ transfer force field of OH₃⁺

OD₂H⁺, 38.16; ODH₂⁺, 9.33; OH₃⁺, 0.77) exhibits two bands at 1601 and 1388 cm⁻¹ (see trace B of Figure 6). These bands are in excellent agreement with our expectations^{49,51-54} (see Table VIII) for δ_{aa}(A'') and δ_{aa}(A'), respectively, of ODH₂⁺ and are assigned accordingly. The OD and OH₂ stretching modes of ODH₂ are again buried in the broad intense bands centered at about 2400 and 3300 cm⁻¹ and therefore cannot be located with any reliability. The symmetric deformation modes of OD₂H⁺ and ODH₂⁺ are probably giving rise to the strong shoulder in the 800-900 cm⁻¹ range (trace B of Figure 6) but cannot be located precisely due to their broadness.

The above assignments for OD₂H⁺ and ODH₂⁺ are further substantiated by the low-temperature spectra shown in Figures 4 and 7, with the decreased line widths allowing a more precise location of the individual frequencies. Most of the infrared bands observed in the 320-510 cm⁻¹ region for the low-temperature spectra of the different oxonium SbF₆⁻ salts are attributed to the D-F and H-F stretching modes of the hydrogen bridges.

In summary, most of the features observed for the vibrational spectra of the oxonium salts can satisfactorily be accounted for by the assumption of disordered higher temperature and ordered, hydrogen-bridged, lower temperature phases. Reasonable assignments can be made for the series OH₃⁺, ODH₂⁺, OD₂H⁺, and OD₃⁺ (see Table VI) that are in excellent agreement with those of the corresponding iso-electronic ammonia molecules⁵¹⁻⁵⁴ and the results of recent ab initio calculations⁴⁹ (see Tables VII and VIII). The only discrepancy between the ab initio calculations and the experimental data exists in the area of the symmetric deformation modes. This could be caused by the low barrier to inversion in OH₃⁺.⁴⁹

Force Constants. In view of our improved assignments for the oxonium cation, it was interesting to redetermine its force field. The frequencies and assignments given in Table VIII, a bond length of 1.01 Å, and a bond angle of 110° were used to calculate a valence force field of OD₃⁺ by using a previously described method⁴ to obtain an exact fit between calculated and observed frequencies. The results of these computations are summarized in Table IX.

Since isotopic shifts obtained by light-atom substitution such as H-D are virtually useless for the determination of a general valence force field,⁵⁵ approximating methods were used. Three different force fields were computed for OD₃⁺ to demonstrate that for a vibrationally weakly coupled system such as OD₃⁺ the choice of the force field has little influence on its values.

Our preferred force field is that assuming F₂₂ and F₄₄ being a minimum. This type of force field has previously been shown⁵⁶ to be a good approximation to a general valence force field for vibrationally weakly coupled systems. As can be seen from Table IX, the force field obtained in this manner is indeed very similar to the general force field previously reported⁵⁷ for ND₃ and NH₃. The fact that the force constants of OD₃⁺ deviate somewhat from those of OH₃⁺ is mainly due to the broadness of the OH₃⁺ vibrational bands and the associated uncertainties in their frequencies. Since the stretching frequencies of OD₃⁺ are more precisely known than those of OH₃⁺, the OD₃⁺ force field should be the more reliable one. The fact that F₁₂ in NH₃ and ND₃ is somewhat larger than the value obtained for F₁₂ in our F₂₂ = minimum force field is insignificant because in the published⁵⁷ NH₃ force field F₁₂ was not well determined and was consequently assumed to equal -2F₃₄. The fact that the stretching force constant f_r in OD₃⁺ is slightly lower and the deformation constant f_α in OD₃⁺ is slightly higher than those in ND₃ is not unexpected. The ND₃ frequencies were those of the free molecule, whereas the OD₃⁺ values are taken from the ionic solid OD₃⁺AsF₆⁻. In this solid, D-F bridging occurs (see above), thereby lowering the OD stretching and increasing the deformation frequencies. As secondary effects, the higher electronegativity of oxygen and the positive charge in OD₃⁺ are expected to increase the polarity of the O-D bonds, thereby somewhat decreasing all the frequencies. These explanations can well account for the observed differences.

For the bending force constant f_α, values of 0.563 and 0.542 mdyn/Årad² were obtained for OD₃⁺ and OH₃⁺, respectively. These values are in excellent agreement with the value of 0.55 mdyn/Årad² obtained for OH₃⁺ by an ab initio calculation.⁴⁷

In summary, the results from our normal-coordinate analysis lend strong support to our analysis of the vibrational spectra. They clearly demonstrate the existence of discrete OH₃⁺ ions that in character closely resemble the free NH₃ molecule, except for some secondary effects caused by hydrogen-fluorine bridging.

Conclusion. The results of this study show that OD₃AsF₆ exists at room temperature in a plastic phase, whereas OD₃SbF₆ has an ordered structure. Based on diffraction data and vibrational spectra, a structural model is proposed for the ordered phase of OD₃SbF₆. More experimental data are needed to define the exact nature of the ion motions and the associated phase changes in these salts. Many of the obser-

(55) Maban, N.; Mueller, A.; Nakamoto, K. *Adv. Infrared Raman Spectrosc.* 1975, 1, 180.

(56) Sawodny, W. *J. Mol. Spectrosc.* 1969, 30, 56.

(57) Shimanouchi, T.; Nakagawa, I.; Hiraishi, J.; Ishii, M. *J. Mol. Spectrosc.* 1966, 19, 78.

vations made in this study are in poor agreement with previous reports for other oxonium salts and cast some doubt on the general validity of some of the previous conclusions. Due to their good thermal stability, oxonium salts of complex fluoro cations are well suited for further experimental studies.

Acknowledgment. The authors are indebted to Drs. C. Schack, R. Wilson, and W. Wilson of Rocketdyne, Dr. P. Meriel of CEN Saclay, and Dr. P. Aldebert of ILL Grenoble

for their help with experiments. K.O.C. thanks the U.S. Army Research Office and the Office of Naval Research for financial support.

Registry No. $\text{OH}_3^+\text{AsF}_6^-$, 21501-81-5; $\text{OD}_3^+\text{AsF}_6^-$, 92186-28-2; $\text{O}_2^+\text{AsF}_6^-$, 12370-43-3; $\text{OD}_3^+\text{SbF}_6^-$, 92186-29-3; $\text{OH}_3^+\text{SbF}_6^-$, 55649-03-1; D_2O , 7789-20-0; DF , 14333-26-7; AsF_5 , 7784-36-3; SbF_5 , 7783-70-2; $\text{OD}_2\text{H}^+\text{SbF}_6^-$, 92186-30-6; $\text{ODH}_2^+\text{SbF}_6^-$, 92186-31-7; OD_3^+ , 24847-51-6; MoF_6O , 14459-59-7; D_3 , 7782-39-0.

APPENDIX D

Reprinted from *Inorganic Chemistry*, 1984, 23, 4283
Copyright © 1984 by the American Chemical Society and reprinted by permission of the copyright owner.

Contribution from the Institut für Physikalische und Theoretische Chemie der Universität Tübingen, 7400 Tübingen, West Germany,
and Rocketdyne, A Division of Rockwell International Corporation, Canoga Park, California 91304

Gas-Phase Structure of Azidotrifluoromethane. An Electron Diffraction, Microwave Spectroscopy, and Normal-Coordinate Analysis

KARL O. CHRISTE,^a DINES CHRISTEN,^b HEINZ OBERHAMMER,^{a,b} and CARL J. SCHACK^a

Received February 28, 1984

The geometric structure of azidotrifluoromethane has been obtained by a combined analysis of electron diffraction intensities and ground-state rotational constants derived from the microwave spectrum. The following parameters were obtained (r_e values in Å and deg with 2σ uncertainties in units of the last decimal): C-F = 1.328 (2), C-N_a = 1.425 (5), N_a-N_b = 1.252 (5), N_b-N_c = 1.118 (3), \angle CN_aN_b = 112.4 (2), \angle N_aN_bN_c = 169.6 (3.4), \angle FCF = 108.7 (2). The CF₃ group is in the staggered position with respect to the N₃ group and tilted away from it by 5.8 (4)°.

Introduction

Structural data on covalent azides are rare due to the explosive nature^{2,3} and handling difficulties encountered with these compounds. One of the more stable covalent azides is CF₃N₃, a compound originally prepared by Makarov and co-workers^{4,5} and recently studied in more detail by two of us.⁶ Although the closely related CH₃N₃ molecule has previously been studied by both electron diffraction⁷ and microwave

spectroscopy,⁸ the available data were insufficient to determine whether the N₃ group is linear and to obtain a reliable value for the tilt angle of the methyl group. Furthermore, a comparison of the structures of CH₃N₃ and CF₃N₃ was expected to contribute to our knowledge of how the substitution of a CH₃ group by a CF₃ group influences the structure of the rest of the molecule.⁹

Experimental Section

Synthesis and Handling of CF₃N₃. The sample of CF₃N₃ was prepared as previously described.⁶ Prior to the electron diffraction experiments, a small amount of N₂ formed by decomposition of some CF₃N₃ was pumped off at -196 °C. The only other decomposition

- (1) (a) Rocketdyne. (b) University of Tübingen.
- (2) Patai, S., Ed.; "The Chemistry of the Azido Group"; Wiley-Interscience: New York, 1971.
- (3) Dehaeck, K. *Adv. Inorg. Chem. Radiochem.* 1983, 26, 169.
- (4) Makarov, S. P.; Yakubovich, A. Ya.; Ginsburg, V. A.; Filatov, A. S.; Englin, M. A.; Privezentseva, N. F.; Nikiforova, T. Ya. *Dokl. Akad. Nauk SSSR* 1961, 141, 357.
- (5) Makarov, S. P.; Yakubovich, A. Ya.; Filatov, A. S.; Englin, M. A.; Nikiforova, T. Ya. *Zh. Obshch. Khim.* 1968, 38, 709.
- (6) Christe, K. O.; Schack, C. J. *Inorg. Chem.* 1981, 20, 2566.

- (7) (a) Livingston, R. L.; Rao, C. N. R. *J. Phys. Chem.* 1960, 64, 756. (b) Anderson, D. W. W.; Rankin, D. W. H.; Robertson, A. *J. Mol. Struct.* 1972, 14, 385.
- (8) Salathiel, W. M.; Curl, R. F., Jr. *J. Chem. Phys.* 1966, 44, 1284.
- (9) Oberhammer, H. *J. Fluorine Chem.* 1983, 23, 147.

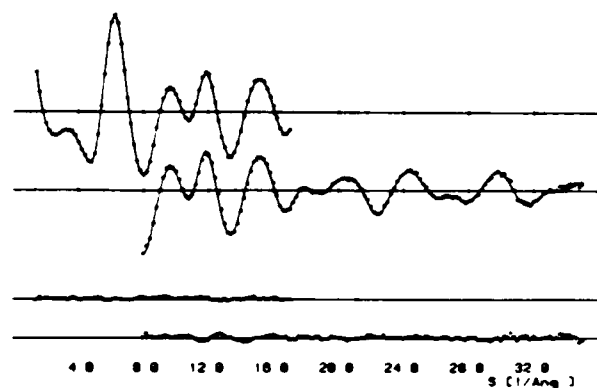

Figure 1. Experimental (---) and calculated (—) molecular intensities and differences.

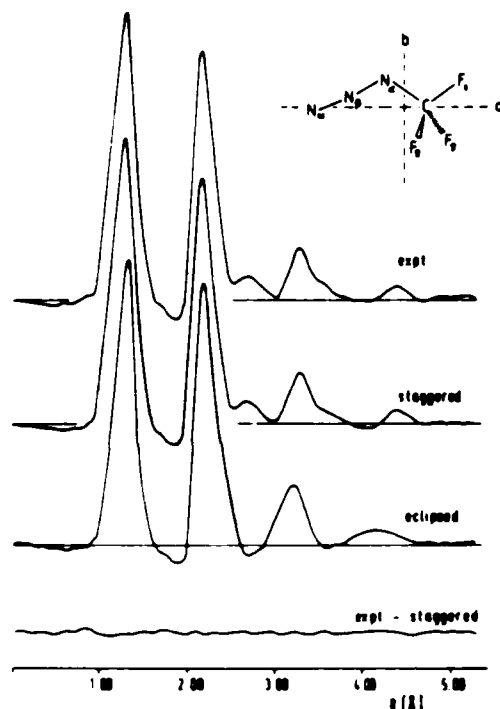

Figure 2. Experimental radial distribution function, theoretical functions for staggered and eclipsed conformations, and the difference curve between experimental and theoretical staggered conformation.

products were nonvolatile and therefore did not interfere with the measurements.

Electron Diffraction. The scattering intensities were recorded with the Belzers gas diffractograph at two camera distances (25 and 50 cm) on Kodak electron image plates (13 × 18 cm). The accelerating voltage was about 60 kV. The sample was cooled to -80 °C, and the nozzle temperature was 15 °C. The camera pressure never exceeded 2×10^{-5} torr during the experiment. Exposure time was 6–9 s for the long and 15–25 s for the short camera distance. The electron wavelength was calibrated with ZnO diffraction patterns. Two plates for each camera distance were analyzed by the usual procedures. Background scattering recorded without gas was subtracted from the 25-cm data. Averaged molecular intensities for both camera distances ($s = 1.4$ – 17 and 8 – 35 \AA^{-1}) are presented in Figure 1, and numerical values for the total scattering intensities are available as supplementary data.¹⁰

Microwave Spectroscopy. The microwave spectrum was recorded at temperatures between -70 and -40 °C at pressures around 10 mtorr and at frequencies between 7 and 25 GHz (X- and K-band) on a

Table I. Interatomic Distances, Vibrational Amplitudes from Spectroscopic and Electron Diffraction Data, and Vibrational Corrections Δ (Å)

atom pair	r_{ij}	vibrational amplitudes		
		spectr	ed ^a	$\Delta = r_a - r_z$
N_β - N_ω	1.12	0.034	0.034 ^b	0.0060
N_α - N_β	1.25	0.042	0.042 (4) ^c	0.0004
C-F	1.33	0.045	0.045 (4) ^c	0.0013
C- N_α	1.43	0.053	0.053 (4) ^c	-0.0001
F...F	2.16	0.054	0.056 (3) ^c	0.0009
N_α ...F _t	2.18	0.061	0.063 (3) ^c	0.0004
N_α ...F _s	2.30	0.063		0.0001
C... N_β	2.23	0.067	0.067 ^b	-0.0006
N_α ... N_ω	2.36	0.046	0.046 ^b	0.0028
N_β ...F _s	2.71	0.169	0.174 (26)	-0.0072
C... N_ω	3.27	0.085	0.095 (40)	-0.0003
N_β ...F _t	3.31	0.092	0.092 ^b	0.0021
N_ω ...F _s	3.56	0.229	0.250 (33)	-0.0096
N_ω ...F _t	4.42	0.141	0.096 (57)	0.0130

^a Error limits are 3σ values. ^b Not refined. ^c Ratio constrained to spectroscopic ratio.

Table II. Geometric Parameters (Å and deg) for CF_3N_3 from Electron Diffraction and Combined Electron Diffraction-Microwave Analysis

	r_α ^a	r_{av} ^b
C-F	1.329 (3)	1.328 (2)
C- N_α	1.427 (5)	1.425 (5)
N_α - N_β	1.250 (7)	1.252 (5)
N_β - N_ω	1.117 (4)	1.118 (3)
CN _α N _β	111.8 (1.1)	112.4 (0.2)
N _α N _β N _ω ^c	175.3 (4.3)	169.6 (3.4)
FCF	108.4 (0.4)	108.7 (0.2)
tilt ^d	4.4 (1.2)	5.8 (0.4)

^a Results from electron diffraction analysis; error limits are 2σ values and include a possible scale error of 0.1% for bond lengths.

^b Results from combined electron diffraction-microwave analysis; error limits are 2σ values. ^c Bend away from CF_3 group. ^d Tilt of CF_3 group away from N_3 group.

standard 100-kHz Stark spectrometer.

CF_3N_3 was initially flowed through the cell, but since the sample proved to be very stable, it was only changed at intervals of several hours.

An initial broad-band sweep in the K-band, applying a 0–20-V ramp voltage at the external sweep connector of the Marconi sweeper, immediately revealed the μ_a R-branch heads typical of a nearly prolate rotor and thus restricted the ranges to be searched.

Structure Analysis

A preliminary analysis of the radial distribution function (Figure 2) clearly demonstrates that the CF_3 group is staggered with respect to the N_3 chain. Model calculations for the eclipsed configuration result in very bad agreement with the experimental data in the range $r > 2.5 \text{ \AA}$ (see Figure 2). The radial distribution function for the eclipsed configuration was calculated with the final geometric parameters derived for the staggered conformation. Increase of the CN_αN_β angle to about 130° improved the fit for the peak at 3.3 Å, but the disagreement for the peaks around 2.7 and 4.5 Å remained. Therefore, in the following analysis the CF_3 group was constrained to the staggered position. However, small torsional deviations ($<10^\circ$) from this position cannot definitely be excluded.

In the least-squares analysis a diagonal-weight matrix was applied to the intensities and scattering amplitudes, and the phases of Haase¹¹ were used. The spectroscopic corrections, Δr (Table I), were incorporated into the refinement. For torsional vibrations, the concept of perpendicular (rectilinear)

(10) Supplementary data available (see paragraph at end of paper)

(11) Haase, J. Z. *Naturforsch.*, A 1970, 25A, 936.

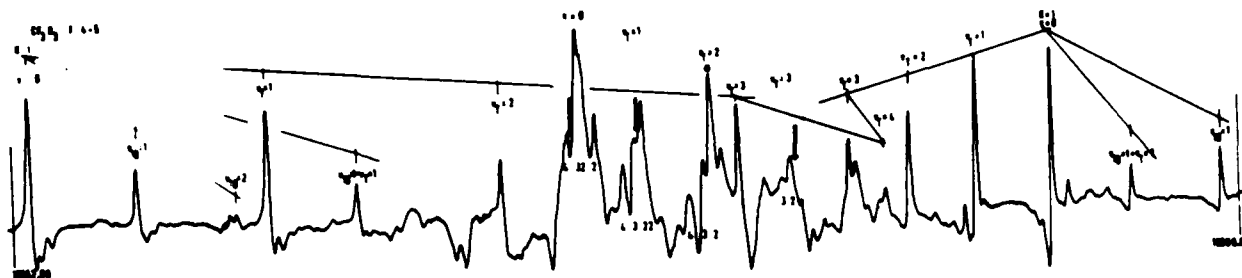

Figure 3. The $J = 4 \rightarrow 5$ rotational transitions at a Stark field of 200 V/cm. Arrows indicate frequencies at which $K_{-1} = 0$ lines appear at higher Stark fields. $\nu_T = \nu_{15}$. $\nu_T = 4$ indicates the center of the A components of the torsionally split $\nu_T = 4$ state. The $K_{-1} = 1$ lines have not definitively been assigned.

amplitudes results in unrealistically large contributions to these corrections for torsion-independent distances (C-F, F-F, and N-F). Therefore, contributions from the CF_3 torsion, which is a large-amplitude vibration, were neglected for torsion-independent distances.¹² Assuming local C_{3v} symmetry for the CF_3 group with a possible tilt angle between the C_3 axis and the C-N bond, eight geometric parameters (including the $N_2N_2N_2$ angle) are required for the determination of the structure of CF_3N_3 . These parameters were refined simultaneously with six vibrational amplitudes (see Table I). The remaining vibrational amplitudes, which either cause high correlations or are badly determined in the electron diffraction experiment, were constrained to the spectroscopic values, calculated from the force field. This is justified, since the refined amplitudes agree very well with the spectroscopic values. The result from the electron diffraction analysis is included in Tables I and II.

In the final stage of the analysis, structural parameters were fitted to electron diffraction intensities as well as rotational constants.¹³ Although the method for calculating $\Delta B^e = B^e - B^g$ is based on the assumption of small-amplitude vibrations, which certainly does not describe the torsional motion, this approximation has a minor effect on the determination of the geometric parameters. In order to test this effect, structural parameters were calculated by using three different corrections: (1) assuming all vibrations to have small amplitudes ($\Delta A = 0.39$, $\Delta B = 1.98$, and $\Delta C = -0.78$ MHz), (2) disregarding torsion ($\Delta A = 4.42$, $\Delta B = 1.16$, and $\Delta C = 1.22$ MHz), and (3) no corrections at all. The relative weight between electron diffraction and microwave data was adjusted, until the rotational constants were fitted to within 20% of the corrections in cases 1 and 2 and to within 1 MHz in case 3. These calculations demonstrate that the small differences in the rotational constants do not affect the geometric parameters outside the error limits given in Table II.

The results demonstrate the usefulness of the rotational constants for the reduction of the uncertainties in the CN_2N_2 and the CF_3 tilt angle, which are very sensitive to the asymmetry or, in other words, to $B_2 - C_2$.

Normal-Coordinate Analysis

A force field, required for the joint analysis of microwave and electron diffraction data, was derived from the 14 fundamental frequencies determined in a previous study,⁶ the torsional frequency, derived from relative intensity measurements of rotational transitions of the excited torsional states, and the centrifugal distortion constant D_{JK} , determined from the rotational spectrum of the ground state.

Valence force constants were refined with the program NCA¹⁴ on the basis of mass-weighted Cartesian coordinates.

Table III. Force Field^a for CF_3N_3

CF	6.69	CF/CF	1.06
CN	4.84	CF/CN	0.46
N_2N_2	7.75	CF/FCF (adj)	0.51
$N_2N_2\omega$	16.88	CF/FCF (opp)	-0.33
FCF	1.82	CN/FCF	-1.00
NCF	1.20	CN/NCF (adj)	0.42
CNN	1.49	CN/NNN	-0.54
NNN	0.67	FCF/FCF	0.23
tors	0.03	FCF/NNN	-0.18
		NNN/tors	-0.07

^a Stretch in m dyn/A, stretch/bend in m dyn/rad, and bend in m dyn A/rad².

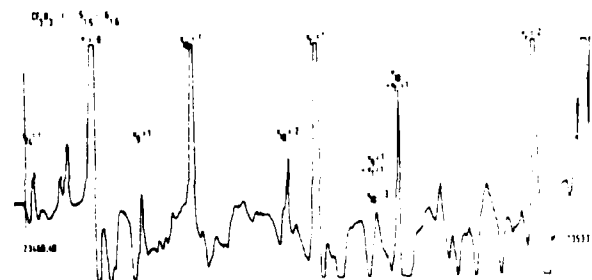

Figure 4. The $J = 5_{15} \rightarrow 6_{16}$ transitions showing several vibrationally excited states at a Stark field of 800 V/cm. $\nu_T = \nu_{15}$.

The modified harmonic force field (Table III) looks reasonable, but is, of course, underdetermined.

The mean deviation between measured and calculated frequencies is $\overline{\Delta\nu} = 4 \text{ cm}^{-1}$.

Rotational Spectrum

The assignment of the band heads in the K-band region to the $J = 4 \rightarrow 5$ (19.62 GHz) and $J = 5 \rightarrow 6$ (23.54 GHz) transitions was straightforward since these band heads appeared very close to the frequencies predicted by the preliminary electron diffraction model ($B + C = 3.94$ GHz), but the high-resolution recordings did not openly display the characteristic pattern of a nearly prolate ($K = -0.989$) rotor (see Figure 3). The deviations arise from excited vibrational states—especially the low-lying torsional states—as will be discussed below. The frequencies of all measured transitions and the ensuing rotational constants have been collected in Table IV. The $K_{-1} = 1$ lines stand out quite clearly, though, and recording at different Stark fields permitted the identification of $K_{-1} = 0$ lines that appear only at high fields. Subsequently higher K_{-1} lines were identified, but because many of them are subject to heavy overlapping, some of them could only be measured using a radio-frequency/microwave double-resonance technique (RFMWDR) as described below.

The lowest J lines show signs of quadrupole hyperfine structure, but no attempt was made to resolve and analyze these splittings. Stark measurements on different M compo-

(12) Oberhammer, H. *J. Chem. Phys.* 1978, 69, 468.

(13) Typke, V.; Dakkhouri, M.; Oberhammer, H. *J. Mol. Struct.* 1978, 44, 85.

(14) Christen, D. *J. Mol. Struct.* 1978, 48, 101.

Table IV. Measured Rotational Transitions and Derived Rotational Constants (MHz)

	$\nu = 0$	$\nu_{10} = 1$	$\nu_{10} = 2$	$\nu_{10} = 3$	$\nu_{10} = 4^a$	$\nu_{10} = 1$	$\nu_{10} = 2$	$\nu_{10} = 1, \nu_{10} = 1$	$\nu_9 = 1$
$1_{01} 2_{02}$	7 845.90	7 848.36	7 851.39	7 854.87	7 858.13	7 851.84	7 857.67	7 853.68	
$2_{12} 3_{13}$	11 738.22	11 750.70	11 764.13	11 778.62		11 743.79	11 749.23	11 755.80	
$2_{02} 3_{03}$	11 768.73	11 772.52	11 777.05	11 782.32	11 787.38	11 777.53		11 780.40	
$2_{21} 3_{22}$	11 768.73	11 772.33	11 776.69	11 781.82		11 777.72		11 780.28	
$2_{20} 3_{21}$	11 768.93	11 772.49	11 776.69	11 781.82		11 778.00		11 780.51	
$2_{11} 3_{12}$	11 799.67	11 794.40	11 789.80	11 785.77				11 805.19	
$4_{14} 5_{15}$	19 563.32	19 584.34	19 606.66	19 630.92		19 572.60	19 581.52	19 592.76	
$4_{41} 5_{42}$	19 612.98	19 618.70	19 625.77	19 633.66		19 627.90		19 632.07	
$4_{40} 5_{41}$	19 613.36	19 620.17	19 627.90	19 637.11	19 646.89	19 627.75	19 641.95	19 633.17	
$4_{32} 5_{33}$	19 614.09	19 619.84	19 626.93	19 635.37		19 629.06	19 643.67	19 633.17	
$4_{31} 5_{32}$	19 614.28	19 620.17	19 627.75	19 636.38		19 629.06	19 643.67	19 633.58	
$4_{22} 5_{23}$	19 615.96	19 621.02	19 627.90	19 636.38			19 646.29	19 634.74	
$4_{21} 5_{22}$	19 665.79	19 657.02	19 649.58	19 642.92		19 686.00	19 706.00	19 675.23	
$5_{15} 6_{16}$	23 475.69	23 500.96	23 527.92	23 557.02		23 486.68	23 497.42	23 510.98	23 480.85
$5_{51} 6_{52}$	23 534.01	23 540.81	23 549.30			23 551.87			
$5_{50} 6_{51}$	23 534.97	23 543.71	23 553.54	23 564.72		23 552.18	23 568.80		
$5_{42} 6_{43}$	23 535.65	23 542.48	23 551.08	23 560.39		23 553.51			
$5_{41} 6_{42}$	23 536.98	23 544.36	23 553.06	23 563.73		23 554.88		23 560.39	
$5_{32} 6_{33}$	23 537.01	23 543.71	23 552.40	23 562.22		23 554.88			
$5_{31} 6_{32}$	23 540.01	23 545.76	23 553.54	23 563.73		23 558.48		23 562.22	
$5_{14} 6_{15}$	23 598.62	23 588.29	23 579.39	23 571.50		23 662.84	23 646.77	23 609.94	23 607.58
A^b	5544	5631.5	5722.4	5817.2	5880.5	5517.5	5490	5600	5526.5
B	1971.750 (4)	1969.374 (6)	1967.121 (6)	1964.924 (7)	3929.1 ^c	1974.335 (6)	1976.896 (5)	1971.679 (6)	1967.30
C	1951.260 (4)	1954.825 (6)	1958.544 (6)	1962.519 (7)		1951.648 (6)	1952.002 (5)	1955.188 (6)	1956.74
D_{JK}^d	0.0142 (1)	0.0150 (2)	0.0158 (2)	0.0220 (31)		0.0143 (2)	0.0141 (5)	0.0148 (3)	0 ^e

^a A species. ^b Fixed to value determined from structural model and harmonic effects. ^c $B + C$. ^d kHz. ^e Assumed.

nents of the transitions $4_{14} \rightarrow 5_{15}$, $4_{13} \rightarrow 5_{14}$, $5_{15} \rightarrow 6_{16}$, and $5_{14} \rightarrow 6_{15}$ (calibrating the field against the OCS shifts and using Muentzer's value for its dipole moment¹⁵) yielded a dipole moment in the a direction of $\mu_a = 1.15$ (10) D.

To understand the microwave spectrum in detail, especially the many lines between the two $K_{-1} = 1$ transitions, it is necessary to consider the possible molecular vibrations. In an earlier study,⁶ the vibrational spectra were investigated and 14 of the 15 fundamentals identified. The missing one, the torsion of the CF_3 group, was predicted to lie below 90 cm^{-1} but could not experimentally be observed.

Figure 4 shows the $5_{15} \rightarrow 6_{16}$ transition in a highly amplified recording. From the characteristic Stark patterns it is possible to identify all of the obvious lines with the same transition, only in different vibrational states. The very intense progression to higher frequency must be assigned to the torsion, and relative intensity measurements using the Wilson-Nesbitt method¹⁶ yield an energy above the ground state of 47 (3) cm^{-1} for the first excited torsional state and thus for the torsional frequency.

To test the reliability of this method, the energies of excited states of other vibrations were determined and compared to the fundamental frequencies determined from the IR and Raman spectra (in parentheses): ν_{10} 177 (179), ν_9 409 (402), ν_{14} 459 (450), $\nu_{10} + \nu_{15}$ 221 cm^{-1} comprised of ν_{10} 174 and ν_{15} 47 cm^{-1} .

The reliability of the method obviously decreases with increasing frequency (decreasing intensity), and the method fails for transitions falling between the two $K_{-1} = 1$ lines because of serious overlapping of lines and Stark components.

Examination of the $5_{14} \rightarrow 6_{15}$ transitions to determine their relative intensities revealed that the ν_{15} progression extends toward lower frequencies, and thus the frequency difference between the $K_{-1} = 1$ lines decreases with increasing excitation

of ν_{15} . This effect is not observed with the other excited states (notably ν_{10}). The frequency difference between the $K_{-1} = 1$ lines directly determines $B - C$, and thus the observed trend indicates an increase in symmetry in the ν_{15} progression.

In order to explain this trend, it must be noted that a structural model having the C_3 axis of the CF_3 group collinear with the C-N bond only produces a $B - C$ value of 1–2 MHz. To reproduce the observed $B - C$ value for the ground state (20.5 MHz), it is necessary to assume a tilt angle of $\sim 5^\circ$.

Consequently, one could propose that the effect of higher torsional excitation is the removal of the tilt of the CF_3 group. In that case one would expect higher torsional states to have $B - C$ values between 1 and 2 MHz.

On the other hand, if one realizes that most of the molecular mass is concentrated in the trifluoromethyl group, it is possible to visualize the light "frame" rotating about the heavy "top", and higher excitation would lead to an effective symmetric-top molecule with the excited energy levels lying well above the barrier to the torsional motion. In that case, however, as the energy levels approach the top of the barrier, tunneling through the threefold barrier would cause the rotational lines to split into nondegenerate A and doubly degenerate E components.

Unfortunately, this splitting is expected to take place at the frequency where the center of the rotational transitions of the excited torsional states have "turned back" (see Figure 3) into the upper $K_{-1} = 1$ lines of the lower torsional states, and thus it is impossible to clearly distinguish the weaker lines of the higher excited states.

It was hoped that double-resonance experiments (RFMWDR) could circumvent this problem.¹⁷ RFMWDR techniques were used to identify and measure the $J = 5 \rightarrow 6$, $K_{-1} = 2$ transitions of the molecule in its ground as well as its first excited torsional state, with a pump frequency of 3.1 MHz, which happens to be the asymmetry splitting of the $J = 5$ levels for the ground state and the splitting of the $J = 6$

(15) Muentzer, J. S. *J. Chem. Phys.* 1968, 48, 4544.

(16) Nesbitt, A. S., Jr.; Wilson, E. B., Jr. *Rev. Sci. Instrum.* 1963, 34, 901.

(17) Wodarczyk, F. J.; Wilson, E. B., Jr. *J. Mol. Spectrosc.* 1971, 37, 445.

Table V. Principal Geometric Parameters (A and deg) of Some Azides, XN_3 , Studied in the Gas Phase

	HN_3^b	$CH_3N_3^c$	$Me_3SiN_3^d$	CN_3^e	NCN_3^f	$CF_3N_3^g$
$X-N_\alpha$	1.015 (15)	1.468 (5)	1.734 (7)	1.745 (5)	1.355 (2)	1.425 (5)
$N_\alpha-N_\beta$	1.243 (5)	1.216 (4)	1.198 (8)	1.252 (10)	1.261 (2)	1.252 (5)
$N_\beta-N_\omega$	1.134 (2)	1.130 (5)	1.150 (11)	1.133 (10)	1.121 (2)	1.118 (3)
$XN_\alpha N_\beta$	108.8 (4.0)	116.8 (0.3)	128.0 (1.6)	108.7 (0.5)	114.5 (0.2)	112.4 (0.2)
$N_\alpha N_\beta N_\omega$	171.3 (5.0)	180 ^h	180 ^h	171.9 (0.5)	169.2 (1.6)	169.6 (3.4)
τ^d		35.0 (7.0)	24.0 (5.0)			0.0

^a Torsional angle of group X around X-N bond. $\tau = 0^\circ$ corresponds to staggered position. ^b r_s values; ref 18. ^c r_s values; ref 7b. ^d r_s values; ref 19. ^e r_o/r_e values; ref 20. ^f r_o values; ref 21. ^g r_{av} values; this study. ^h Estimated value.

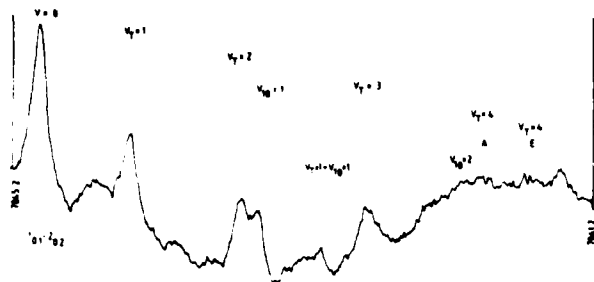

Figure 5. The $J = 1_{01} \rightarrow 2_{02}$ transitions at a Stark field of 800 V/cm. Marker spacing is 0.8 MHz. The assignment of $v_{15} = 4$ is speculative, although other J candidates for the A components have been located.

levels for the first excited torsional state. With a pump frequency of 6.15 MHz (the ground-state splitting of the $J = 6$ levels) only the ground-state transitions are observed.

It was also possible to observe the $K_{-1} = 1$ lines in RFMWR ($J = 5 \rightarrow 6$) for the ground state ($v_p = 307.0$ MHz) and the first ($v_p = 218.4$ MHz), the second ($v_p = 128.7$ MHz), and, barely, the third excited torsional states ($v_p = 36.1$ MHz).

The weakness of the third excited torsional state transitions extinguished the hope of finding the $v_{15} = 4$ lines by using the DR technique, which would otherwise have overcome the problem of overlapping.

Fortunately, however, the $J = 1 \rightarrow 2$ transitions around 7.9 GHz (Figure 5), modulated at a Stark field of 800 V/cm, only show the $K_{-1} = 0$ transitions and thus provide a somewhat clearer picture. It looks as though the $v_{15} = 3$ transition is somewhat broadened compared to the $v_{15} = 0, 1,$ and 2 transitions, and the $v_{15} = 4$ transition is possibly split into two components, indicating a torsional level approaching the top of the barrier.

The assumption of a purely sinusoidal potential allows a determination of the barrier heights from the torsional force constant, known from the normal-coordinate analysis

$$\text{force constant} = \frac{\partial^2 V}{\partial \alpha^2} = \frac{\partial^2}{\partial \alpha^2} \left[\frac{V_3}{2} (1 - \cos(3\alpha)) \right]$$

$$\text{at } \alpha = 0 = 9V_3/2$$

or $0.03 \text{ mdyn } \text{\AA}^2 = 4.35 \text{ kcal/mol} = 9V_3/2$ and $V_3 = 0.97 \text{ kcal/mol}$.

Thus, the $v_{15} = 4$ state with an energy of 0.675 kcal is in fact quite close to the top of the barrier, especially since the addition of a few percent V_6 potential would somewhat lower the value of V_3 . It seems, although the evidence is sparse, that the decrease in $B - C$ on excitation of v_{15} is due to the hindered internal rotation of the trifluoromethyl group.

Discussion

The most significant features of the CF_3N_3 structure are the bond lengths, the nonlinearity of the N_3 group, and the torsion and tilt angle of the CF_3 group with respect to the N_3 group. These features are discussed in the following paragraphs.

Bond Lengths. The above results clearly demonstrate that in CF_3N_3 the $N_\beta-N_\omega$ bond is significantly shorter than the $N_\beta-N_\alpha$ bond. This can be attributed to the electron-withdrawing effect of the CF_3 group. A comparison of the MN_3 series ($M = \text{alkali metal}, (CH_3)_3Si, H, Cl, CF_3$) shows that if M is of very low electronegativity, as for example in the alkali metals, we have an ionic $M^+N_3^-$ structure (I) with two

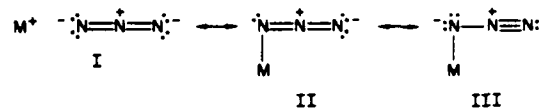

degenerate N-N bonds of 1.16 Å each. With increasing electronegativity of M , the M-N bond becomes more covalent and the contribution from resonance structure III increases, due to the electron-withdrawing effect of M . This causes an increase in the bond length difference between $N_\beta-N_\omega$ and $N_\beta-N_\alpha$ (see Table V). A comparison of the C-N bond lengths in CH_3N_3 and CF_3N_3 also shows the expected effect.⁹ Replacement of the CH_3 by the CF_3 group results in bond shortening if the groups are bonded to electronegative atoms or groups. Hence the C-N bond in CF_3N_3 (1.425 Å) is significantly shorter than that in CH_3N_3 (1.468 Å).

Torsional Angle of the CX_3 Group. In general, methyl or trifluoromethyl groups prefer the staggered position with respect to single bonds but prefer an eclipsed position with respect to double bonds. Representative examples in the case of C=C double bonds are $CX_3CH=CH_2$ ²² and *trans*- $CX_3CH=CHCX_3$.^{23,24} Only strong steric repulsions can force CF_3 groups to abandon the eclipsed position, such as in *cis*- $CF_3CH=CHCF_3$.²⁴ Only one example is known for N=N double bonds: *trans*- $CX_3N=N CX_3$,²⁴⁻²⁶ where the CX_3 groups again eclipse the N=N double bond and stagger the N lone pair. In CF_3N_3 the CF_3 group occupies a staggered position with respect to the N_3 group as shown by IV, and this

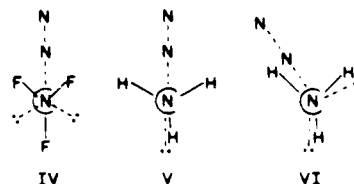

indicates a significant contribution from resonance structure III. For this structure, configuration IV minimizes the re-

- (18) Winnewisser, B. P. *J. Mol. Spectrosc.* **1980**, *82*, 220.
 (19) Dakikhoun, M.; Oberhammer, H. *Z. Naturforsch.* **1972**, *27A*, 1331.
 (20) Cook, R. L.; Gerry, M. C. L. *J. Chem. Phys.* **1970**, *53*, 2525.
 (21) Almennigen, A.; Bak, B.; Jansen, P.; Strand, T. G. *Acta Chem. Scand.* **1973**, *27*, 1531.
 (22) Tokue, J.; Fukuyama, T.; Kuchitsu, K. *J. Mol. Struct.* **1973**, *17*, 207.
 (23) Almennigen, A.; Anfinson, I. M.; Haaland, A. *Acta Chem. Scand.* **1970**, *24*, 43.
 (24) Bürger, H.; Pawelke, G.; Oberhammer, H. *J. Mol. Struct.* **1982**, *94*, 49.
 (25) Chiang, C. H.; Porter, R. F.; Bauer, S. H. *J. Am. Chem. Soc.* **1970**, *92*, 5315.
 (26) Almennigen, A.; Anfinson, I. M.; Haaland, A. *Acta Chem. Scand.* **1970**, *24*, 1230.

pulsion between the fluorine free valence electrons and the two sterically active free electron pairs on the N_a atom (indicated by broken lines in IV). In contrast to CF_3N_3 , the CH_3 group in CH_3N_3 appears to be in an intermediate position between eclipsed and staggered,^{7b} ($25 \pm 7^\circ$ from the eclipsed position), which may be explained in the following manner: resonance structure II should result in a staggered configuration (V) and resonance structure III in an eclipsed (VI) configuration. Since, as discussed above, the bond lengths indicate that structure II contributes more strongly to the structure of CH_3N_3 than to that of CF_3N_3 , the observation of an intermediate torsional angle is not surprising.

Linearity of the N_3 Group and CF_3 Tilt Angle. In CF_3N_3 the N_3 group is slightly (10°) bent away from the CF_3 group, and the CF_3 group is tilted away from the N_3 group by 5.8° . This is readily explained by the repulsion between the fluorine free valence electron pairs and the π -bond electron system of the N_3 group. A comparison of these values with those in CH_3N_3 would be most interesting, but unfortunately no experimental values are presently available for CH_3N_3 . It is interesting to note that the angles of the N_3 group found for HN_3 , CIN_3 , NCN_3 , and CF_3N_3 are all very similar. However,

it should be kept in mind that most of these values carry rather large uncertainties.

Torsional Effects on the Structure. The present data for the excited torsional states do not allow a determination of the structural changes upon excitation of ν_{15} . It is clear from model calculations, however, that several parameters must change their value in order to reproduce the rotational constants of the excited states. Thus heavy relaxation, not only in the trifluoromethyl group but also in the tilt and the CN_aN_b angle, is assumed to take place.

Acknowledgment. We are grateful to Dr. G. Pawelke for providing a sample of CF_3N_3 for the RFMWDR measurements. D.C. and H.O. acknowledge financial support by the Fonds der Chemie. K.O.C. and C.J.S. thank the Office of Naval Research and the U.S. Army Research Office for financial support.

Registry No. CF_3N_3 , 3802-95-7.

Supplementary Material Available: Listings of total electron diffraction intensities for two camera distances (50 and 25 cm) for two sets of plates (2 pages). Ordering information is given on any current masthead page.

APPENDIX E

Journal of Fluorine Chemistry, 25 (1984) 269-273

269

Received: August 22, 1983; accepted: August 29, 1983

POSITIVE FLUORINE - REALITY OR MISCONCEPTION?

K. O. CHRISTE

Rocketdyne, A Division of Rockwell International,
Canoga Park, Calif. 91304 (U.S.A.)

SUMMARY

Polar covalence theory arguments are presented against the existence of a permanent positive polarization of fluorine in heteronuclear X-F molecules and against the existence of X groups having a higher electronegativity than fluorine itself. The heterolytic fission of fluorine and the possibility of inducing a positive fluorine dipole in X-F molecules with highly electro-negative X groups are briefly discussed.

INTRODUCTION

Fluorination reactions with highly electronegative compounds are frequently explained by invoking a positive fluorine. In a recent note [1], this author took exception to the postulate of positive fluorine by criticizing a recent paper of Cartwright and Woolf on this subject [2]. In the preceding paper [3], the same authors (C+W) summarized some arguments in favor of positive fluorine. Since the issue of a positive fluorine is largely a conceptual problem and is not readily accessible to direct experimental measurements, a speculative interpretation of the mechanism of poorly studied complex organic reactions has little merit. A systematic analysis of this problem therefore appeared more rewarding and is given below.

DISCUSSION

Definition of a Positive Fluorine

A positive fluorine is the direct result of a transfer of electron density in a covalent X-F bond from F to X resulting in the following polar covalence $\overset{\delta-}{\text{X}}-\overset{\delta+}{\text{F}}$, where XF can be either heteronuclear (X is different from F) or homonuclear (X equals F). If XF is homonuclear, i.e. F_2 , one cannot have a permanent but only an induced dipole. If XF is heteronuclear, one can have both a permanent and an induced dipole. It should be noted that this dipole is not identical with the experimentally measurable overall dipole moment of the XF molecule due to other factors such as lone valence electron pair effects.

Definition of the Problem

The issue raised by us in our previous critique [1] was that there is no experimental and theoretical justification for the assumption of a permanent $\overset{\delta-}{\text{X}}-\overset{\delta+}{\text{F}}$ polarity in a heteronuclear XF molecule. Therefore, unless stated otherwise, the following arguments will be referring to this issue.

Theoretical Arguments

The assumption of a permanent positive fluorine dipole in a heteronuclear XF atom violates the principle of electronegativity equalization which was first published in 1951 by Sanderson [4] and proven correct by quantum mechanics in 1978 by Parr and coworkers [5] and in 1979 by Politzer and Weinstein [6]. This principle states that when two or more atoms unite to form a compound, their electronegativities become adjusted to the same intermediate value within the compound. In other words, the different kinds of atoms become equal in electronegativity by unequal sharing of the bonding electrons. This means that the more electronegative atom must acquire a negative charge and the less electronegative atom a positive charge. Since fluorine is without doubt the most electronegative element, a heteroatomic X-F bond can be permanently polarized in only one direction, i.e. $\overset{\delta+}{\text{X}}-\overset{\delta-}{\text{F}}$. This principle also rules out the possibility that X groups, such as $\text{CF}_3\text{O}-$, $\text{SeF}_5\text{O}-$, or $\text{TeF}_5\text{O}-$, which consist of fluorine substituted heteroatoms of lower electronegativity can become more electronegative than fluorine itself [1,7-10].

Experimental Arguments

Electrophilic substitution reactions are not a convincing argument in favor of a positive fluorine. First of all, the mechanisms of most of these complex reactions have not been established. Secondly, in these reactions a strong electrophile attacks an electron rich center, and the polarity of the bonds within the electrophile is of lesser importance than other factors. In NF_4^+ , for example, the nitrogen atom is coordinatively saturated. Consequently, NF_4^+ can attack an electron rich center only through one of its fluorine ligands but not through its nitrogen atom. The fact that NF_4^+ can undergo electrophilic substitution reactions is therefore no indication for a positively polarized fluorine.

On the other hand, addition reactions in which a polar X-F molecule is added across a polar double bond, are capable of yielding information about the polarity of the X-F bond. Several such studies have recently been carried out using ClO_3OF [11], TeF_5OF , and CF_3OF [12] and did not provide any evidence for a positive fluorine in these hypofluorites.

One piece of experimental evidence for positive fluorine, cited by (C+W) is the selective substitution at acidic hydrogens,

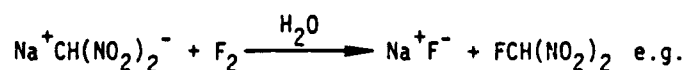

(C+W) concluded that, if half the fluorine becomes fluoride, by a simple charge-balance the other half must be positive fluorine. The shallowness of this conclusion can easily be demonstrated by the following analogous equation which would prove that the fluorine in HF must be positive.

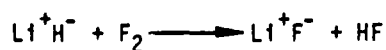

Induced Polarization and Heterolytic Fission of Fluorine

Although our original critique of the paper by (C+W) was only concerned with the permanent dipole of a heteronuclear XF molecule, the preceding paper [3] requires some comment on the heterolytic fission of fluorine. If in XF molecules X becomes more and more electronegative and eventually becomes F, the energy required to induce a dipole moment decreases and the possibility of forming an induced positive fluorine dipole increases. Although the formation of NF_4AsF_6 was originally postulated [13] to involve the heterolytic fission of F_2 ,

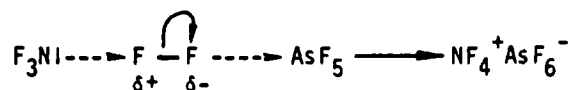

subsequent studies [14-16] have shown that the mechanism of this reaction is more complicated, requires predissociation of F_2 , and involves the formation of the NF_3^+ radical cation as an intermediate. However, if the hard Lewis base NF_3 is replaced by the soft base Xe, the following reaction proceeds spontaneously even in the dark [17].

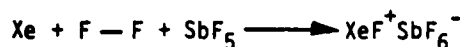

It is likely that this reaction is a rare example of an actual heterolytic fission of fluorine and therefore involves a Lewis acid - Lewis base induced polarization of fluorine. However, the possible existence of such a reaction for homonuclear difluorine has no bearing on the formation of a permanent positive fluorine in the heteronuclear XF molecules discussed above.

ACKNOWLEDGEMENT

The author wishes to thank Drs. C. J. Schack and W. W. Wilson for helpful discussions and the Army Research Office and the Office of Naval Research for financial support.

REFERENCES

- 1 K. O. Christe, *J. Fluorine Chem.*, 22 (1983) 519.
- 2 M. Cartwright and A. A. Woolf, *J. Fluorine Chem.*, 19 (1981) 101.
- 3 M. M. Cartwright and A. A. Woolf, *J. Fluorine Chem.* 25 (1984) 263.
- 4 R. T. Sanderson, *Science*, 114 (1951) 670; 'Polar Covalence, Academic Press, New York, 1983.
- 5 R. G. Parr, R. A. Donnelly, M. Levy, and W. E. Palke, *J. Chem. Phys.*, 68 (1978) 3801.
- 6 P. Politzer and H. Weinstein, *J. Chem. Phys.*, 71 (1979) 4218.
- 7 D. Lentz and K. Seppelt, *Angew. Chem. Int. Ed. Engl.*, 17 (1978) 355.
- 8 D. Lentz and K. Seppelt, *Z. anorg. allg. Chem.*, 460 (1980) 5.
- 9 P. Huppmann, D. Lentz, and K. Seppelt, *Z. anorg. allg. Chem.*, 472 (1981) 26.
- 10 T. Birchall, R. D. Myers, H. de Waard, and G. J. Schrobilgen, *Inorg. Chem.*, 21 (1982) 1068.
- 11 C. J. Schack and K. O. Christe, *Inorg. Chem.*, 18 (1979) 2619.
- 12 K. K. Johri and D. D. Des Marteau, *J. Org. Chem.*, 48 (1983) 242.
- 13 K. O. Christe, J. P. Guertin, and A. E. Pavlath, U.S. Pat. 3 503 719 (1970).
- 14 K. O. Christe, R. D. Wilson, and A. E. Axworthy, *Inorg. Chem.*, 12 (1973) 2478.
- 15 I. B. Goldberg, H. R. Crowe, and K. O. Christe, *Inorg. Chem.*, 17 (1978) 3189.
- 16 K. O. Christe and W. W. Wilson, *Inorg. Chem.*, in press.
- 17 L. Stein, *J. Fluorine Chem.*, 20 (1982) 65.

Reprinted from *Inorganic Chemistry*, 1984, 23, 3261
 Copyright © 1984 by the American Chemical Society and reprinted by permission of the copyright owner.

Contribution from Rocketdyne, A Division of
 Rockwell International, Canoga Park, California 91304

**Synthesis and Characterization of
 Bis(difluoroxychlorine(V)) Hexafluoronickelate(IV),
 (ClF₂O)₂NiF₆**

William W. Wilson and Karl O. Christe*

Received January 10, 1984

It is well-known that ClF₃O can form with strong Lewis acids, such as BiF₃, SbF₃, AsF₃, PF₃, TaF₃, NbF₃, VF₃, PtF₃, UF₃, SiF₄, BF₃, HF, and MoF₄O, adducts containing the ClF₂O⁺ cation.¹⁻⁶ All these adducts have been prepared by the direct combination of ClF₃O with the corresponding Lewis acids. The purpose of this study was to examine whether ClF₂O⁺-containing salts derived from unstable Lewis acids, such as NiF₄, can be prepared by the indirect metathetical methods developed for NF₄⁺ salt chemistry.⁷

Experimental Section

Materials and Apparatus. Literature methods were used for the syntheses of Cs₂NiF₆⁷ and ClF₂OSbF₆⁴ and the drying of the HF solvent.⁸ Volatile materials were manipulated in a well-passivated (with ClF₃) stainless-steel Teflon FEP vacuum system.⁹ Solids were handled in the dry-N₂ atmosphere of a glovebox.

Infrared spectra were recorded on a Perkin-Elmer Model 283 spectrometer, which was calibrated by comparison with standard gas calibration points.^{10,11} Gas spectra were recorded with a Teflon cell of 5-cm path length equipped with AgCl windows. Spectra of solids were recorded as dry powders pressed between AgCl windows in an Econo press (Barnes Engineering Co.). Raman spectra were recorded on a Cary Model 83 spectrophotometer using the 4880-Å exciting line of an Ar ion laser and a Spex Model 1403 spectrophotometer using the 6471-Å exciting line of a Kr ion laser and premonochromators for the elimination of plasma lines. Sealed quartz tubes were used as sample containers. The low-temperature spectra were recorded by using a previously described device.¹²

Synthesis of (ClF₂O)₂NiF₆. A mixture of ClF₂OSbF₆ (7.008 mmol) and Cs₂NiF₆ (3.505 mmol) was loaded in the drybox into a previously

described¹⁰ double-U-tube filter apparatus. Dry HF (185 mmol) was condensed at -196 °C into the apparatus on the vacuum line, and the mixture was warmed for 30 min to 25 °C with agitation. The apparatus was cooled to -78 °C and inverted, and the solid and liquid phases were separated by filtration assisted by 2 atm of dry N₂ gas. The material volatile at 25 °C was pumped off for 12 h and consisted mainly of HF. The filter cake (2.768 g; weight calculated for 7.01 mmol of CsSbF₆, 2.584 g) was shown by vibrational spectroscopy to consist of mainly CsSbF₆ containing small amounts of ClF₂O⁺¹¹ and NiF₆²⁻.⁷ The filtrate residue (965 mg; weight calculated for 3.505 mmol of (ClF₂O)₂NiF₆, 1.232g, corresponding to a 78% yield) was shown by elemental analysis and vibrational spectroscopy to have the following composition (wt %): (ClF₂O)₂NiF₆, 93.04; ClF₂OSbF₆, 1.49; CsSbF₆, 5.47. Anal. Calcd: Ni, 15.54; Cl, 18.93; Cs, 1.97; Sb, 2.36. Found: Ni, 15.6; Cl, 18.7; Cs, 2.07; Sb, 2.48. The losses of (ClF₂O)₂NiF₆ can be attributed mainly to hang-up of some (ClF₂O)₂NiF₆ on the filter cake.

Results and Discussion

Synthesis and Properties of (ClF₂O)₂NiF₆. The metathetical process previously developed for (NF₄)₂NiF₆⁷ has successfully been transferred to the synthesis of (ClF₂O)₂NiF₆ according to

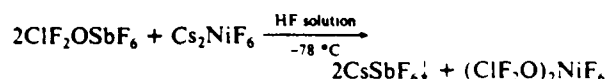

The new compound (ClF₂O)₂NiF₆ is a deep purple crystalline solid that is stable at 60 °C under a dynamic vacuum. At 110 °C the observed decomposition rate was about 25%/h. The main decomposition products, volatile at ambient temperature but condensable at -196 °C, were ClF₃O and a small amount of FClO₂ (arising from handling of the ClF₃O) as shown by their ¹⁹F NMR and infrared spectra.¹¹ An exhaustive pyrolysis of a sample in a sapphire reactor at 110 °C under a dynamic vacuum resulted in quantitative ClF₃O evolution and the

- (1) Christe, K. O.; Schack, C. J.; Pilipovich, D. *Inorg Chem* 1972, 11, 2205.
- (2) Christe, K. O.; Curtis, E. C.; Schack, C. J. *Inorg Chem* 1972, 11, 2212.
- (3) Bougon, R.; Isabey, J.; Plurien, P. C. *R. Acad. Sci., Ser. C* 1971, 273, 415.
- (4) Bougon, R.; Bui Huy, T.; Cadet, A.; Charpin, P.; Rousson, R. *Inorg Chem* 1974, 13, 690.

- (5) Bougon, R.; Isabey, J.; Plurien, P. C. *R. Seances Acad. Sci., Ser. C* 1970, 271, 1366.
- (6) Zuechner, K.; Glemser, O. *Angew Chem* 1972, 84, 1147.
- (7) Christe, K. O. *Inorg Chem* 1977, 16, 2238 and references cited therein.
- (8) Christe, K. O.; Wilson, W. W.; Schack, C. J. *J. Fluorine Chem* 1978, 11, 71.
- (9) Christe, K. O.; Wilson, R. D.; Schack, C. J. *Inorg Synth*, in press.
- (10) Christe, K. O.; Wilson, W. W.; Schack, C. J.; Wilson, R. D. *Inorg Synth*, in press.
- (11) Christe, K. O.; Schack, C. J. *Adv. Inorg Chem Radiochem* 1976, 19, 319.
- (12) Miller, F. A.; Harney, B. M. *J. Appl. Spectrosc.* 1970, 24, 271.

formation of a previously described⁷ nonstoichiometric brown nickel fluoride $\text{NiF}_{2,x}$ residue. Contrary to the pyrolysis of $(\text{NO})_2\text{NiF}_6$, which results in the formation of NF_3O ,¹³ no evidence for the formation of the unknown compound ClF_5O was observed.

The presence of ClF_2O^+ and NiF_6^{2-} ions in $(\text{ClF}_2\text{O})_2\text{NiF}_6$ was established by vibrational spectroscopy. The spectra of the solid showed bands characteristic for ClF_2O^+ (IR, 1324 vs (ν_1), 700 vs, br (ν_2, ν_3), 502 s (ν_3), 406 m (ν_4), 376 m (ν_6))¹¹ and NiF_6^{2-} (IR, 625 vs (ν_3), 330 m (ν_4); Raman, 565 vs (ν_1), 525 s, 512 ms (ν_2), 308 m, 290 w (ν_3))⁷ with ν_2 and ν_3 of NiF_6^{2-} showing splittings due to lifting of the degeneracies of these modes. Due to the intense color of the sample, it was difficult to obtain Raman spectra and only the bands due to NiF_6^{2-} could be observed even at -100°C .

Conclusion. The above results show that ClF_2O^+ salts derived from unstable Lewis acids, such as NiF_4 , can be prepared by metathetical methods. Furthermore, $(\text{ClF}_2\text{O})_2\text{NiF}_6$ is the first example of ClF_2O^+ having been coupled successfully to a highly energetic anion in the form of a stable salt.

Acknowledgment. The authors are grateful to Drs. C. J. Schack and L. R. Grant and R. D. Wilson for their help. This work was supported in part by the Office of Naval Research.

Registry No. $(\text{ClF}_2\text{O})_2\text{NiF}_6$, 91443-95-7; $\text{ClF}_2\text{OSbF}_6$, 38199-85-8; Cs_2NiF_6 , 17218-49-4.

(13) Bartlett, N.; Passmore, J.; Wells, E. J. *Chem. Commun.* 1966, 213

APPENDIX G

Reprinted from *Inorganic Chemistry*, 1985, 24, 303
Copyright © 1985 by the American Chemical Society and reprinted by permission of the copyright owner.

Contribution from Rocketdyne, A Division of
Rockwell International, Canoga Park, California 91304

Lewis Acid Induced Intramolecular Redox Reactions of Difluoramino Compounds

KARL O. CHRISTE,* WILLIAM W. WILSON, CARL J. SCHACK, and RICHARD D. WILSON

Received March 30, 1984

It is shown that strong Lewis acids, such as AsF_5 or SbF_5 , which are good fluoride ion acceptors, strongly catalyze an intramolecular redox reaction of difluoramino compounds, such as CF_3NF_2 , SF_3NF_2 , CIN_2 , CF_2ONF_2 , and SF_2ONF_2 . In the CIN_2 - AsF_5 system a thermally unstable intermediate is formed at -78°C , which on the basis of its Raman spectra is the fluorine-bridged donor-acceptor adduct CIN_2AsF_5 . The nature of the final decomposition products can be rationalized in terms of their stability. In connection with the low-temperature Raman studies, an unidentified, unstable, blue-green species was observed that gives rise to a resonance Raman spectrum with $\nu = 177\text{ cm}^{-1}$ and that is also formed from $\text{Cl}_3^+\text{AsF}_6^-$ and excess Cl_2 . For NF_2Cl , ^{14}N - ^{19}F spin-spin coupling was observed in its ^{19}F NMR spectrum.

Introduction

During experiments aimed at the oxidative fluorination of CF_3NF_2 to $\text{CF}_3\text{NF}_3^+\text{AsF}_6^-$ by $\text{KrF}^+\text{AsF}_6^-$, an unusual observation was made. Besides the NF_3 and CF_4 products expected for an oxidative fission of the C-N bond, significant amounts of gaseous *trans*- N_2F_2 and solid $\text{N}_2\text{F}^+\text{AsF}_6^-$ were obtained. Since KrF^+ is the strongest oxidative fluorinating agent presently known¹ and

N_2F_2 is a reduction product of CF_3NF_2 , KrF^+ was unlikely to cause the observed N_2F_2 formation. Since $\text{KrF}^+\text{AsF}_6^-$ is thermally unstable and decomposes to Kr, F_2 , and AsF_5 ,² we have considered

- (1) Christe, K. O.; Wilson, W. W.; Wilson, R. D. *Inorg Chem* 1984, 23, 2058
- (2) Gillespie, R. J.; Schrobilgen, G. J. *Inorg Chem* 1976, 15, 22

the possibility that the strong Lewis acid AsF_5 might induce this decomposition of CF_3NF_2 . Many difluoramino compounds are thermodynamically unstable toward decomposition reactions involving the formation of multiply bonded nitrogen species, such as N_2F_2 or N_2 , and more highly fluorinated byproducts. Therefore, these difluoramino compounds are only kinetically but not thermodynamically stable, and their kinetic stability is determined by the activation energy barrier toward decomposition. Hence, it would not be surprising that complexing with a strong Lewis acid could lower this activation energy barrier.

Previous reports on the interaction of difluoramino compounds with Lewis acids or bases are scarce. Although the instability of HNF_2 in the presence of alkali-metal fluorides, for example, is well documented,^{3,4} only one detailed study on the interaction of difluoramino compounds with Lewis acids has been published.⁵ It was found that, with HNF_2 and alkyldifluoramines, BF_3 forms unstable, N→B bridged, donor-accepted complexes, which on warming reversibly decompose to the starting materials. With ClNF_2 , BF_3 was found to be only weakly associated below -78°C , and with NF_3 , a large positive deviation from Raoult's law was observed,⁶ indicating no association. For PF_5 , a positive interaction was reported only with HNF_2 and CH_3NF_2 , and the resulting adducts underwent irreversible decomposition on warming.⁵ Although low-temperature infrared spectra of the $\text{HNF}_2\cdot\text{PF}_5$ adduct were recorded, they were very complex and did not permit any conclusions concerning the nature of the adduct.⁵ In view of the paucity of the available information and our above mentioned observations, a more systematic study of the interaction of difluoramino compounds with strong Lewis acids was of interest.

Experimental Section

Caution! Some difluoramino compounds are known to be sensitive, and appropriate safety precautions should be used when working with larger amounts of these materials.

Materials and Apparatus. Literature methods were used for the syntheses of KrF_2 ,⁷ KrFSbF_6 ,¹ CF_3NF_2 ,⁸ SF_3NF_2 ,⁹ CF_3ONF_2 ,^{10,11} ClNF_2 ,¹² $\text{N}_2\text{F}_2\cdot\text{AsF}_6^-$,¹³ SF_3Br ,¹⁴ and SF_3ONF_2 .¹¹ For some of the compounds the previously reported product yields were significantly improved: for CF_3NF_2 from 70 to 99% by carrying out the fluorination of CF_3N_3 with a fourfold excess of F_2 in a Monel cylinder at 70°C for 24 h; for SF_3ONF_2 from 60 to 84% by carrying out the UV photolysis of equimolar amounts of SF_3OF and N_2F_4 in a flamed-out quartz bulb at 1.5-atm pressure for 16 h with water-filtered radiation from a 140-W medium-pressure mercury arc lamp; for SF_3NF_2 from 30 to 78% by UV photolysis of equimolar amounts of N_2F_4 and SF_4 in a stainless-steel cell equipped with a sapphire window, using the water-filtered radiation from a 1-kW Oriol Model 6141 HgXe lamp and an irradiation time of 2 h. HF (Matheson Co.) was dried by storage over BiF_3 ,¹⁵ AsF_5 (Ozark-Mahoning Co.) was purified by fractional condensation prior to use, SbF_5 (Ozark-Mahoning Co.) was purified by distillation, and SO_2 (Matheson Co.) was used as received.

Volatile materials were manipulated in a well-passivated (with ClF_3) stainless-steel Teflon-FEP vacuum system.¹⁶ Solids were handled in the dry N_2 atmosphere of a glovebox.

The ^{19}F NMR spectra were recorded on a Varian Model EM390 spectrometer at 84.6 MHz using Teflon-FEP sample tubes (Wilmad

Glass Co.) with positive shifts being downfield from the external standard, CFCl_3 .

Infrared spectra were recorded on a Perkin-Elmer Model 283 spectrometer. Gas spectra were recorded with a Teflon cell of 5-cm path length equipped with AgCl windows. Spectra of solids were recorded as dry powders pressed between AgCl windows in an Econo press (Barnes Engineering Co.). Raman spectra were recorded either on a Cary Model 83 spectrophotometer using the 4880-Å exciting line of an Ar ion laser, a Claassen filter¹⁷ for the elimination of plasma lines, and sealed melting point capillaries as sample containers or on a Spex Model 1403 spectrophotometer using the 6471-Å exciting line of a Kr ion laser. The low-temperature spectra were recorded by using a previously described device.¹⁸

SF_3NF_2 - KrFSbF_6 System. $\text{KrF}^+\text{SbF}_6^-$ (2.14 mmol) was placed in the drybox into a prepassivated (with ClF_3 and HF) Teflon-FEP ampule closed by a stainless-steel valve. The ampule was connected to the vacuum line, and HF (1 mL, liquid) and SF_3NF_2 (4.63 mmol) were added at -196°C . The mixture was warmed to ambient temperature for 18 h, and the volatile products were separated by fractional condensation. They consisted of SF_6 (4.4 mmol), Kr, and a mixture (4.1 mmol) of NF_3 and *trans*- N_2F_2 . The residue in the ampule consisted of SbF_5 and polyantimonate salts of N_2F^+ ¹⁹ and small amounts of N_2F_3^+ .¹³

SF_3NF_2 - KrFAAsF_6 System. A reaction between $\text{KrF}^+\text{AsF}_6^-$ (2.65 mmol) and SF_3NF_2 (5.31 mmol) in HF solution was carried out at -31°C for 6.5 h in the same manner as described for the SF_3NF_2 - KrFSbF_6 system. The volatile products consisted of SF_6 (5.2 mmol), Kr, and a mixture (3.3 mmol) of mainly NF_3 and some *trans*- N_2F_2 , whereas the solid residue was $\text{N}_2\text{F}^+\text{AsF}_6^-$ (0.95 mmol).

CF_3NF_2 - KrFSbF_6 System. The reaction was carried out at 25°C for 3 h as described for the SF_3NF_2 - KrFSbF_6 system by using CF_3NF_2 (3.55 mmol) and KrFSbF_6 (1.94 mmol) in HF (2 mL, liquid). The volatile products (5.27 mmol) consisted of CF_4 , NF_3 , and *trans*- N_2F_2 , and the white solid residue (429 mg) was a mixture of N_2F^+ and NF_4^+ polyantimonates. The formation of NF_4^+ from NF_3 and KrF^+ in HF solution has previously been reported.¹

CF_3NF_2 - KrF_2 - AsF_5 System. KrF_2 (2.29 mmol), CF_3NF_2 (6.89 mmol), and AsF_5 (1.23 mmol) were condensed at -196°C into a passivated 10-mL nickel cylinder. The cylinder was allowed to warm slowly to -78°C and then to 25°C by the use of a liquid N_2 - CO_2 slush bath and was then heated in an oven to 50°C for 6 h. The volatile products consisted of a mixture (10.4 mmol) of NF_3 and CF_4 , *trans*- N_2F_2 (0.43 mmol), and AsF_5 . A white solid residue, left behind in the cylinder, consisted of $\text{N}_2\text{F}^+\text{AsF}_6^-$ (0.65 mmol).

SF_3NF_2 - AsF_5 System. SF_3NF_2 (2.31 mmol) and AsF_5 (2.31 mmol) were combined in a prepassivated Teflon-FEP ampule and kept at -78°C for 1.75 h. At this point the pressure in the ampule was 373 torr, and a white solid had precipitated out of the liquid phase. The volatile materials were separated by fractional condensation and consisted of SF_6 (2.3 mmol), AsF_5 (1.5 mmol), and *trans*- N_2F_2 (0.3 mmol). The white solid residue consisted of $\text{N}_2\text{F}^+\text{AsF}_6^-$ (0.8 mmol).

When SF_3NF_2 (1.90 mmol) and AsF_5 (0.11 mmol) were kept in a sapphire tube at 25°C for 20 h, the reaction products consisted of SF_6 (0.95 mmol), *trans*- N_2F_2 (0.30 mmol), unreacted SF_3NF_2 (0.90 mmol), and solid $\text{N}_2\text{F}^+\text{AsF}_6^-$ (0.11 mmol).

CF_3NF_2 - AsF_5 System. CF_3NF_2 (6.32 mmol) and AsF_5 (6.32 mmol) were combined in a Teflon-FEP ampule and kept at -78°C . The vapor pressure of the mixture at -78°C steadily increased and was measured as a function of time (P in torr, t in h): 348, 0.17; 365, 0.67; 495, 1.17; 507, 1.67; 520, 2.67; 871, 20; 911, 21.5; 924, 22. The pressure calculated from the known vapor pressures of the pure compounds^{20,21} and Raoult's law is 447 torr. After 22 h, the reaction was stopped. The volatile products that were separated consisted of AsF_5 (5.91 mmol) and a mixture (6.71 mmol) of CF_3NF_2 , CF_4 , *trans*- N_2F_2 , and small amounts of NF_3 . The white solid residue consisted of $\text{N}_2\text{F}^+\text{AsF}_6^-$ (0.21 mmol).

When a mixture of CF_3NF_2 (3.00 mmol) and AsF_5 (3.00 mmol) was kept at room temperature for 3 days, all the CF_3NF_2 had decomposed, producing solid $\text{N}_2\text{F}^+\text{AsF}_6^-$ (0.10 mmol), *trans*- N_2F_2 (1.4 mmol), CF_4 (3.0 mmol), and AsF_5 (2.90 mmol). However, when CF_3NF_2 (3.27 mmol) and AsF_5 (0.33 mmol) were kept at ambient temperature for 20 h, no significant decomposition of CF_3NF_2 was observed and the starting materials were recovered unchanged.

SF_3ONF_2 - AsF_5 System. SF_3ONF_2 (3.99 mmol) and AsF_5 (3.99 mmol) were combined in a Teflon-FEP ampule and kept for 2 h at -78°C

- (3) Lawton, E. A.; Pilipovich, D.; Wilson, R. D. *Inorg Chem* 1965, 4, 118.
- (4) Dobb, H. E.; Greenough, R. C.; Curtis, E. C. *Inorg Chem* 1965, 4, 648.
- (5) Craig, A. D. *Inorg Chem* 1964, 3, 1628.
- (6) Aldersley, S. C.; Calado, J. C. G.; Staveley, L. A. K. *J Inorg Nucl Chem* 1979, 41, 1269.
- (7) Christe, K. O.; Wilson, R. D. *Inorg Chem* 1975, 14, 694 and references cited therein.
- (8) Schack, C. J. *J Fluorine Chem* 1981, 18, 583.
- (9) Fraser, G. W.; Shroeve, J. M.; Lustig, M.; Bumgardner, L. *Inorg Synth* 1970, 12, 299.
- (10) Shroeve, J. M.; Duncan, L. C.; Cady, G. H. *Inorg Chem* 1965, 4, 1342.
- (11) Hale, W. J.; Williamson, S. A. *Inorg Chem* 1965, 4, 1342.
- (12) Zaborovskii, L. M.; DeMarco, R. A.; Shroeve, J. M. *Inorg Synth* 1973, 14, 34.
- (13) Christe, K. O.; Schack, C. J. *Inorg Chem* 1978, 17, 2749 and references cited therein.
- (14) Christe, K. O.; Curtis, E. C.; Schack, C. J.; Roland, A. *Spectrochim Acta, Part A* 1977, 33A, 69.
- (15) Christe, K. O.; Wilson, W. W.; Schack, C. J. *J Fluorine Chem* 1978, 11, 71.
- (16) Christe, K. O.; Wilson, R. D.; Schack, C. J. *Inorg Synth* in press.

(17) Claassen, H. H.; Selig, H. *Shamer J Appl Spectrosc* 1969, 23, 8.

(18) Miller, F. A.; Harney, B. M. *Appl Spectrosc* 1970, 24, 271.

(19) Christe, K. O.; Wilson, R. D.; Sawaday, W. *J Mol Struct* 1971, 9, 245.

(20) Ruff, O. Z. *Anorg Allg Chem* 1932, 206, 59.

(21) Coates, G. E.; Harris, J.; Satchell, T. *J Chem Soc* 1951, 2762.

°C. The volatile materials consisted of SF₆ (3.83 mmol) and AsF₅ (0.14 mmol). The white solid residue in the ampule consisted of NO⁺AsF₆⁻ (2.44 mmol). Some NO⁺AsF₆⁻ had deposited in the vacuum-line section and therefore could not be recovered.

CF₃ONF₂-AsF₅ System. CF₃ONF₂ (0.49 mmol) and AsF₅ (0.49 mmol) were combined at -196 °C in a flamed-out 3-mm-o.d. quartz tube. The mixture was kept at -78 °C for 3.5 h. Separation of the products resulted in CF₄ (0.46 mmol), CF₃ONF₂ (0.03 mmol), and solid NOAsF₆ (0.42 mmol).

SF₅Br-AsF₅ System. SF₅Br (2.28 mmol) was condensed into a passivated sapphire tube at -196 °C, and its vapor pressure at -79 °C was measured to be 11 ± 1 torr. The vapor pressure of liquid AsF₅ under the same conditions was found to be 182 torr. The tube was cooled back to -196 °C, and AsF₅ (2.38 mmol) was added. The mixture was warmed to -79 °C, and the vapor pressure above the resulting clear liquid was determined as 75 ± 1 torr (calculated vapor pressure for an ideal mixture based on Raoult's law = 100 torr). All material could be removed from the sapphire tube by pumping at -79 °C.

CINF₂-AsF₅ System. The vapor pressures of pure CINF₂ and pure AsF₅ were measured at -79 °C and found to be 405 and 182 torr, respectively. Then equimolar amounts (5.65 mmol each) of CINF₂ and AsF₅ were combined at -196 °C in a passivated Teflon-FEP U-trap. The trap was allowed to slowly warm from -196 to -79 °C by means of a liquid N₂-dry ice slush bath. At -79 °C, the tube contained a white solid with a pressure of about 220 torr above it. The tube was cooled to -196 °C, and 0.16 mmol of noncondensable material (N₂) was pumped off. The tube was warmed again to -79 °C, and the pressure above the solid was 120 torr. In addition to a white solid, some yellow solid was also formed, particularly at temperatures slightly higher than -79 °C. Most of these solids were unstable at ambient temperature, and fractional condensation of the volatile decomposition products through a series of traps kept at -78, -126, -156, -196, and -210 °C showed NF₃, N₂F₄, *trans*-N₂F₂, AsF₃, and Cl₂. Smaller amounts of a stable white solid residue, left behind at room temperature, were shown by vibrational spectroscopy to be a mixture of N₂F₃⁺AsF₆⁻ and N₂F₂⁺AsF₆⁻.¹⁹

More accurate material balances for this system were obtained by using different ratios of starting materials and either sapphire or flamed-out quartz reactors and by recording low-temperature Raman spectra of the intermediate unstable products formed in this system. With a 1:1 mole ratio of CINF₂ and AsF₅, a typical material balance was as follows: starting materials, CINF₂ and AsF₅ (2.59 mmol each); products, NF₃ (1.50 mmol), AsF₃ (2.4 mmol), Cl₂ (1.3 mmol), N₂ (0.35 mmol), *trans*-N₂F₂ (0.10 mmol), and N₂FAsF₆ + N₂F₂AsF₆ (0.10 mmol). For CINF₂ (3.60 mmol) and AsF₅ (1.25 mmol), the products consisted of NF₃ (2.28 mmol), N₂ (0.40 mmol), Cl₂ (1.78 mmol), AsF₃ (1.07 mmol), *trans*-N₂F₂ (trace), and N₂F₃AsF₆ + N₂FAsF₆ (0.17 mmol). For CINF₂ (3.67 mmol) and AsF₅ (0.037 mmol), the products were CINF₂ (2.40 mmol), NF₃ (0.26 mmol), N₂ (0.06 mmol), N₂F₄ (0.43 mmol), Cl₂ (0.62 mmol), and N₂FAsF₆ + N₂F₂AsF₆ (0.03 mmol).

Cl₂-AsF₅ System. An equimolar mixture of Cl₂ and AsF₅, when kept at -79.0 °C in a sapphire tube, resulted in a clear yellow liquid exhibiting a vapor pressure of 115 torr (calculated vapor pressure for an ideal mixture based on Raoult's law = 121 torr). All material could be removed from the sapphire tube by pumping at -78 °C.

Results and Discussion

A study of the binary CF₃NF₂-AsF₅ system showed that in the presence of AsF₅ the normally stable CF₃NF₂ undergoes even at -78 °C a slow decomposition according to (1). Since N₂F₂ exists



as two isomers, *cis* and *trans*, and since only the *cis* isomer forms an adduct with AsF₅,²²



the observation of both, gaseous *trans*-N₂F₂ and solid N₂F⁺AsF₆⁻, can readily be rationalized by the formation of both N₂F₂ isomers in reaction 1.

Therefore, the surprising observation of *trans*-N₂F₂ and N₂F⁺AsF₆⁻ in the KrF⁺AsF₆⁻-CF₃NF₂ reaction system can be attributed to a Lewis acid promoted intramolecular redox reaction of CF₃NF₂ in which the CF₃ groups are oxidized to CF₄ and the NF₂ groups are reduced to N₂F₂.

To test the generality of this Lewis acid promoted intramolecular redox reaction, we have also studied the effect of AsF₅

on CINF₂, SF₅NF₂, CF₃ONF₂, and SF₅ONF₂, which, in the absence of strong Lewis acids, are all thermally stable compounds.^{10-12,23} It was found that AsF₅ strongly affects the decomposition of all of these difluoramino compounds. Thus, SF₅NF₂ undergoes an analogous, albeit faster and quantitative, decomposition according to (3) and (2). It should be pointed out

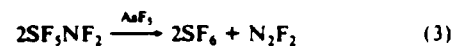

that the SF₆ and N₂F₂ products formed in (3) are different from those (S₂F₁₀ and N₂F₄) formed in the uncatalyzed thermal decomposition of SF₅NF₂.²³

For CF₃ONF₂ and SF₅ONF₂, the addition of AsF₅ also promoted an intramolecular redox reaction at low temperatures. After several hours at -78 °C almost quantitative CF₄ or SF₆ elimination was observed for stoichiometric mixtures of either CF₃ONF₂ or SF₅ONF₂ with AsF₅. However, the solid byproduct was not N₂F⁺AsF₆⁻, but NO⁺AsF₆⁻:

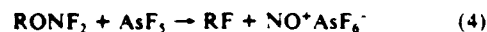

Thus, the RONO₂ compounds also exhibit a Lewis acid promoted intramolecular redox reaction, analogous to those found for the RNF₂ compounds. Again R- is oxidized to RF while -ONO₂ is reduced to FNO. Since FNO readily forms with AsF₅ a stable NO⁺AsF₆⁻ salt, this salt is the only observed coproduct. In the case of RONO₂, however, the products, RF and FNO, are identical with those^{10,11} observed for the uncatalyzed thermal decomposition of these compounds.

Of the difluoramino compounds investigated in this study, CINF₂ is the least stable. Therefore, it was not surprising that CINF₂ rapidly reacts with AsF₅. Under carefully controlled conditions, an unstable, white, solid, 1:1 intermediate is formed at -78 °C, which at slightly higher temperature starts to decompose with AsF₅, Cl₂, N₂, and NF₃ evolution. In addition to these products, smaller amounts of *trans*-N₂F₂, N₂F₄, N₂F⁺AsF₆⁻, and N₂F₃⁺AsF₆⁻ are formed. On the basis of the observed reaction stoichiometry, the principal reaction is (5), with some contributions from (6) and (7).

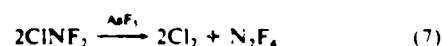
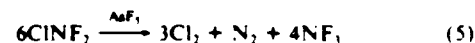

The mechanism of the above described AsF₅-aided decomposition of difluoramino compounds presents an interesting problem. The Lewis acid AsF₅ could interact with RNF₂ molecules through either the R or the NF₂ group. Interaction through R (R = CF₃, SF₅, or Cl) is unlikely because compounds such as CF₄ or SF₆ do not form adducts with AsF₅. However, if in SF₅ one fluorine ligand is replaced by a group of very low electronegativity, such as CH₃, the SF₅ group can become basic enough to donate a fluoride ion to AsF₅ with formation of an ionic RSF₄⁺ salt, such as CH₃SF₄⁺AsF₆⁻.²⁴ To show that with SF₅NF₂ the formation of such a salt, i.e. F₂NSF₄⁺AsF₆⁻, as an intermediate is unlikely, we have studied the interaction of SF₅Br with AsF₅. Since Br and NF₂ have comparable electronegativities, the fluoride donor abilities of SF₅Br and SF₅NF₂ should be similar. Measurements of the vapor pressure at -79 °C above a roughly stoichiometric mixture of SF₅Br and AsF₅, however, revealed only a very weak negative deviation from Raoult's law, indicating little or no interaction. Similarly, the vapor pressure of a stoichiometric mixture of Cl₂ and AsF₅ at -79 °C deviated only slightly from Raoult's law. Therefore, we can limit the following discussion to a consideration of the interaction of the NF₂ group with AsF₅.

The NF₂ group could interact with AsF₅ through a free valence-electron pair on either nitrogen or fluorine. If fluorine is

(23) Borvin, J. I. *Can J Chem* 1964, 42, 2744.

(24) Wesel, J. Kleemann, G. Seppelt, K. *Chem Ber* 1983, 116, 2199.

(25) Byler, D. M.; Shriver, D. F. *Inorg Chem* 1974, 13, 2697.

(22) Ruff, J. K. *Chem Rev* 1967, 67, 665.

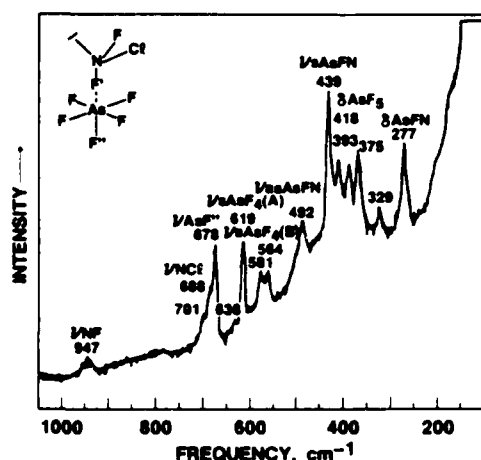
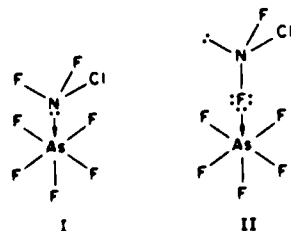

Figure 1. Raman spectrum of the low-temperature 1:1 adduct between NF_2Cl and AsF_5 , prepared at -78°C . Conditions: -130°C , $6471\text{-}\text{\AA}$ excitation, and spectral slit width of 8 cm^{-1} .

the donor, either a fluorine-bridged, covalent, donor-acceptor complex or a predominantly ionic adduct, $\text{RNF}^+\text{AsF}_6^-$, could be formed, depending on which product is kinetically and energetically more favorable. Analogies can be cited for both types of interaction. Thus, HNF_2 has previously been shown to form with BF_3 a $\text{>N:}\rightarrow\text{B}<$ type, covalent, donor-acceptor complex.³ On the other hand, it is well-known that N_2F_4 forms with AsF_5 the ionic salt $\text{N}_2\text{F}_4^+\text{AsF}_6^-$.^{13,22} In view of these alternatives, an extensive effort was made to establish by experiment the nature of the RNF_2 -Lewis acid intermediate involved in the above described decomposition reactions. Since even at -78°C CF_3NF_2 and SF_3NF_2 do not form a solid adduct with AsF_5 , whereas CINF_2 does, we have concentrated our studies on the CINF_2 system.

^{19}F NMR studies of equimolar mixtures of CINF_2 and AsF_5 in anhydrous HF at -78°C and of CINF_2 and SbF_5 in SO_2 at -60°C showed that in both cases CINF_2 had undergone decomposition. In the absence of AsF_5 or SbF_5 , CINF_2 was stable in both solvents. Its NMR spectra showed signals at δ 141 in SO_2 at -60°C and at δ 137 in HF at -80°C . In both cases, a partially resolved triplet was observed due to nitrogen-fluorine spin-spin coupling $J_{\text{N-F}} = 120\text{ Hz}$. To our knowledge, no N-F spin-spin coupling has previously been reported for CINF_2 .

In view of the instability of CINF_2 in solutions containing AsF_5 or SbF_5 , Raman spectra of the solid 1:1 adduct formed between CINF_2 and AsF_5 at -78°C were recorded at -130°C . A typical spectrum is shown in Figure 1. On the basis of the large number of observed bands and the absence of the characteristic AsF_6^- vibrations,¹³ an ionic $\text{CINF}^+\text{AsF}_6^-$ structure can be ruled out. Of the two possible covalent, donor-acceptor complexes, structure II is preferred, on the basis of a comparison with the Raman



spectrum of the known N-donor adduct $\text{CH}_3\text{CN}\rightarrow\text{AsF}_5$. The intense Raman bands at 492 , 439 , and 277 cm^{-1} can only be reconciled satisfactorily with structure II. The observed frequencies and their tentative assignments for II are given in Figure 1. In the spectra a weak band of variable intensity was also observed at about 1060 cm^{-1} , which could be due to small amounts of N_2F^+ .¹⁹ However, the possibility cannot be ruled out that this band represents the NF stretching mode. Then, the 947-cm^{-1} band must be assigned to the NCl stretching mode and the 710- and

688-cm^{-1} bands to the doubly degenerate antisymmetric AsF_6^- stretching mode.

Several interesting observations were made in connection with these Raman studies. When the sample was warmed to above -78°C , the white solid decomposed and an unstable yellow solid formed, which was shown by Raman spectroscopy to contain $\text{Cl}_3^+\text{AsF}_6^-$.²⁶ During its decomposition in a closed system, a blue-green unstable material also formed, which with $6471\text{-}\text{\AA}$ excitation gave a resonance Raman spectrum with its fundamental at 177 cm^{-1} . After pumping off all material volatile at room temperature, a small amount of a white solid was left behind, which on the basis of its Raman and infrared spectra was a mixture of $\text{N}_2\text{F}^+\text{AsF}_6^-$ and $\text{N}_2\text{F}_3^+\text{AsF}_6^-$. The origin of the unstable blue-green species was shown to be due to $\text{Cl}_3^+\text{AsF}_6^-$ and an excess of Cl_2 . A sample of $\text{Cl}_3^+\text{AsF}_6^-$, when warmed in the presence of an excess of Cl_2 to temperatures slightly above -78°C , produced the same blue-green species. Possible candidates for this species could be the unknown Cl_3^+ cation or Cl_3 radical, but the frequency of 177 cm^{-1} appears rather low for either one of these, and attempts were unsuccessful to isolate a $\text{Cl}_3^+\text{Cl}_2\text{AsF}_6^-$ species from $\text{Cl}_3^+\text{AsF}_6^-$ and an excess of Cl_2 at temperatures as low as -95°C . It should be noted that the 177-cm^{-1} band, which previously has also been reported²⁶ for $\text{Cl}_3^+\text{AsF}_6^-$ as an unassigned band of 20% intensity at 170 cm^{-1} , most likely does not belong to $\text{Cl}_3^+\text{AsF}_6^-$. In our study, this band was completely absent in some of the $\text{Cl}_3^+\text{AsF}_6^-$ spectra and was observed with variable intensity in others.

The possibility of attributing the complexity of the Raman spectrum of Figure 1 to a polyanion, such as $\text{As}_2\text{F}_{11}^-$,²⁷ was also investigated but rejected. When AsF_5 was reacted with a large excess of CINF_2 , the solid residue at -78°C exhibited a spectrum identical with that in Figure 1.

Another interesting question was whether catalytic amounts of AsF_5 suffice to decompose these RNF_2 type compounds. It was found that, for example, 6 mol % of AsF_5 resulted in the decomposition of 53 mol % of the SF_3NF_2 starting material and in the formation of 6 mol % of $\text{N}_2\text{F}^+\text{AsF}_6^-$. It thus appears that the SF_3NF_2 decomposition requires only catalytic amounts of AsF_5 , but that the relatively slow SF_3NF_2 decomposition reaction comes to a halt when all the available AsF_5 is converted by *cis*- N_2F_2 in a faster reaction to solid $\text{N}_2\text{F}^+\text{AsF}_6^-$. For the RONF_2 type compounds, obviously larger amounts of AsF_5 are required because of the quantitative formation of FNO and its fast and quantitative conversion to solid $\text{NO}^+\text{AsF}_6^-$. The fact that only AsF_5 , but not AsF_6^- , catalyzes the RNF_2 decomposition was demonstrated by the fact that CINF_2 was recovered unchanged when exposed to a stoichiometric amount of $\text{N}_2\text{F}_3^+\text{AsF}_6^-$ for 2 days at ambient temperature.

Finally, the different behavior of N_2F_4 and the difluoroamino compounds toward strong Lewis acids needs to be discussed. Whereas the difluoroamino compounds of this study appear to form fluorine-bridged donor-acceptor complexes, N_2F_4 forms ionic $\text{N}_2\text{F}_3^+\text{AsF}_6^-$. This different behavior is attributed to the fact that in N_2F_4 removal of a fluoride anion is greatly facilitated by the availability of a free valence-electron pair on the vicinal N atom. This free pair can migrate to form an $\text{N}=\text{N}$ double bond, thus yielding an energetically favorable, stable cation (eq 8). In the

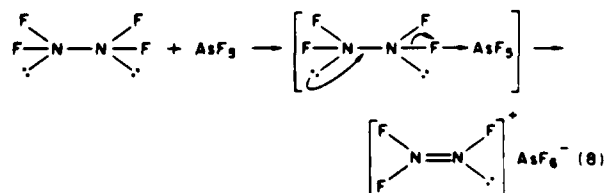

case of CF_3NF_2 and SF_3NF_2 , the C and S atoms, respectively, do not possess a free valence-electron pair that by migration could stabilize a corresponding $\text{R}=\text{NF}^+$ cation. Therefore, for RNF_2

(26) Gillespie, R. J.; Morton, M. J. *Inorg. Chem.* 1970, 9, 811

(27) Dean, P. A. W.; Gillespie, R. J.; Hulme, R. J. *Chem. Soc. D* 1969, 990

the reaction analogous to (8) stops at the thermally unstable intermediate donor-acceptor stage, which on warm-up can decompose to the observed products by attack of a negatively polarized fluorine atom bound to As on the positively polarized central atom of the R group (eq 9). Such a mechanism, involving

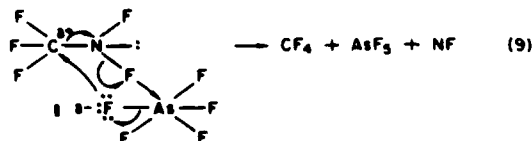

the formation of NF radicals, could explain the formation of both *cis*- and *trans*-N₂F₂ isomers and could also account for the observation of side reactions, as in the case of ClNF₂.

In summary, this study has shown that (i) strong Lewis acids, which are good fluoride acceptors, catalyze the decomposition of difluoramino compounds, (ii) the thermally unstable intermediates, which are initially formed, appear for RNF₂ compounds with highly electronegative R groups to be fluorine-bridged donor-acceptor complexes, and (iii) the exact nature of the final products is governed by their relative stabilities.

Acknowledgment. The authors are grateful to Dr. L. R. Grant for his help and to the Office of Naval Research and the Army Research Office for financial support.

Registry No. II, 93782-55-9; SF₃NF₂, 13693-10-2; KrFSbF₆, 52708-44-8; KrFAsF₆, 50859-36-4; CF₃NF₂, 335-01-3; KrF₂, 13773-81-4; AsF₃, 7784-36-3; SF₂ONF₂, 14521-09-6; CF₃ONF₂, 4217-93-0; ClNF₂, 13637-87-1; SF₃Br, 15607-89-3; Cl₂, 7782-50-5.

Reprinted from *Inorganic Chemistry*, 1985, 24, 2286
 Copyright © 1985 by the American Chemical Society and reprinted by permission of the copyright owner.

Contribution from Rocketdyne, A Division of Rockwell International,
 Canoga Park, California 91304

Synthesis and Characterization of NF_4CrF_6 and Reaction Chemistry of CrF_5

ROLAND BOUGON,¹ WILLIAM W. WILSON, and KARL O. CHRISTE*

Received October 2, 1984

NF_4CrF_6 , a new stable NF_4^+ salt containing an energetic counterion, was prepared by treatment of CrF_5 with an excess of NF_4HF_2 in HF solution. The composition and ionic nature of NF_4CrF_6 was established by elemental analysis, vibrational and ^{19}F NMR spectroscopy, and its X-ray powder pattern. Reactions of CrF_5 with H_2O in HF, ClF_3 , FNO , Cl_2 , $CFCl_3$, and KrF_2 were studied to determine its acidity and oxidizing power. With FNO , a stable 1:1 adduct is formed, which on the basis of its vibrational spectra has the ionic structure $NO^+CrF_5^-$. The reaction of $NOCrF_5$ with NO produced $(NO^+)_2CrF_6^{2-}$, which by controlled pyrolysis was converted to $NO^+CrF_5^-$. With stoichiometric amounts of H_2O in HF, CrF_5 did not form a stable $OH_3^+CrF_6^-$ salt but the reaction resulted in hydrolysis to CrF_3O . The influence of the strong Lewis acids AsF_5 and SbF_5 on the oxidizing power of CrF_5 was also investigated. On the basis of the fact that CrF_5-SbF_5 mixtures can oxidize O_2 (IP = 12.06 eV) but not NF_3 (IP = 13.00 eV), the following qualitative oxidizer strength scale is proposed: $KrF_2 > PtF_6 > SbF_5 + F_2 + \text{activation energy} > CrF_5-SbF_5$. The results of a normal-coordinate analysis of CrF_5^- and CrF_6^{2-} show the expected decrease in force constants with increasing negative charge.

Introduction

Chromium pentafluoride is a known, powerful oxidizer capable of fluorinating, for example, Xe to XeF_2 and XeF_4 .^{2,3} Furthermore, it is known that the oxidizing power of CrF_5 can be enhanced by the addition of a strong Lewis acid, such as SbF_5 .⁴ Thus, these CrF_5 -Lewis acid mixtures can oxidize O_2 to O_2^+ and therefore are assigned an electron affinity comparable to that of PtF_6 .⁴ In view of this demonstrated high oxidizing power of CrF_5 , the known existence of the CrF_6^- anion,⁴ and the exceptional stability of NF_4^+ salts,^{5,6} the synthesis of the new oxidizer $NF_4^+CrF_6^-$ appeared feasible.

Experimental Section

Apparatus. Volatile materials were manipulated in stainless-steel vacuum lines equipped with Teflon-FEP U-traps, 316 stainless-steel bellows-seal valves, and a Heise Bourdon tube-type pressure gauge.⁷ Either quartz or sapphire tubes or Teflon-FEP ampoules, equipped with stainless-steel valves, were used as reaction vessels. The lines and other hardware used were passivated with ClF_3 and, if HF was to be used, with HF. Nonvolatile or marginally volatile materials, such as SbF_5 and CrF_5 , were handled in the dry N_2 atmosphere of a glovebox. Antimony pentafluoride was added to the reactors with a Teflon-needle syringe, and CrF_5 , due to its tackiness at ambient temperature, was preferably handled after it had been cooled by liquid nitrogen. Metathetical reaction and

solvolysis studies were carried out in HF solution by using an apparatus consisting of two Teflon-FEP U-traps interconnected through a coupling containing a porous Teflon filter.⁸

High-pressure, high-temperature reactions were carried out in 95- or 1000-cm³ Monel cylinders equipped with Monel valves. The loaded cylinders were placed into an oven set at the desired reaction temperature. Decomposition studies were carried out in a sapphire reactor (Tyco Co.). The reactor was connected to a stainless-steel valve by a Swagelok compression fitting using Teflon ferrules. The reactor was heated by immersion into a stirred oil bath.

Infrared spectra were recorded in the range 4000–200 cm⁻¹ on a Perkin-Elmer Model 283 spectrophotometer. Spectra of solids were obtained by using dry powders pressed between AgCl or AgBr windows in an Econo press (Barnes Engineering Co.). Spectra of gases were obtained by using a Teflon cell of 5-cm path length equipped with AgCl windows. Raman spectra were recorded on either a Cary Model 83 or a Spex Model 1403 spectrophotometer using the 488-nm exciting line of an Ar ion laser or the 647.1-nm exciting line of a Kr ion laser, respectively. Sealed quartz, Teflon-FEP, or sapphire tubes were used as sample containers in the transverse-viewing-transverse-excitation mode. A previously described⁹ device was used for recording the low-temperature spectra. The ^{19}F NMR spectra of the samples contained in sealed, 5-mm-o.d. Teflon-FEP tubes (Wilmad Glass Co.) were recorded at 84.6 MHz on a Varian Model EM390 spectrometer equipped with a variable-temperature probe. X-ray diffraction patterns of the powdered samples in sealed 0.5-mm quartz capillaries were obtained by using a General Electric Model XRD-6 diffractometer, Ni-filtered $Cu K\alpha$ radiation, and a 114.6-mm-diameter Philips camera.

Elemental analyses were performed by Mikroanalytische Laboratorium, Elbach, West Germany.

Materials. Literature methods were used for the syntheses of NF_4^+ , SbF_5 ,¹⁰ KrF_2 ,¹¹ $KrFSbF_6$,¹² and FNO ¹³ and for the drying of HF .¹⁴

- (1) Permanent address: Centre d'Etudes Nucleaires de Saclay, ICRD/DESICP/DPC, 91191 Gif sur Yvette, France.
- (2) Zemva, B.; Zupan, J.; Slivnak, J. *J. Inorg. Nucl. Chem.* 1973, 35, 3941.
- (3) Brown, S. D.; Gard, G. L. *Inorg. Nucl. Chem. Lett.* 1975, 11, 19.
- (4) Brown, S. D.; Loehr, T. M.; Gard, G. L. *J. Fluorine Chem.* 1976, 7, 19.
- (5) Christe, K. O.; Wilson, R. D.; Goldberg, I. B. *Inorg. Chem.* 1979, 18, 2572 and references cited therein.
- (6) Christe, K. O.; Wilson, W. W.; Wilson, R. D. *Inorg. Chem.* 1980, 19, 1494.
- (7) Christe, K. O.; Wilson, R. D.; Schack, C. J. *Inorg. Synth.*, in press.

- (8) Christe, K. O.; Schack, C. J.; Wilson, R. D. *Inorg. Chem.* 1977, 16, 849.
- (9) Miller, F. A.; Harnay, B. M. *Appl. Spectrosc.* 1969, 23, 8.
- (10) Christe, K. O.; Schack, C. J.; Wilson, R. D. *J. Fluorine Chem.* 1976, 8, 541.
- (11) Christe, K. O.; Wilson, R. D. *Inorg. Chem.* 1975, 14, 694.

Nitrogen trifluoride (Rocketdyne), F₂ (Air Products), NO, O₂, ClF₃, Cl₂ (Matheson), CrF₃, SbF₅, AsF₅ (Ozark Mahoning), CrF₃·3H₂O (Baker and Adamson), and Cr powder (Sargent, 100 mesh) were commercially available. Anhydrous CrF₃ was also obtained by dehydrating the hydrate at 200 °C. The purity of the volatile compounds was checked by vibrational spectroscopy prior to use and, where necessary, improved by fractional condensation. The CCl₄ (Du Pont) was dried by storage over P₂O₅ and transferred by distillation without further purification.

Synthesis of CrF₃. It was found that the synthesis of CrF₃ can be carried out under reaction conditions milder than those previously reported.¹⁵ In a typical preparation, CrF₃ (91.75 mmol) was loaded in the drybox into a prepassivated 1-L Monel high-pressure reactor. The reactor was connected to the vacuum line, and F₂ (947.66 mmol) was added at -196 °C. After 65 h at 260 °C, the remaining F₂ was removed at -196 °C, and CrF₃ (84.88 mmol, 92.5% yield based on CrF₃) was pumped off at 60–100 °C and trapped in a U-tube maintained at -78 °C.

Attempts to fluorinate Cr powder with ClF₃ in HF solution at room temperature for 16 h were unsuccessful, even in the presence of 2 atm of F₂, and the Cr powder was quantitatively recovered.

Preparation of NF₄CrF₆. A mixture of CsF (10.11 mmol) and NF₄SbF₆ (10.15 mmol) was loaded in the drybox into half of a prepassivated Teflon double-U metathesis apparatus.¹ Dry HF (~8 mL) was added on the vacuum line to the half containing NF₄SbF₆-CsF, and the resulting mixture was stirred for 30 min at 25 °C. After this mixture and the filter were cooled to -78 °C, the metathesis apparatus was inverted and the resulting solution of NF₄HF₂ in HF was filtered into the other half of the apparatus. Part of the HF solvent was pumped off during warm-up toward 0 °C until the first signs of decomposition of NF₄HF₂ were noted. The apparatus was then cooled to -196 °C and taken into the drybox and CrF₃ (5.34 mmol) added to it. The apparatus was reattached to the vacuum line and warmed to room temperature. The HF solvent and the excess of NF₄HF₂ were pumped off successively for 2 h at 25 °C and 45 min at 40 °C. Since the weight and the infrared spectrum of the solid residue still indicated the presence of bifluoride species, the solid was transferred to a sapphire tube and heated in a dynamic vacuum for 2 h at 95 °C. The resulting deep red, solid residue (1.5 g, corresponding to a quantitative yield based on CrF₃) was shown by vibrational spectroscopy to consist mainly of NF₄CrF₆ with small amounts of SbF₆⁻ as the only detectable impurity. On the basis of its elemental analysis, the product had the following composition (mol %): NF₄CrF₆, 96.3; CsSbF₆, 3.7. Anal. Calcd for the NF₄CrF₆ (96.3%)-CsSbF₆ (3.7%) mixture: Cr, 19.25; F, 71.96; Cs, 1.88; Sb, 1.73. Found: Cr, 19.69; F, 70.15; Cs, 1.90; Sb, 1.79.

The filter cake from the metathetical preparation of the NF₄HF₂ solution consisted of 3.6806 g of CsSbF₆ (weight calculated for 10.113 mmol of CsSbF₆, 3.7281 g), identified by its Raman and infrared spectra.

Decomposition Study of NF₄CrF₆. The compound was heated stepwise from 75 to 145 °C in a sapphire tube in a dynamic vacuum. Traps kept at -78 and -210 °C were used for collecting CrF₃ and NF₃, respectively. A pyrolysis temperature of 125 °C was required for the slow evolution of CrF₃ and NF₃. The vibrational spectra of the solid residue at the end of the incomplete pyrolysis showed no significant changes, indicating that NF₄CrF₆ does not undergo a stepwise decomposition to salts containing polyanions.

Reaction of NF₃ and F₂ with CrF₃ or CrF₄. CrF₃, when heated in a high-pressure Monel cylinder with a twofold excess of NF₃ and a threefold excess of F₂ at an autogenous pressure of 100 atm to 260 °C for 45 h, was converted to CrF₃ in high yield without any NF₃ uptake. Heating of the resulting CrF₃ with a fivefold excess each of NF₃ and F₂ for 140 °C for 6 days and subsequently to 125 °C for 41 days did not produce any detectable amounts of NF₄CrF₆.

Synthesis of NOCrF₆. CrF₃ (2.06 mmol) was loaded into a Teflon-FEP ampule in the drybox. The ampule was connected to the vacuum line, and anhydrous HF (1.8 mL, liquid) was added at -196 °C. The CrF₃ only partially dissolved in the HF at room temperature, resulting in a light red-brown solution. FNO (2.21 mmol) was added to the ampule at -196 °C, and the mixture was slowly warmed to room temperature, resulting in a dark purple solution. All volatile material was pumped off at room temperature, leaving behind a dark red-brown solid (0.399 g, weight calculated for 2.06 mmol of NOCrF₆, 0.404 g), which was identified by vibrational spectroscopy and elemental analysis as NOCrF₆. Anal. Calcd for NOCrF₆: N, 7.15; Cr, 26.53; F, 58.16; O, 8.16. Found: N, 6.90; Cr, 26.30; F, 58.10; O (by difference), 8.70.

Synthesis of (NO)₂CrF₆. In a Teflon-FEP ampule NOCrF₆ (2.03 mmol) was dissolved in anhydrous HF (96.5 mmol), and NO (2.03 mmol) was added at -196 °C. The mixture was warmed to room temperature for several hours. All material that was volatile at room temperature was pumped off until the solid, yellow-brown (pink when finely ground) residue showed a constant weight (0.456 g; weight calculated for 2.03 mmol of (NO)₂CrF₆, 0.459 g). The material was identified as (NO)₂CrF₆²⁻ by vibrational spectroscopy. Anal. Calcd for (NO)₂CrF₆: Cr, 23.01; F, 50.44. Found: Cr, 22.8; F, 50.2.

Synthesis of NOCrF₅. A sample of (NO)₂CrF₆ (0.885 mmol) was heated in a sapphire tube to 130 °C in a dynamic vacuum until a constant weight (0.157 g; weight calculated for 0.885 mmol of NOCrF₅, 0.157 g) was obtained. The volatile material consisted of FNO, and the solid, brown residue was identified by vibrational spectroscopy as NO⁺CrF₅⁻. Attempts to convert NOCrF₅ to CrF₄ by vacuum pyrolysis at higher temperatures resulted in sublimation of the NOCrF₅ without decomposition.

The ClF₃-CrF₃ System. In a flamed-out quartz tube ClF₃ (12.22 mmol) was condensed at -196 °C onto CrF₃ (2.04 mmol). A deep red-brown solution was formed on warming the reaction mixture to 25 °C. The tube was cooled to -78 °C and material volatile at -78 °C was pumped off for 7 h. On the basis of the weight increase of the tube, the CrF₃ had retained 0.195 mmol of ClF₃. The Raman spectrum of this mixture, recorded at -130 °C, showed only bands due to solid ClF₃ and solid CrF₃.

The Cl₂-CrF₃ System. A mixture of CrF₃ (5.44 mmol) and Cl₂ (2.68 mmol) was heated in a sapphire tube to 127 °C for 57 h. On the basis of the observed material balance and infrared spectra of the solid residue, only 49% of the CrF₃ was reduced to CrF₄. Heating to higher temperatures resulted in a complete reduction of CrF₃, but also in the formation of some CrF₅ as a byproduct. Thus, heating of CrF₃ (4.71 mmol) and Cl₂ (2.44 mmol) to 185 °C for 20 h produced 0.6034 g of a brown solid (weight calculated for 4.71 mmol of CrF₄, 0.6031 g) and ClF (3.99 mmol) and ClF₃ (about 0.3 mmol). Although the Cr analysis of the solid product was close to that expected for CrF₄ (calcd 40.62; found 40.42), its X-ray powder pattern and infrared spectrum showed the presence of some CrF₃.

The KrFSbF₆-CrF₃ and KrFSbF₆-CrF₃-HF Systems. In a sapphire tube a mixture of KrFSbF₆ (1.09 mmol) and CrF₃ (1.96 mmol) was warmed to the melting point of CrF₃ (34 °C), at which point gas evolution started. On the basis of the observed material balance and vibrational spectra, all KrFSbF₆ had decomposed to Kr, F₂, and SbF₅, but no oxidation of CrF₃ to CrF₄ had occurred. Similar results were obtained when this reaction was repeated in HF solution.

The CrF₃-H₂O-HF System. A Teflon-FEP ampule containing a Teflon-coated magnetic stirring bar was loaded in the drybox with CrF₃ (2.58 mmol), and HF (2.19 mmol) was added on the vacuum line. The ampule was taken to the drybox and cooled to -196 °C, and a preweighed amount of H₂O (2.58 mmol), sealed in a Teflon tube, was added by cooling the tube to -196 °C, cutting it open, and placing it inside the ampule. The ampule was closed, evacuated at -196 °C, and kept at 25 °C for 20 h with stirring. A pink solid and an orange-pink solution were formed. Removal of all volatile material at 25 °C in a dynamic vacuum resulted in the formation of a brownish solid residue, which was identified as CrF₃O by its vibrational spectrum, elemental analysis, and X-ray powder diffraction pattern.¹⁶

Reaction of CrF₃-SbF₅ with O₂. The reaction between CrF₃·4SbF₅ and O₂ was conducted in a manner similar to that reported by Gard et al.,⁴ except that it was carried out in a 45-mL Teflon-FEP ampule. A mixture of CrF₃ (2.37 mmol) and SbF₅ (6.54 mmol) was dynamically pumped at room temperature in an attempt to reach the previously reported⁴ CrF₃·2SbF₅ composition. The pumping had to be stopped before reaching this composition since CrF₃ was removed together with SbF₅. At this stage with the assumption that only minor amounts of CrF₃ had been removed, the molar ratio of SbF₅:CrF₃ approximated 2.47:1. Oxygen (4.736 mmol) was then admitted into the ampule at -196 °C. When the mixture was warmed to room temperature, a pale yellow-green solid was formed. On the basis of the observed O₂ material balance, about 1 mol of O₂ was taken up per 1 mol of CrF₃. No significant loss of mass was observed by dynamic pumping on the solid at room temperature for 1 h. The presence of O₂²⁻Sb₂F₁₁⁺ in the solid product was established by Raman spectroscopy and its X-ray powder diffraction pattern.¹⁷

Reaction of CrF₃-SbF₅ with NF₃. Chromium pentafluoride (29.30 mmol) was combined in a Teflon-FEP ampule with SbF₅ (59.05 mmol). The mixture was outgassed by repeated pumping at -78 °C, followed by

(12) Christie, K. O.; Wilson, W. W.; Wilson, R. D. *Inorg Chem* 1984, 23, 2058.

(13) Christie, K. O. *Inorg Chem* 1973, 12, 1580.

(14) Christie, K. O.; Wilson, W. W.; Schack, C. J. *J Fluorine Chem* 1978, 11, 1.

(15) Shvnik, J.; Zemva, B. *Z Anorg Allg Chem* 1971, 385, 137.

(16) Green, P. J.; Johnson, B. M.; Loehr, T. M.; Gard, G. L. *Inorg Chem* 1982, 21, 3562.

(17) McKee, D. E.; Bartlett, N. *Inorg Chem* 1973, 12, 2738.

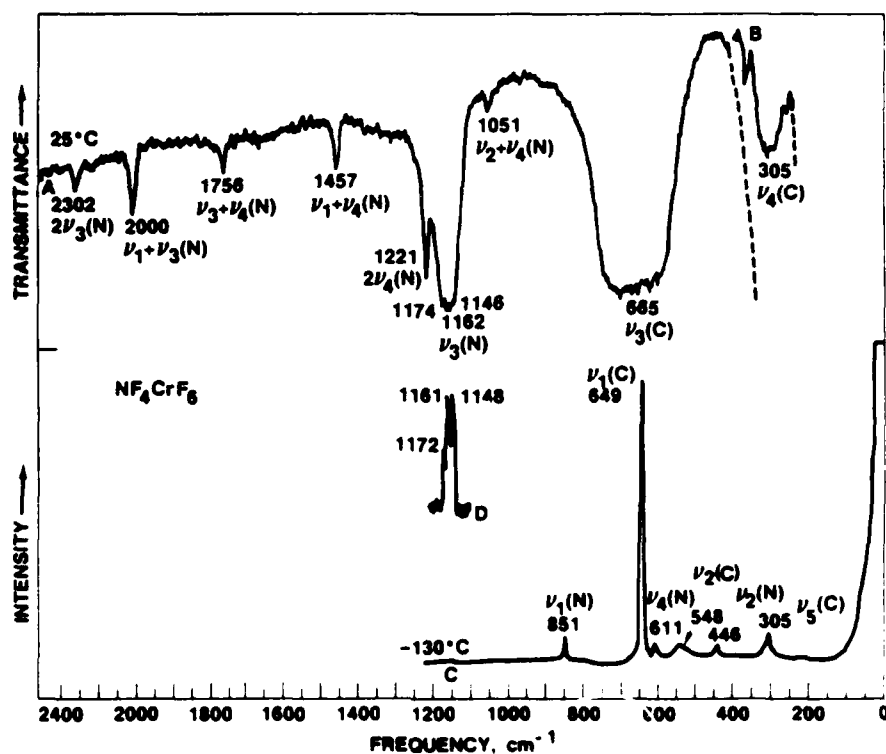

Figure 1. Vibrational spectra of solid NF_4CrF_6 : traces A and B, infrared spectra of the powder at 25 °C pressed between AgCl and AgBr disks, respectively; traces C and D, Raman spectra of the solid recorded at -130 °C with 617.1-nm excitation at two different sensitivity levels, respectively. The listed assignments are based on space group T_d for NF_4^+ (N) and O_h for CrF_6^- (C).

warming to 25 °C. The solution was then magnetically stirred and pressurized with about 2 atm of NF_3 gas. No significant NF_3 uptake was noticed after 1 h at room temperature and 1 hour at 60 °C. All other attempts to react CrF_3 - SbF_5 with NF_3 , such as those using longer reaction times, increased NF_3 pressures, and liquid NF_3 as a solvent, were equally unsuccessful.

Reaction of CrF_3 - SbF_5 with CFCl_3 . CFCl_3 (10.21 mmol) was condensed at -196 °C onto a mixture of CrF_3 (1.45 mmol) and SbF_5 (1.56 mmol) in a Teflon-FEP ampule. When the mixture was warmed to 25 °C, a brown precipitate was formed, together with chlorine as evidenced by the yellow color of the CFCl_3 solution. An amorphous, yellow-green, solid residue was obtained after pumping off the volatile material at 25 °C. The ^{19}F NMR spectrum of the volatiles showed that part of the CFCl_3 had been fluorinated to CF_2Cl_2 , CF_2Cl , and CF_4 .

When this reaction was repeated in the absence of SbF_5 with a 20-fold excess of CFCl_3 , the main products were Cl_2 , CCl_4 , or CF_2Cl_2 , and CF_2Cl . An amorphous, brownish, solid residue was obtained whose Cr analysis corresponded closely to the value expected for CrF_4 . Anal. Calcd for CrF_4 : Cr, 40.62. Found: Cr, 40.55.

Reaction of CrF_3 - AsF_5 with O_2 . Equimolar amounts of AsF_5 and CrF_3 , when combined in a Teflon-FEP ampule, formed a deep red solution at -78 °C and did not undergo a visible reaction on warm-up to 25 °C. Upon addition of a threefold excess of O_2 at -196 °C and subsequent repeated temperature cycling between -78 and +25 °C, a rust-colored solid formed that, on the basis of its infrared spectrum and X-ray powder diffraction pattern, contained $\text{O}_2^+\text{AsF}_6^-$ ¹⁸ in addition to some unidentified material.

Results and Discussion

Synthesis and Characterization of NF_4CrF_6 . Since CrF_3 is a relatively strong and volatile Lewis acid, the direct synthesis¹⁹ of NF_4CrF_6 from NF_3 , F_2 , and CrF_3 at elevated temperature and pressure seemed feasible. However, our attempts using conditions (125 °C, 100 atm, 41 days) similar to those²⁰ that previously had

been successful for NF_4AsF_6 failed. Since NF_4CrF_6 is marginally stable at 125 °C (see below), the failure of the high-temperature-high-pressure method appears not to be caused by insufficient thermal stability of the NF_4CrF_6 final product. On the basis of similar experiences with other relatively stable NF_4^+ salts, such as NF_4BF_6 or NF_4PF_6 , the failure of the direct thermal synthesis methods for these compounds might be attributed to the inability of the corresponding Lewis acids to stabilize, under the given reaction conditions, the required NF_4^+ radical cation intermediate.¹²

Since NF_4CrF_6 could not be obtained by direct thermal synthesis, indirect methods¹⁹ were investigated. It was found that the reaction of NF_4HF_2 ⁶ with CrF_3 in HF solution affords NF_4CrF_6 in essentially quantitative yield:



The use of an excess of NF_4HF_2 in this reaction is advantageous to ensure complete conversion of the CrF_3 . Since NF_4HF_2 is thermally unstable, decomposing above room temperature to gaseous NF_3 , F_2 , and HF ,⁶ its excess can easily be removed from the solid NF_4CrF_6 product by pumping at 25–100 °C.

The NF_4CrF_6 salt is a deep red, crystalline solid, stable in a dynamic vacuum to about 120 °C. It starts to decompose slowly at 125 °C to NF_3 , F_2 , and CrF_3 . No species such as $\text{NF}_4\text{Cr}_2\text{F}_{11}$, $(\text{NF}_4)_2\text{CrF}_6$, or CrF_6 was observed when the compound was gradually pyrolyzed under pumping at temperatures ranging from 125 to 145 °C. In HF at 23 °C the NF_4CrF_6 salt is highly soluble at a rate of 6.39 g of NF_4CrF_6 /g of HF.

The ionic nature of NF_4CrF_6 , both in the solid state and in HF solution, was verified by vibrational and ^{19}F NMR spectroscopy. The Raman and infrared spectra of the solid, together with the observed frequencies and assignments for tetrahedral NF_4^+ (T_d)²¹ and octahedral CrF_6^- (O_h), are shown in Figure 1. The splittings into the three degenerate components observed for $\nu_3(\text{F}_2)$ of NF_4^+

(18) Young, A. R.; Hirata, T.; Morrow, S. I. *J. Am. Chem. Soc.* 1964, 86, 20.

(19) Christe, K. O.; Wilson, W. W.; Schack, C. J.; Wilson, R. D. *Inorg. Synth.* in press.

(20) Tolberg, W. E.; Rewick, R. T.; Stringham, R. S.; Hill, M. E. *Inorg. Chem.* 1967, 6, 1156.

(21) Christe, K. O. *Spectrochim. Acta, Part A* 1980, 36A, 921.

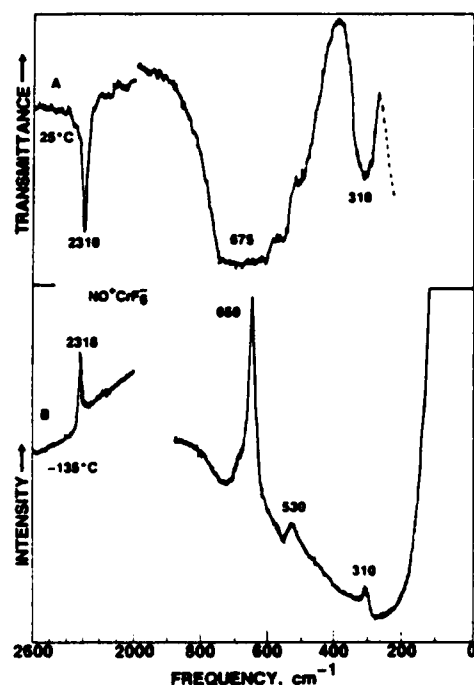

Figure 2. Vibrational spectra of solid NOCrF₆: trace A, infrared spectrum of the powder pressed between AgBr disks; trace B, low-temperature Raman spectrum.

in the Raman spectrum are due to solid-state effects and are frequently observed for NF₄⁺ salts.²¹ For CrF₆⁻, only the two infrared-active modes, ν₃(F_{1u}) and ν₄(F_{1u}), have previously been reported for their Cs⁺ and NO₂⁺ salts.⁴ In spite of the broadness of the observed bands and the associated difficulty in choosing their band centers, the previously reported frequencies (CsCrF₆ ν₃ = 600, ν₄ = 295 cm⁻¹; NO₂CrF₆ ν₃ = 600, ν₄ = 275 cm⁻¹)⁴ are in poor agreement with our values for NF₄CrF₆ and NOCrF₆ (see Figures 1 and 2). The results of a normal-coordinate analysis for CrF₆⁻ are given below.

The Raman spectrum of NF₄CrF₆ in HF solution at ambient temperature showed only minor shifts from the spectrum of the solid for the bands due to NF₄⁺ (ν₁ = 854, ν₂ = 612, ν₃ = 446 cm⁻¹) but showed shifts to significantly higher frequencies for the bands due to CrF₆⁻ (ν₁ = 649→678, ν₂ = 305→348 cm⁻¹). These shifts, together with the surprisingly high solubility of NF₄CrF₆ in HF (see above) and the ¹⁹F NMR observations (see below), suggest strong interaction between CrF₆⁻ and the HF solvent.

The ¹⁹F NMR spectrum of NF₄CrF₆ in HF solution at 29 °C showed a triplet of equal intensity at δ = 215.2 with J_{HF} = 118 Hz, characteristic^{20,22} for NF₄⁺. A very broad line centered at δ = -136 was assigned to the HF solvent in exchange with CrF₆⁻, which contains a paramagnetic Cr(V) central atom.

The X-ray powder diffraction pattern of NF₄CrF₆ was recorded and is given as supplementary material. The observed pattern is very complex and could not be indexed, suggesting that NF₄CrF₆ is not isotypic with the previously known tetragonal NF₄MF₆-type (M = P, As, Sb, Bi) salts.²³

Synthesis and Characterization of NOCrF₆, (NO)₂CrF₆, and NOCrF₅. Before this study, only two CrF₆⁻ salts had been known, i.e. CsCrF₆ and NO₂CrF₆.⁴ It was now found that, in addition to NF₄CrF₆ (see above), CrF₃ also forms a stable 1:1 adduct with FNO. When stoichiometric amounts of CrF₃ and FNO are combined in HF solution, the compound NOCrF₆ is formed:



(22) Christie, K. O.; Guertin, J. P.; Pavlath, A. E.; Sawodny, W. *Inorg. Chem.* 1967, 6, 533.
 (23) Christie, K. O.; Wilson, R. D.; Schack, C. J. *Inorg. Chem.* 1977, 16, 937.

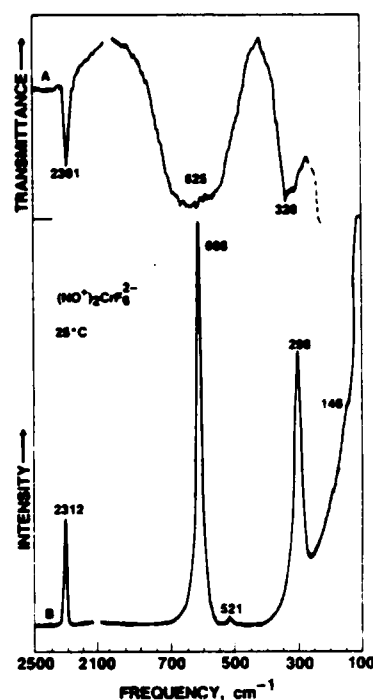
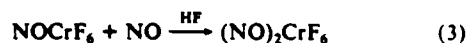

Figure 3. Vibrational spectra of solid (NO)₂CrF₆: trace A, infrared spectrum; trace B, Raman spectrum.

The deep red solid is stable at room temperature and sublimes at higher temperatures. Its X-ray powder diffraction pattern (given as supplementary material) is too complex for indexing and strongly differs from that of cubic NO⁺AsF₆⁻.¹⁸ This is a further confirmation that CrF₆⁻ salts appear not to be isotypic with their corresponding main group metal(V) salts.

The ionic nature of solid NOCrF₆ was established by vibrational spectroscopy (see Figure 2). The infrared and Raman spectra clearly show a band at about 2310 cm⁻¹ characteristic for the NO stretching mode of the NO⁺ cation,^{18,24} in addition to the bands characteristic for the CrF₆⁻ anion (see above).

When an HF solution of NOCrF₆ was treated with a stoichiometric amount of NO, the Cr^VF₆⁻ anion was reduced to Cr^{IV}F₆²⁻, resulting in the formation of the new (NO)₂CrF₆ salt:



This salt is a yellow-brown (pink when finely ground), crystalline solid that is stable at room temperature but decomposes in a dynamic vacuum at 130 °C. Its X-ray powder diffraction pattern is given as supplementary material. The ionic nature of (NO)₂CrF₆ was established by vibrational spectroscopy (see Figure 3). The NO⁺ stretching mode is again observed around 2300 cm⁻¹, with the slightly lower frequency, when compared to that of NOCrF₆, being due to the presence of a doubly charged counterion. The bands due to CrF₆²⁻ are similar to those of CrF₆⁻ but are shifted to slightly lower frequencies. This frequency shift is caused by the increased negative charge of the anion (see the normal-coordinate analysis). On the basis of the number of bands and their relative intensities, it appears safe to conclude that CrF₆²⁻ is also octahedral. The results of a normal-coordinate analysis for CrF₆²⁻ are given below.

Although the synthesis of K₂CrF₆ has been reported as early as 1950,²⁵ very little is known about the CrF₆²⁻ anion.^{26,27} Furthermore, the reported syntheses involving the fluorination of

(24) Geichman, J. R.; Smith, E. A.; Trond, S. S.; Ogle, P. R. *Inorg. Chem.* 1962, 1, 661.
 (25) Huss, E.; Klemm, W. Z. *Anorg. Chem.* 1950, 262, 25.
 (26) Bode, H.; Voss, E. Z. *Anorg. Chem.* 1956, 286, 136.
 (27) Clark, H. C.; Sadana, Y. N. *Can. J. Chem.* 1964, 42, 50.

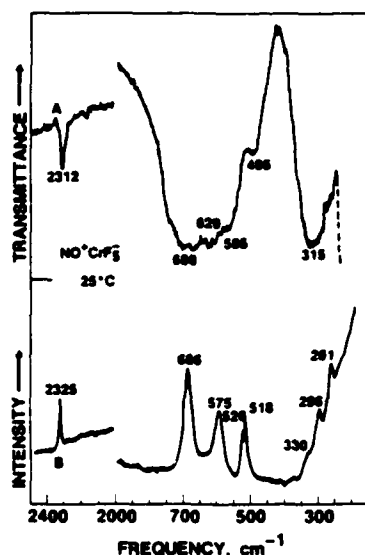

Figure 4. Vibrational spectra of solid NOCrF_5 : trace A, infrared spectrum; trace B, Raman spectrum.

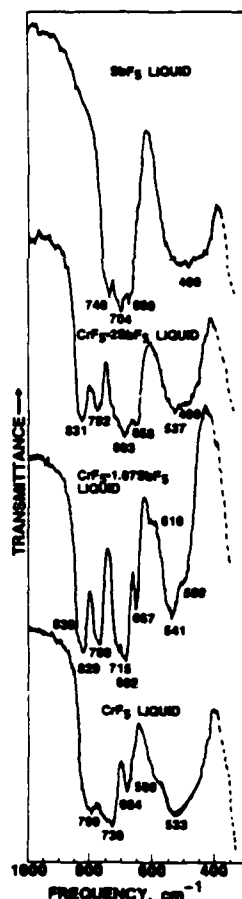

Figure 5. Infrared spectra of liquid SbF_5 , CrF_5 , and their mixtures at 35 °C between AgCl disks.

either a mixture of $\text{KCl} + \text{CrCl}_3$ with F_2 or a mixture of $\text{KCl} + \text{CrF}_4$ with BrF_3 yielded products that varied in composition.^{25,27} Therefore, the above described synthesis, based on the readily accessible and purifiable CrF_5 , FNO , and NO , offers a superior route to CrF_6^{2-} salts of excellent purity, as shown by the Raman spectrum of $(\text{NO})_2\text{CrF}_6$ in Figure 3.

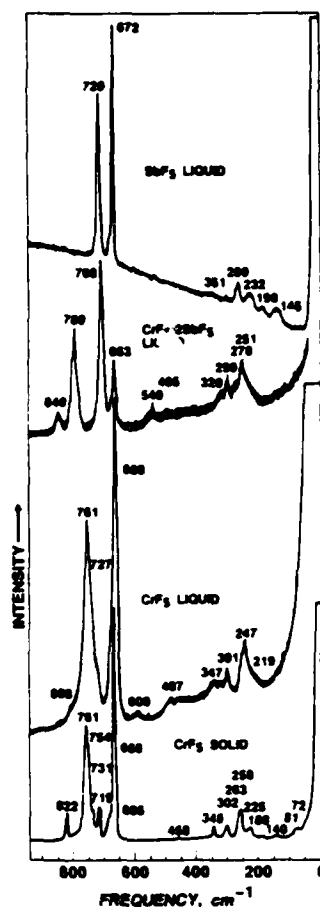

Figure 6. Raman spectra of liquid SbF_5 , $\text{CrF}_5 \cdot 2\text{SbF}_5$, and CrF_5 (at 35 °C) and of solid CrF_5 (at -130 °C).

When a sample of $(\text{NO})_2\text{CrF}_6$ was subjected to vacuum pyrolysis at 130 °C, the following stepwise decomposition occurred resulting in the formation of NOCrF_5 , another new compound:



This salt is a brown, crystalline solid that sublimes above 130 °C without further decomposition, thus preempting the use of its pyrolysis as a method for the preparation of CrF_4 . The X-ray powder diffraction pattern of NOCrF_5 is given as supplementary material. The ionic nature of NOCrF_5 was established by vibrational spectroscopy (see Figure 4), which showed the presence of the NO^+ cation (ν_{NO} at about 2320 cm^{-1}). On the basis of the general similarity of the CrF_5^- bands to those observed for several GeF_5^- salts,^{28,29} a polymeric cis-fluorine-bridged structure appears most likely for CrF_5^- .

Lewis Acid Strength of CrF_5 . On the basis of a previous report, CrF_5 is amphoteric, forming adducts with the Lewis bases CsF and FNO_2 and the Lewis acid SbF_5 .⁴ The Lewis acid character of CrF_5 was confirmed by the results of this study, which showed that CrF_5 forms stable $\text{NO}^+\text{CrF}_6^-$ and $\text{NF}_4^+\text{CrF}_6^-$ salts. Therefore, CrF_5 must be considered a relatively strong Lewis acid. However, it is significantly weaker than AsF_5 , as shown by the fact that, even at -78 °C, CrF_5 does not form a stable adduct with ClF_3 , while $\text{ClF}_3 \cdot \text{AsF}_6^-$ is marginally stable at ambient temperature.³⁰ Similarly, attempts failed to prepare a $\text{KrF}^+\text{CrF}_6^-$

(28) Christe, K. O.; Wilson, R. D.; Goldberg, I. B. *Inorg. Chem.* 1976, 15, 1271.

(29) Mallouk, T. E.; Desbat, B.; Bartlett, N. *Inorg. Chem.* 1984, 23, 3160.

Table I. Vibrational Frequencies and Modified Valence Force Fields^a of CrF₆⁻ and CrF₆²⁻

assign in point group O _h	freq. cm ⁻¹				force const. mdyn/Å		
	CrF ₆ ⁻			CrF ₆ ²⁻ (NO) ₂ CrF ₆	CrF ₆ ⁻		CrF ₆ ²⁻
	NOCrF ₆	NF ₄ CrF ₆	av				
A _{1g} ν ₁ ν _{sym} in phase	650	649	649	608	F ₁₁ = f _r + 4f _{rr} + f _{rr'}	4.714	4.137
E _g ν ₂ ν _{sym} out of phase	530	548	537	521	F ₂₂ = f _r - 2f _{rr} + f _{rr'}	3.227	3.038
F _{1u} ν ₃ ν _{asym}	675	665	670	625	F ₃₃ = f _r - f _{rr}	3.108	2.748
ν ₄ δ _{asym}	310	305	308	320	F ₄₄ = f _a + 2f _{aa} - 2f _{aa'} - f _{aa''}	0.2878	0.3107
					F ₃₄ = 2(f _{ra} - f _{ra'})	0.2430	0.2623
F _{2g} ν ₅ δ _{sym}	310	305	308	298	F ₅₅ = f _a - 2f _{aa'} + f _{aa''}	0.2654	0.2485
					f _r	3.416	3.077
					f _{rr}	0.248	0.183
					f _{rr'}	0.308	0.329

^a Assuming F₃₄ = minimum.

salt from KrF₂ and CrF₅ in either the presence or absence of HF as a solvent. For comparison, KrF⁺AsF₆⁻ is well-known and decomposes only slowly at room temperature.³¹

Although a distinct CrF₅·2SbF₅ adduct, formulated as CrF₄·Sb₂F₁₁, has previously been reported,⁴ we could not verify the existence of such an adduct. Attempts to reach this composition through vaporization of SbF₅ from CrF₅ solutions in an excess of SbF₅, as well as vibrational spectra (see Figures 5 and 6), failed to give any evidence for a definite compound and resulted in the simultaneous removal of both components. In our opinion, the spectra of these CrF₅-SbF₅ mixtures are best interpreted in terms of intersolutions of the two compounds, with the observed changes in the spectra being due to different degrees of mixed fluorine bridging between the individual components. This view is also supported by the fact that the viscosity of SbF₅ is strongly decreased by the dissolution of the highly polymeric CrF₅. If a predominantly ionic CrF₄·Sb₂F₁₁ adduct were formed, an increase in viscosity or formation of a solid would be expected. Liquid AsF₅ was found to be also an excellent solvent for CrF₅, resulting in dark brown solutions of low viscosity.

Oxidation Reactions with CrF₅. Oxidation reactions involving either neat CrF₅ or CrF₅-Lewis acid (SbF₅ or AsF₅) mixtures were carried out to determine its relative oxidative power. It was found that neat CrF₅ does not oxidize ClF₃ to ClF₅. Furthermore, even in the presence of F₂, it does not oxidize O₂ to O₂⁺ at 30 °C and NF₃ to NF₄⁺ at 125 °C. It is capable, however, of oxidizing Cl₂ to ClF at 120 °C and CFCl₃ to Cl₂ and a mixture of CF₂Cl₂, CF₃Cl, and CF₄ at room temperature. In both reactions, CrF₅ is reduced to lower valent chromium fluorides. Some brown solid, presumably CrF₄,^{27,32} could be sublimed from the crude CrF₅ + Cl₂ reaction product in a static vacuum at 185 °C. The sublimation residue was shown by vibrational spectroscopy and X-ray powder diffraction data to contain also some CrF₃. The brown sublimate showed a broad, strong Raman line at 780 cm⁻¹, no detectable X-ray diffraction lines, and two broad infrared bands ranging from 830 to 740 and 640 to 490 cm⁻¹, respectively. The infrared spectrum is quite distinct from that of CrF₃, which does not exhibit a band in the 800-cm⁻¹ region. The brown color observed for our sample of CrF₄ is in good agreement with Wartenberg's original report³² and does not confirm a subsequent report stating that CrF₄ is dark green and that the brown color is due to an oxide layer generated by exposure to air.²⁷

The oxidizing power of CrF₅ is significantly enhanced by strong Lewis acids, such as SbF₅ and AsF₅. This is not surprising and is generally the case for many oxidizers. Thus, CrF₅·2SbF₅ has been reported to oxidize O₂ to O₂⁺ at room temperature, and the solid reaction product has been formulated as O₂(CrF₄Sb₂F₁₁).⁴ We have confirmed this reaction and its approximate 1:1 stoichiometry and have identified the solid reaction product as a mixture of O₂⁺Sb₂F₁₁⁻ and lower valent chromium fluorides:

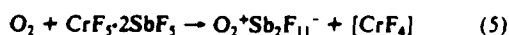

Extraction of O₂⁺SbF₆⁻ from the product was possible by treatment with liquid HF.

The oxidation of O₂ to O₂⁺ can also be achieved with CrF₅-AsF₅ mixtures at or below room temperature. By analogy with the corresponding SbF₅ system, the solid reaction product contained O₂⁺AsF₆⁻.

Attempts were unsuccessful to oxidize NF₃ to NF₄⁺ using similar conditions, i.e. pressurizing liquid CrF₅·2SbF₅ with several atmospheres of NF₃ at room temperature. On the basis of the facts that CrF₅-Lewis acid mixtures are capable of oxidizing O₂ and Xe,⁴ which have ionization potentials of 12.06 and 12.13 eV, respectively, but cannot oxidize NF₃ with an IP of 13.00 eV, their electron affinity or oxidizing power can be limited to the relatively narrow range of 12.13-13.00 eV. Since PtF₆, KrF⁺ salts, and F₂-Lewis acid mixtures activated by a suitable activation energy source are all capable of oxidizing NF₃ to NF₄⁺ under comparable conditions,¹² CrF₅-Lewis acid mixtures are a weaker oxidizer than any one of these systems. On the basis of the above and previous¹² results, the following order of decreasing oxidizer strength can be proposed for these systems: KrF⁺ salts > PtF₆ > Lewis acid + F₂ + activation energy > CrF₅-Lewis acid.

Reactions of CrF₅ with either KrF₂ or KrF⁺ salts were carried out in attempts to produce CrF₆, but so far all attempts in this direction have been unsuccessful.

Synthesis and Properties of CrF₃O. Our attempts to isolate a stable oxonium salt of CrF₆⁻ according to

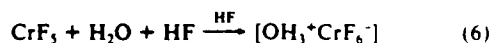

were unsuccessful but resulted in the formation of CrF₃O after removal of the HF solvent:¹⁶

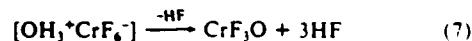

The intermediate formation of OH₃CrF₆ was not unequivocally established but appears very likely from the observation of a pink solid and stable pink HF solution. This reaction produces CrF₃O in quantitative yield and is superior to the previously reported¹⁶ synthesis, which involves the reaction of CrO₃ with ClF, followed by multiple treatments with F₂ at 120 °C. The properties observed for CrF₃O were in good agreement with those previously reported.¹⁶ The observed X-ray powder diffraction pattern is given as supplementary material.

Normal-Coordinate Analyses of CrF₆⁻ and CrF₆²⁻. Since for CrF₆²⁻ no vibrational spectra at all and for CrF₆⁻ only incomplete data⁴ had previously been reported, normal-coordinate analyses were carried out for these two anions. Modified valence force fields were computed, assuming F₃₄ = minimum, due to the underdetermined nature of the F_{1u} block. On the basis of a previous study³³ and experience with similar octahedral ions,³⁴ this condition is expected to be a good approximation to a general valence force field. The observed frequencies, their assignments in point group O_h, and the computed force constants are summarized in Table

(30) Christie, K. O.; Pavlath, A. E. *Z. Anorg. Allg. Chem.* **1965**, *335*, 210.
 (31) Gillespie, R. J.; Schrobilgen, G. J. *Inorg. Chem.* **1976**, *15*, 22.
 (32) Wartenberg, H. V. *Z. Anorg. Allg. Chem.* **1941**, *247*, 135.

(33) Sawodny, W. *J. Mol. Spectrosc.* **1969**, *30*, 56.
 (34) Christie, K. O.; Wilson, W. W.; Curtis, E. C. *Inorg. Chem.* **1983**, *22*, 3056 and references cited therein.

I. As expected, the Cr-F stretching force constant f , decreases from CrF_6^- to CrF_6^{2-} due to a bond weakening caused by the increased Cr^{3+} - F^- polarity of the bonds in CrF_6^{2-} .

Conclusion. Chromium pentafluoride is a moderately strong Lewis acid capable of forming stable CrF_6^- salts with NF_4^+ and NO^+ . The NF_4^+ salt is of particular interest as an oxidizer because in it an oxidizing anion is combined with a strongly oxidizing cation. Contrary to previous reports,⁴ no evidence was found for CrF_5 forming a distinct, predominantly ionic $\text{CrF}_5\text{Sb}_2\text{F}_{11}$ adduct with SbF_5 . The oxidizing power of CrF_5 is greatly enhanced by strong Lewis acids but does not match that of PtF_6 . Chromium(V) salts can selectively be reduced to Cr(IV) salts with NO . In this manner the new Cr(IV) salts $(\text{NO})_2\text{CrF}_6$ and NOCrF_5 can be prepared. Similarly, CrF_5 can be reduced to mainly CrF_4 with

either Cl_2 or CFCl_3 . Reaction of CrF_5 with stoichiometric amounts of H_2O in HF produces an unstable oxonium salt that decomposes on HF removal to CrF_3O , thus providing a convenient new synthesis for this compound.

Acknowledgment. The authors are grateful to Drs. C. J. Schack and L. R. Grant and R. D. Wilson for their help and to the U.S. Army Research Office and the Office of Naval Research for financial support. R.B. is also indebted to Dr. W. Kaska and the University of California, Santa Barbara, for their hospitality and to the DRET for financial support.

Supplementary Material Available: A table of X-ray powder diffraction patterns for some Cr-containing compounds (1 page). Ordering information is given on any current masthead page.

APPENDIX I

Communications

Cyanation and Nitration of Toluene with Cyanamide and Nitramide through Intermediate Cyano- and Nitrodiazonium Ions. Attempted Fluorination of Aromatics with Fluorodiazonium Ion¹

Summary: Toluene is cyanated and nitrated with cyano- and nitrodiazonium ion, generated via in situ diazotization of cyanamide and nitramide, respectively, with NO^+BF_4^- . Attempted fluorination with fluorodiazonium ion, prepared from *cis*-difluorodiazene and arsenic pentafluoride, gave only trace amounts of fluoroaromatics.

Sir: In previous studies from our laboratory aminodiazonium ions were generated by protonation of hydrazoic acid and alkyl azides in superacids and their ability for amination of aromatics was demonstrated.² In continuation of our studies we have found that cyanodiazonium tetrafluoroborate ($\text{NCN}_2^+\text{BF}_4^-$, 1) can be generated in situ by reaction of cyanamide with purified NO^+BF_4^- (1:1) at atmospheric pressure in CH_2Cl_2 at 0 °C and gives in the

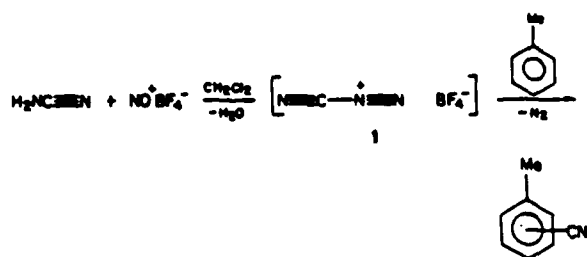

presence of excess toluene (3-fold) isomeric toluenitriles (12 mol % overall yield). The observed isomer distribution of toluenitriles is 48% ortho, 17% meta, and 35% para, close to that obtained for amination of toluene with aminodiazonium ion (46–48% ortho, 13–14% meta, and 38–39% para).³ Slightly better conversion was achieved by using CH_3CN as solvent (14–15%) in which both NO^+BF_4^- and H_2NCN are more soluble.

In control experiments, when NO^+BF_4^- was allowed to react with cyanamide in acetonitrile at room temperature in the absence of toluene, the initial formation of a pale yellow solution was followed by an exothermic reaction (temperature 70–80 °C) with gas evolution (N_2 , BF_3), suggesting that the initial formation of NCN_2^+ or its precursor complex is followed by rapid dediazonation. Alternatively, NCN_2^+ can be ¹so generated from cyanamide with thionyl chloride and NO^+BF_4^- under argon (500 psi) and reacted with toluene (50% ortho, 15% meta, 35% para).

(1) Onium ions. 29. For part 28, see: Leali, K.; Olah, G. A. *J. Org. Chem.*, in press.

(2) Mertens, A.; Lammerstma, K.; Arvanaghi, M.; Olah, G. A. *J. Am. Chem. Soc.* 1983, 105, 5657.

(3) Commercially available NO^+BF_4^- (Aldrich) was purified from impurity $\text{NO}_2^+\text{BF}_4^-$ by repeated washing with dry benzene. After removal of solvent (and formed nitrobenzene), the salt was evacuated in vacuum.

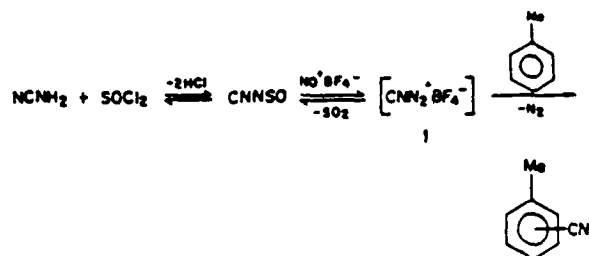

We have also found that nitrodiazonium tetrafluoroborate $\text{O}_2\text{N}^+\text{N}=\text{N} \text{BF}_4^-$ (2) can be generated when a freshly prepared sample of nitramide⁴ (from ethyl carbamate and amyl nitrate) is allowed to react with a molar equivalent of purified NO^+BF_4^- in CH_2Cl_2 at 0 °C. De-

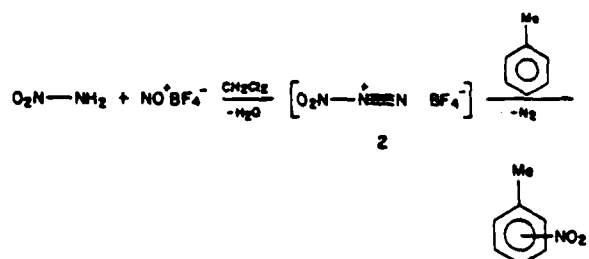

diazonative nitration of toluene (4 equiv) gave isomeric nitrotoluenes in 36% overall yield. The observed isomer distribution of nitrotoluenes is 71% ortho, 3.5% meta, and 25.5% para and closely resembles that of electrophilic nitration of toluene with strongly electrophilic nitrating agents, such as nitronium salts.⁵

In a control experiment when nitramide was added to dry toluene in CH_2Cl_2 under the experimental condition, no nitrotoluenes were observed after workup and GC analysis, ruling out any possible nitration of toluene by nitramide itself or by nitric acid formed upon hydrolysis.

Aromatic cyanation via the cyanodiazonium ion 1 is in all probability a concerted reaction, as the cyanyl cation ^+CN is not expected to be formed, but the reaction could also involve a radical cation pathway. In contrast, dediazonation of the nitrodiazonium ion 2 to the nitronium ion is thermodynamically favorable and thus it cannot be excluded that its formation precedes nitration of aromatics.

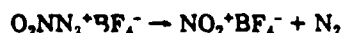

(4) (a) Marlies, C. A.; La Mer, V. K.; Greenspan, J. *Inorg. Synth.* 1939, 1, 68. (b) Nitramide was also prepared by the reaction of acetamide (2 equiv) and $\text{NO}_2^+\text{BF}_4^-$ (1 equiv) in tetramethylene sulfone/ CH_2Cl_2 solution at 0 °C for 1 h.



(5) For a review on aromatic nitration with $\text{NO}_2^+\text{BF}_4^-$ see: Olah, G. A.; Narang, S. C.; Olah, J. A. *Proc. Natl. Acad. Sci. U.S.A.* 1978, 75, 1045.

As pointed out by a referee, one equimolar amount of water is also formed in the diazotization of nitramide which will hydrolyze nitronium ion, and the de facto nitrating agent may not be the free nitronium ion, although it is still possible that it is also involved in the overall nitration.

The ability of electronegative substituents in stabilizing diazonium ions was also demonstrated previously by the preparation of isolable fluorodiazonium salts, such as hexafluoroantimonate and hexafluoroarsenate, from *cis*-difluorodiazene and the strong Lewis acid fluorides SbF_5 or AsF_5 .⁶



We have in the course of our studies also attempted fluorination of aromatics such as benzene, toluene, and nitrobenzene with fluorodiazonium hexafluoroarsenate. Clearly FN_2^+ is unable to form F^+ ; thus, the reaction is expected to be that of displacement by the aromatics. The reactions were carried out at -78°C in anhydrous hydrogen fluoride solution with careful addition of the solution of the fluorodiazonium ion to excess of the aromatics. The reaction was found to be extremely exothermic even under these conditions, and only trace amounts of fluoroaromatics were formed (analyzed by gas-liquid chromatography and NMR spectroscopy). The fluorodiazonium ion thus seems to be a very strong oxidizing agent and of little practical value for aromatic fluorination.

All reported reactions can be best visualized as displacements of the diazonium ions by the aromatics, either giving the substituted products with simultaneous evolution of nitrogen or by competing reaction on nitrogen with subsequent decomposition of the intermediately formed aryldiazonium ions by the counterions (i.e., cyanide, nitrite, or fluoride).

Acknowledgment. Support of the work at USC by the National Science Foundation and the U.S. Army Research Office, Durham, NC, is gratefully acknowledged.

Registry No. 1, 95512-44-0; 2, 95512-46-2; PhCH_3 , 108-88-3; NO^+BF_4^- , 14635-75-7; H_2NCN , 420-04-2; SOCl_2 , 7719-09-7; NO_2NH_2 , 7782-94-7; $\text{NH}_2\text{C(O)OEt}$, 51-79-6; $\text{CH}_3(\text{CH}_2)\text{ONO}_2$, 1002-16-0; *NC-o-C}_6\text{H}_4\text{Me}*, 529-19-1; *NC-m-C}_6\text{H}_4\text{Me}*, 620-22-4; *NC-p-C}_6\text{H}_4\text{Me}*, 104-85-8; *NO}_2\text{-o-C}_6\text{H}_4\text{Me}*, 88-72-2; *NO}_2\text{-m-C}_6\text{H}_4\text{Me}*, 99-08-1; *NO}_2\text{-p-C}_6\text{H}_4\text{Me}*, 99-99-0; $\text{FN}_2^+\text{AsF}_6^-$, 12005-87-7; $(Z)\text{-FN}=\text{NF}$, 13812-43-6; AsF_5 , 7784-36-3.

(6) Christe, K. O.; Wilson, R. D.; Sawodny, W. *J. Mol. Struct.* 1971, 8, 245 and references given therein.

George A. Olah,* Khosrow Laali, Morteza Farnia
Joseph Shih, Brij P. Singh
Carl J. Schack, Karl O. Christe

Donald P. and Katherine B. Loker
Hydrocarbon Research Institute
and Department of Chemistry
University of Southern California
University Park, Los Angeles, California 90089, and
Rocketdyne, Division of Rockwell International
Canoga Park, California 91304

Received December 12, 1984

APPENDIX J

Reprinted from *Inorganic Chemistry*, 1986, 25, 1904
 Copyright © 1986 by the American Chemical Society and reprinted by permission of the copyright owner.

Contribution from Rocketdyne, A Division of Rockwell
 International, Canoga Park, California 91303

Synthesis and Characterization of $\text{NF}_4^+\text{BrF}_4^-$ and $\text{NF}_4^+\text{BrF}_6^-$

Karl O. Christe* and William W. Wilson

Received November 13, 1985

Although the NF_4^+ cation is known to form salts with a large variety of anions, such as XF_2^- (X = H), XF_4^- (X = B, Al), XF_5^- (X = Ge, Sn, Ti), XF_6^- (X = P, As, Sb, Bi, Pt, Cr), $\text{X}_2\text{F}_{11}^-$ (X = Sb, Bi, Pt), XF_8^{2-} (X = Si, Ge, Sn, Ti, Mn, Ni), XF_7^- (X = W, U, Xe), XF_8^{2-} (X = Xe), XF_3O^- (X = W, U), XO_3F^- (X = S), and XO_4^- (X = Cl),¹ no salts are presently known in which the anion is derived from a halogen fluoride or oxyfluoride. Previous attempts² have been unsuccessful to prepare and isolate, for example, $\text{NF}_4^+\text{XF}_6\text{O}^-$ (X = Br, Cl), by metathesis according to



When HF was used as a solvent, solvolysis of CsXF_6O occurred according to



For CsClF_6O , substitution of HF by BrF_3 also resulted in a displacement reaction:



For CsBrF_6O the analogous displacement by BrF_3 was not observed, and the observation of the correct amounts of CsSbF_6 , NF_4^+ , F_2 , and BrF_3O for reaction 1 indicated the possible formation of $\text{NF}_4^+\text{BrF}_6\text{O}^-$ as an unstable intermediate. These results encouraged us to attempt the isolation and characterization of $\text{NF}_4^+\text{BrF}_6\text{O}^-$ and possibly $\text{NF}_4^+\text{BrF}_4^-$.

Experimental Section

Materials. Literature methods were used for the synthesis of NF_4^+ , SbF_6^- ,¹ CsBrF_6O ,³ and CsBrF_4 .⁴ The BrF_3 (Matheson) was treated with

(1) For a compilation of references see: Christe, K. O.; Wilson, W. W.; Schack, C. J.; Wilson, R. D. *Inorg. Synth.*, in press.
 (2) Christe, K. O.; Wilson, W. W.; Wilson, R. D. *Inorg. Chem.* 1980, 19, 1494.

(3) Christe, K. O.; Wilson, R. D.; Curtis, E. C.; Kuhlmann, W.; Sawodny, W. *Inorg. Chem.* 1978, 17, 533
 (4) Christe, K. O.; Schack, C. J. *Inorg. Chem.* 1970, 9, 1852

35 atm of F_2 at 100 °C for 24 h and then purified by fractional condensation through traps kept at -64 and -95 °C, with the material retained at -95 °C being used. These materials are powerful oxidizers, and contact with organic materials or moisture must be avoided.

Apparatus. Volatile materials used in this work were handled in a well-passivated (with ClF_3 and/or BrF_3) stainless-steel Teflon FEP vacuum line.⁵ Nonvolatile materials were handled in the dry nitrogen atmosphere of a glovebox. For the transfer of unstable solids, the cold materials were taken into the drybox and handled under a layer of either liquid Ar or liquid N_2 in an aluminum dish placed inside a Styrofoam-brand dish. Metathetical reactions were carried out in BrF_3 solution by using an apparatus consisting of two FEP U-traps interconnected through a coupling containing a porous Teflon filter.⁶

Infrared spectra were recorded in the range 4000–200 cm^{-1} on a Perkin-Elmer Model 283 spectrophotometer by placing the chilled powder between two cold, thin AgCl disks. The remaining AgCl sandwich was held in a liquid- N_2 -cooled sample holder of an evacuated low-temperature infrared cell with external CsI windows.⁶ The Raman spectra were recorded on a Cary Model 83 spectrophotometer using the 488-nm exciting line of an Ar ion laser and a Chance filter⁷ for the elimination of plasma lines. Sealed 3-mm-o.d. quartz tubes were used as sample containers in a previously described⁸ low-temperature device.

Preparation of $NF_4^+BrF_4^-O$. Inside the drybox, $CaBrF_2$ (3.06 mmol) and NF_3SbF_6 (3.06 mmol) were loaded into a passivated Teflon FEP double-U-tube metathesis apparatus. On the vacuum line BrF_3 (81.11 mmol) was added at -196 °C. The mixture was allowed to warm to -55 °C and stored in a freezer at this temperature for 8 days with periodic agitation. The cold apparatus was reconnected to the vacuum line, pressurized with 2 atm of dry N_2 , and inverted, and the pressure-assisted filtration was carried out at -55 °C. Although the reaction mixture had the appearance of a clear colorless gas with few solid particles in it, a copious white precipitate was collected on the filter. The receiver U-tube was kept at -55 °C and all volatile material was pumped off through two traps kept at -126 °C (methylcyclohexane slush) and 210 °C (nitrogen slush) for the collection of BrF_3 and NF_3 , respectively. After 3 h of pumping, BrF_3 (72.64 mmol) and NF_3 (6.08 mmol) were collected. Pumping was continued for an additional 95 h with periodic measurement of the collected BrF_3 and NF_3 , until no more BrF_3 was collected and essentially all of the BrF_3 solvent (81 mmol) had been recovered. The filter was separated from the apparatus, and the filter cake consisted of 1.146 g (weight calculated for 3.06 mmol of $CaSbF_6$, 1.28 g) of a white solid, which based on its Raman spectrum was $CaSbF_6$, containing a trace of $NF_4^+SbF_6^-$. The filtrate residue was identified by low-temperature infrared and Raman spectroscopy as $NF_4^+BrF_4^-O$ contaminated by a trace of SbF_5 and some BrF_3O .

Preparation of $NF_4^+BrF_4^-$. This preparation was analogous to that of $NF_4^+BrF_4^-O$ except for the following modifications. The reaction mixture (NF_3SbF_6 and $CaBrF_2$, 3.02 mmol each in 1 mL of BrF_3) was stored at -55 °C for 4 months before the filtration was carried out at -55 °C. The volatile material was pumped off at -31 °C for 6 h and then at -22 °C for 1 h until no more volatile material was trapped. The filter cake consisted of 1.108 g (weight calculated for 3.02 mmol of $CaSbF_6$, 1.4 g) of a white solid, which based on its Raman spectrum was $CaSbF_6$. The white residue remaining after evaporation of the solvent was identified as $NF_4^+BrF_4^-$ by its low-temperature infrared and Raman spectra and thermal decomposition at 25 °C, which yielded the correct amount of an equimolar mixture of NF_3 and BrF_3 .

Results and Discussion

The first examples of NF_4^+ salts with halogen fluoride and halogen oxyfluoride anions were prepared by the following low-temperature metathetical reactions in BrF_3 solution:

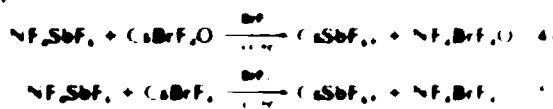

Both NF_4^+ salts are white solids that are unstable at room temperature. The $NF_4^+BrF_4^-O$ salt is less stable than $NF_4^+BrF_4^-$, as evidenced by the fact that even at -55 °C a very small but constant and measurable amount of NF_3 was evolved during removal of the BrF_3 solvent in a dynamic vacuum. This renders the synthesis of $NF_4^+BrF_4^-O$ time-consuming (about 90-h pumping

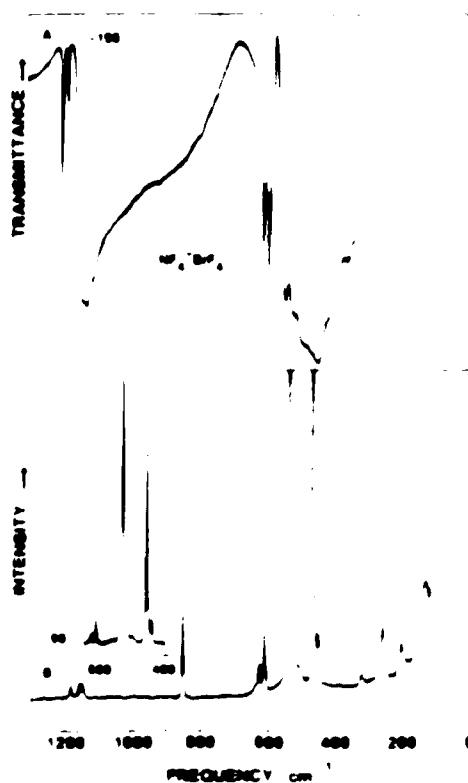
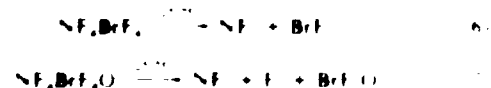

Figure 1. Vibrational spectra of solid $NF_4^+BrF_4^-$ salts: trace A, infrared spectrum; trace B, Raman spectrum recorded at two different sensitivities.

time) and requires close temperature control. The $NF_4^+BrF_4^-$ salt is stable at -22 °C (thus permitting a more rapid BrF_3 removal). The thermal decomposition of the two solids follows a different path:



Whereas NF_4^+ is a strong enough oxidizer to oxidatively fluorinate BrF_3 to BrF_4^- , it is not capable of fluorinating BrF_3O to either BrF_4^- or BrF_5O .

The composition of the $NF_4^+BrF_4^-O$ and $NF_4^+BrF_4^-$ salts was established by the material balances observed for both the synthesis and decomposition reactions and by low-temperature Raman and infrared spectroscopy. The observed spectra are shown in Figures 1 and 2 and the frequencies and their assignments are summarized in Table I. Since the vibrational spectra of the NF_4^+ cation,⁹ the BrF_4^- anion,¹⁰ and the BrF_3 anion¹¹ are well established, the discussion of the above results can be kept brief. In both salts the degeneracy of the ideally triply degenerate F_2 modes (e_2 and e_2') of NF_4^+ is removed and these bands are split into their components. The number of fundamental vibrations and the frequencies observed for the BrF_4^- bands in $NF_4^+BrF_4^-$ agree well with those previously reported for its BrF_4^- and BrF_3O salts. However, the BrF_3 bands in $NF_4^+BrF_4^-$ do not obey the selection rules for a square planar XY_4 species of point group D_{4h} : $A_{1g} + B_{1g} + B_{2g} + B_{3g}$ (R) + A_{2g} (IR) + B_{1g} (R) + B_{2g} (inactive) + E_{1g} (IR) but follow those of point group C_{4v} : A_1 (IR, R) + B_1 (R) + B_2 (R) + E [(IR, R)].¹² This strongly suggests that the BrF_3 anion in $NF_4^+BrF_4^-$ is not square planar but slightly distorted from D_{4h} to C_{4v} symmetry by the influence of the nonspherical NF_4^+ cation.¹³ The bands of BrF_4^- in $NF_4^+BrF_4^-O$ are a good

(5) Chrusa, R. O.; Wilson, R. D. *Synthesis* (C) 1984, Synthesis, in press.
 (6) Lutz, R. R.; Campana, V. R.; Costanzo, T. J. *Spectrochim. Acta* Part A 1970, 26A, 165.
 (7) Chrusa, R. H.; Sotgiu, M.; Shuman, J. *Appl. Spectrosc.* 1969, 13, 11.
 (8) Miller, F. A.; Horvay, B. M. *Appl. Spectrosc.* 1970, 24, 29.

(9) Chrusa, R. O. *Spectrochim. Acta* Part A 1969, 25A, 1237 and references cited therein.

Table I. Vibrational Spectra of NF_4BrF_4 and $\text{NF}_4\text{BrF}_4\text{O}$

obsd freq. cm^{-1} , and rel intens ^a				assignments (point group)		
NF_4BrF_4		$\text{NF}_4\text{BrF}_4\text{O}$		NF_4^+ (T_d)	BrF_4^- (C_{2v})	BrF_4O^- (C_{2v})
IR	RA	IR	RA			
1220 mw		1220 sh		$2\nu_2$ ($A_1 + E + F_2$)		
1202 w		1216 mw				
1156 sh	1182 (0.2)	1165 s	1165 (0.4)	ν_1 (F_2), ν_{10}		
1147 vs	1158 (0.2)	1149 vs	1152 sh			ν_1 (A_1), $\nu(\text{BrO})$
	1149 (0.2)	999 s	953 (1.7)			
			853 (2.7)	ν_1 (A_1), ν_1		
618 mw	851 (2.0)	614 w	614 (2.0)	ν_4 (F_2), δ_{10}		
608 w	622 (0.5)	608 ms	605 sh			
600 m	608 (1.0)	600 sh				
(550 vw)						
530 sh	535 (1.0)	520 sh, br	506 (1.0)		ν_1 (A_1), ν_1	ν_2 (A_1), ν_1 (BrF_4)
500 sh	505 sh	470 vs	470 (0.4)		ν_6 (E), ν_{10}	ν_1 (E), ν_{10} (BrF_4)
452 vs		449 sh	451 (1.4)			
430 sh		420 vw	427 (7.5)		ν_1 (B_1), ν_1	ν_4 (B_1), ν_1 (BrF_4)
	466 (7.2)		451 (3)	ν_2 (E), δ_1		
	448 (0.8)		402 (0+)			ν_6 (E), $\delta(\text{OBrF}_4)$
		388 w	389 (0.8)			
			352 (0+)			
(363 vw)			304 (0.2)		ν_2 (A_1), δ_1 out of plane	ν_1 (A_1), δ_1 out of plane
325 vw	320 (0.2)		251 (0.7)		ν_3 (B_2), δ_1 in plane	ν_4 (B_2), δ_1 in plane
	258 (1.0)		225 (0+)		ν_1 (B_1), δ_{10} out of plane	ν_1 (B_1), δ_{10} out of plane
			184 (0.5)		ν_1 (E), δ_{10} in plane	ν_6 (E), δ_{10} in plane
	202 (0.5)					
	129 (1.0)			lattice mode		

^aUncorrected Raman intensities (peak heights)

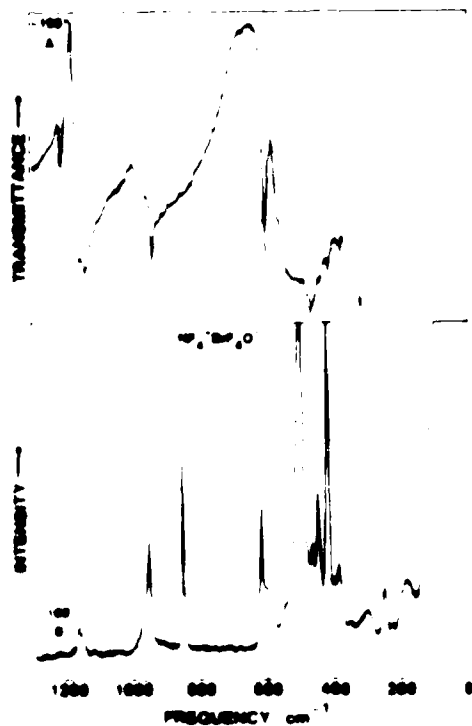

Figure 2. Vibrational spectra of solid $\text{NF}_4\text{BrF}_4\text{O}$: trace A, infrared spectrum; trace B, Raman spectrum.

agreement with those previously observed for $\text{Cs}^+\text{BrF}_4\text{O}^-$ and were assigned correspondingly.

In conclusion, the above results show that the NF_4^+ cation is capable of forming marginally stable salts with certain halogen fluoride or oxyfluoride anions. The synthesis of such salts is difficult and requires the use of a solvent that is (i) sufficiently polar to dissolve ionic salts, (ii) sufficiently volatile to allow solvent removal at low temperature, (iii) stable toward the strongly oxidizing NF_4^+ cation, and (iv) incapable of undergoing a solvolysis reaction with the starting materials. So far, the only solvent known to meet or approximate these requirements is BrF_3 .

Acknowledgment. The authors are indebted to C. J. Schack, R. D. Wilson, and L. R. Grant for help and to the Army Research Office and the Office of Naval Research for financial support.

Registry No. $\text{NF}_4^+\text{BrF}_4\text{O}^-$ 101652-54-4; $\text{NF}_4^+\text{BrF}_4$ 101756-83-6; CsBrF_4O 65391-03-9; NF_4SbF_6 16871-76-4; CsBrF_4 15705-88-1; $\text{NF}_4^+\text{BrF}_4\text{O}^-$ 61519-37-7; F_2 7782-41-4.

APPENDIX K
2. CHLORYL FLUORIDE

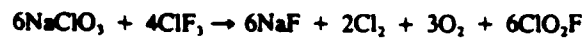

Submitted by KARL O. CHRISTE,* RICHARD D. WILSON,* and CARL J. SCHACK*
Checked by D. D. DESMARTEAU†

‡The checker used one-half the amounts of starting materials in a 150 mL Monel cylinder and obtained the same yield.

*Rocketdyne, A Division of Rockwell International Corp., Canoga Park, CA 91304.

†Department of Chemistry, Clemson University, Clemson, SC 29631.

4 Fluorine-Containing Compounds

Chloryl fluoride is the most common chlorine oxyfluoride. It is always encountered in reactions of chlorine mono-, tri-, or pentafluorides with oxides, hydroxides, or poorly passivated surfaces. It was first obtained¹ in 1942 by Schmitz and Schumacher by the reaction of ClO_2 with F_2 . Other methods involve the reaction of KClO_3 with either BrF_3 ² or ClF_3 .^{3,4} The simplest method⁵ involves the reaction of NaClO_3 with ClF_3 , resulting in the highest yields and products that can readily be separated.

Procedure

■ **Caution.** *The hydrolysis of ClO_2F can produce shock-sensitive ClO_2 .⁶ Therefore, the use of a slight excess of ClF_3 is recommended for the synthesis to suppress any ClO_2 formation. Chlorine trifluoride is a powerful oxidizer and ignites most organic substances on contact. The use of protective face shields and gloves is recommended when working with these materials.*

In the dry box, dry sodium chlorate (30 mmol, 3.193 g) is loaded into a 30-mL high-pressure stainless steel Hoke cylinder equipped with a stainless steel Hoke valve. The cylinder is connected to a stainless steel-Teflon FEP vacuum manifold (Fig. 1) that has been well passivated with ClF_3 [Ozark-Mahoning] until the ClF_3 , when condensed at -196° , shows no color. The cylinder is then evacuated and ClF_3 (21.5 mmol) is condensed into the cylinder at -196° . The cylinder is allowed to warm to room temperature and is kept at this temperature for 1 day. The cylinder is then cooled back to -196° , and during subsequent warm-up of the cylinder the volatile products are separated by fractional condensation under dynamic vacuum through a series of U-traps kept by liquid N_2 slush baths at -95° (toluene), -112° (CS_2), and -126° (methylcyclohexane). The trap at -95° contains only a trace of chlorine oxides, the trap at -112° contains most of the ClO_2F (29 mmol), and the trap at -126° (7 mmol) contains mainly Cl_2 and some ClO_2F . The yield of ClO_2F is almost quantitative based on the limiting reagent NaClO_3 (29.4 mmol, 98%).[‡] The purity of the material is checked by infrared spectroscopy in a well-passivated Teflon or metal cell equipped with AgCl windows. The product should not show any impurities. A small amount of chlorine oxides, which can be readily detected by their intense color if present or if formed during handling of ClO_2F , can readily be removed by conversion to ClO_2F with elemental F_2 or will decompose to Cl_2 and O_2 during storage at ambient temperature. Chloryl fluoride can be stored in a metal vessel at room temperature for long time periods without significant decomposition.

[‡]The checker used one-third of the stated scale and obtained ClO_2F in a yield of 95%.

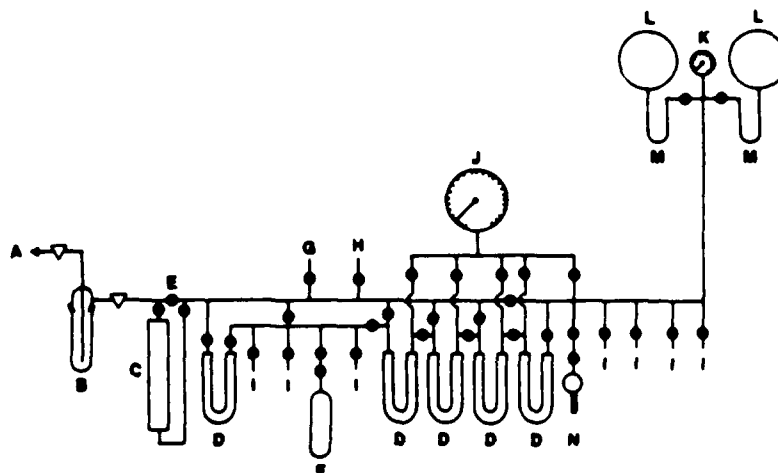

Fig. 1. Typical metal-Teflon vacuum system used for handling strongly oxidizing or corrosive fluorine compounds. As the vacuum source A, a good mechanical pump (10^{-4} torr or better) is normally sufficient. The use of a fluorocarbon oil, such as Halocarbon [Halocarbon Products] as a pump oil is strongly recommended for safety reasons. B, glass waste trap with glass or Teflon stopcocks and a detachable bottom; only fluorocarbon grease [Halocarbon Products] should be used for the stopcocks and joint; the trap is kept cold by a Dewar flask with liquid nitrogen; great care must be taken, and a face shield and heavy leather gloves must be worn when pulling off the cold lower half of the waste trap for disposal of the trapped material by evaporation in a fume hood. The glass waste trap can be connected to the metal line by a glass-metal joint, a graded glass-metal seal, or most conveniently by a quick-coupling compression fitting with Viton O-ring seals. C, scrubber for removal of fluorine; the scrubber consists of a glass tower packed with alternating layers of NaCl and soda lime that are held in place by plugs of glass wool at either end. The valves E are arranged in such a manner that the scrubber can be bypassed during routine operation. D, Teflon-FEP (fluoro-ethylene-propylene copolymer [Zeus]) or PFA (polyperfluoroether) U-traps made from $\frac{1}{2}$ - or $\frac{3}{8}$ -in o.d. commercially available heavy wall tubing; all metal lines are made from either 316 or 321 $\frac{1}{2}$ -in o.d. stainless steel or Monel tubing, except for the lines from the U-traps to the Heise gage [Dresser] J, for which $\frac{1}{8}$ -in o.d. tubing is preferred, stainless steel bellows valves E such as Hoke Model 4200 series, are used throughout the entire line, metal-metal or metal-Teflon connections are all made with either flare or compression (Swagelok [Crawford Fitting] or Gyrolok) fittings. F, lecture bottle of ClF₃, [Ozark-Mahoning] used for passivation of the vacuum line. G, He gas inlet. H, F, gas inlet. I, connectors for attaching reaction vessels, reagent containers, etc. J, Heise Bourdon tube pressure gage (0-1000 mm \pm 0.1%). K, crude pressure gage (0-5 atm). L, 2-L steel bulbs used for either measuring or storing larger amounts of gases. M, $\frac{1}{8}$ -in o.d. metal U-tubes to permit condensation of gases into the storage bulbs. N, infrared cell for gases, Teflon body with condensing tip, 5 cm path length, AgCl windows. The four U-traps D, connected in series, constitute the fractionation train used routinely for the separation of volatile materials by fractional condensation employing slush baths of different temperatures. The volumes of each section of the vacuum line are carefully calibrated by PVT measurements using a known standard volume.

Properties⁶

Chloryl fluoride is a colorless liquid boiling at -6° . The IR spectrum of the gas⁴ shows the following major bands: 1271 (vs), 1106 (ms), 630 (s), and 547 (ms) cm^{-1} . The ^{19}F NMR spectrum⁷ of the liquid at -80° consists of a singlet at 315 ppm downfield from external CFCl_3 .

References

- 1 H. Schmitz and H. J. Schumacher, *Z. Anorg. Allgem. Chem.* **209**, 238 (1942).
- 2 A. A. Woolf, *J. Chem. Soc.* **1984**, 4113.
- 3 A. Engelbrecht and H. Atzwanger, *J. Inorg. Nucl. Chem.* **2**, 348 (1956).
- 4 D. F. Smith, G. M. Begun, and W. H. Fletcher, *Spectrochim. Acta*, **20**, 1763 (1964).
- 5 K. O. Christe, R. D. Wilson, and C. J. Schack, *Inorg. Nucl. Chem. Lett.* **11**, 161 (1975).
- 6 K. O. Christe and C. J. Schack, *Adv. Inorg. Chem. Radiochem.* **18**, 319 (1976).
- 7 K. O. Christe, J. F. Hon, and D. Pilipovich, *Inorg. Chem.* **12**, 84 (1973).

APPENDIX L
12. TUNGSTEN TETRAFLUORIDE OXIDE

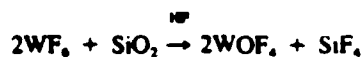

Submitted by WILLIAM W. WILSON* and KARL O. CHRISTE*
Checked by ROLAND BOUGON†

Tungsten tetrafluoride oxide can be prepared by numerous methods, such as the fluorination of WO_3 at 300° ,¹ slow hydrolysis of WF_6 ,² the direct fluorination of W in the presence of O_2 at 300° ,³ the reaction of WF_6 with WO_3 at 400° ,⁴ the reaction of WOCl_4 with HF ,^{5,6} or oxygen-fluorine exchange between WF_6 and B_2O_3 .⁶ The method given below is a modification of the method of Paine and McDowell, who used stoichiometric amounts of SiO_2 and WF_6 in anhydrous HF for the controlled hydrolysis of WF_6 .² In our experience,⁷ the use of stoichiometric amounts of SiO_2 and WF_6 leads to the formation of some $[\text{H}_2\text{O}]^+[\text{WOF}_5]^-$ and $[\text{H}_2\text{O}]^+[\text{W}_2\text{O}_2\text{F}_6]^-$ as by-products that are difficult to separate from WOF_6 . This problem can, however, be minimized by the use of an excess of WF_6 . Tungsten tetrafluoride oxide is a starting material for the syntheses of numerous WOF_6 salts.

*Rocketdyne, A Division of Rockwell International Corp., Canoga Park, CA 91304
†Centre d'Études Nucléaires de Saclay, 91191 Gif sur Yvette, France

Procedure

■ **Caution.** Anhydrous HF causes severe burns. Protective clothing and safety glasses should be worn when working with liquid HF.

Quartz wool [Preiser Scientific] (1.048 g, 17.44 mmol) is placed into a $\frac{3}{8}$ -in. o.d. Teflon FEP (fluoroethylene propylene copolymer) ampule [Zeus] equipped with a Teflon-coated magnetic stirring bar and a stainless steel valve. The ampule is connected to a metal-Teflon vacuum system⁸ and evacuated, and dry⁹ HF [Matheson] (19 g) and WF₆ [Alfa] (22.102 g, 74.21 mmol) are condensed into the ampule at -196°. The contents of the ampule are allowed to warm to room temperature and are kept at this temperature for 15 hr with stirring. All material volatile at room temperature is pumped off (10⁻⁴ torr) for 12 hr, leaving behind 9.723 g of a white solid (weight calcd. for 34.89 mmol WOF₄ is 9.624 g). This crude product usually still contains [H₂O]⁺[W₂O₂F₉]⁻ (IR spectrum of the solid pressed as a AgCl disk: 3340, 3100, 1625, 1040, 1030, 908 cm⁻¹) and can be purified by vacuum (10⁻⁴ torr) sublimation in an ice water-cooled Pyrex sublimator at 55°, resulting in 4.245 g of sublimate. The purity of the sublimate is verified by vibrational spectroscopy of the solid (IR spectrum as a AgCl disk: 1054 (vs), 733 (s), 666 (vs), and 550 (vs) cm⁻¹. Raman: 1058 (10), 740 (1.9), 727 (6.3), 704 (0+), 668 (0+), 661 (0.9), 559 (0+), 518 (0.7), 325 (sh), 315 (sh), 311 (5), 260 (0+), 238 (0.7), 212 (0.5), 185 (0+) cm⁻¹.)¹⁰

Anal. Calcd. for WOF₄: W, 66.65; F, 27.55. Found: W, 66.5; F, 27.7.

Properties

Tungsten tetrafluoride oxide is a white hygroscopic solid (mp 104.7 at 25 torr, bp 185.9°) which can be sublimed readily. It is soluble in HF and in propylene carbonate. The ¹⁹F NMR spectrum in propylene carbonate solution consists of a singlet at 65.2 ppm downfield from external CFC₃, with two satellites with $J_{WF} = 69$ Hz.¹¹

References

1. G. H. Cady and G. B. Hargreaves, *J. Chem. Soc.*, 1961, 1563.
2. R. T. Paine and R. S. McDowell, *Inorg. Chem.*, 13, 2367 (1974).
3. H. Meiner, L. Friedrich, and W. Kohl, *Z. Chem.*, 15, 492 (1975).
4. F. N. Tobbe and E. L. Muonartas, *Inorg. Chem.*, 7, 172 (1968).
5. O. Ruff, F. Eisner, and W. Heller, *Z. Anorg. Allgem. Chem.*, 52, 256 (1907).
6. R. C. Burns, T. A. O'Donnell, and A. B. Waugh, *J. Fluorine Chem.*, 12, 505 (1978).
7. W. W. Wilson and K. O. Christe, *Inorg. Chem.*, 20, 4139 (1981).
8. K. O. Christe, R. D. Wilson, and C. J. Schack, *Inorg. Synth.*, 24, 3 (1986).
9. K. O. Christe, W. W. Wilson, and C. J. Schack, *J. Fluorine Chem.*, 11, 71 (1978).
10. I. R. Beattie, K. M. S. Livingston, D. J. Reynolds, and G. A. Ozin, *J. Chem. Soc. A*, 1970, 1210.
11. R. Bougon, T. Bui Huy, and P. Charpen, *Inorg. Chem.*, 14, 1822 (1975).

13. TETRAFLUOROAMMONIUM SALTS

Submitted by **KARL O. CHRISTE,* WILLIAM W. WILSON,* CARL J. SCHACK,***
and RICHARD D. WILSON*
 Checked by **R. BOUGON†**

Since $[\text{NF}_4]^+$ is a coordinatively saturated complex fluoro cation, the syntheses of its salts are generally difficult.¹ A limited number of salts can be prepared directly from NF_3 , and these salts can then be converted by indirect methods into other $[\text{NF}_4]^+$ salts that are important for solid propellant $\text{NF}_3\text{-F}_2$ gas generators or reagents for the electrophilic fluorination of aromatic compounds.

The two direct methods for the syntheses of $[\text{NF}_4]^+$ salts are based on the reaction of NF_3 with either $[\text{KrF}]^+$ salts²

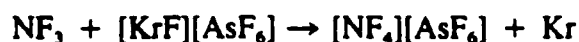

or F_2 and a strong Lewis acid in the presence of an activation energy source E .³

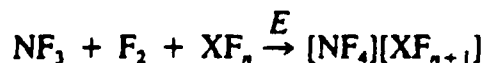

For the chemist interested in synthesis, the second method³ is clearly superior, due to its high yields, relative simplicity, and scalability.

Four different activation energy sources have been used for the direct synthesis of $[\text{NF}_4]^+$ salts:

1. Heat⁴⁻⁷: $[\text{NF}_4][\text{BiF}_6]$, $[\text{NF}_4][\text{SbF}_6]$, $[\text{NF}_4][\text{AsF}_6]$, $[\text{NF}_4]_2[\text{TiF}_6 \cdot n\text{TiF}_4]$
2. Glow discharge^{8,9}: $[\text{NF}_4][\text{AsF}_6]$, $[\text{NF}_4][\text{BF}_4]$
3. UV photolysis^{10,11}: $[\text{NF}_4][\text{SbF}_6]$, $[\text{NF}_4][\text{AsF}_6]$, $[\text{NF}_4][\text{PF}_6]$, $[\text{NF}_4][\text{GeF}_5]$, $[\text{NF}_4][\text{BF}_4]$
4. Bremsstrahlung¹²: $[\text{NF}_4][\text{BF}_4]$

Of these, the thermal synthesis of $[\text{NF}_4][\text{SbF}_6]^4-7$ is most convenient (Synthesis A) and provides the starting material required for the synthesis of other $[\text{NF}_4]^+$ salts by indirect methods. For the synthesis of pure $[\text{NF}_4]^+$ salts on a small scale, low-temperature UV photolysis is preferred (Synthesis B).¹¹

The following indirect methods for the interconversion of $[\text{NF}_4]^+$ salts are known:

*Rocketdyne, A Division of Rockwell International Corp., Canoga Park, CA 91304.

†Centre d'Études Nucléaires de Saclay, 91191 Gif sur Yvette, France.

1. Metathesis reaction:

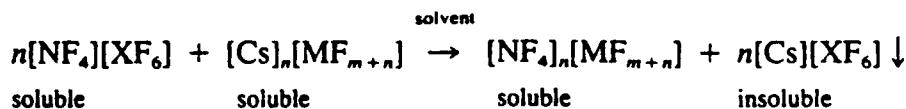

where typically X = Sb and the solvent is anhydrous HF or BrF₃. This method is limited to anions that are stable in the given solvent and results in an impure product. Typical compounds prepared in this manner include [NF₄][BF₄],^{6,13,14} [NF₄][HF₂] (Synthesis C),¹⁵ [NF₄][SO₃F],¹⁶ [NF₄][ClO₄],¹⁵ and [NF₄]₂[MF₆] (M = Sn,¹⁷ Ti,¹⁸ Ni,¹⁹ Mn²⁰) (Synthesis D).

2. Reaction of solid [NF₄][HF₂]·xHF with a weak Lewis acid: When the MF_{m+n}⁻ anion is unstable in a solvent, such as HF, and the Lewis acid MF_m is volatile, the equilibrium

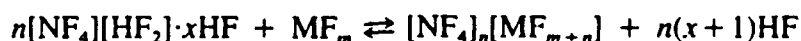

can be shifted to the right by the use of an excess of MF_m and continuous removal of HF with the excess of MF_m. Typical salts prepared in this manner include [NF₄]₂[SiF₆]²¹ (Synthesis E) and [NF₄][MF₇] (M = U, W,²² Xe²³).

3. Reaction of [NF₄][HF₂] with a nonvolatile polymeric Lewis acid: When, in the metathesis (1), all the materials except [NF₄][XF₆] are insoluble, product separation becomes impossible. This problem is avoided by digesting the Lewis acid in a large excess of [NF₄][HF₂] in HF solution, followed by thermal decomposition of the excess [NF₄][HF₂] at room temperature.

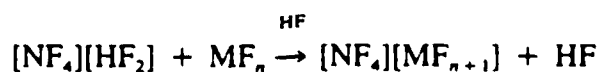

Salts prepared in this manner include [NF₄][MOF₅] (M = U,²⁴ W²⁵) (Synthesis F), [NF₄][AlF₄],²⁶ and [NF₄][Be₂F₅].²⁶

4. Displacement reaction: Displacement of a weaker Lewis acid by a stronger Lewis acid can be carried out easily, as demonstrated for [NF₄][PF₆].¹¹



5. Rearrangement reaction: When [NF₄][GeF₅] is treated with anhydrous HF, the following equilibrium is observed:

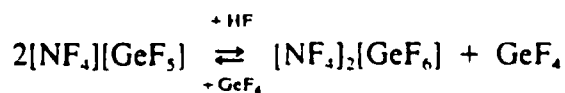

This equilibrium can be shifted to the right by repeated treatments of $[\text{NF}_4][\text{GeF}_5]$ with HF and GeF_4 removal, and to the left by treatment of $[\text{NF}_4]_2[\text{GeF}_6]$ with GeF_4 .¹¹

A. TETRAFLUOROAMMONIUM HEXAFLUOROANTIMONATE(V)

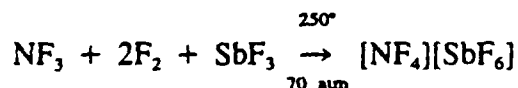

Procedure

■ **Caution.** High-pressure fluorine reactions should be carried out only behind barricades or in a high-pressure bay using appropriately pressure-temperature-rated nickel or Monel reactors that have been well passivated with several atmospheres of F_2 at the described reaction temperature. Stainless steel reactors should be avoided owing to the potential of metal fires. All $[\text{NF}_4]^+$ salts are moisture-sensitive and must be handled in a dry atmosphere. They are strong oxidizers—contact with organic materials and fuels must be avoided.

A prepassivated (with ClF_3), single-ended 95-mL Monel cylinder [Hoke, rated for 5000 psi working pressure], equipped with a Monel valve [Hoke 3232 M4M or equivalent], is loaded in the dry nitrogen atmosphere of a glove box with SbF_3 [Ozark-Mahoning] (31 mmol). The cylinder is connected to a metal vacuum system,²⁷ evacuated, vacuum leak tested, and charged with NF_3 [Air Products and Chemicals] (65 mmol) and F_2 [Air Products and Chemicals] (98 mmol) by condensation at -196° . The barricaded cylinder is heated for 5 days to 250° . The cylinder is allowed to cool by itself to ambient temperature and is then cooled to -196° . The unreacted F_2 and NF_3 are pumped off at -196° (the pump must be protected by a fluorine scrubber²⁸); during the subsequent warm-up of the cylinder to ambient temperature, $[\text{NF}_4][\text{SbF}_6]$ (10.1 g, 31 mmol, 100% yield based on SbF_3) is left behind as a solid residue. The product is either scraped out of the cylinder in the dry box or, more conveniently, dissolved in anhydrous HF that has been dried over BiF_3 .¹³ Small amounts of $\text{Ni}(\text{SbF}_6)_2$ and $\text{Cu}(\text{SbF}_6)_2$, formed as impurities in the attack of the Monel reactor by F_2 and SbF_3 , are only sparingly soluble in HF and are removed from the $[\text{NF}_4][\text{SbF}_6]$ solution by filtration using a porous Teflon filter [Pallflex]. If desired, the SbF_3 starting material can be replaced by SbF_5 [Ozark-Mahoning] without changing the remaining procedure.

*Anal.*²⁹ Calcd. for $[\text{NF}_4][\text{SbF}_6]$: NF, 21.80; Sb, 37.38. Found: NF, 21.73; Sb, 37.41.

Properties

Tetrafluoroammonium hexafluoroantimonate(V) is a hygroscopic, white crystalline solid that is stable to about 270°. ^{4,5,30} It is highly soluble in anhydrous HF (259 mg per g of HF at -78°)¹³ and moderately soluble in BrF₃. Its ¹⁹F NMR spectrum⁴ in anhydrous HF solution consists of a triplet of equal intensity at 214.7 ppm downfield from CFCI₃ ($J_{\text{NF}} = 231$ Hz) for [NF₄]⁺. The vibrational spectra⁵ of the solid exhibit the following major bands: IR (pressed AgCl disk): 1227 (mw), 1162 (vs), 675 (vs), 665 (vs), 609 (m) cm⁻¹. Raman 1160(0.6), 1150(0.2), 843(7.0), 665(1), 648(10), 604(3.9), 569(0.9), 437(1.5), and 275(3.8) cm⁻¹.

B. TETRAFLUOROAMMONIUM TETRAFLUOROBORATE(III)

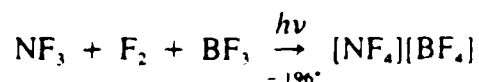

Procedure

■ **Caution.** *Ultraviolet goggles should be worn for eye protection when working with higher power UV lamps, and the work should be carried out in a fume hood. [NF₄][BF₄] is a strong oxidizer; contact with organic materials, fuels, and moisture must be avoided.*

The low-temperature UV photolysis reaction is carried out in a quartz reactor with a pan-shaped bottom and a flat top consisting of a 7.5-cm diameter optical grade quartz window (Fig. 1). The vessel has a side arm connected by a Teflon O-ring joint to a Fischer-Porter Teflon valve to facilitate removal of solid reaction products. The depth of the reactor is about 4 cm, and its volume is about 140 mL. The UV source consists of a 900-W, air-cooled, high pressure mercury arc (General Electric Model B-H6) positioned 4 cm above the flat reactor surface. The bottom of the reactor is kept cold by immersion in liquid N₂. Dry gaseous N₂ is used as a purge gas to prevent condensation of atmospheric moisture on the flat top of the reactor. As a heat shield, a 6-mm-thick quartz plate is positioned between the UV source and the top of the reactor.

Premixed NF₃ [Air Products] and BF₃ [Matheson] (27 mmol of each) are condensed into the cold bottom of the quartz reactor. Fluorine [Air Products, 9 mmol] is added, and the mixture is photolyzed at -196° for 1 hr. After termination of the photolysis, volatile material is pumped out of the reactor (through a scrubber²⁸) during its warm-up to room temperature. The nonvolatile white solid residue (1.0 g) is pure [NF₄][BF₄]. Instead of the pan shaped reactor, a simple round quartz bulb can be used with a [NF₄][BF₄] yield of about 0.5 g/hr.

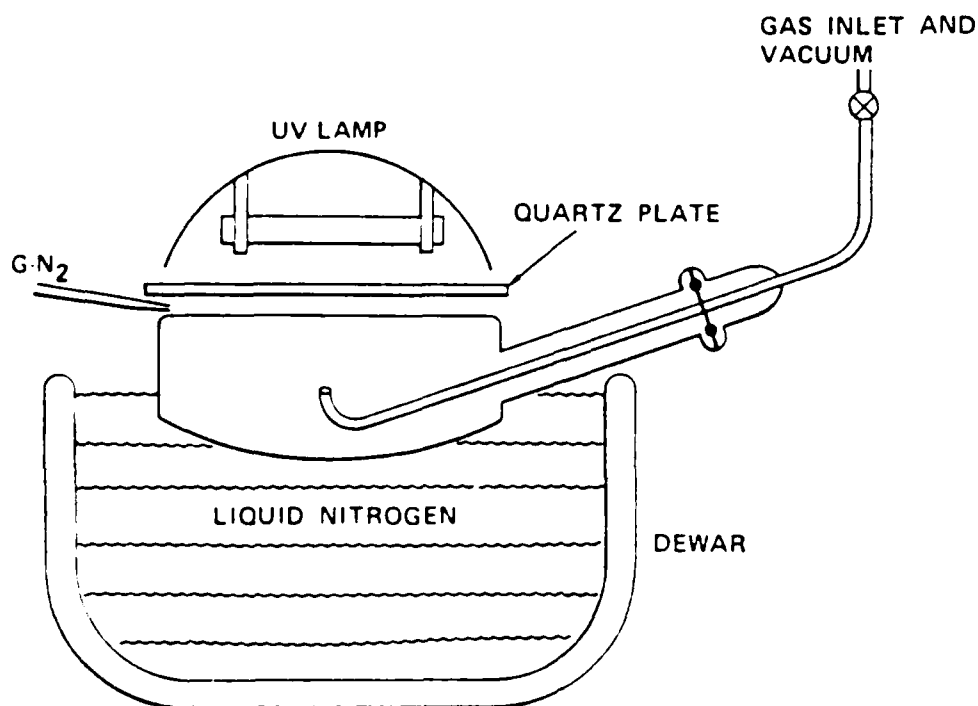

Fig. 1 Apparatus for synthesis of $[\text{NF}_4][\text{BF}_4]$.

Anal.²⁹ Calcd. for $[\text{NF}_4][\text{BF}_4]$: NF_3 , 40.16; B, 6.11. Found: NF_3 , 40.28; B, 6.1

Properties

Tetrafluoroammonium tetrafluoroborate(III) is a hygroscopic white crystalline solid that is stable up to about 150° .^{9, 11, 12, 30} It is highly soluble in anhydrous HF and moderately soluble in BrF_3 . Its ^{19}F NMR spectrum in anhydrous HF solution consists of a sharp triplet of equal intensity at δ 220 ppm downfield from CFCl_3 ($J_{\text{qf}} = 230$ Hz) for $[\text{NF}_4]^+$ and an exchange broadened singlet at δ -158 ppm upfield from CFCl_3 for $[\text{BF}_4]^-$. The vibrational spectra of the solid exhibit the following major bands: IR (pressed AgCl disk): 1298 (ms), 1222 (mw), 1162 (vs), 1057 (vs), 609 (s), and 522 (s) cm^{-1} . Raman: 1179(0.6), 1148(0.6), 1130(0+), 1055(0.2), 884(0+), 844(10), 772(3.2), 609(6.3), 524(0.4), 443(2.6), and 350(0.9) cm^{-1} .

C. TETRAFLUOROAMMONIUM (HYDROGEN DIFLUORIDE)

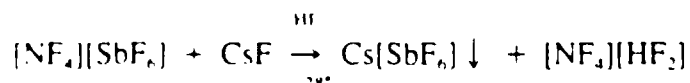

Procedure

■ **Caution.** *Anhydrous HF causes severe burns. Protective clothing should be worn when working with this material. The HF solutions of $[\text{NF}_4]^+$ salts are strongly oxidizing; contact with fuels must be avoided.*

A mixture of dry CsF [Kawecki Berylco] (2.361 g, 15.54 mmol) and $[\text{NF}_4][\text{SbF}_6]$ (5.096 g, 15.64 mmol) is placed inside the dry box into trap I of the leak-checked and passivated (with ClF_3 and dry HF^{13}) Teflon FEP Monel metathesis apparatus shown in Fig. 2. The CsF is dried by fusion in a platinum crucible, immediately transferred to the dry box, cooled, and finely ground. The apparatus is attached to a metal Teflon vacuum system²⁷ by two flexible corrugated Teflon tubes [Penntube Plastics], and the connections are vacuum leak-checked and passivated. The system is repeatedly exposed to anhydrous HF [Matheson], until the HF is colorless when frozen out at -196° in a Teflon U-trap of the vacuum system to avoid contamination of the product with any chlorine fluorides that may be adsorbed onto the walls of the metal vacuum system. Anhydrous HF^{13} (16.2 g, 810 mmol) is added to trap I, and the mixture is stirred magnetically for 1 hr at room temperature. The metathesis apparatus is cooled with powdered Dry Ice to -78° for 1 hr and then inverted. The HF solution that contains the

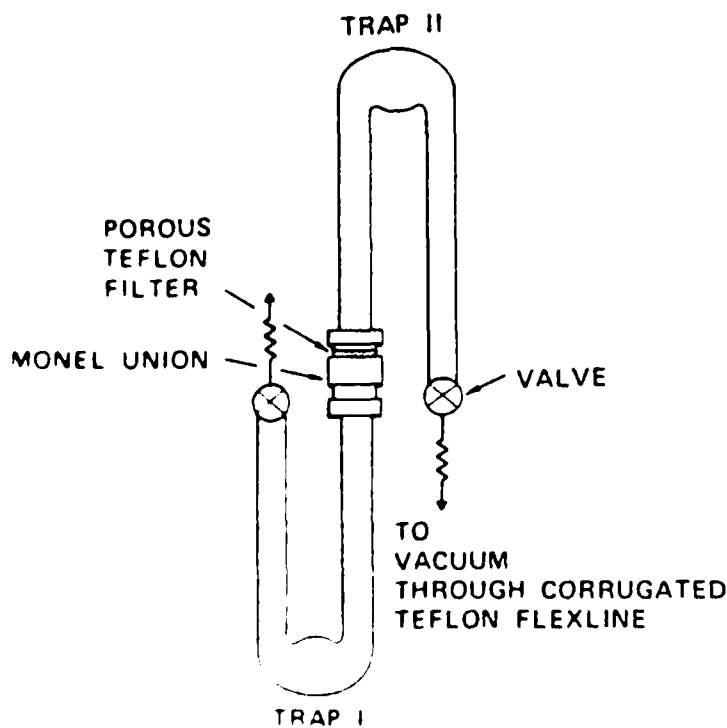

Fig. 2. Metathesis apparatus for $[\text{NF}_4][\text{HF}]$, $[\text{NF}_4][\text{MnF}_6]$, $[\text{NF}_4][\text{SiF}_6]$, and

$[\text{NF}_4][\text{HF}_2]$ is separated from the $\text{Cs}[\text{SbF}_6]$ precipitate by filtration. To facilitate the filtration step, trap I is pressurized with 2 atm of dry N_2 after inversion. A pressure drop in trap I indicates the completion of the filtration step. If desired, repressurization of trap I may be repeated to minimize the amount of mother liquor held up in the filter cake. The desired HF solution of $[\text{NH}_4][\text{HF}_2]$ is collected in trap II. It contains about 94% of the original $[\text{NF}_4]^+$ values, with the remainder being adsorbed on the $\text{Cs}[\text{SbF}_6]$ filter cake. The $[\text{NF}_4][\text{HF}_2]$ solution has a purity of about 97 mole % and contains small amounts of $\text{Cs}[\text{SbF}_6]$ (solubility of $\text{Cs}[\text{SbF}_6]$ in HF at -78° is 1.8 mg/g HF)¹³ and $[\text{NF}_4][\text{SbF}_6]$ (if a slight excess of $[\text{NF}_4][\text{SbF}_6]$ has been used in the reaction to suppress, by the common ion effect, the amount of dissolved $\text{Cs}[\text{SbF}_6]$).

An unstable solid having the composition $[\text{NF}_4][\text{HF}_2] \cdot n\text{HF}$ ($n = 2-10$) can be prepared by pumping off as much HF as possible below 0° .

Properties

Tetrafluoroammonium (hydrogen difluoride) is stable in HF solution at room temperature but decomposes to NF_3 , F_2 , and HF on complete removal of the solvent.¹⁵ The ^{19}F NMR spectrum of the solution shows a triplet of equal intensity of ϕ 216.2 ppm downfield from CFCl_3 with $J_{\text{NF}} = 230 \text{ Hz}$. The Raman spectrum of the HF solution has bands at 1170 (w), 854 (vs), 612 (m), and 448 (mw) cm^{-1} .

D. BIS(TETRAFLUOROAMMONIUM) HEXAFLUOROMANGANATE(IV)

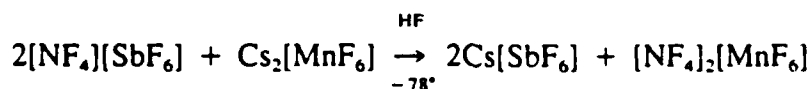

Procedure

■ **Caution.** *Anhydrous HF can cause severe burns; protective clothing should be worn when working with this solvent. $[\text{NF}_4]_2[\text{MnF}_6]$ is a strong oxidizer; contact with water and fuels must be avoided.*

The same apparatus is used as for synthesis C. In the dry N_2 atmosphere of a glove box, a mixture of $[\text{NF}_4][\text{SbF}_6]$ (37.29 mmol) and $\text{Cs}_2[\text{MnF}_6]$ ²⁰ (18.53 mmol) is placed in the bottom of a prepassivated (with ClF_3) Teflon FEP (fluoroethylene propylene copolymer) double U-tube metathesis apparatus. Dry HF¹³ (20 mL of liquid) is added at -78° on the vacuum line,²⁷ and the mixture is warmed to 25° for 30 min with stirring. The mixture is cooled to -78° and

pressure-filtered at this temperature. The HF solvent is pumped off at 30° for 12 hr, resulting in 14 g of a white filter cake (mainly Cs[SbF₆]) and 6.1 g of a yellow filtrate residue having the approximate composition (weight %): [NF₄]₂[MnF₆], 92, [NF₄][SbF₆], 4, Cs[SbF₆], 4. Yield of [NF₄]₂[MnF₆] is 87% based on Cs₂[MnF₆].

Properties

Bis(tetrafluoroammonium) hexafluoromanganate(IV) is a yellow crystalline solid that is stable at 65° but slowly decomposes at 100° to NF₃, F₂, and MnF₃.²⁰ It is highly soluble in anhydrous HF and reacts violently with water. Its ¹⁹F NMR spectrum in anhydrous HF solution shows a broad resonance at δ 218 ppm below CFCI₃, due to [NF₄]⁺. The vibrational spectra of the solid show the following major bands: IR (pressed AgCl disk): 1221 (mw), 1160 (vs), 620 (vs), and 338 (s) cm⁻¹. Raman: 855 (m), 593 (vs), 505 (m), 450 (w), and 304 (s) cm⁻¹.

E. BIS(TETRAFLUOROAMMONIUM) HEXAFLUROSILICATE(IV)



Procedure

■ **Caution.** *Anhydrous HF can cause severe burns, and protective clothing should be worn when working with liquid HF. All [NF₄]⁺ salts are strong oxidizers, and contact with fuels and water must be avoided.*

A solution of [NF₄][HF₂] (27 mmol) in anhydrous HF¹³ is prepared at -78° by synthesis C. Most of the HF solvent is pumped off during warm-up toward 0° until the first signs of decomposition of [NF₄][HF₂] are noted from the onset of gas evolution. The resulting residue is cooled to -196°, and SiF₄ [Matheson] (33 mmol) is added. The mixture is allowed to warm to ambient temperature while providing a volume of about 1 L in the vacuum line for expansion. During warm-up of the apparatus, the SiF₄ evaporates first and, upon melting of the [NF₄][HF₂] \cdot nHF phase, a significant reduction in the SiF₄ pressure is noted, resulting in a final pressure of about 400 torr. A clear, colorless solution is obtained without any sign of solid formation. The material volatile at 0° is pumped off and separated by fractional condensation through traps at -126 and -196°. The SiF₄ portion (about 22 mmol), trapped at -196°, is condensed back into the reactor, which contains a white fluffy solid. After this mixture has been kept at 25° for 24 hr, all volatile material is pumped off at 25° and the SiF₄ is separated again from the HF. The solid residue is treated again with the unreacted SiF₄ at

25° for 14 hr. The materials volatile at 25° are pumped off again. They contain less than 1 mmol of HF at this point. The solid residue is heated in a dynamic vacuum to 50° for 28 hr or until no further HF evolution is noticeable. The white solid residue (about 3.8 g, 80% yield) has the approximate composition (weight %): $[\text{NF}_4]_2[\text{SiF}_6]$ 95.0, $\text{Cs}[\text{SbF}_6]$ 2.2, $[\text{NF}_4][\text{SbF}_6]$ 2.3.

Properties

Bis(tetrafluoroammonium) hexafluorosilicate(IV) is a white crystalline solid that is stable at 25° but slowly decomposes at 90° to NF_3 , F_2 , and SiF_4 .²¹ The vibrational spectra of the solid show the following major bands: IR (pressed AgCl disk): 1223 (mw), 1165 (vs), 735 (vs,br), 614 (m), 609 (mw), 478 (s), and 448 (w) cm^{-1} . Raman: 1164 (1.5), 895 (0+), 885 (0+), 859 (10), 649 (3.2), 611 (5.8), 447,441 (3.8), and 398 (1) cm^{-1} .

F. TETRAFLUOROAMMONIUM PENTAFLUOROOXOTUNGSTATE(VI)

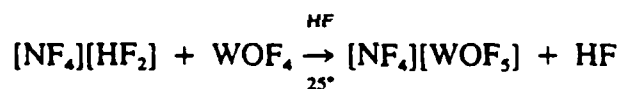

Procedure

■ **Caution.** *Anhydrous HF can cause severe burns. Protective clothing should be worn when working with liquid HF. All $[\text{NF}_4]^+$ salts are strong oxidizers, and contact with fuels and water should be avoided.*

A solution of 20 mmol of $[\text{NF}_4][\text{HF}_2]$ in 16 mL of dry HF^{13} is prepared at -78° by synthesis C and pressure-filtered into the second half of the metathesis double U-tube containing 14.6 mmol of WOF_4 .³¹ The mixture is stirred with a magnetic stirring bar for 30 min at 25°. The volatile material is pumped off at 25° for 12 hr. The solid residue (about 5 g, 86% yield based on WOF_4) has the approximate composition (weight %): $[\text{NF}_4][\text{WOF}_5]$ 96, $\text{Cs}[\text{SbF}_6]$ 2, $[\text{NF}_4][\text{SbF}_6]$ 2.

Properties

Tetrafluoroammonium pentafluorooxotungstate(VI) is a white crystalline solid that is stable at 55° but slowly decomposes at 85° to yield NF_3 , OF_2 , WF_6 , and $[\text{NF}_4][\text{W}_2\text{O}_2\text{F}_9]$.²⁵ The vibrational spectra of the solid show the following major bands: IR (pressed AgCl disk): 1221 (mw), 1160 (vs), 991 (vs), 688 (vs), 620 (vs,br), and 515 (vs) cm^{-1} . Raman: 1165 (0.7), 996 (10), 852 (8.4), 690 (5.4), 613 (4.9), 446 (1.6), 329 (6.8), and 285 (0.5) cm^{-1} .

References

1. K. O. Christe, W. W. Wilson, and E. C. Curtis, *Inorg. Chem.*, **22**, 3056 (1983).
2. A. A. Artyukhov and S. S. Koroshev, *Koord. Khim.*, **3**, 1478 (1977); K. O. Christe, W. W. Wilson, and R. D. Wilson, *Inorg. Chem.*, **23**, 2058 (1984).
3. K. O. Christe, J. P. Guertin, and A. E. Pavlath, U.S. Pat. 3503719 (1970).
4. W. E. Tolberg, R. T. Rewick, R. S. Stringham, and M. E. Hill, *Inorg. Chem.*, **6**, 1156 (1967).
5. K. O. Christe, R. D. Wilson, and C. J. Schack, *Inorg. Chem.*, **16**, 937 (1977).
6. K. O. Christe, C. J. Schack, and R. D. Wilson, *J. Fluorine Chem.*, **8**, 541 (1976).
7. W. W. Wilson and K. O. Christe, *J. Fluorine Chem.*, **15**, 83 (1980).
8. K. O. Christe, J. P. Guertin, and A. E. Pavlath, *Inorg. Nucl. Chem. Lett.*, **2**, 83 (1966); *Inorg. Chem.*, **5**, 1921 (1966).
9. S. M. Sinel'nikov and V. Ya. Rosolovskii, *Dokl. Akad. Nauk SSSR*, **194**, 1341 (1970).
10. K. O. Christe, R. D. Wilson, and A. E. Axworthy, *Inorg. Chem.*, **12**, 2478 (1973).
11. K. O. Christe, C. J. Schack, and R. D. Wilson, *Inorg. Chem.*, **15**, 1275 (1976).
12. C. T. Goetschel, V. A. Campanile, R. M. Curtis, K. R. Loos, D. C. Wagner, and J. N. Wilson, *Inorg. Chem.*, **11**, 1696 (1972).
13. K. O. Christe, W. W. Wilson, and C. J. Schack, *J. Fluorine Chem.*, **11**, 71 (1978).
14. W. E. Tolberg, private communication.
15. K. O. Christe, W. W. Wilson, and R. D. Wilson, *Inorg. Chem.*, **19**, 1494 (1980).
16. K. O. Christe, R. D. Wilson, and C. J. Schack, *Inorg. Chem.*, **19**, 3046 (1980).
17. K. O. Christe, C. J. Schack, and R. D. Wilson, *Inorg. Chem.*, **16**, 849 (1977).
18. K. O. Christe and C. J. Schack, *Inorg. Chem.*, **16**, 353 (1977).
19. K. O. Christe, *Inorg. Chem.*, **16**, 2238 (1977).
20. W. W. Wilson and K. O. Christe, *Inorg. Synth.*, **24**, 48 (1986).
21. W. W. Wilson and K. O. Christe, *J. Fluorine Chem.*, **19**, 253 (1982).
22. W. W. Wilson and K. O. Christe, *Inorg. Chem.*, **21**, 2091 (1982).
23. K. O. Christe and W. W. Wilson, *Inorg. Chem.*, **21**, 4113 (1982).
24. W. W. Wilson, R. D. Wilson, and K. O. Christe, *J. Inorg. Nucl. Chem.*, **43**, 1551 (1981).
25. W. W. Wilson and K. O. Christe, *Inorg. Chem.*, **20**, 4139 (1981).
26. K. O. Christe, W. W. Wilson, and C. J. Schack, *J. Fluorine Chem.*, **20**, 751 (1982).
27. K. O. Christe, R. D. Wilson, and C. J. Schack, *Inorg. Synth.*, **24**, 3 (1986).
28. G. H. Cady, *Inorg. Synth.*, **8**, 165 (1966).
29. R. Rushworth, C. J. Schack, W. W. Wilson, and K. O. Christe, *Anal. Chem.*, **53**, 845 (1981).
30. K. O. Christe, R. D. Wilson, and I. B. Goldberg, *Inorg. Chem.*, **18**, 2578 (1979).
31. W. W. Wilson and K. O. Christe, *Inorg. Synth.*, **24**, 37 (1986).

APPENDIX N
14. CESIUM HEXAFLUOROMANGANATE(IV)

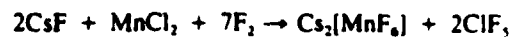

Submitted by WILLIAM W. WILSON* and KARL O. CHRISTE*
Checked by ROLAND BOUGON†

*Rocketdyne, A Division of Rockwell International Corp., Canoga Park, CA 91304
†Centre d'Études Nucléaires de Saclay, 91191 Gif sur Yvette, France

Several methods have been described in the literature for the syntheses of alkali metal hexafluoromanganates(IV). The reactions of $K_2[MnO_4]$,¹ MnO_2 , and KF mixtures, or $KMnO_4$ and 30% H_2O_2 ,² with aqueous HF produce $K_2[MnF_6]$. However, the yields and product purities are low. Pure alkali metal hexafluoromanganates(IV) are obtained in high yield by fluorination with F_2 in a flow system of either $MnCl_2 + 2MCl$ at 375 to 400°,^{3,4} $MnF_3 + 2KF$ in a rotating Al_2O_3 tube at 600°,⁵ or $MnCl_2 + 2KCl$ at 280°,⁶ or by the fluorination of a $KMnO_4$ -KCl mixture with BrF_3 .⁷ The method described below is based on the fluorination of a stoichiometric mixture of CsF and $MnCl_2$ in a static system at 400°. Hexafluoromanganate(IV) salts have interesting spectroscopic properties,^{8,10} and $Cs_2[MnF_6]$ is a starting material for the metathetical synthesis of $(NF_6)_2[MnF_6]$.¹¹

Procedure

■ **Caution.** Safety barricades must be used for carrying out high-pressure fluorination reactions. The CIF_3 - CIF_5 by-products are strong oxidizers. Contact with fuel, water, or reducing agents must be avoided.

Commercially available $MnCl_2 \cdot 4H_2O$ [Alfa] is dehydrated by heating in a Pyrex flask to 255° under vacuum (10^{-4} torr) for 24 hr. The completeness of the dehydration step is verified by recording the infrared spectrum, which should not show any water bands. Commercially available CsF [Kawecki Beryco] is dried by fusion in a platinum crucible and is immediately transferred to the dry box.

A mixture of finely ground dry CsF (7.717 g, 50.80 mmol) and $MnCl_2$ (3.150 g, 25.40 mmol) is placed inside the dry box into a prepassivated (with CIF_3) 95-mL high-pressure Monel cylinder (Hoke Model 4HSM, rated for 5000 psi working pressure) equipped with a Monel valve (Hoke, Model 3212M4M). The cylinder is attached to a metal-Teflon vacuum system,¹² evacuated, and cooled to -196° with liquid N_2 . Fluorine* (262 mmol) is condensed into the cylinder. The cylinder is disconnected from the vacuum line, heated in an oven to 400° for 36 hr, and then cooled again to -196° on the vacuum line. Unreacted F_2 is pumped off at -196° through a fluorine scrubber,¹² and the CIF_3 - CIF_5 byproducts are pumped off during the warm-up of the cylinder toward room temperature. The yellow solid residue (11.045 g, 100% yield) is pure $Cs_2[MnF_6]$.

Anal. Calcd. for $Cs_2[MnF_6]$: Cs, 61.14; Mn, 12.63. Found: Cs, 61.2; Mn, 12.5.

*[Air Products and Chemicals] Prior to use, the fluorine should be passed through a NaF scrubber to remove any HF present, which would promote attack of the Monel reactor as evidenced by the formation of some Cs_2NiF_6 .

Properties

Cesium hexafluoromanganate(IV) is a stable yellow solid that decomposes only slowly in moist air. The IR spectrum of the solid as a dry powder pressed between AgCl plates shows the following major absorptions: 620 (vs) (antisymmetric stretch) and 338 (s) (antisymmetric deformation) cm^{-1} . The Raman spectrum of the solid shows bands at 590 (vs) (symmetric in-phase stretch), 502 (m) (symmetric out-of-phase stretch), and 304 (s) (symmetric deformation) cm^{-1} .⁸ The compound $\text{Cs}_2[\text{MnF}_6]$ crystallizes at room temperature in the cubic $\text{K}_2[\text{PtCl}_6]$ system with $a = 8.92 \text{ \AA}$.⁴

References

- 1 R F Weinland and O Lauenstein, *Z Anorg Chem.* **20**, 40 (1899)
- 2 H Bode, H Jensen, and F Bante, *Angew Chem.* **65**, 304 (1953)
- 3 E Huss and W Klemm, *Z Anorg. Allgem Chem.* **262**, 25 (1950)
- 4 H Bode and W Wendt, *Z. Anorg. Allgem Chem.* **269**, 165 (1952)
- 5 C B Root and R A Sutula, Proc 22nd Ann Power Sources Conf., U S Army Electronics Command, 1968, p 100
- 6 T L Court, Ph D thesis, University of Nottingham, England, 1971.
- 7 A G Sharpe and A A Woolf, *J Chem Soc.* **1951**, 798.
- 8 K O Christie, W W Wilson, and R. D Wilson, *Inorg. Chem.* **19**, 3254 (1980).
- 9 C D Flint, *J Mol. Spectry.* **37**, 414 (1971).
- 10 S L Chodos, A M Black, and C. D Flint, *J. Chem. Phys.* **65**, 4816 (1976).
- 11 K O Christie, W W Wilson, C J Schack, and R. D Wilson, *Inorg. Synth.* **24**, 45 (1986)
- 12 K O Christie, R D Wilson, and C J Schack, *Inorg. Synth.* **24**, 3 (1986)

APPENDIX O

Reprinted from *Inorganic Chemistry*, 1986, 25, 2163
Copyright © 1986 by the American Chemical Society and reprinted by permission of the copyright owner.

Contribution from Rocketdyne, A Division of Rockwell International,
Canoga Park, California 91303

Synthesis and Characterization of CrF_4O , $\text{KrF}_2\text{-CrF}_4\text{O}$, and $\text{NO}^+\text{CrF}_5\text{O}^-$

Karl O. Christe,* William W. Wilson, and Roland A. Bougouf

Received January 14, 1986

Chromium(VI) tetrafluoride oxide can be prepared in high yield and purity from CrO_2F_2 and KrF_2 in HF solution. The vibrational spectra of gaseous, solid, and matrix-isolated CrF_4O and its BrF_3 and HF solutions are reported, as well as the ^{19}F NMR spectra of the BrF_3 and SO_2ClF solutions. The data confirm for gaseous, matrix-isolated, and dissolved CrF_4O a monomeric, square-pyramidal structure of symmetry C_{4v} and for solid CrF_4O a fluorine-bridged polymeric structure. CrF_4O is a strong Lewis acid, and with FNO it forms a stable $\text{NO}^+\text{CrF}_5\text{O}^-$ salt, which was characterized by vibrational spectroscopy. With KrF_2 it forms an unstable 1:1 adduct that has in the solid phase an essentially covalent structure containing a $\text{Kr-F}\cdots\text{Cr}$ bridge but is completely dissociated in SO_2ClF solution. With AsF_5 it does not form a stable adduct at temperatures as low as -78°C , indicating that CrF_4O is a weak Lewis base. It was also shown that CrF_4O is a weak Lewis base and does not form a stable adduct at -78°C

Introduction

Chromium tetrafluoride oxide, CrF_4O , was first described by Edwards in 1963 as a byproduct in the direct fluorination of metallic chromium, and its unit cell dimensions were reported.¹ In 1974, Edwards and co-workers published an improved synthesis from CrO_3 and F_2 at 220°C and gave the melting point, boiling point, vapor pressure, and description of a solid-solid transition

at 24°C .² Reference was made in this paper to unpublished work indicating that the low-temperature phase of CrF_4O has an endless, cis-fluorine-bridged chain structure, similar to those of MoF_4O ³ and ReF_4O .⁴ The only other report on CrF_4O is a recent paper by Ogden and co-workers, who studied its infrared and UV-visible

* Permanent address: Centre d'Etudes Nucleaires de Saclay, IRDI, DE SICP/DPC, 91191 Gif sur Yvette, France

- (1) Edwards, A. J. *Proc. Chem. Soc. London* 1963, 205.
- (2) Edwards, A. J.; Falconer, W. E.; Sunder, W. A. *J. Chem. Soc. Dalton Trans.* 1974, 541.
- (3) Edwards, A. J.; Stevenson, B. R. *J. Chem. Soc.* 1968, 2503.
- (4) Edwards, A. J.; Jones, G. R. *J. Chem. Soc.* 1968, 2503.

spectra in N_2 matrices.⁵ From a measurement of the chromium isotopic shifts and relative intensities they concluded that monomeric CrF_4O has a square-pyramidal structure of symmetry C_{4v} and an $OCrF$ bond angle of about 106° . In addition, they found that CrF_4O combines with CsF and that the resulting 1:1 adduct has infrared bands at 955 cm^{-1} ($\nu(Cr=O)$) and $650\text{--}720\text{ cm}^{-1}$ ($\nu(Cr-F)$).⁵ In this paper we present the results from an independent study that was undertaken in our laboratory before the paper of Ogden et al. appeared. It includes a new synthesis for CrF_4O and spectroscopic data for CrF_4O in the gas phase, in the solid state, and in different solvents. In addition, the previously reported matrix isolation data⁵ were confirmed and the amphoteric nature of CrF_4O was studied.

Experimental Section

Apparatus. Volatile materials were manipulated in stainless-steel vacuum lines equipped with Teflon-FEP U-traps, 316 stainless-steel bellows-seal or Teflon-PFA (Fluoroware, Inc.) valves, and a Heise Bourdon tube-type pressure gauge.⁶ Either Teflon-FEP ampoules or sapphire tubes (Tycos Co.) equipped with stainless-steel or Teflon valves were used as reaction vessels. The vacuum lines and other hardware employed were passivated with ClF_3 and BrF_3 and, if HF was to be used, with HF. Nonvolatile or marginally volatile materials were handled in the dry nitrogen atmosphere of a glovebox.

Infrared spectra were recorded in the range $4000\text{--}200\text{ cm}^{-1}$ on a Perkin-Elmer Model 283 spectrophotometer. Spectra of solids were obtained by using dry powders pressed between $AgCl$ or $AgBr$ windows in an Econo press (Barnes Engineering Co.). Spectra of gases were obtained by using a Teflon cell of 5-cm path length equipped with $AgCl$ windows. Matrix isolation spectra were obtained at 6 K with an Air Products Model DE202S helium refrigerator equipped with CsI windows. Research-grade Ne and N_2 (Matheson) were used as matrix materials in mole ratios of 400:1. Raman spectra were recorded on either a Cary Model 83 or a Spex Model 1403 spectrophotometer using the 488-nm exciting line of an Ar ion laser or the 647.1-nm exciting line of a Kr ion laser, respectively. Sealed quartz, Teflon-FEP, and sapphire tubes were used as sample containers in the transverse-viewing-transverse-excitation mode. A previously described⁷ device was used for recording the low-temperature spectra. The ^{19}F NMR spectra of the samples contained in sealed, 5 mm o.d. Teflon-FEP tubes (Wilmad Glass Co.) were recorded at 84.6 MHz on a Varian Model EM390 spectrometer equipped with a variable-temperature probe. X-ray diffraction patterns of the powdered samples in sealed 0.5-mm quartz capillaries were obtained by using a General Electric Model XRD-6 diffractometer, Ni-filtered $Cu\ K\alpha$ radiation, and a 114.6-mm-diameter Philips camera.

Materials. Literature methods were used for the syntheses of FNO^+ and CrO_2F_2 ,⁸ and for the drying of HF.¹⁰ For KrF_2 , the literature method involving UV photolysis of Kr and liquid F_2 in Pyrex¹¹ was modified by the use of a stainless-steel reactor equipped with a sapphire window.¹² AsF_3 and SO_2ClF (Ozark Mahoning) and BrF_3 (Matheson) were purified by fractional condensation prior to their use.

Synthesis of CrF_4O . Into a passivated 0.75 in. o.d. Teflon-PFA U-tube attached to two Teflon-PFA valves (Fluoroware, Inc.) was condensed a weighed amount (5.50 mmol) of KrF_2 at $-78^\circ C$ under a dynamic vacuum. Then CrO_2F_2 (5.6 mmol) and dry HF (~ 2.3 mL of liquid) were added at $-196^\circ C$. The mixture was allowed to warm from $-196^\circ C$ to ambient temperature. The resulting dark brown solution was kept at ambient temperature for 2 days until no further gas evolution was observed and the color of the solution had changed from brown to purple. The mixture was cooled to $-196^\circ C$, and oxygen (2.7 mmol) was measured. The residue was separated on warmup from $-196^\circ C$ by fractional condensation under a dynamic vacuum through a series of cold traps kept at -31 , -78 , -126 , and $-210^\circ C$. The following products were collected in these traps: -31 (CrF_4O , 5.5 mmol), -78 (small amount of CrO_2F_2), -126 (HF), -196 (Kr , 5.5 mmol). CrF_4O was characterized by its

vibrational and ^{19}F NMR spectra and its melting point ($55^\circ C$) and vapor pressure.²

Synthesis of $NO^+CrF_3O^-$. Into a passivated 0.5 in. o.d. Teflon-FEP U-tube, attached to two Teflon valves, were condensed CrF_4O (0.957 mmol) and FNO (2.15 mmol) at $-196^\circ C$. The contents of the tube were allowed to warm to ambient temperature. At first a dark red-brown solid formed, which turned progressively lighter and finally resulted in a pink color. The material volatile at $25^\circ C$ was pumped off and consisted of FNO (1.19 mmol), leaving behind 185.3 mg (weight calculated for 0.957 mmol of $NO^+CrF_3O^-$ 184.7 mg) of a pink solid that was characterized by vibrational spectroscopy as $NO^+CrF_3O^-$ and according to its DSC analysis starts to decompose exothermically at about $237^\circ C$. Its X-ray powder pattern showed the following d spacings (\AA): 6.51 w, 5.94 vw, 5.12 m, 4.84 vs, 4.46 mw, 4.02 vs, 3.89 vw, 3.342 vs, 3.005 mw, 2.882 m, 2.231 ms, 2.015 w, 1.992 w, 1.949 w, 1.914 vw, 1.845 w, 1.799 w, 1.770 w, 1.717 w, 1.677 w, 1.586 w, 1.511 vw, 1.453 vw, 1.426 vw, 1.409 vw.

The CrF_4O - AsF_3 System. Into a 0.5 in. o.d. sapphire tube, capped off by a Teflon valve, were condensed CrF_4O (0.370 mmol) and AsF_3 (0.515 mmol) at $-196^\circ C$. The temperature of the mixture was cycled several times between -196 and $25^\circ C$. In contrast with pure CrF_4O , which exhibits a purple color in the gas phase, the gaseous AsF_3 - CrF_4O mixture did not show any detectable color at $25^\circ C$ and the color of the solid in the bottom of the tube had changed from the dark purple of CrF_4O to a red-brown. The mixture was cooled to $-78^\circ C$, and the volatile material was pumped off. It consisted of AsF_3 (0.50 mmol). The residue, non-volatile at $-78^\circ C$, consisted of CrF_4O (0.37 mmol), indicating that CrF_4O does not form a stable adduct with AsF_3 at temperatures as low as $-78^\circ C$.

The CrF_3O - AsF_3 System. When CrF_3O (obtained from the reaction of CrF_4O -HF mixtures in stainless-steel equipment) was treated with an excess of AsF_3 , as described above for the CrF_4O - AsF_3 system, all the AsF_3 starting material was quantitatively recovered by pumping on the mixture at $-78^\circ C$.

Results and Discussion

CrF_4O Synthesis. The reaction of CrO_2F_2 with KrF_2 in anhydrous HF solution at room temperature provides a new synthesis for CrF_4O . The reaction proceeds quantitatively according to

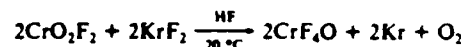

The reaction is initially slow, as can be judged from the color of the HF solution, but once started it proceeds faster. The use of steel equipment should be avoided for this reaction because a mixture of HF and CrF_4O rapidly attacks steel with formation of CrF_3O .

The use of a twofold excess of KrF_2 in the above reaction did not result in additional oxygen-fluorine exchange and concomitant CrF_3 formation. Instead, the formation of an unstable 1:1 adduct between CrF_4O and KrF_2 was observed. When it was warmed to room temperature, the KrF_2 - CrF_4O adduct slowly decomposed with Kr , F_2 , and CrF_4O evolution. The nature of the adduct was studied and will be discussed below. In view of the tendency of CrF_4O to form an adduct with an excess of KrF_2 and the relative ease of separating CrF_4O from CrO_2F_2 by fractional condensation using trapping temperatures of $-31^\circ C$ (bromobenzene slush bath) for CrF_4O and $-78^\circ C$ for CrO_2F_2 , the use of a slight excess of CrO_2F_2 is preferable for the synthesis of CrF_4O .

The previously reported method^{2,11} for the synthesis of CrF_4O involved the fluorination of CrO with F_2 at elevated temperature and pressure in a Monel reactor with a water-cooled lid. This method requires careful temperature control. The recommended conditions are $140^\circ C$ with yields of 25% of CrF_4O and 75% of CrO_2F_2 . If the reaction temperature is increased the yield of CrF_4O increases but CrF_3 is obtained as a byproduct, which is very difficult to separate from CrF_4O .¹¹ It thus appears that the advantage of the previous method^{2,11} of more readily available starting materials (CrO + F_2 vs CrO_2F_2 + KrF_2) is mitigated by lower yields, more complex hardware requirements, and more difficult product purification.

Preparation. CrF_4O was identified by its vapor pressure, melting point ($55^\circ C$), and vibrational spectra (see below). It is highly soluble in BrF_3 , SO_2ClF , and anhydrous HF. The ^{19}F NMR spectrum of CrF_4O in BrF_3 at $40^\circ C$ shows a broad singlet ($\delta = 0$) at 400 ppm and in SO_2ClF between 100 and 150 ppm.

- (5) Hope E G, Jones P J, Loveman W, Ogden J S, Tark M, Turff J W. *J Chem Soc Dalton Trans* 1988, 529.
- (6) Christe R O, Wilson R D, Schack C J. *Inorg Synth* 1986, 24, 1.
- (7) Miller F A, Harvey B M. *Appl Spectrosc* 1980, 34, 8.
- (8) Christe R O. *Inorg Chem* 1973, 12, 1500.
- (9) Jordan P J. *Coord Chem Rev* 1977, 6, 241.
- (10) Christe R O, Wilson W W, Schack C J. *J Fluorine Chem* 1978, 1, 171.
- (11) Shriver J, Smith A, Lutz A, Zenne B, Fritz B. *J Fluorine Chem* 1979, 1, 221.
- (12) Baughman R, Burley T, Lance M, Alford H. *Inorg Chem* 1984, 23, 146.

Table I. Vibrational Spectra (cm⁻¹) of Monomeric and Polymeric CrF₅O Compared to Those of MoF₅O

RA, HF soln	CrF ₅ O						MoF ₅ O				
	monomer			polymer			polymer				
	RA, BrF ₃ soln	IR, matrix	IR, gas (C _{4v})	IR solid		RA solid	monomer IR gas ^a	IR solid ^b	RA solid ^c		RA melt ^d
1008 w, br	1027 m, p	1028	1028 m (ν ₁ (A ₁)) 828 vw	998 s	996 s	999 ms 789 mw 718 sh	1049 (ν ₁)	1035 s 735 sh 715 m	1039 s 740 m 721 mw	1042 s 740 m 721 mw	712 s, p
677 vs	d	746, 742 686	755 vs (ν ₂ (E)) 695 ms (ν ₂ (A ₁))	709 vs	725 vs, br	704 s 692 ms 666 mw 650 vs	721 vs (ν ₂) (721) (ν ₂)	700 vs 690 sh	706 s 692 vw, sh		
590-570 w, vbr				665 ms	660 ms			665 s	661 m	668 s	665 m, p
				530 m	525 m	528 vw 517 vw 377 w		538 m 508 m	530 vw 506 vw 334 w, sh 316 mw	571 w 529 w 506 vw 333 m	
					336 m	350 mw			308 mw	309 ms	310 m
345 w	340 mw, dp	320	(ν ₃ (E))			299 w 273 w 260 sh 188 vw			258 m 244 w, sh	275 w	244 vw, br
	269 w, p	277 271	(ν ₃ (E)) (ν ₃ (A ₁))						222 m 216 vw, sh		
									172 w 122 w		

^aReference 13. ^bApproximate frequencies from ref 3. ^cReference 19, for the solid two different spectra were obtained depending on whether the sample had been prepared by sublimation or by solidification of the melt. ^dObscured by BrF₃ solvent band.

°C a narrow singlet (~20 Hz) at about 485 ppm downfield from external CFC₃. This suggests that all four fluorines are equivalent as expected for a monomeric, square-pyramidal CrF₅O molecule. This was also confirmed by Raman spectroscopy (see below). CrF₅O is stable in passivated steel, Teflon, or flamed-out quartz but not in Pyrex.

Vibrational Spectra and Structure. The square-pyramidal tetrafluoride oxides of Mo, W, and Re are rare exceptions¹³ to the Gillespie-Nyholm valence shell electron pair repulsion (VSEPR) theory,¹⁴ which predicts for pentacoordinated XF₅O molecules C_{4v} symmetry, i.e. a trigonal-bipyramidal structure. Whereas the square-pyramidal structures of monomeric WF₅O and MoF₅O are well-established by electron diffraction studies,^{13,16} the only previous evidence for CrF₅O having an analogous C_{4v} structure was based on a recent infrared matrix isolation study.³ The results of our study confirm the previous matrix data³ and provide additional data on the infrared spectrum of the gas, the Raman spectra of its solutions, and the infrared and Raman spectra of solid, polymeric CrF₅O.

We were in the process of studying the infrared spectra of CrF₅O in nitrogen and neon matrices when we learned of the independent work at the University of Southampton.³ Since our data for the N₂ matrices were in excellent agreement with the results of the Southampton group, we discontinued that part of our study. Our results for the neon matrices raise, however, one minor question concerning the splitting of ν₂(E) into two components in the N₂ matrix. This splitting has been attributed to a matrix site effect.³ Since in the neon matrix a similar splitting is observed for ν₂, alternate explanations might have to be considered.

The infrared spectra of gaseous CrF₅O (see Figures 1 and 2 and Table I) provide further evidence for a monomeric CrF₅O molecule of symmetry C_{4v}. A six-atom XF₅O molecule of symmetry C_{4v} has nine fundamental vibrations, which are classified as 1A₁ + 2B₁ + B₂ + 1E, of which only the A₁ and the E modes are infrared active. Of the six infrared active modes three are stretching vibrations and are the only ones expected to occur above the cutoff frequency of the AgCl windows used. As can be seen from Figure 1, three bands were observed and their frequencies

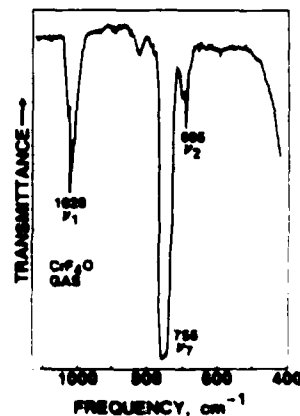

Figure 1. Infrared spectrum of gaseous CrF₅O at 13 torr in a 5-cm Teflon cell with AgCl windows.

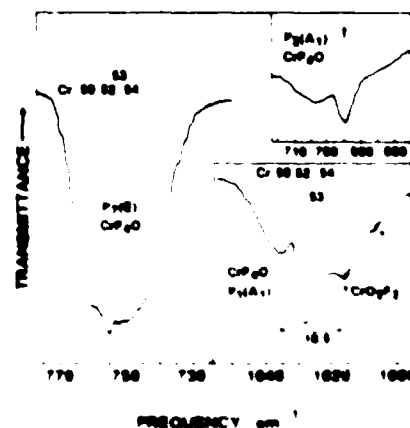

Figure 2. Infrared band contours of gaseous CrF₅O and its matrix isolations in Kr and Ne. The 100% transmittance indicates the relative abundance and splitting of the chromium isotopes as observed in matrix isolation (Fig. 1). The band contour of ν₂ is slightly distorted by the presence of the ν₁ band.

are in good agreement with the matrix data.³ Additional evidence for the C_{4v} structure comes from the observed band contours, see

1. Paine, R. T.; McIlroy, B. N. *J. Chem. Phys.* 1974, 61, 1164.
2. Gillespie, R. T. *Molecular Geometry*; Van Nostrand Reinhold: London, 1970.
3. Babin, A. G.; Hedberg, K.; Hedberg, L. *J. Mol. Spectr.* 1977, 67, 155.
4. Jones, R. *Rev. Phys. Chem.* 1977, 51, 171.

Figure 2). Although these contours are complicated by the presence of four chromium isotopes (^{50}Cr , 4.5%; ^{52}Cr , 83.8%; ^{53}Cr , 9.4%; ^{54}Cr , 2.3%), the PR branch splittings of about $18\text{--}19\text{ cm}^{-1}$ for the A_1 parallel bands and of about 12 cm^{-1} for the perpendicular band of species E are in good agreement with a previous analysis for square-pyramidal MoF_5O , WF_5O , and ReF_5O .¹³ In all infrared spectra of gaseous CrF_5O we have observed a weak infrared band at 826 cm^{-1} of constant relative intensity. This band is probably due to a combination band or overtone of CrF_5O but at the present time cannot positively be assigned.

Since CrF_5O is highly soluble in both BrF_3 and HF , it was possible to obtain partial Raman spectra for solutions. In agreement with the ^{19}F NMR data (see above), the Raman data (see Table I) suggest that CrF_5O is monomeric in BrF_3 solution. Within experimental error the $\text{Cr}=\text{O}$ stretching frequency for the BrF_3 solution is identical with those of the gas and the matrix-isolated species. Although the symmetric CrF_4 stretching mode, $\nu_2(A_1)$, was obscured by an intense BrF_3 band, two deformation modes were observable at 340 and 269 cm^{-1} . The latter was polarized, thus confirming its assignment to the symmetric CrF_4 deformation mode, $\nu_3(A_1)$, as previously proposed.⁵

For the HF solution of CrF_5O , a relatively broad band at 1008 cm^{-1} and a very intense band at 677 cm^{-1} were observed in the $\text{Cr}=\text{O}$ and $\text{Cr}-\text{F}$ stretching mode regions, respectively. Their frequencies are intermediate between those of monomeric CrF_5O (see Table I) and CrF_5O^- (see below). Therefore, it is not unreasonable to attribute these observed bands to a polyanion such as $\text{Cr}_2\text{F}_9\text{O}_7^{2-}$ formed according to



This interpretation is in accord with previous results obtained for the $\text{HF}-\text{MoF}_5\text{O}$ and $\text{HF}-\text{WF}_5\text{O}$ systems¹⁷ and is further supported by the observation of a broad weak Raman band at about 580 cm^{-1} , similar to that observed at 576 cm^{-1} for $\text{Mo}_2\text{F}_9\text{O}_7^{2-}$.¹⁸

The ^{19}F NMR spectrum of the HF solution of CrF_5O at -30°C was also recorded and showed in addition to the HF signal at $\phi -199$ a very broad unresolved signal at $\phi 467$. The upfield shift of 21 ppm relative to monomeric CrF_5O in BrF_3 (see above) parallels that previously observed for WF_5O and $\text{W}_2\text{F}_9\text{O}_7^{2-}$.¹⁷

The infrared and Raman spectra of solid CrF_5O are shown in Figure 3. A comparison of the observed spectra to those of solid MoF_5O ¹⁹ (see Table I) shows close similarities, indicating similar structures for the two compounds, i.e. endless cis-fluorine-bridged chains of XF_5O pseudooctahedrons.¹ For solid MoF_5O , two slightly different Raman spectra have been reported¹⁹ for sublimed MoF_5O and the solidified melt, respectively (see Table I). Although CrF_5O is known² to undergo a solid-solid phase transition at 24°C , the Raman spectra of sublimed CrF_5O and of the solidified melt were found to be identical within experimental error. It appears that the polymorphism observed for both MoF_5O and CrF_5O may involve only slightly different packings of the chains and that the packings in MoF_5O may differ from those in CrF_5O , as indicated by the fact that sublimed MoF_5O and CrF_5O have vastly different unit cells and X-ray powder patterns.

Amphoteric Nature. By analogy with MoF_5O ¹⁶ and WF_5O ¹¹ and on the basis of its vibrational spectra (see above), monomeric CrF_5O has a square-pyramidal structure of symmetry C_4 . This square-pyramidal-type structure differs only very little in energy from that of the more common trigonal bipyramid.¹⁴ Since trigonal-bipyramidal molecules generally exhibit a very pronounced tendency to form both tetrahedral cations and octahedral anions²⁰

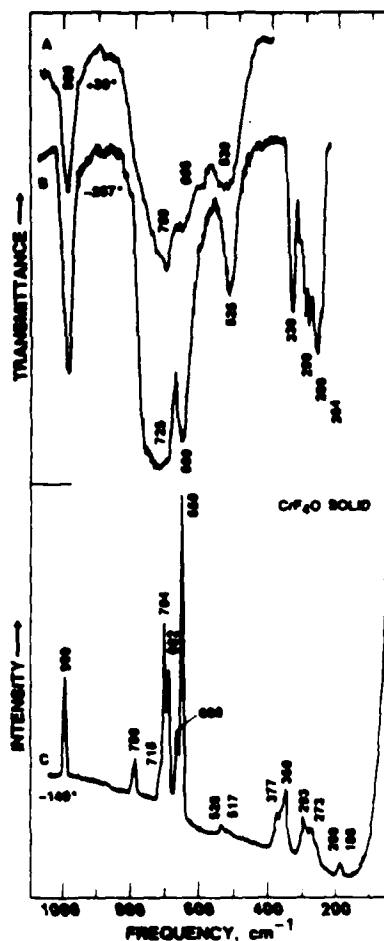
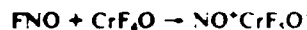

Figure 3. Vibrational spectra of solid CrF_5O : (A) infrared spectrum of the solid between AgCl disks at room temperature; (B) infrared spectrum of the solid at 6 K on a CsI window; (C) Raman spectrum of the solid in a quartz tube recorded at -140°C with 647.1-nm excitation

it was interesting to explore whether square-pyramidal molecules, such as CrF_5O , exhibit a similarly strong amphoteric character. It was found that CrF_5O is a very strong Lewis acid, capable of forming a stable NO^+ salt with FNO



On the basis of its DSC, $\text{NO}^+\text{CrF}_5\text{O}^-$ starts to decompose exothermically at about 237°C with formation of the polyanion salt $\text{NO}^+\text{CrF}_5\text{O}^- \cdot n\text{CrF}_5\text{O}$, which was characterized by its infrared spectrum (see below).

The Lewis basicity of CrF_5O was also studied. With AsF_5 it does not form a stable adduct at temperatures as low as -78°C . This indicates that CrF_5O is a rather weak Lewis base. A similar behavior has previously been found for MoF_5O , WF_5O , and ReF_5O . For example, MoF_5O and WF_5O form with the strong Lewis acid SbF_5 only marginally stable 1:1 adducts that consist of either fluorine-bridged zigzag chains ($\text{MoF}_5\text{O} \cdot \text{SbF}_5$) or dimers containing eight-membered rings with two Re , two Sb , and four F atoms ($\text{ReF}_5\text{O} \cdot \text{SbF}_5$).²¹ It therefore appears that all these square-pyramidal molecules are strong fluoride ion acceptors (Lewis acids) but relatively weak F^- donors (Lewis bases).

$\text{NO}^+\text{CrF}_5\text{O}^-$ Synthesis and Properties. CrF_5O combines with FNO in a 1:1 mole ratio to yield the solid adduct $\text{NO}^+\text{CrF}_5\text{O}^-$. The compound is a stable crystalline pink solid. Its ionic nature

(17) Bousquet, R.; Buisson, M.; Charpin, P. *Inorg. Chim. Acta* 1974, 4, 322.

(18) Bousquet, R.; Charpin, P. *Inorg. Chim. Acta* 1972, 5, 1029.

(19) Bousquet, R.; Livingston, A. M.; Reynolds, D. J. *Inorg. Chim. Acta* 1976, 210.

(20) Christe, K. O.; Schack, C. J.; Pilipovich, D. *Inorg. Chim. Acta* 1972, 220.

(21) Fawcett, J.; Holmes, J. H.; Russell, D. R. *J. Chem. Soc. Chem. Commun.* 1961, 222.

Table II. Vibrational Spectra (cm⁻¹) of CrF₃O⁻ Compared to Those of MoF₃O⁻ and WF₃O⁻

assign in point group C _{2v}	approx describe of mode	NO ⁺ CrF ₃ O ⁻		NO ⁺ MoF ₃ O ⁻ ^a		Cs ⁺ MoF ₃ O ⁻ ^a		NO ⁺ WF ₃ O ⁻ ^a		Cs ⁺ WF ₃ O ⁻ ^a	
		IR (25 °C)	RA (-140 °C)	IR	RA	IR	RA	IR	RA	IR	RA
$\nu_1(A_1)$	$\nu(XO)$	980 s	993 vs	990 s	985 (10)	973 vs	973 vs	1003 s	1001 (10)	987 vs	989 vs
$\nu_2(A_1)$	$\nu_2(XF_2)$		613 s		665 (7.2)	662 vw	666 m	680 sh	684 (3.5)	686 w	689 m
$\nu_3(A_1)$	$\nu(XF)$	520 sh	530 sh	436 ms		492 m		455 ms		507 m	
$\nu_4(A_1)$	$\delta_s(XF_2)$		302 m		293 (1)	300 w			292 sh	286 m	287 vw
$\nu_5(B_1)$	$\nu_2(XF_2)$		577 m		557 (0.6)		(580)		591 (0.4)		594 vw
$\nu_6(B_1)$	$\delta(XF_2)$										
$\nu_7(B_2)$	$\delta_{\text{asym}}(XF_2)$										
$\nu_7(E)$	$\nu_{\text{as}}(XF_2)$	586 vs. br		650 vs. br		605 vs		610 vs. br		608 vs	
$\nu_8(E)$	$\delta(OXF_2)$	330 m	346 mw		317 (6.2)		324 m		327 (5.9)	329 s	331 m
$\nu_{10}(E)$	$\delta(F'XF_2)$	279 m	277 m			252 s				242 s	
$\nu_{11}(E)$	$\delta_{\text{as}}(XF_2)$										

^aReference 17. ^bReference 22.

Figure 4. Vibrational spectra of solid NO⁺CrF₃O⁻: (A) infrared spectrum of a mixture of NO⁺CrF₃O⁻ and NO⁺CrF₃O⁻*m*CrF₃O between AgCl disks at room temperature; (B) infrared spectrum of NO⁺CrF₃O⁻ on AgCl disks at room temperature; (C) Raman spectrum of solid NO⁺CrF₃O⁻ in a glass capillary recorded at -140 °C with 647.1-nm excitation.

was established by infrared and Raman spectroscopy (see Figure 4 and Table II), which shows the characteristic NO⁺ stretching mode at about 2310 cm⁻¹.¹⁷ The assignments for CrF₃O⁻ in point group C_{2v} were made by analogy with those previously reported^{17,22} for MoF₃O⁻ and WF₃O⁻ (see Table II) and show plausible trends if the corresponding mass and coupling effects are taken into consideration. Of the given assignments, those for ν_1 , ν_2 , and ν_3 are firm while those for ν_4 , ν_6 , ν_7 , ν_8 , and ν_{10} are somewhat tentative.

A comparison of the vibrational spectra of NO⁺CrF₃O⁻ with the two previously reported bands³ for Cs⁺CrF₃O⁻ shows substantial frequency differences. The drop in the Cr—O stretching frequency by 25 cm⁻¹ from NO⁺CrF₃O⁻ (980 cm⁻¹) to Cs⁺CrF₃O⁻ (955 cm⁻¹) is larger but similar to those previously found^{17,22} for the corresponding NO⁺-Cs⁺ couples of MoF₃O⁻ and WF₃O⁻ and most likely is caused to some extent by the different degree of anion-cation interactions. The large frequency increase of about 100 cm⁻¹ for the antisymmetric CrF₂ stretching mode from NO⁺CrF₃O⁻ to Cs⁺CrF₃O⁻ is more difficult to explain. This band is generally very broad, and the choice of the band center can be difficult. However, in this case the shift is opposite to that reported for the NO⁺MoF₃O⁻ and Cs⁺MoF₃O⁻ couple and the

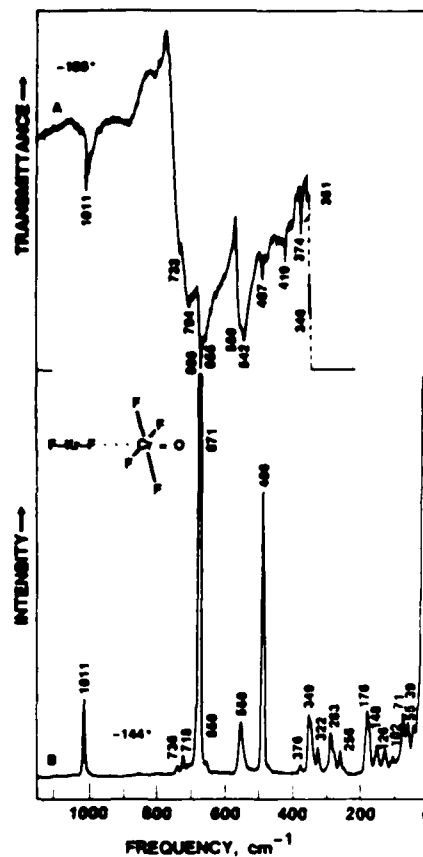

Figure 5. Vibrational spectra of solid KrF₂-CrF₃O⁻: (A) infrared spectrum of the solid between AgCl disks at -196 °C (broken line indicates absorption due to the AgCl window material); (B) Raman spectrum of the solid in a quartz capillary recorded at -144 °C with 647.1-nm excitation.

reported Cs⁺CrF₃O⁻ value (650–720 cm⁻¹) is outside the range (550–650 cm⁻¹) of this band in NO⁺CrF₃O⁻ but falls within the range observed for the polyanion CrF₃O⁻*m*CrF₃O (see below). A comparison of the data of Table II shows that for the NO⁺ and Cs⁺ salts of MoF₃O⁻ and WF₃O⁻ there are also some large frequency shifts for the bands assigned to the X—F stretching mode $\nu_3(A_1)$.^{17,22} At this time it is difficult to say to what extent these shifts are for real.

The infrared spectrum of a mixture of NO⁺CrF₃O⁻ and NO⁺CrF₃O⁻*m*CrF₃O obtained by controlled pyrolysis of NO⁺CrF₃O in a DSC cell is shown as trace A in Figure 4. Compared to that of NO⁺CrF₃O⁻ the spectrum shows the expected changes, i.e., both the Cr—O and Cr—F stretching modes are shifted toward higher frequencies, which are intermediate between those of CrF₃O and solid CrF₃O. These data indicate that salts such as

Table III. Vibrational Spectra (cm^{-1}) and Relative Intensities^a of Solid $\text{KrF}_2\cdot\text{CrF}_4\text{O}$ Compared to Those of KrF_2 , $\text{KrF}_2\cdot\text{MoF}_4\text{O}$, and $\text{KrF}_2\cdot\text{WF}_4\text{O}$

KrF_2^b		$\text{KrF}_2\cdot\text{CrF}_4\text{O}$		$\text{KrF}_2\cdot\text{MoF}_4\text{O}^c$	$\text{KrF}_2\cdot\text{WF}_4\text{O}^c$	assign ^t
IR (gas)	RA (gas, solid)	IR (-196 °C)	RA (-144 °C)	RA	RA	
		1011 m	1011 (1.1)	1034 (1.2), 1025 (3.3)	1041 (0.8), 1034 (4.5)	$\nu(\text{X}=\text{O})$
		733 w	736 (0.05)	702 (0.5)		
		704 s	718 (0.2)	698 (0.7)	712 (0.4)	
		668 s	671 (10)	691 (6.3)	706 (1.8)	$\nu_s(\text{XF}_4)$ (in phase)
		655 vs	650 (0.1)	661 (0.2)		$\nu_{as}(\text{XF}_4)$
			550 (0.7)	582 (1.6)	611 (0.3)	$\nu_s(\text{XF}_4)$ (out of phase)
588 vs		550 sh	550 (0.7)	579 (5.3)	581 (4.5)	} $\nu(\text{Kr}-\text{F}_t)^d$ or $\nu_{as}(\text{KrF}_2)$
		542 vs		566 (10)	571 (10)	
					504 (0.4)	
	462 (s) (10)	487 w	486 (4.1)	479 (4.0)	469 (1.7)	} $\nu(\text{Kr}-\text{F}_b)^d$ or $\nu_s(\text{KrF}_2)$
	449 (g) (10)			462 (5.9)	450 (4.2)	
		419 w				$\nu(\text{F}_b-\text{---Cr})^d$
		374 w	376 (0.1)			
		351, 341 w	349 (0.8)	312 (3.6)	312 (1.6)	$\delta(\text{OXF}_4)$
			322 (0.3)	303 (1.5)	301 (1.2)	$\delta_s(\text{XF}_4)$ (out of phase)
			283 (0.5)	260 (0.01)		$\delta_{\text{sym}}(\text{XF}_4)$
				266 (0.7)	221 (0.4)	} $\delta_{\text{as}}(\text{XF}_4)$ (in plane)
			256 (0.2)	220 sh		
				210 (0.4)	206 (0.2)	
233			176 (0.9)	170 (2.0)	172 (1.8)	$\pi, \delta(\text{F}_t-\text{Kr}-\text{F}_b)$
			148 (0.3)	155 (0.8)	158 (0.6)	} $\delta(\text{F}_b-\text{---XF}_2\text{O})$
				140 (0.8)	144 (0.8)	
				130 (0.6)	132 (0.7)	
				116 (0.2)	115 (0.3)	
			126 (0.3)	79 (1.7)	78 (1.0)	} lattice modes
			102 (0.1)	74 (1.5)	68 (1.2)	
				60 (0.5)		
			71 (0.6)	52 (3.0)		
			55 (0.2)	37 (1.2)		
			39 (0.1)	29 (0.6)		

^aRelative RA intensities based on peak heights and not peak areas. ^bReference 24. ^cReference 23. ^d F_t = terminal fluorine, F_b = bridging fluorine.

$\text{NO}^+\text{Cr}_2\text{F}_9\text{O}_2^-$ exist and are thermally more stable than $\text{NO}^+\text{CrF}_5\text{O}^-$.

$\text{KrF}_2\cdot\text{CrF}_4\text{O}$. During preparations of CrF_4O from CrO_2F_2 and an excess of KrF_2 it was noticed that KrF_2 was not only unable to replace the second oxygen of CrO_2F_2 by two fluorines but also formed a $\text{CrF}_4\text{O}\cdot\text{KrF}_2$ adduct. This adduct formation rendered the removal of the excess KrF_2 quite difficult. The adduct was found to be a purple solid that at room temperature reversibly dissociates to KrF_2 and CrF_4O . The formation of a $\text{KrF}_2\cdot\text{CrF}_4\text{O}$ adduct is not surprising in view of the fact that both WF_4O and MoF_4O form adducts with KrF_2 .²³ The nature of $\text{KrF}_2\cdot\text{CrF}_4\text{O}$ was established by low-temperature infrared, Raman, and ¹⁹F NMR spectroscopy.

Vibrational Spectra. The low-temperature infrared and Raman spectra of $\text{KrF}_2\cdot\text{CrF}_4\text{O}$ were recorded and are shown in Figure 5. The observed frequencies are summarized in Table III. The structural identification of this adduct was facilitated by the fact that the analogous $\text{KrF}_2\cdot\text{MoF}_4\text{O}$ and $\text{KrF}_2\cdot\text{WF}_4\text{O}$ adducts had previously been thoroughly characterized by Holloway and Schrobilgen.²³ These investigators have established by nuclear magnetic resonance and vibrational spectroscopy that these adducts are predominantly covalent, containing a Kr-F-metal bridge in a position trans to the oxygen ligand

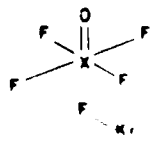

A comparison of the vibrational spectra of $\text{KrF}_2\cdot\text{CrF}_4\text{O}$ with those of $\text{KrF}_2\cdot\text{MoF}_4\text{O}$ and $\text{KrF}_2\cdot\text{WF}_4\text{O}$ and KrF_2 (see Table III) shows smooth trends for this series and the absence of any

Table IV. Frequencies (cm^{-1}) of the KrF_2 Stretching Modes in KrF_2 Adducts

	$\text{KrF}_2\cdot\text{SbF}_6^-^a$	$\text{KrF}_2\cdot\text{WF}_4\text{O}^b$	$\text{KrF}_2\cdot\text{MoF}_4\text{O}^b$	$\text{KrF}_2\cdot\text{CrF}_4\text{O}$
$\nu(\text{F}_t-\text{Kr})$	619, 615	581, 571	579, 566	581
$\nu(\text{Kr}-\text{---F}_b)$	338	469, 450	479, 462	486

^aReference 25. ^bReference 23.

characteristic for either KrF_2^+ ^{23,26} and CrF_4O (see above) or KrF_2 ²⁴ and CrF_4O (see above). This is convincing proof that $\text{KrF}_2\cdot\text{CrF}_4\text{O}$ must also be considered as a predominantly covalent adduct with a Kr-F-X bridge. From the relative Raman intensities of the CrF_4O stretching modes it can further be concluded that the CrF_4O part of the adduct must be trans to the bridging fluorine, i.e., that the fluorine bridge must be trans to the oxygen ligand. The assignments for $\text{KrF}_2\cdot\text{CrF}_4\text{O}$ are given in Table III. The assignments made by analogy to those of $\text{KrF}_2\cdot\text{MoF}_4\text{O}$ and $\text{KrF}_2\cdot\text{WF}_4\text{O}$ are given in Table III. When the spectra of this series are compared with those of KrF_2 (see above) be kept in mind, as we give the assignments in Table III, the Raman intensities of the XF_4 modes in the adducts are in the order $\text{X}=\text{O} > \nu_s(\text{XF}_4) > \nu_{as}(\text{XF}_4) > \nu_s(\text{XF}_4)$ (out of phase), which can lead to the assignments in Table III. The assignments for $\nu(\text{Kr}-\text{F}_t)$ and $\nu(\text{Kr}-\text{---F}_b)$ are made in phase with the assignments for $\nu_s(\text{XF}_4)$ and $\nu_{as}(\text{XF}_4)$ (out of phase) in KrF_2 (see above). The assignments for $\nu(\text{F}_b-\text{---Cr})$ are made in phase with the assignments for $\nu_s(\text{XF}_4)$ and $\nu_{as}(\text{XF}_4)$ (out of phase) in KrF_2 (see above). The assignments for $\delta(\text{OXF}_4)$ and $\delta_s(\text{XF}_4)$ (out of phase) are made in phase with the assignments for $\nu_s(\text{XF}_4)$ and $\nu_{as}(\text{XF}_4)$ (out of phase) in KrF_2 (see above). The assignments for $\delta_{\text{sym}}(\text{XF}_4)$ and $\delta_{\text{as}}(\text{XF}_4)$ (in plane) are made in phase with the assignments for $\nu_s(\text{XF}_4)$ and $\nu_{as}(\text{XF}_4)$ (out of phase) in KrF_2 (see above). The assignments for $\pi, \delta(\text{F}_t-\text{Kr}-\text{F}_b)$ and $\delta(\text{F}_b-\text{---XF}_2\text{O})$ are made in phase with the assignments for $\nu_s(\text{XF}_4)$ and $\nu_{as}(\text{XF}_4)$ (out of phase) in KrF_2 (see above). The assignments for lattice modes are made in phase with the assignments for $\nu_s(\text{XF}_4)$ and $\nu_{as}(\text{XF}_4)$ (out of phase) in KrF_2 (see above).

23. Holloway, H.; Schrobilgen, D. G. *J. Chem. Phys.* 1974, 60, 1094.

24. G. Mason, H. H. Woodman, and D. G. Semakula, *J. Chem. Phys.* 1964, 40, 1094.

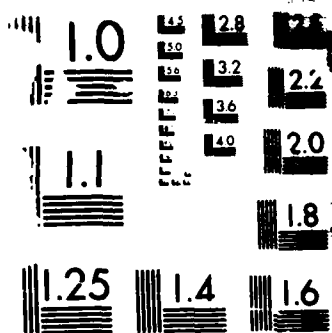

M

F_2-CrF_4O exhibits the smallest frequency separation, suggesting that the covalency of the $KrF_2 \cdot XF_4O$ adducts increases on going from $X = W$ to $X = Cr$.

^{19}F NMR Spectra. The increase in covalency for $KrF_2 \cdot CrF_4O$ was further supported by ^{19}F NMR spectroscopy. Whereas $KrF_2 \cdot XF_4O$ ($X = Mo, W$) show unequivocal NMR evidence for a fluorine-bridged adduct in SO_2ClF solution,²³ the corresponding $KrF_2 \cdot CrF_4O$ adduct in SO_2ClF showed in the temperature range -120 to -10 °C only two sharp signals due to CrF_4O and KrF_2 without any sign of coupling. The chemical shift of the CrF_4O resonance exhibited relatively little temperature dependence and occurred in the range 482–486 ppm. However, the chemical shift of KrF_2 showed a very pronounced temperature dependence varying from about 63 ppm at -118 °C to about 82 ppm at -10 °C. A similarly pronounced temperature dependence of the chemical shift of KrF_2 has previously been observed for BrF_3 solutions (68 ppm at -150 °C and 78 ppm at 27 °C) and was attributed to solvation effects.²⁵

Conclusion. The structure and physical and chemical properties of CrF_4O resemble those of WF_4O and MoF_4O . Thus, CrF_4O

is also a strong Lewis acid and forms a stable $NO^+CrF_3O^-$ salt. With KrF_2 it forms an unstable, highly covalent 1:1 adduct which in SO_2ClF solution, contrary to those of WF_4O and MoF_4O , is completely dissociated to KrF_2 and CrF_4O . The major difference between CrF_4O and MoF_4O and WF_4O is the strong increase in oxidizing power from WF_4O to CrF_4O with the latter being capable of oxidizing O_2 to O_2^+ and NF_3 to NF_4^+ .²⁷

Acknowledgment. We are grateful to Drs. C. J. Schack and L. R. Grant and R. D. Wilson for their help and to the U.S. Army Research Office and the Office of Naval Research for financial support. R.A.B. is also indebted to Dr. W. Kaska and the University of California, Santa Barbara, CA, for their hospitality and to the DRET for financial support.

Registry No. CrF_4O , 23276-90-6; CrO_2F_2 , 7788-96-7; HF, 7664-39-3; $NO^+CrF_3O^-$, 102110-04-3; AsF_5 , 7784-36-3; CrF_3O , 43997-25-7; $KrF_2 \cdot CrF_4O$, 102110-05-4.

(27) Christe, K. O.; Wilson, W. W., unpublished data.

RESEARCH NOTE

ESTIMATION OF THE N-F BOND DISTANCE IN NF_4^+ FROM ITS GENERAL VALENCE FORCE FIELD

(Received 12 October 1985; accepted 31 January 1986)

Abstract—The estimate of the bond length in NF_4^+ from the published general valence force field was revised and a value of 1.31 Å is suggested.

Although the NF_4^+ cation has been known for two decades [1, 2], so far all attempts have failed to obtain a crystal structure of one of its salts and thus a value for its N-F bond length. Based on its known general valence force field, the N-F bond length of NF_4^+ has been estimated as 1.24 Å [3]. Since this value is unusually short and disagrees with that of 1.32 Å recently predicted by *ab initio* studies [4], the basis for the previous estimate of 1.24 Å was reexamined.

For the previous estimate of $r_{\text{N-F}}$ of NF_4^+ from its stretching force constant f_s (6.15 N/cm) a linear extrapolation was used which was based on only two data points (FNO, $r = 1.512$ Å, $f_s = 2.15$ N/cm; and NF_3 , $r = 1.365$ Å, $f_s = 4.31$ N/cm). If additional NF compounds for which reliable bond distances and force constants are available (NF,

$r = 1.3173$ Å [5], $f_s = 5.90$ N/cm [6]; FNO_2 , $r = 1.467$ Å [7], $f_s = 2.678$ N/cm [8]) are included in the bond length extrapolation, it becomes obvious (see Fig. 1) that the previous linear extrapolation is a poor approximation. As has previously been shown for other bonds, the plots of f_s against r are nonlinear [9] and resemble that of Fig. 1. Using the curve of Fig. 1 and a f_s value of 6.15 N/cm, the N-F bond length of NF_4^+ is estimated as about 1.31 Å. This value is in excellent agreement with the *ab initio* value of 1.32 Å and clearly is a better estimate than the previously published value of 1.24 Å.

Acknowledgement—The author is indebted to the U.S. Army Research Office and the Office of Naval Research for financial support.

Rocketdyne,
A Division of Rockwell International,
Canoga Park,
California 91303, U.S.A.

KARL O. CHRISTE

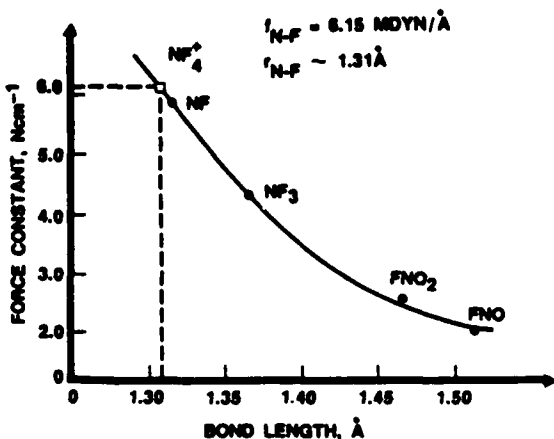

Fig. 1. Extrapolation of the N-F bond length of NF_4^+ from its stretching force constant.

REFERENCES

- [1] K. O. CHRISTE, J. P. GUERTIN and A. E. PAVLATH, *Inorg. nucl. Chem. Lett.* 2, 83 (1966).
- [2] W. E. TOLBERG, R. T. REWICK, R. S. STRINGHAM and M. E. HILL, *Inorg. nucl. Chem. Lett.* 2, 79 (1966).
- [3] K. O. CHRISTE, *Spectrochim. Acta* 36A, 921 (1980).
- [4] N. J. S. PETERS, Dissertation, Princeton University (1982).
- [5] A. E. DOUGLAS and W. E. JONES, *Can. J. Phys.* 44, 2251 (1966).
- [6] D. E. MILLIGAN and M. E. JACOX, *J. chem. Phys.* 40, 2461 (1964).
- [7] A. C. LEGON and D. J. MILLEN, *J. chem. Soc. A* 1736 (1968).
- [8] K. MOLT, W. SAWODNY, P. PULAY and G. FOGARASI, *Molec. Phys.* 32, 169 (1976).
- [9] J. STALS, *Rev. pure appl. Chem.* 20, 1 (1970).

APPENDIX Q

Reprinted from *Inorganic Chemistry*, 1986, 25, 3721
Copyright © 1986 by the American Chemical Society and reprinted by permission of the copyright owner.

Chemical Synthesis of Elemental Fluorine

Sir:

The chemical synthesis¹ of elemental fluorine has been pursued for at least 173 years² by many notable chemists, including Davy,² Fremy,³ Moissan,⁴ and Ruff.⁵ All their attempts have failed, and the only known practical synthesis of F₂ is Moissan's electrochemical process, which was discovered exactly 100 years ago.⁶

Although in principle the thermal decomposition of any fluoride is bound to yield fluorine, the required reaction temperatures and conditions are so extreme that rapid reaction of the evolved fluorine with the hot reactor walls preempts the isolation of significant amounts of fluorine. Thus, even in the well-publicized case of K₂PbF₇,^{7,8} only trace amounts of fluorine were isolated.^{9,9}

These failures, combined with the fact that fluorine is the most electronegative element and generally exhibits the highest single bond energies in its combinations with other elements,¹⁰ have led to the widely accepted¹¹⁻¹³ belief that it is impossible to generate fluorine by purely chemical means.

The purpose of this communication is to report the first purely chemical synthesis of elemental fluorine in significant yield and concentration. This synthesis is based on the fact that thermodynamically unstable high-oxidation-state transition-metal

fluorides can be stabilized by anion formation. Thus, unstable NiF₄, CuF₄, or MnF₄ can be stabilized in the form of their corresponding MF₄²⁻ anions. Furthermore, it is well-known that a weaker Lewis acid, such as MF₄, can be displaced from its salts by a stronger Lewis acid, such as SbF₅.



If the liberated MF₄ is thermodynamically unstable, it will spontaneously decompose to a lower fluoride, such as MF₃ or MF₂, with simultaneous evolution of elemental fluorine.

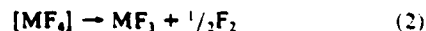

Since a reversal of (2) is thermodynamically not favored, fluorine can be generated even at relatively high pressures.

Consequently, the chemical generation of elemental fluorine might be accomplished by a very simple displacement reaction, provided a suitable complex fluoro anion is selected which can be prepared without the use of elemental fluorine and is derived from a thermodynamically unstable parent molecule. The salt selected for this study was K₂MnF₆. It has been known¹⁶ since 1899 and is best prepared from aqueous HF solution.¹⁷

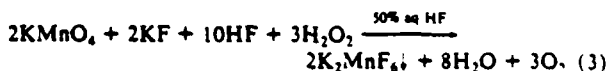

The literature yield of 30% was increased to 73% and can probably be improved further by refining the washing procedure (use of acetone instead of HF).¹⁸ The other starting material, SbF₅, can be prepared¹⁹ in high yield from SbCl₃ and HF.

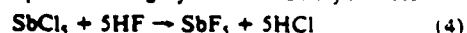

Since both starting materials, K₂MnF₆ and SbF₅, can be readily prepared without the use of F₂ from HF solutions, the reaction



represents a truly chemical synthesis of elemental fluorine.

The displacement reaction between K₂MnF₆ and SbF₅ was carried out in a passivated Teflon-stainless-steel reactor at 150 °C for 1 h. The gas, volatile at -196 °C, was measured by PVT and shown by its reaction with mercury and its characteristic odor to be fluorine. The yield of fluorine based on (5) was found to be reproducible and in excess of 40% but most likely can be improved upon significantly by refinement of the experimental conditions. Fluorine pressures of more than 1 atm were generated in this manner.

In summary, the purely chemical generation of elemental fluorine can be achieved in high yield and concentration by a very simple displacement reaction between starting materials that can

- (1) In the context of this communication, the term "chemical synthesis of elemental fluorine" implies the generation of F₂ by purely chemical means and excludes either techniques such as electrolysis, photolysis, discharge, etc. or the use of elemental fluorine for the synthesis of any of the starting materials. The regeneration of fluorine from materials prepared from fluorine obviously is just a method for chemically storing but not for chemically generating fluorine.
- (2) Davy, H. *Phil. Trans. R. Soc. London* 1813, 103, 263.
- (3) Fremy, M. E. *Ann. Chim. Phys.* 1836, 47, 44.
- (4) Moissan, H. C. *R. Hebd. Seances Acad. Sci.* 1886, 102, 1543; 1886, 103, 202, 256, 850; 1884, 99, 655, 874; 1885, 100, 272, 1348; 1885, 101, 1490; 1886, 102, 763, 1245; 1886, 103, 1257; 1889, 109, 862, 637; *Ann. Chim. Phys.* 1887, 12, 472; 1891, 24, 224; *Bull. Soc. Chim. Fr.* 1891, 5, 880.
- (5) Ruff, O. *Z. Angew. Chem.* 1907, 20, 1217; *Z. Anorg. Chem.* 1916, 98, 27.
- (6) Moissan, H. C. *R. Hebd. Seances Acad. Sci.* 1886, 102, 1543.
- (7) Brauner, B. *Z. Anorg. Chem.* 1884, 7, 1.
- (8) Clark, G. L. *J. Am. Chem. Soc.* 1919, 41, 1477.
- (9) Argo, W. L.; Mathers, F. C.; Humiston, B.; *Anal. An. C. O. Trans. Am. Electrochem. Soc.* 1911, 35, 335.
- (10) See for example: Cotton, F. A.; Wilkinson, G. *Advanced Inorganic Chemistry*; Interscience: New York, 1972; p 113.
- (11) Schmitz-Dumont, O.; Oppenhoff, P. *Z. Anorg. Allg. Chem.* 1952, 268, 57.
- (12) Rys, I. G. In *The Chemistry of Fluorine and Its Inorganic Compounds*; USAEC Translation 3927; AEC: Oak Ridge, TN, 1956; p 31.
- (13) Cady, G. H. In *Fluorine Chemistry*; Simons, J. H., Ed.; Academic: New York, 1950; pp 293-294.
- (14) O'Donnell, T. A. In *Comprehensive Inorganic Chemistry*; Bailar, J. C., Emeleus, H. J., Nyholm, R., Trotman-Dickenson, A. F., Eds.; Pergamon: Oxford, U.K., 1973; pp 1010-1013.
- (15) Naumann, D. In *Fluor und Fluorverbindungen*; Spezielle Anorganische Chemie in Einzeldarstellungen, Vol. 2; Schneider, A., Ed.; Steinkopff: Darmstadt, W. Germany, 1980; p 3.

- (16) Weinland, R. F.; Lauenstein, O. *Z. Anorg. Allg. Chem.* 1899, 20, 40.
- (17) Bode, H.; Jensen, H.; Bandte, F. *Angew. Chem.* 1953, 65, 304.
- (18) Chaudhuri, M. K.; Das, J. C.; Dasgupta, H. S. *J. Inorg. Nucl. Chem.* 1981, 43, 85.
- (19) Ruff, O. *Ber. Dtsch. Chem. Ges.* 1906, 39, 4310.

be prepared in high yields from HF solutions and have been known for 80 years or longer. As in the cases of noble gas²⁰ or NF_3 ,²¹ chemistry, the successful chemical synthesis of elemental fluorine demonstrates that one should never cease to critically challenge accepted dogmas.

Acknowledgment. The author is grateful to R. D. Wilson for his assistance with some of the experiments, to Drs. C. J. Schack, W. W. Wilson, and L. R. Grant for help, and to the U.S. Army Research Office and Office of Naval Research for financial support.

(20) Bartlett, N. *Proc. Chem. Soc., London* 1962, 218.

(21) Christe, K. O.; Guerin, J. P.; Pavlath, A. E. *Inorg. Nucl. Chem. Lett.* 1966, 2, 83.

Rocketsdyne
A Division of Rockwell International
Canoga Park, California 91303

Karl O. Christe

Received August 20, 1986

Received: March 12, 1986; accepted: May 20, 1986

PREPARATION AND CHARACTERIZATION OF $\text{Ni}(\text{SbF}_6)_2$

KARL O. CHRISTE*, WILLIAM W. WILSON
Rocketdyne, A Division of Rockwell International
Canoga Park, California 91303 (USA)

ROLAND A. BOUGON and PIERRETTE CHARPIN
Centre d'Etudes Nucleaires de Saclay,
91191 Gif sur Yvette, Cédex (France)

SUMMARY

$\text{Ni}(\text{SbF}_6)_2$ was prepared from Ni powder, F_2 and SbF_5 at 270°C and 250 atm pressure. The yellow, crystalline material is stable to at least 230°C and was characterized by elemental analysis, x-ray powder data, and vibrational spectroscopy. The crystal structure of $\text{Ni}(\text{SbF}_6)_2$, (hexagonal, $a = 5.16\text{\AA}$, $c = 27.90\text{\AA}$, $Z = 3$), can be related to the rhombohedral-hexagonal LiSbF_6 structure by occupation of only every second Li^+ site with Ni^{2+} and by the concomitant doubling of the c-axis of its hexagonal unit cell.

INTRODUCTION

In high temperature fluorination reactions involving elemental fluorine and a strong Lewis acid in a metal cylinder, the metal cylinder is usually strongly attacked by the reagents. To minimize these side reactions, cylinders made from either nickel or nickel-copper alloys, such as Monel, are generally used. Even under these conditions the attack on the cylinder is still appreciable and often can compete with the desired reactions [1-3]. Although it has repeatedly been stated that the side products in $\text{F}_2\text{-MF}_5$ ($M=\text{As, Sb, Bi}$) reactions in nickel reactors are $\text{Ni}(\text{MF}_6)_2$ salts [1-3], very few data have been

published for these compounds. For $\text{Ni}(\text{AsF}_6)_2$, only its x-ray powder pattern and vibrational spectra [4] and, for $\text{Ni}(\text{SbF}_6)_2$, only its magnetic moment [5] have been published. In view of the fact that these salts are very common impurities in most high-temperature, high-pressure fluorination reactions involving these Lewis acids and fluorine, a better characterization of these nickel salts was highly desirable.

EXPERIMENTAL

Apparatus

Fluorine (Air Products) was handled in a conventional stainless steel-Teflon FEP vacuum line. Solids and SbF_5 (Ozark Mahoning, purified by vacuum distillation prior to use) were handled in the dry nitrogen atmosphere of a glove box. Infrared spectra were recorded on a Perkin Elmer Model 283 spectrometer. Raman spectra were recorded on a Spex Model 1403 spectrophotometer using the 647.1 nm exciting line of a Kr-ion laser and melting point capillaries as sample containers. X-ray diffraction patterns were obtained using 0.5 mm quartz capillaries, a General Electric Model XRD-6 diffractometer, Ni-filtered CuK_α radiation, and a 114.6 mm diameter Phillips camera.

$\text{Ni}(\text{SbF}_6)_2$

Nickel powder (7.968 mmol) was placed into a 20 mL nickel cylinder equipped with a nickel valve. The cylinder containing the Ni powder was passivated at ambient temperature with 2 atm of gaseous F_2 for 2.5 hr. The F_2 was pumped off and distilled SbF_5 (53.80 mmol) was added to the cylinder in the dry box. The cylinder was connected to a stainless steel vacuum line, evacuated and cooled to -196°C . Fluorine (60.5 mmol) was condensed into the cylinder, and the cylinder was allowed to warm to ambient temperature behind a barricade. The cylinder was placed into an oven and heated

to 270°C for 88 hr, cooled, and then reconnected to the vacuum line. The excess of F_2 was pumped off at room temperature, and the reactor was heated in a dynamic vacuum to 180°C for 7 hr. The yellow crystalline residue (14.257g, weight calcd. for 26.90 mmol of $Ni(SbF_6)_2 = 14.262g$) did not lose any weight on heating to 230°C for 4 hr in a dynamic vacuum. Anal. Calcd for $Ni(SbF_6)_2$ Ni, 11.07; Sb, 45.93; F, 43.00. Found: Ni, 11.22; Sb, 46.20; F, 42.67.

RESULTS AND DISCUSSION

Synthesis and Properties of $Ni(SbF_6)_2$

The reaction of F_2 and SbF_5 with nickel powder was carried out in a nickel reactor at 270°C and about 250 atm pressure. It resulted not only in a quantitative conversion of the nickel powder to $Ni(SbF_6)_2$, but also in an attack on the walls of the nickel vessel until the limiting reagent, SbF_5 , was completely consumed by formation of $Ni(SbF_6)_2$. The product was a finely divided, pale yellow, hygroscopic, crystalline powder which is stable in a dynamic vacuum up to at least 230°C. Its composition was established by the observed material balance and elemental analysis. It readily dissolves in water with the green color characteristic for aqueous solutions of Ni^{2+} . With CH_3CN it forms a bright blue solid and solution. By analogy with the known [6] compound $[Ni(CH_3CN)_6]^{2+}(BF_4^-)_2$, the blue color suggests the formation of the corresponding $[Ni(CH_3CN)_6]^{2+}(SbF_6^-)_2$ complex. In anhydrous HF, $Ni(SbF_6)_2$ is quite soluble. Large cube-shaped crystals were grown from this solvent. However, they tended to be multiple crystals, thus preempting a crystal structure determination.

X-Ray Diffraction Data

Due to the lack of suitable single crystals, only powder data could be recorded for $Ni(SbF_6)_2$. The observed pattern (see Table I)

closely resembles those previously reported for the hexagonal-rhombohedral AMF_6 -type compounds $LiBiF_6$ and $NaBiF_6$ [7]. These compounds are isotypic with $LiSbF_6$ whose structure is well known from single crystal data and can be considered as a rhombohedrally distorted, face-centered cubic $NaSbF_6$ -type structure [8].

Replacement of the singly charged Li^+ cations by doubly charged Ni^{2+} cations in the $LiSbF_6$ lattice results in half of the cation sites becoming vacant. The distribution of the Ni^{2+} sites and vacancies could be either ordered or disordered. If it is ordered, Ni^{2+} sites alternate with vacancies, and therefore the unit cell dimensions of $LiSbF_6$ must be doubled for $Ni(SbF_6)_2$.

A closer inspection of the powder pattern of $Ni(SbF_6)_2$ reveals indeed the presence of a weak line at 4.03\AA . This line can only be indexed if the value of the c-axis of the hexagonal ($Z = 3$) $LiSbF_6$ unit cell is doubled, resulting in the following unit cell parameters for $Ni(SbF_6)_2$: $a = 5.16\text{\AA}$, $c = 27.90\text{\AA}$, $V = 643.3\text{\AA}^3$, and $Z = 3$. Other super-structure lines were not observed, but their relative intensities might be very low. If the $Ni(SbF_6)_2$ pattern is indexed based on this doubled hexagonal cell, the rhombohedral condition, $-h + k + l = 3n$, obviously is no longer met.

On the other hand, if the distribution of the Ni^{2+} and vacancy sites were disordered, no super-structure lines should be observable. Consequently, the x-ray powder diffraction data of $Ni(SbF_6)_2$ are best interpreted in terms of a $LiSbF_6$ -type structure with an ordered occupation of the Li^+ sites by Ni^{2+} and vacancies.

In $LiSbF_6$ each Li is surrounded by six F from six different SbF_6^- octahedra [8]. Thus, both Li and Sb are hexacoordinated

TABLE I

X-RAY POWDER DATA FOR $\text{Ni}(\text{SbF}_6)_2^a$

$d(\text{obsd}), \text{Å}$	$d(\text{calcd}), \text{Å}$	Intens.	h	k	l
4.61	4.65	ms	0	0	6
4.24	4.26	s	1	0	2
4.03	4.03	w	1	0	3
3.75	3.76	s	0	1	4
2.744	2.750	ms	1	0	8
2.576	2.582	mw	1	1	0
2.363	2.367	m	0	1,10	
2.252	2.257	s	1	1	6
2.207	2.208	mw	0	2	2
2.125	2.129	mw	2	0	4
1.881	1.882	m	0	2	8
1.819	1.820	m	1	0,14	
1.745	1.745	w	2	0,10	
1.728	1.728	s	1	1,12	
1.681	1.678	m	2	1	2
1.646	1.643	m	1	2	4
1.625	1.625	w	0	1,16	
1.550	1.550	vw	0	0,18	
1.521	1.521	m	2	1	8
1.491	1.491	m	3	0	0
1.447	1.446	mw	1	2,10	
1.420	1.419	mw	3	0	6
1.377	1.375	w	2	0,16	
1.332	1.332	m	1	0,20	
1.292	1.291	mw	2	2	0
1.257	1.255	w	3	0	12
1.246	1.244	w	2	2	6
1.235	1.235	w	1	3	2
1.223	1.221	mw	1	3	4
1.216	1.214	mw	1	2	16

^aHexagonal; $a = 5.16\text{Å}$, $c = 27.90\text{Å}$, $Z = 3$, $V = 643.3\text{Å}^3$;
 CuK_α radiation, Ni filter.

with respect to fluorine, and each fluorine has one nearest Sb and Li neighbor. In $\text{Ni}(\text{SbF}_6)_2$ half of the Li sites of LiSbF_6 have been substituted with Ni while the other half is vacant. Assuming an ordered distribution of Ni sites and vacancies, only three of the six fluorines of each SbF_6^- anion can form fluorine bridges to Ni^{2+} cations. Furthermore, a close inspection of the LiSbF_6 structure suggests that for $\text{Ni}(\text{SbF}_6)_2$ the three bridging fluorines of each SbF_6^- anion must be cis with respect to each other, *i.e.* share a common face of the SbF_6 octahedron. Consequently, the site symmetry of the Sb atom in $\text{Ni}(\text{SbF}_6)_2$ may not be higher than C_{3v} .

A comparison of the unit cell of $\text{Ni}(\text{SbF}_6)_2$ with those of numerous other AMF_6 -type compounds [9] shows excellent agreement. The ionic radius of Ni^{2+} (0.69Å) [10] is similar to that of Li^+ (0.60Å) [9], and all the LiMF_6 -type compounds of [9] possess the rhombohedral-hexagonal LiSbF_6 structure. As discussed above, the $\text{Ni}(\text{SbF}_6)_2$ structure can be derived directly from the LiSbF_6 structure by converting the unimolecular rhombohedral LiSbF_6 cell to its corresponding trimolecular hexagonal cell, and then doubling the c-axis of the latter to accommodate a whole number of both, Ni^{2+} cation and vacancy sites.

A comparison of the powder pattern of $\text{Ni}(\text{SbF}_6)_2$ with that published for $\text{Ni}(\text{AsF}_6)_2$ [4] shows that the two compounds are not isotypic. This is unexpected because LiAsF_6 and NaAsF_6 are both isotypic with LiSbF_6 [9]. The pattern of $\text{Ni}(\text{AsF}_6)_2$ has previously been indexed [4] for a pseudo-cubic ($a/c = \sqrt{2}$), tetragonal unit cell with $a = 13.62$, $c = 9.63\text{Å}$, and $Z = 8$.

Vibrational Spectra

In A^+MF_6^- -type compounds, the nature and extent of the cation-anion interaction are of particular interest [4]. For $\text{B}^{2+}(\text{MF}_6^-)_2$ -type compounds, this interaction becomes even more interesting because only half of the fluorines can participate in bridges and the increased positive charge of the cations should result in stronger anion-cation attractions. As a consequence, the high symmetry of the MF_6^- anions in a compound such as LiSbF_6 [8] is

destroyed and vibrational spectroscopy should be well suited for the study of this problem.

According to the above x-ray data, the site symmetry of the SbF_6^- anions in $\text{Ni}(\text{SbF}_6)_2$ must be C_{3v} or lower and further splittings of bands are possible because the unit cell contains six SbF_6^- anions. The number of the possible fundamental vibrations and their expected infrared and Raman activities are shown in Table II for symmetry C_{3v} and the appropriate subgroups. However, without knowledge of the space group and factor group of $\text{Ni}(\text{SbF}_6)_2$, a detailed analysis is not possible.

TABLE II

Correlation table for SbF_6^- IN $\text{Ni}(\text{SbF}_6)_2$

	free SbF_6^-	SbF_6^- distorted by 3F bridges		
	O_h	C_{3v}	C_3	C_s
ν_{sym} in phase	A_{1g}	A_1	A	A'
ν_{sym} out of phase	E_g	E	E	A' A''
ν_{asym}	F_{1u}	A_1 E	A E	A' A' A''
δ_{sym}	F_{1u}	A_1 E	A E	A' A' A''
δ_{sym} in plane	F_{2g}	A_1 E	A E	A' A' A''
δ_{sym} out of plane	F_{2u}	A_1 E	A E	A' A' A''
IR active	F_{1u}	A_1, E	A, E	A', A''
RA active	A_{1g}, E_g, F_{2g}	A_1, E	A, E	A', A''

The observed infrared and Raman spectra are shown in Fig. 1, and the frequencies are summarized in Table III. In the frequency range expected for Sb-F stretching vibrations ($500-750\text{ cm}^{-1}$), at least eight infrared and seven Raman bands are observed which are not mutually exclusive. These data clearly indicate that SbF_6^- in $\text{Ni}(\text{SbF}_6)_2$ is not octahedral, but strongly distorted. The number of observed Sb-F stretching modes exceeds not only that (four) expected for either C_{3v} or C_3 symmetry, but also that (six) predicted for either C_s or C_1 symmetry, and is attributed to a low site symmetry of SbF_6^- and a dynamic coupling of the anions in the unit cell.

Based on frequency and intensity arguments, the following tentative assignments are proposed for the Sb-F stretching modes (see Table III). The three nonbridging fluorines should have higher frequencies and narrower and more intense Raman bands than the bridging ones. Furthermore, the symmetric stretching modes should be more intense in the Raman and the antisymmetric ones more intense in the infrared spectra. The relative sharpness of the nonbridging SbF_3 Raman bands lends additional support to our assumption of an ordered structure for $\text{Ni}(\text{SbF}_6)_2$.

For a disordered structure we would expect even more bands and, in particular, more diffuse Raman bands due to the irregularities in the fluorine bridging.

The bands in the 170 to 320 cm^{-1} frequency range are assigned to the Sb-F deformation modes. As for the stretching modes, the frequency range covered by these vibrations is again considerably wider than, for example, for free SbF_6^- [11,12]. This effect is attributed to the influence of the fluorine bridges which will weaken the bridging Sb-F and strengthen the nonbridging Sb-F bonds. The frequency of a medium intensity infrared band with a very weak Raman counterpart in the 350 cm^{-1} region appears high for an Sb-F deformation mode, but is in the range expected for the Ni...FSb stretching mode and, therefore, is assigned accordingly.

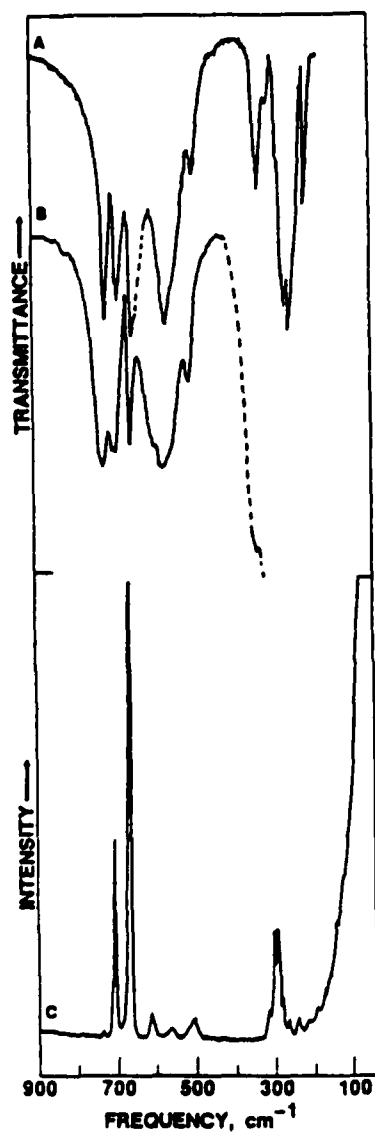

Fig. 1. Vibrational Spectra of Solid $\text{Ni}(\text{SbF}_6)_2$. Traces A and B, infrared spectra as KBr and AgCl pellets, respectively. The broken line in trace A probably contains a contribution from KSbF_6 generated by interaction of KBr with $\text{Ni}(\text{SbF}_6)_2$. The broken line in B is due to absorption by the AgCl window material. Trace C, Raman spectrum, recorded with a slit width of 5 cm^{-1} .

TABLE III
Vibrational frequencies and assignments for $\text{Ni}(\text{SbF}_6)_2$

Ir	obsd freq, cm^{-1} , and rel intens ^a		Assignment
	Ra	Ra	
740vs	742(1)		vas SbF_3 out of phase
716s	717(12)		vas SbF_3 in phase
708s	710(44)		vsym SbF_3 out of phase
673ms	674(100)		vsym SbF_3 in phase
615sh	618(5)		vsym SbF_3 out of phase
583s			vas SbF_3 out of phase
568sh	568(2)		vas SbF_3 in phase
521m	511(5)		vsym SbF_3 in phase
354m	348(0+)		Ni...Fsb stretching
331w	322(5)		
	308(24)		
302w	299(25)		
280s	287(9)		
267vs	272(3)		Sb-F deformations
233m	246(4)		
	220(1)		
	198(2)		
	172sh		
	146sh		Ni...F deformations
	130sh		or lattice modes

^a uncorrected Raman intensities based on relative peak heights

CONCLUSION

The above data demonstrate that, compared to $\text{Ni}(\text{AsF}_6)_2$ [3], $\text{Ni}(\text{SbF}_6)_2$ is thermally much more stable and is readily formed in high pressure-high temperature fluorination reactions involving SbF_5 in nickel reactors. X-ray powder diffraction data and vibrational spectra show that the $\text{Ni}(\text{SbF}_6)_2$ structure can be derived from the rhombohedral-hexagonal LiSbF_6 structure by substitution of the Li^+ cations by half as many Ni^{2+} cations and vacancies. The observation of a super-structure line in the x-ray powder data and the well defined and sharp Raman spectra support a structural model in which the Ni^{2+} sites and vacancies are ordered.

ACKNOWLEDGEMENT

The authors are grateful to Mrs. M. Lance, Mr. J. Isabey, Dr. C. J. Schack and Mr. R. D. Wilson for their help, to the US Army Research Office and the Office of Naval Research for financial support, and to Dr. R. Bau of the University of Southern California for the examination of $\text{Ni}(\text{SbF}_6)_2$ crystals by x-ray diffraction.

REFERENCES

- 1 J. P. Guertin, K. O. Christe, and A. E. Pavlath, *Inorg. Chem.*, 5 (1966) 1921.
- 2 W. E. Tolberg, R. T. Rewick, R. S. Stringham, and M. E. Hill, *Inorg. Chem.*, 6 (1967) 1156.
- 3 C. D. Desjardins and J. Passmore, *J. Fluorine Chem.*, 6 (1975) 379.
- 4 B. Frlec, D. Gantar, and J. H. Holloway, *J. Fluorine Chem.*, 19 (1982) 485.

- 5 P. A. W. Dean, *J. Fluorine Chem.*, 5 (1975) 499.
- 6 B. J. Hathaway and D. G. Holah, *J. Chem. Soc.*, (1964) 2400.
- 7 Č. Hebecker, *Z. anorg. allgem. Chem.*, 376 (1970) 236.
- 8 J. H. Burns, *Acta Cryst.*, 15 (1962) 1098.
- 9 R. D. Kemmitt, D. R. Russell and D. W. A. Sharp, *J. Chem. Soc.*, (1963) 4408.
- 10 R. D. Shannon, *Acta Cryst. Part A*, 32 (1976) 751.
- 11 G. M. Begun and A. C. Rutenberg, *Inorg. Chem.*, 6 (1967) 2212.
- 12 K. O. Christe and C. J. Schack, *Inorg. Chem.*, 9 (1970) 2296.

APPENDIX S

Contribution from Rocketdyne, A Division of Rockwell
International, Canoga Park, California 91303

On the Condensed Phases of Difluoramine and its
Alkali Metal Fluoride Adducts

Karl O. Christe* and Richard D. Wilson

Abstract

Infrared and Raman spectra of HNF_2 and DNF_2 in the liquid and the solid phases show that the compounds are associated through hydrogen bridges between the nitrogen atoms. Raman spectra of the KF, RbF and CsF adducts and infrared spectra of the RbF adduct of difluoramine are interpreted in terms of strongly hydrogen bridged $[\text{F}\cdots\text{HNF}_2]^-$ anions. For the CsF and RbF adducts evidence was obtained for the existence of a distinct second modification of the $[\text{F}\cdots\text{HNF}_2]^-$ anion with a significantly stronger hydrogen bridge. The reactions of $\text{KF}\cdot\text{HNF}_2$ with TeF_5OF , OF_2 , FONO_2 and FOClO_3 were studied and resulted in the fluorination of HNF_2 to HF and N_2F_4 .

Introduction

Although HNF_2 (difluoramine or fluorimide) has been known^{1,2} since 1959, the literature on this interesting compound is sparse. This lack of data may be attributed to the fact that HNF_2 is a vicious explosive.³⁻⁵ While studying alkali metal fluoride catalyzed⁵⁻⁷ reactions of HNF_2 with various inorganic hypofluorites, we became interested also in the nature of the $\text{MF}\cdot\text{HNF}_2$ adducts

(M=K, Rb, Cs). The existence of these adducts was reported⁶ in 1965, and it was shown that $\text{KF}\cdot\text{HNF}_2$, $\text{RbF}\cdot\text{HNF}_2$ and $\text{CsF}\cdot\text{HNF}_2$ are stable up to about -90° , -72° and -64°C , respectively. Whereas $\text{KF}\cdot\text{HNF}_2$ and $\text{RbF}\cdot\text{HNF}_2$ undergo smooth dissociation on warmup, $\text{CsF}\cdot\text{HNF}_2$ invariably explodes before reaching room temperature.⁶ The nature of these adducts has previously been studied by low-temperature infrared spectroscopy, and it was postulated that $\text{CsF}\cdot\text{HNF}_2$ possesses a structure different from those of the other $\text{MF}\cdot\text{HNF}_2$ adducts.⁸ However, the experimental evidence in support of either structure was not convincing due to strong interference from water and impurity bands. In order to obtain more reliable data on these interesting adducts, we have recorded their low-temperature Raman and infrared spectra. Since for difluoramine only gas phase⁹ and partial, low resolution, solid phase¹⁰ infrared spectra had previously been reported, it became also necessary to record its infrared and Raman spectra in the condensed phases. This allowed a better distinction between $\text{MF}\cdot\text{HNF}_2$ bands and those due to associated HNF_2 and provided some insight into the nature of the association of HNF_2 in the condensed phases.

Experimental Section

Caution! Difluoramine is highly explosive,^{10,11} and protective shielding and clothing should be used during handling operations. The compound was always condensed at -142°C , and the use of a -196°C bath for condensing HNF_2 should be avoided.³ Furthermore, the $\text{CsF}\cdot\text{HNF}_2$ adduct invariably explodes before reaching 0°C .⁶ The hypofluorites FOClO_3 ,¹¹ FONO_2 ¹¹ and TeF_5OF ¹² are also shock-sensitive and must be handled with the same precautions.

Materials and Apparatus

Difluoramine was handled in either a glass or all Teflon-FEP and -PFA vacuum line to avoid metal fluoride catalyzed HF elimination. Other volatile materials were handled in a stainless steel vacuum line equipped with Teflon-FEP U-traps, 316 stainless steel bellows-seal valves, and a Heise Bourdon tube-type pressure gauge. Nonvolatile materials were handled in the dry N_2 atmosphere of a glove box.

Difluoramine was prepared by hydrolysis of difluorourea using a literature method.³ For the synthesis of DNF_2 , a previously reported method involving H-D exchange between HNF_2 and a large excess of D_2O ⁹ produced only a low yield of DNF_2 , and the sample still contained 14% of HNF_2 . Essentially pure DNF_2 was obtained in high yield by the method used for the preparation of HNF_2 ³, but substituting NH_2CONH_2 , H_2O and H_2SO_4 by their deuterated analogues. The alkali metal fluorides were dried by fusion in a platinum crucible, followed by immediate transfer of the hot clinkers to the dry N_2 atmosphere of a glove box. The RbF crystal (Semi-Elements Inc.) used for the low-temperature infrared study of the $RbF \cdot HNF_2$ adduct was freshly cleaved with a razor blade in the dry box and mounted in a dry N_2 atmosphere into the tip of the helium refrigerator. Small amounts of moisture absorbed onto the surface of the RbF crystal were completely removed by pumping on the crystal in the infrared beam for 24 hrs at 10^{-6} torr. Literature methods were used for the syntheses of $FONO_2$,¹³ TeF_5OF ,¹⁴ and $FOClO_3$.¹⁵ OF_2 (Allied Chemical) was purified by fractional condensation at -210° prior to its use. The alkali metal fluoride-difluoramine adducts were generally prepared by condensing an excess of HNF_2 onto the alkali metal fluoride at -142° , warming the mixture to -78° for several hours, and then removing the excess of HNF_2 in a dynamic vacuum at -64° , -78° and -95° for $CsF \cdot HNF_2$.

$\text{RbF}\cdot\text{HNF}_2$, and $\text{KF}\cdot\text{HNF}_2$, respectively. The composition of the resulting adducts generally approached a 1:1 mole ratio.

Infrared spectra were recorded in the range $4000\text{--}200\text{ cm}^{-1}$ on a Perkin-Elmer Model 283 spectrophotometer. The spectra of gases were obtained by using a Teflon cell of 5-cm path length equipped with AgCl windows. The low-temperature infrared spectra were obtained at various temperatures with an Air Products Model DE 202S helium refrigerator equipped with an internal RbF and external CsI windows. The Raman spectra were recorded on a Spex Model 1403 spectrophotometer using the 647.1-nm exciting line of a Kr ion laser. Sealed, 3mm o.d., quartz tubes were used as sample containers in the transverse-viewing-transverse-excitation mode. For neat HNF_2 the tip of the tube was drawn out to a smaller diameter to minimize the sample size. A previously described¹⁶ device was used for recording the low-temperature spectra.

The $\text{TeF}_5\text{OF}\text{--}\text{KF}\cdot\text{HNF}_2$ System. A passivated (with ClF_3), 0.5 in. o.d. Teflon-FEP ampule equipped with a Teflon-PFA valve (Galtek Corp.) was loaded in the drybox with finely powdered, dry KF (2.0g). On the glass vacuum line, HNF_2 (3.2 mmol) was added to the ampule at -142° and the mixture was kept at -78° for 1 hr. On the steel-Teflon vacuum line, TeF_5OF (1.57 mmol) was added at -196° . The ampule was slowly warmed to -78° for 87 hr by means of a CO_2 -liquid N_2 slush bath, and then to -64° for 1 hr. The material volatile at -64° was fractionated through a series of traps kept at -78° , -95° , -126° and -196° and consisted of N_2F_4 (1.55 mmol) and traces of TeF_6 , $\text{TeF}_5\text{OTeF}_5$ and FNO. Then the ampule was allowed to warm to 25° , and the volatile material was fractionated through traps kept at -78° , -126° and -196° . It consisted of N_2F_4 (0.05 mmol), TeF_5OH (0.35 mmol) and traces of TeF_6 , HF and $\text{TeF}_5\text{OTeF}_5$. The vibrational spectra of the white solid residue showed the presence of HF_2^- and TeF_5O^- .

The OF_2 - $\text{KF}\cdot\text{HNF}_2$ System. The $\text{KF}\cdot\text{HNF}_2$ adduct was prepared as described above from KF (7.3 mmol) and HNF_2 (4.2 mmol), and OF_2 (2.95 mmol) was added at -196° . After slow warmup to -78° no noticeable reaction had occurred. Repeating the reaction at -22° for 1 hr resulted in a 73% consumption of the OF_2 and the formation of N_2F_4 (1.0 mmol) as the main product.

The FOClO_3 - $\text{KF}\cdot\text{HNF}_2$ System. A mixture of FOClO_3 (5.65 mmol) and $\text{KF}\cdot\text{HNF}_2$ (KF 69 mmol, HNF_2 7.44 mmol), when warmed slowly from -196° to -78° , resulted in an explosion.

The FONO_2 - $\text{KF}\cdot\text{HNF}_2$ System. A mixture of FONO_2 (0.92 mmol) and $\text{KF}\cdot\text{HNF}_2$ (KF 172 mmol, HNF_2 1.22 mmol), when warmed slowly from -142° to -78° and then to 25° during fractionation of the volatile material, produced N_2F_4 (0.5 mmol) with NO_2 , FNO_2 and some O_2 as the major volatile by-products.

Results and Discussion

Vibrational Spectra of Difluoramine. Infrared spectra were recorded for gaseous HNF_2 and DNF_2 and solid HNF_2 . Raman spectra were measured for the liquid and solid phases of HNF_2 and DNF_2 . The spectra are given in Figures 1 to 3, and the observed frequencies and their assignments are summarized in Table 1.

The infrared spectrum of gaseous HNF_2 was in excellent agreement with previous results by Lide and coworkers⁹ and requires no further comment. These authors also reported four fundamental vibrations for gaseous DNF_2 which were measured on a partially deuterated sample. In our study using a completely deuterated sample,

a fifth fundamental, ν_4 (a'), was observed at 498 cm^{-1} . Furthermore, we prefer to assign the center of the ν_5 (a'') band to 1028 cm^{-1} and not to the maximum at 1042 cm^{-1} which, we believe, represents the maximum of the R branch of ν_5 (see trace A of Figure 2). This preference is based on the reasonable assumption of similar band contours for ν_5 in HNF_2 and DNF_2 . Similarly, the band center of ν_3 (a') of DNF_2 is preferably assigned to 962 cm^{-1} instead of the previously proposed⁹ value of 972 cm^{-1} . The 962 cm^{-1} value is also supported by the observation of the $(\nu_3 + \nu_6)$ (a'') combination band at 1849 cm^{-1} (calcd for $962 + 888 = 1850 \text{ cm}^{-1}$). It is also noteworthy that our revised frequency values for DNF_2 result in a better match with those obtained by Pulay and co-workers by ab initio calculations from the HNF_2 values.¹⁷

The liquid phase frequencies are almost identical to the gas phase values (see Table 1) indicating only weak association for liquid difluoramine. The only remarkable feature is the splitting of the NH and the ND stretching mode, ν_1 (a'), into two components. These splittings and their relative Raman intensities and polarization ratios are similar for both HNF_2 and DNF_2 and do not permit their attribution to combination bands in Fermi resonance with ν_1 . Similar splittings have been observed for the symmetric stretching modes of liquid NH_3 and ND_3 ¹⁸ and solid HOF ¹⁹ and have been attributed to aggregates.^{19,20} Therefore, this explanation is also preferred for difluoramine.

For solid difluoramine the previously reported infrared spectrum had been recorded with only low precision in the NaCl region¹⁰ and deviates significantly from that given in Figure 3. Compared to the liquid phase values, the NH stretching frequency of solid HNF_2 decreased by about 40 cm^{-1} and the NH deformation frequencies increased by about 23 cm^{-1} . Furthermore, all these modes are split into two

components each and bands due to libration and lattice modes appear below 310 cm^{-1} . All these features suggest an increased degree of association. Since the N-H modes are shifted and split relative to the gas phase, and those of the NF_2 group are not, the association must involve intermolecular $\text{N-H}\cdots\text{N}$ and not $\text{N-H}\cdots\text{F}$ bridges. This surprising result is discussed elsewhere in more detail.²¹ The fact that in HNF_2 the nitrogen is a better electron donor than fluorine is in accord with the previous report by Craig that the weak $\text{HNF}_2\cdots\text{BF}_3$ and $\text{HNF}_2\cdots\text{BCl}_3$ donor-acceptor adducts contain B-N and not B-F bridges.¹⁰ By analogy with the known structure of solid HF ,²¹ a zig-zag chain structure, such as

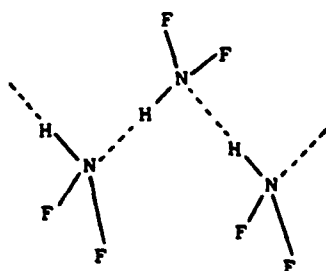

is most likely for $(\text{HNF}_2)_n$, but without additional structural support a more detailed interpretation of the vibrational data appears unwarranted.

Vibrational Spectra and Structure of the $\text{MF}\cdots\text{HNF}_2$ Adducts. Adducts of both HNF_2 and DNF_2 with KF , RbF and CsF were prepared as previously described.⁶ When an excess of HNF_2 was used in the syntheses, followed by removal of unreacted HNF_2 at low temperature, the combining ratios approximated 1:1. Low-temperature Raman spectra were measured for all these adducts (Figures 4 and 5). Low-temperature infrared spectra were recorded only for $\text{RbF}\cdots\text{HNF}_2$ (Figure 3) due to the limited availability of the corresponding alkali metal fluoride windows and the treacherous explosiveness of the $\text{CsF}\cdots\text{HNF}_2$ adduct on warmup to ambient temperature which caused severe damage to the cryostats.

The Raman spectra of $\text{MF}\cdot\text{HNF}_2$ (M=K and Rb) and $\text{MF}\cdot\text{DNF}_2$ (M=K, Rb and Cs) were completely analogous (see Figure 3 and Table II), suggesting essentially identical structures for these adducts. Compared to the spectra of free HNF_2 (see above), the frequency of the N-H stretching mode has decreased by about 600 cm^{-1} and consists of numerous broad bands. The two N-H deformation frequencies have increased by about 100 cm^{-1} and are also split, whereas the three NF_2 modes exhibit only relatively small frequency decreases with vasNF_2 also being split. These observations are thoroughly consistent with an adduct involving a strong hydrogen bridge between HNF_2 and the fluoride anion $[\text{F}\cdots\text{H}-\text{N}\begin{array}{l} \nearrow \text{F} \\ \searrow \text{F} \end{array}]^-$, similar to those previously reported for $\text{CsF}\cdot\text{HONO}_2$ ²³ and $\text{KF}\cdot(\text{CH}_2\text{COOH})_2$ ²⁴. The minor frequency decrease of the NF_2 vibrations can be explained by the electron density release from F^- to HNF_2 which increases the partial negative charges on the two fluorines of the NF_2 group, causing an increase of the $\text{HN}-\text{F}$ bond polarity and decrease of the N-F force constants.

The Raman spectra of the corresponding DNF_2 adducts are completely analogous and show the expected N-H:N-D frequency ratio of about 1.35 to 1.40. In addition to these major effects, all the spectra exhibit some more subtle features. For example, the NF_2 modes show a frequency decrease of about 10 cm^{-1} on going from $\text{KF}\cdot\text{HNF}_2$ to $\text{CsF}\cdot\text{HNF}_2$. This can be ascribed to the higher negative charge on F^- in CsF , relative to that in KF .

In addition to the internal modes of the HNF_2 subunit in the $[\text{F}\cdots\text{H}-\text{N}\begin{array}{l} \nearrow \text{F} \\ \searrow \text{F} \end{array}]^-$ anion, we would also expect librational modes due to the $\text{F}\cdots\text{H}-\text{N}$ bridge, i.e. one $\text{F}\cdots\text{H}$ stretch and two $\text{F}\cdots\text{H}-\text{N}$ deformation modes. Furthermore, bands due to the interaction between the alkali metal cations and the fluoride anions should be observable. All these modes should occur at relatively low frequencies and indeed

numerous bands below 350 cm^{-1} were observed. By analogy with the N-H modes, the F...H modes are probably broad and of low Raman intensity and therefore difficult to observe in the Raman spectra. In the infrared spectra of $\text{RbF}\cdot\text{HNF}_2$ (traces C and D of Figure 3) there is clear evidence for a strong absorption at about 330 cm^{-1} , and this could be one of the F...H libration modes. The sharper features observed in the $240\text{-}190\text{ cm}^{-1}$ region of the Raman spectra do not exhibit the large deuterium isotopic shifts expected for the F...H-N bridge modes and therefore are probably due to modes involving mainly fluoride ion motions in the lattice.

The Raman spectra of $\text{CsF}\cdot\text{HNF}_2$ showed the following interesting additional features. Two different sets of bands were observed which exhibited similar overall patterns but pronounced frequency shifts from each other, as shown by traces A and B of Figure 5. The spectrum depicted as trace A is very similar, although not quite analogous, to those of all the adducts given in Figure 4. The spectrum of trace B shows very pronounced frequency shifts (decrease of ν_{NH} by about 300 cm^{-1} , increase of the N-H deformations by about 40 cm^{-1} , decrease of the NF_2 modes by about $10\text{-}30\text{ cm}^{-1}$, and increase of the librational frequencies) relative to trace A. These shifts are best attributed to a hydrogen bonded $[\text{F}\cdots\text{HNF}_2]^-$ adduct which is very similar to that discussed above for the other adducts, but contains a significantly stronger hydrogen bridge. No evidence was observed for the existence of adducts showing frequencies intermediate between those of traces A and B, thus suggesting the presence of two distinct structures and not a progressive variation of the hydrogen bond strength.

In the case of HF addition to the fluoride anion, each free valence electron pair of the fluoride can form a hydrogen bridge, resulting in the $[F(\cdots HF)_n]^-$ polyanions where n can range from 1 to 4.²⁵⁻²⁸ The interpretation of the second, more strongly hydrogen bridged $F\cdots HNF_2$ type adduct in terms of an analogous $[F(\cdots HNF_2)_n]^-$ anion can be ruled out because the observed frequency changes (decrease of the N-H and NF_2 stretching modes) are opposite to those predicted for these polyanions.

Further evidence for the existence of a second, distinct, more strongly hydrogen bonded adduct was obtained from the low-temperature infrared spectra of $RbF\cdots HNF_2$ (see below). This demonstrates that the occurrence of a second, more strongly bridged HNF_2 adduct is not limited to CsF, but also occurs for RbF.

For the low-temperature infrared spectra of $RbF\cdots HNF_2$, difluoramine was condensed at $-220^\circ C$ onto an RbF single crystal window. After recording the spectrum of the solid HNF_2 deposit (Figure 3, trace B), the temperature of the RbF window was warmed briefly to $-110^\circ C$ in a static vacuum. Volatile material was pumped off quickly at $-110^\circ C$, and the window was cooled back again to $-220^\circ C$. The infrared spectrum of the resulting product (Figure 3, trace C) showed the absence of any unreacted HNF_2 and corresponded well to the low-temperature Raman spectra of the $MF\cdots HNF_2$ adducts shown in Figure 4. When the temperature of the infrared sample was briefly cycled through $-105^\circ C$ and cooled down again to $-220^\circ C$, additional bands were observed which are marked in trace D of Figure 3 by a dagger. The frequencies of these bands are almost identical to the major Raman bands of the more strongly hydrogen bonded modification of the $CsF\cdots HNF_2$ adduct shown in trace B of Figure 5 and were assigned accordingly (see Table II). Cycling of the $RbF\cdots HNF_2$ sample from $-220^\circ C$ through ambient temperature in a dynamic vacuum resulted in the

disappearance of the bands attributed to these $\text{RbF}\cdot\text{HNF}_2$ adducts.

Comparison of the results from this work with those from a previous low-temperature infrared study⁶ show only fair to poor agreement. This disagreement can be attributed to the poor quality of the previously reported data which is no surprise in view of the great experimental difficulties encountered. Although the existence of two different types of compounds, one a hydrogen bonded $\text{MF}\cdots\text{HNF}_2$ and the other an $\text{MNF}_2\cdot\text{HF}$ adduct, had been postulated, this conclusion was based more on the then known reaction chemistry of the adducts than on the spectroscopic data. The $\text{MNF}_2\cdot\text{HF}$ structure had been proposed to account for the fact that only $\text{CsF}\cdot\text{HNF}_2$ exhibited a propensity to explode on warming toward room temperature. The present study demonstrates that the $\text{KF}\cdot\text{HNF}_2$, $\text{RbF}\cdot\text{HNF}_2$ and $\text{CsF}\cdot\text{HNF}_2$ adducts exhibit the same structural features involving a strong hydrogen bridge between the HNF_2 and the fluoride anion of the alkali metal fluoride, and that the existence of a second, distinct modification which differs from the first one only in the strength of its hydrogen bridge is not unique for CsF . Although this second modification appears to form more readily with CsF , it was also observed for RbF and therefore might not necessarily be the main reason for the explosive nature of $\text{CsF}\cdot\text{HNF}_2$. Other factors, such as the higher affinity of CsF for HF , might be significant contributors. No evidence was obtained in this study for the presence of a distinct NF_2^- anion which should exhibit vibrational spectra very different from those observed.

Reaction Chemistry of $\text{MF}\cdot\text{HNF}_2$ Adducts. Since $\text{MF}\cdot\text{HNF}_2$ adducts are known to react with perfluoroalkyl hypofluorites according to



the analogous reactions were studied for several hypofluorites for which the corresponding $-ONF_2$ derivatives are still unknown. The hypofluorites studied included TeF_5OF , $FOClO_3$ and $FONO_2$. In the case of TeF_5OF the observed reaction products are best explained by the oxidation of HNF_2 by TeF_5OF ,



followed by the competing reactions

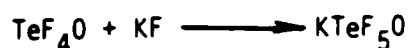

The reaction of OF_2 with $KF \cdot HNF_2$ required a considerably higher temperature and even at $-22^\circ C$ was still incomplete after one hour. Again the main reaction was the oxidation of HNF_2 to N_2F_4 .

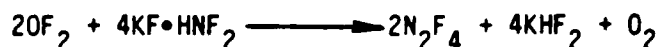

In the case of $FOClO_3$ and $KF \cdot HNF_2$, the mixture exploded when warmed from -196° toward $-78^\circ C$. For $FONO_2$, the reaction could be sufficiently controlled, but again N_2F_4 was formed in almost quantitative yield with NO_2 , O_2 and FNO_2 as the major by-products. It thus appears that with hypofluorites which are powerful oxidizers, fluorination of HNF_2 to N_2F_4 and HF is favored over $XONF_2$ formation.

Acknowledgement. The authors are grateful to Drs. C. J. Schack, W. W. Wilson and L. R. Grant for their help and to the Army Research Office and the Office of Naval Research for financial support.

References

- (1) Kennedy, A.; Colburn, C. B. J. Am. Chem. Soc. 1959, 81, 2906.
- (2) Lawton, E. A.; Weber, J. Q. J. Am. Chem. Soc. 1959, 81, 4755.
- (3) Lawton, E. A.; Weber, J. Q. J. Am. Chem. Soc. 1963, 85, 3595.
- (4) Klopotek, D. L.; Hobrock, B. G. Inorg. Chem. 1967, 6, 1750.
- (5) De Marco, R. A.; Shreeve, J. M. Inorg. Chem. 1973, 12, 1896.
- (6) Lawton, E. A.; Pilipovich, D.; Wilson, R. D. Inorg. Chem. 1965, 4, 118.
- (7) Maya, W.; Pilipovich, D.; Warner, M. G.; Wilson, R. D.; Christe, K. O. Inorg. Chem. 1983, 22, 810.
- (8) Dubb, H. E.; Greenough, R. C.; Curtis, E. C. Inorg. Chem. 1965, 4, 648.
- (9) Comeford, J. J.; Mann, D. E.; Schoen, L. J.; Lide, D. R. Jr. J. Chem. Phys. 1963, 38, 461.
- (10) Craig, A. D. Inorg. Chem. 1964, 3, 1628.
- (11) Lawless, E. W.; Smith, I. C. "Inorganic High Energy Oxidizers," Marcel Dekker: New York, 1968, p. 69.
- (12) Schack, C. J.; Wilson, W. W.; Christe, K. O. Inorg. Chem. 1983, 22, 18.
- (13) Miller, R. H.; Bernitt, D. L.; Hisatsune, I. C. Spectrochim. Acta, Part A 1967, 23, 223.
- (14) Schack, C. J.; Christe, K. O. Inorg. Chem. 1984, 23, 2922.
- (15) Christe, K. O.; Wilson, W. W. Inorg. Chem. 1980, 19, 1494.
- (16) Miller, F. A.; Harney, B. M. Appl. Spectrosc. 1969, 23, 8.
- (17) Fogarasi, G.; Pulay, P.; Molt, K.; Sawodny, W. Mol. Phys. 1977, 33, 1565.
- (18) De Bettignies, B.; Wallart, F. Compt. Rend. 1972, 275B, 283.
- (19) Kim, H.; Appelman, E. H. J. Chem. Phys. 1982, 76, 1664.
- (20) Abouaf-Marguin, L.; Jacox, M. E.; Milligan, D. E. J. Mol. Spectrosc. 1977, 67, 34.
- (21) Christe, K. O. J. Fluorine Chem. in press.
- (22) Atoji, M.; Lipscomb, W. N. Acta Cryst. 1954, 7, 173.
- (23) Al-Zamil, A.; Delf, B. W.; Gillard, R. D. J. Inorg. Nucl. Chem. 1980, 42, 1117.
- (24) Jones, D. J.; Emsley, J.; Roziere, J. J. Chem. Soc. Dalton Trans. 1984, 1625.
- (25) Coyle, B. A.; Schroeder, L. W.; Ibers, J. A. J. Solid State Chem. 1970, 1, 386.
- (26) Gennick, I.; Harmon, K. M.; Potvin, M. M. Inorg. Chem. 1977, 16, 2033.
- (27) Harmon, K. M.; Gennick, I. J. Mol. Spectrosc. 1977, 38, 97.
- (28) Mootz, D.; Poll, W. Z. Naturforsch. Teil B 1984, 39b, 1300.

Diagram Captions

- Figure 1. - Raman spectra of liquid and solid HNF_2 .
- Figure 2. - Vibrational spectra of DNF_2 : trace A, infrared spectrum of the gas at 270 torr in a 5 cm path length cell; traces B and C, Raman spectra of liquid and solid DNF_2 , respectively.
- Figure 3. - Infrared spectra of solid HNF_2 and of the $\text{RbF}\cdot\text{HNF}_2$ adduct at -220°C : trace A, background of the $\text{RbF}\cdot\text{HNF}_2$ window; trace B, solid HNF_2 ; trace C, $\text{RbF}\cdot\text{HNF}_2$ adduct generated by cycling the deposit of trace B through -110°C ; the bands marked by an asterisk are due to cell background; trace D, spectrum produced by cycling deposit of trace C through -105°C ; the new set of bands marked by a dagger are ascribed to the second, more strongly hydrogen bridged species; trace E, cell background after cycling through 25°C with pumping.
- Figure 4. - Raman spectra of $\text{KF}\cdot\text{HNF}_2$ (traces A, A'), $\text{KF}\cdot\text{DNF}_2$ (trace B), $\text{RbF}\cdot\text{HNF}_2$ (traces C and C'), $\text{RbF}\cdot\text{DNF}_2$ (trace D), and $\text{CsF}\cdot\text{DNF}_2$ (traces E and E'), all recorded at -140°C . The traces A', C' and E' were recorded at a higher sensitivity setting.
- Figure 5. - Raman spectra of the two modifications of $\text{CsF}\cdot\text{HNF}_2$ at -140°C . Traces A and A' show the spectrum of the more weakly hydrogen bridged adduct at two different sensitivity levels, respectively, and traces B and B' those of the stronger hydrogen bridged adduct.

Table I. Vibrational Spectra of HMF₂ and DMF₂ in the Gas-, Liquid-, and Solid-Phase

assignment	approx descripn of mode	obsd freq. cm ⁻¹ (rel intens ^a)						
		HMF ₂		DMF ₂				
		gas IR	liquid Ra	solid IR	gas IR	liquid Ra	solid Ra	gas calcd ^b
C _s	v(NH)	3193vw	3210(0.8)p 3185(1.7)p	3215w 3170sh 3158s 2874mw	[2333] ^c	2388(1)p 2365(2.2)p	2353(3.2) 2338(10)	2340
	v ₁ (a')							
	2v ₅ (a')	27390vw		2650mw 2340w	1897vw 1849mw		2107(0+)	
	v ₂ + v ₅ (a'')							
	2v ₂ (a')							
	v ₅ + v ₆ (a')							
	v ₂ + v ₆ (a'')							
	v ₃ + v ₆ (a'')							
	v ₂ + v ₄ (a')							
	v ₅ (a'')	1850mw		1850sh 1825mw 1460sh 1445s 1426s 1343s	1028s	1043(0.8)dp	1070(0.6) 1059(0.6)	1034
	δ _{as} F ₂ NH	1424s	1429(0.9)dp					
	δ _s F ₂ NH	1307s	1310(0.7)p	1310s 1006m	1009s	1007(2)p	1036(0.5) 1003(1.2)	1007
	2v ₄ (a')		1008sh					
	v ₃ (a')	972ms	974(10)p	967s	962ms	970(10)p	977(10)	961
	v ₆ (a'')	888vs	869(4.0)dp	875vs 735mw	888vs	866(3.6)dp	868(8.3)	888
	v ₄ (a')	500mw	504(8.2)p	503m	498mw	501(8.4)p	503(5.2) 284(1.0) 144(1) 114(3) 103(3) 75(2)	498

(a) Uncorrected Raman intensities (peak heights).

(b) Data from ref. 17, calculated by ab initio from HMF₂ values.

(c) Estimated value from ref. 9; not observed in this study because of its low intensity.

Table II. Vibrational Spectra of the Alkali Metal Fluoride - Difluoramine Adducts^a

assignment for $[F \cdots H-N \begin{array}{c} \diagup F \\ \diagdown F \end{array}]^{-c}$	obsd freq, cm^{-1} (rel intens) ^b		KF·HNF ₂		RbF·HNF ₂		RbF·DMF ₂		CsF·HNF ₂		CsF·DMF ₂ Ra
	Ra	Ra	Ra	IR(I)	IR(II)	Ra	IR(I)	Ra	Ra(I)	Ra(II)	
NH-H(I)	2730(0.1)	2600(0.3)	2160(0.3)	3050 _{mw}	2540 _{sh}	2160(0+)	3060(0.2)	2160(0+)	3060(0.2)	2530(0.3)	2080(0+)
	2040(0+)	1990(0.6)	2080(0.1)	2870 _m	2430 _m	2085(0+)	2860(0.1)	2035(0+)	2910(0.2)	2425(0.1)	2035(0+)
NH-H(II)	1937(0.5)		2040(0+)	2658 _s	2325 _m	1990(0.5)	2730(0.1)	1936(0.2)	2750(0.1)	2335(0.2)	1980(0.3)
			1937(0.5)		1553 _{mw}	2600(0.3)	2600(0.3)		2640(0.6)	1552(0.1)	1932(0.2)
δ _{as} HNF ₂ (II)	1529(0.2)			1506 _{mw}	1474 _w				1520(0.1)	1442(0.1)	
					1439 _m						
δ _s HNF ₂ (I)	1440(0.1)	1412(0.4)	1440(0.1)	1420 _{mw}		1420(0.2)		1076(0.2)	1470(0+)		
	949(10)		1412(0.4)	942 _s		944(10)		943(10)	1400(0.1)		941(10)
δ _s HNF ₂ (II)	857(1.7)	836(5.5)	858(1.7)	849 _{sh}	930 _s	852(1.7)		853(2)	864(3)		851(1.5)
			836(5.5)	831 _{vs}		833(5.5)		834(5.7)	848(3.5)		832(5.5)
ν _{as} NF ₂ (I)	499(7.1)		837(5.5)	498 _{mw}	838 _{vs}	496(7.2)		495(7.5)	499(7.1)		492(7.5)
					821 _{sh}						
ν _{as} NF ₂ (II)			497(7.2)	330 _{vs}	490 _{mw}	350(0.1)		340(0.3)	318(1.0)		330(0.5)
									290(0.5)		
librations (I) and (II) and lattice modes	236(0.8)	206(1.5)	240(0.6)			228(0.6)		228(1)	192(0.3)		210(2)
	198 _{sh}	158 _{sh}	206(1)			203(1.2)		203(1.4)	150 _{sh}		198(2)
	132(1)	110(1)	195 _{sh}			190 _{sh}		190(0.4)			190 _{sh}
			156(0.3)			140 _{sh}		142 _{sh}			
			130(1)			125(1)		120 _{sh}			
			113(1)								
		60 _{sh}							122(1)	117(3)	130 _{sh}
											110(1)

(a) I and II refer to the two modifications (see text for explanation). All Raman spectra were recorded at -140°C, infrared spectra at -220°C.

(b) Uncorrected Raman intensities (peak heights).

(c) For the MF·DMF₂ adducts, assignments involving the M-D group have been listed in the M-H rows.

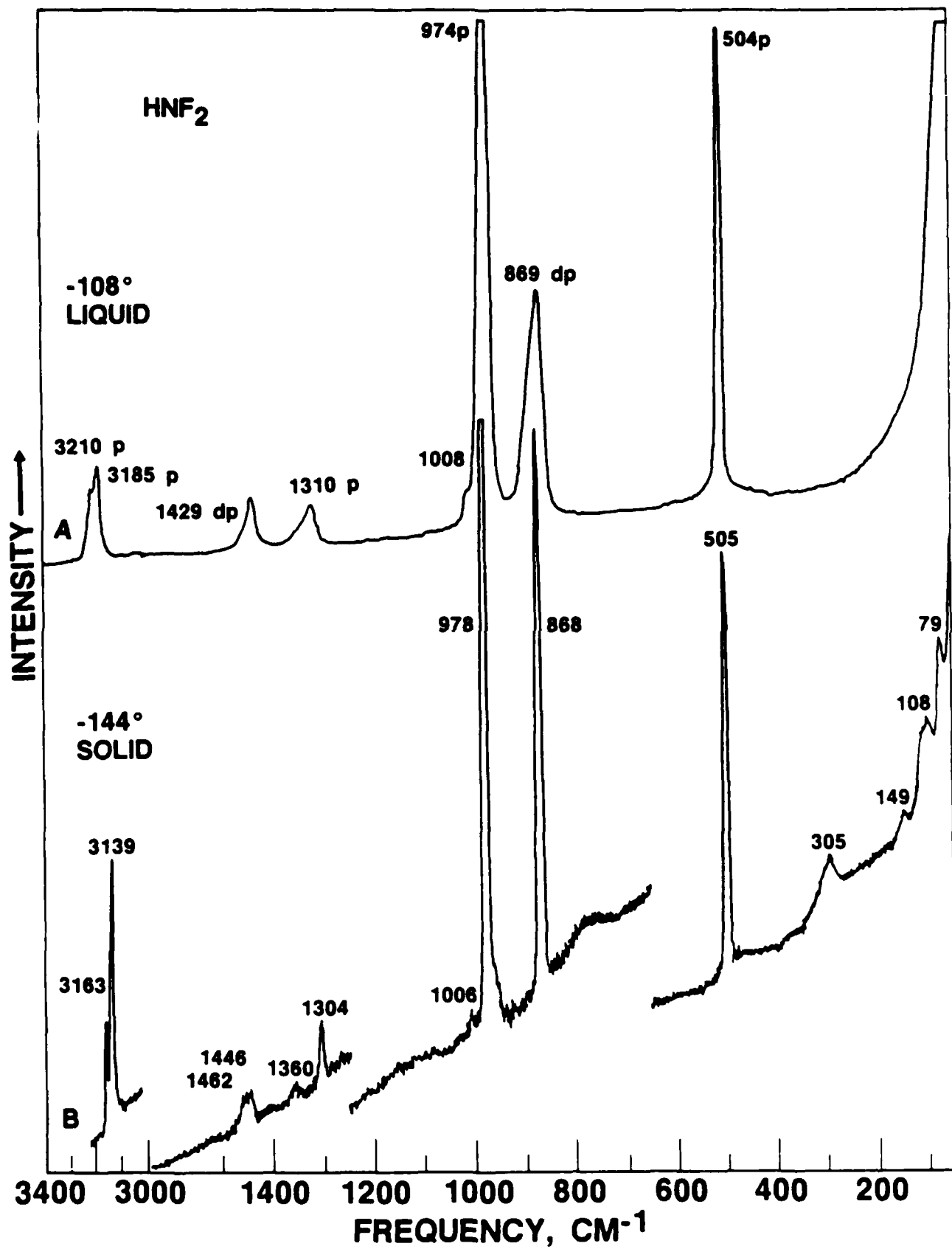

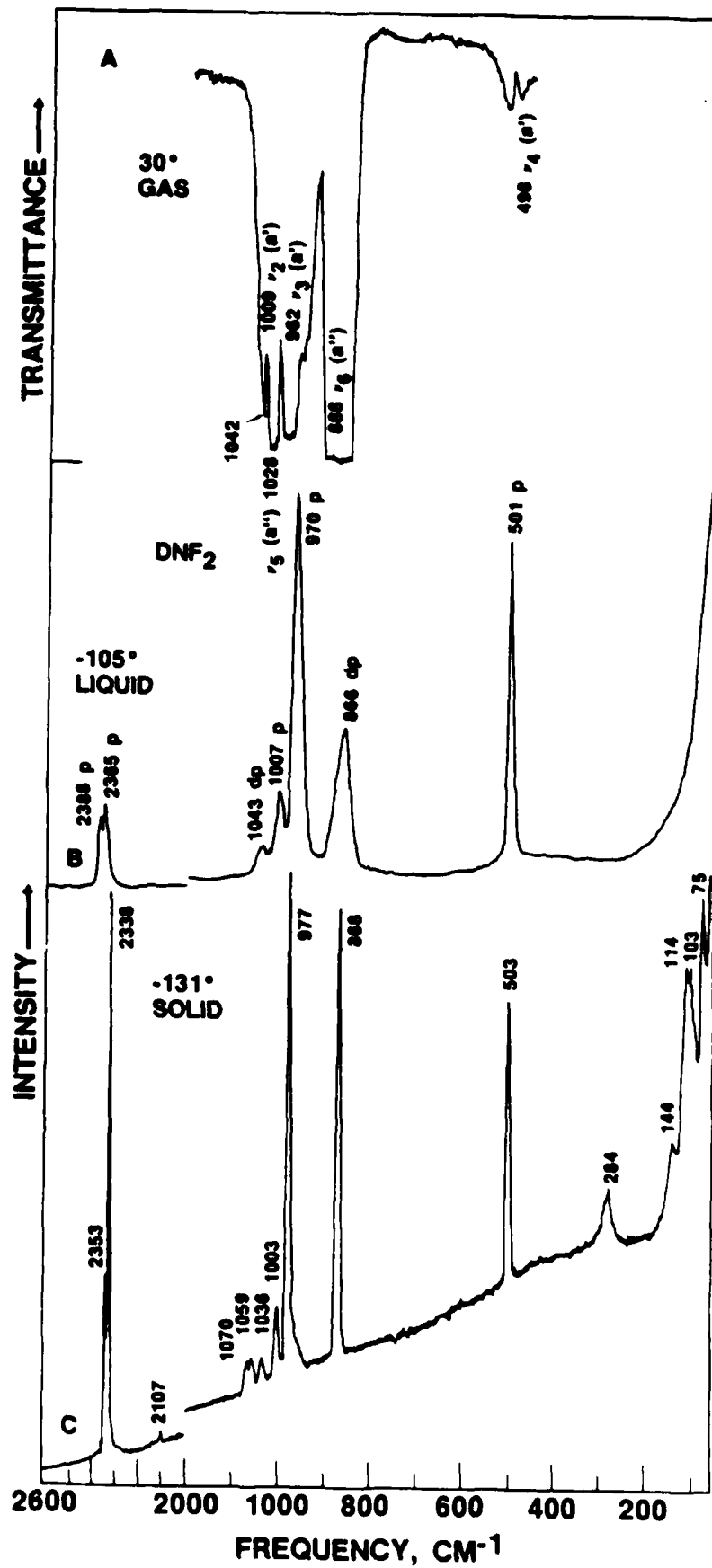

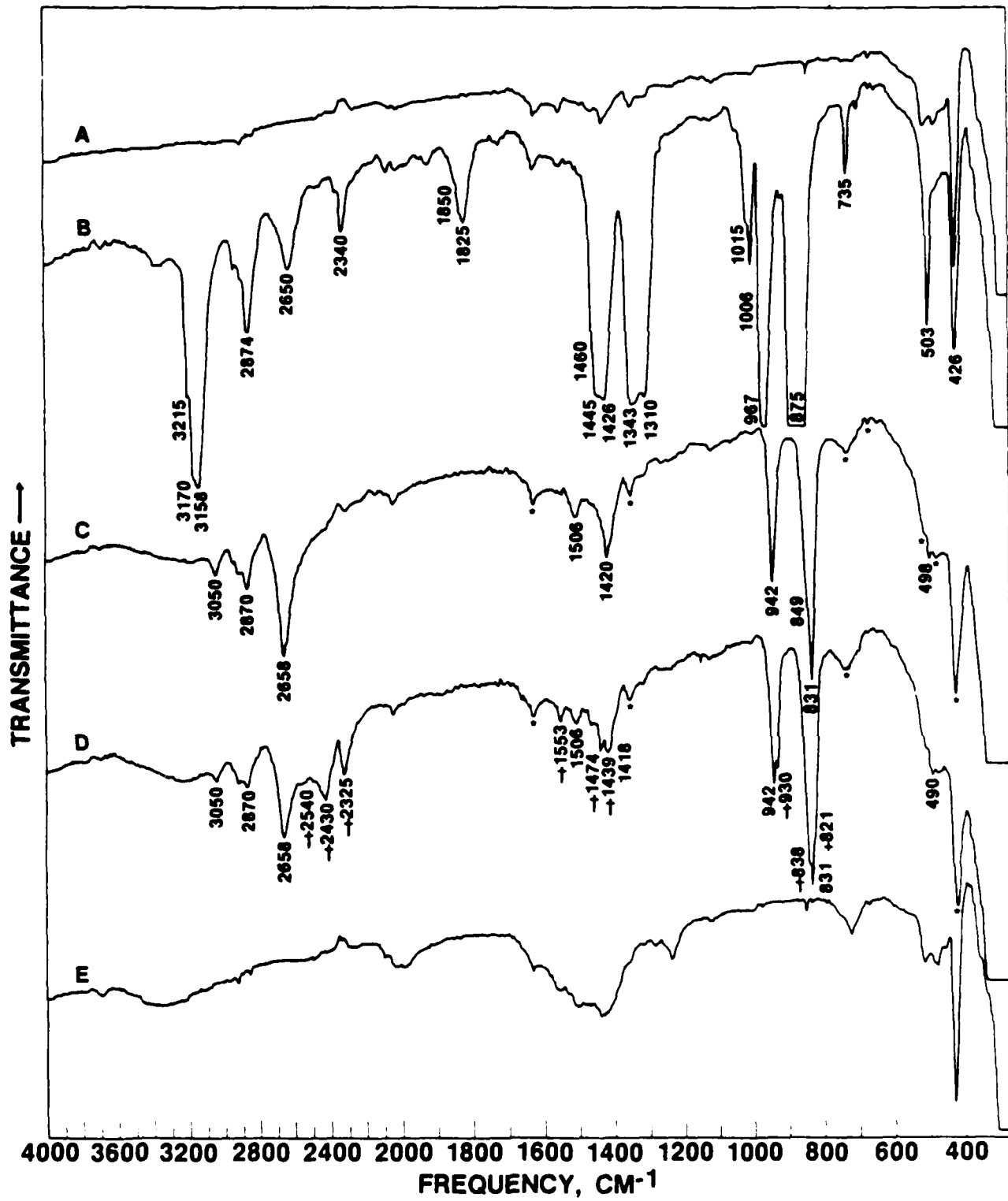

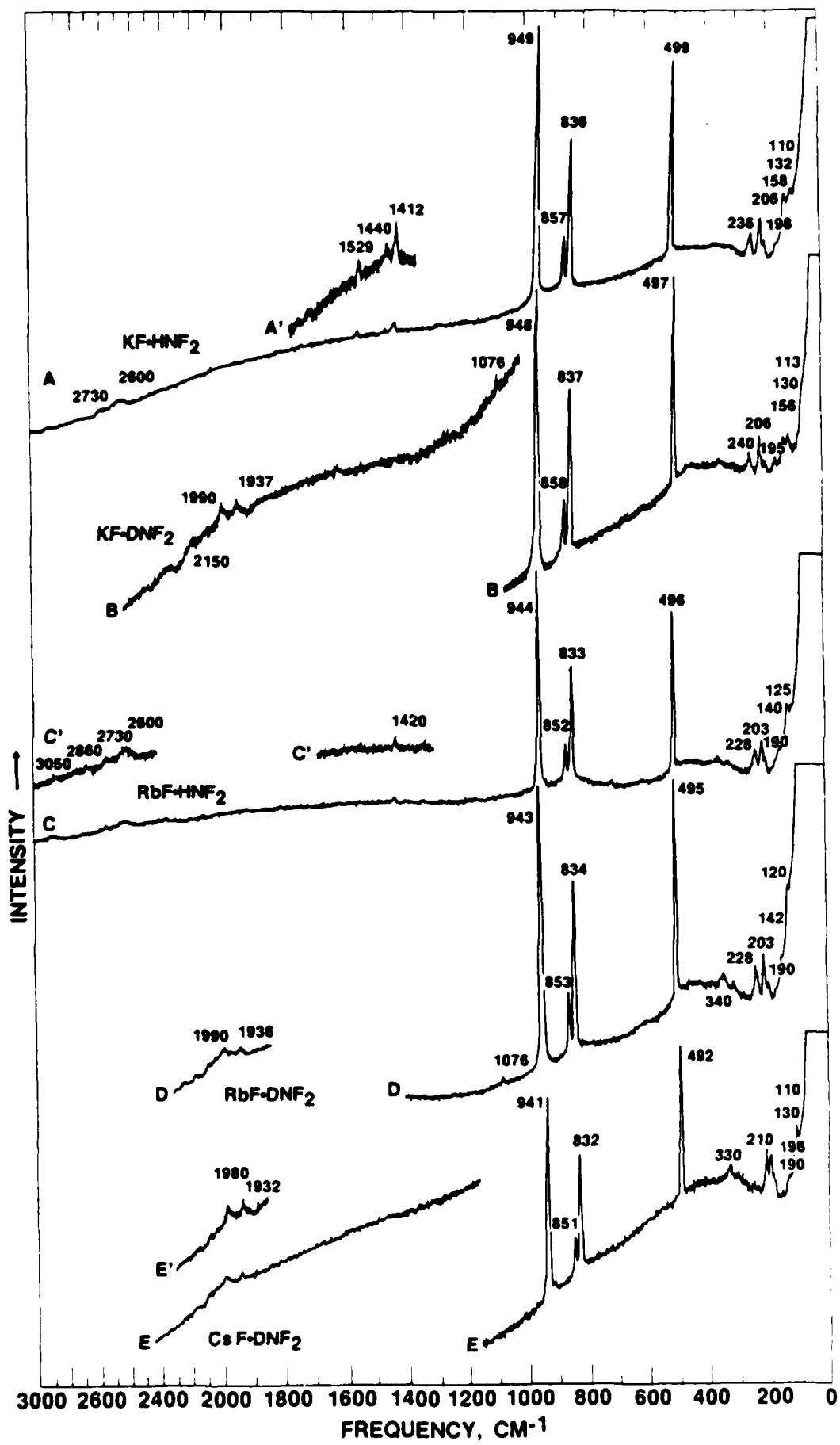

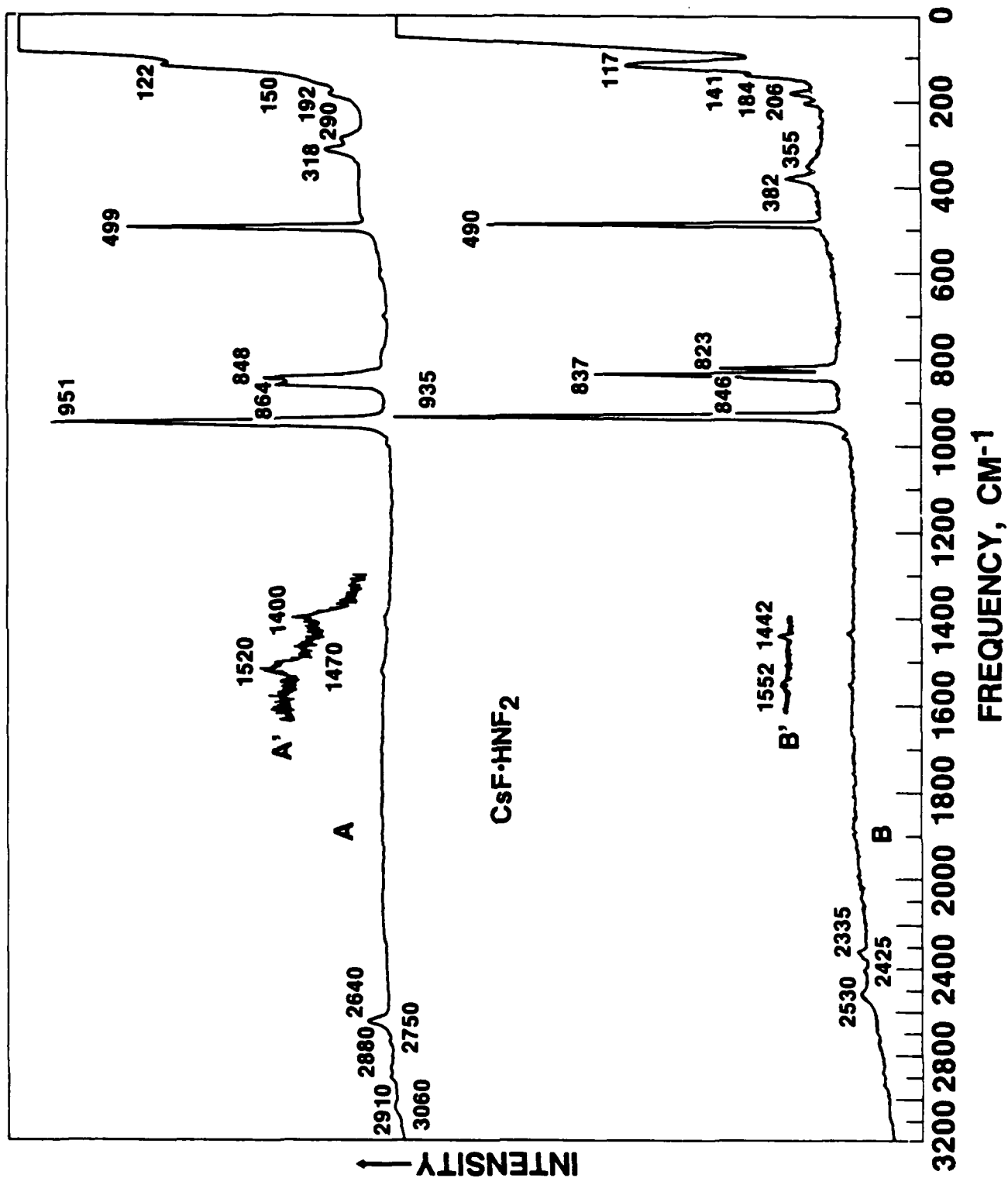

APPENDIX T

Contribution from Rocketdyne, A Division of Rockwell
International, Canoga Park, California 91303

New, One Step Syntheses of BrF_3O and BrF_4O^- Salts and the Preparation and Characterization of RbBrF_4O and NaBrF_4O

WILLIAM W. WILSON and KARL O. CHRIS^{*}

Received...

ABSTRACT

The reactions of an excess of BrF_5 with the alkali metal nitrates NaNO_3 , KNO_3 , RbNO_3 and CsNO_3 provide new, simple, high yield syntheses of the corresponding BrF_4O^- salts and FNO_2 . The NaBrF_4O and RbBrF_4O salts have been prepared for the first time and were characterized by vibrational spectroscopy, DSC and their x-ray powder diffraction patterns. The reaction of LiNO_3 with an excess of BrF_5 does not result in the formation of a stable LiBrF_4O salt but produces free BrF_3O in high yield. This provides a simple, one step synthesis of BrF_3O from commercially available starting materials.

INTRODUCTION

The existence of KBrF_4O was discovered in 1976 both by Bougon and coworkers¹ and by Gillespie and Spekkens.² It was prepared either by the reaction¹ of KBrO_3 with a large excess of BrF_5 at 80°C in the presence of F_2 or by the reaction² of KBrF_6 with KBrO_3 in CH_3CN solution. Both methods have drawbacks. Although Bougon's method¹ can yield a pure product, the course of the reaction is difficult to control and frequently KBrF_4 is obtained as the only product.³ Gillespie's method² produces a mixture of KBrF_2O_2 and KBrF_4O which must be separated by numerous extractions with CH_3CN .

An improved synthesis of BrF_4O^- salts was reported by Christie and coworkers³ who reacted BrO_4^- salts with BrF_5 and F_2 . In addition to KBrF_4O , the latter authors also prepared and characterized CsBrF_4O . Although this method results in a pure product in essentially quantitative yield,³ the required BrO_4^- starting materials are difficult to prepare.⁴ Except for $\text{NF}_4^+\text{BrF}_4\text{O}^-$ ⁵ no other BrF_4O^- salts have been reported.

Three methods have previously been reported for the synthesis of BrF_3O . Bougon and Bui Huy⁶ reacted KBrF_4O with O_2AsF_6 in BrF_5 solution.

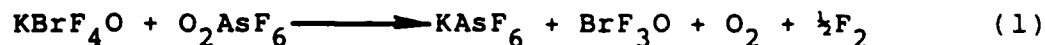

Gillespie and Spekkens² dissolved KBrF_4O in anhydrous HF,

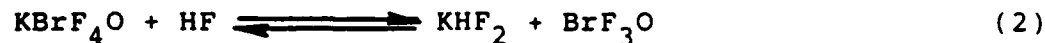

and extracted the formed BrF_3O with BrF_5 at low temperature. Adelhelm and Jacob⁷ obtained BrF_3O , together with FBrO_2 , by treatment of a mixture of $\text{BrF}_2\text{OPtF}_6$ and BrO_2PtF_6 with FNO_2 .

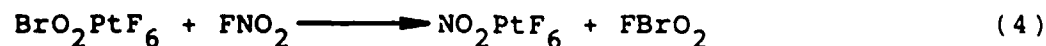
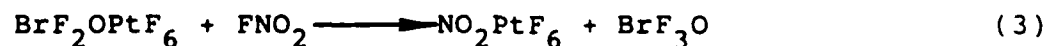

All three methods are elaborate and involve several steps and exotic starting materials. The development of a new, simple, one-step synthesis of BrF_3O from commercially available starting materials was therefore highly desirable.

EXPERIMENTAL

Materials. Commercial LiNO_3 (J. T. Baker, 99.7%), NaNO_3 (J. T. Baker, 99.5%), KNO_3 (J. T. Baker, 99.1%), and RbNO_3 (K & K Labs, Inc., 99.9%) were dried in a vacuum oven at 120°C for one day prior to their use. The CsNO_3 was prepared from Cs_2CO_3 and HNO_3 and dried in the same manner. The BrF_5 (Matheson) was treated with 35 atm of F_2 at 100°C for 24 hr and then purified by fractional condensation through traps kept at -64 and -95° , with the material retained at -95° being used. BrF_5 and BrF_3O are powerful oxidizers and contact with organic materials or moisture must be avoided.

Apparatus. Volatile materials used in this work were handled in a well-passivated (with BrF_5 until it was recovered as a white solid at -196°) stainless steel Teflon FEP vacuum line.⁸ Non-volatile materials were handled in the dry nitrogen atmosphere of a glovebox.

Infrared spectra were recorded in the range $4000\text{-}200\text{ cm}^{-1}$ on a Perkin-Elmer Model 283 spectrophotometer. Spectra of solids were obtained by using dry powders pressed between AgCl or AgBr windows in an Econo press (Barnes Engineering Co.). Spectra of gases were obtained by using a Teflon cell of 5-cm path length equipped with AgCl windows. Raman spectra were recorded on either a Cary Model 83 or a Spex Model 1403 spectrophotometer using the 488-nm exciting line of an Ar ion laser or the 647.1-nm exciting line of a Kr ion laser, respectively. Sealed glass tubes were used as sample containers in the transverse-viewing-transverse-excitation mode. X-ray diffraction patterns of the powdered samples in sealed 0.5-mm quartz capillaries were obtained by using a General Electric Model XRD-6 diffractometer, Ni-filtered $\text{Cu K}\alpha$ radiation, and a 114.6-mm-diameter Phillips camera. DSC measurements were carried out with a Perkin-Elmer Model DSC-1B using crimp sealed aluminum pans and a heating rate of $10^\circ/\text{min}$.

Preparation of $M^+BrF_4O^-$ (M=Cs, Rb, K, Na). Inside the dry box, a weighed amount (typically about 3 mmol) of MF was loaded into a prepassivated reactor (either a 30 mL stainless steel cylinder or a 0.75" o.d. Teflon-FEP ampule) which was closed by a valve. The reactor was connected to the vacuum line and a fivefold excess of BrF_5 was added at -196° . The reactor was warmed to a given temperature for a specified period of time with occasional agitation, followed by fractional condensation of the volatile products through a series of two U-traps kept at -142° (BrF_5) and -196° (FNO_2). The material balances were determined from the weight gain of the solid residue in the reactor and the amounts of volatiles collected in the cold traps. All materials were identified by vibrational spectroscopy. The reaction conditions and product yields for the various BrF_4O^- salts are summarized in Table I.

Preparation of BrF_3O . Inside the dry box, $LiNO_3$ (2.12 mmol) was loaded into a passivated 30 mL stainless steel cylinder. On the vacuum line, BrF_5 (31.93 mmol) was added at -196° , and the cylinder was stored at 0° for 20 days with occasional agitation. The cylinder was reconnected to the vacuum line, cooled to -196° and did not contain any material volatile at this temperature. While allowing the cylinder to slowly warm toward ambient temperature, the volatile material was separated in a dynamic vacuum by fractional condensation through a series of traps kept at -64 , -142 and -196° . The -64° trap contained BrF_3O (2.01 mmol, 95% yield based on $LiNO_3$), the -142° trap collected the excess of BrF_5 and a small amount of BrF_3O , and the -196° trap retained the FNO_2 (2.05 mmol, 97% yield based on $LiNO_3$). The white, solid residue (about 0.06g, weight calcd for 2.12 mmol of $LiF = 0.055g$) was identified by its x-ray powder pattern as LiF . Its powder pattern and vibrational spectra did not exhibit any lines attributable to either $LiNO_3$ or a BrF_4O^- salt. When the duration of this reaction was shortened to 4 hr, the conversion of $LiNO_3$ and the concomitant yield of BrF_3O decreased to 70%.

RESULTS AND DISCUSSION

Syntheses of BrF_4O^- Salts and BrF_3O . The reaction of an excess of BrF_5 with the alkali metal nitrates CsNO_3 , RbNO_3 , KNO_3 , or NaNO_3 proceeds in high yield according to (5).



The reactivity of MNO_3 decreases from Cs to Na. Thus, the reaction of CsNO_3 is complete within one hour at -31° (see Table I, run 1). For KNO_3 , a 31% conversion to KBrF_4O was obtained under the same conditions (run 5), but thereafter the reaction progressed only very slowly. Because tripling the amount of BrF_5 did not significantly increase the conversion of KNO_3 (run 6), and since the solubility of KBrF_4O in BrF_5 is quite low, coating of the solid KNO_3 phase by product was suspected as the principal cause for the observed fall-off in the reaction rates. This suspicion was confirmed. Fine grinding of the product, followed by a second treatment with BrF_5 , almost doubled the yield of KBrF_4O (run 5). Complete conversion of KNO_3 to KBrF_4O was achieved at ambient temperature by ballmilling the reagents during the reaction (run 8). Alternatively, complete conversion of KNO_3 to KBrF_4O could be achieved by heating to 100°C (run 10). Run 11 shows that these reactions do not require a fivefold excess of BrF_5 , but also go to completion with lower BrF_5 to metal nitrate ratios.

The reactions of NaNO_3 with BrF_5 differed somewhat from those of CsNO_3 , RbNO_3 and KNO_3 which produced exclusively the corresponding BrF_4O^- salts. At a reaction temperature of 0° , some free BrF_3O was always isolated in addition to NaBrF_4O (run 13). When the reaction temperature was increased to 25° , the solid products contained significant amounts of BrF_4^- and BrO_2F_2^- salts (run 14). The formation of BrF_4^- and BrO_2F_2^- at 25° is not surprising.

BrF_3O is known^{5,6,9} to decompose above 0° to $\text{BrF}_3 + \text{O}_2$, and reaction of BrF_3O with a second mole of NaNO_3 can generate BrO_2F . Both, BrF_3 and BrO_2F , can then react with NaF to give the corresponding anions, as shown in equations (6) to (10).

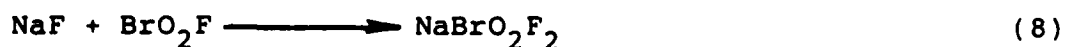
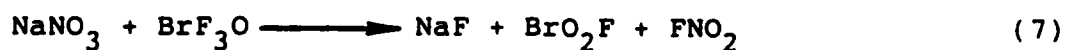
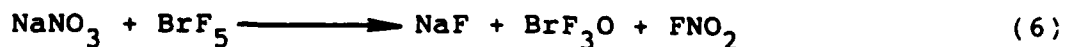

A rationale for the formation of free BrF_3O in the $\text{NaNO}_3\text{-BrF}_5$ system will be given below.

The isolation of some free BrF_3O from the $\text{NaNO}_3\text{-BrF}_5$ reaction suggested the possibility of preparing BrF_3O in a simple, one step synthesis from a metal nitrate whose metal fluoride does not form a stable BrF_4O^- salt at 0° or below. This concept was verified for LiNO_3 . When LiNO_3 is reacted with an excess of BrF_5 at 0° , BrF_3O is formed in essentially quantitative yield according to (11).

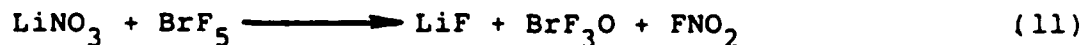

Ballmilling of the solid reagents during the reaction, as in run 8, might also be advantageous for this system if shorter reaction times are desired.

When BrF_5 was reacted for 1 hr at either -31 or 25°C with an excess of CsNO_3 , a quantitative conversion of BrF_5 to CsBrF_4O and FNO_2 was observed. The solid product consisted exclusively of CsBrF_4O and unreacted CsNO_3 . With an excess of LiNO_3 , however, the course of the reaction was very different and will be reported in a separate paper.

The above described syntheses of MBrF_4O and BrF_3O offer numerous advantages over the previously used methods. Among these are:

(i) the starting materials, BrF_5 and MNO_3 , are commercially

available and relatively inexpensive; (ii) the yields are essentially quantitative; (iii) the reactions can be carried out at convenient temperatures and at autogenous pressures; and (iv) these syntheses are one step reactions requiring only simple equipment. In addition to being useful methods for the preparation of $MBrF_4O$ and BrF_3O , these reactions also can be used as a convenient new laboratory method for the preparation of FNO_2 under mild conditions. The yields of FNO_2 are quantitative, and product separation is very easy. The FNO_2 is much more volatile than the other products and can readily be isolated in high purity by either fractional condensation or removal in vacuo at low temperature (BrF_5 stops at -95° , whereas FNO_2 still passes through a -142° trap but stops at -196°).

Some interesting questions concerning the mechanism of the $MNO_3^-BrF_5$ reactions are raised by the following facts. For the $NaNO_3-BrF_5$ system at 0° some BrF_3O was obtained as a by-product besides $NaBrF_4O$, and at 25° the formed BrF_3O underwent either fast decomposition to $BrF_3 + O_2$ or further reaction with $NaNO_3$ to BrO_2F , followed by complexing with NaF to form the corresponding sodium salts. In marked contrast to these observations, the heavier alkali metal salts (K, Rb and Cs) form, even at reaction temperatures as high as 100° , the corresponding $MBrF_4O$ salts in quantitative yield. As shown below, $NaBrF_4O$ is stable up to about 160° . Therefore the free BrF_3O could not have formed by decomposition of $NaBrF_4O$, but must have been generated from a less stable intermediate which is capable of generating either $BrF_3O + MF + FNO_2$ or $MBrF_4O + FNO_2$.

A logical candidate for this intermediate is the $[NO_3 \cdot BrF_5]^-$ polyanion. BrF_5 is well known to exhibit some Lewis acidity and forms, for example with F^- , an octahedral BrF_6^- anion in which the free valence electron pair on bromine occupies a sterically inactive s orbital.¹⁰ Therefore, the formation of

an analogous $[\text{NO}_3 \cdot \text{BrF}_5]^-$ anion is quite plausible. Decomposition of the resulting $\text{M}^+[\text{NO}_3 \cdot \text{BrF}_5]^-$ salt could involve either FNO_2 elimination from the anion resulting in the direct formation of $\text{M}^+\text{BrF}_4\text{O}^-$ (12), or F^- abstraction from the $[\text{NO}_3 \cdot \text{BrF}_5]^-$ anion by M^+ followed by FNO_2 elimination from an unstable BrF_4ONO_2 molecule thus producing free BrF_3O (13). Whether (10) or (13) dominates should depend on the F^- ion affinity of M^+ and the thermal stability of $\text{M}^+[\text{NO}_3 \cdot \text{BrF}_5]^-$. Sodium is expected to form the least stable $\text{M}^+[\text{NO}_3 \cdot \text{BrF}_5]^-$ salt and therefore should be most prone to decomposition to MF and BrF_4ONO_2 . Based on these arguments, the following mechanism is proposed to explain the observed reaction chemistry.

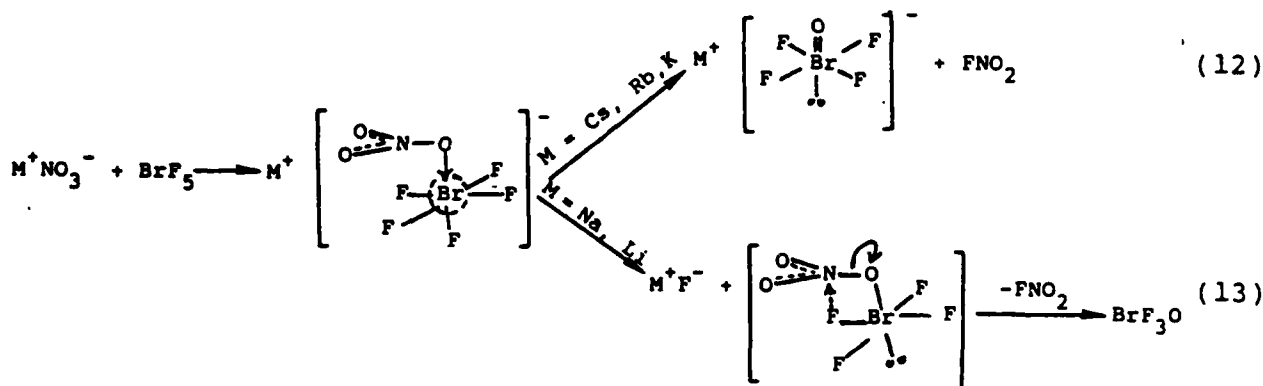

For $\text{M} = \text{Na}$, dissociation of the intermediate $\text{M}^+[\text{NO}_3 \cdot \text{BrF}_5]^-$ salt to MF and BrF_4ONO_2 would be faster than intramolecular FNO_2 elimination, while the reverse could be said for $\text{M} = \text{Cs, Rb,}$ or K .

Attempts were unsuccessful to isolate the proposed $[\text{NO}_3 \cdot \text{BrF}_5]^-$ intermediate anion by condensation of BrF_5 onto an excess of CsNO_3 at -196° , brief warming of the mixture to the mp of BrF_5 (-60.5°), and recooling it to -196° . Low-temperature Raman spectra of the resulting product showed only CsBrF_4O , FNO_2 and unreacted BrF_5 .

Properties of the $M\text{BrF}_4\text{O}$ Salts. The only previously known BrF_4O^- salts were $\text{KBrF}_4\text{O}^{1,2}$, CsBrF_4O^3 and $\text{NF}_4\text{BrF}_4\text{O}^5$. It was therefore of interest to characterize the two new salts, NaBrF_4O and RbBrF_4O . All these alkali metal BrF_4O^- salts are white, stable crystalline solids. Based on DSC data, the onset of thermal decomposition occurs at the following temperatures: NaBrF_4O , 161° ; KBrF_4O , 221° ; RbBrF_4O , 226° ; CsBrF_4O , 189° . The x-ray powder diffraction patterns were also recorded for these salts. It was found that RbBrF_4O is isotypic with KBrF_4O and its diffraction pattern (see Table II) was indexed for a tetragonal cell by analogy to that previously published for KBrF_4O^1 . Many of the lines in the powder patterns of CsBrF_4O and NaBrF_4O (see Table III) can be indexed for similar tetragonal cells, however, the correspondence is not as good and in view of the large unit cells involved, our confidence in such an indexing is low.

The vibrational spectra of BrF_4O^- salts are interesting. For KBrF_4O^1 and CsBrF_4O^3 numerous splittings of degenerate modes into their components were observed which made assignments³ difficult. The vibrational spectra of RbBrF_4O (see Figure 1) are similar to those of CsBrF_4O and also exhibit these pronounced splittings. However, the spectra of NaBrF_4O (see Figure 2) are much simpler and therefore can be used to examine the correctness of the previous assignments.³ As can be seen from Table IV, the Raman spectrum of NaBrF_4O allows unambiguous assignments for ν_1 , ν_2 , ν_3 , ν_4 , ν_6 and ν_9 . The extra Raman bands in the spectra of KBrF_4O^1 , CsBrF_4O^3 and RbBrF_4O are due to splittings of the degenerate E modes into their components, accompanied by significant gains in intensity, and have previously been assigned³ correctly. The minor frequency differences between RbBrF_4O and NaBrF_4O are normal for salts with different cations and are as expected, i.e. strongest interaction of the anion with the smallest cation.

Acknowledgement. The authors are indebted to Drs. C. J. Schack and L. R. Grant and Mr. R. D. Wilson for their help and to the Army Research Office and the Office of Naval Research for financial support.

REFERENCES

- (1) Bougon, R.; Bui Huy, T.; Charpin, P.; Tantot, G. C. R. Hebd. Seances Acad. Sci., Ser. C 1976, 283, 71.
- (2) Gillespie, R. J.; Spekkens, P. J. Chem. Soc., Dalton Trans. 1976, 2391.
- (3) Christe, K. O.; Wilson, R. D.; Curtis, E. C.; Kuhlmann, W.; Sawodny, W. Inorg. Chem. 1978, 17, 533.
- (4) Appelman, E. H. Inorg. Chem. 1969, 8, 223.
- (5) Christe, K. O.; Wilson, W. W. Inorg. Chem. 1986, 25, 1904.
- (6) Bougon, R.; Bui Huy, T. C. R. Hebd. Seances Acad. Sci. Ser. C 1976, 283, 461.
- (7) Adelhelm, M.; Jacob, E. Angew. Chem. Int. Ed. Engl. 1977, 16, 461.
- (8) Christe, K. O.; Wilson, R. D.; Schack, C. J. Inorg. Synth. 1986, 24, 3.
- (9) Gillespie, R. J.; Spekkens, P. J. Chem. Soc. Dalton Trans. 1977, 1539 and Israel J. Chem. 1978, 17, 11.
- (10) Tantot, G.; Bougon, R. C. R. Hebd. Seances Acad. Sci., Ser. C 1975, 281, 271.

Diagram Captions

Figure 1. Vibrational spectra of solid RbBrF_4O : trace A, infrared spectrum of a sample in an AgCl disk; trace B, Raman spectrum.

Figure 2. Vibrational spectra of solid NaBrF_4O : trace A, infrared spectrum of a sample in an AgBr disk; trace B, Raman spectrum.

Table I. Reaction Conditions and Yields for the Syntheses
of $MBrF_4O$ Salts

M	Run No	React temp (°C)	React Time (hr)	Mole Ratio $BrF_5:MNO_3$	Conversion of MNO_3 to $MBrF_4O$ (%)
Cs	1 ^a	-31	1	4.9	99.8
Rb	2 ^a	-31	1	5.0	73.2
	3 ^b	25	1	5.1	98.7
	4 ^b	25	96	5.1	99.5
K	5 ^a	-31	1	5.0	34.3
			4		37.1
			5		63.3 ^c
	6 ^a	-31	1	15.1	33.5
	7 ^a	25	1	5.2	37.5
			4		55.6
			5		68.8 ^c
			6		77.7 ^d
	8 ^b	25	20	15.2	99.7 ^e
	9 ^b	70	4	15.1	72.1
	10 ^b	100	20	15.1	99.9
	11 ^b	100	88	2.9	99.9
Na	12 ^a	-31	1	5.0	0
	13 ^b	0	624	15.1	72 ^f
	14 ^a	25	67	5.0	53 ^g

(a) reactor: 0.75" o.d. Teflon FEP ampule; (b) reactor: 30 ml stainless steel cylinder; (c) sample was reground after 4 hr reaction time; (d) sample was reground after 5 hr reaction time; (e) reactants were subjected to ballmilling during reaction; (f) volatile products contained 14% free BrF_3O and solid residue showed the presence of a trace of $NaBrO_2F_2$; (g) volatile products contained BrF_3O and BrF_3 and solid residue $BrO_2F_2^-$ and BrF_4^- as by-products.

Table II. X-Ray Powder Data for $\text{RbBrF}_4\text{O}^{\text{a}}$

$d_{\text{obsd}}, \text{\AA}$	$d_{\text{clcd}}, \text{\AA}$	Intens	h k l
7.22	7.214	m	2 0 0
5.34	5.336	m	2 0 2
4.61	4.602	w	3 0 1
4.38	4.385	w	3 1 1
3.95	3.964	vs	{ 0 0 4
	3.954		{ 3 1 2
3.61	3.607	s	4 0 0
3.45	3.454	w	3 1 3
3.276	3.283	w	4 0 2
3.124	3.125	vs	{ 3 3 2
	3.130		{ 2 2 4
2.914	2.918	ms	4 1 3
2.860	2.860	ms	3 3 3
2.650	2.647	vw	3 0 5
2.583	2.582	vw	3 3 4
2.427	2.428	w	4 4 2
2.351	2.350	m	{ 4 1 5
	2.346		{ 2 2 6
2.285	2.281	s	{ 6 2 0
	2.287		{ 3 1 6
2.236	2.231	s	5 4 1
2.099	2.099	ms	5 3 4
2.050	2.049	ms	3 0 7
1.984	1.982	mw	7 2 0
1.934	1.931	m	5 1 6
1.836	1.837	ms	{ 5 4 5
	1.835		{ 6 5 1
1.804	1.804	m	8 0 0

(a) $\text{Cu K}\alpha$ radiation and Ni filter; tetragonal; $a = 14.43\text{\AA}$,
 $c = 15.86\text{\AA}$, $Z = 32$, $V = 3302\text{\AA}^3$, d (calcd) = 4.14 gcm^{-3} .

Table III. X-Ray Powder Data for NaBrF₄O and CsBrF₄O^a

NaBrF ₄ O		CsBrF ₄ O	
d _{obsd} , Å	Intens	d _{obsd} , Å	Intens
5.43	s	4.02	s
5.02	vs	3.70	m
4.40	m	3.206	s
4.01	vs	2.976	m
3.84	vw	2.516	w
3.69	s	2.427	mw
3.46	vs	2.330	vs, br
3.312	s	2.174	w
2.919	vs	2.102	mw
2.661	vw	2.004	w
2.489	w	1.981	mw
2.390	w		
2.302	m		
2.255	m		
2.189	m		
2.036	s		
1.986	m		
1.945	m		
1.868	mw		
1.829	m		
1.797	ms		
1.717	ms		

(a) Cu K α radiation and Ni filter

Table IV. Vibrational Spectra^a of NaBrF₄O and RbBrF₄O

IR ^c	Ra	IR ^d	Ra	Assignments in point group C _{4v}
1015vw				$\nu_2 + \nu_7(E)$
930s	929(7.0)	943s	941(7.0)	$\nu_1(A_1), \nu(BrO)$
570-450vs, br	505sh	482(8.7)	590-450vs, br	$\nu_7(E), \nu_{as}(BrF_4)$
	456(6)			
420sh	513(10)		528(10)	$\nu_2(A_1), \nu_{s}(BrF_4)$ in phase
	431(7)		421(6.7)	$\nu_4(B_1), \nu_{s}(BrF_4)$ out of phase
	419(6)	410sh		$\nu_8(E), \delta(OBrF_4)$
	401(4)		405sh	
392mw	393sh			
	309(1.2)	320m	303(0.4)	$\nu_3(A_1), \delta_{s}(BrF_4)$ out of plane
	242(2.2)		262(1.9)	$\nu_6(B_2), \delta_{s}(BrF_4)$ in plane
	189(0.9)		172(1.2)	$\nu_9(E), \delta_{as}(BrF_4)$ in plane

- (a) All spectra recorded at ambient temperature.
- (b) Uncorrected Raman intensities (peak heights).
- (c) AgCl disk.
- (d) AgBr disk.

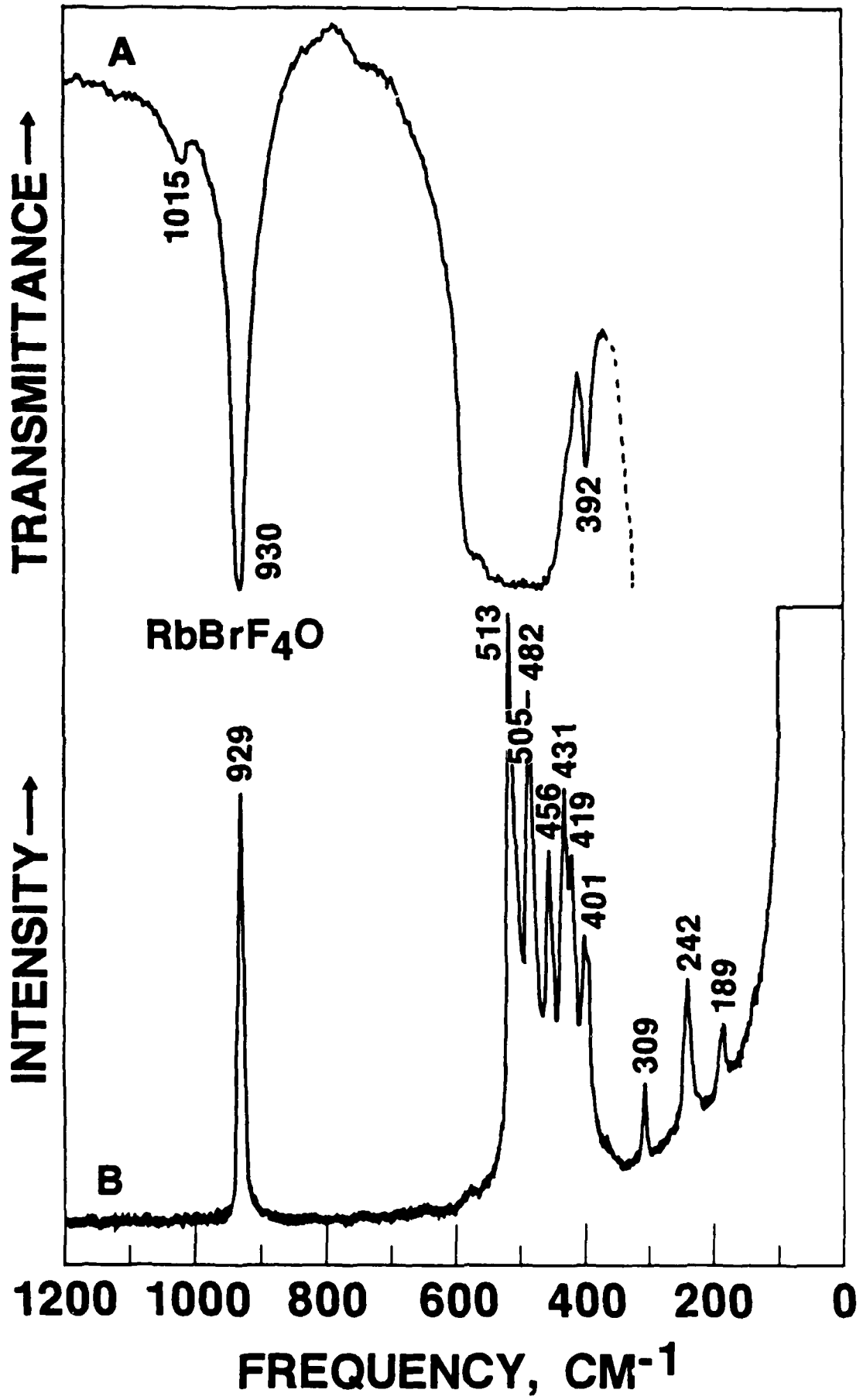

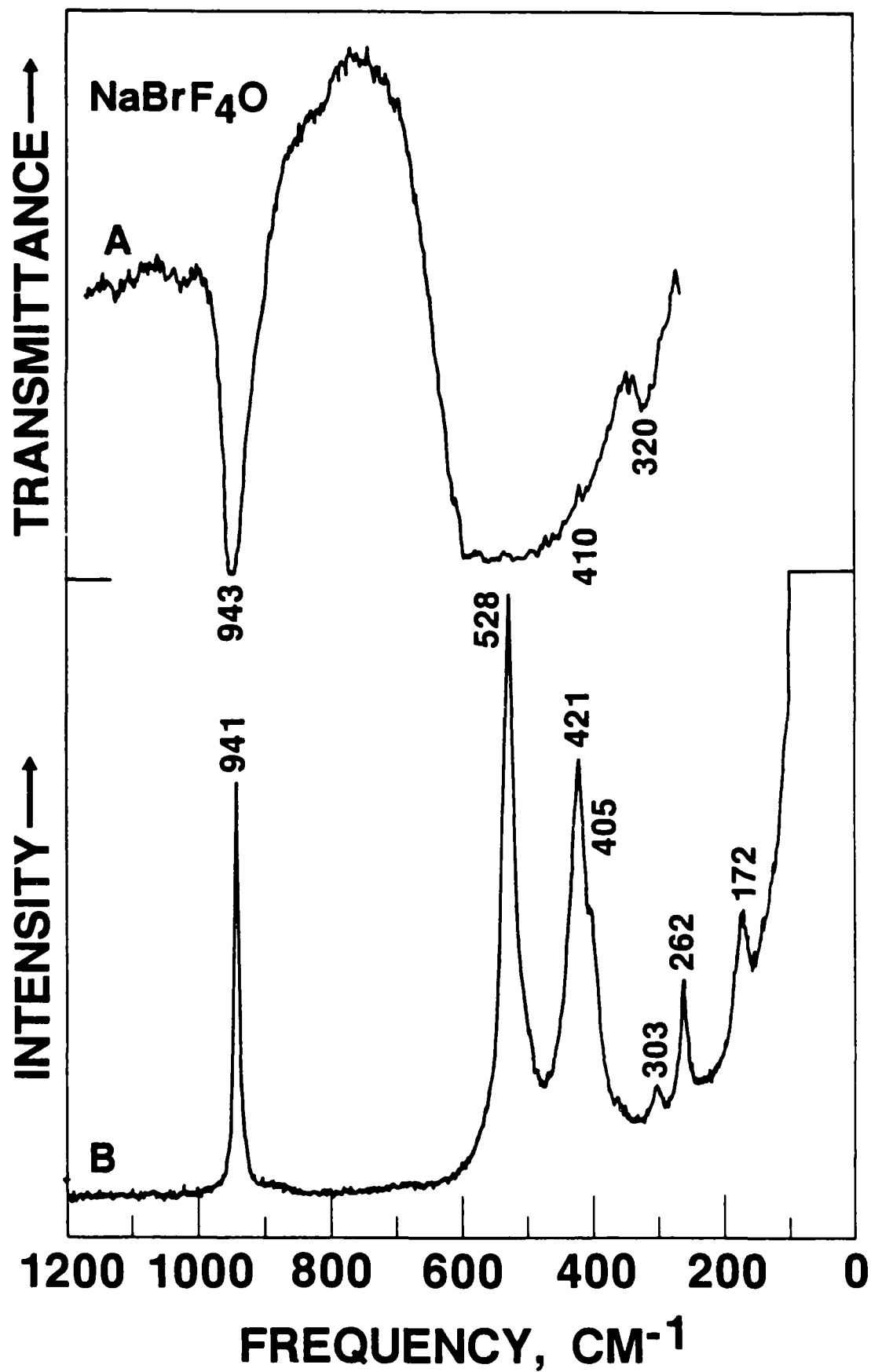

APPENDIX U

Contribution from Rocketdyne, A Division of Rockwell
International, Canoga Park, California 91303

Dinitrogen Pentoxide. New Synthesis and Laser Raman Spectrum

William W. Wilson and Karl O. Christe*

Dinitrogen pentoxide, the anhydride of nitric acid, was first prepared in 1849 from the reaction of Cl_2 with dry AgNO_3 at 60°C .¹ Subsequent methods involve either the dehydration of concentrated nitric acid by phosphorous pentoxide²⁻⁷ or the oxidation of N_2O_4 with ozone.^{8,9} Since N_2O_5 is unstable at ambient temperature and decomposes to N_2O_4 and O_2 , the above methods require the use of an efficient ozone generator to suppress the formation of N_2O_4 . Dinitrogen pentoxide is also formed when a mixture of oxygen and nitrogen is passed through an electric arc at high voltages¹⁰ and in the reactions of POCl_3 or NO_2Cl with AgNO_3 .^{1,11}

The gas phase structure of N_2O_5 has been established by electron diffraction and consists of two $-\text{NO}_2$ groups joined by an oxygen atom. The N-O-N bond angle is 111.8° and the $-\text{NO}_2$ groups undergo large amplitude torsional motions about a point of minimum energy corresponding to C_2 symmetry.¹² In the solid phase, N_2O_5 has the ionic structure $\text{NO}_2^+\text{NO}_3^-$, which was supported by vibrational spectroscopy¹³⁻¹⁵ and was subsequently confirmed by an x-ray diffraction study.¹⁶ The latter indicated linear symmetric NO_2^+ cations with an N-O bond length of $1.154 \pm 0.01\text{\AA}$.

In a recent study¹⁷ we have shown that BrF_5 interacts with an excess of LiNO_3 to give BrONO_2 and FNO_2 (1).

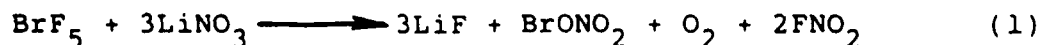

However, when the ratio of $\text{LiNO}_3:\text{BrF}_5$ was significantly higher than three, N_2O_5 was produced instead of FNO_2 , implying (2) as a secondary reaction.

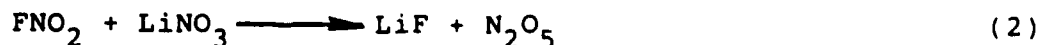

Since the methods generally used for the synthesis of N_2O_5 require an efficient ozone generator and, particularly when HNO_3 is the starting material, involve cumbersome purification steps, we examined reaction (2) for its potential as a simple, new synthesis of pure N_2O_5 .

During the characterization of N_2O_5 , its laser Raman spectrum was also recorded. Although the observed spectrum confirms the ionic $\text{NO}_2^+\text{NO}_3^-$ structure of solid N_2O_5 , previously unreported bands were observed which are incompatible with a completely linear NO_2^+ cation.

Experimental

Materials and Apparatus. The FNO_2 was prepared from BrF_5 and alkali metal nitrates, as previously described.¹⁸ The LiNO_3 (J. T. Baker, 99.7%) was dried in vacuo at 120°C for 12 hr before use. Volatile materials were handled in a well passivated (with ClONO_2) stainless steel Teflon-FEP vacuum line.¹⁹ Non-volatile materials were handled in the dry nitrogen atmosphere of a glovebox.

Infrared spectra were recorded in the range $4000\text{-}200\text{ cm}^{-1}$ on a Perkin-Elmer Model 283 spectrophotometer. Raman spectra were taken on a Spex Model 1403 spectrophotometer using the 647.1-nm exciting line of a Kr ion laser and a previously described²⁰ device for recording the low-temperature spectra. Sealed glass tubes were used as sample containers in the transverse-viewing-transverse-excitation mode.

Preparation of N_2O_5 : A prepassivated 30mL stainless steel cylinder was loaded in the drybox with $LiNO_3$ (2.85 mmol). The cylinder was connected to the vacuum line and FNO_2 (1.34 mmol) was condensed in at $-196^\circ C$. The cylinder was slowly warmed from -196 to $0^\circ C$ and kept at this temperature for 24 hours. It was then cooled back to $-196^\circ C$ and checked for noncondensable material (O_2), but none was observed. The material volatile at $20^\circ C$ was then separated by fractional condensation in a dynamic vacuum through traps kept at -142 and $-196^\circ C$ while the cylinder was allowed to warm up from -196 to $20^\circ C$. The $-142^\circ C$ trap contained a white solid (146mg, weight calcd for 1.34 mmol of $N_2O_5 = 145mg$) which was shown by low-temperature Raman spectroscopy to be pure N_2O_5 . The $-196^\circ C$ trap contained nothing. The nonvolatile residue in the cylinder consisted of a white solid (140mg, weight calcd for 1.51 mmol of $LiNO_3$ and 1.34 mmol of $LiF = 139mg$) which was spectroscopically identified as a mixture of $LiNO_3$ and LiF .

Results and Discussion

Synthesis of N_2O_5 : Nitryl fluoride reacts with an excess of $LiNO_3$ to provide pure N_2O_5 in quantitative yield. By limiting the reaction temperature to $0^\circ C$ and using well passivated equipment, decomposition or hydrolysis of N_2O_5 is avoided and the need for an ozone generator is eliminated. Furthermore, the product separation is extremely simple because N_2O_5 is the only volatile material.

Raman Spectrum and Structure of N_2O_5 : During the characterization of the N_2O_5 prepared by the above method from FNO_2 and $LiNO_3$, its low-temperature laser Raman spectrum was also recorded. The observed spectrum (see Figure 1 and Table 1) exhibited more bands than previously reported^{13,14} and predicted from the known crystal structure¹⁶ and a factor group analysis (see Table 2). To verify

that these additional Raman bands belonged indeed to N_2O_5 , a sample of N_2O_5 was also prepared from N_2O_4 and ozone and its Raman spectrum was recorded. The observed spectrum was identical to that of Figure 1.

According to the previous x-ray crystal study,¹⁶ N_2O_5 crystallizes in the space group D_{6h}^4 (C6/mmc) with $Z=2$ and trigonal planar NO_3^- anions in D_{3h} sites and linear symmetric NO_2^+ cations in D_{3d} sites. The structure was based on 64 non-zero reflections with a final R value of 0.120. The refinement of this structure was subsequently confirmed by Cruickshank and coworkers but raised a question concerning the bond lengths of the NO_2^+ cations in $NO_2^+NO_3^-$ and $NO_2^+ClO_4^-$. Although the symmetric NO_2^+ stretching modes are practically identical in both compounds, the bondlengths differed by 0.049Å and rotational oscillation corrections were suggested as a possible explanation for this large discrepancy.²¹

Returning to the Raman spectrum of solid N_2O_5 , the only two previous studies^{13,14} were carried out with Toronto arc excitation. Only two Raman lines at about 1400 and 1050 cm^{-1} were observed and correctly attributed to the symmetric NO_2^+ and NO_3^- stretching modes, respectively. We have now also observed (see Figure 1 and Table 1) the antisymmetric stretch and the in-plane deformation modes for NO_3^- at 1350 and 722 cm^{-1} , respectively, and the deformation mode for NO_2^+ at 534 cm^{-1} . Whereas the Raman activity of ν_{as} and $\delta_{in-plane}$ of NO_3^- is in accord with the results of the factor group analysis (see Table 2), the latter cannot explain the intense Raman band observed for the NO_2^+ deformation mode.

The Raman and infrared activities and relative intensities of the NO_2^+ modes in $NO_2^+NO_3^-$ closely resemble those in $NO_2^+ClO_4^-$ ²² which contains a slightly bent ($\angle ONO = 175.2 \pm 1.4^\circ$) NO_2^+ cation.²¹ Our data for $NO_2^+NO_3^-$, therefore, suggest that the NO_2^+ cation in solid N_2O_5 might be similarly bent. The failure of the x-ray crystal structure study to detect this nonlinearity of NO_2^+

for $\text{NO}_2^+\text{NO}_3^-$ might be attributed to facts such as the low precision of the x-ray study (64 reflections, $R = 0.12$)¹⁶ or, more likely, rotational oscillation of the NO_2^+ cation²¹ which could result in an averaged linear structure for a slightly nonlinear ion. Such an averaging would not be observable on the vibrational spectroscopy time scale.

In addition to the above discussed fundamental vibrations, several very weak bands were observed in the Raman spectrum of solid $\text{NO}_2^+\text{NO}_3^-$. The three bands at 1087, 1079 and 1065 cm^{-1} can be attributed to the first overtone of the NO_2^+ deformation mode in Fermi resonance with the symmetric stretching mode. The splitting into three components can be explained by the assumption of an E_{2u} component for the deformation mode which is inactive in both the infrared and Raman spectra but whose overtone and combination bands are Raman active (see Table 2). The weak band at 687 cm^{-1} is attributed to a combination band of the NO_2^+ deformation with the 161 cm^{-1} lattice mode. For the very weak band at 1028 cm^{-1} we do not have, at the present time, a plausible explanation.

Acknowledgement. The authors thank Drs. C. J. Schack and L. R. Grant and Mr. R. D. Wilson for their help and the U.S. Army Research Office and the Office of Naval Research for financial support.

References

- (1) Sainte-Claire Deville, H. Compt. rend. 1849, 28,257.
- (2) Weber, R. Pogg. Ann. 1872, 147,113.
- (3) Berthelot, M. Bull. soc. chim. 1874, 21,53.
- (4) Russ, F.; Pokorny, E. Monatsh. 1913, 34,1051.
- (5) Daniels, F.; Bright, A. C. J. Am. Chem. Soc. 1920, 42,1131.
- (6) Berl, E.; Saenger, H. H. Monatsh. 1929, 53-54, 1036.
- (7) Gruenhut, N. S.; Goldfrank, M.; Cushing, M. L.; Caesar, G. V. Inorg. Synth. 1950, 3,78.
- (8) Helbig, D. Atti. accad. Lincei, 1902, 2,311.
- (9) Yost, D. M.; Russell, H. "Systematic Inorganic Chemistry", Prentice-Hall, Inc. New York, 1944.
- (10) Ehrlich, V.; Russ, F. Monatsh. 1911, 32,917.
- (11) Odet, M.; Vignon, L. Compt. rend. 1869, 69,1142, and 1870, 70,96.
- (12) McClelland, B. W.; Hedberg, L.; Hedberg, K.; Hagen, K. J. Am. Chem. Soc. 1983, 105,3789.
- (13) Chédin, J. Thesis, Paris, 1937, Compt. rend., 1935, 200,1397.
- (14) Millen, D. J. J. Chem. Soc. 1950, 2606.
- (15) Teranishi, R.; Decius, J. C. J. Chem. Phys. 1954, 22,896.
- (16) Grison, E.; Eriks, K.; DeVries, J. L. Acta Cryst. 1950, 3,290.
- (17) Wilson, W. W.; Christe, K. O. Inorg. Chem. in press.
- (18) Wilson, W. W.; Christe, K. O. Inorg. Chem. 1987.
- (19) Christe, K. O.; Wilson, R. D.; Schack, C. J. Inorg. Synth. 1986, 24,3.
- (20) Miller, F. A.; Harney, B. M. Appl. Spectrosc. 1969, 23,8.
- (21) Truter, M. R.; Cruickshank, D. W. J.; Jeffrey, G. A. Acta Cryst. 1960, 13,855.
- (22) Nebgen, J. W.; McElroy, A. D.; Klodowski, H. F. Inorg. Chem. 1965, 4, 1796.

Table 1. Vibrational Spectra of Solid N_2O_5

obsd freq, cm^{-1} , and rel intens	assignment (point group) ^a
Raman	$NO_2^+(D_{\infty h})$ $NO_3^-(D_{3h})$
IRb	
2375 } s	vas $\nu_3(\Sigma u^+)$
2365 }	
1397(72)	vs, $\nu_1(\Sigma g^+)$
1350(4)	
1087(1)	
1079(1)	
1065(3)	
1048(84)	
1028(0+)	
1350-1450vs, br	vas, $\nu_3(E')$
1078w	$2\nu_2$
824m	vs, $\nu_1(A_1')$? δ out of plane, $\nu_2(A_2'')$
722w	δ in plane, $\nu_4(E')$
538s	(534+161) δ , $\nu_2(\Pi u)$
170sh	lattice vibrations
161(61)	
156sh	
105(100)	
73(1)	

(a) In view of the uncertainty about the actual symmetry of the ions, the idealized $D_{\infty h}$ and D_{3h} symmetries were used for NO_2^+ and NO_3^- , respectively.

(b) Values from ref. 15.

Table 2. Correlation for the Intramolecular Vibrations of NO_2^+ and NO_3^- in the $\text{NO}_2^+\text{NO}_3^-$ Crystal between their Point Groups, Site Groups and Factor Groups and their Infrared and Raman Activities

approx description of mode	point group	site group	factor group
NO_3^-	D_{3h}	D_{3h}	D_{6h}
	symmetric stretch	$A_1'(R)$ ——— $A_1'(R)$	$A_{1g}(R)$ $B_{1u}-$
	out of plane deformation	$A_2''(IR)$ ——— $A_2''(IR)$	$A_{2u}(IR)$ $B_{2g}-$
	antisymmetrical stretch	$E'(R, IR)$ ——— $E'(R, IR)$	$E_{1u}(IR)$ $E_{2g}(R)$
	in-plane deformation	$E'(R, IR)$ ——— $E'(R, IR)$	$E_{1u}(IR)$ $E_{2g}(R)$
NO_2^+	$D_{\infty h}$	D_{3d}	D_{6h}
	symmetric stretch	$\Sigma_g^+(R)$ ——— $A_{1g}(R)$	$A_{1g}(R)$
	antisymmetric stretch	$\Sigma_u^+(IR)$ ——— $A_{2u}(IR)$	$A_{2u}(IR)$ $B_{1u}-$
	deformation	$\Pi_u(IR)$ ——— $E_u(IR)$	$E_{1u}(IR)$ $E_{2u}-$
2x deformation (D_{6h})			
$2E_{1u} = A_{1g} + A_{2g} + E_{2g}(R)$			
$2E_{2u} = A_{1g} + A_{2g} + E_{2g}(R)$			
$E_{1u} \cdot E_{2u} = B_{1g} + B_{2g} + E_{1g}(R)$			

DIAGRAM CAPTION

Figure 1. Low-temperature laser Raman spectrum of solid N_2O_5 .

ABSTRACT

The reaction of FNO_2 with an excess of LiNO_3 at 0°C provides a new, simple and quantitative synthesis for N_2O_5 . It eliminates some of the drawbacks of previously used syntheses such as the need for an efficient ozone generator and cumbersome purification steps. The laser Raman spectrum of solid N_2O_5 was recorded and suggests that, contrary to a previous low-precision x-ray crystal structure study, the NO_2^+ cation in solid N_2O_5 might not be completely linear.

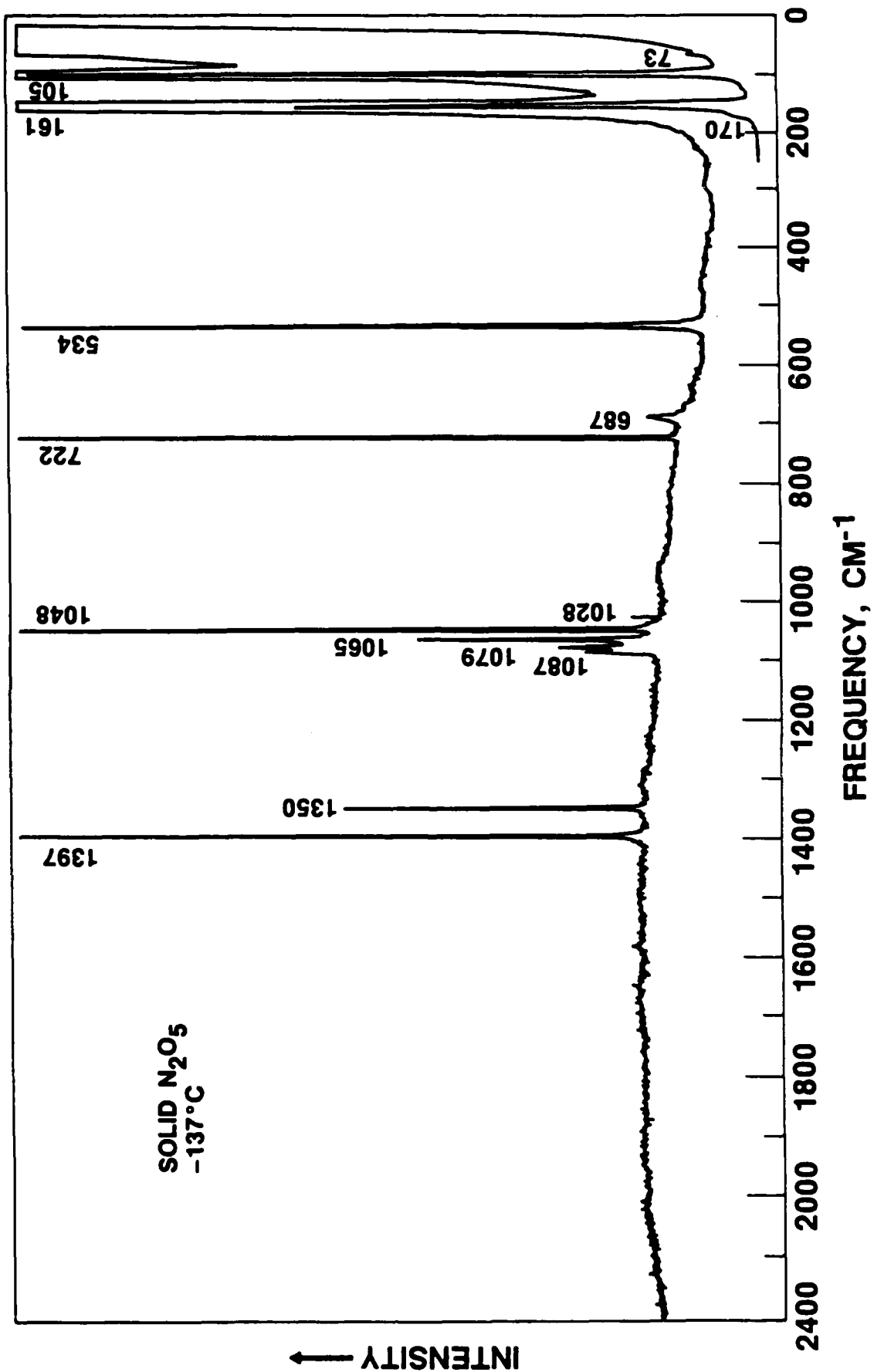

APPENDIX V

Contribution from Rocketdyne, A Division of Rockwell
International, Canoga Park, California 91303

Bromine Nitrates

William W. Wilson and Karl O. Christe*

Received.

Abstract

The reaction of BrF_5 with a large excess of LiNO_3 at 0°C produces LiF , BrONO_2 , N_2O_5 and O_2 as the principal products. The infrared spectra of BrONO_2 in the gas and solid phases and in N_2 and Ne matrices, and the Raman spectrum of the solid phase were recorded. With the exception of the N-OBr torsional mode, all fundamental vibrations of BrONO_2 can be assigned and support a planar structure for this molecule. The fundamental vibrations involving the NO_2 group exhibit pronounced frequency shifts on going from the gas to the solid indicating association in the solid phase. With N_2O_5 the BrONO_2 molecule forms an unstable adduct which was shown by Raman spectroscopy to possess the ionic structure $\text{NO}_2^+[\text{Br}(\text{ONO}_2)_2]^-$. Based on a comparison of our results with those found in the literature and three unpublished dissertations, it is concluded that the previously reported compounds $\text{BrO}_2 \cdot 3\text{NO}_2$, $\text{Br}(\text{NO}_3)_3$ and $\text{BrNO}_3 \cdot \text{N}_2\text{O}_5$ are all identical with our material and therefore must be assigned the composition $\text{NO}_2^+[\text{Br}(\text{ONO}_2)_2]^-$. For comparison, $\text{Cs}^+[\text{Br}(\text{ONO}_2)_2]^-$ was also prepared, and its vibrational spectra were recorded and assigned.

Introduction

In a recent study from our laboratory it was shown that the reactions of an excess of BrF_5 with the nitrates of Na, K, Rb and Cs provide simple, high yield, one step syntheses for the corresponding BrF_4O^- salts and FNO_2 . Since lithium does not

form a stable BrF_4O^- salt, the use of LiNO_3 as a starting material in the above reaction afforded a direct, one step synthesis of BrF_3O .¹ During the study of the $\text{LiNO}_3\text{-BrF}_5$ system, it was found that the use of an excess of LiNO_3 in this reaction dramatically altered its course and produced bromine nitrate containing material.

Very few papers dealing with bromine nitrates have previously been published. The first report on the existence of bromine nitrates was published in 1961 by Schmeisser and Taglinger.² From the reaction of BrF_3 with N_2O_5 they obtained a compound believed to be $\text{Br}(\text{NO}_3)_3$. By reaction with iodine this material was converted to BrONO_2 which was also prepared from BrCl and ClONO_2 . Ozonization of BrONO_2 resulted in the formation of O_2BrONO_2 .² The only other published reports on these compounds were a confirmation³ of the $\text{BrONO}_2 + \text{O}_3$ reaction and a study of the stratospheric significance of BrONO_2 in which its gas phase ultraviolet and infrared spectra and some physical properties were also reported.⁴ In addition, the synthesis and a partial infrared spectrum were reported for $[\text{N}(\text{CH}_3)_4]^+[\text{Br}(\text{ONO}_2)_2]^-$ which was prepared from $[\text{N}(\text{CH}_3)_4]^+\text{BrCl}_2^-$ and ClONO_2 .⁵

Toward the end of our study, Professor Naumann from the University of Dartmund, Germany, kindly provided us with copies of three unpublished dissertations⁶⁻⁸ which were carried out between 1963 and 1977 under the late Professor Schmeisser. The pertinent results of these studies are summarized in the following three paragraphs.

In 1963 Schuster⁶ found that the interaction between Br_2 and ClONO_2 at room temperature can produce two different products. At short reaction times BrONO_2 was obtained in good yield, whereas at extended reaction times the principal product was $\text{BrONO}_2 \cdot \text{N}_2\text{O}_5$. The latter compound was also obtained by reaction (1),

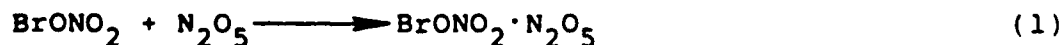

and found in the residue from the partial decomposition of Taglinger's " $\text{Br}(\text{NO}_3)_3$ ".² Furthermore, it was shown that the compound trinitrobromine dioxide, $\text{BrO}_2 \cdot 3\text{NO}_2$, reported in 1953 by Pflugmacher,⁹ was identical with $\text{BrONO}_2 \cdot \text{N}_2\text{O}_5$. Although no structural information on $\text{BrO}_2 \cdot 3\text{NO}_2$ and $\text{BrONO}_2 \cdot \text{N}_2\text{O}_5$ was available, their compositions were firmly established by elemental analyses, and the possibility of the ionic structure $\text{NO}_2^+[\text{Br}(\text{NO}_3)_2]^-$ was suggested.

Holthausen⁷ confirmed for $\text{BrONO}_2 \cdot \text{N}_2\text{O}_5$ the ionic $\text{NO}_2^+[\text{Br}(\text{NO}_3)_2]^-$ structure by low-temperature infrared spectroscopy and by the metathetical reaction (2).

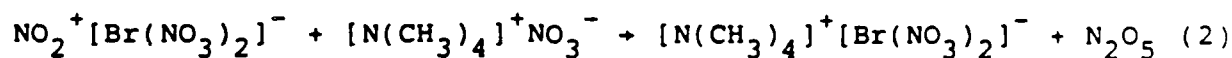

The $[\text{N}(\text{CH}_3)_4]^+[\text{Br}(\text{NO}_3)_2]^-$ salt was also prepared according to reactions (3), (4) and, interestingly, (5).

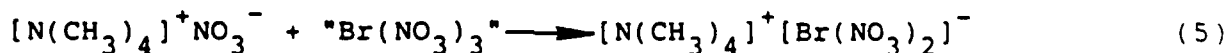
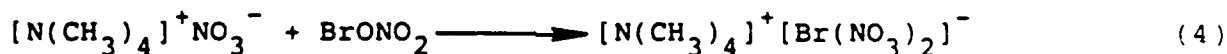
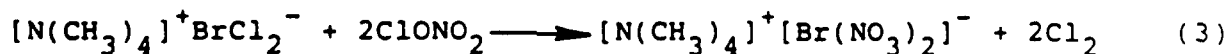

Attempts to prepare $\text{NO}^+[\text{Br}(\text{NO}_3)_2]^-$ and $\text{Cs}^+[\text{Br}(\text{NO}_3)_2]^-$ were either unsuccessful or resulted in an impure product, respectively. The low temperature infrared spectrum of BrONO_2 was also recorded and showed the following absorptions (cm^{-1}): 1655s, 1615vs, 1260vs, 830vs, 725s, 630s, 395s.⁷

Stosz⁸ repeated the previous preparations^{2,6,7} of BrONO_2 , $\text{NO}_2^+[\text{Br}(\text{NO}_3)_2]^-$, and " $\text{Br}(\text{NO}_3)_3$ ", recorded their low-temperature Raman spectra and redetermined some physical properties, such as melting points and vapor pressures (BrONO_2 : mp = -28°C , $\Delta H_{\text{vap}} = 8.0$ kcal/mol)⁸. He showed that the Raman spectra of $\text{NO}_2^+[\text{Br}(\text{NO}_3)_2]^-$

and "Br(NO₃)₃" were identical and concluded that NO₂⁺[Br(NO₃)₂]⁻ actually was Br(NO₃)₃. Attempts to prepare K⁺[Br(NO₃)₂]⁻ were unsuccessful.⁸

Based on the above data, the identity of BrONO₂ appeared well established; however, serious doubts existed concerning the exact nature of either BrO₂·3NO₂, BrONO₂·N₂O₅, NO₂⁺[Br(NO₃)₂]⁻, or Br(NO₃)₃. The fact that all four compounds represent one single species has been well established.⁶⁻⁸ However, the recent Raman spectroscopic identification of this species as Br(NO₃)₃ by Stosz⁸ could not explain the results of both Schuster⁶ and Holthausen⁷ and required a thorough reexamination.

Experimental

Materials. Commercial LiNO₃ (J. T. Baker, 99.7%) and CsBr (Aldrich, 99.9%) were dried in a vacuum oven at 120°C for one day prior to their use. The BrF₅ (Matheson) was treated with 35 atm of F₂ at 100°C for 24 hr and then purified by fractional condensation through traps kept at -64 and -95°C, with the material retained at -95° being used. The Br₂ (J. T. Baker, purified) was stored over P₂O₅ prior to its use. The CsBrCl₂ was prepared from CsBr and Cl₂ in CH₃CN solution.¹⁰ After addition of about the stoichiometric amount of Cl₂ to the CsBr-CH₃CN solution, a small amount of undissolved white solid was removed by filtration in a dry N₂ atmosphere. The clear, yellow filtrate was pumped to dryness at ambient temperature. The resulting yellow solid was identified as CsBrCl₂ by its strong Raman band at 294 cm⁻¹.¹⁰ The synthesis of ClONO₂ has previously been described.¹¹

Apparatus. Volatile materials used in this work were handled in a well-passivated (with BrF₅ until it was recovered as a white solid at -196°C or with ClONO₂ when no fluoride coatings were desired) stainless steel Teflon FEP vacuum line.¹² Non-

volatile materials were handled in the dry nitrogen atmosphere of a glovebox.

Infrared spectra were recorded in the range $4000\text{-}200\text{ cm}^{-1}$ on a Perkin-Elmer Model 283 spectrophotometer. Spectra of solids were obtained by using dry powders pressed between AgCl or AgBr windows in an Econo press (Barnes Engineering Co.). Spectra of gases were obtained by using a Teflon cell of 5-cm path length equipped with AgCl windows. The low-temperature infrared spectra of solid and matrix-isolated materials were obtained with an Air Products Model DE202S helium refrigerator equipped with CsI windows. For the matrix isolation spectra of BrONO_2 , the N_2 or Ne matrix gas was swept through a Teflon FEP U-tube containing BrONO_2 at -31°C .

Raman spectra were recorded on either a Cary Model 83 or a Spex Model 1403 spectrophotometer using the 488-nm exciting line of an Ar ion laser or the 647.1-nm exciting line of a Kr ion laser, respectively. Sealed glass tubes were used as sample containers in the transverse-viewing-transverse-excitation mode. A previously described¹³ device was used for recording the low-temperature spectra.

Preparation of BrONO_2 . Since the reaction of BrCl with ClONO_2 gives only low yields of BrONO_2 ,^{2,4,6} the reaction of Br_2 with ClONO_2 was used for its synthesis.^{6,8} In a typical experiment, dry Br_2 (10.43 mmol) and ClONO_2 (31.82 mmol) were successively condensed into a prepassivated (with ClONO_2) 75mL stainless steel cylinder. The cylinder was warmed from -196° to 25°C and was kept at this temperature for 1.5 hr with frequent agitation. It was then cooled to -196°C and contained no noncondensable material (no O_2 evolution). The cylinder was allowed to slowly warm to 25°C while separating the volatile material by fractional condensation in an oil pump vacuum through a series of traps kept at -31° (bromobenzene

slush), -45° (chlorobenzene slush), and -196°C . The trap at -45° contained 3.90 mmol of a yellow solid which was identified by its vibrational spectra as BrONO_2 (18.6% yield based on Br_2). The -196° trap contained the Cl_2 by-product and the unreacted Br_2 and ClONO_2 .

When the reaction between Br_2 and ClONO_2 is carried out for prolonged time periods at room temperature, the main product becomes $\text{NO}_2^+[\text{Br}(\text{ONO}_2)_2]^-$.⁶ Separation of BrONO_2 from $\text{NO}_2^+[\text{Br}(\text{ONO}_2)_2]^-$ can be achieved by pumping on a mixture of the two kept at -35°C . The $\text{NO}_2^+[\text{Br}(\text{ONO}_2)_2]^-$ is less volatile and remains as a white or very pale yellow residue, whereas the BrONO_2 can be collected as a yellow sublimate.

Preparation of $\text{Cs}^+[\text{Br}(\text{NO}_3)_2]^-$. A prepassivated (with ClONO_2) 30mL stainless steel cylinder was loaded in the drybox with CsBrCl_2 (2.432 mmol). On the vacuum line, ClONO_2 (19.68 mmol) was added at -196°C . The cylinder was allowed to warm to 0°C and was kept at this temperature for 4 hr with occasional agitation. The cylinder was cooled to -196°C and contained no noncondensable gas. The material volatile at 0°C was pumped off and separated by fractional condensation through traps kept at -112° and -196°C during warm up of the cylinder from -196° to 0°C . The -196° trap contained Cl_2 (4.51 mmol), whereas the -112° trap had unreacted ClONO_2 (14.78 mmol). The cylinder contained 743 mg of a white solid which based on its vibrational spectra was $\text{Cs}^+[\text{Br}(\text{ONO}_2)_2]^-$ containing a small amount of CsNO_3 . The latter was formed by slow decomposition of $\text{Cs}^+[\text{Br}(\text{ONO}_2)_2]^-$ at ambient temperature which was shown to yield CsNO_3 and BrONO_2 as the primary products, followed by decomposition of BrONO_2 to Br_2 , N_2O_5 , NO_2 and O_2 . Attempts to prepare $\text{Cs}^+[\text{Br}(\text{ONO}_2)_2]^-$ directly with CsBr and ClONO_2 at 0°C were unsuccessful and produced only a product consisting of CsNO_3 and an unidentified cesium polyhalide which was also obtained from the reaction of CsBr with Cl_2 in aqueous

solution. Its solid phase Raman spectrum showed the following bands, 340vw, 230sh, 215s, 203vs, 142m, 126w, 108w, 80m, 62mw, and resembled that of CsIBr_2 ¹⁴, except for significant shifts to higher frequencies.

The LiNO_3 - BrF_5 System. A prepassivated (with BrF_5) 30mL stainless steel cylinder was loaded in the drybox with LiNO_3 (20.065 mmol). On the vacuum line, BrF_5 (2.485 mmol) was added at -196°C . The cylinder was kept at 0°C for 3.5 days and then cooled to -196°C . The material volatile at -196°C consisted of O_2 (2.481 mmol). The cylinder was allowed to slowly warm to 25°C while the volatile material was separated in a dynamic vacuum by fractional condensation through two traps kept at -142 and -196°C . The -196°C trap contained a trace of FNO_2 , whereas the -142°C trap had 894 mg of a white solid consisting of an equimolar mixture of $\text{NO}_2^+[\text{Br}(\text{ONO}_2)_2]^-$ and N_2O_5 (weight calcd for 2.485 mmol $\text{NO}_2^+[\text{Br}(\text{ONO}_2)_2]^-$ and 2.485 mmol of N_2O_5 = 889 mg). The white solid residue (851 mg) in the cylinder consisted of LiF and LiNO_3 (weight calcd for 12.423 mmol of LiF and 7.643 mmol of LiNO_3 = 849 mg). Separation of $\text{NO}_2^+[\text{Br}(\text{ONO}_2)_2]^-$ from N_2O_5 was achieved by fractional condensation. The $\text{NO}_2^+[\text{Br}(\text{ONO}_2)_2]^-$ was trapped at -35°C whereas the N_2O_5 slowly passed. Vibrational spectroscopy was used for the identification of the materials.

When the ratio of LiNO_3 to BrF_5 was less than five, the formation of some free FNO_2 was observed together with a decreased yield of N_2O_5 .

Results and Discussion

In this section, we will first present our results on the syntheses and characterization of BrONO_2 , $\text{Cs}^+[\text{Br}(\text{ONO}_2)_2]^-$ and $\text{NO}_2^+[\text{Br}(\text{ONO}_2)_2]^-$,

followed by a critical review of the presently known bromine nitrate chemistry based on our data and the unpublished dissertations of Schuster⁶, Holthausen⁷ and Stosz.⁸

Syntheses. When BrF_5 is reacted with a threefold amount of LiNO_3 , the main products are BrONO_2 and FNO_2 (6).

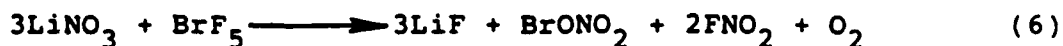

At a mole ratio of LiNO_3 to BrF_5 above five, BrONO_2 and N_2O_5 (or their adduct, depending on the temperature) become the main products (7).



Subtraction of equation (6) from (7) implies reaction (8) which was experimentally verified and will be reported on separately.¹⁶

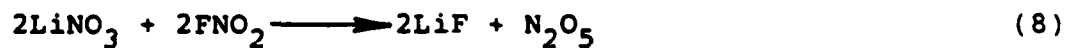

Furthermore, it was found that, in agreement with Schuster⁶ and Holthausen,⁷ BrONO_2 forms with N_2O_5 the 1:1 adduct $\text{BrONO}_2 \cdot \text{N}_2\text{O}_5$ (1) which has, as shown below, the ionic structure $\text{NO}_2^+ [\text{Br}(\text{ONO}_2)_2]^-$. Since our vibrational spectra for $\text{NO}_2^+ [\text{Br}(\text{ONO}_2)_2]^-$ (see below) were almost identical to those attributed by Stosz⁸ to " $\text{Br}(\text{NO}_3)_3$ ", additional synthetic work was carried out to resolve some of the previously reported discrepancies. For example, BrONO_2 was prepared by Schuster's method⁶ (9)

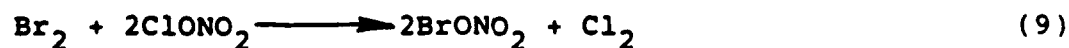

and was characterized. For the unambiguous identification of the $[\text{Br}(\text{ONO}_2)_2]^-$ anion, the $\text{Cs}^+ [\text{Br}(\text{ONO}_2)_2]^-$ salt was prepared according to (10) and characterized.

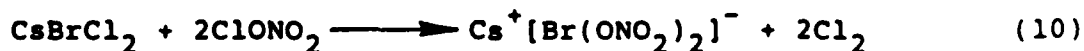

Characterization of BrONO₂

Physical Properties. BrONO₂ is the best characterized bromine nitrate. It is a yellow solid with a melting point of -28°C. This value agrees well with that reported by Stosz,⁸ but is significantly higher than those of -42° and -33° reported previously.^{2,4} These low values were probably due to the presence of some impurities. It has a vapor pressure of 114mm at 23°C and slowly decomposes at ambient temperature to Br₂, N₂O₅, NO₂, and O₂.

Vibrational Spectra and Structure. Only limited data were previously available on the vibrational spectra and structure of BrONO₂. A partial infrared spectrum of the gas had been published,⁴ and one of the dissertations contained a Raman spectrum of the solid⁸ whose frequencies deviated significantly from the gas-phase values. No conclusions were reached whether the bromine atom is coplanar or perpendicular to the O₂NO-plane. For the closely related ClONO₂ molecule, the question concerning its planarity was hotly disputed¹⁷⁻²⁵ and finally settled in favor of a planar structure.²⁶⁻³² In view of the scarcity of data for BrONO₂, we have recorded its infrared spectra in the gas phase and in N₂ (see Figure 1) and Ne matrices, and the infrared and Raman spectra of the neat solid (see Figure 2). The observed frequencies are summarized in Table 1.

Vibrational Assignments. A comparison of the fundamental vibrations of BrONO₂ with those of the closely related molecules ClONO₂,^{17-22,27,28,30} FONO₂,¹⁹⁻²¹ CH₃ONO₂,³³ and HONO₂³⁴ shows excellent agreement both with respect to frequencies and relative infrared and Raman intensities (see Table 2). Since the planarity of ClONO₂,²⁶⁻³² CH₃ONO₂³⁵ and HONO₂³⁶ is well established, the data of Table 2 strongly supports a planar structure for BrONO₂ as well.

The assignments of the observed fundamental vibrations to the individual modes is straight forward. A planar BrONO_2 molecule has symmetry C_s . The irreducible representation for the intramolecular vibrations is $\Gamma = 7A' + 2A''$. The intense 1714, 1288, 806, and 564 cm^{-1} infrared gas-phase bands are characteristic for all covalent nitrates and are due to the antisymmetric NO_2 stretching, the symmetric NO_2 stretching, the NO_2 scissoring, and the ONO_2 antisymmetric in plane deformation vibrations, respectively.²¹

The N-O stretching mode has very high Raman intensities in all the covalent nitrates listed in Table 2 and occurs in FONO_2 and ClONO_2 at 457 and 436 cm^{-1} , respectively.²¹ Therefore, this mode is assigned to the very intense Raman band at 397 cm^{-1} in solid BrONO_2 .

A cursory inspection of Table 2 might raise questions of why the N-O stretching modes should be of such high Raman intensities, exhibit negligible ^{14}N - ^{15}N isotopic shifts, and have surprisingly low frequencies. A comparison with the well known and analyzed vibrational spectra of FNO_2 provides the answer to these questions. The FNO_2 molecule is a good approximation to the ONO_2 part of the XONO_2 compounds, but due to its higher symmetry and lower number of fundamental vibrations is much more amenable to a thorough normal coordinate analysis. Thus, the A_1 block of FNO_2 contains only three fundamental vibrations at about 1308, 810 and 555 cm^{-1} which are best assigned to the symmetric NO_2 stretching, the NO_2 scissoring and the NF stretching mode, respectively.^{21,37-39} The observed frequencies, intensities, and ^{14}N - ^{15}N isotopic shifts are similar to those of the corresponding ONO_2 modes in XONO_2 . The potential energy distribution (Set I in Table VII of Mirri et al.)³⁸ shows that the highest frequency is almost pure NO_2 stretching, the intermediate frequency is mainly an antisymmetric combination of the NO_2

scissoring motion and the NF stretching motion with some contribution from NO₂ stretching, while the lowest frequency is best described as a symmetric combination of NF stretching and some NO₂ stretching. These results account nicely for the experimental observations and should be directly transferrable to the XONO₂ molecules of this study. A normal coordinate analysis for BrONO₂, however, would be of little value in view of the grossly undetermined nature of the problem (28 symmetry force constants from seven frequencies in the A' block) and the expected strong coupling effects.

It should be noted that in the infrared spectrum of solid BrONO₂ the N-O stretching mode becomes quite intense (see 400 cm⁻¹ band in trace A of Figure 2). This increase in intensity for the neat solid is attributed to pronounced association effects (see below).

The N-O-Br in plane bending mode should result in an intense Raman band between 300 and 200 cm⁻¹ and therefore can readily be assigned to the strong Raman band at 244 cm⁻¹. The N-OBr torsional mode should occur below 140 cm⁻¹ and cannot be assigned with confidence based on the available data.

The only two fundamental vibrations yet unaccounted for are the ONO₂ out of plane deformation and the O-Br stretching modes. The O-Br stretching mode should be of high Raman and low infrared intensity, whereas the δONO₂ out-of-plane mode should be of medium IR and low Raman intensity and occur in the 700 to 770 cm⁻¹ region. Based on these predictions, the intense Raman band at 761 cm⁻¹ with a weak matrix infrared counterpart at 750 cm⁻¹ is assigned to νO-Br, and the medium strong matrix infrared band at 725 cm⁻¹ with a very weak Raman counterpart at 738 cm⁻¹ to the δ out of plane ONO₂ mode. This accounts for all the nine fundamental vibrations of BrONO₂ and provides consistent frequency and intensity trends for the series HONO₂, CH₃ONO₂, FONO₂, ClONO₂, and

BrONO₂ (see Table 2). Essentially all of the observed weak bands can be assigned in terms of overtones and combination bands of these fundamental vibrations (see Table 1).

Association in the Solid Phase. As mentioned above, some of the fundamental vibrations in solid BrONO₂ significantly deviate from those of the gas and the matrix isolated molecule. From the fundamental vibrations involved and the magnitudes and directions of the shifts, conclusions can be drawn concerning the nature of the association. The involvement of the NO₂ group in the bridging is indicated by a lowering of its stretching frequencies ($\Delta\nu_{as} = -98, \Delta\nu_s = -23 \text{ cm}^{-1}$) and an increase of its in-plane deformation frequencies ($\Delta\delta_{as} = 77, \Delta\delta_s = 34 \text{ cm}^{-1}$). The fact that the δ out-of-plane ONO₂ frequency is essentially unshifted, suggests that the bridging occurs in the ONO₂ plane and does not directly involve the nitrogen atom. Hence, the NO₂ group should bridge to either the bromine or the oxygen atom of the O-Br group of another BrONO₂ molecule. Of these two alternatives, bromine definitely is the better acceptor as shown by the existence of the $[\text{Br}(\text{ONO}_2)_2]^-$ anion. Since in this anion the nitrate ligands are monodentate, we prefer for solid BrONO₂ a model involving intermolecular BrON(O)O \rightarrow BrONO₂ bridges which are also monodentate.

Characterization of $\text{Cs}^+[\text{Br}(\text{ONO}_2)_2]^-$ and $\text{NO}_2^+[\text{Br}(\text{ONO}_2)_2]^-$

Physical Properties. $\text{Cs}^+[\text{Br}(\text{ONO}_2)_2]^-$ is a white crystalline solid. It is only marginally stable at room temperature and dissociates to CsNO₃ and BrONO₂ with the latter decomposing further to Br₂, N₂O₅, NO₂, and O₂. Therefore it is difficult to obtain samples which are completely free of CsNO₃.

$\text{NO}_2^+[\text{Br}(\text{ONO}_2)_2]^-$ is a white crystalline solid which can be purified by vacuum sublimation. It is stable at -35°C and can be trapped at this temperature. At 23°C it has a dissociation pressure of about 130 torr and decomposes to BrONO₂ and N₂O₅

which can then undergo further slow decomposition to $\text{Br}_2 + \text{N}_2\text{O}_5 + \text{O}_2$ and $\text{N}_2\text{O}_4 + \text{O}_2$, respectively. It melts at about 46°C with decomposition.

Vibrational Spectra. The vibrational spectra of $\text{Cs}^+[\text{Br}(\text{ONO}_2)_2]^-$ and $\text{NO}_2^+[\text{Br}(\text{ONO}_2)_2]^-$ are shown in Figures 3 and 4, respectively. The observed frequencies and their assignments are summarized in Table 3. A cursory inspection of Figures 3 and 4 reveals that the main features in the spectra of both materials are very similar, except for three extra bands in $\text{NO}_2^+[\text{Br}(\text{ONO}_2)_2]^-$. These extra bands occur at 1395 cm^{-1} in the Raman and at 2370 cm^{-1} and $566\text{-}551\text{ cm}^{-1}$ in the infrared spectra. These bands are characteristic for the NO_2^+ cation^{40,41} and establish the ionic structure $\text{NO}_2^+[\text{Br}(\text{ONO}_2)_2]^-$ for this $\text{BrONO}_2 \cdot \text{N}_2\text{O}_5$ adduct.

The first question which must be answered with respect to the $[\text{Br}(\text{ONO}_2)_2]^-$ anion is the nature of the nitrate groups. These groups could be either ionic or covalent. From the complexity of the observed spectra and the absence of bands characteristic for a free NO_3^- anion,⁴⁰ it can be concluded that the nitrate groups must be covalent.

A covalent nitrate ligand could be either mono- or bi-dentate. Based on previous thorough vibrational analyses,^{42,43} covalent bidentate nitrate ligands should exhibit in the $900\text{-}1700\text{ cm}^{-1}$ range three groups of Raman bands at about 1600 ($\nu\text{N}=\text{O}$), 1200 ($\nu\text{as NO}_2$) and 1000 cm^{-1} ($\nu\text{s NO}_2$) with their intensities decreasing in the order $I_{1600} > I_{1000} > I_{1200}$. On the other hand, covalent monodentate nitrate groups should exhibit two bands in the $900\text{-}1700\text{ cm}^{-1}$ frequency range at about 1700 ($\nu\text{as NO}_2$) and 1300 cm^{-1} ($\nu\text{s NO}_2$) with the 1300 cm^{-1} band being more intense in the Raman spectrum.¹⁷⁻²² For molecules containing more than one nitrate ligand, coupling of the vibrations of these ligands is expected which should result in splittings due to in-phase and out-of-phase motions. Furthermore, the formal negative charge in the ion is predicted to increase

the polarity of the nitrogen-oxygen bands, thereby lowering their frequencies somewhat. Inspection of Figures 3 and 4 shows that the observed spectra are in accord with these predictions for strongly coupled monodentate ligands and therefore will be assigned in this manner.

The next question is how are the two nitrate ligands in $[\text{Br}(\text{ONO}_2)_2]^-$ most likely arranged with respect to each other? Treating the $-\text{ONO}_2$ group as a pseudo-halide, the O-Br-O part of $[\text{Br}(\text{ONO}_2)_2]^-$ is expected to be, for practical purposes, linear. Since the N-O-Br angle should be close to tetrahedral (109°), the two nitrate ligands could be either cis or trans to each other, or form a dihedral angle. If the nitrate ligands would be trans to each other, the $[\text{Br}(\text{ONO}_2)_2]^-$ anion would possess a symmetry center, and the infrared and Raman bands should be either mutually exclusive or at least differ dramatically in intensity. Since this is not the case, a trans-configuration can be ruled out. Since mutual repulsion arguments mitigate against a cis-isomer, we prefer a configuration with a dihedral angle. Such an anion would possess symmetry C_2 , with the twofold rotation axis passing through the Br atom at a right angle to the O-Br-O axis and splitting the dihedral angle in half.

The irreducible representation for the intramolecular vibrations of $[\text{Br}(\text{ONO}_2)_2]^-$ of symmetry C_2 is $\Gamma = 10A + 11B$, where the A modes are symmetric and the B modes antisymmetric to the twofold axis. Of these 21 modes, 9 belong to the $\begin{array}{c} \text{O}-\text{Br}-\text{O} \\ \diagup \quad \diagdown \\ \text{N} \quad \quad \text{N} \end{array}$ skeleton and 12 involve motions of the nitrate ligands. A breakdown into the individual modes is given in Table 4. Since the unit cells of these $[\text{Br}(\text{ONO}_2)_2]^-$ salts might contain more than one molecule, additional splittings might be observed in the actual spectra due to ion coupling and anion-cation interactions.

Tentative assignments for some of the fundamental vibrations of $[\text{Br}(\text{ONO}_2)_2]^-$ can be made on the following basis. The four groups of bands between 900 and 1600 cm^{-1} should represent the four NO_2 stretching modes. Of these, the symmetric, in-phase NO_2 stretch should be very strong in both the Raman and the infrared spectra and therefore must be assigned to either the 1280 or the 1530 cm^{-1} group. Since in BrONO_2 (see above) the symmetric NO_2 stretch is about 370 cm^{-1} lower than the anti-symmetric one, the 1280 cm^{-1} group in the spectra of $[\text{Br}(\text{ONO}_2)_2]^-$ is assigned to the symmetric, in-phase NO_2 stretch. This leaves the 1530 cm^{-1} group for assignments to one of the two anti-symmetric NO_2 stretches. From these two, the out-of-phase mode should be of much higher infrared intensity than the in-phase mode and therefore the 1530 cm^{-1} group is assigned to the anti-symmetric, out-of-phase NO_2 stretch. Based on its low infrared intensity, the 1100 cm^{-1} group is assigned to the antisymmetric, in-phase NO_2 stretch, leaving the 950 cm^{-1} group for assignment to the symmetric, out-of-phase NO_2 stretch.

Two comments are required with respect to these NO_2 stretching bands: (i) for $\text{NO}_2^+[\text{Br}(\text{ONO}_2)_2]^-$ the Raman bands show additional splittings into 3 components for the antisymmetric and 2 components for the symmetric modes and also their frequencies significantly deviate in most cases from those of their infrared counterparts. This is attributed to the influence of the NO_2^+ counterion which is less symmetrical than Cs^+ thus causing stronger cation-anion interactions in the solid; and (ii) for $\text{Cs}^+[\text{Br}(\text{ONO}_2)_2]^-$ the failure to observe a Raman band around 1130 cm^{-1} might be due to the lower signal to noise ratio in the spectrum.

There is a group of three distinct bands in the 690 to 790 cm^{-1} region which are assigned by analogy with the spectra of solid BrONO_2 (see above) to the scissoring, the out-of-plane, and the

antisymmetric in-plane deformation modes of the NO_2 groups (see Table 3). No detectable splittings due to in-phase and out-of-phase coupling were observed for these modes.

The O-N torsional mode is expected to be of low frequency and to occur in the frequency range of the skeletal modes. Therefore, no attempt was made to assign this mode.

The assignments for the NOBrON skeletal modes are more difficult because few data are available for comparable systems. If the nitrate group is treated as a pseudo-halide, the known spectra of certain $[\text{BrHal}_2]^-$ species will give us an estimate for the frequency range to be expected for the OBrO vibrations. In BrF_2^- , BrCl_2^- and Br_3^- the symmetric stretching vibration has frequencies of 442,⁴⁴ 272,⁴⁵ and 162 cm^{-1} ,⁴⁵ respectively. Furthermore, the N-O stretching vibration in the halogen nitrates occurs between 390 and 460 cm^{-1} (see Table 2). Therefore, it seems reasonable to assume that the NOBrON skeletal modes should occur in similarly low frequency ranges and not be assignable to the bands observed in the 700-800 cm^{-1} range. Based on these comparisons, we tentatively assign the strong Raman bands at 317 and 298 cm^{-1} in $\text{Cs}^+[\text{Br}(\text{ONO}_2)_2]^-$ to the symmetric in-phase N-O stretch and the symmetric BrO_2 stretch, respectively, and the weak Raman bands at about 460 and 400 cm^{-1} to the corresponding antisymmetric stretching motions, respectively. Due to the overlap of the frequency ranges of the skeletal deformation modes and the lattice vibrations, no assignments are proposed at this time for the lower frequency bands.

Critical Review of Bromine Nitrate Chemistry. A combination of our results with those of Taglinger,² Schuster,⁶ Hothausen,⁷ Stosz,⁸ and Pflugmacher⁹ allows the following conclusions concerning the presently known bromine nitrates: (i) the compound obtained originally from BrF_3 and N_2O_5 and ascribed to " $\text{Br}(\text{NO}_2)_3$ "²

is actually $\text{NO}_2^+[\text{Br}(\text{ONO}_2)_2]^-$. Stosz⁸ repeated the original synthesis² and recorded a low temperature Raman spectrum which is identical to that obtained by us for $\text{NO}_2^+[\text{Br}(\text{ONO}_2)_2]^-$. Furthermore, the physical and chemical properties reported^{2,8} for " $\text{Br}(\text{NO}_3)_3$ " are practically identical to those of $\text{NO}_2^+[\text{Br}(\text{ONO}_2)_2]^-$. Schuster had previously shown⁶ that Pflugmacher's " $\text{BrO}_2 \cdot 3\text{NO}_2$ "⁹ is identical to " $\text{BrNO}_3 \cdot \text{N}_2\text{O}_5$ ", which has been shown by this study to be $\text{NO}_2^+[\text{Br}(\text{ONO}_2)_2]^-$. Therefore the previously reported compounds " $\text{Br}(\text{NO}_3)_3$ ", " $\text{BrO}_2 \cdot 3\text{NO}_2$ ", and " $\text{BrNO}_3 \cdot \text{N}_2\text{O}_5$ " are all one and the same compound, i.e. $\text{NO}_2^+[\text{Br}(\text{ONO}_2)_2]^-$; and (ii) based on the fact that " $\text{Br}(\text{NO}_3)_3$ " is actually $\text{NO}_2^+[\text{Br}(\text{ONO}_2)_2]^-$, we have critically reviewed the known reaction chemistry of the bromine nitrates. The most important reactions are presented in Scheme 1. The formation of $\text{NO}_2^+[\text{Br}(\text{ONO}_2)_2]^-$ from BrF_3

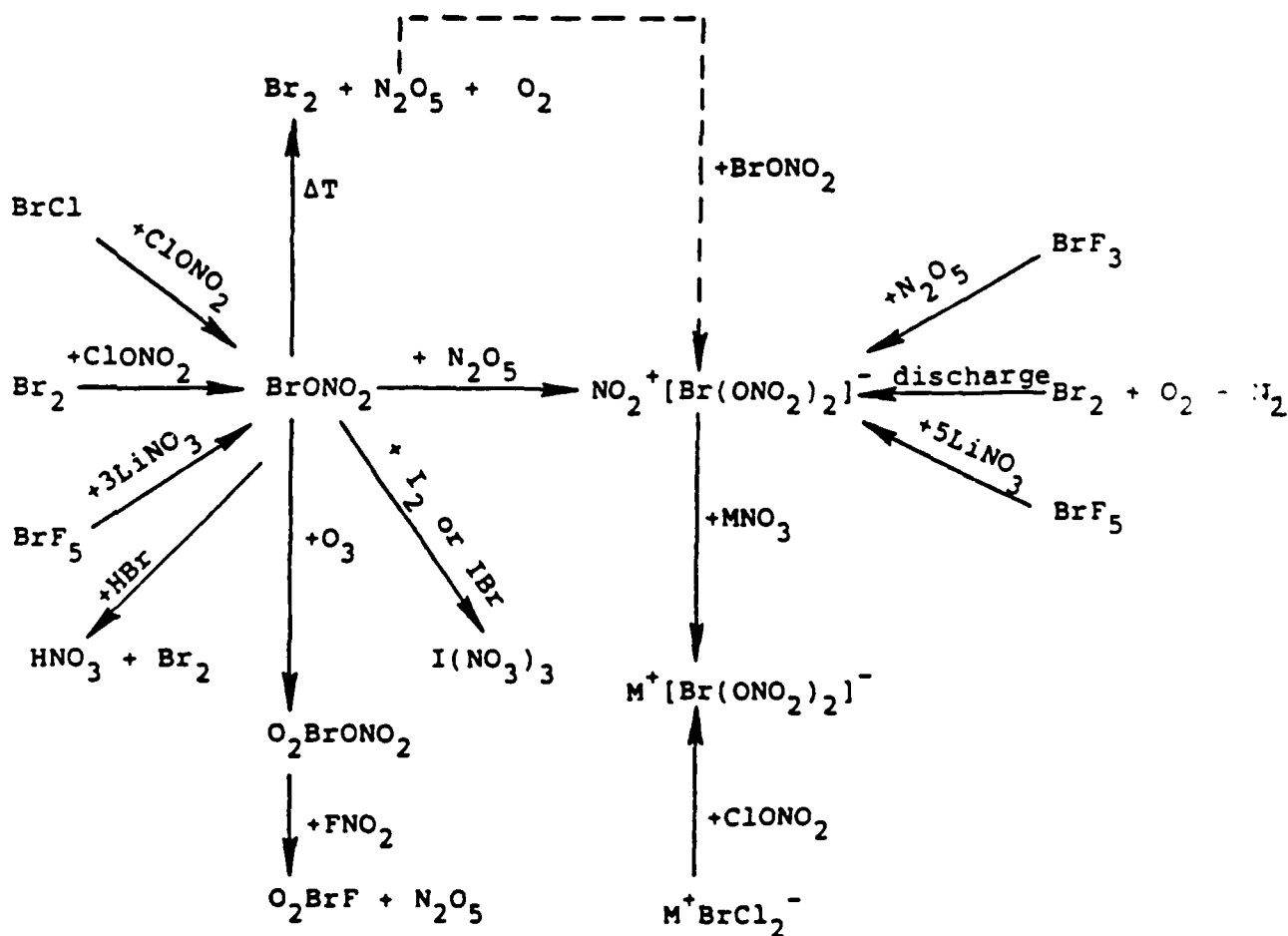

Scheme 1. Reaction Chemistry of Bromine Nitrates

and N_2O_5 in the original " $Br(NO_3)_3$ " preparation² can readily be explained in terms of reactions (11) through (14).



Experimental support for this sequence was obtained by Stosz⁸ who demonstrated the formation of $FBrO_2$ as a by-product in this system. Similarly, $BrONO_2$ does not disproportionate according to (15),⁸ but produces $NO_2^+[Br(ONO_2)_2]^-$ according to (16) and (17).

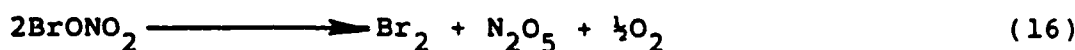
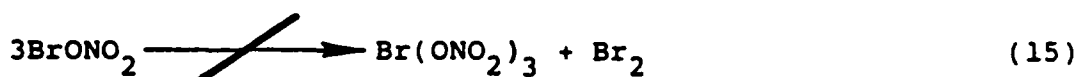

The formation of $NO_2^+[Br(ONO_2)_2]^-$ from Br_2 and $ClONO_2$ at room temperature and extended reaction times can similarly be explained by (9), followed by (16) and (17) resulting in (18)

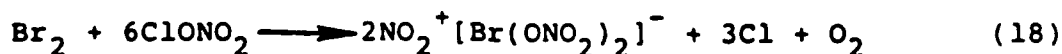

as the overall reaction. By limiting the reaction time of (9) to about one hour, the thermal decomposition of $BrONO_2$ (16) and $NO_2^+[Br(ONO_2)_2]^-$ formation (17) can be minimized and (9) becomes a useful $BrONO_2$ synthesis.

From a historical point of view it is interesting to note that the original misidentification² of " $Br(NO_3)_3$ " was not recognized

inspite of all the experimental evidence by Schuster, Holthausen, and Stosz. None of them questioned the correctness of the claim for " $\text{Br}(\text{NO}_3)_3$ " and, ironically, the last one of these investigators even concluded that $\text{NO}_2^+[\text{Br}(\text{ONO}_2)_2]^-$ actually was " $\text{Br}(\text{NO}_3)_3$ ".

Acknowledgement. The authors are indebted to Drs. C J. Schack and L. R. Grant and Mr. R. D. Wilson for their help, to Prof. D. Naumann for providing us with copies of the theses of L. Taglinger, E. Schuster, R. Holthausen, and A. Stosz, and to the Army Research Office and the Office of Naval Research for financial support.

REFERENCES

- (1) Wilson, W. W.; Christe, K. O. Inorg. Chem. in press.
- (2) Schmeisser, M.; Taglinger, L. Chem. Ber. 1961, 94, 1533;
see also Schmeisser, M.; Brändle, K. Angew. Chem. 1961,
73, 388; and Schmeisser M.; Schuster, E. in "Bromine and
its Compounds", Z. E. Jolles, Ed. Academic Press, New York,
N.Y. 1976, 209-213.
- (3) Schack, C. J.; Christe, K. O. Inorg. Chem. 1974, 13, 2378.
- (4) Spencer, J. E.; Rowland, F. S. J. Phys. Chem. 1978, 82, 7.
- (5) Lustig, M.; Ruff, J. K. Inorg. Chem. 1966, 5, 2124.
- (6) Schuster, E. Dissertation, Technische Hochschule Aachen, W-
Germany, 1963.
- (7) Holthausen, R. Dissertation, Technische Hochschule Aachen,
W-Germany, 1968.
- (8) Stosz, A. Dissertation, Universität Dortmund, W-Germany,
1977.
- (9) Pflugmacher, A. Z. anorg. allg. Chem. 1953, 273, 41.
- (10) Evans, J. C.; Lo, G. Y. S. J. Chem. Phys. 1966, 44, 4356.
- (11) Schack, C. J. Inorg. Chem. 1967, 6, 1938.
- (12) Christe, K. O.; Wilson, R. D.; Schack, C. J. Inorg. Synth.
1986, 24, 3.
- (13) Miller, F. A.; Harney, B. M. Appl. Spectrosc. 1969, 23, 8.
- (14) Hayward, G. C.; Hendra, J. P. Spectrochim. Acta, Part A
1967, 23A, 2309.
- (15) Maki, A. G.; Forneris, R. Spectrochim. Acta, Part A, 1967,
23A, 867.
- (16) Wilson, W. W.; Christe, K. O. to be published.
- (17) Brändle, K.; Schmeisser, M.; Lüttke, W. Chem. Ber. 1960,
93, 2300.
- (18) Arvia, A. J.; Cafferata, L. F. R.; Schumacher, H. J. Chem.
Ber. 1963, 96, 1187.
- (19) Miller, R. H.; Bernitt, D. L.; Hisatsune, I. C. Spectrochim.
Acta, Part A, 1967, 23A, 223.
- (20) Shamir, J.; Yellin, D.; Claassen, H. H. Isr. J. Chem. 1974,
12, 1015.

- (21) Christe, K. O.; Schack, C. J.; Wilson, R. D. *Inorg. Chem.* 1974, 13, 2811.
- (22) Amos, D. W.; Flewett, G. W. *Spectrochim. Acta, Part A*, 1975, 31, 213.
- (23) Graham, R. A.; Tuazon, E. C.; Winer, A. M.; Pitts, J. N. Jr.; Molina, L. T.; Beaman, L.; Molina, M. J. *Geophys. Res. Lett.* 1977, 4, 3.
- (24) Fleming, J. W. *Chem. Phys. Lett.* 1977, 50, 107.
- (25) Fleming, J. W. *Infrared Phys.* 1978, 18, 791.
- (26) Suenram, R. D.; Johnson, D. R. *J. Mol. Spectrosc.* 1977, 65, 239.
- (27) Van Der Verken, B. J.; Odeurs, R. L.; Shamir, J.; Herman, M. A. *J. Mol. Struct.* 1981, 74, 155.
- (28) Chance, K. V.; Traub, W. A. *J. Mol. Spectrosc.* 1982, 95, 306.
- (29) Bhatia, S. C.; George-Taylor, M.; Merideth, C. W.; Hall, J. H. *J. Phys. Chem.* 1983, 87, 1091.
- (30) Bhatia, S. C.; Hall, J. H. *J. Chem. Phys.* 1985, 82, 1991.
- (31) Griffith, D. W. T.; Tyndall, G. S.; Burrows, J. P.; Moortgat, G. K. *Chem. Phys. Lett.* 1984, 107, 341.
- (32) Suenram, R. D.; Lovas, F. J. *J. Mol. Spectrosc.* 1984, 105, 351.
- (33) Brand, J. C. D.; Cawthon, T. M. *J. Am. Chem. Soc.* 1955, 77, 319.
- (34) McGraw, G. E.; Bernitt, D. L.; Hisatsune, I. C. *J. Chem. Phys.* 1965, 42, 237.
- (35) Dixon, W. B.; Wilson, E. B. Jr. *J. Chem. Phys.* 1961, 35, 191.
- (36) Cox, A. P.; Riveros, J. M. *J. Chem. Phys.* 1965, 42, 3106.
- (37) Bernitt, D. L.; Miller, R. H.; Hisatsune, I. C. *Spectrochim. Acta, Part A*, 1967, 23A, 237.
- (38) Mirri, A. M.; Cazzoli, G.; Ferretti, L. *J. Chem. Phys.* 1968, 49, 2775.
- (39) Molt, K.; Sawodny, W.; Pulay, P.; Fogarazi, G. *Mol. Phys.* 1976, 32, 169.
- (40) Teranishi, R.; Decius, J. C. *J. Chem. Phys.* 1954, 22, 896.
- (41) Nebgen, J. W.; McElroy, A. D.; Klodowski, H. F. *Inorg. Chem.* 1965, 4, 1797.

- (42) Addison, C. C.; Amos, D. W.; Sutton, D. J. Chem. Soc. A. 1967, 808.
- (43) Amos, D. W.; Flewett, G. W. Spectrochim. Acta, Part A 1974, 30A, 453.
- (44) Surles, T.; Quarterman, L. A.; Hyman, H. H. J. Inorg. Nucl. Chem. 1973, 35, 668.
- (45) Person, W. B.; Anderson, G. R.; Fordemwalt, J. N.; Stammreich, H.; Forneris, R. J. Chem. Phys., 1961, 33, 908.

DIAGRAM CAPTIONS

Figure 1. Infrared spectra of BrONO_2 . Trace A, N_2 matrix (MR=300) isolated sample at 5°K ; trace B, infrared spectrum of the gas at 120 and 10mm pressure in a 5cm path length cell.

Figure 2. Vibrational spectra of solid BrONO_2 . Trace A, infrared spectrum of the neat solid on a CsI window at 5°K ; traces B and C, Raman spectra of the neat solid in a glass tube at -135°C , recorded at two different sensitivity settings.

Figure 3. Vibrational spectra of solid $\text{Cs}^+[\text{Br}(\text{ONO}_2)_2]^-$. Trace A, infrared spectrum of the solid as an AgCl disk at 20°C ; the absorptions shown with a broken line are due to CsNO_3 formed by slow decomposition of the compound at this temperature; trace B, Raman spectrum of the solid at -134°C .

Figure 4. Vibrational spectra of solid $\text{NO}_2^+[\text{Br}(\text{ONO}_2)_2]^-$. Trace A, infrared spectrum of the solid at -186°C between CsI windows; trace B, Raman spectrum of the solid at -132°C .

Table 1. Vibrational Spectra of Gaseous, Matrix-Isolated, and Solid BrONO₂

Gas	Infrared		Raman Solid	assignment in point group C _s
	N ₂ Matrix	Ne Matrix		
3406vw				2ν ₁
2982vw				ν ₁ + ν ₂
2565vw				2ν ₂
2273vw				ν ₁ + ν ₅
1719 } vs	1702vs	1709vs	1622(10)	ν ₁
1709 }	1683m			ν ₂ + ν ₆
1610vw				2ν ₃
1449vw		1468vw	1468(1)	2ν ₈
			1460(0+)	ν ₃ + ν ₅
			1397(0+)	ν ₄ + ν ₅
			1307(0+)	
			1260sh	2ν ₅
1292 } vs, PQR	1285vs*	1285vs	1251(29)	ν ₂
1288 }	1279w			2ν ₅
1281 }				ν ₅ + ν ₆
1112vw				ν ₅ + ν ₇
958vw				ν ₃
825sh				ν ₄
810 } vs, PQR	805vs*	802vs	830(2)	ν ₈
806 }	798w	750w	761(18)	
799 }	750w	723mw	738(1)	
738 } w	725mw			
728 }	574*	642s	639sh	
569 }	569	637sh	635(5)	
559 }		400s	413(2)	
		365sh	397(100)	ν ₅
		245w	368(2)	ν ₆
			244(40)	ν ₇ + 122
			198(0+)	ν ₇
			145(2)	
			122(5)	
			106(10)	
			91(12)	
			60(20)	
			49(9)	
			41(38)	
			30(0+)	

(*) the splittings observed for these three bands are attributed to matrix effects. In the neon matrix, for example, only a single band was observed for ν₅.

Table 2. Fundamental Vibrations of Covalent Nitrates

MONO ₂ ^a		CH ₃ ONO ₂ ^d		ONO ₂ ^e		ClONO ₂ ^e		BrONO ₂ ^f		assignments in point group C _s and approx description of mode		
Ir	Ra	Ir	Ra	Ir	Ra	Ir	Ra	Ir	Ra			
gas	solid	gas	liquid	gas	liquid	gas	liquid	gas	matrix solid			
(36.2) ^b 1708vs	1646vs	1675w,dp	1669vs	(39)1759vs	1760(3),dp	(41)1735vs	1728(4),dp	1714vs	1702vs	1616vs	1622(10)	A' v ₁ vs NO ₂
(4.3)1325vs	1256vs	1303vs,p	1287s	(10)1301vs	1302(59),p	(12)1292vs	1290(30),p	1288vs	1285vs	1265vs	1251(29)	v ₂ vs NO ₂
(7.8)879s	958s	926s,p	854s	(12)804s	800(17),p	(7)780ms ^g	779(6),p	806vs	803vs	819vs	830(2)	v ₃ facies NO ₂
(0)3550m	3106m	3410w,p	3017s	(0)928m	929(67),p	(6)809s ^g	810(49),p	750w	750w	765vw	761(18)	v ₄ v OX
(1)579w	707s	612m,dp	657m	(1)633m	636(31),dp	(3)560s	561(20),dp	564s	572s	642s	635(5)	v ₅ facies OMO ₂ in-plane
(0)647w	722s	677s,p	(578)	(0)454m	457(100),p	(2)434m	436(100),p	(394)	(398)	400s	397(100)	v ₆ v M-O
(3.7)1331s	1420m	1395w,p	(340)	(1)303vw	304(33),p	270vw	267(47),p			245w	244(40)	v ₇ v NOX in-plane
(18.6)762S	773s	(771) ^c	759m	(18)708m	708(0.6)	(17)711mw	710(1)	728mw	725mw	735m	738(1)	A' v ₈ v OMO ₂ out-of-plane
(0)456m	737m	485w		152vw	165(4),dp							v ₉ v M-OX

(a) ref 34.

(b) numbers in brackets ¹⁴N-¹⁵N isotopic shifts.

(c) frequencies in parentheses calculated from overtones.

(d) ref 33.

(e) ref. 19-21, the previously reported polarization data for v₈ are questionable due to the extremely low Raman intensities of this mode.

(f) this work.

(g) based on the observed ¹⁴N-¹⁵N (Ref. 19) and ³⁵Cl-³⁷Cl (Ref. 31) isotopic shifts, these two vibrations are strongly mixed.

Table 3. Vibrational Spectra of Solid $\text{Cs}^+[\text{Br}(\text{ONO}_2)_2]^-$ and $\text{NO}_2^+[\text{Br}(\text{ONO}_2)_2]^-$ assignments for NO_2^+ and $[\text{Br}(\text{ONO}_2)_2]^-$

obsd freq, cm^{-1} , rel intens		assignments for NO_2^+ and $[\text{Br}(\text{ONO}_2)_2]^-$	
$\text{Cs}^+[\text{Br}(\text{ONO}_2)_2]^-$		$\text{NO}_2^+[\text{Br}(\text{ONO}_2)_2]^-$	
Ra	Ir	Ra	Ir
1530(12)	1520vs	1569(1) 1529(26) 1493(1) 1395(35) 1308(2) 1283(21) 1130(2) 1118(3) 1103(5) 982(4) 964(14)	2370m 1530vs 1265vs
1283(14)	1285vs	787(1) 747(100) 700(4)	965sh 930vs 782s 750s 706s 566ms 551ms
975(4) 960sh	955s 935vs 786s 735s 699s	480(0+),br 400(2),br 315(63)	vs NO_2^+ vs NO_2 , out-of-phase vs NO_2^+ vs NO_2 , in-phase vs NO_2 , in-phase vs NO_2 , out-of-phase
791(2) 732(63) 697(1)	460(0+),br 400(0+),br 317(71) 298(35) 230(10)	175(33) 162(32) 126(21) 105(100) 93(5) 80(57)	δ sciss NO_2 δ as ONO_2 in-plane δ ONO_2 out-of-plane δ NO_2^+
157(47) 128sh 110(64) 87(100)	53sh		vs O-N vs BrO_2 vs O-N vs BrO_2

Table 4. Summary of the 21 Fundamental Vibrations
Expected for $[\text{Br}(\text{ONO}_2)_2]^-$ in Point Group C_2

NOBrON Skeletal Modes

- ν_{as} BrO₂ (B)
- ν_s BrO₂ (A)
- ν O-N in-phase (A)
- ν O-N out-of-phase (B)
- δ BrON in-plane, in-phase (A)
- δ BrON in-plane, out-of-phase (B)
- δ OBrO out-of-plane (B)
- τ Br-O in-phase (A)
- τ Br-O out-of-phase (B)

NO₂ Modes

- ν_{as} NO₂, in-phase (A)
- ν_{as} NO₂, out-of-phase (B)
- ν_s NO₂, in-phase (A)
- ν_s NO₂, out-of-phase (B)
- δ_{sciss} NO₂, in-phase (A)
- δ_{sciss} NO₂, out-of-phase (B)
- δ ONO₂ out-of-plane, in-phase (A)
- δ ONO₂ out-of-plane, out-of-phase (B)
- δ_{as} ONO₂ in-plane, in-phase (A)
- δ_{as} ONO₂ in-plane, out-of-phase (B)
- τ O-N, in-phase (A)
- τ O-N, out-of-phase (B)

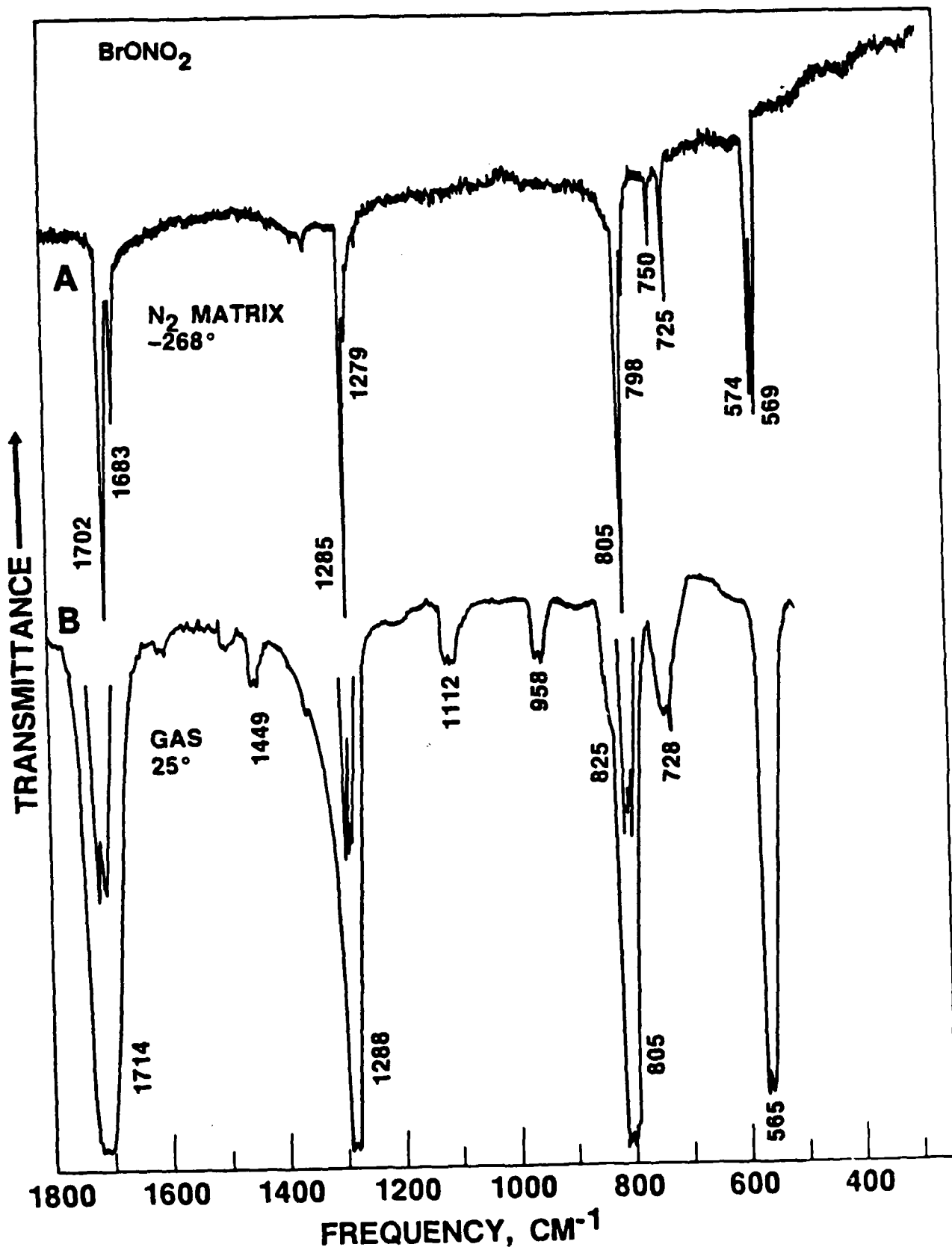

Figure 1.

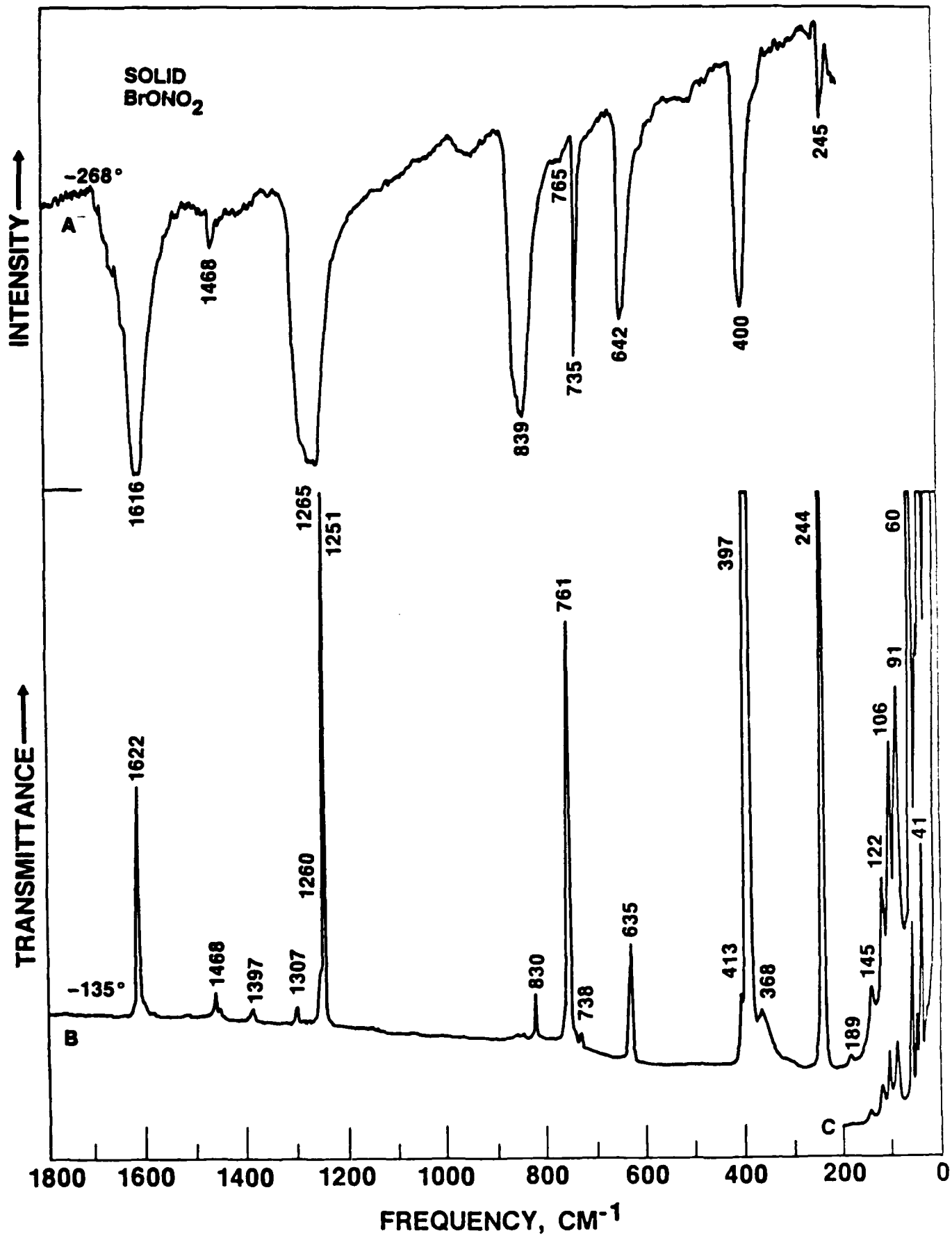

Figure 2.
V-29

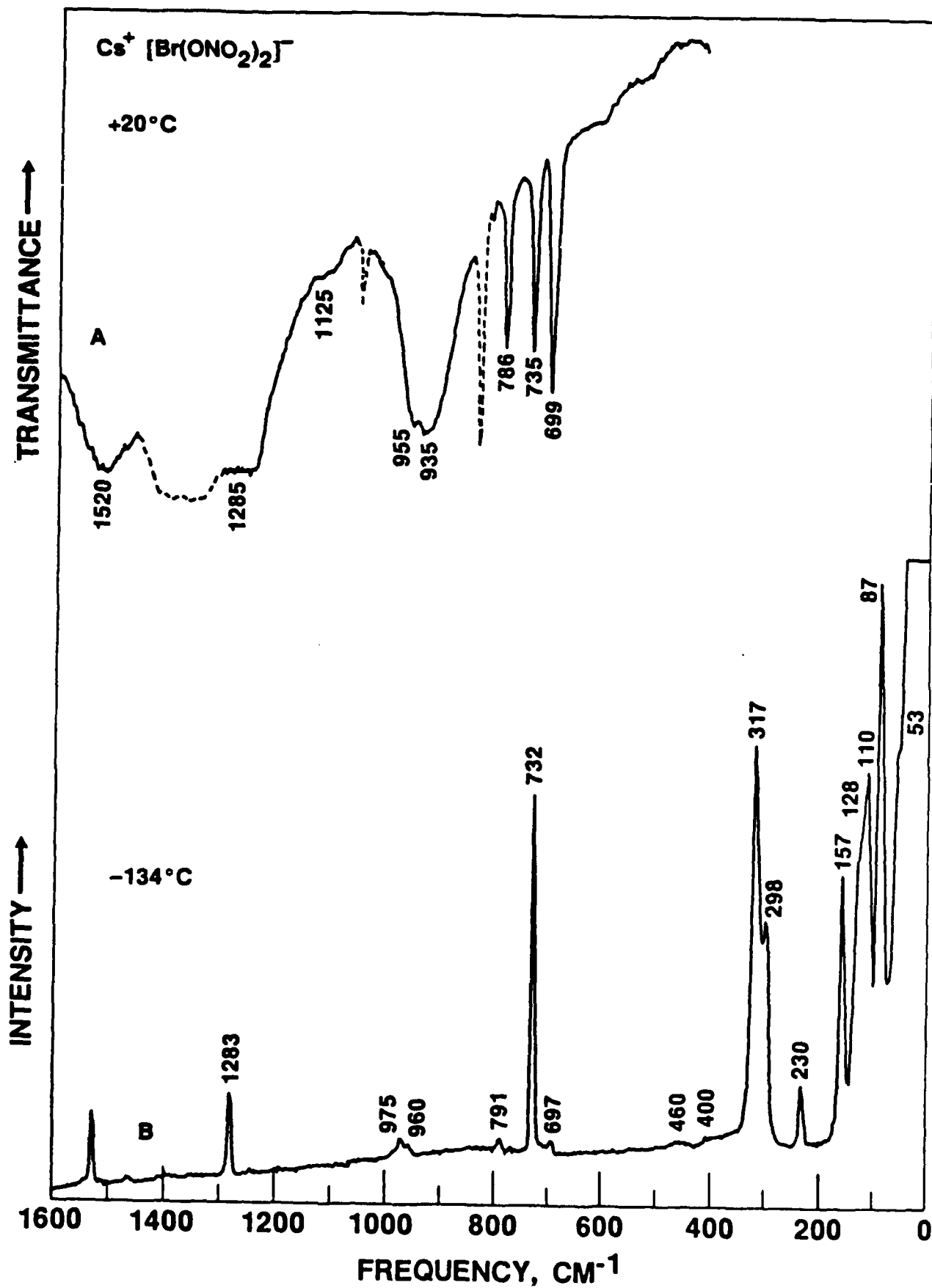
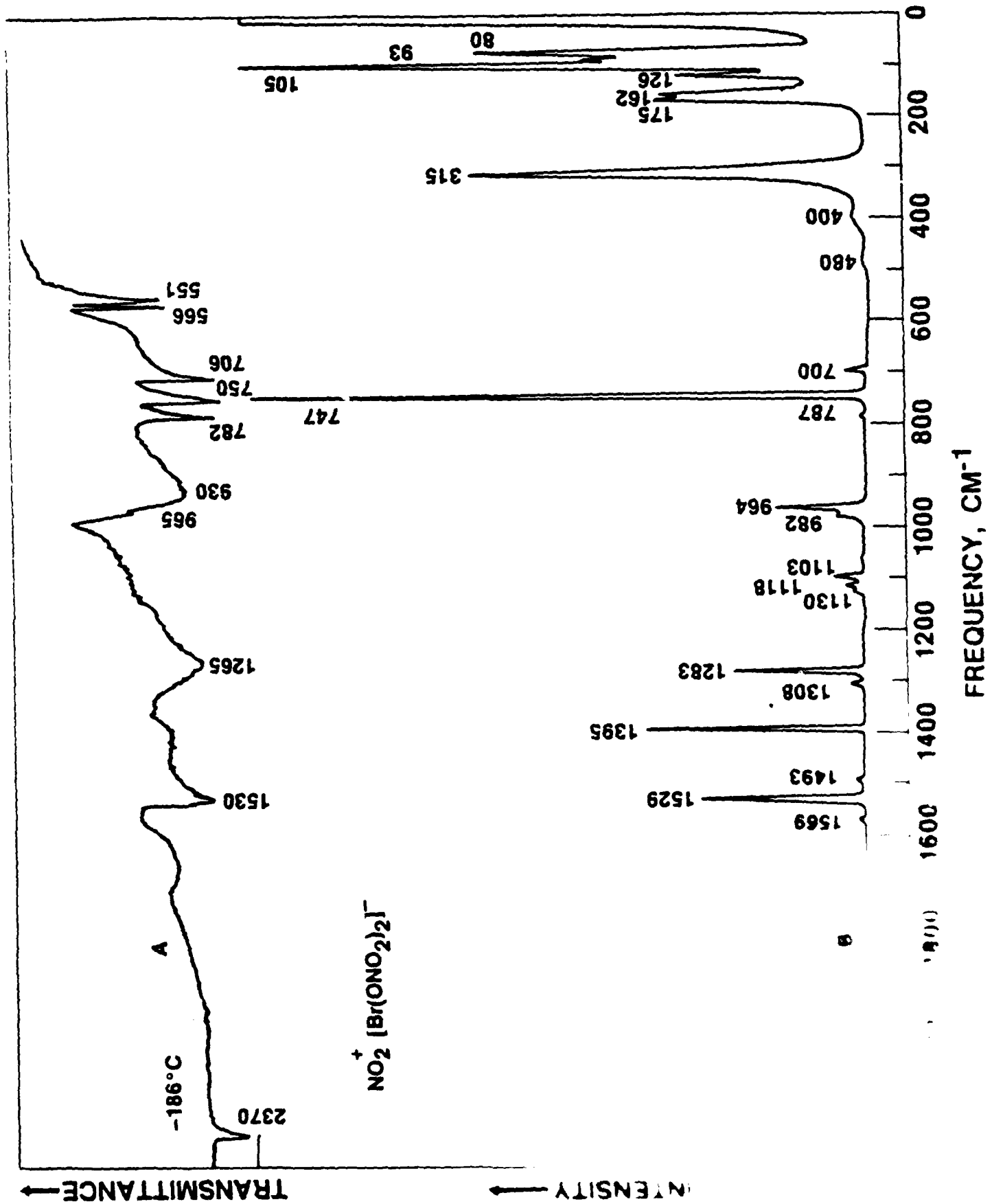
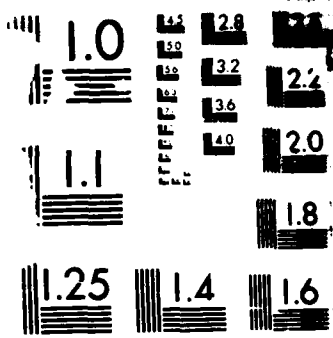

Figure 3.





MI

APPENDIX W

Contribution from Rocketdyne, A Division of Rockwell International,
Canoga Park, California 91303

Solid Propellant Based Pure Fluorine Gas Generators

Karl O. Christe* and Richard D. Wilson

Received

Abstract

Solid propellant based gas generators are described which can rapidly produce pure fluorine at superatmospheric pressure. These generators are based on the in situ formation of a thermodynamically unstable transition metal fluoride from its stable anion by a simple displacement reaction with a stronger Lewis acid. The formed unstable transition metal fluoride undergoes spontaneous decomposition to a stable lower oxidation state fluoride and elemental fluorine. The given examples include K_2NiF_6 , Cs_2CuF_6 or Cs_2MnF_6 as the transition metal salts and BiF_5 , TiF_4 or mixtures thereof as the Lewis acids.

Introduction

The storage and handling of either cryogenic liquid or high-pressure gaseous fluorine frequently presents safety and logistics problems. These problems can be overcome by the use of solid propellant, fluorine gas generators. During the past fifteen years numerous fluorine gas generators were developed which are based on NF_4^+ salts.¹ In these systems, a highly overoxidized grain, consisting mainly of an NF_4^+ salt and several percent of a fuel, such as powdered aluminum, is burned. The heat, Q , generated in the burning process dissociates the bulk of the NF_4^+ salt, as shown in (1).

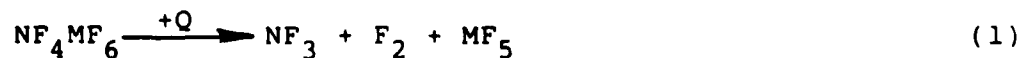

If the heat Q is high enough, some of the NF_3 is also dissociated as shown in (2).



Although impressive fluorine yields were achieved with these generators, they suffer from the disadvantage of producing NF_3 and some N_2 as by-products. Whereas in many cases these by-products can be tolerated, there are certain applications which require pure F_2 . Consequently, the development of solid propellant systems capable of generating pure fluorine gas was highly desirable.

Experimental

Materials. BiF_5 and K_2NiF_6 (both from Ozark Mahoning Co.) were of high purity and used without further purification. TiF_4 (Allied Chemical) was treated in a Monel cylinder for 2 days at $250^\circ C$ with F_2 at 70 atm to eliminate some impurities formed by hydrolysis during prolonged storage of the material. The syntheses of Cs_2CuF_6 and Cs_2MnF_6 have previously been described.² Prior to its use, CoF_3 (Ozark Mahoning Co.) was prefluorinated for 3 days with 8 atm of F_2 at $300^\circ C$.

Apparatus and Procedure

All solid propellant F_2 gas generation reactions were carried out in a well passivated (with 2 atm of F_2 at $200^\circ C$) stainless steel apparatus consisting of a 30 ml Hoke cylinder equipped with a cross fitting and a feed-through for a sheathed thermocouple which almost touched the bottom of the cylinder. A pressure transducer (Validyne DP-15) and a Hoke valve leading to a stainless steel vacuum line were connected to the two remaining sides of the cross. Weighed amounts of the transition metal fluoride salt and the Lewis acid were thoroughly mixed in the

dry nitrogen atmosphere of a glove box and loaded into the apparatus. The apparatus was then connected to the vacuum line, evacuated, and leak checked. The bottom of the cylinder was rapidly heated by the hot air stream from a heat gun, and the pressure evolution and inside temperature of the reactor were followed on a strip chart recorder. The evolved fluorine was measured by standard PVT methods and analyzed for its purity by reacting it with mercury. The material balance was further cross-checked by weighing the reactor before the reaction and after removal of the evolved fluorine.

The CoF_3 decomposition experiments were carried out in either a Monel reactor with an Al_2O_3 boat as a sample container or a sapphire tube (Tyco). Pressure and temperature were monitored as described above. The reactors were heated by a fluidized sand bath.

Results and Discussion

Generation of F_2 by Reversible Reactions. Since certain transition metal fluorides, such as CoF_3 , are known to decompose at elevated temperatures to a lower fluoride and fluorine,³ the equilibrium (3)



was examined for its potential as a fluorine gas generator. The CoF_3 system was found to exhibit the following drawbacks: (i) relatively high temperatures (in excess of 500°C) were required for the generation of even moderate fluorine pressures (about 268 torr at 514°C); (ii) long reaction times were required to reach equilibrium; (iii) on cooling of the system, the back reaction to CoF_3 consumed most of the fluorine formed; (iv) reaction of the fluorine with the hot reactor walls was difficult

to suppress; and (v) the yields of fluorine were disappointingly low. These drawbacks appear to be generally true for equilibrium reactions of this type and therefore render these reversible systems unattractive for fluorine gas generator applications.

Generation of F₂ by Irreversible Reactions. Most of the above drawbacks of the reversible reactions can be avoided by the use of irreversible reactions. This principle has been applied by us in previous work.¹ For example, the thermal decomposition of NF₄BF₄ (4) in an NF₃-F₂ gas generator is irreversible,

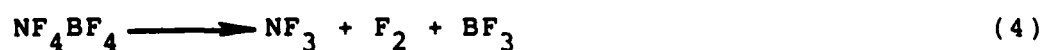

i.e. NF₃, F₂ and BF₃, even at elevated temperature and pressure, do not reform NF₄BF₄.⁴ This concept of irreversibility was further exploited^{2,5} by replacing the BF₄⁻ anion in the NF₄⁺ salt by anions such as NiF₆²⁻ or MnF₆²⁻ which themselves are stable but are derived from thermodynamically unstable parent molecules. In the thermal decomposition of these (NF₄⁺)₂MF₆²⁻ type salts, thermodynamically unstable MF₄ molecules are formed (5) which then decompose in a second irreversible step to a stable lower fluoride and F₂ (6).

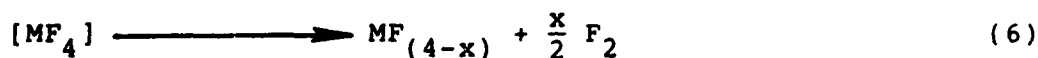
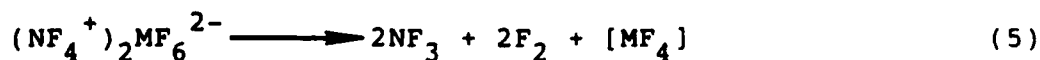

The concept of generating a thermodynamically unstable fluoride from its stable anion, followed by its irreversible decomposition with spontaneous fluorine evolution, has recently been utilized for the purely chemical generation of elemental fluorine.⁶ Using starting materials, i.e. K₂MnF₆ and SbF₅, which can be prepared from HF, elemental fluorine was generated by the simple displacement reaction (7), followed by the irreversible decomposition of

the unstable MnF_4 (8).

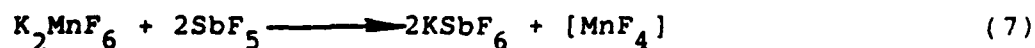

If in this scheme, the liquid Lewis acid SbF_5 is replaced by a solid Lewis acid of sufficient strength and suitable melting or sublimation point, a pure fluorine, solid propellant based gas generator is obtained, as demonstrated by equations (9) and (10),

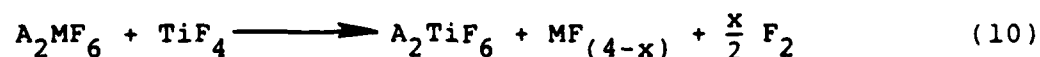
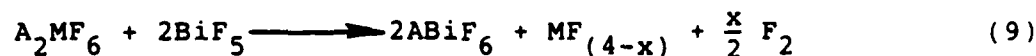

where A can be an alkali metal and M can be Ni, Cu or Mn. The results of five typical experiments are summarized in Table 1. Although no systematic effort was made to maximize the F_2 yields, the results of Table 1 show that the F_2 yields are generally very good. From both yield and molecular weight considerations, K_2NiF_6 appears to be the most attractive starting material. Of the two Lewis acids tested, BiF_5 (mp 151.4°C, bp 230°C) appears to be superior to TiF_4 (subl. p 283.1°C), although on a weight basis, the considerably lighter bifunctional acid TiF_4 might be attractive, particularly as an additive to other Lewis acids as shown by run 5 of Table 1.

The starting materials used in this study can be readily premixed at ambient temperature and stored safely. When heated to about 60 to 70°C, fluorine evolution starts. The fluorine evolution was measured as a function of time and temperature and a typical curve for the K_2NiF_6 - BiF_5 system is shown in Figure 1. The fluorine evolution is rapid, the gas can be generated at super-atmospheric pressure, and there is no evidence for any reversible

reactions. Furthermore, the F_2 is evolved at such moderate temperatures that reaction of the fluorine with the container walls is of no concern. The purity of the generated fluorine was shown to be in excess of 99% by its quantitative reaction with mercury.

Conclusion. Application of the same principle which was recently used for the chemical synthesis of elemental fluorine,⁶ to solid Lewis acids results in useful, solid propellant based, pure fluorine gas generators. The validity of the concept has been demonstrated for A_2MF_6 salts (A = K or Cs and M = Ni, Cu or Mn) and BiF_5 or TiF_4 as the Lewis acids. Further improvements in the attainable fluorine yields are anticipated by variation of the starting materials and Lewis acids and an optimization of the stoichiometries and reaction conditions.

Acknowledgement. The authors are grateful to Drs. L. R. Grant, C. J. Schack, and W. W. Wilson for their help, and to the U.S. Army Research Office and the Office of Naval Research for partial financial support.

Table 1. Results from Solid Propellant, Pure Fluorine, Gas Generator Experiments

Run #	starting materials (mmol)	F ₂ generated (mmol)	peak pressure (torr)	F ₂ yield (mol %)
1	K ₂ NiF ₆ (1.47) BiF ₅ (4.51)	1.1	990	75 ^a
2	Cs ₂ CuF ₆ (2.01) BiF ₅ (3.95)	0.9	836	46 ^a
3	Cs ₂ MnF ₆ (4.86) BiF ₅ (14.85)	1.0	929	41 ^b
4	K ₂ NiF ₆ (6.31) TiF ₄ (6.25)	0.87	810	14 ^a
5	K ₂ NiF ₆ (1.94) TiF ₄ (1.94) BiF ₅ (1.94)	0.88	820	45 ^a

(a) yields based on the limiting reagent and the following stoichiometry:



(b) yield based on the limiting reagent and the following stoichiometry:

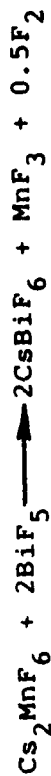

References

- (1) See Christe, K. O.; Wilson, W. W. *Inorg. Chem.* 1982, 21, 4113 and references cited therein.
- (2) Christe, K. O.; Wilson, W. W.; Wilson, R. D. *Inorg. Chem.* 1980, 19, 3254.
- (3) Nicholls, D. in "Comprehensive Inorganic Chemistry," Bailar, J. C.; Emeléus, H. J.; Nyholm, R.; Trotman-Dickenson, A. F. Edit., Pergamon Press, 1973, Vol. 1, p. 1093.
- (4) Christe, K. O.; Wilson, R. D.; Goldberg, I. B. *Inorg. Chem.*, 1979, 18, 2572.
- (5) Christe, K. O. *Inorg. Chem.* 1977, 16, 2238.
- (6) Christe, K. O. *Inorg. Chem.*, 1986, 25, 3721.

Diagram Caption

Figure 1. Pressure and temperature versus time curves for the K_2NiF_6 - BiF_5 system.

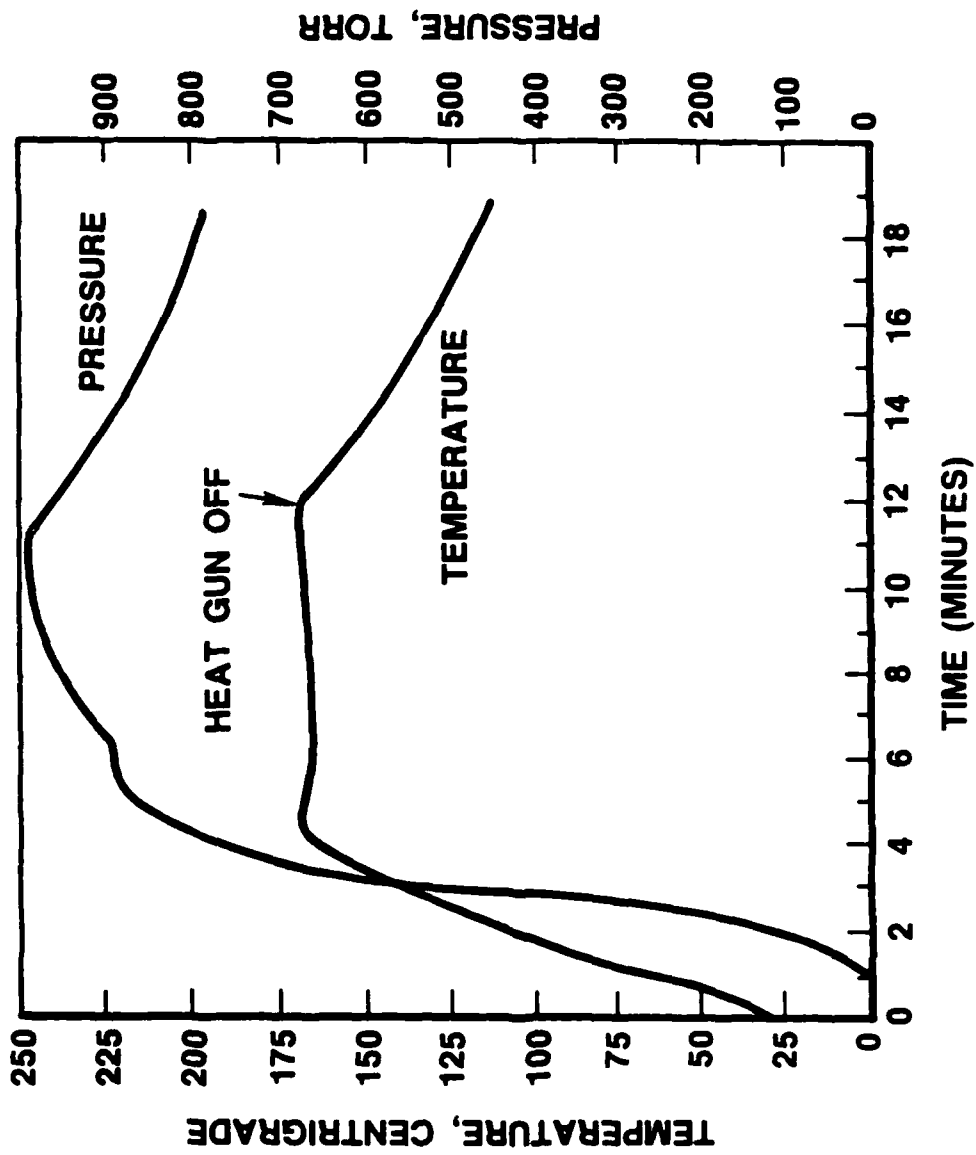

APPENDIX X

ON THE EXISTENCE OF A $\text{CrF}_4\text{O}\cdot\text{SbF}_5$ ADDUCT

WILLIAM W. WILSON AND KARL O. CHRISTE

Rocketdyne, A Division of Rockwell International Corporation,
Canoga Park, California 91303 (U.S.A.)

SUMMARY

CrF_4O is capable of forming a stable adduct with SbF_5 . Based on its low-temperature Raman spectrum, this adduct has a predominantly covalent, fluorine bridged structure, similar to that of $\text{MoF}_4\text{O}\cdot\text{SbF}_5$.

INTRODUCTION

In a recent paper the amphoteric nature of CrF_4O has been investigated. It was shown that CrF_4O is a very strong Lewis acid, but only a rather weak Lewis base and does not form a stable adduct with AsF_5 at temperatures as low as -78°C [1]. In view of the fact that the closely related MoF_4O , WF_4O and ReF_4O molecules can form stable 1:1 adducts with SbF_5 [2], it was interesting to study the interaction between CrF_4O and SbF_5 .

EXPERIMENTAL

Materials. Literature methods were used for the synthesis of CrF_4O [1] and the drying of the HF solvent [3]. SbF_5 (Ozark Mahoning) was distilled prior to its use.

Apparatus. Volatile materials were manipulated in stainless-steel vacuum lines equipped with Teflon-FEP U-traps, 316 stainless steel bellows-seal or Teflon-PFA (Fluoroware, Inc.) valves, and a Heise Bourdon tube-type pressure gauge [4]. The vacuum lines and other hardware employed were passivated with ClF_3 and HF. Nonvolatile or low volatility materials were handled in the dry nitrogen atmosphere of a glove-box. Raman spectra were recorded on a Spex Model 1403 spectrophotometer using the 647.1-nm exciting line of a Kr ion laser. The sample was contained in a sealed 1 mm o.d. quartz capillary, and the spectra were recorded at -140°C using a previously described device [5].

Reaction of CrF_4O with SbF_5 . A passivated 0.5" o.d. Teflon-FEP U-tube, closed by two valves, was loaded in the dry-box with SbF_5 (0.89 mmol). The U-tube was connected to the vacuum line and HF (1.08g) and CrF_4O (0.31 mmol) were condensed in at -196°C . The contents of the tube were warmed to room temperature resulting in a light red solution. All material volatile at room temperature was pumped off and passed through a -78° and a -196°C trap. Nothing was trapped at -78°C , but the -196°C trap contained the HF solvent. The residue was a dark red-brown liquid which upon heating to 55°C for 15 hr in a dynamic vacuum condensed on the colder parts of the tube. The volatile material trapped at -78°C was white and consisted of SbF_5 . The condensate (143 mg) consisted of dark red droplets and crystals. The appearance of some liquid material can be accounted for by the fact that, based on the material balance, the condensate still contained 31 mg (0.14 mmol) of SbF_5 in excess over that required for the 1:1 adduct $\text{CrF}_4\text{O}\cdot\text{SbF}_5$. The crystals were characterized by low-temperature Raman spectroscopy, but were not suitable for a crystal structure determination because of twinning or disorder.

RESULTS AND DISCUSSION

CrF_4O , when combined with an excess of SbF_5 in anhydrous HF solution, forms after removal of the solvent a dark brown-red liquid adduct. In a dynamic vacuum at 55°C , most of the excess SbF_5 can be pumped off. As the $\text{CrF}_4\text{O}\cdot\text{SbF}_5$ mol ratio approaches 1:1, dark red crystals are obtained which are stable at 55°C . Attempts to determine their structure by single crystal x-ray diffraction techniques failed because of twinning or disorder. However, their low-temperature Raman spectrum (see Figure 1) indicates that their structure closely resembles those of the mainly covalent $\text{MoF}_4\text{O}\cdot\text{SbF}_5$ and $\text{WF}_4\text{O}\cdot\text{SbF}_5$ adducts [2], (see Table 1). The minor differences

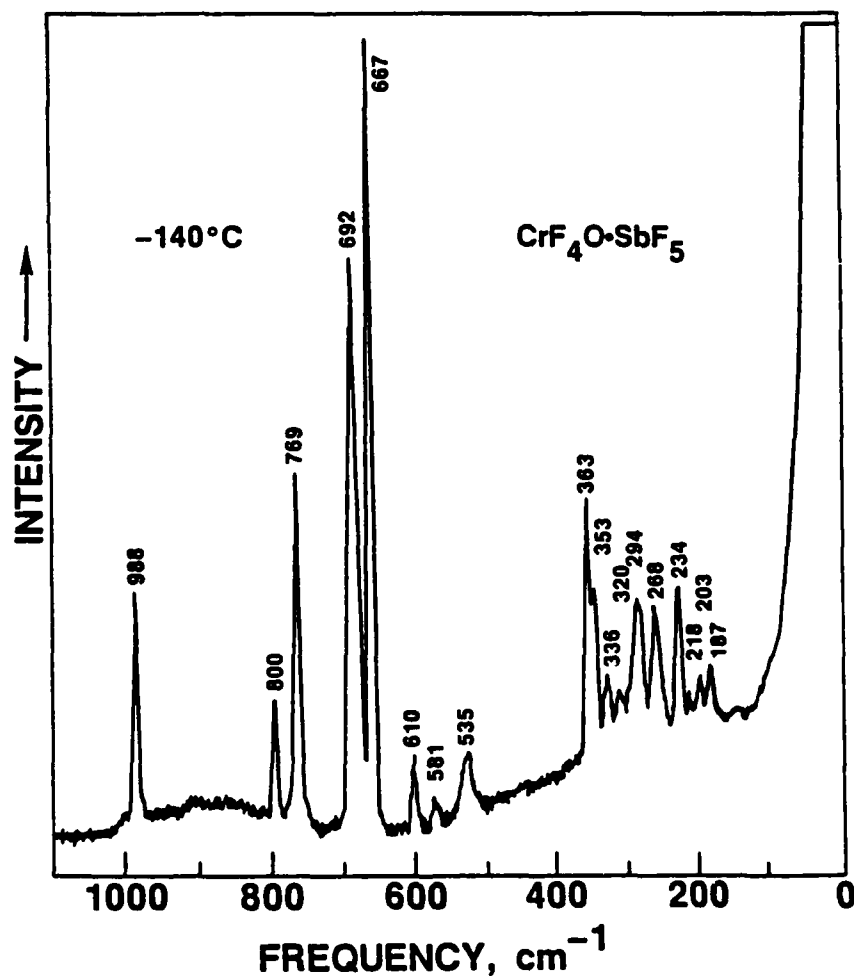

Figure 1. The Raman Spectrum of $\text{CrF}_4\text{O}\cdot\text{SbF}_5$ at -140°

TABLE 1.
Raman Spectrum of $\text{CrF}_4\text{O}\cdot\text{SbF}_5$ Compared to Those of $\text{MoF}_4\text{O}\cdot\text{SbF}_5$,
 $\text{WF}_4\text{O}\cdot\text{SbF}_5$ and Their Parent Molecules

observed frequencies (cm^{-1}) and relative intensities						
$\text{WF}_4\text{O}\cdot\text{SbF}_5$ [2]	$\text{MoF}_4\text{O}\cdot\text{SbF}_5$ [2]	$\text{CrF}_4\text{O}\cdot\text{SbF}_5$	WF_4O [2]	MoF_4O [2]	CrF_4O [1]	SbF_5 [2]
1061 vs	1047 s	988 (3)	1058 vs	1042 s	999 m	
758 mw	766 mw	{ 800 (1.5) 769 (4.4)	744 m	740 m	789 mw	
710 s	704 m	692 (7.1)	728 w	721 mw	{ 718 sh 704 m	718 s
670 s	675 s	667 (10)	687 vw	688 s	{ 692 m 666 mw 650 vs	670 vs
556 vw	621 w	610 (0.9)	669 vw		663 mw	
	578 w	581 (0.3)	563 m		571 w	
		535 (0.9)	532 vw	529 w	528 w	
			523 w	506 vw	517 vv	
			388 w		377 w	
		363 (3.2)	367 vw		350 mw	
334 w	338 w	336 (0.7)	330 mw	333 m		349 vw
		320 (0.3)	318 m sh			
312 w	314 w	294 (1.5)	314 s	309 ms	293 w	
279 w		268 (1.5)	265 w	275 w	273 w	268 m
242 vw	233 w	234 (1.6)	242 mw	222 mw		231 mw
		218 (0.2)	215 mw			
		203 (0.4)	151 mw			
		187 (0.6)	135 w			
				188 vw		189 mw

in the observed spectra can be attributed to (i) the low temperature at which the $\text{CrF}_4\text{O}\cdot\text{SbF}_5$ spectrum was recorded which may cause some additional splittings, (ii) the mass and force constant differences between Cr, Mo, and W, and (iii) the increasing ionicity of the metal-F bonds from Cr to W which causes the relative Raman intensity of the metal oxygen vibrations to increase with respect to those of the metal-fluorine vibrations. Thus, the above results show that CrF_4O is also capable of forming a stable adduct with SbF_5 and that the resulting adduct has a mainly covalent, fluorine bridged structure similar to that of $\text{MoF}_4\text{O}\cdot\text{SbF}_5$ [2].

ACKNOWLEDGEMENTS

The authors are grateful to Drs. R. Bougon, C. Schack and L. Grant and Mr. R. Wilson for their help, to Dr. R. Bau for the examination of the crystals by x-ray diffraction, and to the Office of Naval Research and the Army Research Office for financial support.

REFERENCES

- 1 K. O. Christe, W. W. Wilson and R. A. Bougon, *Inorg. Chem.*, in press.
- 2 J. Fawcett, J. H. Holloway and D. R. Russell, *J. C. S. Dalton*, 1212 (1981).
- 3 K. O. Christe, W. W. Wilson and C. J. Schack, *J. Fluorine Chem.*, 11, 71 (1978).
- 4 K. O. Christe, R. D. Wilson and C. J. Schack, *Inorg. Synthesis*, 24, 3 (1986).
- 5 F. A. Miller and B. M. Harney, *Appl. Spectrosc.*, 23, 8 (1969).

APPENDIX Y

SELF-ASSOCIATION IN HOF AND HNF₂. WHICH ATOMS ARE THE BETTER PROTON ACCEPTORS, FLUORINE, OXYGEN OR NITROGEN?

KARL O. CHRISSTE

Rocketdyne, A Division of Rockwell International,
Canoga Park, California 91303 (U.S.A.)

SUMMARY

The infrared and Raman spectra of solid HOF and HNF₂ are best interpreted in terms of hydrogen bridged aggregates involving the oxygen or nitrogen atoms, respectively, and not fluorine as proton acceptors. This result is contrary to intuition and the conclusions previously reached for solid HOF [1,2].

INTRODUCTION

The vibrational spectra of solid HOF have recently been studied [1,2]. A detailed analysis of the data was presented [2] in which it was tacitly assumed that the intermolecular hydrogen bridges involve the fluorine and not the oxygen atom. A more recent study of the vibrational spectra of solid HNF₂ in this laboratory provided experimental evidence for intermolecular hydrogen bridging through the nitrogen atoms [3]. Since both, NF₂ and OF, are paraelements of F [4] and

therefore should exhibit similar properties [4], the basis for the previous conclusion concerning the $(\text{HOF})_n$ structure was critically reviewed in the light of our data.

DISCUSSION

General Considerations

Very polar molecules of the type HX , where X is a highly electronegative group or atom, exhibit a pronounced tendency to associate in the solid phase through hydrogen bridges. If X is either a single atom, such as fluorine, or is a group, such as $-\text{OH}$ or $-\text{NH}_2$, which contains only one highly electronegative atom, there is no ambiguity as to which atom is the proton acceptor. Thus, the self-association of water obviously involves hydrogen bridges between oxygen atoms. If however the X group, as for example in $-\text{OF}$ or $-\text{NF}_2$, contains two or more different atoms of high electronegativity, ambiguity arises as to which of these atoms is the better proton acceptor. Although a wealth of information exists on hydrogen bonded systems [5], the more specific problem of competing proton acceptors has found only little attention.

A priori, it is difficult to predict for self-associated HOF whether oxygen or fluorine is the better proton acceptor. In systems, such as $(\text{HOF})_n$, which involve moderately strong hydrogen bonds between uncharged polar molecules, numerous factors contribute to the strength of the hydrogen bond. Among these factors, five main contributions which are of similar magnitude, have been proposed: (a) electrostatic or coulomb energy, (b) exchange repulsion, (c) polarization energy, (d) charge transfer energy or covalent contribution, and (e) dispersion energy. Although these contributions are superpositioned

in a complicated manner, there is general agreement that considerable molecular orbital overlap occurs between the involved atoms leading to preferred geometries, such as the linearity of the hydrogen bridge [6]. In addition to the molecular orbital overlap, the charge distribution in the molecule is also very important because of its strong influence on the coulomb energy. In view of these complications and the difficulties encountered with carrying out reliable molecular orbital computations for relatively large systems, it is not surprising that either empirical or intuitive approaches have frequently been used to choose the most likely proton acceptor site.

With respect to the $(\text{HOF})_n$ problem, there are two pieces of information available which suggest that oxygen might be the better proton acceptor. First, the charge distribution in HOF has been determined by ab initio calculations as roughly
+0.50 -0.31 -0.19
 $\text{H} \text{---} \text{O} \text{---} \text{F}$ [7,8], indicating that a hydrogen bridge to oxygen should result in the largest coulomb energy. Second, an MO study of the proton affinities of oxygen and fluorine in HOF favored oxygen by 10 kcal/mol [9]. These data and our experimental results for $(\text{HNF}_2)_n$ which suggest nitrogen protonation [3], prompted the examination of whether the previously published vibrational spectra of $(\text{HOF})_n$ [1,2] can be reinterpreted in terms of oxygen protonation.

Vibrational Spectra of $(\text{HOF})_n$ and $(\text{HNF}_2)_n$

The previous studies [1,2] on solid HOF showed the following salient features. The O-F stretching vibration appeared as a sharp, unsplit band, which was virtually unshifted from its gas phase value. The O-H stretching band, on the other hand, was quite broad and appeared as a doublet, red shifted from the gas-phase by about 200 cm^{-1} . The HOF

bending mode was unsplit and blue shifted by 42 cm^{-1} . In addition to these three internal vibrational modes, intermolecular modes were observed in the infrared spectrum at 628 and 448 cm^{-1} which exhibited large shifts on deuteration. In the Raman spectra six low-frequency bands were seen which showed no significant deuterium isotope shifts.

The vibrational spectra of solid HNF_2 showed the following salient features. The two NF_2 stretching and the NF_2 scissoring modes were sharp, unsplit and essentially unshifted from the gas phase values. The N-H stretching mode was a sharp doublet, red shifted from the gas-phase by about 43 cm^{-1} . The two HNF_2 bending modes were split and blue shifted by about 30 cm^{-1} . In addition to these six internal vibrational modes, five low-frequency Raman bands were observed which exhibited only small shifts on deuteration.

Interpretation of the Spectra

A comparison of the two sets of spectra reveals that HOF and HNF_2 exhibit the same characteristic changes on going from the gas phase to the solid phase. The pronounced frequency shifts of the modes involving motions of the hydrogens establish the presence of hydrogen bridging for both molecules. For HNF_2 the lack of frequency shifts, splittings or line broadening for the NF_2 modes indicates that the hydrogen bonds must involve the nitrogen and not one of the two fluorines. If the hydrogen would be bridging to one of the two fluorine atoms, the latter would become non-equivalent causing significant shifts and splittings. The failure to observe evidence for two nonequivalent fluorine atoms might be explained in terms of a bifurcated structure, such as

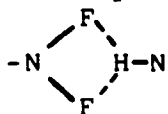

highly unlikely from molecular orbital arguments which favor linear hydrogen bridges [6]. Assuming smooth trends for the paraelements -OF and -NF₂ and accepting the spectroscopic evidence for N···H-N bridging in HNF₂, we can then conclude that, contrary to the previous interpretation [2], (HOF)_n should be oxygen and not fluorine bridged. The observed vibrational spectra with an undisturbed O-F mode lend strong support to this interpretation, as do the above given, theoretical arguments, i.e. proton affinity [9] and charge distribution [7,8].

In the absence of crystal structure data for solid HNF₂ and HOF, there is no point in assigning the low-frequency modes observed for the two compounds. Based on analogy to similar systems [6], structures containing zig-zag chains or large rings would seem most probable:

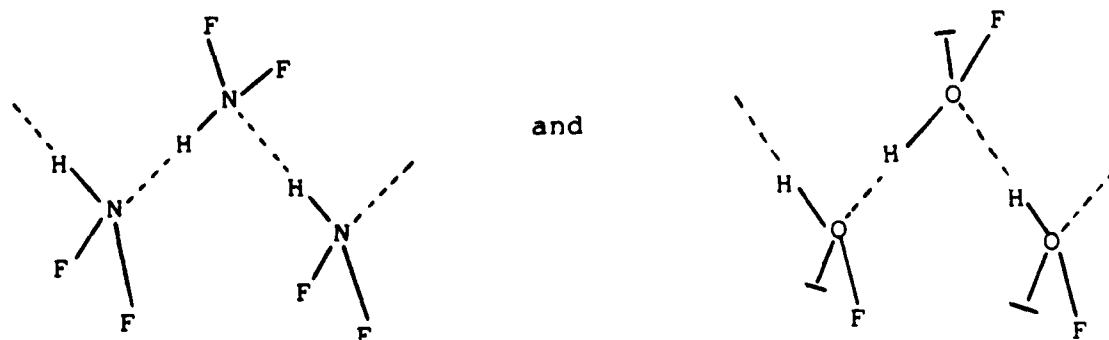

Conclusions

The fact that the oxygen in HOF and the nitrogen in HNF₂ are better proton acceptors than fluorine seems reasonable for the following reasons: (a) in both molecules the hydrogen atoms are attached to O and N, respectively, thus releasing electron

density to them which is only partially transferred to the fluorine ligands. Thus, most of the negative charge resides on O and N (note the charge distribution in HOF [7,8]) rendering the -OH and -NH groups more basic than the fluorine ligands, and (b) the molecular orbitals of the free valence electrons on fluorine are more contracted than those on N or O due to its increased nuclear charge, and therefore provides less overlap energy with the hydrogen orbital. It thus appears that the negative charge density and the size of the free valence pair orbitals of an atom are more important than factors, such as its number of free valence electron pairs or its electronegativity, which might be chosen intuitively as a measure for its proton acceptor strength.

ACKNOWLEDGEMENT

The author wishes to thank Drs. C. J. Schack and W. W. Wilson for helpful discussions and the Army Research Office and the Office of Naval Research for financial support.

REFERENCES

- 1 E.H. Appelman, W.W. Wilson and H. Kim, *Spectrochim. Acta*, Part A, 37 (1981) 385.
- 2 H. Kim and E.H. Appelman, *J. Chem. Phys.*, 76 (1982) 1664.
- 3 K.O. Christe and R.D. Wilson, to be published.
- 4 A. Haas, *Adv. Inorg. Chem. Radiochem.*, 28 (1984) 168.
- 5 See for example the three volume series "The Hydrogen Bond" by P. Schuster, G. Zundel and C. Sandorfy, Edit., North Holland Publishing Co., Amsterdam (1976).
- 6 P. Schuster in Volume I of ref. 5.
- 7 H. Kim and J.R. Sabin, *Chem. Phys. Lett.*, 20 (1973) 215.
- 8 T. Ha, *J. Mol. Structure*, 15 (1973) 486.
- 9 A. Johansson, P.A. Kollman, J.F. Liebman, and S. Rothenberg, *J. Amer. Chem. Soc.*, 96 (1974) 3750.

APPENDIX AA

United States Patent [19]

[11] **4,410,377**

Christe et al.

[45] **Oct. 18, 1983**

[54] **NF₃-F₂ GAS GENERATOR COMPOSITIONS**

[75] **Inventors:** Karl O. Christe, Calabasas; William W. Wilson, Canoga Park, both of Calif.

[73] **Assignee:** The United States of America as represented by the Secretary of the Army, Washington, D.C.

[21] **Appl. No.:** 361,638

[22] **Filed:** Mar. 25, 1982

[51] **Int. Cl.³** C06B 43/00

[52] **U.S. Cl.** 149/109.4; 149/119

[58] **Field of Search** 149/109.4, 119

[56] **References Cited** . . .

U.S. PATENT DOCUMENTS

3,325,318 6/1967 Paulukonis 149/109

3,980,509	9/1976	Lubowitz et al.	149/19.3
4,001,136	1/1977	Channell et al.	149/119
4,003,771	1/1977	Lubowitz 149/17	
4,108,965	8/1978	Christe 423/351	
4,152,406	5/1979	Christe et al. 423/351	
4,172,881	10/1979	Christe et al. 423/301	
4,284,617	8/1981	Bowen et al. 423/504	

Primary Examiner—Edward A. Miller
Attorney, Agent, or Firm—Robert P. Gibson; Anthony T. Lane; Jack W. Voigt

[57] **ABSTRACT**

Improved compositions are described for solid propellant NF₃-F₂ gas generators using (NF₄)₂TiF₆ and clinkering agents derived from LiF, KF, and NaF, either alone or in mixtures.

6 Claims, No Drawings

NF₃-F₂ GAS GENERATOR COMPOSITIONS

DEDICATORY CLAUSE

The invention described herein was made in the course of or under a contract or subcontract thereunder with the Government and may be manufactured, used, and licensed by or for the Government for governmental purposes without the payment to us of any royalties thereon.

BACKGROUND OF THE INVENTION

1. Field of the Invention

This invention relates to improved compositions for solid propellant NF₃-F₂ gas generators, useful, for example, in chemical HF-DF lasers.

2. Description of Prior Art

NF₄+ salts are the key ingredients for solid propellant NF₃-F₂ gas generators, as shown by D. Pilipovich in U.S. Pat. No. 3,963,542. These propellants consist of a highly over-oxidized grain using NF₄+ salts as the oxidizer. Burning these propellants with a small amount of fuel, such as aluminum powder, generates sufficient heat to thermally dissociate the bulk of the oxidizer. This is shown for NF₄BF₄ in the following equation:



As can be seen from the equation the gaseous combustion products contain the volatile Lewis acid BF₃. This disadvantage of a volatile Lewis acid byproduct is shared by most known NF₄+ compositions. These volatile Lewis acids possess a relatively high-molecular weight and a low γ value ($\gamma = C_p/C_w$), relative to the preferred diluent helium and frequently act as a deactivator for the chemical HF-DF laser. Consequently, these volatile Lewis acids must be removed from the generated gas prior to its use in an efficient chemical laser. Based on the state of the art, heretofore, this would be achieved by adding a clinker forming agent, such as KF, to the solid propellant formulation. The function of this additive served to convert the volatile Lewis acid, such as BF₃, to a non-volatile salt as shown by the following equation:



Since the addition of KF significantly increases the weight of the formulation while the amount of evolved NF₃ and F₂ remains the same, the yield of NF₃ and F₂ per pound of formulation is decreased. For NF₄BF₄ based formulations, the replacement of KF by the lighter alkali metal fluorides NaF or LiF would theoretically improve the obtainable NF₃-F₂ yield, but was found to be impractical due to the insufficient thermal stability of NaBF₄ and LiBF₄, resulting in incomplete clinkering of the BF₃.

The use of self-clinkering formulations based on (NF₄)₂TiF₆ has previously been proposed by Christie et al (U.S. Pat. No. 4,152,406) as means of increasing the theoretically obtainable NF₃-F₂ yield relative to that of the state of the art NF₄BF₄·1.2KF formulation. However, test firings of (NF₄)₂TiF₆ based formulations showed that the relatively high volatility of TiF₄ (boiling point of 284° C.) resulted in the deposition of TiF₄ throughout the whole gas generator system. To eliminate TiF₄ from the generated gas, KF had to be added to the (NF₄)₂TiF₆ based formulations. This necessary

KF addition lowered the theoretically obtainable NF₃-F₂ yield to a value of 39.5 weight % which is comparable to that of 38.5 weight % of the KF clinkered NF₄BF₄ system and thus eliminated most of the improvement offered by the use of (NF₄)₂TiF₆.

BRIEF SUMMARY AND OBJECTS OF THE INVENTION

The above described problem of obtaining an (NF₄)₂TiF₆ based formulation of significantly higher performance than that offered by the state of the art NF₄BF₄·1.2KF system is overcome by the present invention. We have found that, contrary to NF₄BF₄, (NF₄)₂TiF₆ forms thermally stable clinkers with the lighter alkali metal fluorides NaF and LiF and that less than stoichiometric amounts of these alkali metal fluorides are required for the formation of a stable clinker due to the ability of TiF₄ to form polytitanate anions. The improvements resulting from this concept are summarized in Table I.

TABLE I

Theoretical Yields of Usable Fluorine	
System	F Yield (Weight %)
NF ₄ BF ₄ ·1.2KF	38.7
(NF ₄) ₂ TiF ₆ ·2.4KF	39.5
(NF ₄) ₂ TiF ₆ ·2.4NaF	42.9
(NF ₄) ₂ TiF ₆ ·2.4LiF	47.0
(NF ₄) ₂ TiF ₆ ·1.2NaF	48.4
(NF ₄) ₂ TiF ₆ ·1.2LiF	50.9

Accordingly, it is an object of the present invention to provide high performing solid propellant NF₃-F₂ gas generator formulations based on (NF₄)₂TiF₆ and low molecular weight alkali metal fluorides.

This and other objects and features of the present invention will be apparent from the following examples. It is understood, however, that these examples are merely illustrative of the invention and should not be considered as limiting the invention in any sense.

DETAILED DESCRIPTION OF THE INVENTION

EXAMPLE 1

A formulation containing 81.44 weight % (NF₄)₂TiF₆, 14.71 weight % LiF and 3.83 weight % Al was fired in a typical gas generator. Smooth burning was observed. Disassembly of the generator after completion of the test showed that the desired clinker had formed in the combustion chamber with essentially no TiF₄ deposited in the coolant pack section of the generator. The clinker was shown by chemical analysis and vibrational spectroscopy to consist mainly of M₂TiF₆ where M is Li.

EXAMPLE 2

A formulation containing 85.2 weight % (NF₄)₂TiF₆, 3.8 weight % LiF, 8.5 weight % KF and 2.5 weight % Al was fired in a typical gas generator. Again essentially complete clinkering of the TiF₄ was observed and the clinker was shown by elemental and spectroscopic analysis to consist mainly of M₂Ti₂F₁₀ where M is Li and/or K.

EXAMPLE 3

A formulation containing 86.0 weight % (NF₄)₂TiF₆, 7.3 weight % NaF, 6.7 weight % KF and 2.5 weight % Al was fired in a typical gas generator. Again essentially

NF₃-F₂ GAS GENERATOR COMPOSITIONS

DEDICATORY CLAUSE

The invention described herein was made in the course of or under a contract or subcontract thereunder with the Government and may be manufactured, used, and licensed by or for the Government for governmental purposes without the payment to us of any royalties thereon.

BACKGROUND OF THE INVENTION

1. Field of the Invention

This invention relates to improved compositions for solid propellant NF₃-F₂ gas generators, useful, for example, in chemical HF-DF lasers.

2. Description of Prior Art

NF₄⁺ salts are the key ingredients for solid propellant NF₃-F₂ gas generators, as shown by D. Pilipovich in U.S. Pat. No. 3,963,542. These propellants consist of a highly over-oxidized grain using NF₄⁺ salts as the oxidizer. Burning these propellants with a small amount of fuel, such as aluminum powder, generates sufficient heat to thermally dissociate the bulk of the oxidizer. This is shown for NF₄BF₄ in the following equation:



As can be seen from the equation the gaseous combustion products contain the volatile Lewis acid BF₃. This disadvantage of a volatile Lewis acid byproduct is shared by most known NF₄⁺ compositions. These volatile Lewis acids possess a relatively high-molecular weight and a low γ value ($\gamma = C_p/C_w$), relative to the preferred diluent helium and frequently act as a deactivator for the chemical HF-DF laser. Consequently, these volatile Lewis acids must be removed from the generated gas prior to its use in an efficient chemical laser. Based on the state of the art, heretofore, this would be achieved by adding a clinker forming agent, such as KF, to the solid propellant formulation. The function of this additive served to convert the volatile Lewis acid, such as BF₃, to a non-volatile salt as shown by the following equation:



Since the addition of KF significantly increases the weight of the formulation while the amount of evolved NF₃ and F₂ remains the same, the yield of NF₃ and F₂ per pound of formulation is decreased. For NF₄BF₄ based formulations, the replacement of KF by the lighter alkali metal fluorides NaF or LiF would theoretically improve the obtainable NF₃-F₂ yield, but was found to be impractical due to the insufficient thermal stability of NaBF₄ and LiBF₄, resulting in incomplete clinkering of the BF₃.

The use of self-clinkering formulations based on (NF₄)₂TiF₆ has previously been proposed by Christie et al (U.S. Pat. No. 4,152,406) as means of increasing the theoretically obtainable NF₃-F₂ yield relative to that of the state of the art NF₄BF₄·1.2KF formulation. However, test firings of (NF₄)₂TiF₆ based formulations showed that the relatively high volatility of TiF₄ (boiling point of 284° C.) resulted in the deposition of TiF₄ throughout the whole gas generator system. To eliminate TiF₄ from the generated gas, KF had to be added to the (NF₄)₂TiF₆ based formulations. This necessary

KF addition lowered the theoretically obtainable NF₃-F₂ yield to a value of 39.5 weight % which is comparable to that of 38.5 weight % of the KF clinkered NF₄BF₄ system and thus eliminated most of the improvement offered by the use of (NF₄)₂TiF₆.

BRIEF SUMMARY AND OBJECTS OF THE INVENTION

The above described problem of obtaining an (NF₄)₂TiF₆ based formulation of significantly higher performance than that offered by the state of the art NF₄BF₄·1.2KF system is overcome by the present invention. We have found that, contrary to NF₄BF₄, (NF₄)₂TiF₆ forms thermally stable clinkers with the lighter alkali metal fluorides NaF and LiF and that less than stoichiometric amounts of these alkali metal fluorides are required for the formation of a stable clinker due to the ability of TiF₄ to form polytitanate anions. The improvements resulting from this concept are summarized in Table I.

TABLE I

Theoretical Yields of Usable Fluorine	
System	F Yield (Weight %)
NF ₄ BF ₄ ·1.2KF	38.7
(NF ₄) ₂ TiF ₆ ·2.4KF	39.5
(NF ₄) ₂ TiF ₆ ·2.4NaF	42.9
(NF ₄) ₂ TiF ₆ ·2.4LiF	47.0
(NF ₄) ₂ TiF ₆ ·1.2NaF	48.4
(NF ₄) ₂ TiF ₆ ·1.2LiF	50.9

Accordingly, it is an object of the present invention to provide high performing solid propellant NF₃-F₂ gas generator formulations based on (NF₄)₂TiF₆ and low molecular weight alkali metal fluorides.

This and other objects and features of the present invention will be apparent from the following examples. It is understood, however, that these examples are merely illustrative of the invention and should not be considered as limiting the invention in any sense.

DETAILED DESCRIPTION OF THE INVENTION

EXAMPLE 1

A formulation containing 81.44 weight % (NF₄)₂TiF₆, 14.71 weight % LiF and 3.83 weight % Al was fired in a typical gas generator. Smooth burning was observed. Disassembly of the generator after completion of the test showed that the desired clinker had formed in the combustion chamber with essentially no TiF₄ deposited in the coolant pack section of the generator. The clinker was shown by chemical analysis and vibrational spectroscopy to consist mainly of M₂TiF₆ where M is Li.

EXAMPLE 2

A formulation containing 85.2 weight % (NF₄)₂TiF₆, 3.8 weight % LiF, 8.5 weight % KF and 2.5 weight % Al was fired in a typical gas generator. Again essentially complete clinkering of the TiF₄ was observed and the clinker was shown by elemental and spectroscopic analysis to consist mainly of M₂Ti₂F₁₀ where M is Li and/or K.

EXAMPLE 3

A formulation containing 86.0 weight % (NF₄)₂TiF₆, 7.3 weight % NaF, 6.7 weight % KF and 2.5 weight % Al was fired in a typical gas generator. Again essentially

3

complete clinkering of the TiF_4 was observed and the clinker was shown by elemental and spectroscopic analyses to consist mainly of $M_2Ti_2F_{10}$ where M is Na and/or K.

Obviously, numerous variations and modifications may be made without departing from the present invention. Accordingly, it should be clearly understood that the forms of the present invention described above are illustrative only and are not intended to limit the scope of the present invention.

We claim:

1. Solid propellant NF_3-F_2 gas generator composition comprising $(NF_4)_2TiF_6$ with LiF as a clinker forming agent.

4

2. Solid propellant NF_3-F_2 gas generator compositions according to claim 1 wherein the mole ratio of LiF to $(NF_4)_2TiF_6$ is from 1 to 2.4.

3. Solid propellant NF_3-F_2 gas generator composition comprising $(NF_4)_2TiF_6$ with NaF as a clinker forming agent.

4. Solid propellant NF_3-F_2 gas generator compositions according to claim 3 wherein the mole ratio of NaF to $(NF_4)_2TiF_6$ is from 1 to 2.4.

5. Solid propellant NF_3-F_2 gas generator compositions comprising $(NF_4)_2TiF_6$ with mixtures of LiF with heavier alkali metal fluorides MF, where M is selected from Na and K, as a clinker forming agent.

6. Solid propellant NF_3-F_2 gas generator compositions according to claim 5 wherein the mole ratio of LiF and MF to $(NF_4)_2TiF_6$ is from 1 to 2.4.

20

25

30

35

40

45

50

55

60

65

United States Patent [19]

[11] 4,421,727

Wilson et al.

[45] Dec. 20, 1983

- [54] **NF_n + WF_n - AND NF_n + UF_n - AND METHODS OF PREPARATION**
- [75] Inventors: William W. Wilson, Simi Valley; Karl O. Christe, Calabasas, both of Calif.
- [73] Assignee: The United States of America as represented by the Secretary of the Navy, Washington, D.C.
- [21] Appl. No. 392,100
- [22] Filed Jun. 25, 1982
- [51] Int. Cl.³ C01G 43/00; C01G 41/00; C01B 21/083
- [52] U.S. Cl. 423/253; 423/19; 423/59; 423/351; 149/119
- [58] Field of Search 423/19, 59, 253, 351, 149/119

[56] References Cited

U.S. PATENT DOCUMENTS

3,039,846	6/1962	Ogle	423/253
3,383,183	5/1968	Grant	423/19
3,765,174	10/1973	MacLaren	149/119
3,794,716	2/1974	Ogle	423/253
4,003,771	1/1977	Lubowitz	149/119
4,169,132	9/1979	Neff et al.	423/351

4,207,124 6/1980 Christe 149/119

OTHER PUBLICATIONS

- Wilson et al., *J. Inorg. Nucl. Chem.*, 43, pp. 1551-1553 (1981).
- Wilson et al., *Inorg. Chem.*, 1981, (20), 4139-4143.
- Kigoshi, *Thermochimica Acta.*, 29 (1979), 147-155.
- Kunze et al., *J. Chem. Soc., Dalton Trans.*, 1978, (5), 443-440.
- George et al., *Chem. Abs.*, 90, Abs. #153359e (1979), p. 321.

Primary Examiner—Edward A. Miller
 Attorney, Agent, or Firm—R. F. Beers; K. E. Walden; R. D. Johnson

[57] ABSTRACT

Salts of the formula NH_n + MH_n - are produced by the following reaction

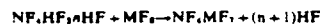

wherein M is uranium (U) or tungsten (W).

8 Claims, No Drawings

NF₄+WF₇- AND NF₄+UF₇- AND METHODS OF PREPARATION

BACKGROUND OF THE INVENTION

1. Field of the Invention

This invention relates to energetic inorganic salts and more particularly to salts containing the NF₄⁺ cation.

2. Description of the Prior Art

NF₄⁺ salts are key ingredients for solid propellant NF₃-F₂ gas generators, as shown by D. Pilipovich in U.S. Pat. No. 3,963,542, and for high detonation pressure explosives, as shown by K. O. Christe in U.S. Pat. No. 4,207,124. The synthesis of NF₄⁺ salts is unusually difficult because the parent molecule NF₃ does not exist and the salts must be prepared from NF₃ which amounts formally to a transfer of F⁺ to NF₃ accordingly to:

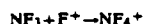

Since fluorine is the most electronegative of all elements, F⁺ cannot be generated by chemical means. This difficult synthetic problem was overcome by K. O. Christe and co-workers, as shown in U.S. Pat. No. 3,503,719. By the use of an activation energy source and a strong volatile Lewis acid, such as AsF₅, the conversion of NF₃ and F₂ to an NF₄⁺ salt became possible:

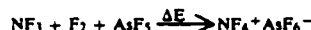

However, only few Lewis acids are known which possess sufficient strength and acidity to be effective in this reaction. Therefore, other indirect methods were needed which allowed conversion of the readily accessible NF₄⁺ salts into other new salts. Two such methods are presently known. The first one involves the displacement of a weaker Lewis acid by a stronger Lewis acid, as shown by K. O. Christe and C. J. Schack in U.S. Pat. No. 4,172,881 for the system:

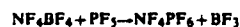

but obviously is again limited to strong Lewis acids. The second method is based on metathesis, i.e., taking advantages of the different solubilities of NF₄⁺ salts in solvents such as HF or BrF₃. For example, NF₄SbF₆ can be converted to NF₄BF₄ according to:

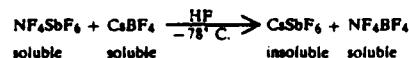

This method has successfully been applied by K. O. Christe and coworkers, as shown in U.S. Pat. Nos. 4,108,965; 4,152,406; and 4,172,884, to the syntheses of several new salts. However, this method is limited to salts which have the necessary solubilities and are stable in the required solvent. The limitations of the above two methods are quite obvious and preempted the syntheses of NF₄⁺ salts of anions which are either insoluble in those solvents or are derived from a Lewis acid weaker than the solvent itself and therefore are displaced from their salts by the solvent.

SUMMARY OF THE INVENTION

Accordingly an object of this invention is to provide methods which permit the syntheses of new NF₄⁺ salts containing anions derived from very weak Lewis acids.

Another object of this invention is to provide new energetic NF₄⁺ compositions which are useful in explosives and solid propellants.

A further object of this invention is to provide NF₄⁺ compositions for solid propellant NF₃-F₂ gas generators for chemical HF-DF lasers which deliver a maximum of NF₃ and F₂ while not producing any gases which deactivate the chemical laser.

Yet another object of this invention is to provide NF₄ fluorotungstates which on burning with tungsten powder can produce hot WF₆ gas in high yield.

These and other objects of this invention are achieved by providing:

Salts of the formula NF₄⁺MF₇⁻ by the following reaction



wherein M is uranium (U) or tungsten (W). These salts are useful as ingredients in solid propellants and in high detonation pressure explosives.

A method of generating hot WF₆ gas by burning a mixture of NF₄WF₇ and tungsten metal.

DETAILED DESCRIPTION OF THE PREFERRED EMBODIMENT

Surprisingly, it has now been found that the salts NF₄UF₇ and NF₄WF₇ can be prepared from the very weak and volatile Lewis acids UF₆ and WF₆. The salts are prepared by the following methods.

First, readily available NF₄SbF₆ salt is converted by metathesis into NF₄HF₂ according to the reaction

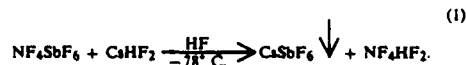

The details of this procedure are disclosed by K. O. Christe, W. W. Wilson, and R. D. Wilson in Inorg. Chem., 19, pp. 1494+(1980), herein incorporated by reference. A method of preparing NF₄SbF₆ is disclosed by K. O. Christe, C. J. Schack, and R. D. Wilson, J. Fluorine Chem., 8, pp. 541+(1976), herein incorporated by reference.

The NF₄HF₂ produced by the above procedure will be complexed with HF and can be represented by the formula NF₄HF₂·nHF. Because HF is a stronger Lewis acid than either UF₆ or WF₆, as much HF as possible has to be removed from the NF₄HF₂ without decomposing the NF₄HF₂. This can be achieved by judicious pumping at about 0° C. This is continued until a solid having the composition NF₄HF₂·nHF wherein n is from about 0.5 to about 10.0 is obtained.

NF₄UF₇ and NF₄WF₇ are produced by the following reactions:

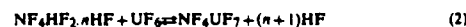

These reactions may be run at ambient (25° C.) temperature. Repeated treatments of NF₄HF₂·nHF with a large excess of UF₆ or WF₆, followed by the removal of the

3

volatile products at ambient temperatures, surprisingly shifted the equilibrium in reaction (2) and the equilibrium in reaction (3) quantitatively to the right. This is probably due to the thermal stability of NF_4UF_7 and of NF_4WF_7 being significantly higher than that of NF_4HF_2 .

The addition of UF_6 or WF_6 and subsequent evacuation of volatile reaction products is continued until the conversion of $NF_4HF_2 \cdot nHF$ to NF_4UF_7 or NF_4WF_7 is substantially completed. This will be the point at which no significant amount of UF_6 or WF_6 is taken up and no significant amount of volatile reaction products (e.g., HF gas) is generated. Thus, by monitoring the gases evacuated from the reaction chamber, the progress of the reaction may be monitored.

Examples 1 and 2 further illustrate these procedures. NF_4UF_7 and NF_4WF_7 are useful as key ingredients for solid propellant NF_3-F_2 gas generators and for high detonation pressure explosives.

NF_4WF_7 is of particular interest as an ingredient for hot WF_6 gas generators. Hot WF_6 is an excellent electron capturing agent and therefore useful for reducing radar signatures. For example, formulations based on



can theoretically produce up to 97 weight percent of WF_6 with flame temperatures in excess of 2000° C. A pyrotechnic mixture of finely powdered NF_4WF_7 and tungsten in approximately a 6:5 molar ratio may be used.

The general nature of the invention having been set forth, the following examples are presented as specific illustrations thereof. It will be understood that the invention is not limited to these examples but is susceptible to various modifications that will be recognized by one of ordinary skill in the art.

EXAMPLE 1

Preparation of NF_4WF_7

Dry CsF (15.0 mmol) and NF_4SbF_6 (15.0 mmol) were loaded in the drybox into one half of a prepassivated Teflon double U-metathesis apparatus. Dry HF (15 ml liquid) was added on the vacuum line and the mixture was stirred with a Teflon coated magnetic stirring bar for 15 minutes at 25° C. After cooling the apparatus to -78° C., it was inverted and the NF_4HF_2 solution was filtered into the other half of the apparatus. Tungsten hexafluoride (22.5 mmol) was condensed at -196° C. onto the NF_4HF_2 . The mixture was warmed to ambient temperature, and two immiscible liquid phases were observed. After vigorous stirring for 30 minutes at 25° C., the lower WF_6 layer dissolved in the upper HF phase. Most of the volatile products were pumped off at ambient temperature until the onset of NF_4HF_2 decomposition became noticeable (NF_3 evolution). An additional 8.0 mmol of WF_6 was added at -196° C. to the residue. When the mixture was warmed to ambient temperature, a white solid product appeared in the form of a slurry. All material volatile at -31° C. was pumped off for 1 hour and consisted of HF and some NF_3 . An additional 14.5 mmol of WF_6 was added to the residue and the resulting mixture was kept at 25° C. for 14 hours. All material volatile at -13° C. was pumped off for 2 hours and consisted of HF and WF_6 . The residue was kept at 22° C. for 2.5 days and pumping was resumed at -13° C. for 2.5 hours and at 22° C. for 4 hours. The volatiles collected at -210° C., consisted of some HF and small amounts of NF_3 and WF_6 . The white

4

solid residue (5.138 g, 84% yield) was shown by vibrational and ^{19}F NMR spectroscopy to consist mainly of NF_4WF_7 with small amounts of SbF_6^- as the only detectable impurity. Based on its elemental analysis, the product had the following composition (weight %):

NF_4WF_7 , 98.39; $CsSbF_6$, 1.61. Anal. Calcd: NF_3 , 17.17; W, 44.46; Cs, 0.58; Sb, 0.53. Found: NF_3 , 17.13; W, 44.49; Cs, 0.54; Sb, 0.55.

EXAMPLE 2

Preparation of NF_4UF_7

A solution of NF_4HF_2 in anhydrous HF was prepared from CsF (14.12 mmol) and NF_4SbF_6 (14.19 mmol) in the same manner as described for example 1 (NF_4WF_7). Most of the HF solvent was pumped off on warm up from -78° C. towards ambient temperature, until the onset of NF_4HF_2 decomposition became noticeable. Uranium hexafluoride (14.59 mmol) was condensed at -196° C. into the reactor, and the mixture was stirred at 25° C. for 20 hours. The material volatile at 25° was briefly pumped off and separated by fractional condensation through traps kept at -78°, -126° and -210° C. It consisted of HF (6.3 mmol), UF_6 (9.58 mmol) and a trace of NF_3 . Since the NF_4HF_2 solution had taken up only about one third of the stoichiometric amount of UF_6 , the recovered UF_6 was condensed back into the reactor. The mixture was stirred at 25° C. for 12 hours and the volatile material was pumped off again and separated. It consisted of HF (12.8 mmol), UF_6 (1.7 mmol) and a trace of NF_3 . Continued pumping resulted in the evolution of only a small amount of UF_6 , but no NF_3 or HF, thus indicating the absence of any unreacted NF_4HF_2 . The pale yellow solid residue (5.711 g, 88% yield) was shown by vibrational and ^{19}F NMR spectroscopy and elemental analysis to have the following composition (weight %): NF_4UF_7 , 97.47; NF_4SbF_6 , 1.50; $CsSbF_6$, 1.03. Anal. Calcd: NF_3 , 15.34; U, 50.32; Sb, 0.90; Cs, 0.37. Found: NF_3 , 15.31; U, 50.2; Sb, 0.90; Cs, 0.37.

Obviously, numerous modifications and variations of the present invention are possible in light of the above teachings. It is therefore to be understood that within the scope of the appended claims the invention may be practiced otherwise than as specifically described herein.

What is claimed as new and desired to be secured by Letters Patent of the United States is:

1. NF_4UF_7 .
2. NF_4WF_7 .
3. A process or preparing NF_4UF_7 comprising the following steps in order:
 - (1) placing $NF_4HF_2 \cdot nHF$ into a reaction vessel.
 - (2) adding an excess of UF_6 to the reaction vessel.
 - (3) allowing the UF_6 to react with the $NF_4HF_2 \cdot nHF$.
 - (4) pumping off the volatile products of the reaction, and
 - (5) repeating steps (2) through (4) until the $NF_4HF_2 \cdot nHF$ is substantially converted to NF_4UF_7 .
4. The process of claim 3 wherein n is from about 0.5 to about 10.0.
5. The process of claim 3 wherein steps (2), (3), and (4) are performed at ambient temperature.
6. A process for preparing NF_4WF_7 comprising the following steps in order:
 - (1) placing $NF_4HF_2 \cdot nHF$ into a reaction vessel;
 - (2) adding an excess of WF_6 to the reaction vessel;

5

6

- (3) allowing the WF_6 to react with the $NF_4HF_2 \cdot nHF$;
- (4) pumping off the volatile products of the reaction;
and
- (5) repeating steps (2) through (4) until the

$NF_4HF_2 \cdot nHF$ is substantially converted to NF_4WF_7 .

7. The process of claim 6 wherein n is from about 0.5 to about 10.0.

5 8. The process of claim 6 wherein steps (2), (3), and (4) are performed at ambient temperature.
* * * * *

10

15

20

25

30

35

40

45

50

55

60

65

United States Patent [19][11] **4,423,260****Christe et al.**[45] **Dec. 27, 1983**[54] **METHOD FOR INTRODUCING FLUORINE INTO AN AROMATIC RING**[75] **Inventors:** Karl O. Christe, Calabasas; Carl J. Schack, Chatsworth, both of Calif.[73] **Assignee:** The United States of America as represented by the Secretary of the Air Force, Washington, D.C.[21] **Appl. No.:** 343,033[22] **Filed:** Jan. 27, 1982[51] **Int. Cl.³** C07C 17/12[52] **U.S. Cl.** 570/147; 568/937;
568/938[58] **Field of Search** 570/147; 568/937, 938

[56]

References Cited**U.S. PATENT DOCUMENTS**

2,488,216	11/1949	McBee et al.	260/651
2,568,660	9/1951	Rosen	260/653
2,993,937	7/1961	Paolath	570/147
4,075,252	2/1978	Boudakian	260/649

Primary Examiner—Anton H. Sutto*Assistant Examiner*—Joseph A. Boska*Attorney, Agent, or Firm*—Donald J. Singer; William J. O'Brien

[57]

ABSTRACT

A process for introducing a fluorine atom into an aromatic hydrocarbon by effecting a substitution reaction between an aromatic hydrocarbon and an NF_4^+ cation containing salt.

3 Claims, No Drawings

METHOD FOR INTRODUCING FLUORINE INTO AN AROMATIC RING

STATEMENT OF GOVERNMENT INTEREST

The invention described herein may be manufactured and used by or for the Government for governmental purposes without the payment of any royalty thereon.

FIELD OF THE INVENTION

This invention relates to fluorocarbons and to a novel method for their synthesis. In a more particular aspect, this invention concerns itself with a novel method for introducing a fluorine atom into an aromatic ring.

Aromatic fluorocarbons are a well known class of chemical compounds that find wide utility for a variety of industrial applications and in the fabrication of various commercial products. They are useful as solvents, electrical fluids, heat transfer fluids and as components in the manufacture of resins, waxes, greases and oils. However, presently known methods for synthesizing such compounds by introducing a fluorine atom into an aromatic ring structure are severely limited.

The classic Balz-Schiemann reaction, for example, and methods such as the decarboxylation of fluoroformates are useful for the introduction of a single fluorine atom, but are generally less useful for multiple fluorine substitution. The use of elemental fluorine or electrochemical fluorination methods result mainly in addition and not in substitution. Halogen fluorides, such as ClF_3 , BrF_3 , or IF_3 , produce, in addition to fluorine substituted compounds, large amounts of the corresponding halogen substituted compounds and also some addition products. The yield of substitution products obtainable with halogen fluorides can be improved by the use of strong Lewis acids. However, the extreme reactivity of the resulting compounds, such as $\text{ClF}_2^+\text{BF}_4^-$ or $\text{ClF}_2^+\text{SbF}_6^-$, makes control of their reactions with organic compounds extremely difficult and unsafe. The utilization of transition metal fluorides, such as CoF_3 or CeF_4 results in addition and saturation, requiring subsequent rearomatization. Therefore, this method is limited to highly or perhalogenated aromatics. Pyrolysis of aliphatic fluorocarbons, such as CFBr_3 , can also produce fluoroaromatics. However, this method is limited again to the synthesis of perfluorinated aromatics. Halogen exchange reactions, such as Cl versus F, using HF, alkali metal or metal fluorides are useful, but are restricted to systems strongly activated towards nucleophilic attack by fluoride ion. Hypofluorites, such as CF_3OF , are useful for electrophilic and photolytic fluorinations. The electrophilic fluorinations are limited again to activated aromatics, whereas the free radical photolytic fluorinations often lack selectivity resulting in $-\text{OCF}_3$ substituted by-products and side chain fluorination. The xenon fluorides and especially XeF_2 are promising reagents for electrophilic aromatic substitution, but the full extent of their usefulness is still unknown. The limited availability of xenon, its high price, and the treacherous explosiveness of their hydrolysis product, XeO_3 , are drawbacks curtailing its extensive use.

The above listing of some of the known methods of preparing aromatic fluorine compounds, although not extensive, clearly illustrates the problems prevalent in this area of technology and points out the need for a reliable, readily available and economically feasible reagent for accomplishing the electrophilic fluorine

substitution of aromatic ring compounds. Therefore, a research effort was undertaken in an attempt to satisfy the need for a generally usable reagent.

In theory, the ideal reagent for electrophilic substitution would be a salt containing the F^+ cation. Unfortunately, such salts do not exist. As an alternative, salts containing complex fluoro cations of the type $\text{XF}_{(n+1)}^+$ could be used. However, to be a strong electrophile, such a cation should possess high electronegativity. Since highly electronegative fluorine compounds generally are very strong oxidizers, most of these cations react too violently with organic compounds to be of practical interest. As a consequence, the research effort referred to above proved to be unsuccessful. Additional research, however, proved to be fruitful and culminated in the discovery that the NF_4^+ cation constitutes an exception to the general rule that such cations react too violently with organic compounds. As a result of the present invention, therefore, it was found that aromatic ring compounds, such as benzene, toluene, and nitrobenzene, interact rapidly with NF_4BF_4 in anhydrous HF to give, almost exclusively, fluorine substituted aromatic derivatives.

SUMMARY OF THE INVENTION

The present invention concerns itself with a method for introducing fluorine into an aromatic ring structure by using NF_4BF_4 as a reaction reagent. The introduction is accomplished by an electrophilic substitution reaction in which up to five hydrogen atoms in the aromatic ring can be substituted by fluorine atoms. The reaction can be carried out by either adding the aromatic compound, such as benzene in vapor form, to a cooled solution of NF_4BF_4 in HF or, alternatively, by adding slowly a solution of NF_4BF_4 to a solution of benzene in HF.

Accordingly, the primary object of this invention is to provide a novel method for introducing a fluorine atom into an aromatic ring structure.

Another object of this invention is to provide a method for substituting fluorine atoms for the hydrogen atoms in an aromatic ring structure.

Still another object of this invention is to provide for the synthesis of fluorine containing aromatic ring compounds by effecting a reaction between a non-fluorine containing aromatic compound and salts containing an NF_4^+ cation.

A further object of this invention is to provide a method for introducing a fluorine atom into an aromatic ring by using NF_4BF_4 as a reaction reagent in the electrophilic substitution of a fluorine atom for a hydrogen atom in an aromatic ring structure.

The above and still further objects and advantages of the present invention will become more readily apparent upon consideration of the following detailed description thereof.

DETAILED DESCRIPTION OF THE PREFERRED EMBODIMENT

Pursuant to above-defined objects, the present invention concerns itself with a novel method for introducing fluorine atoms into an aromatic ring compound through the electrophilic substitution of a hydrogen atom by a fluorine atom. The known methods for introducing fluorine into an aromatic ring are quite limited and are often not generally applicable. A widely applicable reagent for carrying out electrophilic substitution reac-

tions on aromatic ring systems, therefore, would be highly desirable. As a result, a concentrated research effort was undertaken based on the hypothesis that the use of NF_4^+ ion containing salts in this regard would be promising. A continued investigation of aromatic hydrocarbon reactions with NF_4^+ ion containing species confirmed the hypothesis. It was found that a reaction between an aromatic hydrocarbon ring compound, such as benzene, toluene or nitrobenzene with an NF_4^+ salt accomplished the substitution of up to five hydrogen atoms in the aromatic ring by fluorine atoms.

Hydrogen fluoride was used as a solvent because of the high solubility of NF_4^+ salts in it and also because the diluent and heat dissipation properties of a solvated system were found to be beneficial in the anticipated vigorous fluorination. As stated hereinbefore, the reaction was carried out by either adding benzene vapor to a cooled solution of NF_4BF_4 in HF or by adding slowly a solution of NF_4BF_4 to a solution of benzene in HF. On contact gas evolution was noted. When rapid addition occurred some apparent charring occurred. The step-wise substitution of H by F was observed according to the following general equation:



The evolved gas was removed under vacuum and trapped at $-196^\circ C$. It was found to be NF_3 and the amount corresponded to that expected on the basis of one mole of NF_3 per mole of NF_4BF_4 . Hexafluorobenzene was not observed although all other substitution products from mono-to-penta-fluorobenzene were obtained. Almost no saturated or partially saturated fluorocarbons were produced which makes this process of special interest in generating aromatic fluorocarbons directly from their hydrocarbon analogues.

The benzene, toluene, and nitrobenzene reactants interacted rapidly with NF_4BF_4 in anhydrous HF to give, almost exclusively, fluorine substituted aromatic derivatives. With benzene, up to five hydrogens were replaced, while a maximum of four hydrogens were displaced in $C_6H_5CH_3$ and $C_6H_5NO_2$. The direction of the substitution in $C_6H_5CH_3$ and $C_6H_5NO_2$ and the lack of side chain fluorination in $C_6H_5CH_3$ support an electrophilic substitution mechanism when using NF_4BF_4 as a reactant. Although highly electronegative fluorine compounds generally are very strong oxidizers, most cations react too violently with organic compounds to be of practical interest. The NF_4^+ cation, however, was found to be an exception. It combines high electronegativity (oxidation state of +V) with high kinetic stability (it is isoelectronic with CF_4), and its reactions require significant activation energies. Furthermore, NF_4^+ salts, such as NF_4BF_4 , offer the advantage of generating in an electrophilic aromatic substitution reaction only by-products, such as NF_3 and BF_3 , which are unreactive toward the organic compounds. In view of these properties and its ready availability, NF_4BF_4 was found to be an ideal candidate for electrophilic aromatic substitution reactions. A vigorous ring hydrogen substitution occurred even at $-78^\circ C$. in HF solution.

In carrying out the reactions of this invention, the nonvolatile materials were manipulated in a well-passivated (with ClF_3) stainless steel vacuum line equipped with Teflon FEP U traps, 316 stainless steel bellows seal valves and a Heise Bourdon tube-type pressure gauge.

Hydrogen fluoride work was carried out in an all Monel and Teflon vacuum system. Transfers outside the vacuum line were carried out in a drybox. Infrared spectra were obtained using 5 cm path stainless steel cells with $AgCl$ windows and a PE Model 283 spectrophotometer. Mass spectra were measured with an EA1 Quad 300 quadrupole spectrometer and ^{19}F and 1H nmr spectra were determined with a Varian EH390 spectrometer operating at 84.6 and 90 MHz, using $CFCl_3$ or TMS as internal standards, respectively. Positive chemical shifts are upfield from $CFCl_3$ and downfield from TMS. Raman spectra were recorded on a Cary Model 83 using the 4800 A exciting line. Gas chromatographic data were obtained using a Varian Aerograph GC with a thermal conductivity detector under isothermal conditions (135°) with a stainless steel column ($1/8 \times 10'$) packed with Poropak PS. For the GC determination of the quantitative composition of mixtures, uncorrected peak areas were used since response factors were not available for all compounds. The solid NF_4BF_4 was prepared from $NF_3-F_2-BF_3$ at low temperature using UV activation, which gives analytically pure material.

The simplest aromatic hydrocarbon studied in the previously referred to research effort was benzene. With NF_4^+ substrate mole ratios of about three, up to five hydrogens were substituted by F as shown in the following generalized equation.

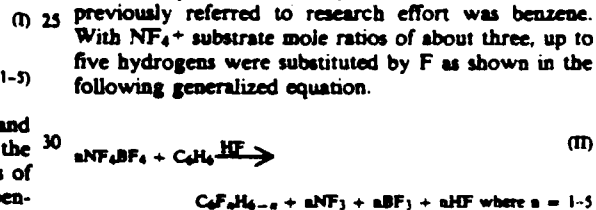

However, at these higher NF_4^+ to substrate ratios, the reaction was more difficult to control and more "char" formation was noted. Hexafluorobenzene was not observed as a product. If significant amounts had been formed, it would have easily been detected by mass spectroscopy since its base peak is the parent ion. Only trace quantities of partially saturated species, $C_6F_6H_2$ and C_6F_7H were observed, indicating that very little addition occurred.

In order to determine the nature of the reaction, two substituted benzenes, $C_6H_5CH_3$ and $C_6H_5NO_2$ were also studied. These were chosen for their well known ability to differentiate between an electrophilic and a free radical reaction path, based on the observed ortho-meta-para product distribution.

In the toluene reaction, the ratio of NF_4^+ to toluene was in the range 2-4:1. Thus, an excess of fluorine was available (assuming one F/ NF_4^+ is available for substitution) and multisubstitution was expected. The result of a very rapid reaction is illustrated by the following equation:

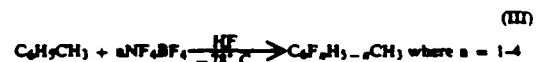

The mass spectra of the products strongly indicate that no side chain fluorination had occurred, in agreement with other spectroscopic evidence. Typical isomer distributions for the ring substitution were: o-F(15), m-F(8), p-F(15), 2,4 di-F(30), and mixed di- and tri-F(25). Obviously, o- and p- products predominate for this electron rich ring, a result which is compatible with an electrophilic substitution process.

For the nitrobenzene reaction, a 3:10 mole ratio of NF_4BF_4 : substrate was used. Even under these conditions, this reaction was less vigorous than those of benzene or toluene, as exemplified by a slightly slower NF_3 evolution and the lack of "darkening" of the solution until the mixture was finally warmed to about 0° . Fluorine substitution occurred to give $\text{C}_6\text{F}_n\text{H}_{6-n}\text{NO}_2$ (where $n=1-4$) compounds. Minor amounts of $\text{FNO}_2(\text{HF})_n$ were formed and traces of $\text{C}_6\text{F}_n\text{H}_{6-n}$ species were observed, but overwhelmingly the NO_2 group was not displaced. The observed products were mainly monosubstituted with the following isomer distribution: o-F(16), m-F(62), and p-F(7).

The observation of predominantly ortho and para substitution and the lack of side chain fluorination in toluene, and the meta substitution in nitrobenzene establishes these NF_4BF_4 reactions as electrophilic substitutions.

For nitrobenzene, the yield of fluorinated products was not determined due to separation problems caused by the low volatility of the products and the large excess of nitrobenzene used. However, in view of the high relative amount of mono-F species, and the limited amount of charring, it is estimated that the yield of substituted products was high. For the much more reactive C_6H_6 and $\text{C}_6\text{H}_5\text{CH}_3$, yields varied widely. Volatile, fluorinated species were observed equivalent to 30-60% of the aromatic starting compounds.

The following examples are presented in order to point out the invention with greater detail. The examples, however, are illustrative only and are not to be construed as limiting the invention in any way.

EXAMPLE I

$\text{C}_6\text{H}_5\text{NO}_2$. To a stirred solution of $\text{C}_6\text{H}_5\text{NO}_2$ (10 mmol) in 5 ml HF at -78° was added dropwise over 30 min. a solution of NF_4BF_4 (2.88 mmol) in 5 ml HF. Reaction of the NF_4BF_4 was shown by an increase in pressure due to NF_3 evolution. When all the NF_4BF_4 had been added, the reaction was gradually warmed to 0° C. and left overnight. During the warming, the reaction solution changed from pale yellow to dark brown. Keeping the reaction ampoule at -45° , the NF_3 , HF, and other volatile materials were pumped away through -78° C. and -196° C. traps. After the majority of the HF was removed, the reactor was maintained at 0° C. The material passing the -78° C. fraction consisted of a few droplets of a liquid with a low vapor pressure at ambient temperature. Mass spectroscopy of the vapor from the drops showed minor amounts of aromatic fluorocarbons which did not contain NO_2 substituents. These were of the empirical formula $\text{C}_6\text{F}_n\text{H}_{6-n}$, ($n=1-4$). The principal ion peaks observed were m/e (assign): 85($\text{NO}_2\text{F}\cdot\text{HF}$), 49 (NOF), and 30(NO). Examination of the liquid non-volatiles at 0° C. which remained in the reactor, by NMR spectroscopy, showed that five fluorinated compounds were present and all were found to be substituted nitrobenzenes by comparison of the observed chemical shifts with reported values. By measurement of the area of the resonances the amount of each compound was calculated: o- $\text{C}_6\text{FH}_4\text{NO}_2$ (14%), m- $\text{C}_6\text{FH}_4\text{NO}_2$ (62%), p- $\text{C}_6\text{FH}_4\text{NO}_2$ (6%), 2,6-or 3,5-difluoronitrobenzene (14%), and 2,4-difluoronitrobenzene. The large excess of $\text{C}_6\text{H}_5\text{NO}_2$ employed, and still present, masked the ^1H spectra of these products and thus the ^{19}F spectra were relied on for identification.

EXAMPLE II

$\text{C}_6\text{H}_5\text{CH}_3$. Toluene and NF_4BF_4 (1:4 molar ratio) were reacted by condensing the hydrocarbon onto the stirred HF solution of the salt at -78° C. Alternatively, toluene in HF at -78° C. was treated dropwise with a solution of NF_4BF_4 (1:2 molar ratio). In either case, instantaneous reaction occurred and the solution became black. After warming to 0° C. for a few hours, these reactions were worked up in the usual manner. Much tar like residue remained in the reactor in each case. Infrared spectroscopic examination of the volatile species, trapped at -78° C., showed strong bands near 1500 cm^{-1} confirming the presence of aromatic species. Mass spectra of these fractions showed in both experiments that only aromatic substitution products were present; these were of the empirical formula $\text{C}_7\text{F}_n\text{H}_{8-n}$ (where $n=1-4$). The low intensity of the m/e 69 and 51 peaks indicated the absence of CF_3 or CF_2H groups in these compounds with the observed intensities of these peaks being due to C_6FH_2 and C_6H_3 ions. From the reaction using a higher ratio of NF_4BF_4 to toluene, a significant amount of $\text{C}_6\text{F}_4\text{H}_2$ was found indicating some displacement of CH_3 from the ring. The NMR spectra of these products confirmed that various fluorotoluenes were present approximately in the amounts given (%): o- $\text{C}_6\text{FH}_4\text{CH}_3$ (15), p- $\text{C}_6\text{FH}_4\text{CH}_3$ (16), m- $\text{C}_6\text{FH}_4\text{CH}_3$ (8), 2,4-difluorotoluene (30), other di- and tri-fluorotoluenes (25), and 2,4,5,6-tetra-fluorotoluene(7).

EXAMPLE III

C_6H_6 . Benzene and NF_4BF_4 were reacted using the same two techniques described for toluene. It was not possible to prevent charring and blackening of the benzene. Nevertheless, isolation of the volatile products condensable at -78° C. and examination of their mass spectra showed that substantial substitution of H by F had occurred, resulting in the formation of $\text{C}_6\text{F}_n\text{H}_{6-n}$ ($n=1-5$). C_6F_6 was not observed and only minor amounts of the addition products $\text{C}_6\text{F}_6\text{H}_2$ and $\text{C}_6\text{F}_7\text{H}$ were observed.

In consideration of the aforementioned detailed description, it is obvious that the present invention provides a novel method for substituting fluorine atoms for hydrogen atoms in an aromatic ring structure without affecting saturated or oxidized substituents. The results of this invention clearly demonstrates the utilization of NF_4^+ ion containing salts as powerful reagents for the introduction of fluorine atoms into aromatic rings by electrophilic substitution. Up to five hydrogens can be substituted in aromatic systems by a rapid substitution reaction, found to be highly efficient and relatively safe, before a much slower addition reaction takes over.

This slower fluorine addition reaction was also studied and found to produce the corresponding cyclo-hexadienes and hexenes. The addition reactions are novel and offer a controlled, high yield path to dienes which have previously only been obtained as parts of complex mixtures.

To obtain more data on the reactions of aromatics with NF_4^+ salts, an examination of aromatic systems, which were already highly fluorinated, was carried out. It was found that these starting materials are more inert toward the strongly fluorinating NF_4BF_4 , thus allowing better control of the reaction. Experiments were carried out using tetra-, penta-, and hexafluorobenzene as starting materials. All reacted gradually at, or near, ambient

temperature. All solutions and products were colorless throughout the reactions. Liberated NF_3 and excess, unreacted NF_4BF_4 were recoverable. The products were identified spectroscopically and most of them have been reported in the literature, making their identification unequivocal. The overall results are shown by the equations.

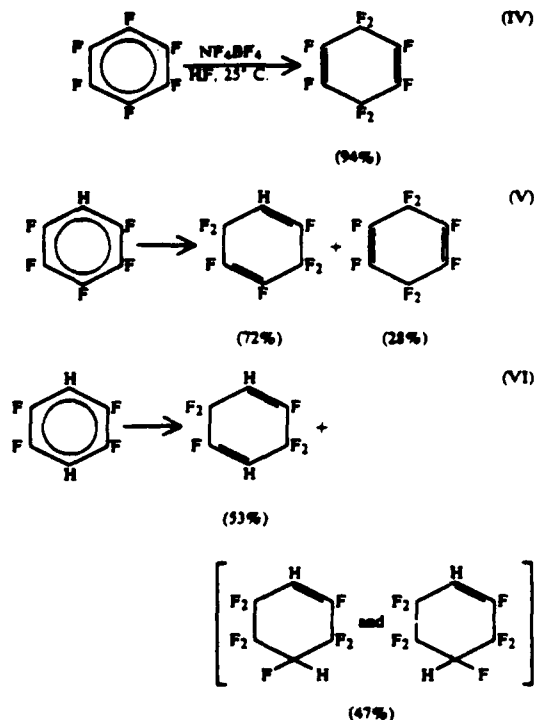

For these three highly fluorinated benzenes, the addition of the first two fluorines occurs in para position to each other (1,4 addition) and ortho to any hydrogen, if present. The addition of a second pair of fluorines cannot proceed by a 1,4 mechanism without changing the ring into a bicyclo form, which is generally encountered only under photolytic conditions. Thus, the second pair of fluorines undergoes a 1,2 addition to yield a cyclohexene.

For pentafluorobenzene, some substitution was also observed. It is not clear whether this is the result of a true substitution or of an addition-elimination reaction. In the case of $p\text{-C}_6\text{F}_4\text{H}_2$, the second F_2 addition produces the 1H,4H-octafluorocyclohexene which has two possible geometric isomers. Trace quantities of the saturated product, $\text{C}_6\text{F}_{10}\text{H}_2$, were also detected by mass spectroscopy.

In order to provide greater detail in connection with the addition reactions referred to above, Examples IV, V and VI are presented. In these addition reactions, almost no hydrogen substitutions occurred. The addition of the first pair of fluorine atoms always gave 1,4-cyclohexadiene in which the CF_2 group was ortho to hydrogen on the ring. The addition of the second pair of fluorine atoms results in the formation of cyclohexenes. These reactions occurred in high yield. All products were characterized spectroscopically and by comparison to literature data.

EXAMPLE IV

C_6F_6 . A sample of NF_4BF_4 (4.07 mmol) contained in a Teflon (FEP) ampoule was dissolved in anhydrous HF (4 ml) and cooled to -78°C . Hexafluorobenzene (1.25 mmol) was condensed into the ampoule which was then warmed gradually while stirring magnetically. After being kept overnight at $0^\circ\text{--}10^\circ\text{C}$, the clear, colorless solution was cooled to -78°C and the volatile material quickly removed by condensation into a -196°C trap. The -196°C trap contained NF_3 (1.24 mmol) contaminated with traces of HF as shown by infrared spectroscopy. The reaction was allowed to continue for another day at room temperature. While maintaining the reaction ampoule at 0°C , the volatile products and HF were separated by fractional condensation in a series of U-traps cooled at -45° , -78° , and -196°C . The -196°C fraction, NF_3 and HF, was discarded and the -45°C trap was empty. The -78°C trap contained a white solid, which melted to a colorless liquid above 0°C . Examination of this material by infrared and gas chromatography showed it to be 1,4-perfluorocyclohexadiene (1.18 mmol, 94.3% yield, based on C_6F_6) with a slight amount (2-3%) of unreacted C_6F_6 . Intense ions in the mass spectrum were observed at m/e (assign.): 224(C_6F_8), 205 (C_6F_7), 186(C_6F_6), 174(C_5F_6), 155 (C_5F_5 , base), 136(C_5F_4), 124(C_4F_4), 117(C_5F_3), 105(C_4F_3), 93(C_3F_3), 86(C_4F_2), 74(C_3F_2), 69(CF_3), 55 (C_3F), and 31(CF). The ^{19}F NMR spectrum showed two equal area multiplets at 113.1 and 158.3 ppm in agreement with the literature for 1,4- C_6F_8 . A white solid remained in the reaction ampoule and was shown by Raman spectroscopy to be NF_4BF_4 (1.48 mmol).

EXAMPLE V

$\text{C}_6\text{F}_5\text{H}$. As before, a mixture of NF_4BF_4 (4.29 mmol) and $\text{C}_6\text{F}_5\text{H}$ (1.35 mmol) in HF was stirred and warmed during several hours from -78°C toward ambient temperature where it was kept for 12 hours. Evolved NF_3 (3.3 mmol) was monitored. After several more hours of stirring at room temperature, the products were separated by vacuum fractionation through U-traps cooled at -45° , -78° , and -196°C . All material passed the -45° trap except for a small amount of NF_4BF_4 remaining in the reactor. The -196°C fraction was discarded. The -78°C trap contained 1.24 mmol of a colorless liquid whose infrared spectrum indicated that it was composed of more than one cyclohexene [1170(ms), 1740(s), and 1720 cm^{-1} (vs)], as well as unreacted $\text{C}_6\text{F}_5\text{H}$. Gas chromatography showed three components which were analyzed individually by mass spectroscopy. In order of elution they were; (1) 1,4- C_6F_8 , 26.1%, (2) 1H-heptafluorocyclohexa-1,4-diene, 66.3%, and (3) $\text{C}_6\text{F}_5\text{H}$, 7.6% with the composition based on GC peak areas. The mass spectra of the fractions agreed very well with published data for the assigned compounds. In addition, the ^{19}F NMR spectra confirmed the formulated structures. For 1-H heptafluorocyclohexa-1,4-diene, a literature report of the NMR spectrum could not be found, but by comparison with related compounds it was apparent that the observed resonances and area ratios were reasonable for that structure. Chemical shifts of H or F, ppm or δ (rel. F peak area): 1-H, 5.93; 2-F, 127.7(1); 3-F, 115.2(2); 4-F, 160(1); 5-F, 155(1), 6-F, 101.7(2). The conversion of the $\text{C}_6\text{F}_5\text{H}$ was 92%. The composition of the product was 28% 1,4- C_6F_8 and 72% 1,4- $\text{C}_6\text{F}_7\text{H}$, with a total of 91% of the organic material being recovered.

EXAMPLE VI

$p\text{-C}_6\text{F}_4\text{H}_2$. A mixture of NF_4BF_4 (4.18 mmol) and $p\text{-C}_6\text{F}_4\text{H}_2$ (1.43 mmol) in 4 ml HF at -78°C . was stirred and warmed to 0°C . over 3 hours, followed by overnight stirring at $0^\circ\text{--}20^\circ\text{C}$. Fractional condensation at -78°C . and -196°C . was used to separate HF and NF_2 from the products which were retained in the -78°C . trap. No unreacted NF_4BF_4 remained in the reactor. The original -78°C . fraction was further separated by refractionating through -45° and -78°C . traps. The former contained 0.21 mmol of a colorless liquid whose infrared spectrum showed a strong band at 1710 cm^{-1} typical for the double bond of a --CF=CH-- group. Analysis using GC/MS procedures showed this material to be 1H, 4H-hexafluorocyclohexa-1,4-diene. Prominent mass spectral peaks were found at m/e (assign.): 188($\text{C}_6\text{F}_8\text{H}_2$), 169($\text{C}_6\text{F}_5\text{H}_2$), 150($\text{C}_6\text{F}_4\text{H}_2$), 138($\text{C}_5\text{F}_4\text{H}_2$), 137($\text{C}_5\text{F}_4\text{H}$), 119($\text{C}_5\text{F}_3\text{H}_2$, base), 99($\text{C}_5\text{F}_2\text{H}$), 94($\text{C}_5\text{F}_3\text{H}$), 93(C_5F_3), 88($\text{C}_4\text{F}_2\text{H}_2$), 81($\text{C}_5\text{F}_2\text{H}$), 80(C_5FH), 75($\text{C}_5\text{F}_2\text{H}$), 69(CF_3), 68(C_4FH), 61(C_5H), 57(C_5FH_2), 56(C_5FH), 51(CF_2H), 50(CF_2), 44(C_2FH), and 31(CF). The ^{19}F NMR spectrum for this compound agreed with published data. Similar analysis of the -78°C . fraction showed it to be a mixture of unreacted $p\text{-C}_6\text{F}_4\text{H}_2$, the above described 1H,4H cyclohexa-1,4-diene, and a compound of empirical formula $\text{C}_6\text{F}_8\text{H}_2$. An infrared spectrum of the latter compound showed bands at cm^{-1} (intens.): 3070(w), 2960(w), 1710(ms), 1380(s), 1355(w), 1260(m), 1150(s), 1065(m), 1030(m), 743(mw), 637(w), 580(w), and 582(w). The bands near 3000 cm^{-1} are assignable to the carbon-hydrogen stretches of --C=C--M and C--H groups while the 1710 cm^{-1} peak is typical of a

--CF=CH-- stretching vibration. Strong ion peaks in the mass spectrum were at m/e (assign.):

226($\text{C}_6\text{F}_8\text{H}_2$), 207($\text{C}_6\text{F}_7\text{H}_2$), 186(C_6F_6), 157($\text{C}_5\text{F}_5\text{H}_2$), 144($\text{C}_4\text{F}_5\text{H}$), 137($\text{C}_5\text{F}_4\text{H}$), 119($\text{C}_5\text{F}_3\text{H}_2$), 117(C_5F_3), 113($\text{C}_4\text{F}_4\text{H}$), 94($\text{C}_5\text{F}_3\text{H}$), 93(C_5F_3), 75($\text{C}_5\text{F}_2\text{H}$), 69(CF_3), 57(C_5FH_2), 51(CF_2H), and 50(CF_2). The NMR spectra of the -78°C . fraction confirmed the presence of $p\text{-C}_6\text{F}_4\text{H}_2$, 1H,4H-hexafluorocyclohexa-1,4-diene, and 1H,4H-octafluorocyclohexene; chemical shift of H or F, ppm or δ (rel. area) of 1H,4H- $\text{C}_6\text{F}_8\text{H}_2$: 1-H, 5.1(1); 2-F, 121.5(1), 3-F, 118.1(2), 4-H, 4.7(1), 4-F, 134.4(1), 5-F, 130.3(2), 6-F, 110.4(2). The conversion of starting material was 78%. The composition of the products was 53% $\text{C}_6\text{F}_8\text{H}_2$ and 47% $\text{C}_6\text{F}_6\text{H}_2$, with a total of 92% of the organic material being recovered.

As will be clearly evident to those skilled in the art, various alterations and modifications of the present invention can be made without departing from the spirit thereof, since it is intended that the invention be limited only by the scope of the appended claims.

What is claimed is:

1. A process for introducing a fluorine atom into the ring structure of an aromatic compound which comprises the step of effecting a substitution reaction between (1) an aromatic compound selected from the group consisting of benzene, toluene and nitrobenzene and (2) a hydrogen fluoride solvent solution of NF_4BF_4 .
2. A process in accordance with claim 1 wherein said aromatic compound is benzene.
3. A process in accordance with claim 1 wherein said aromatic compound is toluene.

• • • • •

United States Patent [19]

[11] 4,428,913

Christe et al.

[45] Jan. 31, 1984

[54] PERFLUOROAMMONIUM SALT OF
HEPTAFLUOROXENON ANION[75] Inventors: Karl O. Christe, Calabasas; William
W. Wilson, Simi Valley, both of
Calif.[73] Assignee: United States of America as
represented by the Secretary of the
Navy, Washington, D.C.

[21] Appl. No.: 391,786

[22] Filed: Jun. 24, 1982

[51] Int. Cl.³ C01B 23/00[52] U.S. Cl. 423/262; 149/119;
423/351; 423/462; 204/157.1 H

[58] Field of Search 423/262

[56] References Cited
PUBLICATIONSPeacock et al. "Complex Compounds of Xenon Hexa-
fluoride with the Alkali Fluorides", *J. Inorg. Nucl.
Chem.* (1966) vol. 28, pp. 2561-2567.Christe et al., "Synthesis and Properties of $NF_4^+C-10_4^-$
and $NF_4^+HF_2^-$ HF and Some Reaction Chem-
istry of NF_4^+ Salts", *Inorg. chem.* (1980), 19, pp.
1494-1498.*Primary Examiner*—Herbert T. Carter*Attorney, Agent, or Firm*—Robert F. Beers; Thomas M.
Phillips

[57] ABSTRACT

New energetic salts NF_4XeF_7 and $(NF_4)_2XeF_8$ are pre-
pared by reacting NF_4HF_2 with XeF_6 and exposing
 NF_4XeF_7 to blue 4880Å laser light.

1 Claim, No Drawings

**PERFLUOROAMMONIUM SALT OF
HEPTAFLUOROXYENON ANION**

BACKGROUND OF THE INVENTION

This invention relates to energetic inorganic salts and more particularly to salts containing the NF_4^+ cation.

NF_4^+ salts are key ingredients for solid propellant NF_3-F_2 gas generators, as shown by D. Pilipovich in U.S. Pat. No. 3,963,542, and for high detonation pressure explosives, as shown by K. O. Christe in U.S. Pat. No. 4,207,124. The synthesis of NF_4^+ salts is unusually difficult because the parent molecule NF_3 does not exist and the salts must be prepared from NF_3 which amounts formally to a transfer of F^+ to NF_3 according to:



Since fluorine is the most electronegative of all elements, F^+ cannot be generated by chemical means. This difficult synthetic problem was overcome by K. O. Christe, et al as shown in U.S. Pat. No. 3,503,719. By the use of an activation energy source and a strong volatile Lewis acid, such as AsF_5 , the conversion of NF_3 and F_2 to an NF_4^+ salt became possible:



However, only few Lewis acids are known which possess sufficient strength and acidity to be effective in this reaction. Therefore, other indirect methods were needed which allowed conversion of the readily accessible NF_4^+ salts into other new salts. Two such methods are presently known. The first one involves the displacement of a weaker Lewis acid by a stronger Lewis acid, as shown by K. O. Christe and C. J. Schack in U.S. Pat. No. 4,172,881 for the system:



but is again limited to strong Lewis acids. The second method is based on metathesis, i.e., taking advantage of the different solubilities of NF_4^+ salts in solvents such as HF or BrF_3 . For example, NF_4SbF_6 can be converted to NF_4BF_4 according to:

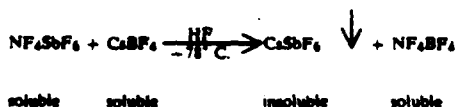

This method has successfully been applied by K. O. Christe, et al as shown in U.S. Pat. Nos. 4,108,965; 4,152,406; and 4,172,884 to the synthesis of several new salts. However, this method is limited to salts which have the necessary solubilities and are stable in the required solvent. The limitations of the above two methods are quite obvious and preempted the synthesis of NF_4^+ salts of anions which are either insoluble in these solvents or are derived from Lewis acids weaker than the solvent itself and therefore are displaced from their salts by the solvent.

SUMMARY OF THE INVENTION

The limitations of the previously known reactions for the synthesis of NF_4^+ salts are overcome by the present

invention. It was found that NF_4^+ salts derived from very weak and volatile Lewis acids, such as XeF_6 , which are weaker than the solvent itself, can be prepared by the following method. A solid having the composition $NF_4HF_2 \cdot nHF$, where n ranges from about 0.5 to 10, was obtained as described by K. O. Christe et al in Inorganic Chemistry, 19, 1494 (1980). Repeated treatments of $NF_4HF_2 \cdot nHF$ with a large excess of XeF_6 followed by removal of the volatile products at ambient temperature, permitted to shift the following equilibrium:

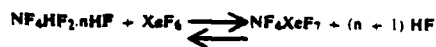

quantitatively to the right.

For applications, such as solid propellant NF_3-F_2 gas generators for chemical HF-DF lasers, the NF_3-F_2 yields must be as high as possible and no volatile products which would deactivate the excited species can be tolerated. The highest usable fluorine contents theoretically available from the thermal decomposition of a previously known sufficiently stable NF_4^+ salt were 64.6 and 59.9 weight percent for $(NF_4)_2NiF_6$ and $(NF_4)_2MnF_6$, respectively. Although these fluorine yields are high, the solid NiF_2 and MnF_3 byproducts render their formulations difficult to burn and require higher fuel levels thus reducing the practically obtainable fluorine yields. Consequently, NF_4^+ salts decomposing exclusively to NF_3 , F_2 and inert diluents, such as noble gases or nitrogen, were highly desirable. The new NF_4XeF_7 salt, described in this invention, fulfills all of these requirements and provides a theoretical usable fluorine yield of 62.9 weight percent. On decomposition, it produces only NF_3 , F_2 and inert Xe. A further increase in the usable fluorine yield to 71.7 weight percent, the highest presently known value, was achieved by converting NF_4XeF_7 into $(NF_4)_2XeF_8$ according to:



This conversion was achieved by irradiating the yellow NF_4XeF_7 salt with blue 4880 Å light from an Ar ion laser. The yellow NF_4XeF_7 strongly absorbs the blue light and is photolytically decomposed to $(NF_4)_2XeF_8$ and gaseous XeF_6 . Since $(NF_4)_2XeF_8$ is white it does not absorb the blue light and is not further decomposed. Therefore, this invention also provides a new, selective, laser-induced, photolytic method for converting NF_4XeF_7 into $(NF_4)_2XeF_8$. The latter compound not only provides the highest NF_3-F_2 yield of any presently known compound, but also gives the highest theoretical detonation pressures in explosive formulations (about 50 kbar higher than corresponding formulation containing $(NF_4)_2NiF_6$).

Accordingly, an object of this invention is to provide a new compound.

Another object of this invention is to provide new energetic NF_4^+ compositions which are useful in explosives, and solid propellants.

A further object of this invention is to provide NF_4^+ compositions for solid propellant NF_3-F_2 gas generators for chemical HF-DF lasers which deliver a maximum of NF_3 and F_2 while not producing any gases which deactivate the chemical laser.

Still another object of this invention is to provide a novel method of preparing new energetic compounds.

These and other objects of this invention will become apparent from the following detailed description.

DETAILED DESCRIPTION OF THE INVENTION

EXAMPLE 1

Dry CaF (15.54 mmol) and NF_4SbF_6 (15.65 mmol) were loaded in the drybox into one half of a prepassivated Teflon U metathesis apparatus. Dry HF (9 ml liquid) was added on the vacuum line and the mixture was stirred with a Teflon-coated magnetic stirring bar for 45 minutes at 25° C. After cooling the apparatus to -78° C., it was inverted and the NF_4HF_2 solution was filtered into the other half of the apparatus. Most of the HF solvent was pumped off during warm up from -78° C. towards room temperature until the first signs of NF_4HF_2 decomposition became noticeable. At this point the solution was cooled to -196° C. and XeF_6 (17.87 mmol) was added. The mixture was warmed to 25° C. and stirred for 12 hours. Although most of the XeF_6 dissolved in the liquid phase, there was some evidence for undissolved XeF_6 . Material volatile at 25° C. was removed in a static vacuum and separated by fractional condensation through traps kept at -64° and -196° C. Immediately, a white copious precipitate formed in the reactor, but disappeared after about 10 minutes resulting in a clear colorless solution. As soon as the first signs of NF_4HF_2 decomposition were noted, removal of volatiles was stopped and the reactor cooled to -196° C. The HF collected in the -196° C. trap was discarded, but the XeF_6 collected in the -64° C. trap was recycled into the reactor resulting in a yellow solution at room temperature. This mixture was stirred at 25° C. for several hours, followed by removal of the material volatile at 25° C. in a dynamic vacuum. The volatiles were separated by fractional condensation through traps kept at -210°, -126° and -64° C. and consisted of NF_3 (~0.3 mmol), HF (~11 mmol), and XeF_6 , respectively. The reactor was taken to the dry-

box and the solid products were weighed. The yellow filtrate residue (5.149 g, weight calcd for 15.54 mmol NF_4XeF_7 = 5.506 g, corresponding to a yield of 93.5 percent) consisted of NF_4XeF_7 , and the white filter cake (5.78 g, weight calcd for 15.54 mmol of CsSbF_6 = 5.72 g) consisted of CsSbF_6 . The composition of these solids was confirmed by vibrational and ^{19}F NMR spectroscopy, pyrolysis and analysis of the pyrolysis residue for NF_4^+ , Cs^+ and SbF_6^- . Based on these results, the reaction product had the following composition (weight %): NF_4XeF_7 (98.01), NF_4SbF_6 (0.88) and CsSbF_6 (1.11).

The NF_4XeF_7 salt was identified by its Raman spectrum which exhibited the bands characteristics for NF_4^+ (1159, 1149, (ν_3), 841, (ν_1), 603 (ν_4), 440 (ν_2) and XeF_7^- (558, 495, 464, 233, 212 cm^{-1}).

EXAMPLE 2

A sample of NF_4XeF_7 was exposed at room temperature for prolonged time to blue 4880 Å laser light. Photolytic decomposition of NF_4XeF_7 occurred resulting in $(\text{NF}_4)_2\text{XeF}_8$ formation (time of exposure depends upon the intensity and power of the light source)



The $(\text{NF}_4)_2\text{XeF}_8$ salt was identified by its Raman spectrum which exhibited the bands characteristic for NF_4^+ (1158, 1145, 841, 602, 440 cm^{-1}) and XeF_8^{2-} (500, 433, 416, 380, 374 cm^{-1}).

Obviously many modifications and variations of the present invention are possible in the light of the above teachings. It is therefore to be understood that within the scope of the appended claims the invention may be practiced otherwise than as specifically described.

What is claimed is:

1. NF_4XeF_7 .

• • • • •

United States Patent [19]

[11] 4,447,407

Christe et al.

[45] May 8, 1984

[54] **PERFLUOROAMMONIUM SALTS
FLUOROXYENON ANIONS**[75] **Inventors:** Karl O. Christe, Calabasas; William
W. Wilson, Simi Valley, both of
Calif.[73] **Assignee:** The United States of America as
represented by the Secretary of the
Navy, Washington, D.C.[21] **Appl. No.:** 540,951[22] **Filed:** Oct. 11, 1983**Related U.S. Application Data**[62] Division of Ser. No. 391,786, Jun. 24, 1983, Pat. No.
4,428,913.[51] **Int. Cl.³** C01B 23/00[52] **U.S. Cl.** 423/262; 149/119;
423/351; 423/462; 204/157.1 R; 204/157.1 H[58] **Field of Search** 423/262; 204/157.1 R,
204/157.1 H[56] **References Cited****U.S. PATENT DOCUMENTS**

4,001,135 1/1977 O'Pray et al. 149/119

OTHER PUBLICATIONSChriste et al., "Inorg. Chemistry", vol. 19, 1980, pp.
1494-1498.Peacock et al., "J. Inorg. and Nucl. Chemistry", vol. 28,
1966, pp. 2561-2567.Wilson et al., "Inorg. Chemistry", vol. 21, 1982, pp.
2091-2094.*Primary Examiner*—Herbert T. Carter*Attorney, Agent, or Firm*—Robert F. Beers; Thomas M.
Phillips[57] **ABSTRACT**New energetic salts NF_4XeF_7 and $(\text{NF}_4)_2\text{XeF}_8$ are pre-
pared by reacting NH_4HF_2 with XeF_6 and exposing
 NF_4XeF_7 to blue 4880 Å laser light.

2 Claims, No Drawings

**PERFLUOROAMMONIUM SALTS
FLUOROXYENON ANIONS**

This application is a division of application Ser. No. 391,786, filed June 24, 1983 now U.S. Pat. No. 4,428,913.

BACKGROUND OF THE INVENTION

This invention relates to energetic inorganic salts and more particularly to salts containing the NF_4^+ cation.

NF_4^+ salts are key ingredients for solid propellant NF_3 - F_2 gas generators, as shown by D. Pilipovich in U.S. Pat. No. 3,963,542, and for high detonation pressure explosives, as shown by K. O. Christe in U.S. Pat. No. 4,207,124. The synthesis of NF_4^+ salts is unusually difficult because the parent molecule NF_3 does not exist and the salts must be prepared from NF_3 which amounts formally to a transfer of F^+ to NF_3 according to:

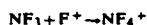

Since fluorine is the most electronegative of all elements, F^+ cannot be generated by chemical means. This difficult synthetic problem was overcome by K. O. Christe, et al as shown in U.S. Pat. No. 3,503,719. By the use of an activation energy source and a strong volatile Lewis acid, such as AsF_5 , the conversion of NF_3 and F_2 to an NF_4^+ salt become possible:



However, only few Lewis acids are known which possess sufficient strength and acidity to be effective in this reaction. Therefore, other indirect methods were needed which allowed conversion of the readily accessible NF_4^+ salts into other new salts. Two such methods are presently known. The first one involves the displacement of a weaker Lewis acid by a stronger Lewis acid, as shown by K. O. Christe and C. J. Schack in U.S. Pat. No. 4,172,881 for the system:



but is again limited to strong Lewis acids. The second method is based on metathesis, i.e., taking advantage of the different solubilities of NF_4^+ salts in solvents such as HF or BrF_3 . For example, NF_4SbF_6 can be converted to NF_4BF_4 according to:

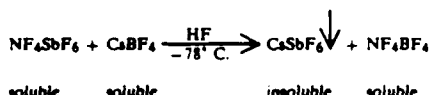

This method has successfully been applied by K. O. Christe, et al as shown in U.S. Pat. Nos. 4,108,965; 4,152,406; and 4,172,884 to the synthesis of several new salts. However, this method is limited to salts which have the necessary solubilities and are stable in the required solvent. The limitations of the above two methods are quite obvious and preempted the synthesis of NF_4^+ salts of anions which are either insoluble in these solvents or are derived from Lewis acids weaker than the solvent itself and therefore are displaced from their salts by the solvent.

SUMMARY OF THE INVENTION

The limitations of the previously known reactions for the synthesis of NF_4^+ salts are overcome by the present invention. It was found that NF_4^+ salts derived from very weak and volatile Lewis acids, such as XeF_6 , which are weaker than the solvent itself, can be prepared by the following method. A solid having the composition $NF_4HF_2 \cdot nHF$, where n ranges from about 0.5 to 10, was obtained as described by K. O. Christe et al in Inorganic Chemistry, 19, 1494 (1980). Repeated treatments of $NF_4HF_2 \cdot nHF$ with a large excess of XeF_6 followed by removal of the volatile products at ambient temperature, permitted to shift the following equilibrium:

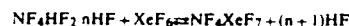

quantitatively to the right.

For applications, such as solid propellant NF_3 - F_2 gas generators for chemical HF-DF lasers, the NF_3 - F_2 yields must be as high as possible and no volatile products which would deactivate the excited species can be tolerated. The highest usable fluorine contents theoretically available from the thermal decomposition of a previously known sufficiently stable NF_4^+ salt were 64.6 and 59.9 weight percent for $(NF_4)_2NiF_6$ and $(NF_4)_2MnF_6$, respectively. Although these fluorine yields are high, the solid NiF_2 and MnF_3 byproducts render their formulations difficult to burn and require higher fuel levels thus reducing the practically obtainable fluorine yields. Consequently, NF_4^+ salts decomposing exclusively to NF_3 , F_2 and inert diluents, such as noble gases or nitrogen, were highly desirable. The new NF_4XeF_7 salt, described in this invention, fulfills all of these requirements and provides a theoretical usable fluorine yield of 62.9 weight percent. On decomposition, it produces only NF_3 , F_2 and inert Xe. A further increase in the usable fluorine yield to 71.7 weight percent, the highest presently known value, was achieved by converting NF_4XeF_7 into $(NF_4)_2XeF_8$ according to:



This conversion was achieved by irradiating the yellow NF_4XeF_7 salt with blue 4880 Å light from an Ar ion laser. The yellow NF_4XeF_7 strongly absorbs the blue light and is photolytically decomposed to $(NF_4)_2XeF_8$ and gaseous XeF_6 . Since $(NF_4)_2XeF_8$ is white it does not absorb the blue light and is not further decomposed. Therefore, this invention also provides a new, selective, laser-induced, photolytic method for converting NF_4XeF_7 into $(NF_4)_2XeF_8$. The latter compound not only provides the highest NF_3 - F_2 yield of any presently known compound, but also gives the highest theoretical detonation pressures in explosive formulations (about 50 kbar higher than corresponding formulation containing $(NF_4)_2NiF_6$).

Accordingly, an object of this invention is to provide a new compound.

Another object of this invention is to provide new energetic NF_4^+ compositions which are useful in explosives, and solid propellants.

A further object of this invention is to provide NF_4^+ compositions for solid propellant NF_3 - F_2 gas generators for chemical HF-DF lasers which deliver a maximum of NF_3 and F_2 while not producing any gases which deactivate the chemical laser.

Still another object of this invention is to provide a novel method of preparing new energetic compounds.

These and other objects of this invention will become apparent from the following detailed description.

DETAILED DESCRIPTION OF THE INVENTION

Example 1

Dry CsF (15.54 mmol) and NF_4SbF_6 (15.65 mmol) were loaded in the drybox into one half of a prepassivated Teflon U metathesis apparatus. Dry HF (9 ml liquid) was added on the vacuum line and the mixture was stirred with a Teflon-coated magnetic stirring bar for 45 minutes at 25° C. After cooling the apparatus to -78° C., it was inverted and the NF_4HF_2 solution was filtered into the other half of the apparatus. Most of the HF solvent was pumped off during warm up from -78° C. towards room temperature until the first signs of NF_4HF_2 decomposition became noticeable. At this point the solution was cooled to -196° C. and XeF_6 (17.87 mmol) was added. The mixture was warmed to 25° C. and stirred for 12 hours. Although most of the XeF_6 dissolved in the liquid phase, there was some evidence for undissolved XeF_6 . Material volatile at 25° C. was removed in a static vacuum and separated by fractional condensation through traps kept at -64° and -196° C. Immediately, a white copious precipitate formed in the reactor, but disappeared after about 10 minutes resulting in a clear colorless solution. As soon as the first signs of NF_4HF_2 decomposition were noted, removal of volatiles was stopped and the reactor cooled to -196° C. The HF collected in the -196° C. trap was discarded, but the XeF_6 collected in the -64° C. trap was recycled into the reactor resulting in a yellow solution at room temperature. This mixture was stirred at 25° C. for several hours, followed by removal of the material volatile at 25° C. in a dynamic vacuum. The volatiles were separated by fractional condensation through traps kept at -210°, -126° and -64° C. and consisted of NF_3 (~0.3 mmol), HF (~11 mmol), and XeF_6 , respectively. The reactor was taken to the drybox and the solid products were weighed. A yellow filtrate residue (5.149 g, weight calcd for 15.54 mmol

$\text{NF}_4\text{XeF}_7 = 5.506$ g, corresponding to a yield of 93.5 percent) consisted of NF_4XeF_7 , and the white filter cake (5.78 g, weight calcd for 15.54 mmol of $\text{CsSbF}_6 = 5.72$ g) consisted of CsSbF_6 . The composition of these solids was confirmed by vibrational and ^{19}F NMR spectroscopy, pyrolysis and analysis of the pyrolysis residue for NF_4^+ , Cs^+ and SbF_6^- . Based on these results, the reaction product had the following composition (weight %): NF_4XeF_7 (98.01), NF_4SbF_6 (0.88) and CsSbF_6 (1.11).

The NF_4XeF_7 salt was identified by its Raman spectrum which exhibited the bands characteristics for NF_4^+ (1159, 1149, (ν_3), 841, (ν_1), 603 (ν_4), 440 (ν_2) and XeF_7^- (558, 495, 464, 233, 212 cm^{-1}).

EXAMPLE 2

A sample of NF_4XeF_7 was exposed at room temperature for prolonged time to blue 4880 Å laser light. Photolytic decomposition of NF_4XeF_7 occurred resulting in $(\text{NF}_4)_2\text{XeF}_8$ formation (time of exposure depends upon the intensity and power of the light source)

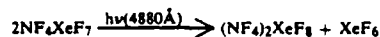

The $(\text{NF}_4)_2\text{XeF}_8$ salt was identified by its Raman spectrum which exhibited the bands characteristic for NF_4^+ (1158, 1145, 841, 602, 440 cm^{-1}) and XeF_8^{2-} (500, 433, 416, 380, 374 cm^{-1}).

Obviously many modifications and variations of the present invention are possible in the light of the above teachings. It is therefore to be understood that within the scope of the appended claims the invention may be practiced otherwise than as specifically described.

We claim:

1. $(\text{NF}_4)_2\text{XeF}_8$.
2. A method of preparing $(\text{NF}_4)_2\text{XeF}_8$ comprising the following steps in order:
 - (1) exposing NF_4XeF_7 to a blue 4880 Å laser light source until photolytic decomposition of NF_4XeF_7 occurs resulting in $(\text{NF}_4)_2\text{XeF}_8$ formation, and
 - (2) isolating the product $(\text{NF}_4)_2\text{XeF}_8$.

45

50

55

60

65

United States Patent (19)
Schack et al.

(11) **Patent Number:** 4,462,975
 (45) **Date of Patent:** Jul. 31, 1984

[54] **SYNTHESIS OF
 PENTAFLUOROTELLURIUM
 HYPOFLUORITE**

[75] **Inventors:** Carl J. Schack, Chatsworth; William W. Wilson, Simi Valley; Karl O. Christie, Calabasas, all of Calif.

[73] **Assignee:** The United States of America as represented by the Secretary of the Air Force, Washington, D.C.

[21] **Appl. No.:** 478,581

[22] **Filed:** Mar. 24, 1983

[51] **Int. Cl.** CO1B 11/24

[52] **U.S. Cl.** 423/473; 423/508

[58] **Field of Search** 423/473, 508, 579, 467,
 423/472, 641, 642, 643, 512

[56] **References Cited**

U.S. PATENT DOCUMENTS

4,216,338 8/1980 Schack et al. 360/227
 4,222,968 9/1980 Schack et al. 260/653
 4,329,330 5/1982 Christie et al. 423/473

OTHER PUBLICATIONS

J. Fluorine Chem., 7, 192, 193, 195, (1973).
 Mathers et al., Inorg. Syn., 3, 145, (1950).
 Seppelt et al., Inorg. Chem., 12, 2727-2730, (1973).
 Christie et al., Inorg. Chem., 20, 2104-2114, (1981).
 Dudley et al., J. Am. Chem. Soc., 78, (290-292, (1956).
 U.S. Pat. Appl. "Pentafluorotellurium Oxides", Schack et al. identified as AF Inv. No. 15,528, filed of even date herewith.

Primary Examiner—Earl C. Thomas

Assistant Examiner—Jeffrey E. Russel

Attorney, Agent, or Firm—Donald J. Singer; William J. O'Brien

[57] **ABSTRACT**

The present invention concerns itself with a method for synthesizing hypofluorite compounds by utilizing fluorine fluorosulfate as a fluorinating agent and to a novel pentafluorotellurium hypofluorite compound prepared thereby.

4 Claims, No Drawings

SYNTHESIS OF PENTAFLUOROTELLURIUM HYPOFLUORITE

STATEMENT OF GOVERNMENT INTEREST

The invention described herein may be manufactured and used by or for the Government for governmental purposes without the payment of any royalty thereon.

BACKGROUND OF THE INVENTION

This invention relates to hypofluorite compounds and to a novel method for their preparation. In a more particular aspect, this invention concerns itself with a novel route for effecting the synthesis of pentafluorotellurium hypofluorite (TeF_5OF) using fluorine fluorosulfate as a reaction component.

Hypofluorite compounds are well known and find utility for a wide variety of industrial applications. They are particularly useful as fluorinating agents for introducing fluorine atoms into another compound, and as intermediates in synthetic reactions. At the present time, however, there is no simple and convenient process for producing these compounds. Until recently, the number of elements known to form hypofluorites was limited to the nonmetal main group elements of hydrogen, carbon, nitrogen, oxygen, sulfur, selenium, fluorine and chlorine.

Generally, the method used heretofore for the synthesis of these hypofluorites involved the fluorination of the corresponding hydroxyl compounds or their metal salts with elemental fluorine. An attempt was made by Seppelt et al. *Inorg. Chem.* 1973, 12, 2727, to apply this method to the synthesis of the hitherto unknown TeF_5OF . The attempt was unsuccessful. An analogous method, however, proved fruitful in synthesizing TeF_5OCl which led to the conclusion that TeF_5OF is unstable or actually nonexistent. Additionally, further research efforts, as reported by Christie et al. *Inorg. Chem.*, 1981, 20, 2104, proved to be successful in synthesizing a stable iodine hypofluorite with the observation that hypofluorites are generally more stable than the other hypohalites and the suggestion that TeF_5OF should exist and should also be stable.

In line with the observations noted above, additional experimental efforts proved successful and a novel method for synthesizing TeF_5OF was discovered. It was found that the hitherto unknown TeF_5OF compound could be produced in stable form and in relatively high yield by a process which provided for the use of fluorine fluorosulfate as the fluorinating agent.

SUMMARY OF THE INVENTION

The present invention concerns itself with a novel method for synthesizing hypofluorites by utilizing fluorine fluorosulfate as a fluorinating agent. The method of this invention proved successful in synthesizing in high yield the novel compound, pentafluorotellurium hypofluorite. Synthesis is achieved by effecting a reaction between CsTeF_5O and FOSO_2F at relatively low temperatures.

Accordingly, the primary object of this invention is to provide a novel method for synthesizing hypofluorite compounds.

Another object of this invention is to provide a method for synthesizing hypofluorite compounds that utilizes fluorine fluorosulfate as a fluorinating agent.

Still another object of this invention is to provide a method for synthesizing the novel compound, pentafluorotellurium hypofluorite.

The above and still other objects and advantages of the present invention will become more readily apparent upon consideration of the following detailed description thereof.

DESCRIPTION OF THE PREFERRED EMBODIMENTS

Pursuant to the above-defined objects, the present invention is brought into effect by accomplishing a reaction between CsTeF_5O and FOSO_2F within a closed environment at temperatures ranging from about -10° to -45° C. The known methods for preparing hypofluorites are quite limited and attempts at using these previously known methods for producing the hitherto unknown TeF_5OF have not been successful. For example, the fluorination of either CsTeF_5O or KTeF_5O with F_2 at -45° to -10° C. resulted only in the formation of TeF_6 . However, with the present invention, it was found that a fairly high yield synthesis of TeF_5OF could be accomplished by reacting CsTeF_5O with FOSO_2F at temperatures ranging from about -10° to -45° C. This reaction is illustrated by the following general equation:

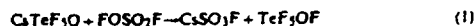

This novel reaction represents a new synthetic route to the preparation of hypofluorite compounds. Based on the general usefulness of the analogous ClOSO_2F reagent for the syntheses of hypochlorites, it would appear that FOSO_2F will become a similarly useful, versatile and general reagent for the synthesis of hypofluorite compounds.

When the synthesis of TeF_5OF from CsTeF_5O and FOSO_2F was carried out above -45° C., the amount of TeF_6 by-product sharply increased. For example, at -10° C. and with a reaction time of 7 days, the TeF_6 to TeF_5OF ratio in the product increased to 1:1. The use of an excess of CsTeF_5O in this reaction was found advantageous for the product purification since it eliminated the need for separating TeF_5OF from FOSO_2F .

The reaction scheme for synthesizing the novel TeF_5OF compound of this invention is further illustrated with greater specificity by Example I which follows.

EXAMPLE I

A 30 ml stainless steel Hoke cylinder was loaded with CsTeF_5O (3.42 mmol) in the glove box. After evacuation and cooling of the cylinder to -196° C., FOSO_2F (2.79 mmol) was added from the vacuum line. The closed cylinder was slowly warmed to -78° C in a liquid nitrogen- CO_2 slush bath and finally kept at -45° C for 9d. Upon recooling to -196° C. about 4-5 cm^3 of noncondensable gas was observed to be present. This was pumped away and the condensable products were separated by fractional condensation in a series of U-traps cooled at -78° , -126° , and -196° C. The -78° C. fraction was TeF_5OH (0.19 mmol) while the -196° C. fraction was TeF_6 (0.49 mmol).

A white solid was retained at -126° C. which changed to a colorless glass and melted, over a range of a few degrees, near -80° C to a clear, colorless liquid. This material was identified as TeF_5OF (1.91 mmol, 68% yield) based on its vapor density molecular weight: found, 256.2, calc., 257.6 g/mol. Further identification

was based on its spectroscopic properties and on the preparation of derivatives. The observed weight loss of the solid (0.375 g) agreed well with that calculated (0.389 g) for the conversion of 2.79 mmol CsTeF₅O to CsSO₃F. Vapor pressure-temperature data of TeF₅OF were measured: T°C., Pmm; -79.3, 16; -64.2, 45; -57.6, 63; -46.9, 108; -32.5, 210; -23.0, 312.

The TeF₅OF compound of Example I is colorless as a gas and liquid. Its vapor pressure-temperature relationship for the range -79° to -23° C. is given by the equation

$$\log P_{\text{mm}} = 6.9022 - 1101.2/T^{\circ}\text{K}$$

The extrapolated boiling point is 0.6° C. The derived heat of vaporization is $H_{\text{vap}} = 5039 \text{ cal mol}^{-1}$ and the Trouton constant is 18.4 indicating little or no association in the liquid phase. Vapor density measurements showed that in the gas phase the compound is also not associated. A sharp melting point for TeF₅OF was not observed because the samples showed a tendency to form a glass near -80° C. The compound appears to be completely stable at ambient temperature and has been stored in stainless steel cylinders for more than four months without any sign of decomposition.

The mass spectrum of TeF₅OF is listed in Table I together with the spectra of TeF₅OCl and TeF₅OH which were measured for comparison. All of the listed fragments showed the characteristic tellurium isotope pattern and therefore the individual m/e listings were omitted for simplicity. The spectra of all three compounds show weak parent ions and TeF₃⁺ as the base peak.

TABLE I

MASS SPECTRUM OF TeF ₅ OF COMPARED TO THOSE OF TeF ₅ OCl AND TeF ₅ OH					
TeF ₅ OF		TeF ₅ OCl		TeF ₅ OH	
assign	intens	assign	intens	assign	intens
TeF ₅ OF ⁺	vw	TeF ₅ OCl ⁺	vw	TeF ₅ OH ⁺	w
TeF ₄ OF ⁺	vw	TeF ₄ OCl ⁺	vw	TeF ₄ OH ⁺	vw
TeF ₃ O ⁺					
TeF ₃ ⁺	s	TeF ₃ ⁺	s	TeF ₃ ⁺	vs
TeF ₄ ⁺	w	TeF ₄ ⁺	vw	TeF ₄ ⁺	w
TeF ₃ O ⁺	m	TeF ₃ O ⁺	ms	TeF ₃ O ⁺	s
TeF ₃ ⁺	vs	TeF ₃ ⁺	vs	TeF ₃ ⁺	vs
TeF ₂ ⁺	m	TeF ₂ ⁺	m	TeF ₂ ⁺	m
TeFO ⁺	vw	TeFO ⁺	w	TeFO ⁺	w
TeF ⁺	w	TeF ⁺	w	TeF ⁺	w
Te ⁺	w	Te ⁺	w	Te ⁺	w

The infrared spectra of gaseous and of neon matrix isolated TeF₅OF and the Raman spectra of liquid and solid TeF₅OF were recorded and the observed frequencies are summarized in Table II.

TABLE II

VIBRATIONAL SPECTRA OF TeF ₅ OF					
obsd freq, cm ⁻¹ , and rel intens ^a					
gas	IR		Raman		assignment ^b
	Ne matrix	liquid	liquid	solid	
1800 vw					2ν ₁₂
1449 vw					2ν ₁
1403 w					ν ₂ + ν ₈
906 vw					ν ₁₂
738	738 ^c vs	738 sh dp	904(0.8)	735 sh	ν ₈
	727 vs	721(1.1)p	721(1.3)		ν ₁
	718 vw				impurity ^d
	709 vw				

TABLE II-continued

VIBRATIONAL SPECTRA OF TeF ₅ OF					
obsd freq, cm ⁻¹ , and rel intens ^a					
gas	IR		Raman		assignment ^b
	Ne matrix	liquid	liquid	solid	
	668 vw		669(10)p	670(10)	ν ₂
			660(0.3)dp	662 sh	ν ₃
616 m	618 m		613(3.8)p	613(4)	ν ₃
	327 vs		325 sh, dp	325 sh	ν ₉
324 vs					
	318 vs		319 sh		ν ₁₀
	308 vw		309(1.0)dp	309(1.6)	ν ₇
300 sh	302 m		301(0.3)p	301 sh	ν ₄
280 mw	278 m		279(0.2)dp	279(0.2)	ν ₁₁
241 mw	239 mw		240(0.2)p	240(0.2)	ν ₁₃
			166(0.1)dp	167(0.1)	ν ₁₄

^aUncorrected Raman intensities (peak heights)

^bFor mode description see Table IV

^cBand shows tellurium isotope fine structure with splittings of about 130 cm⁻¹

The vibrational spectra of TeF₅OF can be readily assigned as shown in Table III assuming a model with C_{4v} symmetry for the TeF₅O part and C_s symmetry for the TeOF part of the molecule.

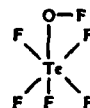

Except for the symmetric out of phase, out of plane TeF₄ deformation mode in species B₁ which is usually observed for pseudo-octahedral molecules and is inactive under O_h symmetry, all fundamentals expected for the above C_{4v}-C_s model were observed. Using the well established assignments of TeF₅Cl, the assignments (see Table III) are straight forward and show for the two molecules almost identical frequencies for the TeF₅ part of the molecules. The weak band observed at about 906 cm⁻¹ in both the infrared and Raman spectra is characteristic for the OF stretching vibrations in hypofluorites.

TABLE III

Vibrational Spectra of TeF ₅ OF and their Assignment Compared to Those of TeF ₅ Cl							
obsd freq, cm ⁻¹ , and rel intens ^a							
assign-ment	approx description of mode	TeF ₅ Cl		TeF ₅ OF		IR (gas, matrix)	RA (liquid)
		IR (gas)	RA (liquid)	IR (gas, matrix)	RA (liquid)		
C_{4v}							
A ₁	ν ₁ νTeF	711 sh, m	708 (3.1)p	727 vs	721 (1.1)p		
	ν ₂ ν ₂ TeF ₄	662 vw	659 (10)p		669 (10)p		
	ν ₃ νTeX	411 ms	413 (7.7)p	616 m	613 (3.8)p		
	ν ₄ δ ₂ TeF ₄	317 s	312 (0.8)p	301 m	301 (0.5)p		
B ₁	ν ₅ ν ₂ TeF ₄		651 (0.8)dp		660 (0.3)dp		
B ₂	ν ₆ δTeF ₄		302 (0.5)dp	308 vw	309 (1.0)dp		
	ν ₇ δ _{asym} TeF ₄		726 (0.6)dp	738 vs	738 sh, dp		
E	ν ₈ ν _{as} TeF ₄		327 (0.9)dp	327 vs	325 sh, dp		
	ν ₉ νTeF ₄		167 (1.8)dp	318 vs	(309-325)		
	ν ₁₀ 8XTeF ₄		259 (1.7)dp	280 mw	279 (0.2)dp		
	ν ₁₁ δ _{as} TeF ₄						

TABLE III-continued

Vibrational Spectra of TeF ₅ OF and their Assignment Compared to Those of TeF ₅ Cl					
obsd freq, cm ⁻¹ , and rel intens ^a					
assign- ment	approx descrip- tion of mode	TeF ₅ Cl		TeF ₅ OF	
		IR (gas)	RA (liquid)	IR (gas, matrix)	RA (liquid)
C _{2v}					
A'	ν ₁₂ νXY			908 vw	905 (0.4) _p
A''	ν ₁₃ δTeXY			240 mw	240 (0.2) _p
	ν ₁₄ γTeXY				166 (0.1) _{dp}

^aUncorrected Raman intensities (peak heights)

In preparing and testing the novel hypofluorite compound of this invention, the volatile materials were manipulated in a stainless steel vacuum line equipped with Teflon FEP (a polyperfluoroethylene propylene copolymer) U traps and 316 stainless steel bellows-seal valves and a Heise Bourdon tube-type pressure gauge. Telluric acid was prepared by the literature method of Mathers et al, Inorg. Syn., 1950, 3, 145, and also purchased from Cerac, Inc., and from Pfaltz and Bauer. Fluorosulfuric acid obtained from Allied was used both as received (light brown color) and after distillation to obtain the clear colorless material. The fluorine fluoro-sulfate was synthesized as described by Dudley et al, J. Am. Chem. Soc. 1956, 78, 290. The reaction of TeF₅OH with either ClOSO₂F or ClF was used to prepare TeF₅OCl. Cesium and potassium chloride were oven dried, then cooled and powdered in the dry N₂ atmosphere of a glove box.

Infrared spectra were recorded in the range 4000-200 cm⁻¹ on a Perkin-Elmer Model 283 spectrophotometer calibrated by comparison with standard gas calibration points, and the reported frequencies are believed to be accurate to ±2 cm⁻¹. The spectra of gases were obtained using either a Teflon cell of 5-cm path length

equipped with AgCl windows or a 10-cm stainless steel cell equipped with polyethylene windows which were seasoned with ClF₃. The spectra of matrix isolated TeF₅OF and TeF₅OCl were obtained at 6K with an Air Products Model DE202S helium refrigerator equipped with CsI windows. Research grade Ne(Matheson) was used as a matrix material in a mole ratio of 400:1.

The Raman spectra were recorded on a Cary Model 83 spectrophotometer using the 488 nm exciting line of an Ar-ion laser and a Claassen filter for the elimination of plasma lines. Quartz tubes (3 mm o.d.), closed by a metal valve, were used as sample containers in the transverse-viewing, transverse-excitation technique. A device described in Miller et al, Appl. Spectrosc. 1970, 24, 271 was used for recording the low-temperature spectra. Polarization measurements were carried out by method VIII as described by Claassen et al in J. Appl. Spectrosc. 1969, 23, 8.

From an examination of the above, it can be seen that the FOSO₂F is a useful reagent for the synthesis of hypofluorites. Furthermore, it is shown that TeF₅OF, as expected from comparison with TeF₅OCl, TeF₅OBr and FOIF₄O, indeed exists and is a stable molecule.

What is claimed is:

1. The compound pentafluorotellurium hypofluorite.
2. A method for synthesizing pentafluorotellurium hypofluorite which comprises the steps of:
 - (a) effecting a reaction between (1) CsTeF₅O and (2) FOSO₂F at a temperature between about -45° to -10° C.;
 - (b) continuing said hypofluorite reaction at said temperature for a period of time sufficient to prepare a pentafluorotellurium reaction product; and
 - (c) separating said reaction product.
3. A method in accordance with claim 2 wherein said temperature is about -45° C.
4. A method in accordance with claim 2 wherein said period of time is about nine days.

• • • • •

United States Patent [19]

[11] Patent Number: 4,476,337

Christe et al.

[45] Date of Patent: Oct. 9, 1984

[54] METHOD FOR INTRODUCING FLUORINE
INTO AN AROMATIC RING[75] Inventors: Karl O. Christe, Calabasas; Carl J.
Schack, Chatsworth, both of Calif.[73] Assignee: The United States of America as
represented by the Secretary of the
Air Force, Washington, D.C.

[21] Appl. No.: 534,030

[22] Filed: Sep. 20, 1983

Related U.S. Application Data

[62] Division of Ser. No. 343,033, Jan. 27, 1982, Pat. No.
4,423,260.[51] Int. Cl.³ C07C 17/04

[52] U.S. Cl. 570/148; 570/147

[58] Field of Search 570/147, 148

[56] References Cited

U.S. PATENT DOCUMENTS

3,235,608 2/1966 Gibbs 570/148

Primary Examiner—Charles F. Warren*Assistant Examiner*—Joseph A. Boska*Attorney, Agent, or Firm*—Donald J. Singer; William J.
O'Brien

[57] ABSTRACT

A process for introducing a fluorine atom into an aromatic hydrocarbon by effecting a substitution reaction between an aromatic hydrocarbon and an NF_4^+ cation containing salt.

4 Claims, No Drawings

METHOD FOR INTRODUCING FLUORINE INTO AN AROMATIC RING

STATEMENT OF GOVERNMENT INTEREST

The invention described herein may be manufactured and used by or for the Government for governmental purposes without the payment of any royalty thereon. This is a division of application Ser. No. 343,033, filed Jan. 27, 1982, now U.S. Pat. No. 4,423,260.

FIELD OF THE INVENTION

This invention relates to fluorocarbons and to a novel method for their synthesis. In a more particular aspect, this invention concerns itself with a novel method for introducing a fluorine atom into an aromatic ring.

Aromatic fluorocarbons are a well known class of chemical compounds that find wide utility for a variety of industrial applications and in the fabrication of various commercial products. They are useful as solvents, electrical fluids, heat transfer fluids and as components in the manufacture of resins, waxes, greases and oils. However, presently known methods for synthesizing such compounds by introducing a fluorine atom into an aromatic ring structure are severely limited.

The classic Balz-Schiemann reaction, for example, and methods such as the decarboxylation of fluoroformates are useful for the introduction of a single fluorine atom, but are generally less useful for multiple fluorine substitution. The use of elemental fluorine or electrochemical fluorination methods result mainly in addition and not in substitution. Halogen fluorides, such as ClF_3 , BrF_3 , or IF_3 , produce, in addition to fluorine substituted compounds, large amounts of the corresponding halogen substituted compounds and also some addition products. The yield of substitution products obtainable with halogen fluorides can be improved by the use of strong Lewis acids. However, the extreme reactivity of the resulting compounds, such as $\text{ClF}_2^+ \text{BF}_4^-$ or $\text{ClF}_2^+ \text{SbF}_6^-$, makes control of their reactions with organic compounds extremely difficult and unsafe. The utilization of transition metal fluorides, such as CoF_3 or CeF_4 results in addition and saturation, requiring subsequent rearomatization. Therefore, this method is limited to highly or perhalogenated aromatics. Pyrolysis of aliphatic fluorocarbons, such as CFBr_3 , can also produce fluoroaromatics. However, this method is limited again to the synthesis of perfluorinated aromatics. Halogen exchange reactions, such as Cl versus F, using HF, alkali metal or metal fluorides are useful, but are restricted to systems strongly activated towards nucleophilic attack by fluoride ion. Hypofluorites, such as CF_3OF , are useful for electrophilic and photolytic fluorinations. The electrophilic fluorinations are limited again to activated aromatics, whereas the free radical photolytic fluorinations often lack selectivity resulting in $-\text{OCF}_2$ substituted by-products and side chain fluorination. The xenon fluorides and especially XeF_2 are promising reagents for electrophilic aromatic substitution, but the full extent of their usefulness is still unknown. The limited availability of xenon, its high price, and the treacherous explosiveness of their hydrolysis product, XeO_3 , are drawbacks curtailing its extensive use.

The above listing of some of the known methods of preparing aromatic fluorine compounds, although not extensive, clearly illustrates the problems prevalent in this area of technology and points out the need for a

reliable, readily available and economically feasible reagent for accomplishing the electrophilic fluorine substitution of aromatic ring compounds. Therefore, a research effort was undertaken in an attempt to satisfy the need for a generally usable reagent.

In theory, the ideal reagent for electrophilic substitution would be a salt containing the F^+ cation. Unfortunately, such salts do not exist. As an alternative, salts containing complex fluoro cations of the type $\text{XF}_{(n+1)}^+$ could be used. However, to be a strong electrophile, such a cation should possess high electronegativity. Since highly electronegative fluorine compounds generally are very strong oxidizers, most of these cations react too violently with organic compounds to be of practical interest. As a consequence, the research effort referred to above proved to be unsuccessful. Additional research, however, proved to be fruitful and culminated in the discovery that the NF_4^+ cation constitutes an exception to the general rule that such cations react too violently with organic compounds. As a result of the present invention, therefore, it was found that aromatic ring compounds, such as benzene, toluene, and nitrobenzene, interact rapidly with NF_4BF_4 in anhydrous HF to give, almost exclusively, fluorine substituted aromatic derivatives.

SUMMARY OF THE INVENTION

The present invention concerns itself with a method for introducing fluorine into an aromatic ring structure by using NF_4BF_4 as a reaction reagent. The introduction is accomplished by an electrophilic substitution reaction in which up to five hydrogen atoms in the aromatic ring can be substituted by fluorine atoms. The reaction can be carried out by either adding the aromatic compound, such as benzene in vapor form, to a cooled solution of NF_4BF_4 in HF or, alternatively, by adding slowly a solution of NF_4BF_4 to a solution of benzene in HF.

Accordingly, the primary object of this invention is to provide a novel method for introducing a fluorine atom into an aromatic ring structure.

Another object of this invention is to provide a method for substituting fluorine atoms for the hydrogen atoms in an aromatic ring structure.

Still another object of this invention is to provide for the synthesis of fluorine containing aromatic ring compounds by effecting a reaction between a non-fluorine containing aromatic compound and salts containing an NF_4^+ cation.

A further object of this invention is to provide a method for introducing a fluorine atom into an aromatic ring by using NF_4BF_4 as a reaction reagent in the electrophilic substitution of a fluorine atom for a hydrogen atom in an aromatic ring structure.

The above and still further objects and advantages of the present invention will become more readily apparent upon consideration of the following detailed description thereof.

DETAILED DESCRIPTION OF THE PREFERRED EMBODIMENT

Pursuant to above-defined objects, the present invention concerns itself with a novel method for introducing fluorine atoms into an aromatic ring compound through the electrophilic substitution of a hydrogen atom by a fluorine atom. The known methods for introducing fluorine into an aromatic ring are quite limited and are

often not generally applicable. A widely applicable reagent for carrying out electrophilic substitution reactions on aromatic ring systems, therefore, would be highly desirable. As a result, a concentrated research effort was undertaken based on the hypothesis that the use of NF_4^+ ion containing salts in this regard would be promising. A continued investigation of aromatic hydrocarbon reactions with NF_4^+ ion containing species confirmed the hypothesis. It was found that a reaction between an aromatic hydrocarbon ring compound, such as benzene, toluene or nitrobenzene with an NF_4^+ salt accomplished the substitution of up to five hydrogen atoms in the aromatic ring by fluorine atoms.

Hydrogen fluoride was used as a solvent because of the high solubility of NF_4^+ salts in it and also because the diluent and heat dissipation properties of a solvated system were found to be beneficial in the anticipated vigorous fluorination. As stated hereinbefore, the reaction was carried out by either adding benzene vapor to a cooled solution of NF_4BF_4 in HF or by adding slowly a solution of NF_4BF_4 to a solution of benzene in HF. On contact gas evolution was noted. When rapid addition occurred some apparent charring occurred. The stepwise substitution of H by F was observed according to the following general equation:

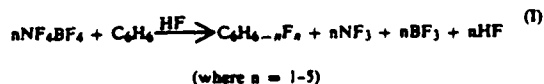

The evolved gas was removed under vacuum and trapped at -196°C . It was found to be NF_3 and the amount corresponded to that expected on the basis of one mole of NF_3 per mole of NF_4BF_4 . Hexafluorobenzene was not observed although all other substitution products from mono-to-penta-fluorobenzene were obtained. Almost no saturated or partially saturated fluorocarbons were produced which makes this process of special interest in generating aromatic fluorocarbons directly from their hydrocarbon analogues.

The benzene, toluene, and nitrobenzene reactants interacted rapidly with NF_4BF_4 in anhydrous HF to give, almost exclusively, fluorine substituted aromatic derivatives. With benzene, up to five hydrogens were replaced, while a maximum of four hydrogens were displaced in $\text{C}_6\text{H}_5\text{CH}_3$ and $\text{C}_6\text{H}_5\text{NO}_2$. The direction of the substitution in $\text{C}_6\text{H}_5\text{CH}_3$ and $\text{C}_6\text{H}_5\text{NO}_2$ and the lack of side chain fluorination in $\text{C}_6\text{H}_5\text{CH}_3$ support an electrophilic substitution mechanism when using NF_4BF_4 as a reactant. Although highly electronegative fluorine compounds generally are very strong oxidizers, most cations react too violently with organic compounds to be of practical interest. The NF_4^+ cation, however, was found to be an exception. It combines high electronegativity (oxidation state of +V) with high kinetic stability (it is isoelectronic with CF_4), and its reactions require significant activation energies. Furthermore, NF_4^+ salts, such as NF_4BF_4 , offer the advantage of generating in an electrophilic aromatic substitution reaction only by-products, such as NF_3 and BF_3 , which are unreactive toward the organic compounds. In view of these properties and its ready availability, NF_4BF_4 was found to be an ideal candidate for electrophilic aromatic substitution reactions. A vigorous ring hydrogen substitution occurred even at -7.8°C . in HF solution.

In carrying out the reactions of this invention, the nonvolatile materials were manipulated in a well-passivated (with ClF_3) stainless steel vacuum line equipped

with Teflon FEP U traps, 316 stainless steel bellows seal valves and a Heise Bourdon tube-type pressure gauge. Hydrogen fluoride work was carried out in an all Monel and Teflon vacuum system. Transfers outside the vacuum line were carried out in a drybox. Infrared spectra were obtained using 5 cm path stainless steel cells with AgCl windows and a PE Model 283 spectrophotometer. Mass spectra were measured with an EA1 Quad 300 quadrupole spectrometer and ^{19}F and ^1H nmr spectra were determined with a Varian EH390 spectrometer operating at 84.6 and 90 MHz, using CFCl_3 or TMS as internal standards, respectively. Positive chemical shifts are upfield from CFC_3 and downfield from TMS. Raman spectra were recorded on a Cary Model 83 using the 4880 Å exciting line. Gas chromatographic data were obtained using a Varian Aerograph GC with a thermal conductivity detector under isothermal conditions (135°) with a stainless steel column ($1' \times 10'$) packed with Poropak PS. For the GC determination of the quantitative composition of mixtures, uncorrected peak areas were used since response factors were not available for all compounds. The solid NF_4BF_4 was prepared from $\text{NF}_3-\text{F}_2-\text{BF}_3$ at low temperature using UV activation, which gives analytically pure material.

The simplest aromatic hydrocarbon studied in the previously referred to research effort was benzene. With NF_4^+ substrate mole ratios of about three, up to five hydrogens were substituted by F as shown in the following generalized equation.

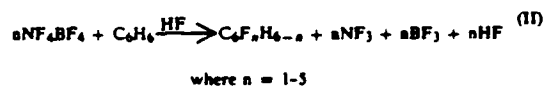

However, at these higher NF_4^+ to substrate ratios, the reaction was more difficult to control and more "char" formation was noted. Hexafluorobenzene was not observed as a product. If significant amounts had been formed, it would have easily been detected by mass spectroscopy since its base peak is the parent ion. Only trace quantities of partially saturated species, $\text{C}_6\text{F}_6\text{H}_2$ and $\text{C}_6\text{F}_7\text{H}$ were observed, indicating that very little addition occurred.

In order to determine the nature of the reaction, two substituted benzenes, $\text{C}_6\text{H}_5\text{CH}_3$ and $\text{C}_6\text{H}_5\text{NO}_2$ were also studied. These were chosen for their well known ability to differentiate between an electrophilic and a free radical reaction path, based on the observed ortho-meta-para product distribution.

In the toluene reaction, the ratio of NF_4^+ to toluene was in the range 2-4:1. Thus, an excess of fluorine was available (assuming one F/ NF_4^+ is available for substitution) and multisubstitution was expected. The result of a very rapid reaction is illustrated by the following equation:

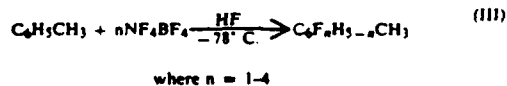

The mass spectra of the products strongly indicate that no side chain fluorination had occurred, in agreement with other spectroscopic evidence. Typical isomer distributions for the ring substitution were: o-F(15), m-F(8), p-F(15), 2,4 di-F(30), and mixed di- and tri-F(25). Obviously, o- and p- products predominate for

this electron rich ring, a result which is compatible with an electrophilic substitution process.

For the nitrobenzene reaction, a 3:10 mole ratio of $\text{NF}_4\text{BF}_4\text{F}$: substrate was used. Even under these conditions, this reaction was less vigorous than those of benzene or toluene, as exemplified by a slightly slower NF_3 evolution and the lack of "darkening" of the solution until the mixture was finally warmed to about 0°. Fluorine substitution occurred to give $\text{C}_6\text{F}_n\text{H}_{5-n}\text{NO}_2$ (where $n=1-4$) compounds. Minor amounts of FNO_2 (HF) $_n$ were formed and traces of $\text{C}_6\text{F}_n\text{H}_{4-n}$ species were observed, but overwhelmingly the NO_2 group was not displaced. The observed products were mainly monosubstituted with the following isomer distribution: o-F(16), m-F(62), and p-F(7).

The observation of predominantly ortho and para substitution and the lack of side chain fluorination in toluene, and the meta substitution in nitrobenzene establishes these NF_4BF_4 reactions as electrophilic substitutions.

For nitrobenzene, the yield of fluorinated products was not determined due to separation problems caused by the low volatility of the products and the large excess of nitrobenzene used. However, in view of the high relative amount of mono-F species, and the limited amount of charring, it is estimated that the yield of substituted products was high. For the much more reactive C_6H_6 and $\text{C}_6\text{H}_5\text{CH}_3$, yields varied widely. Volatile, fluorinated species were observed equivalent to 30-60% of the aromatic starting compounds.

The following examples are presented in order to point out the invention with greater detail. The examples, however, are illustrative only and are not to be construed as limiting the invention in any way.

EXAMPLE I

$\text{C}_6\text{H}_5\text{NO}_2$. To a stirred solution of $\text{C}_6\text{H}_5\text{NO}_2$ (10 mmol) in 5 ml HF at -78° was added dropwise over 30 min. a solution of NF_4BF_4 (2.88 mmol) in 5 ml HF. Reaction of the NF_4BF_4 was shown by an increase in pressure due to NF_3 evolution. When all the NF_4BF_4 had been added, the reaction was gradually warmed to 0° C. and left overnight. During the warming, the reaction solution changed from pale yellow to dark brown. Keeping the reaction ampoule at -45° , the NF_3 , HF, and other volatile materials were pumped away through -78° and -196° C. traps. After the majority of the HF was removed, the reactor was maintained at 0° C. The material passing the -78° C. fraction consisted of a few droplets of a liquid with a low vapor pressure at ambient temperature. Mass spectroscopy of the vapor from the drops showed minor amounts of aromatic fluorocarbons which did not contain NO_2 substituents. These were of the empirical formula $\text{C}_6\text{F}_n\text{H}_{6-n}$ ($n=1-4$). The principal ion peaks observed were m/e (assign.): 85($\text{NO}_2\text{F HF}$), 49 (NOF), and 30(NO). Examination of the liquid non-volatiles at 0° C. which remained in the reactor, by NMR spectroscopy, showed that five fluorinated compounds were present and all were found to be substituted nitrobenzenes by comparison of the observed chemical shifts with reported values. By measurement of the area of the resonances the amount of each compound was calculated: o- $\text{C}_6\text{FH}_4\text{NO}_2$ (14%), m- $\text{C}_6\text{FH}_4\text{NO}_2$ (62%), p- $\text{C}_6\text{FH}_4\text{NO}_2$ (6%), 2,6- or 3,5-difluoronitrobenzene (14%), and 2,4-difluoronitrobenzene. The large excess of $\text{C}_6\text{H}_5\text{NO}_2$ employed, and still present, masked the

^1H spectra of these products and thus the ^{19}F spectra were relied on for identification.

EXAMPLE II

$\text{C}_6\text{H}_5\text{CH}_3$. Toluene and NF_4BF_4 (1:4 molar ratio) were reacted by condensing the hydrocarbon onto the stirred HF solution of the salt at -78° C. Alternatively, toluene in HF at -78° C. was treated dropwise with a solution of NF_4BF_4 (1:2 molar ratio). In either case, instantaneous reaction occurred and the solution became black. After warming to 0° C. for a few hours, these reactions were worked up in the usual manner. Much tar like residue remained in the reactor in each case. Infrared spectroscopic examination of the volatile species, trapped at -78° C., showed strong bands near 1500 cm^{-1} confirming the presence of aromatic species. Mass spectra of these fractions showed in both experiments that only aromatic substitution products were present; these were of the empirical formula $\text{C}_7\text{F}_n\text{H}_{8-n}$ (where $n=1-4$). The low intensity of the m/e 69 and 51 peaks indicated the absence of CF_3 or CF_2H groups in these compounds with the observed intensities of these peaks being due to C_6FH_2 and C_6H_3 ions. From the reaction using a higher ratio of NF_4BF_4 to toluene, a significant amount of $\text{C}_6\text{F}_4\text{H}_2$ was found indicating some displacement of CH_3 from the ring. The NMR spectra of these products confirmed that various fluorotoluenes were present approximately in the amounts given (%): o- $\text{C}_6\text{FH}_4\text{CH}_3$ (15), p- $\text{C}_6\text{FH}_4\text{CH}_3$ (16), m- $\text{C}_6\text{FH}_4\text{CH}_3$ (8), 2,4-difluorotoluene (30), other di- and tri-fluorotoluenes (25), and 2,4,5,6-tetrafluorotoluene (7).

EXAMPLE III

C_6H_6 . Benzene and NF_4BF_4 were reacted using the same two techniques described for toluene. It was not possible to prevent charring and blackening of the benzene. Nevertheless, isolation of the volatile products condensable at -78° C. and examination of their mass spectra showed that substantial substitution of H by F had occurred, resulting in the formation of $\text{C}_6\text{F}_n\text{H}_{6-n}$ ($n=1-5$). C_6F_6 was not observed and only minor amounts of the addition products $\text{C}_6\text{F}_6\text{H}_2$ and $\text{C}_6\text{F}_7\text{H}$ were observed.

In consideration of the aforementioned detailed description, it is obvious that the present invention provides a novel method for substituting fluorine atoms for hydrogen atoms in an aromatic ring structure without affecting saturated or oxidized substituents. The results of this invention clearly demonstrates the utilization of NF_4^+ ion containing salts as powerful reagents for the introduction of fluorine atoms into aromatic rings by electrophilic substitution. Up to five hydrogens can be substituted in aromatic systems by a rapid substitution reaction, found to be highly efficient and relatively safe, before a much slower addition reaction takes over.

This slower fluorine addition reaction was also studied and found to produce the corresponding cyclo-hexadienes and hexenes. The addition reactions are novel and offer a controlled, high yield path to dienes which have previously only been obtained as parts of complex mixtures.

To obtain more data on the reactions of aromatics with NF_4^+ salts, an examination of aromatic systems, which were already highly fluorinated, was carried out. It was found that these starting materials are more inert toward the strongly fluorinating NF_4BF_4 , thus allowing better control of the reaction. Experiments were carried out using tetra-, penta-, and hexafluorobenzene as start-

ing materials. All reacted gradually at, or near, ambient temperature. All solutions and products were colorless throughout the reactions. Liberated NF_3 and excess, unreacted NF_4BF_4 were recoverable. The products were identified spectroscopically and most of them have been reported in the literature, making their identification unequivocal. The overall results are shown by the equations.

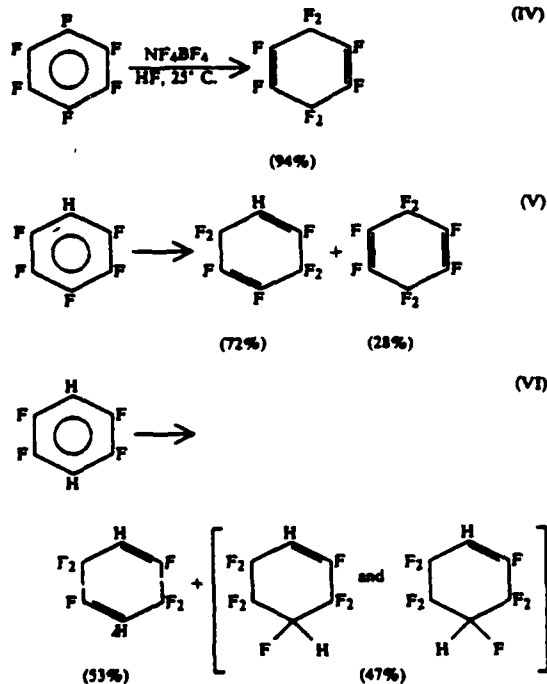

For these three highly fluorinated benzenes, the addition of the first two fluorines occurs in para position to each other (1,4 addition) and ortho to any hydrogen, if present. The addition of a second pair of fluorines cannot proceed by a 1,4 mechanism without changing the ring into a bicyclo form, which is generally encountered only under photolytic conditions. Thus, the second pair of fluorines undergoes a 1,2 addition to yield a cyclohexene.

For pentafluorobenzene, some substitution was also observed. It is not clear whether this is the result of a true substitution or of a addition-elimination reaction. In the case of $p\text{-C}_6\text{F}_4\text{H}_2$, the second F_2 addition produces the 1H,4H-octafluorocyclohexene which has two possible geometric isomers. Trace quantities of the saturated product, $\text{C}_6\text{F}_{10}\text{H}_2$, were also detected by mass spectroscopy.

In order to provide greater detail in connection with the addition reactions referred to above, Examples IV, V and VI are presented. In these addition reactions, almost no hydrogen substitutions occurred. The addition of the first pair of fluorine atoms always gave 1,4-cyclohexadiene in which the CF_2 group was ortho to hydrogen on the ring. The addition of the second pair of fluorine atoms results in the formation of cyclohexenes. These reactions occurred in high yield. All products were characterized spectroscopically and by comparison to literature data.

EXAMPLE IV

C_6F_6 . A sample of NF_4BF_4 (4.07 mmol) contained in a Teflon (FEP) ampoule was dissolved in anhydrous HF (4 ml) and cooled to -78°C . Hexafluorobenzene (1.25 mmol) was condensed into the ampoule which was then warmed gradually while stirring magnetically. After being kept overnight at $0^\circ\text{--}10^\circ\text{C}$., the clear, colorless solution was cooled to -78°C . and the volatile material quickly removed by condensation into a -196°C . trap. The -196°C . trap contained NF_3 (1.24 mmol) contaminated with traces of HF as shown by infrared spectroscopy. The reaction was allowed to continue for another day at room temperature. While maintaining the reaction ampoule at 0°C ., the volatile products and HF were separated by fractional condensation in a series of U-traps cooled at -45 , -78 , and -196 . The -196°C . fraction, NF_3 and HF, was discarded and the -45°C . trap was empty. The -78°C . trap contained a white solid, which melted to a colorless liquid above 0°C . Examination of this material by infrared and gas chromatography showed it to be 1,4-perfluorocyclohexadiene (1.18 mmol, 94.3% yield, based on C_6F_6) with a slight amount (2-3%) of unreacted C_6F_6 . Intense ions in the mass spectrum were observed at m/e (assignment): 224(C_6F_8), 205(C_6F_7), 186(C_6F_6), 155(C_5F_5 , base), 136(C_5F_4), 124(C_4F_4), 117(C_5F_3), 105(C_4F_3), 93(C_3F_3), 86(C_4F_2), 74(C_3F_2), 69(CF_3), 55(C_3F), and 31(CF). The ^{19}F NMR spectrum showed two equal area multiplets at 113.1 and 158.3 ppm in agreement with the literature for 1,4- C_6F_8 . A white solid remained in the reaction ampoule and was shown by Raman spectroscopy to be NF_4BF_4 (1.48 mmol).

EXAMPLE V

$\text{C}_6\text{F}_5\text{H}$. As before, a mixture of NF_4BF_4 (4.29 mmol) and $\text{C}_6\text{F}_5\text{H}$ (1.35 mmol) in HF was stirred and warmed during several hours from -78°C . toward ambient temperature where it was kept for 12 hours. Evolved NF_3 (3.3 mmol) was monitored. After several more hours of stirring at room temperature, the products were separated by vacuum fractionation through U-traps cooled at -45 , -78 , and -196°C . All material passed the -45° trap except for a small amount of NF_4BF_4 remaining in the reactor. The -196°C . fraction was discarded. The -78°C . trap contained 1.24 mmol of a colorless liquid whose infrared spectrum indicated that it was composed of more than one cyclohexene [1170(ms), 1740(s), and 1720 cm^{-1} (vs)], as well as unreacted $\text{C}_6\text{F}_5\text{H}$. Gas chromatography showed three components which were analyzed individually by mass spectroscopy. In order of elution they were; (1) 1,4- C_6F_8 , 26.1%, (2) 1H-heptafluorocyclohexa-1,4-diene, 66.3%, and (3) C_6FH , 7.6% with the composition based on GC peak areas. The mass spectra of the fractions agreed very well with published data for the assigned compounds. In addition, the ^{19}F NMR spectra confirmed the formulated structures. For 1-H heptafluoro-cyclohexa-1,4-diene, a literature report of the NMR spectrum could not be found, but by comparison with related compounds it was apparent that the observed resonances and area ratios were reasonable for that structure. Chemical shifts of H or F, ppm or δ (rel. F peak area): 1-H, 5.93; 2-F, 127.7(1); 3-F, 115.2(2); 4-F, 160(1); 5-F, 155(1); 6-F, 101.7(2). The conversion of the $\text{C}_6\text{F}_5\text{H}$ was 92%. The composition of the product was 28% 1,4- C_6F_8 and 72% 1,4- $\text{C}_6\text{F}_7\text{H}$, with a total of 91% of the organic material being recovered.

EXAMPLE VI

$p\text{-C}_6\text{F}_4\text{H}_2$. A mixture of NF_4BF_4 (4.18 mmol) and $p\text{-C}_6\text{F}_4\text{H}_2$ (1.43 mmol) in 4 ml HF at -78°C . was stirred and warmed to 0°C . over 3 hours, followed by overnight stirring at $0^\circ\text{--}20^\circ\text{C}$. Fractional condensation at -78°C . and -196°C . was used to separate HF and NF_3 from the products which were retained in the -78°C . trap. No unreacted NF_4BF_4 remained in the reactor. The original $-78\text{--}20^\circ\text{C}$ fraction was further separated by refractionating through -45 and -78°C . traps. The former contained 0.21 mmol of a colorless liquid whose infrared spectrum showed a strong band at 1710 cm^{-1} typical for the double bond of a --CF=CH-- group. Analysis using GC/MS procedures showed this material to be 1H, 4H-hexafluorocyclohexa-1,4-diene. Prominent mass spectral peaks were found at m/e (assign.): 188($\text{C}_6\text{F}_8\text{H}_2$), 169($\text{C}_6\text{F}_7\text{H}_2$), 150($\text{C}_6\text{F}_6\text{H}_2$), 138($\text{C}_5\text{F}_4\text{H}_2$), 137($\text{C}_5\text{F}_4\text{H}$), 119($\text{C}_5\text{F}_3\text{H}_2$, base), 99($\text{C}_3\text{F}_2\text{H}$), 94($\text{C}_3\text{F}_3\text{H}$), 93(C_3F_3), 88($\text{C}_4\text{F}_2\text{H}_2$), 81($\text{C}_3\text{F}_2\text{H}_2$), 80($\text{C}_3\text{F}_2\text{H}$), 75($\text{C}_3\text{F}_2\text{H}$), 69(CF_3), 68(C_4FH), 61(C_3H), 57(C_3FH_2), 56(C_3FH), 51(CF_2H), 50(CF_2), 44(C_2FH), and 31(CF). The ^{19}F NMR spectrum for this compound agreed with published data. Similar analysis of the -78°C . fraction showed it to be a mixture of unreacted $p\text{-C}_6\text{F}_4\text{H}_2$, the above described 1H,4H cyclohexa-1,4-diene, and a compound of empirical formula $\text{C}_6\text{F}_8\text{H}_2$. An infrared spectrum of the latter compound showed bands at cm^{-1} (intens.): 3070(w), 2960(w), 1710(ms), 1380(s), 1355(w), 1260(m), 1150(s), 1065(m), 1030(m), 743(mw), 637(w), 580(w), and 582(w). The bands near 3000 cm^{-1} are assignable to the carbon-hydrogen stretches of --C=C--H and C--H groups while the 1710 cm^{-1} peak is typical of a --CF=CH-- stretching vibration. Strong ion peaks in the mass spectrum were at m/e (assign.): 226($\text{C}_6\text{F}_8\text{H}_2$),

207($\text{C}_6\text{F}_7\text{H}_2$), 186(C_6F_6), 157($\text{C}_5\text{F}_3\text{H}_2$), 144($\text{C}_4\text{F}_3\text{H}$), 137($\text{C}_5\text{F}_4\text{H}$), 119($\text{C}_5\text{F}_3\text{H}_2$), 117(C_5F_3), 113($\text{C}_4\text{F}_4\text{H}$), 94($\text{C}_3\text{F}_3\text{H}$), 93(C_3F_3), 75($\text{C}_3\text{F}_2\text{H}$), 69(CF_3), 57(C_3FH_2), 51(CF_2H), and 50(CF_2). The NMR spectra of the -78°C . fraction confirmed the presence of $p\text{-C}_6\text{F}_4\text{H}_2$, 1H,4H-hexafluorocyclohexa-1,4-diene, and 1H,4H-octafluorocyclohexene; chemical shift of H or F, ppm or (rel. area) of 1H,4- $\text{C}_6\text{F}_7\text{H}_2$: 1-H, 5.1(1); 2-F, 121.5(1), 3-F, 118.1(2), 4-H, 4.7(1), 4-F, 134.4(1), 5-F, 130.3(2), 6-F, 110.4(2). The conversion of starting material was 78%. The composition of the products was 53% $\text{C}_6\text{F}_8\text{H}_2$ and 47% $\text{C}_6\text{F}_7\text{H}_2$ with a total of 92% of the organic material being recovered.

As will be clearly evident to those skilled in the art, various alterations and modifications of the present invention can be made without departing from the spirit thereof, since it is intended that the invention be limited only by the scope of the appended claims.

What is claimed is:

1. A process for adding flourine across the double bonds in a highly halogenated aromatic hydrocarbon which comprises the step of effecting an addition reaction between a highly halogenated aromatic hydrocarbon and a hydrogen fluoride solvent solution of NF_4BF_4 .

2. A process in accordance with claim 1 wherein said highly halogenated aromatic hydrocarbon is tetrafluorobenzene.

3. A process in accordance with claim 1 wherein said highly halogenated aromatic hydrocarbon is pentafluorobenzene.

4. A process in accordance with claim 1 wherein said highly halogenated aromatic hydrocarbon is hexafluorobenzene.

• • • • •

40

45

50

55

60

65

END

5-87

DTIC