

6

AD-A164 293

DTIC FILE COPY

DTIC
ELECTE
FEB 18 1986
S D D

DISTRIBUTION STATEMENT A
Approved for public release;
Distribution Unlimited

McLEAN RESEARCH CENTER, INC.
1483 Chain Bridge Road, Suite 205
McLean, Virginia 22101

Reproduced From
Best Available Copy

86 2 14 . 00

20000801239

2

Final Technical Report
MRC-386
MORTAR BALLISTICS COMPUTER, M23

1 February 1986

Prepared by
Filmore Richter

Approved by
George Schechter

for

U.S. ARMY BELVOIR R&D CENTER
Fort Belvoir, VA

and

U.S. ARMY ARMAMENT R&D CENTER
Dover, NJ

Contract No.: DAAK70-84-D-0052, TASK 0011

McLEAN RESEARCH CENTER, INC.
1483 Chain Bridge Road, Suite 205, McLean, VA 22101 (703) 734-1410

DISTRIBUTION STATEMENT A
Approved for public release;
Distribution Unlimited

DTIC
SELECTE
FEB 18 1986
S **D**
D

UNCLASSIFIED.

SECURITY CLASSIFICATION OF THIS PAGE (When Data Entered)

REPORT DOCUMENTATION PAGE		READ INSTRUCTIONS BEFORE COMPLETING FORM
1. REPORT NUMBER	2. GOVT ACCESSION NO.	3. RECIPIENT'S CATALOG NUMBER
	AD-A164	293
4. TITLE (and Subtitle)		5. TYPE OF REPORT & PERIOD COVERED
Mortar Ballistics Computer, M23		Final Technical Jul-Dec 1985
		6. PERFORMING ORG. REPORT NUMBER
		MRC-386
7. AUTHOR(s)		8. CONTRACT OR GRANT NUMBER(s)
Filmore Richter George Schecter		DAAK70-84-D-0052 Task 0011
9. PERFORMING ORGANIZATION NAME AND ADDRESS		10. PROGRAM ELEMENT, PROJECT, TASK AREA & WORK UNIT NUMBERS
McLean Research Center, Inc. 1483 Chain Bridge Rd., Suite 205 McLean, VA 22101		
11. CONTROLLING OFFICE NAME AND ADDRESS		12. REPORT DATE
US Army Armament R&D Center Dover, N.J. 07801-5001 Attn: AMCPM-MCD		1 Feb 86
		13. NUMBER OF PAGES
		180
14. MONITORING AGENCY NAME & ADDRESS (if different from Controlling Office)		15. SECURITY CLASS. (of this report)
US Army Belvoir R&D Center Fort Belvoir, VA 22060 Attn: STRBE-HP		UNCLASSIFIED
		15a. DECLASSIFICATION/DOWNGRADING SCHEDULE
		N/A
16. DISTRIBUTION STATEMENT (of this Report)		
Approved for public release; distribution unlimited.		
17. DISTRIBUTION STATEMENT (of the abstract entered in Block 20, if different from Report)		
18. SUPPLEMENTARY NOTES		
19. KEY WORDS (Continue on reverse side if necessary and identify by block number)		
COMPUTER, BALLISTICS, MORTAR, TYPE CLASSIFICATION, MATERIEL RELEASE		
20. ABSTRACT (Continue on reverse side if necessary and identify by block number)		
The Mortar Ballistics Computer, M23, was found to be suitable for type reclassification from Limited Procurement to Standard and full release approval was granted for full production and deployment. Program Management Documentation is appended, including the Computer Resources Management Plan, Materiel Release, Production Validation IPR package.		

DD FORM 1473 EDITION OF 1 NOV 68 IS OBSOLETE

UNCLASSIFIED
SECURITY CLASSIFICATION OF THIS PAGE (When Data Entered)

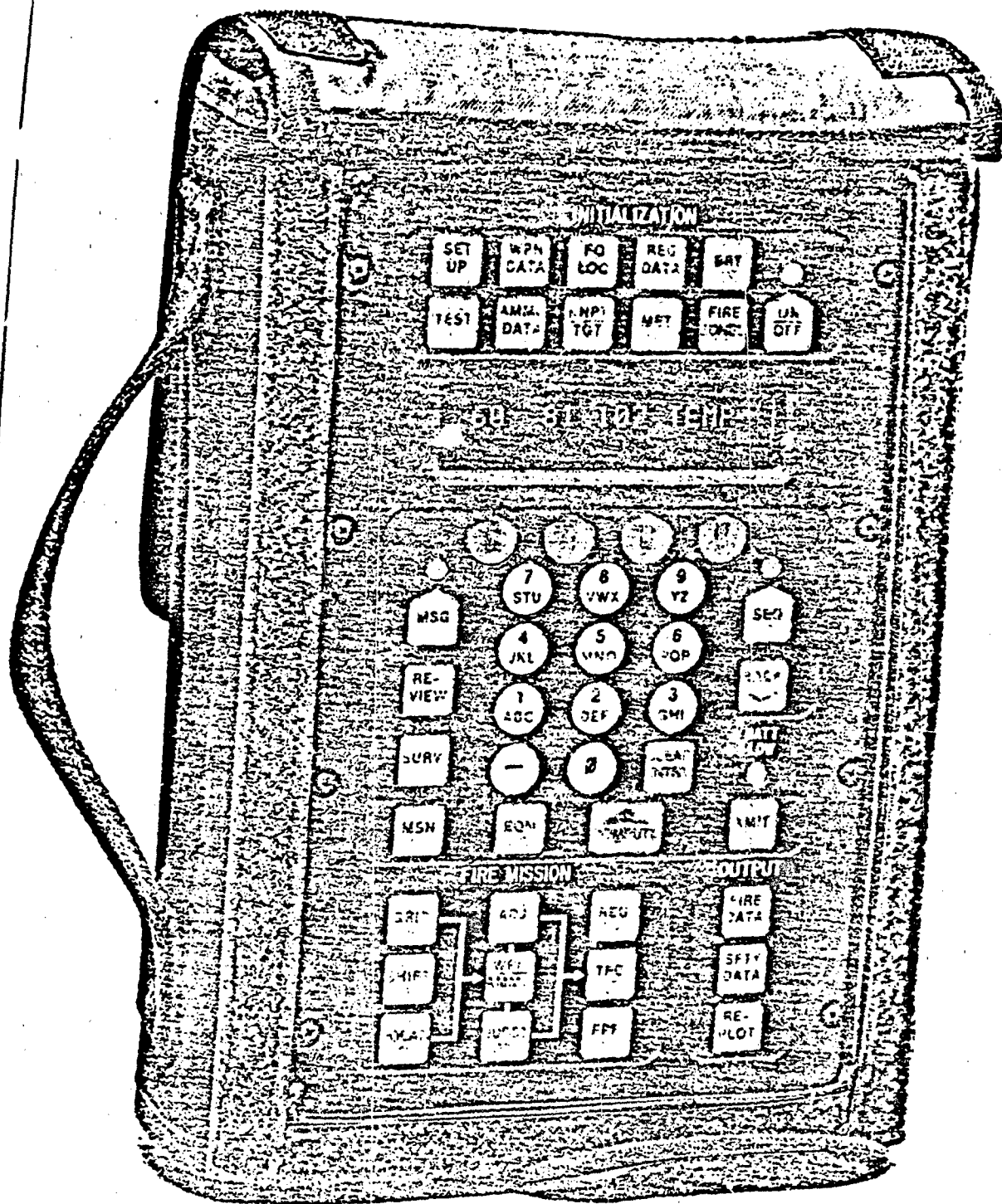

1 Feb 86

STUDY GIST
TROSCOM

MORTAR BALLISTICS COMPUTER, M23

The Principal Findings

1. The Mortar Ballistics Computer, M23, was found to be suitable for Type Reclassification from Limited Procurement to Standard, and for full release for production and deployment to the field.

2. All required Program Management Documents were prepared or put in order, all necessary reviews were conducted successfully, and full release approval was obtained.

Main Assumptions

It was assumed that current decisions would be consistent with past positions taken by TRADOC and AMC, and that the modifications required were well within the state-of-the-art, very low risk, and low cost.

Principal Limitations

The User community is eager to have this item issued to the field, and the only practical limitations have to do with the urgent target date for full release.

Scope of the Study

It was required that all elements of the system acquisition plan, management documentation, and the system itself be ready to support the Type Reclassification and full materiel release decisions. Special emphasis was required in the preparation of the Computer Resources Management Plan, Materiel Release document package, Production Validation IPR package, and the Engineering Changes identified in previous reviews.

Objectives

To achieve a successful Type Reclassification from Limited Procurement to Standard, and to obtain approval for full release for production and deployment.

Basic Approach

The approach was straightforward: to verify readiness of the system for full release in all pertinent respects and to comply with all applicable documentation requirements.

Reason for Performing the Study

To enable full production to meet full deployment needs.

Sponsor

U.S. Army Belvoir R&D Center and U.S. Army Armament R&D Center.

Performing Activity and Principal Investigator

McLean Research Center, Inc. (MRC)
Principal Investigator: Filmore Richter & George Schecter

Comments and Questions

McLean Research Center, Inc.
1483 Chain Bridge Road, Suite 205
McLean, VA 22101

Attn: Mr. George Schecter, (703) 734-1410

Actions Taken as a Result of Findings

The Mortar Ballistics Computer, M23, was Type Reclassified from Limited Procurement to Standard, and full release was authorized for production and deployment.

DTIC/DLSIE Accession Number of Final Report

To be assigned.

ABSTRACT

This technical report for Mortar Ballistics Computer, M23 (MBC), contains the technical and management support items developed to support the MBC project milestones and life cycle planning factors (July through December 1985) to achieve type reclassification to "Standard" and obtain authority to release the MBC for field issue.

STUDY APPROACH

See p 2

The technical effort and activity began with a review of pertinent literature, documentation requirements, and policy regarding type classification, materiel release, and management of computer resources in battlefield automated systems.

Selected Armaments Research and Development Center (ARDC) personnel -- Development Project Office and other offices within ARDC -- were contacted to gain insights into potential problem areas.



Accession For	
NTIS CRA&I	<input checked="" type="checkbox"/>
DTIC TAB	<input type="checkbox"/>
U.announced	<input type="checkbox"/>
Justification	
By	
Distribution/	
Availability Codes	
Dist	Avail and/or Special
A-1	

TABLE OF CONTENTS

	<u>TITLE</u>	<u>PAGE</u>
Section 1. INTRODUCTION		
1.1	Background	1
1.2	Description of Materiel	2
1.3	Objectives	3
1.4	Scope	4
Section 2. DETAILS OF TASKS		
2.1	Task 1. Computer Resources Management Plan	5
2.2	Task 2. Materiel Release	6
2.3	Task 3. Production Validation - IPR	8
2.4	Task 4. Engineering Changes	11
ANNEX A	REFERENCES	A1
ANNEX B	LIST OF ACRONYMS	B1
ANNEX C	LETTER REQUIREMENT FOR MORTAR FIRE CONTROL CALCULATOR	C1
ANNEX D	DEVA IPR RECOMMENDATIONS FOR TYPE CLASSIFICATION OF COMPUTER, BALLISTICS: MORTAR, XM23	D1
ANNEX E	PRODUCT IMPROVEMENTS IDENTIFIED IN THE SCOPE OF WORK (CONTRACT)	E1
ANNEX F	COMPUTER RESOURCES MANAGEMENT PLAN FOR THE COMPUTER, BALLISTICS: MORTAR, M23 (FINAL DRAFT)	F1

TABLE OF CONTENTS (Continued)

	<u>TITLE</u>	<u>PAGE</u>
ANNEX G	SUPPORTING DATA FOR MATERIEL RELEASE OF COMPUTER, BALLISTICS: MORTAR, M23	G1
ANNEX H	COPY OF VU-GRAPHS USED BY DPO AT THE MATERIEL REVIEW BOARD	H1
ANNEX I	FULL RELEASE OF COMPUTER, BALLISTICS: MORTAR, M23	I1
ANNEX J	MATERIEL STATUS RECORD SUBMISSION	J1

SECTION 1. INTRODUCTION

1.1 BACKGROUND

a. Speed and accuracy are essential in locating and attacking targets and are major contributing factors to success in battle. The infantry rifle company, infantry battalion, and armor units are highly dependent on the fire support provided by organic mortars. By automating the Fire Direction Center (FDC), more speed, accuracy, and responsiveness to fire requests are achieved. The calculator assists greatly in rapidly computing firing data. This permits immediate engagement of targets without expending large amounts of ammunition in fire adjustment, and minimizes the time for target evasive maneuver or hardening.

b. Infantry mortar systems firing data are presently calculated through the use of graphical fire control equipment. Operation of this equipment is time consuming and the procedures involved make it subject to human error. The accuracy of the firing data provided to the mortar gunners by the FDC depends on the skill and experience of the soldier computing the data. Therefore, the need was recognized for a data calculator to replace the graphical fire control equipment as a primary method for determining mortar firing data in a timely manner under prevailing conditions of climate and enemy actions. The calculator is to be used in mortar fire direction centers.

c. The technical feasibility of the Mortar Ballistics Computer (MBC), previously called the Mortar Fire Control Calculator (MFCC), was proven with the fabrication and concept evaluation testing of a feasibility model in FY74 by the U.S. Army Infantry Center (USAIC) and Human Engineering Laboratory (HEL).

d. The USAIC prepared and forwarded a requirements document. The Letter Requirement (LR) for the MFCC was approved 13 December 1977 (Annex C). A full-scale development (FSD) contract was issued in July 1979.

e. Development Test II (DTII) and Operational Test II (OTII) on production prototype models were conducted by the U.S. Army Electronic Proving Ground (USAEPG), Fort Huachuca, Arizona, and the U.S. Army Infantry Board (USAIB), Fort Benning, Georgia, respectively, between October 1980 and January 1981.

f. A Development Acceptance In-Process Review (DEVA-IPR) was held on 1 July 1981, resulting in a determination that the MBC essentially met the requirements delineated in the LR, was acceptable for calculating infantry mortar systems firing data, is acceptable for introduction into the Army inventory after improvements have been incorporated into the system, and recommended that the MBC be type classified Limited Procurement (LCC-U). The urgent requirement reflects the need to equip key Rapid Deployment Force units and to establish a training base (see Annex D).

g. The initial production contract was awarded to Magnavox Company, Fort Wayne, Indiana, on 26 May 1983 under contract DAAK10-83-C-0135. The product improvements identified in the Scope of Work section of the above reference contract is contained in Annex E.

1.2 DESCRIPTION OF MATERIEL

The MBC is a small, hand-portable, rugged computer developed to replace current graphical fire control equipment as the principal means of computing firing data in the mortar FDC.

→ It calculates all fire control information required to lay and fire the 60mm, the 81mm, and the 107mm mortars and will accommodate all ammunition types for these mortars currently in use. All pertinent computational parameters utilized in the modified point mass ballistics techniques are taken into account to achieve accuracies and computation times not previously attainable. It also has the capacity to store battlefield information, including the locations of forward observers, weapons, known points, and no-fire zones, and to store message backlogs. It communicates with TACFIRE elements via digital burst transmissions, assuring the efficient transfer of mission data without relying on voice communication. ←

Fire mission data may be received by the MBC Fire Direction Center (FDC) by either voice commands (radio or field wire equipment) or TACFIRE formal digital messages. Fire mission execution consists of receiving a fire request, selecting the desired weapon and ammunition, selecting the tactical fire control to shoot a mission, and computing and issuing firing orders. When fire mission data are received by voice, the data must be manually entered and read out of the MBC. When the data are received by digital communication, from the Digital Message Device (DMD), the fire mission is automatically entered into the MBC.

1.3 OBJECTIVES

The MBC is entering the production and deployment phase of the acquisition cycle and the mid-term and long-term readiness plans and documentation were to be updated and developed as required. This includes:

- a. Revision of the Computer Resources Management Plan (CRMP),
- b. Updating of the Materiel Release (MR) documentation,
- c. Development of the Production Validation In-Process Review (PROD-VAL-IPR) documentation, and
- d. Analysis, evaluation, and integration of proposed changes to the item configuration.

1.4 SCOPE

The following tasks were accomplished to achieve the stated objectives:

- a. Task 1. The Computer Resources Management Plan was revised to be in consonance with the updated performance and technical requirements of the MBC.

- b. Task 2. A Materiel Release supporting data package was prepared for the New Materiel Release Review Board when convened to consider full release of the MBC.

- c. Task 3. A Production Validation IPR supporting data package was prepared for the IPR Chairman to consider reclassification of the MBC from Limited Procurement (LCC-U) to Standard.

- d. Task 4. Technical evaluations were conducted on proposed engineering changes and the recommendations were submitted to the Development Project Officer for his consideration and implementation.

SECTION 2. DETAILS OF TASKS

2.1 TASK 1. COMPUTER RESOURCES MANAGEMENT PLAN (CRMP)

The CRMP is the primary document used to establish the necessary framework and support system for computer software control during production and after deployment. The CRMP identifies computer resources acquisition and life cycle planning factors and insures that these factors are adequately considered in the acquisition planning process.

A review of the current CRMP indicated that this plan had to be updated to reflect the software change activity during initial production. Some of the changes were corrective actions as specified at the DEV-IPR (see Annex D); and others were product improvement changes as specified in the production contract (see Annex E).

The updated CRMP addressed the following:

a. The integration of computer resources into the MBC system and the test and evaluation of the system to determine the quality of the MBC.

b. The computer programs required to support the production, deployment, and post deployment support of the MBC system.

c. Personnel requirements for developing and supporting computer resources. Computer resources, as defined in DARCOM-R 70-16, is the totality of computer equipment, computer programs, computer data, associated computer documentation, contractual services, personnel, and computer supplies.

d. Provisions for the transfer of system management from the Development Project Officer to the Life Cycle Software Support (LCSS) Center.

e. Management planning for the acquisition, test, evaluation, and post deployment software support for all functions related to computer resources in support of the MBC system.

f. The method by which the post deployment software support procedures are tested.

A preliminary draft CRMP was circulated among responsible personnel of the following agencies and offices: U.S. Armament Munitions and Chemical Command; U.S. Army Test and Evaluation Command; U.S. Army Training and Doctrine Command; Development Project Office (M23); U.S. Army Armament Research and Development Center (Product Assurance, Test Measurement and Diagnostic Equipment, and Life Cycle System Support offices). The recommendations and changes proposed by the foregoing agencies and offices were incorporated into the final draft.

The final draft, Annex F, was forwarded to the Life Cycle System Support Division for final review and submission to the U.S. Army Materiel Command for approval.

2.2 TASK 2. MATERIEL RELEASE (MR)

Materiel Release certification is required for new and follow-on acquisition of end items, and for first time and follow-on production. The materiel release program requires management controls for review, evaluation, and certification that Army materiel is suitable for release for field issue. A

formal review board is established at ARDC to verify that all materiel release requirements have been met, documented, and that an audit trail is provided.

In the case of the Mortar Ballistics Computer, the task was to determine through documented data that the MBC is suitable for issue in terms of quality, performance, safety, environmental requirements, reliability, maintainability, and supportability. Further, it was to be determined that required New Equipment Training had been provided and that a Materiel Fielding Plan had been developed, coordinated with gaining commands, and a Materiel Fielding Agreement had been signed.

The final draft of the supporting data for materiel release, Annex G, was prepared for the Development Project Officer for submission to the Materiel Review Board.

A series of vu-graphs representing a checklist of questions/answers, Annex H, was prepared for the Development Project Officer to be used at his appearance and presentation before the formal Materiel Release Board. This material addressed the major items of concern to the board such as: the development and production status of the MBC project; inspection and test reports; safety and hazard evaluations; materiel fielding plans; hardware and software support equipment including test measurement and diagnostic equipment; maintenance plans; technical manuals; and training.

In summary, there were conditions or limitations that could have precluded release of the Mortar Ballistics Computer for field use. A full release of the initial production quantity of MBC was approved by the AMCCOM Deputy Commanding General for Armament and Munitions on 7 November 1985 (see Annex I).

2.3 TASK 3. PRODUCTION VALIDATION IN-PROCESS REVIEW

In-process reviews (IPR) are held during the life cycle of programs to review the project status and recommend a course of action. In this instance, the Production Validation IPR was to be convened to provide recommendations as a basis for type classification of, and production decisions for, the Mortar Ballistics Computer by the appropriate level of authority.

At the Development Acceptance IPR, held in 1981, it was recommended that until specified improvements have been incorporated into the system and tested, the MBC be type classified "Limited Procurement" (see Annex D). The limited procurement, a low rate of production, provided adequate quantity production units for First Article and Initial Production Testing.

The hardware and software improvements delineated in the DEVA-IPR recommendations were incorporated into the MBC during the limited production phase without further development effort. First Article and Initial Production testing of the initial production units was conducted by the contractor and TECOM, respectively, during the period July-December 1984.

An in-depth review was conducted of the following documents:

1. Letter, TRADOC, ATCD-M-I, 30 Dec 77, subject: Letter Requirement (LR) for Mortar Fire Control Calculator (MFCC), TRADOC ACN 16906.

2. Letter, ARRADCOM, DRSMC-SD(D)(XM23), 12 Jun 84, subject: In-Process Review (IPR) Recommendations for Computer Ballistics: Mortar, XM23.

3. DRDAR-QA Form 337, Evaluation of Acceptance Inspection Equipment Designs, 7 Dec 84, for the M23 Mortar Ballistic Computer.

4. First Article Test Report for Mortar Ballistics Computer (MBC), M23, Dec 84, prepared under contract DAAK10-83-C-0135 for U.S. Army Armament Research and Development Command, CDRL Item A034.

5. MIL-C-70489, Prime Item Product Fabrication for Computer Set, Ballistics: Mortar M23, 25 Jan 85.

6. Final Report, First Article/Initial Production Test (FA/IPT) of Computer, Ballistics: Mortar, M23, WSMR, Jan 85.

7. Letter, Magnavox Electronic System Company, 25 Jan 85, subject: DAAK10-83-C-0135 MBC Humidity Test.

8. Letter, WSMR, STEWS-TE-LG, 31 Jul 85, subject: Software Verification Test for the Computer, Ballistics: Mortar (MBC), M23.

The review indicates that the previously identified problems at the DEVA-IPR have been corrected. During First Article/Initial Production Test, four new software deficiencies were uncovered but of such a nature that they could be corrected prior to full-scale production with minimal risk. The noted deficiencies were as follows:

1. The MBC does not permit individual piece adjustments after registration.

2. The test for charges greater than 32 for the 107mm carrier-mounted mortars elevated to 1065 mils is reversed.

3. The MBC will not accurately compute 107mm mortar high angle solutions.

4. The MBC keyboard will lock up and preclude any subsequent actions.

A Pre-IPR was conducted by letter to determine the AMC position. The substance of the letter was that the MBC: (1) meets the requirements delineated in the Letter Requirement (LR) against which it was evaluated, (2) is acceptable for calculating Infantry Mortar Systems firing data, (3) is acceptable for introduction into the Army inventory, (4) should be reclassified as Standard, and (5) software changes will be incorporated into the system prior to full-scale production. The above proposed AMC position was reviewed and concurred in by the voting members representing AMCCOM, ARDC, and TECOM.

Subsequent to the Pre-IPR, a Production Validation IPR package was prepared and distributed. The PROD-VAL-IPR Package covered all aspects of the program from the DEVA-IPR through First Article/Initial Production Testing and included the documentation attesting to the acceptability, producibility, safety, and logistic supportability of the MBC.

In the interim between the Pre-IPR and the scheduled PROD-VAL-IPR, the software changes to correct the deficiencies uncovered during FAT/IPT were incorporated into the MBC and

successfully retested by TECOM. Since there were no unresolved problems at this time, it was recommended that the IPR voting members consider the possibility of conducting the PROD-VAL-IPR by mail in lieu of attending a formal meeting at ARDC. This recommendation was acceptable and a correspondence IPR was conducted by the chairperson. As a result of that IPR, both the U.S. Army Training and Doctrine Command (TRADOC) and the U.S. Army Logistics Evaluation Agency (LEA) concurred in the type reclassification "Standard." Headquarters, Army Materiel Command (AMC) concurred in the Type Classification Standard without exception. A Memorandum for Record and the Type Classification Recommendation were prepared and forwarded to Commanding General, AMCCOM, for signature/approval.

Subsequent to the approval of the reclassification action, the record of decision and action on the type classification (Standard) of the MBC together with documentation were submitted to the U.S. Army Materiel Status Office for recording and distribution to Headquarters, Department of the Army (see Annex I).

2.4 TASK 4. ENGINEERING CHANGES

During this period, several engineering changes proposed by the current production contractor were reviewed and evaluated. The conclusions reached after evaluation, and the suggested actions to be taken in each instance, were submitted to the Development Project Officer (DPO) for his consideration in the problem solution.

These changes were primarily in the areas of micro-chips and other semi-conductor devices, and are classified into two categories:

1. Potential (near-future) non-availability of some components specified in the technical data package.

2. Modifications/changes in component specifications resulting from changes in suppliers' manufacturing processes.

A major claim against the Government, submitted by a contractor, was reviewed and evaluated. The findings and recommendations were presented to the DPO for his consideration during ensuing discussions with the Contracting Officer and the legal office.

Currently, the Engineering Change Proposals are yet to be negotiated with the initial and follow-on production contractors and the above mentioned claim is in litigation. Therefore, any disclosures regarding these pending actions is considered procurement sensitive, premature, and beyond the scope of this task.

With the impending deprojectizing of the Development Project Office, the technical responsibility during the production and deployment phase of the MBC life cycle is being assigned to Program Manager, Mortars. Consequently, a list of pertinent documents was prepared for transmittal to the Program Manager's Office. This effort also entailed an update of the five-year production schedule (through FY90) and a revision to the in-house funding synopsis for FY85 and FY86 allocations.

ANNEX A

REFERENCES

DEPARTMENT OF DEFENSE DIRECTIVES (DODD)

- 5000.1 Major Systems Acquisition
- 5000.3 Test and Evaluation
- 5000.39 Acquisition and Management of Integrated Logistic Support for Systems and Equipment

ARMY REGULATIONS (AR)

- 11-18 Cost Analysis Program
- 70-1 Systems Acquisition Policy and Procedures
- 70-2 Materiel Status Recording
- 70-10 Test and Evaluation during Development and Acquisition of Materiel
- 70-37 Configuration Management
- 70-61 Type Classification of Army Materiel
- 71-3 User Testing
- 700-127 Integrated Logistic Support
- 702-3 Army Materiel Systems Reliability, Availability, and Maintainability (RAM)
- 702-9 Production Testing of Army Materiel
- 750-1 Army Materiel Maintenance Concepts and Policies
- 750-43 Test, Measurement, and Diagnostic Equipment (including Prognostic Equipment and Calibration Test/Measurement)
- 1000-1 Basic Policies for System Acquisition

DARCOM REGULATIONS (DARCOM-R)

11-1 Systems Analysis
11-27 Life Cycle Management of DARCOM Materiel
70-1 Transition of Management Responsibility from a
Research and Development Command Manager to a
Materiel Readiness Command Manager.
70-16 Management of Computer Resources in Battlefield
Automated Systems
70-46 Technical Data Package for Procurement and Production
70-55 Component Testing
70-60 Materiel Status Office
700-13 Integrated Logistic Support Performance Evaluation
Report (ILSPER)
700-15 Integrated Logistic Support
700-34 Release of Materiel for Issue

DARCOM SUPPLEMENTS TO ARMY REGULATIONS

Suppl 1
to
AR 70-37 Configuration Management

Suppl 1
to
AR 700-127 Integrated Logistics Management

Suppl 1
to
AR 702-3 Army Materiel Systems Reliability, Availability, and
Maintainability

MILITARY STANDARDS (MIL STD)

480	Configuration Management
490	Specification Practices
882	System Safety Program for System and Associated Subsystems and Equipment, Requirement for
1388	Logistic Support Analysis
S83490	Specifications, Types and Forms

ANNEX B

LIST OF ACRONYMS

ANNEX B

LIST OF ACRONYMS

AMC	U.S. Army Materiel Command
AMCCOM	U.S. Armament Munitions and Chemical Command
AR	Army Regulation
ARDC	U.S. Army Research and Development Center
ATE	Automatic Test Equipment
BAS	Battlefield Automated System
BIT	Built-In-Test
CCB	Configuration Control Board
CM	Configuration Management
CRMP	Computer Resources Management Plan
DA	Department of the Army
DEVA-IPR	Development Acceptance In-Process Review
DOD	Department of Defense
DODD	Department of Defense Directive
DPO	Development Project Officer
DT/OT	Development Test/Operational Test
ECP	Engineering Change Proposal
FAT	First Article Test
FDC	Fire Direction Center
FQT	Formal Qualification Test
FSD	Full Scale Development
FUE	First Unit Equipped
HFE	Human Factors Engineering
ILS	Integrated Logistics Support
IOC	Initial Operational Capability
IPR	In-Process Review
IPT	Initial Production Test

ANNEX C

LETTER REQUIREMENT (LR)
FOR
MORTAR FIRE CONTROL CALCULATOR

USATRADO ACN 16906



DEPARTMENT OF THE ARMY
HEADQUARTERS UNITED STATES ARMY TRAINING AND DOCTRINE COMMAND
FORT MONROE, VIRGINIA 23651

ATCD-M-I

30 December 1977

SUBJECT: Letter Requirement (LR) for Mortar Fire Control Calculator
(MFCC), USATRADO ACN 16906

SEE DISTRIBUTION

1. Reference AR 71-9.
2. Subject LR (inclosure 1) was approved on 13 December 1977. The following information is applicable to this document:
 - a. System designation: Nonmajor.
 - b. Materiel Developer: DARCOM.
 - c. Combat Developer: USATRADO.
 - d. User Representative: USATRADO.
 - e. Trainer: USATRADO.
 - f. Logistician: USALEA.
 - g. CARDS Reference Number: 112b.
 - h. Operational Test Responsibility: USATRADO.
 - i. USATRADO Proponent Activity: USA Infantry Center.
3. Completion of action on MFCC BOIP, number 78-0018-I (USATRADO ACN 36674), is expected NLT 15 March 1978.

CF: Ch, Dev Eng
MRR - E Brezon
Prod Eng
Sys Eng
J Purfell - 3 cys
D Roock - orig + 2
P Runnel





DEPARTMENT OF THE ARMY
HEADQUARTERS UNITED STATES ARMY TRAINING AND DOCTRINE COMMAND
FORT MONROE, VIRGINIA 23651

ATCD-M-I

30 December 1977

SUBJECT: Letter Requirement (LR) for Mortar Fire Control Calculator
(MFCC), USATRADO ACN 16906

SEE DISTRIBUTION

1. Reference AR 71-9.
2. Subject LR (inclosure 1) was approved on 13 December 1977. The following information is applicable to this document:
 - a. System designation: Nonmajor.
 - b. Materiel Developer: DARCOM.
 - c. Combat Developer: USATRADO.
 - d. User Representative: USATRADO.
 - e. Trainer: USATRADO.
 - f. Logistician: USALEA.
 - g. CARDS Reference Number: 112b.5b.
 - h. Operational Test Responsibility: USATRADO.
 - i. USATRADO Proponent Activity: USA Infantry Center.
3. Completion of action on MFCC BOIP, number 78-0018-I (USATRADO ACN 36674), is expected NLT 15 March 1978.

CF: Ch, Dev Eng
MRR - E Brezon
Prod Eng
Sys Eng
J Purcell - 3 cys
D Roeck - orig # 2
P Rumel



ATCD-M-I

30 December 1977

SUBJECT: Letter Requirement (LR) for Mortar Fire Control Calculator
(MFCC), USATRADOC ACN 16906

4. Subject Requirement Document is forwarded to major Army commands, other services and other DOD agencies for harmonization and to all other addressees for information.

FOR THE COMMANDER:

1 Incl
as



J. M. LARKINS
LTC, AGC
Assistant AG

CY DISTRIBUTION
1 HQDA (DAMO-RQD)
1 HQDA (DAMO-RQA)
1 HQDA (DAMA-WSW)
1 CINCUSAREUR & Seventh Army
Cdr.
2 DARCOM, ATTN: DRCDE-DW
1 FORSCOM, ATTN: AFOP-DA
1 TECOM
1 Eighth USA
1 ARRADCOM
1 AMSAA, ATTN: DRXS-GI
1 Watervliet Arsenal, ATTN: DRDAR-LCB
1 USAOTEA
2 USAARMC & Ft Knox
1 USA CA Cen & Ft Leavenworth
1 USMC Dev & Educ Command
1 USALC
1 USAMCS
1 USAOCCS
2 USAIC & Ft Benning
2 USAFACFS
2 USA CA CD Actv & Ft Leavenworth
1 Tng Spt Ctr
1 Comdt, USAIMA
1 Dir, TRASANA
1 Pres, US Army Tng Bd
LO at TRADOC:
1 USMC
1 USAF
TRADOC LO:
1 USA Rep, USMC Dev & Educ Comd
1 USAREUR & Seventh Army
1 Fed Republic of Germany
(See next page)

2

C-4

ATCD-M-I

30 December 1977

SUBJECT: Letter Requirement (LR) for Mortar Fire Control Calculator
(MFCC), USATRADC ACN 16906

CY DISTRIBUTION
1 Eighth USA
1 DARCOM
1 USAOTEA
1 TECOM

LETTER REQUIREMENT (LR)
FOR
MORTAR FIRE CONTROL CALCULATOR (ACN 16906)

1. TITLE OF ITEM: Mortar Fire Control Calculator (MFCC)

2. STATEMENT OF NEED:

a. The battlefield of the future will be fast moving and highly fluid. Speed and accuracy will be essential in locating and attacking targets and will be major contributing factors to success in battle.

b. Infantry Mortar Systems firing data is presently calculated through the use of mortar graphical fire control equipment, firing tables and charts. Operation of this equipment is time consuming and the procedures involved make it highly subject to human error. The accuracy of the firing data obtained is directly related to the skill and experience of the Fire Direction Center (FDC) computer and the sharpness of his pencil. A need exists for a data calculator to replace existing mortar graphical fire control equipment as a primary method for determining mortar firing data in a timely manner under prevailing conditions of weather, climate and enemy actions. The calculator will be used in mortar fire direction centers.

c. CARDS Reference Number:

3. JUSTIFICATION:

a. The Infantry rifle company, Infantry battalion and Armor units are extremely dependent on the fire support provided by organic mortars. Automation of the mortar fire direction center will enable mortar elements to respond more quickly and accurately to the needs of the maneuver elements. It is always desirable and often necessary to engage targets immediately without expending a large number of rounds adjusting onto the target area. The data calculator will be capable of providing firing data for organic mortar units and will be utilized in all operations where mortars are employed.

b. The data calculator will provide the following advantages over existing methods of obtaining data for mortar firing:

(1) Necessary firing data will be provided more quickly as computations are performed electronically. There will be no need for manual calculations, graphical work or the use of firing tables and charts except as a backup means.

Incl 1

(2) Data provided by the calculator will be more accurate; the chance for human error will be minimized. The operator needs only be taught how to insert the proper inputs and read the outputs.

c. By automating the FDC, more speed, accuracy, and responsiveness to fire requests will be achieved. The calculator will greatly assist in getting rounds fired rapidly onto the target and in permitting immediate engagement of targets without expending large amounts of ammunition in fire adjustment. Greater accuracy, speed of operation, responsiveness and simplicity are principal elements on which justification is based.

4. BASIS OF ISSUE: The basis of issue will be two (2) Mortar Fire Control Calculators per mortar Fire Direction Center. BOIP I action has been initiated by the USAIS. (USMC BOI will be two (2) per mortar platoon and two (2) per rifle company mortar section).

5. PRINCIPAL CHARACTERISTICS: The basic objective of this program is to produce a preliminary design of a small, rugged, easy to operate and inexpensive computer that will eliminate the use of existing graphical fire control equipment. The MFCC shall be a solid state electronic computing device with waterproof membrane switch keyboard and panel switches, circuit boards, display elements and power supply. The MFCC shall be capable of being powered by interchangeable primary (non-rechargeable) or secondary (rechargeable) batteries. The operator will operate the calculator through switch controls, a keyboard and a digital display. The MFCC must:

a. Be capable of calculating all fire control information required to lay and fire 81mm and 4.2 inch mortar ammunition and the Lightweight Company Mortar System (LWCMS) (60mm) that was Type Classified Standard in Jul 77.

b. Accept both grid coordinates and polar plot information and produce accurate mortar firing data.

c. Have the capability of quickly storing ballistic data or utilizing a conversion factor for all known cartridge/fuze combinations for the LWCMS (60mm), 81mm and 4.2 inch mortars and the capability of changing stored ballistic data whenever new firing tables are published.

d. Be capable of operating in environmental extremes, categories 1-6 as prescribed in AR 70-38.

e. Be capable of storing initialization data (referred deflection, mounting azimuth and mortar altitude) and generating fire control data for a minimum of six mortar firing positions in sequence.

f. Be capable of accepting the following inputs:

(1) Mortar to target azimuth (Mils).

- (2) Observer to target azimuth (Mils).
- (3) Propellant charge.
- (4) Mortar to target range (Meters).
- (5) Observer to target range (Meters).
- (6) Mortar, target and observer altitudes (Meters).
- (7) Meteorological (MET) message in standard terms used in FM23-91 (paragraph 13-22).
- (8) Observer correction for deviation, range and height of burst.
- (9) Range and deflection corrections after registration within transfer limits as defined in Figure 12-15, FM 23-91.
- (10) Mortar, target, and observer locations in grid coordinates.
- (11) Mortar referred deflection.
- (12) Mortar mounting azimuth.
- (13) Propellant temperature.
- X (14) Magnetic to grid azimuth conversion factor.
- (15) Deflection corrections after registration.
- (16) Location of No-Fire-Areas expressed in grid coordinates with as many as eight points each.
- (17) Manual entry of laser designator data (range, vertical angle and azimuth) for both target designation and correction.

g. Be capable of providing the following outputs:

- (1) Mortar to target range (Meters).
- (2) Mortar to target azimuth and deflection (Mils).
- (3) Mortar tube elevation (Mils), corrected to include altitude difference between position and target.
- (4) Propellant charge (Increments).
- (5) Time of flight (Seconds to nearest 1/10).

- (6) Maximum ordinate (Meters).
 - (7) Fuze setting for illumination, smoke and HE airburst ammunition (Seconds to nearest 1/10).
 - (8) Replot target coordinates.
 - (9) Replot target altitude (Meters).
 - (10) Firing azimuth (Mils).
 - (11) Firing deflection.
 - (12) Range and impact coordinates for illumination round cannister.
 - (13) Violation of No-Fire-Areas.
- h. Firing data computation time shall be less than five seconds.
 - i. Be designed for simplicity of operation so that it may be utilized by any member of the mortar crew with a minimum of training.
 - j. Have a memory capability for storing nine forward observer locations.
 - k. Permit the operator to verify entered data and correct such data during a fire mission.
 - l. Be hand portable and weigh no more than six pounds to include internal power source.
 - m. Have a self-contained throwaway and/or rechargeable power source with a life of 1000 one-minute computations under a daily ambient temperature range of 70°F (+20°). For test purposes, each typical computation (fire mission) includes shift from registration point, the initial fire command and one observer correction.
 - n. Have a low voltage indicator.
 - o. Have a power source that can be carried in the operator's pocket in low temperatures and supply power to the unit through an interconnecting cable. Stored data should be retained for five minutes to allow for battery replacements and changes to pocket carry mode.
 - p. Provide means to use both vehicular and common generator power. Memory content will not be lost in the changeover from internal to external power or vice versa. Provisions shall be incorporated to protect the calculator against excessive voltage and reverse polarity when operating on external power source.

q. Be capable of storing data for eight (8) registration points, up to three (3) final protective fires and at least 50 reference points or other targets (total of 61 locations) to include 6-10 No-Fire Areas. (FM 23-91, Sec I, Ch 16).

r. Compute firing data that is accurate within 10 meters in both range and deflection for all ranges out to the maximum range of the mortar.

s. Have electronic components that are capable of reliable operation in the electromagnetic environment normal to combat operations, to include enemy electronic countermeasures (ECM). Calculator must not be damaged or degraded by electromagnetic pulse (EMP).

t. Have a display that is legible under all expected ambient light conditions. The readout display should not give the appearance of being illuminated when it is not or vice versa.

u. Be capable of accepting and computing data for standard training rounds for all types of mortars.

v. Must not require nuclear hardening due to sufficient density on the battlefield.

w. Must be capable of interfacing with the DMD and/or future digital type devices over wire and radio circuits.

x. Have built in self-test capability.

y. Be capable of storing ballistic data, or utilizing a conversion factor, for all known cartridge/fuze combinations and be capable of changing programmed data by plug in elements when new firing tables are published.

z. Have the following Reliability, Availability and Maintainability (RAM) characteristics:

(1) Reliability: The system will have a Minimum Acceptable Value (MAV) of 5,000 hours Mean-Time-Between-Failure (MTBF) and a Best Operational Capability (BOC) of 15,000 hours.

(2) Availability: The achieved availability rate (Aa) of the system shall be no less than 99%.

(3) Maintainability:

(a) The Maintenance Ratio (MR) should be no greater than 0.049.

(b) The MTTR and MaxTTR will not exceed the following limits:

<u>LEVEL</u>	<u>MMTR</u>	<u>MaxTTR</u>
Direct Support	2 hours	8 hours
General Support	8 hours	16 hours

All times are exclusive of logistic support times such as travel to and from the service point and operational site and assumes availability of parts and test equipment.

(c) Scheduled maintenance requirement shall not exceed the following:

1. Operator crew checks and service: 20 minutes per 24 hours.
2. Organizational: 2 hours per week.

(4) The quantitative RAM requirements contained in this LR represent the best estimate of the operational and technical requirements for this system based upon current available knowledge; however, when information is gained from subsequent studies, trade-off analyses and cost effectiveness evaluations that indicate a change in the need, operational/technical capabilities or breach of thresholds, the combat and materiel developers may jointly initiate a change to the appropriate RAM requirement.

6. TESTING REQUIRED:

a. Critical Issues for Tests to be determined by EDT-G, EDT-C and DT/OT II.

(1) The data calculator must be capable of calculating all firing data required to lay and fire mortar systems.

(2) The data calculator shall accept grid coordinate or polar plot information and provide the correct mortar firing data.

(3) The data calculator must be capable of operating in environmental extremes categories 1-6 as prescribed in AR 70-38 when operating with either an external or internal power source.

(4) The data calculator must be capable of accepting all of the above specified input data (paragraph 5).

(5) The data calculator shall provide all of the above specified output data (paragraph 5).

(6) The MFCC shall provide an increase in speed, accuracy and responsiveness to fire requests over current fire control methods.

X (7) The data calculator shall provide readout mortar firing data in less than five seconds.

X (8) The data calculator, including internal power source, will be hand portable and weigh no more than six pounds.

(9) The data calculator's power source will be self-contained, throwaway and/or rechargeable and will have a life of at least 1000 one-minute computations.

(10) The data calculator shall be simple enough in operation that it may be utilized by any member of the mortar crew with a minimum of training.

(11) The data calculator must be capable of storing data for eight registration points, up to three (3) final protective fires and at least 50 reference points or other targets (total of 61):).

(12) The MFCC shall meet RAM requirements.

(13) The MFCC shall not lose stored data during changing of batteries.

(14) The MFCC shall have the capability of storing ballistic data, or utilizing a conversion factor, for all known cartridge/fuze combinations of organic mortars.

(15) The MFCC shall meet electromagnetic environmental and electromagnetic pulse (EMP) requirements.

b. Schedules and Milestones:

<u>Month after Program Initiation</u>	<u>Milestones</u>
0	LR approval and funding authorization
5	Award contract for prototype
16	Receive prototypes and initiate DT II
17	Initiate OT II
20	Complete DT/OT II
24	DEVA IPR

7. LOGISTICAL SUPPORT IMPLICATIONS:

a. The MFCC will be designed for "repair at DS/GS level" with the normal daily operational checks and cleaning and battery replacement or recharging at operator or organizational level. Due to low field density and the similarity of other types of military electronic equipment, there should be no adverse effects on the logistical system. Testing conducted as of this date indicates no logistical constraints or special considerations applicable to the design or development of this item.

b. Technical Risks - The technical feasibility of the Mortar Fire Control Calculator (MFCC) has been proven with the construction and concept evaluation testing of a feasibility model in FY 74 by the USAIC and HEL. Low technical risks exist only in the development of a set of batteries that are within acceptable size and weight limits over the complete range of operating temperatures and that meet Reliability, Availability and Maintainability requirements. Insofar as possible, the MFCC will be constructed of off-the-shelf mil-spec available components.

c. Training Support Implications:

(1) General. Technical documentation developed in accordance with MIL-M-632-XXX(TM) will be the principal instructional resource for operator/crew and organizational through general support maintenance training. ITDT is required. The TRADOC/DARCOM ITDT Policy that is being developed will apply to this requirement upon issuance.

(2) Training Package. Job oriented criterion referenced, individualized, training packages (courses) will be developed based on the technical documentation and will employ training devices to train operator/crew and maintenance personnel. These packages will be specifically geared to the mental and physical capabilities of soldiers typical of those who will operate and maintain the system when it is fielded. In addition to ITDT itself, the training package will include system training devices (operator and maintainer), and other instructional and job aid media appropriate to the tasks being taught such as TEC, films, TVT, correspondence courses and other literature deemed appropriate by the developer. Courses will be required both for individuals and for collectives (crew/unit) and will be produced in forms administerable in both the institutional and unit training environments. The unit training environment includes the garrison area, local training area, and major training area. The job training courses will be designed to develop and sustain proficiency. A training package of effective and practical instructional media, to include TEC, TVT devices and training literature suitable for introductory and continuing use by both units and institutions, must be available at test DT/OT II.

8. FUNDING. The estimated total funding (6.4) required to conduct engineering development (ED) under this LR is under \$2,000,000. The following research and development costs as defined in AR 37-18 is expressed as follows:

a. Summary of estimated life cycle costs as expressed in constant and inflated dollars (\$M-Millions):

	<u>CONSTANT DOLLARS (FY 78)</u>			<u>INFLATED DOLLARS (FY 78)</u>		
	<u>LOW</u>	<u>MOST LIKELY</u>	<u>HIGH</u>	<u>LOW</u>	<u>MOST LIKELY</u>	<u>HIGH</u>
R&D	1.07	1.12	1.86	1.11	1.17	1.93
Non-Recurring	.11	.12	.20	.13	.14	.23
Investment Recurring	6.91	7.27	11.99	8.88	9.35	15.43
	<u>8.09</u>	<u>8.51</u>	<u>14.05</u>	<u>10.12</u>	<u>10.66</u>	<u>17.59</u>
O&S (3 yrs)	.32	.34	.56	.37	.39	.64
TOTAL	8.41	8.85	14.61	10.49	11.05	18.23

b. Quantity/unit costs, estimated design to unit flyaway and unit procurement costs expressed in constant FY 78 dollars.

<u>ITEM</u>	<u>QTY</u>	<u>UNIT FLYAWAY</u>	<u>UNIT PROCUREMENT</u>
Mortar Fire Control Calculator (MFCC)	2520-US Army	\$2344.00	\$2447.00
	500-US Marines		
TOTAL	3020		

NOTE 1: Sunk Costs:

a. R&D \$0.15 b. Investment \$ - c. Other \$ -

NOTE 2: Quantity of Prototypes - 20.

c. *Recommended funding profile expressed in constant FY 78 dollars and inflated dollars (\$M-Millions). Constant dollars in brackets to left of inflated dollars.

* Costs have been validated by ARRADCOM (DRDAR-SEC-D), Control Number 746, 4 No 77, with Revision Number 1, 22 Nov 77.

	<u>FY 78</u>	<u>FY 79</u>	<u>FY 80</u>
Qty	0	20	620
RDTE	(.85) .87	(.27) .30	
Prod Proc			(1.63) 1.96
	<u>FY 81</u>	<u>FY 82</u>	<u>FY 83</u>
Qty	655	630	605
RDTE			
Prod Proc	(1.59) 1.99	(1.52) 1.99	(1.46) 1.98
	<u>FY 84</u>	<u>TOTALS</u>	
Qty	490	20	3000
RDTE		(1.12) 1.17	
Prod Proc	(1.19) 1.64		(7.39) 9.59

Robert J. Lunn
ROBERT J. LUNN
 Major General, USA
 Director of Development
 and Engineering

James H. Merryman
JAMES H. MERRYMAN
 Major General, GS
 Deputy Chief of Staff
 for Combat Developments

ANNEX D

DEVA IPR RECOMMENDATIONS
FOR
TYPE CLASSIFICATION
OF
COMPUTER, BALLISTICS: MORTAR, XM23



DEPARTMENT OF THE ARMY
US ARMY ARMAMENT RESEARCH AND DEVELOPMENT COMMAND
BOYER, NEW JERSEY 07801

DRDAR-SC-XM23

1 July 1981

SUBJECT: DEVA IPR Recommendations for Type Classification of the
Computer, Ballistics: Mortar, XM23 (MFCC)

Commander
U.S. Army Materiel Development and
Readiness Command
ATTN: DRCDE
5001 Eisenhower Avenue
Alexandria, VA 22333

Forwarded for approval are the recommendations of the Computer,
Ballistics: Mortar, XM23 (MFCC) DEVA IPR held on 1 July 1981.

- 3 Incl
1. TC Recommendation
 2. MSR Submission
 3. DEVA IPR Minutes (DEVA IPR
Recommendation incl 2 to this incl)

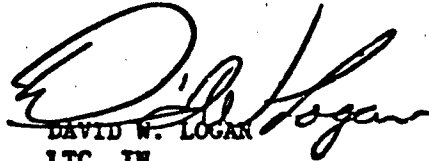
DAVID W. LOGAN
LTC, IN
IPR Chairman

TYPE CLASSIFICATION

RECOMMENDATION

1. A Development Acceptance In-Process Review (DEVA-IPR) was held on 1 July 1981, resulting in a determination that the Computer, Ballistics: Mortar, XM23:

a. Is acceptable for the mission intended.

b. Does meet regulatory prerequisites for entry into the Army Inventory.

c. Is required, in limited quantity (468) for a limited time (through Sep 1983) for an urgent operational requirement which will allow the currently scheduled IOC date to be met and will expedite getting an urgently needed system into the hands of soldiers in the field.

d. Is safe for all aspects of use (Safety and Health Data Sheet attached).

2. Accordingly, recommend the item/system be type classified Limited Procurement (LCC-U).

3. Replacement information: None

4. Specific end item recommended for type classification:

a. Federal Item Identification: 1220

b. LIN: Z17218

c. NSN: NYA

d. RICC: NYA

e. Type classification; Limited Procurement (LCC-U)

f. BOIP number: 78-00187

g. Requirement: Letter Requirement (LR) for Mortar Fire Control Calculator (MFCC), USATRADOC ACN 16906, dtd 30 December 1977.

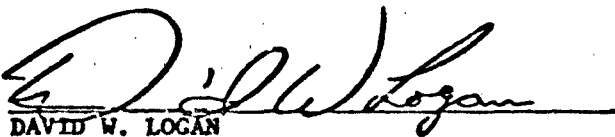

DAVID W. LOGAN
LTC, IN, IPR CHAIRMAN

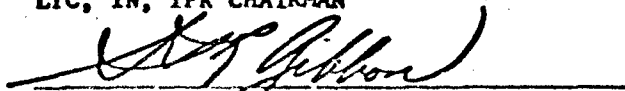

STEVE R. GIBBON
DAC GS-11 USMIS



RONALD L. DOYLE
USALEA

SUBJECT: Materiel Status Record Submission

**TO: Headquarters
U.S. Army Materiel Development
and Readiness Command
ATTN: DRCDE-AP
5001 Eisenhower Avenue
Alexandria, VA 22333**

Computer, Ballistics: Mortar, XM23

Together with the attached documents, are forwarded for recording in the Materiel Status Record in accordance with AR 70-2:

GENERAL INFORMATION:

- a. Project/Task Title: Computer, Ballistics: Mortar XM23 (Mortar Fire Control Calculator).
- b. Program Element: 6.47.25.A
- c. Project/Task Number: 1W464727A57000
- d. CARDS Paragraph Reference: 112B
- e. Previously Recorded Item Numbers: None
- f. LIN: Z17218
- g. NSN: to be assigned at a later date

TYPE CLASSIFICATION/RECLASSIFICATION

- a. Item: Computer, Ballistics: Mortar, XM23
- b. Date of Review: 1 July 1981
- c. TC Decision: XM23 TC LCCU to M23
- d. Other Decisions: None
- e. Approved by: _____ Date: _____

DRDAR-SC

SUBJECT: Material Status Record Submission

PREPARED BY:

Office:

Name of Contact: J.A. Schmitz

Telephone: AUTOVON 880 14/4619

3 Incl

- 1. Ltr, DRCDE, 1 July 1981**
- 2. DEVA IPR Minutes, 1 July 1981**
- 3. TC Recommendation, 1 July 1981**

DEVA IPR MINUTES

DATE 1 July 1981

PURPOSE: XM23 DEVA IPR to Establish DEVA IPR Recommendation

ATTENDEES: See Inclosure 1

1. The XM23 DEVA IPR was held at ARRADCOM on 1 July 1981 and was chaired by LTC David W. Logan. Names of attendees are provided at Inclosure 1; voting members are preceded with an asterisk.

2. A copy of the presentation given by Mr. J.A. Schmitz, DPO, XM23 is attached as Inclosure 3 Recommended improvements introduced as a result of discussions during the meeting have been incorporated via hand-written additions. It was the concensus that these improvements are of acceptable technical risk and could be incorporated into the unit during the next contractual phase.

3. The IECOM representative, via FONECON, recommended in light of the planned improvements to eliminate the battery adapter wand and the W-1 wire adapter with case integral connectors, that testing of these items be delayed until these improvements have been incorporated into the unit. Testing then could be accommodated during the First Article - Initial Production Test (FA-IPT). Recommendation accepted.

4. The following facts/clarification were identified for consideration by the User in regard to a review of the Letter Requirements (LR) and the XM23 capabilities.

a. Ref LR5g(12) the word "canister" will be changed to the word "dud". The XM23 computes dud range and impact coordinates for the 81mm and 4.2" illumination rounds. One of the software improvements to be incorporated into the unit is to provide the added capability to calculate the range/impact coordinates for the 60mm illumination rounds.

b. Ref LR 5k Verification and correction of operator entered data will be possible even after the calculation has been completed. This improvement will be incorporated during the next contractual phase.

c. The wording in LR para 5i will be changed to reflect that mortar men trained in Fire Direction (FDC) Operation should be able to operate the XM23 with minimum training, as opposed to stating that any member of the mortar crew can operate it with minimum training.

DEVA IPR MINUTES

(cont'd)

5. The urgent requirement reflects the quantity needed to equip key Rapid Deployment Force units and establish a training base, plus 30% additional float quantity for support.
6. TRADOC representatives recommended that a IOC FDTE be conducted. This is presently in the program schedule.
7. LEA representative identified a need for maintenance floats/DX quantities be included in the procurement quantity. (Para 5 above addresses these quantities.)
8. Logistic Support Milestones will be finalized by 3rd QTR, FY82. ILS element milestones will be published in an updated Logistic Support Plan to establish logistic support when items are type classified standard.
9. The DEVA IPR recommendation is at Inclosure 2.

2 Incl

as

PREPARED BY:

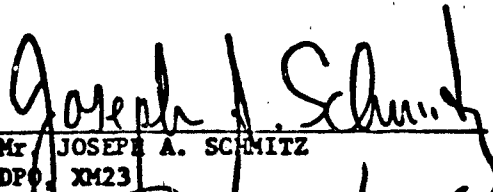
Mr. JOSEPH A. SCHMITZ
DPO, XM23

CONCURRED:

DAVID W. LOGAN, LTC, IN, IPR CHAIRMAN

STEVE R. GIBBON
DAC GS-11 USAIS

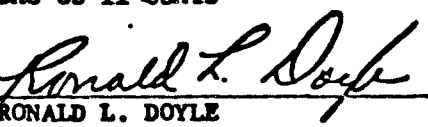
RONALD L. DOYLE
USALEA

DEVA IPR RECOMMENDATION

FOR

THE COMPUTER, BALLISTICS: MORTAR XM23

1. The Computer, Ballistics: Mortar XM23 (MFCC) essentially meets the requirements delineated in the Letter Requirement (LR) against which it was evaluated.
2. The XM23 is acceptable for calculating Infantry mortar systems firing data, (60mm, 81mm, and 107mm mortar systems) and should be classified as Limited Production (LCC-U). The XM23 is acceptable for introduction into the Army inventory after the improvements listed in Para 3 are incorporated into the system, which can be accomplished during limited production without further development effort.
3. The following improvements will be incorporated into the XM23 system prior to fielding:

HARDWARE

- a. Add voltage protection circuit for protection against excessive voltages.
- b. Insure minimum of 50% reserve memory for future expansion after 4 new rounds have been incorporated (see para 3h below).
- c. Prevent data loss when low voltage indicator light comes on.
- d. Provide for operation with primary and secondary (rechargeable) batteries.
- e. Eliminate the need for separate 2/4 wire adapter with case integral connector.
- f. Replace W-1 "Pig Tail" with case integral connector.
- g. Eliminate the battery adapter wand.

SOFTWARE

- h. Program 4 new rounds into XM23 (M374A3, XM630, M335A1, M329A2).
- i. Provide dud illumination round impact point and warning fire zone violation for 60mm.

Ref 2 = end 3

DEVA IPR RECOMMENDATION

FOR

THE COMPUTER, BALLISTICS: MORTAR XM23 (Cont'd)

- j. Delete 2nd application of adjustment during shift mission.
 - k. Provide operator override to change selected charge (60/81mm) and selected elevation (4.2") program to apply registration correction to FPF.
 - l. Lift restrictions on mortars to permit deflection capability of 6400 mils.
 - m. Implement changes specified in OTII IER Para 7b, 7i and 7m.
 - n. Lift max range restrictions of 60mm to calc. Max range for max charge.
 - o. Include conversions for ammo wt. (lbs/squares), alt. (ft/meters), muzzle velocity (ft/sec or m/sec), training rounds (decimeters).
 - p. Capability to review and correct all data even after calculation is completed.
 - q. Incorporate a standby indicator.
 - r. Ability to correct OT direction if GT switch is incorrectly pushed when computing grid mission.
 - s. Implement MPI registration procedure.
 - t. Display warning when friendly positions are entered as targets.
 - u. Program calculator to converge sheaf when desired in fire for effect.
4. It is agreed that the wording in the LR, para 5i, be changed to reflect that mortar men trained in Fire Direction Center (FDC) Operation should be able to operate the XM23 with minimum training. Other LR requirements not met are considered waived for TC-LPU. Consideration will be given to providing keyboard illumination at no trade off of battery life.

DEVA IPR RECOMMENDATION

FOR

THE COMPUTER, BALLISTICS: MORTAR XM23 (Cont'd)

5. The above position has been reviewed and concurred in by the undersigned.

CONCURRENCES:



DAVID W. LOGAN
LTC, IN, IPR CHAIRMAN



STEVE R. GIBSON
DAC GS-11 USAIS



RONALD L. DOYLE
USALEA

ANNEX E

PRODUCT IMPROVEMENTS IDENTIFIED IN THE
SCOPE OF WORK SECTION OF PRODUCTION CONTRACT

Product Improvements Identified in the Scope of Work (SOW)
Section of Contract DAAK10-83-C-0135, 26 May 83

The following product improvements, some of which resulted from shortcomings uncovered during DT/OT, are to be incorporated in the improved mortar ballistics computer:

a. Hardware

(1) The audio frequency coupler, P/N 11795856, shall be eliminated as a major assembly and its function, to provide a communication link between the digital message device (DMD) and the mortar computer, incorporated within the computer case. Input terminals shall be mounted on the computer case.

(2) The electronic power adapter, P/N 11785911, which provides a physical connection between an external power source and the computer shall be eliminated. Provisions for an external power source shall be accomplished through a cable connector mounted flush on the computer case.

(3) A visual means shall be provided to indicate that the computer is in the "on" mode.

(4) The computer keyboard shall be provided with night illumination; evenly distributed and continuously adjustable from "off" to full brightness.

(5) The computer shall provide a battery level indicator which presents an identifiable indication of the remaining capacity of the battery. If the remaining battery capacity is below the level required for proper operation of the computer, the indicator shall indicate that replacement is required. The battery level indication will be based on a real measurement of low battery level and must be visible to the operator. Incorporation of an analog or digital indicator is at the discretion of the offeror.

(6) The computer shall be capable of accepting power from either internal batteries or 20-32 volt DC vehicular power. It is desirable, not mandatory that the charging of the internal battery, when rechargeable batteries are used, shall be possible while the computer is operating on external power.

(7) The computer shall be provided with the means to protect the unit from excessive voltages and reverse polarity. The magnitude of excessive voltages is not to exceed the voltage transients as defined in MIL-STD-1275, "Characteristics of 28 Volt DC Electrical System in Military Vehicles."

(8) The computer shall have an internal elapsed time meter to register running time whenever the computer is turned on. It is not mandatory that the elapsed time meter be resettable. The elapsed time meter is to be visible to maintenance personnel only.

(9) The computer shall be powered through an internal power source (battery) and have the capability of accepting both a throwaway and a

- rechargeable power source. These batteries should be standard military batteries. They shall be available in the military inventory or off the shelf from commercial sources. Therefore, it is up to the contractor as to what type of batteries should be..." only indicates a preference for standard military batteries not a contractual requirement.

(10) The computer shall be provided with a minimum of 100 percent additional memory that is available for future requirements since the zilox 280 microprocessor will only support addressing a memory space of 65,536 bytes, a redesign using a microprocessor with addressing capabilities above 65,536 bytes would be acceptable in meeting this requirement and should be discussed in the offeror's proposal. This increase of memory will be performed by insertion of additional memory components or module(s). The 100 percent growth is to be based on the program with all requested software changes incorporated.

(a) If an offeror decides to incorporate a new microprocessor to meet the 100 percent additional memory requirement to satisfy all the requirements delineated in Attachment 1 to the solicitation and the requirements of the Scope of Work, (Para A Section IV - Requirements; subsection b. Software Shortcomings), then it would be acceptable with the understanding that changes to the specifications will be necessary as a result of the PPE effort.

(b) The 100 percent additional memory is a requirement.

(c) No current available memory circuits shall be used.

(d) A package size increase is permitted within the dimensional limitations stated.

b. Software Shortcomings

(1) Final Protective Fire (FPF). The FPF format shall be revised to be in accordance with the procedures used by the Fire Direction Center:

(a) Remove left and right flank and replace with the actual gun numbers in the display.

(b) Enable the computer operator to go directly to the gun he wants to adjust without sequencing through all fire data for other guns.

(c) FPF shall be considered as an active fire mission and allow for safety data entry.

(d) The M-23 shall display safety data, i.e., maximum ordinate, impact coordinates, time of flight, etc., under FPF action mission.

(e) The computer operator shall be able to enter direction (observer-target) before the first round is fired so that the M-23 does not default to gun-target azimuth instead of maintaining the actual operator-entered observer-target azimuth.

(f) The computer operator shall have the capability of adjusting the charge during final protective fire (FPF). The computer-selected charge for FPF for the 60mm and 81mm mortars cannot be manually changed by the operator. If adjustments to the FPF exceed (go above or below) the pre-selected charge, the mission must be ended and a new mission started.

(g) Mortars do not use time corrections for registration, but do differentiate shell/fuze types for registration. The firing tables, not the FM (field manual) indicate how these corrections are to be applied.

(2) Deflection Limitations

(a) The M-23 program shall be revised so that all ground-mounted mortars are capable of firing in a 6400 mil circle.

(b) The 107mm (4.2 inch) carrier-mounted mortar shall have a 1600 mil traverse limit from mounting azimuth as follows: 825 mils right and 775 mils left.

(c) The M-23 shall be programmed to apply muzzle velocity corrections to carrier-mounted (81m and 107mm) mortars.

(3) Mission Switch Abbreviations. When the "mission" switch is activated, the display shall display "UNA" (Unassigned) to be compatible with the display "UNASSIGNED" when the display switch is depressed.

(4) Survey Shortcomings

(a) Intersection. The M-23 shall be reprogrammed to display "NO TRIANGLE" when two non-intersecting azimuths are entered by the operator. Presently, the computer generates a resection (an intersection in the opposite direction) i.e., when the same FO (Forward Observer) is used to enter two different azimuths, the M-23 will display the location of the FO already assigned.

(b) Resection. The M-23 shall be reprogrammed to display "NO TRIANGLE" when two azimuths are entered by the operator which will not resect. Presently, the M-23 reverses the direction of the entered azimuths and generates an intersection.

(c) Traverse. The M-23 shall be reprogrammed to permit traverse to continue after the base mortar is entered by the operator. Presently, traverse will only continue if points are stored as target (TGT), known point (KNPT), and forward observer (FO). If base mortar is stored, the traverse stops; operator shall have the option of storing TGT, KNPT, FO and RP (basepiece) in any sequence.

(5) Illumination Safety Diagram. The M-23 shall be reprogrammed to compute and display both burst coordinates and the impact coordinates and display a safety violation if the impact point is outside the safety diagram.

The M-23 now displays a safety violation only if the burst is out of the safety diagram. In many cases, the planned burst is within the safety diagram, but if the round fails to function, the trajectory of the round is such that the round will impact the ground outside the safety diagram. Current FDC (Fire Direction Center) procedure is to construct the safety diagram at range to impact for maximum range.

The terminology in the M-23 shall be redefined to indicate that the impact points are the burst coordinated and the canister points are the impact coordinates if the round fails to function properly. The intent is to keep both HE (High Explosive) and ILLUM (Illumination) rounds within the safety limits at maximum range only. The program shall not be altered for minimum range in comparing the safety diagram with the burst coordinates.

(6) Safety Data. Safety diagrams for the M-23 are applied to the base mortar only. The safety diagram may be different for other mortars in the mortar platoon, therefore, the M-23 shall be reprogrammed to allow the operator to enter safety diagrams for each mortar associated with the base mortar.

(7) Backstep Capability. The M-23 shall be reprogrammed to allow the operator to backstep through each step of an operation in order to make corrections. The M-23 reweiv capability is limited at present to backstepping one step of an operation of sequencing ahead to a desired point.

(8) Special Sheaf/Parallel Sheaf Corrections

(a) Special Sheaf. The M-23 shall be reprogrammed to follow the FPF (Final Protective Fire) sequence for special sheaf.

(b) Parallel Sheaf. The M-23 shall be reprogrammed to allow adjustment of parallel sheaf after the registration is completed by the base mortar.

(9) Surveyed Points As References. The M-23 shall be reprogrammed so that when an engaged target is a surveyed point, and the mortar position is a surveyed point, the rounds for FFE (Fire For Effect) shall impact at the original surveyed grid point. When a converged sheaf is selected by the operator, the 100/R used to close the sheaf shall be taken from the range to the surveyed point.

(10) Converge Mission. The M-23 shall be reprogrammed so that the capability for convergence is selectable by the operator throughout the entire mission. At present, if the "converge" switch is not selected at the beginning of a fire mission, the M-23 will not allow the operator to select it during the mission. Concurrently, the DST (Destruct) operation, displayed under the TFC (Technical Fire Control) switch, shall be programmed to converge all mortars firing onto the target.

(11) Non-Convergent Mission. The M-23 shall be reprogrammed to eliminate the following operational shortcoming: when firing a polar mission, the M-23 will display initial firing data and first subsequent adjustment. However, when a second subsequent adjustment is entered, the M-23 displays "NON-CONVERGENT". Depressing the "COMPUTE" switch a second time for this adjustment, will display the desired firing data. Further, the term "NONCONVERGENT" is meaningless to the computer operator and shall be eliminated.

(12) Vertical Interval (VI) Between Target and Mortar Locations. When the difference in altitude (VI) between target and location is extreme, the M-23 displays "BAD HEIGHT". The M-23 is programmed with limitations on the magnitude of VI for which it will provide a correction. Reprogramming is necessary because:

(13) Minimum Firing Elevations. The M-23 shall be reprogrammed so that firing data is not displayed for elevations less than 800 mils. When this condition occurs, the computer shall display "ELEVATION TOO LOW".

(14) With and Without Extension (107mm). The M-23 shall be reprogrammed to provide the capability of changing from "with extension" to "without extension" during subsequent adjustments of a mission in progress.

(15) Charge Change (81mm). The M-23 shall be reprogrammed to provide the capability of changing "charges" during adjustment of a mission in progress.

(16) Weight Corrections, Grid Declination, Grid Zone, Latitude Data. Discrepancies in these data elements between the M-23 and firing tables are as follows:

(a) Weight Corrections. 81mm and 60mm ammunition is computed as one standard weight. The M-23 allows for weight corrections under the "AMMO DATA" switch; however, the firing tables do not give data for these corrections. The 107mm illumination round is not "squared" as the HE (High Explosive) and WP (white Phosphorous) rounds are. The M-23 allows weight corrections to be applied to illumination rounds to compensate for differences in muzzle velocity; again no data in this regard are contained in the firing tables. Therefore, weight corrections, which cannot be correlated with published firing tables, are to be deleted from the M-23 program.

(b) Grid Declination. Grid declination variations do not affect fire data or any of the options under "survey": switch (intersection, resection, or traverse) and can be deleted from the M-23.

(c) Grid Zone. Grid zone remains as standard and cannot be manually changed, and can be deleted from the M-23.

(d) Latitude Data. Latitude data is a mandatory entry for the M-23 and cannot be bypassed. This information has a minimal effect on fire data at maximum range and can be deleted from the M-23.

(17) Registration (Survey Grid). Registrations are conducted by firing from one survey point to another. After firing registration and the registration corrections are determined, the M-23 presents the option EOM (End of Mission) or EOMRAT (End of Mission Record As Target) under the "EOM" switch. If the operator selects the EOMRAT, the M-23 records the grid coordinates of the final plot with all the subsequent corrections included. This is not the location of the target registration point (RP). When the forward observer (FO) decides to use this RP to shift onto another target, the M-23 will apply these new shift corrections to the final plot. The M-23 should be using the surveyed grid and not the final plot to be shifting onto the new target. Therefore, the M-23 shall be reprogrammed to record the surveyed grid coordinates as the target when a registration is completed.

(18) Temperature (107mm). The firing tables for the 107, state that rounds are not to be fired with extension below -30°F. The M-23 shall be reprogrammed to give warning that "TEMP TOO LOW" to fire this mission with extension at that elevation.

(19) Elevation Default (107mm). The M-23 now defaults to elevation 900 mils for all missions; operators must either stay with default elevation, or determine the elevation change required to fire the mission. The M-23 shall be reprogrammed to select one of the three possible elevations (0800, 0900, 1065 mils) to fire mission, i.e., if programmed to give the lowest elevation and the display indicates "RANGE TOO BIG" then the target is out of range; if at the highest elevation the display indicates "RANGE TOO SMALL", then the round cannot reach the target.

(20) Cartridge-Fuze-Charge Combinations. The M-23 shall be reprogrammed to display "CHARGE VIOLATION" when computing firing data under the following conditions:

- (a) 81mm cartridges are used with fuze, VT, M532 at charge 0.
- (b) 107mm cartridges are used with fuze, VT, M513, M513A1, M513A2, or M513B1 below 10 increments.
- (c) 107mm carrier-mounted, when firing above 32 at an elevation of 1065 mils

(21) Mission Format Sequence. The M-23 shall be reprogrammed so that after "TFC" (Technical Fire Control) mission is selected, the operator shall be directed to enter "WPN/AMMO" data which was omitted instead of defaulting to "READY" i.e., after a GRID, POLAR or SHIFT MISSION is selected, the M-23 displays "NO WPN DATA" then default to the data entry that was missed by the operator.

(22) Minimum Range-Illumination. The M-23 shall be reprogrammed to provide the capability of firing illumination at the minimum range as listed in the respective firing tables. In this regard, the M-23 shall display "TGT LOW/RNG SMALL" for ranges less than minimum.

(23) Registration Corrections. The computer when calculating data for a shift mission from a target previously engaged with registration corrections, applies the registration corrections twice. This condition shall be eliminated since the FFE (Fire For Effect) mission, without fire conducting and adjustment, the target would be missed by the range and deflection distance resulting from those corrections.

(24) Weight Corrections (107mm). The M-23 shall be reprogrammed so as to provide the operator with the capability of entering projectile weight in "squares" or "pounds" to obtain the range correction due to nonstandard projectile weight.

(25) Muzzle Velocity, Altitude Data and Recall. The M-23 shall be reprogrammed to provide the computer operator with the following capabilities:

(a) Muzzle velocity. Muzzle velocity variations for range correction, shall be entered in either meters per second or feet per second.

(b) Altitude. Altitude data for firing correction shall be entered in either meters or feet.

(c) Recall. The recall capability to review data that has been entered into the M-23, shall be retained after the "COMPUTE" switch has been activated.

(26) Maximum Range - Maximum Charge. The M-23 shall be reprogrammed to compute maximum range with maximum charge for all mortars.

(27) Observer-Target (OT) Azimuth. The M-23 shall be reprogrammed to retain the entered OT azimuth, (entered when initiating the "SHIFT" or "GRID" mission), so that any subsequent adjustments are made relative to the OT line and not the gun target (GT) line. In the present program, the M-23 defaults to the GT azimuth.

(28) MPI (Mean Point of Impact). The M-23 shall be reprogrammed to implement the MPI format. The MPI registration may be used to determine either initial firing corrections or updated corrections from earlier registration or application of MET (Meteorological) corrections. Method and procedures are discussed in the FM (Field Manual).

(29) Friendly Positions. The M-23 shall be reprogrammed to display a warning if friendly positions are stored in the computer as targets. This warning shall be programmed on a radius rather than exact location: the latter would be within the bursting radius of a round of ammunition. The M-23 shall still compute and display fire data as it currently does for fire line and zone violations.

(30) Safety Data. Safety diagrams for the M-23 are applied to only one mortar location. The M-23 shall be reprogrammed to apply safety diagrams for all mortar sections since the safety diagram may be different for other mortars in the mortar platoon.

(31) Additional Mortar Rounds. The M-23 shall be programmed to compute firing data for the following additional mortar rounds.

81mm mortar	HE, M374A3
107mm mortar	HE, M329A2
	CS, M4630

ANNEX F

COMPUTER RESOURCES MANAGEMENT PLAN (CRMP)
FOR THE
COMPUTER, BALLISTICS: MORTAR, M23

(FINAL DRAFT)

COMPUTER RESOURCES MANAGEMENT PLAN (CRMP)

FOR THE

COMPUTER, BALLISTICS: MORTAR, M23

US ARMY ARMAMENT MUNITIONS AND CHEMICAL COMMAND

US ARMY ARMAMENT RESEARCH AND DEVELOPMENT CENTER

ABSTRACT

This Computer Resources Management Plan (CRMP) identifies important computer resource acquisition and life cycle planning factors and establishes specific guidelines to ensure that these factors are adequately considered in the acquisition planning process of the Mortar Ballistics Computer, M23. In addition, this plan establishes the necessary framework and support system for software configuration management during production, test, evaluation, and post deployment.

TABLE OF CONTENTS

<u>Section</u>	<u>Title</u>	<u>Page No.</u>
1.0	GENERAL	1
1.1	System Description	1
1.2	Background	9 - 9A
1.3	Weapons System Computer Resource Identification	10
1.4	Applicable Documents	11
2.0	PROGRAM MANAGEMENT	12
2.1	Computer Resource Technical and Managerial Expertise	12
2.2	Computer Program Development and Support Requirements	14
2.3	Computer Equipment and Computer Program Standardization	16
2.4	Plan for Development of Computer Software and Equipment	17
2.5	Risk Assessment	22
2.6	Use of Existing Systems, Equipment and Concepts	22
2.7	System Capacity to Provide for Growth	23
2.8	Computer Program Development Cost	23
3.0	ACQUISITION MANAGEMENT	24
3.1	Technical and Managerial Expertise for the Acquisition Management of Computer Equipment and Programs	24
3.2	Operational and Support Concepts	24
3.3	System Engineering Approach	25

TABLE OF CONTENTS (Cont'd)

Section	Title	Page No.
3.4	Standardization and Commonality	25
3.5	Computer Program Data Rights	26
3.6	A Master Schedule of Major Milestones, Key Events, and Critical Actions	26
3.7	Identification of Required Interfaces Between The Computer Resources of the System and Other Systems	26
3.8	Requirements for Acquisition and Support of Documentation	28
3.9	Facilities to Support Testing of Computer Programs	28
3.10	Configuration Management Concepts	30
3.11	Criteria For The Transfer of Program Management Responsibility	31
4.0	DEVELOPMENT MANAGEMENT	32
4.1	Organization, Responsibilities, and Structure of Group (s) that Will Be Designing, Producing, and Testing All Computer Programs	32
4.2	Development Management and Technical Controls	34
4.3	Methodology For Insuring Satisfactory Design and Testing, Including Quality Control	35
4.4	Development Schedule For Each CPCI and Proposed Milestone Review Points	36
4.5	The Procedure For Monitoring and Reporting The Status Of Computer Program Development	36

TABLE OF CONTENTS (Cont'd)

Section	Title	Page No.
4.6	The Resources Required To Support Development And Test of Computer Program	36
4.7	The General Procedures For, Monitoring, And Resolving Computer Program Errors and Deficiencies During DT	36
4.8	The Method And Procedures For Collecting Data, Analyzing, Monitoring, and Reporting on the Timing Of Time Critical Computer Programs	36
4.9	The Management of Previous, Current, and Proposed Revisions of Computer Program Masters, Data Base, and Associated Documentation	37
4.10	Guideline and Checkpoint For Insuring Future Computer Program Growth, Modularity, and Ease of Modification	37
4.11	Documentation Approach	37
4.12	Training Requirements and Associated Equipment for the Deployment Phase	37
4.13	Software Engineering Practices	38
4.14	Security Control and Requirements	39
4.15	Schedule and Description of the Technical Milestones and Attainment Criteria	39

TABLE OF CONTENTS (Cont'd)

Section	Title	Page No.
5.0	COORDINATED TEST PROGRAM MANAGEMENT	40
5.1	Responsibility and Interrelationships	40
5.2	Organization/Activities Responsible for Verification and Validation	40
5.3	Development/Acquisition Schedule for Special Test Tools	40
5.4	Test Requirements Analysis Methodology	41
5.5	Methodology and Schedules of Benchmark Test Cases for Various Levels of Software Testing	41
5.6	Software Development Monitoring Plan	42
5.7	Procedures for Reporting and Resolving Computer Program Errors and Deficiencies during Testing	42
5.8	Schedule for Test Plans and Testing	42
.6.0	POST DEPLOYMENT SUPPORT	43
6.1	Responsibility	43
6.2	Configuration Management	43
6.3	Responsibilities for Composite System Integrity	44
6.4	Documentation Required to Support Each Type of Computer Program	44

TABLE OF CONTENTS (Cont'd)

Section	Title	Page No.
6.5	Responsibility for Funding	44
6.6	Personnel Required for Computer Resources Support	44
6.7	Computer Equipment Required to Facilitate Computer Program Changes and Acquisition Responsibilities	45
6.8	Computer Programs Required to Support Computer Equipment and Other Computer Programs	45
6.9	Verification and Validation of Computer Programs	47
6.10	Plans to Establish and Operate Necessary Support Facilities	47
6.11	Provisions for the Transfer of Program Management Responsibility	47
6.12	Provisions for System/Equipment Deployment	47
APPENDIX A	MBC System Test Console	A - 1-4
APPENDIX B	Independent Verification and Validation Program Plan	B 1-9 (B i-iii)
APPENDIX C	Glossary - List of Key Terms and Acronyms	C 1-7

LIST OF FIGURES

<u>Figure Number</u>	<u>Title</u>	<u>Page No.</u>
2.1	MBC Project Organization	13
3.1	MBC Program Milestones	27
3.2	Processing of MBC Software Changes	29
4.1	MBC Program Management/Interface	33

LIST OF TABLES

<u>Table Number</u>	<u>Title</u>	<u>Page No.</u>
1.1	Performance Characteristics of Mortar Ballistics Computer, M23	4
2.1	Software Integration	17

COMPUTER RESOURCE MANAGEMENT PLAN (CRMP)

FOR

COMPUTER, BALLISTICS: MORTAR, M23

1. GENERAL

This Computer Resource Management Plan (CRMP) is for the life cycle management of the computer resources of the M23 Mortar Ballistics Computer (MBC). The CRMP is guided by the Department of Defense Directive (DODD) 5000.29, "Management of Computer Resources in Major Defense Systems", DARCOM-R 70-16, "Management of Computer Resources in Battlefield Automated Systems", dated 16 July 1979, as tailored to meet the requirements of the MBC program.

The objective of this plan is to ensure that the principles of computer resources support management and configuration management as prescribed in DARCOM-R 70-16 and AR70-37 respectively, are applied to the MBC computer resources. This will ensure that changes made to hardware/software are properly evaluated, documented and distributed to using elements.

1.1 System Description

The MBC is a lightweight, portable, battery-powered data entry terminal and computer used for automated computation, digital communication, and display of mortar-related information within the tactical Fire Direction System (TACFIRE), communicating with the Digital Message Device (DMD) through standard Army communication radios or field wire. The MBC calculates all fire control information required to lay and fire the 60mm Light Weight Company Mortar System (LWCMS), the 81mm and the 107mm mortars.

It will accommodate all ammunition types for these mortars currently in use. All pertinent computational parameters utilized in the modified point mass ballistics techniques are taken into account to achieve accuracies and computation times not previously attained with standard graphical fire control equipment. It also has the capacity to store battlefield information, including the locations of forward observers, weapons, known points, and no-fire zones and to store message backlogs as well. It communicates with TACFIRE elements via digital burst transmissions, assuring the efficient transfer of mission data without relying on voice communication.

Fire mission data may be received by the MBC Fire Direction Center (FDC) by either voice commands (radio or field wire equipment) or TACFIRE formal digital messages. Fire mission execution consists of receiving a fire request, selecting the desired weapon and ammunition, selecting the tactical fire control to shoot a mission, and computing and issuing firing orders. When fire mission data is received by voice, the data must be manually entered and read out of the MBC. When the data is received by digital communication, from the DMD, the fire mission is automatically entered into the MBC.

The MBC is a microprocessor-controlled data entry terminal and computer. The versatility of the MBC hardware stems from its CMOS (Complementary Metal Oxide Semiconductor) CPU (Central Processing Unit) that combines the benefits of a powerful general purpose instruction set and low power consumption. The total CPU is contained on one circuit board (Display/Circuit Card Assembly) and is separate from most of the memory. Built-in-Test (BIT) memory is included on this board to allow BIT fault isolation to separate CPU board faults from memory board faults.

The NSC300 (CPU) is an 8 bit, 158 instruction set, 64K byte address, both maskable and unmaskable interrupt microprocessor. Memory is implemented in EPROM (Erasable Programable Read Only Memory) and low power static RAM; (Random Access Memory). All EPROMs are reprogrammable at the memory board or CPU board level without the need to remove individual EPROMs. RAM keep-alive power is provided to protect volatile data base information during temporary power loss. The memory capacity is 160K bytes of EPROM and 14K bytes of RAM. Approximately 45 percent (72K bytes) of the total memory capacity is presently being utilized. Memory expansion can be accomplished without altering the physical configuration of the existing memory board.

The display is provided by a high brightness 16-character, 5 X 7 dot matrix vacuum fluorescent panel. The keyboard is a rugged 48-position flat membrane keyswitch design. It is waterproof and back-lighted for night-time use.

Digital input-output interface is provided for base-band FSK, (Frequency Shift Keying) Radio/Crypto and for baseband FSK wireline communication. These FSK interfaces provide time-dispersion and hamming error control in accord with the TACFIRE protocol.

System power may be provided by either of the following internal battery types:

Ni-Cad BB-588/U

Mercury BB-1588/U

Lithium BB-5588/U

or it may be provided by an external 20-32 volt dc military power source.

The performance characteristics of the MBC are shown in Table 1.1.

TABLE 1.1 PERFORMANCE CHARACTERISTICS OF MORTAR BALLISTICS COMPUTER, M23

WEAPONS SUPPORTED

Mortar - M224 (60mm), M29A1/M29 (81mm), M30 (107mm)

Ammunition - High Explosive, White Phosphorous, Illumination Gas

Fuzes - Point Detonating, Mechanical Time, Variable Time

STORAGE CAPACITY

3 concurrent missions

3 digital messages

3 firing unit locations

6 individual firing position solutions

18 individual weapon locations

3 safety zone diagrams

50 known points

1 no fire line

10 no fire area

8 points per no fire areas

3 final protective fire

12 forward observer locations

16 registration points

BALLISTIC CORRECTION FACTORS

Powder Temperature

Muzzle Velocity

Projectile Weight

Standard Met Data

Current Met Data

TABLE 1.1. (Continued) - PERFORMANCE CHARACTERISTICS of
MORTAR BALLISTICS COMPUTER, M23

MESSAGES TRANSMITTED

Message to Forward Observer (FO)

FO Command

High Burst/Mean Point-of-Impact

Acknowledged (ACK)

MESSAGES RECEIVED

Fire Request (FR) Grid

FR Polar

FR Quick

FR Laser

FR Shift

Precision Adjust

Subsequent Adjust

Subsequent Adjust Laser

Radar Registration

High Burst/Mean Point-of-Impact

EOM & Survey

Front Line Trace

Observer Location

Free Text

Acknowledged (ACK)

Not Acknowledged (NAK)

**Table 1.1 Continued - PERFORMANCE CHARACTERISTICS of
MORTAR BALLISTICS COMPUTER M23**

FIRING DIRECTIONS

Deflection

Elevation

Fuze Time Setting

Charge

Time of Flight

1.1.1 Technical Characteristics

a. Processor

Entire CPU contained on one circuit card; 8 bit tri-state data bus; 16 bit address space; EPROM programmable at board level.

b. Memory

Memory management logic for addressing beyond 64K bytes; 16K bytes of directly addressed EPROM; 128K bytes of bank switchable EPROM; addressed 32K bytes at a time expandable to 160K bytes on board; 16K bytes of directly addressed RAM; EPROM programmable at board level; RAM keep-alive greater than an hour.

c. Display

High brightness Vacuum Fluorescent; Brightness adjustable to full off; 16 characters (1 row of 16 characters); 5 X 7 dot matrix characters (3.3 X 3.05mm).

d. Keyboard

48 keys, flat membrane key switch design; Key legends user definable and easily changed; 4 software programmable keys; Back-lighted for night use;

e. Signal Interfaces

TACFIRE compatible FSK for Radio/Wireline; 1200-2400 Hz mark-space, 600-1200 baud; Single/Double block, time-dispersed, Hamming encoded.

OPERATOR ALERTS

Audio (beeper), 2400 Hz; LEDs (4) - User function definable.

f. General Applications

<u>Fire Missions</u>	<u>Adjustments</u>	<u>Sheafs</u>	<u>Survey</u>
Grid, Shift, Polar, Laser Registration Final Protective fire	Shift Laser (on Burst)	Parallel Convergent Special	Traverse Intersection Resection

g. Application of Ballistic Algorithms

Applies Correction for:

Ammo Temperature
Muzzle Velocity
Projectile Weight
Standard Met Conditions
Current Met Conditions
Other Variables

Provides Corrected Firing Data for:

Deflection (Direction)
Range (Elevation)
Time (Fuze Setting)
Charge

h. Weapons Supported

<u>WEAPON</u>	<u>CARTRIDGE</u>	<u>FUZE</u>
60mm M224	HE, M720 HE, M49A4 WP, M302A1 ILLUM, M83A3	MD, M734 PD, M525 PD, M52781 M65A1 (Time fixed)
81mm: M29A1/M29	HE, M374A3 HE, M374A2 HE, M374 WP, M375A2 ILLUM, M301A3 Tng, M68 TD, M1	PD, M567 PD, M567 PD, M567 M524 Series M84A1 (Time) No Fuze No Fuze
107mm: M30	HE, M329A2 HE, M329A1 WP, M32BA1 ILLUM, M35A2 GAB, XM630	PD, M557 PD, M557 PD, M521 MT, M565 MTSG, M548 VT, 513 VT, M513A1 VT, 513A2 VT, M513B1

1.2 Background

The developmental effort on a Mortar Fire Control Calculator (MFCC) began in October 1971 at Frankford Arsenal with the preparation of a technical scope of work for a feasibility study for a hand held militarized calculator. Two contracts were awarded for feasibility studies, followed by the fabrication of feasibility models. From 1974 through 1976 engineering models of the MFCC underwent field testing by the US Army and the Marine Corps. In December 1977, a Letter Requirement for the MFCC was approved and an RFQ for an engineering development contract was issued one year later. During the interim, the MFCC nomenclature was changed to Computer, Ballistics: Mortar, XM23.

In July 1979, Litton Data Systems, Van Nuys, CA, was awarded a Full-Scale Development (FSD) contract for the development of a Technical Data Package (TDP) suitable for competitive procurement and the fabrication of twenty (20) engineering models for testing and evaluation by TECOM and USAIS.

It is to be noted that Full-Scale Development planning of the M23 was initiated in 1977 which preceded the policies set forth in DARCOM-R 70-16 (dated July 1979) which mandated the use of High Order Programming Languages (HOL's) in the Army battlefield automated system software. At this point in time it is neither technically practicable nor cost effective to rewrite the software in a DOD approved HOL. Therefore, the MBC is being fielded with the source code in assembly language; the AMCCOM PDSS center is capable of supporting the MBC in assembly language.

The FSD phase was completed in July 1980 followed by the DEVA-IPR at which time the MSC was Type Classified (TC) for limited production. Subsequently, the TDP was released for competitive procurement of the initial production quantity of MBC systems. On 26 May 1983, Magnavox, Fort Wayne, IN, was awarded contract DAAK10-83-C-0135 to correct the technical shortcomings uncovered during development and operational testing, to update the product baseline (hardware and software), and to fabricate 183 MBC Systems.

9-A

F-19

Since the MBC utilizes computer resources, an MBC Computer Resource Working Group (CRWG) was established in 1979 and was operational until the DEVA-IPR. Now that the MBC and its associated Automatic Test Equipment (ATE) will utilize additional computer resources, the MBC CRWG has been re-established and is operational.

1.3 Weapon System Computer Resource Identification

The computer resources for the MBC are:

- a. The operational computer resource systems include the MBC MSC 800 microprocessor
- b. HP 64000 Computer
- c. MBC Software Emulator for VAX
- d. MBC Assembler/Linker for VAX
- e. Test and Integration Software
- f. MBC EPROM Board Burner
- g. MBC Maintenance Support Equipment, f.e. EQUATE
- h. Test Program Sets (TPS's)
- i. Computer software support systems for ATE
- j. Other MBC support software as available
- k. Tactical Communications Model (TCM)

1.4 Applicable Documents

The following documents are applicable to the MBC system and software development:

DOD-STD-480A	Configuration Control-Engineering Changes Deviations and Waivers
AR 70-10	Test and Evaluation During Development and Acquisition of Material
AR 70-37	Configuration Management
DARCOM-R-70-16	Management of Computer Resources in Battlefield Automated Systems.
DARCOM-R 702-4	Army Defense Systems Software Control During Production and Deployment
MIL-STD-483	Configuration Management Practices for Systems, Equipment, Munitions and Computer Programs as applicable to Computer Program Specifications
MIL-STD 490	Specification Practices
MIL-STD-1345B	Test Requirements Document, Preparation of
MIL-STD-1521A	Technical Reviews and Audits for Systems, Equipment and Computer programs
MIL-STD-2076	Unit Under Test Compatibility with Automatic Test Equipment
MIL-STD-2077	Test Program Sets, General Requirements for
MIL-S-52779A	Software Quality Assurance Program Requirements.
EL-SS-2603TF	Prime Item Product Specification for the Digital Message Device (DMD), AN/PSG-2.
11785850	Technical Data Package: Computer Set Mortar Ballistics; M23

2.0 PROGRAM MANAGEMENT

This section identifies the MBC computer resource management structures and related issues.

2.1 Computer Resources Technical and Managerial Staffing

AMCCOM is responsible for management of the overall MBC program. The Development Project Officer (DPO) for the Mortar Ballistics Computer is managing the program for AMCCOM until the PROD-VAL-IPR, at which time the MBC will be type classified (TC). The DPO is responsible for the development, initial acquisition and deployment of the MBC.

Engineering support for the MBC and its associated ATE is being provided by the Fire Control and Small Caliber Weapon Systems Laboratory (ARDC) and the Tobyhanna Army Depot (TOAD) respectively. Logistic and Post Deployment Support is being provided by the Maintenance Directorate AMCCOM. After the PROD-VAL-IPR management responsibility for the MBC will be transferred to the Weapon Systems Management Directorate (AMCCOM).

Figure 2.1 shows the MBC project office organization and indicates the relationship of the software engineering group to the overall project organization.

The lead software engineer has overall technical responsibility for the documentation of the software corrections required by the MBC Computer Program Configuration Item (CPCI). Specifically he is responsible for project control, program discipline and integrity, and software that reflects the user requirements and specifications that fulfill mission requirements.

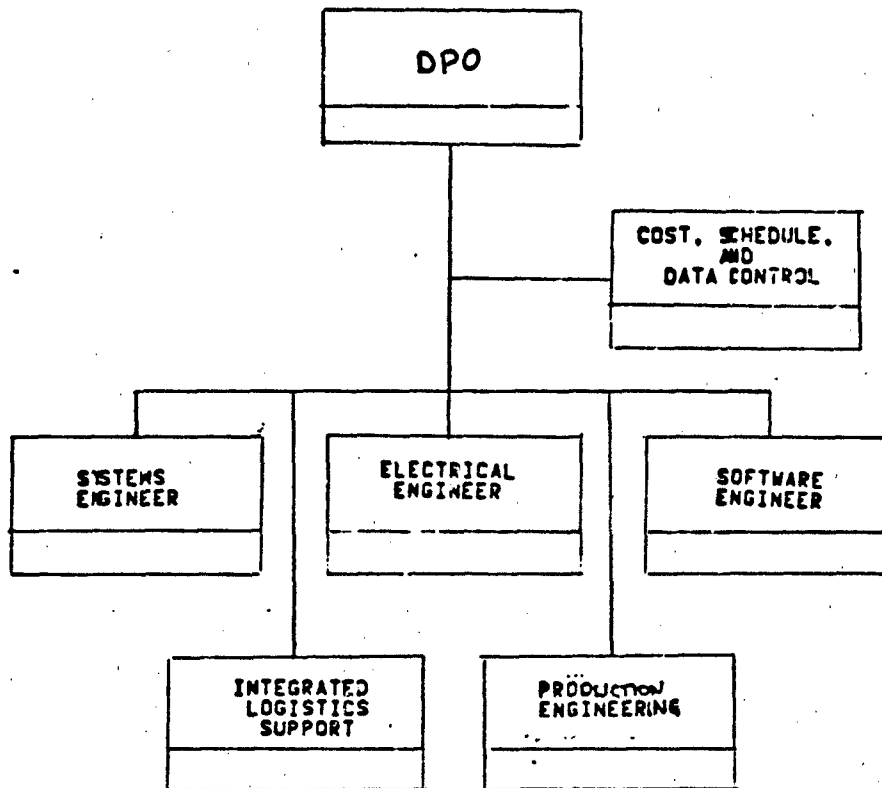

Figure 241 MBC Project Organization

Additional skilled, experienced personnel in the Computer Applications Branch, FSL, will be available on an as-required basis for consultation and assistance in areas of their special expertise.

In addition to the software engineering team, other organizations involved in the software effort are Product Assurance and Technical Data/ Configuration Management Directorates.

Product Assurance, Software Quality Assurance (SQA), personnel performs/ audits of software modifications during software corrections required by the MBC Computer Program Configuration Items (CPCI) to assure compliance with the functional requirements and will monitor software testing to assure compliance with approved standards and specifications.

Established Configuration Management procedures will be used for identification and control of software and software related items according to the configuration management plan developed for the MBC.

Independent evaluations and assessment of the MBC system is being provided by the Product Assurance Directorate, AMCCOM; White Sands Missile Range (WSMR), TECOM; and US Army Infantry School (USAIS).

2.2 Computer Program Development and Support Requirements

The basic software task during the Initial Production phase of the MBC project life cycle is to update the current CPCI to correct shortcomings uncovered during DT/OT II testing and to verify that these corrections accomplish the desired results and that the changes do not effect the performance of existing unaltered functions. In addition to the above task, the software documentation will be updated to reflect the final program configuration for future maintenance and enhancement activities.

The MBC software improvements and functional performance evaluation will be based on the following:

- a. DT/OT II Test Reports
- b. Existing MBC Software Program Source Listings
- c. Updated MBC Computer Program Development Specification
- d. Updated MBC Computer Program Product Specification
- e. Computer Program Configuration Item Specification

Part 1 - Performance and Design Requirements
Part 2 - Product Configuration and Detailed Technical Description

- f. MBC Software Development Plan
- g. Formal Qualification Test Procedure

The principle equipments to be used by the contractor for the software maintenance effort are the following:

<u>EQUIPMENT</u>	<u>USE</u>
IBM 3033	Support Software Host
Cross Assembler	Source Program
DTL (Display Terminal Language Processor)	Interpreters
Z80 Simulator	Hardware Independent Program Debugging
Program Support Center	Software and Hardware Integration
TSO (Time Sharing Option)	Host to Support Center Interface

2.3 Computer Equipment and Computer Program Standardization

The microprocessor hardware configuration will not change throughout production once the initial production units have been tested. The versatility of the MBC hardware stems from its CMOS CPU (NSC800) that combines the benefits of a powerful general purpose instruction set and low power consumption. The Z80 microprocessor in the Full Scale Development (FSD) units executes a subset of the NSC800 instruction set. The only software differences between instruction sets is that the NSC800 has an enhanced interrupt handling scheme. The assembler installed by the contractor (Magnavox) uses mnemonic operation codes and assembler directives that are identical to those utilized by Zilog.

The assembler program is written in American National Standard Instruction (ANSI) Standard Fortran IV and is compatible with most computer systems. The assembler can generate data in several number based systems, as well as supporting both ASCII (American Standard Code for Information Interchange) and EBCDIC (Expanded Binary Coded Decimal Interchange Code) character codes.

The software effort is the modification of an existing program to include new and revised functions. The modified end item program will be documented, structured and designed consistent with the established standard and procedures of the original program. Program module integrity will be maintained and non-structured "patches" will not be used.

Tested program modules once they have been verified, validated and released to production will be controlled items. As controlled items, changes will be recorded, described and approved through formal Engineering Change Proposal (ECP) procedures.

Modifications to the software to include new weapons/ammunitions or corrections to any part of the technical data/documentation will be controlled by AMCCOM to assure that subsequent MBC procurements will be in accordance with the latest updated Technical Data Package (TDP).

2.4 Plan for Development of Computer Software and Equipment

The computer software development plan, as presented by the contractor, in essence has two phases. The first is a preliminary integration of the software system and its internal controls and the second phase is the integration of the system with its hardware environment. For this software effort, the program exists in an integrated form and therefore, the first phase involves the logical introduction and testing of correction designs into this program.

The major phases of software integration and support elements required for each are listed in Table 2.1.

<u>INTEGRATION PHASE</u>	<u>SUPPORT ELEMENTS (SE)</u>
1. Install Support Facility	IBM3033 MBC Support Center Support Software Existing MBC Program
2. Operator Interface	MBC Support Center with Emulated Display/Keyboard
3. Ballistic Computation	Simulator and SE2
4. Message/Survey	Emulated Modem, DMD equipment and SE2
5. Software System	Functional Performance Test and SE4
6. Software and Hardware	MBC hardware EPROM programmer In-Circuit emulation test SE for microprocessor

Table 2.1 SOFTWARE INTEGRATION PHASES

2.4.1 Software Corrections

The software tasks have been categorized by the contractor into three types 1) operator interface, 2) ballistic computation and 3) message/survey processing. These tasks have been selected according to these categories because they can initially be worked on concurrently and require different MBC hardware resources.

The accomplishments of each integration phase are:

1. The support facilities involve the host computer and the MBC software support facility. All support software is installed and tested and the MBC program is made operational as the starting point software base. MBC hardware components are emulated at the software support facility for initial functional testing.

2. Operator interface functions involve the MBC display and keyboard functions. Although operator inputs interact with all functions of the MBC, in this phase the principle testing will be of the display/keyboard and the MBC data base.

3. Ballistic computation deals with testing of the ballistic correction factors enumerated in Table 1.1. These corrections will be integrated in and tested using the simulator and then transferred to the software support facility for system integration.

4. Message/survey processing requires the most complex configuration of equipment. The initial integration will be done at the software support facility with the MBC hardware components emulated, and DMD's attached to provide message generation and reception testing.

5. The total system software will be integrated on the fully configured MBC software support center prior to testing on the MBC hardware. A functional performance test procedure will be used during this phase.

6. In-circuit emulation test equipment will be utilized until the MBC hardware is available. In this configuration the program will reside in the emulation test equipment and run on the MBC hardware through in-circuit cable. This technique aids identifying hardware versus software anomalies. Following the emulation step, the program will be transferred to EPROMS and installed in the MBC for final integration testing.

2.4.2 Software Testing

Software testing is dictated by the need to assure that the software meets the program function and to uncover problems early in the development process to minimize their impact. Testing actually begins prior to coding through the use of design reviews (contractor and government), and ECP's which attempt to locate errors at the design level.

The testing phase of software development is conducted to assure that the implemented software performs correctly and that system requirements are met. Software testing will be conducted at the module, integration, and qualification test levels.

Testing at the module level is the responsibility of the programmer who coded the module. The programmer will ensure that the module functions meet the requirements of the detailed design. Testing at this level will be informal. Module testing will be performed utilizing the MBC software support center and host simulator.

Integration testing will proceed in two levels. Software module integration testing will be started prior to full hardware availability, using the MBC Software Support Center. Although this testing will be informal, it will be performed by experienced software personnel under the direction of the software engineer. The next level of testing will be according to a software test procedure based on updated software specifications. This procedure will be designed to thoroughly exercise all functions and modules of the Software System. Problems uncovered at this level will be fed back into the development cycle and then re-evaluated by a complete rerun of the acceptance test. These tests will initially be conducted at the Software Support Center and finally on the target MBC hardware as it becomes available. All testing will be performed by software engineering personnel.

2.4.3 Software Development Facility

The basic approach for MBC program development is to link a program development facility with the target hardware to a high level support software on a host computer. The host computer is used for program compilation, editing, simulation, and storage for source code DTL (Display Terminal Language) preprocessing, and object code downloading to the development facility. At the development facility, the actual MBC hardware is emulated; thus program testing, debugging, and EPROM generation can be accomplished.

The Host Computer is connected to the Support Center through dedicated communications ports. This configuration provides simultaneous access to the Host facilities for all phases of the design effort. The MBC Program Support Center provides a centralized facility for the evolution, preparation, verification, updating, programming of EPROMS and programming and program update for

the reprogramming of MBC units. It also has the capability of providing programmed format or freetext radio or wire communications with an MBC.

The Program Support Center may be interfaced to the host computer directly through an RS232 interface or through other intermediate devices, i.e., dual-in-modems or Magnetic Tape Cartridge reader/recorder. If the host computer is not continually available, an intermediate download media can be used. The intermediate device stores assembler output for later programmer usage. Both batch job and interactive jobs will be run on the Host. Source Code will be submitted to the Cross Assembler to obtain executable code which can then be interactively exercised on the simulator from the work station terminal and downloaded for execution on the Support System.

All MBC software support documentation of TDP 11785850 will be updated to reflect the updated configuration. The support documentation to be maintained and utilized for program development is as follows:

- a. Program Support Center Documentation (Attachment 5 of M23 RFQ),
- b. Display Terminal Language User Manual (Attachment 6 of M23 RFQ),
- c. Software Programs Listings (Attachment 10 of M23 RFQ),
- d. Software Program Source Listing (Attachment 14 of M23 RFQ),
- e. Installation instructions for hosted support software,
- f. All commercial equipment manuals, printer, terminal, PROM burner, and
- g. Assembler and Simulator manuals.

Production status programs are protected from modification and secured in a software vault from which copies can be retrieved when required.

2.5 Risk Assessment

The software risks during this phase of the MBC life cycle are relatively low due to the following facts: a) The starting point is a working program, b) the processor uses a standard well supported language, c) the hardware configuration is functionally not complex and d) very little concurrent processing is required.

The areas of potential risks are listed below. It is to be noted that these areas are not considered to be high risk items.

- a. Meeting schedules and milestones;
- b. Timely integration of software and hardware functions;
- c. Memory sizing and management;
- d. Human interface factors.

The potential risk areas will be minimized during development by frequent status reviews and close coordination between the contractor and Government technical personnel, and the contractor's of allocating additional support as may be necessary to resolve problem situations that may arise.

2.6 Use of Existing Systems, Equipment and Concepts

The software facilities, systems, equipment, concepts, etc., used for this effort utilizes high payoff low risk technology, and are considered normal engineering facilities. The techniques are common to those used when maintaining a modular designed program. The approach involves first analyzing the logic and structure of the module to be changed and then integrating in the required changes consistent with the original design characteristics. The MBC development effort is based upon tested systems and technology used by the contractor in the DMD programs.

2.7 System Capacity to Provide for Growth

The MBC is presently configured so that approximately 75 percent of the total memory capacity will be available for growth to accommodate additional shell types, ammunition types, and possibly new mortar calibers. The memory circuit board is sized and wired to accommodate two additional EPROM modules, for 32K bytes expansion. Provisions have been considered for the technical interface requirements for implementation of the Fire Support Team (FIST) DMD in future production of MBC units.

2.8 Computer Program Development Cost

The projected program development cost for the Pre-Production Engineering (PPE) phase of the MBC life cycle is \$273,000.00 (in-house and out-house).

3.0 ACQUISITION MANAGEMENT

3.1 Technical and Managerial Expertise for the Acquisition Management of Computer Equipment and Programs

The DPO, XM23 has primary responsibility for the acquisition of computer resources, including computer equipment and programs, as related to operational, maintenance, utility support, factory inspection, and simulation software. To assist the DPO in computer resource acquisition management, several key areas of technical and managerial expertise have been identified as follows:

a. Fire Control and Small Caliber Weapon Systems Laboratory (FCL), will provide technical expertise in the areas of MBC system engineering to include functional computer hardware and software requirements and ATE.

b. Product Assurance Directorate (PAD) AMCCOM, will provide independent AMCCOM verification and validation of the MBC including computer resources prior to release of the MBC to TECOM for Initial Production Test.

c. The AMCCOM PDSS center in conjunction with the AMCCOM ATE/PDSS/TMDE Control Office will provide policy and guidance for computer resources.

The DPO, XM23 manages the overall computer resources acquisition effort. The computer resources support effort is portrayed by organization in Figure 2.1, and Figure 4.1. Technical expertise in digital communication interface (FIST DMD) is being provided by PII-FATDS.

3.2 Operational and Support Concepts

The concept of computer resources support for the MBC is based on a life cycle approach with the early involvement of all key participants.

A formal Computer Resources Working Group (CRWG) has been re-established to aid in the formulation of an overall computer resources support plan, updating of the CRMP, initiating tasks, assigning responsibilities and providing the MBC Project office with support as needed.

Meetings will be scheduled to identify problems, make assignments of action items, monitor progress with relation to assigned task completion dates and milestones, and assess delivery of related data items with respect to contract schedules. Minutes of each meeting will be prepared for distribution to attendees and key personnel associated with the program. Thus, a written record of action items and progress will be available and potential problem areas identified early. Frequency of the meetings will be determined by the progress of the overall program.

3.3 System Engineering Approach

The TDP 11785850 will form the Product Baseline for system requirements definition of the MBC computer resources. During development all changes to the Product Baseline will be via Engineering Change Proposal (ECP) actions in accordance with MIL-STD-480A. All ECP's will be incorporated into the TDP by the contractor prior to production. This will allow a clean TDP to be available for subsequent procurements.

3.4 Standardization and Commonality

Standard computer resources will be used to the fullest extent. Standard Army ATE, e.g., simplified test equipment (STE) and AN/USM-410 (EQUATE) will be utilized for maintenance support.

3.5 Computer Program Data Rights

The Government shall have unlimited data rights to all MBC support software as well as operational software. The MBC rights include the right to use, modify, combine, reproduce and distribute all computer programs and associated documentation.

3.6 A Master Schedule of 4 Major Milestones, Key Events, and Critical Actions

The master schedule for the overall MBC program is shown in Figure 3.1.

3.7 Identification of Required Interfaces Between the Computer Resources of the System and Other Systems

3.7.1 The MBC/DMD interface allows for the automated exchange of data between the MBC at the Fire Direction Center and the DMD located at Forward observer locations. Total implementation of the MBC/DMD Interoperability Program Technical Interface Requirements requires:

- a. Explicit statement of system interoperability requirements at system specification level.
- b. Standardization or compatible usage of data elements, codes, terms, formatting, and communication protocols, communication means, and data message exchange across the system-to-system interface.
- c. Availability of system interface documentation for planning, conducting, and analyzing system interface tests, to include configuration management.

3.8 Requirements for Acquisition and Support of Documentation

3.8.1 The following data shall form the product baseline for system software requirements of the MBC computer resources:

Computer Program Development Specifications - Part I (B5)

Computer Program Configuration Item (CPCI) Test Plans/Procedures

Computer Program Product Specifications (C5) - Part II (C5).

3.8.2 The computer programs developed for the MBC are identified and grouped into one CPCI. The structuring of the specification for the CPCI shall be in accordance with MIL-STD-483/490.

3.8.3 Subsequent to the establishment of the CPCI Product Baseline at type classification, all changes will be made by ECP action.

3.9 Facilities to Support Testing of Computer Programs

3.9.1 The prime contractor's plant shall be used as the Software Support Facility (SSF) to support development test and evaluation of the MBC deliverable computer programs.

3.9.2 The AMCCOM PDSS Center at Dover, NJ will be the Software Support Facility (SSF) during the post deployment phase to perform maintenance and modification of operational computer programs and associated documentation. ARDC, FSL will provide software support for ATE. The contractor's plant shall continue as the SSF during post development until such time as the Government acquires the computer programs and associated documentation.

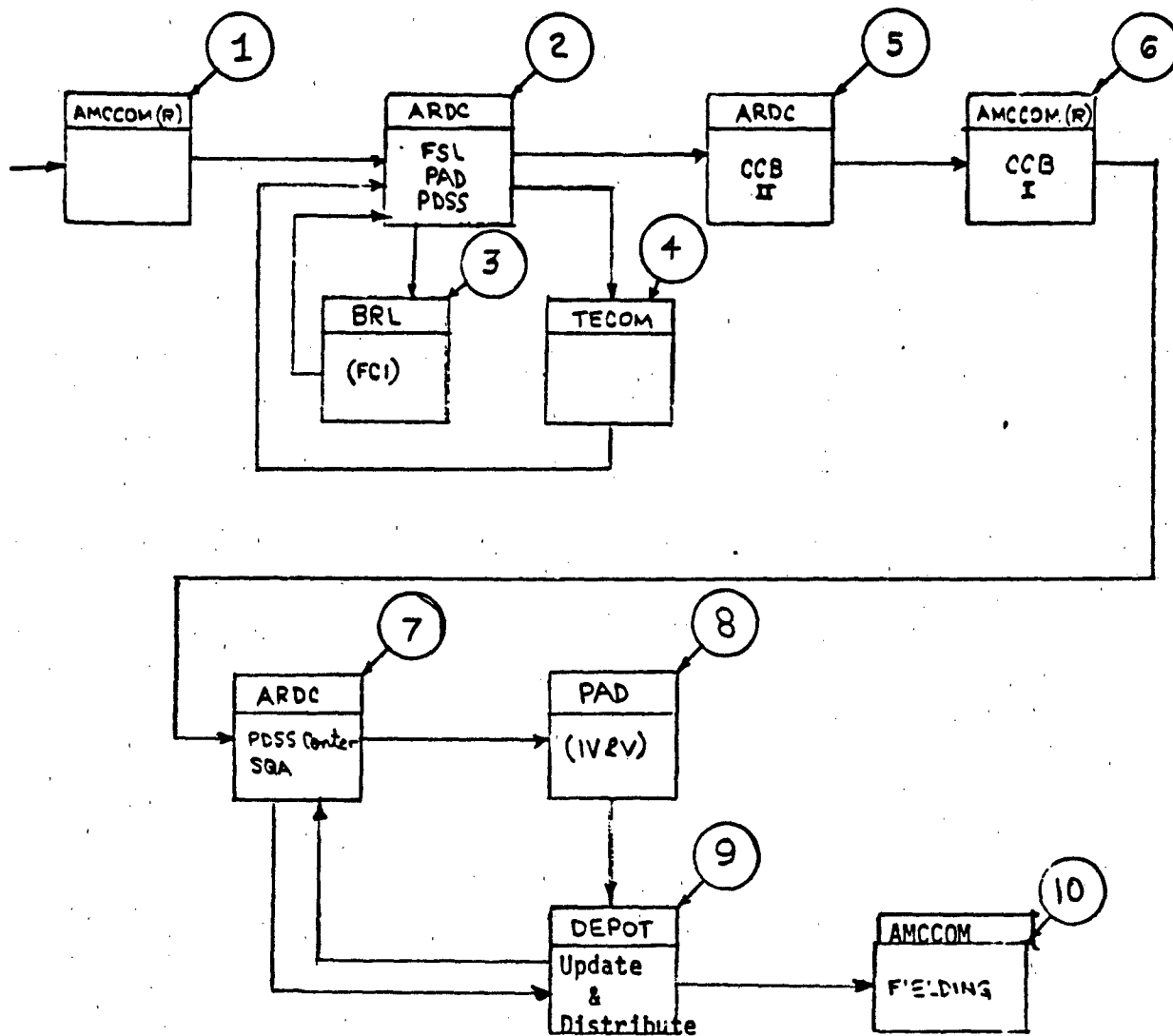

Figure 3.2 - Processing of MBC Software Changes

3.10 Configuration Management Concepts

The contractor is using a formal Configuration Management Program (CMP) to assure traceability of changes. He will configuration manage the MBC, and support systems until the Government assumes a formal configuration management role after FAT. Subsequent to FAT ARDC will hold and maintain the updated Technical Data Package (TDP); processing of software changes from initiation to fielding shall be as shown in figure 3.2.

3.10.1 Processing of Software Changes from Initiation to Fielding

<u>Element</u>	<u>Activity</u>
1	AMCCOM (R) reviews ECP/SCP/PIP requests and forwards validated requests to ARDC for action
2	ARDC technical personnel, representing FSL, PAD and the PDSS Center: <ul style="list-style-type: none">o Develop the software (coding specifications, etc.) to update the MBC.o Prepare a preliminary ECP/SCP.o Develop and test new updated circuit boards.o Forward updated circuit boards to TECOM for confirmatory test.o Review test results and make appropriate changes as may be required.o Prepare final ECP/SCP, to include ILS considerations, and submit to ARDC-CCB.o Update TSP's as may be required.
3	BRL acting on the ARDC request develops the Fire Control Inputs (FCI) and test problems as may be required for any new weapon/ammunition combination.
4	TECOM, acting on an ARDC request prepares test plans, conducts tests and prepares the test report for submission to ARDC-CCB.

3.10.1 (continued) Processing of Software Changes from Initiation to Fielding

<u>Element</u>	<u>Activity</u>
5	ARDC-CCB reviews the final ECP/SCP and forwards its recommendation to the AMCCOM (R)-CCB.
6	AMCCOM (R)-CCB approves the ARDC-CCB recommendation, authorizes the changes and forwards the approved SCP to the PDSS Center for implementation.
7	Responsible PDSS Center personnel: <ul style="list-style-type: none">o Update software documentation and revise the product baseline.o Prepare the master bit pattern (for the MBC EPROM's) and forward to the responsible DEPOT.o Verify the initial production boards with TECOM.o Approve production release of the circuit boards by the DEPOT.o Store the revised production baseline in the TSD files.
8	PAD is assigned the responsibility for the Independent Verification and Validation (IV&V) Program Plan. For IV&V tasks during post deployment see Appendix B.. Table 3.3.
9	The DEPOT is assigned the responsibility for the updating, repair and distribution of revised circuit boards.
10	The fielding process is the assigned responsibility of AMCCOM (R).

3.11 Criteria for the Transfer of Program Management Responsibility

The MBC program management responsibility will be transferred from DPO, XM23 to AMCCOM (R) 120 days after Initial Operational Capability (IOC).

4.0 DEVELOPMENT MANAGEMENT

4.1 Organization, Responsibilities, and Structure of Group(s) that will be Designing, Producing, and Testing All Computer Programs

The organization structure which will be managing the design, production and test of the MBC is indicated in Figure 4.1. The DPO, XM23 has the overall responsibility to ensure that the MBC meets the Army's requirements. He is assisted in this effort by the contractor and AMCCOM. Integrated Logistics Support/Logistics Support Analysis management activities are within AMCCOM for coordination of logistics with computer resources activities. The prime contractor, is responsible for the design, development and testing (contractor) of the MBC and its associated ILS package. The AMCCOM segments are involved as follows: FSL is responsible to assist the DPO in the technical evaluation of the contractor design/development implementation, testing and documentation; the AMCCOM PDSS Center will ensure software compliance with policies, standards and procedures for Battlefield Automated Systems (BAS), and interoperability-related software pertaining to the Army Command and Control System for non-ATE software; FSL will ensure BAS compliance for ATE software; the Product Assurance Directorate is the AMCCOM independent evaluator for verification and validation of the MBC and its maintenance support equipment, including computer resources. AMCCOM will provide logistics support in the area of ILS planning and implementation as well as the conduct of Logistic Support Analysis (LSA). TECOM is responsible for conduct of the Initial Production Test (IPT). USAIS represents the user and will coordinate the Force Development Testing and Experimentation (FDTE). The DPO in conjunction with the PM-FATDS has established specific quantitative design requirements for communications, information exchange procedures, and software.

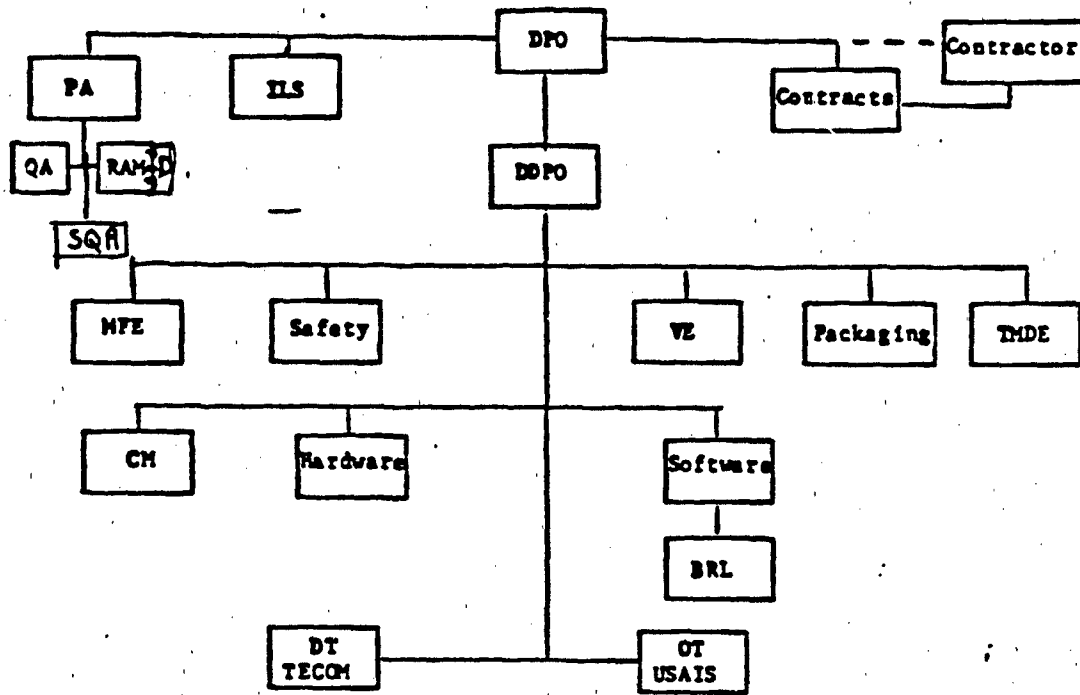

Figure 4.1a Program Management

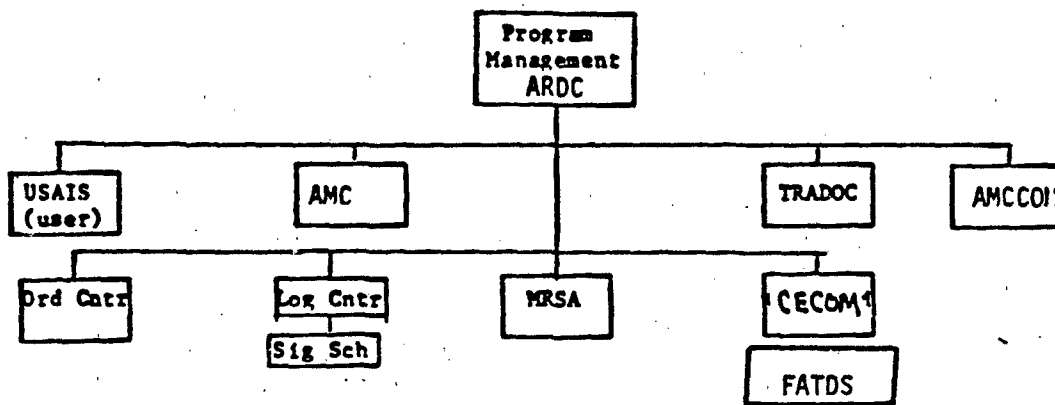

Figure 4.1b. Program Interface

Figure 4.1 MBC Program Management/Interface

4.2 DEVELOPMENT MANAGEMENT AND TECHNICAL CONTROLS

4.2.1 Design reviews, tests and audits will be in accordance with the contract schedule. CRWG teams will monitor these actions and will advise the DPO accordingly.

4.2.2 The B5 Computer Program Development Specification for the MBC Computer Program Configuration Item (CPCI) was updated by the contractor.

The CPCI is allocated to functions and tasks to be performed by individual computer subprograms which are identified and described in the C5 Computer Program Product Specification.

4.2.3 The updated C5 specification were submitted to DPO, XM23 for approval at the conclusion of the Critical Design Review (CDR). The DPO will establish the updated Product Baseline at the conclusion of the Formal Qualification Test (FQT). The objectives of the FQT will be to verify that the actual performance of the CPCI complies with its development specification, and to identify test reports and data that document the results of the program qualification tests.

4.3 Methodology for Ensuring Satisfactory Design and Testing, Including Quality Control

1. Testing shall be in accordance with the Coordinated Test Program Management of Section 5 of this CRMP.

2. AMCCOM Product Assurance will participate in the design, development, testing, configuration management, and maintenance of the computer resources through the following functions:

a. Perform continuous assessments of the contractor's Software Quality Assurance (SQA) Program to ensure that reviews, audits, verification, testing, and procedural and product aspects of system development are performed in accordance with the guidelines of MIL-STD-52779A and contract requirements.

b. Participate in all formal review and walk-throughs to ensure their completeness and accuracy.

c. Review and take part in the approval of all contractor submitted software documentation.

d. Maintain appropriate records of all assessments and tests in support of the following activities:

- (1) Program validation
- (2) Post deployment baseline change evaluation
- (3) Post deployment test management
- (4) Technical Data base

e. Advise the DPO, XM23 on the performance, quality and supportability of the software program.

f. Provide input on computer resources to required Government Product Assurance documentation.

g. Evaluate and participate in the approval of the final CPCI test plans/procedures and monitor the actual acceptance test of the software program to ensure all requirements and documentation are verified.

4.4 Development Schedule for each CPCI and Proposed Milestone Review Points

The development schedule for the MBC CPCI and milestone review points appear in Figure 3-1. ATE milestones will be determined prior to MR (Material Release).

4.5 The Procedure for Monitoring and Reporting the Status of Computer Program Development

The status of computer program development shall be monitored via technical reviews, tests, and audits that are held to control CPCI.

4.6 The Resources Required to Support Development and Test of Computer Programs

These resources are identified in paragraph 2.2.

4.7 The General Procedures for Reporting, Monitoring, and Resolving Computer Program Errors and Deficiencies During Development Test

The general procedures are outlined in the CPCI Test Plans/Procedures and the contractor's Software Product Assurance Manual.

4.8 THE Method and Procedures for Collecting Data, Analyzing, Monitoring and Reporting on the Timing of Time Critical Computer Programs

The DPO will provide and maintain timing and sizing budget estimates for the CPCI as specified in the B-5 specification.

4.9 The Management of Previous, Current, and Proposed Revisions of Computer Program Masters, Data Base, and Associated Documentation

During PPE the contractor shall manage all versions of computer program masters and data bases and documentation. After deployment the AMCCOM PDSS Center and FSL shall assume this responsibility in accordance with the HQDA PDSS concept plan approved May 1981.

4.10 Guideline and Checkpoints for Ensuring Future Computer Program Growth, Modularity, and Ease of Modification

During periodic reviews computer program growth, modularity, and ease of modification will be examined.

4.11 Documentation Approach

For the CPI the following documentation will be prepared: a B5 specification, C5 specification, program listing and firmware documentation.

4.12 Training Requirements and Associated Equipment

The contractor will develop and conduct operator and maintenance courses for Instructor/Key Personnel (IKP). The IKP courses will cover tasks associated with the new items to be introduced. The difficulty level of the instruction will not exceed the mental and physical requirements outlined in AR 611-201 for each MOS. The date of course delivery, the number of courses, the course lengths, the number of students shall be consistent with the IKP requirements. The instruction will be consistent with and will as a minimum, train the critical tasks identified by the ongoing LSAR. The instruction will be supported by reproducible draft TM's and will be a combination of classroom and practical training. All operator courses will be conducted at the USAIS, Fort Benning, GA; the maintenance courses will be conducted at AMCCOM (R), Rock Island, IL.

4.13 Software Engineering Practices

The DPO has the responsibility for identifying the software engineering practices that will result in the design, development, test, and delivery of software that is acceptable and maintainable. The PDSS Center will provide the expertise as requested by the DPO to assure this responsibility.

The design approach will stress structure, independence of components, modularity, and clarity of interconnections. Documentation shall stress traceability, formal standards, clarity of descriptions, and easily readable listings. Testing will stress formal demonstration of mission requirements and use formal error data collection methods.

The contractor will be guided by the following practices:

- a. Structured Design
- b. Top Down Development
- c. Formal Standards and Guidelines
- d. Data Item Index
- e. Program Design Language
- f. Structured Programming
- g. MBC Development Folder
- h. Structured Walkthrough
- i. Programming Support Library
- j. Formal Error Data Collection

4.14 Security Control and Requirements

Classified data within MBC Computer Programs will be treated with the same standard safeguards which are required for all classified information.

4.15 Schedule and Description of the Technical Milestones and Attainment Criteria

<u>MILESTONE</u>	<u>SCHEDULE or ACTUAL DATE</u>
System Specification	Nov 81
Contractor Developed Specification	Jan 84
Computer Program Development Specification (B5)	May 84
Computer Program Product Specification (C5)	May 84
Computer Program Configuration Item Test Plan/Procedures	Jun 84
Critical Design Review	Sep 83
Formal Qualification Test	Oct 84
Physical Configuration Audit	May 85
MBC Support Software	Oct 85
EPROM Programming Station	Oct 85
MBC Software Development System	Oct 85
ATE Test Program Sets	Sep 86

5.0 COORDINATED TEST PROGRAM MANAGEMENT

5.1 Responsibility and Interrelationships

The Test Integration Working Group (TIWG) which has been established for the Mortar Ballistics Computer will ensure that the MBC computer resources are properly tested and evaluated. The responsibilities of the Commands for this effort are described in Paragraph 4.1 of this CRMP.

5.2 Organization/Activities Responsible for Verification and Validation

5.2.1. The Product Assurance Directorate is the AMCCOM independent evaluator for verification and validation of the MBC and its maintenance support equipment, including computer resources.

The Product Assurance Directorate will participate in the review and approval of contractor CPCI Test Plans/Procedures and the Product Assurance Test, Demonstration and Evaluation Plan. These procedures will be utilized for software validation and verification. Validation and verification results will be reported by the contractor in the Quality Inspection Test, Demonstration and Evaluation Report.

5.3 Development/Acquisition Schedule for Special Test Tools

MBC maintenance will require the use of Automatic Test Equipment. This will necessitate the development of Test Program Sets (TPS's) for the MBC and Circuit Card Assemblies. These will be initially developed by TOAD under supervision of FSL for the specific ATE requirements of the MBC maintenance concept. The ATE milestone is scheduled for 4QFY86.

5.4 Test Requirements Analysis Methodology

Analysis methodology is described in the CPCI Test Plans/Procedures. It identifies those tools, techniques, and methodologies in the software development which support QA objectives.

5.5 Methodology and Schedules of Benchmark Test Cases for Various Levels of Software Testing

Testing activities shall continue throughout the entire PPE phase. Two distinct levels of testing are defined as part of this activity: Unit Testing and Software Integration Testing. As modifications are made to the program as the result of change activity, error correction or required re-design, and as these modifications are integrated into the system, it shall be necessary to repeat tests at either level to verify the operation of the modified program system. Tests shall verify that specific inputs produce the proper responses.

5.5.1 Unit Testing

This activity will proceed as an extension of the top-down approach to the software design and implementation. Testing will consist of exercising programs and routines in programs individually by using a range of known expected inputs and comparing the resulting programs outputs with expected outputs. Such testing shall continue until the results indicate that the computer program unit reflects the program design and is "error free".

5.5.2 Software Integration Testing

Program units will be incrementally integrated and tested to exercise functional compatibility. This testing will emphasize the interaction

between related performance characteristics of the MBC to verify program interfaces and to ensure that the program operates in accordance with the Computer Program Development Specification (B5). Simulated systems inputs in varying degrees of complexity will test and verify the integrity of the software. All software will be integrated and tested on MBC hardware prior to First Article Test (FAT).

5.6 Software Monitoring Design Plan

The contractor will use his own policies, procedures and documentation to monitor software and ensure that computer software delivered to the Government fulfills all contractual requirements.

5.7 Procedures for Reporting and Resolving Computer Program Errors and Deficiencies During Testing

The procedures for reporting and resolving computer program errors during contractor PPE testing include the use of letter reports and recommend corrective resolutions in the form of preliminary engineering change proposals (PECPs). Prior to FAT the contractor will act on Government approved PECPs to correct the errors and shortcomings uncovered during PPE. After implementation the contractor will document and validate all mandatory changes. The software changes will be implemented by the development of new memory coding by reprogramming the existing erasable programmable read only memory (EPROM) chips.

5.8 Schedule for Test Plans and Testing

The test plans and test schedules are contained in the Coordinated Test Program (CTP) dated 15 July 1984.

6.0 POST DEPLOYMENT SUPPORT

6.1 Responsibility

AMCCOM (R) is responsible for post deployment management of the MBC program. The AMCCOM PDSS Center, FSL, and PAD have responsibility for providing computer resource support to the deployed MBC and to Government users.

6.1.1 The PDSS Center Computer Resource Support will include ECP evaluation, software management, maintenance (software change implementation and control), test and other related functions necessary to ensure the operational capabilities of the fielded MBC. The computer resource management procedures will be consistent with DARCOMR 70-16 and with this CRMP.

6.1.2 FSL is responsible for system engineering, to include ECP evaluations, system level change integration, and system level testing. FSL is also responsible for ATE and TPS's which include maintenance, test and other related functions.

6.1.3 The AMCCOM Product Assurance Directorate is responsible for all software QA functions to include generating all test procedures, monitoring tests performed by PDSS and assessing test results for final program validation and verification.

6.1.4. The ATE/PDSS/TMDE Control Office, AMSMC-MA-ATE will provide user field software support via strategically placed Field Service Requirements (FSR). This office will also serve as the AMCCOM National Maintenance Point (NMP) liaison to the AMCCOM PDSS Center on matters concerning software maintenance of Battlefield Automated Systems (BAS).

6.2 Configuration Management

Configuration Management is the responsibility of AMCCOM for baseline and change control of the MBC. The AMCCOM level II CCB, including the PDSS Center, FSL, and PAD, will handle AMCCOM actions directed by the AMCCOM level I CCB. Overall configuration management will be conducted in accordance with AR 70-37 with change control actions (ECP's, VECP's and RFD/W's) prepared in accordance with DOD-STD-480A.

6.3 Responsibilities for Composite System Integrity

After the initial production phase of the MBC program is completed, the responsibility for software support will be transferred to the LCSS Center. The LCSS Center will maintain the composite system integrity including:

- a. Computer memory storage utilization
- b. Computer program time constraints and priorities
- c. Computer program interface techniques
- d. Computer program baseline integrity
- e. Use of computer modules and peripherals
- f. Software change engineering and implementation.

6.4 Documentation Required to Support Each Type of Computer Program

Documentation requirements are identified in Section 3.8 and 6.8. The repository for these documents will be the LCSS Center. These documents will be utilized by the various AMCCOM elements, which will be involved during the post deployment phase (e.g., FSL, PAD, TSD).

6.5 Responsibility for Funding

The Post-Deployment funding for the support of operational software will be the responsibility of AMCCOM. AMCCOM (R) will be responsible for obtaining funds for the engineering and installation of changes/modifications to software. AMCCOM (R) will also be responsible for obtaining funds for the procurement of the hardware/software resulting from these changes.

6.6 Personnel Required for Computer Resources Support

The personnel required for supporting computer equipments and programs will be supplied by the LCSS Center, FSL and PAD. Each organization will be tasked with identifying the core personnel.

6.7. Computer Equipment Required to Facilitate Computer Program Changes and Acquisition Responsibilities

The acquisition responsibility for the computer equipment and devices required to facilitate computer program changes lies with the DPO with recommendations from the LCSS Center. The minimum hardware requirements comprise 4 Mortar Ballistics Computers, M23, and 2 Tactical Communications Modems (TCM). FSL and the AMCCOM PDSS Center will each have 2 MBC's and 1 TCM so that each organization can perform its mission responsibilities. The following is a list of additional equipment items recommended by the LCSS Center for MBC support:

MBC EPROM Programming Station
HP 64000 NSC800 Accessories
8 Bit Emulator Memory Part No. 64152S
with option 011 32 Kbyte additional memory
NSC800 Emulator Pod Part No. 64292S

6.8. Computer Programs Required to Support Computer Equipment and Other Computer Programs

The following is a list of software items needed by the LCSS Center to support the MBC:

NSC800 Emulator (comes with Pod)
NSC800 Assembler and Linker, Part NO. 64842AF
EPROM Burner Software
Magnavox generated software package and documentation
Magnavox generated test and support software consisting of the following items:

AMSZ80.EXE	Microtex Z80 Assembler
LODZ80.EXE	Microtec Linker/Loader
MBCSIMZ80.EXE	Modified Microtex Simulator (MBC)
DTL.EXE	DTL Preprocessor
DTL.CLD	DTL Command Definition File
GETERRORS.EXE	Assembly error reporting
GETERRORS.CLD	GETERRORS Command Definition File
COMPRESS.EXE	Compress Symbol Table in Linker Output Files
COMPRESS.CLD	COMPRESS Command Definition File
GETSYMBOL.EXE	Generate Symbol List File
GETSYMBOL.CLD	GETSYMBOL Command Definition File

6. 8 (Continued) - Computer Programs Required to Support Computer Equipment and Other Computer Programs

GENTABLE.EXE GENTABLE.CLD	Generate Microtec Linker Format Symbol Tables GENTABLE Command Definition File
CONVRTSYM.EXE FIX.EXE	Convert Linker Output Files to INTEL Format Fixed Point/Floating Point Conversions
UPDATE.COM MBC.MMS	Command Procedure Driver for MMS Updating MMS Command File for MBC Update
UPDABS.COM UPDOBJ.COM UPDDEF.COM GENLOD.EXE GENLOD.CLD	Command Procedure Called in MBC.MMS Command Procedure Called in MBC.MMS Command Procedure Called in MBC.MMS Generate Loader Command File from Skeleton GENLOD Command Definition File
ORDERSYM.EXE ORDERSYM.CLD	Generate Symbol List Sorted by Name, Value ORDERSYM Command Definition File

6.9 Verification and Validation of Computer Programs

The approval for Materiel Release of post deployment software changes will be the responsibility of the Product Assurance Directorate of AMCCOM.

6.10 Plans to Establish and Operate Necessary Support Facilities

The AMCCOM PDSS Center will establish the requirements for support facilities. The plan for the PDSS supportability demonstration will be formulated when the PDSS requirements for the MBC computer resource items become clearly defined by the DPO, XM23.

6.11 Provisions for the Transfer of Program Management Responsibility

The MBC System is under management of DPO, XM23. All computer resources files and technical data will be provided to the AMCCOM PDSS Center within 30 days after the PROD-VAL IPR.

6.12 Provisions for System/Equipment Deployment

The system shall be deployed in accordance with the Materiel Fielding Plans after materiel release.

APPENDIX A
SYSTEM TEST CONSOLE
FOR THE
MORTAR BALLISTICS COMPUTER, M23

A-1

F-58

Appendix A

1.0 INTRODUCTION

This section describes the System Test Console used to test the Mortar Ballistics Computer, M23. The block diagram denotes the components of the test station and the interconnection of each.

2.0 HARDWARE

2.1 System Test Panel

The system test panel contains an 8080A microprocessor with two (2) kilobytes of RAM and eight (8) kilobytes of EPROM. The microprocessor controls the station operation via the resident software in EPROM and the command instructions it reads and executes from the paper tape. The panel contains the hardware to transmit messages to and receive messages from the MBC through the modem and analog interface circuitry and can also make any keyboard entries using the keyboard interface. The video interface informs the operator of test status and results and prompts for any manual operations required.

2.2 Power Supply Panels

The power supply panels supply the +5vdc and +12vdc to the system test panel and an adjustable DC power source required by the MBC.

2.3 AC Power Control Panel

The AC power control panel distributes the AC power to the DC power panels and the commercial equipment as required. It also provides the circuit breaker protection for the station.

2.4 Commercial Equipment

The commercial equipment utilized in this station includes:

A. Video Monitor	Conrac Model SNA14/C
B. Paper Tape Reader	Addmaster Model 650-2
C. Oscilloscope	Philips Model PM3217
D. Digital Voltmeter	Fluke Model 8040A
E. Frequency Counter	GenRad Model 1191B

3.0 SOFTWARE

3.1 System Test Panel Software

The software contained in the eight (8) kilobytes of EPROM in the system test panel is an interpreter for the command instructions on the paper tape. This software reads the command instructions from the paper tape and executes them as they are read. The video modem, analog, relay, and keyboard interfaces are all controlled by this software. The command instructions are further discussed below in the paper tape software section.

Appendix A

3.2 Paper Tape Software

The command instructions contained on the paper tape are executed sequentially by the system test panel as they are read. Each command begins with an asterisk (*) which is followed by a single character which determines the type of command to be executed. The characters which follow are parameters of the command type and are dependent on the command type. The command type characters and their functions are briefly described below.

<u>COMMAND TYPE CHARACTER</u>	<u>DESCRIPTION</u>
C	Compose message on UUT keyboard.
D	Display message on video monitor.
E	Introduce single bit error into every character transmitted to UUT.
H	Halt test station.
I	Induce error in any character or bit position in transmitted message.
K	Switches relays in test panel to correct audio signal and level.
N	Load test number into station buffers.
R	Loads message to be received into station then activates key to transmit message and then compares received message.
S	Sets station status for correct parameters.
T	Loads message to be transmitted into station and time disperse message and parity buffers.
X	Transmits message setup in T command.

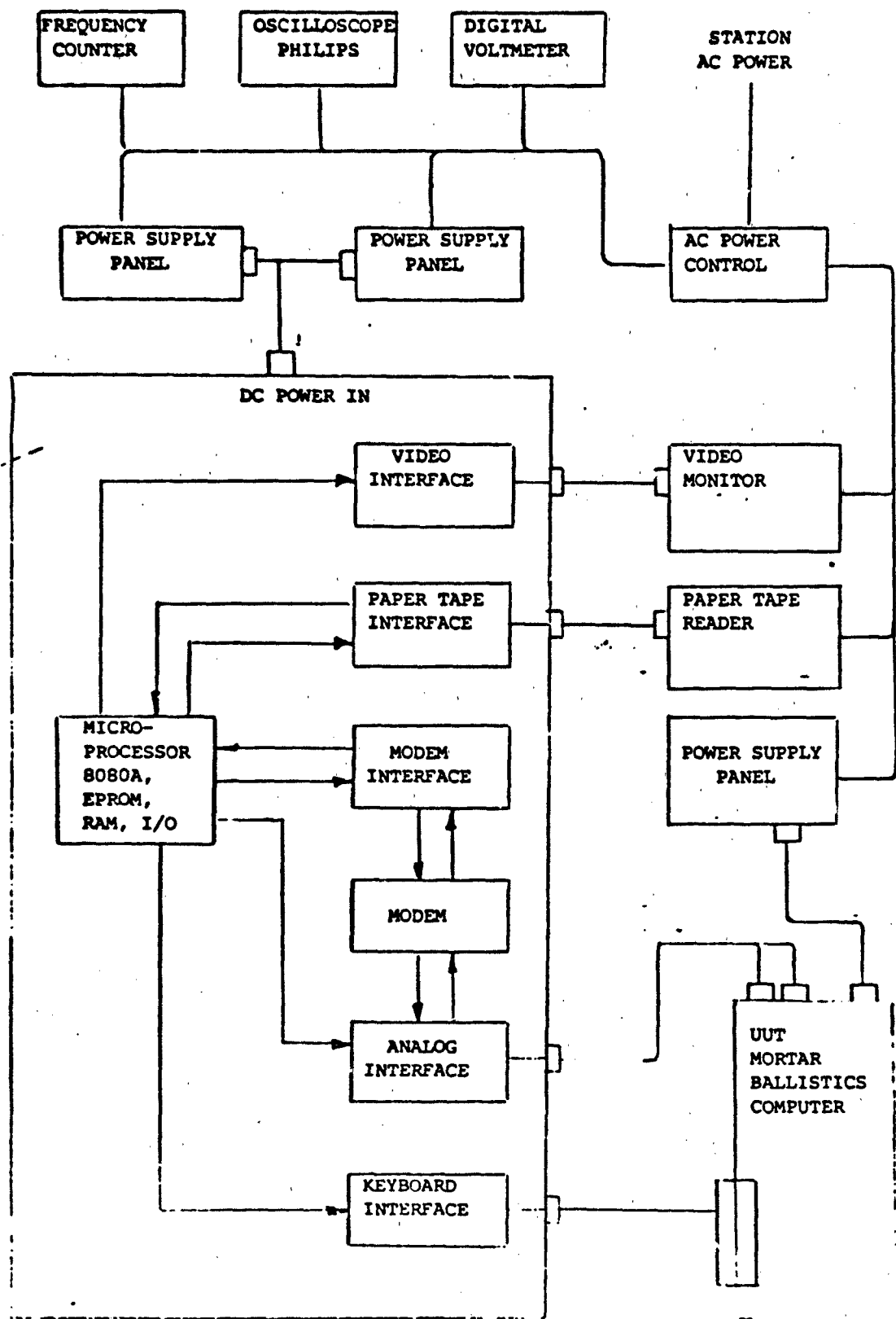

BLOCK DIAGRAM - MRC SYSTEM TEST CONSOLE

1 2 3 4 5 6 7 8 9 10 11 12 13 14 15 16 17 18 19 20 21 22 23 24 25 26 27 28 29 30 31 32 33 34 35 36 37 38 39 40 41 42 43 44 45 46 47 48 49 50 51 52 53 54 55 56 57 58 59 60 61 62 63 64 65 66 67 68 69 70 71 72 73 74 75 76 77 78 79 80 81 82 83 84 85 86 87 88 89 90 91 92 93 94 95 96 97 98 99 100

APPENDIX B

INDEPENDENT VERIFICATION AND VALIDATION PROGRAM PLAN

FOR THE
COMPUTER, BALLISTICS: MORTAR, M23
(MBC)

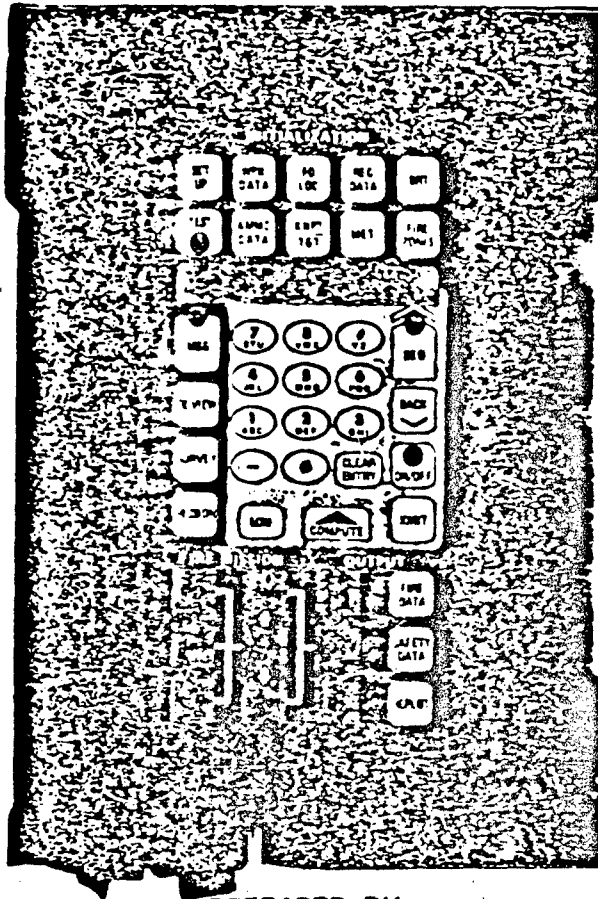

PREPARED BY

TECHNOLOGY OFFICE
SOFTWARE QUALITY ASSURANCE/MATHEMATICS BRANCH
of the
PRODUCT ASSURANCE DIRECTORATE
U.S. ARMY ARMAMENT, MUNITIONS, CHEMICAL COMMAND
Dover, New Jersey 07801

ABSTRACT

This Independent Verification and Validation (IV&V) Program Plan contains information on the planning, coordination, and specific V&V tasks required to conduct an IV&V program on the Computer, Ballistics: Mortar, M23(MBC). This program will provide the DPO MBC and AMCCOM with an independent and continuous assessment of the MBC computer resources during production and post deployment phases of the MBC life-cycle.

TABLE OF CONTENTS

Paragraph	Page
<u>SECTION I GENERAL</u>	
1.1 INTRODUCTION.....	1
1.1.1 Purpose.....	1
1.1.2 Scope.....	1
1.1.3 Authority.....	1
1.1.4 Definition.....	1
<u>SECTION II IV&V PROGRAM APPROACH</u>	
2.1 PROGRAM OVERVIEW.....	3
2.2 PROGRAM ADMINISTRATION.....	3
2.3 PROGRAM FUNDING ESTIMATION AND DISTRIBUTION.....	3
2.4 INTERFACES AND COORDINATION.....	3
<u>SECTION III IV&V TASK DEFINITION</u>	
3.1 IV&V PHASE DEFINITION.....	4
3.1.1 Milestone III Program Review & Procurement Contract..	4
3.1.2 IV&V Tasks During Production.....	4
3.1.3 IV&V Tasks During Post Deployment.....	4
3.2 IV&V TASKS TO IMPROVE MBC QUALITY, RELIABILITY, AND SUPPORTABILITY.....	4
<u>SECTION IV TOOLS AND EQUIPMENT</u>	
4.1 TOOLS.....	9
4.2 EQUIPMENT.....	9
4.3 USE OF THE DEVELOPER'S RESOURCES.....	9

LIST OF TABLES

Table	Title	Page
3.1	MILESTONE III PROGRAM REVIEW AND PRODUCTION CONTRACT IV&V TASKS.....	5
3.2	IV&V TASKS DURING PRODUCTION.....	6
3.3	IV&V TASKS DURING POST DEPLOYMENT.....	7
3.4	IV&V TASKS TO IMPROVE MBC QUALITY, RELIABILITY AND SUPPORTABILITY.....	8

SECTION I

GENERAL

1.1 INTRODUCTION

This section provides an overview of the purpose, scope, and authority for the preparation of this Independent Verification and Validation (IV&V) Plan for the Computer, Ballistics: Mortar, M23 (MBC).

1.1.1 PURPOSE

The purpose of this IV&V Plan is to identify those specific V&V tasks that must be performed adequately to provide the necessary data, analyses, and testing to assure a thorough IV&V for the MBC program during the production and post deployment phases of its life-cycle.

1.1.2 SCOPE

This plan applies to the IV&V effort during the production and post deployment phases of the MBC life cycle. Specific V&V tasks which are performed during these phases to accomplish overall IV&V objectives are identified in Section III.

1.1.3 AUTHORITY

This plan was prepared under the auspices of the Development Project Office (DPO) MBC for inclusion in the Computer Resources Management Plan (CRMP) for the MBC and in accordance with AMC R 70-16 and the Draft AMC Product Assurance & Test (PA&T) policy on Independent Verification & Validation.

1.1.4 DEFINITION

Independent Verification and Validation- is a major activity of the total quality program (both software and hardware) to independently assess/confirm compliance with requirements.

Independent - an organization that is separate from the development activity from a contractual and organizational standpoint.

Verification - is the evaluation process designed to ensure the consistency and completeness of the software product at any given phase within the MBC. life-cycle.

Consistency is concerned with measuring the degree to which a given phase (e.g., design) is in agreement with the previous phase (e.g., requirements) in the development and post deployment change cycles.

Completeness is a measure of the readiness to initiate the next phase in the development and post deployment change cycles.

Validation - is the integration, testing, and/or evaluation activities carried out at the system and subsystem level to evaluate the developed computer program against the system specifications and the user's requirements.

T

SECTION II

IV&V PROGRAM APPROACH

2.1 PROGRAM OVERVIEW

The IV&V program will provide an independent and continuous assessment of the MBC computer resources through the production and post deployment phases. This effort will ensure that all necessary analyses, evaluations, and tests are conducted efficiently and effectively to preserve the pre-established levels of quality, reliability and maintainability of the MBC software. This IV&V effort will also include assessments of the equipment necessary to support the production, factory testing, and the post-deployment software change environment to assure its proper functioning. Additional IV&V tasks may be conducted to improve the quality, reliability, and supportability of the MBC.

2.2 PROGRAM ADMINISTRATION

PAD has been assigned responsibility for the IV&V program in support of the DPO MBC and AMCCOM. PAD will utilize data generated from V&V activities performed by all organizations in the accomplishment of the overall IV&V program. Additional tasks to improve the quality, reliability and supportability of the MBC may be performed by an IV&V contractor or PAD.

2.3 PROGRAM FUNDING ESTIMATION AND DISTRIBUTION

PAD as the responsible organization in support of the DPO MBC and AMCCOM will control all necessary funds to assure completion of the IV&V program.

2.4 INTERFACES AND COORDINATION

The DPO-MBC as the overall MBC program manager will be the focal point of communication between the developer(s) and the IV&V effort. All data and documents required will be requested through the DPO and all reports and analyses generated will be submitted to the DPO. This policy will maintain an orderly flow of information and reduce interference with the developer(s).

All IV&V plans/activities as with all MBC related actions are subject to final approval of the DPO-MBC.

SECTION III

IV&V TASK DEFINITION

3.1 IV&V PHASE DEFINITIONS

3.1.1 MILESTONE III PROGRAM REVIEW & PRODUCTION CONTRACT

This phase of the IV&V program will be initiated after First Article Testing (FAT) has been completed by Magnavox. The final product baselines for the MBC software will be established and the production phase will be initiated. Specific tasks to be accomplished during this phase are identified in Table 3.1.

3.1.2 IV&V TASKS DURING PRODUCTION

Table 3.2 defines all the tasks which will be executed during the production phase of the MBC.

3.1.3 IV&V TASKS DURING POST DEPLOYMENT

The designated PDSS center for the MBC will be the AMCCOM LCSS center located at ARDC Dover, NJ. The tasks which will be performed during the post-deployment phase of the MBC are identified in Table 3.3.

3.2 IV&V TASKS TO IMPROVE MBC QUALITY, RELIABILITY & SUPPORTABILITY

Table 3.4 identifies IV&V tasks which may be performed in order to improve the quality, reliability and supportability of the MBC. These tasks will establish a traceability data base between requirements and design documentation to the source listings. This will greatly improve the current documentation of the MBC software program. Also static as well as dynamic analyses will be conducted to determine complexity, improve test coverage and measure as well as improve the quality and reliability of the MBC software program.

TABLE 3.1

MILESTONE III PROGRAM REVIEW & PRODUCTION CONTRACT

- Assist in Functional & Physical Configuration Audits
- Assess and evaluate all equipments necessary to support the production process (ATE etc.)
- Review Production Planning
- Assess Configuration Management for Production
- Assess Quality Assurance for Production
- Assist in Reviewing/Preparing Technical Data Package
- Assess Computer Resource Needs for Production
- Assess Production Contract for Computer Related Items
- Assess Production Testing Plan & Procedures
- Assess Software Handling Procedures for Production
- Establish the pre-PDSS baseline for requirements specs, test procedures etc.

TABLE 3.2

IV&V TASKS DURING PRODUCTION

- ECP evaluation and trace maintenance
- Review for Compliance to Software Standards, Policies and Procedures
- Assist in Establishing Audit Trail
- Assess Production Testing for Continuance of Performance Baseline
- Review QA and CM Procedures
- Assist in Establishing System Assessment Pipeline for Operational/Fielded Systems
- Monitor Approval & Disposition of Formal Releases
- Continual assessment of all production test equipment
- Acceptance test analysis for software "bug" symptoms

TABLE 3.3

IV&V TASKS DURING POST DEPLOYMENT

- **Conduct PDSS supportability demonstration**
 - Assess MBC development environment
 - Certify all support equipment
 - Evaluate CM procedures
 - Evaluate Software Engineering procedures
- **Assess/Evaluate Software QA Plan/Procedures for PDSS**
- **Evaluate/Assess Failures in Operation/Fielding**
- **Assess System Failures and Need for Change (ECP)**
- **Perform Revalidation**
 - Reverify that Requirements are Being Met
 - Use Tracking Data Base
 - Evaluate Impact of Change
- **Redesign and Recode as Required**
 - Use Test Tools as Required
 - Assess Changes to Documentation
 - Update Configuration
- **Revalidate Software**
 - Repeat Key Tests to Reaffirm Confidence in System Software
 - Review Baseline and Archive Data & Programs
- **Maintain IV&V baseline and technical competence**

TABLE 3.4

IV&V TASKS TO IMPROVE MBC QUALITY, RELIABILITY & SUPPORTIBILITY

- Establish a Requirements Tracing Data Base between LR and MBC software development specifications
- Use Metrics to Assess Quality factors
- Trace software requirements into Design documentation
- Run models and simulations
- Review code against Design documentation
- Trace code to design
- Use static and dynamic analysis tools
- Establish a trace between test and requirements documents
- Develop independent test scenerios
- Perform a reliability assessment

SECTION IV

TOOLS AND EQUIPMENT

4.1 TOOLS

The IV&V Program may procure MBC specialty tools or modify already existing tools to accomplish many of the IV&V tasks. Equipment needed to support the development/fabrication/testing of the MBC will be shared with the LCSS center.

4.2 EQUIPMENT

The IV&V program will have access to a CP/M compatible Z80 distributed processing TURBO DOS microcomputer system and a Digital Equipment Corporation VAX 11/780 Computer system with VMS and UNIX operating systems. Also, a Input-Output Requirements Language (IORL) developed by Teledyne-Brown Engineering will be loaded on the VAX and Apollo work station. IORL will be used for all requirements tracing which will establish a tracking data base system for the MBC.

Additional equipment for independent tests and/or evaluation assessments of the MBC may be purchased as required.

4.3 USE OF THE DEVELOPER'S RESOURCES

The possible use of a developer's tools and/or equipment will be coordinated through the DPO-MBC to assure no interference with the development process.

APPENDIX C

GLOSSARY

List of Key Terms and Acronyms

C-1

F-75

APPENDIX C

A

ACK Acknowledged
AMC US Army Materiel Command
AMCCOM US Armament Munitions and Chemical Command
ANSI American National Standard Instruction
AR Army Regulation
ARDC US Army Research and Development Command
ASCII American Standard Code for Information Interchange
ASL Authorized Stockage List
ATE Automatic Test Equipment

B

BAS Battlefield Automated Systems
BAUD Measurement of data transmission rates expressed as "bits per second" or bps
BIT Build-In-Test
bit A unit of data in the binary numbering system
BRL Ballistics Research Laboratory
byte A generic term to indicate a measurable portion of consecutive binary digits

C

CCB Configuration Control Board
CDR Critical Design Review
CECOM US Army Communication and Electronics Command
CM Configuration Management
CMOS Complementary Metal Oxide Semiconductor
CMP Configuration Management Program
CPCI Computer Program Configuration Item
CP/M Control Program for Microcomputers
CPU Central Processing Unit

APPENDIX C

CRMP Computer Resources Management Plan
CRWG Computer Resources Working Group
CTP Coordinated Test Program

D

DA Department of the Army
DEVA-IPR Development Acceptance In-Process Review
DMD Digital Message Device
DOD Department of Defense
DODD Department of Defense Directive
DOS Disk Operating System
DPO Development Project Officer
DTL Display Terminal Language
DT/OT Development Test/Operational Test

E

EBCDIC Expanded Binary Coded Decimal Interchange Code
ECP Engineering Change Proposal
EMD Electro Magnetic Device
EOM End of Mission
EPROM Erasable Programmable Read Only Memory

F

FAT First Article Test
FATDS Field Artillery Tactical Data Systems
FCA Functional Configuration Audit
FCI Fire Control Inputs
FDC Fire Direction Center
FDTE Force Development Testing and Experimentation

APPENDIX C

F

FIST Fire Support Team
FO Forward Observer
FQT Formal Qualification Test
FR Fire Request
FSD Full-Scale Development
FSK Frequency Shift Keying
FSL Fire Control and Small Caliber Weapon Systems Directory
FSR Field Service Requirements
FUE First Unit Equipped

G

SFE Government Furnished Equipment

H

HFE Human Factors Engineering
HOL High Order Programming Language

I/O Input/Output
IKP Instructor/Key Personnel
ILS Integrated Logistic Support
IOC Initial Operational Capability
IORL Input-Output Requirements Language
IPR In-Process Review
IPT Initial Production Test
IV&V Independent Verification and Validation

J

APPENDIX C

K

K A symbol which is equivalent to the numeral 1024
Kilobyte Denotes 1,000 "bytes"

L

Language A defined set of characters used to form symbols, words, etc., and the rules for combining these into meaningful communications
LED Light Emitting Diode
LSA Logistic Support Analysis
LSAR Logistic Support Analysis Record
LWCMS Light Weight Company Mortar System
LCSS Life Cycle Software Support
LR Letter Requirement

M

MBC Mortar Ballistics Computer, M23
MFCC Mortar Fire Control Calculator
MODEM MOdulator DEModulator Unit. A device that converts data from a form which is compatible with data-processing equipment to a form that is compatible with transmission facilities, and vice-versa.
MOS Military Occupational Sepecialty
MR Materiel Release
MRSA US Army AMC Materiel Readiness Support Activity

N

NAK Not Acknowledged
NET New Equipment Training
N1 Cad Nickel Cadmium
NMP National Maintenance Point

O

APPENDIX C

P

PAD	Product Assurance Directorate
PA&T	Product Assurance & Test
PCA	Physical Configuration Audit
PDSS	Post Deployment Software Support
PE	Production Engineering
PIP	Product Improvement Proposal
PLL	Prescribed Load List
PPE	Pre-Production Engineering
PROD-VAL	Production Validation
PROGRAM	A set of instructions or steps that tells the computer exactly how to handle a complete problem, e.g. ballistics

Q

QA Quality Assurance

R

RAM Random Access Memory

RAM-D Reliability, Availability, and Maintainability-Durability

RFQ Request for Quotation

ROM Read Only Memory

S

SCP Software Change Proposal

SP Software Package - Various Computer programs or sets of programs used in a particular application such as a mortar ballistics package

SQA Software Quality Assurance

APPENDIX C

S

SSF Software Support Facility
SSP System Support Package
STE Simplified Test Equipment

T

TACFIRE Tactical Fire Direction System
TC Type Classified
TCM Tactical Communications Modem
TDP Technical Data Package
TECOM US Army Test and Evaluation Command
TIWG Test Integration Working Group
TM Technical Manual
TMDE Test, Measurement, and Diagnostic Equipment
TOAD Tobyhanna Army Depot
TPS Test Program Set
TRADOC US Army Training and Doctrine Command
TSD Technical Support Directorate
TSO Time Sharing Option

U

UNIX An operating system for 16-bit computers
USAIS US Army Infantry School
UUT Unit Under Test

V

VE Value Engineering

W

WSMR White Sands Missile Range

ANNEX G

SUPPORTING DATA
FOR
MATERIEL RELEASE
OF
COMPUTER, BALLISTICS: MORTAR, M23

MATERIEL RELEASE
SUPPORTING DATA FOR

Item Nomenclature: Computer, Ballistics; Mortar Set M23

MSN: 1220-01-119-6049

Contractor: Magnavox Company

Contract No. DAAK10-83-C-0135

Quantity: 180 Units

Dates of Production: _____

Type of Release: Full Release

Release Category: First Time Procurement

DATE PREPARED:

TABLE OF CONTENTS

<u>Paragraph</u>	<u>Page</u>
1. Description	1
2. Background Summary	1
3. Status of Type Classification	1
4. Testing	2
5. Reliability Status	2
6. Achievement of Requirements	2
7. Deficiencies and Shortcomings	4
8. Resolution of Equipment Performance Reports (EPR's) and Quality Deficiency Reports (QDR's)	4
9. System Safety	5
10. Cumulative Effect of Changes	5
11. Interface Documentation	5
12. Technical Data Package (TDP) and Physical Configuration Audit (PCA)	6
13. Materiel Fielding Plan (MFP) and Materiel Fielding Agreement (MFA)	6
14. Integrated Logistics Support	6
a. ILS Influence on Design	6
b. Maintenance Plan	6
c. Manpower and Personnel	7
d. Supply Support	7
e. Support Equipment and Test Measurement and Diagnostic Equipment	7
f. Training and Training Devices	8
g. Technical Data	8
h. Computer Resources Support	8
i. Packaging, Handling, Storage	9
j. Transportation and Transportability	9
k. Facilities	9
l. Not used	
m. Rationalization, Standardization and Interoperability (RSI)	10
15. Basis of Issue (BOI)	10
16. Basic Issue Items (BII)	10
17. Materiel Deterioration Prevention and Control	10
18. Human Factors	10
19. Health Hazard Evaluation	10
20. Environmental Quality (Ref AR 200-1)	10
21. Publications	10
22. Availability of Materiel	11
23. Warranty Provisions	11
Appendix A, Reliability Status	

1. Description.

The M23 Mortar Ballistics Computer (MBC) provides fully automated fire direction computation, communication, and display capabilities for the 60mm (Light Weight Company Mortar), 81mm and 107mm (4.2 in) mortars. It is a hand-held, lightweight, battery powered unit capable of rapidly computing ballistics trajectories for these mortar systems. All pertinent computational parameters utilized in the point mass ballistics technique are taken into account to achieve accuracies and computation times previously achievable only in the largest computer systems. When used in conjunction with the Digital Message Device or FIST-DMD, the M23 can receive incoming messages from the Forward Observer (FO) or the Fire Direction Center and display each on command and perform all required computations for firing from any of three battery or platoon positions (up to 18 individual weapon locations). It will also perform survey computations, process inputs from FO's, store and access up to 50 known points and 12 FO locations; handle 3 concurrent missions, store up to 3 digital messages; 4 no-fire lines; 10 no-fire areas; 16 registration points; and 3 Final Protective Fires. Because the M23 is so versatile and easy to use, it allows one man to perform in seconds, the calculations which now require a 2 to 5 man team many minutes to perform. Furthermore, the M23 gun orders are more accurate and consistent from mission to mission. The ability to provide 1 meter accuracy for ballistic computations in less than 5 seconds using a calculator weighing 6 pounds, (including batteries), has been achieved through years of development on the hardware, software and processing algorithms.

The M23 is designed for ease of supportability. No repair is necessary at the organizational level and a defective calculator is identified through the calculator's built in test. Repairs at the DS level are limited to Printed Circuit Board (PCB) and case parts replacement. Computer built in tests will isolate defective PCBs for the DS repairman significantly reducing turn around time. Repairs to the PCBs will be accomplished at depot utilizing the equate standard test equipment. The M23 will operate off of three standard military batteries as well as DC vehicular power.

2. Background Summary.

In December 1977, a Letter Requirement for a Mortar Ballistic Computer (MBC) was approved by the Army and an RFQ to industry issued one year later. A Full Scale Engineering Development (FSED) contract was awarded in July 1979. The XM23 completed FSED in July 1980 and was approved for Limited Production.

In May 1983, a competitive production contract was awarded to Magnavox Company, Fort Wayne, Indiana, for the fabrication of 180 MBC's with an option to purchase 518 more.

All of the recommended improvements from the July 1980 DEVA-IPR were incorporated into the MBC which successfully passed First Article Test in January 1985.

3. Status of Type Classification. The Mortar Ballistic Computer (XM23) was Type Classified LCC-U on 8 July 1980 and will be subsequently reclassified standard on 29 August 1985.

4. Testing.

Summary of Tests

May - June 1980	Contractor testing
July - September 1980	Operational Test (II)
September - November 1980	Engineering Development Test
May - June 1984	Physical Teardown/Logistics Demonstration
July 1984 - January 1985	First Article Testing at Magnavox. All tests completed successfully.
September - December 1984	Initial Production Test at White Sands Missile Range (WSMR), New Mexico. All tests were completed. Pertinent software shortcomings will be corrected prior to first production. A final report was distributed in June 1985.
September - November 1984	Electro Magnetic Radiation/Radiation Frequency Interferences (EMR/RFI). All shortcomings have been corrected. Data was reported in WSMR report received June 1985.
May 1984 - July 1985	Physical Configuration Audit and Functional Configuration Audit (PCA/FCA)
July 1985	TECOM Verification of IPT software shortcomings

5. Reliability Status. DARCOM Form 1576-R, Part B is attached at Appendix A to this document.

6. Achievement of Requirements.

<u>Requirement</u>	<u>Status</u>
1. Powered by interchangeable primary or secondary batteries.	Met
2. Calculate fire control data for the 60, 81, and 107 mm mortars.	Met
3. Accept both grid coordinates and polar plot to generate firing data.	Met
4. Capable of storing and/or changing stored data.	Met
5. Operate in environmental extremes categories 1-6 as prescribed in AR 70-38.	Met
6. Store initialization data for 6 mortar firing positions in sequence.	Met
7. Accept all specified inputs as required by the FO/FDC.	Met

Requirement (cont)

Status (cont)

- | | |
|--|-----|
| 8. Provide all specified outputs as required by the FO/FDC. | Met |
| 9. Computation time shall be less than 5 sec. | Met |
| 10. Simplicity of operation. | Met |
| 11. Store 9 FO locations. | Met |
| 12. Verification of entered data by operator and correction of data during fire mission. | Met |
| 13. Hand portable and weigh no more than 6 pounds. | Met |
| 14. Have a self-contained throwaway and/or rechargeable power source with a life of 1000 one-minute computations. | Met |
| 15. Have a low voltage indicator. | Met |
| 16. Operate from vehicular power. | Met |
| 17. Have excessive voltage and reverse polarity protection. | Met |
| 18. Capability of storing data for:
8 registration points
3 final protective fires
50 reference points or other targets to include 6-10 fire areas. | Met |
| 19. Firing data accurate to within 10 meters in both range and deflection. | Met |
| 20. Capability of operation in the electromagnetic environment; no damage or degradation by electromagnetic pulse. | Met |
| 21. Display to be legible under all ambient light conditions using sun shield. | Met |
| 22. Accept and compute data for training rounds. | Met |
| 23. Capability of interfacing with the DMD over wire and radio link. | Met |
| 24. Have built in self-test capability. | Met |
| 25. Capability of storing ballistic data for all known cartridge/ fuze combinations; change program data by plug in components when new FCI's are published. | Met |

Requirements (cont)

Status (Cont)

26. Have the following RAM characteristics:

- a. Reliability: MAV 5,000 hours MTBF
BOC 15,000 hours *
- b. Availability: AA greater than 99% Met
- c. Maintainability
 - (1) MR less than 0.049 Met
 - (2) MTTR and MAXTTR will not exceed the following limits:

<u>Level</u>	<u>MTTR</u>	<u>MAXTTR</u>	
DS	2 hrs.	8 hrs.	Met
GS	8 hrs.	16 hrs.	N/A

* Failure rate analysis indicated characteristics are achievable. Limited number production units have precluded demonstrating required RAM goals. First article Test units have demonstrated a MTBF of 300 hours with an 80% confidence level. This value will be updated as more test data and units become available through Initial Production Test and Fielding. During OT II Scoring Conference, TRADOC proposed that a reliability test time of 300 hours would be sufficient testing to establish an acceptable MTBF. The proposal was acceptable to USAIS and this revised requirement was also reiterated at the DEVA/IPR.

7. Deficiencies and Shortcomings.

a. Deficiencies.

<u>Deficiencies</u>	<u>Corrective Action</u>
(1) Unit failed emersion test.	An improved waterproof adhesive was used to glue membrane switch to unit. Units then passed emersion test successfully.
(2) Unit failed RE02 and CE04	Additional capacitors were incorporated into the audio interface unit which corrected problem.
(3) An integrated Circuit failed during humidity testing.	Analysis did not identify the exact cause of the failure. The test was repeated in January 1985 without incident.

8. Resolution of Equipment Performance Reports (EPR's) and Quality Deficiency Reports (QDR's). All EPR's reported by TECOM were forwarded to the contractor for resolution in Dec. 84. The contractor was tasked to resolve all EPR's by 31 Jan 85. No QDR's have been received to date.

9. System Safety

There are no safety issues that would preclude full release of the MBC.

April 1980	Safety Statement for the Mortar Fire Control Calculator
June 1980	Safety Release
September 1984	Safety Statement (update)
August 1985	Safety Confirmation and Adequacy Statement

a. Safety Evaluation.

(1) The MBC is totally safe for testing with the only potential hazard being the primary battery. There are no nuclear, electrical/electronic, or mechanical hazards associated with the MBC.

(2) The primary battery used with the MBC is a lithium organic cell construction. It is a standard Army battery used to power existing FM field radios (BA-5588, MSN: 6135-01-088-2708).

(3) The probability of the battery becoming a hazard in normal operation is infinitesimal. It is possible, by abusive handling, or fire, to cause the cell to vent. Storage areas for large numbers of batteries should have a "Lith-X" fire extinguisher.

b. Safety Committee Findings.

(1) The M23 has been designed with safety as a major objective. There are no dangerous voltage, hazardous or toxic materials used anywhere in the unit. The M23 has been safety engineered to eliminate any operator exposure to miscellaneous hazards such as sharp edges which might injure the operator.

(2) A safety assessment report was prepared by ARDC, PAD Sep 84 and approved by the ARDC Safety Office.

10. Cumulative Effect of Changes. Corrected software shortcoming, identified during IPT, was tested by TECOM prior to first production acceptance.

11. Interface Documentation. The MBC interfaces with the Army Forward Observer Digital Message Device (DMD) AN/PSG-2 and Fire Support Team DMD (FIST-DMD) over both radio or wire link.

a. Interface Procedures. Changes to the MBC message type and format, must be coordinated and approved by the PM FAT DS, Fort Monmouth, New Jersey. Conversely, changes to the DMD and FIST-DMD must be coordinated with the DPO-M23 or his/her authorized representative.

b. Interface Drawings.

(1) The Prime Item Product Specification for the Digital Message Device, AN/PSG-2(b), EL-SS-2603-2F(II), dated 13 September 1977, is the primary document which specifies message formats and signal characteristics for the interface of the MBC with the DMD.

(2) The Prime Item Development Specification for the FIST-DMD (CR-CE-009-001A), dated October 1983 is the primary interface document for the AN/PSG-5 interface.

12. Technical Data Package and Physical Configuration Audit. An updated Technical Data Package (TDP) suitable for competitive procurement was developed by Magnovox Company. Final delivery of the TDP was in January 1985. The DCASPRO Quality Assurance Initial Product Inspection (IPI) has been completed and will be substituted for the Physical Configuration Audit (PCA). All problems encountered have been corrected or are being resolved through minor drawing changes.

13. Materiel Fielding Plan and Materiel Fielding Agreement. A FORSCOM Materiel Fielding Plan with Materiel Fielding Agreement (MFP/MFA) was approved and signed on 15 June 1984. A schedule for future MFP/MFA's is as follows:

TRADOC	30 November 1985
USA REUR	30 November 1985
WESTCOM	30 July 1987
Korea	30 March 1987
NGB	TBA

From the date of materiel release to the user, the Army Materiel Command (AMC) will warranty, for a period of 60 days, the Computer Set, Ballistics: Mortar M23. Should the computer fail, due to poor workmanship or quality, the US Army Armament, Munitions and Chemical Command will replace the item/items free of charge.

14. Integrated Logistics Support (ILS). The requirements of each ILS element is listed in AR 700-127, paragraph 4-3b(5) have been met.

a. ILS Influence on Design. A major factor in the design effort relevant to ILS concerns was the design requirement to use existing standard military batteries for the primary power for the MBC. The MBC is capable of using three different military standard batteries all of which are currently available within Army stores. In addition, the MBC can be operated from a 28Vdc military vehicle battery as well as using standard existing power cables. The maintenance concept also reflects the "fix forward" concept and utilized built in test and circuit board replacement at DS.

b. Maintenance Plan. A three level maintenance (crew/org, DS, and depot) structure will be employed with this system. The provision of AR 750-1, "Army Materiel Maintenance Concepts and Policies" apply. The Maintenance Allocation chart (MAC), included in the appropriate TM, outlines the tasks to be performed and the level at which they are to be accomplished. Higher level maintenance is authorized to perform all the functions authorized at the lower levels.

(1) (a) Operator/Organizational. Performs preventive maintenance checks and services. The Preventive Maintenance Checks and Services (PMCS) function includes cleaning, self-tests and replacements of the primary batteries.

(b) Direct Support. Disassemblies and test to determine the cause of malfunctions by using built in test (BIT) to fault isolate printed circuit boards and replaces printed circuit board and keeps alive batteries. Testing of cables is accomplished through the use of a multimeter AN/USM-486, NSN: 6625-01-145-2430.

(c) Depot. Disassemblies and inspections to determine the cause of malfunction. Test of returned defective printed circuit boards will be accomplished with the use of Equate, AN/USM-410; ABA Code P, and Digital Card Tester, AN/USM-465A.

(2) Maintenance Man-Hours. The maintenance man-hours are as shown below:

OPERATOR - MOS 11C Indirect Fire Infantryman - 10 hrs/yr/item.

ORGANIZATIONAL - MOS 31V Tactical Communications System Operator/Mechanic - 3.2 hrs/yr/item.

DIRECT SUPPORT - MOS 34Y - Field Artillery Computer Repairman - 1.0 hrs/yr/item.

c. Manpower and Personnel. The final approved QQPRI documentation is dated 3 December 1980.

d. Supply Support. The policies and procedures set forth in Chapter 5, AR 700-120 govern the initial distribution of repair parts, special tools, test equipment, maintenance literature, calibration standards, equipment and materials required for organizational, direct and general maintenance. The MBC will be organically supported. Depot interim support will be provided until Test Program Set (TPS) development is completed. The DPO-XM23 has procured 18 additional MBC's and will stock them at the wholesale level to provide commands with a Direct Exchange Concept if they opt to exercise it. This concept is only an interim measure until TPS completion and full Depot support is available.

(1) Spare/Repair Parts. Spare/Repair parts will be available through the Army Supply system by utilization of normal requisitioning procedures. The total Packaging/Unit Materiel Fielding (TP/UMF) concept will apply to the MBC. End items will be sent to New Cumberland Army Depot, the Authorized Stockage List/Prescribed Load List (ASL/PLL) will be sent to redstone Army Packaging Point (PPP). No end items will be delivered to a gaining command without adequate ASL/PLL items. The initial provisioning for all Long Lead Items (LLI) on the basic contract has been completed.

(2) Special Tools. A bit, cross tip screwdriver (NSN 5120-01-161-1729), utilized for removal of security screws, will be required for DS and will be a free issue item with initial fielding of computers. This tool will be requisitioned through normal supply channels at DS and depot level only.

e. Support Equipment and Test Measurement and Diagnostic Equipment.

(1). Support Equipment. Support equipment for the MBC consists of a combination of common tools already in the system at various maintenance levels. No new common tools are required to support the MBC. Existing tool kits needed are:

(a) Direct Support. Electronic tool kit TK 101 (NSN 5180-00-064-5178) and Electronic tool kit TK 105G (NSN 5180-00-610-8177) or equivalent.

(b) Depot Support. Electronic tool kit TK 105G or equivalent.

(2) Test Measurement and Diagnostic Equipment (TDME). TDME at the direct support level consists of MBS Built-In Test (BIT). Several types of faults will be detected and isolated by BIT to the board level. Depot level maintenance will include the AN/USM-410 equate and the AN/USM-465A Digital Card Tester. Three test program sets will be utilized for Depot level maintenance. The depot and D/S units will both use the common multimeter AN/USM-486 (NSN-6625-01-145-2430) or equivalent.

f. Training and Training Devices. No new Training Device Requirement (TDR) is anticipated. The instructor will require an overhead projector, appropriate TM's and one Computer Ballistic Mortar per student to conduct the training. New Equipment Training (NET) will be conducted by AMCCOM and TRADOC. AMCCOM will train MOS qualified 34Y personnel and their immediate supervisors and TRADOC will train MOS qualified 11C and their supervisors. This cadre will establish the follow-on unit level training capability. Training is scheduled for 3rd Qtr FY85. Instructor for the New Equipment Training Teams (NETT) (who will conduct NET) were trained in 3rd and 4th Qtr FY84. Each NETT will require a classroom for 12 students and access to a 120 vac outlet.

g. Technical Data. Draft Technical Manuals (TM) were contractor developed and utilized during testing. No separate training instructions or manuals are planned. No special purpose computer programs are required.

h. Computer Resources Support.

(1) Computer Hardware. The MBC is a small, rugged, easy to operate and inexpensive computer that eliminates the use of existing graphical fire control equipment. The MBC is a solid state electronic computing device with waterproof membrane switch keyboard and panel switches, circuit boards, display elements and power supply. The MBC is capable of being powered by standard Army interchangeable primary (non-rechargeable) or secondary (rechargeable) batteries. The operator will operate the calculator through switch controls, a keyboard and a digital display. The MBC is capable of operating in environmental extremes, categories 1-6 as prescribed in AR 70-38. It's projected life is 15 years and it is anticipated that parts can be obtained to maintain the MBC over that period of time. A three level maintenance (crew/org, DS, depot) structure will be employed with this system. The provisions of AR 750-1, "Army Materiel Maintenance Concepts and Policies" will apply.

The Maintenance Allocation Chart (MAC), included in the appropriate TM, outlines the tasks to be performed and the level at which they are to be accomplished. Higher level maintenance is authorized to perform all the functions authorized at the lower levels.

(a) Operator/Organizational. Performs preventive maintenance checks and services. The Preventive Maintenance Checks and Services (PMCS) functions includes cleaning, self-tests and replacement of the primary batteries.

(b) Direct Support. Disassembles and test to determine the cause of malfunctions by using Built-In-Test (BIT) to fault isolate printed circuit boards and replaces printed circuit board and keeps alive batteries. Testing of cables is accomplished through the use of a multimeter AN/USM-486 (NSN 6625-01-145-2430) or equivalent.

(c) Depot. Disassembles and inspects to determine the cause of malfunction. Tests of returned defective printed circuit boards will be accomplished with the use of Equate, AN/USM-410; ABA Code P, and Digital Card Tester, AN/USM-465A.

(d) The MTR and MAXTR will not exceed the following limits:

<u>Level</u>	<u>MMTR</u>	<u>MAXTR</u>
Direct Support	2 hours	8 hours
General Support	8 hours	16 hours

The lowest replaceable unit at D/S will be at the board level. Defective boards will be repaired at depot where defective parts (chips, resistors, capacitors, etc.) will be replaced and the boards refurbished.

(2) Software.

(a) The Computer Program Configuration Item (CPCI) has been updated, validated and documented to reflect the changes required by the DEVA-IPR.

(b) There are no outstanding trouble reports.

(c) The Computer Resource Management Plan (CRMP) has been updated and is currently being coordinated within AMCCOM prior to submission to AMC.

(d) An FQT was conducted by AMCCOM Product Assurance, Life Cycle Software Support (LCSS), and TECOM. No problems were encountered during the conduct of the tests.

(e) Post Deployment Software Support (PDSS) plans, facilities and the PDSS center have been identified in the CRMP.

(f) BIT verification testing has been completed successfully.

(g) Full depot level support will be available in 4th Qtr. FY 85. Tobyhanna Army Depot (TOAD) has been funded and will develop the required Test Program Sets (TPS) for use on the AN/USM 465A. Interim contractor support will be utilized until completion of TPS's. Funding has been made available for this effort. This test set, a component of the M-107 van is preferred over the AN/USM 410 because of its speed and simplicity in testing digital boards. During TPS development a direct exchange program, to be administered by DS, will be available to enhance operational readiness. Validation and certification of TPS is projected for 4th QTR FY86.

i. Packaging, Handling, Storage. Preservation and packaging is designated for Level A and B in accordance with AR 700-15, MIL-P-116, and MIL-P-14232. All instructions are included in the Technical Data Package (TDP) and Technical Manuals (TM). Current facilities will meet storage requirements and no environmental control is required.

j. Transportation and Transportability. No new procedures are required. Due to the computer being a hand-held device (240 cu in, 0.0037 measurement tons or 6 lbs), transportability requirements do not present a problem. No loading/tiedown drawings are applicable.

k. Facilities. Existing facilities are sufficient to support the computer and will meet all storage and repair facility requirements. No environmental control or site activation/preparation are required.

l. Not used.

m. Rationalization, Standardization and Interoperability (RSI). Requirements do not apply. There are no RSI requirements for the MBC. However, the battery is Army standard.

15. Basis of Issue. The Basis of Issue (BOI) is 2 MBC's per each mortar Fire Direction Center (FDC).

16. Basis Issue Items (BII) and Additional Authorization List (AAL) Items. The following are BII for the MBC:

- a. Case, carrying.
- b. Cable assembly - primary radio interface.
- c. Cable assembly - AN/GRC-106 interface.
- d. Cable assembly - vehicle receptacle.
- e. Cable assembly - vehicle battery.
- f. Field case.
- g. Battery, Lithium - model 13A55BB/U.

The only item for AAL is the NICAD battery, model BB-583/U which would be used in classroom training.

All BII and AAL will be available to the user at FUE.

17. Materiel Deterioration Prevention and Control. There is no specific requirement in the Magnavox contract for delivery of a MADPAC study/evaluation. However, the MADPAC requirements have been considered in that the contractor has addressed materials concerns including: (a) use of CARC chemical resistant paint on calculator exterior surfaces, (b) utilized materials that are resistant to electro-chemical action and environmental degradation in the field and (c) used an improved field proven keyboard design (from the Digital Message Device AN/PSG-2) which has a much higher tolerance for operator abuse. Major components and subassemblies in addition to the MBC system, are being subjected to environmental testing to determine the deleterious effects on materials and performance.

18. Human Factors. Human Factors has been integrated into the M23 design to meet Human Factors Engineering (HFE) requirements. One HFE consideration has been to design the M23 so as to properly align the various functions (such as handling mortar types and firing positions, recalling data, displaying data) between the machine and the operator. Another HFE consideration was to allocate a proper amount of space in the unit for maintenance. The alpha numeric keyboard arrangement was considered in view of HFE. Complete human factors considerations were elevated throughout all phases of testing.

19. Health Hazard Evaluation. The M23 will have no impact on health standards, emission controls or pollution abatement since the unit has no toxic or harmful materials. It is a solid-state electronic computing device.

20. Environmental Quality. Environmental assessments during the development phase of the MBC has determined that this system is of such an environmentally insignificant nature as not to meet the threshold for requiring an environmental impact statement as delineated in AR200-2.

21. Publications.

a. The following publications are available in verified final draft form:

- (1) TM9-1220-246-12&P - Operators Manual.
- (2) TM9-1220-246-34&P - Maintenance Manual.

Camera ready copies of the above manuals will be forwarded to TAC for printing in September 1985.

- b. Handling Equipment. Not Required.
- c. Test, Measuring and Diagnostic Equipment Manuals. Not Required.
- d. Calibration Listing Requirement. Not applicable.
- e. Calibration Procedure Technical Bulletin. Not applicable.
- f. Ammunition Gage Listing Requirement. Not applicable.
- g. Storage Serviceability Standards or Surveillance Supply Bulletin. Not Required.
- h. Changes/Additions to record and reporting system TM38-750. Not Required.
- i. Firing Table. Not applicable.
- j. Lubrication Order (LO). Not applicable.
- k. Explosive Ordnance Disposal Manual. Not applicable.
- l. Separate publications on emergency destruct procedures. Not Required.
- m. Depot Maintenance Work Requirement (DMWR). A DMWR will also be available in July 1986 and will include the TPS's developed by TOAD. As planned, contractor support will be utilized until DMWR's are available.
- n. Modification Work Order (MWO). Not Required.
- o. Demilitarization/Disposal plans. Not applicable.

22. Availability of Materiel. Fourteen (14) MBC's one ASL and nine PLL's will be located at Red River Army depot awaiting release to the user. The condition code of the materiel available for issue is "A".

23. Warranty Provisions. Warranty Provisions and Procedures are specified in Section V of the FORSCOM Materiel Fielding Plan/Agreement dated June 1984. AMC will warrant the MBC for a period of 60 days from the date of Materiel Release to the user.

ANNEX H

COPY OF
VU-GRAPHS USED BY DPO
AT THE
MATERIEL REVIEW BOARD

RELEASE OF MATERIEL FOR
FULL RELEASE-FIRST TIME PROCUREMENTS

OF

COMPUTER, BALLISTICS: MORTAR SET M23

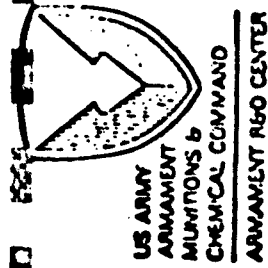

AUTHORITY:

Q 1. IF THE ITEM IS FOR A PM OUTSIDE AMCCOM OR FOR ANOTHER COMMAND OR AGENCY WHAT DOCUMENTATION COVERS AMCCOM MATERIEL RELEASE RESPONSIBILITIES?

A 1. THE ITEM IS FOR A DPO WITHIN AMCCOM.

MATERIEL:

Q 2. WHEN WAS THE MATERIEL TYPE CLASSIFIED?

A 2. THE MORTAR BALLISTICS COMPUTER WAS TYPE CLASSIFIED LP (LIMITED PROCUREMENT) ON 8 JULY 1981 AND WAS RECLASSIFIED STANDARD SEPTEMBER 1985.

Q 3. HAS THE FIRST ARTICLE INSPECTION BEEN CONDUCTED AND WERE RESULTS ACCEPTABLE?

A 3. YES, AND THE RESULTS WERE TOTALLY ACCEPTABLE.

Q 4. HAS THE INITIAL PRODUCTION TEST (IPT) BEEN COMPLETED?

A 4. YES, THE FINAL REPORT WAS DISTRIBUTED IN JUNE 1985.

Q 5. IS THE MATERIEL AVAILABLE FOR ISSUE? (ACCEPTANCE TEST COMPLETED, DD250 SIGNED?)

A 5. YES.

RELEASE OF MATERIEL FOR
FULL RELEASE-FIRST TIME PROCUREMENTS
OF
COMPUTER, BALLISTICS: MORTAR SET M23

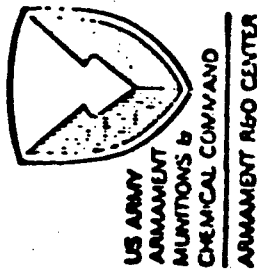

Q 6. DOES THE SYSTEM HAVE ANY SAFETY DEFICIENCIES?

A 6. NO.

Q 7. WHAT SAFETY AND HEALTH HAZARD EVALUATIONS HAVE BEEN CONDUCTED TO SHOW THAT HAZARDS DO NOT EXIST OR HAVE BEEN MINIMIZED TO THE EXTENT POSSIBLE?

A 7. TECOM HAS REVIEWED THE RESULTS OF THE FA/IPT FOR THE MORTAR BALLISTICS COMPUTER (M3C) AND CONCLUDED THAT THE ITEM PRESENTS NO HARDWARE OR SOFTWARE SAFETY HAZARDS, AND PRECAUTIONS REQUIRED FOR USE/DISPOSAL OF THE LITHIUM BATTERIES ARE ADEQUATELY COVERED IN THE MANUALS. THE MBC HAS NO IMPACT ON HEALTH STANDARDS, EMISSION CONTROLS OR POLLUTION ABATEMENT SINCE THE ITEM HAS NO TOXIC OR HARMFUL MATERIALS.

Q 8. HAVE THE EXPLOSIVE ORDNANCE DISPOSED (EOD) PROCEDURES BEEN PUBLISHED?

A 8. NOT APPLICABLE

Q 9. HAS THE FINAL SHIPPING HAZARD CLASSIFICATION BEEN APPROVED?

A 9. NOT APPLICABLE

Q 10. WERE THERE ANY CRITICAL TEST INCIDENTS?

A 10. NO

RELEASE OF MATERIEL FOR
FULL RELEASE-FIRST TIME PROCUREMENTS
OF
COMPUTER, BALLISTICS: MORTAR SET M23

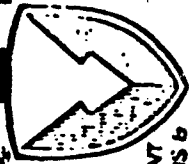

US ARMY
ARMAMENTS &
MUNITIONS &
CHEMICAL COMMAND
ARMAMENT R&O CENTER

- Q 11. HAVE DEFICIENCIES AND SHORTCOMINGS BEEN RESOLVED? HAVE YOU PROVIDED A STATEMENT TO THE INDEPENDENT EVALUATOR, ATTESTING THAT ALL CRITICAL AND MAJOR TEST INCIDENTS REPORTED AS EPR'S OR QDR'S DURING GOVERNMENT VALIDATION TESTING HAVE BEEN RESOLVED, OR PROVISIONS MADE FOR RESOLUTION PRIOR TO FULL RELEASE OF MATERIEL? DATE SENT? GIVE THE STATUS OF OPEN EPR'S/QDR'S.
- A 11. ALL DEFICIENCIES AND SHORTCOMINGS HAVE BEEN RESOLVED. THERE ARE NO OPEN EPR'S/QDR'S FOR THE MBC.
- Q 12. HAVE YOU RECEIVED THE INDEPENDENT EVALUATION REPORT AS TO THE ADEQUACY OF THE MATERIEL TO MEET SPECIFIED REQUIREMENTS AND DOES IT SUPPORT RELEASE?
- A 12. AN ADEQUACY STATEMENT WAS RECEIVED FROM TECOM ON 1 AUG 85. TECOM CONCLUDES THAT THE MBC IS READY FOR FIELDING.

INTEGRATED LOGISTIC SUPPORT

- Q 13. HAS THE FINAL MATERIEL FIELDING PLAN(S) BEEN DISTRIBUTED TO THE GAINING COMMAND(S) AND HAS A MATERIEL FIELDING AGREEMENT BEEN RECEIVED?
- A 13. THE FORSCOM MATERIEL FIELDING PLAN AND MATERIEL FIELDING AGREEMENT WAS SIGNED ON 15 JUNE 1984. THE SCHEDULE FOR FUTURE MFP/MFA'S IS AS FOLLOWS: TRADOC, 30 NOV 85; USAEUR, 30 NOV 86; WESTCOM, 30 JULY 87; KOREA, 30 MAR 87.



US ARMY
ORDNANCE
MUNITIONS &
CHEMICAL COMMAND
ARMY CENTER

RELEASE OF MATERIEL FOR
FULL RELEASE-FIRST TIME PROCUREMENTS
OF
COMPUTER, BALLISTICS: MORTAR SET M23

Q 14. WHAT SUPPORT EQUIPMENT FOR THE SYSTEM IS LISTED ON THE TABLE OF ORGANIZATION AND EQUIPMENT (TOE) AND HOW IS IT BEING RELEASED?

A 14. NONE

Q 15. WHAT BASIC ISSUE ITEMS (BII) WILL ACCOMPANY THE ITEM/SYSTEM? ARE THEY AVAILABLE?

A 15. THE FOLLOWING IS THE LIST OF BII WHICH ARE AVAILABLE AND WILL ACCOMPANY THE
FIELDED MBC:

- BATTERY, DRY BA-5588/U
- CABLE ASSEMBLY, SPECIAL PURPOSE, ELECTRICAL SM-D-875489
- CABLE ASSEMBLY, SPECIAL PURPOSE, ELECTRICAL SM-D-875498
- CABLE ASSEMBLY, SPECIAL PURPOSE, ELECTRICAL SM-D-917637
- CABLE ASSEMBLY, SPECIAL PURPOSE, ELECTRICAL SM-D-955457
- CASE, COMPUTER, BALLISTICS 9355747
- CASE, RADIO SET CONTAINER SM-C-456359

RELEASE OF MATERIEL FOR
FULL RELEASE-FIRST TIME PROCUREMENTS

OF

COMPUTER, BALLISTICS: MORTAR SET M23



US ARMY
ARMAMENT
MUNITIONS &
CHEMICAL COMMAND
ARMAMENT RSO CENTER

- Q 16. IS REQUIRED SUPPORT EQUIPMENT, TMDE, SPARE/REPAIR PARTS ADEQUATE AND AVAILABLE WITHIN THE HQ, AMC WHOLESALE SUPPLY SYSTEM OR BEING PROVIDED SIMULTANEOUSLY WITH THE ITEM/SYSTEM?
- A 16. SUPPORT EQUIPMENT AND TMDE ARE AVAILABLE WITHIN THE SUPPLY SYSTEM. SPARE/REPAIR PARTS WILL BE AVAILABLE THROUGH THE ARMY SUPPLY SYSTEM BY UTILIZATION OF NORMAL REQUISITIONING PROCEDURES.

RELEASE OF MATERIEL FOR
FULL RELEASE-FIRST TIME PROCUREMENTS
OF
COMPUTER, BALLISTICS: MORTAR SET M23

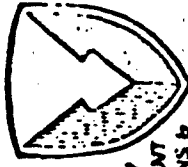

US ARMY
ARMAMENT
MUNITIONS &
CHEMICAL COMMAND
ARMAMENT R&D CENTER

Q 17. WHAT SPECIFIC ACTIONS HAVE BEEN TAKEN TO ASSURE THAT SUCH MISSION ESSENTIAL ITEMS, INCLUDING SUPPORT EQUIPMENT, SOFTWARE AND SPARE/REPAIR PARTS ARE AVAILABLE TO INSURE SPECIFIED MINIMUM ACCEPTABLE SYSTEM READINESS (REF AR 700-120 PARA 5-5 AND AR 700-120 PARA 5-4)?

A 17. THE POLICIES AND PROCEDURES SET FORTH IN CHAPTER 5, AR 700-120, APPLY IN PROVIDING INITIAL SUPPORT FOR THE XM23 COMPUTER. THESE POLICIES AND PROCEDURES GOVERN THE INITIAL DISTRIBUTION OF REPAIR PARTS, SPECIAL TOOLS, TEST EQUIPMENT, ETC., REQUIRED AT THE VARIOUS FIELD MAINTENANCE LEVELS IN SUPPORT OF NEW/IMPROVED EQUIPMENT DISTRIBUTED TO A COMMAND FOR THE FIRST TIME.

THE CURRENT AMC POLICY ON TOTAL PACKING/UNIT MATERIAL FIELDING TP/UMF APPLY. SOFTWARE SUPPORT EQUIPMENT, SUFFICIENT TO MEET THE REQUIREMENTS OF THE LCSS CENTER HAS BEEN ORDERED. DELIVERY/ACCEPTANCE OF THESE EQUIPMENTS IS SCHEDULED FOR OCT. 35. THERE WILL BE NO WHOLESAL LEVEL DX PROGRAM FOR THE COMPUTER SET. SUFFICIENT INITIAL STOCKAGE QUANTITIES WILL BE ESTABLISHED AT DS LEVEL TO ACCOMODATE EXPECTED FAILURES AND MAINTENANCE TURN-AROUND TIME. 18 PSC'S HAVE BEEN ALLOCATED TO DEPOT TO SUPPORT AN INTERIF. DX PROGRAM DURING FY86 SHOULD THE USER DESIRE TO DO SO. THE ESTABLISHMENT OF A RETAIL (USER) LEVEL DX PROGRAM IS THE RESPONSIBILITY OF THE USING UNIT AND SHOULD BE IN ACCORD- DANCE WITH AR 700-120 AND LOCAL PROCEDURES. ANY DEMAND JUSTIFIED INCREASES TO STOCKAGE

RELEASE OF MATERIEL FOR
FULL RELEASE-FIRST TIME PROCUREMENTS
OF
COMPUTER, BALLISTICS: MORTAR SET M23

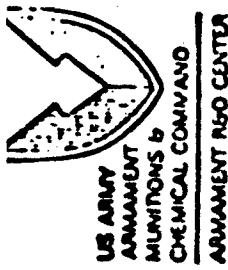

- Q 18. WHAT IS THE MAINTENANCE PLAN? IS CONTRACTOR SUPPORT REQUIRED? WHEN AND WHERE WAS THE PHYSICAL TEARDOWN/LOGISTICS DEMONSTRATION CONDUCTED?
- A 18. A THREE LEVEL MAINTENANCE STRUCTURE (CRE/ORG., DS, AND DEPOT) WILL BE EMPLOYED WITH THE MBC. THE PROVISION OF AR 750-1, "ARMY MATERIEL MAINTENANCE CONCEPTS AND POLICIES" APPLY. THE MBC WILL BE SUPPORTED WITH TEST PROGRAM SETS AT DEPOT. THE PHYSICAL TEARDOWN/LOGISTIC DEMONSTRATION WAS CONDUCTED AT THE CONTRACTOR'S FACILITY IN MAY-JUNE 1984.
- Q 19. WHAT WAS THE DATE THAT THE TMS, TBS, DMRS, SUPPLY BULLETINS, ETC, WERE FORWARDED TO THE ADJUTANT GENERAL FOR PUBLICATION? (NORMALLY TAKES 1 YEAR.) DO THEY REFLECT THE ITEM CONFIGURATION TO BE FIELD? ARE ALL PUBLICATIONS AVAILABLE?
- A 19. CAMERA READY COPIES OF THE TM'S WERE FORWARDED TO TAG FOR PRINTING IN AUGUST 1985; AND REFLECT THE ITEM CONFIGURATION TO BE FIELD. THE DMNR WILL BE AVAILABLE IN JUNE 1986. ADVANCE COPIES OF THE TM'S WILL BE PROVIDED WITH THE MBC DELIVERIES.
- Q 20. DO YOU HAVE AN APPROVED QUALITATIVE AND QUANTITATIVE PERSONNEL REQUIREMENT INFORMATION (OOPRI) LETTER? (SETS UP REQUIRED OPERATOR AND MAINTENANCE MOS AS WELL AS PREDICTED ANNUAL MAINTENANCE MANHOURS.)

A 20 YES

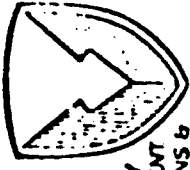

US ARMY
ARMAMENTS
& MUNITIONS &
CHEMICAL COMMAND
ARMAMENT R&O CENTER

RELEASE OF MATERIEL FOR
FULL RELEASE-FIRST TIME PROCUREMENTS
OF

COMPUTER, BALLISTICS: MORTAR SET M23

Q 21. HAVE PROVISIONS FOR ALL REQUIRED TRAINING BEEN ACCOMPLISHED? ARE TRAINING AIDS AVAILABLE?

NET TEAM AVAILABLE?

A. 21. PROVISIONS HAVE BEEN MADE FOR OPERATOR AND MAINTENANCE TRAINING. TRAINING AIDS ARE CURRENTLY AVAILABLE AND NO ADDITIONAL TRAINING DEVICES ARE ANTICIPATED. THE NET TEAM IS AVAILABLE HAVING BEEN TRAINED IN THE 3RD AND 4TH QTR FY84.

Q 22. HAVE YOU RECEIVED THE COMMANDER, USATSG CERTIFICATION OF LOGISTICS SUPPORTABILITY OF TMDE TO BE RELEASED FOR THE SYSTEM?

A 22. YES.

Q 23. IS THERE SUFFICIENT AMMUNITION TO SUPPORT INITIAL FIELDING OF THE SYSTEM? WHAT ARE THE AMMUNITION NEEDS FOR BASIC LOAD, TRAINING, AND WAR RESERVES?

A 23. NOT APPLICABLE.

Q 24. IF THE ITEM IS BEING FIELDED UNDER TOTAL PACKAGE/UNIT MATERIEL FIELDING CONCEPT, PROVIDE DETAILS AND POSSIBLE PROBLEMS.

A. 24. THE TP/UMF CONCEPT APPLIES TO THE MBC. END ITEMS WILL BE SENT TO NEW CUMBERLAND, ARMY DEPOT. THE AUTHORIZED STOCKAGE LIST/PREScribed LOAD LIST (ASL/PLL) WILL BE SENT TO REDSTONE ARMY DEPOT. REDSTONE WILL ALSO SERVE AS THE PROCESS PACKAGING POINT (PPP). NO END ITEMS WILL BE DELIVERED TO A GAINING COMMAND WITHOUT ADEQUATE ASL/PLL ITEMS. THE INITIAL PROVISIONING

FOR ALL LONG LEAD ITEMS ON THE BASIC CONTRACT HAS BEEN COMPLETED.

1 2 3 4 5 6 7 8 9 10 11 12 13 14 15 16 17 18 19 20 21 22 23 24 25 26 27 28 29 30 31 32 33 34 35 36 37 38 39 40 41 42 43 44 45 46 47 48 49 50 51 52 53 54 55 56 57 58 59 60 61 62 63 64 65 66 67 68 69 70 71 72 73 74 75 76 77 78 79 80 81 82 83 84 85 86 87 88 89 90 91 92 93 94 95 96 97 98 99 100

RELEASE OF MATERIEL FOR
FULL RELEASE-FIRST TIME PROCUREMENTS

OF

COMPUTER, BALLISTICS: MORTAR SET M23



US ARMY
ARMAMENTS &
MUNITIONS &
CHEMICAL COMMAND
ARMAMENT R&D CENTER

Q 25. IF FIELDING TO USAREUR PROVIDE DETAILS ON HOW THE USAREUR FIELDING CRITERIAL HAS BEEN MET.

A 25. USAREUR FIELDING IS SCHEDULED FOR JUNE 1987.

Q 26. HAVE THE NECESSARY MANPRINT ANALYSES BEEN COMPLETED?

A 26. YES.

GENERAL:

Q 27. DOES THE TECHNICAL DATA PACKAGE REFLECT THE CONFIGURATION SUBMITTED FOR IPT AND THE CONFIGURATION BEING FIELDDED?

A 27. YES.

Q 28. ARE THERE ANY CONDITIONS OR LIMITATIONS THAT PRECLUDE FULL RELEASE?

A 28. NO.

ANNEX I

FULL RELEASE
OF
COMPUTER, BALLISTICS: MORTAR, M23



DEPARTMENT OF THE ARMY
HEADQUARTERS US ARMY ARMAMENT, MUNITIONS AND CHEMICAL COMMAND
BOVER, NEW JERSEY 07001

REPLY TO
ATTENTION OF:

AMSMC-DCGAM

NOV 7 1985

SUBJECT: Full Release of Computer, Ballistics: Mortar, M23

Commander
U.S. Army Materiel Command
ATTN: AMCQA-ST
5001 Eisenhower Avenue
Alexandria, VA 22333-0001

1. A full release of 180 each Computer, Ballistics: Mortar, M23 (NSN 1220-01-119-6049), and subsequent quantities produced by Magnavox Company commencing with contract DAAK10-83-C-0135 has been approved by the undersigned. This materiel is identified as an IPR system based on the criteria set forth in AR 70-1.
2. Prior to approving this release, I have determined to the best of my knowledge and belief that the requirements for a full release as specified in AMCR 700-34 have been satisfied and that:
 - a. Adequate test and evaluation effort has been expended, all deficiencies revealed therein have been resolved or provisions made for resolution, and the item complies with stated performance and technical requirements.
 - b. Required BII accompanied the item.
 - c. Required support equipment, including TM's, repair parts, TMDE, is adequate and available within the wholesale supply system or is being provided simultaneously with the item.
 - d. Provisions for all required training have been accomplished for this item.
 - e. Safety and health hazard evaluations have shown that hazards do not exist that would preclude full release of this materiel.
 - f. The AMC Independent Evaluator has provided documentation which supports this release.

AMSMC-DCGAM

SUBJECT: Full Release of Computer, Ballistics: Mortar, M23

3. AMCCOM - Providing Leaders the Decisive Edge.



RICHARD D. BELTSON
Brigadier General, USA
Deputy Commanding General
for Armament and Munitions

ANNEX J

MATERIEL STATUS RECORD SUBMISSION
INCLUDING
TYPE CLASSIFICATION RECOMMENDATION
AND
MEMO FOR RECORD



DEPARTMENT OF THE ARMY
ARMAMENT RESEARCH AND DEVELOPMENT CENTER
US ARMY ARMAMENT, MUNITIONS AND CHEMICAL COMMAND
DOVER, NEW JERSEY 07801

REPLY TO
ATTENTION OF

SMCAR-SC

SUBJECT: Materiel Status Record Submission

TO: Commander, AMC
US Army Materiel Status Office
ATTN: AMCDE-PA
5001 Eisenhower Avenue
Alexandria, VA 22333

The following record of decision and action on Type Classification Standard of Computer, Ballistics: Mortar M23 together with the attached documents, are forwarded for recording in the materiel status record per AR70-2.

General Information.

- a. Program element: OPAII funded.
- b. Project number: Not applicable
- c. Project title: Computer, Ballistics: Mortar (MBC) M23
- d. Requirements document: Letter Requirement (LR) for Mortar Fire Control Calculator (MFCC), USATRADOC ACN16906, dtd 30 December 1977.
- e. Previously recorded MSR number: 09816001
- f. SLIN: C60294
- g. NSN: 1220-01-119-6049

Section 6 - Type Reclassification

- a. Item: Mortar Ballistics Computer Set, M23
- b. Date of review: 29 August 1985
- c. TC decision: Reclassification from Limited Procurement (LCC-U) to Standard.
- d. ZLIN: Z17218
- e. SLIN: C60294
- f. NSN: 1220-01-119-6049
- g. Other decisions: None
- h. Approved by: MG Fred Hissong, Jr.

Prepared by:

Office: Development Project Office, XM23
Name of Contract: Joseph Schmitz AV880-7051

- 3 Encl
1. TC Recommendation
 2. MFR
 3. PROD-VAL-IPR Package

CF: HQDA (DAMA-PPM)

J. A. Schmitz
J. A. SCHMITZ
DPO, XM23



DEPARTMENT OF THE ARMY
ARMAMENT RESEARCH AND DEVELOPMENT CENTER
US ARMY ARMAMENT, MUNITIONS AND CHEMICAL COMMAND
DOVER, NEW JERSEY 07801

REF TO
ATTENTION OF

SMCAR-SC

SUBJECT: Type Classification (TC) of Computer, Ballistics: Mortar M23

SEE DISTRIBUTION

Forwarded is the approved TC action for reclassification of the Mortar Ballistics Computer Set, M23 from Limited Procurement (LCC-U) to Standard.

2 Encl
TC Recommendation
MFR

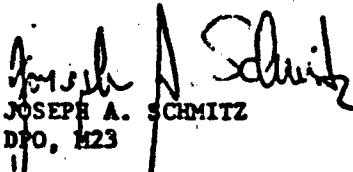
JOSEPH A. SCHMITZ
DPO, M23

Distribution

- ✓ Commander, US Army Training & Doctrine Command, ATTN: ATCD-L (CPT Mills), Ft. Monroe, VA 23651
- ✓ Commandant, US Army Infantry School, ATTN: ATSH-CD-MS-F (D. Turner), Ft. Benning, GA. 31905
- ✓ Commander, US Army Test & Evaluation Command, ATTN: DRSTE-CM-F, (E. Boyd), Aberdeen Proving Ground, MD 21005
- ✓ Commander, US Army Armament, Munitions and Chemical Command, ATTN: SMCAR-ESW-F (C. Hicks) AMSMC-LEW, Rock Island, IL 61299-6000
- ✓ Commander, US Army Logistic Evaluation Agency, ATTN: DALO-LEI (F. McKown), New Cumberland, PA 17070
- ✓ Commander, US Army Materiel Command, ATTN: AMCDE-SG (J. Lamb) 5001 Eisenhower Avenue, Alexandria, VA 22333

TYPE CLASSIFICATION

Recommendation of the Computer, Ballistics: Mortar XM23 (MBC)

1. A Production-Validation In-Process Review (PROD-VAL-IPK) was held, by letter, on 29 August 1985 resulting in a determination that the Computer, Ballistics: Mortar XM23 (MBC):
 - a. Is acceptable for the mission intended.
 - b. Does meet regulatory prerequisites for entry into the Army inventory.
 - c. Is safe for all aspects of use (Safety and Health Data Sheet attached).
 - d. Is logistically supportable in its intended environment.
2. Accordingly, recommend that the item/system be reclassified from Limited Procurement (LCC-U) to Standard.
3. Replacement information: None.
4. Specific end item recommendation for type reclassification:
 - a. Federal Item Identification: 1220.
 - b. ZLIN: Z17218.
 - c. SLIN: C60294
 - d. NSN: 1220-01-119-6049
 - e. RICC: 1.
 - f. Type reclassification from LCC-U to STD.
 - g. BOIP number: 78-0018F.
 - h. Requirement: Letter Requirement (LR) for Mortar Fire Control Calculator (MFCC), USATRADGC ACN 16906, dtd 30 December 1977.
5. Major end items recommended for material condition: None. This item is not a component of a major system identified in AR 750-40.

NAME:

ORGANIZATION:

IPR CHAIRMAN
J.A. SCHMITZ
SMCAR-SC (XM23)

CONCURRENCE RECEIVED VIA MSG DATED 111400Z SEP 85, ENCLOSURE 1.

NAME:

ORGANIZATION:

TRADOC VOTING MEMBER
CPT L. MILLS
ATCO-ML

CONCURRENCE RECEIVED VIA MSG DATED 221730Z AUG 85, ENCLOSURE 2.

NAME:

ORGANIZATION:

USA-LEA VOTING MEMBER
F. C. McKOWN
DALO-LEI

APPROVED:

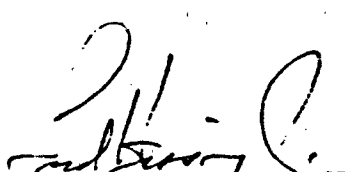
FRED HISSONG, JR.
Major General, USA
Commanding

18 SEP 1985

PRIORITY

* U N C L A S S I F I E D *

PT 01043 254/2051Z

PAGE 01

ACTION INFO SMCAR-CO DC TO CS 6S 6SP IN EE SF SS AS PH RA R
RAM PT PTH PTC PTP-T PTA PTA-M MS CP CPF LC LCA LCE LCH LC
LCS LCU- **SC** SA SCA SCF SCJ SCS SCH CA IS ISE ISI ISL ISL
ISO TS TSF TSA TSE GLOAS COMSY APT APT-TC 9020 USASSU MHD
ACTION INFO AMSMC-MAY MAY-W MAY-P MAY-T MAY-S MAY-F LS OSM-A USM
QAA QAT QAF QAN QAR QAO PC PCC PCM PCT PCW TO TOA CA MG AVD
ACT INFO PB AL NUC CIMS THAS SGT YORK SFA HELIPORT

ACTION SC INFO

ACTION: INFO:

PITUZYUW RUCLAIAS179 2541835-UUUU--RUEOEKA.
ZNR UUUUU

P 111400Z SEP 85

FM CDR TRADOC FT MONROE VA //ATCD-ML//

TO RUEOEKA/CDR ARJC DOVER NJ //SMCAR-SC//

INFO RUKLDAR/CDR AMC ALEX VA //AMCDE-SG//

RUMTFHA/CDR USACAC FT LEAVENWORTH KS //ATZL-C6/ATZL-CAM-I/ATZL-TIE//

RUEOAGE/CDR USALOGC FT LEE VA //ATCL-M//

RUCLBFA/CDR TRADOC COMB ARMS TEST ACTV FT HOOD TX //ATTE-ZA//

RUEAHOF/CDR SOLDIER SPTCEN NCR ALEX VA //ATZI-NCP-M//

RUCIAFB/CDR AMCCOM ROCK ISL IL //AMSMC-ASI/AMSMC-LEW//

RJEMANA/CDR LOG EVAL AGCY NCAD NEW CUMBERLAND PA //DALO-LEI//

RUCLDNA/COMDT INFSCB FT BENNING GA //ATSH-CD//

BT

UNCLAS

0000

SUBJ PRODUCTION VALUATION IN-PROCESS REVIEW (PROD-VAL-IPR) FOR
COMPUTER BALLISTICS, MORTAR XM23 (MBC)

A. LTR, ARDC, SMCAR-SC, 27 AUG 85, SAB.

1. REF A FORWARDED AN IPR AGENDA PACKAGE AND AMC RECOMMENDATION THAT THE MBC BE TYPE RECLASSIFIED FROM LIMITED PROCUREMENT-URGENT TO STANDARD. THIS LETTER FURTHER STATES IN PARAGRAPH 8 THAT ALL

PAGE 02 RUCLAIAS179 UNCLAS

REQUIRED SOFTWARE CORRECTIONS WILL BE INCORPORATED INTO THE XM23 SYSTEM PRIOR TO PRODUCTION. (TRADOC CONCURS) WITH THE AMC POSITION.

2. AN IOC-FOTE TEST WILL BE CONDUCTED BY THE INFANTRY SCHOOL TO VALIDATE THAT THE SOFTWARE IMPROVEMENTS HAVE BEEN MADE AND THE SYSTEM IS CAPABLE OF MEETING ALL OPERATIONAL REQUIREMENTS UPON FIELDING.

3. POC AT THIS HEADQUARTERS IS CPT MILLS, AV 680-4414.

BT

65179

NNNN

PRIORITY

* U N C L A S S I F I E D *

J-5

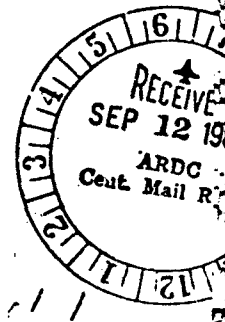

ROUTINE

* UNCLASSIFIED *

PT 02876 236/0236Z

PAGE 01

ACTION INFO SMCAR-CO DC TD CS GS GSP IN EE SF SS AS PH RA RAI
 RAM PT PTM PTC PTP-T PTA PTA-M MS CP CPF LC LCA LCE LCH LC LCP
 LCS LCU- SC SA SCA SCF SCJ SCS SCM CA IS ISE ISI ISL ISL-T
 ISO TS TSF TSA TSE GLOAS COMSY APT APT-TC 9020 USASSJ MHD

ACTION INFO ANSMC-MAY MAY-W MAY-P MAY-T MAY-S MAY-F LS DSM-A USM-B
 GAA QAT QAF QAN QAR QAZ PC PCC PCM PCT PCW TD TDA CA MG AVD
 ACT INFO PB AL AUC CAWS THAS SGT YORK SFA HELIPOINT

ACTION INFO

ACTION: INFO:

RTTUZYUW RUEHANA5096 2360209-UUUU--RUEOEKA.
 ZAR UUUUU
 R 221730Z AUG 85

FM CDR USALEA NCAO NEW CUMBERLAND PA //DALO-LEI//
 TO RUEOEKA/CDR ARDC DOVER NJ //SMCAR-SC/EHSMC-QAF-A//
 RUCLAIA/CDR TRADOC FT MONROE VA //ATCD-L//
 RUMTFMA/CDR CAC FT LEAVENWORTH KS //ATZL-CA//
 RUKLDAR/CDR USAMC ALEX VA //MCDE-DW-06//

BT

UNCLAS

SUBJ PRODUCTION VALIDATION IN-PROCESS REVIEW (PROD-VAL-IPR) FOR
 COMPUTER BALLISTICS, MORTAR XM23 (MBC)

A. LTR, ARDC, SMCAR-SC (XM23), 1 AUG 85, SAB

1. (USALEA CONCUPS) IN THE TYPE RECLASSIFICATION OF SUBJ ITEM AS
 RECOMMENDED IN REF A FROM LIMITED PROCUREMENT (LCC-U) TO STD (LCC-A).

2. USALEA POC IS MR. MCKOWN, AUTOVON 977-6704.

BT

#5096

NNNN

ROUTINE

* UNCLASSIFIED *

J-61

Encl 2

SMCAR-SC XM23

MEMORANDUM FOR RECORD

SUBJECT: In-Process Review (IPR) for Computer, Ballistics: Mortar, XM23

1. A correspondence IPR for subject Mortar Ballistics Computer was conducted from 27 August through 12 September 1985 by Mr. Joseph A. Schmitz, IPR chairperson.
2. Provided at enclosure 1 is the transmittal letter for the PROD-VAL-IPR Package for the XM23 Mortar Ballistics Computer.
3. As a result of that IPR, both the USA Training and Doctrine Command (TRADOC) and the USA Logistics Evaluation Agency (LEA) concurred in the Type Classification (TC) Standard (STD) recommendation providing four (4) minor software changes are incorporated into the XM23 System prior to full scale production.
4. HQ, AMC concurred in the Type Classification Standard without exception.
5. The software changes requested by TRADOC have been made and as a result, no outstanding issues remain. Concurrence is therefore unanimous.

Encl

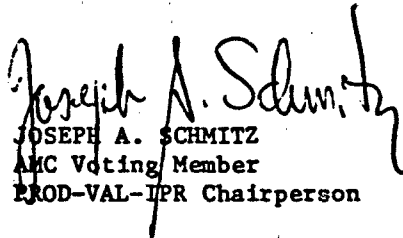
JOSEPH A. SCHMITZ
AMC Voting Member
PROD-VAL-IPR Chairperson

APPROVED:

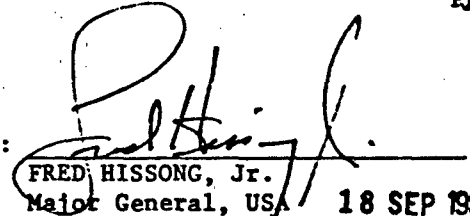
FRED HISSONG, Jr.
Major General, USA 18 SEP 1985
Commanding