

MICROCOPY RESOLUTION TEST CHART
NATIONAL BUREAU OF STANDARDS 1963-A

12

USAFSAM-TR-84-52

ANTIEMETIC DRUGS AND PILOT PERFORMANCE

Henry L. Taylor, Ph.D.

John A. Dellinger, M.S.

Martha H. Weller, Ph.D.

Bruce C. Richardson, M.S.

Fred C. Hyman, M.S.

James E. LeGrand, M.D.

Edward F. Domino, M.D.

(Department of Pharmacology, University of Michigan)

Stephen W. Porges, Ph.D.

(Department of Psychology, University of Illinois at Urbana-Champaign)

Institute of Aviation

University of Illinois

Willard Airport

Savoy, IL 61874

November 1985

Interim Report for Period February 1983 - February 1984

DTIC
EXECTE
DEC 06 1985
S D

Approved for public release; distribution is unlimited.

Prepared for

USAF SCHOOL OF AEROSPACE MEDICINE

Aerospace Medical Division (AFSC)

Brock Air Force Base, TX 78235-5301



85 12 4 006

AD-A162 109

DTIC FILE COPY

NOTICES

✓
This interim report was submitted by the Institute of Aviation, University of Illinois at Urbana-Champaign, Urbana, IL 61874, under contract F33615-83-K-0612, job order 7757-03-60, with the USAF School of Aerospace Medicine, Aerospace Medical Division, AFSC, Brooks Air Force Base, Texas. Dr. Thomas G. Wheeler was the Laboratory Project Scientist-in-Charge.

When Government drawings, specifications, or other data are used for any purpose other than in connection with a definitely Government-related procurement, the United States Government incurs no responsibility or any obligation whatsoever. The fact that the Government may have formulated or in any way supplied the said drawings, specifications, or other data, is not to be regarded by implication, or otherwise in any manner construed, as licensing the holder, or any other person or corporation; or as conveying any rights or permission to manufacture, use, or sell any patented invention that may in any way be related thereto.

The Office of Public Affairs has reviewed this report, and it is releasable to the National Technical Information Service, where it will be available to the general public, including foreign nationals.

This report has been reviewed and is approved for publication.

Thomas G. Wheeler

THOMAS G. WHEELER, Ph.D.
Project Scientist

Donald N. Farrer

DONALD N. FARRER, Ph.D.
Supervisor

Jeffrey G. Davis

JEFFREY G. DAVIS, Colonel, USAF, MC
Commander

UNCLASSIFIED

SECURITY CLASSIFICATION OF THIS PAGE

REPORT DOCUMENTATION PAGE

AD-A162109

1a. REPORT SECURITY CLASSIFICATION Unclassified		1b. RESTRICTIVE MARKINGS	
2a. SECURITY CLASSIFICATION AUTHORITY		3. DISTRIBUTION/AVAILABILITY OF REPORT Approved for public release; distribution is unlimited.	
2b. DECLASSIFICATION/DOWNGRADING SCHEDULE			
4. PERFORMING ORGANIZATION REPORT NUMBER(S)		5. MONITORING ORGANIZATION REPORT NUMBER(S) USAFSAM-TR-84-52	
6a. NAME OF PERFORMING ORGANIZATION Institute of Aviation, University of Illinois	6b. OFFICE SYMBOL (If applicable)	7a. NAME OF MONITORING ORGANIZATION USAF School of Aerospace Medicine (RZV)	
6c. ADDRESS (City, State and ZIP Code) Willard Airport Savoy, IL 61874		7b. ADDRESS (City, State and ZIP Code) Aerospace Medical Division (AFSC) Brooks Air Force Base, TX 78235-5301	
8a. NAME OF FUNDING/SPONSORING ORGANIZATION	8b. OFFICE SYMBOL (If applicable)	9. PROCUREMENT INSTRUMENT IDENTIFICATION NUMBER F33615-83-K-0612	
8c. ADDRESS (City, State and ZIP Code)		10. SOURCE OF FUNDING NOS.	
		PROGRAM ELEMENT NO. 62202F	TASK NO. 05
		PROJECT NO. 7757	WORK UNIT NO. 60
11. TITLE (Include Security Classification) Antiemetic Drugs and Pilot Performance			
12. PERSONAL AUTHOR(S) Taylor, Henry L.; Dellinger, John A.; Weller, Martha H.; Richardson, Bruce C.; Hyman, Fred C.; LeGrand, James E.; Domino, Edward F.; and Porges, Stephen W.			
13a. TYPE OF REPORT Interim Report	13b. TIME COVERED FROM Feb 1983 to Feb 1984	14. DATE OF REPORT (Yr., Mo., Day) 1985 November	15. PAGE COUNT 39
16. SUPPLEMENTARY NOTATION			
17. COSATI CODES		18. SUBJECT TERMS (Continue on reverse if necessary and identify by block number)	
FIELD	GROUP	Emesis, Performance, Drug Effects	
06	16		
06	15		
19. ABSTRACT (Continue on reverse if necessary and identify by block number) This study evaluated the effects on human performance of four blood alcohol levels and three antiemetic drugs. The effects on pilot performance of four blood alcohol levels were investigated in order to determine the sensitivity of the methodology. The effects on pilot performance in a flight simulator were determined using the commonly prescribed dosages, standardized for a 70 kg person, of thiethylperazine (10 mg), promethazine hydrochloride (25 mg), cimetidine (300 mg), and a placebo control. The three drugs and the placebo were administered to 16 male subjects. Two tasks, a two-dimensional tracking task which is part of an instrument landing system (ILS) approach and the Sternberg choice reaction time task, were used to generate pilot performance data. A Latin square design was used to balance treatment order effects, and each subject received each treatment condition. Log root mean square (RMS) deviation values, computed from the simulator flight data (altitude straight and level, altitude turning, localizer lateral tracking, glideslope vertical tracking) were used in a multivariate analysis of variance to test —			
20. DISTRIBUTION/AVAILABILITY OF ABSTRACT UNCLASSIFIED/UNLIMITED <input checked="" type="checkbox"/> SAME AS RPT. <input type="checkbox"/> OTIC USERS <input type="checkbox"/>		21. ABSTRACT SECURITY CLASSIFICATION Unclassified	
22a. NAME OF RESPONSIBLE INDIVIDUAL Thomas G. Wheeler, Ph.D.		22b. TELEPHONE NUMBER (Include Area Code) (512) 536-3685	22c. OFFICE SYMBOL USAFSAM/RZV

DD FORM 1473, 83 APR

EDITION OF 1 JAN 73 IS OBSOLETE.

1

Unclassified

SECURITY CLASSIFICATION OF THIS PAGE

19. ABSTRACT (continued)

the main effects. An approximate F-test, based on Wilk's criterion, resulted in $F(12,87) = 2.47$, ($P < 0.008$) for the treatment main effect (drug). Univariate analyses resulted in a significant drug main effect on two primary task variables--altitude straight and level and localizer tracking. Contrasts between the three antiemetic drugs and the placebo were used to test the hypothesis of no significant difference between treatment pairs. The contrasts between promethazine hydrochloride and the control were significant for altitude straight and level and for glideslope tracking. The other contrasts were not significant except for the control-thiethylperazine contrast for the localizer tracking variable. This difference was due to the RMS mean for thiethylperazine being lower than the control mean. Another study has indicated that when the three drugs were administered singly to dogs, only thiethylperazine effectively increased the radiation threshold compared to a control group. In the present experiment, thiethylperazine produced no significant performance effects. These results suggest that thiethylperazine should be used if a single drug is to be administered to prevent radiation-induced emesis in aircrews.

CONTENTS

	<u>Page No.</u>
INTRODUCTION.	1
METHOD.	2
Equipment	2
Procedures.	6
Experimental Scenario	6
Primary Task.	6
Secondary Task.	7
Experimental Sessions	7
Subjects.	7
Experiment I.	7
Experiment II	7
Experimental Design	9
Experiment I.	9
Experiment II	9
RESULTS	10
Experiment I.	10
Experiment II	15
DISCUSSION.	22
REFERENCES.	24
APPENDIX A: ALCOHOL ANOVAS, USING ALL SUBJECTS ON PRIMARY VARIABLES NUMBER OF OBSERVATIONS IN DATA SET = 156.	27
APPENDIX B: ANTIEMETIC ANOVAS, USING ALL SUBJECTS ON PRIMARY VARIABLES NUMBER OF OBSERVATIONS IN DATA SET = 314.	31



Accession No.	
NRIS - GRN	<input checked="" type="checkbox"/>
END - 105	<input type="checkbox"/>
Unreel - 105	<input type="checkbox"/>
Justification	
By	
Date	
Auxiliary Codes	
Date	Number of Pages
A-1	

ANTIEMETIC DRUGS AND PILOT PERFORMANCE

INTRODUCTION

The effects of nausea and emesis as a result of exposure to ionizing radiation are well known. Clinically, physicians have treated this nausea-emesis syndrome with a variety of drugs including the phenothiazines (1). Marks (2) reported the use of chlorpromazine to treat radiation sickness. The USAF School of Aerospace Medicine is interested in the problem of inhibition of radiation-induced emesis since military personnel may have to perform critical jobs in spite of exposure to radiation (3). The U.S. Air Force is particularly interested in the performance capability of aircrews in the event of radiation exposure.

The effects of drug inhibition of first-stage radioemesis were investigated using young male beagle dogs (4). Gralla et al. (4) found that chlorpromazine was the most effective of seven drugs tested in inhibiting first-stage emesis. The use of a powerful phenothiazine such as chlorpromazine to inhibit emesis in military personnel, however, appears to be contraindicated due to potential performance decrements caused by the drug. To test the ability of the drugs to inhibit emesis in dogs, Cooper and Mattsson (5) selected the following off-the-shelf drugs: thiethylperazine, promethazine hydrochloride, cimetidine, and naloxone. Thiethylperazine is a phenothiazine; promethazine hydrochloride is a phenothiazine derivative; cimetidine is a histamine H₂ receptor antagonist, and naloxone is a narcotic antagonist. Thiethylperazine, promethazine hydrochloride, and cimetidine all significantly increased the radiation threshold for emesis, but the threshold in dogs treated with naloxone was not significantly different from the controls.

Since the threshold for emesis in the dog and human are comparable, the dog was chosen as the experimental model to study the prevention of radiation-induced emesis in humans (6, 7). The need remains, however, to determine if drugs that have been shown to inhibit radioemesis in dogs cause significant performance decrements in humans.

Klein (8) proposed that ethyl alcohol could be used as a reference substance for evaluating the relative performance decrements of drugs. The ingestion of ethyl alcohol has been shown to impair pilot performance on instrument flying tasks in simulators (9, 10) and in a light aircraft (11). Aksnes (9) concluded that a blood alcohol level of about 0.05% impairs a pilot's ability to perform elementary flight maneuvers in a Link trainer. Henry et al. (10) used pilot performance in a Link General Aviation Trainer (GAT-1) to evaluate the effects of alcohol and other drugs and/or stressors on pilot performance. The United States Air Force instructor pilots received 0.3, 0.6, and 0.9 g alcohol/kg body weight, and subsequently performed a series of instrument flight maneuvers. The investigators found statistically significant performance decrements at the measured blood alcohol levels of approximately 60 and 100 mg percent (equivalent to percent BAL) but not at 30 mg percent.

A methodology, using a digital microprocessor to automatically measure pilot performance in a general aviation flight simulator, has been developed at the Aviation Research Laboratory (ARL), Institute of Aviation (12). The laboratory is interested in evaluating the effects of toxic substances on pilot performance (13) and in examining physiological correlates of these effects. Two correlates, heart period (HP) or the beat-to-beat interval, and heart period variability (HPV) or the change in sequential beat-to-beat intervals over time, have been investigated extensively. It is also well known that respiration induces phasic modulation of vagal influence on the heart. Recently, researchers have sought noninvasive methods for measuring respiratory sinus arrhythmia (RSA) in order to estimate the vagal influence on the heart. Vagal control of the heart can be estimated by examining the mean heart period (MHP) and the heart period variability associated with the normal respiratory frequency band (14). Analysis was used to derive a measure of RSA, \bar{V} , which is the representation of the amplitude of heart period variance due to respiration. Yongue et al. (15) demonstrated, in a free-moving, unanesthetized rat, that \bar{V} was sensitive to manipulations of vagal tone by atropine and phenylephrine. Since RSA is modulated both centrally and peripherally, the effects of thiethylperazine and promethazine hydrochloride may modulate RSA.

This report describes the development of a methodology to measure pilot performance and studies the effects of three antiemetic drugs, promethazine, thiethylperazine, and cimetidine, on pilot performance. Two experiments were conducted. The purpose of the first experiment was to evaluate the performance effects of four blood alcohol levels in order to determine the sensitivity of the methodology. The objective of the second experiment was to evaluate the performance effects of the commonly prescribed dosages of promethazine, thiethylperazine, and cimetidine.

METHOD

Equipment

The equipment for both Experiment I and Experiment II consisted of a fixed-base flight simulator that was driven by a single 16-bit computer. The simulator was referred to as ILLIMAC 2, an acronym for Illinois Micro Aviation Computer, and was modeled after the ILLIMAC engineering prototype simulator (16). Both the ILLIMAC engineering prototype and the ILLIMAC 2 were designed and developed by ARL personnel at the Institute of Aviation, University of Illinois at Urbana-Champaign. The shell, base, and rudder pedals of a Link GAT-1 trainer (Fig. 1) were used by ARL personnel. The instrumentation, computer, and electronic components were designed and constructed by ARL personnel.

The ILLIMAC 2 computer consists of a microprocessor section, a special function section, and an input/output (I/O) section. The microprocessor section contains an Intel Corporation 8086 chip on the Microprocessor board plus two additional boards: (1) a PROM/RAM board that contains 32K bytes of memory, and (2) an Address Decode and Clock Frequencies board.

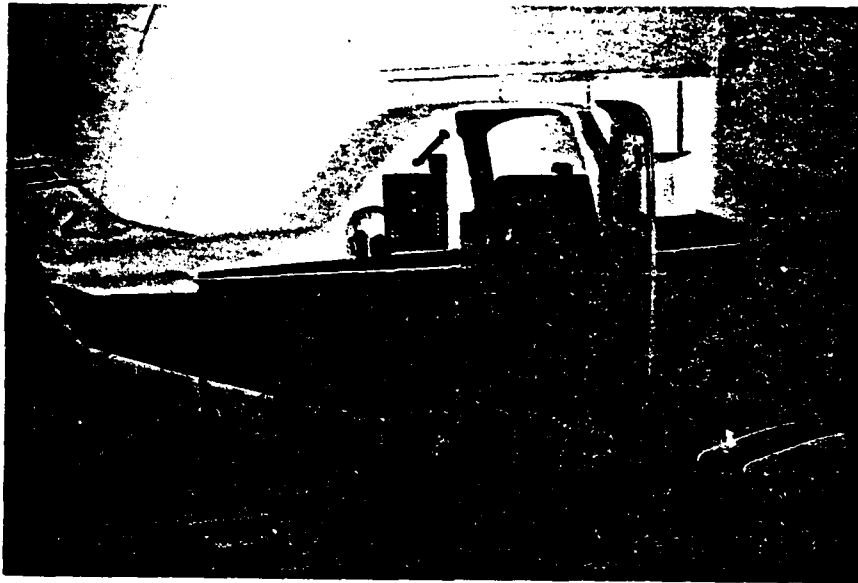

Figure 1. ILLIMAC 2 simulator.

The special function section consists of an Array Processor board, a Trigonometric Digital/Analog (D/A) board, and a Trigonometric Look-Up Tables board. The Array Processor board enables the single microprocessor to achieve the speed necessary to perform simulation functions at a 30-Hz update rate.

The input/output section contains twelve printed circuit boards that control I/O functions between the cockpit and the computer. These boards drive all analog functions in the cockpit, and receive digital and analog information from the cockpit.

The ILLIMAC 2 simulates the flight characteristics of the Piper Lance, a complex, high-performance, single-engine aircraft. The ILLIMAC 2 flight panel, shown in Figure 2, contains the instrumentation and navigation/communication equipment to facilitate instrument flight rules (IFR) approaches. The navigational facilities, and airports within a 512 x 512 mile radius centered around the University of Illinois-Willard Airport, are programmed in the computer. The ILLIMAC 2 system includes an X-Y flight path recorder (Fig. 3) that can be used to record approaches to terminal facilities.

A CompuPro computer, connected to the ILLIMAC 2 by an RS 232c line, recorded digital performance data generated during flight. The CompuPro is a commercial 8086 computer with two 8-in floppy disk drives and a cathode-ray tube (CRT) (Fig. 4). The CompuPro drove a speech synthesizer (Netronics, Inc., New Milford, Conn., Electric Mouth, VOX II) to generate and present auditory stimuli to the ILLIMAC cockpit.

During Experiment I, a Breathalyzer Model 1000 was used to estimate blood alcohol levels from breath samples.

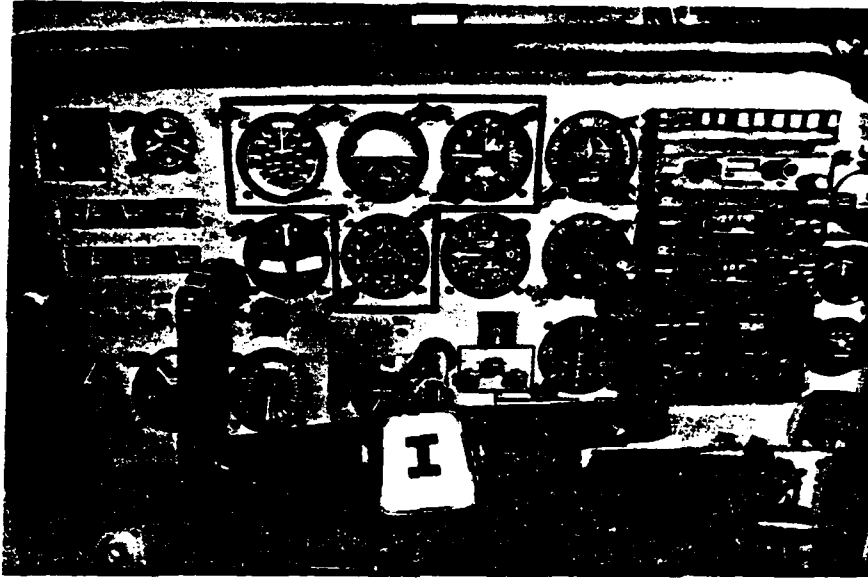

Figure 2. ILLIMAC 2 flight panel.

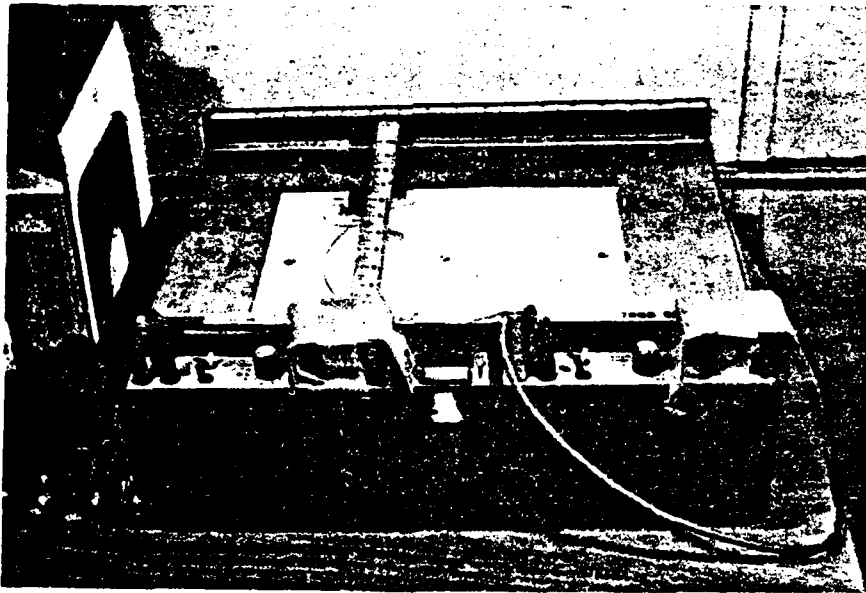

Figure 3. ILLIMAC 2 X-Y flight path recorder.

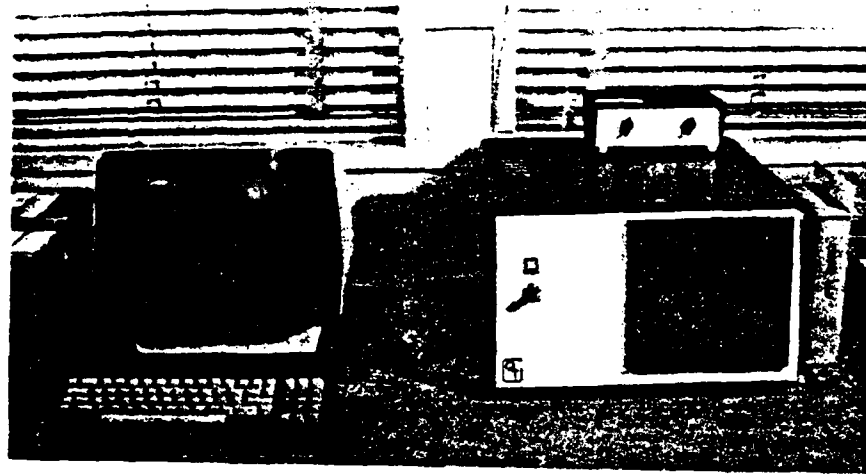

Figure 4. CompuPro 8086 computer.

During Experiment II, a thoracic expansion belt was used to record respiratory cycles. Standard electrocardiogram (ECG) techniques were used to monitor cardiac function. Heart electrical potentials were transmitted via three Beckman biopotential silver-silver chloride electrodes to a Beckman Type RP Dynograph Recorder that in turn amplified the signal and relayed it for recording to a Hewlett-Packard Model 3960 FM tape recorder (Fig. 5). A PDP 11 computer was used later to analyze the beat-by-beat heart period and to perform four samplings per second of respiratory amplitude.

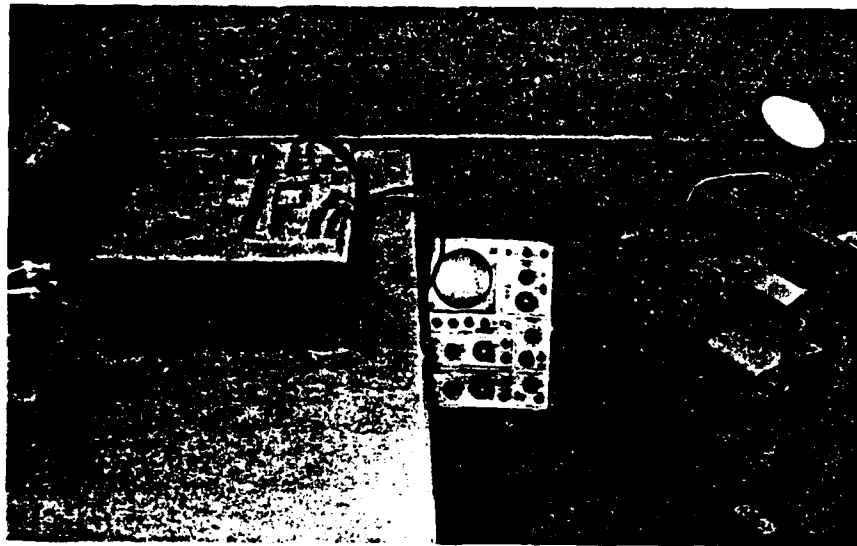

Figure 5. Beckman Dynograph Recorder and Hewlett-Packard FM Tape Recorder.

Procedures

Experimental Scenario. The experimental scenario for both experiments included a primary task, flying the simulator using standard instrument flight procedures, and a secondary task, the Sternberg choice reaction time task. The primary task was representative of procedures that a skilled pilot flying under IFR conditions can perform. The secondary task was representative of communication tasks that increase pilot workload by requiring the subject to receive, understand, and respond to verbal information.

Primary Task. The primary task included three procedures: (1) a direct entry to a holding pattern, (2) the execution of three holding patterns, and (3) a simulated ILS approach for a landing on runway 31 at the University of Illinois-Willard Airport (Fig. 6). The task, flown in a no-wind condition, began 5 mi from the outer marker (OM) on a magnetic bearing of 313° to the ILS navigational aid located at the airport. The bearing of 313° represented the extended centerline of runway 31. The OM was a low-frequency radio station; a visual alert was provided on the simulator instrument panel when directly over the OM. The subject was instructed to track the 313° bearing to the OM, execute three holding patterns, and complete an ILS approach. The standard holding pattern was oval, consisting of a 180° standard rate turn (20° of bank, at 3° rate of turn per second), tracking an outbound heading of 133° for 1 min, a second 180° standard rate turn, and tracking an inbound bearing of 313° for 1 min. The holding pattern was initiated and completed at the OM.

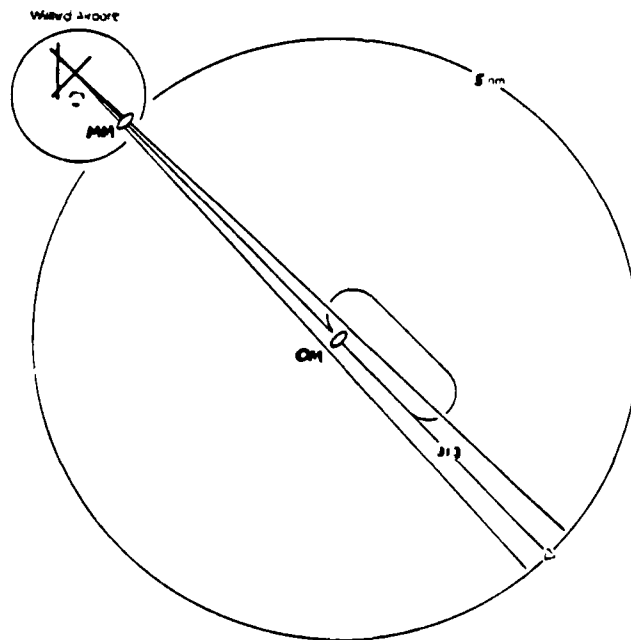

Figure 6. Primary task (holding pattern and ILS approach to Willard Airport).

Prior to completion of the third holding pattern, the computer automatically generated verbal instructions that the subject was cleared for the ILS approach. The ILS approach consisted of a two-dimensional tracking task involving indicators that operate independently. For this task, the subjects used a standard ILS approach indicator, shown as the top, center indicator in Figure 7. The vertical indicator, the localizer of the ILS instrument, represented the extended runway centerline bearing of 313° and provided lateral tracking information. The deflection limits of the localizer indicator were $\pm 1.5^{\circ}$. Therefore, the difficulty of the tracking task increased as the runway was approached. The horizontal indicator, the glideslope of the ILS instrument, represented a 3° angle of descent to the runway and provided vertical tracking information. The deflection limits of the glideslope (GS) indicator were $\pm 0.7^{\circ}$. The subject was instructed to keep both tracking needles centered. The GS trajectory is illustrated in Figure 8.

Secondary Task. During the flight, the Sternberg choice reaction time task was randomly presented as a secondary task to increase the workload of the subject. The secondary task consisted of the presentation of a warning signal, followed by a set of 3 letters (1-s later) that were randomly generated for each presentation from a pool of 18 letters. A test letter, which had a 50% probability of being a member of the set, was presented 2 s after the last letter of the set. The presentation of the secondary task required 10 s; the secondary task was programmed to occur randomly at a 40% probability (i.e., 48 times out of 120 possible 10-s intervals during a 20-min flight). The subject was instructed to press the thumbswitch forward on the control wheel, if the test letter was a member of the set, "True", and to pull aft if the test letter was "False" (i.e., not a member (17)).

Experimental Sessions. For Experiments I and II, 4-h experimental sessions were scheduled 1 week apart for 6 consecutive weeks. Each session had six 20-min flights separated by 20 min of rest.

Subjects

Each subject in Experiment I and Experiment II signed a consent form approved by the University of Illinois Institutional Review Board. Each subject in both experiments received a preexperimental physical including an ECG, and each subject was scheduled for a postexperimental physical.

Experiment I. Eight male general aviation pilots ranging in age from 21 to 23 years served as subjects for Experiment I. With the exception of 1 subject, minimum flight experience was 150 h; flight experience ranged from 105 to 460 h with a mean time of 275 h. Simulator experience ranged from 28 to 57 h with a mean time of 40 h. A problem drinker questionnaire was used to select light-to-moderate drinkers with no histories of alcohol abuse (18).

Experiment II. Sixteen male general aviation pilots ranging in age from 19 to 32 years served as subjects. The minimum flight experience of 1 subject was 97 h; flight experience for the remaining 15 subjects ranged from 133 to 600 h with a mean time of 264 h. Simulator experience ranged from 20 to 70 h with a mean time of 41 h.

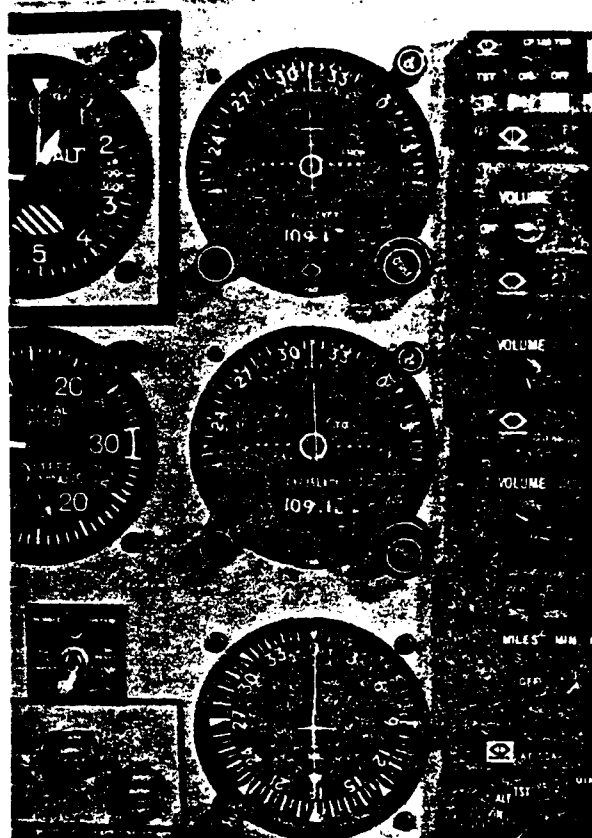

Figure 7. ILS indicator.

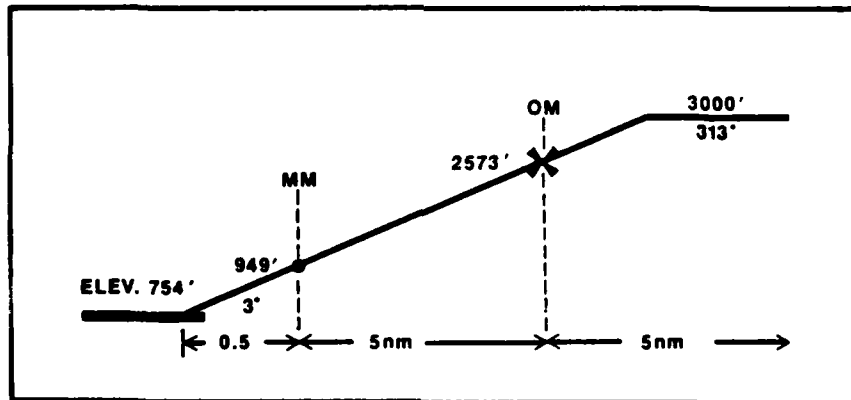

Figure 8. Glideslope trajectory.

Experimental Design

The first session for Experiment I and Experiment II was used as an orientation and screening session. Each subject was screened for the ability to perform the primary task within the limits set by the Federal Aviation Administration Flight Test Guide for Instrument Pilot Candidates (19). The following limits were used: altitude deviation, ± 30.48 m (100 ft); horizontal tracking deviation (localizer), $\pm 1.5^\circ$; vertical tracking deviation (glideslope), $\pm 0.7^\circ$; and rate of turn, $6^\circ/\text{s}$. The second session served to establish a preexperimental baseline.

Experiment I. Four levels of ethyl alcohol were administered to each subject during the four remaining experimental sessions of Experiment I. The amount of alcohol was adjusted for body weight and build (estimated body fat) in order to produce the following target percent blood alcohol levels (BAL): 0.0%, 0.0225%, 0.045%, and 0.09% (20). A Latin Square within subjects, repeated measures design (Plan 12 described by Winer (21)) was used to balance BAL order effects for the multivariate analysis of variance (MANOVA) and the analysis of variance (ANOVA) procedures. Winer's plan assumes that treatment, experimental session, and flight are fixed effects and that subjects within the groups is a random variable. Residual (1), the MS for subjects (within groups) \times treatment, was used as the error term to test for significance for (A) treatment, (B) experimental session, and (AB)' Latin Square error. Residual (2), the MS for subjects (within groups) \times flight interaction, was used as the error term to test for the flight (C) main effect and flight \times groups interaction. Residual (3) was used to test the AC and the BC interaction, and (AB)'C. The error terms were not pooled for any of the statistical analyses. Two subjects were randomly assigned to each group and each subject received each BAL condition. Five variables were tested for significance: (1) treatment (BAL), (2) flight, (3) experimental session (column), (4) group (row), and (5) subject (nested within group). Also, three interactions were tested for significance: (1) treatment (BAL) \times flight, (2) experimental session (column) \times flight, and (3) group (row) \times flight.

The subjects reported to the experimental session in a fasting state. Prior to the first flight, the subjects received one piece of toast. The first flight, for each experimental session, served as a baseline flight. Alcohol was administered during the rest period following the first flight. The drink consisted of 120 ml of distilled water and alcohol in appropriate proportions mixed with 306 ml of orange juice, with 4 ml of alcohol floated on top. Performance data on the primary and secondary tasks were collected during the five remaining flights, and BAL was measured during the five remaining rest periods. All data were collected using double blind conditions.

Experiment II. The following commonly prescribed dosages for 3 drugs (promethazine hydrochloride: 25 mg; thiethylperazine: 10 mg; and cimetidine: 300 mg), standardized for a 70 kg person, and a placebo were administered to each of the 16 subjects over the course of 4 experimental sessions during Experiment II. A 4×4 Latin Square within subjects, repeated measures design, described earlier for Experiment I, was used to balance drug order effects for the MANOVA and ANOVA procedures. Four subjects were randomly assigned to each cell and each subject received each of the 3 drugs and placebo. Five variables were tested for significance: (1) treatment (drug),

(2) flight, (3) experimental session (column), (4) group (row), and (5) subject (nested within group). Three interactions were tested for significance: (1) treatment (drug) x flight, (2) experimental session (column) x flight, and (3) group (row) x flight.

The height and weight tables of Freireich et al. (22) were used to determine the quantity of drugs to be administered to each subject. The body surface area was used to determine drug quantity (mg/m^2) in order to equate dosages to those used by Mattsson et al. (6). The 3 drugs and placebo control were administered in opaque capsules. The placebo capsules contained lactose, and the drug capsules contained the appropriate drug quantity and lactose in order to achieve an identically weighted capsule for each subject, for the 4 experimental sessions.

The fasting subjects reported to the experimental session and underwent an initial medical interview conducted by a registered nurse (RN). The RN questioned each subject concerning his drug, food, and liquid intake and the amount of sleep he had had within the past 24 h. Then, the RN took the subject's pulse and blood pressure.

The first flight for each experimental session served as a baseline flight. The appropriate capsule was administered during the rest period following the first flight. Performance data on the primary and secondary tasks were collected for the remaining five flights. Respiration rate and ECG were recorded during the rest periods following the first, third, and fifth flights. All data were collected under double blind conditions.

RESULTS

Experiment I

The results of using the Breathalyzer to determine BAL indicated that all subjects, with the possible exception of one subject in the 0.0225 BAL experimental condition and one in the 0.045 BAL condition, were administered the programmed amount of alcohol. The highest BAL readings for these two subjects for the stated conditions were 0.000 and 0.008 respectively. An error in preparing the alcohol drink was suspected. Excluding these two errors, there was no overlap on the distribution of scores. The 0.000 BAL condition had only two values greater than zero: 0.003 and 0.004. The 0.0225 BAL experimental condition had a measured median value of 0.014 and a range of 0.011-0.017; the 0.045 BAL condition had a measured median value of 0.038 and a range of 0.031-0.041; the 0.090 condition had a measured median value of 0.082 and a range of 0.072-0.093. For all BAL levels, except for the 0.0 BAL condition, the median measured BAL was less than the target BAL. All further reference to BAL refers to target BAL.

Ink tracings of the lateral tracking task were recorded for all flights and analyzed to determine if the subjects were able to successfully complete the primary task. Visual examination of the plots of the holding patterns and the ILS approach for all experimental conditions indicated that each subject was able to complete the procedures and fly the simulator to the middle marker. The middle marker is the point at which the pilot takes over visually to land the aircraft on an ILS approach. All subjects completed every flight

with the exception of one subject in the highest BAL condition who experienced severe nausea and was unable to complete one flight. For all subjects except one, however, visual inspection of the plots comparing the 0.09 BAL condition with the 0.0 BAL condition, indicated the effects of alcohol on pilot performance. Performance on the primary task typical for the BAL 0.0 experimental condition resulted in holding patterns that were essentially superimposed, and there was no evidence of significant deviation from the extended centerline. The performance typical for the BAL 0.0 condition is shown in Figure 9.

The performance typical for the BAL 0.09 experimental condition is shown in Figure 10. Effects include erratic lateral tracking and extended inbound and outbound legs on the holding patterns. Deviation outside the lateral tracking limit was also observed just prior to middle marker (MM).

Flight data for heading, airspeed, relative bearing, rate of turn, and lateral and vertical tracking were sampled once per second; and four RMS deviation values were computed. For the entry into the holding pattern and the three holding patterns, RMS deviations were computed for altitude straight and level (ALT 1), and for altitude while turning (ALT 2). Root mean square deviations were computed for lateral tracking or localizer (LOC) during the entire flight, and for vertical tracking or GS during the ILS approach. The mean RMS values for the four dependent variables (ALT 1, ALT 2, LOC, and GS) were computed for each of the four BAL levels. Figures 11 through 14 show the means and standard error of the means for the four BAL levels for all subjects during the last five flights (post-alcohol) for each dependent variable. The means for all four variables showed a monotonic increase from 0.0 through 0.09 BAL.

Data for four dependent variables for the primary task (the RMS deviations of the two altitudes, and RMS deviations of the lateral and vertical tracking) were transformed using a log transformation. The transformed scores for all eight subjects during the last five flights (post-drug) were used in a multivariate analysis of variance (MANOVA) to test the main effects of treatment (BAL), flight, experimental session (column), group (row), and subject (nested within group). The data set contained 156 observations of 160 possible observations; four observations were lost. One subject experienced nausea and was unable to complete one flight; the remaining three unavailable observations resulted from computer malfunctions. An approximate F-test, based on Wilks' criterion (23), resulted in $F(12,24) = 1.64$ ($P < 0.1469$) for the treatment main effect (BAL level). An approximate F-test was conducted using as the error term the interaction, flight x subject (nested within group), to test the significance of the flight main effect. The test resulted in an $F(16,40) = 2.49$ ($P < 0.0099$). The main effect of subject (nested within group) was significant, $F(16,199) = 14.05$ ($P < 0.0001$). The main effects of experimental session (column) and group (row) were not significant.

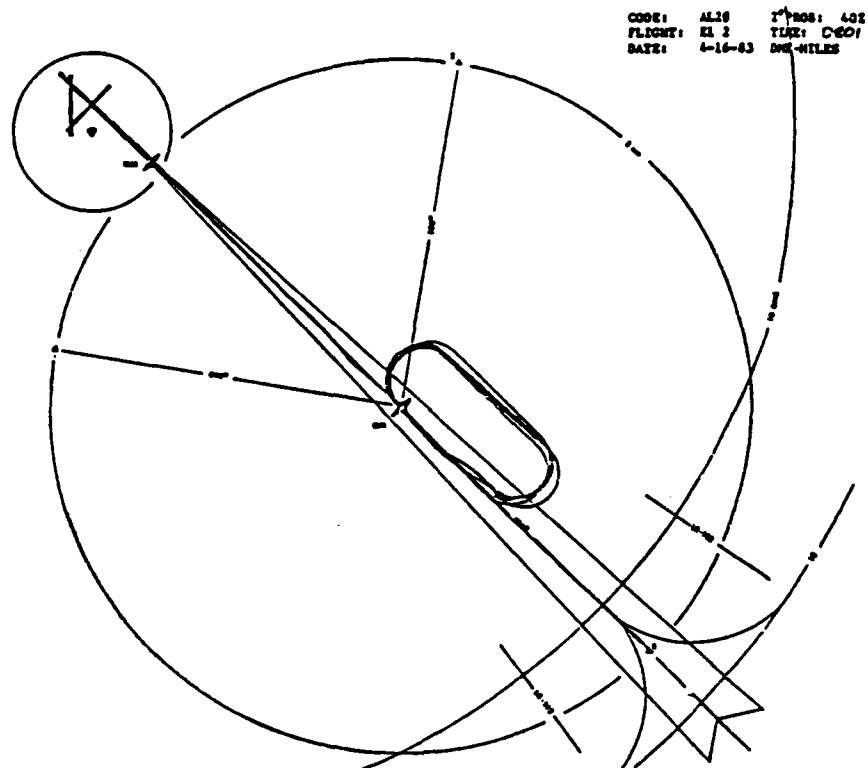

Figure 9. Lateral tracking (localizer), subject #AL20, BAL 0.0, flight #2.

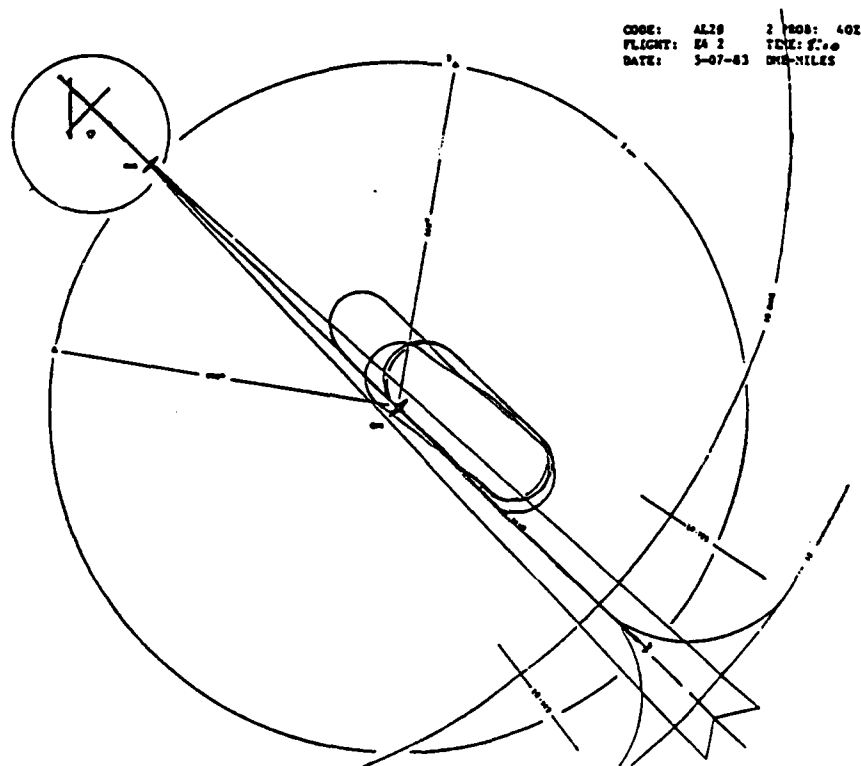

Figure 10. Lateral tracking (localizer), subject #AL20, BAL 0.09, flight #2.

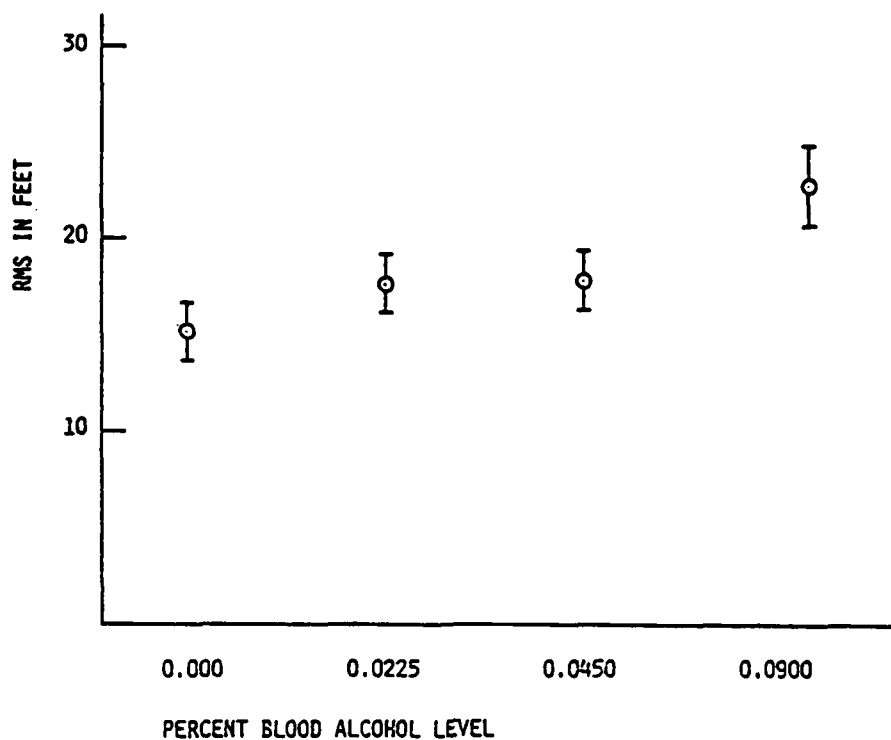

Figure 11. RMS means and standard error of the means for blood alcohol levels for ALT 1, for 8 subjects.

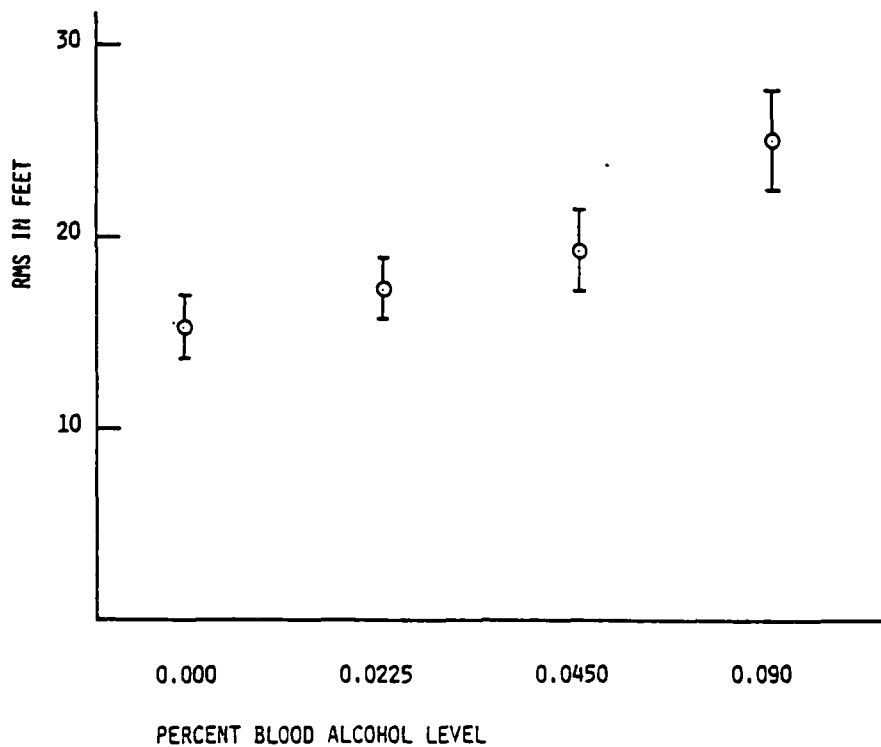

Figure 12. RMS means and standard error of the means for blood alcohol levels for ALT 2, for 8 subjects.

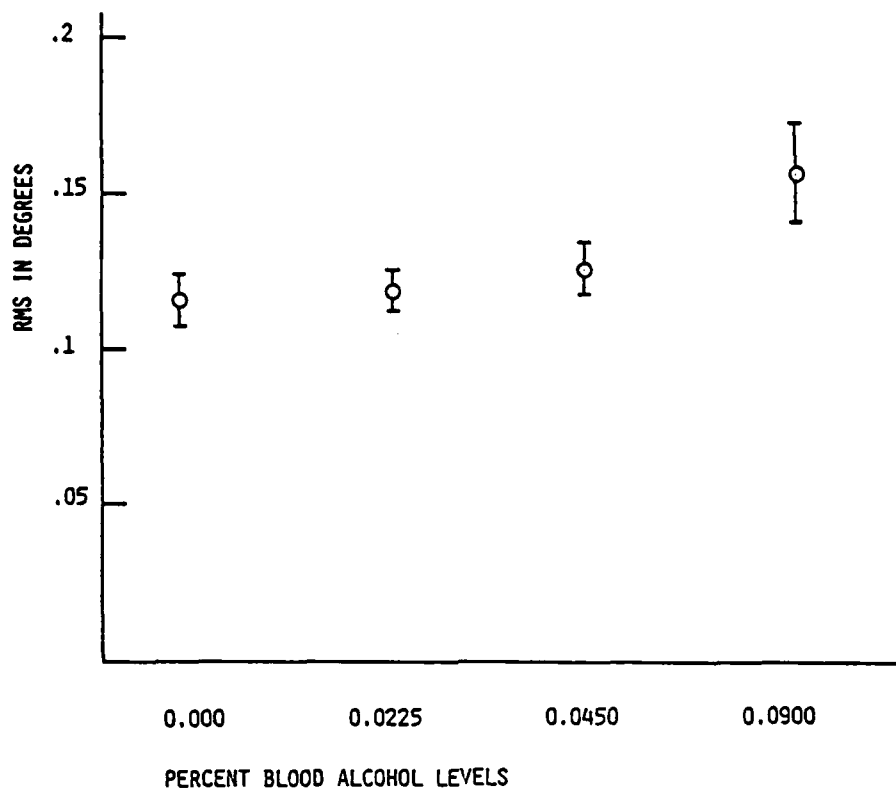

Figure 13. RMS means and standard error of the means for blood alcohol levels for GS, for 8 subjects.

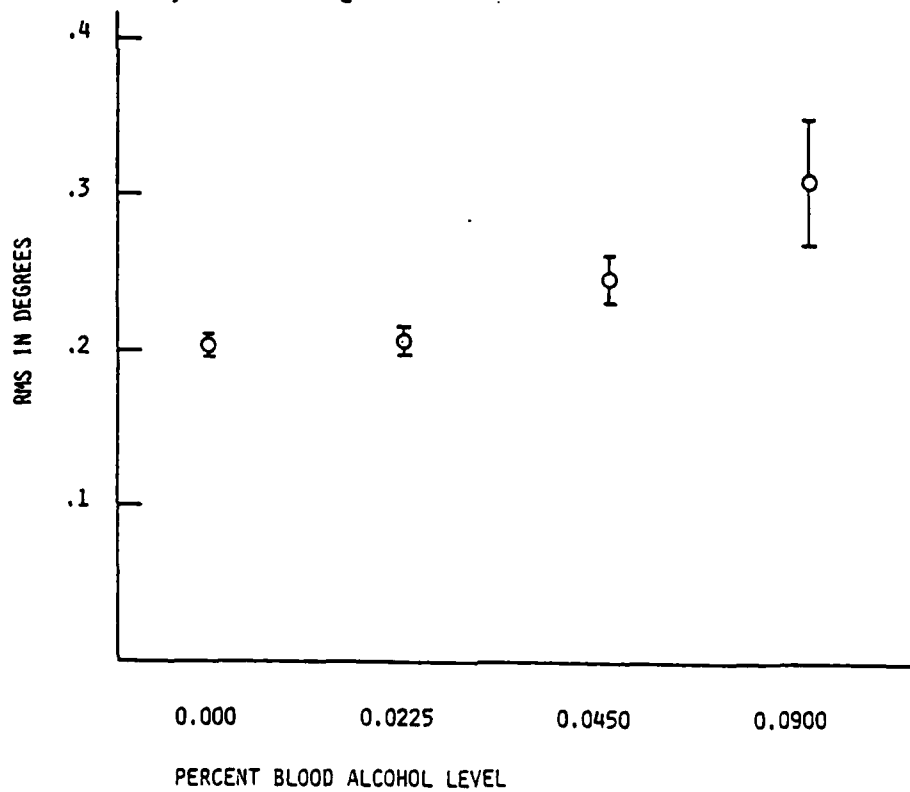

Figure 14. RMS means and standard error of the means for blood alcohol levels for LOC, for 8 subjects.

Univariate analyses of variance (ANOVA) were computed for each primary task dependent variable using all subjects (24); a summary of the analysis is presented in Appendix A. The analyses of three of the four variables (Altimeter 1 (ALT 2), Altimeter 2 (ALT 2), and GS) resulted in a significant treatment (BAL) main effect. The LOC variable was not significant. Contrasts were computed between the 0.0 BAL and the other three BAL conditions and between the 0.0225 BAL and the 0.09 BAL. Table 1 summarizes the results of the contrasts. None of the contrasts between BAL 0.0 and 0.0225 and between 0.0 and 0.045 were significant, but three of the contrasts between 0.0 and 0.09 and between 0.0225 and 0.09 were significant.

TABLE 1. SIGNIFICANCE PROBABILITIES OF CONTRASTS BETWEEN BAL LEVELS FOR THE DEPENDENT VARIABLES

Dependent variables	BAL conditions			
	0.0 - 0.0225	0.0 - 0.045	0.0 - 0.09	0.0225 - 0.09
ALT 1	NS	NS	0.0091	0.0473
ALT 2	NS	NS	0.0029	0.0149
GS	NS	NS	0.0049	0.0121
LOC	NS	NS	NS	NS

NS = not significant

The univariate analyses for the altitude control while turning (ALT 2) and vertical tracking (GS) variables resulted in significant main effects for flight: ALT 2, $F(4,16) = 3.93$ ($P < 0.02$); GS, $F(4,16) = 3.11$ ($P < 0.05$).

The computer random number generator malfunctioned during Experiment I. The random number generator was used to determine the sequence in which the three-letter sets of the secondary task were presented. The malfunction resulted in a repetitive pattern of sets of stimuli being presented. Since some experimental sessions were conducted with random sets of secondary task stimuli and some sessions with repetitive sets being presented, the true (hits) and false (correct rejections) reaction times were discarded. The incorrect responses for the secondary task were also discarded.

Experiment II

The ink tracings that were recorded for lateral tracking task (localizer) were analyzed to determine if the subjects were able to successfully complete the primary task. Visual examination of the holding patterns and the ILS approach for all experimental conditions for each subject indicated that each subject completed the primary task for each flight (i.e., flew the simulators to the middle marker). Comparisons of the flights for each of the three anti-emetic drugs with the control flights indicated no consistent patterns of

gross differences. Figure 15 illustrates the performance that was typical for the control (placebo) condition, and Figure 16 illustrates the performance that was typical for the promethazine hydrochloride condition.

The flight data sampling and the RMS computations described for Experiment I were also performed for Experiment II. The mean RMS values for the 4 dependent variables (ALT 1, ALT 2, LOC, and GS) were computed for each of the 4 experimental treatment conditions (drug). The means and the standard error of the means for the treatment conditions, for all subjects during the last five flights (post-drug) are shown in Figures 17 through 20. For all four dependent variables, the RMS mean for promethazine hydrochloride was higher than the control mean. Examination of the means for the RMS LOC dependent variable indicated that the RMS means for thiethylperazine and cimetidine were lower than the control mean.

The scores for 4 dependent variables for the primary task, the RMS deviations of the 2 altitudes (ALT 1 and ALT 2), and RMS deviations of the lateral and vertical tracking (GS and LOC) were transformed using a log transformation. The transformed scores for all 16 subjects during the last 5 flights (post-drug) were used in a MANOVA to test the main effects of treatment (drug), flight, experimental session (column), group (row), and subject (nested within group). The data set contained 314 observations of 320 possible observations; 6 observations were lost due to computer malfunctions. An approximate F-test, based on Wilks' criterion, resulted in $F(12,87) = 2.47$ ($P < 0.008$) for the treatment main effect (drug). The MANOVA tests of significance for the main effects for flight and group, and for the interactions for experimental session (column) x flight, treatment (drug) x flight and flight x group (row) were all nonsignificant. The main effect of subject (nested within group) resulted in an $F(48,614) = 21.80$ ($P < 0.0001$). An approximate F-test of the main effect of experimental session (column) based on Wilks' criterion resulted in $F(12,87) = 2.64$ ($P < 0.0046$). Figure 21 illustrates the RMS means and standard error of the means across 16 subjects for all treatment conditions for the localizer for the 4 experimental sessions. The means show a monotonic decrease across the 4 sessions. The performance increase on the localizer tracking variable indicated that the subjects were not stabilized when experimental session 1 began.

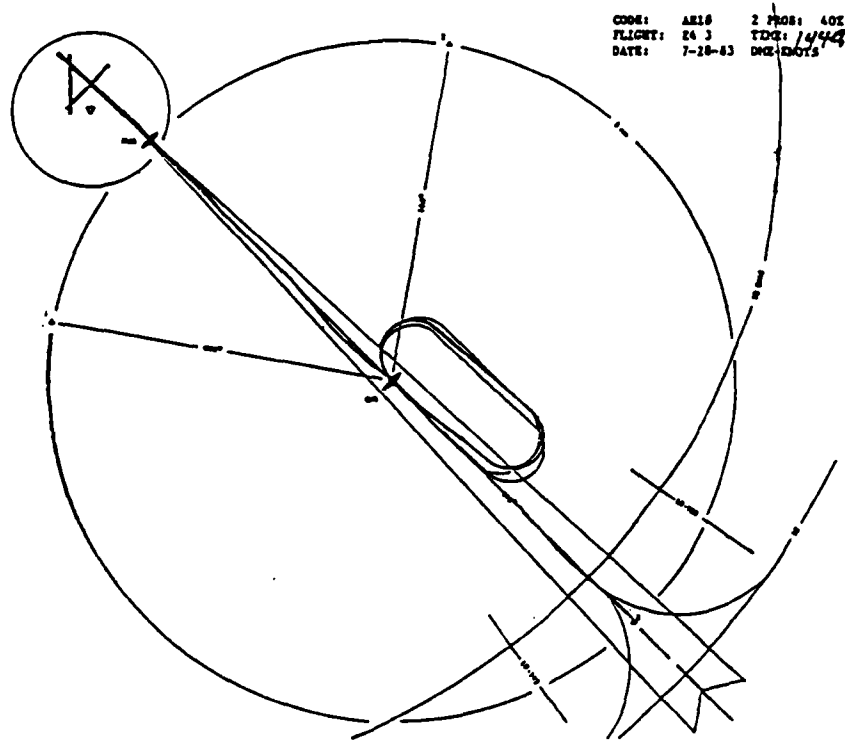

Figure 15. Lateral tracking (localizer), subject #AE10, placebo, flight #3.

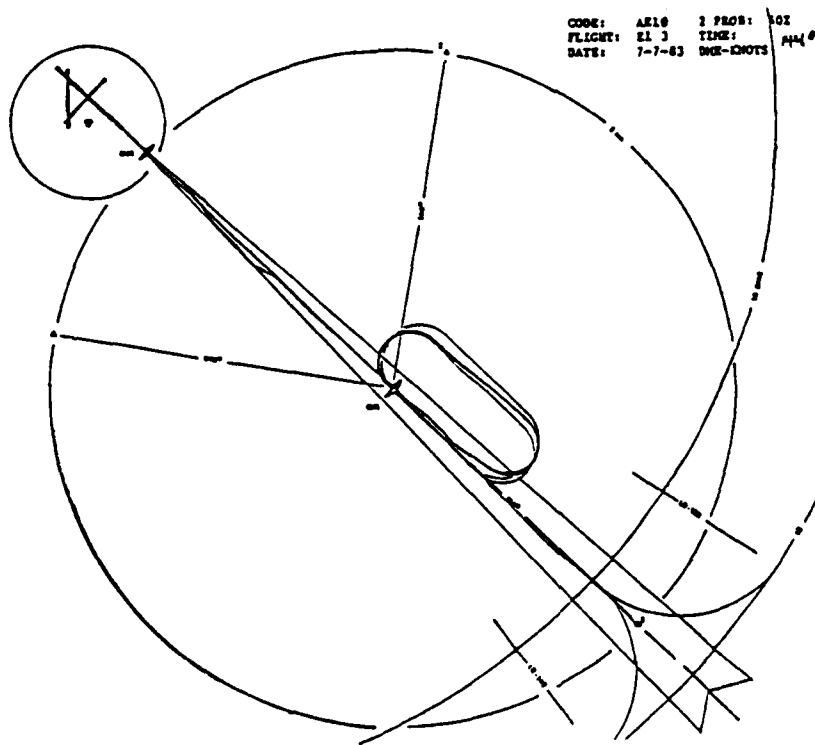

Figure 16. Lateral tracking (localizer), subject #AE10, promethazine hydrochloride, flight #3.

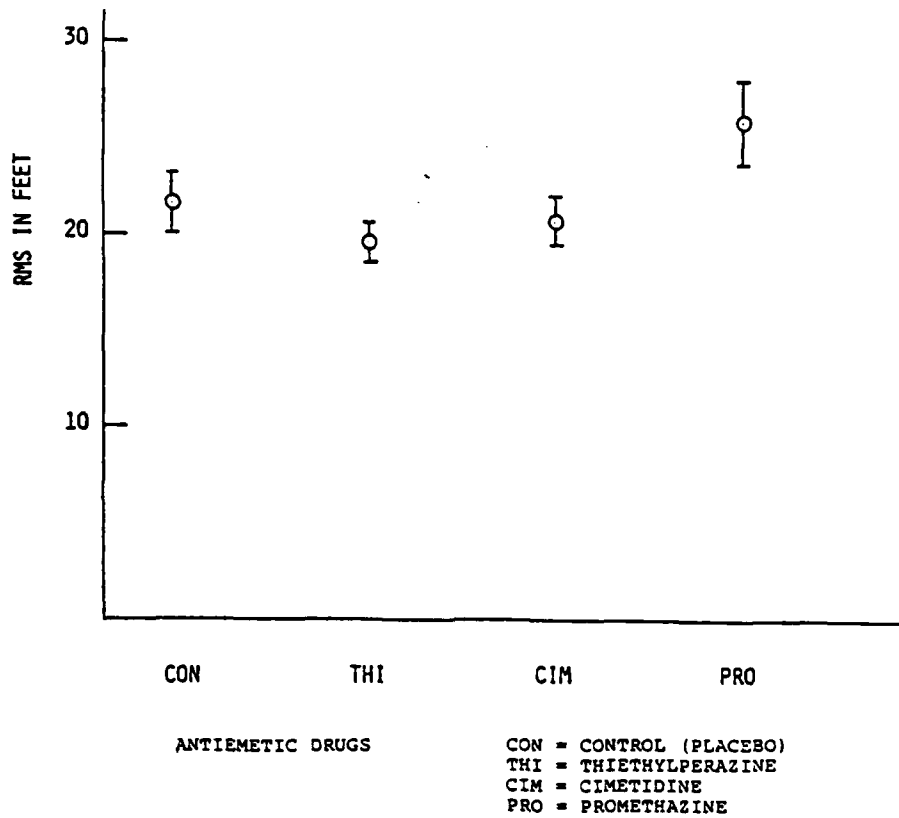

Figure 17. RMS means and standard error of the means for the antiemetic drugs for ALT 1, for 16 subjects.

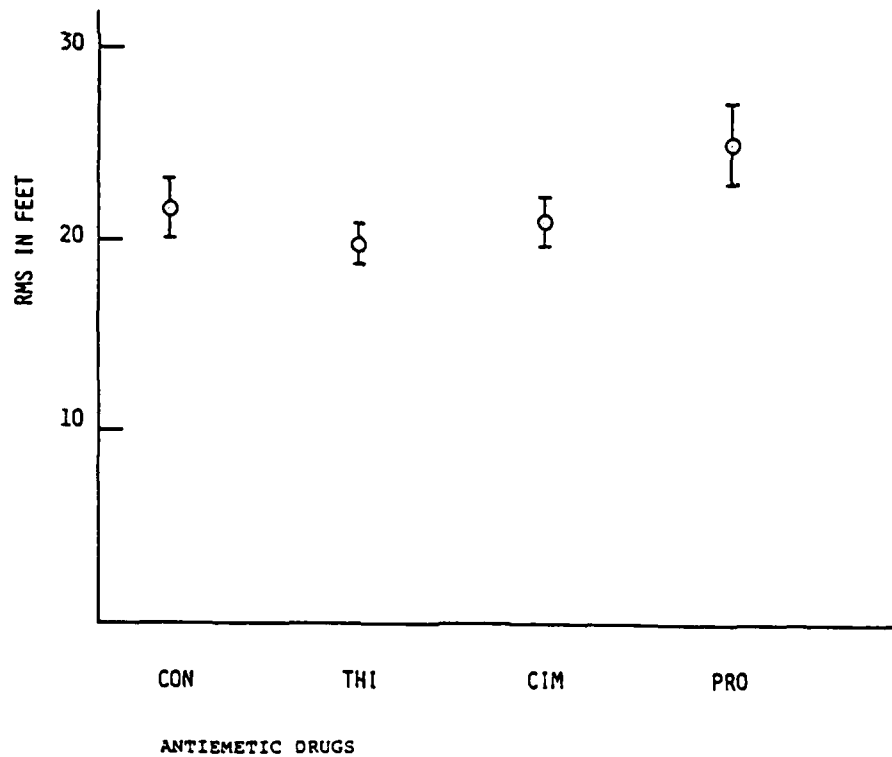

Figure 18. RMS means and standard error of the means for the antiemetic drugs for ALT 2, for 16 subjects.

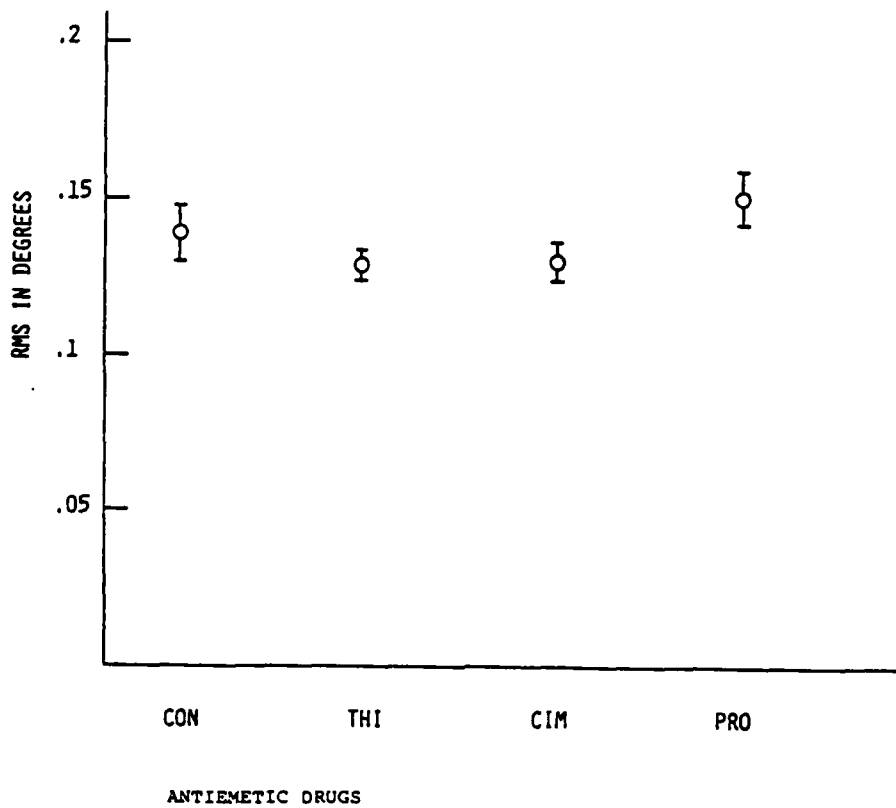

Figure 19. RMS means and standard error of the means for the antiemetic drugs for GS, for 16 subjects.

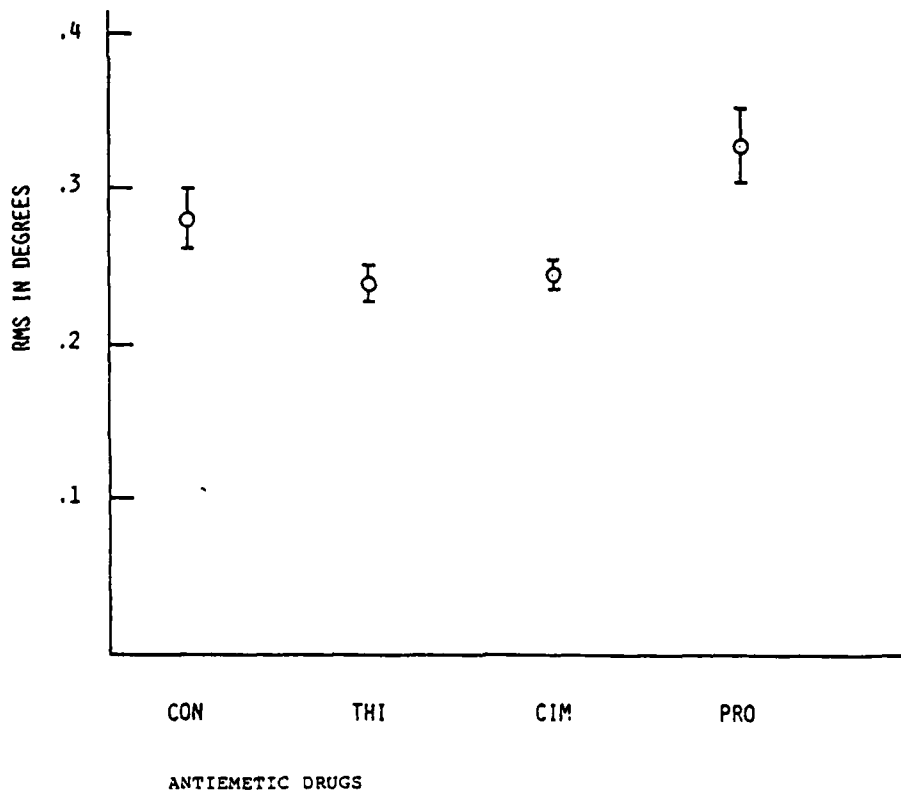

Figure 20. RMS means and standard error of the means for the antiemetic drugs for LOC, for 16 subjects.

Univariate analyses were computed for each primary task dependent variable using all subjects; a summary of the analyses is presented in Appendix B. The analyses of two of the variables (ALT 1 and LOC) supported the findings of the MANOVA test of a significant treatment (drug) main effect. The treatment main effect for ALT 2 and GS was not significant. F-tests resulted in the following values: ALT 1, $F(3,36) = 4.12$ ($P < 0.0131$) and LOC, $F(3,36) = 8.12$ ($P < 0.003$). Contrasts for the univariate analysis for the treatment (drug) effect between the control and each of the antiemetic drugs were conducted using the MS for drug x subject (groups) as the error term. Table 2 summarizes the results of the contrasts.

TABLE 2. SIGNIFICANCE PROBABILITIES OF CONTRASTS BETWEEN THE CONTROL AND EACH ANTIEMETIC DRUG FOR THE DEPENDENT VARIABLES

Dependent Variables	Treatment Contrasts		
	CON-CIM	CON-THI	CON-PRO
ALT 1	NS	NS	0.0184
ALT 2	NS	NS	NS
GS	NS	NS	0.0291
LOC	NS	0.013	NS

NS = nonsignificant

A significant difference was found between the control and promethazine hydrochloride for ALT 1 and GS, but not between the control and either cimetidine or thiethylperazine for these dependent variables. The contrasts for ALT 2 were not significant. For the LOC dependent variable, contrasts between the control and thiethylperazine were significant. Examination of Figure 20 indicates that the RMS mean for thiethylperazine was lower than the control mean.

Univariate analyses for the four dependent variables for the experimental session main effect resulted in a significant F-test for the LOC variable, $F(3,36) = 7.86$ ($P < 0.0004$). The other three dependent variables were not significant.

During Experiment II, the random number generator for the Sternberg task malfunctioned for 4 of the antiemetic subjects. The true (hits) and the false (correct rejections) reaction times were discarded for these subjects. The data pertaining to the incorrect responses for the secondary tasks were also discarded for these 4 subjects.

For the remaining 12 subjects, the true and the false reaction times were used in a MANOVA to test the main effects of treatment (drug), flight, experimental session (column), group, and subject (nested within group). An approximate F-test, based on Wilks' criterion, resulted in $F(6,70) = 3.35$ ($P < 0.0059$) for the treatment (drug) main effect. The main effects of experimental session, flight, and group were not significant, but subject (nested within group) resulted in an $F(24,322) = 16.81$ ($P < 0.0001$).

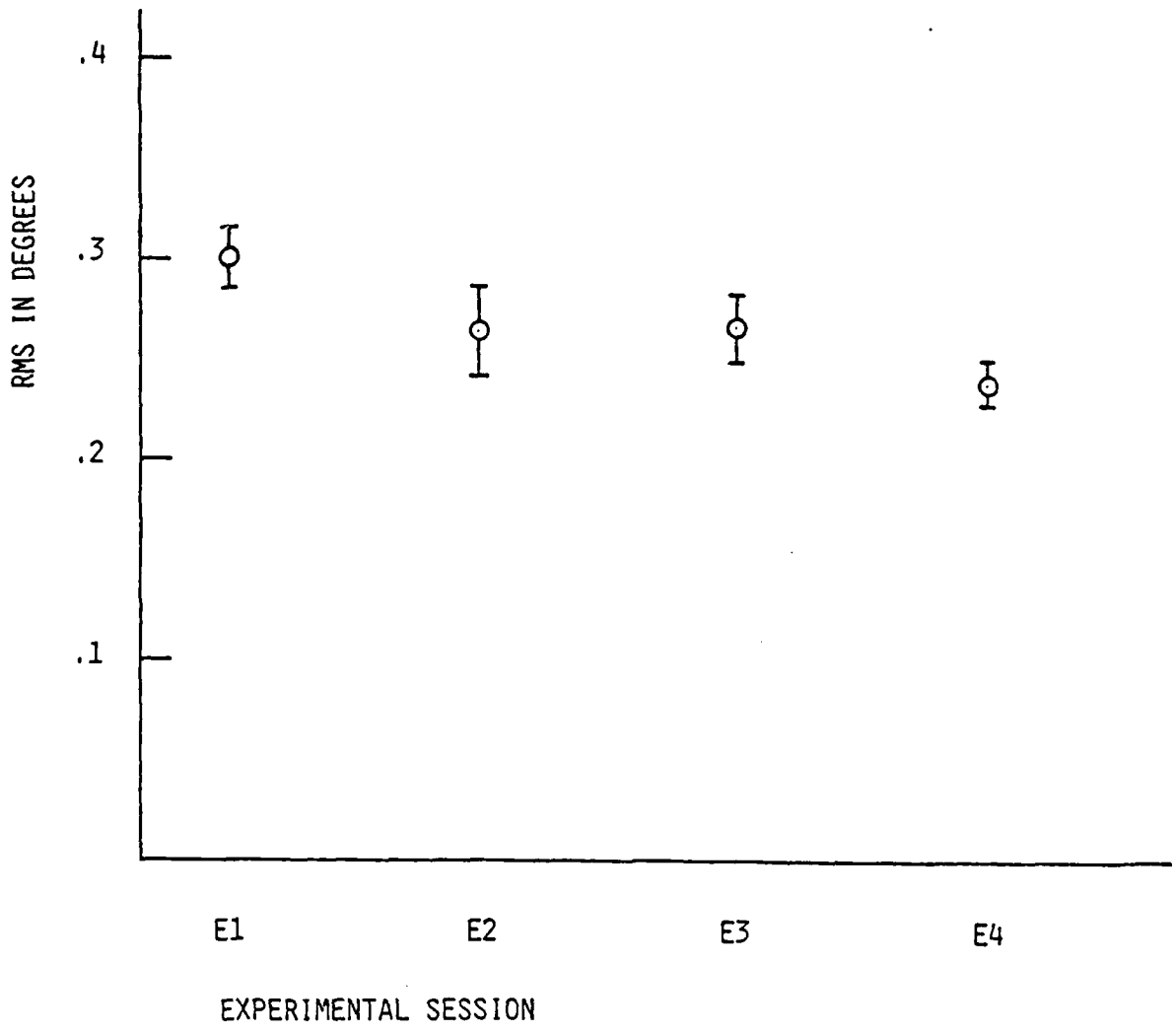

Figure 21. RMS means and standard error of the means for the experimental session for LOC, for 16 subjects.

Univariate analyses for the true reaction times and the false reaction times were computed. No significant main effects were found for the true reaction time, but the analysis for the false reaction time resulted in $F(3,36) = 2.81$ ($P < 0.05$). Linear contrasts indicated that the effect was due to the differences between promethazine hydrochloride and cimetidine.

A stepwise logistic regression analysis was computed to determine the effect of the antiemetic drugs on accuracy for the secondary task. The analysis indicated that accuracy showed little variation as a result of the antiemetic drugs.

The ECG data collected during the two post-drug periods, were digitized and the MHP and the HPV were computed. The digitized data were analyzed to compute the variance of the heart period data for the frequency band associated with spontaneous respiration (i.e., 0.12 to 0.40 Hz). This variance, \bar{V} , and the HPV were transformed using a log transformation to normalize the distributions.

The MHP and the means for the HPV and the \bar{V} distributions were computed. The MHP for the baseline condition (pre-drug following the first flight) and the two post-drug periods were examined. The means for the placebo and for the three antiemetic drugs showed a monotonic increase in heart period for the three post-flight data periods which indicated subject adaptation to the data collection procedure. From the baseline condition, the total heart period increase during the two post-drug periods was 100 ms for cimetidine, 110 ms for thiethylperazine and 121 ms for both the placebo and promethazine hydrochloride. A univariate analysis of variance was computed for MHP for the two post-drug rest periods (flights 3 and 5) in order to test the main effects of treatment (drug), flight, experimental session (column), group (row), and subject (nested within group). The drug effect results, $F(3,80) = 2.51$ ($P = 0.063$), were not significant at the 0.05 level of confidence. The flight main effect was significant, $F(1,80) = 7.94$ ($P < 0.05$). The experimental session and group main effects were not significant. The main effect of subject (nested within group) was significant, $F(12,80) = 37.77$ ($P < 0.001$). ANOVAS for the HPV and \bar{V} were also computed using the same model described for the MHP analysis. The treatment main effect (drug) was not significant at the 5% alpha level for either of the two dependent variables.

DISCUSSION

The results from Experiment I provided calibration of the sensitivity of the automated performance methodology for evaluating the effects of toxic substances on pilot performance. The performance decrement on the primary task was significant for three of the four dependent variables for a measured median percent BAL of 0.082, but not for a median value of 0.038 or 0.014. These results are consistent with the findings of other investigators who used experienced pilots flying similar instrument flight tasks in a simulator (8, 9). The lack of significance of the MANOVA treatment main effect was probably due to the small number of subjects (eight) in the study. A significant subject (nested within group) main effect suggests that, for future experiments involving the evaluation of toxic substances, the use of an experimental design in which each subject experiences all treatment conditions may be the most efficient design. No significant effect was found concerning

the experimental session, indicating that the subjects' performances did not change over the course of the experiment as a result of practice on the primary task.

The results on the secondary task were not used since the malfunction of the random number generator introduced variability across experimental sessions that could neither be evaluated nor controlled. The subjects reported that they were able to anticipate the correct response from the repetitive pattern of three-letter sets.

The results from Experiment II indicate that all subjects were able to complete the primary task of flying the aircraft as well as to maintain a high degree of accuracy on the secondary task. Of the three antiemetic drugs, promethazine hydrochloride produced a performance decrement for two of the four dependent variables. The decrements were statistically reliable, but the decrements were not large. The decrements for promethazine hydrochloride were smaller than decrements observed for the highest measured BAL level (0.082%). Thiethylperazine and cimetidine did not produce significant performance decrements when compared with control flights, although the performance on the localizer variable was superior to the control for the thiethylperazine treatment condition.

Wood et al. (25) found that 25 mg oral or intramuscular (IM) promethazine hydrochloride significantly increased errors on a computerized pursuit meter task. These investigators reported the most pronounced error rate 4.5 h after drug administration for the oral dose.

Cooper and Mattsson (5) reported that promethazine hydrochloride increased the ED₅₀ for radiation-induced emesis in dogs to 402 rad compared to 170 rad in control dogs. Thiethylperazine increased the ED₅₀ to 320 rad and cimetidine increased it to 331 rad. Mattsson et al. (6) administered to dogs lower doses of promethazine hydrochloride (13.92 mg/m²) and thiethylperazine (5.57 mg/m²) and higher doses of cimetidine (167 mg/m²) in order to determine the ED₅₀ level of radiation-induced emesis. These drugs were administered singly and in combination. The results indicated that, of the three drugs administered singly, only thiethylperazine was statistically more effective in increasing the radiation threshold compared to the control group (7). The equivalent levels of the three antiemetic drugs were used in this study to determine the performance effects of the drugs in pilots. Since thiethylperazine produced no significant performance decrements and has been shown to be effective in increasing the radiation-induced emesis threshold, the results suggest that thiethylperazine should be used if a single drug is to be administered to prevent radiation-induced emesis in aircrew members.

Performance on the localizer tracking task improved during the experiment, while the performance on the other three dependent variables in the primary task remained stable. Even though all subjects met the screening criteria for localizer tracking prior to the first experiment session, the results clearly indicate that the subjects' performance continued to improve with practice. The data suggest that one additional day of practice would probably have stabilized the baseline for this group of subjects.

The secondary task provided very little discrimination between the control and the antiemetic drugs. False reaction times were significantly

different between control and cimetidine, but the false reaction times between the control and the other two drugs were not significant. No significant differences were found for either true reaction times or for accuracy.

REFERENCES

1. Goodman, L.S., and Gilman, A.G. Pharmacological Basis of Therapeutics, 5th edition, MacMillan, New York, N.Y., 1975.
2. Marks, J.H. Use of chlorpromazine in radiation sickness and nausea from other causes. N Engl J Med 250:999-1001 (1954).
3. Luthra, Y.K., Mattsson, J.L., and Yochmowitz, M.G. Inhibition of radioemesis by disruption of catecholamines in dogs. Radiat Res 85:583-591 (1981).
4. Gralla, E.J., Krupp, J.H., Yochmowitz, M.G., and Mattsson, J.L. Drug inhibition of first-stage radioemesis. SAM-TR-77-12, USAF School of Aerospace Medicine, Brooks Air Force Base, Tex., June 1977.
5. Cooper, J.R., and Mattsson, J.L. Control of radiation-induced emesis with promethazine, cimetidine, thiethylperazine, or naloxone. Am J Vet Res 40:1057-1061 (1979).
6. Mattsson, J.L., Cordts, R.E., Yochmowitz, M.G., and Hardy, K.A. Prevention of radiation emesis in dogs by combinations of drugs. (In Press). Intl J Rad Oncology Biol and Physics (1984).
7. Cordts, R.E. Animal-model studies of radiation-induced emesis and its control. SAM-TR-82-26, USAF School of Aerospace Medicine, Brooks Air Force Base, Tex., August 1982.
8. Klein, K.E. Prediction of flight safety hazards from drug induced performance decrements with alcohol as a reference substance. Aerospace Med 43:1207-1214 (1972).
9. Aksnes, E.G. Effects of small dosages of alcohol upon performance in a Link Trainer. J Aviat Med 25:680-688 and 693 (1954).
10. Henry, P.H., Davis, T.Q., Engelken, E.J., Triebwasser, J.H., and Lancaster, M.C. Alcohol-induced performance decrements assessed by two Link Trainer tasks using experienced pilots. Aerospace Med 45:1180-1189 (1974).
11. Billings, C.E., Wick, R.L., Goike, R.J., and Chase, R.C. Effects of ethyl alcohol on pilot performance. Aerospace Med 44:379-382 (1973).
12. Dellinger, J.A. ILLIMAC pilot performance evaluation system. Link Foundation Final Report, Part A, Institute of Aviation, Aviation Research Laboratory, University of Illinois, Savoy, IL, 1983.

13. Dellinger, J.A. and Taylor, H.L. Measuring the pilot performance effects of neurotoxicosis. Proceedings: Second Symposium on Aviation Psychology Columbus, Ohio, 1983.
14. Porges, S.W., McCabe, P.M., and Yongue, B.G. Respiratory-heart rate interactions: psychophysiological implications for pathophysiology and behavior. pgs 223-264; 1982. In J.T. Cacioppo and R.E. Petty (Eds), Perspectives in Cardiovascular Psychophysiology. Guilford Press, New York.
15. Yongue, B.G., McCabe, P.M., Porges, S.W., Rivera, M., Kelley, S.L., and Ackles, P.K. The effects of pharmacological manipulations that influence vagal control of the heart on heart period, heart period variability and respiration in cats. Psychophysiology 19:426-432 (1982).
16. Taylor, H.L., Staples, L.A., Todd, R.E., and Harshbarger, T.L. The ILLImac Micro Aviation Computer (ILLIMAC) Simulator. (In press), 1984.
17. Wolf, J.D. Crew workload assessment: Development of a measure of operator workload. AFFDL-TR-78-165, USAF Flight Dynamics Laboratory, Wright-Patterson Air Force Base, Ohio, 1978.
18. Mortimer, R.G., Filkins, L.D., Lower, J.S. Development of court procedures for identifying problem drinkers: DOT-HS-800631, NHTSA, U.S. Department of Transportation, Highway Safety Research Institute, University of Michigan, Ann Arbor, MI, 1971.
19. Flight Test Guide for Instrument Pilots. EA-AC-61-56A, U.S. Department of Transportation, Federal Aviation Administration, 1976.
20. Mortimer, R.G. and Sturgis, S.P. Effects of alcohol on safe driving skills. UM-HSRI-HF-75-1, Highway Safety Research Institute, University of Michigan, Ann Arbor, MI, 1975.
21. Winer, B.J. Statistical Principles in Experimental Design. (2d) pgs 745-748, McGraw-Hill Company, Inc., New York, 1971.
22. Freireich, E.J., Gehan, E.A., Rall, D.P., Schmidt, L.H., and Skipper, H.E. Quantitative comparison of toxicity of anticancer agents in mouse, rat, hamster, dog, monkey, and man. Cancer Chemotherapy Reports 50 (4):219-244 (1966).
23. Rao, C.R. Linear Statistical Inference and its Application. (2d) p 555, Wiley, New York, 1973.
24. Scheffe, H. The Analysis of Variance. Wiley, New York, 1959.
25. Wood, C.D., Manno, J.E., Manno, B.R., Redetzki, H.M., Wood, M., and Vekovius, W.A. Side effects of antimotion sickness drugs. Aviat Space Environ Med 55(2):113-116 (1984).

APPENDIX A

ALCOHOL ANOVAS, USING ALL SUBJECTS ON PRIMARY VARIABLES
 NUMBER OF OBSERVATIONS IN DATA SET = 156

General Linear Models Procedures SAS

Dependent Variable: LGALT1

<u>Source</u>	<u>DF</u>	<u>Sum of Squares</u>	<u>F Value</u>	<u>PR>F</u>	<u>R-Square</u>
Model	87	45.77228554	9.23	0.0001	0.921947
Error	68	3.87511151		<u>Root MSE</u>	
Corrected Total	155	49.64739704		0.23871936	

<u>Source</u>	<u>DF</u>	<u>SS</u>	<u>F Value</u>	<u>PR>F</u>
Subject (Group)	4	11.57833429	50.79	0.0001
Treatment*Subject (Group)	12	3.97821492	5.82	0.0001
Flight*Subject (Group)	16	0.76378581	0.84	0.6397
Period*Flight	12	0.98226865	1.44	0.1713
Treatment*Flight	12	0.34092076	0.50	0.9086

Tests of hypotheses using the MS for Flight*Subject (Group) as an error term

<u>Source</u>	<u>DF</u>	<u>SS</u>	<u>F Value</u>	<u>PR>F</u>
Flight	4	0.06968274	0.36	0.8300
Flight*Group	12	0.42544367	0.74	0.6951

Tests of hypotheses using the MS for Subject (Group) as an error term

<u>Source</u>	<u>DF</u>	<u>SS</u>	<u>F Value</u>	<u>PR>F</u>
Group	3	22.32823218	2.57	0.1919

Tests of hypotheses using the MS for Treatment*Subject (Group) as an error term

<u>Source</u>	<u>DF</u>	<u>SS</u>	<u>F Value</u>	<u>PR>F</u>
Period	3	0.28203903	0.28	0.8363
Treatment	3	3.42354187	3.44	0.0518

Note: LGALT1 = Log RMS Altitude while straight and level.

Dependent Variable: LGALT2

<u>Source</u>	<u>DF</u>	<u>Sum of Squares</u>	<u>F Value</u>	<u>PR>F</u>	<u>R-Square</u>
Model	87	48.69820324	10.82	0.0001	0.932624
Error	68	3.51811799	<u>Root MSE</u>		
Corrected Total	155	52.21632123	0.22745775		

<u>Source</u>	<u>DF</u>	<u>SS</u>	<u>F Value</u>	<u>PR>F</u>
Subject (Group)	4	15.33601864	74.11	0.0001
Treatment*Subject (Group)	12	3.80882326	6.13	0.0001
Flight*Subject (Group)	16	0.54970093	0.66	0.8183
Period*Flight	12	0.42116261	0.68	0.7661
Treatment*Flight	12	0.23603190	0.38	0.9663

Tests of hypotheses using the MS for Flight*Subject (Group) as an error term

<u>Source</u>	<u>DF</u>	<u>SS</u>	<u>F Value</u>	<u>PR>F</u>
Flight	4	0.53975498	3.93	0.0209
Flight*Group	12	0.29652915	0.72	0.7148

Tests of hypotheses using the MS for Subject (Group) as an error term

<u>Source</u>	<u>DF</u>	<u>SS</u>	<u>F Value</u>	<u>PR>F</u>
Group	3	20.80725720	1.81	0.2852

Tests of hypotheses using the MS for Treatment*Subject (Group) as an error term

<u>Source</u>	<u>DF</u>	<u>SS</u>	<u>F Value</u>	<u>PR>F</u>
Period	3	0.25046253	0.26	0.8507
Treatment	3	4.78249802	5.02	0.0175

Note: LGALT2 = Log RMS Altitude while turning.

Dependent Variable: LGGS

<u>Source</u>	<u>DF</u>	<u>Sum of Squares</u>	<u>F Value</u>	<u>PR>F</u>	<u>R-Square</u>
Model	87	15.18880970	1.69	0.0122	0.684347
Error	68	7.00578830		<u>Root MSE</u>	
Corrected Total	155	22.19459800		0.32097710	

<u>Source</u>	<u>DF</u>	<u>SS</u>	<u>F Value</u>	<u>PR>F</u>
Subject (Group)	4	1.84153128	4.47	0.0029
Treatment*Subject (Group)	12	1.51561596	1.23	0.2841
Flight*Subject (Group)	16	1.69981911	1.03	0.4367
Period*Flight	12	2.37396462	1.92	0.0469
Treatment*Flight	12	0.86008717	0.70	0.7500

Tests of hypotheses using the MS for Flight*Subject (Group) as an error term

<u>Source</u>	<u>DF</u>	<u>SS</u>	<u>F Value</u>	<u>PR>F</u>
Flight	4	1.32127902	3.11	0.0452
Flight*Group	12	2.17988666	1.71	0.1567

Tests of hypotheses using the MS for Treatment*Subject (Group) as an error term

<u>Source</u>	<u>DF</u>	<u>SS</u>	<u>F Value</u>	<u>PR>F</u>
Period	3	0.26726098	0.71	0.5670
Treatment	3	1.73908342	4.59	0.0232

Note: LGGS = Log RMS Glide Slope.

Dependent Variable: LGLOC

<u>Source</u>	<u>DF</u>	<u>Sum of Squares</u>	<u>F Value</u>	<u>PR>F</u>	<u>R-Square</u>
Model	87	17.05031629	2.75	0.0001	0.778528
Error	68	4.85039662			
Corrected Total	155	21.90071291		<u>Root MSE</u> 0.26707557	

<u>Source</u>	<u>DF</u>	<u>SS</u>	<u>F Value</u>	<u>PR>F</u>
Subject (Group)	4	4.13400433	14.49	0.0001
Treatment*Subject (Group)	12	3.41764480	3.99	0.0001
Flight*Subject (Group)	16	0.81842847	0.72	0.7672
Period*Flight	12	0.26556855	0.31	0.9854
Treatment*Flight	12	0.50375286	0.59	0.8440

Tests of hypotheses using the MS for Flight*Subject (Group) as an error term

<u>Source</u>	<u>DF</u>	<u>SS</u>	<u>F Value</u>	<u>PR>F</u>
Flight	4	0.20875608	1.02	0.4265
Flight*Group	12	0.63683344	1.04	0.4630

Tests of hypotheses using the MS for Subject (Group) as an error term

<u>Source</u>	<u>DF</u>	<u>SS</u>	<u>F Value</u>	<u>PR>F</u>
Group	3	4.33819178	1.40	0.3654

Tests of hypotheses using the MS for Treatment*Subject (Group) as an error term

<u>Source</u>	<u>DF</u>	<u>SS</u>	<u>F Value</u>	<u>PR>F</u>
Period	3	0.33111834	0.39	0.7640
Treatment	3	1.63807865	1.92	0.1807

Note: LGLOC = Log RMS Localizer.

APPENDIX B

ANTIEMETIC ANOVAS, USING ALL SUBJECTS ON PRIMARY VARIABLES
 NUMBER OF OBSERVATIONS IN DATA SET = 314

General Linear Models Procedures SAS

Dependent Variable: LGALT1

<u>Source</u>	<u>DF</u>	<u>Sum of Squares</u>	<u>F Value</u>	<u>PR>F</u>	<u>R-Square</u>
Model	151	74.72128445	10.58	0.0001	0.907942
Error	162	7.57611883			
Corrected Total	313	82.29740329			
				<u>Root MSE</u>	
				0.21625486	

<u>Source</u>	<u>DF</u>	<u>SS</u>	<u>F Value</u>	<u>PR>F</u>
Subject (Group)	12	47.27940268	84.25	0.0001
Drug*Subject (Group)	36	3.43157252	2.04	0.0014
Flight*Subject (Group)	48	2.99412639	1.33	0.0952
Period*Flight	12	0.89994350	1.60	0.0951
Drug*Flight	12	0.77606455	1.38	0.1788

Tests of hypotheses using the MS for Flight*Subject (Group) as an error term

<u>Source</u>	<u>DF</u>	<u>SS</u>	<u>F Value</u>	<u>PR>F</u>
Flight	4	0.26947249	1.08	0.3769
Flight*Group	12	0.72843513	0.97	0.4868

Tests of hypotheses using the MS for Subject (Group) as an error term

<u>Source</u>	<u>DF</u>	<u>SS</u>	<u>F Value</u>	<u>PR>F</u>
Group	3	14.86342018	1.26	0.3327

Tests of hypotheses using the MS for Drug*Subject (Group) as an error term

<u>Source</u>	<u>DF</u>	<u>SS</u>	<u>F Value</u>	<u>PR>F</u>
Period	3	0.36965632	1.29	0.2918
Drug	3	1.17702221	4.12	0.0131

Note: LGALT1 = Log RMS Altitude while straight and level.

Dependent Variable: LGALT2

<u>Source</u>	<u>DF</u>	<u>Sum of Squares</u>	<u>F Value</u>	<u>PR>F</u>	<u>R-Square</u>
Model	151	86.22911203	10.73	0.0001	0.909066
Error	162	8.62553604			
Corrected Total	313	94.85464806			
				<u>Root MSE</u>	
				0.23074672	

<u>Source</u>	<u>DF</u>	<u>SS</u>	<u>F Value</u>	<u>PR>F</u>
Subject (Group)	12	59.97788489	93.87	0.0001
Drug*Subject (Group)	36	4.08619635	2.13	0.0007
Flight*Subject (Group)	48	3.55623274	1.39	0.0667
Period*Flight	12	0.57759618	0.90	0.5444
Drug*Flight	12	0.98128269	1.54	0.1161

Tests of hypotheses using the MS for Flight*Subject (Group) as an error term

<u>Source</u>	<u>DF</u>	<u>SS</u>	<u>F Value</u>	<u>PR>F</u>
Flight	4	0.28325443	0.96	0.4403
Flight*Group	12	0.78277099	0.88	0.5717

Tests of hypotheses using the MS for Subject (Group) as an error term

<u>Source</u>	<u>DF</u>	<u>SS</u>	<u>F Value</u>	<u>PR>F</u>
Group	3	12.79292480	0.85	0.4914

Tests of hypotheses using the MS for Drug*Subject (Group) as an error term

<u>Source</u>	<u>DF</u>	<u>SS</u>	<u>F Value</u>	<u>PR>F</u>
Period	3	0.44572445	1.31	0.2865
Drug	3	0.80051770	2.35	0.0886

Note: LGALT2 = Log RMS Altitude while turning.

Dependent Variable: LGGS

<u>Source</u>	<u>DF</u>	<u>Sum of Squares</u>	<u>F Value</u>	<u>PR>F</u>	<u>R-Square</u>
Model	151	37.40353655	3.44	0.0001	0.762070
Error	162	11.67795951		<u>Root MSE</u>	
Corrected total	313	49.08149605		0.26848868	

<u>Source</u>	<u>DF</u>	<u>SS</u>	<u>F Value</u>	<u>PR>F</u>
Subject (Group)	12	20.88101195	24.14	0.0001
Drug*Subject (Group)	36	5.05448150	1.95	0.0027
Flight*Subject (Group)	48	2.73450587	0.79	0.8279
Period*Flight	12	0.75059895	0.87	0.5810
Drug*Flight	12	1.04383647	1.21	0.2825

Tests of the hypotheses using MS for Flight*Subject (Group) as an error term

<u>Source</u>	<u>DF</u>	<u>SS</u>	<u>F Value</u>	<u>PR>F</u>
Flight	4	0.32925900	1.44	0.2338
Flight*Group	12	1.12262611	1.64	0.1114

Tests of the hypotheses using MS for Subject (Group) as an error term

<u>Source</u>	<u>DF</u>	<u>SS</u>	<u>F-Value</u>	<u>PR>F</u>
Group	3	4.29214103	0.82	0.5064

Tests of hypotheses using the MS for Drug*Subject (Group) as an error term

<u>Source</u>	<u>DF</u>	<u>SS</u>	<u>F-Value</u>	<u>PR>F</u>
Period	3	0.51368565	1.22	0.3166
Drug	3	1.09841524	2.61	0.0665

Note: LGGS = Log RMS Glide Slope

Dependent Variable: LGLOC

<u>Source</u>	<u>DF</u>	<u>Sum of Squares</u>	<u>F Value</u>	<u>PR>F</u>	<u>R-Square</u>
Model	151	45.70958486	4.94	0.0001	0.821625
Error	162	9.92358968			
Corrected Total	313	55.63317454		<u>Root MSE</u>	
				0.24750096	

<u>Source</u>	<u>DF</u>	<u>SS</u>	<u>F Value</u>	<u>PR>F</u>
Subject (Group)	12	27.05374699	36.80	0.0001
Drug*Subject (Group)	36	2.87353544	1.30	0.1365
Flight*Subject (Group)	48	4.72165033	1.61	0.0155
Period*Flight	12	0.88730531	1.21	0.2822
Drug*Flight	12	0.72212979	0.98	0.4679

Tests of hypotheses using the MS for Flight*Subject (Group) as an error term

<u>Source</u>	<u>DF</u>	<u>SS</u>	<u>F Value</u>	<u>PR>F</u>
Flight	4	0.25579708	0.65	0.6296
Flight*Group	12	0.95346132	0.81	0.6410

Tests of hypotheses using the MS for Subject (Group) as an error term

<u>Source</u>	<u>DF</u>	<u>SS</u>	<u>F Value</u>	<u>PR>F</u>
Group	3	2.86334956	0.42	0.7397

<u>Source</u>	<u>DF</u>	<u>SS</u>	<u>F Value</u>	<u>PR>F</u>
Period	3	1.88175198	7.86	0.0004
Drug	3	1.94442946	8.12	0.0003

Note: LGLOC = Log RMS Localizer

END

FILMED

1-86

DTIC