

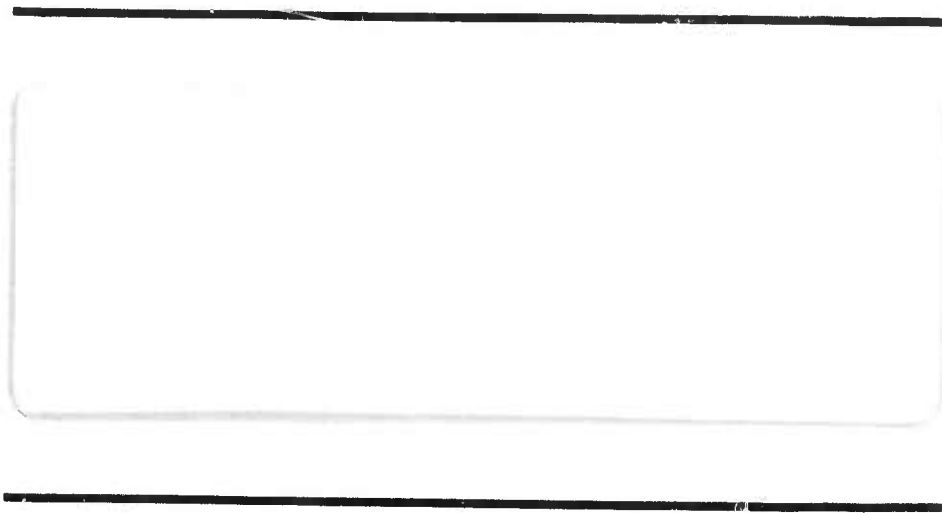

NORTH BUILDING, 2600 GARDEN ROAD, MONTEREY, CALIFORNIA 93940 • (408) 649-3880

AD A118310



Copy available to DTIC does not permit fully legible reproduction

DTIC FILE COPY

DTIC
ELECTE
AUG 17 1982
S D D

DISTRIBUTION STATEMENT A
Approved for public release
Distribution Unlimited *

82 08 16 200



NORTH BUILDING, 2600 GARDEN ROAD, MONTEREY, CALIFORNIA 93940 • (408) 649-3880

BDM/M-003-80

June 15, 1980

HIDEF IGNITER TECHNOLOGY PROGRAM
PHASE I FINAL REPORT
APPENDIX A
POLYHEDRAL BORANES IN PYROTECHNIC APPLICATIONS

Prepared by: Dr. Terrence P. Goddard
Contract MDA903-79-C-0090, Mod P00003

Accession For	
NTIS GRA&I	<input checked="" type="checkbox"/>
DTIC TAB	<input type="checkbox"/>
Unannounced	<input type="checkbox"/>
Justification	
By _____	
Distribution/	
Availability Codes	
Dist	Avail and/or Special
A	23 P



DISTRIBUTION STATEMENT A
Approved for public release;
Distribution Unlimited

DISCLAIMER NOTICE

THIS DOCUMENT IS BEST QUALITY PRACTICABLE. THE COPY FURNISHED TO DTIC CONTAINED A SIGNIFICANT NUMBER OF PAGES WHICH DO NOT REPRODUCE LEGIBLY.

REPORT DOCUMENTATION PAGE		READ INSTRUCTIONS BEFORE COMPLETING FORM
1. REPORT NUMBER BDM/M-003-80	2. GOVT ACCESSION NO. AD-A729 320	3. RECIPIENT'S CATALOG NUMBER
4. TITLE (and Subtitle) HIDEF Igniter Technology Program, Phase I Final Report - Appendix A		5. TYPE OF REPORT & PERIOD COVERED Technical - Final Report
7. AUTHOR(s) Dr. T. P. Goddard		6. PERFORMING ORG. REPORT NUMBER
9. PERFORMING ORGANIZATION NAME AND ADDRESS The BDM Corporation 2600 Garden Road, North Building Monterey, California 93940		8. CONTRACT OR GRANT NUMBER(s) MDA903-79-C-0090 Mod P00003
11. CONTROLLING OFFICE NAME AND ADDRESS DARPA, Tactical Technology Office 1400 Wilson Blvd. Arlington, Virginia 22207		10. PROGRAM ELEMENT, PROJECT, TASK AREA & WORK UNIT NUMBERS A03672
14. MONITORING AGENCY NAME & ADDRESS (if different from Controlling Office)		12. REPORT DATE June 15, 1980
		13. NUMBER OF PAGES 425
		15. SECURITY CLASS. (of this report) UNCLASSIFIED
		15a. DECLASSIFICATION/DOWNGRADING SCHEDULE
16. DISTRIBUTION STATEMENT (of this Report) Unlimited APPROVED FOR PUBLIC RELEASE DISTRIBUTION UNLIMITED		
17. DISTRIBUTION STATEMENT (of the abstract entered in Block 20, if different from Report) Unlimited		
18. SUPPLEMENTARY NOTES		
19. KEY WORDS (Continue on reverse side if necessary and identify by block number) Polyhedral boranes, HIDEF, ignition technology		
20. ABSTRACT (Continue on reverse side if necessary and identify by block number) A large body of literature exists on polyhedral boranes and the $B_{10}H_{10}^{(-2)}$ and $B_{12}H_{12}^{(-2)}$ ions in particular. The deca- and dodeca-ions are known to be of pyrotechnic utility, based on work performed in the early 1960s by DuPont and from 1975 to the present by a number of government and private laboratories. This Appendix contains the results of a concise literature search on polyhedral boranes (including synthesis, properties, and pyrotechnic OVER		

behavior) which hold definite promise of being a "HIDEF" black powder ignitor replacement. Much of the published information is patents. Section B gives a listing and abstracts of patents appropriate to HIDEF applications. Section C describes a literature survey on synthesis and properties of the basic ionic salts of $B_{10}H_{10}^{-2}$ and $B_{12}H_{12}^{-2}$. Section D lists references that describe the pyrotechnic behavior of basic salts, double salts, and mixtures that might be HIDEF candidates. Also reviewed in Section D are results from Government programs that have utilized certain $B_{10}H_{10}^{-2}$ compositions. Section E discusses availability and cost of polyhedral boranes and starting materials. Copies of the most pertinent patents are appended for convenience to the user.

TABLE OF CONTENTS

	<u>Page</u>
A. INTRODUCTION	1
B. PATENT LITERATURE	1
1. Decahydrodecaborates ($B_{10}H_{10}^{-2}$) and Related Compounds	2
2. Dodecahydrododecaborates ($B_{12}H_{12}^{-2}$) and Related Compounds	5
3. Higher Polyhedral Boranes	6
4. Substituted Decahydrodecaborates	7
5. Double Salts of Pyrotechnic Utility	8
6. Pyrotechnic and Propellant Compositions with Polyhedral Boranes	9
C. SYNTHESIS AND PROPERTIES	12
1. Methods for Synthesizing the $B_{10}H_{10}^{-2}$ Ion	12
a. Synthesis Via Decaborane	12
b. Thermolysis of Tetrahydroborates and Octahydrotriborates	13
2. Methods for $B_{12}H_{12}^{-2}$	14
a. Synthesis Via Decaborane	14
b. Synthesis Via Diborane	15
c. Synthesis Via Alkali Metal Borohydride and Dimethylsulfideborane	16
d. Use of Borax	16
3. Coupled Polyhedral Boranes	16
4. Polyhedral Borane Salts	17
a. $B_{10}H_{10}^{-2}$ and $B_{12}H_{12}^{-2}$ Ions	17
b. Synthesis of Polyhedral Borane Salts	18
c. Properties of $B_{10}H_{10}^{-2}$ and $B_{12}H_{12}^{-2}$ Salts	18
D. IGNITION AND PYROTECHNIC CHARACTERISTICS OF POLYHEDRAL BORANES	20
1. Simple Salt Monopropellants and High Energy Fuels	20
2. Double and Complex Salts	20

TABLE OF CONTENTS (Continued)

	<u>Page</u>
D. IGNITION AND PYROTECHNIC CHARACTERISTICS OF POLYHEDRAL BORANES (Continued)	
3. Pyrotechnic Compositions Incorporating Polyhedral Boranes	21
4. Government Programs Using Polyhedral Boranes	22
a. ARRADCOM	23
1) Large Caliber Soft Recoil Igniter	23
2) Telescoped Ammunition Ignition	24
3) Ballistic Research Laboratory	25
b. Air Force Armament Laboratory (AFATL)	26
c. Naval Surface Weapons Center (NSWC)	26
1) EX 164 Electric Primer	26
2) FILMBAL Propellants	29
E. AVAILABILITY	29
F. REFERENCES	31
G. PATENTS	35

A. INTRODUCTION

A large body of literature exists on polyhedral boranes and the $B_{10}H_{10}^{-2}$ and $B_{12}H_{12}^{-2}$ ions in particular.¹ The deca- and dodeca- ions are known to be of pyrotechnic utility, based on work performed in the early 1960's by DuPont and from 1975 to the present by a number of government and private laboratories.

Because the polyhedral boranes hold definite promise of being a "HIDEF" black powder ignitor replacement, this Appendix concerns itself with a concise literature search on polyhedral borane of interest, including synthesis, properties, and pyrotechnic behavior.

Much of the published information is in patents. Section B gives a listing and abstracts of patents appropriate to HIDEF applications.

Section C describes a literature survey on synthesis and properties of the basic ionic salts of $B_{10}H_{10}^{-2}$ and $B_{12}H_{12}^{-2}$. It is not intended as a comprehensive treatise, but gives an overview of the topic and guides the user to the most pertinent literature and patent references.

Section D lists references that describe the pyrotechnic behavior of basic salts, double salts, and mixtures that might be HIDEF candidates. Also reviewed in Section D are results from Government programs that have utilized certain $B_{10}H_{10}^{-2}$ compositions.

Section E discusses availability and cost of polyhedral boranes and starting materials.

Copies of the most pertinent patents are appended for convenience to the user.

B. PATENT LITERATURE

The patents listed on the following pages are applicable to polyhedral boranes and their use in ignition and pyrotechnic chemistry. Certain patents covering substituted polyhedral boranes are included, for information. If a patent is currently known to be licensed to other than the assignee, the

licensee is indicated. For convenience, the list is by chemical structure or application. The references shown have been filed and abstracted on a Tektronix 4051 data system.

1. Decahydrodecaborates ($B_{10}H_{10}^{-2}$) and Related Compounds

- a. PATENT NUMBER: 3,138,602
DATE: 23 JUNE 1964
TITLE: AMINE-DECABORANE ADDUCTS AND PREPARATION THEREOF
AUTHOR: SZYMANSKI, J.W.; TROTZ, S.I.
ASSIGNEE: OLIN MATHIESON
LICENSEE:
SUBJECT: SOLIDS PRODUCTS RESULTING FROM REACTION OF LOWER ALKYL AMINES, LOWER MONOCHLOROALKYLAMINES, MORPHOLINE, AND PIPERIDINE WITH DECABORANE AT ELEVATED TEMPERATURE. THESE ARE DESCRIBED AS ADDUCTS, BUT ACTUAL PRODUCTS MIGHT INCLUDE IONIC $B_{10}H_{10}$ PRODUCTS, AS THE COMMONLY USED SYNTHETIC ROUTE TO THE ION $B_{10}H_{10}(-2)$ PROCEEDS VIA A HEARLY IDENTICAL ROUTE. APPLICATION OF PYROTECHNIC UTILITY WHEN BLENDED WITH OXIDIZER ARE MENTIONED
- b. PATENT NUMBER: 3,148,939
DATE: 15 SEPT 1964
TITLE: AMMONIA AND HYDRAZINE SALTS OF THE $B_{10}H_{10}(-2)$ ANION
AUTHOR: KNOTH, W.H. JR
ASSIGNEE: DUPONT
LICENSEE:
SUBJECT: SIMPLE SALTS $(NH_4)_2B_{10}H_{10}$ AND $(NH_2NH_3)_2B_{10}H_{10}$; PREPARATION; PROPERTIES; USEFUL AS HIGH ENERGY FUELS.
- c. PATENT NUMBER: 3,149,163
DATE: 15 SEPT 1964
TITLE: AMINE AND ORGANO-SUBSTITUTED HYDRAZINE SALTS OF THE $B_{10}H_{10}(-2)$ ANION AND PROCESS FOR PREPARING SAME
AUTHOR: KNOTH, W.H. JR
ASSIGNEE: DUPONT
LICENSEE:
SUBJECT: COMPOUNDS OF THE GENERAL FORMULA $(RR'NH_2)_2B_{10}H_{10}$ AND $(RR'NHNH'R')_2B_{10}H_{10}$ WHERE R IS A MONOVALENT HYDROCARBON GROUP AND R' IS HYDROGEN OR OF THE SAME TYPE AS R. R IS LIMITED TO 12 CARBONS. AS WRITTEN, THE SUBSTITUTED HYDRAZINES MAY INCLUDE ONLY SYMMETRICALLY SUBSTITUTED GROUPS AND IT IS NOT CLEAR IF A COMPOUND SUCH AS THE UNSYMMETETRIC DIMETHYLHYDRAZINIUM SALT WOULD BE INCLUDED.
- d. PATENT NUMBER: 3,148,939
DATE: 15 SEPT 1964
TITLE: HYDRATES, METAL SALTS, AND HYDRATED METAL SALTS OF ACID $H_2B_{10}H_{10}$
AUTHOR: KNOTH, W.H. JR
ASSIGNEE: DUPONT
LICENSEE: TELEDYNE MCCORMICK SELPH (MOLLISTER, CA)
SUBJECT: METALLIC SALTS OF $B_{10}H_{10}$; PREPARATION; PROPERTIES

THE BDM CORPORATION

- e. PATENT NUMBER: 3,264,071
DATE: 2 AUG 1966
TITLE: BIS(AMMONIO) DECABORANE
AUTHOR:
ASSIGNEE: CALLERY CHEMICAL COMPANY
LICENSEE:
SUBJECT:
- f. PATENT NUMBER: 3,373,203
DATE: 12 MAR 1968
TITLE: PREPARATION OF DECAHYDRODECABORATES
AUTHOR: MAKHLOUF, J.M.; HOUGH, W.O.
ASSIGNEE: CALLERY CHEMICAL COMPANY (BEFORE NSA ACQUISITION)
LICENSEE:
SUBJECT: PYROLYSIS OF POTASSIUM, CESIUM, TETRAMETHYLAMMONIUM, OR
TETRAETHYLAMMONIUM OCTAHYDROTRIBORATE TO THE CORRESPONDING B10H10
SALT.
- g. PATENT NUMBER: 3,373,202
DATE: 12 MAR 1968
TITLE: METHOD OF PREPARING TETRAETHYLAMMONIUM DECAHYDRODECA-
BORATES
AUTHOR: MAKHLOUF, J.M.; HEFFERNAN, G.T.
ASSIGNEE: CALLERY CHEMICAL COMPANY (BEFORE NSA ACQUISITION)
LICENSEE:
SUBJECT: PYROLYSIS OF $(C_2H_5)_4NBH_4$ TO THE CORRESPONDING B10H10
SALT.
- h. PATENT NUMBER: 3,426,071
DATE: 4 FEB 1969
TITLE: METHOD OF PREPARING TETRAETHYLAMMONIUM DECAHYDRODECA-
BORATE(2)
AUTHOR: HEFFERNAN, G.T.
ASSIGNEE: MINE SAFETY APPLIANCES (CALLERY CHEMICAL)
LICENSEE:
SUBJECT: PYROLYSIS OF $(C_2H_5)_4NB_3H_8$ TO THE CORRESPONDING B12H12
SALT
- i. PATENT NUMBER: 3,455,661
DATE: 15 JULY 1969
TITLE: BIS(HYDRAZINE) DECABORANE(12) COMPOUNDS
AUTHOR:
ASSIGNEE: CALLERY CHEMICAL COMPANY
LICENSEE:
SUBJECT:

THE BDM CORPORATION

- j. PATENT NUMBER: 3,393,399
DATE: 14 MAY 1968
TITLE: SALTS OF BORON-HYDRIDE ANIONS AND BORON CONTAINING ORGANIC CATIONS AND METHOD OF THEIR PREPARATION
AUTHOR: STAFIEJ, S.F.; TAKACS, E.A.
ASSIGNEE: AMERICAN CYANAMID COMPANY (STAMFORD, CT)
LICENSEE:
SUBJECT: SALTS OF THE GENERAL FORMULA $[BH_2Z_1Z_2]_m$, WHERE H IS A BORON HYDRIDE ION SUCH AS $B_1OH_10(-2)$ OR $B_12H_12(-2)$ AND THE Z'S ARE TERTIARY AMINES OR TERTIARY PHOSPHINES OF SELECTED CLASSES. AN EXAMPLE IS $C((CH_3)_3N)Z_1Z_2B_1OH_10$. A STATED USAGE IS HIGH ENERGY SOLID ROCKET PROPELLANT INGREDIENTS.
- k. PATENT NUMBER: 4,002,601
DATE: 11 JAN 1977
TITLE: BIS-GUANIDINIUM DECAHYDRODECABORATE AND A PROCESS FOR ITS PREPARATION
AUTHOR: GODDARD, T.P.
ASSIGNEE: TELEDYNE MCCORMICK SELPH
LICENSEE:
SUBJECT: SALT $C((NH_2)_3)_2B_1OH_10$. HIGH NITROGEN CONTENT HIGH ENERGY FUEL
- l. PATENT NUMBER: 4,164,513
DATE: 14 AUG 1979
TITLE: AMINO-SUBSTITUTED GUANIDINE SALTS OF DECAHYDRODECABORIC ACID
AUTHOR: GODDARD, T.P.
ASSIGNEE: TELEDYNE MCCORMICK SELPH
LICENSEE:
SUBJECT: AMINOGUANIDINE AND DIAMINOGUANIDINE SALTS OF THE B_1OH_10 ANION. $(CNHNH_2(NH_2)_2)_2B_1OH_10$ AND $(C(NHNH_2)_2NH_2)_2B_1OH_10$. THE FORMER IS A MILD REACTING MONOPROPELLANT AND THE LATTER IS A VERY SENSITIVE INITIATING EXPLOSIVE.
- m. PATENT NUMBER: 4,130,585
DATE: 19 DEC 1978
TITLE: BIS-TRIAMINOGUANIDINE DECAHYDRODECABORATE, PROCESS FOR PREPARATION, AND HIGH ENERGY PROPELLANT
AUTHOR: GODDARD, T.P.
ASSIGNEE: TELEDYNE MCCORMICK SELPH
LICENSEE:
SUBJECT: COVERS THE TAG SALT OF B_1OH_10 . $(C(NHNH_2)_3)_2B_1OH_10$. A STABLE, NONMETALLIC SALT OF DECAHYDRODECABORIC ACID THAT HAS A VERY HIGH NITROGEN CONTENT AND IS A POWERFUL MONOPROPELLANT. HEAT OF EXPLOSION IS OVER 1350 CALORIES/GRAM. THIS IS A BORON-NITROGEN MONOPROPELLANT.

2. Dodecahydrododecaborates ($B_{12}H_{12}^{-2}$) and Related Compounds

- a. PATENT NUMBER: 3,169,044
DATE: 9 FEB 1965
TITLE: DIHYDROGEN DODECAHYDRODODECABORATE AND METHOD FOR PRODUCING SAME
AUTHOR:
ASSIGNEE: DUPONT
LICENSEE: MINE SAFETY APPLIANCES (CALLERY CHEMICAL CO.)
SUBJECT:
- b. PATENT NUMBER: 3,169,045
DATE: 9 FEB 1965
TITLE: DODECAHYDRODODECABORATE COMPOUNDS
AUTHOR:
ASSIGNEE: DUPONT
LICENSEE: MINE SAFETY APPLIANCES (CALLERY CHEMICAL COMPANY)
SUBJECT:
- c. PATENT NUMBER: 3,355,261
DATE: 28 NOV 1967
TITLE: CHEMICAL PROCESS
AUTHOR: MILLER, H.C.; MUETTERTIES, E.L.
ASSIGNEE: DUPONT
LICENSEE:
SUBJECT: METHOD FOR PRODUCTION OF $B_{12}H_{12}^{-2}$ BY PYROLYSIS OF DIBORANE AND ALKALI SALTS OF TETRAHYDROBORATE. METAL SALTS OF $B_{12}H_{12}^{-2}$ ARE PRODUCED DIRECTLY.
- d. PATENT NUMBER: 3,961,017
DATE: 1 JUNE 1976
TITLE: PRODUCTION OF DODECAHYDRODODECABORATE (-2)
AUTHOR: HOUGH, W.V.; GUIBERT, C.R.; HEFFERAN, G.T.
ASSIGNEE: MINE SAFETY APPLIANCES (CALLERY CHEMICAL)
LICENSEE:
SUBJECT: PREPARATION OF THE $B_{12}H_{12}^{-2}$ ION VIA REACTION OF ALKALI METAL BOROHYDRIDE WITH DIMETHYLSULFIDEBORANE AT 100 TO 150 DEG. CENTIGRADE. YIELD IS ABOUT 98%.
- e. PATENT NUMBER: 3,509,152
DATE: 28 APR 1970
TITLE: BIS-POLYQUATERNARY AMMONIUM DODECAHYDRODODECABORATES AND OCTAHYDROTRIBORATES
AUTHOR: ERLICH, R.; SHAPIRO, P.
ASSIGNEE: THIOKOL CHEMICAL CORP. (BRISTOL, PA)
LICENSEE:
SUBJECT: POLYQUATERNARY AMMONIUM SALTS OF $B_{12}H_{12}^{-2}$ AND RELATED COMPOUNDS.

3. Higher Polyhedral Boranes

- a. PATENT NUMBER: 3,431,089
DATE: 4 MAR 1969
TITLE: REACTION PRODUCTS AND PROCESSES
AUTHOR: ENGELHARDT, U.A.
ASSIGNEE: DUPONT
LICENSEE:
SUBJECT: AMMONIUM, SUBSTITUTED AMMONIUM, HYDRAZINE, AND SUBSTITUTED HYDRAZINE SALTS OF THE $B_{20}H_{18}(-2)$ ANION. STATED AS BEING USEFUL AS COMPONENTS OF HIGH ENERGY FUELS.
- b. PATENT NUMBER: 3,365,275
DATE: 23 JAN 1969
TITLE: POLYHYDROPOLYBORATES AND PROCESSES FOR PREPARING THEM
AUTHOR: MUETTERTIES, E.L.
ASSIGNEE: DUPONT
LICENSEE:
SUBJECT: ACID, METAL, METAL-AMINE, R_4N^+ , AR_3N^+ , R_3S^+ , AND R_4P^+ SALTS OF THE $B_{20}H_{18}(-2)$ ION.
- c. PATENT NUMBER: 3,446,684
DATE: 27 MAY 1969
TITLE: ACID AND SALTS OF $B_{20}H_{18}(-2)$ ION
AUTHOR: MUETTERTIES, E.L.
ASSIGNEE: DUPONT
LICENSEE:
SUBJECT: ACID AND SALTS OF THE $B_{20}H_{18}(-4)$ ION. TITLE IN ERROR?

4. Substituted Decahydrodecaborates

- a. PATENT NUMBER: 3,265,737
DATE: 9 AUG 1966
TITLE: BORON AMINES AND PROCESS FOR FORMATION THEREOF
AUTHOR: MILLER, N.E.
ASSIGNEE: DUPONT
LICENSEE:
SUBJECT: SUBSTITUTED $B_{12}H_{12}$ ANIONS OF THE GENERAL FORMULA $(B_{12}H_{11}NR'R'')$ WHERE R AND R' ARE ALIPHATICALLY SATURATED HYDROCARBONS AND R'' IS AN ALIPHATICALLY SATURATED HYDROCARBON THAT CAN CONTAIN AT MOST ONE DILOWERALKYLAMINO GROUP BONDED TO CARBON AT LEAST ONCE REMOVED FROM THE CARBON BONDED TO NITROGEN. RELATED COMPOUNDS CONTAINING HALOGENS ARE INCLUDED.
- b. PATENT NUMBER: 3,328,422
DATE: 27 JUNE 1967
TITLE: DERIVATIVES OF POLYHEDRAL DODECABORANES
AUTHOR:
ASSIGNEE: DUPONT
LICENSEE: MINE SAFETY APPLIANCES (CALLERY CHEMICAL COMPANY)
SUBJECT:
- c. PATENT NUMBER: 3,296,260
DATE: 3 JAN 1967
TITLE: NEUTRAL AND SINGLY CHARGED DERIVATIVES OF DECABORANES AND DECABORATES
AUTHOR:
ASSIGNEE: DUPONT
LICENSEE: MINE SAFETY APPLIANCES (CALLERY CHEMICAL COMPANY)
SUBJECT:
- d. PATENT NUMBER: 3,372,006
DATE: 5 MAR 1968
TITLE: HALOGEN DERIVATIVES OF POLYHEDRAL BORON COMPOUNDS
AUTHOR: CHAMBERLAND, B.L.; HUETTERTIES, E.L.
ASSIGNEE: DUPONT
LICENSEE:
SUBJECT: HALOGEN SUBSTITUTED $B_{20}H_{18}(-2)$ ION AND METAL AND NON-METAL SALTS THEREOF.
- e. PATENT NUMBER: 3,551,120
DATE: 29 DEC 1970
TITLE: SUBSTITUTED DODECABORATES
AUTHOR:
ASSIGNEE: DUPONT
LICENSEE: MINE SAFETY APPLIANCES (CALLERY CHEMICAL COMPANY)
SUBJECT:

5. Double Salts of Pyrotechnic Utility

- a. PATENT NUMBER: 3,187,613
DATE: 22 OCT 1963
TITLE: BORON COMPOUND
AUTHOR: ARMSTRONG, R.K.; ENGLAND, D.C.; PARSHALL, G.W.; THATCHER, D.H.
ASSIGNEE: DUPONT
LICENSEE: TELEDYNE MCCORMICK SELPH (HOLLISTER, CA)
SUBJECT: DOUBLE SALT $\text{CSNO}_3 \cdot \text{CS}_2\text{B}_1\text{O}_{10}\text{H}_{10}$ PREPARATION; PERFORMANCE IN SQUIBS AND DETONATORS; SENSITIVITY.
- b. PATENT NUMBER: 3,184,286
DATE: 18 MAY 1965
TITLE: $\text{CS}_2\text{B}_1\text{Z}_{12}\text{H}_{12} \cdot \text{CSNO}_3$ PRODUCT AND PROCESS FOR MAKING SAME
AUTHOR: ENGLAND, D.C.
ASSIGNEE: DUPONT
LICENSEE: TELEDYNE MCCORMICK SELPH (HOLLISTER, CA)
SUBJECT: DOUBLE SALT $\text{CS}_2\text{B}_1\text{Z}_{12}\text{H}_{12} \cdot \text{CSNO}_3$; PROCESS FOR MANUFACTURE; PERFORMANCE IN SQUIBS AND DETONATORS; SENSITIVITY
- c. PATENT NUMBER: 3,256,856
DATE: 14 JUNE 1966
TITLE: $(\text{CS}_2\text{B}_1\text{O}_{10}\text{H}_{10})_2 \cdot \text{CS}_2\text{CR}_{207}$ PRODUCT AND PROCESS FOR PREPARING SAME
AUTHOR: ARMSTRONG, R.K.
ASSIGNEE: DUPONT
LICENSEE:
SUBJECT: DOUBLE SALT $(\text{CS}_2\text{B}_1\text{O}_{10}\text{H}_{10})_2 \cdot \text{CS}_2\text{CR}_{207}$; PREPARATION; PERFORMANCE IN ELECTRIC INITIATORS AND DELAY LINES; SENSITIVITY; THIS IS A SLOW BURNING, ALMOST COMPLETELY GASLESS DELAY COMPOSITION
- d. PATENT NUMBER: 3,411,990
DATE: 13 NOV 1968
TITLE: CHEMICAL PRODUCTS AND PROCESSES
AUTHOR: BALTHIS, J.H.
ASSIGNEE: DUPONT
LICENSEE:
SUBJECT: DOUBLE SALTS OF COBALT(III) AND CHROMIUM(III) AMINES AND $\text{B}_1\text{O}_{10}\text{H}_{10}(-2)$ AND $\text{B}_1\text{Z}_{12}\text{H}_{12}(-2)$ ANIONS WITH A SECOND OXIDIZING ANION (SUCH AS NITRATE); THESE ARE USEFUL AS INITIATING EXPLOSIVES. AN EXAMPLE IS $[\text{CO}(\text{NH}_3)_6][\text{B}_1\text{Z}_{12}\text{H}_{12}(\text{NO}_3)_2 \cdot 2\text{H}_2\text{O}]$

6. Pyrotechnic and Propellant Compositions with Polyhedral Boranes

- a. PATENT NUMBER: 7,126,305
DATE: 24 MARCH 1964
TITLE: IGNITION COMPOSITIONS COMPRISING BORON CONTAINING SALTS
AUTHOR: ARMSTRONG, R.F.
ASSIGNEE: DUPONT
LICENSEE: TELEDYNE MCCORMICK SELPH (HOLLISTER, CA)
SUBJECT: PHYSICAL BLENDS OF METAL SALTS OF $B_{10}H_{10}$ AND $B_{12}H_{12}$ WITH COMMON OXIDIZERS. METAL SALTS INCLUDE ALKALI, ALKALINE EARTH, AND HEAVY (TRANSITION) METALS. OXIDIZERS INCLUDE PERCHLORATES, NITRATES, CHROMATES, PEROXIDES, ETC. PERFORMANCE IN SQUIBS AND PYROTECHNIC CORDS; SENSITIVITY; THERMAL STABILITY.
- b. PATENT NUMBER: 4,135,956
DATE: 23 JAN 1979
TITLE: COPRECIPITATED PYROTECHNIC COMPOSITION PROCESSES AND RESULTANT PRODUCTS
AUTHOR: GODDARD, T.P.; THATCHER, D.H.
ASSIGNEE: TELEDYNE MCCORMICK SELPH
LICENSEE:
SUBJECT: COCRYSTALLIZED SALTS OF DECAHYDRODECABORIC ACID AND SELECTED OXIDIZING AGENTS. THE COPRECIPITATED PRODUCTS ARE CHEMICALLY AND PHYSICALLY DISTINCT FROM PHYSICAL BLENDS OF THE SAME INGREDIENTS. MANY OF THE PRODUCTS EXHIBIT VERY HIGH BURNING RATES UNDER MILD CONFINEMENT OR HEAT. SOME DO NOT EXHIBIT DDT, EVEN UNDER EXTREME CONFINEMENT AND STIMULUS.
- c. PATENT NUMBER: 4,138,282
DATE: 5 FEB 1979
TITLE: HIGH BURNING RATE PROPELLANTS WITH COPRECIPITATED SALTS OF DECAHYDRODECABORIC ACID
AUTHOR: GODDARD, T.P.; THATCHER, D.H.
ASSIGNEE: TELEDYNE MCCORMICK SELPH
LICENSEE:
SUBJECT: VERY HIGH BURN RATE PROPELLANTS, UP TO 20 INCHES PER SECOND, FROM BLENDS OF BINDER, PLASTICIZER, ADDITIVES, AND A MAJOR FRACTION OF COPRECIPITATED $B_{10}H_{10}$ /OXIDIZER SOLIDS.
- d. PATENT NUMBER: 4,172,743
DATE: 30 OCT 1979
TITLE: COMPOSITIONS OF BIS-TRIAMINO GUANIDINE DECAHYDRODECABORATE AND TAGH
AUTHOR: GODDARD, T.P.
ASSIGNEE: TELEDYNE MCCORMICK SELPH
LICENSEE:
SUBJECT: COPRECIPITATED OR PHYSICALLY BLENDED COMPOSITIONS FROM VARIOUS PROPORTIONS OF THE TRIAMINO GUANIDINE SALT OF THE $B_{10}H_{10}$ ION WITH TRIAMINO GUANIDINE NITRATE. THESE ARE VERY HIGH IMPULSE IGNITION OR PROPELLANT INGREDIENTS.

THE BDM CORPORATION

- e. PATENT NUMBER: 4,108,697
DATE: 22 AUG 1978
TITLE: NOVEL TRIAMINOGUANIDINE NITRATE PROPELLANTS
AUTHOR: GODDARD, T.P.
ASSIGNEE: TELEDYNE MCCORMICK SELPH
LICENSEE:
SUBJECT: PYROTECHNIC COMPOSITIONS BASED ON COPRECIPITATED TRI-AMINOGUANIDINE DECAHYDRODECABORATE AND TRIAMINOGUANIDINE NITRATE, AND PROPELLANTS MADE FROM THEM. BURNING RATES OF APPROXIMATELY 500 INCHES PER SECOND AT 2000 PSI ARE OBSERVED FOR A NITROCELLULOSE BINDER PROPELLANT INCORPORATING THE COPRECIPITATE AS THE MAJOR SOLIDS FRACTION.
- f. PATENT NUMBER: 4,139,484
DATE: 13 FEB 1979
TITLE: ACTIVE BINDER PROPELLANTS INCORPORATING BURNING RATE CATALYSTS
AUTHOR: GODDARD, T.P.; THATCHER, D.H.
ASSIGNEE: TELEDYNE MCCORMICK SELPH
LICENSEE:
SUBJECT: MODIFICATION OF NITROCELLULOSE BASED PROPELLANTS BY ADDITION OF SIMPLE AND DOUBLE SALTS OF B10H10 AND COPRECIPITATED SALTS OF B10H10 WITH OXIDIZER. BURNING RATE ENHANCEMENTS OF UP TO 80% ARE ACHIEVED.
- g. PATENT NUMBER: 4,080,902
DATE: 28 MARCH 1978
TITLE: HIGH SPEED IGNITOR DEVICE
AUTHOR: GODDARD, T.P.; WEBB, S.D.; THATCHER, D.H.
ASSIGNEE: TELEDYNE MCCORMICK SELPH
LICENSEE:
SUBJECT: LINEAR IGNITION CORD CONSISTING OF A CENTRAL CORE OF METAL CLAD MILD DETONATION CORD SURROUNDED BY LAYER(S) OF METAL CLAD IGNITION COMPOSITION CONTAINING SALTS OF B10H10. THE DEVICE PRODUCES A LINEAR PROPAGATION RATE TYPICAL OF A DETONATION VELOCITY, BUT A RADIAL IGNITION IMPULSE THAT IS VERY FAST, BUT NON-DETONATING.
- h. PATENT NUMBER: 4,089,716
DATE: 16 MAY 1978
TITLE: IGNITION ENHANCING PROPELLANT COATINGS
AUTHOR: GODDARD, T.P.; THATCHER, D.H.; GARRISON, C.G.
ASSIGNEE: TELEDYNE MCCORMICK SELPH
LICENSEE:
SUBJECT: MEDIUM CALIBER PROPELLANT GRAINS COATED WITH SIMPLE SALTS OF B10H10 OR COPRECIPITATES OF B10H10 SALTS WITH OXIDIZERS. A LAYER OF VERY FAST BURNING AND IGNITABLE MATERIAL IS DEPOSITED ON THE GRAIN EXTERNAL SURFACE, WHICH FACILITATES IGNITION OF THE SURFACE. USEFUL FOR HEAVILY DETONATED PROPELLANTS.

THE BDM CORPORATION

- i. PATENT NUMBER: 4,094,712
DATE: 13 JUNE 1978
TITLE: CONSOLIDATED CHARGES INCORPORATING INTEGRAL IGNITION
COMPOUNDS
AUTHOR: GODDARD, T.P.; THATCHER, D.N.; GARRISON, C.G.
ASSIGNEE: TELEDYNE MCCORMICK SELPH
LICENSEE:
SUBJECT: PREPARATION OF MEDIUM CALIBER CHARGES OF CONSOLIDATED
GRAINS OF PROPELLANT, WHEREIN AN IGNITION COMPOUND, SPECIFICALLY SIMPLE
SALTS OF $B_{10}H_{10}$ AND COPRECIPITATED OF SALTS OF $B_{10}H_{10}$ AND OXIDIZER, IS
INCORPORATED INTO THE CHARGE BETWEEN AND AROUND THE INDIVIDUAL GRAINS.
THE INTEGRAL IGNITION COMPOUND FACILITATES BREAKUP OF THE CHARGE AND
IGNITION OF THE INDIVIDUAL GRAINS.

C. SYNTHESIS AND PROPERTIES

The principal anions of interest for pyrotechnic applications are $B_{10}H_{10}^{-2}$, and $B_{12}H_{12}^{-2}$ and possibly higher boranes. A concise review of synthetic routes and properties explored in the 1950's and 1960's is given in Scholer and Todd^{1c} and updated in Muetterties^{1a}. While some of the sythetic methods appear to be fairly straightforward and give good yields, often starting materials (like B_2H_6) are dangerous to handle or conditions are exotic.

1. Methods for Synthesizing the $B_{10}H_{10}^{-2}$ Iona. Synthesis Via Decaborane

The most convenient laboratory syntheses of $B_{10}H_{10}^{-2}$ involves preparation of $B_{10}H_{12}(\text{ligand})_2$ from decaborane followed by reaction with ammonia or triethylamine to yield the $B_{10}H_{10}^{-2}$ salt. The mechanism has been postulated as follows.²

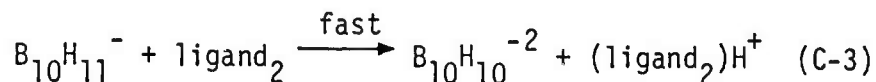
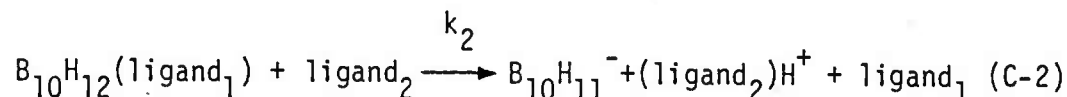
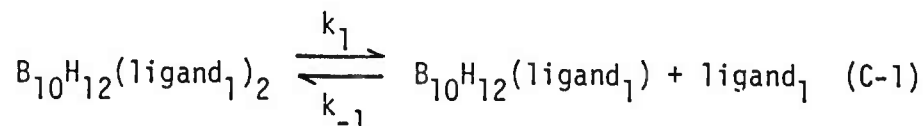

Synthesis using $(C_2H_5)_3N$ as ligand are given in Volume 9 of Inorganic Synthesis.³ (U.S. patent 3,138,602)

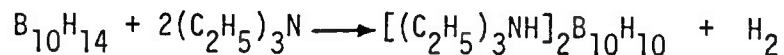

Decaborane and triethylamine are refluxed in xylene under nitrogen for

several hours. The solution is cooled and the product filtered (93%). Recrystallization is from hot water/ethanol.

Despite the toxicity of decaborane, this method appears to be uncomplicated. The product is very soluble in water and acetonitrile. Treatment with alkali metal hydroxides gives the alkali metal salts, which are very stable.

The ammonium salt, which is more soluble in water than the triethylammonium salt is prepared by a sequence of reactions using dimethylsulfide as ligand.⁴ (U.S. patents 3,148,938; 3,148,939; 3,149,163)



Decaborane is dissolved in dimethylsulfide and allowed to stand at room temperature for four days. Crystals of $\text{B}_{10}\text{H}_{12} \cdot 2\text{S}(\text{CH}_3)_2$ are collected, dried and then dissolved in liquid ammonia which is then allowed to evaporate leaving $(\text{NH}_4)_2\text{B}_{10}\text{H}_{10}$ which is dried and recrystallized from cold water (83%). If a satisfactory hood system is available this method is also not complicated and is, in fact, the method described in many industrial patents.

b. Thermolysis of Tetrahydroborates and Octahydrotriborates

High yield synthesis of $\text{B}_{10}\text{H}_{10}^{-2}$ has been reported from thermolysis of $(\text{C}_2\text{H}_5)_4\text{NBH}_4$ or $(\text{C}_2\text{H}_5)_4\text{NB}_3\text{H}_8$ in a steel cylinder at 185° for 16 hours.⁵ (U.S. patents 3,373,202; 3,373,203; and 3,426,071)

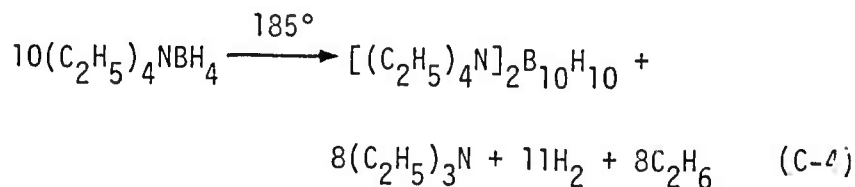

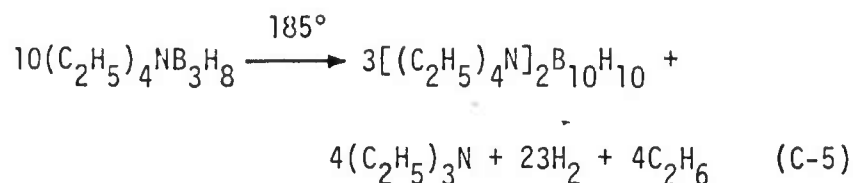

Solids from (C-4) and (C-5) were dissolved in acetonitrile, filtered and crystallized (94% yield). Depending on availability of starting material this method is a simple route to $[(\text{C}_2\text{H}_5)_4\text{N}]_2\text{B}_{10}\text{H}_{10}$. Related salts of potassium and cesium give different products.

High yield syntheses of $[(\text{C}_2\text{H}_5)_4\text{N}]_2\text{B}_{10}\text{H}_{10}$ were reported from the tetramethylammonium salts by pyrolysis at slightly higher temperatures (185 - 220°, 15 - 25 hours) in the French patent literature (FR 2,314,921). Product dependence on pressure changes were reported.

2. Methods for $\text{B}_{12}\text{H}_{12}^{-2}$

a. Synthesis Via Decaborane

As with $\text{B}_{10}\text{H}_{10}^{-2}$, a convenient laboratory synthesis of $\text{B}_{12}\text{H}_{12}^{-2}$ involves preparation from decaborane, viz.⁶

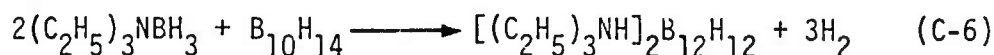

This synthesis involves triethylamineborane which may be purchased or prepared in situ from triethylamine and diborane and then purified by distillation at 87° (12mm). Reagents are then heated to 190° in ultrasene (a purified kerosene) under nitrogen. Purification involves cooling and filtering the solid product (92%) which may be recrystallized from hot water. The cesium salt is prepared by passing an ethanol solution of the triethylammonium salt through a strong acid ion exchange resin and then neutralizing the product with CsOH. Boiling the product in aqueous NaOH (or KOH) expels free triethylamine and yields $\text{Na}_2\text{B}_{12}\text{H}_{12}$.

A similar synthesis uses decaborane and borohydride ion in diglyme.⁷



The reagents are refluxed under nitrogen until hydrogen evolution ceases. The solution is cooled and solid $\text{Na}_2\text{B}_{12}\text{H}_{12}$ diglyme is filtered and dried. The product is recrystallized from water several times for a diglyme-free salt (60%). Addition of $(\text{C}_2\text{H}_5)_3\text{NHCl}$ and cooling causes precipitation of $[(\text{C}_2\text{H}_5)_3\text{NH}]_2\text{B}_{12}\text{H}_{12}$. It may be worthwhile to attempt synthesis of other salts directly from the initial diglyme adduct to avoid repeated recrystallization to remove diglyme.

b. Synthesis Via Diborane

Various synthesis of $\text{B}_{12}\text{H}_{12}^{-2}$ directly from diborane are reported in the literature:

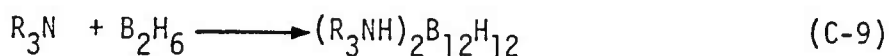
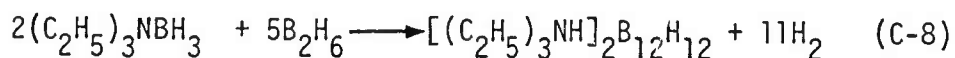
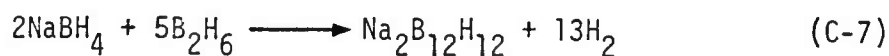

Synthesis (C-7) uses a high pressure vessel at 180° for about 10 hours. Purification involves several steps to give 75-85% yield.⁸

Synthesis (C-8) involves charging a pressure vessel with triethylamine and diborane and heating at 180° for 2 hours. Purification involves several steps and yields 83%.⁸ (U.S. patent 3,355,261)

Synthesis (C-9) (U.S. patent 3,265,737) describes a method for producing amine salts directly from diborane and amine in a sealed tube.

A similar reaction involves in situ preparation of NaB_3H_8 from NaBH_4 and B_2H_6 and refluxing in diglyme; addition of $(\text{CH}_3)_3\text{NHCl}$ caused formation of $[(\text{CH}_3)_3\text{NH}]_2\text{B}_{12}\text{H}_{12}$ in 65% yield. The product is contaminated by the $\text{B}_{10}\text{H}_{10}^{-2}$ salt however.⁹

c. Synthesis Via Alkali Metal Borohydride and Dimethylsulfideborane

This reaction is patented by Mine Safety Appliance (Callery Chemical) (U.S. patent 3,961,017):

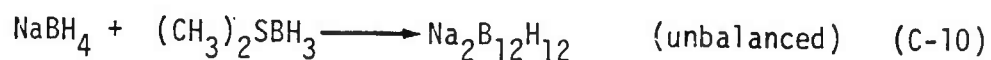

This reaction is carried out at 105-140° in diglyme solvent in a steel reactor with reflux condensor. The mixture is then cooled and hexane is added to precipitate $\text{Na}_2\text{B}_{12}\text{H}_{12}$, which has some diglyme contamination.

d. Use of Borax

A novel and large scale preparation has been described using dehydrated borax.¹⁰

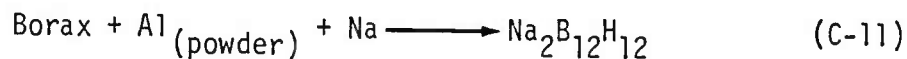

Directions call for 402g Borax, 200g aluminum powder and 100g sodium reacting for 2 hours at 620° under 3 atmospheres hydrogen.

Sparingly soluble salts $\text{Cs}_2\text{B}_{12}\text{H}_{12}$ and $[(1,10\text{-phenanthroline})_3\text{Ni}]\text{B}_{12}\text{H}_{12}$ were prepared by precipitation from aqueous solution. Passage of a basic solution of $\text{B}_{12}\text{H}_{12}^{-2}$ (KOH or NaOH) through a cation exchange resin yielded a strong acid $(\text{H}_3\text{O})_2\text{B}_{12}\text{H}_{12}$ from which the salt $\text{Ag}_2\text{B}_{12}\text{H}_{12}$ precipitated with AgNO_3 .

3. Coupled Polyhedral Boranes

A large chemistry of oxidatively coupled $\text{B}_{10}\text{H}_{10}$ polyhedral are known.¹¹ Certain salts of the $\text{B}_{20}\text{H}_{18}^{-2}$ and $\text{B}_{20}\text{H}_{18}^{-4}$ ions may be of pyrotechnic utility (U.S. patents 3,431,089; 3,365,275; 3,446,604).

4. Polyhedral Borane Saltsa. $B_{10}H_{10}^{-2}$ and $B_{12}H_{12}^{-2}$ ions

The polyhedral boranes $B_nH_n^{-2}$ are analogous to planar aromatic systems in organic chemistry. The B_{10} and B_{12} "cage" structures are unusually stable, the B_{12} being somewhat more stable towards substitution reactions than the B_{10} .

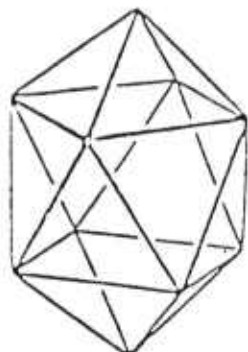
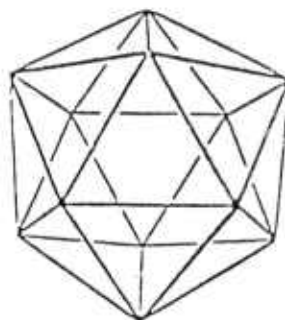
 $B_{10}H_{10}^{-2}$  $B_{12}H_{12}^{-2}$

The structure of the $B_{10}H_{10}^{-2}$ ion is a symmetrically bicapped square antiprism and is one of the few known chemical species with D_{4d} symmetry. The structure has been confirmed by IR and Raman spectroscopy^{4,12}, ^{11}B nmr,¹³ and x-ray crystallography of the Cu salt.^{14,15} Ab initio self consistent field (SCF) wave function calculation of $B_{10}H_{10}^{-2}$ properties have been performed.¹⁶ A considerable derivative chemistry is known for the $B_{10}H_{10}^{-2}$ ion;^{1a} the apical hydrogen sites (1,10) are in general more reactive than equatorial sites. The ion is believed to be kinetically rather than thermodynamically stabilized.¹⁷ The ion demonstrates an unusually fast decomposition upon oxidation, which may proceed through the labile apical hydrogen atoms.

The $B_{12}H_{12}^{-2}$ ion is an icosahedron (I_h symmetry), in accordance with infrared and Raman spectra.¹² It is believed to be slower reacting toward oxidation than the B_{10} ion (see section C.5.a.).

There is a great deal of similarity in the chemical properties of the $B_{10}H_{10}^{2-}$ and $B_{12}H_{12}^{2-}$ ions. Both anions have unusually good kinetic stability in the presence of acids and bases. They are oxidatively and hydrolytically stable, and their alkali-metal salts are stable under vacuum to 600 to 800°C, respectively.^{1c}

A substantial derivative chemistry from substitution on the cage is known.^{1a}

d. Synthesis of Polyhedral Borane Salts

Synthesis of various salts of $B_{10}H_{10}^{2-}$ and $B_{12}H_{12}^{2-}$ generally involves metathesis starting with the acid, sodium salt, ammonium or triethylammonium salt, or by reaction of amines with $B_{10}H_{12}[S(CH_3)_2]$. Direct metathesis via base displacement, followed by precipitation or evaporation, is possible for cations of strong bases. Many salts can be prepared by stoichiometrically neutralizing the aqueous acid $H_2B_{10}H_{10}$ or $H_2B_{12}H_{12}$ with (1) a soluble hydroxide of the desired cation, such as ammonium hydroxide, (2) the conjugate Brønsted base of the desired cation, such as a free amine, or (3) a soluble salt of the desired cation, such that the salt anion is destroyed during the reaction, such as guanidine carbonate. The aqueous solutions of the salts may be evaporated to dryness to recover the crystalline salt. Alternatively, some salts may be precipitated from the aqueous solution by a nonsolvent that is miscible with water. The salts may be purified by recrystallization. (U.S. patent 4,135,956)

Many synthetic routes to various salts are viewed in the literature^{1,4} and in virtually all the applicable patents.

c. Properties of $B_{10}H_{10}^{2-}$ and $B_{12}H_{12}^{2-}$ Salts

Muetterties⁴ reports salts of alkali metals, transition metals and complex ions of water or ammonia (i.e. $[Ni(H_2O)_6]B_{10}H_{10}$), Cs, Tl, tetra-n-alkylammonium, trimethylsulfonium and quaternary phosphonium. Cesium tends to precipitate double salts $Cs_2B_{12}H_{12} \cdot CsX$, $X = Cl, CN, BH_4$, if sufficient X is available. Preparation of

(pyridinium) $_2$ B $_{10}$ H $_{10}$, (quinolinium) $_2$ B $_{10}$ H $_{10}$, (2,2'-bipyridinium) $_2$ B $_{10}$ H $_{10}$ give deep yellow crystals. Many simple salts of metals and nonmetals as well as the acids are described in early DuPont patents [U.S. patents 3,148,938 (ammonia and hydrazine salts of B $_{10}$ H $_{10}^{-2}$); 3,148,939 (metal salts of B $_{10}$ H $_{10}^{-2}$); 3,149,163 (amine and organo-substituted salts of B $_{10}$ H $_{10}^{-2}$); 3,169,044 (acid H $_2$ B $_{12}$ H $_{12}$); 3,169,045 (metal and nonmetal salts of B $_{12}$ H $_{12}^{-2}$)]. More recently, salts of B $_{10}$ H $_{10}^{-2}$ and B $_{12}$ H $_{12}^{-2}$ with boron-containing cations are described by Stafiej (U.S. patent 3,383,399); salts of guanidine and substituted guanidine with B $_{10}$ H $_{10}^{-2}$ by Goddard (U.S. patents 4,002,681; 4,164,513; 4,130,585); and polyquaternary ammonium salts of B $_{12}$ H $_{12}^{-2}$ by Ehrlich (U.S. patent 3,509,152).

The salts of B $_{10}$ H $_{10}^{-2}$ and B $_{12}$ H $_{12}^{-2}$ are more water-insoluble if the cation is large, although salts of B $_{10}$ H $_{10}^{-2}$ are more water soluble than analogous salts of B $_{12}$ H $_{12}^{-2}$. Salts of aquo-metal cations are more soluble than similar salts of amine-metal cations. B $_{10}$ H $_{10}^{-2}$ salts of smaller organic cations such as NH $_4^+$ are soluble in the lower aliphatic alcohols (see U.S. patent 4,135,956). Salts of Ag $^+$, Cu $^+$, Hg $^{+2}$ form water-soluble salts with no B-H reduction.

The boron cage structures are readily identified by IR spectra in Nujol, Fluorolube, and KBr pellet by the B-H stretching frequencies near 2470 cm $^{-1}$ and cage deformation frequencies near 1015cm $^{-1}$ for B $_{10}$ H $_{10}^{-2}$ and 1070cm $^{-1}$ for B $_{12}$ H $_{12}^{-2}$. The salts are conveniently analyzed by boron assay by oxidizing the cage ion to boric acid with a platinum catalyst in hot acidic solution and titrating against the boric acid.^{1b}

Unhydrated alkali salts are thermally stable to at least 600°C. Most organic salts are characterized by a well defined melting point (or autoignition, for the monopropellants). One exception is the ammonium salt of B $_{10}$ H $_{10}^{-2}$, which exhibits a crystallization-technique dependent melting point (239°C for acetone washed crystals, ~300°C for water or ethanol recrystallized material).¹⁸ The hydrazine salt appears in 2 forms, (N $_2$ H $_5$) $_2$ B $_{10}$ H $_{10}$ and (N $_2$ H $_5$) $_2$ B $_{10}$ H $_{10}$ ·2N $_2$ H $_4$.¹⁸

The toxicity of the salts appears to be low^{19,20}; that of the sodium salts of both $B_{10}H_{10}^{-2}$ and $B_{12}H_{12}^{-2}$ is comparable to sodium chloride.⁴ This is in contrast to the high toxicity of decaborane and its usual derivatives.²¹

D. IGNITION AND PYROTECHNIC CHARACTERISTICS OF POLYHEDRAL BORANES

1. Simple Salt Monopropellants and High Energy Fuels

Kaczmarczyk et al¹⁷ report the aqueous heat of formation of the $B_{10}H_{10}^{-2}$ ion as +22+5 kcal/mole and of the $B_{12}H_{12}^{-2}$ ion, +11+10 kcal/mole. This indicates that, depending on the heat of formation of the salt cation and the energy bound in the crystal lattice, certain of these polyhedral borane salts may contain substantial free energy, i.e., exhibit exothermic composition per se.

Goddard reports such B-N monopropellant behavior for the mono, di-, and triamino substituted guanidine salts of $B_{10}H_{10}^{-2}$, which exhibit heat of explosions (under argon) of 1228, 1556, and 1367 cal/gram respectively (U.S. patents 4,164,513 and 4,130,585). The calculated heat of formation of the triaminoguanidine salt is substantially positive. Other simple salts which should contain substantial internal energy include hydrazine, substituted hydrazine, and hydroxylammonium salts of both polyhedral ions.

High energy fuels include almost any salt containing the $B_{10}H_{10}^{-2}$ or $B_{12}H_{12}^{-2}$ ion, but the most energetic should include ammonium and substituted ammonium (U.S. patents 3,148,938; 3,149,163; 3,169,845), guanidine (U.S. patent 4,002,681), and those with boron-containing cations (U.S. patent 3,383,399). The more stable should include alkali and alkaline-earth metal salts and quaternary ammonium salts.

2. Double and Complex Salts

As reported by Muetterties,⁴ cesium tends to precipitate double salts (see Section C,4,c); if the attending anion is an oxidizer, a molecular monopropellant results. Known double salt monopropellants

of this type include $\text{Cs}_2\text{B}_{10}\text{H}_{10} \cdot \text{CsNO}_3$ (U.S. patent 3,107,613), $\text{Cs}_2\text{B}_{12}\text{H}_{12} \cdot \text{CsNO}_3$ (U.S. patent 3,184,286) and $(\text{Cs}_2\text{B}_{10}\text{H}_{10})_2\text{Cs}_2\text{Cr}_2\text{O}_7$ (U.S. patent 3,256,056). The nitrate double salts exhibit very fast reaction; in squibs, the B_{10} function time is reported to be about 30 times faster than the B_{12} material.

The dichromate double salt is a slow burning, gasless delay mix. Burning rates in drawn cords (0.15 to 0.25 in dia) are in the range of 0.4 inches per second.

Another class of complex salts consisting of complexed ions of cobalt and chromium, polyhedral boranes, and oxidizer have been patented (U.S. patent 3,411,890). Representative compounds include the following:

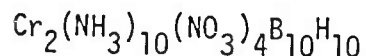
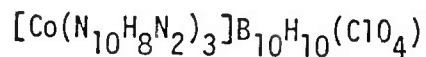
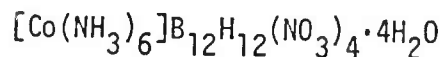
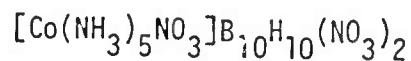

These are believed to be (possibly) detonating materials useful as ignition and primer explosives.

3. Pyrotechnic Compositions Incorporating Polyhedral Boranes

Physical blends of simple $\text{B}_{10}\text{H}_{10}^{-2}$ and $\text{B}_{12}\text{H}_{12}^{-2}$ metal salts, primarily cesium, were characterized in early work at DuPont (U.S. patent 3,126,305). Linear burning rates as high as 12,000 inches per second were reported for compositions in cord form.

Similar fast burning materials based on the $\text{B}_{10}\text{H}_{10}^{-2}$ ion were explored in some detail in the 1960's, 70's, and continuing to the present by Teledyne McCormick Selph (Hollister, California). Some specialized materials are marketed under the tradename HIVELITE. Goddard and Thrasher

characterized physical blends of nonmetallic salts of $B_{10}H_{10}^{-2}$ with common oxidizers.²² A coprecipitation process was developed that produced uniform and reproduceable high burn rate ignition materials (U.S. Patent 4,135,956). Specific compositions reported include:

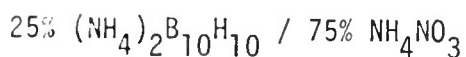
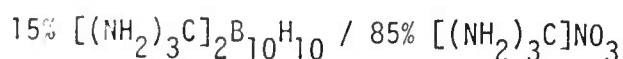
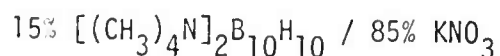
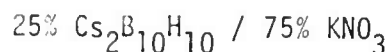

A wide range of heats of reaction and gas/solid combustion product ratios were obtained. Burn rates in cord form were in the 10,000 in/sec category. Similar coprecipitated compositions were reported for the triaminoguanidine salt of $B_{10}H_{10}^{-2}$ with triaminoguanidine nitrate (U.S. patent 4,172,743). Applications of these materials in ignition systems, transfer ordnance, and propellants were numerous.²³ Ammunition ignition applications are reported,^{24,25} including linear primers for large caliber guns (U.S. patent 4,080,902), propellant coatings (U.S. patent 4,089,716), and consolidated grains incorporating integral ignition compounds (U.S. patent 4,094,712).

The higher burn rates, 10,000 in/sec and up, place these materials in a unique category of compounds having propagation rates midway between deflagration and detonation.²⁶ The non-detonating high burn rates have been confirmed in limited testing at Lawrence Livermore Laboratory.²⁷

4. Government Programs Using Polyhedral Boranes

Several Recent government programs have used decahydrodecaborates (supplied by Teledyne and R & N Chemical/Roberts Research) in ignition and propellant applications. A major problem with some $B_{10}H_{10}^{-2}$ containing salts appears to be sensitivity (impact, friction, and especially static). The sensitivity of materials tested to date is of such a magnitude as to possibly preclude generalized service use as a bulk ignitor material. No systematic exploration of $B_{12}H_{12}^{-2}$ and the B_{20} anions comparable to that done on the B_{10} family has been performed.

a. ARRADCOM

1) Large Caliber Soft Recoil Igniter

A program within LCWSL has been under way since 1975 to develop reproduceable ignition in the Large Caliber Soft Recoil System. Mr. Sid Bernstein of ARRADCOM reviewed the program with BDM; no report has been published. Two series of test firings were conducted using an XM119 center core igniter configuration that incorporated strands of HIVEHITE (metal encapsulated proprietary ignition compositions based on $B_{10}H_{10}^{-2}$ manufactured by Teledyne McCormick Selph) in various geometries.

In a first series of tests, long (about 24") HIVEHITE strands were placed in the axial sausage bag with Class 3 black powder; the breech ends protruded into the base ignition pad. A limited series of firings indicated that normal ignition delays of 60 msec were reduced to 20-30 msec with very good reproduceability across the temperature range.

el test shots, stick propellant in the center core in place of gave 20-30 msec (± 1.5 msec deviation) ignition delays.

A second series of about 40 firings was conducted using a similar configuration of 6 or 7 HIVELITE strands without a base pad. The strands were arranged in a hex pattern on the base closure. No black powder base pad was used. Class 5 BP was used in the sausage bag. The HIVELITE strands were difficult to ignite in this configuration, and misfires occurred. The tests were inconclusive as to the contribution of HIVELITE in reducing ignition delay, as it is known that class 5 BP also reduces delay.

In further testing, strands of PETN and dextrinated lead azide mild detonating fuse (MDF) were used with black powder and found to give reduced ignition delays with good uniformity.

The conclusions reached by the experimenters were that reduced ignition delays and uniformity for large caliber soft recoil applications could be accomplished cheaper and easier with methods other than HIVELITES.

2) Telescoped Ammunition Ignition

In a series of tests conducted at Frankford Arsenal,²⁸ "AMMOLITE" ignition materials (Teledyne McCormick Selph proprietary compositions based on $B_{10}H_{10}^{-2}$) identified as #'s 300432 and 300473 were evaluated for use in medium caliber telescoped ammunition. These are described as fine powders with heats of explosion of 717 and 1348 cal/gram respectively and high temperature stability. Characterization tests including hygroscopicity, IR spectra, and DSC were run by ARRADCOM. The 300432 material was found to have relatively high hygroscopicity.

The AMMOLITES were evaluated in comparison to black powder and $BKNO_3$ in a 25mm telescoping round shot-start test fixture. Principal test data results are stated as follows:

THE BDM CORPORATION

	Charge Weight (Grains)	Extreme Temp. Pressure Variation - -65° to 165°F (p.s.i.)	Extreme Temp. Action Time Variation -65° to 165°F (msec)
BKNO ₃ (2K)	7.7	2939	0.69
Class 3 B.P.	13.8	4230	0.51
Class 5 B.P.	10.5	2300	0.19
TMS 300,432	5.6	2180	0.09
TMS 300,473	3.1	2282	0.05

Conclusions from the studies were that the "...tests have shown that the Ammolite materials examined, when used in telescoped ammunition, are capable of providing more consistently reproducible projectile seating action times over the temperature extremes than either black powder or boron/potassium nitrate igniters. Also, the required charge weights for the Ammolites are generally much less than the other igniters tested."

3) Ballistic Research Laboratory

A series of high burn rate propellants were developed by the Interior Ballistics Division of BRL for use in a 40mm hypervelocity travelling charge experimental gun. The compositions, based on B₁₀H₁₀⁻² salts and various combinations of oxidizers and binders, were developed in cooperation with Mr. Ray Price of the Naval Weapons Center/China Lake and Teledyne McCormick Selph. A high burn rate combustor was used to measure consumption rates of pressed pellets. Burning rates on unconfined pellets of eight different compositions were estimated as follows: 28; 60; 169; 614; 1380; 2330; 3488; and 10,600 inches per second. Burning rates for pellets with circumferential confinement were 30 to 130% higher than unconfined pellets of the same material. Experimental measurements of impetus were 50-70% of theoretical.

Such compositions might be very useful as HIDEF experimental materials because of the intermediate burn rates observed.

b. Air Force Armament Laboratory (AFATL)

The Ballistics Branch of the Guns, Rockets, and Explosives Division of AFATL has had medium (20-40mm) caliber propellant ignition studies ongoing for almost a decade. Theoretical and experimental work has been contracted to OEA, Inc. (Denver, CO).²⁹ OEA conducted a recent series of tests on ignition of deterred triple base propellant in the GAU-8 round using perforated flash tubes containing various types, configurations, and quantities of ignition materials.³⁰ Among materials tested were A4 black powder, BKNO₃, ITLX detonating cords (1/8" dia), HIVELITE part numbers 134024 and 300435 (Teledyne McCormick Selph).³¹ The objective of the development testing was to reduce action times on the deterred tri-base GAU-8 round to the order of 3 milliseconds. In 56 firings between Sept 1978 and Feb 1979, only the ITLX (833 mg load) and HIVELITE 134024 (733 mg) gave the desired performance.

In a second series of tests conducted at Eglin, a test fixture was developed to observe and measure luminosity (intensity, duration) in the medium caliber ignition sequence.³² No published report is available. The general conclusions were that HIVELITE performance was on a par with ALCL0. Both were substantially better than BKNO₃, which in turn was better than black powder.

An additional study was done at Eglin to characterize HIVELITE propellant igniter material 134473 and a granulated version of it, as well as propellant burning rate modifiers 510104 and 134465, to modify burning rates of nitrocellulose and nitrocellulose/HMX propellants.³³ Increases in burn rates up to 50% were observed.

c. Naval Surface Weapons Center (NSWC)

1) EX 164 Electric Primer

A true HIDEF ignitor is being developed for limited production for the 5"/54 gun at NSWC by East, McClure, and Burrell, culminating an 8 year effort to characterize ignition phenomena and develop a high

performance igniter.³⁴⁻⁴¹ The current configuration uses a central HNS lead jacketed mild detonating cord as the linear propagation element; it is surrounded by pellets of HIVEHITE (Teledyne McCormick Selph part no. 300435):

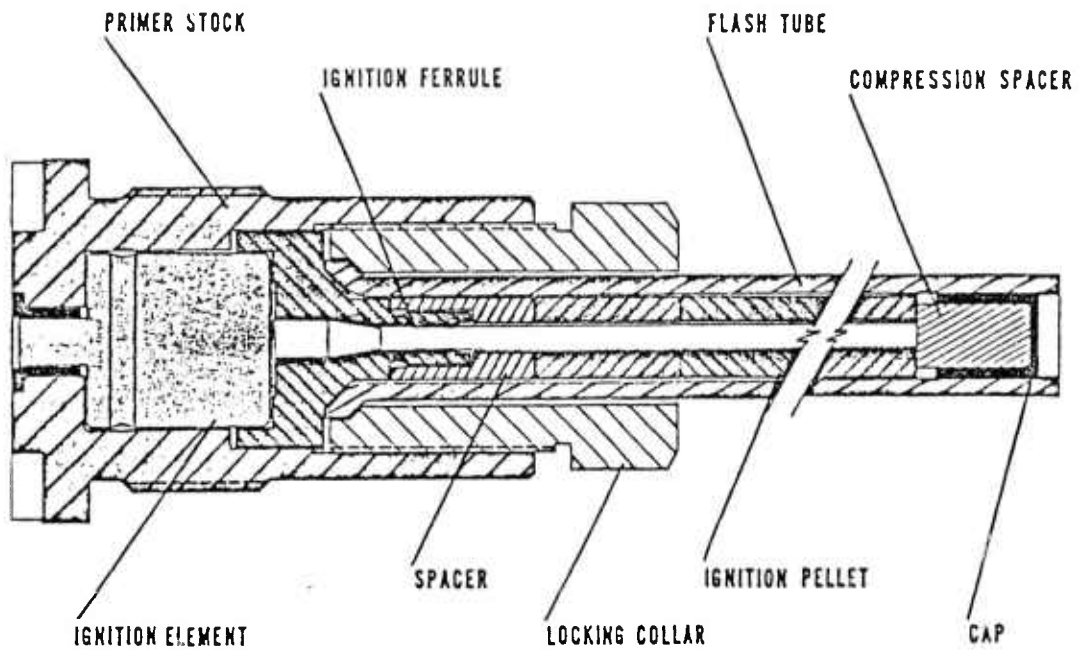

EX 164 ELECTRIC PRIMER

THE BDM CORPORATION

A standard electric primer for the MK1 MOD1 is used. The flash from the black powder charge in the primer is picked up by a booster assembly (lead azide/PETN) that ignites the MDF cord. The cord is surrounded by pressed pellets about 0.3 in diameter made from a pyrotechnic mix containing cesium decahydrodecaborate ($\text{Cs}_2\text{B}_{10}\text{H}_{10}$) and potassium nitrate.⁴¹ The active ingredients are housed in an extruded nitrocellulose primer tube. The complete assembly is called the Rapid Ignition Propagation (RIP) igniter.

Comparative tests at Dahlgren showed the RIP igniter was superior to igniters with black powder, MDF/black powder, and MDF/ALCLO materials in reducing pressure transients and propellant bed movement in the chamber. The RIP igniter achieved a dramatic reduction in acceleration loads on the projectile base.

As part of the EX 164 primer development, a series of characterization tests on the ignition material 300435 were done at ARRADCOM.⁴² The tests included impact, friction and electrostatic sensitivity; vacuum stability; autoignition temperature; detonation velocity; density; DTA/TGA; physical stability; effect of moisture. No detonation was observed when pressed pellets were ignited. Deflagration rates of about 12,000 in/sec were observed. Thermal stability data (vacuum stability and TGA) suggested some instability at elevated temperatures (TGA showed a 6% weight loss between 190 and 370°C). The material was exceptionally friction and static sensitive (~ 9000 ergs) and was also quite impact sensitive (10% point - 6 in, P.A. apparatus). The composition was hygroscopic and possible deliquescent at very high humidities (90-99%).

Compatibility tests between the HIVELITE and components of the EX 164 were conducted at NSWC.⁴³ No incompatibilities between HIVELITE and any of the proposed EX 164 components in contact with it were observed. There was a possible problem between HIVELITE and cellulose acetate butrate tubing which was originally considered as the primer tube.

2) FILMBAL Propellants

A series of fast burning propellants were developed and characterized by the Weapons Systems Department of NSWC in support of the 3-inch Lightweight Intermediate Caliber Gun System (LICGS).⁴⁴ These incorporated coprecipitated $B_{10}H_{10}^{-2}$ ignition compositions with nitrocellulose binders. Burn rates for propellant type 1 were 20-50 inches per second with an apparent negative pressure exponent. Propellant type 2 burn rates were 140-250 inches per second with a positive pressure exponent.

E. AVAILABILITY

At present there are (at least) three producers of basic polyhedral borane and pyrotechnic materials:

- Callery Chemical Company (Division of Mine Safety Appliances Co., Callery, PA). $B_{12}H_{12}^{-2}$ salts. No pyrotechnic or explosive materials. Patented and licensed products are indicated in Section B.
- Teledyne McCormick Selph (Hollister, CA). $B_{10}H_{10}^{-2}$ salts and pyrotechnic/ignition compositions based on them (some of which are marketed under the tradename HIVELITE). Patented and known licensed products are indicated in Section B.
- R & N Chemical/Roberts Research (Hollister, CA). Certain types of $B_{10}H_{10}^{-2}$, $B_{12}H_{12}^{-2}$ and pyrotechnic/ignition compositions.

A limiting factor in any future large scale production of polyhedral boranes is the availability of starting materials. The most convenient starting material is decaborane, $B_{10}H_{14}$, which until recently was available only in small (10 lb) quantities at about \$2500/lb from a sole supplier (Callery Chemical Co.). Discussions with Dr. Niles White at MICOM revealed that the U. S. Army has recently brought on-line a carborane plant at Callery that uses a continuous vapor phase pyrolysis to convert diborane to decaborane in parallel unit reactors.⁴⁵ The present facility is sized for 15,000 lb/year with expansion potential to 30,000 lb/year. The projected

THE BDM CORPORATION

cost at the lower production figure is about \$500/lb in FY '80. Using the following estimates of conversion efficiencies and stoichiometry,

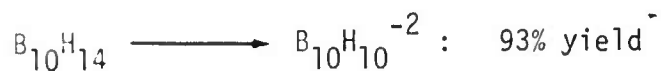

the price of the polyhedral borane per pound of igniter composition is about \$42. If 3 oz are required per large caliber round, the basic borane material cost per round is less than \$8, a not at all unreasonable amount considering the cost of advanced ammunition. Other synthetic routes not involving decaborane as an intermediate could possibly produce substantially cheaper material.

F. REFERENCES

1. Recent reviews include: a) Richard L. Middaugh "Closa-Boron Hydrides" ch. 8 in Earl L. Muetterties, ed., Boron Hydride Chemistry, (Academic Press, N. Y., 1975); b) Earl L. Muetterties and Walter H. Knoth, Polyhedral Boranes, (Marcel Dekker, Inc., N.Y., 1968); c) Fred R. Scholer and Lee J. Todd, "Polyhedral Boranes and Heteroatom Boranes", in W. L. Jolly, ed., Preparative Inorganic Reactions, V7, (Wiley, N.Y., 1971); d) Lee J. Todd, "The Chemistry of Polyhedral Borane Ions", in Progress In Boron Chemistry, Vol. 2, (Pergamon Press, Oxford, 1970).
2. M. F. Hawthorne, R. L. Pilling and R. N. Grimes, JACS 86, 5338 (1964).
3. M. F. Hawthorne and R. L. Pilling, Inorg. Syn. 9, 16 (1967).
4. E. L. Muetterties et al, Inorg. Chem. 3, 444, (1964).
5. J. M. Makhlof, W. V. Hough, and G. T. Hefferan, Inorg. Chem. 6 (6), 1196, (1967).
6. H. C. Miller and E. L. Muetterties, Inorg. Syn. 10, 88, (1967).
7. R. M. Adams, A. R. Siedle, J. Grant, Inorg. Chem., 3, 461 (1964).
8. H. C. Miller, N. E. Miller and E. L. Muetterties, Inorg. Chem., 3, 1456 (1964).
9. I. A. Ellis, D. F. Gaines and R. Schaeffer J. Am. Chem. Soc., 85, 3885 (1963).
10. C. Harzdorf, et al, Z. Naturforsch B 1970, 25, 6 (German).
11. B. L. Chamberland and E. L. Muetterties, Inorg. Chem. 3, (10), 1450 (1964).
12. E. L. Muetterties et al., JACS 84, 2506 (1962).
13. W. N. Lipscomb, A. R. Pitrochelli, and M. F. Hawthorne, JACS 81, 5833 (1959).
14. R. D. Dobrott and W. N. Lipscomb, J. Chem. Phys. 37, 1779, (1962).
15. T. E. Paxson et al, Inorg. Chem. 13, (11), 2772 (1974).
16. J. H. Hall et al, JACS 96, (3), 770 (1974).

THE BDM CORPORATION

17. A. Kaczmarczyk et al, Inorg. Chem 7, (6), 1057 (1968).
18. J. D. Clark, Picatinny Technical Report 3000, April 1962 (Picatinny Arsenal, Dover, NJ).
19. W. H. Sweet, A. N. Soloway, and R. L. Wright, J. Pharmacol. Expt. Ther. 137, 263 (1962).
20. H. F. Smyth et al, Amer. Ind. Hyg. Assn. J. 30, 470, (1969).
21. Richard T. Holzmann, ed. "Production of the Boranes and Related Research", (Academic Press, NY, 1967), p. 302.
22. T. P. Goddard and D. N. Thatcher "Ignition and Pyrotechnic Materials" (patent application 694,625, 1975).
23. "HIVELITE Briefing Book", June 1977, and subsequent revisions (Teledyne McCormick Selph, Hollister, CA).
24. T. P. Goddard "Enhanced Small Caliber Ammunition Ignition Using HIVELITES", TR 904-2, (Teledyne McCormick Selph, Hollister, CA) April 1977.
25. C. Leveritt, "HIVELITE Ignition Materials", paper presented at the JANNAF Gun Igniter Workshop, Sep 1978.
26. John A. Brown and Morton Collins, "Explosion Phenomena Intermediate between Deflagration and Detonation", Office of the Chief of Research and Development, Dept. of the Army, Washington, D.C., 1967. (AD662778).
27. Milton Finger and Bernard Hayes "HIVELITE Propellant Characterization", UCID-16748, Lawrence Livermore Laboratory, University of California, Livermore, CA, Mar 1975.
28. a) Ludwig Stiefel, John P. Mikulich and George Meranshian "Evaluation of AMMOLITE TMC/S 3000432 as an Ignitor for Telescoped Ammunition - Phase I", FA-TR-75093, Oct '75, (U.S. Army Armament Command, Frankford Arsenal, Philadelphia, PA); b) Michael Ennis, John Mikulich and Ludwig Stiefel "Evaluation of AMMOLITE as an Ignitor for Telescoped Ammunition - Phase II", FA-TM-76041, July 1976, (U.S. Army Armament Command, Frankford Arsenal, Philadelphia, PA).
29. "Propellant Ignition Studies", report AFATL-TR-72-83, OEA, Inc, 1972.
30. "Progress Report for Research Studies on Nitramine Propellant Ignition", OEA, Inc., 1979.

31. Part number 134024 is reported to be ignition mix 134473 granulated with nitrocellulose binder and glazed. Part number 300435 is ignition mix 300432 with polyethylene glycol binder.
32. Personal communication, Capt. Robert West to T. Goddard.
33. B. K. Moy "Characterization of Some HIVELITE Compounds", AFATL-TR-78-115, (Air Force Armament Laboratory, Eglin AFB, FL) 1978.
34. East, J. J. and D. R. McClure, "Projectile Motion Predicted by a Solid/Gas Flow Interior Ballistic Model", 10th JANNAF Combustion Meeting, Naval War College, Newport, RI, CPIA Publication 243, Aug 1973.
35. McClure, D. R. and J. L. East, "Experimental Techniques for Investigating the Start-Up Ignition/Combustion Transients in Full-Scale Charge Assemblies", 11th JANNAF Combustion Meeting, Jet Propulsion Laboratory, Pasadena, CA, CPIA Publication 261, Sept 1974.
36. East, J. L. and D. R. McClure, "Experimental Studies of Ignition and Combustion in Naval Guns", 12th JANNAF Combustion Meeting, Naval War College, Newport, RI, CPIA Publication 273, Aug 1975.
37. East, J. L., "A Consumable Tubeless Igniter for Gun Pressure Wave Reduction and Improved Ignition", 13th JANNAF Combustion Meeting, Naval Postgraduate School, Monterey, CA, CPIA Publication 281, Sept 1976.
38. East, J. L. and W. R. Burrell, "Solutions to Ignition-Related Problems in Navy Guns Via a Rapid Ignition Propagation (RIP) Igniter", 14th JANNAF Combustion Meeting, Air Force Academy, Colorado Springs, CO, CPIA Publication 282, Aug 1977.
39. Burrell, W. R. and J. L. East, "Effects of Production Packing Depth and Ignition Techniques on Propelling Charge Reaction and Projectile Response", NSWC/DL TR-3705, Jan 1978.
40. East, J. L., and D. S. Downs, JANNAF Workshop Report on "Improved Ignition Systems for Guns", 16th JANNAF Combustion Meeting, Naval Postgraduate School, Monterey, CA, Sept 1979, pending CPIA Publication.
41. J. L. East, Jr. "Ignition and Flamespreading Phenomena in Granular Propellant Gun Charges", in "Interior Ballistics of Guns", Prog. Astronautics and Aeronautics 66 (AIAA, NY, NY) 1979.

THE BDM CORPORATION

42. L. Avrami, ARRADCOM DRDAR-LCE, "Safety and Characterization Tests for HIVEHITE 300435", Nov. 1979, and supporting Picatinny Arsenal data.
43. NSWC memorandum G-51: JMG/FBA, 9 April 1979, Subject: "Compatibility Test of the Contact Interfaces in the HIVEHITE RIP Primer".
44. James L. Johndrow a) "Design, Fabrication, Operation, and Testing of the 3-Inch, Lightweight Intermediate Caliber Gun", NSWC/DL-TR-3494, 1976. b) "Component Redesigns and Firing Tests of the Improved 3-Inch Prototype Lightweight Intermediate Caliber Gun", NSWC/DL TN-DG-42/76, 1976. c) "Development of the Film Ballistics (FILMBAL) Gun Propulsion Concept, NSWC/DL TR-3820, 1978.
45. "Design of a Facility to Implement a Low Cost Process for Production of NHC", Report DAAK40-76-C-1256-A001, (Callery Chemical Co., Callery, PA) 1979.

G. PATENTS

Following is list of patents appended for convenience to the user:

- U.S. Patent 3,107,613 - Boron Compound
- U.S. Patent 3,126,305 - Ignition Compositions Comprising Boron Containing Salts
- U.S. Patent 3,138,602 - Amine-Decaborane Adducts and Preparation Thereof
- U.S. Patent 3,148,938 - Ammonia and Hydrazine Salts of The $B_{10}H_{10}^{-2}$ Anion
- U.S. Patent 3,148,939 - Hydrates, Metal Salts and Hydrated Metal Salts of Acid $H_2B_{10}H_{10}$
- U.S. Patent 3,149,163 - Amine and Organo-Substituted Hydrazine Salts of the $B_{10}H_{10}^{-2}$ Anion and Process For Preparing Same
- U.S. Patent 3,169,044 - Dihydrogen Dodecahydrododecaborate and Method for Producing Same
- U.S. Patent 3,169,045 - Dodecahydrododecaborate Compounds
- U.S. Patent 3,184,286 - $Cs_2B_{12}H_{12}NO_3$ Product and Process for Making Same
- U.S. Patent 3,256,056 - $(Cs_2B_{10}H_{10})_2 - Cs_2 CR_2 O_7$ Product and Process for Preparing Same
- U.S. Patent 3,264,071 - BIS(Ammonio) decaborane
- U.S. Patent 3,265,737 - Boron Amines and Process for Formation Thereof
- U.S. Patent 3,296,260 - Neutral and Singly Charged Derivatives of Decaboranes and Decaborates
- U.S. Patent 3,328,422 - Derivatives of Polyhedral Dodecaboranes
- U.S. Patent 3,355,261 - Chemical Process
- U.S. Patent 3,365,275 - Polyhydropolyborates and Processes for Preparing Them
- U.S. Patent 3,372,006 - Halogen Derivatives of Polyhedral Boron Compounds
- U.S. Patent 3,373,202 - Method of Preparing Tetraethylammonium Decahydrodecaborates
- U.S. Patent 3,373,203 - Preparation of Decahydrodecaborates
- U.S. Patent 3,383,399 - Salts of Boron-Hydride Anions and Boron Containing Organic Cations and Method of Their Preparation

THE BDM CORPORATION

- U.S. Patent 3,411,890 - Chemical Products and Processes
- U.S. Patent 3,431,089 - Reaction Products and Processes
- U.S. Patent 3,446,604 - Acid and Salts of $B_{20}H_{18}^{-2}$ Ion
- U.S. Patent 3,455,661 - Bis-(Hydrazine) Decaborane(12) Compounds
- U.S. Patent 3,509,152 - Bis - Polyquaternary Ammonium Dodecahydrododecaborates and Octahydrotriborates
- U.S. Patent 3,551,120 - Substituted Dodecaborates
- U.S. Patent 3,961,017 - Production of Dodecahydrododecaborate (2-)
- U.S. Patent 4,002,681 - Bis-Guanidinium Decahydrodecaborate and A Process for its Preparation
- U.S. Patent 4,080,902 - High Speed Igniter Device
- U.S. Patent 4,089,716 - Ignition Enhancing Propellant Coatings
- U.S. Patent 4,094,712 - Consolidated Charges Incorporating Integral Ignition Compounds
- U.S. Patent 4,108,697 - Novel Triaminoguanidine Nitrate Propellants
- U.S. Patent 4,130,585 - Bis-Triaminoguanidine Decahydrodecaborate, Process For Preparation, and High Energy Propellant
- U.S. Patent 4,135,956 - Coprecipitated Pyrotechnic Composition Processes and Resultant Products
- U.S. Patent 4,138,282 - High Burning Rate Propellants with Coprecipitated Salts of Decahydrodecaboric Acid
- U.S. Patent 4,139,404 - Active Binder Propellants Incorporating Burning Rate Catalysts
- U.S. Patent 4,164,513 - Amino-Substituted Guanidine Salts of Decahydrodecaboric Acid
- U.S. Patent 4,172,743 - Compositions of Bis-Triaminoguanidine Decahydrodecaborate and Tagn

1

3,107,613

BORON COMPOUND

Robert K. Armstrong, Glassboro, N.J., David C. England, Wilmington, Del., George W. Parrshall, London, England, and Donald N. Thatcher, Pittman, N.J., assignors to E. I. du Pont de Nemours and Company, Wilmington, Del., a corporation of Delaware
Filed Feb. 17, 1961, Ser. No. 90,143
7 Claims. (Cl. 102-28)

The present invention relates to a novel boron compound and to its preparation. More particularly this invention relates to a double salt of cesium nitrate and cesium decahydrodecaborate represented by the formula $\text{CsNO}_3 \cdot \text{Cs}_2\text{B}_{10}\text{H}_{10}$ (hereinafter sometimes referred to simply as the "double salt").

Conveniently, the double salt of this invention is prepared by reacting a boron hydride amine salt having the formula $(\text{R}_3\text{NH})_2\text{B}_{10}\text{H}_{10}$, wherein R is hydrogen or a lower alkyl radical with a nitrate and a cesium salt, e.g. cesium nitrate, cesium carbonate, or cesium fluoride. The boron hydride amine salts can be prepared by reacting two moles of a primary, secondary, or tertiary alkyl amine or of ammonia with 1 mole of a decaboryl bis(alkyl sulfide), e.g. decaboryl bis(dimethyl sulfide) as described in detail in copending applications Serial No. 6,854 filed February 5, 1960 and Serial No. 6,853 filed February 5, 1960 in the name of W. H. Knott, Jr. and assigned to the present assignee. The amine salt also can be prepared by refluxing $\text{B}_{10}\text{H}_{14}$ with a lower alkyl tertiary amine in benzene for several hours, cooling the mixture, adding acetone and filtering out the desired amine salt.

The preferred solvent system for use in preparing the double salt of cesium nitrate and cesium decahydrodecaborate is water. The double salt is insoluble in solvents such as lower alcohols, ketones, and the like. However, it is soluble in a more polar solvent such as water or acetic acid. For this reason, a binary solvent system may be desirable so that one component will maintain the unreacted ions in solution while the other component will effect precipitation of the product. Solvent systems which have been used include water with 95% ethanol, and acetic acid with 95% ethanol. However, the salt is stable at temperatures up to 420° C. and can be isolated from the reaction mass by simple evaporation of the solvent. The mode of recovery of the double salt is not critical and will vary from case to case depending upon the other ions present in solution, the characteristics of the solvent used in its preparation, etc.

Alternatively, the double salt can be prepared by reacting a boron-containing acid represented as a hydronium compound, i.e., by the formula $(\text{H}_3\text{O})_2\text{B}_{10}\text{H}_{10} \cdot (\text{H}_2\text{O})_m$, where m is 0 or a positive integer with nitric acid and a cesium compound. The boron-containing acid may be prepared by treating, at temperatures between 0° C. and 100° C., an aqueous solution of a boron hydride amine salt having the formula $(\text{R}_3\text{NH})_2\text{B}_{10}\text{H}_{10}$, where R is hydrogen or a lower alkyl radical, with an ion exchange resin capable of replacing the amine cations by hydrogen, e.g. a copolymer base of styrene cross-linked with divinylbenzene, sulfonated to introduce sulfonic acid groups into the aryl nucleus as polar groups. The boron-containing acid can be isolated from the aqueous effluent by evaporation of the water at elevated temperatures, e.g. 30-40° C., preferably under reduced pressure (0.1-5 mm. of mercury). A more detailed discussion of the preparation of the acid is disclosed in copending application Serial No. 6,855 filed February 5, 1960 in the name of W. H. Knott, Jr. and assigned to the present assignee.

In preparing the double salt, aqueous solutions of the cesium salts are used in which the cesium is present to

2

the extent of at least three equivalents of cesium per equivalent of the decahydrodecaboric acid.

The combination of the cesium, nitrate, and decahydrodecaborate ions to form the double salt occurs at room temperature (20-25° C.). When the double salt is prepared from the boron hydride amine salt, a water-soluble nitrate and a cesium salt, heating is desirable to drive off volatile compounds such as the free amine, ammonia, and carbon dioxide. The heating serves to effect more efficient recovery of the double salt from the reaction mass and to eliminate tedious separation of the double salt from other compounds which otherwise might be coprecipitated. At temperatures below 0° C. the mobility of the ions lessens so that the reaction rate is decreased and, additionally, recovery of the double salt from the reaction mass is more involved.

The double salt of this invention is stable indefinitely at room temperature. Surprisingly, it also is stable when heated without exposure to flame to temperatures up to 420° C. even though it ignites easily when held in an open flame.

Significant bands found in the infrared absorption spectrum of the double salt are very strong, conventional inorganic nitrate bands at 7.3 and 12.1 microns, absorption peaks with shifting at 9.55 and 9.80 microns, which bands are indicative of the $\text{B}_{10}\text{H}_{10}$ nucleus, and a splitting found at approximately 4.0 microns indicative of a disturbance in the B-H stretch, which disturbance demonstrates that a true molecular compound is formed.

The following examples in which parts are given by weight illustrate specific embodiments of the present invention.

Example 1

A solution of 6.4 parts of triethylammonium decahydrodecaborate and 1.7 parts of sodium nitrate in 50 parts of water was filtered and a solution of 9.8 parts of cesium carbonate in 30 parts of water was added to the filtrate. A precipitate formed, but, upon heating on a steam bath, it dissolved to form a clear solution. Ethanol (95%) was added to the hot solution until it became turbid, and the reaction mixture was cooled further in an ice bath. The cooled mixture was filtered and the residue dried. There was obtained 5.65 parts of white, fibrous solid which on analysis was shown to be $\text{CsNO}_3 \cdot \text{Cs}_2\text{B}_{10}\text{H}_{10}$.

Analysis.—Calculated for $\text{Cs}_3\text{B}_{10}\text{H}_{10}\text{NO}_3$: Cs, 68.9%; H, 1.74%; N, 2.42%. Found: Cs, 68.4%; H, 2.58%; N, 2.38%.

The infrared absorption spectrum obtained with this mixed salt was very clean and characterized by splitting at 4.0 microns and peaks at 7.3, 12.1, 9.55 and 9.80 microns. The mixed salt was differentiated from a simple mixture of its components by the X-ray diffraction pattern and by the infrared spectrum.

Example 2

A solution of 100 parts of triethylammonium decahydrodecaborate in 200 parts of water was prepared, and the resulting solution was filtered to remove a very small amount of insoluble material. A solution of 24.9 parts of NaOH in 100 parts of water was added to the filtrate. The mixture then was heated on a steam bath for 1.5 hours to drive off extraneous, easily vaporized materials such as the triethylamine displaced from the amine salt. A solution of 26.5 parts of sodium nitrate in 50 parts of water was added to the hot solution, and then a solution of 153.2 parts of cesium carbonate dissolved in 100 parts of water was added. After addition of 360 ml. of water, the mixture was filtered, and the residue dried in air. The residue consisted of 135.4 parts of the double salt of cesium nitrate and cesium decahydrodecaborate. The identity of the product was confirmed by infrared analysis.

Example 3

To twenty-five parts of aqueous $(\text{H}_2\text{O})_2\text{B}_{10}\text{H}_{10} \cdot (\text{H}_2\text{O})_m$ containing 0.037 mole of acid was added 30 milliliters of acetic acid, and the mixture was cooled to approximately 3° C. One part of 96% nitric acid in 10 parts of acetic acid was added dropwise to the mixture. The resulting solution was stirred overnight while it came to room temperature. Upon neutralization of the solution with excess cesium carbonate, white needles of the



were formed which were subsequently filtered from the mother liquor, then recrystallized from 95% ethanol, and dried in air. The identity of the compound was confirmed by infrared and elemental analysis.

The double salt thus produced has several properties which make it very useful for use as an ignition agent in electric blasting caps. For example, in electric blasting caps to be used for certain special purposes, such as seismographic exploration, the accuracy of the work is dependent upon knowledge of the instant of detonation. At present, lead styphnate is a preferred composition for such uses because it is considered "fast." However, lead styphnate is known to be highly sensitive to ignition by discharges of static electricity and, accordingly, must be handled with extreme caution.

The double salt of cesium nitrate and cesium decahydrodecaborate has been found to be very insensitive to ignition by discharges of static electricity and, at the same time, to be ignitable with sufficient rapidity to meet the requirements of a "fast" ignition charge.

To evaluate the performance of the double salt of cesium nitrate and cesium decahydrodecaborate, electric blasting caps were prepared having the design illustrated in the accompanying drawing. Referring to the drawing, the electric blasting cap comprises a shell 11 having an integral closed end. Adjacent the end is loaded a base charge 12. Such base charge may consist of any explosive conventionally employed for such purposes, such as cyclotrimethylenetrinitramine, pentaerythritol tetranitrate, picric acid, trinitrotoluene, tetryl or mixtures thereof. Above base charge 12, is primer charge 13 which may be any of the primary explosives (highly sensitive to flame and/or shock) conventionally employed, e.g. lead azide or mercury fulminate. Above primer charge 13 is the loose igniting charge 14 which in this case consists of the double salt of cesium nitrate and cesium decahydrodecaborate. A bridgewire 15 connecting the terminals of lead wires 16 is embedded within the ignition composition 14. The shell 11 is sealed with rubber plug 17 which also holds the lead wires 16 firmly in position. Alternatively, other conventional shell sealing means may be substituted for the rubber plug 17.

Example 4

A series of electric blasting caps were assembled as illustrated in the attached drawing. The shell was of bronze and was 1 1/4 inches long with an outer diameter of 0.272 inch and an average inner diameter of 0.26 inch. Into this shell was loaded approximately 4.9 grains of pentaerythritol tetranitrate pressed at 225-250 lbs. immediately above this base charge, approximately 2.2 grains of lead azide was loaded and pressed at about 200 lbs. Two grains of the loose double salt of cesium nitrate and cesium decahydrodecaborate was inserted as the ignition charge. A conventional rubber plug assembly was inserted in which a 0.0019 inch diameter 80/20 rickel chromium bridge wire (resistance, $1.37 \pm 0.50\Omega$) was soldered to the lead wires separated to provide a 1/2 inch span and projecting 1/4 inch from the base of the rubber plug. The lead wires contained in the rubber plug were of 20 gage copper insulated by nylon. After the cap was loaded and the plug inserted, three peripheral crimps were made in the shell wall to seal the plug.

To test for static resistance, the lead wires of a thus assembled cap were twisted together and connected to the high voltage terminal of "leg-to-shell" static sensitivity apparatus consisting essentially of a source of variable voltage and a series of microfarad condensers ranging in capacitance from 250-2000 μf ; the shell of the cap was connected to a ground line. Voltages from 0 to 30,000 volts were applied to a condenser of known capacitance in increments of 1,000 volts and the condenser was allowed to discharge through the cap. The cap did not detonate at the upper limit of the machine, e.g. at voltages of 30,000 volts applied through a 2000 μf condenser, indicating that the double salt has a static resistance greater than 77,500 man-equivalent volts (m.e.v.). When the cap was disconnected from the static testing apparatus and the lead wires connected in a conventional blasting circuit, ignition occurred within 0.082 millisecond with the passage of a 5 ampere (6.85 volts) firing current through the bridge wire of the cap.

Similar caps containing lead styphnate as the ignition charge customarily detonate in the static test when a potential of 4,000 volts is applied through a 2,000 μf condenser indicating a static resistance of 9630 m.e.v., and the ignition time is approximately 0.3 millisecond, which is almost 4-fold longer than caps with the aforesaid double salt.

Another important characteristic of the double salt of cesium nitrate and cesium decahydrodecaborate as an ignition charge is its stability at elevated temperatures. Although it is easily ignited by an incandescent resistance wire, an arc discharge, or an "exploding bridge wire," the salt has been found to be stable in the absence of flame up to its very high melting point. When the double salt was heated on a hot metal bar to temperatures up to 420° C., no evidence of decomposition was noted. The significance of this may be more readily appreciated by comparing it to lead styphnate which begins to vaporize at 100° C., with mercury fulminate which flashes at about 180° C., and with diazodinitrophenol which is more sensitive to heat than either lead styphnate or mercury fulminate. This ability to withstand high temperatures is a desirable characteristic for initiating explosives used in oil well perforating devices, in rocket applications, in tapping steel furnaces and other environments involving exposure to high temperature.

Squibs were also prepared using the double salt of cesium nitrate and cesium decahydrodecaborate. The shell and plug assembly including the bridge wire was identical to that described in Example 4 for the electric blasting cap, the only difference being that the detonating base charges and the priming charges were omitted and the charge weight for the double salt was increased to three grains. Squibs thus prepared fired satisfactorily at temperatures as low as -56.6° C. (imbedded in Dry Ice). In the vacuum firing test, a leak was simulated by providing a vent opening in the shell; satisfactory ignition occurred at the lowest pressure obtainable in the test apparatus, about 23 mm. of mercury. With a 5 ampere current, the squibs functioned in an average time of 0.96 millisecond; the minimum current required for initiation averaged 0.37 ampere. Black powder, aluminum/potassium perchlorate pellets, cannon powders, and a number of conventional rocket propellant compositions were ignited by means of these squibs, and in all cases the functioning was satisfactory.

Although our invention has been described with reference to specific embodiments thereof, the same are given by way of illustration only. Modifications and variations will be apparent from our description to those skilled in the art and may be made without departing from the spirit and scope of the invention.

We claim:

1. As a new composition of matter: $\text{Cs}_2\text{NO}_3 \cdot \text{Cs}_2\text{B}_{10}\text{H}_{10}$.
2. A process for the preparation of the double salt of

5

cesium nitrate and cesium decahydrodecaborate which comprises the steps of reacting in solution, a boron-containing compound selected from the group consisting of an acid represented by the formula

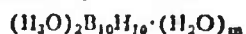

wherein m is a whole number selected from the group 0 and positive integers and boron hydride amine salts of the formula $(R_2NH)_2B_{10}H_{10}$, wherein R is selected from the group consisting of hydrogen and alkyl groups having less than five carbon atoms, with a nitrogen compound selected from the group consisting of nitric acid and nitrates soluble in the reaction mixture and with a salt of cesium which is soluble in the reaction medium, and thereafter separating the resulting precipitate of the double salt of cesium nitrate and cesium decahydrodecaborate.

3. The process of claim 2, wherein the reaction medium is selected from the group consisting of water, water and ethanol, acetic acid, and acetic acid and ethanol.

4. The process of claim 2, wherein the boron-containing compound is triethylamine decahydrodecaborate.

5. An ignition composition comprising double salt of cesium nitrate and cesium decahydrodecaborate.

6

6. An electric initiator comprising a shell, an electric heating element within said shell, and a loose ignition composition in contact with said heating element, said composition comprising double salt of cesium nitrate and cesium decahydrodecaborate.

7. An electric initiator comprising a shell, an electric heating element within said shell, a loose ignition composition in contact with said heating element, said composition comprising the double salt of cesium nitrate and cesium decahydrodecaborate, a lead azide initiator charge adjacent the initiator charge, and a base charge selected from the group of explosives consisting of cyclomethylenetrinitroamine, trinitrotoluene, ethylenedinitraamine, picric acid, and tetryl adjacent said initiator charge on the side of the latter remote from the ignition composition.

References Cited in the file of this patent

UNITED STATES PATENTS

20	2,715,561	Knotz	Aug. 16, 1955
	2,837,400	Blumenthal	June 3, 1958
	2,953,447	Schulz	Sept. 20, 1960
	2,976,136	Heiskell	Mar. 21, 1961

Oct. 22, 1963

R. K. ARMSTRONG ET AL

3,107,613

BCRON COMPOUND

Filed Feb. 17, 1961

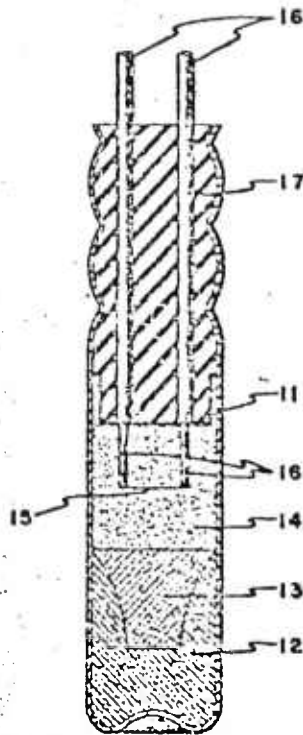

INVENTORS

ROBERT K. ARMSTRONG
DAVID C. ENGLAND
GEORGE W. PARSHALL
DONALD N. THATCHER

BY

Jules H. Steinberg
ATTORNEY

1

3,126,305

IGNITION COMPOSITIONS COMPRISING BORON
CONTAINING SALTSRobert K. Armstrong, Glasboro, N.J., assignor to E. I.
du Pont de Nemours and Company, Wilmington, Del.,
a corporation of Delaware

Filed Jan. 12, 1962, Ser. No. 166,469

7 Claims. (Cl. 149-77)

This invention relates to a composition, and more particularly, to an ignition composition.

Ignition compositions find wide utility in the explosives art in such uses, for example, as in ignition cords and in electric initiators such as blasting caps and squibs. This invention provides a broad new class of ignition compositions. The compositions of this invention are characterized, among other things, by outstanding versatility. Thus, for example, compositions of this invention range, depending upon the particular constituents employed, from fast functioning ignition compositions to slow functioning compositions useful, for example, in delay blasting caps.

The ignition compositions of this invention comprise an intimate physical mixture of (a) a metal salt of a boron-containing acid selected from the group consisting of decahydrodecaboric acid and dodecahydrododecaboric acid, and (b) a solid inorganic oxidizing agent.

Illustrative products prepared employing the compositions of this invention are shown in the accompanying drawings wherein FIGURE 1 is a cross-sectional view of an electric initiator containing an ignition composition of this invention and FIGURE 2 is a representative longitudinal cross-section of a piece of ignition cord containing a composition of this invention.

The solid metal salts of decahydrodecaboric acid employed in the instant invention are conveniently prepared by reacting an aqueous solution of the acid represented by the formula $H_2B_{10}H_{10} \cdot (H_2O)_m$ where m is zero or a positive integer, e.g., 1 to 3, or as the hydronium compound $(H_3O)_2B_{10}H_{10} \cdot (H_2O)_m$ where m is the same as above, or a soluble salt of this acid, for example, an ammonium salt, with a solution of a soluble salt of that metal whose $B_{10}H_{10}$ salt is desired under such conditions, e.g., particular solvent and concentration, that the desired $B_{10}H_{10}$ salt precipitates from the reaction solution. A preferred solvent system for this process employs water. When aqueous solutions are used, the process involves the step of adding to an aqueous solution of a water-soluble salt of such metal a second aqueous solution of a compound selected from the group consisting of the acid $H_2B_{10}H_{10}$, the hydronium compound, or water-soluble salts of the acid. Alternative methods of preparing the solid metal salts of decahydrodecaboric acid, as well as a more detailed discussion of the above preparation are disclosed in copending application Serial No. 6,855, filed February 5, 1960, in the name of W. H. Knott, Jr., and assigned to the present assignee. All of the preparation methods disclosed in the aforementioned application are incorporated herein by reference.

The solid metal salts of dodecahydrododecaboric acid used in the instant invention also are conveniently prepared by the above procedure in which an aqueous solution of the acid represented by the formula

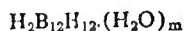

2

where m is zero or a positive integer, e.g., 1 to 4, or as the hydronium compound $(H_3O)_2B_{12}H_{12} \cdot (H_2O)_m$ where m is the same as above or a soluble salt of the acid, for example, an ammonium salt, is caused to react with a solution of a soluble salt of that metal whose $B_{12}H_{12}$ salt is desired under such conditions, e.g., particular solvent employed, that the desired $B_{12}H_{12}$ salt precipitates from the reaction solution. Alkali and alkaline-earth dodecahydrododecaborates can be prepared by reacting an alkali or alkaline-earth metal hydroborate with diborane under superatmospheric pressure. The above and alternative methods of preparing metal salts of dodecahydrododecaboric acid are disclosed in copending application Serial No. 30,443, filed May 20, 1960, now abandoned, in the name of H. C. Miller and E. L. Muettterties and assigned to the present assignee and the methods described therein are incorporated herein by reference.

Metal cations of the decahydrodecaboric and dodecahydrododecaboric acid salts can be derived generally from any metal. The metals according to the periodic table in Deming's General Chemistry, edition 5, chapter 11, John Wiley and Sons, Inc., and in Lange's Handbook of Chemistry, edition 9 pp. 56-57, Handbook Publishers, Inc. (1956), are the elements of groups I, II, VIII, IIIB, IVB, VB, VIB, VIIB as well as the elements of groups IIIA, IVA, VA, and VIA which have atomic numbers above 5, 14, 33, and 52, respectively. These metals include both light and heavy metals. The light metals are also known as the alkali metals and the alkaline-earth metals. The heavy metals include brittle, ductile, and low-melting metals as described in the above-mentioned periodic table in Lange's Handbook of Chemistry.

Preferred metals for use in the boron acid salts of this invention are the light metals, particularly the alkali and alkaline-earth metals of groups IA and IIA having an atomic number less than 87, including, for example, lithium, sodium, potassium, cesium, magnesium, calcium, and barium, because these boron acid salts are easier to isolate from the reaction mixture. Cesium is a particularly preferred metal cation.

Examples of metal salts of boron-containing acids which can be used in the subject compositions are sodium decahydrodecaborate, magnesium decahydrodecaborate, titanium decahydrodecaborate, vanadium decahydrodecaborate, chromium decahydrodecaborate, manganese decahydrodecaborate, iron decahydrodecaborate, cobalt decahydrodecaborate, nickel decahydrodecaborate, copper decahydrodecaborate, zinc decahydrodecaborate, aluminum decahydrodecaborate, antimony decahydrodecaborate, tin decahydrodecaborate, potassium dodecahydrododecaborate, calcium dodecahydrododecaborate, lanthanum dodecahydrododecaborate, zirconium dodecahydrododecaborate, molybdenum dodecahydrododecaborate, iron dodecahydrododecaborate, cobalt dodecahydrododecaborate, silver dodecahydrododecaborate, cadmium dodecahydrododecaborate, aluminum dodecahydrododecaborate, lead dodecahydrododecaborate, bismuth dodecahydrododecaborate and mixtures thereof. Double metal salts of the aforementioned acids such as, for example, the double salt of cesium decahydrodecaborate and cesium nitrate, the double salt of cesium decahydrodecaborate and cesium dichromate, the double salt of cesium nitrate and mixtures thereof can also be employed in the subject invention. Such double salts can be prepared, for example, by bringing together in aqueous solution, the

various constituents of the double salt in substantially stoichiometric proportions and precipitating the resulting products from the aqueous medium. Thus, for example, the double salt of cesium decahydrodecaborate and cesium dichromate can be prepared by bringing together in an aqueous solution a substantially stoichiometric mixture of triethylammonium decahydrodecaborate, potassium dichromate and cesium hydroxide and precipitating the double salt from the resulting mixture.

Any solid inorganic oxidizing agent which will yield oxygen or sulfur upon decomposition and which will readily oxidize the boron-containing acid employed in the subject compositions, that is, will readily react or burn with the boron-containing acid, can be employed as the second essential constituent of the compositions of this invention. Solid oxygen-containing metal salts are preferred as oxidizing agents because of their availability and ease of incorporation into the composition.

Examples of solid inorganic oxidizing agents which can be used in the subject invention are ammonium, alkali, and alkaline-earth salts of inorganic oxygen-containing acids, such as nitric, chloric, perchloric, persulfuric, thiosulfuric, permanganic, periodic, iodic, bromic and chromic acids. Representative of these are cesium nitrate, barium nitrate, ammonium nitrate, sodium nitrate, potassium nitrate, potassium perchlorate, ammonium perchlorate, potassium chlorate, potassium permanganate, lithium perchlorate, sodium perchlorate, sodium dichromate, sodium thiosulfate, and lead chromate. Other solid inorganic oxidizing agents include lead thiocyanate, the oxides and peroxides of the light and heavy metals and nonmetals, such as barium peroxide, lead peroxide (PbO_2), lithium peroxide, ferric oxide, red lead (Pb_3O_4), cupric oxide, tellurium dioxide, antimonite oxide, etc. Mixtures of the aforementioned oxidizing agents also can be used.

As indicated hereinbefore the properties of the compositions of this invention can be varied widely depending upon the particular boron-containing acid and solid inorganic oxidizing agent employed and the ratio therefor. Generally, the molar ratio of the solid inorganic oxidizing agent to the metal salt of the boron-containing acid is preferably within the range of about from 0.5/1 to 10/1 respectively.

Additives conventionally employed in ignition compositions such as linear vinylidene fluoride-hexafluoropropylene copolymer; methylcellulose; gum arabic; dextrin; elastomeric compositions including, for example, polyurethanes, chloroprene rubbers, natural rubbers, acrylonitrile-butadiene elastomers, styrene-butadiene rubbers, polyisobutylene rubbers, and polysulfides, can be added to the compositions of this invention in conventional amounts, for example, in amounts up to about 2% by weight.

The compositions of this invention are prepared by merely intimately mixing the finely divided constituents therefor in conventional mixing equipment. Usually, although not necessarily, constituents having a particle size of less than 40 mesh (U.S. standard series) are employed in order to obtain optimum intermixture of the constituents. The preferred particle size is 100 mesh. The compositions of this invention are incorporated in various articles such as, for example, electric initiators and ignition cords, by procedures conventionally employed in the art for known ignition compositions.

Referring now to the drawings which illustrate the use of the ignition compositions of this invention, in FIGURE 1, 1 represents a tubular shell, e.g., of aluminum, copper, bronze, etc., 2 is a sealing plug, e.g., of natural or synthetic rubber, 3 are peripheral crimps in the shell wall for maintaining the plug in position, 4 are leg wires, 5 is a resistance bridgewire, 6 is an intimate blend of the novel ignition composition of the invention. It will be noted that in the embodiment of FIGURE 1, charge 6 is the only charge present in the igniter; however, additional charges conventionally used as priming or base charges

may be positioned below and adjacent charge 6 and may, in turn, be initiated or ignited by charge 6 and this is intended to be within the scope of the invention. All of the above features, except the novel ignition composition, represent conventional elements of electric initiators.

In FIGURE 2, 7 represents a continuous core of the composition of the invention contained within a flexible sheath 8, e.g., of nonmetallic material, such as fiberglass, or a ductile metal, e.g., aluminum, lead, copper, or a braided metal wire.

In addition to the foregoing specific examples, the following more detailed working examples illustrate numerous compositions of this invention and the properties thereof. In Example 1, immediately following, the effect of varying the proportions of the metal salt of the boron-containing acid and the solid inorganic oxidizing agent on the properties of the various compositions of this invention is illustrated.

EXAMPLE 1

Blends of cesium decahydrodecaborate ($Cs_2B_{10}H_{10}$) or cesium dodecahydrodecaborate ($Cs_2B_{12}H_{12}$), respectively, and potassium perchlorate were prepared by intimately mixing 100-mesh cesium decahydrodecaborate or dodecahydrodecaborate and 100-mesh potassium perchlorate in a mechanical blender. The various blends prepared and the physical and explosive properties of these blends are given in the following tables.

Table I

Blends of $Cs_2B_{10}H_{10}/KClO_4$ (moles)	Impact Sensitivity (inches)	Static Sensitivity (mev.)	Ignition Time (milliseconds) 2 grains loose	Thermal Stability ($^{\circ}C.$)
1/0.5	>45	>77,500	4.2	480
1/1	6	>77,500	3.4	485
1/2	8	•	•	490
1/8	8	>77,500	•	495
1/8	2	>77,500	3.8	500
1/10	3	25,600	3.5	510

*Not determined.

Table II

Blends of $Cs_2B_{12}H_{12}/KClO_4$ (moles)	Impact Sensitivity (inches)	Static Sensitivity (mev.)	Ignition Time (milliseconds) 2 grains loose	Thermal Stability ($^{\circ}C.$)
1/0.5	>45	>77,500	•	475
1/1	>45	>77,500	5.0	450
1/8	5	>77,500	4.5	440

*Not determined.

The impact sensitivity of the compositions in the above tables was determined by placing a portion of the composition of this invention in a thin, uniform layer on a steel plate and determining the height at which a 1/2-inch diameter steel ball (8.3 grams) dropped on the mixture will detonate the mixture. When the steel ball is dropped from a height of at least 45 inches and the mixture does not detonate, the mixture is termed impact insensitive. The static sensitivity was determined conventionally by placing a portion of the mixture in a copper shell having leg wires. The leg wires were twisted together and connected to the high voltage terminal of a double "leg-to-shell" static sensitivity apparatus consisting essentially of a source of variable voltage and a series of micromicrofarad condensers ranging in capacitance from 250-2000 $\mu\mu\text{f.}$; the shell was connected to a ground line. Voltages from 0 to 30,000 volts were applied to a condenser of known capacitance in increments of 1,000 volts and the condenser was allowed to discharge through the shell containing the mixture. Those mixtures are considered not static sensitive in which a static charge of at least 10,000 volts at 0.0003 microfarad, i.e., 10,000 man-

equivalent volts (m.e.v.) is needed to ignite or detonate the mixture (1 man-equivalent-volt charge is the energy of a condenser of 0.0003 microfarad capacitance charged to a potential of 1 volt). The maximum charge which may be applied in conventional equipment is 77,500 m.e.v. The ignition time was determined in the above tables by using 2 grains of a loose or pressed composition of this

EXAMPLE 3

A number of ignition cords were prepared by drawing down through a series of dies a lead tube filled with one of the following mixtures. The distribution of the mixture within the lead sheath, the outer diameter of the cords, and the burning rate of the cords are summarized in Table IV.

Table IV

Mixtures		Outer Diameter of cord (Lch)	Distribution of Mixture (grains/ft.)	Burning Rate (meter/sec.)	Burning Rate (in./sec.)
Boron-Containing Salt/Oxidant	Mole Ratio				
Cs ₂ B ₁₀ H ₁₀ /KClO ₄	1/6	0.105	11.05	329	•
Cs ₂ B ₁₀ H ₁₀ /NaNO ₃	1/6	0.105	10.5	158	•
Cs ₂ B ₁₀ H ₁₀ /Pb ₂ O ₃	1/3	0.105	28.4	•	0.86
Cs ₂ B ₁₀ H ₁₀ /KMnO ₄	1/3	0.103	18.4	14.8	•
Cs ₂ B ₁₀ H ₁₀ /Na ₂ Cr ₂ O ₇ ·2H ₂ O	1/2	0.105	11.03	•	0.31
Cs ₂ B ₁₀ H ₁₀ /BaO ₂	1/6	0.105	19.4	•	1.75
Cs ₂ B ₁₀ H ₁₀ /Na ₂ S ₂ O ₈	1/2	0.105	11.2	•	1.0

*Not determined.

invention as the ignition charge in a conventional electric blasting cap assembly consisting of a copper shell containing 4 grains of pentaerythritol tetranitrate pressed at 200 pounds as the base charge and 3 grains of lead azide pressed at 200 pounds as the primer charge, applying a direct current of 5 amperes to a 0.0019-inch diameter "Nichrome" (80/20 alloy of nickel and chromium) bridgewire imbedded in the ignition charge, and measuring the time interval between the closing of the switch on the source of the firing current and a bursting of the shell. The thermal stability is that temperature up to which the mixture exhibited no change in appearance or did not detonate.

An equimolar amount of other metal salts of the aforementioned boron-containing acids such as, for example, sodium, magnesium, barium, potassium, calcium, silver decahydrodecaborate or dodecahydrododecaborate can be employed in the above compositions to yield ignition compositions having generally similar properties.

The following example illustrates the use of various different solid oxidants in the compositions of this invention.

EXAMPLE 2

Mixtures in the proportions indicated in the following tables were prepared according to the procedure of Example 1. The physical and explosive properties of these blends are as follows.

Table III

Mixtures	Mole Ratio	Ignition Time (milliseconds)		Impact Sensitivity (inches)	Static Sensitivity (mev.)	Thermal Stability (°C.)
		3 grains pressed at 200 lbs	2 grains loose			
Cs ₂ B ₁₀ H ₁₀ /CsNO ₃	1/1	•	5.0	>45	21,000	290
Cs ₂ B ₁₀ H ₁₀ /KClO ₄	1/6	•	3.2	3	27,400	330
Cs ₂ B ₁₀ H ₁₀ /NaNO ₃	1/6	17.9	4.8	>45	54,800	335
Cs ₂ B ₁₀ H ₁₀ /Pb ₂ O ₃	1/3	29.6	6.7	>45	28,400	510
Cs ₂ B ₁₀ H ₁₀ /KMnO ₄	1/3	43.7	5.6	>10	14,680	280
Cs ₂ B ₁₀ H ₁₀ /Na ₂ Cr ₂ O ₇ ·2H ₂ O	1/2	238.6	135.1	>45	>77,500	260
Cs ₂ B ₁₀ H ₁₀ /BaO ₂	1/6	68.6	16.3	>45	54,100	•
Cs ₂ B ₁₀ H ₁₀ /Na ₂ S ₂ O ₈	1/2	52.6	12.1	35	24,600	•

*Not determined.

The impact and static sensitivity and the ignition time and thermal stability of the mixtures in Table III were determined by the methods described in Example 1. All of the squibs functioned satisfactorily.

The use of the novel ignition compositions in ignition cord depicted in FIGURE 2 is illustrated by the following.

In a like manner, ignition cords can be prepared as described above with ignition compositions in which sodium, barium, potassium decahydrodecaborate, or dodecahydrododecaborate is substituted, on a molar basis, for some or all of the cesium decahydrodecaborate employed above.

I claim:

1. An ignition composition comprising an intimate physical mixture of (a) a metal salt of a boron-containing acid selected from the group consisting of decahydrodecaboric acid and dodecahydrododecaboric acid, and (b) a solid inorganic oxidizing agent.

2. An ignition composition of claim 1 wherein said metal in said metal salt is selected from the group consisting of alkali and alkaline earth metals of groups IA and IIA having an atomic number of less than 87 and said solid inorganic oxidizing agent is an oxide or peroxide.

3. An ignition composition of claim 1 wherein said metal in said metal salt is selected from the group consisting of alkali and alkaline earth metals of groups IA and IIA having an atomic number of less than 87 and said solid inorganic oxidizing agent is selected from the group consisting of ammonium, alkali, and alkaline earth salts of oxygen-containing inorganic acids.

4. An ignition composition of claim 3 wherein said metal salt is a salt of decahydrodecaboric acid.

5. An ignition composition of claim 3 wherein said metal salt is a salt of dodecahydrododecaboric acid.

6. An ignition composition comprising an intimate physical mixture of cesium decahydrodecaborate and potassium perchlorate.

7. An ignition composition comprising an intimate physical mixture of cesium dodecahydrododecaborate and potassium perchlorate.

No references cited.

March 24, 1964

R. K. ARMSTRONG

3,126,305

IGNITION COMPOSITIONS COMPRISING BORON CONTAINING SALTS

Filed Jan. 12, 1962

FIG. 1

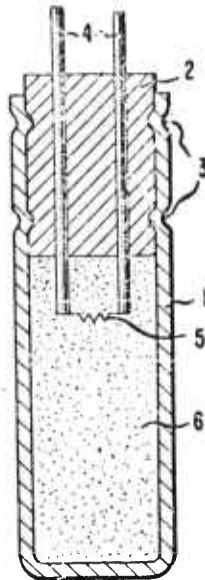
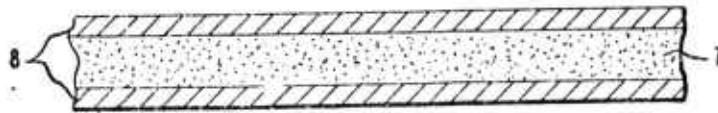

FIG. 2



INVENTOR
ROBERT K. ARMSTRONG

BY

John F. Schmitt

ATTORNEY

1

3,138,602

AMINE-DECABORANE ADDUCTS AND PREPARATION THEREOF

John W. Szymanski, Niagara Falls, and Samuel I. Trotz, Tonawanda, N.Y., assignors to Olin Mathieson Chemical Corporation, a corporation of Virginia
No Drawing. Filed Nov. 16, 1959, Ser. No. 853,370
12 Claims. (Cl. 260-293)

This invention relates to solid reaction products of certain amines and decaborane.

The solid products of this invention when incorporated with suitable oxidizers, such as ammonium perchlorate, potassium perchlorate, sodium perchlorate, ammonium nitrate and etc., yield solid propellants suitable for rocket power plants and other jet propelled devices. Such propellants burn with high flame speeds, have high heats of combustion and are of the high specific impulse type. Probably the single most important factor in determining the performance of a propellant charge is the specific impulse, and appreciable increases in performance will result from the use of the higher specific impulse materials. The products of this invention when incorporated with oxidizers are capable of being formed into a wide variety of grains, tablets and shapes, all with desirable mechanical and chemical properties. Propellants produced by the methods described in this application burn uniformly without disintegration when ignited by conventional means, such as a pyrotechnic type igniter, and are mechanically strong enough to withstand ordinary handling.

Several investigations have been reported concerning the simple acid-base adduct formation between decaborane and amines. Note, for example, the article reporting decaborane-dimethylamine adducts by S. J. Fitch and A. W. Laubengayer, J. Am. Chem. Soc., vol. 80, page 5911-5913 (1958). The simple acid-base reaction yields adducts whose compositions are dependent on the temperature of the reaction mixture and the ratio of amine to decaborane. The amine molecules may be removed in a somewhat stepwise manner by warming and evacuation. Apparently the monamine and diamine adducts are quite stable at ambient temperatures but may be decomposed into the original components at slightly elevated temperatures. It is possible to regenerate the decaborane quantitatively by displacement with hydrogen chloride, and presumably other strong acids will effect the same displacement.

It has been found that in the presence of excess amine and heat, an additional reaction occurs according to the following equations:

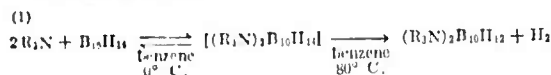

or



The reaction involves the loss of hydrogen and the formation of the very stable bis-aminodecaborane compound. The compounds are usually white, crystalline materials with high melting points. They are quite insoluble in the common aliphatic hydrocarbons and in ether, but demonstrate moderate solubility in alcohols and acetone from which they may be crystallized. The degradative alcoholysis which occurs with decaborane at room temperature does not take place in the case of these diamino-decaborane compounds even at the reflux temperature of the alcohol.

In the normal course of synthesis, one mole of hydrogen is evolved for each mole of decaborane used. The fact that the loss of hydrogen occurs in the case of the

2

tertiary amines as well as primary and secondary amines suggests that the amino hydrogen atom is not involved but that the hydrogen atoms evolved originate exclusively from the decaborane.

The infrared spectra of mono amine adducts, bis amine adducts and bis amino compounds, when compared to the spectrum of decaborane itself, exhibit definite alterations. The most obvious differences occur in the regions ascribed to the bridge hydrogen B-H stretch frequencies, normally a doublet at 5.20 and 5.30 μ and a triplet over the 6.40-6.80 μ region. The B-H absorption band normally at 3.85 μ is displaced slightly to about 4.0 μ .

Hence, the solid reaction products of this invention are prepared by reacting decaborane with a primary, secondary or tertiary amine at a temperature above about 75° C.

Suitable primary amines include, for example, methylamine, ethylamine, n-propylamine, isopropylamine, n-butylamine, isobutylamine, sec-butylamine, tert-butylamine, n-amyamine, isoamyamine, 2-aminopentane, tert-amyamine, n-hexylamine and n-octylamine. Suitable secondary amines include, for example, dimethylamine, diethylamine, di-n-propylamine, diisopropylamine, di-n-butylamine, diisobutylamine, di-sec-butylamine, methylethylamine, piperidine, morpholine and the like. Suitable tertiary amines include for example, trimethylamine, triethylamine, tri-n-propylamine, ethyldimethylamine, n-propyldimethylamine, methyl-diethylamine, 2-chloroethyldimethylamine, tri-n-butylamine, triisobutylamine, tri-n-amyamine, triisoamyamine, and the like.

The ratio of reactants can be varied widely, generally being in the range 2 to 20 moles of amine per mole of decaborane, preferably 3 to 10:1. The reaction temperature can vary from about 75° C. to 150° C. and the pressure can vary from subatmospheric to several atmospheres, although atmospheric pressure reactions are convenient. The reaction to go to completion generally requires from one to fifty hours depending upon the ratio of reactants, the particular reactants utilized, and the temperature and pressure employed. Hydrogen is evolved in the amount of one mole per mole of decaborane.

Although the reaction will proceed in the absence of a solvent, best results are obtained by carrying out the reaction in a solvent common for the reactants but inert with respect to the reactants. Such solvents include aliphatic hydrocarbon solvents such as n-pentane, hexane and heptane, aromatic hydrocarbon solvents such as benzene, toluene and xylene, cycloaliphatic solvents such as cyclohexane and methylcyclopentane and oxygenated organic solvents such as dioxane, ethyl acetate, and diisopropyl ether. Dioxane and ethyl acetate form shock sensitive solutions with decaborane and so are less favorable solvents. The amount of solvent can vary widely but generally ranges up to about 70 times the weight of the reactants.

The process of the invention is illustrated in detail by the following examples which are to be considered not limitative.

EXAMPLE I

In a 500 ml., three-necked, round bottomed flask, were placed 12.2 g. of decaborane (0.1 mole) dissolved in 300 ml. of benzene. The flask was fitted with a dewar-type condenser, cooled by a Dry-Ice acetone mixture, and a dropping funnel topped by a similar Dry-Ice condenser. Trimethyl amine was condensed into the dropping funnel to the extent of 60 ml., slightly in excess of 0.6 mole.

The benzene solution of decaborane was then maintained at 0° C. and stirred with a magnetic stirrer while the liquefied amine was added dropwise over a one hour period. During the addition of the amine a white precipitate formed which turned light green on continued amine

addition. The precipitate appeared to go into solution for the most part during the later stages of amine addition. When the final reaction mixture was permitted to warm to room temperature, a white crystalline material was formed. A portion of this material was removed, washed with benzene, and submitted as a sample for infrared analysis. The body of the reaction mixture was then heated slowly to the reflux temperature of benzene and the volatile materials which were evolved passed through Dry-Ice and liquid nitrogen traps and into a "wet test meter." Thirty-one ml. of trimethylamine were collected and 2870 ml. of hydrogen were measured over a 12 hour period.

The reaction mixture was then cooled to room temperature and filtered. The solid obtained was washed three times with benzene and three times with anhydrous diethyl ether. The crude product weighed 18.5 g. It was found that a portion of this final solid could be extracted with acetone. Approximately 23 percent of the solid reaction mixture was insoluble in acetone. The extracted portion was recrystallized from acetone and samples submitted for chemical analysis of boron and nitrogen as well as for infrared analysis.

Calculated for $B_{10}H_{12}(CH_3)_3N)_2$: B, 45.74; N, 11.84. Found: B, 45.5; N, 12.39.

There are characteristic differences between the infrared spectra of decaborane, the amine adduct, and the amino compound.

EXAMPLE II

To 1.2 g. of decaborane (0.01 mole) in 25 ml. of benzene were added 10 ml. of condensed trimethylamine while the mixture was maintained at 0° C. Slight yellowing of the solution occurred as the amine was introduced. The large amount of precipitate initially formed was converted to a yellowish oil as the excess amine was added. The mixture was then heated and the excess amine distilled while the non-condensable gas was measured.

The net volume of hydrogen evolved was measured as 228 ml. (204 ml. S.T.P.). There was an obvious cessation of gas evolution at a point which corresponded closely to one mole of hydrogen per mole of decaborane. Evaporation of the solvent left a solid, slightly yellow in color, weighing 2.3 g., 96 percent of theoretical.

This product was purified by recrystallizations from n-butanol and the identity was confirmed by elemental analysis. Comparison of the infrared spectra of the purified and crude materials indicated that the product, as isolated from the reaction mixture, was nearly pure.

Calculated for $B_{10}C_6H_{30}N_2$: B, 45.36; N, 11.75. Found: B, 45.5, 44.9; N, 12.45, 12.24.

EXAMPLES III THROUGH VI

In a manner similar to that described in Examples I and II, decaborane was reacted respectively with dimethylamine, triethylamine, piperidine, and 2-chloroethyltrimethylamine. The pertinent data are given in Table I below:

Table I

BIS-AMINO DECABORANE COMPOUNDS

Example	Compound	M.W.	Analysis		M.P., °C.	Yield, Percent	Solvent of Crystallization
			Calc., percent	Found, percent			
II	$B_{10}H_{12}(CH_3)_2N)_2$	298.52	B, 45.36 N, 11.75	45.5, 44.0 12.45, 12.24	255	96	n-Butanol.
III	$B_{10}H_{12}(CH_2)_3NH)_2$	210.44	B, 51.42 N, 13.31	51.5 13.41, 13.38	220-230.5	50	Do.
IV	$B_{10}H_{12}(C_2H_5)_2N)_2$	322.68	B, 33.53 N, 8.68	32.9, 32.9 8.48, 8.45	223-224	92	Acetone.
V	$B_{10}H_{12}(C_6H_{11})N)_2$	296.60	B, 37.23 N, 9.64	37.1, 37.3 9.88	234-235	95	Benzene.
VI	$B_{10}H_{12}(ClCH_2CH_2-N(CH_3)_3)_2$	335.47	B, 32.25 C, 28.61 H, 9.62	31.4, 31.9, 31.2 28.4, 30.2, 29.1 9.04, 9.51, 9.81	183	83.5	Acetone.

There was a tendency on the part of some of the amino compounds to crystallize with solvent of crystallization. In the case of the piperidino compound, the mono-benzenate was isolated and identified. The solvent was easily removed from the solvated materials by mild heating under vacuum for a few hours.

The boron containing solid materials produced by practicing the methods of this invention, can be employed as ingredients of solid propellant compositions in accordance with general procedures which are well understood in the art, inasmuch as the solids produced are readily oxidized using conventional solid oxidizers such as ammonium perchlorate, potassium perchlorate, sodium perchlorate and the like. In formulating a solid propellant composition employing one of the materials produced in accordance with the present invention, generally from 10 to 35 parts by weight of boron containing material and from 65 to 90 by weight of oxidizer are present in the final propellant composition. In the propellant, the oxidizer and the product of the present process are formulated in intimate admixture with each other, as by finely dividing each of the materials separately and thereafter intimately mixing them. The purpose of doing this, as the art is well aware, is to provide proper burning characteristics of the final propellant. In addition to the oxidizer and the oxidizable material, the final propellant can also contain an artificial resin or polymer such as the polyurethane type, the function of the resin being to give the propellant mechanical strength and at the same time improve its burning characteristics. Thus, in manufacturing a suitable propellant, proper proportions of finely divided oxidizer and finely divided boron containing material can be admixed with a high solids content solution of a resin such as that mentioned previously or a prepolymer of the resin, the proportions being such that the amount of resin is about 5 to 10 percent by weight based on the weight of oxidizer and boron compound. The ingredients are thoroughly mixed with the simultaneous removal of solvent, and following this the solvent free mixture is molded into the desired shape, as by extrusion. Thereafter the resin can be cured by resorting to heating at moderate temperatures. For further information concerning the formulation of solid propellant compositions, a reference is made to U.S. Patent 2,622,277 to Bonnell and U.S. Patent 2,646,596 to Thomas.

We claim:

1. A process for the preparation of solid reaction products of amines and decaborane which comprises reacting from 2 to 20 moles of an amine selected from the class consisting of lower alkyl amines, lower monochloroalkylamines, morpholine and piperidine per mole of decaborane with the evolution of hydrogen at a temperature above about 75° C. and up to about 150° C.

2. A process for the preparation of solid reaction products of amines and decaborane which comprises reacting from 2 to 20 moles of an amine selected from the class consisting of lower alkyl amines, lower monochloroalkyl-

5

amines, morpholine and piperidine per mole of decaborane with the evolution of about one mole of hydrogen per mole of decaborane while the reactants are in admixture with a solvent inert with respect to the reactants at a temperature above about 75° C. and up to about 150° C. 5

3. The process of claim 2 wherein the amine is trimethylamine.

4. The process of claim 2 wherein the amine is dimethylamine.

5. The process of claim 2 wherein the amine is triethylamine. 10

6. The process of claim 2 wherein the amine is piperidine.

7. The process of claim 2 wherein the amine is 2-chloroethyldimethylamine.

8. The process of claim 1 wherein the amine is trimethylamine and the solvent is benzene.

9. The process of claim 1 wherein the amine is dimethylamine and the solvent is benzene.

6

10. The process of claim 1 wherein the amine is triethylamine and the solvent is benzene.

11. The process of claim 1 wherein the amine is piperidine and the solvent is benzene.

12. The process of claim 1 wherein the amine is 2-chloroethyldimethylamine and the solvent is benzene.

References Cited in the file of this patent

UNITED STATES PATENTS

2,558,560	Safford	June 26, 1951
2,961,444	Aftandilian	Nov. 22, 1960

OTHER REFERENCES

- Schechter et al.: "Boron Hydrides and Related Compounds," Callery Chemical Co., Jan. 8, 1951, p. 37.
 Broadley: General Electric Co., Report No. 55248, Jan. 6, 1948, pp. 8, 9 and 11.
 Fitch et al.: J. Am. Chem. Soc., vol. 80, pp. 5911-5913.

1

3,148,938

AMMONIA AND HYDRAZINE SALTS OF
THE $B_{10}H_{10}^{2-}$ ANION

Walter H. Knuth, Jr., Mendenhall, Pa., assignor to E. I. du Pont de Nemours and Company, Wilmington, Del., a corporation of Delaware
No Drawing. Filed Feb. 5, 1960, Ser. No. 6,853
6 Claims. (Cl. 23-14)

This invention relates to boron compounds. More particularly, it relates to novel boron hydride derivatives and to a method for their preparation.

Boron hydrides have recently become of interest in various applications. One such application for which they have been found especially useful is in the field of high energy fuels. The principal object of the present invention is therefore, to provide new boron hydride derivatives suitable as a high energy fuel and for other utilities. Another object is provision of a process for making the novel compounds.

In the furtherance of the above-mentioned and yet other objects, there are now provided compounds which are the ammonium and hydrazine salts of the boron hydride anion of the formula $B_{10}H_{10}^{2-}$. These compounds have the formulas $(NH_4)_2B_{10}H_{10}$ and $(NH_2NH_2)_2B_{10}H_{10}$. These compounds are solids having a high heat of combustion and, because of this property, they are especially useful as high energy fuels. They are free of carbon and other elements of atomic number higher than 14, which elements, if present, would result in lower heats of combustion.

The boron hydride salts of this invention are prepared by reaction of 2 moles of ammonium hydroxide or hydrazine hydrate with 1 mole of the boron hydride acid, $H_2^{+}B_{10}H_{10}^{2-} \cdot (H_2O)_3$ for, as the hydronium compound, $[H_3O]_2^{+}B_{10}H_{10}^{2-} \cdot (H_2O)$, in aqueous solution. The reaction is conveniently carried out by neutralizing ammonium hydroxide or hydrazine hydrate with an aqueous solution of the boron hydride acid at ordinary temperatures (20°-30° C.). The resulting neutral solution is evaporated to dryness to leave a solid crystalline residue of the salt. This salt can then be dried at ordinary or moderately elevated temperatures under reduced pressure.

The acid, $H_2^{+}B_{10}H_{10}^{2-} \cdot (H_2O)_3$, used as starting material in the process of this invention can be prepared by treating an aqueous solution of an amine salt of a boron hydride having the formula $(R_{4-x}NH_x)_2B_{10}H_{10}$, wherein R is alkyl and x is 1, 2 or 3, with a strongly acidic ion exchange resin capable of replacing cations, e.g., the ion exchange resin of the sulfonic acid type known commercially as "Amberlite" grade "IR-120," acid form (see U.S. Patent 2,901,398). The free acid is obtained from the aqueous solution by evaporation at moderately elevated temperatures, e.g., 40-50° C., at reduced pressure. This process is described in greater detail in application S.N. 6,855, filed February 5, 1960.

An alternative method for the preparation of the ammonium salt of the $B_{10}H_{10}^{2-}$ anion comprises the reaction of liquid ammonia with a decaboryl bis(organic sulfide), preferably a decaboryl bis(dialkyl sulfide), at a temperature between about -50° C. and 0° C. Bis(low- or dialkyl sulfides), i.e., those in which each alkyl group has up to 8 carbons, are especially useful as starting materials in this reaction. After the reaction between the ammonia and the decaboryl derivative is complete (about 1 hour being sufficient under these reaction conditions) the resulting solution of the ammonium salt of the $B_{10}H_{10}^{2-}$ anion is isolated by allowing the excess ammonia to evaporate. The crude product is purified by subjecting it to a high vacuum (0.01 mm. of mercury) at a temperature of 25° C.

2

Another embodiment of the method for the preparation of the ammonium salt of the $B_{10}H_{10}^{2-}$ anion comprises the reaction of ammonium hydroxide in aqueous or aqueous-alcoholic solution with a decaboryl bis(alkyl sulfide), preferably a decaboryl bis(alkyl sulfide) in which each alkyl group has up to eight carbon atoms. This embodiment can be carried out at temperatures ranging from room temperature (20-30° C.) up to 100° C., and preferably at a temperature between 60° and 85° C. The resulting ammonium salt is isolated from the reaction mixture by evaporation of the filtered reaction solution to dryness.

The decaboryl bis(dialkyl sulfide) used as starting material in this alternative process can be prepared by contacting a dialkyl sulfide with decaborane at a temperature between 0° C. and 150° C. until approximately 1 mole of hydrogen is evolved. The preparation of decaboryl bis(alkyl sulfides) is described in greater detail in U.S. application S.N. 750,862, filed July 25, 1958, by E. L. Muettterties.

The products of this invention are illustrated in further detail by the following examples:

Example I

PREPARATION OF $(NH_4)_2B_{10}H_{10}$

Decaboryl bis(dimethyl sulfide) (8.5 g., 3.5 millimoles) is mixed into 50 ml. of liquid ammonia and stirred in a round-bottomed reaction vessel for 1 hour with the vessel being cooled to a temperature of about -50° C. by partial immersion in a bath of a mixture of solid carbon dioxide and acetone. The cooling bath is then removed and the excess ammonia is allowed to evaporate with stirring. The remaining traces of ammonia are removed by subjecting the residue to a high vacuum (0.01 mm. of mercury) at 25° C. There is obtained 5.6 g. of solid residue which is a virtually quantitative yield of $(NH_4)_2B_{10}H_{10}$.

Analysis.—Calcd. for $B_{10}H_{10}N_2$: B, 70.0%; H, 11.7%; N, 18.2%. Found: B, 66.7%; H, 12.2%; N, 18.5%.

This salt is water soluble. Its aqueous solutions are highly conductive to an electric current. The high dissociation of this compound in water is also shown by its apparent molecular weight, as determined by freezing point lowering in water. The observed value is 64 compared to a true molecular weight of 154 and a theoretical molecular weight, assuming complete dissociation, of 51.3.

Example II

PREPARATION OF $(NH_2NH_2)_2B_{10}H_{10}$

Hydrazine hydrate is added to an aqueous solution of $H_2^{+}B_{10}H_{10}^{2-} \cdot (H_2O)_3$ until the resulting clear solution is neutral. The reaction solution is evaporated and the resulting crystalline solid residue is then dried at 25° C. under a pressure of 1 mm. mercury for 4 hours.

Analysis.—Calcd. for $B_{10}H_{20}N_4$: B, 58.6%. Found: B, 56.87%.

This $(NH_2NH_2)_2B_{10}H_{10}$ burns extremely rapidly compared to amine salts of $B_{10}H_{10}$.

When the process of Example II is repeated with the single exception that the hydrazine hydrate is replaced by an equivalent quantity of ammonium hydroxide, the ammonium salt $(NH_4)_2B_{10}H_{10}$ is obtained.

Example III

ALTERNATE PREPARATION OF $(NH_4)_2B_{10}H_{10}$

Decaboryl bis(dimethyl sulfide) and a mixture of equal parts of concentrated aqueous ammonium hydroxide and methyl alcohol are heated on a steam bath for several minutes. The reaction mixture is then cooled and filtered and the filtrate is evaporated to dryness. The re-

3

sulting solid is the ammonium salt of the formula

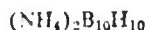

The identity of this salt is confirmed by its infrared absorption spectrum.

The salts of this invention are especially useful as high energy fuels, because of their high heats of combustion. The ammonium and hydrazine salts of $\text{B}_{10}\text{H}_{10}^-$ anion, being free of carbon, have a marked advantage over the substituted ammonium salts of $\text{B}_{10}\text{H}_{10}^-$ in their value as high energy fuels.

The salts of this invention are also useful as chemical intermediates.

Since obvious modifications and equivalents in the invention will be evident to those skilled in the chemical arts, I propose to be bound solely by the appended claims.

The embodiments of the invention in which an exclusive property or privilege is claimed are defined as follows:

1. The ammonium and hydrazine salts of the boron hydride anion $\text{B}_{10}\text{H}_{10}^-$, said salts being selected from

4

the class consisting of $(\text{NH}_4)_2\text{B}_{10}\text{H}_{10}$ and



2. $(\text{NH}_4)_2\text{B}_{10}\text{H}_{10}$.

3. $(\text{NH}_2\text{NH}_3)_2\text{B}_{10}\text{H}_{10}$.

4. The process which comprises reacting a member of the group consisting of ammonium hydroxide and hydrazine hydrate with the boron hydride acid

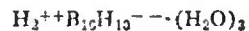

and isolating the resulting product.

5. The process which comprises reacting, at a temperature in the range -50° to 0° C., ammonia with a decaboryl bis(lower alkyl sulfide), and isolating the resulting product.

6. Process for preparing $(\text{NH}_4)_2\text{B}_{10}\text{H}_{10}$ which comprises reacting at a temperature in the range of 20° to 100° C. ammonium hydroxide with a decaboryl bis(lower alkyl) sulfide and isolating the resulting $(\text{NH}_4)_2\text{B}_{10}\text{H}_{10}$.

References Cited in the file of this patent

Lipscomb: J. Am. Chem. Soc., vol. 81, No. 21, pp. 5833, 5834, Nov. 5, 1959.

1

2

3,148,939
HYDRATES, METAL SALTS AND HYDRATED
METAL SALTS OF ACID $H_2B_{10}H_{10}$

Walter Henry Knott, Jr., Mendonhall, Pa., assignor to
E. I. du Pont de Nemours and Company, Wilmington,
Del., a corporation of Delaware
No Drawing. Filed Feb. 5, 1960, Ser. No. 6,855
18 Claims. (Cl. 23-14)

This invention relates to a novel boron-containing acid
and metal salts thereof and to methods for their prepara-
tion.

More particularly, this invention is directed to com-
pounds which can be represented by the formula:

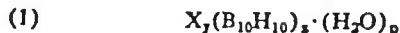

where X is selected from the group consisting of hydrogen
and metal ions, y is the number of X ions and is a positive
whole number greater than 0 and smaller than 3 (i.e., 1
or 2), z is equal to

$$\frac{y \text{ times the valence of the X ions}}{2}$$

and p is the number of molecules of water of hydration
and is a cardinal number from 0 to 3, inclusive.

In Formula 1, the value of p is independent of that for
either y or z. When two or more X ions are present, these
can be ions of the same or different element (i.e., hydro-
gen or a metal), but usually such ions in any given salt
will all have the same valence, as in Formula 1.

The metal ions in the salts of this invention can be de-
rived generally from any metal. The metals according to
the Periodic Table in Deming's "General Chemistry," 5th
ed., chap. 11, John Wiley & Sons, Inc., and in Lange's
"Handbook of Chemistry," 9th ed., pp. 56-57, Handbook
Publishers, Inc. (1956), are the elements of Groups I, II,
VIII, III-B, IV-B, V-B, VI-B, VII-B and the elements of
Groups III-A, IV-A, V-A, and VI-A which have atomic
numbers above 5, 14, 33 and 52, respectively. These
metals include both light and heavy metals. The light
metals are also known as the alkali metals and the alkaline
earth metals. The heavy metals include brittle, ductile
and low-melting metals as described in the above-men-
tioned Periodic Table in Lange's "Handbook of Chem-
istry."

Preferred metal cations are derived from the elements
of Groups I-A, II-A, I-B, II-B, and of Groups VI-B and
VIII having an atomic number less than 75.

Most preferred metals for use in the salts of this inven-
tion are the light metals (the alkali and alkaline earth
metals of Groups I-A and II-A, having an atomic num-
ber less than 87, i.e., lithium, sodium, potassium, rubidium,
cesium, beryllium, magnesium, calcium, strontium, and
barium, and elements of Group I-B having an atomic
number less than 79 and of Group II-B having an atomic
number less than 81, i.e., copper, silver, zinc, cadmium
and mercury.

The anion of the novel boron-containing acid of this
invention can be conveniently represented by the formula:



The acid of this invention can be represented by the
formula:

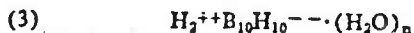

where n is a positive whole number greater than 1 and
less than 4 (i.e., 2 or 3). The acid can also be repre-
sented as a hydronium compound, and as such is charac-
terized by the formula:

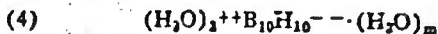

where m is the whole number 0 or 1. Formula 4 shows
perhaps most clearly the form of the association of two
moles of water in the acid. However, in this application,
Formula 3 will be used to identify the novel acid of the
present invention, except that when the acid is in H_2O
solution, water of hydration may be disregarded.

The boron-containing acid of Formula 3 is prepared by
contacting an aqueous solution of a boron hydride amine
salt with a strongly acidic cation exchange resin.

The boron hydride amine salt used can be represented
by the formula:

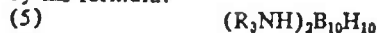

wherein R is hydrogen or an alkyl radical (preferred alkyl
radicals contain less than 19 carbon atoms). More pre-
ferred boron hydride amine salts for use in the present in-
vention are those of Formula 5 wherein R is hydrogen
or an alkyl radical of less than 7 carbon atoms.

The strongly acidic cation exchange resin is preferably
of the sulfonic acid variety, for sulfonic acid resins are
commonly available strongly acidic resins as the art appre-
ciates.

Common strongly acid cation exchange resins which are
commercially available include "Amberlite" IR-120-H, a
trademark of the Rohm & Haas Co., and "Dowex" 50,
a trademark of the Dow Chemical Co. These resins, in
general, comprise a copolymer base of a styrene polymer
cross-linked with a divinylbenzene which base is sulfon-
ated to introduce sulfonic acid groups into the aryl nu-
cleus as the polar groups.

As indicated, the boron hydride amine salt of Formula
5 is contacted with such a strongly acidic cation exchange
resin. This contact is accomplished by passing an aque-
ous solution of the amine salt through the ion exchange
resin, or, alternatively, by stirring the ion exchange resin
in an aqueous solution of the amine salt. While the con-
centration of amine salt in the aqueous solution can vary
over extremely wide limits and is entirely non-critical in
value, it is preferred to use an aqueous solution containing
from about 5 to 75 weight percent of the amine salt. Time
of contacting is not critical.

The aqueous solution of the amine salt is conveniently
passed through a cylindrical reaction tube packed with the
ion exchange resin, or the ion exchange resin is stirred
with an aqueous solution of the amine salt in a corrosive
resistant container. Any operating temperature between the
freezing point and boiling point of water can be used.

In general, the pH of the effluent or filtrate (as the case
may be) following contact with the exchange resin de-
pends at least in part on concentration of $B_{10}H_{10}^{--}$
anion. Such effluent or filtrate is thus never neutral or
basic (i.e., the pH is always less than 7).

The boron-containing acid is soluble in water and can
be isolated from the clear, colorless, aqueous effluent
by evaporation of the water at moderately elevated tem-
peratures, e.g., 30-40° C. for several hours, preferably
under reduced pressure (0.1-5 mm. of mercury). The
residue is a liquid which is free of nitrogen.

The acid of this invention is strongly acidic and is
stable indefinitely in aqueous solution. This is a unique
property that is not exhibited by any other known boron
hydride acid. This acid also has the unique property of
being hypergolic with phosphorus pentoxide. The acid
is soluble in ethers, alcohols, and water and it forms a red
dye when reacted with concentrated nitric acid under
certain conditions. The most significant bands in the in-
frared absorption spectrum of this acid are found at ap-
proximately 2.75, 4.0, 6.2, 9.25 and 9.7 microns. This
acid is also a polymerization initiator, e.g., it polymerizes
isobutylene at room temperature under a pressure of 1-3
atmospheres or more. This acid has a pKa value of
approximately 1.5.

The metal salts of this invention can easily be prepared by any of three routes. On one, the acid is neutralized to a pH of at least 7 in aqueous solution with an aqueous dispersion (i.e., a solution or suspension) of an inorganic base containing the desired metal, such as an alkali or alkaline earth metal hydroxide.

In general, one will employ an aqueous solution of the inorganic base which contains from about 1 up to say 75 weight percent of the desired metal. In any given instance, of course, the actual amount of metal needed will be the molal equivalent weight needed to form the metal salt of the desired acid. Thus, this process involves the step of neutralizing an aqueous solution of the acid $H_2^{++}B_{10}H_{10}^{--}$ with an aqueous dispersion of an inorganic base containing the metal whose salt of $B_{10}H_{10}$ anion is desired.

The resulting aqueous solution of the metal salt of the $B_{10}H_{10}^{--}$ anion is concentrated by evaporation of water until the salt crystallizes out. The crystalline salt is then dried under reduced pressure, e.g., 0.1 mm. of mercury, and moderately elevated temperatures, e.g., 100° C. The water of hydration of the metal salts can be removed by heating for several hours at a temperature of about 200° C. under low pressure, e.g., 0.1 mm. mercury or even lower. This method is especially suitable for preparing alkali metal and alkaline earth metal salts.

In the second method, the salts of this invention can be prepared by reaction of a decaboryl bis(alkyl sulfide) with an inorganic base in aqueous, alcoholic, or aqueous-alcoholic solution. This reaction can be carried out at temperatures ranging from room temperature (20–30° C.) up to 100° C., the exact temperature selected in any particular case being dependent on the particular base employed. Preferably, the reaction is carried out at a temperature between 60° and 85° C.

The term "base" is used herein in its conventional meaning where it signifies any molecule or ion which is capable of combining with a proton (i.e., of acting as a proton acceptor)—see, for example, p. 309 of Moeller's "Inorganic Chemistry," John Wiley & Sons, Inc. (1952). Inorganic bases which are especially suitable for use in this process include the oxides, hydroxides and alkoxides of the metals of Groups I–A and II–A of the Periodic Table (e.g., the Table shown on p. 122 of Moeller's "Inorganic Chemistry") having an atomic number less than 57. Of course, when an oxide is employed as a reactant in an aqueous solution, the oxide is converted to the hydroxide which can then react with the decaboryl bis(alkyl sulfide).

A third way of preparing metal salts of the $B_{10}H_{10}^{--}$ anion is to add a solution of the boron hydride acid, $H_2^{++}B_{10}H_{10}^{--} \cdot (H_2O)_n$, or of a soluble salt of this acid, e.g., the ammonium salt, to a solution of a soluble salt of that metal whose $B_{10}H_{10}$ salt is desired under such conditions, e.g., particular solvent employed, that the desired $B_{10}H_{10}$ metal salt precipitates from the reaction solution. Thus, this process involves the step of adding to a solution of a soluble salt of that metal whose $B_{10}H_{10}$ salt is desired a second solution containing a member of the group consisting of the acid $H_2^{++}B_{10}H_{10}^{--}$ and metal salts thereof which are soluble in the chosen solvent system, the solvent system for the reactants being one in which the desired metal salt of the $B_{10}H_{10}^{--}$ anion is relatively insoluble and in which the other reaction products are relatively soluble.

A preferred solvent system for this process employs water. When one uses aqueous solutions, the process involves the step of adding to an aqueous solution of a water-soluble salt of such metal a second aqueous solution of a compound selected from the group consisting of the acid $H_2^{++}B_{10}H_{10}^{--}$ and its water-soluble salts. For example, an aqueous solution of silver nitrate or mercuric nitrate is added to an aqueous solution of the boron hydride acid whereupon the metal salt of the $B_{10}H_{10}$ ion

precipitates out as a white or light-colored salt. This method is especially suitable for preparing heavy metal salts, although it is not restricted to these particular metals. It is preferable that the preparation of the silver salt be conducted under conditions providing minimum exposure to light, although exclusion of light is not essential for operability. Another example of this method is to add an aqueous solution of a metal salt, e.g., cesium fluoride or silver nitrate, to an aqueous solution of the ammonium salt of $B_{10}H_{10}^{--}$, whereupon the cesium or silver salt of $B_{10}H_{10}$ precipitates immediately as a white or light-colored salt.

The metal salts of this invention, as well as the free acid, possess high hydrolytic stability. For example, they can be refluxed with methanolic solutions of sodium methoxide for several hours without undergoing hydrolysis. This stability is quite unusual for boron hydride salts.

The amine salts of the $B_{10}H_{10}^{--}$ anion used as starting materials in the process of this invention can be prepared by reaction of 2 moles of a primary, secondary, or tertiary alkylamine or of ammonia with 1 mole of a decaboryl bis(alkyl sulfide), e.g., decaboryl bis(dimethyl sulfide), at a temperature between about –50° and 100° C. The preparation of such amine salts of the $B_{10}H_{10}^{--}$ anion is described in greater detail in Serial No. 6,853, filed February 5, 1960, and Serial No. 6,854, filed February 5, 1960.

The decaboryl bis(alkyl sulfide) used as the precursor for the amine salts can be prepared by reaction of 1 mole of decaborane with 2 moles of a dialkyl sulfide at a temperature between 0° and 100° C., as described in greater detail in U.S. application Ser. No. 750,862, filed July 25, 1958.

The products and process of this invention are illustrated in further detail in the following examples:

Example A

PREPARATION OF $B_{10}H_{12} \cdot 2(CH_3)_2S$

A reaction vessel having capacity of about 365 ml. is charged with 0.79 g. (6.5 millimoles) of decaborane, cooled in liquid nitrogen, and then evacuated to a pressure of 10 microns of mercury. Approximately 21 g. of methyl sulfide is condensed onto the decaborane in the reaction vessel. The reaction vessel is closed, and then allowed to warm to room temperature and stand for 4 days. During this time, 6.6 millimoles of hydrogen is evolved. The reaction vessel is then opened and excess methyl sulfide is removed by distillation, leaving a practically quantitative yield of white solid residue of

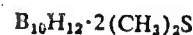

Analysis.—Calc'd. for $B_{10}C_4H_{34}S_2$: B, 44.26%; C, 19.67%; H, 9.84%; mol. wt., 244. Found: B, 43.67%; C, 21.17%; H, 10.00%; mol. wt., 220, 213.

Example B

PREPARATION OF $(NH_4)_2B_{10}H_{10}$

Decaboryl bis(dimethyl sulfide) (8.5 g., 3.5 millimoles) is mixed into 50 ml. of liquid ammonia and stirred in a round-bottomed reaction vessel for 1 hour with the vessel being cooled to a temperature of about –50° C. by partial immersion in a bath of a mixture of solid carbon dioxide and acetone. The cooling bath is then removed and the excess ammonia is allowed to evaporate with stirring. The remaining traces of ammonia are removed by subjecting the residue to a high vacuum (0.01 mm. of mercury) at 25° C. There is obtained 5.6 g. of solid residue which is a virtually quantitative yield of $(NH_4)_2B_{10}H_{10}$.

Analysis.—Calc'd. for $B_{10}H_{18}N_2$: B, 70.0%; H, 11.7%; N, 18.2%. Found: B, 66.7%; H, 12.7%; N, 18.5%.

5
Example CPREPARATION OF $[(CH_3)_2CNH_2]_2B_{10}H_{10}$

Five grams of decaboryl bis(dimethyl sulfide) of the formula $B_{10}H_{12} \cdot 2(CH_3)_2S$ (2.5 millimoles) and 50 ml. of tert-butylamine are mixed and heated at reflux temperature (approximately 45° C.) for 1.5 hours. The solid reaction product that is formed is removed by filtration and dried under vacuum (0.1 mm. of mercury). There is obtained 4.6 g. (83.5% of theory) of the boron hydride amine salt $[(CH_3)_2CNH_2]_2B_{10}H_{10}$ in almost pure form.

Analysis.—Calc'd. for $B_{10}C_8H_{34}N_2$: B, 40.6%; C, 36.06%; H, 12.86%; N, 10.51%. Found: B, 39.73%; C, 36.56%; H, 12.72%; N, 10.47%.

A small amount of water-insoluble material is present in this product. This can easily be removed by extracting the $[(CH_3)_2CNH_2]_2B_{10}H_{10}$ with water.

Example I

PREPARATION OF $H_2^{++}B_{10}H_{10}^{--}(H_2O)_2$

A solution of 3.6 g. of $[(CH_3)_2CNH_2]_2B_{10}H_{10}$ in 30 ml. of water is passed through a 0.5" diameter chromatography column containing 80 ml. of the ion exchange resin known commercially as "Amberlite," IR-120, acid form. The water effluent obtained is clear, colorless and acidic. The column is rinsed with more water until the effluent is no longer acidic and the water fractions are combined. Evaporation of this aqueous solution under reduced pressure (1 mm. mercury) at a temperature of about 40° C. leaves a yellow liquid acid which is



As noted previously, the formula for this acid can also be written as $(H_2O)_2^{++}B_{10}H_{10}^{--}(H_2O)$. Comparison of the infrared absorption spectrum of this acid with the spectra of other salts of the $B_{10}H_{10}^{--}$ anion establishes the presence of the anion. The complete removal of the tert-butyl-ammonium cation is proved by the absence of nitrogen in the product as determined by elemental analysis. The presence of the hydronium cation is shown by the acidic nature of the product and is in agreement with the infrared absorption spectrum.

Analysis.—Calc'd. for $B_{10}H_{10}O_2$: B, 61.9% H, 10.5%; N, 0.0%. Found: B, 61.4% H, 9.52%; N, 0.0%.

The acid is unique in that it is hypergolic with phosphorus pentoxide. This provides a new high energy combination for propulsion purposes. The addition of the acid to phosphorus pentoxide causes the acid to ignite and to burn rapidly. The acid is stable at ordinary and slightly elevated temperatures, i.e., up to about 50° C.

Further drying under vacuum of the compound of Example I produces a compound of the formula

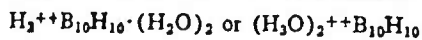

This dihydrate is a water-soluble white solid with essentially the same infrared absorption spectrum as the trihydrate of Example I.

Example II

PREPARATION OF $Na_2B_{10}H_{10}$

A solution of $H_2^{++}B_{10}H_{10}^{--}(H_2O)_2$ in about 100 ml. of water is prepared from $(NH_4)_2B_{10}H_{10}$ and an acidic ion exchange resin as described in Example I. The solution is neutralized with 2 N sodium hydroxide solution and the resulting reaction mixture is concentrated under reduced pressure until crystallization of the residue occurs. The residue is further dried under reduced pressure (about 0.1 mm. of mercury) at 56° C. for 18 hours.

Analysis.—Calc'd for $Na_2B_{10}H_{10} \cdot H_2O$: B, 59.4%; H, 6.6%; Na, 25.3%. Found: B, 57.13%; H, 5.83%; Na, 24.6%.

The water of hydration of the sodium salt, prepared as described above, can be removed by heating at 180° C. for 3 hours at a pressure of less than 0.1 mm. of mercury.

Analysis.—Calc'd for $Na_2B_{10}H_{10}$: Na, 66.0%. Found: Na, 64.35%.

6

Example III

PREPARATION OF $BaB_{10}H_{10}$

An aqueous solution of $H_2^{++}B_{10}H_{10}^{--}(H_2O)_2$ having a concentration of 3 g. of acid per 100 ml. of water is added to a slurry of 1.8 g. of barium hydroxide in water until the barium hydroxide is neutralized. Evaporation of the water leaves a crystalline white solid residue. The residue is heated at 110° C. for 4 hours at a pressure of less than 0.1 mm. of mercury. The dried product is a compound of the formula $BaB_{10}H_{10}$.

Analysis.—Calc'd for $BaB_{10}H_{10}$: Ba, 53.6%; B, 42.4%. Found: Ba 53.11%; B, 41.26%.

The barium salt can also be obtained as a trihydrate, i.e., $BaB_{10}H_{10} \cdot 3H_2O$ [Ba (calc'd), 44.4%; Ba (found), 43.69%].

Example IV

PREPARATION OF $Ag_2B_{10}H_{10}$

An aqueous solution of silver nitrate is added to a solution of $H_2^{++}B_{10}H_{10}^{--} \cdot 3H_2O$ in water. A white or slightly cream colored solid precipitates from the reaction mixture. To obtain a white precipitate, it is preferable to employ an excess of the acid, i.e., an excess of



The reaction may be performed in the absence of light to minimize darkening of the silver salt but it is not essential that light be excluded. The salt is separated by filtration. The solid residue is rinsed with ethyl alcohol and it is then dried in air. The identity of the compound is confirmed by elemental analysis.

Analysis.—Calc'd for $Ag_2B_{10}H_{10}$: Ag, 64.7%; B, 32.4%. Found: Ag, 65.42%; B, 31.88%.

Infrared absorption spectra obtained from the silver salt shows that it is anhydrous.

The compound of Example IV is a unique silver salt of a boron hydride. All other such compounds are unstable and yield elemental silver. The silver salt, after exposure to light, can be reduced, i.e., developed, by commercially available photographic developers and it, therefore, has potential usefulness in photographic and copying processes.

Examples II-IV illustrate the salts of the invention by reference to three particular metal salts. However, other metal salts are included. Thus, if the process of Example II is repeated with the exception that the sodium hydroxide is replaced with lithium, potassium, rubidium or cesium hydroxides, the corresponding lithium, potassium, rubidium and cesium salts of the $B_{10}H_{10}^{--}$ anion are produced. Likewise, when the barium hydroxide used in Example III is replaced by other alkaline earth metal hydroxides, e.g., beryllium, magnesium, calcium or strontium hydroxides, the corresponding beryllium, magnesium, calcium and strontium salts of the $B_{10}H_{10}^{--}$ anion are produced. Oxides of metals, as well as the hydroxides, can be employed in the process of Example III to obtain metal salts. To illustrate, the oxides (or hydroxides) of nickel, tin, lead, chromium, bismuth and iron may be used to obtain the nickel, tin, lead, chromium, bismuth and iron salts of the $B_{10}H_{10}^{--}$ anion.

Nitrates of metals generally can be employed in the process of Example IV to obtain heavy metal salts. To illustrate, by using mercuric nitrate in the process of Example IV, there is obtained the mercury salt of the $B_{10}H_{10}^{--}$ anion, i.e., $HgB_{10}H_{10}$.

Carbonates of metals can be used with aqueous solutions of the boron acid of the invention to obtain the corresponding metal salts. To illustrate, the carbonates of beryllium, magnesium, zirconium, manganese, cobalt, nickel, or zinc react with an aqueous solution of

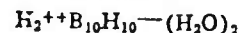

to form the corresponding metal salts of the acid. A wide range of metal salts of the boron-containing acid can thus be obtained by using the appropriate metal compound as

a reactant. These metal salts include, in addition to those named previously, the salts of vanadium, molybdenum, tungsten, copper, germanium, antimony, and the like.

The soluble metal salts of this invention can be converted to the free acid $H_2^{++}B_{10}H_{10}^{--}(H_2O)_n$, by passing the aqueous solution of the salts through an ion exchange column as described in Example I.

Example V

PREPARATION OF $Cs_2B_{10}H_{10} \cdot H_2O$

A solution of 55 g. of $(NH_4)_2B_{10}H_{10}$ in 105 ml. of water is mixed with 120 ml. of a 50% aqueous solution of cesium fluoride. A white precipitate forms immediately. This precipitate is recrystallized from water and there is obtained 83 g. of coarse, white needles of

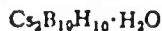

The infrared absorption spectrum obtained with this salt has a very intense BH band at 4.0 microns and weak skeletal bands at 9.1, 9.3 and 9.7 microns. NH_4 bands are totally absent. This salt is slightly hygroscopic.

Analysis.—Calc'd for $Cs_2B_{10}H_{10}O$: B, 26.91%; H, 3.09%. Found: B, 27.23%; H, 3.16%.

Example VI

PREPARATION OF $ZnB_{10}H_{10}$

A saturated solution of zinc acetate in ethyl alcohol (30 ml.) is mixed with a solution of 0.5 g. of $(NH_4)_2B_{10}H_{10}$ in 2 ml. of ethyl alcohol. The solid which precipitates from the reaction mixture is rinsed with a small amount of ethyl alcohol and dried. The infrared absorption spectrum of this product indicates that $ZnB_{10}H_{10}$ is present.

Example VII

PREPARATION OF $CsCuB_{10}H_{10}$

A solution of 12.0 g. of cupric nitrate trihydrate in 30 ml. of water is mixed with a solution of 1.1 g. of $(NH_4)_2B_{10}H_{10}$ in 15 ml. of water (acidified with nitric acid) and a dark blue color forms. Approximately 10 ml. of this blue reaction mixture is mixed with 3 ml. of a concentrated (approximately 50%) aqueous solution of cesium chloride. A light gray solid precipitates from the reaction mixture and this solid is filtered out and dried at room temperature. This is the mixed copper cesium salt of the $B_{10}H_{10}$ anion.

Analysis.—Calc'd for $CsCuB_{10}H_{10}$: B, 34.4%; Cs, 42.3%; Cu, 20.2%; H, 3.18%. Found: B, 36.53%; Cs, 38.5%; Cu, 16.79%; H, 4.08%.

Example VIII

A solution of 10.8 g. (0.2 mole) of sodium methylate in 100 ml. of methyl alcohol is added to a solution of 24.4 g. (0.1 mole) of decaboryl bis(dimethyl sulfide) in 100 ml. of methyl alcohol. The mixture is stirred for 1 hour at room temperature (approx. 25° C.) and for 1.5 hours under reflux. At the end of this period, the reaction mixture is filtered and the filtrate is evaporated to dryness. There is obtained 18 g. of a white, powdery solid. The infrared absorption spectrum of this solid indicates the product to be the sodium salt of the $B_{10}H_{10}^{--}$ anion, i.e., $Na_2B_{10}H_{10}$.

Example IX

A mixture of 2.25 g. of decaboryl bis(dimethyl sulfide), 0.55 g. of sodium hydroxide and 20 ml. of water is heated on a steam bath for 15 minutes. The reaction mixture is filtered, and the filtrate is evaporated to dryness. The residue, which is the sodium salt $Na_2B_{10}H_{10}$, is dissolved in methyl alcohol. The addition of a methyl alcoholic solution of tetramethylammonium chloride to the solution of $Na_2B_{10}H_{10}$ causes a precipitate of $[(CH_3)_4N]_2B_{10}H_{10}$. The infrared absorption spectrum of this tetramethylammonium salt of $B_{10}H_{10}^{--}$ is in agree-

ment with the spectrum of an authentic sample of this salt.

The acid of this invention and its metal salts are useful as intermediates in the formation of dyes. For example, when concentrated nitric acid is added dropwise to a 50% aqueous solution of the acid



a point is reached at which a dark blue color forms.

10 Addition of the nitric acid is stopped and the solution is stirred for several minutes, at which point the color of the solution is dark red. The solution is useful for dyeing polyacrylonitrile fibers. Polyacrylonitrile staple fiber, immersed in this red solution and boiled for about 2 minutes, is dyed an attractive red color. The solution of the dye prepared as described above can be diluted with water, if desired, for using it as a dye bath. When the pH of the solution is brought to 4-5 by addition of sodium carbonate, the solution is suitable for dyeing fibers of cellulose acetate and of nylon. Various shades can be produced by changing the pH of the dye bath or the duration and temperature of the dyeing step. Treatment of salts of the boron hydride anion $B_{10}H_{10}^{--}$ with nitric acid in the manner described above for the free acid produces dyes that are useful for dyeing cellulose acetate, nylon and polyacrylonitrile fibers and fabrics.

The acid of this invention and its hydrates are useful in high energy fuels. The acid and its hydrates are ignited by treatment with concentrated nitric acid or with phosphorus pentoxide and the compounds burn rapidly. The salts are also useful as compounds of high energy fuels, particularly with nitric acid. The silver salt can be used in photographic processes.

The foregoing detailed description has been given for clearness of understanding only and no unnecessary limitations are to be understood therefrom. The invention is not limited to the exact details shown and described, for obvious modifications will occur to those skilled in the art.

40 The embodiments of the invention in which an exclusive property or privilege is claimed are defined as follows:

1. A compound having the formula

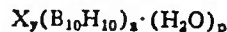

45 where X is selected from the group consisting of hydrogen and metal ions, y is the number of X ions and is a positive whole number greater than 0 and smaller than 3 (i.e., 1 or 2), z is equal to

$$\frac{y \text{ times the valence of the X ions}}{2}$$

and p is the number of molecules of water of hydration and is a cardinal number from 0 to 3, inclusive.

2. Salts of the formula:

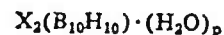

where X is a Group I-A metal and p is a positive whole number less than 4.

3. The acid having the formula:



where n is a positive whole number greater than 1 and less than 4.

4. The compound having the formula:

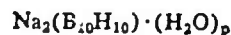

where p is a whole number from 0 through 3.

5. The compound having the formula:

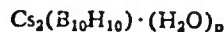

where p is a whole number from 0 through 3.

6. The compound having the formula:

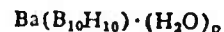

75 where p is a whole number from 0 through 3.

9

7. The compound having the formula:

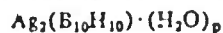

where p is a whole number from 0 through 3.

8. The compound having the formula:

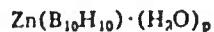

where p is a whole number from 0 through 3.

9. In a method for preparing the acid



where n is a positive whole number greater than 1 and less than 4, the step of contacting an aqueous solution of an amine salt having the formula:

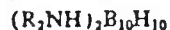

where R is selected from the group consisting of hydrogen and alkyl radicals having less than 19 carbon atoms each with a strongly acidic cation exchange resin.

10. The process of claim 9 wherein the amine salt is $[(CH_3)_2CNH_2]_2B_{10}H_{10}$.

11. The process of claim 9 wherein the amine salt is $(NH_4)_2B_{10}H_{10}$.

12. In a method for preparing a metal salt of the $B_{10}H_{10}^{--}$ anion, the step of neutralizing an aqueous solution of the acid $H_2^{++}B_{10}H_{10}^{--}$ with an aqueous dispersion of an inorganic base containing a metal cation.

13. In a method for preparing a metal salt of the $B_{10}H_{10}^{--}$ anion, the step of adding to a first solution of a soluble salt of a metal with an anion other than $B_{10}H_{10}^{--}$ a second solution containing a member of the group con-

10

sisting of the acid $H_2^{++}B_{10}H_{10}^{--}$ and salts thereof with metals other than those in the first solution, the solvent system for the reactants being one in which the first-mentioned metal salt of the $B_{10}H_{10}^{--}$ anion is relatively insoluble and in which the other reaction products are relatively soluble.

14. The process of claim 13 wherein that metal whose metal salt is desired is a Group I-A metal.

15. In a method for preparing a relatively water-insoluble metal salt of the $B_{10}H_{10}^{--}$ anion, the step of adding to an aqueous solution of a relatively water-soluble salt of such metal a second aqueous solution of a compound selected from the group consisting of the acid



and its water-soluble salts.

16. In a method for preparing a metal salt of the $B_{10}H_{10}^{--}$ anion, the step of reacting a decaboryl bis-(alkyl sulfide) with a base.

17. In a method for preparing a metal salt of the $B_{10}H_{10}^{--}$ anion, the steps of reacting a decaboryl bis-(alkyl sulfide) with an amine to form an amine salt of the $B_{10}H_{10}^{--}$ anion, and then reacting said amine salt with an inorganic base.

18. An aqueous solution of the acid having the formula

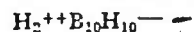

References Cited in the file of this patent

Lipscomb: J. Am. Chem. Soc., vol. 81, No. 21, pp. 5833, 5834, Nov. 5, 1959.

UNITED STATES PATENT OFFICE CERTIFICATE OF CORRECTION

Patent No. 3,148,939

September 15, 1964

Walter Henry Knoth, Jr.

It is hereby certified that error appears in the above numbered patent requiring correction and that the said Letters Patent should read as corrected below.

Column 10, line 14, the formula should appear as shown below instead of as in the patent:

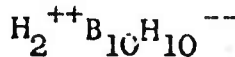

Signed and sealed this 5th day of January 1965.

(SEAL)

Attest:

ERNEST W. SWIDER
Attesting Officer

EDWARD J. BRENNER
Commissioner of Patents

**Best
Available
Copy**

1

3,149,163
AMINE AND ORGANO-SUBSTITUTED HYDRAZINE SALTS OF THE $B_{10}H_{10}^{2-}$ ANION AND PROCESS FOR PREPARING SAME

Walter Henry Knuth, Jr., Mendenhall, Pa., assignor to E. I. du Pont de Nemours and Company, Wilmington, Del., a corporation of Delaware

No Drawing. Filed Feb. 5, 1960, Ser. No. 6,854
10 Claims. (Cl. 260-583)

This invention is directed to ionic boron compounds and methods for their preparation. More particularly, it is directed to methods for preparing amine and organo-substituted hydrazine salts of a boron hydride anion and to certain novel and highly useful salts prepared by these methods.

A number of amines are known to form adducts with decaborane without loss of hydrogen to form $B_{10}H_{12}$ complexes that decompose in contact with water. Certain cyclic amines, e.g., pyridine, are also known to react with decaborane to form $B_{10}H_{12}$ and $B_{10}H_{11}$ adducts; however, the $B_{10}H_{12}$ adducts are soluble only to a limited extent in water and are non-ionic.

The present invention provides a novel class of ionic salts of the $B_{10}H_{10}^{2-}$ anion which are highly water-soluble. The novel salts of this invention are amine and organo-substituted hydrazine salts of the $B_{10}H_{10}^{2-}$ anion having the general formula

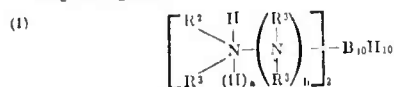

wherein a and b are integers whose sum is equal to 1, i.e., a and b are zero or 1; R^2 is a monovalent hydrocarbon such as an alkyl, alkenyl, cycloalkyl, cycloalkenyl, aryl, alkaryl or aralkyl group; R^3 is hydrogen or a group as defined for R^2 . In a preferred group of compounds the substituents R^2 and R^3 have at most 12 carbons.

The novel compounds are further characterized as selected from the group consisting of

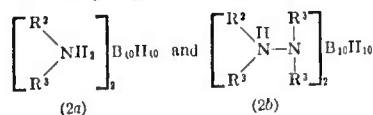

where R^2 and R^3 have the meanings defined earlier and wherein the groups bonded to $B_{10}H_{10}^{2-}$ are derived from primary amines, secondary amines and organo-substituted hydrazines which can form salts with hydrochloric acid.

The compounds of the invention can be prepared by a single step process or by a multiple step process, as illustrated in the following schematic diagram.

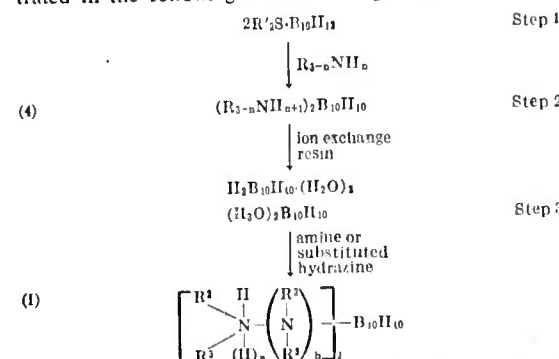

The group $R_{3-n}NH_{n+1}$ in the above formula represents the cation derived from an amine of the formula

2

where R is an alkyl, alkenyl, cycloalkyl or cycloalkenyl group; n is an integer of at most 2, i.e., n can be 0, 1 or 2. The R groups, preferably, have at most 12 carbons.

Step 1, in the above process outline, permits the preparation of salts from primary, secondary and tertiary aliphatic or cycloaliphatic amines. Step 3 in the process permits the preparation of salts, not only from aliphatic and cycloaliphatic amines, but also from aryl substituted amines and from substituted hydrazines. Thus, salts which fall within the scope of the invention, if not obtainable directly by step 1, can be obtained by employing steps 1, 2 and 3 shown.

The method of Step 1 relates to the reaction of one mole of a decaboryl bis(organic sulfide) having the formula



where R' is a monovalent hydrocarbon radical, preferably of at most 8 carbons, with at least two moles (based on available amine groups) of an amine compound of the formula R_nNH_n where R and n have the meanings previously defined (3).

The salts derived from primary and secondary amines are obtained in substantially higher yields and they are substantially more soluble in water than the salts derived from tertiary amines. Because of the advantage of high yield and high water-solubility, these salts form a preferred group of novel compounds which are part of this invention. This preferred group of salts are represented by the formula

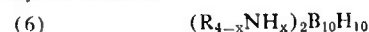

wherein R has the meaning defined previously (3), and x has a value of 2 or 3. In an especially preferred group of amine salts of the above formula, each R represents an alkyl group of less than 7 carbons.

As stated earlier, a broad range of amine salts and of organo-substituted hydrazine salts of the $B_{10}H_{10}^{2-}$ anion of this invention can be prepared by neutralization of the acid $H_2^{+}B_{10}H_{10}^{2-} \cdot (H_2O)_m$, where m is 2 or 3, with an appropriate nitrogen base. Thus, for preparation of substituted hydrazine salts the acid is neutralized in aqueous solution with an organo-substituted hydrazine of the formula



wherein R^2 and R^3 have the meanings given earlier (2b). The substituted hydrazine salt that forms remains in solution in the reaction mixture and can be isolated by conventional methods.

The organo-substituted hydrazine salts have the formula given earlier (see 2b) and these salts also form a part of this invention.

The salts obtained by the processes of this invention, including both the amine and organo-substituted hydrazine salts, are stable, non-hygroscopic, crystalline white solids which are very soluble in water. The salts do not reduce silver nitrate in aqueous solution, a behavior which is a sharp contrast with the reducing action of other boron hydride compounds. Their aqueous solutions are very stable and they exhibit high electrical conductivity. This high conductivity demonstrates the high degree of ionic character of the novel compounds.

The process of step 1 of this invention is carried out simply by contacting at least two moles of an amine of the types described previously with one mole of a decaboryl bis(organic sulfide) of the formula $B_{10}H_{12} \cdot 2R'_2S$, wherein R' has the meaning defined above. Preferably,

amine is employed whereby the excess amine acts as reaction medium. The excess amine can readily be recovered at the completion of the reaction. The reaction temperature is not critical, temperatures ranging from as low as -50°C . up to 100°C . or more being operable, the exact temperature being dependent on the particular amine being employed. When amines having a boiling points of less than 115°C . are employed, it is very convenient to carry out the reaction at the temperature at which the amine reactant refluxes. It is preferred that a reaction temperature below that at which the decaboryl bis(organic sulfide) decomposes be employed. For $\text{B}_{10}\text{H}_{12}\cdot 2(\text{CH}_3)_2\text{S}$, this temperature is approximately 115°C .

The reaction between the amine and the decaboryl bis-sulfide takes place quite rapidly, the exact time of reaction being dependent on the particular reactants and reaction temperature being employed. Reaction times ranging from a few minutes, e.g., 2-10 minutes, at the higher temperature in the above-mentioned range and from 10 minutes to 5 hours at the lower temperatures are sufficient.

The pressure under which the reaction is carried out is not critical. Atmospheric pressure is very convenient, but subatmospheric or superatmospheric pressure can be used if desired.

It is not necessary to use an added solvent or reaction medium in the process of this invention. The reaction takes place readily with the stoichiometric amount of amine and decaboryl bis-sulfide reactant, although the use of an excess of the amine is preferred. However, if it is desired, an inert reaction medium can be used. Examples of suitable inert reaction media include hydrocarbons, e.g., benzene, and ethers, e.g., tetrahydrofuran.

The amine salts of the $\text{B}_{10}\text{H}_{10}^{-}$ anion are readily isolated from the reaction mixture by conventional methods. The solid salt that is formed can be removed from the reaction mixture either by filtration or by evaporation of the solvent. The crude salt can be purified by extraction with water followed by evaporation of the solvent. In some cases it is convenient to simply remove the excess amine from the reaction medium by evaporation or distillation leaving the boron hydride amine salt as a residue.

It was stated earlier that the nitrogen bases employed in the process had in common the capacity of forming salts with hydrogen chloride. This common property can be determined readily by dissolving the base in a suitable solvent, e.g., diethyl ether, and bubbling HCl gas through the solution. The formation of a white precipitate or an oil shows that the base forms a salt with HCl.

The decaboryl bis(organic sulfide) used as one of the reactants in the process for the preparation of the amine salts can be prepared by the reaction of one mole of decaborane with two moles of an organic sulfide of the formula $\text{R}'_2\text{S}$, wherein R' is monovalent hydrocarbyl, i.e., alkyl, aryl, cycloalkyl, alkenyl and cycloalkenyl (with the proviso that not more than one R' is aryl), at a temperature between 0° and 100°C . until approximately one mole of hydrogen is evolved. This process is described in greater detail in U.S. application Serial No. 750,862, filed July 25, 1958, by E. L. Muetterties. In the above definition of R' , the monovalent hydrocarbyl group preferably is selected from the group consisting of alkyl radicals containing less than 6 carbon atoms each, and cycloalkyl radicals containing from 4 to 6 carbon atoms each. The most preferred R' for use in this process is methyl. The amines used in this process can be any of the commercially available amines of the formulas given hereinbefore or they can be made by known methods.

The acid $\text{H}_2^{++}\text{B}_{10}\text{H}_{10}^{--}\cdot(\text{H}_2\text{O})_n$ used in the process for the preparation of the substituted hydrazine salts can be prepared by treating an aqueous solution of a

boron hydride salt obtained in step 1 of the process as outlined with a strongly acidic ion exchange resin. The preferred amine salts for this procedure have the general formula



where R^1 is hydrogen or an alkyl radical. Preferably, a sulfonic acid type ion exchange resin is employed, for example, the types known commercially as "Amberlite" IR-120-II and "Dowex" resins.

The process and products of this invention are illustrated in further detail by the following examples.

EXAMPLE I

Preparation of $[(\text{CH}_3)_3\text{CNH}_3]_2\text{B}_{10}\text{H}_{10}$

Five grams of decaboryl bis(dimethyl sulfide) of the formula $\text{B}_{10}\text{H}_{12}\cdot 2(\text{CH}_3)_2\text{S}$ (2.5 millimoles) and 50 ml. of tert-butylamine are mixed and heated at reflux temperature (approximately 45°C .) for 1.5 hours. The solid reaction product that is formed is removed by filtration and dried under vacuum (0.1 mm. of mercury). There is obtained 4.6 g. (83.5% of theory) of the boron hydride amine salt, $[(\text{CH}_3)_3\text{CNH}_3]_2\text{B}_{10}\text{H}_{10}$, in almost pure form.

Analysis.—Calc'd for $\text{B}_{10}\text{C}_8\text{H}_{34}\text{N}_2$: B, 40.6%; C, 36.06%; H, 12.86%; N, 10.51%. Found: B, 39.73%; C, 36.56%; H, 12.72%; N, 10.47%. A small amount of water-insoluble material is present in this product. This can easily be removed by extracting the



with water. The aqueous solutions of this boron hydride salt have approximately the same equivalent conductance as equimolar solutions of ammonium chloride.

EXAMPLE II

Preparation of $[(\text{C}_2\text{H}_5)_2\text{NH}_2]_2\text{B}_{10}\text{H}_{10}$

Four grams (1.6 millimoles) of decaboryl bis(dimethyl sulfide), $\text{B}_{10}\text{H}_{12}\cdot 2(\text{CH}_3)_2\text{S}$, and 50 ml. of diethylamine are mixed in a reaction vessel fitted with a reflux condenser and the mixture is heated to reflux temperature (55°C .) for a period of 1 hour. The reaction mixture is filtered and there is obtained 4.0 g. of a white solid. Extraction of this solid with water followed by evaporation of the extracts gives a white crystalline solid, decomposition point $233-234^{\circ}\text{C}$., which is $[(\text{C}_2\text{H}_5)_2\text{NH}_2]_2\text{B}_{10}\text{H}_{10}$. Aqueous solutions of this salt are highly conducting.

Analysis.—Calc'd for $\text{B}_{10}\text{C}_8\text{H}_{34}\text{N}_2$: B, 40.70%; C, 35.7%; H, 12.8%; N, 10.5%. Found: B, 40.27%; C, 36.8%; H, 13.1%; N, 10.5%.

Aqueous extraction of the white solid formed as the reaction product of this example leaves a residue of 1.3 g. of a white, water-insoluble solid. This is a non-ionic isomer of the water-soluble ionic salt described above.

Analysis.—Calc'd for $\text{B}_{10}\text{C}_8\text{H}_{34}\text{N}_2$: B, 40.70%; C, 35.70%; H, 12.80%; N, 10.50%. Found: B, 40.12%; C, 32.11%; H, 11.85%; N, 10.48%.

The ionic isomer of Example II does not reduce silver nitrate in aqueous solution but the silver salt is formed instead. To illustrate, an aqueous solution of



is treated with dilute nitric acid until the solution is slightly acid. An aqueous solution of silver nitrate (ca. 10% concentration) is added dropwise and with stirring to the acidified solution until a large quantity of white precipitate forms. The reaction mixture is heated to boiling for a short period and no change in the color of the precipitate occurs, i.e., no reduction of the silver salt to free silver is noted.

EXAMPLE III

Preparation of $[(\text{C}_2\text{H}_5)_3\text{NH}]_2\text{B}_{10}\text{H}_{10}$

Decaboryl bis(dimethyl sulfide), $\text{B}_{10}\text{H}_{12}\cdot 2(\text{CH}_3)_2\text{S}$, (0.72 g.) and excess triethylamine (40 ml.) are mixed

in a reaction vessel fitted with a reflux condenser and heated to reflux temperature (90° C.) for 10 minutes. On filtration of the reaction mixture, there is obtained 0.72 g. of a solid from which an ionic compound can be extracted with either water or tetramethylene sulfone. A white, solid, insoluble residue remains after the water extraction. Evaporation of the aqueous extracts leaves an ionic solid. The infrared absorption spectrum of this ionic solid is consistent with the formula



its identity as a salt of the boron hydride anion $B_{10}H_{10}^{--}$ is further demonstrated by its conversion to

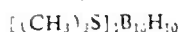

by reaction with aqueous trimethylsulfonium iodide. The ionic salt $[(C_2H_5)_3NH]_2B_{10}H_{10}$ has a decomposition point of 227–228° C. Aqueous solutions of this salt have approximately the same equivalent conductance as equimolar solutions of ammonium chloride.

The solid residue remaining from the extraction of the crude solid reaction product has the formula

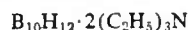

and is an isomer of the ionic salt $[(C_2H_5)_3NH]_2B_{10}H_{10}$. *Analysis.*—Calc'd for $B_{10}C_{10}H_{30}N_2$: B, 33.60%; N, 8.68%. Found: B, 33.63%; N, 8.45%.

EXAMPLE IV

Decaboryl bis(dimethyl sulfide) (12.8 g.) and excess isopropylamine (100 ml.) are mixed in a reaction vessel fitted with a reflux condenser. Spontaneous refluxing occurs and the solid dissolves. The mixture is heated at reflux for an additional 2 hours. The reaction mixture is filtered and the filtrate is evaporated under slightly reduced pressure. The residue is dissolved in water, the solution filtered and the water evaporated. The residue of $(i-C_3H_7NH_2)_2B_{10}H_{10}$ is dried for 4 hours at 25° C. under a pressure of approximately 1 mm. Hg.

Analysis.—Calc'd for $B_{10}C_6H_{30}N_2$: B, 45.50%. Found: B, 44.09%.

In addition to the particular salts illustrated in Examples I–IV, the products of this invention also include other salts of Formula (2a) supra. These salts are preparable by the procedure of Example I by reacting one mole of the decaboryl bis(organic sulfide) compound with two moles of the amine:

TABLE I

Example No.	Reactants	Products	
V.....	CH_3NH_2	$B_{10}H_{12} \cdot 2(C_2H_5)_2S$	$(CH_3NH)_2B_{10}H_{10}$
VI.....	$(n-C_3H_7)_2NH$	$B_{10}H_{12} \cdot 2 \left(\begin{array}{c} CH_2-CH_2 \\ \quad \\ H_2C \quad CH \\ \quad \\ CH_2-CH_2 \end{array} \right)_2$	$(n-C_3H_7)_2NH_2B_{10}H_{10}$
VII.....	$(CH_3)(n-C_4H_9)NH$	$B_{10}H_{12} \cdot 2(CH_3)_2S$	$[(CH_3)(n-C_4H_9)NH]_2B_{10}H_{10}$
VIII.....	$(n-C_{11}H_{23})NH_2$	$B_{10}H_{12} \cdot 2(n-C_6H_{13})_2S$	$(n-C_{11}H_{23})NH_2B_{10}H_{10}$
IX.....	$(CH_3)(n-C_7H_{15})NH$	$B_{10}H_{12} \cdot 2(CH_2-CH)_2S$	$(CH_3)(n-C_7H_{15})NH_2B_{10}H_{10}$

The preparation of free acids containing the $B_{10}H_{10}^{--}$ anion (step 2) is accomplished by treatment of the amine salt with an acidic ion exchange resin, e.g., "Amberlite" IR-120-H. The aqueous solution of the amine salt is conveniently passed through a cylindrical reaction tube packed with the ion exchange resin. Any operating temperature between the freezing point and boiling point of water can be used. The boron-containing acid is soluble in water and can be isolated from the clear, colorless, aqueous effluent by evaporation of the water at moderately elevated temperatures, e.g., 30–40° C., preferably under reduced pressures, e.g., 0.1–5 mm. of mercury. This process is described in greater detail in U.S. Patent Application Serial No. 6,855, filed February

zines used in step 1 of the process can be any of the commercially available hydrazines of this type or they can be made by known methods.

EXAMPLE X

An aqueous solution containing 2 g. of $B_{10}H_{12} \cdot 2R'S$ is passed through a column containing the ion exchange resin, "Amberlite" IR-120-H. The aqueous solution which contains the acid $H_2B_{10}H_{10}$ is neutralized by adding 1,2-dimethylhydrazine $(CH_3)_2NHNH_2$ until the pH of the solution is 7. The solvent is evaporated to leave a slightly wet solid which is washed with a small amount of water and dried on a porous plate. The solid is shown by infrared analysis to be the 1,2-dimethylhydrazinium salt of the $B_{10}H_{10}^{--}$ anion. The compound has the formula $[(CH_3)_2NH-(CH_3)_2NH]_2B_{10}H_{10}$. The presence of the $B_{10}H_{10}^{--}$ anion is confirmed by conversion of the hydrazinium salt to the tetramethylammonium salt by reaction with tetramethylammonium chloride.

Other organo-substituted hydrazine salts of the $B_{10}H_{10}^{--}$ anion are obtained by employing the process described in Example X. To illustrate, when phenylhydrazine or 1,1-dimethylhydrazine are substituted for the 1,2-dimethylhydrazine the salts obtained have the formulas

$(C_6H_5NHNH_2)_2B_{10}H_{10}$ and $[(CH_3)_2NNH_2]_2B_{10}H_{10}$. Other salts which can be obtained in a similar manner from methylhydrazine, ethylhydrazine, and 1,1-diethylhydrazine are

$(CH_3NH-NH_2)_2B_{10}H_{10}$, $(C_2H_5NH-NH_2)_2B_{10}H_{10}$ and $[(C_2H_5)_2N-NH_2]_2B_{10}H_{10}$, respectively.

Diamines can be employed in the process in place of monoamines. To illustrate, decaboryl bis(dimethylsulfide) can be reacted with ethylenediamine, 1,3-propylenediamine, 1,6-hexamethylenediamine or 1,4-diaminocyclohexane to obtain the corresponding boron hydride-diamine salts.

The decaboryl bis(dimethyl sulfide) used in Examples I–IV and VII can be replaced by any other decaboryl bis(organic sulfides) of the formula $B_{10}H_{12} \cdot 2R'S$, where R' has the significance defined previously. Thus, derivatives of decaborane with the following specific organic sulfides can be used in the process of this invention: di-n-propyl, di-n-butyl, methyl p-tolyl, dicyclohexyl, dicyclohexenyl, dioctyl, diallyl, divinyl, allyl benzyl, and tetramethylene sulfides. While any of these decaboryl bis(or-

ganic sulfides) are operable, it is preferable from a practical standpoint to use the decaborane derivatives of readily available low molecular weight sulfides, especially dimethyl sulfide and diethyl sulfide, since it is the decaborane moiety of the derivative that forms part of the salts of the present invention. The organic sulfide moiety is a by-product of the reaction which can be recovered if desired for reuse.

The products of this invention are useful for a variety of purposes. For example, aqueous solutions of the amine and substituted hydrazine salts of the anion $B_{10}H_{10}^{--}$ are useful as electrolytes. These electrolytes are useful in many electrical applications including electrical switches, where good electrical contact is desired.

7

invention are inflammable in contact with excess concentrated nitric acid. This particular property makes the products of this invention useful as components of rocket fuels.

The foregoing detailed description has been given for clearness of understanding only and no unnecessary limitations are to be understood therefrom. The invention is not limited to the exact details shown and described, for obvious modifications will occur to those skilled in the art.

The embodiments of the invention in which an exclusive property or privilege is claimed are defined as follows:

1. A compound having the formula selected from the group consisting of

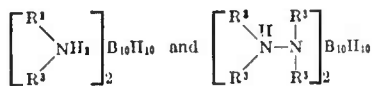

wherein R^2 is monovalent hydrocarbon; and R^3 is selected from the group consisting of hydrogen and monovalent hydrocarbon; the group bonded to $\text{B}_{10}\text{H}_{10}^-$ being derived from the class consisting of primary amines, secondary amines and organo-substituted hydrazines which can form salts with hydrochloric acid.

2. A compound having the formula

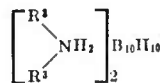

wherein R^2 is monovalent hydrocarbon; and R^3 is selected from the group consisting of hydrogen and monovalent hydrocarbon; and wherein the group bonded to $\text{B}_{10}\text{H}_{10}^-$ is derived from the class consisting of primary amines and secondary amines which can form salts with hydrochloric acid.

3. A compound having the formula

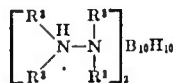

wherein R^2 is monovalent hydrocarbon; and R^3 is selected from the group consisting of hydrogen and monovalent hydrocarbon; and wherein the group bonded to $\text{B}_{10}\text{H}_{10}^-$ is derived from organo-substituted hydrazines which can form salts with hydrochloric acid.

4. $[(\text{CH}_3)_2\text{CNH}_2]_2\text{B}_{10}\text{H}_{10}$.

5. $[(\text{C}_2\text{H}_5)_2\text{NH}_2]_2\text{B}_{10}\text{H}_{10}$.

6. $(i\text{-C}_3\text{H}_7\text{NH}_2)_2\text{B}_{10}\text{H}_{10}$.

7. $[(\text{CH}_3)\text{NH}-(\text{CH}_3)\text{NH}_2]_2\text{B}_{10}\text{H}_{10}$.

8

8. In a process for preparing a compound selected from the class consisting of



wherein R^2 is monovalent hydrocarbon; and R^3 is selected from the group consisting of hydrogen and monovalent hydrocarbon; the group bonded to $\text{B}_{10}\text{H}_{10}^-$ being derived from the class consisting of primary amines, secondary amines and organo-substituted hydrazines which can form salts with hydrogen chloride, the step of contacting an aqueous solution of the acid



with a nitrogen base selected from the class consisting of

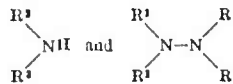

wherein R^2 and R^3 are defined as above.

9. In a process for making a compound of the formula

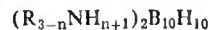

wherein R is selected from the group consisting of alkyl, alkenyl, cycloalkyl and cycloalkenyl, and n is an integer of at most 2, the step of reacting one mole of a compound having the formula

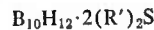

wherein R' is a monovalent hydrocarbon radical provided that not more than one R' is aryl with at least two moles, based on available amine groups, of an amine having the formula

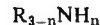

wherein R and n have their above-defined meanings.

10. In a process for making a compound of the formula

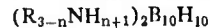

wherein R is selected from the group consisting of alkyl, alkenyl, cycloalkyl and cycloalkenyl, and n is an integer of at most 2, the step of reacting one mole of a compound having the formula

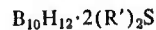

wherein R' is a monovalent hydrocarbon radical provided that not more than one R' is aryl with an excess of an amine having the formula

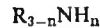

wherein R and n have their above-defined meanings while maintaining temperatures between -50° and 115° C.

References Cited in the file of this patent

Hawthorne et al.: J.A.C.S., vol. 81, p. 5519 (1959),

1

3,169,044

DIHYDROGEN DODECAHYDRODODECABORATE
AND METHOD FOR PRODUCING SAMEHenry C. Miller, Wilmington, Del., and Earl L. Mueffler,
West Chester, Pa., assignors to E. I. du Pont de
Nemours and Company, Wilmington, Del., a corporation
of DelawareNo Drawing. Filed May 20, 1960, Ser. No. 30,441
6 Claims. (Cl. 23-14)

This invention relates to a novel boron-containing acid and to methods for its preparation.

Compounds of boron and hydrogen whose properties are described in the literature are limited to products having at most 10 boron atoms. The known covalent hydrides include such compounds as B_2H_6 , B_3H_8 , B_4H_{10} , and $B_{10}H_{12}$. Known derivatives of borohydride anions include salts of BH_4^- , $B_2H_7^-$, $B_3H_{10}^-$ and $B_{10}H_{12}^-$. Free acids having these anions are unknown; in fact, acidification of aqueous solutions of salts of the above anions results in rapid decomposition of the boron compounds. In particular, no free acids, or even salts, of hydroborates are known in which there are 12 or more boron atoms and the molar ratio of boron to hydrogen in the anion is 1.

This invention is directed to a highly unusual and very useful dibasic acid of a hydroborate which acid consists of two ionizable hydrogens and a divalent anion consisting of 12 borons and 12 hydrogens. By ionizable hydrogens, we mean hydrogens which form H^+ ions in aqueous solution and which can be neutralized with an inorganic aqueous base, e.g., sodium hydroxide.

More specifically, this new acid is a white crystalline hygroscopic, non-volatile, solid compound of boron and hydrogen having for each 6 boron atoms, one acidic ionizable hydrogen atom and six non-acidic non-ionizable hydrogen atoms, such compound being characterized by having infrared absorption bands at $4.0\mu \pm 0.10$ and $9.35\mu \pm 0.10$, a pK_a of about 2 at $25^\circ C$. It is a solid at temperatures below about $80^\circ C$.

The acid of this invention is believed to be represented by the following empirical formula:



The acid will be termed herein dihydrogen dodecahydrododecaborate (2^-). It is noted that no official system of nomenclature of boron compounds has been adopted at the present time. The nomenclature used herein follows the proposals made by a group of the Committee on Nomenclature of the American Chemical Society Division of Organic Chemistry. These proposals are discussed in (1) a paper presented by G. W. Schaeffer at the American Chemical Society Meeting, San Francisco, California, April 13-18 (1953), (2) a paper presented by K. L. Loening to the Division of Chemical Literature, American Chemical Society Meeting, Chicago, Illinois, September 7-12 (1958), and (3) a publication by Patterson, Chemical Engineering News 34, 560 (1956).

The new compound is a strong acid which can be neutralized with strong inorganic bases and it shows an equivalence point at a pH of 7. In aqueous solution at $25^\circ C$, the acid has a pK_a value of about 2.0 as noted above. One or both of the acidic hydrogens can be replaced to form monobasic or neutral salts.

The acid is readily soluble in water and it is, in fact, rather hygroscopic. In view of this property, it is conveniently isolated as a hydrate in which the number of moles of water of hydration (or crystallization) is determined to some extent by the intensity and duration of the drying of the acid. In general, the maximum number of moles of water of crystallization does not exceed 4.

2

Generically, therefore, the acid and its hydrates are represented by the empirical formula



where n is a cardinal number of at most 4, i.e., n is 0, 1, 2, 3, or 4. Two moles of water of hydration are considered to be associated with the protonic (acidic) hydrogens and the hydrated acid can, optionally, be represented by the following empirical formula:

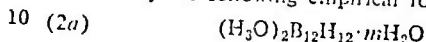

where m is a cardinal number of at most 2, i.e., m is 0, 1, or 2.

The novel acid is soluble in other oxygenated solvents, e.g., ethers, alcohols, esters, and the like. Solutions of the acid in these solvents can, if desired, be facilitated by adding a very minor quantity of water.

The novel acid and its hydrates are white crystalline solids which show characteristic and identifying absorption bands in the infrared spectrum at $4.0\mu \pm 0.10$ and $9.35\mu \pm 0.10$.

The strong tendency of the acid to form hydrates makes it difficult at times to determine the exact molar ratio of boron to hydrogen in the anion solely on the basis of elemental analyses. However, such analyses, considered in combination with the characterizing, but heretofore unknown, infrared absorption spectrum permits positive identification of the product. Confirmation of the $H_2B_{12}H_{12}$ formula is also obtained by conversion of the solvated acid to a solvate-free salt, e.g., a substituted phosphonium salt, showing the same characteristic infrared absorption bands at $4.0\mu \pm 0.10$ and $9.35\mu \pm 0.10$ as the free acid.

The novel acid, particularly the dodecahydrododecaborate anion, shows unusual stability for a hydroborate. To illustrate, an aqueous solution of the acid containing 5% hydrogen chloride has been refluxed for 1 hour with no evidence of hydrolysis of the dodecahydrododecaborate anion. This remarkable stability of the dodecahydrododecaborate anion is in striking contrast to the low stabilities of known hydroborates, e.g., tetrahydroborate (BH_4^-), octahydrotriborate ($B_3H_8^-$), and the like, which decompose rapidly even at $25^\circ C$ when solutions of their salts are acidified.

The novel acid is obtained by contacting a solution of salt containing a dodecahydrododecaborate anion with a strong acid. The reaction is a metathesis in which an exchange of cations occurs. Strong acid reactants which are used should, preferably, have a pK_a value which is lower than or, at least, approximately equal to, the pK_a value for $H_2B_{12}H_{12}$. Strong inorganic or mineral acids can be conveniently employed, e.g., hydrochloric acid, sulfuric acid, phosphoric acid, and the like. Strong organic acids can also be employed, e.g., polyhalogenated acetic acids or substituted aromatic sulfuric acids. In general, the acid reactant should have a pK_a value less than that of the dihydrogen dodecahydrododecaborate (2^-).

The reaction is most conveniently conducted in aqueous solution. However, solvents other than water can be employed, if desired. Examples of nonaqueous solvents include alcohols such as methanol, ethanol, or cyclohexanol; esters such as methyl acetate, butyl propionate, or ethyl butyrate; ethers such as glyme, or dioxane; nitriles such as acetonitrile or benzonitrile; carboxylic acids such as acetic acid or propionic acid; and the like. The solution of the acid, as obtained in the reaction, can be employed directly for many uses without separation of by-product salts.

A substantially salt-free (i.e., pure) solution of the acid is obtained by maintaining an aqueous solution of a do-

dodecahydrododecaborate (2-) salt in contact with an acidic ion exchange resin for a time sufficient to exchange the cation of the salt for the acidic hydrogen of the ion-exchange resin. The solution, after contact with the ion-exchange resin, can be evaporated by conventional procedures to obtain the acid, generally as a hydrate. By intensive and prolonged drying under reduced pressure, a substantially hydrate-free product can be obtained.

The ion exchange resins employed in the process are, preferably, of the sulfonic acid variety, which are available commercially, e.g., "Amberlite" IR-120-H, acid form and "Dowex" 50.

The acid is isolated from its solvent carrier and other dissolved salts formed in metathesis by the well-known, conventional separation procedures.

The dodecahydrododecaborate salt employed in the process is represented by the formula



where M is a cation having a valence of 1 through 4 and the values of a and b are determined by the valence of M , i.e., a multiple of the valence of M is equal to $2b$. The relationship between a and b is further shown by the following equation:

$$b = \frac{a \times \text{Valence of } M}{2}$$

The values of a and b are the smallest numbers which satisfy the equation and these values lie between 1 and 3.

The alkali metal and alkaline earth metal salts are most conveniently used in the process and they are a preferred group. Thus, in Formula (3), M is preferably an alkali or alkaline earth metal, a has a value of 1 or 2, and b has a value of 1. In an especially preferred group, M is an alkali metal and a , therefore, is 2 and b is 1, i.e., Formula (3) becomes $M_2B_{12}H_{12}$. The ammonium salt can also be used. When M is an alkali metal, an alkaline earth metal, or an ammonium ion, a will be a positive whole number between 0 and 13, i.e., 1 or 2.

The dodecahydrododecaborate salts, employed as reagents, are conveniently prepared by the method illustrated in Examples A, B, and C. Briefly, the method consists in reacting diborane (B_2H_6) with an alkali or alkaline earth metal hydroborate under superatmospheric pressure (at 12-13 atmospheres). Any alkali metal or alkaline earth metal hydroborate can be used but sodium and potassium hydroborates ($NaBH_4$ and KBH_4) are the most readily available salts and they, therefore, are most commonly used in the preparation of the dodecahydrododecaborate salts. The salts can be used as obtained without special purification steps.

Aqueous solutions of the salts are preferably used for contacting with the ion-exchange resin. Any convenient method of operation can be employed, e.g., mechanical mixing of the ion-exchange resin with the aqueous solution followed by filtration to separate the resin or by passing the aqueous solution through a column of the ion-exchange resin. The rate of reaction is rapid and time is not a critical factor in the process.

The aqueous solution, obtained after contact with the ion-exchange resin, contains the acid, $H_2B_{12}H_{12}$, and the solution is evaporated by any conventional means to obtain the solid acid. The solution can be evaporated, for example, by warming under reduced pressure, by flowing in thin layers over heated surfaces, by flashing into a chamber under reduced pressure and by other well-known procedures.

The product is stable in storage and it can be kept in conventional stoppered glass containers or in containers of other corrosion-resistant materials.

This application is a continuation-in-part of our co-pending application Serial No. 15,042, filed March 15, 1960, and now abandoned.

The examples which follow illustrate (1) the preparation of the alkali metal dodecahydrododecaborate (2-) 75

which is employed as a reactant and (2) the preparation of the acid $H_2B_{12}H_{12}$.

Example A

A pressure vessel of 400 ml. capacity is charged with 9.5 g. of sodium hydroborate and 75 ml. of glyme. The vessel is closed, cooled to $-80^\circ C.$ and evacuated to a pressure of about 0.001 mm. of mercury. Diborane (14.0 g.) is charged into the vessel which is then sealed and heated with agitation under autogenous pressure for 10 hours at $120^\circ C.$ The molar ratio of $NaBH_4$ to B_2H_6 in this reaction is 1:2. The reactor is cooled, the volatile products are released by venting and the contents of the tube are washed into a receiver with glyme. A suspension of a white solid in a yellow liquid is formed from which the solid is separated by filtration. The solid is dissolved in hot tetrahydrofuran and the solution is filtered to remove a trace of unreacted sodium hydroborate. The hot filtrate is diluted with glyme and chilled to yield 14.0 g. of a disodium polyhydropolyborate (2-) as long, glistening white needles. This compound is known to be disodium dodecahydrododecaborate (2-). The compound crystallizes with 1,2-dimethoxyethane and water. The compound has the following infrared absorption frequencies: 2.8μ , sharp, medium; 3.9μ with 4.02μ shoulder, sharp, strong; 6.2 , 7.8 and 8.4μ , sharp, medium; 9.3μ , medium sharp, strong; 10.9μ , sharp, strong; and 13.9μ , broad weak.

Analysis.—Calc'd for $Na_2B_{12}H_{12} \cdot 59C_4H_{10}O_2 \cdot 56H_2O$: C, 15.37; H, 7.98; B, 46.67; Na, 16.49. Found: C, 15.52, H, 8.43; B, 47.12; Na 15.3.

The compound can be obtained as its hydrate free of ether solvation by recrystallization from a large quantity of diethyl ether or tetrahydrofuran/diethyl ether mixtures. The ether-free hydrate has infrared absorption characteristics as follows: 2.8μ , sharp, medium; 3.9μ , sharp, strong; 6.2μ , sharp, medium; 9.25μ , sharp, medium; and 13.9μ , broad, medium.

Analysis.—Calc'd for $Na_2B_{12}H_{12} \cdot H_2O$: H, 6.85; B, 63.45; Na, 22.32. Found: H, 6.56; B, 62.02; Na, 20.5.

The elemental analyses may be interpreted as showing the sodium salt to contain the dodecahydrododecaborate anion. As is shown in Example D below, the sodium salt of Example A is converted to a diphosphonium salt whose infrared absorption spectrum shows the same characteristic absorption bands at $4.0\mu \pm 0.1$ and $9.35\mu \pm 0.1$ as the disodium salt of Example A. The elemental analysis of the diphosphonium salt shows that the anion is $B_{12}H_{12}^{2-}$.

Example B

A pressure vessel of 80 ml. capacity is charged with 1.9 g. of sodium hydroborate, 2.3 g. of diborane and 10 ml. of glyme. The mixture is heated with agitation under autogenous pressure at $160^\circ C.$ for 10 hours. The reaction vessel is cooled and it is vented to remove volatile products. It is noted that these products contain about 0.187 mole of free hydrogen and no diborane. The residue in the reaction vessel consists of a white solid suspended in a yellow liquid. The solid is separated by filtration and washed with glyme. After drying, the solid weighs 3.2 g. and it is found by elemental analysis to be polyhydropolyborate containing some unchanged hydroborate.

Analysis.—Calc'd for

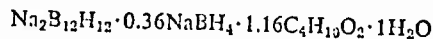

C, 17.20; H, 8.40; B, 41.27; Na, 16.74. Found: C, 17.07, H, 8.36; B, 40.66; Na, 16.5.

For reasons given earlier the compound is known to be disodium dodecahydrododecaborate (2-) with solvent of crystallization.

Example C

Using the procedure of Example B, a mixture of 2.8 g. of potassium hydroborate, 2.8 g. of diborane and 15 ml. of glyme is heated for 10 hours at $120^\circ C.$ under autoge-

nous pressure. A total of 0.281 mole of hydrogen is formed. The yellow solid in the reaction vessel is collected on a filter and it is washed with glyme until it is colorless. The solid is dried under very low pressure (less than 1 mm. of mercury) at 90° C. to yield 3.93 g. of a dipotassium polyhydroxypolyborate (2⁻), K₂B₁₂H₁₂.

Any alkali metal or alkaline earth metal hydroborate can be employed in the method illustrated in Examples A, B, and C, e.g., hydroborates of Li, Cs, Ca, Mg, and Ba can be used. The alkali metal hydroborates, especially LiBH₄, NaBH₄, and KBH₄, are most readily available and they are, therefore, preferred.

Example D

A. An aqueous solution of 3.2 g. of Na₂B₁₂H₁₂ (with water and glyme of crystallization) is mixed with an aqueous solution of 12 g. of cesium fluoride. A heavy white precipitate forms which dissolves on warming the reaction mixture. On cooling, fine white crystals form which are separated by filtration and dried. There is obtained 3.2 g. cesium dodecahydrododecaborate with solvent (glyme) of crystallization.

B. A solution of 0.89 g. of P,P,P',P',P'- (hexamethyl) ethylenediphosphonium bromide in 5 ml. of water is added with stirring to a solution of 1.13 g. of the cesium salt of Part A in 100 ml. of water. A voluminous white precipitate forms. The mixture is boiled to dissolve most of the precipitate. Cooling of the hot solution results in precipitation of a white solid which is separated by filtration. The solid is recrystallized from 1 liter of water to form soft white needles. The product is P,P,P',P',P'- (hexamethyl) ethylenediphosphonium dodecahydrododecaborate, i.e., [(CH₃)₂POCH₂CH₂P(CH₃)₂]₂B₁₂H₁₂. The identity of the compound is confirmed by the infrared spectrum and by elemental analysis. The product, as obtained, is free of water of hydration.

Analysis.—Calc'd for C₆H₃₄B₁₂P₂: C, 29.83; H, 10.64; B, 40.29; P, 19.24. Found: C, 29.89; H, 10.94; B, 39.86; P, 19.31.

Example 1

An aqueous solution containing 0.43 g. of

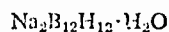

is passed through a 0.5" diameter chromatography column containing 80 ml. of an acid ion exchange resin known commercially as "Amberlite" IR-120-H. The strongly acid effluent from the column is evaporated to remove all materials volatile at less than 0.001 mm. at 45° C. There remains 0.38 g. of a very white, crystalline, very hygroscopic solid which is dihydrogen dodecahydrododecaborate (2⁻). The acid has a pK_a value at 25° C. of about 2.0 and it titrates as a very strong acid, having an equivalence point at a pH of 7. The infrared absorption spectrum of the acid, which, free of solvent of crystallization, has the formula H₂B₁₂H₁₂, shows strong and characterizing absorption in the infrared spectrum at 3.98μ and 9.3μ.

Example 2

The process of Example 1 is repeated, employing an aqueous solution of 5.7 g. of Na₂B₁₂H₁₂·H₂O. The solution is passed through a 48" by 1" (I.D.) ion exchange column packed with an ion exchange resin ("Amberlite" IR-120-H). The acidic eluent from the column is evaporated under reduced pressure in a rotating evaporator. The white crystalline acidic product which remains is dried at 40° C. at 0.05 mm. pressure for 1 hour. The product so obtained is dihydrogen dodecahydrododecaborate with 4 moles of water of hydration, i.e., H₂B₁₂H₁₂·4H₂O or (H₃O)₂B₁₂H₁₂·2H₂O.

Analysis.—Calc'd for B₁₂H₁₂O₄: B, 60.11; H, 10.27. Found: B, 60.73; H, 10.40.

Example 3

An aqueous solution of 6.10 g. of disodium dodecahy-

dodecaborate containing water and glyme as solvent of crystallization, is passed through a column (40" x 1") packed with an acidic ion exchange resin ("Amberlite" IR-120-H). The acidic eluent is evaporated under reduced pressure to yield dihydrogen dodecahydrododecaborate (2⁻) in the form of a hydrate as a white, crystalline solid.

Any alkali metal or alkaline earth metal dodecahydrododecaborate can be used in the processes illustrated in Examples 1, 2, and 3. Thus, the potassium derivative of Example C can be employed or the corresponding lithium, cesium, calcium, barium and magnesium derivatives. The sodium and potassium dodecahydrododecaborates are generally used because they are readily available.

Examples 1, 2, and 3 are illustrative of the broad process of metathesis employed in preparing the acid. Modifications of the procedure can be employed. To illustrate, a methanol solution of disodium dodecahydrododecaborate (2⁻) is treated with hydrogen chloride or with sulfuric acid in methanol solution. The by-product salts, sodium chloride or sodium sulfate, have low solubility in this solvent and they are separated by filtration to obtain a methanol solution of dihydrogen dodecahydrododecaborate (2⁻). Similarly, an aqueous solution of barium dodecahydrododecaborate (2⁻) can be reacted with an aqueous solution of sulfuric acid. Barium sulfate, which precipitates, can be separated by filtration and the aqueous filtrate can be evaporated to yield the free acid, H₂B₁₂H₁₂, as its hydrate. In like manner, diammonium dodecahydrododecaborate (2⁻) in aqueous solution can be reacted with dilute hydrochloric acid. The solvent can be removed by evaporation and the solid residue can be heated under reduced pressure to sublime the ammonium chloride. The non-volatile H₂B₁₂H₁₂ is obtained as the residue.

The novel acid, with or without solvent of crystallization, is useful as a sequestering agent for metals, especially heavy metals. To illustrate, a mixture of hydrocarbons in the boiling range of gasoline, which contains in solution a copper salt of an organic acid (copper stearate), is thoroughly agitated with an aqueous ammoniacal solution of H₂B₁₂H₁₂. The hydrocarbon layer, which is separated from the aqueous reagent, is completely free of the deleterious copper salt.

The new compound is useful as sequestering agents for metals in aqueous media. Thus, copper, nickel, cobalt, zinc and cadmium are removed from aqueous solutions of salts containing these metals by mixing the solutions with an ammoniacal solution of the acid.

The novel acid is useful as an intermediate in the preparation of valuable compounds. The acid is self-catalyzing in a Friedel-Crafts type reaction wherein the B₁₂H₁₂ anion is alkylated. To illustrate, the acid or its hydrate can be reacted in aqueous, alcohol or ethereal solutions with olefins to obtain polyhydrododecaborates having hydrocarbon substituents. Thus, a mixture of (H₃O)₂B₁₂H₁₂, water, propyl alcohol and propylene can be reacted under autogenous pressure in a closed vessel at about 75-100° C. to obtain compounds having isopropyl groups as substituents, e.g.,

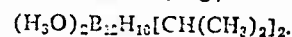

Other substituents which can be introduced on the anion by reaction of the acid with the appropriate olefin are butyl, cyclohexyl, and the like.

The acid is useful in industrial applications, especially in those situations where one desires to avoid contamination from sulfate, chloride, bromide, chlorate, phosphate and like strong acid anions. Thus, the acid is useful for etching metals, such as steel and for rust removal, for pickling, for scale removal and for similar metal processing operations.

The substituted derivatives, in the form of salts, are useful as surface active agents, particularly as wetting agents. To illustrate, a glass surface, coated with a film

of a silicone, is not wetted when brought into contact with water. The addition of a small quantity of dicesium cyclohexylundecahydrododecaborate to the water results in immediate wetting of the glass surface, i.e., the treated water spreads readily over the surface of the glass. The dicesium cyclohexylundecahydrododecaborate is obtained by reaction of the acid, $H_2B_{12}H_{12}$, with cyclohexene, with subsequent reaction with cesium hydroxide.

The foregoing detailed description has been given for clearness of understanding only and no unnecessary limitations are to be understood therefrom. The invention is not limited to the exact details shown and described, for obvious modifications will occur to those skilled in the art.

The embodiments of the invention in which an exclusive property or privilege is claimed are defined as follows:

1. Compounds having the formula

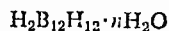

where n is a cardinal whole number of less than 5.

2. The acid

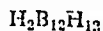

3. An aqueous solution of $H_2B_{12}H_{12}$.

4. A composition selected from the class consisting of $H_2B_{12}H_{12}$, hydrates thereof, and aqueous solutions thereof.

5. In a process for making dihydrogen dodecahydrododecaborate (2^-), the step comprising reacting in solution a salt containing the dodecahydrododecaborate anion $B_{12}H_{12}^{2-}$, said salt being selected from the class consisting of ammonium salts, alkali metal salts and alkaline earth metal salts with an acid having a pK_a value less than that of the dihydrogen dodecahydrododecaborate (2^-) and isolating the resulting acid.

6. In a process for making a substantially pure aqueous solution of the acid of claim 3, the step of contacting with an acidic ion-exchange resin a salt represented by the formula

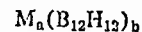

- where M is a cation selected from the group consisting of alkali metals, alkaline earth metals and ammonium and a and b are determined by the valence of M and are integers greater than 0 and less than 3 for a time sufficient to exchange the cation of such salt for the acidic hydrogen of the ion-exchange resin.

References Cited in the file of this patent

- Lipscomb: J. Phys. Chem. 62, pp. 381-392 (1958).
Lipscomb: Abstracts of Papers, 133rd, ASC Meeting, San Francisco.

1

3,169,045

DODECAHYDRODODECABORATE COMPOUNDS

Henry C. Miller, Wilmington, Del., and Earl L. Muetterties, West Chester, Pa., assignors to E. I. du Pont de Nemours and Company, Wilmington, Del., a corporation of Delaware

No Drawing. Filed May 20, 1960, Ser. No. 30,442
19 Claims. (Cl. 23-14)

This invention relates to certain new polyhydropolyborate salts and to methods for making the same.

Compounds of boron and hydrogen whose properties are described in the literature are limited to products having at most 10 boron atoms. The known covalent hydrides include such compounds as B_2H_6 , B_3H_8 , B_5H_{11} , and $B_{10}H_{14}$. The known salts of borohydride anions include salts of BH_4^- , $B_2H_7^-$, $B_3H_8^-$, $B_{10}H_{13}^-$, and $B_{12}H_{12}^-$. Salts of borohydride anions having more than 10 boron atoms are unknown. Salts of known borohydride anions decompose readily in acid solution and, in fact, the acids of borohydrides were heretofore unknown.

In particular, this invention is directed to a class of polyhydropolyborates characterized by the generic formula



where M is a cation having a total atomic weight of at least 5 and, further, having a valence of less than 5, $(B_{12}H_{12})$ is an anion having a valence of 2; a and b are each positive whole numbers of 1 through 3 (i.e., greater than 0 and less than 4) whose respective values are determined by the valence of M.

In Formula 1, the term "cation" has reference to an atom or group of atoms with a total atomic weight of at least 5 which, in aqueous solution, forms a positively charged ion. Examples of suitable cations include metals, ammonium (NH_4^+), hydrazonium ($NH_2-NH_3^+$), N-substituted ammonium, N-substituted hydrazonium, substituted phosphonium, aryl diazorium ($aryl-N=N^+$), and the like.

Metal cations in the compounds of Formula 1 can be derived generally from any metal. The metals according to the Periodic Table in Deming's "General Chemistry," 5th ed., chap. 11, John Wiley & Sons, Inc., and in Lange's "Handbook of Chemistry," 9th ed., pp. 56-57, Handbook Publishers, Inc. (1956), are the elements of Groups I, II, VIII, II-B, IV-B, V-B, VI-B, VII-B and the elements of Groups III-A, IV-A, V-A, and VI-A which have atomic numbers above 5, 14, 33 and 52, respectively. These metals include both light and heavy metals. The light metals are also known as the alkali metals and the alkaline earth metals. The heavy metals include brittle, ductile and low-melting metals as described in the above-mentioned Periodic Table in Lange's "Handbook of Chemistry." Metals having a wide range of atomic weights, e.g., from 6.9 for lithium to 209 for bismuth or even higher, are operable as cations in the compounds of Formula 1.

Preferred metal cations are derived from the elements of Groups I-A, II-A, I-B and II-B having an atomic number up to and including 80, inclusive. These compounds are dodecahydrododecaborates having as cations Li, Na, K, Rb, Cs, Be, Mg, Ca, Sr, Ba, Cu, Ag, Zn, Cd, and Hg.

Most preferred metals for use in the compounds of this invention are the light metals (the alkali and alkaline earth metals of Groups I-A and II-A) having an atomic number less than 87, i.e., lithium, sodium, potassium, rubidium, cesium, beryllium, magnesium, calcium, strontium, and barium.

The lithium, silver, and mercury dodecahydrododecaborates form an especially preferred group of salts.

2

A further group of particularly useful products are dodecahydrododecaborates in which the cations are derived, directly or indirectly, from nitrogen bases, e.g.,

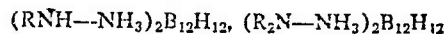
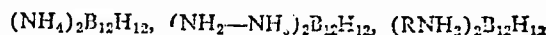

and

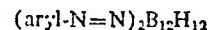

In the preceding formulas for compounds derived from nitrogen bases, R represents an organic group bonded to nitrogen. The R groups are not critical features of these cation groups; thus, R can be an open-chained, closed-chained, saturated or unsaturated hydrocarbon or substituted hydrocarbon group, or R can be a heterocyclic ring of which the nitrogen atom is a component part, such as pyridine, quinoline, morpholine, hexamethylenimine, and the like. Preferably, R, for reasons of availability of reactants, contains not more than 18 carbon atoms. R can be, for example, methyl, 2-ethylhexyl, octadecyl, allyl, cyclohexyl, cyclohexenyl, phenyl, naphthyl, anthryl, cyclohexylphenyl, diphenyl, benzyl, chloroethyl, *o*-cyanoamyl, beta-hydroxyethyl, p-hydroxyphenyl, and the like. The aryl group in the aryl diazonium cation preferably contains at most 18 carbons, e.g., a terphenyldiazonium group.

Examples of N-substituted hydrazonium radicals include those wherein R has the same significance as indicated in the preceding paragraph. To illustrate, the hydrazonium cation can be derived from phenylhydrazine, methyl hydrazine, 1,1-dimethylhydrazine, 1,2-dimethylhydrazine, ethylhydrazine, 1,1-diethylhydrazine, and similar compounds. Examples of aryl diazonium radicals include phenyldiazonium, tolyldiazonium, p-thoxyphenyldiazonium, and the like.

Thus, the atomic weights of nitrogen bases from which cations are derived can range from a low value of about 17 for ammonia (NH_3) to a value as high as about 800 or even higher for long chain substituted nitrogen bases, e.g., trioctadecylamine.

The nitrogen bases can be polybasic, i.e., the bases can form cations having valences of 2, 3, and higher. To illustrate, polybasic nitrogen compounds which can be employed to form salts include diamines (for example, hexamethylenediamine, p-phenylene diamine or piperazine), triamines (for example, diethylenetriamine), tetramines (for example, triethylenetetramine), and the like.

The valence of the cation M_a will be between 1 and 4, i.e., M can have a valence of 1, 2, 3 or 4. In most cases the valence of M will be 1 or 2 and this group of compounds in which the valence of M is at most 2 are readily preparable and so form a preferred group of compounds in this invention.

The group M can be a combination of cations whose total atomic weight is at least 5. To illustrate, M can be two monovalent metals or a monovalent metal and hydrogen, e.g., $(NaK)(B_{12}H_{12})$ or $(KH)(B_{12}H_{12})$ or, more simply, $NaKB_{12}H_{12}$ and $KHB_{12}H_{12}$. As a further illustration, M can be a complex cation such as amino metal groups, e.g., $(NH_3)_nY$, where Y is cobalt, nickel, copper, zinc, cadmium, mercury or silver and n is a positive number of at most 6. Compounds of the invention where M is an amino metal group, as discussed above, generally have low solubility in water and they are of particular interest because of this property.

The valence of the polyhydropolyborate anion in Formula 1 is 2. The values of a and b, therefore, in the generic formula are determined by the valence of M, i.e., a multiplied by the valence of M is equal to 2b.

stepwise procedure or the desired temperature may be reached by a one-step process.

It is essential that the reaction be conducted at a pressure higher than atmospheric. Accurate control of the pressure is not necessary and autogenous pressure obtained in the reaction chamber is normally used. This pressure may lie between about 3 to 500 atmospheres (absolute) or even higher. It is preferable that the reaction be conducted at a pressure of 5 atmospheres (absolute) or higher.

Mixing of the reactants during the process is desirable although not essential. Mixing can be accomplished by any suitable means, e.g., by mechanical stirring, shaking or tumbling of the entire reactor.

The time of the reactants during the process is desirable although not essential. Mixing can be accomplished by any suitable means, e.g., by mechanical stirring, shaking or tumbling of the entire reactor.

The time of the reaction is not critical. In a batch process, the time will generally lie between about 1 hour and 50 hours. In general, a reaction time of 5 hours to 25 hours is sufficient for batch operation. For a continuous process, which can also be employed, shorter reaction times are used and unreacted components can be recirculated.

In working up the reaction products, the volatile reaction products are generally removed by venting the vessel to the atmosphere. Hydrogen is a by-product of the reaction and it is removed with the volatile products. Suitable precautions should be observed in venting the reaction vessel in view of the flammability, toxic or, possibly, explosive hazards of the volatile products.

The reaction products, left after venting, are generally liquids or solids. They can be separated and purified by conventional procedures, e.g., filtration, crystallization, solution chromatography, and the like. The products should be handled with the customary precautions observed in handling chemical compounds to prevent undue contact with the skin or inhalation of fine powders.

In a preferred form of these processes, the reaction between diborane and the alkali metal or alkaline earth metal hydroborate is conducted in the presence of an inert solvent, i.e., a liquid which is unreactive under the conditions of the reaction with the components of the process and with the products which are derived. Ethers, thioethers (i.e., sulfides), tertiary amines, trisubstituted phosphines and hydrocarbons can be used in the process. The solvents preferably are liquids at the operating temperature and, in most cases, are liquids at prevailing atmospheric temperatures. Examples of operable solvents are diethyl ether, 1,2-dimethoxyethane (glyme), 1,2-diethoxyethane, benzene, hexane, triethylamine, tributylamine, dimethyl sulfide, dibutyl sulfide, triethylphosphine, tributylphosphine, and the like. Ethers and tertiary amines are preferred solvents. Relatively high boiling ethers or amines, such as glyme or triethylamine, are especially preferred.

The alkali metal and alkaline earth metal dodecahydrododecaborates can be employed to prepare compounds of Formula 1. For example, an aqueous solution of an alkali metal or alkaline earth metal salt is contacted with a strong acid or with a strongly acidic cation exchange resin to obtain the free acid, $H_2B_{12}H_{12}$. The acid, generally in solution, is reacted with oxides of metals, hydroxides of metals, salts of metals (both organic and inorganic), nitrogen bases, salts of nitrogen bases (both organic and inorganic), and similar types of compounds to obtain dodecahydrododecaborates which have the desired cation M. In a process employing an ion exchange resin, strongly acidic resins of the sulfonic acid variety are preferred because of availability, e.g., "Amberlite" IR-120-H and "Dowex" 50. To illustrate, an aqueous solution of $Na_2B_{12}H_{12}$ is passed through a column packed with "Amberlite" IR-120-H. The eluent, which contains the acid $H_2B_{12}H_{12}$, is evaporated under reduced pres-

sure to obtain the concentrated acid, generally as a hydrate, in the form of a white crystalline solid. The acid, in aqueous solution, can be reacted with nitrates, chlorides, bromides, acetates, benzoates and similar salts of metals or other bases to obtain salts of Formula 1.

In a second mode of operation the alkali metal and alkaline earth metal dodecahydrododecaborates can undergo simple metathetic reactions with other salts to effect an exchange of cations. Thus, $Na_2B_{12}H_{12}$ can be reacted with ammonium sulfate, pyridinium chloride, morpholinium sulfate, silver nitrate and ferric sulfate in aqueous or non-aqueous solution (e.g., methanol) to form dodecahydrododecaborates having as cations ammonium, pyridinium, morpholinium, silver and iron. These illustrations are not limiting and they demonstrate the breadth of metathetic reactions which can be used.

The novel products obtained by the processes of this invention are useful as sequestering agents for metals, especially heavy metals.

To illustrate, a mixture of hydrocarbons in the boiling range of gasoline, which contains in solution a copper salt of an organic acid (copper stearate), is thoroughly agitated with an aqueous ammoniacal solution of $Na_2B_{12}H_{12}$. The hydrocarbon layer, which is separated from the aqueous reagent, is completely free of the deleterious copper salt.

The new compounds are useful as sequestering agents for metals in aqueous media. Thus, copper, nickel, cobalt, zinc and cadmium are removed from aqueous solutions of salts containing these metals by mixing the solutions with an ammoniacal solution of an alkali metal or alkaline earth metal salt of a dodecahydrododecaborate, e.g., $Na_2B_{12}H_{12}$, $K_2B_{12}H_{12}$, $Cs_2B_{12}H_{12}$ and $CaB_{12}H_{12}$.

The ammonium, tetramethylammonium and, in general, nitrogen-base salts are also useful in the field of sequestering agents to remove undesirable metals from aqueous or hydrocarbon media. In addition to the metals named in the preceding paragraphs, silver ions are removed from solutions containing them by treatment with $Na_2B_{12}H_{12}$. Mercury anions are removed by treatment with ammoniacal solutions of dodecahydrododecaborates.

The diazonium salts, when heated or struck, decompose with rapid energy release and they are useful in compositions employed as explosion initiators.

In the especially preferred group of salts, lithium dodecahydrododecaborate is useful for modifying the combustion characteristics of hydrocarbon fuels; silver dodecahydrododecaborate is useful in the field of light-sensitive chemicals employed in photography; and mercury dodecahydrododecaborate is useful in biochemical applications for which mercury compounds are frequently employed.

The invention is further illustrated by reference to the following examples. In each of the examples the product which is isolated and characterized is a dodecahydrododecaborate. However, other polyhydropolyborates can also be obtained. These compounds have the following general formula:



wherein M' is selected from the group consisting of alkali metals and alkaline earth metals, $(B_n H_m)$ is an anion having a valence of 1-3, inclusive, a' and b' are positive whole numbers of 1 through 3 whose values are determined by the valences of M' and $(B_n H_m)$, n is an integer of at least 3, m is an integer greater than 3 and is at least equal to n , and the sum of m , n , and the valence of $(B_n H_m)$ is a positive even number.

The valence of M' can be 1 or 2, and the value of n can range up to 14, 20, or even more. The relationship between a' and b' is more particularly expressed by the equation

$$(5) \quad b' = \frac{a' \times \text{valence of } M'}{\text{valence of } B_n H_m}$$

Note that the value of m is at least 4 and that it can be equal to or greater than n but never less than n .

The composition of the hydroborates obtained in the process can be controlled by conditions under which the reaction is conducted so as to fix the atomic ratio of boron to hydrogen.

Example I

A pressure vessel (capacity, 80 ml.), is charged with 1.9 g. of sodium hydroborate, 2.8 g. of diborane and 10 ml. of glyme. The mixture is heated with agitation under autogenous pressure at 100° C. for 10 hours. The reaction vessel is cooled and it is vented to remove volatile products. It is noted that these products contain about 0.187 mole of free hydrogen and no diborane. The residue in the reaction vessel consists of a white solid suspended in a yellow liquid. The solid is separated by filtration and washed with glyme. After drying, the solid weighs 3.2 g. and it is found by elemental analysis to be a mixture which, solely on the basis of elemental analysis, can have the following compositions:

Analysis.—Calc'd for

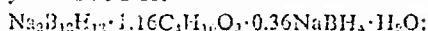

C, 17.20; H, 8.40; B, 41.27; Na, 16.74. Found: C, 17.07; H, 8.36; B, 40.56; Na, 16.5.

The compound shows the characteristic infrared absorption spectra of the $\text{B}_{12}\text{H}_{12}$ anion, i.e., bands at $4.6\mu \pm 0.1$ and $9.35\mu \pm 0.1$ and it is, therefore, evident that the product on the basis of the infrared absorption spectrum and elemental analysis is disodium dodecahydrododecaborate (2-).

Example II

Using the procedure described in Example I, a mixture of 1.9 g. of sodium hydroborate, 10 ml. of dry ethyl ether and 2.7 g. of diborane is heated for 10 hours at 100° C. under autogenous pressure. The volatile products obtained in the reaction contain 0.2 mole of hydrogen and no diborane. A solid product in the reaction vessel is collected, washed thoroughly with dry ether and dried to give 2.68 g. of a white solid. The infrared absorption spectrum of the solid shows that it is a mixture of sodium hydroborate and a disodium polyhydroborate (2-). Crystallization of the crude product from a mixture of tetrahydrofuran and glyme yields a disodium polyhydroborate (2-) containing 1 mole of glyme and 1 mole of water of crystallization. The compound has the formula $\text{Na}_2\text{B}_{12}\text{H}_{12} \cdot \text{C}_4\text{H}_{10}\text{O}_2 \cdot \text{H}_2\text{O}$, as shown by the characteristic absorption bands in the infrared absorption spectrum.

Example III

Using the procedure described in Example I, a mixture of 1.9 g. of sodium hydroborate, 2.8 g. of diborane and 10 ml. of dry triethylamine is heated for 10 hours at 120° C. under autogenous pressure. The volatile reaction products contain 0.18 mole of hydrogen. The non-volatile product in the reactor is diluted with ethyl ether and a quantity (2.64 g.) of insoluble material is separated by filtration. The solid is extracted with hot tetrahydrofuran, leaving 0.74 g. of unchanged sodium hydroborate. Glyme is added to the tetrahydrofuran filtrate to form a precipitate which, when separated and purified in the usual manner, yields 2.0 g. of a disodium polyhydroborate which is $\text{Na}_2\text{B}_{12}\text{H}_{12}$.

Example IV

A mixture of 1.9 g. of sodium hydroborate and 2.8 g. of diborane is heated, as described in Example I, for 10 hours at 120° C. under autogenous pressure. A small amount of diborane and 0.145 mole of hydrogen is recovered in the volatile reaction products. A solid which forms in the reaction vessel is removed, washed with ether and dried to give 2.85 g. of material. The solid is extracted with hot tetrahydrofuran, leaving 1.4 g. of sodium hydroborate. The tetrahydrofuran extract is evaporated,

leaving 0.21 g. of a disodium polyhydroborate, i.e., disodium dodecahydrododecaborate (2-).

Example V

A. A pressure vessel of 400 ml. capacity is charged with 9.5 g. of sodium hydroborate and 75 ml. of glyme. The vessel is closed, cooled to -80° C. and evacuated to a pressure of about 0.001 mm. of mercury. Diborane (14.0 g.) is charged into the vessel which is then sealed and heated with agitation under autogenous pressure for 10 hours at 120° C. The molar ratio of NaBH_4 to B_2H_6 in this reaction is 1:2. The reactor is cooled, the volatile products are released by venting and the contents of the tube are washed into a receiver with glyme. A suspension of a white solid in a yellow liquid is formed from which the solid is separated by filtration. The solid is dissolved in hot tetrahydrofuran and the solution is filtered to remove a trace of unreacted sodium hydroborate. The hot filtrate is diluted with glyme and chilled to yield 14.0 g. of disodium polyhydroborate (2-) as long, glistening white needles. The compound crystallizes with 1,2-dimethoxyethane and water of solvation. The compound has the following infrared absorption frequencies: 2.8 μ , sharp, medium; 3.9 μ with 4.0 μ shoulder, sharp, strong; 6.2, 7.8 and 8.4 μ , sharp, medium; 9.3 μ , medium sharp, strong; 10.9 μ , sharp, strong; and 13.9 μ , broad, weak. It has the following elemental analysis:

Analysis.—Found: C, 15.52; H, 8.43; B, 47.12; Na, 15.3. The compound, therefore, has the following composition: $\text{Na}_2\text{B}_{12}\text{H}_{12} \cdot 0.89\text{C}_4\text{H}_{10}\text{O}_2 \cdot 0.56\text{H}_2\text{O}$ (calc'd anal.: C, 15.37; H, 7.98; B, 46.67; Na, 16.49).

The compound can be obtained as its hydrate, free of ether of solvation, by recrystallization from a large quantity of diethyl ether or tetrahydrofuran/diethyl ether mixtures. The ether-free hydrate has the formula

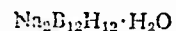

and its infrared absorption characteristics are as follows: 2.8 μ , sharp, medium; 3.9 μ , sharp, strong; 6.2 μ , sharp, medium; 9.25 μ , sharp, medium; and 13.9 μ , broad, medium.

Analysis.—Calc'd for $\text{Na}_2\text{B}_{12}\text{H}_{12} \cdot \text{H}_2\text{O}$: H, 6.85; B, 63.65; Na, 22.32. Found: H, 6.56; B, 62.02; Na, 20.5.

B. The procedure of Part A is repeated, employing 9.5 g. of sodium hydroborate and 26.0 g. of diborane. The molar ratio of NaBH_4 to B_2H_6 is about 1:4. There is obtained 10 g. of a disodium polyhydroborate which is shown to be disodium dodecahydrododecaborate (2-) and 60 g. of another disodium polyhydroborate (2-). The latter compound yields 30 g. of highly purified product on recrystallization.

Example VI

Using the procedure of Example I, a mixture of 1.9 g. of sodium hydroborate, 2.8 g. of diborane and 15 ml. of benzene is heated for 10 hours at 120° C. under autogenous pressure. The volatile reaction product contains 0.19 mole of hydrogen and no diborane. The vessel contains a yellow solid suspended in a clear liquid. The solid is removed by filtration and washed with glyme. The infrared absorption spectrum of the solid shows that it is principally a disodium polyhydroborate (2-) with some unchanged sodium hydroborate, i.e., disodium dodecahydrododecaborate (2-) with a minor quantity of sodium hydroborate.

Example VII

Using the procedure of Example I, a mixture of 2.8 g. of potassium hydroborate, 2.8 g. of diborane and 15 ml. of glyme is heated for 10 hours at 120° C. under autogenous pressure. A total of 0.281 mole of hydrogen is formed. The yellow solid in the reaction vessel is collected on a filter and it is washed with glyme until it is colorless. The solid is dried under very low pressure (less than 1 mm. of mercury) at 90° C. to yield 3.93 g. of dipotassium polyhydroborate (2-), i.e., dipotassium dodecahydrododecaborate ($\text{K}_2\text{B}_{12}\text{H}_{12}$).

One-half of the above solid product is dissolved in water and aqueous tetramethylammonium chloride is added to the solution. A white solid separates which dissolves in completely when the solution is heated to boiling. The solution is filtered and the filtrate is chilled to precipitate bis (tetramethylammonium) dodecahydrododecaborate (2⁻). There is obtained 0.33 g. of the product which has the formula $[(CH_3)_4N]_2B_{12}H_{12}$.

Example VIII

A pressure vessel (capacity, 80 ml.) is charged with 0.76 g. of sodium hydroborate and 15 ml. of tri-(n-butyl)-phosphine. The vessel is closed and cooled to about -80° C. by immersion in a solid carbon dioxide-acetone bath. Pressure in the vessel is reduced to a very low value (0.1 mm. or less) by means of a vacuum pump. Diborane (3.1 g.) is injected into the vessel which is then closed. The reaction mixture is heated with agitation under autogenous pressure for 10 hours at 120° C. The reaction vessel is cooled and volatile gases are removed by venting. The gases contain 0.19 moles of hydrogen. A white solid precipitated in a yellow liquid remains in the reaction vessel. The mixture is filtered to separate the white solid which is washed with glyme and dried at low pressure (0.001 mm. or less) at 90-100° C. There is obtained 1.61 g. of $Na_2B_{12}H_{12}$ containing glyme of solvation. The identity of the product is confirmed by the infrared absorption spectrum.

Example IX

A pressure vessel (capacity, 400 ml.) is charged with 19.0 g. sodium hydroborate and 75 ml. of dry triethylamine. The vessel is cooled in a solid carbon dioxide-acetone bath and the internal pressure is reduced to less than 1.0 mm. pressure by means of a vacuum pump. Diborane (26.0 g.) is introduced into the vessel which is then closed. The mixture is heated with agitation for 10 hours at 120° C. After cooling the vessel and venting to remove volatile products, there remains a solid residue which is washed from the vessel with glyme. The solid is separated by filtration and it is again washed with glyme. The washed solid is dissolved in hot tetrahydrofuran and the solution is filtered to remove a small quantity of insoluble product. The filtrate is heated to boiling and glyme is added slowly until solid material begins to separate. The mixture is chilled and it is then filtered to separate the white crystals. These crystals are washed with glyme and dried at less than 0.001 mm. pressure at 90-100° C. to yield 43.9 g. of $Na_2B_{12}H_{12}$ containing glyme and water of solvation. Further treatment of the filtrate yields an additional 5.4 g. of the product.

Example X

A pressure vessel (50 ml. capacity) is charged as described in Example VIII with 0.76 g. sodium hydroborate, 15 ml. of dimethyl sulfide and 3.3 g. of diborane. The mixture is heated at 120° C. for 10 hours with agitation and the volatile products are removed as described in Example VIII. The volatile products contain 0.123 mole of hydrogen. Dimethyl sulfide is removed from the residue in the reaction vessel by distillation and there remains a white solid which is recrystallized from a tetrahydrofuran/glyme mixture. After drying, the product, which is $Na_2B_{12}H_{12}$ containing glyme and water of solvation, weighs 1.57 g.

In the operation of the process at 100° C. or higher precursors of the alkali metal hydroborate can be employed, e.g., an alkali metal and diborane, in place of the alkali metal hydroborate. This mode of operation is illustrated in Example XI.

Example XI

Using the procedure of Example I, a mixture of 1.07 g. of metallic sodium, 2.5 g. of diborane and 10 ml. of glyme is heated under autogenous pressure for 10 hours

at 100° C. The volatile products obtained on venting the reactor contain 0.12 mole of hydrogen. The reaction vessel contains 1.72 g. of white solid and approximately 0.9 g. of unreacted sodium metal. A portion (0.5 g.) of the white solid, which is shown by infrared spectrographic analysis to contain disodium polyhydropolyborate (2⁻) is dissolved in water and the solution is treated with excess aqueous tetramethylammonium chloride. There is obtained 0.2 g. of bis(tetramethylammonium) polyhydropolyborate (2⁻). The compound has the formula $[(CH_3)_4N]_2B_{12}H_{12}$.

Other precursors for alkali metal hydroborates which may be employed are alkali metal hydrides and diborane or a combination of an alkali metal, hydrogen and diborane.

In Examples I through XI the principal product which is isolated and characterized is a salt of dodecahydrododecaborate. However, as stated previously, the process yields a broad range of polyhydropolyborates represented generically by Formula 4. The preparation and isolation of a representative polyhydropolyborate, falling within the broad scope of compounds of Formula 4, i.e., sodium octahydrotriborate, is illustrated in Example XII.

Example XII

(A) A pressure vessel (capacity 80 ml.) is charged with 1.9 g. (0.05 mole) of sodium hydroborate ($NaBH_4$) and 10 ml. of dry 1,2-dimethoxyethane (glyme). The vessel is closed and it is cooled to -10° C. Pressure in the vessel is then reduced to less than 1 mm. of mercury and 2.0 g. (0.073 mole) of diborane (B_2H_6) is charged into the vessel. The vessel is sealed and the reaction mixture is heated with agitation for 10 hours at 60° C. under autogenous pressure.

The vessel is cooled and it is vented to remove volatile material. A amber liquid remains which is held under reduced pressure (less than 1 micron) at the prevailing atmospheric temperature (about 25° C.) until all volatile material is removed. There remains 5.2 g. of oily product which is sodium octahydrotriborate containing glyme.

(B) The process of Part A is repeated employing 1.9 g. (0.05 mole) of sodium hydroborate, 1.8 g. (9.06 mole) of diborane and 10 ml of glyme. The mixture is held at 25° C. under autogenous pressure (about 18 atmospheres' gauge) for 10 hours. The volatile products contain 0.04 mole of unreacted diborane and 0.05 mole of hydrogen. The residue is a clear liquid which, following evaporation of the solvent, leaves 6.4 g. of sodium octahydrotriborate containing glyme.

(C) A water solution containing 5 g. of tetramethylammonium chloride is added to an aqueous solution of the sodium octahydrotriborate obtained in Part A. A white solid separates which redissolves upon heating the mixture to reflux. The hot solution is mixed with an equal volume of methanol and it is then chilled in an ice bath. Tetramethylammonium octahydrotriborate (1⁻) separates as white crystals. A total of 4.97 g. of product is obtained from several crystallizations. The identity of the compound, which has the formula

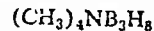

is confirmed by the infrared absorption spectrum which is in agreement with data reported for octahydrotriborate (1⁻) salts.

The oily product obtained initially in the reaction is converted to other metal salts by reaction with the appropriate chloride. To illustrate, a methanol solution containing 0.83 g. of the oily product is mixed with an equal weight of cesium chloride. The mixture is heated to reflux and just enough water is added to form a clear solution. The hot mixture is chilled in an ice bath and dense crystals form which are separated by filtration. The crystals are washed and dried and there is obtained 0.35 g. of cesium octahydrotriborate (1⁻), i.e., CsB_3H_8 .

Analysis.—Calc'd for CsB_3H_8 : Cs, 76.6; B, 18.75; H,

Anal. Found: Cs, 71.55; B, 19.05; H, 4.67.

In each of the foregoing examples, the reaction is conducted under superatmospheric pressure. Reaction of sodium hydroborate and diborane at atmospheric pressure does not yield the desired polyhydrododecaborates. To illustrate, a vessel is charged with 0.55 g. of sodium hydroborate and 15 ml. of dry glyme. The charged vessel is evacuated to about 50 mm. pressure and sufficient diborane (0.8 g.) is added to bring the pressure in the vessel to 1 atmosphere (15 lb./sq. in. absolute) at the prevailing temperature, i.e., about 25° C. The vessel is closed, placed on a mechanical shaker and agitated at 25° C. for about 40 hours. The internal pressure remains unchanged at 1 atmosphere. All of the diborane is recovered unchanged and no hydrogen attributable to the reaction of diborane with sodium hydroborate is found. The process is repeated, charging sufficient diborane (2.3 g.) into the vessel until a pressure of 3 atmospheres (absolute) is reached. After shaking the mixture for 4 hours at 25° C., an increase in pressure is observed on the gauge. Hydrogen is found in the volatile reaction products and only 2.1 g. of diborane is recovered. Sodium octahydrododecaborate (1.0 g.) is isolated from the solid reaction product.

From the foregoing data, it is evident that an essential feature of the process is the use of a pressure of at least about 3 atmospheres, i.e., 45 lb./sq. in. absolute, in the process to obtain totally unexpected results. At higher pressures, e.g., 5 atmospheres or higher, the reaction proceeds rapidly and good yields of desired products are obtained.

Pressures above atmospheric can be obtained by any suitable means. Inert gases, e.g., nitrogen, argon, helium, saturated hydrocarbons, and the like, can be charged into the reaction vessel with diborane to provide the pressure under the reaction conditions. Diborane can be used in excess, as illustrated in the examples, to provide a convenient way of obtaining superatmospheric pressure.

It is not essential that a solvent be employed in the process. However, in the event a solvent is employed care should be exercised in the choice. To illustrate, glyme in the presence of sodium hydroborate and diborane is unreactive, and it is a preferred solvent. However, glyme and diborane in the absence of sodium hydroborate react at 100° C. with cleavage of the glyme. Similarly, at low temperatures, i.e., at less than about 80° C., diethyl ether is a satisfactory solvent but at higher temperatures, generally above 100° C., it shows some cleavage. It is preferable, therefore, to employ the higher boiling solvents at temperatures above 100° C.

Examples I-XI illustrate principally the preparation of alkali metal dodecahydrododecaborates. The free acid, $H_2B_{12}H_{12}$, can be prepared from a salt of this type as illustrated in Example XIII-A below. The acid is then reacted with an appropriate salt or base, as illustrated in Example XIII-B, to obtain a broad range of salts having the dodecahydrododecaborate anion.

Example XIII

(A) An aqueous solution containing 0.43 g. of disodium dodecahydrododecaborate (2^-), obtained by the process described in Example II, is passed through a 0.5" diameter chromatography column containing 80 ml. of the ion exchange resin known commercially as "Amberlite" IR-120-H, acid form. The strongly acid effluent from the column is evaporated to remove all materials volatile at less than 0.001 mm. at 45° C. There remains 0.38 g. of a very white, crystalline, very hygroscopic solid which is dihydrogen dodecahydrododecaborate (2^-). The acid has a pK_a value at 25° C. of about 2.0 and it titrates as a very strong acid, having an equivalence point at a pH of 7. The infrared absorption spectrum of the acid, which has the formula $H_2B_{12}H_{12}$, shows strong absorption at 3.98 μ and 9.3 μ .

(B) An aqueous solution of the free acid ($H_2B_{12}H_{12}$)

obtained from $Na_2B_{12}H_{12}$ is neutralized by treatment with cesium hydroxide. A white solid precipitates which is separated by filtration and dried as described above. The product, which is $Cs_2B_{12}H_{12}$, dicesium dodecahydrododecaborate (2^-) is sparingly soluble in water and it is characterized by the following infrared absorption bands: 3.9 μ , 9.35 μ , sharp, strong; 14.0 μ , sharp, medium; 13.3 μ , medium broad, weak.

Analysis.—Calc'd for $Cs_2B_{12}H_{12}$: Cs, 65.18; B, 31.84; H, 2.97. Found: Cs, 62.7; B, 30.91, 31.08; H, 3.17.

(C) An aqueous solution of the acid, $H_2B_{12}H_{12}$, is neutralized with an aqueous solution of barium hydroxide. The clear neutralized solution is evaporated to dryness under reduced pressure to obtain barium dodecahydrododecaborate as a white crystalline residue. The product which has the formula $BaB_{12}H_{12}$ [barium dodecahydrododecaborate (2^-)], is very soluble in water and ethyl alcohol. The infrared absorption spectrum of the compound shows bands at 4.03 μ and 9.34 μ which are within the range of characterizing absorption bands for the $B_{12}H_{12}$ anion.

Analysis.—Calc'd for $BaB_{12}H_{12} \cdot \frac{1}{2}C_2H_5OH \cdot \frac{1}{2}H_2O$: Ba, 42.30; B, 39.99; H, 5.37; C, 2.46. Found: Ba, 42.16; B, 39.61; H, 5.41; C, 2.37.

An aqueous solution of the acid, upon treatment with tetramethylammonium chloride or tetramethylammonium hydroxide yields $[(CH_3)_4N]_2B_{12}H_{12}$. In like manner, reaction of the acid with aqueous hydrazine yields $(NH_2NH_2)_2B_{12}H_{12}$; with phenylhydrazine,



with morpholine,

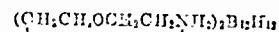

with ferrous sulfate, $FeB_{12}H_{12}$, with calcium hydroxide, $CaB_{12}H_{12}$; with cobalt chloride, $Co(B_{12}H_{12})_2$; with mercuric nitrate, $HgB_{12}H_{12}$; with bismuth chloride,

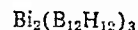

with magnesium chloride, $MgB_{12}H_{12}$; with pyridine, $(C_5H_5NH)_2B_{12}H_{12}$; with ammonium, $(NH_4)_2B_{12}H_{12}$; with ethylamine, $(C_2H_5NH_2)_2B_{12}H_{12}$; with triethylamine,

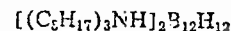

with ω -aminocapronitrile, $[CN(C_5H_9)_5NH_2]_2B_{12}H_{12}$; with cyclohexylamine, $(C_6H_{11}NH_2)_2B_{12}H_{12}$; with diphenylamine, $[(C_6H_5)_2NH]_2B_{12}H_{12}$; and with p-aminobenzoic acid, $(HOOC_6H_4NH_2)_2B_{12}H_{12}$.

A broad range of salts can be obtained by employing metathetic reactions between alkali metal or alkaline earth metal dodecahydrododecaborates and other salts, as illustrated in Example XIV.

Example XIV

(A) An aqueous solution containing 0.3 g. of disodium dodecahydrododecaborate, obtained by a process as described in Example II, is mixed with an aqueous solution containing an equal weight of tetramethylammonium chloride. A white precipitate forms immediately. The mixture is heated to boiling and sufficient methanol is added to form a clear solution. The solution is chilled and white crystals form which are separated by filtration, washed and dried at very low pressure at 90° C. There is obtained 0.14 g. of bis(tetramethylammonium)dodecahydrododecaborate (2^-).

Analysis.—Calc'd for $[(CH_3)_4N]_2B_{12}H_{12}$: C, 33.11; H, 12.5; N, 9.65. Found: C, 30.8; H, 11.77; N, 9.16, 8.88.

The infrared absorption spectrum of the compound is as follows, using a "Nujol" mull: 3.95 μ , sharp, strong; fine structure at 4.9–6.5 μ , weak; 7.8 μ , sharp, medium; 9.4 μ , sharp, strong; acid [for the $(CH_3)_4N^+$ cation], 10.5 μ , sharp, strong.

The compound can be purified by recrystallization from water to yield the monohydrate.

Analysis.—Calc'd for $[(CH_3)_4N]_2B_{12}H_{12} \cdot H_2O$: C, 31.13; H, 12.41; N, 42.07; Found: C, 30.95; H, 11.48; B, 42.68; N, 8.80, 8.91.

(B) An aqueous solution containing 0.25 g. of disodium dodecahydrododecaborate (2^-), obtained by a process as described in Example II, is treated with an aqueous solution containing 0.25 g. of cesium chloride. A white precipitate forms which redissolves when the mixture is heated to boiling. Upon chilling, dense white crystals are precipitated which are a mixture of cesium dodecahydrododecaborate (2^-) and cesium chloride. The crystals are separated and dried at $90^\circ C.$ under reduced pressure (less than 1 mm. of mercury), to obtain 0.31 g. of white crystals. The product can be further purified by recrystallization from water and it has the composition:

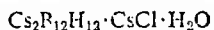

Analysis.—Calc'd for $Cs_2B_{12}H_{12}ClO$: Cs, 61.11; H, 2.37; B, 21.85; Cl, 5.96. Found: Cs, 66.2; H, 2.21; B, 22.14; Cl, 6.33.

The infrared absorption spectrum of a "Nujol" mull of the compound shows the following absorption bands: 3.9μ , 4.1μ , doublet, sharp, strong; 9.25μ , sharp, strong; 9.45μ , sharp, medium; 13.75μ , sharp, medium; 14.05μ , sharp, medium.

Example XV

An aqueous solution of 3.2 g. of $Na_2B_{12}H_{12}$ (with water and glyme of crystallization, obtained by a process as described in Example II) is mixed with an aqueous solution of 12 g. of cesium fluoride. A heavy white precipitate forms which dissolves on warming the reaction mixture. On cooling, fine white crystals form which are separated by filtration and dried. There is obtained 3.2 g. cesium dodecahydrododecaborate (2^-) with solvent (glyme) of crystallization.

Example XVI

A solution of 0.89 g. of P,P,P',P',P'-(hexamethyl) ethylenediphosphonium bromide in 5 ml. of water is added with stirring to a solution of 1.13 g. of the cesium salt of Example XIII(B) in 100 ml. of water. A voluminous white precipitate forms. The mixture is boiled to dissolve most of the precipitate. Cooling of the hot solution results in precipitation of a white solid which is separated by filtration. The solid is recrystallized from 1 liter of water to form soft white needles. The product is P,P,P',P',P'-(hexamethyl) ethylenediphosphonium dodecahydrododecaborate, (2^-), i.e.,

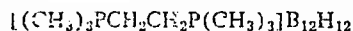

The identity of the compound is confirmed by the infrared spectrum and by elemental analysis. The product, as obtained, is free of water of hydration.

Analysis.—Calc'd for $C_8H_{14}B_{12}P_2$: C, 29.53; H, 10.64; B, 40.29; P, 19.24. Found: C, 29.89; H, 10.94; B, 39.86; P, 19.31.

Example XVII

(A) An aqueous solution containing 0.01 mole of $Na_2B_{12}H_{12}$ is added with stirring to 13 ml. of an aqueous solution containing 2.2 g. of $ZnCl_2$ and 7 ml. of concentrated aqueous NH_4OH . A white solid product precipitates and it is separated by filtration. The solid product is dissolved in about 700 ml. of hot aqueous ammonia (4 parts of water and 1 part of concentrated NH_4OH) and the solution is chilled. The product crystallizes as glistening white plates which are separated by filtration and dried under reduced pressure (less than 0.01 mm. of mercury) at $90^\circ C.$ to yield 2.2 g. of the ammonia complex of zinc dodecahydrododecaborate having the structure $Zn(NH_3)_4B_{12}F_{12}$, which can be called tetraamminezinc (II) dodecahydrododecaborate (2^-). The infrared absorption spectrum shows absorption bands at 4.05μ and 9.45μ , characteristic for the $B_{12}H_{12}$ anion, and it also shows N-H absorption bands for the bound NH_3 molecules.

Analysis.—Calc'd for $[Zn(NH_3)_4B_{12}F_{12}]$: Zn, 23.65; N, 20.4; B, 47.2; H, 8.78. Found: Zn, 23.60; N, 19.55; B, 45.8; H, 8.57.

(B) Using the procedure of Part A, a small quantity of disodium dodecahydrododecaborate is treated with ammoniacal nickel(II) chloride. A lavender-colored solid product precipitates and it is separated by filtration. The product is recrystallized from hot aqueous ammonia solution to form lavender crystals which are dried at $90^\circ C.$ under very low pressure (less than 0.01 mm. of mercury). The product is hexaamminenickel(II) dodecahydrododecaborate (2^-), i.e., a compound of the formula $Ni(NH_3)_6B_{12}F_{12}$. The compound, as obtained under the above conditions of drying, contains 0.5 mole of water of crystallization. The infrared absorption spectrum of the compound shows absorption bands at 4.02μ and 9.44μ , which are characteristic for the $B_{12}H_{12}$ anion, as well as other bands at wave lengths which are characteristic for the hexaamminenickel cation.

Analysis.—Calc'd for $Ni(NH_3)_6B_{12}F_{12} \cdot \frac{1}{2}H_2O$: Ni, 18.61; N, 26.95; B, 41.6. Found: Ni, 18.81; N, 26.86; B, 41.6.

Example XVIII

An aqueous solution of 4.4 g. of p-methoxybenzenediazonium tetrafluoroborate in 50 ml. of water is filtered to remove insoluble material. The filtrate is cooled in an ice bath and an aqueous solution containing 1.0 g. of the monohydrate of disodium dodecahydrododecaborate ($Na_2B_{12}H_{12} \cdot H_2O$) is added to the filtrate with stirring. A heavy white precipitate forms which is separated by filtration. The solid product is dried in air and its infrared absorption spectrum shows bands at 4.0μ and 9.4μ , characteristic for the B—H and B_{12} skeleton structures. The spectrum also shows bands at 4.4μ (for the diazonium structure) and 6.3μ , 9.1μ and 11.9μ (for the aromatic ring structure). The product is p-methoxybenzenediazonium dodecahydrododecaborate (2^-), i.e.

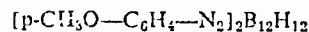

The identity of the compound is confirmed by elemental analysis of a portion of the product which is dried at $25^\circ C.$ and 0.02 mm. pressure for 20 hours. The dried product is shock sensitive and it detonates with a flash of light and evolution of much black ash when placed on a metal block and struck with a hammer. It also detonates in the combustion chamber employed for analysis but, despite this behavior, analytical data conform reasonably well with theoretical values.

Analysis.—Calc'd for $C_{14}H_{16}B_{12}N_4O_2$: C, 40.74; H, 6.36. Found: C, 38.86; H, 6.25.

The diazonium salt of Example XVIII reacts with potassium phenoxide in ethanol solution to form a solution of intense yellow color, characteristic of an aromatic diazonium salt.

A further characteristic reaction of the diazonium salt of Example XVIII is its rearrangement in refluxing ethanol solution to a hydrate of the acid of an arylazo-substituted polyhydrododecaborate, i.e., a compound of the formula $(H_3O)_2B_{12}H_{11} \cdot N_2C_6H_4OCH_3$. This compound dissolves in ethanol to form a solution of violet color. Evaporation of the solvent leaves a tacky purple solid. This product is useful as a dye for fabrics.

By using the processes illustrated in Examples XIV, XV and XVI, sodium or potassium dodecahydrododecaborate can be reacted with rubidium chloride to yield $Rb_2B_{12}H_{12}$; with strontium chloride to yield $SrB_{12}H_{12}$; with tantalum chloride to yield $Ta(B_{12}H_{12})_2$; with chromium sulfate to yield $Cr_2(B_{12}H_{12})_3$; with manganous acetate to yield $MnB_{12}F_{12}$; with cupric chloride to yield $CuB_{12}H_{12}$; with cuprous chloride to yield $Cu_2B_{12}H_{12}$; with zinc bromide to yield $ZnB_{12}H_{12}$; with cadmium chloride to yield $CdB_{12}H_{12}$; with aluminum chloride (hydrated) to yield $Al_2(B_{12}H_{12})_3$; with stannic chloride (hydrated) to yield $Sn(B_{12}H_{12})_2$; with bismuth chloride to yield $Bi_2(B_{12}H_{12})_3$; with benzyltrimethylammonium

15

chloride to yield $[(C_6H_5CH_2)(CH_3)_3N]_2B_{12}H_{12}$; with tetrabutylammonium chloride to yield

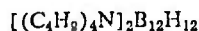

with tetramethylphosphonium bromide to yield

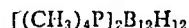

with methyltriphenylphosphonium bromide to yield $[CH_3(C_6H_5)_3P]_2B_{12}H_{12}$; and with dicyclohexyldihydrogenphosphonium bromide to yield $[(C_6H_{11})_2PH_2]_2B_{12}H_{12}$. The reaction can be conducted in nonaqueous solvents, for example, methanol, ethanol, ether and the like, if desired.

By using the process of Example XVII with the appropriate metal halide there can be obtained a wide variety of metal ammine dodecahydrododecaborates, e.g., with cobalt chloride, $[Co(NH_3)_4]B_{12}H_{12}$ is obtained; with copper chloride, $[Cu(NH_3)_4]B_{12}H_{12}$ is obtained.

By using the process illustrated in Example XVIII with the appropriate aryldiazonium halide, a broad range of diazonium salts are obtained, e.g., with phenyldiazonium chloride, there is obtained $(C_6H_5N_2)_2B_{12}H_{12}$, with naphthyldiazonium bromide, $(C_{10}H_7N_2)_2B_{12}H_{12}$ is obtained; and with p-thoxyphenyldiazonium chloride, $(C_6H_4OC_6H_4N_2)_2B_{12}H_{12}$ is obtained.

The dodecahydrododecaborate salts show a remarkable and unexpected stability in solution, particularly in the presence of inorganic acids. To illustrate, 1.00 g. of $Na_2B_{12}H_{12} \cdot H_2O$ is dissolved in 50 ml. of 5% hydrochloric acid solution. The solution is refluxed for 1 hour and it is then cooled rapidly and stored at 0-5°C. After a short period the solution is evaporated to dryness under reduced pressure. There is obtained 1.2 g. of white, crystalline residue which is shown by the infrared absorption spectrum to be $Na_2B_{12}H_{12}$ with a small quantity of $H_2B_{12}H_{12}$. The infrared absorption spectrum shows that the $B_{12}H_{12}$ anion is unaffected by the acid.

The free acid in the form of its hydrate, prepared as described in Example XIII, Part A, is completely stable during storage in conventional containers at ordinary atmosphere conditions. Even after 32 days standing in a closed container, the infrared absorption spectrum is unchanged, showing no evidence of hydrolysis, oxidation, rearrangement or decomposition.

The dodecahydrododecaborate salts are not hydrolyzed or decomposed by refluxing in neutral boiling water for 1 hour.

This application is a continuation-in-part of our earlier filed application Serial No. 15,042, filed March 15, 1960, and now abandoned.

The foregoing detailed description has been given for clearness of understanding only and no unnecessary limitations are to be understood therefrom. The invention is not limited to the exact details shown and described, for obvious modifications will occur to those skilled in the art.

16

The embodiments of the invention in which an exclusive property or privilege is claimed are defined as follows:

1. Compounds having the formula

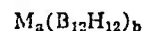

wherein M is a cation having a total atomic weight of at least 5 and a valence of less than 5, and a and b vary from 1 to 3 and satisfy the following relation:

$$b = \frac{a \times \text{valence of } M}{2}$$

2. Compounds having the formula

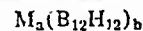

wherein M is a metal having an atomic weight of from about 5 to 209, and a and b vary from 1 and 3 and satisfy the following relation:

$$b = \frac{a \times \text{valence of } M}{2}$$

3. Compounds having the formula

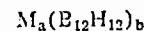

wherein M is a cation of a nitrogen base having a molecular weight of from about 17 to 800, and a and b vary from 1 to 3 and satisfy the following relation:

$$b = \frac{a \times \text{valence of } M}{2}$$

4. Compounds having the formula

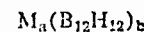

wherein M is a cation of a phosphonium base, and a and b vary from 1 to 3 and satisfy the following relation:

$$b = \frac{a \times \text{valence of } M}{2}$$

5. Disodium dodecahydrododecaborate (2-).

6. Dipotassium dodecahydrododecaborate (2-).

7. Bis(tetramethylammonium) dodecahydrododecaborate (2-).

8. Dicesium dodecahydrododecaborate (2-).

9. The ammonium complex of zinc dodecahydrododecaborate (2-) having the structural formula

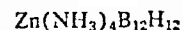

10. Barium dodecahydrododecaborate (2-).

References Cited in the file of this patent

UNITED STATES PATENTS

2,921,963 Baker _____ Jan. 19, 1960

OTHER REFERENCES

Hurd: Chemistry of the Hydrides, John Wiley, pp. 81, 83, August 25, 1952.

Lipscomb: J. Phys. Chem. 62, 381-2 (1958).

Lipscomb: Abstracts of Papers, 153rd ACS Meeting (San Francisco).

1

3,184,286

$Cs_2B_{12}H_{12} \cdot CsNO_3$ PRODUCT AND PROCESS
FOR MAKING SAME

David C. England, Wilmington, Del., assignor to E. I. du Pont de Nemours and Company, Wilmington, Del., a corporation of Delaware

Filed Feb. 17, 1961, Ser. No. 90,012

4 Claims. (Cl. 23-14)

This invention relates to a novel compound which contains boron and to the preparation of this compound. More particularly, the invention relates to a double salt which contains boron and to methods for its preparation.

A need exists for compositions which will yield large quantities of energy under controllable conditions. In recent years boron compounds have been considered for use in this field but many of the available boron compounds are severely limited in use because of hydrolytic, oxidative and other types of instability. Compositions which will provide maximum energy when desired and which have good stability in other respects form a valuable and needed class of products particularly in the field of explosives and high energy fuels.

The composition of the present invention is a double salt of cesium nitrate and cesium dodecahydrododecaborate(2-) in which the nitrate and dodecahydrododecaborate(2-) components are present in equimolar ratios. The composition is represented by the formula

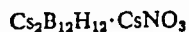

In this formula, the group $B_{12}H_{12}$ is referred to as "dodecahydrododecaborate(2-)" or, more simply, "dodecahydrododecaborate." This group has a negative valence of two, i.e., in reactions it behaves as a divalent anion.

The compound of the invention is a crystalline solid which is substantially white or colorless. It can be stored for indefinite periods in conventional containers, preferably of corrosion-resistant materials. Containers of glass, polyethylene, poly(tetrafluoroethylene)resin, and the like are suitable. The compound is soluble in highly polar liquids such as water. It has only limited solubility in alcohols, esters, ethers, ketones, and the like. The compound is substantially insoluble in hydrocarbons and has reasonably good thermal stability, e.g., the cesium double salt is stable to high temperatures in the absence of an open flame. When exposed to an open flame, the compound burns readily.

The double salt of the invention is obtained by reacting compounds which contain one or more of the anion and cation-forming groups found in the final product. Thus, three reactants can be employed, if desired, which are (1) a dodecahydrododecaborate(2-), i.e., a compound containing the $B_{12}H_{12}$ group, (2) a compound having a nitrate group (NO_3^-), and (3) a salt of cesium. Preferably, water-soluble reactants are employed to facilitate separation of the desired product. In other words, by bringing together sources of the three components which are water-soluble, one may obtain the desired product.

Dodecahydrododecaborates(2-) can be obtained by the process described by Pitochelli and Hawthorne, J. Am. Chem. Soc., 82, 3229 (1960). A general method for the preparation of a typical salt, $Na_2B_{12}H_{12}$, is also described in a subsequent paragraph. In the event other salts are desired, they can be obtained from $Na_2B_{12}H_{12}$ by simple mathematical reactions. Dihydrogen dodecahydrododecaborate(2-), i.e., $H_2B_{12}H_{12}$, if desired as a reactant, can be obtained in water solution by contacting an aqueous solution of $Na_2B_{12}H_{12}$ with the acid form of an ion-exchange resin. Suitable acidic ion-exchange resins are the polysulfonic acid resins which are commercially available, e.g., "Amberlite IR-120 (H)" and

2

"Dowex 50." The aqueous solution of $H_2B_{12}H_{12}$ probably contains the hydronium ion (H_3O^+).

Any dodecahydrododecaborate is operable in the process. However, as a matter of convenience water-soluble dodecahydrododecaborates are preferred. Especially preferred dodecahydrododecaborates are represented generically by the following formula:



where M' is hydrogen, ammonium (NH_4), substituted ammonium ($R_2R'NH$ and R'_4N), or alkali metal. In the substituted ammonium group, R is hydrogen or R' , and R' represents a hydrocarbon group of up to 8 carbons which can be alkyl, cycloalkyl, aryl, alkaryl, and aralkyl. Illustrative of R' are the groups methyl, ethyl, octyl, cyclohexyl, phenyl, benzyl, and the like. The nature of these groups is not a critical factor in the process.

The nitrate-bearing reactant can, as the same implies, be any compound which supplies a nitrate ion (NO_3^-). The compounds which are most readily available are generally employed as a matter of convenience. These are nitric acid and alkali metal nitrates (e.g., $NaNO_3$, KNO_3 and $CsNO_3$) which are preferably used in solution. These compounds form a preferred group of reactants which can be represented generically as $M''NO_3$, where M'' is hydrogen or an alkali metal. Caution is necessary when nitric acid is used as a reactant to avoid a vigorous reaction and for its reason, it is preferable to dilute concentrated nitric acid with an equal volume of water prior to use. Cooling of the reaction mixture to about 25° C. or lower aids in controlling the reaction.

The third reactant supplies the desired cesium which appears in the final product. This reactant need not be employed in cases where at least one of M' and M'' in the two previous reactants is cesium. In the event the third reactant is employed, any available salt can be used which provides the desired cation-forming group. Thus, halides, carbonates, sulfates, phosphates, hydroxides, and the like, of cesium, can be used. To illustrate, cesium hydroxide, cesium fluoride, cesium sulfate, cesium phosphate, and like compounds can be employed.

The process is generally conducted in an inert liquid medium which is a solvent for the reactants. Water is entirely satisfactory as a reaction medium and it is a preferred solvent in view of its availability and ease of handling.

In the simplest mode of operation, an aqueous solution of cesium dodecahydrododecaborate is added with stirring to an aqueous solution of cesium nitrate. The reaction mixture is concentrated, if necessary, by evaporation until the double salt precipitates. Frequently, the double salt precipitates at once and it is separated by filtration. In this mode of operation, temperature is not a critical factor. The reaction is normally operated at prevailing atmospheric temperature (about 25° C.) but lower or higher temperatures can be employed, e.g., from about -20° to 100° C. Concentration of reactants in solution is not critical, i.e., dilute or concentrated solutions can be used. However, by using solutions of maximum concentration, the double salt will usually precipitate at once. To obtain products which can be purified with minimum effort, it is preferred that the ratio, moles of nitrate/moles of dodecaborate, is at least 3 and that the same metal anion, i.e., cesium is present in each reactant. The process is operable even though these reactants are used in a molar ratio of less than 3.

In a modification of the above method of operation, cesium dodecahydrododecaborate is dissolved in an aqueous solution of cesium nitrate to provide a solution which can be processed as described in the preceding paragraph.

In a second mode of operation, an aqueous solution of the dodecahydrododecaborate is prepared and an aqueous

solution of nitric acid is added with stirring to the reaction mixture which, preferably, is cooled. The resulting solution is mixed with a cesium salt. The salt most conveniently used is the nitrate and, in the event another salt is used, e.g., a chloride, fluoride, sulfate, and the like, sufficient nitric acid is employed initially to provide the quantity of nitrate ion needed to form the cesium nitrate and to react with the M' group in M'₂B₁₂H₁₂. Thus, in a preferred method of operation of this process, the moles of cesium salt which are used are greater than the sum of the moles of dodecahydrododecaborate and moles of nitrate. It is not essential for operability that this ratio is used.

The concentration of nitric acid in the aqueous solution employed as a reactant is generally at most 70% and it is preferably lower. When a solution of high concentration of nitric acid is employed the reaction is generally performed at a relatively low temperature. Preferably a temperature of not over about 50° C. is employed. A satisfactory and preferred temperature range is from about -20° to 30° C.

The product is purified by conventional methods. The product can be washed with oxygen-containing liquids, e.g., acetone, 1,2-dimethoxyethane, ethyl acetate, ethyl alcohol, and the like, and it can be recrystallized from suitable solvents. In view of the solubility of the double salt in water, particularly hot water, this solvent is most frequently used as a recrystallizing medium.

Modifications of the above processes can be employed to obtain the double salt. Thus, an aqueous solution of the free dodecahydrododecaborate acid [represented as H₂B₁₂H₁₂ or, in its hydronium form, as (H₃O)₂B₁₂H₁₂] can be admixed with nitric acid and then with a cesium salt. The free dodecahydrododecaborate acid reactant is obtained, as stated previously, by treating at temperatures between 0° and 100° C. an aqueous solution of a metal or ammonium dodecahydrododecaborate with an ion-exchange resin capable of replacing the metal or ammonium group by hydrogen, e.g., polystyrene cross-linked with divinyl benzene which is sulfonated to introduce sulfonic acid groups into the aryl nucleus. The free boron acid reactant can be isolated, if desired, by evaporating the aqueous acid solution at about 50° C. or below, preferably under reduced pressure (10 mm. of Hg or less). The acid is usually and most conveniently obtained as a hydrate.

The preparation of the double salt of the invention is illustrated in further detail in the following example. The preparation of a typical dodecahydrododecaborate, used as one reactant, is also described (Example A).

Example A

(A) A pressure vessel (capacity, 400 ml.) is charged with 19.0 g. of sodium hydroborate (NaBH₄) and 75 ml. of dry triethylamine. The vessel is cooled in a solid carbon dioxide-acetone bath and the internal pressure is reduced to less than 1.0 mm. pressure by means of a vacuum pump. Diborane (36.0 g.) is introduced into the vessel which is then closed. The mixture is heated with agitation for 10 hours at 180° C. After cooling the vessel and venting to remove volatile products, there remains a solid residue which is washed from the vessel with 1,2-dimethoxyethane (glyme). The solid is separated by filtration and it is again washed with glyme. The washed solid is dissolved in hot tetrahydrofuran and the solution is filtered to remove a small quantity of insoluble product. The filtrate is heated to boiling and glyme is added slowly until solid material begins to separate. The mixture is chilled and it is then filtered to separate the white crystals. These crystals are washed with glyme and dried at less than 0.001 mm. pressure at 90-100° C. to yield 43.9 g. of Na₂B₁₂H₁₂ containing glyme and water of solvation. Further treatment of the filtrate yields an additional 5.4 g. of the product.

(B) The product of Part A is recrystallized from a

large quantity of diethyl ether to obtain a hydrate of Na₂B₁₂H₁₂, free of glyme as solvent of crystallization, i.e., the product is Na₂B₁₂H₁₂ containing water of crystallization.

The compound Na₂B₁₂H₁₂ is referred to as disodium dodecahydrododecaborate(2-).

Example I

(A) A reaction vessel is charged with 5 ml. of water and 1 g. of disodium dodecahydrododecaborate(2-) dihydrate (Na₂B₁₂H₁₂·2H₂O). The mixture is stirred to form a solution and the vessel is immersed in a cooling bath to maintain a temperature slightly below 0° C. A solution of 5 g. fuming nitric acid in 15 ml. of water is added dropwise and with vigorous agitation to the reaction mixture, keeping the temperature somewhat below 0° C. The mixture becomes red until about half of the nitric acid solution is added. The color of the solution then becomes yellow. After addition of the nitric acid is completed, the solution is stirred a few minutes in the cooling bath and, while still cold, 5 ml. of an aqueous 50% solution of cesium fluoride is added with stirring. The precipitate which forms is separated by filtration and the solid is washed thoroughly with cold water. The solid is crystallized from water containing an activated decolorizing carbon to yield 2.3 g. of dicesium dodecahydrododecaborate (2-)-cesium nitrate adduct. The product is further purified by recrystallization from water as described. The identity of the compound, which has the formula Cs₂B₁₂H₁₂·CsNO₃, is confirmed by elemental analysis.

Analysis.—Calc'd for Cs₂B₁₂H₁₂NO₃: Cs, 66.2; B, 21.6; H, 2.0; N, 2.3. Found: Cs, 64.8, 65.9; B, 21.39, 21.48; H, 2.19, 2.31; N, 1.21, 1.04.

(B) A reaction vessel is charged with 25 ml. of water and 20 g. of disodium dodecahydrododecaborate(2-) which contains, as solvents of crystallization, about 1 mole of water and 3.5 moles of 1,2-dimethoxyethane. The mixture is stirred to form a solution and it is then cooled in an ice-water bath. A solution consisting of 5 ml. of 70% nitric acid in 10 ml. of water is added to the cooled reaction mixture slowly and with stirring. A faint reddish color develops initially but it fades rapidly. Cooling of the solution in the ice-bath is continued and 20 ml. of a 50% aqueous cesium fluoride solution is added with agitation. A white precipitate forms which is separated by filtration. The solid product is crystallized from water to yield 19 g. of dicesium dodecahydrododecaborate(2-)-cesium nitrate double salt, i.e., Cs₂B₁₂H₁₂·CsNO₃. The identity of the compound is confirmed by its infrared absorption spectrum.

The process illustrated in the above example is operable generally with a wide range of dodecahydrododecaborate salts, i.e., with compounds represented generically as M'_a(B₁₂H₁₂)_b, where *a* and *b* are whole numbers of 1 through 3 whose values are determined by the valence of M'. To illustrate, M' can be ammonium, substituted ammonium, hydrazoneium or any metal which, preferably, yields a water-soluble dodecahydrododecaborate. These salts can be obtained by simple metathetic reactions from Na₂B₁₂H₁₂ in aqueous solution or by neutralization of the hydrated acid, (H₃O)₂B₁₂H₁₂, in aqueous solution with a base, or by other methods which are obvious to those skilled in the art. For example, neutralization of the acid with ammonium hydroxide yields (NH₄)₂B₁₂H₁₂; with cesium hydroxide, Cs₂B₁₂H₁₂ is obtained; with

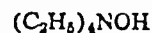

there is obtained [(C₂H₅)₄N]₂B₁₂H₁₂. It is thus evident that a wide range of salts can easily be obtained for use as reactants in the above-described processes for obtaining the double salt of the invention.

The double salt of the invention is particularly useful as an ignition agent in electric blasting caps. For example, in electric blasting caps to be used for special purposes, such as seismographic exploration, the accuracy of the

work is dependent upon knowledge of the instant of detonation. At present, lead styphnate is known to be highly sensitive to ignition by discharges of static electricity and, accordingly, must be handled with extreme caution.

The double salt of cesium nitrate with cesium dodecahydrododecaborate, i.e., $Cs_2B_{12}H_{12} \cdot CsNO_3$, has been found to be very insensitive to ignition by discharges of static electricity and, at the same time, to be ignitable with sufficient rapidity to meet the requirements of a "fast" ignition charge.

To evaluate the performance of this double salt, electric blasting caps are prepared having the design illustrated in the accompanying drawing. Referring to the drawing, the electric blasting cap comprises a shell 11 having an integral closed end. A base charge 12 is loaded adjacent to the end. Such base charge may consist of any explosive conventionally employed for the purpose, such as cyclotrimethylenetrinitramine, pentaerythritol tetranitrate, picric acid, trinitrotoluene, tetryl or mixtures thereof. Above base charge 12 is primer charge 13 which may be any of the primary explosives (highly sensitive to flame and/or shock) usually employed, e.g., lead azide or mercury fulminate. Above primer charge 13 is the loose igniting charge 14 which in this case consists of the double salt of cesium nitrate with cesium dodecahydrododecaborate. A bridgewire 15 connecting the termini of lead wires 16 is disposed within the ignition composition 14. The shell 11 is sealed with rubber plug 17 which also holds the lead wires 16 firmly in position. Alternatively, conventional shell sealing means may be substituted for the rubber plug 17.

Example II

(A) A series of electric blasting caps are assembled as described in the drawing. The shell is of bronze and is $1\frac{1}{4}$ inches long with an outer diameter of 0.272 inch and an average inner diameter of 0.26 inch. Into this shell is loaded approximately 4.9 grains of pentaerythritol tetranitrate, pressed at 225-250 lb. Immediately above this base charge, approximately 2.2 grains of lead azide is loaded and pressed at about 200 lbs. Two grains of the loose double salt of cesium nitrate and cesium dodecahydrododecaborate is inserted as the ignition charge. A conventional rubber plug assembly is inserted in which a 0.0019 inch diameter 80/20 nickel chromium bridge wire is soldered to the lead wires separated to provide a $\frac{1}{8}$ inch span and projecting $\frac{1}{8}$ inch from the base of the rubber plug. The lead wires contained in the rubber plug are of 20 gauge copper insulated with nylon. After the cap is loaded and the plug inserted, three peripheral crimps are made in the shell wall to seal in the plug.

(B) To test for static resistance, the lead wires of the thus assembled caps are twisted together and connected to the high voltage terminal leg-to-shell static sensitivity apparatus consisting essentially of a source of variable voltage and a series of micromicrofarad ($\mu\mu\text{fd.}$) condensers ranging in capacitance from 250-2000 $\mu\mu\text{fd.}$; the shell of the cap is connected to a ground line. Voltages of from 0 to 30,000 volts are applied to a condenser of known capacitance in increments of 1000 volts and the condenser is allowed to discharge through the cap. The caps detonate near the upper limit of the equipment, e.g., when a voltage of 30,000 volts is applied through a 1000 $\mu\mu\text{fd.}$ condenser.

In contrast, caps containing lead styphnate as the ignition charge customarily detonate when a potential of 4000 volts is applied through a 2000 $\mu\mu\text{fd.}$ condenser, i.e., the

static resistance of lead styphnate is only about $\frac{1}{4}$ of the static resistance of $Cs_2B_{12}H_{12} \cdot CsNO_3$.

(C) When caps prepared as described in Part A are connected to a conventional blasting circuit, ignition occurs within 28.9 milliseconds with passage of a 5 ampere (6.85 volts) firing current through the bridge wire of each cap.

(D) When the double salt, $Cs_2B_{12}H_{12} \cdot CsNO_3$, is tested for sensitivity to impact in the standard "5-kg. drop test," the composition does not detonate until the 5-kg. weight is dropped on it from a height of 45 inches.

In contrast, ignition compositions containing conventional agents, e.g., lead styphnate and mercury fulminate, detonate when a 2-kg. weight is dropped on them from heights of 3 and 2 inches, respectively.

(E) Squibs are prepared using the double salt,



The shell and plug assembly including the bridge wire is identical to that described for the electric blasting cap, the only difference being that the detonating base charges and the priming charges are omitted and the charge weight for the double salt is increased to 3 grains. With a 5 ampere current the squibs functioned in an average time of 29.8 milliseconds. Black powder and a number of rocket propellant compositions are ignited by means of these squibs; in all cases the functioning is satisfactory.

Example II illustrates the usefulness of the compound as a component of electric blasting caps. The examples further illustrate the stability of the compound against premature detonation and explosion.

As many apparently widely different embodiments of this invention may be made without departing from the spirit and scope thereof, it is to be understood that this invention is not limited to the specific embodiments thereof except as defined in the appended claims.

The embodiments of the invention in which an exclusive property or privilege is claimed are defined as follows:

1. A double salt of the formula



2. A process for the formation of $Cs_2B_{12}H_{12} \cdot CsNO_3$ which comprises bringing together the following reactants:

(1) a compound of the formula $M'_2B_{12}H_{12}$ wherein M' is a cation selected from the class consisting of hydrogen, ammonium, alkali metal, and N-substituted ammonium in which the substituents are hydrocarbon of 1-8 carbon atoms,

(2) a compound of the formula $M''NO_3$ wherein M'' is a cation selected from the class consisting of hydrogen and alkali metal, and

(3) a cesium salt selected from the class consisting of cesium halide, cesium carbonate, cesium sulfate, cesium phosphate, cesium hydroxide, cesium dodecahydrododecaborate and cesium nitrate,

in a solvent inert to the reactants, and isolating the resulting product.

3. Process of claim 2 wherein the solvent is water.

4. Process of claim 2 wherein the mole ratio of the nitrate compound to dodecahydrododecaborate compound is at least 3.

No references cited.

65 MAURICE A. BRINDISI, *Primary Examiner*.
CARL D. QUARFORTH, *Examiner*.

May 18, 1965

D. C. ENGLAND

3,184,286

$Cs_2B_{12}H_{12}CsNO_3$ PRODUCT AND PROCESS FOR MAKING SAME

Filed Feb. 17, 1961

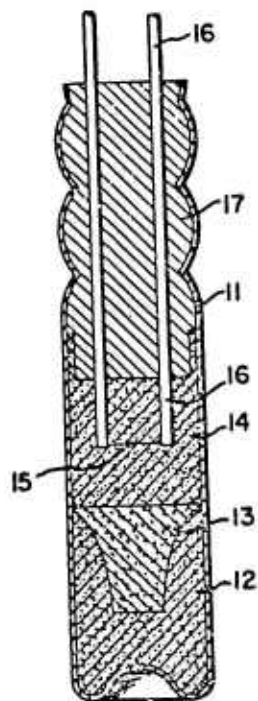

INVENTOR
DAVID C. ENGLAND

BY *Barton J. Rowland*

AGENT

1

3,256,056

(Cs₂B₁₀H₁₀)₂·Cs₂Cr₂O₇ PRODUCT AND PROCESS FOR PREPARING SAME

Robert K. Armstrong, Glassboro, N.J., assignor to E. I. du Pont de Nemours and Company, Wilmington, Del., a corporation of Delaware

Filed Dec. 12, 1961, Ser. No. 159,203

4 Claims. (Cl. 23-14)

This invention relates to a novel compound which contains boron and to the preparation of this compound. More particularly, the invention relates to a double salt which contains boron, to methods for its preparation and to ignition compositions thereof.

There is a need in the explosives and blasting art for ignition compositions which are reliable and have reproducible ignition properties. One particular area in which this need is particularly acute is in delay initiators and delay connecting devices. Conventional delay-producing compositions now used in the art, because they are normally mixtures of materials, often do not achieve the aforementioned end. In addition, it has been the aim of the art to produce ignition compositions which are insensitive to impact and have excellent resistance to static charges.

The subject invention provides a new boron-containing compound which is eminently suited for use in delay producing compositions, which ignites reliably and uniformly, and which has excellent resistance to impact and static electricity.

The compound of this invention is a double salt of cesium dichromate and cesium decahydrodecaborate having the formula:

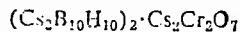

The compound of this invention is prepared by bringing together, as the sole reactants, a source of decahydrodecaborate, B₁₀H₁₀⁻², dichromate, and Cs⁺ in an inert solvent for the reactants.

The decahydrodecaborate can be provided, for example, by decahydrodecaboric acid, its hydronium analog, [H₃O]₂B₁₀H₁₀·(H₂O)_n, wherein *n* is zero or a positive integer] or by salts of decahydrodecaboric acid, such as the amine salts, or metal salts which are soluble in the reaction medium, e.g., the salts of alkali and alkaline-earth metals, copper, lead, silver, etc. Dichromate, Cr₂O₇⁻², can be provided by, for example, ionizable dichromate salts such as sodium, potassium or ammonium dichromate or by dichromic acid. Any ionizable cesium compound bearing an inert anion can be employed. Examples of such cesium compounds include cesium hydroxide or ionizable cesium salts such as cesium carbonate, cesium fluoride, cesium iodide, cesium bromide, cesium chloride, cesium sulfide or cesium sulfate.

Decahydrodecaboric acid and its hydronium compound can be prepared by treating, at a temperature between 0° C. and 100° C., an aqueous solution of a boron hydride amine salt having the formula (R₃NH)₂B₁₀H₁₀, where R is H or an alkyl radical containing less than 5 carbon atoms, with an ion-exchange resin capable of replacing the amine cations by hydrogen. An example of such an ion-exchange resin is a copolymer of styrene cross-linked with divinylbenzene and sulfonated to introduce sulfonic acid groups into the aryl nucleus as polar groups. The

2

boron-containing acid can be isolated from the aqueous effluent by evaporation of the water at elevated temperatures, e.g., 30-40° C., preferably under reduced pressure (0.1-5 mm. of mercury). A more detailed discussion of the preparation of the acid is disclosed in copending application Serial No. 6,855, filed February 5, 1960, now U.S. Patent 3,148,939, in the name of W. H. Knoth Jr. and assigned to the present assignee.

The boron hydride amine salts can be prepared by reacting two moles of a primary, secondary, or tertiary alkyl amine or of ammonia with 1 mole of a decaboryl bis(alkyl sulfide), e.g., decaboryl bis(dimethyl sulfide) as described in detail in copending application Serial No. 6,854, filed February 5, 1960, now U.S. Patent 3,149,163 and Serial No. 6,855, filed February 5, 1960, now U.S. Patent 3,148,938, in the name of W. H. Knoth, Jr. and assigned to the present assignee. The amine salt also can be prepared by refluxing decaborane with a lower alkyl tertiary amine in benzene for several hours, cooling the mixture, adding acetone, and filtering out the desired amine salt.

The preferred solvent system for use in preparing the double salt is water. The double salt is insoluble in solvents such as lower alcohols, ketones, and the like. However, it is soluble in a more polar solvent such as water or acetic acid. For this reason, a binary solvent system can be used, if desired, so that one component will maintain the unreacted ions in solution while the other component will effect precipitation of the product. Examples of such multi-component solvent systems are water with 95% ethanol, acetic acid with 95% ethanol, water and acetone, water and methanol, and water-acetic acid-acetone mixtures. The amount of solvent used is not critical. The minimum amount of solvent used is that necessary to dissolve all of the reactants. Elevated temperatures may be preferred to increase the rate of dissolution and decrease the amount of solvent necessary for dissolution. There is no upper limit to the amount of solvent which may be used except for economic reasons. Usually reaction mixtures with 50 to 95% solvents are employed.

To obtain maximum yield and utilization of the decahydrodecaborate, at least a stoichiometric amount, and preferably excesses of the dichromate (Cr₂O₇⁻²) and Cs⁺ are employed. Thus, for two moles of decahydrodecaborate, usually about 1, and preferably 1.5 to 2 moles of dichromate and at least 6, and preferably 6.5 to 7 moles of Cs⁺ are employed. Generally, greater amounts of dichromate ion, e.g., four moles, are provided when the reaction mixture is basic, e.g., in the case where the amine salts of decahydrodecaboric acid and/or cesium hydroxide or carbonate are used than when the reaction mixture is acidic or neutral. In a basic reaction mixture, the reduction of Cr₂O₇⁻² ion to CrO₄⁻² is encouraged and, hence, the presence of a greater amount of the dichromate initially insures the presence of the Cr₂O₇⁻² ion. Of course, amounts of Cs⁺, B₁₀H₁₀⁻², Cr₂O₇⁻² ions different from those specified above can be used, however, the yields will inherently be less because the ions will always combine in the proportions required for double salt formation and any unreacted excess Cs⁺, B₁₀H₁₀⁻², or Cr₂O₇⁻² ions present will remain in solution.

The combination of the Cs⁺, B₁₀H₁₀⁻², and Cr₂O₇⁻² ions to form the double salt occurs at room temperature

3

(20–25° C.). However, when the double salt is prepared from the boron hydride amine salt; a dichromate; and a cesium salt, such as carbonate, heating, for example, at temperatures of up to 80° C., and preferably 50 to 70° C., is desirable to drive off volatile compounds such as the free amine, ammonia, and carbon dioxide. The heating serves to effect more efficient recovery of the double salt from the reaction mass and to eliminate tedious separation of the double salt from other compounds which otherwise might be coprecipitated. At temperatures below 0° C. the mobility of the ions lessens and, additionally, recovery of the double salt from the reaction mass is more involved.

The manner of recovering the double salt is not critical and will vary from case to case depending upon the other ions present in solution and the characteristics of the solvent used in its preparation. The double salt is stable at temperatures up to 250° C. and can be isolated from the reaction mass by simple evaporation of the solvent or the double salt can be precipitated from the hot solution by cooling the solution and then filtering. As indicated hereinbefore, multi-component solvent systems in which the reactants are soluble, but the double salt is insoluble can be employed.

As illustrated in the examples, the order of addition of the various ions to the reaction mixture is not critical, e.g., the $B_{10}H_{10}^{-2}$ ion may be contacted initially with either Cs^{+} ion or $Cr_2O_7^{-2}$ ion and then contacted with the third ion or the Cs^{+} , $B_{10}H_{10}^{-2}$, or $Cr_2O_7^{-2}$ ions all can be added initially.

The following examples illustrate specific embodiments of the invention. Parts and percentages are by weight unless otherwise designated.

Example 1

Triethylammonium decahydrodecaborate (3.2 parts, 0.01 mole) and 2.94 parts (0.01 mole) of potassium dichromate were dissolved in 50 parts of water. Five parts of 25% aqueous cesium hydroxide then was added to the solution, and the solution was heated on a steam bath for a period of two hours. Next, about 70% of the water was evaporated from the resulting solution, then the resulting concentrate was cooled; a fine, yellow, needle-like precipitate formed. The precipitate was filtered from the concentrate, and the filter cake was washed with 95% ethanol and then dried.

The infrared absorption spectrum of the yellow crystalline product showed the presence of a band at 4.0μ indicative of the B–H bond, bands at 9.3, 9.8, and 13.8μ which are indicative of the $B_{10}H_{10}$ nucleus, and bands at 10.5 and 12.0μ which indicate that a true molecular compound, i.e., the double salt of cesium dichromate and cesium decahydrodecaborate, was formed. These bands are not indicative of potassium dichromate or a physical mixture of the reactants. The product was recrystallized three times from water: by dissolving the double salt in hot water, cooling the solution to precipitate the double salt, and then separating the double salt by filtration. After each recrystallization, the infrared spectrum of the product was determined. No change occurred in the infrared analysis, i.e., the bands remained the same. The melting point of the product was 260–270° C. (with discoloration) and the product flashed at 290° C.

Example 2

Triethylammonium decahydrodecaborate (16.1 parts, 0.05 mole) was dissolved in 60 parts of 25% cesium hydroxide (0.1 mole cesium hydroxide), and the mixture was heated on a steam bath for one and one-half hours. The solution then was filtered, and the filtrate was cooled to near room temperature. To this filtrate was added a second filtrate obtained by (1) dissolving 13.1 parts (0.05 mole) of sodium dichromate in approximately 20 parts of water, (2) adding 16.3 parts (0.05 mole) of cesium carbonate, (3) heating the mixture until dissolu-

4

tion was effected, and (4) filtering the warm solution. The mixture of the combined filtrates then was filtered and cooled. A sample of the resulting precipitate was analyzed as cesium decahydrodecaborate ($Cs_2B_{10}H_{10}$). Additional sodium dichromate (13.1 parts: 0.05 mole) was added to the reaction mixture, then the resulting product was diluted with water and heated at 75° C. until solution resulted. The hot solution was filtered and the filtrate was cooled to precipitate the double salt of cesium dichromate and cesium decahydrodecaborate

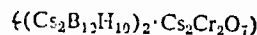

(34.5 parts) as a precipitate. The product was recrystallized from water to give 22.6 parts of the double salt which melted at about 250° C. (with discoloration) and decomposed at about 280–290° C. Analysis of the above double salt showed:

	B, percent	Cr, percent	Cs, percent
Calc. for $B_2Cr_2Cs_2H_{10}O_7$	17.3	8.22	63.8
Found	17.66	8.05	64.28
	19.92	8.57	64.45

The infrared spectrum of the product was identical to that of the product of Example 1.

Example 3

Cesium decahydrodecaborate (3.84 parts, 0.01 mole) and 2.94 parts (0.01 mole) of potassium dichromate were suspended in 50 parts of water and heated until dissolution resulted. The hot solution was filtered and the filtrate cooled. The infrared spectrum of the product which precipitated out of the solution was identical to that of the product of Example 1.

As previously indicated, the double salt of cesium dichromate and cesium decahydrodecaborate has properties which make it useful in explosive applications. Typical of such applications are as an ignition agent in electric initiators and as a slow burning charge in a delay column. For better understanding of the above, reference is now made to the accompanying drawing in which FIGURE 1 represents a conventional electric blasting cap and FIGURE 2 represents a length of delay cord. In FIGURE 1, 1 represents a shell, e.g., of bronze, copper, or aluminum, integrally closed at one end. Adjacent the integrally closed end is a pressed base charge 2, e.g., of any explosive conventionally employed for such purposes, such as cyclotrimethylenetrinitramine (RDX), pentaerythritol tetranitrate (PETN), picric acid, trinitrotoluene (TNT), tetryl or mixtures thereof. Above base charge 2 is primer charge 3 which may be any of the primary explosives (highly sensitive to flame and/or shock) conventionally employed, e.g., lead azide or mercury fulminate. Above primer charge 3 is the loose or pressed igniting charge 4 which in this case consists of the double salt of cesium dichromate and cesium decahydrodecaborate. A bridgewire 5 connecting the terminals of lead wires 6 is embedded within the ignition composition 4. Sealing shell 1 is a plug 7, e.g., of rubber, which also holds the lead wires 6 firmly in position. The plug 7 is held in place by a series of circumferential crimps 8. All of these features, except the novel double salt ignition charge, represent conventional elements of electric initiators.

In FIGURE 2, 9 represents a continuous core of the double salt of cesium dichromate and cesium decahydrodecaborate which is contained within a flexible sheath 10, e.g., of nonmetallic material, such as fibreglass, or a ductile metal, e.g., aluminum, lead, copper, or a braided metal wire.

5

The use of the double salt of cesium dichromate and cesium decahydrodecaborate in electric initiators and in delay cords is illustrated by the following:

Example 4

A series of eight electric blasting caps were assembled as illustrated in FIGURE 1. The bronze shell was 1 1/4 inches long with an outer diameter of 0.272 inch and an average inner diameter of 0.26 inch. Into this shell was loaded 5 grains of pentaerythritol tetranitrate pressed at 200 pounds. Immediately above this base charge was loaded 3 grains of lead azide pressed at 200 pounds. In four shells, 3 grains of the double salt of cesium dichromate and cesium decahydrodecaborate pressed at 200 pounds was inserted as the ignition charge, adjacent to the primer charge. In the remaining four shells, 2 grains of loose double salt of cesium dichromate and cesium decahydrodecaborate was inserted as the ignition charge, adjacent to the primer charge. In each shell was inserted a conventional rubber plug assembly in which the 0.0019 inch diameter bridgewire was soldered to the lead wires separated to provide a 1/8-inch span and projecting 3/16-inch from the base of the rubber plug. The lead wires contained in the rubber plug were of 20-gauge copper insulated by nylon. After the cap was loaded and the plug inserted, three peripheral clips were made in the shell wall to seal the plug. When a 5-ampere direct current was applied to the lead wires, each of the blasting caps detonated. The average time between the application of the current and the detonation of the base charge for the caps with the pressed ignition charge was about 210 milliseconds while that for the caps with the loose ignition charge was about 133 milliseconds. The uniformity in delay within each group of caps was good as compared to conventional delay blasting caps.

Example 5

A lead wire cord with the double salt of cesium dichromate and cesium decahydrodecaborate was drawn down through a series of dies to give a cord having an outer diameter of 0.125 inch and a double salt distribution of 19.56 grains per foot of length. A 6-inch length of the thus-prepared cord, ignited by an electric blasting cap, burned for a period of 13.6 seconds.

The above procedure was followed for preparing a cord drawn down to an outer diameter of 0.15 inch and having a double salt distribution of 26.4 grains per foot of length. A 6-inch length of the thus-prepared cord, ignited by an electric blasting cap burned for a period of 18.2 seconds.

Cords having a double salt distribution of from 15 grains per foot of length to as high as 250 grains per foot of length may similarly be prepared according to the above procedure.

The use of the double salt of cesium dichromate and cesium decahydrodecaborate in delay initiators and delay connecting devices provides distinct advantages over well-known standard delay-producing compositions, e.g., boron-red lead mixtures, barium peroxide, selenium mixtures, antimony-potassium permanganate mixtures, and black powder. For example, the double salt burns at a more uniform rate and exhibits a more reproducible burning rate than do the standard delay compositions. These advantages are believed to be attributed to the fact that the double salt of cesium dichromate and cesium decahydrodecaborate is a single molecule; whereas, the standard delay compositions are generally physical mixtures of two or more components and, if not mixed properly, give unpredictable and unreliable results.

6

The double salt is relatively insensitive to impact and exhibits excellent resistance to static charges. In the impact sensitivity test, the double salt on a steel plate does not detonate when a 1/2-inch diameter steel ball is dropped on the double salt from a height of up to 45 inches.

In the test for static resistance, the lead wires of a cap containing the double salt were twisted together and connected to the high voltage terminal of "leg-to-shell" static sensitivity apparatus consisting essentially of a source of variable voltage and a series of micromicrofarad condensers ranging in capacitance from 250-2000 $\mu\text{mf.}$; the shell of the cap was connected to a ground line. Voltages from 0 to 30,000 volts were applied to a condenser of known capacitance in increments of 1,000 volts and the condenser was allowed to discharge through the cap. The cap did not detonate at the upper limit of the machine, e.g., at voltages of 30,000 volts applied through a 2,000 $\mu\text{mf.}$ condenser, indicating that the double salt has a static resistance greater than 77,500 man-equivalent volts (mev.). Despite the insensitivity to impact and static, the double salt of cesium dichromate and cesium decahydrodecaborate is easily ignited by a heated wire, making the salt highly desirable as an ignition compound in blasting devices.

Not only does the double salt of cesium dichromate and cesium decahydrodecaborate have properties desirable in explosive applications, but also the double salt is light sensitive, i.e., turns brown, and can be used in applications where such a characteristic is desirable.

The invention has been fully described in the foregoing discussion; however, it will be apparent to those skilled in the art that many variations are possible without departure from the scope of the invention. It is intended, therefore, to be limited only by the following claims.

I claim:

1. A double salt of the formula

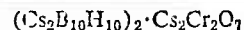

2. A process for preparing $(\text{Cs}_2\text{B}_{10}\text{H}_{10})_2 \cdot \text{Cs}_2\text{Cr}_2\text{O}_7$, which comprises bringing together, as the sole reactants, (a) a compound of the group consisting of decahydrodecaboric acid, its hydronium analog, and an ionizable salt of said acid, (b) an ionizable $\text{Cr}_2\text{O}_7^{2-}$ salt and (c) an ionizable cesium compound, in an inert solvent for said reactants at a temperature of 0 to 250° C.

3. A process of claim 2 wherein the solvent comprises water.

4. A process of claim 2 wherein reactant (a) is triethylammonium decahydrodecaborate.

References Cited by the Examiner

UNITED STATES PATENTS

2,410,801	11/1946	Audrieth	149—22 X
2,988,438	6/1961	Allovio	149—22 X
2,993,751	7/1961	Edwards et al.	23—14
3,033,644	5/1962	Ager	25—14
3,107,613	10/1963	Armstrong et al.	23—14
3,126,305	3/1964	Armstrong	149—22 X

OTHER REFERENCES

Lipscomb: "Boron Hydrides," 1963, page 160.

Lipscomb: "Proceedings of the National Academy of Sciences," volume 47, No. 11, pages 1796-1797 (November 1961).

BENJAMIN HENKIN, *Primary Examiner.*

MAURICE A. BRINDISI, *Examiner.*

M. WEISSMAN, *Assistant Examiner.*

June 14, 1966

R. K. ARMSTRONG

3,256,056

$(C_{22}H_{10}H_{10})_2 - C_{22}O_7$ PRODUCT AND PROCESS FOR PREPARING SAME

Filed Dec. 12, 1961

FIG. 1

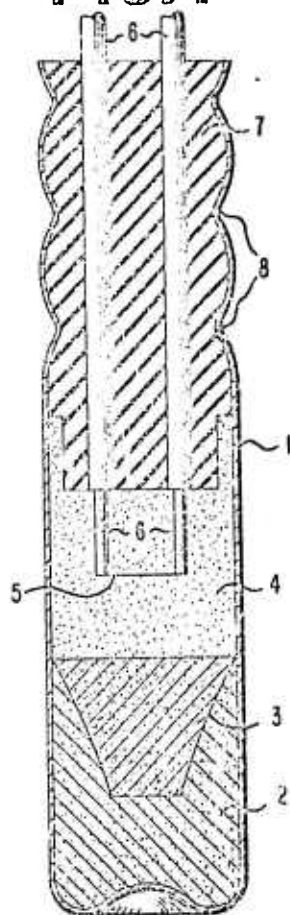

FIG. 2



INVENTOR
ROBERT K. ARMSTRONG

BY

John R. Schmitz

ATTORNEY

1

3,264,071

BIS(AMMONIO) DECABORANE

William V. Hough, Valencia, Pa. assignor to Callery Chemical Company, Pittsburgh, Pa., a corporation of Pennsylvania

No Drawing. Filed Dec. 21, 1959, Ser. No. 863,048
3 Claims. (Cl. 23-358)

This invention relates to a new ammonia decaborane compound, bis(ammonio)decaborane, and to a method for its preparation.

Decaborane, $B_{10}H_{14}$, is a solid, volatile hydride of boron. Although it has been known for some years and is produced in considerable amounts when either diborane or tetraborane is pyrolyzed, its chemistry is still only imperfectly understood. Of late, increasing interest in decaborane and compounds derived from decaborane has resulted from the discovery of several decaborane derivatives having varied and unusual physical and chemical properties.

It is an object of this invention to provide a new ammonia derivative of decaborane, bis(ammonio)decaborane.

Another object is to provide a new derivative of decaborane having physical and chemical properties which make it useful as a fuel component as well as in several other applications.

Still another object is to provide a method for producing the above new compound, bis(ammonio)decaborane.

Other objects will become apparent from time to time hereinafter.

This invention is based upon my discovery that the reaction of ammonia with decaborane in the presence of a lower alkyl ether produces bis(ammonio)decaborane, $(NH_3)_2B_{10}H_{12}$, in accordance with the following equation:

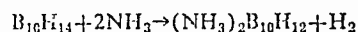

The reaction proceeds in this manner whenever the reactants are contacted in the presence of the ether at ordinary ambient temperatures, i.e., about 25 to 30° C. Thus, elevated temperatures are not necessary, although moderate heating can be used if desired.

The reaction appears to commence as soon as the reactants are mixed at a temperature approximating room temperature; that is, there is no known induction period prior to the start of the reaction. However, the rate of the reaction is relatively slow, so that vigorous agitation, so as to insure adequate mixing, and reaction periods of several hours have been used in order to achieve good yields.

A lower alkyl ether is used as a reaction medium and is believed to cause the reaction to take place as indicated above. Ethyl ether is the most common lower alkyl ether and is generally used in carrying out my method, but other such ethers, e.g., propyl ether, can also be used.

The molar ratio of the reactants used does not appear to be critical, in that some bis(ammonio)decaborane is obtained even when relatively low ratios of ammonia to decaborane are used. However, yields of the desired product are low in such cases and it is preferred to use a ratio of at least about 1.5 mols of ammonia for each mol of decaborane.

The following examples, which are to be considered as illustrative only, will serve to further demonstrate the method and practice of my invention in several of its embodiments.

Example 1.—A round-bottomed flask was charged with 4.9 grams of purified decaborane, $B_{10}H_{14}$, and 25 milliliters of ethyl ether. After the flask had been cooled and evacuated, the contents were warmed to room temperature, 0.996 gram of ammonia was passed into the solution over a period of 30 minutes, and the mixture

2

was stirred for about 8 hours. The reaction mixture was filtered and washed and a white solid which had precipitated during the reaction was recovered. This product weighed 3.5 grams and upon analysis was found to contain 67.5% boron and 18.1% nitrogen, compared to the theoretical values of 70.1% boron and 18.2% nitrogen in bis(ammonio)decaborane, $(NH_3)_2B_{10}H_{12}$. The identification of the product was confirmed through infra-red and X-ray analyses, in addition to reaction stoichiometry and chemical analysis.

Example 2.—A glass reaction tube was charged with 1.27 millimols of decaborane, 2.28 millimols of ammonia and 15.2 millimols of ethyl ether. After the reactants had been condensed into the tube, it was sealed, placed in a shaker, thereby agitating the reaction mixture, and warmed to room temperature (about 25 to 30° C.). After about 40 hours, the tube was opened and its contents were analyzed. No ammonia remained and 0.92 millimol of hydrogen was obtained. No decaborane was recovered, even after heating the reaction product to 75° C. for several hours. The reaction stoichiometry indicated that a white precipitate which had formed was principally bis(ammonio)decaborane, $(NH_3)_2B_{10}H_{12}$, and this conclusion was confirmed by infra-red and X-ray analyses. The infra-red and X-ray spectra of this product were identical with the product obtained in Example 1 above.

Bis(ammonio)decaborane is useful as an intermediate in the synthesis of other boron compounds in which a decaborane-type structure is desired. It is also useful as a fuel, either in ordinary heating applications where it may be burned in air to heat the surroundings, or as a propellant component in formulations for use as high energy fuels in rocket or similar type engines. For example, solutions of bis(ammonio)decaborane in hydrazine are used as monopropellant compositions in rocket engines and provide advantageous impulse characteristics.

According to the provisions of the patent statutes, I have explained the principle and mode of practicing my invention, and have described what I now consider to be its best embodiments. However, I desire to have it understood that within the scope of the appended claims, the invention may be practiced otherwise than as specifically described.

I claim:

1. A method of producing bis(ammonio)decaborane, $(NH_3)_2B_{10}H_{12}$, which comprises reacting ammonia with decaborane at a temperature of at least about 25° C. in the presence of a lower alkyl ether in which up to about 2 mols of ammonia are used for each mol of decaborane and recovering the bis(ammonio)decaborane thus formed.
2. A method in accordance with claim 1 in which from about 1.5 to about 2 mols of ammonia are used for each mol of decaborane.
3. A method in accordance with claim 1 in which the ether is ethyl ether.

References Cited by the Examiner

UNITED STATES PATENTS

2,708,152 5/1955 Schechter ----- 23-190

OTHER REFERENCES

- Adams, "Boron, Metallo-Boron Compounds and Boranes," 1964, pages 657-658.
- Bagley, "A.S.T.I.A. Tech. Abstracts Bulletin," U58-15, 2529 (Oct. 1, 1958).
- "Dissertation Abstracts," volume XX, No. 3, pages 879-880 (September 1959).
- Hurd, "Chemistry of the Hydrides," Aug. 25, 1952, pp. 74 to 78, John Wiley.

(Other references on following page)

OTHER REFERENCES

Kodama et al., "J. Am. Chem. Soc.," vol. 79, page 1007 (1957).

Schechter, "Boron Hydrides and Related Compounds," pp. 26, 27, Second Edition, May 1954, Callery Chemical Co.

Shore, "Dissertation Abstracts," vol. 18, page 1242 (April 1958).

Sinclair et al., "U.S. Gov't Research Reports," vol. 27, No. 6, page 307 (June 14, 1957).

Stock, "Hydrides of Boron and Silicon," pages 84, 85, 123-127, Cornell University Press (1933).

Toeniskoetter, "Some Reactions of Decaborane With Electrons and Electron Pair Donors," a thesis presented to the faculty of the St. Louis University in partial fulfillment of the requirements for the degree of Doctor of Philosophy, 1958, pages 83, 84, 136.

OSCAR R. VERTIZ, *Primary Examiner.*

WILLIAM WILES, ROGER L. CAMPBELL, MAURICE A. BRINDISI, *Examiners.*

C. D. QUARFORTH, R. D. MORRIS, M. WEISSMAN, *Assistant Examiners.*

1

3,265,737

BORON AMINES AND PROCESS FOR FORMATION THEREOF

Norman E. Miller, Vermillion, S. Dak., assignor to E. I. du Pont de Nemours and Company, Wilmington, Del., a corporation of Delaware
 No Drawing. Filed Nov. 3, 1964, Ser. No. 408,690
 26 Claims. (Cl. 260-583)

This application relates to processes for preparing boron compounds and to new products obtained thereby, and is a continuation-in-part of my prior copending applications Serial No. 183,677, filed March 29, 1962, and Serial No. 99,015, filed March 28, 1961, which is the parent application of said Serial No. 183,677, said applications now abandoned. It also relates to a process for preparing polyhydrododecaborates and to a new class of polyhydrododecaborates.

Compounds of boron and hydrogen have achieved technical importance in recent years. The growing interest in these compositions has stimulated an intensive study of processes for obtaining a wide range of boron compounds, particularly compounds having a plurality of boron and hydrogen atoms. Many boron compounds that contain nitrogen, e.g., the amine-borane addition compounds and the borazoles, are hydrolyzed by contact with water or protonic solvents. The "diammoniate of borane," referred to as $B_2H_6 \cdot 2NH_3$ and as $(BH_2 \cdot 2NH_3)BH_4$, is especially sensitive to traces of water [see, for example, Nordham and Peters, J. Am. Chem. Soc. 81, 3552 (1959)]. The pyridine adduct of BI_3 , i.e. $(C_5H_5N)_2BI_3$, is decomposed almost immediately by contact with water [see Muellerties, J. Inorg. Nucl. Chem. 15, 182 (1960)]. Compounds of this type are lacking in the stability which is desired for many industrial applications.

A need exists for boron compositions which possess excellent hydrolytic stability and high resistance to oxidative decomposition. The present invention provides compounds containing boron and nitrogen which possess unusual and unexpected stability.

It has now been found that polyhedral polyhydropolyborates, including dodecahydrododecaborates(2-), i.e., $B_{12}H_{12}^{2-}$ anions, and a hitherto unknown class of polyhydrododecaborates which are represented by the formula $(B_{12}H_{11}NRR^I R^{II})^-$, are obtained by heating a tertiary amine-borane addition compound $(BH_3-NRR^I R^{II})$ with a boron hydride of the formula B_bH_{b+4} where b is 2, 5 or 10 to a temperature at which hydrogen is released as a by-product of the reaction, i.e., to about at least 75° C.

It has also been found that, ordinarily, the cation associated with the polyhydrododecaborate anions is the corresponding substituted ammonium cation. However, when R , R^I , and R^{II} fall within certain limits, defined below, a cation of the formula $(BH_{2-y}X'_y \cdot mCH_3NR^I R^{II})^+$ is obtained.

By metathetical cation exchange methods, the cations obtained with the novel anion, $(B_{12}H_{11}NRR^I R^{II})^-$ can be replaced with any cation (M). Thus one generic formula of novel compounds of this invention is represented by the formula

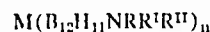

In addition, n novel anions can be substituted with halogen (X) by replacement of a hydrogen bonded to boron. Thus, in the broadest sense, the compounds of this invention can be represented by the formula

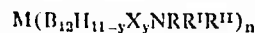

In a similar manner the hydrogens bonded to the boron of the cation $(BH_{2-y}X'_y \cdot mCH_3NR^I R^{II})^+$ can be replaced with halogen or fluorosulfato (X') to form the novel cation $(BH_{2-y}X'_y \cdot mCH_3NR^I R^{II})^+$.

2

By anion exchange methods the novel cation can be obtained in conjunction with any anion (Z) to form the generic compound $(BH_{2-y}X'_y \cdot mCH_3NR^I R^{II})_n Z$ wherein n is a positive whole number equal to the valence of Z.

The foregoing formulas and symbols will be explained in greater detail below.

DISCUSSION OF $BH_3 \cdot NRR^I R^{II} + B_bH_{b+4}$ PROCESS

Boron hydrides which are employed as one reactant in the process are diborane (B_2H_6), pentaborane (B_5H_9) and decaborane ($B_{10}H_{14}$). These boron hydrides are commercially available products and can be used as marketed without special purification. Because of availability and ease of reaction, diborane is preferred.

The tertiary amine-borane addition compounds (also called tertiary amine-boranes), which are used as the second reactant in the process, contain a characteristic group which is

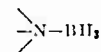

The groups R , R^I , R^{II} , R^V and R^V in the anions and cations of this invention are derived from the tertiary amine-borane used. Thus, the tertiary amine-borane reactants have the following general formula

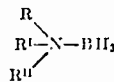

wherein $RR^I R^{II} N$ represents the tertiary amine from which the borane addition compound is derived.

R and R^I in the above formulas are defined as aliphatically saturated (i.e., free of olefinic or acetylenic unsaturation) hydrocarbon groups.

R^{II} is defined as an aliphatically saturated hydrocarbon group that can contain at most one diloweralkylamino (preferably dimethylamino) group bonded to carbon at least once removed from the carbon bonded to nitrogen.

Each group is joined to the nitrogen by singly bonded carbon, i.e., the carbon bonded to the nitrogen is a saturated aliphatic carbon.

The carbon content is not critical, but, solely because of availability, each group is preferably of at most 18 carbons.

In addition, R and R^I can be joined to form a ring with the amino nitrogen. When so joined R and R^I can be alkylene of 4-6 carbons, ethereal oxygen-interrupted alkylene of 4-6 carbons, or lower alkylamino (preferably methylamino)-interrupted alkylene of 4-6 carbons.

Thus, classes of tertiary amines from which the adducts are derived, and consequently the $NRR^I R^{II}$ moieties in the final products include trialkylamines, tricycloalkylamines, dialkylmonocycloalkylamines, dialkylmonoaralkylamines, monoalkyldicycloalkylamines, and heterocyclic amines, exemplified by N-alkylpolymethylenamines, N-alkylmorpholines, and N,N'-dialkylpiperazines.

Thus, R and R^I individually can be alkyl, cycloalkyl or aralkyl; while R^{II} can be alkyl, cycloalkyl, aralkyl, diloweralkylamino-substituted alkyl, and the like. Preferably R , R^I , and R^{II} are each alkyl of up to 8 carbon atoms.

R and R^I joined together can be, for example, the pentamethylene group of an N-alkylpiperidine, the oxydiethylene group of an N-alkylmorpholine, the N-alkyliminodiethylene group of an N,N'-dialkylpiperazine, or the tetramethylene group of an N-alkylpyrrolidine.

As previously stated, when R , R^I , and R^{II} are certain groups the $(BH_2 \cdot mCH_3NR^I R^{II})^+$ cation is formed. These groups are necessarily small due to steric hindrance. Thus, R becomes $-CH_3$; R^I becomes R^V which is defined as alkyl of up to four carbons; and R^{II} becomes R^V which is defined as alkyl of up to four carbons which

bears at most one dimethylamino group bonded to carbon at least once removed from the carbon bonded to nitrogen. R^{IV} and R^V joined together represent a divalent radical of the formula —CH₂CH₂QCH₂CH₂— where Q is —CH₂— or —N(CH₃)—. R^{IV} and R^V are further limited in that the carbon bonded to the tertiary nitrogen is bonded to at most one other carbon atom. *m* is a positive whole number equal to 2 divided by the number of nitrogen atoms in the CH₃NR^{IV}R^V moiety. Preferably R^{IV} and R^V are methyl groups.

Specific illustrations of tertiary amines which form the RRR'R^{IV}N group are trimethylamine, methyldiethylamine, tributylamine, tri(2-ethylhexyl)amine, trioctadecylamine, tricyclohexylamine, methyldicyclohexylamine, butyldiethylamine, butyldicyclohexylamine, N-butylmorpholine, N-dodecylmorpholine, N-ethylpiperidine, dimethylisopropylamine, dimethyl (β-phenylethyl)amine, and the like.

As shown above, the tertiary nitrogen compounds which can be employed to form the amine-borane adduct reactant are not limited to monobasic compounds. Compounds having two tertiary basic nitrogen atoms are operable, e.g., N,N,N',N'-tetramethyl-1,2-diaminoethane, N,N,N',N'-tetraethyl-1,3, -diaminopropane, N,N,N',N'-tetramethyl-1,6-diaminohexane, N,N' - diethylpiperazine. These compounds are included within the definition of the BH₃·NRR'R^{IV} reactant, it being understood that addition compounds derived from these amines will have a BH₃ bonded to each tertiary nitrogen.

The radicals attached to tertiary nitrogen are, therefore, monovalent radicals and divalent radicals, in that the divalent radicals act as a bridge between two tertiary nitrogens or may form a ring with one tertiary nitrogen. Where two divalent radicals form bridges between two tertiary nitrogens, a ring is formed having two annular nitrogen atoms, e.g., piperazine. The divalent radicals may be interrupted by an oxygen, whereupon a ring such as morpholine is formed.

For the preparation of the novel anions with the (BH₃·2CH₃NR^{IV}R^V)⁻ cation, it is seen that the tertiary amine-borane reactant used will have the formula BH₃·CH₃NR^{IV}R^V.

Tertiary amine-borane addition compounds are a known class of products obtained by the direct reaction of a tertiary amine with diborane at relatively low temperatures. These addition compounds can be prepared and isolated for subsequent use in the reaction with a boron hydride. The preparation of representative amine-borane adducts, e.g., (CH₃)₃N—BH₃, is described by Wiberg et al., Zeit. Anorg. U. Allgem. Chem. 256, 285-306 (1948). The compound can be prepared in situ in the reaction chamber and need not be purified or isolated. In this mode of operation the addition compound, without purification, is reacted at the desired temperature with a further quantity of diborane or with a different boron hydride, i.e., pentaborane or decaborane.

With diborane as the boron hydride, the process is advantageously operated by supplying diborane continuously or in sufficient quantity to the tertiary amine at an elevated temperature to form the dodecahydrododecaborate in one step. This method of operation falls within the scope of the present invention and it is, in fact, a preferred procedure in view of the availability of diborane and tertiary amines and the ease with which it can be performed.

The mechanism of the reaction is not clearly understood. Initially, to obtain the tertiary amine-borane adduct, diborane and the tertiary amine are mixed at a convenient temperature, generally not over 35° C., and at atmospheric or subatmospheric pressure. If desired, temperatures as low as -80° C. or lower can be employed. This step, which is preliminary in the process, may be represented by the following equation:

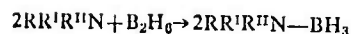

In this step, no volatile by-products are obtained. The reaction is solely addition to form a neutral and non-ionic product. This reactant is then heated to an elevated temperature (at least 75° C.) with a boron hydride which can be diborane (the same boron hydride used for preparing the adduct), pentaborane or decaborane. By employing diborane as the boron hydride in both steps, the tertiary amine and diborane can be reacted and heated to an elevated temperature in one operation to yield the polyhydrododecaborate salts, i.e., the amine and a part of the diborane are employed as precursors to form the addition compound in situ. A gaseous by-product is hydrogen and, as stated earlier, the formation of by-product hydrogen is a characteristic feature of the reaction. The quantity of hydrogen which is formed can be used as an approximate measure of the completeness of the reaction.

It is essential in the operation of the process to heat the reaction mixture to a minimum effective temperature to bring about the desired formation of the polyhydrododecaborate salts, which occurs with rapid hydrogen evolution. The minimum effective temperature is about 75° C., for example, with triethylamine-borane and diborane, but this temperature will, of course, vary somewhat with pressure and with the reactivity of the particular tertiary amine-borane and boron hydride reactants which are used. As is to be expected, an increase in temperature leads to a more rapid rate of reaction. The process is operable at temperatures up to 400° C. or even higher. Excessively high temperatures of operation provide no advantage and may lead to undesirable side reactions. Temperatures which lie between about 100° and 300° C. are preferred. An especially preferred temperature range is between about 100° and 250° C. Heating of the reactants may be accomplished by any suitable means. The temperature may be raised by a stepwise procedure or the desired temperature may be reached by a one-step procedure.

Pressure is not a critical factor in the operation of the process, i.e., the process is operable at subatmospheric, atmospheric and superatmospheric pressures. It is advantageous to maintain the reactants in intimate contact with each other during the process and, for this reason, the process can be conducted profitably under superatmospheric pressures when a volatile boron hydride, such as diborane, is employed as one reactant. Thus, pressures up to 500 atmospheres (absolute) or even higher are operable. Generally, for convenience of operation, a pressure of at least 5 atmospheres is employed with volatile boron hydrides, e.g., diborane, and tertiary amines to maintain good contact between the reactants and thereby obtain good yields of the polyhydrododecaborates. Accurate control of pressure is not necessary and, in the event a closed reaction vessel is employed, the autogenous pressure obtained in the heating step is conveniently used. Pressures above atmospheric can be obtained by any suitable means. The boron hydride can be used in excess, if desired, or it can be mixed with inert gases such as nitrogen, argon, helium, and the like.

The mole ratio in which the reactants are used is not critical. Preferably, the ratio of moles of boron hydride/moles tertiary amine-borane adduct is at least 1. With diborane and a tertiary amine as reactants, the ratio of moles diborane/moles tertiary amine is preferably greater than 1. To obtain high yields of polyhydrododecaborates, it is desirable although not essential to use the boron hydride in considerable excess, particularly when diborane is employed as the reactant. Thus, with diborane, the ratio of moles B₂H₆/moles tertiary amine can be 2, 3, 4, 5, or even higher. The use of excess boron hydride permits maximum utilization of the basic nitrogen reactant or the tertiary amine-borane adduct. The mole ratio in which the reactants are present in the reaction zone will be determined to a large extent by the method which is used, i.e., whether batch, continuous or a combination of the two methods.

5

In the operation of the process, a reaction vessel is used whose inner surfaces are made of corrosion-resistant material, e.g., commercially available stainless steels, platinum, glass, and the like. Conventional vessels or pressure-resistant vessels can be employed. The reaction is preferably conducted under substantially anhydrous conditions and the vessel is generally flushed with an inert gas prior to charging with the reactants. It is then charged with the tertiary amine-borane adduct. Optionally, with diborane as the boron hydride, the vessel is charged with the tertiary amine. In the event a pressure vessel is employed, it can be cooled to a low temperature, e.g., with solid carbon dioxide-acetone mixtures, liquid nitrogen, liquid helium, and the like, and it is optionally evacuated to a low pressure to facilitate charging with a volatile boron hydride. Cooling and evacuation are not essential steps, however. The desired quantity of boron hydride is charged into the vessel, following which it is closed. Vessel and contents are then heated to the desired temperature with agitation.

To conduct the process at atmospheric pressure, the reaction vessel can be fitted (1) with a gas inlet tube to lead the volatile boron hydride below the surface of the tertiary amine-borane adduct, (2) with a reflux condenser to return boiling liquids to the reaction chamber, and (3) a cold trap (cooled to -80°C . or lower) joined to the reflux condenser to collect volatile products which are formed during the reaction.

With a boron hydride of low volatility, e.g., decaborane, the tertiary amine-borane adduct and the boron hydride are simply mixed and heated to reaction temperature, i.e., until rapid release of hydrogen occurs with formation of the desired products.

The procedures described above can be modified or changed as required by convenience or circumstances. It is not essential to conduct the reaction in any particular sequence of steps or by any specific procedure.

Mixing of the reactants during the operation of the process is desirable although not essential. Mixing can be accomplished, e.g., by mechanical

6

be separated and purified by conventional procedures, e.g., filtration, crystallization, solution chromatography, and the like. The products should be handled with the customary precautions observed in handling chemical compounds to prevent undue contact with the skin or inhalation of fine powders.

PRODUCTS CONTAINING THE
($\text{B}_{12}\text{H}_{11}\cdot\text{NRR}^{\text{I}}\text{R}^{\text{II}}$)—ANION

As previously stated, the initial products will be of two types, viz,

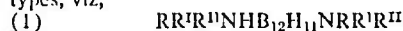

or



These constitute the preferred products of the invention. By metathetical cation exchange, a wide range of salts can be obtained from them. Thus, compounds containing the novel anion have the formula

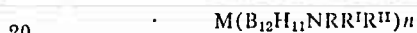

where M is a cation, n is a positive whole number whose value is equal to the valence of M, and R, R^{I} and R^{II} are as previously defined.

In the formula immediately above, the term "cation" has reference to an atom or group of atoms which in aqueous solution forms a positively charged ion. Examples of suitable cations include hydrogen (H^+), hydronium (H_3O^+), a metal, ammonium (NH_4^+), hydrazonium ($\text{NH}_2\text{—NH}_3^+$), N-substituted ammonium, N-substituted hydrazonium, metal-amine complexes,

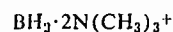

and the like.

Metal cations in the compounds can be derived generally from any metal. The metals according to the Periodic Table in Deming's "General Chemistry," 5th ed., chapter 11, John Wiley & Sons, Inc., and in Lange's "Handbook of Chemistry," 9th ed., pp. 56-57, Handbook Publishers, Inc. (1956), are the elements of Groups I, II, VIII, III-B, IV-B, V-B, VI-B, VII-B and the elements of Groups III-A, IV-A, V-A, and VI-A which have atomic

UNITED STATES PATENT OFFICE
CERTIFICATE OF CORRECTION

Patent No. 3,265,737

265-737
Norman E. Miller

August 9, 1966

It is hereby certified that error appears in the above numbered patent requiring correction and that the said Letters Patent should read as corrected below.

Column 9, line 34, strike out " $(\text{BH}_2\cdot y'\text{x}'\text{y}'\cdot m\text{CH}_3\text{NR}^{\text{I}}\text{R}^{\text{V}})_n$ " and insert instead -- $\text{B}_{12}\text{H}_{12}^{-2}$ or $(\text{B}_{12}\text{H}_{11}\cdot\text{NRR}^{\text{I}}\text{R}^{\text{II}})^{-1}$, --.

Signed and sealed this 29th day of August 1967.

(SEAL)

5

In the operation of the process, a reaction vessel is used whose inner surfaces are made of corrosion-resistant material, e.g., commercially available stainless steels, platinum, glass, and the like. Conventional vessels or pressure-resistant vessels can be employed. The reaction is preferably conducted under substantially anhydrous conditions and the vessel is generally flushed with an inert gas prior to charging with the reactants. It is then charged with the tertiary amine-borane adduct. Optionally, with diborane as the boron hydride, the vessel is charged with the tertiary amine. In the event a pressure vessel is employed, it can be cooled to a low temperature, e.g., with solid carbon dioxide-acetone mixtures, liquid nitrogen, liquid helium, and the like, and it is optionally evacuated to a low pressure to facilitate charging with a volatile boron hydride. Cooling and evacuation are not essential steps, however. The desired quantity of boron hydride is charged into the vessel, following which it is closed. Vessel and contents are then heated to the desired temperature with agitation.

To conduct the process at atmospheric pressure, the reaction vessel can be fitted (1) with a gas inlet tube to lead the volatile boron hydride below the surface of the tertiary amine-borane adduct, (2) with a reflux condenser to return boiling liquids to the reaction chamber, and (3) a cold trap (cooled to -80° C. or lower) joined to the reflux condenser to collect volatile products which are formed during the reaction.

With a boron hydride of low volatility, e.g., decaborane, the tertiary amine-borane adduct and the boron hydride are simply mixed and heated to reaction temperature, i.e., until rapid release of hydrogen occurs with formation of the desired products.

The procedures described above can be modified or changed as required by convenience or circumstances. It is not essential to conduct the reaction in any particular sequence of steps or by any specific procedure.

Mixing of the reactants during the operation of the process is desirable although not essential. Mixing can be accomplished by any suitable means, e.g., by mechanical stirring, shaking, or tumbling of the entire reactor.

The time of the reaction is not critical. In a batch process, the time will generally lie between about 1 hour and about 50 hours. In general, a reaction time of 5 hours to 25 hours is sufficient for a batch operation. For a continuous process, much shorter reaction times can be used and unreacted components can be recirculated for further exposure in the reaction zone.

In an optional method of operation of the process, the reaction between the boron hydride and the tertiary amine-borane adduct is conducted in the presence of an inert solvent, i.e., a liquid which is not decomposed under the conditions of the reaction by the components of the process or by the products which are obtained. In many cases the adduct is a liquid at the temperature of the reaction and it can serve both as a solvent and reactant. The use of a solvent is not essential for operability and its use is based solely on convenience of operation. Solvents, in the event they are employed, are preferably liquids at the operating temperatures and they are in most cases liquids at prevailing atmospheric temperature. Hydrocarbons are particularly useful as solvents, e.g., n-hexane, cyclohexane, benzene, toluene, and the like.

In working up the reaction products, the volatile by-products are generally removed by passing them into a trap cooled to a very low temperature (e.g., liquid nitrogen temperature). Hydrogen, as stated earlier, is a by-product and it is removed with any other volatile products which may be present. Suitable precautions should be observed in venting pressure-reaction vessels in view of possible flammability or toxic hazards of the volatile inhalation of fine powders.

The reaction products, remaining after removal of volatile products, are generally liquids or solids. The principal products, i.e., the polyhydridoborates, can

6

be separated and purified by conventional procedures, e.g., filtration, crystallization, solution chromatography, and the like. The products should be handled with the customary precautions observed in handling chemical compounds to prevent undue contact with the skin or inhalation of fine powders.

PRODUCTS CONTAINING THE ($B_{12}H_{11}NRR'R''$)⁻ ANION

As previously stated, the initial products will be of two types, viz,

- (1) $RR'R''NHB_{12}H_{11}NRR'R''$
or
(2) $[BH_2 \cdot mCH_2NR^IVR^V][B_{12}H_{11}NCH_3R^IVR^V]$

These constitute the preferred products of the invention. By metathetical cation exchange, a wide range of salts can be obtained from them. Thus, compounds containing the novel anion have the formula

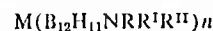

where M is a cation, n is a positive whole number whose value is equal to the valence of M, and R, R' and R'' are as previously defined.

In the formula immediately above, the term "cation" has reference to an atom or group of atoms which in aqueous solution forms a positively charged ion. Examples of suitable cations include hydrogen (H^+), hydronium (H_3O^+), a metal, ammonium (NH_4^+), hydrazonium ($NH_2-NH_3^+$), N-substituted ammonium, N-substituted hydrazonium, metal-amine complexes,

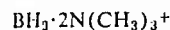

and the like.

Metal cations in the compounds can be derived generally from any metal. The metals according to the Periodic Table in Deming's "General Chemistry," 5th ed., chapter 11, John Wiley & Sons, Inc., and in Lange's "Handbook of Chemistry," 9th ed., pp. 56-57, Handbook Publishers, Inc. (1956), are the elements of Groups I, II, VIII, III-B, IV-B, V-B, VI-B, VII-B and the elements of Groups III-A, IV-A, V-A, and VI-A which have atomic numbers above 5, 14, 33 and 52, respectively. These metals include both light and heavy metals. The light metals are also known as the alkali metals and the alkaline earth metals. The heavy metals include brittle, ductile and low-melting metals as described in the above-mentioned Periodic Table in Lange's "Handbook of Chemistry."

Preferred metal cations are derived from the elements of Groups I-A, II-A, I-B and II-B having an atomic number up to and including 80.

Most preferred metals for use are the light metals (the alkali and alkaline earth metals of Groups I-A and II-A) having an atomic number less than 87, i.e., lithium, sodium, potassium, rubidium, cesium, beryllium, magnesium, calcium, strontium, and barium.

Examples of N-substituted ammonium radicals include those having the formulas $R^{III}NH_3^+$, $R^{III}NH_2^+$, $R^{III}NH^+$, $R^{III}N^+$, and the like, wherein R^{III} represents an organic group bonded to nitrogen. The R^{III} groups are not critical features of these cation groups; thus, R^{III} can be an open-chain, closed-chain, saturated or unsaturated hydrocarbon or substituted hydrocarbon group, or R be a heterocyclic ring of which the nitrogen atom is a component part, such as pyridine, quinoline, morpholine, hexamethylenimine, and the like. Preferably, R^{III} , for reasons of availability of reactants, contains not more than 18 carbon atoms. R^{III} can be, for example, methyl, 2-ethylhexyl, octadecyl, allyl, cyclohexyl, cyclohexenyl, phenyl, naphthyl, aryl, cyclohexylphenyl, diphenyl, benzyl, chloroethyl, ω -cyanoamyl, β -hydroxyethyl, p-hydroxyphenyl, and the like.

Examples of N-substituted hydrazonium radicals include those having the formulas $(R^{III}NHNH_3)^+$, $(R^{III}N-NH_3)^+$, and the like, wherein R^{III} has the same significance as indicated in the preceding paragraph. To

illustrate, the hydrazonium cation can be derived from phenylhydrazine, methylhydrazine, 1,1-dimethylhydrazine, ethylhydrazine, 1,1-diethylhydrazine, and similar compounds.

The valence of the cation M will be between 1 and 4, i.e., M can have a valence of 1, 2, 3, or 4. In most cases the valence of M will be 1 or 2 and this group of compounds in which the valence of M is at most 2 are readily preparable and so form a preferred group of compounds in this invention.

A few typical examples of the new class of compounds defined directly in the process employing the tertiary amine-borane adducts are

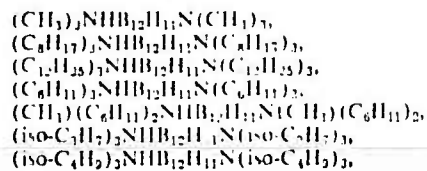

N-methylmorpholinium $\text{B}_{12}\text{H}_{11}(\text{N-methylmorpholine})$, and the like.

The tertiary ammonium salts can be passed in aqueous or alcoholic solution through an acid ion exchange resin to yield a solution of the free acid $\text{HB}_{12}\text{H}_{11}\text{NRR}^1\text{R}^2$ where R, R¹ and R² are as previously defined. The acid is comparable in strength to common mineral acids and it is most conveniently used in solution.

A broad range of salts are obtained by neutralizing aqueous or alcoholic solutions of the acids.

The acids can be neutralized with alkali metal hydroxides (LiOH, NaOH, KOH), alkaline earth metal hydroxides [Ba(OH)₂, Ca(OH)₂], ammonia, ammonium hydroxide, metal-amine hydroxides, hydrazine, substituted hydrazines (phenylhydrazine, N,N-dimethylhydrazine), sulfonium hydroxides [(CH₃)₂SOH],

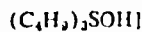

phosphonium hydroxides [C₄H₉]₄POH], tetraalkyl and mixed tetraaryl and alkyl-substituted ammonium hydroxides [(CH₃)₄NOH, (C₆H₅CH₂)(CH₃)₃NOH]. The compounds given in brackets are illustrative of the class of bases named.

The acid in aqueous or alcoholic solution can be agitated with inorganic oxides, hydroxides or carbonates to form metal or metal oxy salts of the $(\text{B}_{12}\text{H}_{11}\text{NRR}^1\text{R}^2)^-$ anion. To illustrate, the solution of the acid can be reacted with Na₂CO₃, CaCO₃, SrCO₃, Zn(OH)₂, V(OH)₃, Cr(OH)₃, Mn(CO)₂, FeCO₃, NiCO₃, Cu(OH)₂, ZnCO₃, Al(OH)₃, Sn(OH)₂, PbCO₃, (SbO)₂CO₃, (BiO)₂CO₃, and the like to obtain the corresponding metal salts.

Examples of these new compounds are as follows:

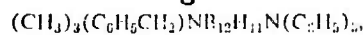
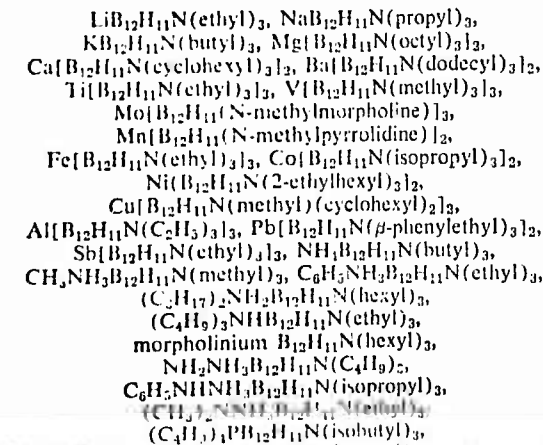

and

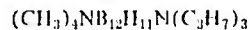

The above compounds are made by one or more of the metathetical processes which have been described previously, i.e., neutralization of the acid with an appropriate base which has the cation group, or reaction of the acid with an oxide, hydroxide or carbonate bearing the desired cation. Other types of metathetical processes can be employed to prepare the compounds of the invention, e.g., reaction between salts to effect an exchange of cations. A water-soluble salt, e.g., cesium fluoride, can be reacted with a water-soluble derivative bearing the

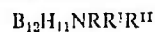

anion, e.g., $\text{NH}_4\text{B}_{12}\text{H}_{11}\text{N}(\text{C}_2\text{H}_5)_3$, to form a salt of lesser solubility in water, in this case, $\text{CsB}_{12}\text{H}_{11}\text{N}(\text{C}_2\text{H}_5)_3$.

These new compounds are generally white crystalline solids which are stable under normal atmospheric conditions. They can be stored in conventional containers made, e.g., of glass polyethylene, polystyrene, and the like, for long periods without decomposition. The free acids are generally hygroscopic and, for this reason, they are most conveniently handled in aqueous solution.

The compounds show much greater chemical stability than many of the known hydrogen-containing boron compositions. The boron-containing group functions as a unit in many chemical reactions and its behavior suggests that the boron atoms are joined to form a boron cage or boron sphere which, although entirely inorganic in structure, undergoes electrophilic substitution reactions in a manner which resembles the behavior of carbocyclic aromatic compounds, e.g., benzene and naphthalene. Specifically, hydrogens bonded to borons in the compounds containing the novel anion are replaceable by halogen substituents denoted by X in the formula, in the same manner that hydrogen bonded to nuclear carbons in benzene or naphthalene is replaced.

Thus, the products will have the formula

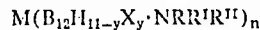

where X is halogen, y is a cardinal number of from 0 to 11, and the other symbols are as previously defined. These compounds are soluble in liquids such as methanol and ethanol. The halogen is substituted by reacting the unsubstituted anionic compound with the halogen (fluorine, chlorine, bromine or iodine).

PRODUCTS CONTAINING THE CATION

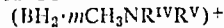

As previously stated, when R, R¹ and R² of the amine-borane reactant fall within certain limits, the cation of the novel products will be the $(\text{BH}_2\text{mCH}_3\text{NR}^1\text{VR}^2)^+$ cation.

These cation-forming groups show remarkable stability, particularly against hydrolytic and oxidative decomposition. This stability, which will be illustrated later, is in marked contrast to the ease of hydrolysis and degradation of known compounds of the type described earlier, e.g., $\text{B}_2\text{H}_6\cdot 2\text{NH}_3$ and $\text{B}_2\text{C}_5\text{H}_5\text{N}$. Compounds of the latter type are decomposed by brief contact with water or with aqueous acid or alkaline solutions. In contrast, the stability of the compounds of the invention is illustrated by the behavior of the group $[\text{BH}_2\cdot 2\text{N}(\text{CH}_3)_3]^+$. This group is not hydrolyzed or degraded in boiling water, hot aqueous inorganic bases or hot aqueous strong acids. The group is not significantly decomposed in boiling aqueous concentrated nitric acid and it is not degraded by hot solutions which contain oxidizing or reducing agents in the ionic form, e.g., AuCl_4^- , $\text{Ag}(\text{CN})_2^-$, BH_4^- , or Ag^+ . Even in the presence of elemental fluorine, the cation possesses sufficient stability to yield a compound in which the hydrogens bonded to boron are replaced with fluorine.

The cation group, represented as

functions as a unit and it passes unchanged through meta-
thetic reactions even reactions which employ power-
ful oxidizing or reducing ionic reagents. In view of this
exceptional stability, it is possible to obtain compounds
containing this cation having a wide range of Z groups as
anions.

The exceptional stability of the cation



permits the use of the salts containing it as reagents in
substitution reaction wherein one or both hydrogens
bonded to boron in the novel cation are replaced with
halogen or fluorosulfate by reaction with halogen or
profluorsulfuric acid without decomposition or degra-
dation of the boron-containing moiety. The com-
pounds so obtained can bear one or two groups, such re-
placement groups which are represented as X'. Thus, the
general formula of the novel cation of this invention is

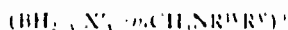

where X' is halogen or fluorosulfate, y is a cardinal num-
ber of from 1 to 2, and the other symbols are as previ-
ously defined.

A preferred group of tertiary amines which are rep-
resented as $\text{CH}_2\text{NR}^{\text{W}}\text{RV}$ in the compounds is selected
from trimethylamine, ethylmethylamine, diethylmethyl-
amine, N,N,N',N'-tetramethylethylenediamine, 1,N,N,N',
N'-pentamethyltrimethylenediamine, N-methylpiperidine,
and N,N'-dimethylpiperazine.

To complete the valence charge associated with the
novel cation $(\text{BH}_{2-y}\text{X}'_y \cdot m\text{CH}_2\text{NR}^{\text{W}}\text{RV})^+$, an anion is
needed. This is provided in the initial reaction by the
polyhydrodopolyborate anion

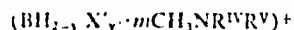

i.e., its narrower form $(\text{B}_{12}\text{H}_{11}\text{CH}_2\text{NR}^{\text{W}}\text{RV})^-$. The
anion, denoted by Z, can be any element or group of ele-
ments which can form a negative ion, i.e., an anion, in
aqueous solution. The group can be monovalent, divalent,
trivalent, quadrivalent, or higher; it can be organic or
inorganic in character. To illustrate, Z groups, expressed
as ions, can be fluoride, chloride, bromide, iodide, hy-
droxide, nitrate, nitrite, sulfate, chlorate (ClO_3^-), phos-
phate (PO_4^{3-}), monohydrogen phosphate (HPO_4^{2-}), dihy-
drogen phosphate (H_2PO_4^-), carbonate (CO_3^{2-}), bicar-
bonate (HCO_3^-), sulfide (S^{2-}), chromate (CrO_4^{2-}), ace-
tate, trichloroacetate, trifluoroacetate, butyrate, acrylate,
methacrylate, crotonate, dodecanoate, stearate, cyclo-
hexanoate, benzoate, toluate, naphthoate, naphthenate,
benzenesulfonate ($\text{C}_6\text{H}_5\text{SO}_3^-$), fluorobenzoate, chloro-
benzoate, benzenephosphonate ($\text{C}_6\text{H}_5\text{PO}_3^{2-}$), benzenear-
sonate ($\text{C}_6\text{H}_5\text{AsO}_3^{2-}$), anthranilate, picolinate, glycinate
[$\text{CH}_2(\text{NH}_2)\text{CO}_2^-$], ϵ -aminocaproate [$\text{NH}_2(\text{CH}_2)_5\text{CO}_2^-$],
tetrahydroborate (BH_4^-), decahydrodecaborate



dodecahydrododecaborate ($\text{B}_{12}\text{H}_{12}^{2-}$), and the like.

A preferred group of compounds are those in which Z
contains a plurality of boron atoms, e.g., $\text{B}_3\text{H}_8^{3-}$,
 $\text{B}_{10}\text{H}_{10}^{2-}$, $\text{B}_{11}\text{H}_{11}^{2-}$, $\text{B}_{12}\text{H}_{12}^{2-}$, and the like. Compounds
in which Z is $-\text{OH}$ or a halide form a valuable group
which are easily obtained and they form an especially
preferred group. The compounds of this especially pre-
ferred group are useful as intermediates in the prepara-
tion of other species.

The novel cation-containing compounds are stable
crystalline solids which can be stored for prolonged
periods without decomposition. They are stored in con-
tainers conventionally used for common chemicals, e.g., in
containers of glass, metal, polystyrene, poly(tetrafluoro-
ethylene)resin, and the like. Provision for exclusion of
air and moisture is not essential although customary pre-
cautions against contamination with adventitious mate-
rial are desirable.

The color of the compounds is determined to some

extent by the elements which are present, especially in the
anion Z. The color of the compounds is most frequently
white with occasional colored products, e.g., yellow or
red.

A particularly valuable property of the compounds of
the invention is the unusual range of solubilities which
are obtained by change in the group Z. In view of these
unexpected solubility characteristics, it is possible to pre-
pare solutions containing, e.g., the cation group

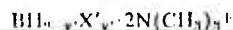

in liquids which range from water to halohydrocarbons.

Compounds in which Z is one of the more common
anions are generally very water-soluble and they form
solutions which conduct an electric current. To illustrate,
the halides (fluoride, chloride, bromide and iodide), sul-
fate, nitrate, phosphate, chromate, chlorate, carbonate,
and the like, dissolve readily in water and they possess
limited solubility in other protonic solvents, such as alco-
hols.

Compounds of the invention in which Z is a relatively
large anion are generally sparingly soluble in water but
they dissolve to a surprising extent in organic solvents,
particularly in nitriles and halohydrocarbons. To illus-
trate, compounds in which Z is $\text{B}_{12}\text{H}_{12}^{2-}$, AuCl_4^- , PF_6^- ,
and the like are soluble in methylene dichloride, chloro-
form, and acetonitrile. These compounds are also solu-
ble in dimethylformamide, butyrolactone and similar
types of liquids. Unusual solubility characteristics are not
necessarily limited to compounds in which Z is a large
anion, e.g., $[\text{BH}_{2-y}\text{X}'_y \cdot 2\text{N}(\text{CH}_3)_3]_2\text{SO}_4$ is soluble in
methylene chloride as well as in water.

As previously stated, the cation-containing compounds
are obtained in the initial reaction when the tertiary amine
employed is of a small size sterically.

An alternate preparation for some specific cation-con-
taining compounds is as follows:

Two reactants are employed, (a) a tertiary amine which
is trimethylamine; N,N,N',N'-tetramethylethylenedi-
amine; 1,N,N,N',N'-pentamethyltrimethylenediamine, or
N,N'-dimethylpiperazine, and (b) a boron compound of the
formula

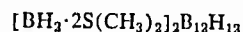

or

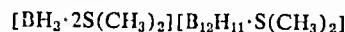

The tertiary amines employed as reactants are readily
available compounds. In most cases, they can be em-
ployed as obtained commercially without especial purifica-
tion.

The boron reactant has not been described in the litera-
ture. It is readily prepared by reaction of dimethyl sul-
fide-borane, i.e., $(\text{CH}_3)_2\text{S}-\text{BH}_3$, with B_2H_6 , B_5H_9 or
 $\text{B}_{10}\text{H}_{14}$, employing process conditions are described above
for the reaction of a tertiary amine with boron hydrides.
Products obtained from the $(\text{CH}_3)_2\text{S}-\text{BH}_3$ reaction in-
clude compounds of the formulas

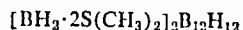

and

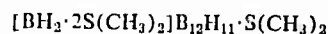

These compounds can be used directly as reactants.

This process is conducted in a simple manner. The
tertiary amine and boron reactant, e.g.,

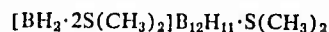

are mixed at a temperature below the boiling point of the
amine and the mixture is agitated by any suitable means
until the dimethyl sulfide in the cation is displaced by the
tertiary amine. Dimethyl sulfide is readily removed from
the reaction mixture by volatilization.

The reaction can if desired, be conducted in an inert
liquid medium to permit intimate contact of the compo-

nents. A solvent is advantageously employed when both reactants are solids. Classes of satisfactory solvents are aromatic hydrocarbons, halohydrocarbons, ethers, and nitriles, e.g., benzene, toluene, carbon tetrachloride, chloroform, diethyl ether, anisole, acetonitrile, and the like.

To place X' groups on the $(BH_2 \cdot mCH_2NR^{IV}RV)^+$ cation, halogens (fluorine, chlorine, bromine, or iodine) or peroxydisulfuryl dihalides are employed. The reaction is conducted in conventional vessels with corrosion-resistant inner surfaces, e.g., glass, platinum, poly(tetrafluoroethylene) resin, and the like. The boron-containing reactant and, optionally, a liquid solvent which is inert toward the reactants, is charged into the reaction vessel. The X' producing reagent is then supplied to the reaction vessel at a temperature and at a rate which will provide a controllable reaction and which will bring the reaction to completion within the reasonable time.

The temperature at which the reaction is conducted will be determined largely by the reactivity of the X' producing reagent. In general, the temperature will be between about -20 and 260° C. Preferably, the temperature will be between about 0° and 150° C.

The time of reaction in a batch process will also depend to a considerable extent on the reactivity of the reagent. The reaction generally proceeds rapidly and, with thorough mixing of the reactants, the time may be as low as 5 minutes or even less. Generally a reaction time between about 10 minutes and 5 hours is sufficient. It is desirable and advantageous to mix the reactants by any suitable means although mixing is not essential for operability.

The reaction can be conducted under pressure, if desired, but it is not essential to use pressure. In most cases the reaction proceeds satisfactorily at atmospheric pressure.

The proportions in which the reactants are used are not critical. It is preferable, in order to obtain maximum yield of desired product, to use at least one mole of reagent for each hydrogen which is to be replaced on the boron-containing reactant. It is not essential, however, that these ratios be used.

The compounds are purified by well known and recognized procedures. For stable products, conventional crystallization procedures are used, employing water or inorganic solvents, e.g., alcohol, benzene, and the like. Solutions of products can be treated with absorptive agents, e.g., activated carbon or silica gel, to absorb the major portion of the impurities.

In the process described above, one or both hydrogens on the boron in the novel cation-containing compounds can be replaced. The groups which replace the hydrogens can be alike or different. To illustrate, the boron-containing reactant can be reacted with one of the reagents, e.g., chlorine, to replace one hydrogen, and the resulting product can be reacted with a second reagent, e.g., bromine or peroxydisulfuryl fluoride, to replace the second hydrogen.

The novel cation-containing compounds wherein Z covers a wide range of anions are obtained by simple metathetic reactions employing the substituted boron-containing cations. To illustrate,



or

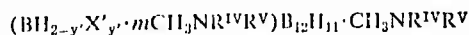

is dissolved in water or aqueous alcohol and the solution is contacted with a strong base or a strongly basic ion-exchange resin to obtain a compound wherein Z is OH. In an alternative mode of operation, the solution of boron-containing salt is contacted with a chloride ion-exchange resin and the effluent is reacted with silver oxide.

Compounds of the formula

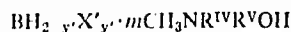

are very strong bases and they can be neutralized with

acids or salts to obtain compounds of the invention having a wide range of Z groups. Organic as well as inorganic acids or their anhydrides can be employed. For example, the hydroxide salt plus phthalic anhydride yields the phthalate salt; with glycine, the glycinate salt is obtained; with citric acid, the salt formed is the citrate salt; with benzenesulfonic acid, the salt is benzenesulfonate; with benzenephosphonic acid, the benzenephosphonate salt is obtained; with benzenephosphinic acid, the salt is benzenephosphinate; with perchloric acid, the perchlorate salt is formed; with pyrosulfuric acid, the salt is pyrosulfate; and with selenic acid, the salt formed is the selenate. These examples are not limiting but serve to illustrate the wide scope of operable metathetic reactions.

The compounds of the invention and their preparation are illustrated more fully in the following examples.

Example I

A. A pressure vessel of corrosion-resistant steel (capacity, 100 ml.) is charged with 1.6 g. of trimethylamineborane adduct, closed and evacuated to a low pressure (less than 1 mm. of mercury). The vessel is then charged with 1.79 g. of diborane (B_2H_6) and sealed. The reaction mixture is heated under autogenous pressure for 10 hours at 125° C. with agitation. The vessel is cooled and volatile products are removed by venting. These products are found to contain hydrogen (0.118 mole) and very small amounts of B_2H_6 and unreacted B_2H_6 . A white crystalline solid (2.6 g.) remains in the reaction vessel. The solid is extracted with boiling water, leaving 0.3 g. of insoluble white material which is called Fraction A and which is discussed in a subsequent paragraph. The hot aqueous extract is cooled slowly and 0.9 g. of a white solid (Fraction X) is obtained initially which is separated by filtration. The filtrate is concentrated by evaporation of the solvent and there is obtained 0.3 g. of bis(trimethylammonium) dodecahydrododecaborate(2-), i.e., $\{[CH_3]_3NH\}_2B_{12}H_{12}$.

The identity of the compound is confirmed by its infrared absorption spectrum.

The solid product, previously referred to as Fraction X, is obtained in larger amount in repeat runs of the process. The fraction is separated into two homogeneous fractions and intermediate mixtures by fractional crystallization from water. The least soluble fraction is referred to as Fraction B and the most soluble fraction as Fraction C. These fractions are new compositions of matter containing boron and nitrogen. They are characterized chemically and by infrared absorption spectra in the following paragraphs. The infrared absorption spectra are obtained on Nujol mulls of the compositions and the characteristic bands are expressed as cm^{-1} units. The bands are exclusive of those common with Nujol.

Fraction A.—A portion of this fraction is crystallized from methylene chloride petroleum ether solution to yield a white solid which is soluble in acetone and liquid sulfur dioxide. The product in acetone solution reduces the silver ion. Characteristic bands in the infrared absorption spectrum of the product are as follows: 2500, strong, sharp; 2150, very weak, sharp; 1490, medium, sharp; 1420, 1400, very weak, sharp; 1260, weak, sharp; 1146, weak, sharp; 1130, 1110, very weak, sharp; 1090, medium, sharp; 1050, medium, sharp; 995, medium, sharp; 985, medium, sharp; 885, medium, sharp; and 725, weak, broad.

The nuclear B^{11} magnetic resonance spectrum of the product consists of a symmetrical doublet and the J_{11} value is 120 c.p.s. The chemical composition of the product is $B_{12}H_{11}C_9N_3$ and it contains the anion

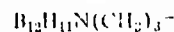

Analysis.—Calc'd for $B_{12}H_{11}C_9N_3$: C, 30.30; H, 12.40; B, 45.60; N, 11.79. Found: C, 29.91; H, 12.23; B, 44.31; N, 11.46.

A mixture of 0.2223 g. of the fraction A product and

10 ml. of aqueous 30% potassium hydroxide is charged into a reaction vessel which is equipped with a reflux condenser. Volatile material is collected in a trap, cooled with liquid nitrogen, which is joined to the reflux condenser. The mixture, which is a slurry, is heated to refluxing temperature for 1-2 hours. White needles of unreacted trimethylamine-borane collect on the cool inner surface of the condenser and a small quantity of trimethylamine is collected in the trap. The slurry changes appearance and substantially all of the solid dissolves during the refluxing operation. The solution is filtered while hot and, on cooling, 150 mg. of white, rod-shaped crystals separate. The crystals are separated by filtration and they are dissolved in water. An aqueous solution of trimethylsulfonium iodide is added to the above solution and white crystals of trimethylsulfonium trimethylamineundecahydrododecaborate(1-) precipitate. The crystals are separated by filtration and they are recrystallized from water to give 100mg. of trimethylsulfonium trimethylamineundecahydrododecaborate(1-). The identity of the compound is confirmed by its infrared absorption spectrum and by elemental analysis. Characteristic absorption bands (expressed as cm^{-1}) in the infrared spectrum of a Nujol mull of the compound are as follows: 2480, very strong, sharp; 1480, medium, sharp; 1320, weak, sharp; 1230, weak, broad; 1050, strong, sharp; 980, with shoulder; 990, medium, sharp; 885, medium, sharp; and 725, medium, broad.

Analysis.—Calc'd for $(\text{CH}_3)_3\text{SB}_{12}\text{H}_{11}\text{N}(\text{CH}_3)_3$: B, 46.84; S, 11.57; N, 5.05; C, 26.00; H, 10.54. Found: B, 45.19; S, 11.62; N, 5.00; C, 25.96; H, 10.32.

Fraction B.—Elemental analyses and the infrared absorption spectrum show that this white crystalline fraction is a compound of the formula

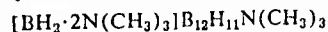

The infrared absorption spectrum is as follows: 2450, strong, sharp; 1480, medium, sharp; 1300, medium, sharp, sharp; 1230, medium, sharp; 1190, medium, sharp; 1110, medium, sharp; 1100, weak, sharp; 1040, medium, sharp; 995, medium, sharp; 975, medium, sharp; 880, medium, sharp; 840, medium, sharp; 740, weak, sharp; 720, medium, broad.

Analysis.—Calc'd for $\text{B}_{13}\text{C}_9\text{H}_{40}\text{N}_3$: C, 32.65; H, 12.18; N, 12.69; B, 42.48. Found: C, 32.74; H, 12.13; N, 12.74; B, 42.46; C, 32.54; H, 12.48; N, 12.47.

Fraction C.—This fraction is a compound of the formula $[(\text{CH}_3)_3\text{NH}][\text{B}_{12}\text{H}_{11}\text{N}(\text{CH}_3)_3]$ wherein the cation-forming group and the anion-forming group are shown in brackets solely for the sake of clarity. The infrared absorption spectrum of this compound shows the following characteristic bands: 3100, medium, sharp; 2480, strong, sharp; 1500, weak, sharp; 1400, weak, sharp; 1230, medium, sharp; 1190, weak, sharp; 1120, weak, sharp; 1040, medium, sharp; 980, medium, sharp; 880, medium, sharp; 810, very weak, broad; 725, weak, broad.

An aqueous solution containing 1.1 g. of the above compound, i.e., $(\text{CH}_3)_3\text{NHB}_{12}\text{H}_{11}\text{N}(\text{CH}_3)_3$, is passed through a column filled with a strong acid ion-exchange resin (a cross-linked polystyrenesulfonic acid) to yield an aqueous solution of the acid, $\text{HB}_{12}\text{H}_{11}\text{N}(\text{CH}_3)_3$, or expressed in the hydronium form, $(\text{H}_3\text{O})\text{B}_{12}\text{H}_{11}\text{N}(\text{CH}_3)_3$. Titration of the aqueous solution with 0.1 N NaOH solution forms the sodium salt, $\text{NaB}_{12}\text{H}_{11}\text{N}(\text{CH}_3)_3$, and the titration indicates an equivalent weight value for the trimethylammonium salt of 250 (calculated value, 260). The pKa value for the acid is about 2, i.e., it behaves as a strong acid. Evaporation of the aqueous solution of the acid under very low pressure (generally less than 1.0 mm. of mercury) yields the acid as a crystalline, hygroscopic white solid.

B. A pressure vessel of corrosion-resistant steel (capacity, 400 ml.) is charged as described in Part A with 21 g. of trimethylamine-borane adduct and 12 g. of diborane. The reaction mixture is heated under at-

enous pressure with agitation for 10 hours at 175° C. The reaction vessel is cooled and volatile products are removed by venting for 1 hour under reduced pressure. The white solid (28.1 g.) which remains in the reaction vessel is removed and it is boiled for about 5 minutes with 50 ml. of water. An insoluble portion is separated by filtration to obtain 9.0 g. of the compound $[\text{H}_2\text{B} \cdot 2\text{N}(\text{CH}_3)_3]_2[\text{B}_{12}\text{H}_{11}\text{N}(\text{CH}_3)_3]$, previously described in Part A under the paragraph "Fraction B."

The filtrate from the above separation is cooled and a crystalline product precipitates which is separated by filtration to yield 9.0 g. of the compound

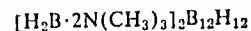

The identity of the compound is confirmed by its infrared absorption spectrum and by comparison with a second sample of the compound whose elemental analysis is as follows.

Analysis.—Calc'd. for $[\text{H}_2\text{B} \cdot 2\text{N}(\text{CH}_3)_3]_2\text{B}_{12}\text{H}_{12}$: B, 37.5; C, 35.7; H, 12.95; N, 13.82. Found: B, 37.0; C, 35.7; H, 13.0; N, 13.8.

C. Using the procedure described in Part B, above, a mixture of 7.4 g. of trimethylamine-borane and 7.0 g. of diborane is heated for 10 hours at 125° C. with agitation. There is obtained 9.6 g. of a white chunky solid which is agitated with methylene dichloride. The mixture is filtered to separate 5.3 g. of a gray insoluble solid. The yellow filtrate is evaporated to yield 4-5 g. of a yellow solid designated as Fraction A.

Fraction A is again dissolved in methylene dichloride and the solution is filtered to remove a small quantity of insoluble material. The filtrate is diluted with petroleum ether and the yellow precipitate which forms is separated by filtration. The solid is extracted with hot water to yield a water-soluble component. Evaporation of the aqueous extract yields $[(\text{CH}_3)_3\text{NH}]_2\text{B}_{12}\text{H}_{12}$ which is identified by its infrared absorption spectrum. The substantially insoluble or, at best, very sparingly soluble product is $[\text{H}_2\text{B} \cdot 2\text{N}(\text{CH}_3)_3]_2\text{B}_{12}\text{H}_{12}$, which is characterized as described in Part B.

Example II

A pressure vessel of corrosion-resistant steel (125 ml. capacity) is charged with 3.23 g. of triethylamine-borane adduct $[(\text{C}_2\text{H}_5)_3\text{N}-\text{BH}_3]$, closed and evacuated to a low pressure (less than 1 mm. Hg). Sufficient diborane (B_2H_6) is charged into the vessel to provide an absolute pressure of approximately 6 atmospheres (73 p.s.i. gauge pressure) at 50° C. The reaction mixture is maintained at this pressure and temperature for 1.5 hours and at the end of this time, no increase in pressure is noted, i.e., no hydrogen is formed under these conditions. The temperature is increased to 75° C. and a pressure increase, resulting from reaction and formation of by-product hydrogen, is noted. The reaction mixture is maintained at 75° C. and an absolute pressure of about 6.2 atmospheres (78 p.s.i. gauge) for 3 hours and it is then heated to 100° C. for 2 hours. The vessel is cooled and unreacted diborane is removed by venting the vessel and passing the volatile products through a trap cooled to about -196° C. There remains in the reaction vessel 3.61 g. of a solid residue. The solid residue is crystallized twice from an ethanol-water mixture to obtain 0.325 g. of bis(trimethylammonium) dodecahydrododecaborate(2-), i.e., $[(\text{C}_2\text{H}_5)_3\text{NH}]_2\text{B}_{12}\text{H}_{12}$. The identity of the product, which is a white solid, is confirmed by its infrared absorption spectrum.

Example III

A pressure vessel (capacity, 100 ml.) is charged as described in Example I with 6.0 ml. of triethylamine-borane addition compound $[(\text{C}_2\text{H}_5)_3\text{N}-\text{BH}_3]$ and 2.78 g. of pentaborane (B_5H_9). The mixture is heated with agitation at 125° C. for 10 hours. The vessel is cooled and volatile products are removed by venting and they

are collected in a cold cylinder. There is obtained in the volatile products 0.104 mole of hydrogen and a small quantity of condensable material which is not characterized.

The non-volatile residue in the reaction vessel consists of 6.8 g. of a pale yellow solid. The product is washed with triethylamine and it is then crystallized from hot water to form 4.5 g. of pure bis(triethylammonium) dodecahydrododecaborate. The identity of the compound is confirmed by its infrared absorption spectrum and by elemental analysis. The yield of product is 50%.

Analysis.—Calcd. for $[(C_2H_5)_3NH]_2B_{10}H_{12}$: C, 41.61; H, 12.81; B, 37.73. Found: C, 41.93, 41.76; H, 12.71, 12.78; B, 37.49.

Example IV

A. A small glass vessel is employed which is fitted with a stirrer, a thermometer and a reflux condenser which is also connected to a wet test meter. The vessel is charged with 5 g. of triethylamine-borane addition compound $[(C_2H_5)_3N-BH_2]$ and 2 g. of decaborane $(B_{10}H_{12})$. A yellow solution forms without gas evolution. The solution is heated to 90–100° C. for one hour, and 10 ml. of gas are evolved as measured by the wet test meter. A yellow somewhat gelatinous solid forms which becomes partially crystalline during the heating period. The temperature is raised to 150° C. and a vigorous reaction occurs with a sharp temperature rise to about 200° C. Evolution of about 670 ml. of gas occurs in less than 2 minutes. The product in the flask is a white solid which is flocced with yellow. The solid is washed with diethyl ether and there remains 5.6 g. of a pale yellow damp solid. The solid is crystallized from hot water to yield 2.8 g. of white crystalline bis(triethylammonium) dodecahydrododecaborate. The identity of the compound is confirmed by its infrared absorption spectrum. The yield of product is almost 100%.

B. A glass vessel, equipped as described in Part A, is charged with 20 ml. of $(C_2H_5)_3N-BH_2$. Nitrogen gas is passed into the vessel and the liquid is heated to 170–175° C. A solution of 29 g. of $B_{10}H_{12}$ in 100 ml. of $(C_2H_5)_3N-BH_2$ is added to the vessel over a period of about one hour with vigorous stirring. After addition is complete, the reaction mixture is stirred 15 minutes, maintaining the temperature at 170–175° C. Hydrogen is evolved during the reaction and evolution of this gas decreases sharply during the final stirring. A total of 19.9 liters of gas is evolved.

The reaction mass is a mixture of a white solid and pale yellow liquid. It is cooled to prevailing air temperature (about 25° C.) and the solid is separated by filtration. The solid is washed with ether and dried. There is obtained 69 g. of bis(triethylammonium) dodecahydrododecaborate(2–) yield, 84% based on $B_{10}H_{12}$ employed. The identity of the compound is confirmed by its infrared absorption spectrum.

The ether washings are diluted with petroleum ether and a white solid (about 1 g.) precipitates. The solid is separated by filtration and it is recrystallized from ethanol to yield a white crystalline solid which is triethylammonium triethylamine-undecahydrododecaborate(1–), i.e., a compound of the formula

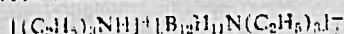

where the anion and cation are shown in brackets. This species of a novel class of compounds is written more conventionally as $(C_2H_5)_3NH[B_{10}H_{11}N(C_2H_5)]_2$. The identity of the compound is confirmed by elemental analysis.

Analysis.—Calcd. for $(C_2H_5)_3NH[B_{10}H_{11}N(C_2H_5)]_2$: C, 41.86; H, 12.29; B, 37.71; N, 8.14. Found: C, 42.01, 41.50; H, 12.61, 12.17; B, 37.06; N, 8.25, 8.29.

The infrared absorption spectrum of triethylammonium triethylamine-undecahydrododecaborate(1–) in a Nujol mull is as follows, exclusive of the bands coincident with Nujol (expressed in cm^{-1}): 3200, medium, sharp; 2500, strong, sharp; 1480, medium, sharp; 1400, weak, sharp;

1360–1380, weak, fine structure; 1180, very weak, sharp; 1160, weak, sharp; 1140, weak sharp; 1120, very weak, sharp; 1080, very weak, sharp; 1060, medium, sharp; 1040, medium, sharp; 1020, very weak, sharp; 1010, very weak, sharp; 985, weak, sharp with shoulder at 950; 890, weak, sharp; 850, weak, sharp; 835, medium, sharp; 800, weak, sharp; 770, very weak, sharp; and 745, weak, broad.

C. A pressure vessel is charged with 2.5 g. of $B_{10}H_{12}$ and 6 ml. of triethylamine-borane. The vessel is chilled, evacuated to a low pressure (less than 1 mm. of Hg) and sealed. The vessel and contents are heated with agitation at 150° C. for 12 hours. The vessel is cooled and volatile products are removed by venting. The remaining reaction mass is processed as described in Parts A and B to obtain the products described in Part A and Part B.

The process described in Example IV, Parts A, B and C, is operable with other boron hydrides. To illustrate, 20 ml. of triethylamine-borane adduct $[(C_2H_5)_3N-BH_2]$ is charged into a reaction vessel and it is heated under a blanket of an inert gas (argon) to a temperature of 175° C. A slow stream of diborane is passed into the vessel below the surface of the triethylamine-borane adduct. The reaction mass is heated gradually to 200° C. for a period of about 2 hours with continued passage of diborane. Vigorous refluxing occurs and hydrogen gas is released. The reaction mass is worked up as described in Example IV to obtain products of the type described in this example.

Examples I through IV illustrate the operation of the process employing as reactants a tertiary amine-borane addition compound and the boron hydrides, diborane, pentaborane and decaborane. This mode of operation is generic to tertiary amine-borane adducts. To illustrate, the boron hydrides can be reacted with tri-n-butylamine-borane, tridodecylamine-borane, trioctadecylamine-borane, tricyclohexylamine-borane, methyldicyclohexylamine-borane, and the like, to form the corresponding bis(tri-substituted ammonium) dodecahydrododecaborates(2–) and tri-substituted ammonium tertiary amine-undecahydrododecaborates(1–).

Example V

A. A corrosion-resistant pressure vessel (capacity, 100 ml.) is charged with 2.63 g. of triethylamine. The charged vessel is closed, cooled to about –78° C. with a carbon dioxide-acetone mixture and connected to a vacuum pump. Pressure in the chilled vessel is reduced to less than 1 mm. of mercury. The vessel is connected to a source of diborane and 2.2 g. of this reactant (B_2H_6) is charged into the reaction chamber. The ratio, moles B_2H_6 /moles $(C_2H_5)_3N$, is 3.1. The vessel is sealed and heated to 100° C. for 10 hours with agitation under autogenous pressure. The vessel is then cooled to about –78° C., and volatile reaction products are removed by venting into a trap cooled to about –196° C. with liquid nitrogen. There is obtained about 0.13 mole of a non-condensable gas which is hydrogen. The material condensed in the trap is separated into three fractions by passage through traps cooled, respectively, to –78° C., –135° C., and –196° C. The product collected at –78° C. is B_2H_6 (0.0034 mole); in the trap at –135° C., less than 0.0001 mole of unidentified product is obtained; in the trap at –196° C., 0.0032 mole of unreacted B_2H_6 is collected.

A non-volatile yellowish solid which remains in the reaction vessel is removed by washing with triethylamine. The washings are filtered and the solid product is dried at 90° C. under very low pressure (about 0.1 μ of H₂). There is obtained 3.27 g. of bis(triethylammonium) dodecahydrododecaborate(2–) as a nearly white powder. The product is crystallized from an ethanol-water mixture to yield crystalline colorless prisms. Successive crops of crystals yield 2.51 g. of very pure product which has the composition $[(C_2H_5)_3NH]_2B_{10}H_{12}$. The identity of the compound is confirmed by its infrared absorption spectrum.

B. Using the procedure described in Part A, a mixture

of 2.77 g. of triethylamine and 2.04 g. of diborane is heated at 100° C. for 2 hours with agitation. Volatile products of the reaction are separated and are found to contain 0.178 g. of hydrogen, 0.24 g. of pentaborane(9), i.e., B₅H₉, and 0.27 g. of unreacted diborane. The product remaining in the reaction vessel is 3.50 g. of a mixture of liquid and solid from which 1.61 g. of



a white solid, is separated by filtration. The identity of this product is confirmed by its infrared absorption spectrum. Yield: 38%, based on the diborane reactant.

C. A reaction vessel is charged, as described in Part A, with 2.75 g. of (C₂H₅)₃N and sufficient diborane to provide a pressure of 6 p.s.i. gauge at 100° C. The mixture is maintained under these conditions for a short period, after which more diborane is charged into the vessel to provide a pressure of about 20 p.s.i. gauge, i.e., an absolute pressure of about 2.3 atmospheres, at 100° C. The release of hydrogen as a by-product results in a pressure rise of about 3 p.s.i. gauge over a period of 5 hours. After this period of time the vessel is cooled and excess diborane is removed by venting. There is obtained 3.25 g. of residue which is filtered to isolate 0.025 g. of solid material. The solid product is crystallized from ethanol-water mixtures to obtain [(C₂H₅)₃NH]₂B₁₂H₁₂.

Example VI

Using the process as described in Example V, Part A, a mixture of 1.7 g. of diborane and 7.2 g. of triethylamine is heated at 150° C. for 10 hours in a pressure vessel under autogenous pressure with agitation. The ratio, moles B₂H₆/moles (C₂H₅)₃N, is 0.9. Volatile products, consisting of 0.0805 mole of hydrogen, are removed by venting as described in Example II. The liquid and solid mixture in the reaction vessel is filtered to yield 1.9 g. of white crystalline bis(triethylammonium)dodecahydrododecaborate(2-). The product is crystallized from an ethanol-water mixture and its identity is confirmed by its infrared absorption spectrum and by elemental analysis.

Analysis.—Calc'd for [(C₂H₅)₃NH]₂B₁₂H₁₂: C, 41.61; H, 12.81; N, 8.09; B, 37.49. Found: C, 41.48, 41.20; H, 12.87, 12.61; N, 8.03, 8.02; B, 37.30, 37.19.

Example VII

Using the procedure described in Example V, Part A, a mixture of 3.945 g. of triethylamine and 2.2 g. of diborane is heated at 175° C. for 12 hours with agitation under autogenous pressure. The ratio, moles B₂H₆/moles (C₂H₅)₃N, is 2.0. There is obtained as by-products 1.42 moles of hydrogen and 1.25 g. of (C₂H₅)₃N-BH₃. The principal product, isolated and purified as described in Example V, is 4.19 g. of bis(triethylammonium) dodecahydrododecaborate(2-). The identity of the compound is confirmed by its infrared absorption spectrum and by elemental analysis.

Analysis.—Calc'd for [(C₂H₅)₃NH]₂B₁₂H₁₂: C, 41.61; H, 12.81, B, 37.49, N, 8.09. Found: C, 39.87, 39.66; H, 12.12, 12.08; B, 37.44, 36.54; N, 8.15, 8.11.

The infrared spectrum (in a Nujol mull) shows bands at the following wavelengths, exclusive of those coincident with Nujol (expressed as cm.⁻¹ units): 3150, medium, sharp; 2480, strong, sharp; 1440, medium; multiplet centered around 1370, weak; 1270, very weak, sharp; 1155, medium, sharp; 1060, strong, sharp; 1015, strong, sharp; 842, medium, sharp; 792, weak; 742, very weak; 715, medium.

Example VIII

Using the procedure described in Example V, Part A, a pressure vessel (capacity, 100 ml.) is charged with 4.9 g. of freshly distilled tri(n-butyl)-amine and 2.11 g. of diborane. The vessel and contents are heated with agitation to 125° C. and the reaction is maintained at this temperature for 5 hours under autogenous pressure. The vessel is cooled and products which are volatile at pre-

vailing atmospheric temperature (about 25° C.) are collected for analysis. There is obtained about 0.26 g. of hydrogen together with boron hydrides which consist principally of pentaborane(9) and diborane. The non-volatile product remaining in the reaction vessel is removed and washed with dry diethyl ether. The ether washings, on evaporation, yield 1 g. of a yellow oil which is not further characterized. The ether-insoluble product is a white crystalline solid, which is crystallized from water-ethanol to yield 4.0 g. of bis(tri-n-butylammonium) dodecahydrododecaborate (2-), i.e.,



yield, 68%. The identity of the product is confirmed by elemental analysis and by its infrared absorption spectrum.

Analysis.—Calc'd for C₂₄H₆₈N₂B₁₂: C, 56.01; H, 13.32; B, 25.23; N, 5.44. Found: C, 56.12, 56.03; H, 13.12, 13.22; B, 24.95; N, 5.66, 5.66.

The infrared spectrum of the compound in a Nujol mull shows the following major absorption bands (expressed as cm.⁻¹ units): 3100, strong, sharp; 2500, strong, sharp; 1140, weak, sharp; 1095, weak, sharp; 1060, strong, sharp; 1030 shoulder, weak, sharp; 975, weak, sharp; 950, weak, sharp; 920, medium, sharp; 900, weak, sharp; 782, weak, sharp; 730, medium, sharp; 710-715 doublet, medium, broad; fine structure in the regions 1200-2100 and 700-900. These bands are exclusive of those coincident with bands due to Nujol.

Example IX

Using the procedure described in Example V, Part A, a mixture of 2.4 g. of N-methylmorpholine and 2.02 g. of diborane is heated for 5 hours at 125° C. under autogenous pressure. There is obtained about 0.21 g. of hydrogen in the volatile by-products and about 2 g. of a sticky yellow solid as the non-volatile product. The non-volatile product is crude bis(N-methylmorpholinium) dodecahydrododecaborate(2-), which has the following structural formula:

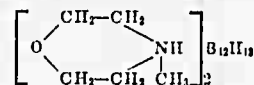

The product is boiled with acidified water (acidified with H₂SO₄) to remove any amine-borane adduct which might be present and the solution is filtered. A clear filtrate is obtained which is an aqueous solution of bis(N-methylmorpholinium) dodecahydrododecaborate(2-).

The above salt is converted to the triethylammonium salt by adding to the solution an aqueous solution of triethylammonium chloride. A white precipitate forms which is separated by filtration to yield 0.9 g. of



Isolation of the above salt shows that the yield of bis(N-methylmorpholinium) dodecahydrododecaborate(2-) obtained in the reaction is 22%.

Example X

Using the procedure described in Example V, Part A, a mixture of 2.6 g. of N-methylpiperidine and 2.09 g. of diborane is heated for 5 hours at 125° C. under autogenous pressure. Volatile products are isolated and are found to contain about 0.248 g. of hydrogen and undetermined quantities of unreacted diborane and pentaborane(9). The non-volatile products consist of about 3 g. of a tacky white solid which is impure bis(N-methylpiperidinium) dodecahydrododecaborate(2-), i.e., a compound of the following structure:

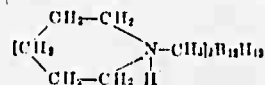

The white solid is boiled with dilute sulfuric acid to remove any borane-amine complex. The solution is filtered

and a clear aqueous solution of bis(N-methylpiperidinium) dodecahydrododecaborate(2-) is obtained.

An aqueous solution of triethylammonium chloride is added with stirring to the hot aqueous filtrate obtained as described in the preceding paragraph. The reaction mixture is cooled and the white solid which forms is separated by filtration. There is obtained 1.99 g. of bis(triethylammonium) dodecahydrododecaborate(2-).

The yield of bis(N-methylpiperidinium) dodecahydrododecaborate(2-) obtained in the reaction is therefore 43%.

Example XI

A. A mixture of 20.4 g. of ethyldimethylamine and 16 g. of diborane is heated in a pressure vessel under autogenous pressure for 10 hours at 175° C. The vessel is cooled and vented under reduced pressure to release volatile products. A gummy solid residue (wt., 27 g.) is removed from the vessel and boiled with aqueous ethanol containing a small quantity of hydrochloric acid. The hot solution is filtered to remove a small amount of insoluble material. The filtrate is cooled and crystals form which are separated to obtain 3.9 g. of



Analysis.—Calc'd for the above $\text{B}_{12}\text{H}_{11}\cdot \text{N}(\text{CH}_3)_2\text{C}_2\text{H}_5$ salt: C, 38.62; H, 12.42; N, 11.26; B, 37.69. Found: C, 39.12, 39.20; H, 12.28, 12.57; N, 11.13, 11.19; B, 37.60, 37.80.

The infrared spectrum of the compound shows absorption bands at the following wavelengths (expressed as cm^{-1}): 2450, strong, sharp; 1400, weak, sharp; 1200, 1170, medium, sharp, shoulders; 1110, 1090, weak, sharp; 1040, 1020, medium, sharp; 990 (shoulder), 980, medium, sharp; 925, weak, broad; 860, medium, sharp; 790, medium, sharp; and 720, medium, broad.

B. The mother liquor is concentrated and cooled further to obtain 2.7 g. of

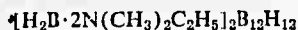

Further concentration and cooling yields an additional 3.2 g. of the dodecahydrododecaborate(2-) salt.

Analysis.—Calc'd for the above $\text{B}_{12}\text{H}_{12}$ salt: C, 41.76; H, 13.14; N, 12.18; B, 32.92. Found: C, 41.46, 41.23; H, 12.94, 12.77; N, 12.28, 12.13; B, 32.8.

The infrared spectrum of the compound shows absorption bands at the following wavelengths (expressed as cm^{-1}): 2450 (shoulder), 2350, strong, sharp; 2000, weak, sharp; about 1480, broad; 1400, weak, sharp; 1380, weak, sharp; 1310-1305, weak, sharp; 1240, medium, sharp; 1210, strong, sharp; 1180, strong, sharp; 1105, medium, sharp; 1090, weak, sharp; 1055, strong, sharp; 1030, strong, sharp; 975, medium, sharp; 925-905, weak, sharp; 860, strong, sharp; 825, strong, sharp; 810, strong, sharp; and 715, strong, broad.

C. An aqueous solution of

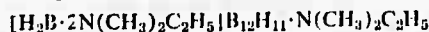

is passed through a column filled with a commercial acid ion-exchange resin of the polyarylsulfonic acid type. The cation $[\text{H}_2\text{B}\cdot 2\text{N}(\text{CH}_3)_2\text{C}_2\text{H}_5]^+$, is retained by the resin in the column. The aqueous effluent, which contains the anion $[\text{B}_{12}\text{H}_{11}\cdot \text{N}(\text{CH}_3)_2\text{C}_2\text{H}_5]^-$, is set aside for other work.

The column containing the acid ion-exchange resin is now washed with dilute aqueous hydrochloric acid solution. The aqueous effluent obtained in this step contains $[\text{H}_2\text{B}\cdot 2\text{N}(\text{CH}_3)_2\text{C}_2\text{H}_5]\text{Cl}$ and it is evaporated to a small volume. An aqueous solution of NH_4PF_6 is added with stirring to precipitate $[\text{H}_2\text{B}\cdot 2\text{N}(\text{CH}_3)_2\text{C}_2\text{H}_5]\text{PF}_6$, a white solid which is separated, washed and dried to obtain about 0.05 g. of product.

Analysis.—Calc'd for $[\text{H}_2\text{B}\cdot 2\text{N}(\text{CH}_3)_2\text{C}_2\text{H}_5]\text{PF}_6$: C, 31.60; H, 7.96; P, 10.19; F, 37.49. Found: C, 31.96, 31.98; H, 8.13, 8.24; P, 9.62; F, 35.71.

The infrared spectra of the above compound shows

absorption at the following wavelengths (expressed as cm^{-1}): 2500, medium, sharp; 2380, weak, sharp; 1410, weak, sharp; 1390, weak, sharp; 1320, weak, sharp; 1240, medium, sharp; 1220, strong, sharp; 1190-1170 (doublet), medium, sharp; 1140, 1120, 1110, 1090, 1070, weak, sharp; 1030, medium, sharp; 1000, medium, sharp; 840, very sharp, broad.

The nuclear magnetic resonance spectrum is determined on $[\text{H}_2\text{B}\cdot 2\text{N}(\text{CH}_3)_2\text{C}_2\text{H}_5]\text{PF}_6$ in acetonitrile solution. The spectrum is calibrated at 14.2 megacycles relative to the boron resonance of $\text{B}(\text{OCH}_3)_3$, using side band technique [see, for example, J. T. Arnold and M. E. Packard, J. Chem. Phys. 19, 1608 (1951)]. These data determined for the B^{11} isotope in the above compound are as follows: $J_{\text{B-H}}$, 105 c.p.s. (a symmetrical triplet, 1:2:1); shift from $\text{B}(\text{OCH}_3)_3$, +17.2 p.p.m.

Example XII

A. A mixture of 25 g. of diethylmethylamine and 16 g. of diborane is heated in a pressure vessel (400 ml. capacity) under autogenous pressure at 175° C. for 10 hours. The vessel is cooled and vented under reduced pressure to remove volatile products. A white semi-solid mass (wt., 34.4 g.) remains which is washed from the vessel with diethyl ether. The ether is removed by evaporation and the solid residue is boiled with acidified water. A gas forms and is released during this step in the process. The solution is now made strongly basic and boiled again to remove excess amine. An insoluble product remains which is separated by filtration to obtain 3.3 g. of

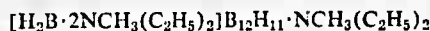

The product is a white solid which is purified by crystallization.

Analysis.—Calc'd for above salt: C, 43.38; H, 12.62; B, 33.87; N, 10.12. Found: C, 44.1; H, 13.1; B, 33.85; N, 10.12.

B. A mixture of 24.5 g. of diethylmethylamine and 16 g. of diborane is heated under autogenous pressure at 175° C. for 25 hours. The reaction mixture is processed as described in Part A to obtain 2.3 g. of

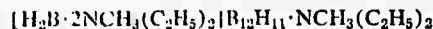

The infrared spectrum of the compound of Parts A and B show absorption at the following wavelengths (expressed as cm^{-1}): 2500, shoulder at 2350, strong, sharp; 1450 (over Nujol band); 1410, weak, sharp; 1380, weak, sharp; 1330, 1300, weak, sharp; 1220, 1180, 1160, medium, sharp; 1110, weak, broad; 1090, 1070, weak, sharp; 1040, strong, sharp; 1030, 1010, medium, sharp; 970, medium, sharp; 910, weak, broad; 870, medium, broad; 850, weak, broad; 820, medium, broad; 790, medium, broad; 770, 750, weak, broad; and 720, medium, broad.

C. A small portion (0.2 g.) of

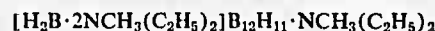

obtained as described in Part A is dissolved in water. The aqueous solution is passed through a column filled with a commercial acid ion-exchange resin of the polyarylsulfonic acid type. After passage is complete, the aqueous effluent is set aside and the column is washed with aqueous hydrochloric acid solution. The aqueous effluent, which now contains $[\text{H}_2\text{B}\cdot 2\text{NCH}_3(\text{C}_2\text{H}_5)_2]\text{Cl}$, is concentrated to a small volume and an aqueous solution of NH_4PF_6 is added with stirring. The solid which forms is separated to obtain 0.04 g. of



as a white solid which melts at 137-142° C. Its identity is confirmed by elemental analysis.

Analysis.—Calc'd for above salt: C, 36.16; H, 8.50; N, 8.44; P, 9.33. Found (average): C, 36.9; H, 8.53; N, 8.31; P, 9.21.

The infrared spectrum of the compound shows bands

Example XVII

A portion of the acid effluent of Example XVI is titrated with an aqueous solution of CsOH to a pH of about 7. There is obtained as a white crystalline product cesium triethylamine-undecahydrododecaborate(1-), i.e.,

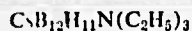

The identity of the compound is confirmed by elemental analysis.

Analysis.—Calc'd for $\text{CsB}_{12}\text{H}_{11}\text{N}(\text{C}_2\text{H}_5)_3$: Cs, 35.44; B, 31.62; C, 19.21; H, 6.90; N, 3.74. Found: Cs, 33.8; B, 34.04; C, 19.78, 19.78; H, 6.93, 7.21; N, 3.79, 3.81.

The infrared absorption spectrum of the cesium compound in a Nujol mull is as follows, expressed as cm^{-1} units, and exclusive of the bands coincident with Nujol: 2500, strong, sharp; 1460–1380, fine structure; 1160 (doublet), very weak, sharp; 1130, weak sharp; 1080, weak, sharp; 1050, medium, sharp; 1020, weak, sharp; 1000, weak, sharp; 975, medium, sharp; 875, weak, sharp; 825, medium, broad; 785, very weak, broad; 765, very weak, broad; 735, medium, broad; and 720, medium, broad.

The acids, such as that prepared in Example XVI can be neutralized with alkali metal hydroxides (LiOH, NaOH, KOH), alkaline earth metal hydroxides [$\text{Ba}(\text{OH})_2$, $\text{Ca}(\text{OH})_2$], ammonia, ammonium hydroxide, metal-amine hydroxides, hydrazine, substituted hydrazines (phenylhydrazine, N,N-dimethylhydrazine), sulfonium hydroxides [$(\text{CH}_3)_2\text{SOH}$, $(\text{C}_6\text{H}_5)_2\text{SOH}$], phosphonium hydroxides [$(\text{C}_6\text{H}_5)_3\text{POH}$], tetraalkyl and mixed tetraalkyl and alkyl-substituted ammonium hydroxides [$(\text{CH}_3)_4\text{NOH}$, $(\text{C}_6\text{H}_5)_3\text{CH}_2(\text{CH}_2)_3\text{NOH}$]. The compounds given in brackets are illustrative of the class of bases named.

The acid in aqueous or alcoholic solution can be agitated with inorganic oxides, hydroxides or carbonates to form metal or metal oxy salts of the $(\text{B}_{12}\text{H}_{11}\text{NRR}'\text{R}'')$ -1 anion. To illustrate, the solution of the acid can be reacted with Na_2CO_3 , CaCO_3 , SrCO_3 , $\text{Zn}(\text{OH})_2$, $\text{V}(\text{OH})_3$, $\text{Cr}(\text{OH})_3$, $\text{Mn}(\text{CO})_2$, FeCO_3 , NiCO_3 , $\text{Cu}(\text{OH})_2$, ZnCO_3 , $\text{Al}(\text{OH})_3$, $\text{Sn}(\text{OH})_4$, PbCO_3 , $(\text{SbO})_2\text{CO}_3$, $(\text{BiO})_2\text{CO}_3$, and the like to obtain the corresponding metal salts.

Example XVIII

A reaction vessel equipped with a stirrer and reflux condenser is charged with 0.8 of



and 50 ml. of methanol. The mixture is stirred and water is added gradually until the point of incipient precipitation is reached. The mixture is then heated to 50° C. and liquid bromine is added dropwise and with stirring. About 1.4 g. of bromine is absorbed and at this point the solution contains the compound



The solution is now heated to refluxing and about 6 g. of liquid bromine is added dropwise. The mixture is maintained at reflux (about 70° C.) for one hour. It is then cooled to about 25° C. and it is partially evaporated by use of a water-aspirator pump. White crystals form which are separated by filtration to yield 1.74 g. of $[(\text{C}_2\text{H}_5)_3\text{NH}][\text{B}_{12}\text{H}_5\text{Br}_6\text{N}(\text{C}_2\text{H}_5)_3]$. The compound is recrystallized from hot 90% methanol and its identity is confirmed by elemental analysis.

Analysis.—Calc'd for $\text{B}_{12}\text{H}_5\text{Br}_6\text{N}_2\text{H}_{36}$: B, 15.87; Br, 58.66; C, 17.62; H, 4.43. Found: B, 15.28; Br, 59.47; C, 17.58; H, 4.58.

Example XIX

The procedure of Example XVIII is repeated employing 0.8 g. $(\text{C}_2\text{H}_5)_3\text{NHB}_{12}\text{H}_{11}(\text{C}_2\text{H}_5)_3$ and 50 ml. of methanol but using chlorine in place of bromine. The initial reaction mixture is heated to reflux temperature and chlorine gas is bubbled through the mixture for

about 1–1.5 hours. The reaction mixture is processed as described in Example XVIII to obtain 1.0 g. of $[(\text{C}_2\text{H}_5)_3\text{NH}][\text{B}_{12}\text{H}_4\text{Cl}_2\text{N}(\text{C}_2\text{H}_5)_3]$, a white crystalline solid whose identity is confirmed by elemental analysis.

Analysis.—Calc'd for $\text{B}_{12}\text{H}_4\text{Cl}_2\text{N}_2\text{H}_{35}$: B, 22.3; Cl, 42.4; C, 24.7; H, 6.05. Found: B, 21.64; Cl, 41.0; C, 25.0; H, 6.27.

The process of Example XVIII can be used to prepare iodine-bearing compounds, employing an iodine chloride as the halogenating agent, e.g.,



can be obtained from $(\text{C}_2\text{H}_5)_3\text{NHB}_{12}\text{H}_{11}\text{N}(\text{C}_2\text{H}_5)_3$ and ICl.

Examples XVIII and XIX illustrate the reaction of the novel anion-containing compounds with halogen reagents to obtain substitution products of the following general formula:

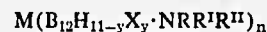

where the symbols have the meanings previously described.

The compounds are soluble in oxygenated liquids, e.g., methanol and ethanol. Solubility in water ranges from the high solubility of the acids to rather low solubility for the amine salts and heavy metal salts.

Example XX

The compound $[\text{H}_2\text{B} \cdot 2\text{N}(\text{CH}_3)_3][\text{B}_{12}\text{H}_{11} \cdot \text{N}(\text{CH}_3)_3]$, obtained as described in Example I, is dissolved in water and the solution is passed through a column packed with a chloride-ion exchange resin ("Amberlite" IRA-400, chloride form). The effluent is evaporated to obtain bis(trimethylamine)dihydroboron(1+) chloride, i.e.,



The compound is most conveniently obtained as a hydrate. The identity of the compound is confirmed by its nuclear magnetic resonance spectrum. In aqueous solution, the nuclear B^{11} magnetic resonance spectrum of the compound consists of a symmetrical 1:2:1 triplet, $\delta=14.8$ p.p.m., from $\text{B}(\text{OCH}_3)_3$, and the $J_{\text{B}-\text{H}}$ value is 119 c.p.s.

The compound is a white crystalline solid which is most conveniently isolated from aqueous solution with water of hydration, i.e., as $[\text{H}_2\text{B} \cdot 2\text{N}(\text{CH}_3)_3]\text{Cl} \cdot x\text{H}_2\text{O}$, where the value of x is determined by the degree to which the compound is dried. Prolonged drying at very low pressures yields a substantially anhydrous product. The value of x can, therefore, be zero and generally does not exceed 8. The hydrate free product is represented by the formula $[\text{H}_2\text{B} \cdot 2\text{N}(\text{CH}_3)_3]\text{Cl}$.

As stated earlier, the cations may be prepared by employing as one reactant a salt having the cation

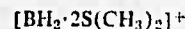

The preparation of a representative salt of this cation is described in Example B.

Example B

A 3-necked glass reaction vessel (capacity 1000 ml.) is equipped with a reflux condenser. The vessel is cooled to about -78° C. with solid carbon dioxide and it is charged with 120 ml. of $(\text{CH}_3)_2\text{S}$. Pressure in the vessel is reduced to a low value and 25 g. of B_2H_6 is introduced into the vessel and absorbed by the $(\text{CH}_3)_2\text{S}$ to form the adduct $\text{BH}_3 \cdot \text{S}(\text{CH}_3)_2$. After warming this adduct to room temperature, 42 g. of $\text{B}_{10}\text{H}_{11}$ is added and the solution is heated to refluxing temperature and stirred for 2–4 hours. About 28 liters of gas is released during this step. The reaction mixture is cooled to 50–60° C. and the pressure in the vessel is reduced to a low value to remove all volatile material. The residue contains



and it can be employed directly as a reactant in subsequent operations.

25

Example XXI

A. A solution is prepared consisting of about 20 ml. of dichloromethane and 2.1 g. of the solid obtained in Example B which contains

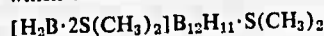

The solution is stirred and 5 ml. of

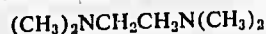

is added to it. The solution is evaporated to dryness, a further quantity of dichloromethane is added with stirring, and the mixture is again evaporated to dryness. Water is added to the residue and the mixture is boiled to remove residual dichloromethane. The hot solution is filtered to separate insoluble material and the filtrate is cooled. A white crystalline solid forms which is separated. The compound is recrystallized from water to obtain 0.40 g. of

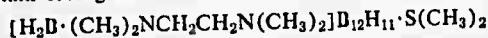

The above process is repeated employing 28 g. of crude $[\text{H}_2\text{B} \cdot 2\text{S}(\text{CH}_3)_2] \text{B}_{12}\text{H}_{11} \cdot \text{S}(\text{CH}_3)_2$, 50 ml. of dichloromethane and 10 ml. of $(\text{CH}_3)_2\text{NCH}_2\text{CH}_2\text{N}(\text{CH}_3)_2$. There is obtained 10 g. of the white crystalline product, described above. The identity of the compound is further confirmed by elemental analysis and by infrared spectroscopy.

Analysis.—Calc'd for



C, 28.93; H, 10.60; N, 8.44; B, 42.35; S, 9.65. Found: C, 29.3; H, 10.5; N, 9.24, 8.57; B, 42.1; S, 9.86.

B. A small quantity (0.8 g.) of the product of Part A is dissolved in water and the solution is passed through a column filled with a commercial chloride-ion exchange resin ("Amberlite" IRA-400). The aqueous effluent is evaporated to dryness to obtain



as a white hygroscopic solid. The infrared spectrum of the compound shows bands at the following wavelengths (expressed as cm^{-1}): 2500, strong, sharp; 2450, medium, sharp; 1420, weak, sharp; 1290, medium, sharp; 1265, very weak, sharp; 1260, medium, sharp; 1240, weak, sharp; 1210, medium, sharp; 1160, strong, sharp; 1140, strong, sharp; 1130, strong, sharp; 1035, strong, sharp; 995, weak, sharp; 970, strong, sharp; 930, weak, broad; 865, strong, sharp; 795, strong, sharp; 725, weak, broad; and 700, weak, broad.

The nuclear magnetic resonance of the above chloride salt, measured in aqueous solution, yields the following data: $J_{\text{B-H}}$, 111 c.p.s. (a symmetrical triplet 1:2:1); shift from $\text{B}(\text{OCH}_3)_3$, +12.0 p.p.m.

C. The chloride salt obtained as described in Part B is dissolved in water and an aqueous solution of NH_4PF_6 is added with stirring. The solid which forms is separated and recrystallized to obtain 0.5 g. of



The identity of the compound is confirmed by elemental analysis.

Analysis.—Calc'd for above PF_6 salt: C, 26.30; H, 6.61; N, 10.22; B, 3.95; P, 11.30; F, 41.60. Found: C, 26.84; H, 6.65; N, 10.08; B, 4.35; P, 10.2; F, 41.84.

Example XXII

A. A mixture of 38 ml. of $(\text{CH}_3)_2\text{S}$, 9 g. of B_2H_6 and 7.1 g. of $\text{B}_{10}\text{H}_{14}$ is reacted as described in Example B to obtain a product containing



The product so obtained is dissolved in about 75 ml. of dichloromethane and 10 ml. of

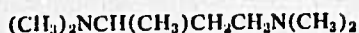

is added with stirring. The temperature of the mixture, which is 19°C ., rises to 32°C . during this step. The mixture is stirred one hour and it is processed as described in Example XXI. There is obtained 3.1 g. of white crystalline solid which is $1, \text{N}, \text{N}, \text{N}, \text{N}'$ -pentamethyltrimethylenediaminedihydroboron(1+) dimethyl sulfide undecahydrododecaborate(1-). The product is purified by recrystallization from water. Its identity is confirmed by elemental analysis and its infrared absorption spectrum.

Analysis.—Calc'd for



C, 33.35; H, 10.92; N, 7.78; B, 39.06; S, 8.96. Found: C, 33.36, 33.06; H, 10.55, 10.70; N, 7.17, 7.58; B, 39.67; S, 9.07.

The infrared spectrum of the compound shows bands at the following wavelengths (expressed as cm^{-1}): 2400, strong, sharp; 2380 (shoulder); 1480, 1420, 1410, very weak, sharp; 1320, 1290, 1260 very weak, sharp; 1225, medium, sharp; 1190, strong, sharp; 1150, medium, sharp; 1115, 1095, weak, sharp; 1040, strong, broad; 1000, medium, sharp; 965, strong with shoulders; 945, weak, sharp; 910, medium, sharp; 870, medium, sharp; 825, strong, sharp; 795, weak, sharp; and 720, medium, broad.

B. A portion (1.5 g.) of the compound of Part A is dissolved in water and the solution is passed through a column filled with a commercial chloride-ion exchange resin. The aqueous effluent is evaporated to obtain a concentrated solution of



C. A portion of the solution obtained in Part B is mixed with an aqueous solution of NH_4PF_6 . An oily insoluble product forms which is separated by a decantation. The oily product is a compound of the formula

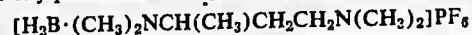

D. A portion of the solution obtained in Part B is mixed with an aqueous solution of chloroauric acid. A yellow solid forms which is separated, washed and dried to obtain the chloroaurate salt of the novel cation.

Analysis.—Calc'd for

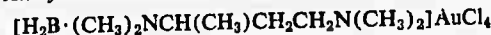

C, 19.37; H, 4.47; N, 5.65; B, 2.18; Cl, 28.59. Found: C, 18.95; H, 4.76; N, 5.82; 5.93; B, 2.29; Cl, 27.82; 27.91.

E. A portion of the solution obtained in Part B is mixed with an aqueous solution of H_2HgCl_4 (obtained from HCl and HgCl_2). A precipitate forms which is separated, washed and dried to obtain

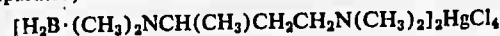

as a white crystalline compound.

F. A portion of the solution obtained in Part B is mixed with a small quantity of monosodium 1,1,3,3-tetracyanopropenide. The product separates as pale yellow needles which become discolored in the presence of daylight. The needles are removed by filtration and they are recrystallized to obtain $1, \text{N}, \text{N}, \text{N}, \text{N}'$ -pentamethyl-trimethylenediamine - dihydroboron(1+) 1,1,3,3-tetracyanopropenide(1-). The identity of the compound is confirmed by elemental analysis and by its infrared spectrum.

Analysis.—Calc'd for



C, 60.41; H, 7.77; N, 28.18; B, 3.63. Found: C, 60.85; H, 8.45; N, 28.45; 27.97; B, 3.82.

The infrared spectrum of the compound shows bands at the following wavelengths (expressed as cm^{-1}): 2450, medium, sharp; 2350, weak, sharp; 2190, strong, sharp;

75 1550, strong, sharp; 1400, weak, sharp; 1370, medium,

sharp; 1330, strong, sharp; 1280, 1260, weak, sharp; 1230, medium, sharp; 1190, strong, sharp; 1150, medium, sharp; 1110, weak, sharp; 1100, weak, sharp; 1050, medium, sharp; 1000, medium, sharp; 985, 965, 950, 920, weak, sharp; 910, 870, medium sharp; 830, medium, broad; 810, weak, broad; 800, weak, sharp; 770, 720, weak, broad.

Example XXIII

A. A mixture of 8 g. of $B_{10}H_{14}$ and the adduct $BH_3 \cdot S(CH_3)_2$

from 50 ml. of $(CH_3)_2S$ and B_2H_6 , is processed as described in Example B to obtain a product containing $[H_2B \cdot 2S(CH_3)_2]B_{12}H_{11} \cdot S(CH_3)_2$. The quantity of product so obtained is dissolved in 100 ml. of dichloromethane and 10 ml. of N,N' -dimethylpiperazine is added to the solution. The temperature of the solution, which is $26^\circ C.$, rises to $35^\circ C.$ The mixture is stirred 0.5 hour and a fine white solid precipitates. The product is separated to obtain 9.3 g. of N,N' -dimethylpiperazinedihydroboron (1+) dimethyl sulfide-undecahydrodecaborate (-). Further processing of the filtrate yields an additional 3.8 g. of the compound. The compound is further purified by recrystallization from aqueous solution.

Analysis.—Calc'd for

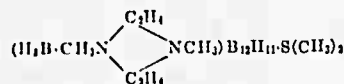

C, 29.11; H, 10.11; N, 8.49; B, 42.61; S, 9.71. Found: C, 29.5; H, 10.2; N, 8.09, 8.39; B, 42.3; S, 9.78.

The infrared spectrum of the compound shows bands at the following wavelengths (expressed as cm^{-1}): 2500, strong, sharp; 2400 (shoulder); 1480, very weak, sharp; 1420, medium, sharp; 1370, medium, sharp; 1330, weak, sharp; 1290, weak, sharp; 1220, medium, sharp; 1190, very weak, sharp; 1170, medium, sharp; 1140, medium, sharp; 1120 (shoulder); 1110, strong, sharp; 1070, weak, sharp; 1045, medium, sharp; 1020, weak, sharp; 1000, weak, sharp; 965, medium, sharp; 930, 915, very weak, sharp; 890, medium, sharp; 830, medium, broad; 770, weak, broad; 720, medium, broad.

B. The compound (5.2 g.) of Part A is dissolved in water and the aqueous solution is passed through a column filled with a commercial chloride-ion exchange resin. The effluent is an aqueous solution of

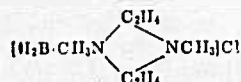

C. The effluent of Part B is evaporated to a small volume and an aqueous solution of NH_4PF_6 is added with stirring. The precipitate which forms is separated and recrystallized to obtain 1.8 g. of N,N' -dimethylpiperazinedihydroboron (1+) hexafluorophosphate. The identity of the compound is confirmed by elemental analysis and its infrared spectrum.

Analysis.—Calc'd for

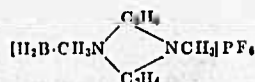

C, 26.49; H, 5.93; N, 10.30; P, 11.39. Found (average): C, 27.1; H, 6.69; N, 9.98; P, 11.1.

The infrared spectrum of the compound shows absorption bands at the following wavelengths (expressed as cm^{-1}): 2500, medium, sharp; 2400, weak, sharp; 2340, weak, sharp; 1300, weak, sharp; 1240, weak, sharp; 1220, medium, sharp; 1180, medium, sharp; 1150, weak, sharp; 1120, strong, sharp; 1020, medium, sharp; 965, weak, sharp; and 850, strong, very broad.

Examples XXI-XXIII illustrate the cation-containing compounds as prepared from boron-sulfur reagents. The examples which follow illustrate substitution prod-

ucts of the cationic boron-containing and the exceptional resistance to degradation of the compounds in vigorous chemical reactions.

Example XXIV

A reaction vessel is charged with an aqueous solution containing 2 g. of the hydrate of $[H_2B \cdot 2N(CH_3)_3]Cl$, and fluorine gas, diluted with about 5-10 nitrogen, is bubbled into the mixture at prevailing atmospheric temperature (about $25^\circ C.$). The vessel is cooled during this operation to maintain the temperature at $20-25^\circ C.$ Passage of gas is continued until a PF_6 -salt prepared from an aliquot portion of the reaction mixture shows substantial absence of the B-H bond in the infrared absorption spectrum. At this point passage of fluorine gas is discontinued and an aqueous solution of NH_4PF_6 is added with stirring to the reaction mixture. The white precipitate which forms is separated by filtration and it is recrystallized twice from water to obtain 0.49 g. of a white salt which consists of $[ClBF \cdot 2N(CH_3)_3]PF_6$ and $[F_2B \cdot 2N(CH_3)_3]PF_6$. An aqueous solution of this salt is passed through a column packed with a chloride anion exchange resin (described in Example XX) and the effluent is evaporated to yield 0.3-0.4 g. of a white solid which is a mixture of $[ClBF \cdot 2N(CH_3)_3]Cl$ and $[F_2B \cdot 2N(CH_3)_3]Cl$.

The infrared absorption spectrum shows only a trace of bands attributable to absorption by B-H bonds and the nuclear F^{19} magnetic resonance spectrum in aqueous solution shows two sets of symmetrical quadruplets, one centered at $\delta=95.0$ p.p.m. from tetrachloro-1,2-difluoroethane with a J_{B-F} value of 133-150 c.p.s., the second at $\delta=106$ p.p.m. from tetrachloro-1,2-difluoroethane with a J_{B-F} value of 45 c.p.s.

Example XXV

A reaction vessel is charged with an aqueous solution containing 1.5 g. of hydrated $[H_2B \cdot 2N(CH_3)_3]Cl$. Fluorine gas, diluted with 5-15% nitrogen, is bubbled into the aqueous solution until it is present in excess. An aqueous solution of NH_4PF_6 is then added to the mixture with stirring until precipitation of a white solid is complete. The precipitate is separated by filtration to yield 0.7 g. of a product which is principally $[FCIB \cdot 2N(CH_3)_3]PF_6$. The product contains about 10% of $[F_2B \cdot 2N(CH_3)_3]PF_6$. It is recrystallized from water to obtain 0.5 g. of white needles. The filtrate is retained for use in the next example.

Analysis.—calc'd for 90% $[FCIB \cdot 2N(CH_3)_3]PF_6$ -10% $[F_2B \cdot 2N(CH_3)_3]PF_6$: Cl, 9.76; P, 9.48; C, 22.05; H, 5.55; B, 3.31; F, 41.27. Found: Cl, 9.40; P, 9.5; C, 22.8; H, 5.6; B, 3.0; F, 41.43.

The compound is soluble in polar organic solvents, e.g., acetonitrile.

Example XXVI

The mother liquor from the second recrystallization of the compound of Example XXV is passed through a column packed with a chloride anion exchange resin of the type described in Example XX. The effluent is evaporated to yield 0.05 g. of a compound which is principally $[FCIB \cdot 2N(CH_3)_3]Cl$ containing about 10% of

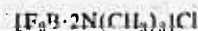

The product is a white crystalline solid. The nuclear magnetic proton resonance spectrum is a singlet, $\delta=2.0$ p.p.m. from water.

The infrared absorption spectrum shows the following band in a Nujol mull (expressed as cm^{-1}) and exclusive of bands coincidental with Nujol): 1480, strong, sharp; 1400, weak, sharp; 1330-1310, multiplet, medium, broad; 1180, 1140, medium, sharp; 1120, very weak, sharp; 1080, 1050, weak, sharp; 1020, medium, sharp; 970-950, doublet, medium, sharp; 870-830, with shoulders, strong, broad; 740-720, doublet, very weak, broad.

Example XXVII

A reaction vessel is charged with about 20 ml. of water and 1 g. of the hydrate of $[\text{H}_2\text{B}\cdot 2\text{N}(\text{CH}_3)_3]\text{Cl}$. The mixture is heated to boiling and chlorine gas is passed through it for 15 minutes at the boiling temperature. The solution contains $[\text{HCIB}\cdot 2\text{N}(\text{CH}_3)_3]\text{Cl}$. The solution is cooled and added with stirring to an aqueous solution of HAuCl_4 . An orange precipitate forms which is separated by filtration. The product is



and it is further purified by recrystallization from water. The identity of the compound is confirmed by elemental analysis.

Analysis.—Calc'd for $[\text{HCIB}\cdot 2\text{N}(\text{CH}_3)_3]\text{AuCl}_4$: B, 2.14; C, 14.29; H, 3.80; N, 5.55; M.W., 504. Found: B, 2.58; C, 15.59; H, 4.49; N, 5.62; M.W., 503, 523.

The compound is soluble in halogenated hydrocarbons, e.g., methylene dichloride and ethylene dichloride.

Example XXVIII

A reaction vessel, fitted with a reflux condenser, is charged with 10–25 ml. of concentrated nitric acid and 1 g. of the hydrate of $[\text{H}_2\text{B}\cdot 2\text{N}(\text{CH}_3)_3]\text{Cl}$, prepared as described in Example XX. The mixture is boiled until evolution of brown vapors subsides; 2–5 ml. of aqueous 5 M hydrochloric acid solution is added and the solution is boiled again for a few minutes. The solution is cooled and it is made slightly basic by addition of aqueous 30% sodium hydroxide. It is heated to boiling to expel a trace of trimethylamine and then made slightly acidic by addition of hydrochloric acid. An aqueous solution containing 3 g. of NH_4PF_6 is added with stirring and the white precipitate which forms is crystallized by heating the mixture. The precipitate is separated by filtration and purified by recrystallization from water to give 1.15 g. of $[\text{HCIB}\cdot 2\text{N}(\text{CH}_3)_3]\text{PF}_6$. The identity of the compound is confirmed by elemental analysis and by its infrared absorption spectrum.

Analysis.—Calc'd for $[\text{HCIB}\cdot 2\text{N}(\text{CH}_3)_3]\text{PF}_6$: B, 3.48; C, 23.21; H, 6.17; N, 9.02; F, 36.72; P, 9.98; Cl, 11.42. Found: B, 3.0; C, 23.5; H, 6.4; N, 9.01, 9.00; F, 36.2; P, 9.9; Cl, 10.7.

The infrared absorption spectrum of the compound in a Nujol mull shows the following bands (expressed as cm^{-1} and exclusive of bands which are coincidental with Nujol): 2500, weak, sharp; 1500, 1480, shoulders, medium, sharp; 1400, medium, sharp; 1300, very weak, sharp; 1240–1220, doublet, medium, sharp; 1170, 1140, 1120, 1100, medium, sharp; 1060, strong, sharp; 975–960, doublet, strong, sharp; 880, weak, sharp; 850–830, strong, broad; 780, 760, very weak, broad; 730, weak, broad.

The compound is soluble in acetonitrile.

Example XXIX

A portion of the compound $[\text{HCIB}\cdot 2\text{N}(\text{CH}_3)_3]\text{PF}_6$, obtained as described in Example XXVIII is dissolved in water and the solution is passed through a column packed with a chloride anion exchange resin of the type described in Example XX. The effluent is evaporated to yield 0.63 g. of $[\text{HCIB}\cdot 2\text{N}(\text{CH}_3)_3]\text{Cl}$, a white crystalline solid.

In aqueous solution the nuclear B^{11} magnetic resonance spectrum of the compound consists of a symmetrical doublet, a $J_{\text{B-H}}$ value of 134 c.p.s., $\delta=17.3$ p.p.m. from trimethyl borate. The compound is soluble in a number of polar organic solvents, e.g., acetonitrile.

Example XXX

A reaction vessel is charged with 15 ml. of iodine monochloride and 3 g. of $[\text{H}_2\text{B}\cdot 2\text{N}(\text{CH}_3)_3]\text{Cl}$ is added in small portions with stirring. The initial reaction is exothermic and after it subsides, the mixture is heated to 85° C. for one hour. The mixture is cooled and it is extracted with carbon disulfide to remove iodine and

unreacted iodine monochloride. The solid which remains is dissolved in water and a solution of NH_4PF_6 is added with stirring. A crystalline solid precipitates which is separated by filtration and recrystallized twice from hot water. The compound which is obtained is bis(trimethylamine)dichloroboron (1+) hexafluorophosphate. Its identity is confirmed by elemental analysis and the infrared absorption spectrum.

Analysis.—Calc'd for $[\text{BCl}_2\cdot 2\text{N}(\text{CH}_3)_3]\text{PF}_6$: P, 8.99; Cl, 20.5; H, 5.37. Found: P, 9.06; Cl, 20.79; H, 5.48.

The infrared absorption spectrum of a Nujol mull of the compound shows the following bands (expressed as microns and exclusive of bands due to Nujol): 6.7, 7.2; 8.25, 8.95, 9.5, 10.35, 10.55, 10.72, 11.4, 11.95, 13.00, and about 13.7.

Example XXXI

A reaction vessel is charged with 0.425 g. of the hydrate of $[\text{H}_2\text{B}\cdot 2\text{N}(\text{CH}_3)_3]\text{Cl}$, a small quantity of water and liquid bromine. The mixture is boiled until it is colorless. A further quantity of liquid bromine is added and a brown oily precipitate forms. The mixture is boiled until the oily precipitate is gone and it is then cooled to prevailing atmospheric temperature. About one-half of it is passed through a column packed with a chloride anion exchange resin ("Amberlite" IRA-400, chloride form). The effluent is evaporated to leave about 0.1 g. of a white crystalline compound which is $[\text{HBrB}\cdot 2\text{N}(\text{CH}_3)_3]\text{Cl}$. The nuclear B^{11} magnetic resonance spectrum of this compound consists of a symmetrical doublet and the $J_{\text{B-H}}$ value is 134 c.p.s., $\delta=+12.2$ p.p.m. from trimethyl borate.

Example XXXII

The compound of Example XXXI, i.e., bis(trimethylamine)monohydromonobromoboron(1+) chloride, is dissolved in water and an aqueous solution of HAuCl_4 is added with stirring. A yellow solid precipitates which is separated by filtration. The product, which is $[\text{HBrB}\cdot 2\text{N}(\text{CH}_3)_3]\text{AuCl}_4$, is purified by recrystallization from water. The identity of the compound is confirmed by elemental analysis and by its infrared absorption spectrum.

Analysis.—Calc'd for $[\text{HBrB}\cdot 2\text{N}(\text{CH}_3)_3]\text{AuCl}_4$: B, 1.97; C, 13.13; H, 3.49; N, 5.10. Found: B, 2.06; C, 13.72; H, 3.80; N, 5.24, 5.14.

The infrared absorption spectrum of the compound in a Nujol mull shows the following bands (expressed as cm^{-1} and exclusive of bands which coincide with bands due to Nujol): 2500, medium, sharp; 1480–1430, shoulders; 1400, weak, sharp; 1230, shoulders, medium, sharp; 1160, medium, sharp; 1040, strong, broad; 970, 955, doublet, strong, sharp; 835, strong, broad; and 750, 730, 710, weak, broad.

The compound dissolves readily in methylene dichloride and ethylene dichloride.

Example XXXIII

A. A reaction vessel is charged with approximately 1 g. of the hydrate of $[\text{H}_2\text{B}\cdot 2\text{N}(\text{CH}_3)_3]\text{Cl}$ and about 1–2 ml. of bromine. The mixture is refluxed until it is colorless and a clear solution is obtained. The solution is passed through a column packed with a chloride anion exchange resin as described in Example XX. The effluent, which is acidic, is neutralized with aqueous sodium hydroxide. The neutral solution is partially evaporated and an aqueous solution of NH_4PF_6 is added with stirring. The white precipitate which forms is separated by filtration to obtain 1.87 g. of $[\text{HBrB}\cdot 2\text{N}(\text{CH}_3)_3]\text{PF}_6$. The compound is recrystallized from water and its identity is confirmed by elemental analysis, nuclear magnetic resonance and infrared absorption spectra.

Analysis.—Calc'd for $[\text{HBrB}\cdot 2\text{N}(\text{CH}_3)_3]\text{PF}_6$: C, 20.30; B, 3.04; N, 7.89; Br, 22.52; F, 8.73; P, 32.12; H, 5.40. Found: C, 20.51; B, 2.63; N, 7.83, 8.00; Br, 22.69; P, 8.79; F, 32.00; H, 5.83.

The infrared absorption spectrum of the compound in a Nujol mull shows the following bands (expressed as cm^{-1} and exclusive of bands coincident with the Nujol spectrum): 2500, weak, sharp; 1480, medium, sharp; 1400, medium, sharp; 1290, very weak; 1260, very weak; 1230-1220, doublet, strong, sharp; 1160, strong, sharp; 1130, medium, sharp; 1120, medium, sharp; 1090, medium, sharp; 1030, strong, sharp; 960-950, doublet, strong, sharp; 875, medium, sharp; 850-830, very strong, broad; 775, 755, 740, 725, 710, and 680, weak, sharp.

The compound dissolves readily in acetonitrile.

B. A reaction vessel, equipped with a reflux condenser, is charged with 40 ml. of liquid bromine and 2 g. of $[\text{H}_2\text{B}\cdot 2\text{N}(\text{CH}_3)_3]\text{Cl}$ is added in small portions with stirring. After the initial reaction, which is exothermic, subsides the mixture is heated to reflux temperature for one hour. The mixture is cooled and maintained under reduced pressure until unreacted bromine is removed. The residue is dissolved in water and an aqueous solution of NH_4PF_6 is added with stirring. A crystalline solid precipitates which is separated by filtration to yield about 4.4 g. of $[\text{HBrB}\cdot 2\text{N}(\text{CH}_3)_3]\text{PF}_6$. The infrared absorption spectrum is identical with the spectrum of the compound obtained in Part A.

Example XXXIV

A. A reaction vessel is charged with about 4 ml. of peroxydisulfuryl difluoride, i.e. $\text{S}_2\text{O}_8\text{F}_2$ [see Wannegat and Minnesken, Z. anorg. u. allgem. Chem. 278, 310-25 (1955)], and about 0.5 g. of $[\text{H}_2\text{B}\cdot 2\text{N}(\text{CH}_3)_3]\text{PF}_6$, prepared as described in Example XI-C by using

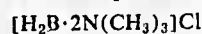

is added in small portions with stirring. An exothermic reaction sets in and brown fumes are released; with addition of a larger portion of the boron reactant, a vigorous puffing reaction develops and charring occurs with loss of a substantial quantity of the reaction mixture. The portion which remains is collected and agitated with water. A white, insoluble product is separated by filtration and it is crystallized from hot water to obtain about 0.14 g. of

bis(fluorosulfato)bis(trimethylamine)boron(1+) hexafluorophosphate

in the form of transparent prisms. The identity is confirmed by elemental analysis.

Analysis.—Calculated for $[(\text{FSO}_3)_2\text{B}\cdot 2\text{N}(\text{CH}_3)_3]\text{PF}_6$: C, 15.2; H, 3.84; N, 5.94; S, 13.62. Found: C, 15.48; H, 3.97; N, 5.10, 5.28; S, 14.25, 13.00.

B. A reaction vessel is charged with about 20 ml. of hexafluoropropene dimer, i.e., perfluorodimethylcyclobutane, containing 2-4 ml. of $\text{S}_2\text{O}_8\text{F}_2$. About 1 g. of $[\text{H}_2\text{B}\cdot 2\text{N}(\text{CH}_3)_3]\text{PF}_6$, prepared as described in Example XI-C by using $[\text{H}_2\text{B}\cdot 2\text{N}(\text{CH}_3)_3]\text{Cl}$ instead of



is added to the solution and the resulting slurry is stirred for about 3 hours at prevailing atmospheric temperature (about 25° C.). The mixture becomes dark and a gummy solid forms which, with continued stirring, becomes granular. At the end of 3 hours, water is added to the mixture with stirring and the dark solid which is present is separated by filtration. An aqueous solution of ammonium hexafluorophosphate is added to the filtrate with stirring and the white precipitate which forms is separated by filtration to yield 0.45 g. of the compound of Part A, i.e., $[(\text{FSO}_3)_2\text{B}\cdot 2\text{N}(\text{CH}_3)_3]\text{PF}_6$. The product is further purified by recrystallization from hot water containing a small quantity of ammonium acid difluoride (NH_4HF_2) to obtain 0.175 g. of the compound as transparent crystals. The analyses are as follows: C, 15.67; H, 4.00; N, 5.86, 5.77; S, 13.64, 13.71; P, 6.66, 6.07; F, 31.65. These values compare favorably with the calculated values given in Part A.

The dark solid, isolated previously in the filtration step,

is dissolved in hot water containing NH_4HF_2 . The solution is cooled and crystals form which are separated to yield 0.40 g. of $[(\text{FSO}_3)_2\text{B}\cdot 2\text{N}(\text{CH}_3)_3]\text{PF}_6$. The infrared absorption spectrum of the compounds isolated in Part A and in this part, taken in a Nujol mull, shows the following bands (exclusive of the bands coincident with Nujol and expressed as cm^{-1}): 1480, medium, sharp; 1440, strong, sharp; 1240, strong, sharp; 1215, medium, sharp; 1120, very weak, sharp; 1080, strong, broad; 1040, strong, broad; 960, medium, broad; 940, very weak, sharp; 895, medium, sharp; 840, strong, broad; 820, medium, sharp; and 740, 720, weak, broad.

The compound, when burned, shows the green color characteristic for boron. It possesses excellent resistance to hydrolysis. It is sparingly soluble in polar organic solvents, e.g., acetonitrile, but dissolves readily in aqueous solutions of polar organic liquids.

Passage of an alcoholic solution of

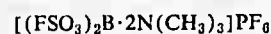

through a column charged with a chloride ion exchange resin, as described in Example XX, yields an alcohol solution of $[(\text{FSO}_3)_2\text{B}\cdot 2\text{N}(\text{CH}_3)_3]\text{Cl}$. Evaporation of the solution to dryness yields the chloride in solid form.

Example XXXV

Liquid bromine (excess) is added to a small portion of the effluent obtained as described in Example XXIII, Part B. The effluent contains

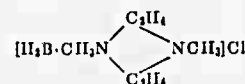

The mixture is boiled to remove excess bromine. The solution at this point contains

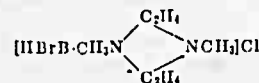

An aqueous solution of NH_4PF_6 is added to the solution and the solid which forms is separated, washed and dried. The product is N,N'-dimethylpiperazine-monobromo-monohydroboron(1+) hexafluorophosphate.

Analysis.—Calc'd for

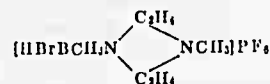

Br, 22.77; C, 20.53; H, 4.31; P, 8.83. Found: Br, 22.11; C, 21.20, 21.46; H, 4.71, 4.69; P, 8.75, 8.75.

The infrared spectrum of the compound shows bands at the following wavelengths (expressed as cm^{-1}): 2550, weak, sharp; 1340, weak, sharp; 1300, medium, sharp; 1230, medium, sharp; 1180, medium, sharp; 1160, weak, sharp; 1100, strong, sharp; 1000, weak, sharp; 940, weak, sharp; 850, very strong, broad; 735, weak, sharp; 710, medium, sharp.

Example XXXVI

A 20-ml. sample of 0.8 M $\text{H}_2\text{B}[\text{N}(\text{CH}_3)_3]_2^+\text{OH}^-$ was neutralized with aqueous hydrogen fluoride in a polyethylene beaker cooled to 0°. A 1:1 mixture of fluorine and nitrogen was passed into the solution (ca. 3 l./hr.). Aliquots were removed at intervals, treated with aqueous NH_4PF_6 , and the infrared spectrum of the salt was checked. Fluorination was continued for a total of 98 min., at which time the B—H absorption in the infrared spectrum had disappeared. The solution was neutralized and treated with aqueous NH_4PF_6 . The precipitate was recrystallized from hot water to give 2.0 g. (37%) of $\text{F}_2\text{B}[\text{N}(\text{CH}_3)_3]_2^+\text{PF}_6^-$ as white needles, M.P. 174-176°.

Analysis.—Calculated for $\text{F}_2\text{B}[\text{N}(\text{CH}_3)_3]_2^+\text{PF}_6^-$: C, 23.1; H, 5.8; N, 9.0; P, 9.9; F, 48.7. Found: C, 23.5; H, 6.4; N, 9.0; P, 9.8; F, 47.7.

The F^{19} n.m.r. spectrum of the product in acetonitrile

consisted of a quadruplet due to the cation ($\delta_{BP}=37$ c.p.s.) and a doublet due to PF_6^- .

Example XXXVII

A 10-ml. portion of 0.8 M aqueous



was neutralized with aqueous hydrogen fluoride and the solution was fluorinated as described in the preceding example. Fluorination was continued for 40 min., at which time the infrared spectra of aliquots had reached a transition point and remained constant for 10 minutes. Changes in the infrared were the collapse of the B—H doublet to a weak singlet (with shoulder), complete disappearance of the 1000 cm^{-1} band, and the appearance of a more or less symmetrical triplet centered at 1180 cm^{-1} . The reaction solution was then neutralized with 20% NaOH and filtered, and the filtrate was treated with concentrated aqueous NH_4PF_6 . The precipitate was recrystallized from hot water to yield



as white crystals, M.P. 159–160°.

Analysis.—Calc'd for $HFB[N(CH_3)_3]_2^+PF_6^-$: C, 24.5; H, 6.5; N, 9.5; F, 45.2; P, 10.5. Found: C, 24.3; H, 6.5; N, 9.3; F, 45.6; P, 10.1.

The F^{19} n.m.r. spectrum of the product showed it to contain some $F_2B \cdot 2N(CH_3)_2PF_6$ since a quartet due to $F_2B[N(CH_3)_3]_2^+$ was found. The F^{19} resonance of $HFB \cdot 2N(CH_3)_2^+$ was an unresolved multiplet centered at 117 p.p.m. in which both BF and HF splitting are to be expected.

All of the products containing the substituted cations described in Examples XXIV through XXXVII can be obtained as the chloride, if needed, by employing the chloride ion-exchange technique. The chlorides are converted to free bases by reaction with freshly washed Ag_2O . By using the processes described in these examples, compounds of the following formulas are obtained:

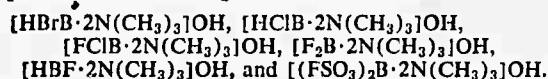

Bases of the type illustrated above can be neutralized with a wide variety of acids to provide compounds in which Z represents a wide range of anions of the type illustrated in previous paragraphs.

Many of the salts of the general formula



are water-soluble. They are readily obtained in solution by mixing an aqueous solution of a salt containing the appropriate cation Z, with an aqueous solution of $BH_{2-y}X'_y \cdot mCH_3NR^{IV}RVCl$, as illustrated below.

Reagent Mixed	Product Formed
$KClO_4$	$[HClB \cdot 2N(CH_3)_3]ClO_4$
$HCl + FeCl_3$	$[BF_2 \cdot 2N(CH_3)_3]FeCl_4$
$HCl + AlCl_3$	$[HBrB \cdot 2N(CH_3)_3]AlCl_4$
KNO_3	$[BCl_2 \cdot 2N(CH_3)_3]NO_3$
KIO_3	$[BBr_2 \cdot 2N(CH_3)_3]IO_3$
H_2PtCl_6	$[HClB \cdot 2N(CH_3)_3]PtCl_6$
$NaBiI_4$	$[HClB \cdot 2N(CH_3)_3]BiI_4$
NaI	$[BF_2 \cdot 2N(CH_3)_3]I$
KBr	$[BCl_2 \cdot 2N(CH_3)_3]Br$
$NaHCO_3$	$[BF_2 \cdot 2N(CH_3)_3]HCO_3$
Na_2CO_3	$[HClB \cdot 2N(CH_3)_3]CO_3$
$HCl + HgCl_2$	$[HClB \cdot 2N(CH_3)_3]HgCl_2$
Na_2BiO_6	$[HClB \cdot 2N(CH_3)_3]BiO_6$
Ammoniacal $NH_4Cr(SCN)_4$	$[BF_2 \cdot 2N(CH_3)_3][Cr(SCN)_4(NH_4)_4]$
$K_2Cr_2O_7$	$[HClB \cdot 2N(CH_3)_3]K_2Cr_2O_7$
H_2CrO_4	$[HClB \cdot 2N(CH_3)_3]H_2CrO_4$
Na_2PO_4	$[HClB \cdot 2N(CH_3)_3]PO_4$

The novel classes of compounds of this invention are generally useful as sequestering agents for metals, especially heavy metals. For example, the admixture of an aqueous solution of $H_2B[N(CH_3)_3]_2^+Cl$ results in the precipitation of $[HClB \cdot 2N(CH_3)_3]AuCl_4$, a solid which can be separated

by conventional means, e.g., filtration or decantation. In addition, a mixture of hydrocarbons in the boiling range of gasoline, which contains in solution a copper salt of an organic acid (copper stearate) can be thoroughly agitated with an aqueous ammoniacal solution of $NaB_{12}H_{11}N(C_2H_5)_3$. The hydrocarbon layer, which is separated from the aqueous reagent, is completely free of the deleterious copper salt.

Thus, copper, nickel, cobalt, zinc and cadmium are removed from aqueous solutions of salts containing these metals by mixing the solutions with an ammoniacal solution of an alkali metal or an alkaline earth metal salt of the $B_{12}H_{11}NRR'R''$ anion, e.g., the sodium, potassium, lithium, cesium, calcium or magnesium salts of the $B_{12}H_{11}N(C_2H_5)_3$ anion. The ammonium, tetraalkylammonium, trialkylsulfonium, tetraalkylphosphonium salts and, in general, the nitrogen-base salts, are also useful in the field of sequestering agents to remove undesirable metals from aqueous or hydrocarbon media.

The dodecahydrododecaborates(2-) can be used as sequestering agents for metals, as described in the preceding paragraphs.

The acids $HB_{12}H_{11-y}X'_y \cdot NRR'R''$ are useful for recovering by-product amines from waste solutions or waste gases. To illustrate, a by-product solution of N-methylcyclohexylamine is contacted with an aqueous solution of $HB_{12}H_{11}N(C_2H_5)_3$ and the amine is recovered as an insoluble salt of the anion. The acids in aqueous solution are useful in metal processing operations, e.g., in scale removal and as agents for etching metals.

The salts of the novel anion-containing compounds can be employed to prepare the corresponding acids which are useful as shown above.

The trialkylammonium salts, e.g.,



fluoresce under ultraviolet light. Salts possessing this property are useful as components of marking inks employed for identification purposes.

Salts of the general formula



can be converted to the free base by contacting aqueous solutions of the salt with a basic ion-exchange resin. The base is a strong base in aqueous solution and these solutions are useful in neutralizing acidic products or in scavenging such products from atmospheres which contain them.

All of the compounds of the invention in which the anion Z is a group other than —OH can be used as intermediates in the preparation of compounds of the formula $[BH_{2-y}X'_y \cdot mCH_3NR^{IV}RV]GH$ by processes described in the examples. The compounds of this formula are strong bases and in aqueous or alcohol solutions they are useful as agents for absorbing acidic gases. For example, an aqueous solution of $[F_2B \cdot 2N(CH_3)_3]OH$ absorbs CO_2 , HCl , HBr , H_2S , SO_2 , and the like, from volatile by-products of chemical reactions.

The novel cation-containing compounds are generically useful as impregnating agents for cellulosic compositions to aid combustion and to provide shaped residues useful in the preparation of resistors. To illustrate, a section of cellulose string is immersed in a methylene chloride solution of $[H_2B \cdot 2N(CH_3)_3]_2B_{12}H_{12}$ for a short period. The string is withdrawn from the solution and the solvent is removed by air-drying. A free flame is applied to the dried impregnated string and it burns easily. The residue from the impregnated string, after burning, has a size and shape similar to the original string and the residual skeleton is of sufficient coherence to permit embedding in paraffin. The section of residue, so treated, has a resistance of about 100 ohms/inch. The residue from a control section of string (untreated) is very small and it cannot be handled.

The new classes of compounds described in the invention, including products having the novel cations and the

novel anions, are useful as combustible components of compositions employed in fireworks displays to impart a pleasing color to the display.

The invention therefore provides a simple, economical method for obtaining valuable classes of compounds which find applications in many fields.

As many apparently widely different embodiments of this invention may be made without departing from the spirit and scope thereof, it is to be understood that this invention is not limited to the specific embodiments thereof except as defined in the appended claims.

The embodiments of the invention in which the exclusive property or privilege is claimed are defined as follows:

1. A compound of the formula

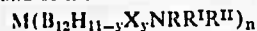

wherein

M is a cation of valence 1-4 inclusive;

X is halogen;

R and R^I are selected from the class consisting of (1) individually, aliphatically saturated hydrocarbon of 1 through 18 carbon atoms, and (2) joined together, a divalent group selected from the class consisting of alkylene of 4 through 6 carbon atoms, ethereal oxygen-interrupted alkylene of 4 through 6 carbon atoms, and loweralkylamino-interrupted alkylene of 4 through 6 carbon atoms, which forms a ring with the amino nitrogen of the NRR^IR^{II} moiety;

R^{II} is aliphatically saturated hydrocarbon of 1 through 18 carbon atoms which can contain up to one di-loweralkylamino substituent located on a carbon at least once removed from the carbon bonded to the amino nitrogen of the NRR^IR^{II} moiety; said R, R^I and R^{II} groups being bonded to the amino nitrogen of the NRR^IR^{II} moiety by a saturated aliphatic carbon;

y is a cardinal number of from 0 through 11; and

n is a positive whole number equal to the valence of M.

2. The compound of claim 1 wherein M is a metal.

3. The compound of claim 1 wherein M is hydrogen.

4. A compound of the formula

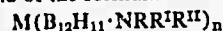

wherein

M is a cation of valence 1-4 inclusive;

R, R^I and R^{II} are each aliphatically saturated hydrocarbon of 1 through 18 carbon atoms bonded to the amino nitrogen of the NRR^IR^{II} moiety by a saturated aliphatic carbon; and

n is a positive whole number equal to the valence of M.

5. The compound of claim 4 wherein M is RR^IR^{II}NH, wherein R, R^I and R^{II} are defined as in claim 4.

6. The compound of claim 4 wherein M is hydrogen.

7. The compound of claim 4 wherein R, R^I and R^{II} are alkyl groups of 1 through 8 carbon atoms.

8. A compound of the formula

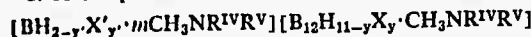

wherein

R^{IV} and R^V are selected from the class consisting of (1) individually, alkyl groups of 1 through 4 carbon atoms in which R^{IV} can contain a dimethylamino substituent located on a carbon at least once removed from the carbon bonded to the amino nitrogen of the CH₃NR^{IV}R^V moiety, and (2) joined together, a divalent group of the formula —CH₂CH₂QCH₂CH₂— wherein Q is of the class consisting of —CH₂— and —N(CH₃)₂—; R^{IV} and R^V being bonded to the amino nitrogen of the CH₃NR^{IV}R^V moiety by carbon bonded to at most one other carbon atom;

X is halogen;

X' is of the group consisting of halogen and fluorosulfato;

y is a cardinal number of 0 through 11;

y' is a cardinal number of 0 through 2; and

m is a positive whole number equal to 2 divided by the number of nitrogens in the CH₃NR^{IV}R^V moiety.

9. The compound of claim 8 wherein R^{IV} and R^V are alkyl of 1 through 4 carbon atoms bonded to the amino nitrogen of the CH₃NR^{IV}R^V moiety by a carbon bonded to at most one other carbon atom; y and y' are each 0; and m is 2.

10. A compound of the formula



wherein

R^{IV} and R^V are selected from the class consisting of (1) individually, alkyl groups of 1 through 4 carbon atoms in which R^{IV} can contain a dimethylamino substituent located on a carbon at least once removed from the carbon bonded to the amino nitrogen of the CH₃NR^{IV}R^V moiety, and (2) joined together, a divalent group of the formula —CH₂CH₂QCH₂CH₂— wherein Q is of the class consisting of —CH₂— and —N(CH₃)₂—; R^{IV} and R^V being bonded to the amino nitrogen of the CH₃NR^{IV}R^V moiety by a carbon bonded to at most one other carbon atom;

X' is selected from the group consisting of halogen and fluorosulfato;

y' is a cardinal number of 1 through 2;

m is a positive whole number equal to 2 divided by the number of nitrogens in the CH₃NR^{IV}R^V moiety;

Z is an anion; and

n' is a positive whole number equal to the valence of Z.

11. The compound of claim 10 wherein R^{IV} and R^V are methyl groups and m is 2.

12. (CH₃)₃NHB₁₂H₁₁N(CH₃)₃.

13. [BH₂·2N(CH₃)₃][B₁₂H₁₁N(CH₃)₃].

14. HB₁₂H₁₁N(CH₃)₃.

15. (C₂H₅)₃NHB₁₂H₁₁N(C₂H₅)₃.

16. [BCl₂·2N(CH₃)₃]Cl.

17. [BH₂·(CH₃)₂NCH₂CH₂N(CH₃)₂]₂B₁₂H₁₂.

18. Process for the formation of polyhydrododecaborates which comprises heating at a temperature in the range of 75° to 400° C. a member of the group consisting of diborane, pentaborane and decaborane with a tertiary amine-borane adduct of the formula



wherein

R and R^I are selected from the class consisting of (1) individually, aliphatically saturated hydrocarbon of 1 through 18 carbon atoms, and (2) joined together, a divalent group selected from the class consisting of alkylene of 4 through 6 carbon atoms, ethereal oxygen-interrupted alkylene of 4 through 6 carbon atoms, and loweralkylamino-interrupted alkylene of 4 through 6 carbon atoms, which forms a ring with the amino nitrogen of the NRR^IR^{II} moiety;

R^{II} is aliphatically saturated hydrocarbon of 1 through 18 carbon atoms which can contain up to one di-loweralkylamino substituent located on a carbon at least once removed from the carbon bonded to the amino nitrogen of the NRR^IR^{II} moiety;

said R, R^I and R^{II} groups being bonded to the amino nitrogen of the NRR^IR^{II} moiety by a saturated aliphatic carbon.

19. The process of claim 18 wherein the adduct is formed in situ by treating diborane with the tertiary amine RR^IR^{II}N, wherein R, R^I and R^{II} are defined as in claim 18, at a temperature in the range of -80° C. to 35° C.

20. Process for the formation of polyhydrododecaborates which comprises heating at a temperature in the range of 75° to 400° C. a member of the group consisting of diborane, pentaborane and decaborane with a tertiary amine-borane adduct of the formula



wherein R, R^I and R^{II} are alkyl groups of 1 through 8 carbon atoms.

21. The process of claim 20 wherein R, R^I and R^{II} are methyl groups.

22. Process for the formation of a compound of the formula

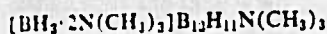

which comprises heating at a temperature in the range of 100° to 300° C. diborane with trimethylamine-borane adduct, and isolating the resulting product.

23. Process which comprises contacting a member of the class consisting of $(\text{BH}_2 \cdot m\text{CH}_2\text{NR}^{\text{IV}}\text{R}^{\text{V}})_2 \text{B}_{12}\text{H}_{12}$ and $(\text{BH}_2 \cdot m\text{CH}_2\text{NR}^{\text{IV}}\text{R}^{\text{V}})(\text{B}_{12}\text{H}_{11} \cdot \text{CH}_2\text{NR}^{\text{IV}}\text{R}^{\text{V}})$ wherein m is a positive whole number of from 1-2 whose value is equal to 2 divided by the total number of nitrogen atoms in the $\text{CH}_2\text{NR}^{\text{IV}}\text{R}^{\text{V}}$ group; and R^{IV} and R^V are selected from the class consisting of (1) individually, alkyl groups of 1 through 4 carbon atoms in which R^{IV} can contain a dimethylamino substituent located on a carbon at least once removed from the carbon bonded to the amino nitrogen of the $\text{CH}_2\text{NR}^{\text{IV}}\text{R}^{\text{V}}$ moiety, and (2) joined together, a divalent group of the formula



wherein Q is of the class consisting of $-\text{CH}_2-$ and $-\text{N}(\text{CH}_3)-$; R^{IV} and R^V being bonded to the amino nitrogen of the $\text{CH}_2\text{NR}^{\text{IV}}\text{R}^{\text{V}}$ moiety by a carbon bonded to at most one other carbon atom; with a strongly basic ion-exchange resin, and isolating the resulting



24. Process which comprises reacting a compound selected from the class consisting of

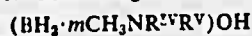

and $(\text{BH}_2 \cdot m\text{CH}_2\text{NR}^{\text{IV}}\text{R}^{\text{V}})\text{Cl}$ wherein m is a positive whole number of from 1-2 whose value is equal to 2 divided by the total number of nitrogen atoms in the $\text{CH}_2\text{NR}^{\text{IV}}\text{R}^{\text{V}}$ moiety; and R^{IV} and R^V are selected from the class consisting of (1) individually, alkyl groups of 1 through 4 carbon atoms in which R^{IV} can contain a dimethylamino substituent located on a carbon at least once removed from the carbon bonded to the amino nitrogen of the $\text{CH}_2\text{NR}^{\text{IV}}\text{R}^{\text{V}}$ moiety, and (2) joined together, a divalent group of the formula $-\text{CH}_2\text{CH}_2\text{QCH}_2\text{CH}_2-$ wherein Q is of the class consisting of $-\text{CH}_2-$ and $-\text{N}(\text{CH}_3)-$; R^{IV} and R^V being bonded to the amino nitrogen of the $\text{CH}_2\text{NR}^{\text{IV}}\text{R}^{\text{V}}$ moiety by a carbon bonded to at most one other carbon atom; with an acid containing a water-soluble anion, Z, whereupon methathesis occurs to produce a compound having the formulas

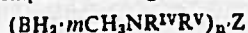

where n' is a positive whole number equal to the valence of Z.

25. Process which comprises reacting a compound selected from the class consisting of

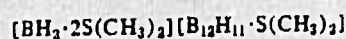

and



with a tertiary amine of the formula $\text{CH}_3\text{NR}^{\text{IV}}\text{R}^{\text{V}}$ wherein R^{IV} and R^V are selected from the class consisting of (1) individually, alkyl groups of 1 through 4 carbon atoms in which R^{IV} can contain a dimethylamino substituent located on a carbon at least once removed from the carbon bonded to the amino nitrogen of the $\text{CH}_3\text{NR}^{\text{IV}}\text{R}^{\text{V}}$ moiety, and (2) joined together, a divalent group of the formula $-\text{CH}_2\text{CH}_2\text{QCH}_2\text{CH}_2-$ wherein Q is of the class consisting of $-\text{CH}_2-$ and $-\text{N}(\text{CH}_3)-$; R^{IV} and R^V being bonded to the amino nitrogen of the $\text{CH}_3\text{NR}^{\text{IV}}\text{R}^{\text{V}}$ moiety by a carbon bonded to at most one other carbon atom, and isolating the resulting products.

26. Process which comprises reacting a compound of the formula



wherein m is a positive whole number of from 1-2 whose value is equal to 2 divided by the total number of nitrogen atoms in the $\text{CH}_2\text{NR}^{\text{IV}}\text{R}^{\text{V}}$ moiety; Z is an anion; n' is a positive whole number whose value is equal to the numerical value of the ionic charge on Z; and R^{IV} and R^V are selected from the class consisting of (1) individually, alkyl groups of 1 through 4 carbon atoms in which R^{IV} can contain a dimethylamino substituent located on a carbon at least once removed from the carbon bonded to the amino nitrogen of the $\text{CH}_2\text{NR}^{\text{IV}}\text{R}^{\text{V}}$ moiety, and (2) joined together, a divalent group of the formula



wherein Q is of the class consisting of $-\text{CH}_2-$ and $-\text{N}(\text{CH}_3)-$; R^{IV} and R^V being bonded to the amino nitrogen of the $\text{CH}_2\text{NR}^{\text{IV}}\text{R}^{\text{V}}$ moiety by a carbon bonded to at most one other carbon atom, with a reagent selected from the class consisting of halogen and peroxy-sulfonyl difluoride, and isolating the resulting product.

No references cited.

CHARLES H. PARKER, *Primary Examiner.*

CARL D. QUARFORTH, *Examiner.*

L. A. SEBASTIAN, R. L. RAYMOND,

Assistant Examiners.

1

3,296,260

NEUTRAL AND SINGLY CHARGED DERIVATIVES OF DECABORANS AND DECARBORATES

Walter H. Knoch, Jr., Menasha, Pa., assignor to E. I. du Pont de Nemours and Company, Wilmington, Del., a corporation of Delaware

No. Drawing. Filed Jan. 13, 1963, Ser. No. 251,697
21 Claims. (Cl. 260-247)

This application is a continuation-in-part of my co-pending application, Serial No. 123,082, filed June 30, 1961, now abandoned.

This invention relates to new boron compounds and to processes for their preparation. More particularly, it relates to new boron compounds having a plurality of boron and hydrogen atoms.

Boron compounds, particularly boron hydrides, have achieved technical importance in recent years in the field of high energy fuels. In other potential applications boron compounds, including boron hydrides, halides and alkyls, have been severely limited by hydrolytic, oxidative and other types of instability. To illustrate, diborane, chlorodiborane, pentaborane and trialkylboron compounds are spontaneously flammable in air. Diborane, pentaborane(9), chlorodiborane, boron trichloride, iododecaborane(14) and most other boron halides are rapidly hydrolyzed in water or alcohol. Other classes of boron compounds, e.g., the borazoles, are hydrolyzed by contact with water. Borazoles also have poor thermal stability and they show reducing properties in chemical reactions, e.g., borazoles reduce silver nitrate. Even the most stable known boron hydride, i.e., decaborane(14), is hydrolyzed at a moderate rate in water. Known ionic borohydrides, e.g., tetrahydroborates (NaBH₄ and the like), are similarly hydrolyzed at a rapid rate at 100° C.

This invention is directed to broad class of boron compounds which have stability characteristics that are unusual among boron compounds. The compounds of the invention generally show hydrolytic, oxidative and chemical stabilities normally associated with aromatic compounds.

Definition and description of new compounds

The novel boron compounds of this invention consist of ten conjoined boron atoms of which at least eight, and at most nine, of the boron atoms are bonded to hydrogen atoms or to groups capable of bonding to a nuclear carbon which is a member of a benzene ring; the compounds consisting further of at least one, and at most two, groups which are selected from organic sulfides, organic sulfones, tri-substituted phosphines, tertiary amines, carboxylic anides, and nitriles; any remaining component in said compound being a group which can form a cation in aqueous solution.

The polyboron compounds of the invention are represented by the following generic formula:

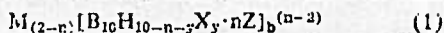

where M is a cation, i.e., an atom or group of atoms which, in aqueous solution, can form a positively charged ion having a valence of 1-3, inclusive; X is a group which can be bonded to a nuclear carbon of a carbocyclic aromatic compound by replacement of hydrogen; Z is an organic sulfide, an organic sulfone, a tertiary phosphine, a tertiary amine, an amide of a carboxylic acid or a nitrile; n is 1 or 2; (2-n) represents the number of M groups which are present in the compound; (n-2) represents the ionic charge, also called valence, of the group in brackets, i.e., the anion; y has a value of 0 to (10-n) and b has a value of at least 1 and is otherwise equal to the valence of M. The group X is further defined as derivable, directly or indirectly, from an electrophilic reagent. To facilitate

2

discussion, the group X will be referred to hereinafter as an "electrophilic group."

The group X is still further defined by considering the method by which the substituent is introduced into the boron compound. The different methods are as follows: (1) by electrophilic substitution, i.e., radicals which bond to a nuclear carbon of a carbocyclic aromatic ring by replacement of hydrogen; (2) by modification of an X group already attached to boron by synthetic methods commonly known to organic chemists for modification of radicals bonded to nuclear carbon of an aromatic or benzene ring; (3) by replacement of a substituent bonded to boron. The same radical may be obtained in one or more ways. For example, a cyano group may be introduced by replacement of halogen using cyanous cyanide or by dehydration of a



substituent.

The portion of Formula 1 which is in brackets, i.e., [B₁₀H_{10-n-y}X_y·nZ], is described as a polyhedral borane having a cage structure. The polyhedral borane cage, considered independently of the X and Z groups, can be electrically neutral, i.e., it can be free of any charge which is inherent in the boron cage structure itself, or it can have a negative ionic charge of 1. The definition of the number of M groups in Formula 1 is based on the charge on the boron cage, independently of the X and Z groups.

However, there may be electrical charges arising from the nature of the X and Z groups in addition to the charge associated with the polyhedral borane cage, as described above. For example, X or Z may bear carboxyl groups which, in ionic form, require the presence of a cation. As a further illustration, X or Z may bear basic groups, e.g., -NH₂, which will form ionizable salts with acids. Cations and anions derived from X and Z groups are considered to be part of these groups and are included within the scope of the definition of X and Z.

Inspection of generic Formula 1 shows that the polyboron compounds fall into two broad subgeneric groups which are based on the value for n. For compounds when n=1, the ionic charge, represented by (n-2), of the group in bracket becomes -1 and the number of cations, M, also becomes 1. This subgeneric group is represented by the following formula:



where M, X, Z and b are defined as in Formula 1, and y is a cardinal number of 0-9, inclusive.

For compounds where n=2, the ionic charge of the group in brackets becomes 0, i.e., the boron entity is electrically neutral and the number of groups, M, also becomes 0. This subgeneric group is represented by the following formula:



where X and Z are defined as in Formula 1 and y has a value of 0-8, inclusive. The compounds of Formula 3 are referred to as "neutral compounds" or "non-ionic compounds." The two formulas shown in (3) are simply alternative ways of writing the structures. They represent the same group of compounds.

Compounds of Formulas 1, 2 and 3 in which y=0, can be considered to be the parent compounds from which other compounds are obtained by procedures which involve substitution of hydrogen, either directly or indirectly, which will be described later. The unsubstituted

3

compounds which fall within the scope of the group of Formula 1 can be represented by the following formula:

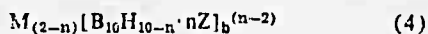

where M, Z, n and b have the meanings given for Formula 1.

The compounds of Formula 4 can be divided into two subgroups which are determined by the value of n, as described earlier for Formula 1. When n=1 in Formula 4, the compounds are represented as follows:



where M, Z and b are defined as in Formula 1. When n=2 in Formula 4, the compounds are represented by the following formula:



where again Z has the meaning given in Formula 1. The compounds of Formula 6 can be used to prepare the compounds of Formula 5 in many cases, as will be described later. However, the compounds of both Formulas 5 and 6 will be referred to hereinafter as "parent compounds." The two formulas given for (6) are, as in (3), alternative ways of writing the structures.

The novel compounds of the invention have a characteristic boron-containing component or group which in Formulas 1, 2, 4, and 5 is the portion in brackets and which in Formulas 3 and 6 is represented by the entire formula. Thus, the boron-containing group can be electrically neutral, i.e., it can have an ionic charge of 0, as in Formulas 3 and 6, or it can have a charge of -1, i.e., it can be a monovalent anion as, e.g., in Formulas 2, 4 and 5.

Both boron-containing groups (neutral and monovalent anion) have at least two characteristics in common, viz., (1) the component Z and the manner in which it is joined to the group, and (2) remarkable and unexpected chemical behavior which resembles in many respects the substitution reactions which aromatic compounds undergo, i.e., a chemical behavior which is best described as "aromatic." The term "aromatic" is well recognized in organic chemistry and is discussed, e.g., in Fuson, "Advanced Organic Chemistry," p. 387, Wiley (1950). These common characteristics will be discussed in the paragraphs which follow. The discussions will include descriptions of the groups Z, X, and M.

The term "boron cage" will be used in the discussions. This term refers to the 10 boron atoms which are present in the compounds of the invention and which are deemed to be joined to form a skeleton-like unit or cage in which each boron atom is adjacent to at least four other boron atoms. The manner in which the boron atoms are linked is not known but the group of which the 10 boron atoms are a part functions as a unit in chemical reactions.

Group Z.—In all of the compounds of the invention, represented by Formulas 1 through 6, the group Z, as previously stated, can be a sulfide in which the divalent sulfur is singly bonded to organic groups, a sulfone in which the hexavalent sulfur is bonded to each of two oxygens through double bonds and to organic groups through single bonds, a phosphine in which the trivalent phosphorus is bonded through single bonds to organic groups, a tertiary amine, an amide of a carboxylic acid, or an organic nitrile, i.e., a compound bearing a —CN group. In each of the above Z groups, the organic radicals (R) are bonded to the sulfur, nitrogen, phosphorus, amide group or cyano group through carbon.

The organic sulfides, sulfones, phosphines, amines, carboxylic acid amides and nitriles which are within the scope of the group Z have the common property of acting as Lewis bases, i.e., compounds which have within their structures an atom which is capable of donating an electron pair to the boron cage to form a stable covalent bond. Lewis bases are a well-known class of compounds and they are defined in conventional textbooks, e.g., Möller, "Inorganic Chemistry," p. 326, Wiley (1954) and

4

Wheland, "Advanced Organic Chemistry," pp. 80-81, Wiley (1949).

The group Z in the compounds of the invention is, therefore, considered to be coordinately bonded to the boron cage largely through two electrons both of which are initially contributed by the Z group.

The organic radicals (R) which are part of the Z groups are bonded to the sulfur, nitrogen or phosphorus through carbon, i.e., the radicals form carbon-sulfur, carbon-nitrogen and carbon-phosphorus bonds. The composition of the organic radicals is not critical and these radicals can have a wide range of structures. The radicals can be aliphatic, cycloaliphatic, aromatic or heterocyclic. Functional or reactive groups can be present in the radical. The radicals bonded to sulfur, in particular, can bear functional substituents, i.e., reactive groups which can take part in conventional chemical reactions, e.g., addition, condensation or polymerization reactions. Illustrations of reactive substituents which can be present on the Z groups are carboxyl, hydroxyl, halogen, amine, nitro and similar functional groups.

Examples of sulfides which are within the scope of Z are as follows: dimethyl sulfide, diethyl sulfide, dipropyl sulfide, dibutyl sulfide, di(2-ethylhexyl) sulfide, didodecyl sulfide, ethyl octadecyl sulfide, butyl dodecyl sulfide, dicyclohexyl sulfide, di(4-dodecylcyclohexyl) sulfide, ethyl cyclohexyl sulfide, methyl cyclopentyl sulfide, methyl (4-methylcyclohexyl) sulfide, methyl decahydronaphthyl sulfide, pentamethylene sulfide, di(β-aminoethyl) sulfide, di(β-cyanoethyl) sulfide, di(4-carboxyphenyl) sulfide, di(4-aminocyclohexyl) sulfide, di(methoxyethyl) sulfide, di(β-acetoxyethyl) sulfide, di(α-chlorobutyl) sulfide, di(4-cyanophenyl) sulfide, di(4-nitrophenyl) sulfide, di(2,4-diaminocyclohexyl) sulfide, (2,4-diaminophenyl) (4-aminocyclohexyl) sulfide, di(4-hydroxyphenyl) sulfide, di(8-hydroxy-naphthyl) sulfide, and the like.

Examples which are illustrative of sulfones are methyl ethyl sulfone, dibutyl sulfone, dicyclohexyl sulfone, ethyl decahydronaphthyl sulfone, dioctyl sulfone, dioctadecyl sulfone, di(2-ethylhexyl) sulfone, diallyl sulfone, ethyl phenyl sulfone, cyclohexyl phenyl sulfone, and the like.

Examples which are illustrative of phosphines and amines are trimethylphosphine, triethylphosphine, cyclohexyldimethylphosphine, dodecyl-diethylphosphine, triethylphosphine, trimethylamine, tripropylamine, triisopropylamine, trioctylamine, tridodecylamine, trioctadecylamine, dihexylmethylamine, tricyclohexylamine, cyclohexyldiethylamine, triethylamine, methyl-diethylamine, ethyldidodecylamine, cyclohexyldibutylamine, methyl-dicyclohexylamine, triallylamine, allyldimethylamine, N-methylpiperidine, N-methylpyrrolidine, pyridine, quinoline, isoquinoline, picolinic acid, N-isobutylpyrrolidine, N-ethylpyrrolidine, and the like.

Examples of amides which are within the scope of the Z group are formamide, acetamide, butylamide, 2-ethylhexenamide, stearamide, propiolamide, dimethylformamide, diethylformamide, dioctylformamide, dimethylacetamide, N-methyl-N-cyclohexylacetamide, N,N-dimethylbenzamide, N,N-diethyltoluamide, N-acetylpiperidine, N-acetylpyrrolidine, N-ethyl-2-pyrrolidone, N-cyclohexyl-2-pyrrolidone, and the like.

Examples of nitriles which are illustrative of and are within the scope of Z are propionitrile, capronitrile, α-carboxycapronitrile, valerionitrile, cyclohexanecarbonitrile, benzonitrile, valeronitrile, stearonitrile, 5-pyrimidine-carbonitrile, furonitrile, tetrahydrofuranitrile, 4-phenoxy-cyclohexanecarbonitrile, β-ethoxypropionitrile, and the like.

For each of the Z groups described above, the compounds of the invention are represented broadly by the following formulas:

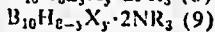
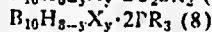
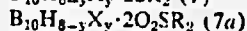
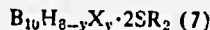

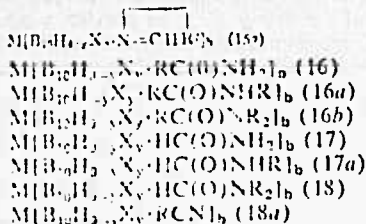
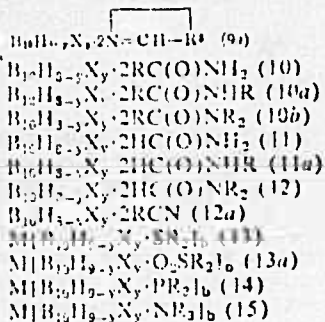

In the above formulas, M, X, *b* and *y* have the meanings given previously for Formulas 2 and 3. The R groups represent the organic radicals discussed in the preceding paragraphs. R² represents the divalent

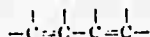

which forms a pyridine ring with the —N=CH— group. The R groups, referred to earlier can be alike or different and two of such R groups can be joined to form a ring of which the sulfur, nitrogen or phosphorus is a part. Formulas 7 through 18 represent species of compounds which fall within the broad scope of compounds included within the scope of Formula 1.

Certain groups of compounds which fall within the scope of Formula 1 are preferred for reasons of availability of reactants, ease of preparation and use as intermediates in the preparation of valuable products.

One preferred group of compounds of Formula 1 are products in which the Z group is an organic sulfide of the formula R²S, where R² is a hydrocarbon radical of up to 18 carbons, free of acetylenic unsaturation, and having at most two substituents selected from halogen (F, Cl, Br, I), —OH (including alcoholic and phenolic), —NO₂, —COOH (including metal and nitrogen-base salts of —COOH), amine (including —NH₂, (lower-alkyl)NH, (dialkyl)N, and salts of these groups with organic and inorganic acids), —C(O)NH₂,

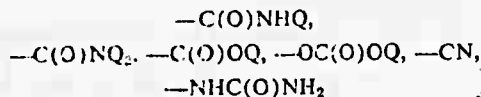

and —NHC(O)NHQ, where Q is a hydrocarbon group of up to 8 carbons which is free of acetylenic unsaturation. The two R² groups can be joined to form a divalent radical which forms a ring, preferably of six members with the sulfur.

A second preferred class of compounds of Formula 1 are products in which the Z group bears hydrocarbon substituents bonded to the nitrogen, sulfur or phosphorus, which hydrocarbon substituents are free of functional groups. This preferred group can be represented by the formulas R'²S, R'²SO₂, R'²P, R'²N, HC(O)NR'²,



and R'CN, wherein the R' groups, which can be alike or different, are hydrocarbon groups of up to 18 carbons and wherein two of the R' groups can be joined to form a ring of which the sulfur, phosphorus or nitrogen is a part. These groups are preferred solely because of avail-

ability and good reactivity to form the compounds of Formula 1.

Hydrocarbon, as used above, includes alkyl, alkenyl, alkynyl, cycloalkyl, cycloalkenyl, aryl, alkaryl, and aralkyl. The aliphatic hydrocarbon groups have preferably at most two carbons joined by multiple bonds, i.e., at most one double or triple bond.

A third class of preferred compounds of Formula 1 are products in which Z is an amide selected from N,N-disubstituted formamides, N,N-disubstituted acetamides, and N-substituted-2-pyrrolidones. The amides have the formulas

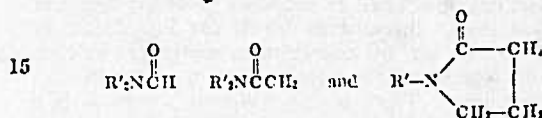

where R' is a hydrocarbon group as defined above.

20 Substitution reactions of the boron-containing group

Prior to discussing the group X in generic Formula 1, a brief description of the chemical properties of the compounds of the invention is desirable, particularly the substitution reactions which the compounds undergo in reactions with electrophilic reagents. It is particularly desirable to note at this point that the compounds of the invention in which the boron-containing unit bears hydrogen, electrophilic substituents, or both hydrogen and electrophilic substituents, show much greater chemical stability than many of the known hydrogen-containing boron compositions.

The boron-containing group functions as a unit in many chemical reactions and its behavior suggests that the boron atoms are joined to form a boron cage or boron sphere which, although entirely inorganic in structure, undergoes electrophilic substitution reactions in a manner which resembles the behavior of carbocyclic aromatic compounds, e.g., benzene or naphthalene. More specifically, hydrogens bonded to borons in the compounds represented by Formulas 1 through 6 are replaceable by substituents which can also replace hydrogens bonded to nuclear carbons in benzene or a substituted benzene. This behavior of the boron-containing entity of Formulas 1 through 6 is particularly surprising in view of the inorganic composition of the group. It is this previously unknown "aromatic character" or "aromaticity" of the boron-containing group which leads to many of the novel compounds of this invention. The substituents which replace the hydrogens, and which fall within the scope of X in the formulas of the compounds of the invention, are defined in more detail in the following paragraphs.

Group X.—The compounds of Formulas 1, 2 and 3 can contain a component represented as X which, in its broadest aspects, is defined as a group capable of bonding to carbon of an aromatic compound by replacement of hydrogen, e.g., a group capable of bonding to a nuclear carbon of benzene, naphthalene, xylene, and the like. The group X is present in the compounds of the invention when *y* has a value of at least 1. In a more restricted sense, X is a group derivable from an electrophilic reagent, i.e., a group which can be bonded to carbon of an aromatic carbocyclic compound by direct electrophilic attack to effect substitution of hydrogen bonded to a nuclear carbon. Preferably, X is a halogen or a monovalent group bonded to boron through nitrogen, carbon, oxygen or sulfur, e.g., for nitrogen: amino, substituted amino, nitroso, nitro, azo and others; for carbon: hydrocarbon groups, e.g., alkyl, alkenyl, alkynyl, aryl, alkaryl and aralkyl and substituted hydrocarbon groups, particularly α -substituted hydrocarbons, cyano, carbonyl and others; for oxygen: hydroxy, hydrocarbonyloxy and hydrocarbyloxy; and for sulfur: thiol, hydrocarbylmercapto, sulfo, sulfonyl, sulfamyl and others.

The definition of X, as stated above, is based on the close similarity in chemical substitution reactions between

the essentially inorganic boron-hydrogen cage of the compounds of the invention and the classical aromatic carbon-hydrogen rings of organic chemistry. X, therefore, represents a broad range of substituents.

The group X can represent a substituent which is introduced by a direct reaction with the parent compound, i.e., a compound of Formulas 5 or 6, or it can represent a substituent obtained by subsequent chemical modification of a group which has been introduced by direct reaction, e.g., a substituent obtained by reduction, esterification, hydrolysis, dehydration or amidation of directly introduced groups. Chemical modification of the substituents can be effected by processes involving single or multiple steps. Substituents which are introduced by direct reaction are, for convenience, referred to as electrophilic groups and these groups form a preferred class of substituents. Thus, in this preferred group, X is a monovalent electrophilic group which is capable of bond to carbon of a benzene nucleus by reaction of benzene or a substituted benzene (toluene, naphthalene) with an electrophilic reagent. These reagents are defined more fully in later paragraphs.

An electrophilic group, derivable from an electrophilic reagent, is deficient in electrons and has a point of low electron density. Electrophilic groups and reagents which are employed to effect substitution of such groups for the hydrogen on a carbon of a benzene nucleus are described in conventional textbooks of which the following are examples:

Remick, "Electronic Interpretations of Organic Chemistry," p. 53, 100-1, Wiley (1943).

Ingold, "Structure and Mechanism in Organic Chemistry," pp. 198-200, 269-304 (especially pp. 202, 211), Cornell University Press (1953).

Fuson, "Advanced Organic Chemistry," chap. 1, Wiley (1953).

Wheland, "Advanced Organic Chemistry," 2nd ed., p. 83, Wiley (1949).

Examples of electrophilic groups, i.e., substituents which are derivable from electrophilic reagents, which are included within the scope of X are as follows: halogens (F, Cl, Br, I), hydrocarbon, carboxyl

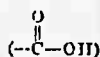

carbamyl and N-substituted carbamyl

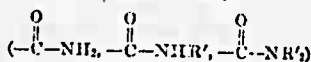

halocarbonyl



where Y is F, Cl, Br, I), halomethyl ($-\text{CH}_2\text{Y}'$, where Y' is F, Cl, Br, I), hydroxy ($-\text{OH}$), hydrocarbyloxy ($-\text{OR}'$), acetal [$-\text{CH}(\text{OR}')_2$], ketal [$-\text{CR}'(\text{OR}')_2$], hydrocarbylcarbonyloxy [$-\text{OC}(\text{O})\text{R}'$], hydrocarbyloxy-carbonyl [$-\text{C}(\text{O})\text{OR}'$], isocyanate ($-\text{NCO}$), thiocyanate ($-\text{CNS}$), isothiocyanate ($-\text{NCS}$), hydrocarbylthio ($-\text{SR}'$), hydroxymethyl ($-\text{CH}_2\text{OH}$), hydrocarbyloxy-methyl ($-\text{CH}_2\text{OR}'$), dihydrocarbylaminoethyl



cyano ($-\text{CN}$), amino ($-\text{NH}_2$), substituted amino ($-\text{NHR}'$, $-\text{NR}'_2$), trihalomethyl ($-\text{CCl}_3$, $-\text{CF}_3$, etc.), acyl



aldehyde



nitro ($-\text{NO}_2$), nitroso ($-\text{NO}$), azo ($-\text{N}=\text{N}-\text{Ar}$, where Ar is an aromatic hydrocarbon of up to 10 car-

bons), sulfo ($-\text{SO}_2\text{H}$), sulfonyl ($-\text{SO}_2\text{R}'$), and acetoxy-mercury

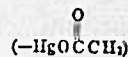

R', where used in the above substituents, is a monovalent organic group which is preferably a hydrocarbon group (alkyl, cycloalkyl, alkenyl, cycloalkenyl, aryl, alkaryl, aralkyl, and the like) of at most 18 carbons.

Description of M.—The compounds of Formulas 1, 2, 4, and 5 include the group M which is defined as an atom or group of atoms which forms a cation in aqueous solution. More explicitly, M is an atom or group of atoms which in aqueous solution forms a positively charged ion. The sole function of the group M is to provide a positively charged component or cation which will unite with the univalent boron-containing anion and thus permit isolation of the anion in compound form. The novelty of the compounds and, therefore, the invention resides in the boron-containing group and not in the group M in the event this group is present.

The properties of the group M are not critical and this group, therefore, represents a broad range of elements and combinations of elements. To illustrate, M can be hydrogen, hydronium (H_3O^+), a metal, a metal-water complex, a metal-amine complex, ammonium (NH_4^+), hydrazonium ($\text{NH}_2-\text{NH}_3^+$), N-substituted ammonium, N-substituted hydrazonium, S-substituted sulfonium, P-substituted phosphonium, and the like. To illustrate further, M can be lithium, sodium, cesium, beryllium, barium, magnesium, calcium, strontium, lanthanum, manganese, iron, cobalt, copper, zinc, mercury, aluminum, thallium, tin, lead, silver, or any other metal. As further and more specific examples, M can be R^4NH_3^+ , $\text{R}^4_2\text{NH}_2^+$, R^4_3NH^+ , R^4_4N^+ , $(\text{R}^4\text{NH}-\text{NH}_3)^+$,

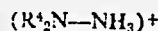

R^4_3S^+ , R^4_4P^+ , $[\text{Zr}(\text{NH}_3)_4]^{+2}$, $[\text{Co}(\text{NH}_3)_4]^{+2}$,



$[\text{Cu}(\text{NH}_2\text{CH}_2\text{CH}_2\text{NH}_2)_2]^{+2}$, and the like. The substituents represented by R^4 in the above illustrations are organic groups whose character or nature is not a critical feature of these cation groups. The substituents represented by R^4 can be open-chain or closed-chain, saturated or unsaturated or the substituents can be composed of heterocyclic rings of which the nitrogen is a component, e.g., pyridine, quinoline, morpholine, hexamethyleneimine, and the like. Preferably, R^4 , for reasons of availability of reactants, is a hydrocarbon group of at most 18 carbons.

Examples of representative and specific compounds are given below solely to illustrate the invention and they are not to be considered as limiting the scope of operable compounds:

60 $\text{B}_{10}\text{H}_8 \cdot 2\text{S}(\text{CH}_3)_2$, $\text{B}_{10}\text{H}_8 \cdot 2\text{S}(\text{C}_2\text{H}_5)_2$, $\text{B}_{10}\text{H}_8 \cdot 2\text{S}(\text{C}_{12}\text{H}_{25})_2$
 $\text{B}_{10}\text{H}_8 \cdot 2\text{S}(\text{C}_2\text{H}_{11})_2$, $\text{B}_{10}\text{H}_8 \cdot 2\text{S}(\text{CH}_3)(\text{C}_{18}\text{H}_{37})$
 $\text{B}_{10}\text{H}_8 \cdot 2\text{O}_2\text{S}(\text{CH}_3)_2$, $\text{B}_{10}\text{H}_8 \cdot 2\text{O}_2\text{S}(\text{C}_2\text{H}_5)_2$
 $\text{B}_{10}\text{H}_8 \cdot 2\text{O}_2\text{S}(\text{C}_6\text{H}_{11})_2$, $\text{B}_{10}\text{H}_8 \cdot 2\text{O}_2\text{S}(\text{C}_6\text{H}_5)_2$
 $\text{B}_{10}\text{H}_8 \cdot 2\text{O}_2\text{S}(\text{C}_2\text{H}_5)_2$, $\text{B}_{10}\text{H}_8 \cdot 2\text{O}_2\text{S}(\text{C}_6\text{H}_5\text{Cl})(\text{C}_2\text{H}_5)$
 $\text{B}_{10}\text{H}_8 \cdot 2\text{O}_2\text{S}(\text{C}_2\text{H}_5)_2$, $\text{B}_{10}\text{H}_8 \cdot 2\text{O}_2\text{S}(\text{C}_6\text{H}_4\text{CH}_3)(\text{C}_2\text{H}_5)$
 $\text{B}_{10}\text{H}_8 \cdot 2\text{P}(\text{C}_2\text{H}_5)_2$, $\text{B}_{10}\text{H}_8 \cdot 2\text{P}(\text{C}_6\text{H}_{11})_2$, $\text{B}_{10}\text{H}_8 \cdot 2\text{P}(\text{C}_3\text{H}_7)_2$
 $\text{B}_{10}\text{H}_8 \cdot 2\text{P}(\text{C}_2\text{H}_5)_2(\text{C}_{12}\text{H}_{25})$, $\text{B}_{10}\text{H}_8 \cdot 2\text{N}(\text{CH}_3)_2$
 $\text{B}_{10}\text{H}_8 \cdot 2\text{N}(\text{C}_6\text{H}_{11})_2$, $\text{B}_{10}\text{H}_8 \cdot 2\text{N}(\text{CH}_3)(\text{C}_6\text{H}_{17})_2$
 $\text{B}_{10}\text{H}_8 \cdot 2\text{HC}(\text{O})\text{NH}_2$, $\text{B}_{10}\text{H}_8 \cdot 2\text{CH}_3\text{C}(\text{O})\text{NH}_2$
 $\text{B}_{10}\text{H}_8 \cdot 2\text{HC}(\text{O})\text{N}(\text{C}_6\text{H}_{13})_2$
 70 $\text{B}_{10}\text{H}_8 \cdot 2\text{CH}_3\text{C}(\text{O})\text{N}(\text{C}_{12}\text{H}_{25})_2$, $\text{B}_{10}\text{H}_8 \cdot 2\text{HC}(\text{O})\text{NHC}_{18}\text{H}_{37}$
 $\text{B}_{10}\text{H}_8 \cdot 2\text{HC}(\text{O})\text{N}(\text{CH}_3)_2$, $\text{B}_{10}\text{H}_8 \cdot 2\text{CH}_3\text{C}(\text{O})\text{N}(\text{C}_2\text{H}_5)_2$

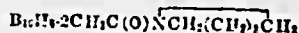

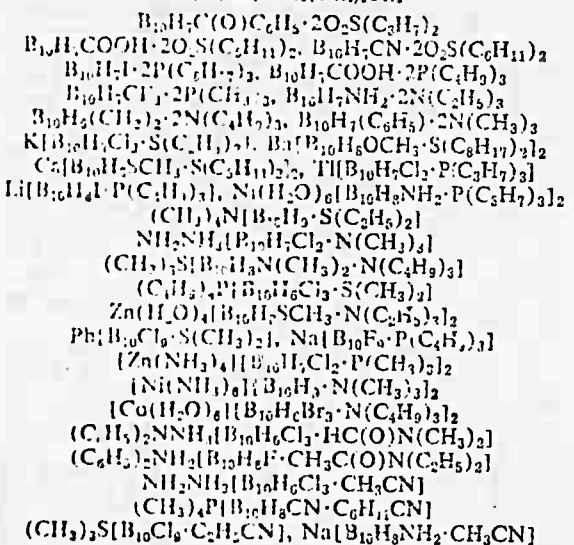
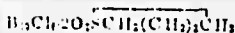
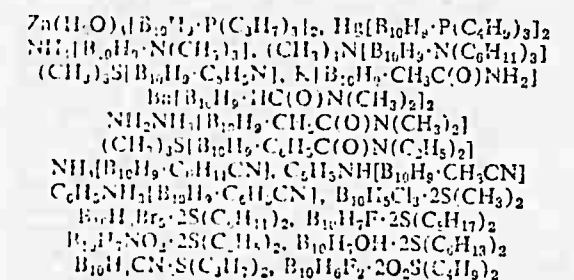
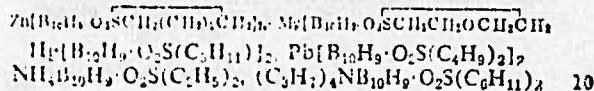
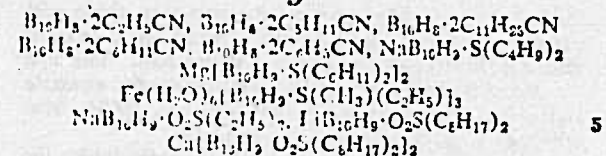

and the like. Further illustrations of compounds of the invention are:

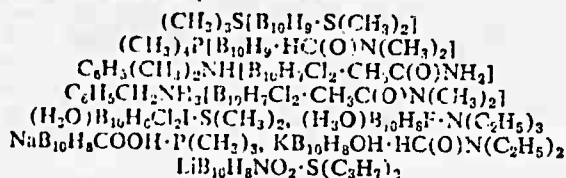

and the like.

Other examples are:

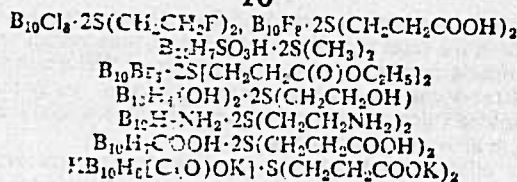
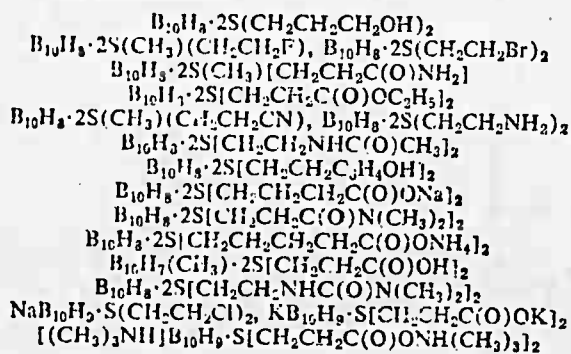

and the like.

Naming of compounds of the invention

It is noted that no official system of naming of boron compounds has been adopted at the present time. The nomenclature used herein follows the proposals made by a group of the Committee on Nomenclature of the American Chemical Society Division of Organic Chemistry. These proposals are discussed in (1) a paper presented by G. W. Schaeffer at the American Chemical Society Meeting, San Francisco, California, April 13-18 (1958), (2) a paper presented by K. L. Locner to the Division of Chemical Literature, American Chemical Society Meeting, Chicago, Illinois, September 7-12 (1958), and (3) a publication by Patterson, Chemical Engineering News 34, 565 (1956). The nomenclature is also in accordance with the system published in "Nomenclature of Inorganic Chemistry—1957," p. 72, International Union of Pure and Applied Chemistry, Butterworths Scientific Publications (London), 1959. Names assigned to non-ionic boron compounds end in "ane" with the number of hydrogens originally present in the compound shown in parentheses, e.g., $B_{10}H_{14}$ is tetradecahydrodecaborane(14), $B_{10}H_8 \cdot 2S(CH_3)_2$ is bis(dimethylsulfide)octahydrodecaborane(8) and $B_{10}Cl_8H_2 \cdot 2N(C_2H_5)_3$ is bis(trimethylamine)pentachlorotrihydrodecaborate(8). Names assigned to ionic boron compounds end in "ate" with the valence of the boron-containing ion designated in parentheses by numeral and charge sign. Thus, $Na_2B_{10}H_{12}$ is disodium decahydrodecaborate(2-),



is sodium (dimethylsulfide)nonahydrodecaborate(1-), and $(CH_3)_4NB_{10}H_7 \cdot Cl_2 \cdot HC(O)N(CH_3)_2$ is tetramethylammonium (dimethylformamide)tetrachloropentahydrodecaborate(1-).

Properties and characteristics of the new compounds

In physical properties, the new compounds range from liquid products to solid products which are stable at conventional atmospheric temperatures and pressures. The products normally are colorless or white and, if solid, they are usually crystalline. However, the color or other physical characteristics are determined to some extent by the substituent X and by the group Z. Thus,



is an orange-colored solid. In the event X bears a chromophoric group (e.g., an azo group), the color of this group may be imparted to the final compound.

Many of the compounds dissolve to some extent in water or hydroxy-lated solvents, e.g., alcohols. The compounds fall into two groups in their behavior in water. The compounds of Formula 2 are ionic in character, i.e., they behave like salts and form ions in solution. The compounds of Formula 3 are neutral, i.e., they are not salt-like in character and they do not form ions.

The ionic and electrically neutral compounds of the invention, i.e., the compounds of Formulas 2 and 3, do not reduce solutions of silver nitrate. The compounds which bear hydrogen bonded to boron react smoothly with halogens with minimum side reactions to form halo-substituted derivatives.

Preparation of the new compounds

Processes for preparing the compounds of the invention employ decahydrodecaborates, either directly or indirectly, as reactants which are the source of boron.

Decahydrodecaborates, employed directly, are used generally in the form of hydrates of the acid, ammonium or substituted ammonium salts or metal salts. The decahydrodecaborates are reacted with sulfoxides, sulfones, phosphine oxides, amine oxides, amides, nitriles, and the like, to arrive at the desired products.

In other procedures, the decahydrodecaborates are modified, as a first step, to obtain non-ionic or ionic compounds in which a number of the hydrogens bonded to the borons in the $B_{10}H_{10}^{2-}$ anion are replaced by reactive groups. The modified boron-containing products, of which $B_{10}H_8 \cdot 2N_2$, $B_{10}H_8 \cdot N_2 \cdot SR_2$, and the like are examples, are then reacted with appropriate reagents to obtain the compounds of the invention.

Thus, a wide range of processes are available which can be used separately or in combination, to provide versatile routes to the new products.

The principal reactants, i.e., the decahydrodecaborates, are presently not generally available materials. They are compounds of the formula $M_a \cdot (B_{10}H_{10})_b$, where M is a group which can form a cation as defined for Formula 1, and a' and b' are whole positive numbers whose values are determined by the valence of M, i.e., a' multiplied by the valence of M is equal to $2b'$. The group $B_{10}H_{10}$ in the formula is divalent. The group M, in a preferred class of reactants, is hydrogen (or, in its hydrated form, hydronium), an alkali metal (i.e., Li, Na, K, Rb or Cs) or ammonium (NH_4). In an especially preferred group of decahydrodecaborate(2^-) reactants, M is H, Na, K or NH_4 . These are represented by the formulas

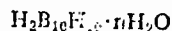

(where n is a positive number of preferably 4-20),

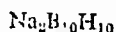

$K_2B_{10}H_{10}$ and $(NH_4)_2B_{10}H_{10}$. The salts can be used as hydrates and, in fact, they are frequently used in this form.

Decahydrodecaborates are obtained by relatively simple methods from a decaborane(12)/organic sulfide compound of the general formula $B_{10}H_{12} \cdot 2USU'$, where U and U' are hydrocarbon groups, preferably alkyl. The compound is prepared by reacting an organic sulfide of the formula USU' with decaborane(14), i.e., $B_{10}H_{14}$, at a temperature between 0° and 150° C. until approximately one mole of hydrogen is evolved. The decaborane(12)/organic sulfide adduct is then reacted with liquid ammonia or an amine at a temperature between about -50° C. and 0° C. for about one hour to obtain the salt $M_a \cdot B_{10}H_{10}$, where M represents the cation obtained from ammonia or the amine. Thus, with liquid ammonia as the reagent, M is NH_4^+ ; with methylamine, M is $CH_3 \cdot NH_3^+$; and with tertiary butylamine, M is $(CH_3)_3C \cdot NH_3^+$.

(1) *Process A.*—A principal and generic process for obtaining the compounds of Formulas 5 and 6, referred to as parent compounds, in which Z is a sulfide, phosphine or tertiary amine consists in reacting in an acidic environment (1) a decahydrodecaborate(2^-) of the formula $M_a \cdot (B_{10}H_{10})_b$, as described in the preceding paragraphs and (2) a sulfoxide, phosphine oxide or tertiary amine oxide.

The sulfoxides, phosphine oxides and amine oxides are members of a well-known group of compounds which can be represented by the formula $Z \rightarrow O$, where Z is R_2S , R_3P , or R_3N , and R has the meaning defined in a previous paragraph for the sulfides, phosphines and amines. The R groups can be alike or different. The examples given earlier for these groups are illustrative for this reactant. In the event $(NH_4)_2B_{10}H_{10}$ is used as the boron-containing reactant, a trisubstituted phosphine (R_3P) can be used, if desired, in place of the phosphine oxide to obtain compounds in which Z is a trisubstituted phosphine.

The acidic environment in which the reaction is per-

formed can be supplied by a third component whose acid strength is at least equal to the strength of a mineral acid, e.g., hydrochloric acid, i.e., a strong acid. The acid environment can be supplied by employing, for example $H_2B_{10}H_{10}$, gaseous hydrogen halides (e.g., HCl), concentrated phosphoric acid, and the like.

The reaction may be represented schematically by the following equation, where M is a monovalent group:

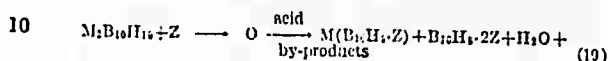

The above equation is not intended to reflect the molar proportions in which the reactants are employed.

The reaction is conducted in conventional vessels with corrosion-resistant inner surfaces, e.g., glass, platinum, poly(tetrafluoroethylene) resin, and the like. The vessel is charged with the decahydrodecaborate(2^-) and the oxide ($Z \rightarrow O$) at atmospheric temperature and atmospheric pressure. The reactants are mixed and the acidic component is added to the mass with stirring. Agitation is continued until the reaction has proceeded to give the desired yield of product. The reaction is exothermic and, where large quantities of reactants are employed, it is generally necessary to provide means for cooling the reaction mass. Processing the mixture to isolate the desired products is accomplished by conventional procedures using readily available solvents. In one procedure, the reaction mixture is filtered to separate solid by-products and the filtrate is stirred with water. The solid which forms is a compound of Formula 6 and, after separation, it is purified further by crystallization from oxygenated solvents, such as alcohol, acetone, aqueous alcohol or aqueous acetone. The aqueous filtrate from the reaction mixture is extracted with an organic ether, e.g., diethyl ether, and the residual aqueous layer is concentrated in volume to yield a solid product which is a compound of Formula 5. This product is purified by reaction with a salt whose cation M forms a compound of Formula 5 of low water-solubility, e.g., M can be R_3N^+ .

In an optional mode of processing the reaction mixture, the mixture is diluted with an aromatic hydrocarbon, e.g., benzene, and the mixture is filtered to remove insoluble by-products. The filtrate is extracted with a saturated hydrocarbon, e.g., ligroin, n-hexane, n-heptane, cyclohexane, and the like, and the portion which remains is diluted with water. The desired boron compounds, principally products of Formula 5, separate and they are purified as described previously.

The mole ratios in which the reactants are employed is not a critical factor in the process. The ratio, moles $M_2(B_{10}H_{10})$ /moles $Z \rightarrow O$, can lie between about 0.1 and 10, preferably the ratio lies between about 0.5 and 2.5. These ratios are preferred solely to provide good yields of the desired products. The acid component is normally used in sufficient quantity to combine with the cation M although it is not essential to use this quantity of acid component.

The temperature at which the reaction is conducted is not critical. Normally the process is operated at prevailing atmospheric temperature but lower and higher temperatures are operable. The use of very low or very high temperatures offers no advantages. Satisfactory operation is generally found within a temperature range of -20° C. to 110° C., preferably a temperature within the range of 0° to 75° C. is employed. The reaction is exothermic and the temperature, if necessary, can be controlled by means of cooling media such as ice, mixtures of ice and water, solutions of solid carbon dioxide in organic solvents and similar conventional means.

The pressure at which the process is operated is not critical. Atmospheric pressure is satisfactory and it is the pressure most conveniently used. However, the pressure can be subatmospheric or superatmospheric, if it is more convenient to operate under these conditions,

e.g., the pressure can lie between about 0.1 atmosphere and 10 atmospheres.

The reaction proceeds rapidly and the time in which the reactants are in contact is not a critical factor. For a batch process, the time can lie between about 5 minutes and 24 hours. However, a continuous flow process can be employed wherein the reactants are fed continuously into one end of a reaction tube and maintained in contact for a brief period, e.g., 0.1-0.5 second, with very efficient mixing and the reaction mixture containing the desired product is discharged continuously from the other end of the tube.

Optionally, the reaction can be conducted in an inert liquid reaction medium. Operable liquid media include hydrocarbon ethers or hydrocarbons which preferably are free of aliphatic unsaturation, i.e., olefinic and acetylenic bonds. Examples of liquid media which can be employed are benzene, xylene, cyclohexane, heptane, diethyl ether, dibutyl ether, and the like. Glacial acetic acid is also operable as a reaction medium. The use of an inert liquid medium is not essential for operability.

(2) *Process B*.—This process, which is a modification of *Process A*, is a second generic procedure for obtaining the compounds of the invention. Decahydrodecaborates of the formula $M_b(B_{10}H_{12})_b$, as defined in *Process A*, are reacted (1) with a nitroating agent, e.g., HNO_3 , and (2) with a reducing agent, e.g., nascent hydrogen, to obtain an inner diazonium salt which has a characterizing group of the formula $-B_{10}H_{12} \cdot N_2-$. The intermediate diazonium salt can be non-ionic, e.g., $B_{10}H_{12} \cdot 2N_2$, or it can be ionic e.g., $M'(B_{10}H_{12} \cdot N_2)_b$, where M' is a cation as defined previously whose valence is b . The inner diazonium salts are reacted with appropriate Z compounds, e.g., sulfides, selenes, tertiary amines, tertiary phosphines, amides or nitriles to obtain the compounds of the invention.

The above procedure is an especially preferred method for the preparation of compounds of the invention in which Z is a tertiary amine, tertiary phosphine, or a nitrile.

In an optional method of operation of *Process B*, a decahydrodecaborate salt is reacted as described in *Process A* to obtain a compound of Formula 5, i.e., $M'(B_{10}H_{12} \cdot Z)_b$. This compound is then reacted with nitrous acid and subsequently reduced to obtain an inner diazonium compound of the general formula $B_{10}H_{12} \cdot N_2 \cdot Z$. The non-ionic compound thus obtained is reacted further with an appropriate member of the Z group of compounds to obtain a compound of the invention in which the Z groups are, most frequently, unlike. This modified procedure is, in fact, most useful in obtaining non-ionic compounds in which the Z groups are dissimilar.

Conditions for the reaction with nitrous acid and subsequent reduction are simple. These steps in the process are conducted in the manner of conventional reactions employing nitrous acid in aromatic chemistry. An acidified solution of an alkali metal nitrite, e.g., $NaNO_2$ in hydrochloric acid solution, is normally employed to which a solution of the decahydrodecaborate salt is added. The reaction is usually conducted at a low temperature, e.g., at $0^\circ C.$ or lower, and a precipitate forms during the operation. This precipitate is separated, redissolved in an alcohol or aqueous alcohol solvent and an appropriate reducing agent is added, e.g., an alkali metal hydroborate ($NaBH_4$), or a combination of reagents which provide active hydrogen, e.g., a metal with a mineral acid (Zn or Fe with HCl). The compound having the inner diazonium structure, i.e., one or two $\cdot N_2-$ units, is isolated by evaporation or precipitated by dilution of the solution with water.

The process is conducted most conveniently at atmospheric pressure and within a temperature range of about $0^\circ C.$ to $50^\circ C.$ Pressure, temperature and mole ratios of reactants are not factors which require critical control. The discussion of these factors, given for *Process*

A, can be applied equally well to the operation of *Process B*.

The preparation of inner diazonium salts employed as reactants in the above process is fully described in my pending application, Ser. No. 186,270, filed January 11, 1962, now abandoned and refiled as Ser. No. 324,835 on November 19, 1963.

(3) *Process C*.—(for preparing compounds where Z is a sulfone, or an amide).—This process employs as reactants (1) a decahydrodecaborate ($2-$) salt previously described, (2) a sulfone or amide derived from a carboxylic acid, and (3) a strong organic or inorganic acid. The sulfone or amide and a decahydrodecaborate salt, e.g., $(NH_4)_2B_{10}H_{10}$ or $Na_2B_{10}H_{10}$, are mixed to form a solution and a hydrogen halide, e.g., hydrogen chloride, is bubbled through the mixture. Optionally, a strong organic acid, e.g., an arylsulfonic acid, can be employed in place of a hydrogen halide. The reaction is exothermic and proceeds rapidly. To obtain the non-ionic species as the principal product, heat is applied to the reaction mixture after the exothermic phase has passed and passage of the hydrogen halide is continued for a further period. To obtain the ionic species as the principal product, passage of hydrogen halide is stopped when the exothermic phase is over, as evidenced by a drop in temperature and no further heat is applied. In either case the reaction mixture is processed by conventional methods. Insoluble material is removed by filtration. The filtrate is diluted with water and the non-ionic species, if present, precipitates and is separated. The remaining clear solution is reacted with a solution of a compound which contains the cation M , desired in the final product. Thus, the solution can be reacted with an inorganic base, an organic base, an inorganic salt, an organic salt, and the like. To illustrate, the solution can be mixed with $NaOH$, $CaOH$, $Ba(OH)_2$, NH_3 , NH_4OH , hydrazine, substituted amines, tetrasubstituted nitrogen bases, pyridine, trialkylsulfonium hydroxides, tetraalkylphosphonium hydroxides, and the like, to obtain compounds in which M covers a broad range of cations. Salts which can be used as reactants are, for example, chlorides, carbonates, acetates of metals or organic bases of the kind illustrated above. This step in the process is a simple metathetic reaction and its many variations are well-known in chemical processes.

The preferred amides for use in the process are formamides and acetamides in which the nitrogen preferably bears two hydrocarbon substituents, i.e., compounds of the formula

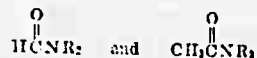

in which R represents a hydrocarbon group as defined earlier for the Lewis bases. However, carboxylic anides generically are operable as reactants, e.g., acetamide, isobutyramide, cyclohexanecarboxamide, benzamide, N,N -dimethylmethacrylamide, N -methylolamide, N,N -diethylstearamide, N,N -dicyclohexylbenzamide, and N,N -dipropyltoluamide.

Preferred sulfones are compounds of the formula $R_2^2SO_2$, where R^2 is a hydrocarbon group as defined earlier.

The products obtained in this process can, if desired, be purified by crystallization from conventional solvents, e.g., water, alcohol, glacial acetic acid, and the like.

(4) *Process D*.—(a general process for compounds having X groups, i.e., groups derived from electrophilic reagents).—Compounds of Formulas 1, 2, and 3 in which the value of y is at least 1 are prepared by employing the following reactants:

(a) A compound of Formula 4 which includes the two subgeneric groups represented by Formulas 5 and 6.

(b) A reagent capable of introducing a monovalent substituent, called herein an electrophilic group, into a benzene nucleus by replacement of hydrogen bonded to a carbon of said nucleus. This reactant is referred to as an electrophilic reagent and it is discussed in more detail in the following paragraphs.

For preparation of compounds which bear two or more X groups which are different, e.g., $-SCH_3$ and Cl, a compound of Formula 1 can be employed as the boron-containing reactant which contains at least one hydrogen and at least one X group bonded to boron atoms.

Electrophilic reagents which are broadly operable in the process are reagents which will effect direct substitution of hydrogen bonded to carbon of a benzene nucleus, i.e., the hydrogen is replaced by a group derived from the electrophilic reagent. Electrophilic reagents are compounds which react by requiring electrons or acquiring a share in electrons which previously belonged to a foreign molecule (see Iago'd, *vide supra*, p. 201). Examples of electrophilic reagents which are within the scope of the above definition and which are operable in the process of the invention are given below, together with the substituent group which in the process is bonded to boron in the final product.

Electrophilic reagent	Electrophilic group bonded to boron
Halogens (F, Cl, Br, I)	Hydrogen (F, Cl, Br, I)
Nitric acid	$-NO_2$
H_2NO_2 or N_2O_4	$-NH_2$
Olefins	-alkyl (e.g., $-C_2H_5$, $-CH(CH_3)_2$)
Alkyl halides	$-MER^1$
Acyl halides	$\begin{array}{c} O \\ \\ -C-R^1 \end{array}$
$H_2C(O)C(H)R^1$	$\begin{array}{c} O \\ \\ -H_2C-C(H)R^1 \end{array}$
$(CN)_2C=C(CN)_2$	$-(CN)_2C=C(CN)_2$
$COCl_2$	$\begin{array}{c} O \\ \\ -C-Cl \end{array}$
CO/HCl	$-CH$
$CO/HN(CH_2CH_2O)POCH_3$	$-CH$
RSO_2Cl	$-SO_2-R^2$
R^2NSO_2Cl	$\begin{array}{c} O \\ \\ -CNR^2 \end{array}$
R^2CH and R^2CO	$-OR^2$
$(H_2O)_2Cl$ (hydrogen peroxide)	$-OH$
$RSOCl$	$-SR^1$

In the above groups, R^1 is a monovalent organic radical, preferably hydrocarbon of at most 18 carbons, which can be alkyl, alkenyl, cycloalkyl, cycloalkenyl, aryl, alkaryl, aralkyl, and the like.

In the reactions employing the above electrophilic reagents, a catalyst may be used, e.g., aluminum trichloride, boron trifluoride and polyphosphoric acid. These catalysts are employed in the same manner as in the well-known procedures in organic chemistry. In some cases the boron compounds themselves function as catalysts, e.g., in alkylation of compounds of the formula $H(B_{10}H_9-Z)$.

The electrophilic reagents employed in the process are materials which are usually readily available or which are obtained by conventional methods.

Reaction of the boron compounds of Formulas 5 and 6 with the electrophilic reagent is conducted in conventional vessels with corrosion-resistant inner surfaces, e.g., glass, platinum, poly(tetrafluoroethylene)resin, and the like. The boron-containing reactant, and optionally an inert liquid solvent, is charged into the reaction vessel

The electrophilic reactant is then supplied to the reaction vessel at a temperature and at a rate which will provide a controllable reaction and which will bring the reaction to completion within a reasonable time. When electrophilic reagents are employed which are hydrolytically stable, water or alcohols (methanol, ethanol) can be used conveniently as a solvent for the reaction. Other solvents can be used, for example, diethyl ether, benzene, heptane, carbon tetrachloride, carbon disulfide, and the like.

The temperature at which the reaction is conducted will be determined largely by the reactivity of the electrophilic reagent. In general, the temperature will be between about -20° and 200° C. Preferably, the temperature will be between about 0° and about 150° C.

The time of reaction in a batch process will also depend to a considerable extent on the reactivity of the electrophilic reagent. The reaction generally proceeds rapidly and, with thorough mixing of the reactants, the time may be as low as 5 minutes or even less. Generally a reaction time between about 10 minutes and 5 hours is sufficient. It is desirable and advantageous to mix the reactants by any suitable means although mixing is not essential for operability.

The reaction can be conducted under pressure, if desired, but it is not essential to use pressure. In most cases the reaction proceeds satisfactorily at atmospheric pressure.

The proportions in which the reactants are used are not critical. It is preferable, in order to obtain maximum yield of desired product, to use at least one mole of the electrophilic reagent for each hydrogen which is to be replaced on the boron-containing reactant. It is not essential, however, that these ratios be used.

The compounds are purified by well-known and recognized procedures. For stable products, conventional crystallization procedures are used, employing water or inert organic solvents, e.g., benzene, alcohol. Solutions of the products can be treated with absorptive agents, e.g., activated carbon or silica gel, to absorb the major portion of the impurities.

(5) *Process E*.—(Optional method for preparing compounds bearing X groups).—The compounds of Formulas 2 and 3 which bear at least one X group can be obtained by a modification of the general processes designated as A and C. In the modified process, a boron-containing reactant is employed in which the desired X group or groups are already present. The substituted decahydrodecaborate, which contains at least one X group and at least one hydrogen bonded to boron, is reacted with the sulfide, phosphine oxide or amine oxide, i.e., the group of reactants previously described as Z-O or with an amide as described in processes A and C.

The conditions described previously for processes A and C apply to the present optional procedure and the discussion of the conditions and modifications of the reactants need not be repeated here. It is emphasized that the previous discussion of the Z-O and amide reactants is fully applicable to the present process.

The substituted decahydrodecaborates employed as one reactant in this mode of operation are a class of compounds which have not been described previously in the literature. This group of reactants is represented by the general formula

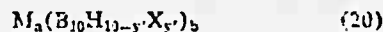

where M and X are defined as in Formula 1; y' is a whole number of 1-9, inclusive; a and b are whole numbers of 1-3, inclusive, whose values are determined by the valence of M according to the equation:

$$b = \frac{ax \text{ valence of } M}{2}$$

The substituted polyhydrodecaborates represented by Formula 20 are obtained by reacting a decahydrodeca-borate salt with an electrophilic reagent as described in

Process D, employing the compounds of Formula 20 in place of the compounds of Formulas 5 and 6. The decaborate salts are described fully in the paragraphs under Process A.

The preparation of substituted polyhydrodecaborates which fall within the scope of Formula 20 is further described in my copending application Serial No. 237,392, filed November 13, 1962.

The operation of Process B can also be modified, as described above for Processes A and C, by employing as a reactant a boron-containing diazonium compound in which the desired X group or groups are present. The substituted compounds employed as reactants in this modification of Process B are represented by the following general formulas:



and



where M, X and b are defined as in Formula 1; s is a positive whole number of 1-8, inclusive and t is a positive whole number of 1-7, inclusive. The compounds of Formulas 20a and 20b are obtained by substitution processes as described in Process D, employing $M(B_{10}H_9 \cdot N_2)_b$ and $B_{10}H_8 \cdot 2N_2$ as the initial reactants. The substituted compounds of Formulas 20a and 20b and their preparation are also fully described in my copending application Serial No. 186,270, filed April 9, 1962 now abandoned and refiled as Ser. No. 324,885 on November 19, 1963.

The procedures described above provide a range of methods for obtaining the compounds of the invention. Combinations of these procedures can be employed and many variations can be used which are within the knowledge of a skilled chemist. To illustrate, a decaborate of Formula 20 bearing X groups of one kind, e.g., acetyl, can be reacted with an oxide of the formula $Z \rightarrow O$, a sulfone, an amide, or nitrile and the resulting product can then be reacted with an electrophilic reagent to provide a different X group, e.g., bromine, to obtain a compound of the Formula 1 in which the X groups in this instance are acetyl and bromine.

(6) *Process E*—(method for preparing compounds in which X is $-SR$).—Compounds of the invention of Formula 2 in which X is $-SR$, Z is $-SR_2$ and y is 1, are obtained readily by a process which employs the following as reactants:

(a) $B_{10}H_9 \cdot 2SR_2$, i.e., a species of the compounds of Formula 7, where $y=0$ and R is defined as in the discussion of Formula 1.

(b) A trisubstituted phosphine (R_3P), where R is defined as in Formula 1, and is preferably an alkyl group of at most 8 carbons; or an alkali metal phthalimide in which the alkali metal is sodium or potassium.

The preparation of the first reactant, $B_{10}H_9 \cdot 2SR_2$, has been described in previous paragraphs. The group of compounds from which the second reactant is selected are readily available and well-known compounds, i.e., tertiary phosphines and alkali metal phthalimides.

The process is conducted most conveniently by simply mixing the reactants in a corrosion-resistant vessel at atmospheric pressure and heating the mixture until the reaction proceeds at a satisfactory rate to bring it to completion within a desired time. The reactants can, if desired, be mixed in an inert liquid medium to assist in maintaining good contact between the components. This mode of operation is generally employed where both reactants are solids at the operating temperature, e.g., in the process employing an alkali metal phthalimide. Inert liquid media are liquids which do not enter into the reaction under the conditions employed and which are recovered unchanged. Classes of operable inert liquid media are N,N-disubstituted amides, nitriles, esters, and the like. Specific examples of liquid media are N,N-dimethylformamide, N,N-dimethylacetamide, acetonitrile, ethyl benzoate, and the like. When one reactant is a liquid at operating temperature, e.g., a trialkylphosphine, the reac-

tion is readily conducted in the absence of any other liquid medium.

As in the description of previous processes, mole ratio of reactants, time of reaction, and pressure are not critical features in the operation of the process. The ratios, moles $B_{10}H_9 \cdot 2SR_2$ /moles R_3P or moles $B_{10}H_9 \cdot 2SR_2$ /moles phthalimide, can lie between about 0.2 and 4, preferably these ratios lie between 0.5 and 2.0. Pressure can be superatmospheric, atmospheric or subatmospheric but for convenience and simplicity, the operation is normally performed at atmospheric pressure. The temperature of the reaction employing phosphines will usually lie between about 140° and 250° C.; with phthalimides as reactants, the temperature is generally between about 100-150° C. In many cases the temperature at which the liquid medium or liquid reactant refluxes is employed as a convenient means of controlling the reaction.

(7) *Process G*—(methods for obtaining compounds in which the R groups in Z are dissimilar).—Compounds in which the R groups in Z, e.g., in SR_2 , PR_3 , and NR_3 , are unlike are obtained as described earlier in Process B and they can also be obtained in general Process A by employing sulfoxides, phosphine oxides and amine oxides as reactants in which the groups bonded to sulfur, phosphorus or nitrogen are unlike. To illustrate, methyl phenyl sulfoxide, dimethyl tolyl phosphine oxide, N-dimethyl-N-butylamine oxide, and the like can be used as reactants to obtain, e.g., $B_{10}H_9 \cdot 2S(CH_3)(C_6H_5)$,

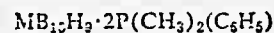

and $B_{10}H_9 \cdot 2N(CH_3)_2(C_6H_5)$.

Optionally, in the general Process A, the reaction can be conducted with one $Z \rightarrow O$ reactant until the ionic compound of Formula 2 or 5 is obtained. The ionic product is then reacted with a second and different $Z \rightarrow O$. To illustrate, $MB_{10}H_9 \cdot Si(C_6H_7)_2$ is prepared by employing $(C_6H_7)_2S=O$, in the first step of the reaction, the ionic product is isolated and then reacted with a second sulfoxide, e.g., $(C_2H_5)_2S=O$, to obtain

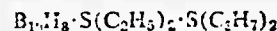

A third process employs as reactants (1) a compound of the formula $MB_{10}H_9SR \cdot SR_2$, obtained by Process F, and (2) an organic sulfate $(R^6)_2SO_4$, where R^6 is a monovalent organic group which can be the same as but, preferably, is different than R. Thus, by employing a boron reactant in which R is alkyl and a sulfate in which R^6 is aryl, a compound of Formula 7 can be obtained in which one R is alkyl and one R is aryl. It is thus obvious that the process is versatile and that it provides means of obtaining non-ionic compounds having a wide range of substituents.

The compound $MB_{10}H_9SR \cdot SR_2$, employed as one reactant, is fully described in all its variations in Process F in which it is a final product. It need not be discussed further in the third process, referred to above.

The group R^6 in $(R^6)_2SO_4$ can be an organic group, preferably hydrocarbon. For reasons of availability, reactants are preferred in which R^6 is an aliphatically saturated hydrocarbon of up to 18 carbons. Thus, R^6 can be alkyl, cycloalkyl, aryl, alkaryl or aralkyl. Examples of compounds which can be employed as reactants in the process are dimethyl sulfate, diethyl sulfate, diphenyl sulfate, and the like.

The process is conducted most conveniently by mixing the reactants in an inert solvent, i.e., a solvent which is unreactive with the components, in a corrosion-resistant vessel. The pressure employed is normally atmospheric although lower or higher pressures can be used if desired. The temperature of the reaction is not critical and it will usually lie between 0° and 225° C. The optimum temperature will depend to some extent on other conditions of the reaction, for example, reactivity of the components, time of reaction, pressure employed, and effectiveness of contact. Determination of the optimum combination of

conditions which can be used is well within the skill of a competent chemist.

The ratio in which the reactants are employed is not critical. Normally the ratio, moles $\text{MB}_2\text{H}_5\text{SR}\cdot\text{SR}_2$ /moles $(\text{R}^2)_2\text{SO}_4$, will lie between 0.1 and 10, preferably between 0.5 and 5.

In an especially preferred method of operation, a water-miscible liquid reaction medium is employed, e.g., dimethylformamide. Upon completion of the reaction, the mixture can be diluted with water which results in precipitation of the desired compound. This mode of operation, therefore, permits easy isolation of the final product.

(8) *Modification of X groups.*—The X groups introduced by direct reaction of polyhydrodecaborates with electrophilic reagents can undergo further modification by conventional chemical processes, e.g., reduction, esterification, hydrolysis, oxidation, amidation, diazotization, and the like. To illustrate, nitro groups are reduced by iron and aqueous acid to amino groups; by lithium aluminum hydride to azo and hydrazo groups; carboxy groups are reacted with alcohols to form esters, with ammonia or amines to form amides, with phosphorus halides to form aryl halides; sulfonyl halide groups are reacted with ammonia or amines to form sulfonamides; diazonium halide substituents are coupled with aromatic compounds to form azo-type linkages; cyano groups are hydrolyzed to amide groups and carboxyl groups; etc. These reactions are well known and fully described in texts on organic chemistry and the methods described in such texts are useful in modifying the X groups in the new compounds of the invention. For a description of organic aromatic reactions, see, for example, Wagner and Zook, "Synthetic Organic Chemistry," John Wiley & Sons, Inc. (1953).

(9) *Metathetic reactions.*—Compounds of Formula 1 wherein M covers a wide range of cations are obtained by simple metathetic reactions employing, e.g., the ammonium or tetraalkylammonium salts obtained in the processes described earlier. To illustrate, an aqueous solution of a compound of Formula 1 where M is NH_4^+ is contacted with a strong acid or with a strongly acidic cation exchange resin to obtain the free acid, i.e., a compound of Formula 1 in which M is H. The acid, generally in solution, is reacted with oxides of metals, hydroxides of metals, salts of metals (both organic and inorganic), nitrogen bases, sulfonium hydroxides or halides, phosphonium hydroxides or halides, aryl diazonium hydroxides or halides, and similar types of compounds to obtain products of Formula 1 which have the desired cation M. In a process employing an ion-exchange resin, strongly acidic resins of the sulfonic acid variety are preferred because of availability, e.g., "Amberlite IR-120-H" and "Dowex 50." The acid, so obtained in aqueous solution, can be reacted with nitrates, chlorides, bromides, acetates, benzoates and similar salts of metals or other bases to obtain salts of Formula 1.

Compounds of Formula 1 where M is an alkali or alkaline earth metal, e.g., Na, K, Cs, Ca, Ba, Mg, and Sr, can undergo simple metathetic reactions with other salts to effect an exchange of cations. Thus, $\text{NaB}_{10}\text{H}_9\cdot\text{Z}$, where Z is defined in Formula 1, can be reacted in aqueous solution with ammonium sulfate, benzenediazonium hydroxide, pyridinium chloride, morpholinium sulfate, polyethylenimine hydrochloride, and the like, to form compounds of Formula 1 having ammonium, benzenediazonium, pyridinium, morpholinium, and the like, as cations. These illustrations are not limiting and they demonstrate the breadth of metathetic reactions which can be used.

The products of the invention and processes for obtaining them are illustrated in the following examples.

Preparation of boron-containing reactants

The preparation of a representative decahydrodecaborate salt used as a reactant, i.e., $(\text{NH}_4)_2\text{B}_{10}\text{H}_{10}$, is described in Example A. The preparation of a representa-

tive substituted polyhydrodecaborate salt, which can be used as a reactant, is described in Example B. The preparation of inner diazonium derivatives having the structural unit $-\text{B}_{10}\text{H}_9\text{N}_2-$ is described in Example C.

EXAMPLE A

Preparation of $(\text{NH}_4)_2\text{B}_{10}\text{H}_{10}$

A reaction vessel having a capacity of about 365 parts of water is charged with 0.79 part of decaborane (14), cooled in liquid nitrogen, and then evacuated to a pressure of 10 microns of mercury. Approximately 21 parts of methyl sulfide is condensed onto the decaborane in the reaction vessel. The reaction vessel is closed, allowed to warm to room temperature about 25° C. and stand for 4 days. During this period, 6.6 millimoles of hydrogen are evolved. The reaction vessel is opened and excess methyl sulfide is removed by distillation, leaving a practically quantitative yield of white solid residue of $\text{B}_{10}\text{H}_{12}\cdot 2\text{S}(\text{CH}_3)_2$. The compound is recrystallized from ethyl acetate and it melts at 122–124° C. The compound is called bis(dimethylsulfide)decaborane (12).

Bis(dimethylsulfide)decaborane (12) (8.5 g.) is mixed with 50 milliliters of liquid ammonia and stirred in a round-bottom reaction vessel for 1 hour with the vessel being cooled to a temperature of about -50° C. by partial immersion in a mixture of solid carbon dioxide and acetone. The cooling bath is then removed and the excess ammonia is allowed to evaporate with stirring. The remaining traces of ammonia are removed by subjecting the residue to a high vacuum (0.01 mm. of mercury) at 25° C. There is obtained 5.6 g. of solid residue which is virtually a quantitative yield of diammonium decahydrodecaborate(2-), i.e., $(\text{NH}_4)_2\text{B}_{10}\text{H}_{10}$.

EXAMPLE B

Preparation of $[(\text{CH}_3)_4\text{N}]_2\text{B}_{10}\text{H}_9\text{C}(\text{O})\text{C}_6\text{H}_5$

An aqueous solution of 40 g. of diammonium decahydrodecaborate(2-) prepared as described in Example A, is passed through a column packed with 2000 ml. of a commercial acidic ion-exchange resin ("Amberlite IR-120-H"). The effluent is warmed to about 40° C. and it is evaporated under reduced pressure (about 10 mm. of Hg or less) to a volume of 70–80 ml. The concentrated solution, which contains the acid $\text{H}_2\text{B}_{10}\text{H}_{10}$, also referred to in solution as $(\text{H}_2\text{O})_2\text{B}_{10}\text{H}_{10}$, is chilled to about 5° C. About 200 ml. of 1,2-dimethoxyethane is added to the chilled solution with stirring and 34 ml. of benzoyl chloride is then added. The reaction mixture is stirred at about 25° C. for two days to yield a dark red solution. A solution is prepared consisting of 80 g. of tetramethylammonium chloride and 375 ml. of methanol and this solution is added with stirring to the red reaction mixture at atmospheric temperature. A precipitate forms which is separated by filtration. The dark red filtrate is stirred and aqueous tetramethylammonium hydroxide is added until the color changes abruptly to a light hue. At this point an additional 5–10 g. of tetramethylammonium hydroxide is added. The reaction mixture is poured slowly and with stirring into 1400 ml. of ethanol. A precipitate forms which is separated by filtration to yield about 25 g. of bis(tetramethylammonium) monobenzenyldecahydrodecaborate(2-), i.e.

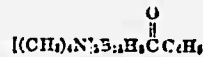

EXAMPLE C

Preparation of $\text{B}_{10}\text{H}_8\cdot 2\text{N}_2$ and $\text{B}_{10}\text{H}_8\cdot \text{S}(\text{CH}_3)_2\cdot \text{N}_2$

A. A solution consisting of 20 g. of $(\text{NH}_4)_2\text{B}_{10}\text{H}_{10}$ in 150 ml. of water is mixed with a solution of 100 g. of NaNO_2 in 250 ml. of water. The solution is chilled to 0–10° C. and a handful of cracked ice is added. As the next step, 100 ml. of 16% hydrochloric acid is added in small portions with stirring and ice is added as needed

to keep the temperature of the reaction mixture below 15° C. A precipitate forms which is separated by filtration to give the solid product and Filtrate "A." The solid is dissolved in methanol and NaBH₄ is added in sufficient quantity to reduce the intermediate product. The solution is stirred a few minutes, water is added and B₁₀H₈·2N₂ precipitates. The compound is separated and recrystallized from aqueous ethanol.

Zinc and hydrochloric acid are added to Filtrate "A" and the mixture is stirred. A further quantity of B₁₀H₈·2N₂ precipitates and it is purified as described earlier. The total quantity of B₁₀H₈·2N₂ which is obtained is 5.2 g.

B. A nitrous acid solution is prepared at about 0° C. (ice-water temperature) consisting of 10 ml. of water, 1.4 g. of NaNO₂ and 6 ml. of 12% HCl solution. The nitrous acid solution is added with stirring to a chilled solution (0-10° C.) consisting of 25 ml. of water and 4.0 g. of the hydrate of NaB₁₀H₉·S(CH₃)₂ obtained as described in Example 43, Part D. A brown solid forms which is separated by filtration and washed thoroughly with water. The solid is extracted three times with ethanol. The ethanol extracts are combined to form a clear red solution, zinc and hydrochloric acid are added in excess, and the mixture is stirred until the color changes from red to green. The solution is separated from unreacted zinc and the liquid is diluted with three times its volume of water. The precipitate which forms is separated, washed and dried to yield 0.25 g. of



The compound is recrystallized from aqueous ethanol. It melts at 135-137° C.

EXAMPLE D

A pressure vessel (capacity, 400 ml.) is charged with 19.0 g. of NaBH₄ and 75 ml. of dry triethylamine. The vessel is cooled in a solid carbon dioxide-acetone bath and the internal pressure is reduced to less than 1.0 mm. pressure by means of a vacuum pump. Diborane (36.0 g.) is introduced into the vessel which is then closed. The mixture is heated with agitation for 10 hours at 150° C. After cooling the vessel and venting to remove volatile products, there remains a solid residue which is washed from the vessel with glyme (1,2-dimethoxyethane). The solid is separated by filtration and it is again washed with glyme. The washed solid is dissolved in hot tetrahydrofuran and the solution is filtered to remove a small quantity of insoluble product. The filtrate is heated to boiling and glyme is added slowly until solid begins to separate. The mixture is chilled and it is then filtered to separate the white crystals. These crystals are washed with glyme and dried at less than 0.001 mm. pressure at 90-100° C. to yield 43.9 g. of Na₂B₁₂H₁₂ containing glyme and water of solvation. Further treatment of the filtrate yields an additional 5.4 g. of the product. The product is dissolved in water and the solution is evaporated to dryness to obtain a compound of the formula Na₂B₁₂H₁₂·H₂O.

A reaction vessel is charged with 120 ml. of water and 20 g. of the monohydrate of Na₂B₁₂H₁₂. The solution is cooled in a mixture of ice and water and chlorine gas is bubbled through the solution until no further absorption of chlorine is evident. The solution is warmed to about 30° C. and passage of chlorine gas is continued until no further uptake of chlorine occurs. The reaction mixture and 50 g. of chlorine is now charged into a corrosion-resistant pressure vessel and the mixture is heated under autogenous pressure at 150° C. for 2 hours. The vessel is cooled, vented to the air, and the reaction mixture is washed from the vessel with water. The solution is neutralized with NH₄OH and filtered. The filtrate is mixed with an aqueous solution of (CH₃)₄NCl and the

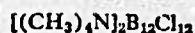

which precipitates is separated, washed and dried in air. It is redissolved in a minimum quantity of water and the solution is passed through a column packed with an acidic ion-exchange resin. The eluate is evaporated under reduced pressure at 25° C. to obtain the hydrate of H₂B₁₂Cl₁₂ as a crystalline white solid.

PREPARATION OF NEUTRAL (NON-IONIC) COMPOUNDS

Example 1

A glass reaction vessel is charged with 3.0 g. of diammonium decahydrodecaborate [(NH₄)₂B₁₀H₁₀] and 50 ml. of dimethyl sulfoxide. Anhydrous hydrogen chloride (0.04 mole) is passed into the mixture with stirring. The reaction mixture is stirred for 1.5 hours at substantially atmospheric pressure. Excess benzene is added to the mixture and the ammonium chloride which precipitates is separated by filtration. The benzene filtrate is extracted with petroleum ether and the solution which is insoluble in petroleum ether is diluted with water. A white solid precipitates which is separated by filtration. There is obtained 0.33 g. of bis(dimethylsulfide)decaborane(8). The compound is recrystallized from alcohol-water solution and it melts at 263-266° C. The compound has the formula B₁₀H₈·2S(CH₃)₂.

Analysis.—Calc'd for B₁₀H₈·2S(CH₃)₂: B, 45.0; C, 19.98; H, 8.39; S, 26.62; M.W., 240. Found: B, 44.29; C, 19.36; H, 7.71; S, 26.65; M.W., 250.

The infrared spectrum of the compound shows a strong absorption band at 4.0μ and weaker absorption bands at 7.0μ, 7.5μ, 9.65μ, 10.0μ, 10.4μ, 10.55μ, 11.5μ, 12.4μ, 13.7μ, and 14.5μ. The compound does not reduce a solution of silver nitrate in alcohol.

Example 2

A. A glass reaction vessel is charged with 30 g. of diammonium decahydrodecaborate and 105 cc. of dimethyl sulfoxide. The mixture is stirred until a clear solution is formed and anhydrous hydrogen chloride is then bubbled into the mixture with continued stirring. An exothermic reaction sets in and the vessel is immersed in an ice bath to maintain the temperature below 45° C. A large quantity of ammonium chloride forms as a precipitate and the solution is filtered to separate the solid. The filtrate is returned to the reaction vessel and passage of hydrogen chloride is continued until the reaction is no longer exothermic. The mixture is filtered again and the filtrate is diluted with water. A sticky mass forms which is separated by decantation of the water. The mass is triturated alternately with water and with acetone to separate the portions which are soluble in each of these liquids. The acetone extract is diluted with water and the solid which precipitates is separated by filtration. The solid is purified by repeated solution in acetone and precipitation with water and, finally, by crystallization from acetone-water solution. The solid so obtained, which is B₁₀H₈·2S(CH₃)₂, melts at 265-266° C.

Analysis.—Calc'd for B₁₀H₈·2S(CH₃)₂: B, 45.0; C, 19.98; H, 8.39; S, 26.62. Found: B, 44.69; C, 19.56; H, 8.32; S, 27.19.

The infrared spectrum shows the same absorption bands as the compound of Example 1. In addition, the following weak bands are also observed: 11.2μ, 11.75μ and 12.1μ.

B. A reaction vessel is charged with a solution consisting of 4.0 g. of (NH₄)₂B₁₀H₁₀ (0.026 moles) and 20 ml. of dimethylsulfoxide (about 0.25 mole). The vessel is immersed in an ice bath and hydrogen chloride gas is bubbled into the mixture for 1 hour at a rate to maintain the temperature at about 6° C. The reaction mixture is poured into 200 ml. of cold water and the solid product which forms is separated by filtration. The product, which is B₁₀H₈·2S(CH₃)₂, is recrystallized from 50% aqueous ethanol. Yield, 41%.

C. A reaction vessel is charged with a mixture consist-

23

ing of 0.026 mole of $(\text{NH}_4)_2\text{B}_{10}\text{H}_{10}$, 20 ml. of glacial acetic acid, and 0.045 mole of dimethylsulfoxide. Hydrogen chloride is bubbled into the mixture for about one hour. The reaction is exothermic in its initial stage (for about 15 minutes) and the mixture is cooled to maintain a temperature of about 60° C. Following completion of the reaction, the mixture is cooled slowly to about 25° C. The precipitated material is separated by filtration and it is washed thoroughly with water. The compound $\text{B}_{10}\text{H}_8\cdot 2\text{S}(\text{CH}_3)_2$ is obtained in substantially pure form in better than 50% yield.

Example 3

A. The process of Example 2, Part B, is repeated employing 0.026 mole $(\text{NH}_4)_2\text{B}_{10}\text{H}_{10}$, 0.045 mole of diethylsulfoxide and 20 ml. of glacial acetic acid. Bis(diethylsulfoxide)decaborane(8), i.e., $\text{B}_{10}\text{H}_8\cdot 2\text{S}(\text{C}_2\text{H}_5)_2$, is obtained in excellent yield as a white crystalline solid, M.P. 70° C.

B. A reaction vessel is charged with 10 ml. of water, 9 p.p. of $(\text{NH}_4)_2\text{B}_{10}\text{H}_{10}$ and 15 ml. of concentrated aqueous hydrochloric acid. The mixture is stirred until a solution is obtained and 14 g. of diethyl sulfoxide is added with stirring. An exothermic reaction sets in and, after a few seconds' warming on a steam bath, about 3 ml. of water is added to the mixture to reduce the vigor of the reaction. The mixture is stirred until it cools to about 25° C. and, at this point, it consists of two layers. The reaction mixture is extracted with chloroform and the extract is dried successively with calcium chloride and with anhydrous calcium sulfate. The dried extract is filtered and the chloroform is removed by evaporation. The residue is dissolved in ethyl acetate and petroleum ether is added

to the solution until an oil separates. The mixture is chilled in ice for about 1 hour, after which it is allowed to stand about 15 hours at prevailing atmospheric temperature (about 25° C.). Partial crystallization of the oil occurs and separation of the crystals is effected by filtration. The crystals are bis(diethylsulfoxide)decaborane(8), i.e., $\text{B}_{10}\text{H}_8\cdot 2\text{S}(\text{C}_2\text{H}_5)_2$. The identity of the compound is confirmed by its infrared absorption spectrum.

In the process, as illustrated in Examples 2 and 3, inert solvents other than water and glacial acetic acid are operable. To illustrate, $(\text{NH}_4)_2\text{B}_{10}\text{H}_{10}$, $(\text{C}_2\text{H}_5)_2\text{SO}$ and HCl are reacted in methanol or in 1,2-dimethoxyethane to form $\text{B}_{10}\text{H}_8\cdot 2\text{S}(\text{C}_2\text{H}_5)_2$.

The sulfoxides employed in the process illustrated in Examples 1-3 can advantageously be prepared in situ by oxidizing the organic sulfide with hydrogen peroxide. This method of operation is illustrated in Examples 3-A, 4 and Examples 6-20.

Example 3-A

A solution of 11.1 g. of dibenzyl sulfide in 20 ml. of glacial acetic acid is cooled, stirred and 5.9 g. of 30% hydrogen peroxide is added dropwise. The temperature is maintained below 20° C. The mixture is allowed to warm to atmospheric temperature (ca. 25° C.) and 4.0 g. of $(\text{NH}_4)_2\text{B}_{10}\text{H}_{10}$ is added. The ammonium salt does not dissolve in the reaction mixture. Hydrogen chloride gas is bubbled into the mixture for one hour and the temperature is maintained below 60° C. A heavy gum forms on the bottom of the reaction mixture. The gum is separated and it is dissolved in chloroform. The solution is washed with water and with aqueous K_2CO_3 solution and

24

then dried over CaCl_2 . The dried solution is filtered and the filtrate is evaporated to dryness to obtain

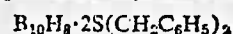

as a white crystalline product. It is purified by recrystallization from chloroform-petroleum mixture. The product melts at 138° C.

Analysis.—Calc'd for $\text{B}_{10}\text{H}_8\cdot 2\text{S}(\text{CH}_2\text{C}_6\text{H}_5)_2$: C, 61.9; H, 6.6; B, 19.9. Found: C, 60.8; H, 6.3; B, 18.9.

Example 4

A reaction vessel is charged with 0.053 mole of an organic sulfide and 20 ml. of glacial acetic acid. The vessel is cooled in an ice bath and 0.053 mole of 30% hydrogen peroxide is added dropwise with stirring. The temperature is maintained at about 50° C. during this phase of the process. After addition of hydrogen peroxide is completed, the mixture is preferably allowed to stand one or more hours at 25° C. if the sulfide employed as a reactant bears an aryl group. In the event alkyl sulfides are employed, the reaction proceeds rapidly and the mixture need not stand for a period of time. Following completion of the hydrogen peroxide reaction, 4 g. of

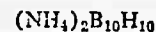

are added to the reaction mixture with stirring. Hydrogen chloride gas is bubbled into the mixture for about 1 hour and the temperature is maintained at about 60° C. during the initial exothermic stage of the reaction. The product is isolated as described earlier. The process described above is used to obtain the compounds described in Table I.

TABLE I

Organic Sulfide Reactant	Decaborate Reactant	Compound Obtained	Physical Properties
$\text{S}(\text{CH}_2\text{CH}_2\text{CH}_3)_2$	$(\text{NH}_4)_2\text{B}_{10}\text{H}_{10}$	$\text{B}_{10}\text{H}_8\cdot 2\text{S}(\text{CH}_2\text{CH}_2\text{CH}_3)_2$	Clear liquid.
$\text{S}(\text{CH}_2\text{CH}_2\text{CH}_2\text{CH}_3)_2$	$(\text{NH}_4)_2\text{B}_{10}\text{H}_{10}$	$\text{B}_{10}\text{H}_8\cdot 2\text{S}(\text{CH}_2\text{CH}_2\text{CH}_2\text{CH}_3)_2$	Do.
$\text{S}(\text{CH}_3)(\text{C}_6\text{H}_5)$	$(\text{NH}_4)_2\text{B}_{10}\text{H}_{10}$	$\text{B}_{10}\text{H}_8\cdot 2\text{S}(\text{CH}_3)(\text{C}_6\text{H}_5)$	White crystalline solid.

Example 5

A solution is prepared consisting of 21.4 g. of thiophenol, 10.9 g. of KOH and 100 ml. of ethanol. To this solution, 31.5 g. of $\text{B}_{10}\text{H}_8\cdot 2\text{CH}_2\text{SC}_6\text{H}_5$ (prepared as described in Example 4) is added and the resulting suspension is refluxed for 6 hours. The reaction mixture is filtered and a solution of 60 g. of CsF in 100 ml. of ethanol is added to the filtrate. A white precipitate forms which is separated, washed and recrystallized from aqueous ethanol to obtain $\text{C}_{52}\text{B}_{10}\text{H}_8(\text{SC}_6\text{H}_5)_2$. This compound is employed as a reactant in the next step of the process.

A solution of 3.2 g. of allyl bromide in 10 ml. of dimethylacetamide is added dropwise and with stirring to a solution of 6.0 g. of $\text{C}_{52}\text{B}_{10}\text{H}_8(\text{SC}_6\text{H}_5)_2$ in 25 ml. of dimethylacetamide. A white precipitate forms immediately which is C_6Br . It is separated by filtration and the filtrate is diluted with 300 ml. of water. The diluted filtrate is cooled and a gum precipitates. The gum is separated, dissolved in ethyl acetate and the solution is treated with activated carbon to remove impurities. The purified solution is evaporated to obtain the gum as a residue. The gum is triturated with petroleum ether to solidify it. The product thus obtained is bis(allyl phenyl sulfide)octahydrodecaborane(8).

Analysis.—Calc'd for

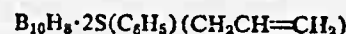

B, 25.95; C, 51.90; H, 6.73; S, 15.42. Found: B, 25.08; C, 50.90; H, 6.58; S, 15.19.

Example 5-A

A reaction vessel is charged with 5.0 g. of

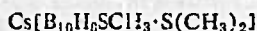

prepared as described in Example 53, and 25 ml. of dimethylacetamide. The mixture is stirred to form a solution to which 2.36 g. of allyl iodide is added gradually. The reaction mixture becomes warm and a white solid separates rapidly. The reaction mixture, of which the liquid portion is pale violet in color, is poured with stirring into 100 ml. of water. A yellow gum-like precipitate forms which is changed to a solid by maceration in water. The solid is separated and recrystallized three times from hot methanol to obtain grayish crystals of



i.e., dimethylsulfidomethyl(allyl)sulfide - octahydrodecaborane(3). The identity of the compound is confirmed by its infrared absorption spectrum.

The process illustrated in Examples 5 and 5-A, which has not been discussed earlier, is particularly appropriate for the preparation of compounds of the invention in which Z is an organic sulfide in which the sulfur is bonded to one or two olefinically unsaturated groups, i.e., a sulfide of the formula SR_2 , where at least one of the R groups is an olefinically unsaturated hydrocarbon. The process employs as one reactant an allylic halide, i.e., a compound which contains the structure

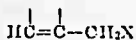

where X is chlorine, bromine or iodine and the free valences on the doubly bonded carbons are satisfied by hydrogen, alkyl, cycloalkyl or aryl groups, and, as a second reactant, a B_{10} compound which bears one or two -SR groups on the boron cage and is represented by one of the following formulas:

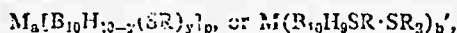

where M is a cation (preferably ammonium or alkali metal), R is an organic radical as defined previously and is preferably a hydrocarbon group up to 12 carbons which is free of acetylenic unsaturation, y is 1 or 2, a and b are positive whole numbers of 1-3, inclusive, whose values are determined by the valence of M and satisfy the equation: $2b = a \times \text{valence of M}$, and b' is the valence of M and has a value of at least 1.

The following examples illustrate products which can be obtained by the process of Examples 5 and 5-A, and the reactants which are employed:

$\text{NaB}_{10}\text{H}_9\text{S}(\text{C}_6\text{H}_5)(\text{CH}_2-\text{CH}=\text{CH}_2)$ from $\text{NaB}_{10}\text{H}_9\text{SC}_6\text{H}_5$ and $\text{CH}_2=\text{CH}-\text{CH}_2\text{I}$;
 $\text{B}_{10}\text{H}_8\text{S}(\text{CH}_3)_2(\text{CH}_2\text{CH}=\text{CH}_2)$ from $\text{Cs}_2\text{B}_{10}\text{H}_8(\text{SCH}_3)_2$ and $\text{CH}_2=\text{CH}-\text{CH}_2\text{Br}$;
 $\text{LiB}_{10}\text{H}_9\text{S}(\text{C}_6\text{H}_5)_2[\text{CH}_2\text{C}(\text{CH}_3)=\text{CH}_2]$ from $\text{Li}_2\text{B}_{10}\text{H}_9\text{SC}_6\text{H}_5$ and $\text{CH}_2=\text{C}(\text{CH}_3)-\text{CH}_2\text{Cl}$;
 $\text{B}_{10}\text{H}_8\text{S}(\text{C}_2\text{H}_5)(\text{CH}_2\text{CH}=\text{CH}_2)\text{S}(\text{C}_6\text{H}_5)_2$ from $\text{KB}_{10}\text{H}_9\text{SC}_2\text{H}_5\text{S}(\text{C}_6\text{H}_5)_2$ and $\text{CH}_2=\text{CH}-\text{CH}_2\text{Cl}$;
 $\text{B}_{10}\text{H}_8\text{S}(\text{CH}_2\text{C}_6\text{H}_5)_2(\text{CH}_2\text{C}(\text{CH}_3)=\text{CH}_2)$ from $\text{Cs}_2\text{B}_{10}\text{H}_8(\text{SCH}_2\text{C}_6\text{H}_5)_2$ and $\text{CH}_2=\text{C}(\text{CH}_3)-\text{CH}_2\text{Br}$; and
 $\text{NH}_4\text{B}_{10}\text{H}_9\text{S}(\text{C}_6\text{H}_5)_2(\text{CH}_2-\text{CH}=\text{CH}-\text{CH}_2)$ from $(\text{NH}_4)_2\text{B}_{10}\text{H}_9\text{SC}_6\text{H}_5$ and $\text{CH}_3\text{CH}=\text{CH}-\text{CH}_2\text{I}$

Example 6

The sulfoxide of chloromethyl methyl sulfide is prepared in situ by oxidation of 19.2 g. (0.20 mole) of chloromethyl methyl sulfide dissolved in 40 ml. of acetic acid by the dropwise addition of 22.3 g. (0.20 mole) of 30% hydrogen peroxide. Temperature is maintained at 10-15° C. during the addition. The solution is allowed to warm to room temperature and 15.4 g. (0.10 mole) of $(\text{NH}_4)_2\text{B}_{10}\text{H}_{10}$ is added. Hydrogen chloride gas is bubbled through the mixture until evolution of heat is no longer observed. About 1 hour is required at a moderate

HCl flow. The product $\text{B}_{10}\text{H}_8\text{S}(\text{CH}_3)_2(\text{CH}_2\text{Cl})$ is isolated by methods described previously.

Example 7

A solution consisting of 29.8 g. of 4-chlorothioanisole and 100 ml. of glacial acetic acid is cooled in ice water and 22.6 g. of 30% hydrogen peroxide is added dropwise and with stirring. The temperature of the solution is kept below 20° C during the operation. After addition of peroxide is completed, the solution is allowed to warm to atmospheric temperature (about 25° C.) and 15.4 g. of $(\text{NH}_4)_2\text{B}_{10}\text{H}_{10}$ is added with stirring. Gaseous hydrogen chloride is bubbled through the mixture for 1 hour and the temperature is kept at 60° C. or below during the exothermic phase of the reaction. A gum separates from the mixture in the process and it is recovered by decantation. The gum is stirred with water to remove NH_4Cl , after which it is crystallized from an aqueous solution of 1,2-dimethoxyethane. The product is di(p-(methylmercapto)-chlorobenzene)octahydrodecaborane(8). The identity of the compound is confirmed by its infrared absorption spectrum and by elemental analysis.

Analysis.—Calc'd for $\text{B}_{10}\text{H}_8(\text{CH}_2\text{SC}_6\text{H}_4\text{Cl})_2$: C, 38.8; H, 5.08; B, 25.0; S, 14.6; Cl, 16.4. Found: C, 38.98; H, 5.43; B, 26.22; S, 14.69; Cl, 17.06.

Example 8

A small quantity of $(\text{CH}_3)_2\text{NB}_{10}\text{H}_9\text{SCH}_2\text{S}(\text{CH}_3)_2$, obtained as described in Example 52, Part A, is dissolved in dimethylformamide. Methylene iodide (CH_2I_2) is added slowly to the solution with stirring until precipitation of tetramethylammonium iodide is complete. The solid is separated by filtration and the filtrate is diluted with water. A gummy solid precipitates which is separated and crystallized from water. There is obtained

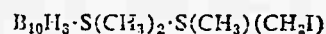

a pale pink solid which melts at 103-104° C.

Analysis.—B (calc'd), 23.2; B (found), 20.1.

Example 9

The sulfoxide of β,β' -thiodipropionitrile is prepared in situ by oxidation of 28.0 g. (0.20 mole) of β,β' -thiodipropionitrile dissolved in 40 ml. of acetic acid by the dropwise addition of 22.3 g. (0.20 mole) of 30% hydrogen peroxide. The temperature is maintained at 10-15° C. during the addition. The solution is allowed to warm to room temperature and 15.4 g. (0.10 mole) of $(\text{NH}_4)_2\text{B}_{10}\text{H}_{10}$ is added. Hydrogen chloride gas is bubbled through the mixture until evolution of heat is no longer observed. About 1 hour is required at a moderate HCl flow. The product $\text{B}_{10}\text{H}_8\text{S}(\text{CH}_2\text{CH}_2\text{CN})_2$ is isolated by methods described previously.

Example 10

A reaction vessel is charged with 11.0 g. of $\text{CH}_3\text{CH}_2\text{SCH}_2\text{CH}_2\text{OH}$ and about 40 ml. of glacial acetic acid. The mixture is stirred to form a solution and it is cooled in an ice bath. Now 11.8 g. of 30% hydrogen peroxide is added dropwise to the solution with stirring, maintaining the temperature below 20° C. during the operation. Stirring is continued and 8.0 g. of $(\text{NH}_4)_2\text{B}_{10}\text{H}_{10}$ is added to the mixture to form a suspension. Hydrogen chloride gas is now bubbled through the mixture for 1 hour and the temperature is maintained at about 60° C. during the initial exothermic phase of the reaction. The mixture is filtered to remove NH_4Cl and the filtrate is poured into 200 ml. of a mixture of ice and water. A tar precipitates from which the water is removed by decantation. The tar is dissolved in CHCl_3 and the solution is washed with dilute aqueous K_2CO_3 solution and distilled water, respectively. The solution is dried over calcium chloride and filtered. The filtrate is kept under reduced pressure to remove the chloroform. An oily residue remains which is a compound of the for-

mole $B_{10}H_8[C_2H_5SCH_2CH_2OC(O)CH_3]_2$. The identity of the product is confirmed by its infrared absorption spectrum.

Example 11

A reaction mixture is prepared consisting of $(NH_4)_2B_{10}H_{10}$ and $C_2H_5S(O)CH_2CHOHCH_2CH_3$ (in 1:2 molar ratio) dissolved in glacial acetic acid. Hydrogen chloride gas is passed into the mixture and the reaction is conducted as described in previous examples. The product which is isolated is



Analysis.—Calc'd for above compound: C, 33.8; H, 7.2; B, 19.4; S, 11.5. Found: C, 34.1; H, 8.07; B, 25.43; S, 13.50.

The infrared spectrum of the compound shows absorption at the following wavelengths (expressed as cm^{-1}): 4.0, 5.8, 8.1, 8.7, and 9.6.

Example 12

The sulfide of 2,2'-thiodiethanol is prepared in situ by oxidation of 24.4 g. (0.20 mole) of 2,2'-thiodiethanol dissolved in 40 ml. of acetic acid by the dropwise addition of 22.3 g. (0.20 mole) of 30% hydrogen peroxide. The temperature is maintained at 10–15° C. during the addition. The solution is allowed to warm to room temperature and 15.4 g. (0.10 mole) of $(NH_4)_2B_{10}H_{10}$ is added. Hydrogen chloride gas is bubbled through the mixture until evolution of heat is no longer observed. About 1 hour is required at a moderate HCl flow. The product which is isolated is $B_{10}H_8 \cdot 2S[CH_2CH_2OC(O)CH_3]_2$.

Example 13

The product obtained in Example 10, i.e.,



is dissolved in ethanol. The solution is heated to boiling and gaseous hydrogen chloride is passed into the solution for 1 minute. Passage of gas is stopped and the solution is warmed at steam bath temperature until the ethanol is evaporated. A heavy oil remains which is



The identity of the compound is confirmed by its infrared absorption spectrum and by elemental analysis.

Analysis.—Calc'd for $B_{10}H_8(C_2H_5OS)_2$: C, 29.07; H, 8.40; B, 29.95. Found: C, 29.3; H, 8.55; B, 32.9.

Example 14

Hydrogen chloride gas is bubbled for 1 minute into a solution of 18.0 g. (0.05 mole) of



obtained in Example 12, in 40 ml. of ethanol. The ethanol is evaporated from the solution by warming on a steam bath. The product, $B_{10}H_8 \cdot 2S(CH_2CH_2OH)_2$, remains as a residue.

Example 15

A reaction vessel is charged with a solution consisting of 29.7 g. of KOH and 200 ml. of methanol. To this solution 57.1 g. of thioglycerol



is added dropwise with stirring at prevailing atmospheric temperature. The temperature rises somewhat in this step but, in this instance, the rise is not enough to require cooling. Ethyl bromide (57.1 g.) is now added dropwise with stirring and the temperature is maintained at 20–25° C. by means of an ice bath. The solution is stirred for 2 hours after addition of the bromide is completed. It is then filtered to separate KBr. The filtrate is strongly basic and solid carbon dioxide is added to reduce the basicity. The solution is warmed to prevailing atmospheric temperature and a white gelatinous

solid precipitates. The solid is separated by filtration, the filtrate is distilled to remove methanol and the liquid residue is again filtered to remove a solid which is present. The clear liquid which remains is



and it is used in the next step in the process.

To a solution of 14.2 g. of $HOCH_2CH_2OHCH_2SC_2H_5$ in acetic acid, cooled in ice, 11.3 g. of 30% H_2O_2 is added dropwise with stirring. The reaction is highly exothermic and cooling is required. When this step is completed, 8.0 g. of $(NH_4)_2B_{10}H_{10}$ is added to the solution and gaseous hydrogen chloride is bubbled through the mixture for 1 hour. The reaction mixture is filtered to remove NH_4Cl and the filtrate is poured into 400 ml. of a mixture of ice and water. An oil forms which is separated by decantation and allowed to dry in the air. It is washed with hot ethyl acetate and macerated with ethyl ether. The oil slowly solidifies to a yellow powder. The powder is washed with petroleum ether and dried in air to yield a compound of the formula

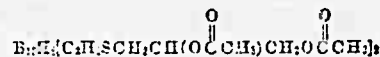

The identity of the compound is confirmed by its infrared absorption spectrum and by elemental analysis.

Analysis.—Calc'd for the above compound: H, 8.25; B, 27.8. Found: H, 8.07; B, 25.43.

Example 16

A solution is prepared consisting of 15.4 g. of ethylmercaptoacetic acid and 40 ml. of glacial acetic acid. The solution is cooled to 0–5° C. and 11.8 g. of 30% hydrogen peroxide is added dropwise with stirring. The temperature of the solution is maintained at about 5° C. during this operation. Eight grams of $(NH_4)_2B_{10}H_{10}$ is now added to the solution and gaseous HCl is bubbled through the mixture for 1 hour. The reaction is exothermic and the temperature of the mixture is not permitted to rise above 60° C. during the exothermic phase. The mixture is filtered to remove NH_4Cl and the filtrate is warmed under reduced pressure to remove the acetic acid. A yellow oil remains which is



The oil is dissolved in water and an aqueous solution of lead acetate is added dropwise until precipitation of the lead salt is complete. The solid is separated and dried to yield the lead salt as a light yellow product. The identity of the compound is confirmed by its infrared absorption spectrum and by elemental analysis.

Analysis.—Calc'd for



C, 17.1; H, 3.91; B, 19.3; Pb, 36.8; S, 11.4. Found: C, 17.89; H, 4.17; B, 15.01; Pb, 38.35; S, 10.30.

The free acid can be obtained from the lead salt by suspending the salt in water and passing hydrogen sulfide into the suspension. Lead sulfide precipitates and the solution is filtered to obtain an aqueous solution of $B_{10}H_8(C_2H_5SCH_2COCH)_2$.

Example 17

A reaction vessel is charged with 17.8 g. of thiodipropionic acid ($HOOCCH_2CH_2SCH_2CH_2COOH$) and 100 ml. of glacial acetic acid. The mixture is cooled to ice bath temperatures and 11.3 g. of 30% hydrogen peroxide is added dropwise with stirring, keeping the temperature of the mixture below 20° C. during the operation. The solid initially present in the mixture dissolves in the process. Now 7.7 g. of $(NH_4)_2B_{10}H_{10}$ is added to the mixture and hydrogen chloride gas is bubbled through the mixture for about 1 hour. The reaction is exothermic in its initial phase and the temperature is maintained at 50° C. or below by ice water cooling. The mixture is filtered to remove NH_4Cl and

the filtrate is poured into 200 ml. of water. A solution of lead acetate is added to the filtrate and a white solid precipitates. The solid is separated, washed with water, ethyl ether and petroleum ether. The washed solid is boiled in 200 ml. of water for a short time and the mixture is filtered while still hot. The solid which remains is again washed with ethanol and ethyl ether to obtain a product which is principally a lead salt of

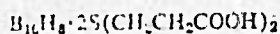

ie,

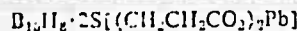

The lead salt can be suspended in water and hydrogen sulfide bubbled through the suspension to precipitate lead sulfide and leave a solution of the acid. Filtration of the mixture followed by evaporation of the filtrate will yield the free tetrabasic acid in which the acidity resides in the four carboxylic groups.

Example 18

A solution consisting of 33.8 g. of 3-nitrophenyl methyl sulfide in 100 ml. of glacial acetic acid is cooled in an ice bath and 22.7 g. of 30% hydrogen peroxide is added with stirring. The temperature of the mixture is maintained below 20° C. during the operation. After addition of peroxide is completed, the solution is allowed to warm to prevailing atmospheric temperature and 15.4 g. of $(NH_4)_2B_{10}H_{10}$ is added with stirring. Gaseous hydrogen chloride is bubbled through the reaction mixture and the temperature is maintained at 60° C. during the exothermic phase of the reaction. After 1 hour, passage of hydrogen chloride is stopped and a gum which forms in the mixture during the operation is separated. The gum is washed with water and crystallized from ethyl ether-petroleum ether mixture to obtain di[m-(methylmercapto)nitrobenzene]octahydrodecaborane (8) as white crystals.

Analysis.—Calc'd for $B_{10}H_8(CH_3SC_6H_4NO_2)_2$: C, 37.0; H, 4.2; N, 6.2. Found: C, 37.18; H, 5.6; N, 5.2.

Example 19

A reaction vessel is charged with a solution consisting of 56.0 g. of KOH and 250 ml. of C_2H_5OH . The vessel is cooled and a solution of 56.5 g. of



in 100 ml. of C_2H_5OH is added dropwise with stirring. The reaction is exothermic and the temperature of the mixture is kept at about 30° C. or less. After addition of the amine is completed, 54.5 g. of C_2H_5Br is added dropwise with stirring. The temperature is maintained at about 30° C. The precipitate (KBr) which forms is separated by filtration and gaseous HCl is bubbled through the filtrate. The warm solution is filtered and the filtrate is chilled to precipitate the hydrochloride of $CH_3CH_2SCH_2CH_2NH_2$ as white crystals. The compound is purified by crystallization from C_2H_5OH and it is used in the next step in the reaction.

Analysis.—Calc'd for $(C_2H_5SC_2H_4NH_2)Cl$: C, 34.1; H, 8.5. Found: C, 33.7; H, 8.5.

A solution of 7.3 g. of $(CH_3CH_2SCH_2CH_2NH_2)Cl$ in 20 ml. of CH_3COOH is cooled in an ice bath and 5.9 g. of 30% hydrogen peroxide is added dropwise with stirring. The solution is permitted to warm to prevailing atmospheric temperature and 4.0 g. of $(NH_4)_2B_{10}H_{10}$ is added. The solution is stirred and gaseous hydrogen chloride is bubbled through it for 1 hour. The reaction is exothermic in its initial phase and the temperature of the solution is not allowed to rise above 60° C. The solution is filtered to separate NH_4Cl and the filtrate is poured into 200 ml. of a mixture composed of equal volumes of ethyl ether and ethanol. A yellow oil separates. The solvent is separated from the oil and 100 ml. of ethyl ether is added to the solvent. A second fraction of oil is obtained. The solvent is again separated from the oil and 50 ml. of

petroleum ether is added to the solvent. The solution is cooled and allowed to stand. Fine white crystals form which are removed by filtration to obtain the hydrochloride of $B_{10}H_8(CH_3CH_2SCH_2CH_2NH_2)_2$. The identity of the compound is confirmed by its infrared absorption spectrum and by elemental analysis.

Analysis.—Calc'd for $B_{10}H_8(C_2H_5SC_2H_4NH_2)Cl$: C, 24.1; H, 8.02; B, 27.1; N, 7.01. Found: C, 23.74; H, 8.16; B, 24.9; N, 7.4.

Example 20

A. A solution consisting of 13.9 g. of 4-aminophenyl methyl sulfide [p-(methylmercapto)aniline] and 50 ml. of glacial acetic acid is cooled and 11.3 g. of 50% hydrogen peroxide is added dropwise with stirring. The temperature of the reaction mixture is kept at less than 20° C. After addition of the peroxide is completed, the reaction mixture is allowed to warm to prevailing atmospheric temperature and 7.7 g. of $(NH_4)_2B_{10}H_{10}$ is added. Hydrogen chloride is bubbled through the mixture for 1 hour, maintaining the temperature at 60° C. during the exothermic phase. After 1 hour, the flow of hydrogen chloride is stopped and the reaction mixture is filtered. The filtrate is diluted with 50 ml. of water and decolorizing carbon is added with stirring. The suspension is filtered, the clear filtrate is poured into 1500 ml. of ice water and a concentrated aqueous solution of 100 g. of sodium acetate is added with stirring. A white curd-like solid precipitates which is separated by filtration and washed. The product is bis[p-(methylmercapto)aniline]octahydrodecaborane (8). Its identity is confirmed by the infrared absorption spectrum and by elemental analysis.

Analysis.—Calc'd for $B_{10}H_8(CH_3SC_6H_4NH_2)_2$: C, 44.6; H, 6.6; N, 7.1. Found: C, 42.36; H, 6.79; N, 6.93.

B. The process of Part A is repeated employing 3-aminophenyl methyl sulfide in place of 4-aminophenyl methyl sulfide. Quantities of reactants are unchanged. The product which is isolated is bis[m-(methylmercapto)aniline]octahydrodecaborane (8).

Analysis.—Calc'd for $B_{10}H_8(CH_3SC_6H_4NH_2)_2$: C, 42.6; H, 6.6; B, 27.4. Found: C, 41.09; H, 6.62; B, 26.56.

The process of preparing the sulfoxides in situ is generic for obtaining compounds of the invention in which Z is an organic sulfide. To illustrate, the sulfoxide of DL-methionine is prepared in situ by oxidation of 29.8 g. (0.2 mole) of DL-methionine dissolved in 40 ml. of acetic acid by the dropwise addition of 22.3 g. (0.20 mole) of 30% hydrogen peroxide. The temperature is maintained at 10–15° C. during the addition. The solution is allowed to warm to room temperature and 15.4 g. (0.10 mole) of $(NH_4)_2B_{10}H_{10}$ is added. Hydrogen chloride gas is bubbled through the mixture until evolution of heat is no longer observed. About 1 hour is required at a moderate HCl flow. The product is isolated as a white crystalline compound which is amphoteric, i.e., it is soluble in acidic and basic solutions.

The compounds obtained in the preceding examples which bear functional substituents can be employed as intermediates to obtain products which fall within the scope of the invention, as illustrated in Examples 21–25 which follow.

Example 21

A solution consisting of 5 ml. of pyridine and 1.3 g. of di[3-(methylmercapto)aniline]octahydrodecaborane (8) is stirred with 2.0 ml. of benzoyl chloride. The solution becomes warm and it is allowed to stand at prevailing atmospheric temperature for 30 minutes. It is then poured into 25 ml. of water. An oil precipitates which is separated and macerated with ethanol until it solidifies. The solid is dissolved in tetrahydrofuran and the solution is passed through a column packed with silica gel. The purified solution is warmed to remove tetrahydrofuran, leaving di[N-(3-methylmercapto)phenyl]benzamide]octahydrodecaborane (8) as a white solid. The identity of the compound is confirmed by elemental analysis.

Analysis.—Calc'd for



C, 55.7; H, 5.65; B, 17.9. Found: C, 55.3; H, 6.14; B, 16.71.

Example 22

A reaction vessel is charged with 1.3 g. of bis-(3-methylmercapto)aniline]octahydrodecaborane(8) and 5 ml. of pyridine. The mixture is stirred and 2 ml. of phenylisocyanate is added. The solution becomes warm, and it is allowed to stand at prevailing temperature for about 30 minutes. The solution is poured into 25 ml. of water and a yellow gum precipitates. The gum is separated and it is stirred repeatedly with water and finally with ethanol to remove impurities. The product which remains is dried to yield di[N-phenyl-N'-(3-methylmercapto)phenyl]urea]octahydrodecaborane(8). The identity of the compound is confirmed by elemental analysis.

Analysis.—Calc'd for

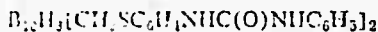

C, 53.2; H, 5.7; B, 17.0. Found: C, 53.2; H, 5.68; B, 15.29.

Example 23

A reaction vessel is charged with 2.5 g. of bis-(p-methylmercapto)aniline]octahydrodecaborane(8), 10 g. of ice and 10 ml. of concentrated hydrochloric acid. The reaction vessel and contents are cooled and a solution (also cooled) of 0.9 g. of NaNO₂ in 10 ml. of H₂O is added dropwise with stirring. The reaction mixture becomes light brown and most of the solid dissolves. The mixture is filtered and 5 ml. of an aqueous 2.5 molar solution of NaOH is added to the filtrate. A brown precipitate forms which is separated by filtration. The solid is washed with a small quantity of water and dried under reduced pressure over P₂O₅ at atmospheric temperature to obtain a product whose infrared spectrum shows it to be principally bis(p-(methylmercapto)phenyl)diazonium tetrafluoroborate]octahydrodecaborane(8), i.e.,

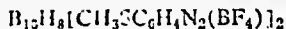

Example 24

A. A reaction vessel is charged with 2.0 g. of bis(m-methylmercapto)aniline]octahydrodecaborane(8), 10 g. of ice and 10 ml. of concentrated hydrochloric acid. The reaction mixture is stirred to form a suspension and it is cooled in an ice bath. A solution of 0.7 g. of NaNO₂ in 10 ml. of water is added dropwise to the suspension with stirring. Substantially all of the solid dissolves to form a pale yellow solution. Cooling of the solution is continued and 1.36 g. of (CH₃)₂NC₆H₅ is added dropwise with stirring. The color of the reaction mixture becomes darker. A solution of about 2.0 g. of sodium acetate in 25 ml. of water is added slowly and with stirring to the mixture and a deep red precipitate forms.

The mixture is allowed to stand for 30 minutes at ice temperature and it is then warmed to atmospheric temperature. After standing 1 hour at this temperature, the mixture is filtered and the deep red solid material is dried to obtain a product whose infrared absorption

spectrum shows that it is principally bis(3-methylmercapto-4'-dimethylaminoazobenzene)octahydrodecaborane(8), i.e.,

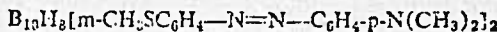

where *m* and *p* in the formula represent meta and para positions for the substituents.

B. The reaction of Part A above is repeated, employing bis(p-(methylmercapto)aniline]octahydrodecaborane(8), as the reactant in place of the meta compound used above. The product which is obtained is shown by its infrared absorption spectrum to be principally bis(4-methylmercapto-4'-dimethylaminoazobenzene)octahydrodecaborane(8), i.e.,

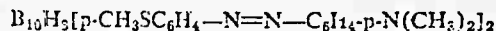

Example 25

A mixture is prepared which consists of 10 g. of ice, 10 ml. of concentrated hydrochloric acid and 2.0 g. of B₁₀H₈(m-CH₂SC₆H₄NH₂)₂. The mixture, which is a suspension, is cooled in ice and to it a solution of 0.7 g. of NaNO₂ in 10 ml. of water is added dropwise with vigorous stirring. Substantially all of the solid dissolves to form a pale yellow solution. This solution is added dropwise to a cold solution which consists of 1.47 g. of α-naphthol, 40 ml. of water and 6.4 g. of NaOH. A dark red brown precipitate forms immediately. The reaction mixture is stirred for 30 minutes at ice bath temperature and it is then allowed to warm to prevailing atmospheric temperature. After standing 1 hour the mixture is filtered to separate the solid product. This product is washed with ethanol, ether and petroleum ether and then dried in air. The product is bis[methylmercapto-3-(4'-hydroxynaphthyl)azobenzene]octahydrodecaborane(8), i.e., a compound of the following formula

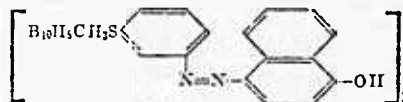

The identity of the compound is confirmed by its infrared absorption spectrum and by elemental analysis.

Analysis.—Calc'd for the above compound: C, 58.2; H, 5.1; N, 7.95; B, 15.4. Found: C, 54.72; H, 5.13; N, 6.00; B, 15.22.

The processes of Examples 1 through 25 are generic for the preparation of compounds of Formula 1 and particularly Formula 4, where Z is an organic sulfide. A broad range of compounds can be obtained by choice of an appropriate sulfide and by modification of functional groups in the sulfide molecule.

To illustrate, the following compounds can be obtained by employing the reactants shown in accordance with the procedures described in the foregoing examples. The sulfide reactants can be oxidized in situ to obtain the sulfoxides.

Boron reactant	Sulfide reactant	Product
Na ₂ B ₁₀ H ₁₀	SCH ₂ CH ₂ OCH ₂ CH ₂	B ₁₀ H ₈ ·2SCH ₂ CH ₂ OCH ₂ CH ₂
(NH ₄) ₂ B ₁₀ H ₁₂	S(CH ₂) ₂ C(CH ₃) ₂ CH ₂	B ₁₀ H ₈ ·2S(CH ₂) ₂ C(CH ₃) ₂ CH ₂
(NH ₄) ₂ B ₁₀ H ₁₂	S(CH ₂) ₂ CH ₂	B ₁₀ H ₈ ·2S(CH ₂) ₂ CH ₂
(C ₆ H ₅) ₂ B ₁₀ H ₁₂	S(CH ₂) ₂ CH ₂	B ₁₀ H ₈ ·2S(CH ₂) ₂ CH ₂
B ₁₀ H ₁₀	S(CH ₂) ₂ C(CH ₃) ₂ CH ₂	B ₁₀ H ₈ ·2S(CH ₂) ₂ C(CH ₃) ₂ CH ₂
(C ₆ H ₅) ₂ B ₁₀ H ₁₂	S(CH ₂) ₂ C(CH ₃) ₂ CH ₂	B ₁₀ H ₈ ·2S(CH ₂) ₂ C(CH ₃) ₂ CH ₂

Example 26

A glass vessel equipped with a reflux condenser and stirrer is charged with 5.0 g. of diammonium decahydrodecaborate and 20 ml. of tri-n-butylphosphine. The mixture is heated to refluxing temperature for 45 minutes

and it is noted that gas is evolved during this period. The excess tri-*n*-butylphosphine is removed by heating the reaction mixture under reduced pressure (less than 1 mm. of H₂). The solid which remains is crystallized from *n*-pentane to give needle-shaped crystals of bis(tri-*n*-butylphosphine)decahydrodecaborane(8), a compound of the formula B₁₀H₈·2P(C₄H₉)₃. The compound melts at 129–130° C. Its identity is confirmed by the infrared absorption spectrum.

The compound does not reduce silver nitrate in alcohol solution and it shows no absorption in the ultraviolet region of the spectrum.

The process of Example 26 is generic for the preparation of compounds of Formula 1, and particularly for compounds of Formula 4, in which Z is phosphine of the formula R₃P, as defined earlier. To illustrate, a decahydrodecaborate salt can be reacted with ethyldiisopropylphosphine to obtain B₁₀H₈·2P(C₂H₅)(C₃H₇)₂, with ethyldiphenylphosphine to obtain



with cyclohexyldiethylphosphine to obtain



and the like.

An optional generic method of preparing compounds of the invention in which Z is a phosphine consists in reacting B₁₀H₈·2N₂ with a phosphine in the manner described in Examples 27 and 28 for tertiary amines.

The following examples illustrate reactants which can be employed in the above processes, and compounds which can be obtained therefrom:

Boron reactant	Phosphine reactant	Product
Na[B ₁₀ H ₁₀] (NH ₄) ₂ B ₁₀ H ₁₀ Cs ₂ B ₁₀ H ₁₀ Li ₂ B ₁₀ H ₁₀	P(CH ₃) ₃ P(C ₂ H ₅) ₃ P(C ₆ H ₅) ₃ P(C ₂ H ₅)(C ₆ H ₅) ₂	B ₁₀ H ₈ ·2P(CH ₃) ₃ NaB ₁₀ H ₁₀ ·P(CH ₃) ₃ B ₁₀ H ₈ ·2P(C ₂ H ₅) ₃ (NH ₄) ₂ B ₁₀ H ₁₀ ·P(C ₂ H ₅) ₃ B ₁₀ H ₈ ·2P(C ₆ H ₅) ₃ (Cs ₂) ₂ B ₁₀ H ₁₀ ·P(C ₆ H ₅) ₃ B ₁₀ H ₈ ·2P(C ₂ H ₅)(C ₆ H ₅) ₂ (Li ₂) ₂ B ₁₀ H ₁₀ ·P(C ₂ H ₅)(C ₆ H ₅) ₂
[(CH ₃) ₄ N] ₂ B ₁₀ H ₁₀	P(C ₂ H ₅)(C ₆ H ₅) ₂	B ₁₀ H ₈ ·2P(C ₂ H ₅)(C ₆ H ₅) ₂ (NH ₄) ₂ B ₁₀ H ₁₀
K ₂ B ₁₀ H ₁₀	P(C ₂ H ₅)(CH ₃) ₂	B ₁₀ H ₈ ·2P(C ₂ H ₅)(CH ₃) ₂ (K ₂) ₂ B ₁₀ H ₁₀ ·P(C ₂ H ₅)(CH ₃) ₂
B ₁₀ H ₈ ·2N ₂ B ₁₀ H ₈ ·2N ₂ B ₁₀ H ₈ ·2N ₂ B ₁₀ H ₈ ·2N ₂ B ₁₀ H ₈ ·2N ₂ B ₁₀ H ₈ ·2N ₂	P(C ₂ H ₅)(C ₆ H ₅) ₂ P(CH ₃)(C ₆ H ₅)(C ₆ H ₅) P(CH ₃)(C ₆ H ₅)(C ₆ H ₅) P(C ₂ H ₅)(C ₆ H ₅) ₂ P(C ₆ H ₅) ₃ P(C ₆ H ₅) ₃	B ₁₀ H ₈ ·2P(C ₂ H ₅)(C ₆ H ₅) ₂ B ₁₀ H ₈ ·2P(CH ₃)(C ₆ H ₅)(C ₆ H ₅) B ₁₀ H ₈ ·2P(CH ₃)(C ₆ H ₅)(C ₆ H ₅) B ₁₀ H ₈ ·2P(C ₂ H ₅)(C ₆ H ₅) ₂ B ₁₀ H ₈ ·2P(C ₆ H ₅) ₃ B ₁₀ H ₈ ·2P(C ₆ H ₅) ₃

Example 27

A mixture of 2.0 g. of B₁₀H₈·2N₂ and 5 ml. of pyridine is refluxed for 20 hours. Solid material which forms is separated by filtration and it is purified by crystallization from dimethyl sulfoxide. The product is bis(pyridine)octahydrodecaborane (8), i.e., B₁₀H₈·2C₅H₅N. The identity of the compound is confirmed by its infrared absorption spectrum and by elemental analysis.

Analysis.—Calc'd for B₁₀H₈·2C₅H₅N: B, 39.4; C, 43.8; H, 6.6; N, 10.2. Found: B, 39.4; C, 43.7; H, 6.5; N, 10.2, 9.9.

Example 28

A mixture of 2.1 g. of B₁₀H₈·2N₂ and 30 ml. of quinoline is heated at 180° C. until 630 ml. of gas is evolved. The dark red mixture which remains is poured with stirring into 400 ml. of methanol and an orange-red solid precipitates. The solid is separated by filtration, placed in a Soxhlet extractor and extracted with acetonitrile for 19 hours. The product which remains in the thimble, i.e., the material not removed by acetonitrile, is bis(quinoline)octahydrodecaborane(8).

Analysis.—Calc'd for B₁₀H₈·2C₉H₇N: B, 28.8; H, 5.9; N, 7.5. Found: B, 28.2; H, 6.0; N, 7.4.

The process of Examples 27 and 28 is generic for the preparation of compounds of Formula 3 where Z is a

tertiary amine. Any tertiary amine can be employed as a reactant with B₁₀H₈·2N₂. Amines in which the substituents are hydrocarbon are preferred, particularly hydrocarbon of up to 18 carbons which is free of acetylenic unsaturation. To illustrate, B₁₀H₈·2N₂ can be reacted with (C₈H₁₇)₃N to give B₁₀H₈·2N(C₈H₁₇)₃, with

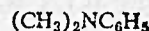

to give B₁₀H₈·2N(CH₃)₂C₆H₅, with ethyl *N,N*-dimethylglycinate to give B₁₀H₈·2N(CH₃)₂CH₂C(O)OC₂H₅, with (C₆H₁₁)₃N to give B₁₀H₈·2N(C₆H₁₁)₃, with



to give B₁₀H₈·2N(CH₂C₆H₅)₃, with (C₃H₇)₃N to give B₁₀H₈·2N(C₃H₇)₃, and the like.

Further illustrations of compounds which can be obtained by the process of Examples 27 and 28, employing B₁₀H₈·2N₂ as the boron-containing reactant are as follows: from (HOCH₂CH₂)₃N, B₁₀H₈·2N(CH₂CH₂OH)₃; from N[CH₂C(O)OH]₃, B₁₀H₈·2N[CH₂C(O)OH]₃; from

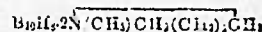

from

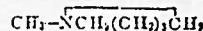

30

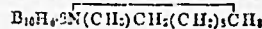

50 from

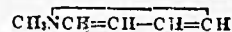

from

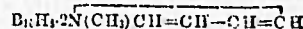

55

from (CNCH₂CH₂)₃N, B₁₀H₈·2N(CH₂CH₂CN)₃; and from (CH₂OCH₂CH₂)₃N, B₁₀H₈·2N(CH₂—CH₂OCH₂)₃.

Non-ionic compounds of Formula 3 in which Z is a tertiary amine are also obtained by employing a tertiary amine oxide in place of the dialkyl sulfoxide in the processes described in Examples 1, 2, 3 and 4. To illustrate, diammonium decahydrodecaborate reacts with trimethylamine oxide to yield B₁₀H₈·2N(CH₃)₃, with triethylamine oxide to yield B₁₀H₈·2N(C₂H₅)₃, with phenyldimethylamine oxide to yield B₁₀H₈·2N(CH₃)₂C₆H₅, and with dimethyldodecylamine oxide to yield



70 Examples of other amine oxides which can be reacted with (NH₄)₂B₁₀H₁₀ are octyldimethylamine oxide, dioctadecylmethylamine oxide, di-*n*-butyl-2-(hydroxyethyl)amine oxide, methylpiperidine oxide, decyldimethylamine oxide, 6-(cyclohexyl)hexyldimethylamine oxide, *N*-methylmorpholine oxide, and *N*-dodecylpiperidine oxide to yield, respectively: B₁₀H₈·2N(CH₃)₂C₈H₁₇,

35

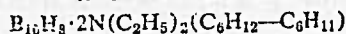
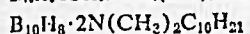
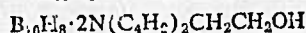
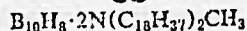

and

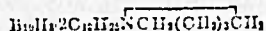

Non-ionic compounds of Formula 3 in which the two Z groups are amides can be obtained by reacting (1) an ionic compound of Formula 4 in which Z is an amide, and (2) a further quantity of the same amide represented by Z or with a different amide to provide a product



in which the Z groups are amides and are alike or different. The ionic compound of Formula 4 is prepared as illustrated for typical salts in Example 45 below. The simplest mode of operation is to prepare the ionic compound in situ as described in Example 45 and to continue the reaction by keeping the temperature of the reaction mixture at 125° C. or higher for about 2 hours or more with continued passage of anhydrous hydrogen chloride. To obtain the neutral species, the mole ratio of amide to decahydrodecaborate (2-) salt is preferably at least 2:1. When the amide serves also as a solvent the above mole ratio is, of course, much higher. Application of the above-described process to the product of Example 42 provides the compound $B_{10}H_8 \cdot 2HC(O)N(CH_3)_2$.

The preparation of non-ionic compounds of the invention in which one or both of the Z groups are amides is illustrated in Examples 29 through 32.

Example 29

Cesium dimethylformamide - nonahydrodecaborate(1-), prepared as described in Example 45, Part A, is dissolved in dimethyl sulfoxide and concentrated hydrochloric acid is added to the solution with stirring. The mixture is heated on a steam bath for 5 minutes and it is then diluted with water. The precipitate which forms is separated by filtration, washed and dried to obtain (dimethylsulfoxide - dimethylformamide)octahydrodecaborane(8), a compound of the formula

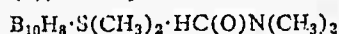

The identity of the compound, in which the Z groups are dissimilar, is confirmed by its infrared absorption spectrum.

Example 30

A reaction vessel, equipped with a stirrer and a condenser, is charged with 20 g. of $(NH_4)_2B_{10}H_{10}$, 22 ml. of concentrated hydrochloric acid and 150 ml. of N-methyl-2-pyrrolidone. The mixture is stirred and it is heated until 20 ml. of water is removed by distillation. The final pot temperature is 170° C. The reaction mixture is cooled to about 25° C. and it is filtered to remove any solid material which may be present. The filtrate is poured with stirring into 800 ml. of water. A solid form which is separated by filtration to yield 3.0 g. of the alpha form of bis(N-methyl-2-pyrrolidone)deca-borane(8), a compound which has the following structure:

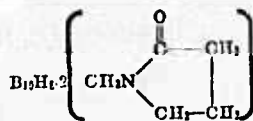

Analysis.—Calc'd for $B_{10}H_8 \cdot 2N(CH_3)(CH_2)_3CO$: C, 38.7; H, 8.3; N, 8.9. Found: C, 38.8; H, 8.6; N, 8.8. C, 39.0; H, 8; N, 3.

The infrared absorption spectrum of the compound,

36

obtained in a Nujol mull, is as follows (values expressed as microns and bands due to C-H bonds and alkyl groups in the 3.2-3.5 micron and 6.5-7.6 micron regions are omitted): 4.0 (strong), 6.05 (strong), 8.0 (medium), 9.15 (medium), 9.6 (medium), 10.0 (weak), 10.4 (weak), 10.5 (medium), 11.0 (medium), and 11.7 (weak).

The filtrate obtained in the process of Example 30 above is set aside for use in preparing an ionic species of Formula 2 as described in Example 46.

Example 31

A mixture consisting of 1.8 g. of $B_{10}H_{12} \cdot 2N_2$ and 6 ml. of N-methyl-2-pyrrolidone is heated to refluxing for 2 hours. The solution is cooled to atmospheric temperature and poured into excess water. The precipitate which forms is coagulated by adding ammonium chloride and stirring. The precipitate is removed by filtration. Acetone is then added in sufficient quantity to dissolve the precipitate, the mixture is filtered and the filtrate is poured into ethanol with stirring. The precipitate which forms is separated by filtration and dried to yield 0.5 g. of

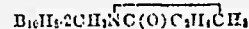

(beta form). The identity of the product is confirmed by its infrared absorption spectrum and by elemental analysis.

Analysis.—Calc'd for the above compound: B, 34.4; C, 38.2; H, 8.3; N, 8.9. Found: B, 32.5; C, 39.7; H, 8.5; N, 8.5.

The infrared absorption spectrum, obtained in a Nujol mull, is as follows (expressed as microns and omitting bands due to C-H bonds and alkyl groups): 4.0 (strong), 6.05 (strong), 8.0 (medium), 8.5 (medium), 8.9 (medium), 9.1-9.3 (medium), 9.6 (weak), 10.0 (medium), 10.3 (medium), 10.6 (medium), 11.0 (medium), and 11.7-12.1 (weak).

Reference is made in Examples 30 and 31 to the alpha and beta forms of compounds. These forms are simply stereoisomers of the same compound which differ in the spatial arrangement of the Z groups around the boron cage. In the particular examples of reference, the Z groups are N-methyl-2-pyrrolidone but differences in spatial arrangements can occur with any Z groups. The assignment of alpha and beta to the forms is solely for convenience in discussing the compounds. Except for the differences in infrared spectra, the two forms have substantially the same physical properties.

Example 32

A. A small portion of



prepared as described in Example 46, is mixed with sufficient dimethyl sulfoxide to form a solution. A small quantity of aqueous hydrochloric acid is added to the solution and the mixture is heated rapidly to boiling for a short time (about 20 seconds). The solution is cooled and poured into water. The precipitate which forms is separated by filtration and dried to obtain the alpha form of (dimethyl - sulfide)(N - methyl-2-pyrrolidone)octahydrodecaborane(8), i.e.

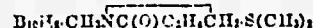

The identity of the compound is confirmed by its infrared absorption spectrum.

B. A solution consisting of 12 g. of

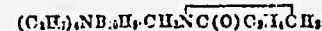

80 ml. of $(CH_3)_2SO$ and 20 ml. of concentrated hydrochloric acid is heated at steam bath temperature for 20 minutes and then on a hot plate until bubbles are forming rapidly. The solution is cooled and poured with stirring into 300 ml. of water. The precipitate which

form is separated and dissolved in acetone. The acetone solution is filtered into 200 ml. of water, a precipitate forms, and sufficient NH₄Br is added to the aqueous filtrate to coagulate the precipitate. The precipitate is separated, washed well with water and dried to obtain the product of Part A. The identity of the compound is confirmed by elemental analysis.

Analysis.—Calc'd for

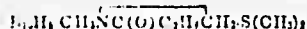

B, 39.0; C, 30.3; H, 8.3; N, 5.0; S, 11.6. Found: B, 37.4; C, 28.8; H, 7.9; N, 5.0; S, 11.8.

The infrared absorption spectrum of the compound (alpha form) obtained in a Nujol mull (expressed as microns and emitting bands due to C-H bonds and alkyl groups is as follows): 4.0 (strong), 6.05 (strong), 8.0 (medium), 8.2 (weak), 9.0 (medium), 9.3 (medium), 9.6 (weak), 10.0 (medium), 10.1 (medium), 10.4 (medium), 10.9 (medium), and 12.0 (weak).

C. A solution consisting of 1 g. of B₁₀H₈·N₂·S(CH₃)₂, prepared as described in Example C, Part B, and 6 ml. of

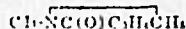

is boiled for a short time (about 20 seconds) and cooled. The clear solution is diluted with water, a precipitate forms, and lithium bromide is added to coagulate the precipitate. The precipitate is separated and dissolved in acetone. The solution is filtered and the filtrate is diluted with water to precipitate the solid product. It is separated, washed and dried to obtain 0.8 g. of the beta form of

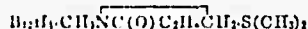

Analysis.—Calc'd for above compound: B, 39.0; C, 30.3; H, 8.5; N, 5.0; S, 11.6. Found: B, 38.7; C, 30.5; H, 8.3; N, 5.2; S, 11.6.

The infrared absorption spectrum (expressed in microns) for the compound (beta form), determined as described in Part B, is as follows: 4.0 (strong), 6.05 (strong), 7.9 (medium), 8.3 (weak), 8.5 (medium), 9.0 (weak), 9.7 (weak), 10.0 (medium), 10.2 (medium), 10.3 (weak), 10.7 (weak), and 11.0 (medium).

The processes of Examples 29-32 are generic for the preparation of compounds of Formula 1, and particularly Formula 4 in which Z is an amide of a carboxylic acid. Any decaborate salt can be employed as a reactant in this process, e.g., mono-, di-, tri-, and tetra-substituted ammonium salts, metal salts, sulfonium and phosphonium salts and metal-amine salts. The ammonium salt, tetraalkylammonium salts and the alkali metal salts are employed most frequently for reasons of availability and cost and these salts form a preferred group.

Further examples of compounds which can be prepared and the reactants employed in their preparation are as follows:

Boron reactant	Amide reactant	Product
(NH ₄) ₂ B ₁₀ H ₈	C ₆ H ₅ C(O)N(CH ₃) ₂	B ₁₀ H ₈ ·2C ₆ H ₅ C(O)N(CH ₃) ₂
(C ₂ H ₅) ₂ N ₂ B ₁₀ H ₈	CH ₃ -C(CH ₃) ₂ C(O)N(CH ₃) ₂	B ₁₀ H ₈ ·2CH ₃ -C(CH ₃) ₂ C(O)N(CH ₃) ₂
N ₂ B ₁₀ H ₈	C ₆ H ₅ C(O)N(C ₂ H ₅) ₂	B ₁₀ H ₈ ·2C ₆ H ₅ C(O)N(C ₂ H ₅) ₂
B ₁₀ H ₈ ·2N ₂	CH ₃ C(O)NCH ₂ CH ₂ OCH ₂ CH ₃	B ₁₀ H ₈ ·2CH ₃ C(O)NCH ₂ CH ₂ OCH ₂ CH ₃
[(C ₂ H ₅) ₄ N] ₂ B ₁₀ H ₈	HC(O)NCH ₂ (CH ₂) ₂ CH ₃	B ₁₀ H ₈ ·2HC(O)NCH ₂ (CH ₂) ₂ CH ₃
C ₂ H ₅ B ₁₀ H ₈	C ₆ H ₅ C(O)NCH ₂ (CH ₂) ₂ CH ₃	B ₁₀ H ₈ ·2C ₆ H ₅ C(O)NCH ₂ (CH ₂) ₂ CH ₃
Li ₂ B ₁₀ H ₈	(C ₆ H ₅) ₂ NC(O)C ₆ H ₅	B ₁₀ H ₈ ·2(C ₆ H ₅) ₂ NC(O)C ₆ H ₅
B ₁₀ H ₈ ·2N ₂	(C ₂ H ₅) ₂ NC(O)C ₆ H ₅	B ₁₀ H ₈ ·2(C ₂ H ₅) ₂ NC(O)C ₆ H ₅
B ₁₀ H ₈ ·2N ₂	C ₆ H ₅ C(O)N(C ₂ H ₅) ₂	B ₁₀ H ₈ ·2C ₆ H ₅ C(O)N(C ₂ H ₅) ₂
B ₁₀ H ₈ ·2N ₂	CH ₃ C(O)NCH ₂ CH ₂ OH	B ₁₀ H ₈ ·2CH ₃ C(O)NCH ₂ CH ₂ OH
B ₁₀ H ₈ ·2N ₂	HOCH ₂ C(O)N(CH ₃) ₂	B ₁₀ H ₈ ·2HOCH ₂ C(O)N(CH ₃) ₂
B ₁₀ H ₈ ·2N ₂	C ₆ H ₅ C(O)N(C ₂ H ₅) ₂	B ₁₀ H ₈ ·2C ₆ H ₅ C(O)N(C ₂ H ₅) ₂

A reaction vessel capable of withstanding pressure is charged with 5.0 g. of B₁₀H₈·2N₂, prepared as described in Example C, Part A, and 40 ml. of CH₃CN. The vessel is closed and evacuated at -70° C., and the reaction mixture is heated at 150° C. for 3.5 hours under autogenous pressure. The vessel is cooled, vented to remove volatile products and the clear reddish solution which remains is evaporated under reduced pressure until a crystalline solid separates. The product is crystallized from acetonitrile to obtain B₁₀H₈·2CH₃CN as a white crystalline compound.

Analysis.—Calc'd for B₁₀H₈·2CH₃CN: B, 54.5; C, 24.2; H, 7.1; N, 14.1. Found: B, 54.4; C, 22.5; H, 7.0; N, 14.7.

The process of Example 33 is generic for the preparation of compounds of Formula 1 and, particularly of Formula 4, in which Z is a nitrile. To illustrate, B₁₀H₈·2N₂ can be reacted with the following nitriles to obtain the named compounds:

Nitrile reactant	Product
C ₆ H ₅ CN	B ₁₀ H ₈ ·2C ₆ H ₅ CN
C ₂ H ₅ CN	B ₁₀ H ₈ ·2C ₂ H ₅ CN
CH ₂ =CH-O-C(CN)=O	B ₁₀ H ₈ ·2CH ₂ =CH-O-C(CN)=O
C ₆ H ₅ CN	B ₁₀ H ₈ ·2C ₆ H ₅ CN
CH ₂ =CHCN	B ₁₀ H ₈ ·2CH ₂ =CHCN
CH ₂ =C(CH ₃)CN	B ₁₀ H ₈ ·2CH ₂ =C(CH ₃)CN
C ₆ H ₅ CN	B ₁₀ H ₈ ·2C ₆ H ₅ CN
C ₆ H ₅ CN	B ₁₀ H ₈ ·2C ₆ H ₅ CN
HO(O)C(CH ₂) ₂ CH ₂ CN	B ₁₀ H ₈ ·2NC(CH ₂) ₂ CH ₂ C(O)OH
HO(O)C(CH ₂) ₂ CN	B ₁₀ H ₈ ·2NC(CH ₂) ₂ C(O)OH
HO(CH ₂) ₂ CH ₂ CN	B ₁₀ H ₈ ·2NC(CH ₂) ₂ OH

Compounds of the invention in which Z is a sulfone are obtained by employing a sulfone in place of the nitrile in the process of Example 33. To illustrate, B₁₀H₈·2N₂ is reacted with (CH₃)₂SO₂ to obtain B₁₀H₈·2O₂S(CH₃)₂, with (C₆H₅)₂SO₂ to obtain

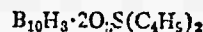

and with (C₆H₅)₂SO₂ to obtain B₁₀H₈·2O₂S(C₆H₅)₂.

Further illustrations of non-ionic compounds which can be obtained and reactants employed with B₁₀H₈·2N₂ are as follows:

Sulfone reactant	Product
O ₂ SCH ₂ (CH ₂) ₂ CH ₃	B ₁₀ H ₈ ·2O ₂ SCH ₂ (CH ₂) ₂ CH ₃
(C ₆ H ₅) ₂ SO ₂	B ₁₀ H ₈ ·2O ₂ S(C ₆ H ₅) ₂
CH ₃ SO ₂ CH ₂ CH=CH ₂	B ₁₀ H ₈ ·2CH ₃ SO ₂ CH ₂ CH=CH ₂
(C ₆ H ₅) ₂ SO ₂	B ₁₀ H ₈ ·2O ₂ S(C ₆ H ₅) ₂
O ₂ SCH ₂ (CH ₂) ₂ CH ₃	B ₁₀ H ₈ ·2O ₂ SCH ₂ (CH ₂) ₂ CH ₃
(C ₆ H ₅) ₂ SO ₂	B ₁₀ H ₈ ·2O ₂ S(C ₆ H ₅) ₂
[HO(O)C(CH ₂) ₂]SO ₂	B ₁₀ H ₈ ·2O ₂ S(C ₆ H ₅) ₂
(C ₆ H ₅) ₂ SO ₂	B ₁₀ H ₈ ·2O ₂ S(C ₆ H ₅) ₂
(C ₂ H ₅) ₂ SO ₂	B ₁₀ H ₈ ·2O ₂ S(C ₂ H ₅) ₂

60

The examples which follow illustrate the preparation of representative non-ionic compounds bearing X substituents.

Example 34

A. A glass reaction vessel, equipped with a stirrer, is charged with 30 ml. of acetonitrile and 4.0 g. of bis(dimethylsulfide)decalborane(8), $B_{10}H_8 \cdot 2S(CH_3)_2$, obtained as described in Example 1. Chlorine gas is bubbled into the reaction mixture and the temperature rises to 25° C.

C. Passage of chlorine gas is continued until the temperature of the reaction mass drops to prevailing atmospheric temperature (about 25° C.). The reaction mass is poured into 200 ml. of water and the mixture is filtered. A sticky mass remains which is boiled in 50 ml. of water to convert it to a powder. The powder is extracted three times with hot alcohol, the alcohol extracts are cooled and a white crystalline solid separates which is isolated by filtration. The dry solid, which is bis(dimethylsulfide)pentachlorotrihydrodecaborane(8)

melts at 314-317° C. The identity of the compound, which has the formula $B_{10}H_2Cl_5 \cdot 2S(CH_3)_2$, is confirmed by elemental analysis.

Analysis.—Calc'd for $B_{10}H_2Cl_5 \cdot 2S(CH_3)_2$: B, 26.3; C, 11.0; H, 3.63; Cl, 42.9; S, 15.5. Found: B, 25.7; C, 11.8; H, 3.91; Cl, 43.9; S, 14.8.

B. A glass reaction vessel equipped with a stirrer and reflux condenser is charged with 30 ml. of acetonitrile and 7.0 g. of $B_{10}H_8 \cdot 2S(CH_3)_2$. Chlorine gas is passed into the reaction mixture and an exothermic reaction ensues. Passage of gas is continued until the reaction temperature drops and for an additional hour thereafter while the mixture is heated to refluxing temperature. The solution is cooled and poured into 500 ml. of water. An oil separates and 250 ml. of ethanol are added with stirring to the aqueous mixture. The oil solidifies and the solid is separated by filtration. The solid product, which is bis(dimethylsulfide)hexachlorodihydrodecaborane(8), is crystallized from ethanol to form a product melting at 330° C. The identity of the compound, which has the formula $B_{10}H_2Cl_6 \cdot 2S(CH_3)_2$, is confirmed by elemental analysis.

Analysis.—Calc'd for $B_{10}H_2Cl_6 \cdot 2S(CH_3)_2$: B, 24.2; C, 10.72; H, 3.14; Cl, 47.6; S, 14.3. Found: B, 24.4; C, 10.90; H, 3.41; Cl, 46.4; S, 14.8.

The compound shows unusual stability and it is recovered unchanged after refluxing for a short period in alcoholic sodium hydroxide.

C. A mixture of 75 ml. of acetonitrile and 10 g. of $B_{10}H_8 \cdot 2S(CH_3)_2$ is reacted with chlorine gas as described in Part A, except that the mixture is refluxed for 7 hours with continued passage of chlorine gas. A small quantity of crystalline solid (Fraction A, M.P., 259° C.) forms which is separated by filtration. The filtrate is evaporated to a volume of about 30 ml., poured into water and the white solid which forms is separated by filtration. The solid is extracted with (1) aqueous ethanol, (2) water-ethanol-acetonitrile mixture, and (3) hot acetonitrile. Each of these extracts are evaporated and cooled to yield white crystalline products which are designated as follows: from aqueous ethanol, Fraction B, M.P. 340-357° C.; from water-ethanol-acetonitrile, Fraction C, M.P. 367-369° C.; from hot acetonitrile, Fraction D, M.P. 360-361° C. Infrared absorption spectra of the various fractions show that products from Fractions A and D are identical and they will be referred to solely as Fraction A; similarly, Fractions B and C are identical (although different from A and D) and they will be referred to as Fraction B.

Elemental analyses of Fractions A and B show that the products have the same composition, i.e., that the products are isomeric forms of bis(dimethylsulfide)hexachlorodihydrodecaborane(8).

Analysis.—Calc'd for $B_{10}H_2Cl_6 \cdot 2S(CH_3)_2$: B, 24.2; C,

10.7; H, 3.14; Cl, 47.6; S, 14.3. Found: Fraction A—B, 24.3; C, 11.0; H, 3.16; Cl, 49.0; S, 13.8. Fraction B—B, 25.0; C, 11.2; H, 3.20; Cl, 47.9; S, 13.7.

Example 35

A. A solution of 6 g. of bromine in 50 ml. of acetonitrile is added with stirring to a solution of 9.0 g. of $B_{10}H_8 \cdot 2S(CH_3)_2$ in 50 ml. of acetonitrile. The resulting mixture is light yellow in color. It is poured into 500 ml. of water with stirring and sufficient solid sodium iodide is added to coagulate the precipitated solid. The solid is separated by filtration and it is extracted three times with ethanol. Evaporation and cooling of the ethanol extracts yields $B_{10}H_7Br \cdot 2S(CH_3)_2$, a white solid which melts at 233-234° C.

Analysis.—Calc'd for $B_{10}H_7Br \cdot 2S(CH_3)_2$: B, 33.8; C, 15.05; H, 5.95; Br, 25.0; S, 20.0. Found: B, 36.09; C, 16.07; H, 6.55; Br, 21.26; S, 20.8.

B. Using the procedure described in Part A, 1.5 g. of $B_{10}H_8 \cdot 2S(CH_3)_2$ and 1 g. of bromine are reacted in 25 ml. of acetonitrile. The reaction mixture is poured into water and the white solid which forms is separated by filtration. It is further purified by crystallization from ethanol to yield bis(dimethylsulfide)monobromoheptahydrodecaborane(8). The identity of the compound, which has the formula $B_{10}H_7Br \cdot 2S(CH_3)_2$, is confirmed by elemental analysis.

Analysis.—Calc'd for $B_{10}H_7Br \cdot 2S(CH_3)_2$: B, 33.8. Found: B, 32.6.

C. A solution of 6.7 g. of bromine in 40 ml. of dichloromethane is added with stirring to a solution of 10 g. of $B_{10}H_8 \cdot 2S(CH_3)_2$ in 75 ml. of dichloromethane. The reaction mixture is evaporated to dryness and the solid residue is extracted successively with n-propyl alcohol, twice with isopropyl alcohol and then with n-propyl alcohol. There is obtained a solid fraction (3.18 g.) which melts at 225-227° C. and which is

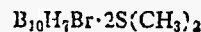

The product is again extracted with n-propyl alcohol and dried. It melts at 230-233° C.

Analysis.—Calc'd for $B_{10}H_7Br \cdot 2S(CH_3)_2$: B, 33.8; Br, 25.0; C, 15.1; H, 5.95; S, 20.0. Found: B, 34.5; Br, 25.2; C, 15.5; H, 6.18; S, 20.2.

D. A glass reaction vessel equipped with a stirrer is charged with a solution of 3.0 g. of $B_{10}H_8 \cdot 2S(CH_3)_2$ in ethanol-acetonitrile mixture. The solution is warmed and 0.9 cc. of liquid bromine is added gradually. An exothermic reaction sets in and the color of the bromine in the reaction mixture is discharged. The solution is poured into water to form an emulsion. Solid sodium bromide is added to break the emulsion and the resulting mixture is filtered to separate a white insoluble product which is bis(dimethylsulfide)dibromohexahydrodecaborane(8). The identity of the compound which the formula $B_{10}H_6Br_2 \cdot 2S(CH_3)_2$ is confirmed by elemental analysis.

Analysis.—Calc'd. for $B_{10}H_6Br_2 \cdot 2S(CH_3)_2$: B, 27.2; S, 16.1. Found: B, 30.36; S, 17.34.

E. A solution of 15 g. of bromine in 75 ml. of acetonitrile is added with stirring to a solution of 10 g. of $B_{10}H_8 \cdot 2S(CH_3)_2$ in 75 ml. of acetonitrile. The solution is refluxed for 30 minutes and it is then poured into excess methanol. The resulting mixture is filtered and the filtrate is chilled. The solid which forms is separated by filtration to yield 7.7 g. of $B_{10}H_6Br_2 \cdot 2S(CH_3)_2$. The filtrate is concentrated by evaporation to a volume of about 30 ml. Additional solid product precipitates which is again separated by filtration. It is crystallized from aqueous methanol to yield the compound $B_{10}H_6Br_2 \cdot 2S(CH_3)_2$, melting at 183-195° C.

Analysis.—Calc'd. for $B_{10}H_6Br_2 \cdot 2S(CH_3)_2$: B, 27.1; S, 16.1; C, 12.1; H, 4.52; Br, 40.2. Found: 1st fraction—B, 27.15; S, 16.16; Br, 41.34. 2nd fraction—B, 26.6; S,

75

The stability of the compounds of the invention is illustrated by the fact that the above $B_{10}H_6Br_2 \cdot 2S(CH_3)_2$ is unchanged after refluxing 15 minutes in alcoholic potassium hydroxide containing hydroxylamine.

F. A solution of 15 g. of bromine in 75 ml. of acetonitrile is added with stirring to a solution of 10 g. of $B_{10}H_8 \cdot 2S(CH_3)_2$ in 75 ml. of acetonitrile. The mixture is refluxed for 30 minutes and a further quantity of bromine solution (13 g. in 50 ml. of acetonitrile) is added. The mixture is refluxed overnight, i.e., about 18 hours. The reaction mixture is concentrated by evaporation of the solvent to about 100 ml. and it is filtered. A tan solid is separated which is crystallized from acetonitrile. There is obtained a white solid, M.P. $282^\circ C.$, which is bis(dimethylsulfide)trithromopentahydrodecaborane(8), i.e., $B_{10}H_3Br_3 \cdot 2S(CH_3)_2$. The identity of the compound is confirmed by elemental analysis.

Analysis.—Calc'd. for $B_{10}H_3Br_3 \cdot 2S(CH_3)_2$: B, 22.7; C, 10.05; H, 3.56; S, 13.4. Found: B, 23.1; C, 10.77; H, 3.78; S, 13.21.

G. A glass reaction vessel equipped with a stirrer is charged with a solution of $B_{10}H_8 \cdot 2S(CH_3)_2$ in acetonitrile. The solution is heated to refluxing temperature and liquid bromine is added slowly until no further absorption of bromine occurs in 2 minutes of refluxing. Excess bromine in the solution is removed by adding a small quantity of $(NH_4)_2B_{10}H_{10}$. The solution is poured into water with stirring and the precipitated material is separated by filtration. This product is

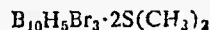

Bromination of $B_{10}H_8 \cdot 2S(CH_3)_2$ is also accomplished by employing N-bromosuccinimide as the brominating agent. For example, a mixture of 2.34 g. of



0.34 g. of N-bromosuccinimide and 25 ml. of carbon tetrachloride is refluxed to form a mixture of bromo compounds of the type described in Parts A-C.

Example 36

A. A glass reaction vessel is charged with 0.7 g. of $B_{10}H_8 \cdot 2S(CH_3)_2$, 0.7 g. of iodine, 0.2 g. of the hydrate of $H_2B_{10}H_{10}$ or its equivalent, and 75 ml. of acetonitrile. The solution is stirred for a few minutes and a further quantity (0.7 g.) of $B_{10}H_8 \cdot 2S(CH_3)_2$ is added. The solution is heated for 5 minutes on a steam bath. Excess iodine is removed by adding a small quantity of

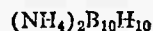

to the solution with stirring. The solution is poured into aqueous sodium bromide solution and the white solid which forms is separated by filtration. The solid is crystallized from ethanol to obtain bis(dimethylsulfide)monoiodoheptahydrodecaborane(8), i.e., $B_{10}H_7I \cdot 2S(CH_3)_2$. The product, as isolated, melts at $208-212^\circ C.$ and contains 39.36% boron and 22.93% iodine.

B. A reaction vessel is charged with a solution consisting of 10 g. of bis(dimethylsulfide)octahydrodecaborane(8) in 100 ml. of dichloromethane. A solution of 6.8 g. of iodine in 75 ml. of dichloromethane is added with agitation to the contents of the reaction vessel at atmospheric temperature (about $25^\circ C.$). Agitation of the solution is continued for 3 hours and the solution is then concentrated by evaporation to a volume of about 20 ml. The residual liquid is added with stirring to about 250 ml. of ethanol. A white solid forms which is separated by filtration. The solid is crystallized twice from ethanol to obtain pure bis(dimethylsulfide)monoiodoheptahydrodecaborane(8), i.e., $B_{10}H_7I \cdot 2S(CH_3)_2$, which melts at $195-198^\circ C.$

Analysis.—Calc'd. for $B_{10}H_7I \cdot 2S(CH_3)_2$: B, 29.5; I, 34.7; S, 17.5. Found: B, 29.9; I, 33.6; S, 17.8.

C. A reaction vessel is charged with 50 ml. of methyl-ene chloride and 5 g. of bis(dimethylsulfide)octahydro-

decaborane(8), obtained as described in Example 1. The mixture is stirred and a solution of 3.4 g. of iodine monochloride in 50 ml. of methylene chloride is added over a period of 10 minutes. The mixture is stirred for one hour at atmospheric temperature (about $25^\circ C.$) and it is then poured with stirring into 500 ml. of petroleum ether. The resulting mixture is filtered and the filtrate is evaporated to leave a solid residue. The residue is crystallized from ethyl alcohol and from ethyl alcohol-water mixtures to obtain a nearly colorless solid, M.P., $139-141^\circ C.$ The product is a mixture of about 70% bis(dimethylsulfide) monoiodoheptahydrodecaborane(8) and 30% bis(dimethylsulfide) diiodohexahydrodecaborane(8). The respective formulas for these compounds are $B_{10}H_7I \cdot 2S(CH_3)_2$ and $B_{10}H_6I_2 \cdot 2S(CH_3)_2$.

Analysis.—Calc'd. for the mixture: C, 11.8; H, 4.7; S, 15.8; I, 41.0. Found: C, 11.7; H, 4.7; S, 15.8; I, 42.1.

Example 37

A reaction vessel is fitted with a reflux condenser equipped with a calcium chloride tube to prevent access of moist air to the vessel. The vessel is charged with 2 ml. of pyridine, 3.2 g. of bis(dimethylsulfide)monobromoheptahydrodecaborane(8), obtained as described in Example 35, Part A, and 0.9 g. of curcous cyanide. The mixture is heated at $160-180^\circ C.$ for 5 hours and cooled to form a semi-solid mass. The mixture is extracted (1) with aqueous concentrated ammonium hydroxide, and (2) with acetone. The acetone extract is diluted with water to form a pale tan precipitate which is separated by filtration and dried in air. The product contains bis(dimethylsulfide) monocyanohexahydrodecaborane(8), whose presence is confirmed by the infrared absorption spectrum of the product. It has the formula

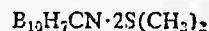

Example 38

A reaction vessel is charged with 100 ml. of acetonitrile and 10 g. of

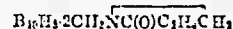

prepared as described in Example 30. The mixture is stirred to form a slurry and chlorine gas is bubbled through for 3 hours. The reaction is exothermic for the first half hour and, after this initial period, the mixture is heated to refluxing for the remaining 2.5 hours. The solution is filtered and the filtrate is diluted with a large amount of water. An oil separates which is extracted from the mixture with hot 50% ethanol. The extracts are cooled and the solid which precipitates is separated, washed and dried. The compound, bis(N-methylpyrrolidone)octachlorodecaborane(8), is obtained as a white crystalline product.

Analysis.—Calc'd for

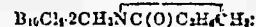

B, 18.3; C, 20.4; H, 3.0; Cl, 48.0. Found: B, 18.4, 18.7; C, 21.4; H, 3.8; Cl, 45.6.

By employing fluorine diluted with nitrogen gas as the halogenating agent, compounds bearing fluorine substituents can be obtained, e.g., $B_{10}H_6F_2 \cdot 2S(CH_3)_2$,

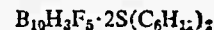

and the like.

The processes of Examples 34-38 are generic for the preparation of compounds of Formula 1 and particularly Formula 3 where X is halogen or $-CN$.

Example 39

A. A glass reaction vessel is charged with 10 g. of



(prepared as described in Example 3), 4.2 g. of dimethyl sulfoxide and 100 ml. of glacial acetic acid. The reaction

mixture is cooled to about 12° C. in an ice-water bath and anhydrous hydrogen chloride is bubbled through the solution at a rapid rate. The temperature rises in 5 minutes to about 20° C. and the cooling bath is removed. Passage of hydrogen chloride is continued for 45 minutes in which time the temperature of the reaction mixture rises to 43.5° C. and then gradually decreases to 32° C. The solution, which is red at this stage, is poured with stirring into 600 ml. of water. An orange solid precipitates which is a mixture of



and $HB_{10}H_6C(O)C_6H_5 \cdot S(CH_3)_2$, i.e., a mixture of the neutral species and the ionic species. The solid is separated by filtration and it is extracted with acetone. The acetone-soluble portion is poured into three times its volume of concentrated sodium hydroxide solution to form a mixture which separates into two layers. The upper layer, which is an acetone solution, is separated and it is poured with stirring into excess water. A sticky solid precipitates which is separated and dissolved again in acetone. The acetone solution is added with stirring to excess propyl alcohol and a solid forms which is bis(dimethylsulfide)benzoylheptahydrodecaborane (8), i.e., $B_{10}H_7C(O)C_6H_5 \cdot 2S(CH_3)_2$. The solid is separated by filtration and dried. The identity of the compound is confirmed by its infrared spectrum and by elemental analysis.

Analysis.—Calc'd for $B_{10}H_7C(O)C_6H_5 \cdot 2S(CH_3)_2$: B, 31.4; C, 38.2; H, 7.0; S, 18.7. Found: B, 29.4, C, 38.4; H, 7.9; S, 16.0.

B. A reaction vessel is charged with 10 g. of

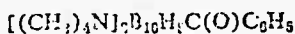

12.2 g. of dimethyl sulfoxide and 100 ml. of glacial acetic acid. Anhydrous hydrogen chloride is passed through this mixture without cooling for 56 minutes during which time the temperature of the mixture rises to a maximum of 80° C. and then drops to 35° C. Passage of hydrogen chloride is stopped and the reaction mixture is poured with stirring in 500 ml. of water. A precipitate forms which is separated by filtration. There is obtained 11.5 g. of $B_{10}H_7C(O)C_6H_5 \cdot 2S(CH_3)_2$ as a white, crystalline solid.

C. A glass reaction vessel equipped with a stirrer is charged with 1.27 g. of $B_{10}H_7 \cdot 2S(CH_3)_2$, 0.85 g. of benzoyl chloride and 30 ml. of polyphosphoric acid. The mixture is stirred for 15 minutes to form a solution of light yellow color. A further quantity of benzoyl chloride (0.85 g.) is added with stirring and the solution becomes darker yellow in color. The solution is stirred for 3 days and it is then poured with agitation into 300 ml. of water. The solid which forms is separated by filtration and dried to form a tan-colored product which contains a benzoylated derivative of $B_{10}H_7 \cdot 2S(CH_3)_2$ of the type illustrated by the formula $B_{10}H_7C(O)C_6H_5 \cdot 2S(CH_3)_2$. One or more hydrogens are replaced by $C_6H_5C(O)-$ groups in the reaction. The infrared absorption spectrum of the product shows the presence of B—H, C=O and phenyl groups.

Example 39 illustrates acyl derivatives of

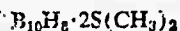

and their preparation. The invention is generic to acyl derivatives which can be prepared by the method of Example 38, 39, or by other methods, e.g., by reaction of $B_{10}H_7 \cdot 2S(CH_3)_2$ with anhydrides of organic acids. To illustrate, $B_{10}H_7 \cdot 2S(CH_3)_2$ is dissolved in acetic anhydride which contains a small quantity of a strong acid ($pK_a=1.7-2.0$) and the solution is warmed on a steam bath for 5 minutes. The solution which is red in color is diluted with ethanol and a tan-colored precipitate forms. The precipitate is separated by filtration and dried. The compound is acetylated $B_{10}H_7 \cdot 2S(CH_3)_2$ in which one or more hydrogens are replaced with $CH_3C(O)-$ groups.

The infrared absorption spectrum of the compound shows the presence of B—H bonds and $>C=O$ groups of the acetyl [$CH_3C(O)-$] radicals. The compound is of the type illustrated by the formulas $B_{10}H_7C(O)C_6H_5 \cdot 2S(CH_3)_2$ and $B_{10}H_6[C(O)CH_3]_2 \cdot 2S(CH_3)_2$.

Example 40

A small portion of $B_{10}H_7C(O)C_6H_5 \cdot 2S(CH_3)_2$, obtained in Example 39, Part A, is dissolved in glacial acetic acid. Excess 30% hydrogen peroxide is added and the solution is stirred. After standing a few minutes at prevailing atmospheric temperature (about 25° C.), the solution is poured into water and the precipitate which forms is separated by filtration. The product is bis(dimethylsulfide) monobenzoyloxyheptahydrodecaborane (8) or, as an alternate name, bis(dimethylsulfide)heptahydrodecaboryl benzoate. The identity of the compound, which has the formula $B_{10}H_7OC(O)C_6H_5 \cdot 2S(CH_3)_2$, is confirmed by its infrared absorption spectrum.

The compound of Example 40 can be hydrolyzed by aqueous alcoholic sodium hydroxide solution to obtain $B_{10}H_7OH \cdot 2S(CH_3)_2$, i.e., a compound of Formula 1 in which X is OH. The process of Example 40 is generic for the preparation of compounds of Formula 1 in which X is $-OC(O)R$, e.g., $-OC(O)CH_3$, $-OC(O)C_6H_5$, and the like.

Example 41

A reaction vessel, equipped with a reflux condenser, is charged with 6.8 g. of $B_{10}H_7 \cdot 2S(CH_3)_2$, 6 g. of $H_2NOSC_3H_7$, 2 g. of NaOH, 50 ml. of water and 50 ml. of ethanol. The mixture is stirred and heated at reflux temperature for about 18 hours. The mixture is cooled and filtered. The filtrate contains in solution an amino-substituted compound of the formula

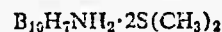

which is a compound of Formula 3.

The compound is basic in view of the presence of the amine group and it can, therefore, form salts with acids. The compound is an example of the group of compounds of the invention in which ionic activity lies in the X substituent and not in the polyhedral boron cage.

The compound is most conveniently isolated in the form of a salt. To illustrate, an aqueous solution of $H_2B_{12}Cl_{12}$, described in Example D, is added to the filtrate obtained above and the precipitate which forms is separated, washed and dried to obtain

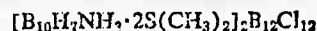

as a white crystalline product. The identity of the compound is confirmed by its infrared absorption spectrum.

The process of Example 41 is generic for the preparation of compounds of Formula 1 in which X is $-NH_2$. The process can be used to prepare, e.g.,

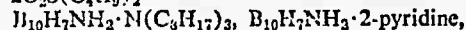
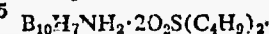

and the like.

Compounds bearing carboxyl groups, e.g.,

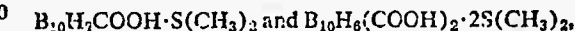

are obtained by hydrolysis of compounds bearing the appropriate number of cyano groups. Compounds bearing nitro groups, e.g.,



and the like are obtained by reaction of $B_{10}H_7 \cdot 2S(CH_3)_2$ with nitric acid. To illustrate, $B_{10}H_7 \cdot 2S(CH_3)_2$ is stirred with concentrated nitric acid at room temperature (about 25° C.) to form a deep red solution. This solution is diluted with water and a red solid is precipitated which is separated by filtration. The red solid is a nitro-substituted compound of the type illustrated above. The compound explodes when dry and analysis is not feasible.

Polyhydrodecaborate(2-) reactants of the type used

in Example 39, Part A, are generically useful in the above-described processes, i.e., polyhydrodecaborates(2-) having one or more X groups bonded to boron can be reacted with oxides of the general formula Z-O to form non-ionic compounds of Formula 3 having one or more X groups in the final product.

The processes described in Examples 1-41 and in the preceding paragraphs are generic to the preparation of neutral (non-ionic) compounds which fall within the scope of Formula 3.

Further illustrations of compounds bearing X substituents and reactants which can be employed to obtain them are as follows:

First reactant	Second reactant	Product
B ₁₀ H ₁₀ S(CH ₃) ₂	F	B ₁₀ H ₁₀ F ₂ ·2S(CH ₃) ₂
B ₁₀ H ₁₀ Cl ₂ CN	C ₆ H ₅ C(O)Cl	B ₁₀ H ₁₀ C(O)C ₆ H ₅ ·2CH ₃ CN
B ₁₀ H ₁₀ Cl ₂ O(S(CH ₃) ₂) ₂	CH ₃ C(O)Cl	B ₁₀ H ₁₀ C(O)CH ₃ ·2CH ₃ C(O)N(CH ₃) ₂
B ₁₀ H ₁₀ S(CH ₃) ₂	ClSO ₂ H	B ₁₀ H ₁₀ SO ₂ H·2S(CH ₃) ₂
B ₁₀ H ₁₀ Cl ₂ N	(C ₆ H ₅) ₂ NC(O)Cl	B ₁₀ H ₁₀ C(O)N(C ₆ H ₅) ₂ ·2C ₆ H ₅ CN
B ₁₀ H ₁₀ Cl ₂ pyridine	C ₆ H ₅ SO ₂ Cl	B ₁₀ H ₁₀ SO ₂ C ₆ H ₅ ·2 pyridine
B ₁₀ H ₁₀ Cl ₂ SO ₂ H	CH ₃ CH=CH ₂	B ₁₀ H ₁₀ C ₃ H ₅ ·2O ₂ S(C ₆ H ₅) ₂
B ₁₀ H ₁₀ S(CH ₃) ₂	C ₆ H ₅ CH=CH ₂	B ₁₀ H ₁₀ C ₆ H ₅ ·2S(CH ₃) ₂
B ₁₀ H ₁₀ Cl ₂ N	HCO ₂ H	B ₁₀ H ₁₀ OH·2CH ₃ CN
B ₁₀ H ₁₀ Cl ₂ SO ₂ H	CH ₂ =CH-CH ₂	B ₁₀ H ₁₀ CH ₂ CH(OH)CH ₂ ·2P(C ₆ H ₅) ₃

The ionic compounds of Formula 2 can be changed to the non-ionic compounds of Formula 3, as illustrated in Example 42, which follows.

Example 42

A small quantity of (CH₃)₄NB₁₀H₉SCH₃·S(CH₃)₂, prepared as described in Example 52, Part A, is dissolved in dimethylformamide and methyl iodide (CH₃I) is added to the solution slowly and with stirring. Tetramethylammonium iodide which precipitates is separated by filtration. The filtrate is diluted with water to precipitate a gummy solid which is separated by filtration. The solid is crystallized from aqueous acetone to yield a white crystalline product which is bis(dimethylsulfide)-octahydrodecaborane(8), i.e., B₁₀H₈·2S(CH₃)₂. The identity of the compound is confirmed by its infrared absorption spectrum.

Example 29, given earlier, also illustrates a process by which the compounds of Formula 2 are changed to compounds of Formula 3.

PREPARATION OF IONIC-TYPE OF COMPOUNDS, FORMULA 2

Example 43

A. A glass reaction vessel, equipped with a stirrer and immersed in an ice bath, is charged with a solution of 40 g. of (NH₄)₂B₁₀H₁₀ in 20 ml. of (CH₃)₂SO. The solution is stirred and cooled while hydrogen chloride gas is passed through it for 1.5 hours at a rate sufficient to maintain the reaction temperature at 44-65° C. At the end of this period, the reaction mixture is poured into 500 ml. of water and the solid B₁₀H₈·2S(CH₃)₂ which precipitates is separated by filtration. The filtrate is extracted three times with 100 ml. portions of ethyl ether and the aqueous liquid which remains is concentrated under reduced pressure to a volume of about 200 ml. The liquid is filtered to separate a white solid which is a mixture of ammonium chloride and a polyhydrodecaborate. The solid is dissolved in water to form Solution A and a small portion of this solution is added with stirring to an aqueous solution of (CH₃)₄NCl. A white solid precipitates which is separated and dried. It is recrystallized from water to obtain pure tetramethylammonium dimethylsulfide-nonahydrodecaborate(1-), i.e.,



The identity of the compound is confirmed by elemental analysis and by its infrared absorption spectrum.

Analysis.—Calc'd for (CH₃)₄NB₁₀H₉·2S(CH₃)₂: B, 42.7; C, 28.4; H, 10.7; S, 12.7. Found: B, 42.0; C, 28.3; H, 10.4; S, 13.3.

B. The process of Part A is repeated except that hydrogen chloride gas is passed into the mixture for only 5 minutes. The reaction mass is processed as described in Part A to obtain a good yield of



C. A second small portion of Solution A, obtained in Part A, is mixed with an aqueous solution of cesium fluoride. The white solid which forms is separated, dried

and crystallized from water to yield pure cesium dimethylsulfide-nonahydrodecaborate(1-), i.e.,

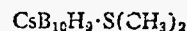

The identity of the compound is confirmed by elemental analysis and by its infrared absorption spectrum.

Analysis.—Calc'd for CsB₁₀H₉·S(CH₃)₂: B, 34.6; C, 7.7; H, 4.8; S, 10.0. Found: B, 33.8; C, 7.8; H, 4.9; S, 10.4.

D. The tetramethylammonium compound, obtained in Part A, is dissolved in hot water and the solution is passed through a column packed with a commercial acid ion-exchange resin of the aryl sulfonic acid type. The acidic effluent is a solution of HB₁₀H₉·S(CH₃)₂ or, more properly, (H₃O)B₁₀H₉·S(CH₃)₂, and it is neutralized (titrated) with aqueous NaOH solution to obtain a solution of NaB₁₀H₉·S(CH₃)₂. The solution of the sodium salt is evaporated to obtain a hydrate of

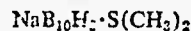

E. A reaction vessel is charged with 40 g. of

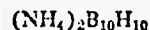

and 200 ml. of (CH₃)₂SO. The mixture is stirred and hydrogen chloride gas is passed into it for 4 minutes. The reaction is exothermic and the temperature is maintained at 75° C. or lower by external cooling of the mixture. Passage of HCl gas is stopped and the reaction mixture is poured into 500 ml. of water. The solution is filtered and 30 g. of triethylamine is added to the filtrate with stirring. Sufficient ammonium hydroxide is added to obtain a neutral solution. (pH=7). The solution is allowed to stand and crystals form which are separated by filtration. The product is recrystallized from ethanol to yield 36 g. of (C₂H₅)₃NHB₁₀H₉·S(CH₃)₂.

F. The triethylanmonium salt, obtained above, is mixed with an equivalent quantity of potassium hydroxide solution and the mixture is boiled to expel triethylamine. The solution is cooled and the crystals which form are separated to obtain KB₁₀H₉·S(CH₃)₂.

Example 44

A reaction vessel is charged with 1.54 g. of

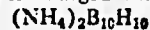

15 ml. of tetramethylene sulfone and 3.92 g. of anhydrous p-toluenesulfonic acid. The charged vessel is placed in an oil bath, the reaction mixture is stirred

and the oil bath is heated to about 85° C. for a period of 70 minutes. Gas is evolved from the reaction mixture during this period. The mixture is cooled, diluted with water and an aqueous solution of a mixture of (CH₃)₂NOH and (CH₃)₂NCl is added. The precipitate which forms is separated, washed and dried in air to obtain 2.77 g. of

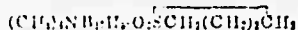

The compound is recrystallized from acetonitrile-methanol mixture to yield large white crystals, M.P. 195-196° C. (with bubbling). The identity of the compound is confirmed by elemental analysis and by its infrared absorption spectrum.

Analysis.—Calc'd for

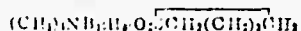

B, 34.73; C, 30.84; S, 19.29; H, 9.33; N, 4.50. Found: B, 34.65; C, 31.08; S, 19.59; H, 9.35; N, 4.30.

The process of Example 44 is generic for the preparation of compounds of Formula 1 and, in particular, for the compounds of Formula 4. To illustrate, by using the process of Example 44, dibutyl sulfone is reacted with NaB₁₀H₉ to obtain NaB₁₀H₉·O₂S(C₄H₉)₂; ethyl phenyl sulfone is reacted with K₂B₁₀H₉ to obtain

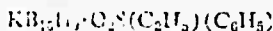

dicyclohexyl sulfone is reacted with [(C₂H₅)₂N]₂B₁₀H₉ to obtain (C₂H₅)₂NB₁₀H₉·O₂S(C₆H₁₁)₂, and the like. It is, of course, possible to obtain a wide range of salts by employing metathatic reactions as described in previous paragraphs.

By extending the heating period in the process of Example 44, non ionic compounds of Formulas 3 and 6 can be obtained in which Z is a sulfone.

Example 45

A. A reaction vessel is charged with 20 g. of diammonium decahydrodecaborate and 100 ml. of N,N-dimethylformamide. The mixture is stirred at atmospheric temperature (about 25° C.) until the boron compound is dissolved and, with continued stirring, gaseous hydrogen chloride is bubbled through the solution. The tem-

B. A solution is prepared as described in Part A consisting of 5.0 g. of diammonium decahydrodecaborate and 75 ml. of N,N-dimethylformamide. Hydrogen chloride gas is passed through the solution with vigorous agitation for a total period of 45 minutes. The temperature of the solution rises to about 90-120° C. during this time and it is also necessary to filter the solution during the interval to remove a large portion of the precipitate which interferes with stirring. At the end of 45 minutes, passage of hydrogen chloride is stopped and the solution is cooled to prevailing atmospheric temperature (about 25° C.). It solidifies and ethanol is added to form a liquid solution. A solution of tetramethylammonium hydroxide in ethanol is added with stirring to precipitate tetramethylammonium N,N-dimethylformamide-nonahydrodecaborate(1-), a compound which has the formula (CH₃)₄NB₁₀H₉·HC(O)N(CH₃)₂. The compound is separated by filtration and it is crystallized twice from hot water to obtain a product of high purity.

Analysis.—Calc'd for (CH₃)₄NB₁₀H₉·HC(O)N(CH₃)₂: B, 41.0; C, 31.3; H, 10.6; N, 10.6. Found: B, 40.5; C, 32.7; H, 10.4; N, 10.5.

Example 46

The filtrate, set aside in Example 30, is used in the process of this example. An aqueous solution of tetrapropylammonium hydroxide is added to the filtrate and a solid precipitates which is separated by filtration to yield 21 g. of tetrapropylammonium (N-methyl-2-pyrrolidone)-nonahydrodecaborate(1-), i.e., a compound of the following formula:

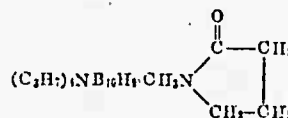

Analysis.—Calc'd for the above: C, 49.6; H, 11.1. Found: C, 49.8, 49.3; H, 11.7, 11.6.

The processes of Examples 45 to 46 are generic to the preparation of ionic compounds of the invention. Examples of products which can be obtained by the processes and the reactants which can be employed are as follows.

Boron Reactant	Second Reactant	Product
(CH ₃) ₂ N ₂ B ₁₀ H ₉	(C ₂ H ₅) ₂ S=O	(CH ₃) ₂ N ₂ B ₁₀ H ₉ ·S(C ₂ H ₅) ₂
Na ₂ B ₁₀ H ₉	(HOOC) ₂ (C ₂ H ₅) ₂ S=O	Na ₂ B ₁₀ H ₉ ·S(C ₂ H ₅) ₂ (OH) ₂
(CH ₃) ₄ N ₂ B ₁₀ H ₉	HC(O)N(CH ₃) ₂	(CH ₃) ₄ N ₂ B ₁₀ H ₉ ·HC(O)N(CH ₃) ₂
Cs ₂ B ₁₀ H ₉	(C ₂ H ₅) ₂ P=O	Cs ₂ B ₁₀ H ₉ ·P(C ₂ H ₅) ₂
(C ₂ H ₅) ₂ SB ₁₀ H ₉	(CH ₃) ₂ N=O	(C ₂ H ₅) ₂ SB ₁₀ H ₉ ·N(CH ₃) ₂
Et ₂ B ₁₀ H ₉	CH ₃ CN	Et ₂ B ₁₀ H ₉ ·CH ₃ CN

perature rises spontaneously to 126° C. over a period of 12 minutes and it then decreases to about 80° C. Flow of hydrogen chloride is stopped at this point and the solution is filtered to remove the ammonium chloride which precipitates in the reaction. The clear filtrate is added with stirring to a solution consisting of 400 ml. of ethanol, 10 ml. of methanol, and 45 g. of cesium hydroxide. A white solid precipitates and it is separated by filtration. The solid is extracted with 100 ml. of hot water. The portion remaining after extraction is crystallized three times from solution in hot water to obtain cesium dimethylformamide-nonahydrodecaborate(1-), i.e., a compound of the formula



The compound is a white crystalline solid whose identity is confirmed by elemental analysis.

Analysis.—Calc'd for CsB₁₀H₉·HC(O)N(CH₃)₂: Cs, 41.0; B, 33.4; C, 11.1; H, 5.0; N, 4.5. Found: Cs, 39.5; B, 32.7; C, 11.3; H, 5.1; N, 4.4.

The examples which follow illustrate the preparation of ionic compounds of the invention which bear X substituents bonded to boron atoms.

Example 47

A reaction vessel is charged with 200 ml. of acetonitrile and 20 g. of CsB₁₀H₉·HC(O)N(CH₃)₂, prepared as described in Example 45, Part A. The vessel is equipped with a gas inlet tube and chlorine gas is bubbled through the reaction mixture, which is a slurry, for 4.5 hours. The mixture forms a clear dark red solution which is diluted with water. The solid which forms is separated by filtration, washed and dried to obtain

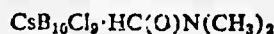

as a white crystalline product. The identity of the compound is confirmed by its infrared absorption spectrum.

Example 48

The compound B₁₀H₉Br₃·2S(CH₃)₂, obtained as described in Example 35, Part G, is added to a solution of

excess potassium phthalimide in dimethylformamide. The solution is refluxed for 15 minutes and it is then diluted with water. An aqueous solution of tetramethylammonium chloride is added with stirring to the reaction mixture and the white product which precipitates is separated by filtration. It is recrystallized from aqueous ethanol to yield tetramethylammonium dimethylsulfide-tribromo(methylmercapto) - pentahydrodecaborate(1-), a white crystalline product of the formula

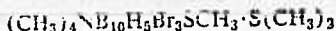

In this compound which is within the scope of Formula 2, Z is $\text{S}(\text{CH}_3)_2$ and there are four X groups, viz., three Br and one $-\text{SCH}_3$. The identity of the compound is confirmed by elemental analysis.

Analysis.—Calc'd for



B, 20.2; C, 15.7; H, 4.86; N, 2.61. Found: B, 18.52; C, 14.8; H, 4.06; N, 2.99.

A by-product obtained in the above process is N-methylphthalimide.

Example 49

A reaction vessel is charged with 10 g. of

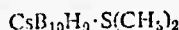

prepared as described in Example 43, Part C, and 110 ml. of dimethylformamide. The mixture is stirred and a solution of 8.1 g. of iodine in 25 ml. of dimethylformamide is added. Stirring is continued for about 5 minutes and the color of the iodine in the solution disappears. The solution is then poured into an aqueous solution containing a mixture of tetramethylammonium hydroxide and tetramethylammonium chloride. A solid precipitates which is separated by filtration and it is recrystallized from water to obtain $(\text{CH}_3)_4\text{NB}_{10}\text{H}_8\text{I} \cdot \text{S}(\text{CH}_3)_2$, a white crystalline solid. The identity of the compound is confirmed by elemental analysis.

Analysis.—Calc'd for $(\text{CH}_3)_4\text{NB}_{10}\text{H}_8\text{I} \cdot \text{S}(\text{CH}_3)_2$: B, 28.5; C, 19.0; H, 7.0; S, 8.45. Found: B, 27.8; C, 19.3; H, 6.9; S, 8.48.

Example 50

A. A reaction vessel is charged with an aqueous solution of sodium hydroxide and the compound of Example 29, $\text{B}_{10}\text{H}_9 \cdot \text{S}(\text{CH}_3)_2 \cdot \text{HC}(\text{O})\text{N}(\text{CH}_3)_2$, is added. The mixture is stirred until all of the solid is dissolved. Aqueous tetramethylammonium chloride solution is added with stirring until precipitation of solid product is complete. The solid is separated by filtration to obtain a compound of the formula $(\text{CH}_3)_4\text{NB}_{10}\text{H}_8\text{OH} \cdot \text{S}(\text{CH}_3)_2$. The identity of the compound is confirmed by its infrared absorption spectrum.

B. A reaction vessel is charged with 5.0 g. of

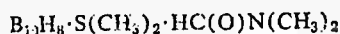

and 50 ml. of aqueous 10% sodium hydroxide solution. The mixture is stirred until the solid component is dissolved and the solution is filtered. An aqueous solution of cesium hydroxide is added with stirring to the filtrate until precipitation of solid product is complete. The solid is separated by filtration and it is purified by recrystallization from water. The compound is cesium dimethylsulfide - monohydroxyoctahydrodecaborate(1-). The identity of the compound, which has the formula $\text{CsB}_{10}\text{H}_8\text{OH} \cdot \text{S}(\text{CH}_3)_2$, is confirmed by its infrared absorption spectrum and by elemental analysis.

Analysis.—Calc'd for $\text{CsB}_{10}\text{H}_8\text{OH} \cdot \text{S}(\text{CH}_3)_2$: B, 32.0; C, 7.3; H, 4.6; S, 9.7. Found: B, 32.6; C, 5.5; H, 4.3; S, 9.5.

C. A reaction vessel is charged with 80 g. of cesium monoformyloxyonahydrodecaborate(2-), obtained as described in Example 57, Part A, 350 ml. of dimethyl sulfoxide and 70 ml. of concentrated hydrochloric acid. The mixture is heated on a steam bath for about 2 hours and it is then poured into two liters of water. The pre-

cipitate which forms is separated by filtration. The solid product is mixed with aqueous sodium hydroxide solution (approximately 20% strength) and the solution is heated to boiling. The solution is filtered to obtain a clear filtrate to which an aqueous solution of tetramethylammonium chloride is added with stirring. The precipitate which forms is separated by filtration to obtain tetramethylammonium dimethylsulfide-mono-hydroxyoctahydrodecaborate(1-) as a white crystalline solid. The compound, for which the formula is

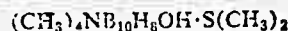

is purified by recrystallization from hot water.

Analysis.—Calc'd for $(\text{CH}_3)_4\text{NB}_{10}\text{H}_8\text{OH} \cdot \text{S}(\text{CH}_3)_2$: C, 26.7; H, 10.0; N, 5.2; S, 11.9. Found: C, 26.6; H, 10.0; N, 5.2; S, 11.8.

D. A mixture is prepared which consists of 25 ml. of 10% NaOH and 1.9 g. of

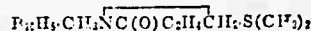

(alpha form), obtained as described in Example 32. The mixture is refluxed for 1 hour, cooled briefly and a solution of 3 g. of CsF in 15 ml. of water is added with stirring. The reaction mixture is warmed and evaporated on a steam bath until a solid separates. The solid is isolated and recrystallized from water to obtain



which is identical with the compound obtained in Part B.

The infrared spectrum of the compound shows absorption at the following wavelengths (expressed in microns): 2.7 (medium), 3.0 (medium), 4.0 (sharp), 8.7 (medium), 9.0 (medium), 9.4 (medium), 9.7 (medium), 10.0 (medium), 10.2 (medium), 10.4 (medium), 10.8 (weak), 11.3 (very weak), 11.6 (very weak), 12.1 (weak), 13.2 (very weak), 13.9 (weak), and 14.3 (weak).

E. A mixture of 4 g. of $\text{B}_{10}\text{H}_9 \cdot \text{N}_2 \cdot \text{S}(\text{CH}_3)_2$ and 20 ml. of

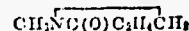

is processed as described in Example 32, Part C. The product



(beta form), is mixed with 25 ml. of aqueous 5% NaOH solution and the mixture is refluxed for 30 minutes. The mixture is filtered and an aqueous solution of TINO_3 is added to the filtrate. The precipitate which forms is separated, washed and dried to obtain



The identity of the compound is confirmed by its infrared spectrum which shows absorption at the following wavelengths (expressed as microns): 2.8 (medium), 3.0 (medium), 4.05 (strong), 8.3 (medium), 8.5 (medium), 9.0-9.3 (medium), 9.7 (medium), 10.0 (medium), 10.4 (weak), and 10.9 (weak).

Example 51

The compound obtained in Example 50, Part B, i.e., $\text{CsB}_{10}\text{H}_8\text{OH} \cdot \text{S}(\text{CH}_3)_2$, is heated on a steam bath with 98% formic acid for about 5 minutes to obtain a solid product whose infrared absorption spectrum shows that it is principally cesium dimethylsulfide monoformyloxyoctahydrodecaborate(1-), i.e., $\text{CsB}_{10}\text{H}_8\text{OC}(\text{O})\text{H} \cdot \text{S}(\text{CH}_3)_2$.

Example 52

A. A glass reaction vessel is charged with 6 ml. of tributylphosphine and 2.0 g. of $\text{B}_{10}\text{H}_9 \cdot 2\text{S}(\text{CH}_3)_2$, obtained as described in Example 1. Nitrogen gas is passed into the vessel to provide an inert atmosphere and the solution is heated for a few minutes to 210° C. Excess tributylphosphine is then removed by distillation of the solution under reduced pressure. The solid residue is washed

51

thoroughly with benzene and the residue is then dissolved in methanol. The solution is filtered and the filtrate is poured with stirring into an ethanol solution of tetramethylammonium chloride. The solid which precipitates is separated by filtration and it is crystallized from hot water to obtain, as a white crystalline product, a compound of the formula $(\text{CH}_3)_4\text{NB}_{10}\text{H}_8\text{SCH}_3\cdot\text{S}(\text{CH}_3)_2$. The compound is referred to as tetramethylammonium dimethylsulfide-methylmercaptooctahydrodecaborate(1-), wherein the Z group of Formula 2 is dimethyl sulfide and the X group is methylmercapto(CH_3S -).

Analysis.—Calc'd for $(\text{CH}_3)_4\text{NB}_{10}\text{H}_8\text{SCH}_3\cdot\text{S}(\text{CH}_3)_2$: B, 36.2; C, 28.1; H, 9.77; N, 4.58; S, 21.4; M.W., 299.6. Found: B, 35.4; C, 27.7; H, 9.52; N, 4.25; S, 21.5; M.W., 299.0.

In a second preparation, a mixture of 0.5 g. of $\text{B}_{10}\text{H}_8\cdot 2\text{S}(\text{CH}_3)_2$ and 8 ml. of tributylphosphine is heated to 220° C. for a short period and the reaction product is processed as described above to obtain the compound described in the preceding paragraph.

B. A glass reaction vessel, equipped with a stirrer and reflux condenser, is charged with 4.0 g. of

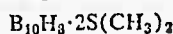

obtained as described in Example 1, 4.0 g. of potassium phthalimide, and 75 ml. of dimethylformamide. The mixture is refluxed for 20 minutes and, after cooling, it is filtered. Solvent is removed from the filtrate by evaporation under reduced pressure until a sludge remains. The residue is stirred with water and the mixture is filtered. An aqueous solution of cesium fluoride is added to the filtrate and the solution is filtered again. An aqueous solution of tetramethylammonium chloride is now added with stirring to the filtrate and the white precipitate which forms is separated by filtration. The product is



i.e., the compound obtained in Part A. The identity of the compound is confirmed by its infrared absorption spectrum and, further, by elemental analysis (boron, calc'd: 36.2; found: 35.87).

C. A mixture of 2.0 g. of $\text{B}_{10}\text{H}_8\cdot 2\text{S}(\text{CH}_3)_2$, 2.0 g. of potassium phthalimide and 50 ml. of dimethylformamide is heated to reflux temperature for 15 minutes. The solution is filtered and the filtrate is treated with an aqueous solution of tetramethylammonium chloride. The white solid which precipitates is purified by crystallization to yield a compound of the formula stated in Parts A and B of this example, i.e., $(\text{CH}_3)_4\text{NB}_{10}\text{H}_8\text{SCH}_3\cdot\text{S}(\text{CH}_3)_2$.

Example 52—A which follows illustrates a further procedure for introducing —SR substituents on the boron cage. In this procedure, a compound of the formula $\text{B}_{10}\text{H}_8\cdot 2\text{SR}_2$ is reacted with a thiophenol in the presence of a strong base.

Example 52—A

A. Two solutions are prepared consisting of (a) 24.0 g. (0.10 mole) of $\text{B}_{10}\text{H}_8\cdot 2\text{S}(\text{CH}_3)_2$ in 22.0 g. of thiophenol and (b) 11.2 g. (0.20 mole) of KOH in 100 ml. of ethanol. The solutions are mixed and the suspension which forms is refluxed for 6 hours. A clear light brown solution forms which, after cooling, is poured into a solution of 30.0 g. of CsF in 200 ml. of $\text{C}_2\text{H}_5\text{OH}$. A white gum precipitates which is solidified by cooling and stirring. The solid is separated by filtration and extracted with 100 ml. of hot water. The insoluble portion from the water extraction is now heated in 300 ml. of water to boil; the solution is filtered and cooled. The precipitate which forms is separated, washed and dried to obtain cesium dimethylsulfide-methylmercaptooctahydrodecaborate(1-).

Analysis.—Calc'd for $\text{CsB}_{10}\text{H}_8\text{SCH}_3\cdot\text{S}(\text{CH}_3)_2$: C, 10.1; H, 4.8; B, 30.2. Found: C, 10.3; H, 4.9; B, 30.4.

B. A solution of 5.0 g. of $\text{CsB}_{10}\text{H}_8\text{SCH}_3\cdot\text{S}(\text{CH}_3)_2$ in 500 ml. of water is passed through a glass column filled with a commercial acid ion-exchange resin. The aqueous

52

effluent, which contains $\text{HB}_{10}\text{H}_8\text{SCH}_3\cdot\text{S}(\text{CH}_3)_2$, or in its hydronium form, $(\text{H}_3\text{O})\text{B}_{10}\text{H}_8\text{SCH}_3\cdot\text{S}(\text{CH}_3)_2$, is evaporated under reduced pressure to dryness. The free acid is obtained as a white crystalline product.

Analysis.—Calc'd for $\text{HB}_{10}\text{H}_8\text{SCH}_3\cdot\text{S}(\text{CH}_3)_2$: C, 15.9; H, 7.9; S, 28.4. Found: C, 13.4; H, 7.3; S, 28.1.

Example 53

The tetramethylammonium salt,



obtained as described in Example 52, is dissolved in hot water and the solution is passed through a column packed with a polysulfonic acid ion-exchange resin ("Amberlite IR-120-H"). The acidic effluent is evaporated to dryness and the white residue is crystallized from a benzene-petroleum ether solution. The compound which is obtained is hydrogen dimethylsulfide-methylmercaptooctahydrodecaborate(1-), i.e., $\text{HB}_{10}\text{H}_8\text{SCH}_3\cdot\text{S}(\text{CH}_3)_2$. It decomposes on heating to 190–195° C. In this compound which falls within the scope of Formula 1, M is H, X is SCH_3 and Z is $\text{S}(\text{CH}_3)_2$.

Analysis.—Calc'd for $\text{HB}_{10}\text{H}_8\text{SCH}_3\cdot\text{S}(\text{CH}_3)_2$: B, 47.7; S, 28.3. Found: B, 47.8; S, 28.4.

The aqueous solution of the acid of Example 53 is neutralized with an aqueous solution of LiOH to obtain $\text{Li}[\text{B}_{10}\text{H}_8\text{SCH}_3\cdot\text{S}(\text{CH}_3)_2]$.

Example 54

A portion of the compound $\text{HB}_{10}\text{H}_8\text{NH}_2\cdot\text{S}(\text{CH}_3)_2$, is dissolved in aqueous sodium hydroxide solution and an aqueous solution of $(\text{CH}_3)_4\text{NCl}$ is added. The precipitate which forms is separated, washed and dried to obtain $(\text{CH}_3)_4\text{NB}_{10}\text{H}_8\text{NH}_2\cdot\text{S}(\text{CH}_3)_2$.

Example 55

A solution consisting of 11.3 g. of hydroxylamine-O-sulfonic acid in 100 ml. of water is neutralized by adding a solution of 5.3 parts of Na_2CO_3 in 20 ml. of water. The neutral solution is added with stirring to a solution of 15 g. of $\text{KB}_{10}\text{H}_9\cdot\text{S}(\text{CH}_3)_2$, prepared as described in Example 43, Part E, in 100 ml. of water. The mixture is heated at 95° C. for 2 hours and then cooled. A sticky mass of crystals form which are separated and dried in air. The dried product is recrystallized from a mixture of ethanol and propanol to obtain 4 g. of

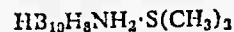

This compound can also be written as an inner salt, i.e., $\text{B}_{10}\text{H}_8\text{NH}_2\cdot\text{S}(\text{CH}_3)_2$. The product melts at 290° C.

Analysis.—Calc'd for $\text{HB}_{10}\text{H}_8\text{NH}_2\cdot\text{S}(\text{CH}_3)_2$: C, 12.3; H, 8.8; B, 55.4; N, 7.17; S, 16.4. Found: C, 12.4; H, 8.6; B, 54.9; N, 7.35; S, 16.6.

Example 56

A. A reaction vessel is charged with 150 ml. of dimethylformamide and 48 ml. of an aqueous solution containing 0.23 mole of $(\text{H}_2\text{O})_2\text{B}_{10}\text{H}_{10}$ is poured into it with stirring. The reaction mixture is distilled at atmospheric pressure until a still head temperature of 130° C. is reached. The solution which remains in the still pot is cooled and it is added with stirring to a solution containing 60 g. of cesium hydroxide in 600 ml. of ethanol and 50 ml. of methanol. A precipitate forms which is separated by filtration. The solid product is dicesium formyloxynonahydrodecaborate(2-), i.e., a compound of the formula $\text{Cs}_2\text{B}_{10}\text{H}_9\text{OC}(\text{O})\text{H}$.

Analysis.—Calc'd for $\text{Cs}_2\text{B}_{10}\text{H}_9\text{OC}(\text{O})\text{H}$: Cs, 62.1; B, 2.50; C, 2.80; H, 2.34. Found: Cs, 62.0; B, 25.6, 25.4; C, 2.74; H, 2.65.

B. The filtrate which is obtained in the above separation step is distilled to remove alcohol solvents. The residue from the distillation is mixed with an aqueous solution containing 20 g. of tetramethylammonium chloride.

The precipitate which forms is separated by filtration and 3.8 g. of the acid salt, tetramethylammonium hydrogen dimethylammonononylhydrodecaborate(2-), is obtained. The identity of the product which has the formula



is confirmed by elemental analysis.

Analysis.—Calcd for $(CH_3)_4NHB_{10}H_9N(CH_3)_2$: B, 45.7; C, 30.5; H, 11.9; N, 11.8. Found: B, 44.0; C, 31.5; H, 11.6; N, 11.8.

A reaction vessel is charged with 1.0 g. of

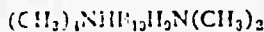

obtained as above, 10 ml. of dimethylsulfoxide and 5 ml. of concentrated hydrochloric acid. The mixture is heated on a steam bath for 30 minutes. It is then poured into 100 ml. of water with stirring and the precipitate which forms is separated by filtration. The solid is dissolved in acetone and reprecipitated with water. The product is recrystallized from methanol-water solution to obtain 0.25 g. of hydrogen dimethylsulfidedimethylammonononylhydrodecaborate(1-), i.e., $[H]B_{10}H_9N(CH_3)_2 \cdot S(CH_3)_2$, a compound which falls within the scope of Formula 2. The compound can also be viewed as an inner salt in which the hydrogen in brackets is associated with the nitrogen of the dimethylamino group. This structure, which is suggested by the infrared absorption spectrum, is represented as $B_{10}H_9NH(CH_3)_2 \cdot S(CH_3)_2$.

The compound is a white crystalline solid which decomposes at 206-207° C. Its identity is confirmed by elemental analysis.

Analysis.—Calcd for $HB_{10}H_9N(CH_3)_2 \cdot S(CH_3)_2$: S, 14.3; N, 6.27. Found: S, 14.3; N, 6.20.

Example 57

A solution of 3.4 g. of tetramethylammonium dimethylsulfide-nonylhydrodecaborate(1-)



obtained as described in Example 43, Part A, is prepared in about 100 ml. of boiling water and the hot solution is passed through a column packed with an acidic ion-exchange resin ("Amberlite IR-120-H"). The effluent, which is a solution of $HB_{10}H_9 \cdot S(CH_3)_2$, or, more properly, $(H_3O)B_{10}H_9 \cdot S(CH_3)_2$, is evaporated under reduced pressure to a volume of about 4 ml. and the liquid residue is filtered. About 20 ml. of 1,2-dimethoxyethane (glyre) is mixed with the filtrate. In this step a transient blue color forms but the final liquid solution is essentially colorless. Benzoyl chloride (8 ml.) is added with stirring to the solution and the mixture is allowed to stand at atmospheric temperature (about 25° C.) for 45 minutes. The solution, which is yellow in color, is heated on a steam bath for 10 minutes during which period the color becomes a deep red. The solution is poured with stirring into 100 ml. of isopropyl alcohol containing sufficient tetramethylammonium hydroxide (as the pentahydrate)

ammonium dimethylsulfide-mono-benzoyloctahydrodecaborate(1-), i.e., $(CH_3)_4NB_{10}H_8C(O)C_6H_5 \cdot S(CH_3)_2$.

Example 58

A reaction vessel is charged with 50 ml. of glacial acetic acid, 2.1 g. of dimethylsulfoxide and 5 g. of bis(tetramethylammonium) mono-benzoylnonylhydrodecaborate(2-), prepared as described in Example B. The charged vessel is cooled in a mixture of ice and water, and the reaction mixture is stirred to form a slurry. Hydrogen chloride gas is passed through the mixture for 5 minutes at a rate which maintains a reaction temperature of 21 to 25° C. The reaction vessel is removed from the ice bath and passage of gaseous hydrogen chloride is continued for 2 minutes without cooling the mixture. A red solution is formed which is poured into 400 ml. of water with stirring. An orange-colored solid precipitates which is separated by filtration. A portion of the solid (called Fraction A) is dissolved in acetone and this solution is poured slowly with stirring into an aqueous potassium hydroxide solution (approximately 2 molar). A cloudy solution forms which contains

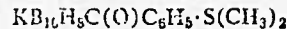

The solution is filtered through a commercial diatomaceous earth to yield a clear filtrate. A saturated aqueous solution of thallium nitrate is poured into the filtrate with stirring to form a light yellow solid which is separated by filtration. The solid is crystallized from solution in water on a steam bath to yield thallium dimethylsulfide-mono-benzoyloctahydrodecaborate(1-), a compound of the formula $TlB_{10}H_8C(O)C_6H_5 \cdot S(CH_3)_2$. The identity of the compound is confirmed by elemental analysis.

Analysis.—Calcd for $TlB_{10}H_8C(O)C_6H_5 \cdot S(CH_3)_2$: B, 22.0; C, 22.1; H, 3.9; S, 6.5; Tl, 42.0. Found: B, 22.7; C, 22.0; H, 4.4; S, 7.4; Tl, 38.5.

Example 59

A solution of 4.6 g. (0.013 mole) of $Cs[B_{10}H_8SCH_3 \cdot S(CH_3)_2]$

in 400 ml. of water is added drop-wise and with stirring to a solution of 1.4 g. (0.013 mole) of BrCN in 200 ml. of water. The solution becomes yellow and a precipitate forms slowly as the reaction progresses. When addition of the solution of the cesium salt is completed, the precipitate is separated by filtration. The precipitate contains $B_{10}H_8 \cdot 2S(CH_3)_2$ and other by-products of the reaction. The filtrate is evaporated almost to dryness under reduced pressure at 25° C. The yellow solid which remains is recrystallized twice from hot water to obtain about 0.2 g. of cesium dimethylsulfide-thiocyanooctahydrodecaborate(1-).

Analysis.—Calcd. for $CsB_{10}H_8SCN \cdot S(CH_3)_2$: C, 9.75; H, 3.79; S, 17.40; NN, 3.75. Found: C, 9.94; H, 4.10; S, 17.50; N, 3.84.

Examples of compounds which can be obtained by the substitution processes, and reactants which can be employed are as follows:

Boron reactant	Second reactant	Product
$[(C_2H_5)_3N]B_{10}H_9 \cdot O_2S(C_2H_5)_2$	Br.....	$(C_2H_5)_3NB_{10}Br_2 \cdot O_2S(C_2H_5)_2$
$CsB_{10}H_8OH \cdot S(CH_3)_2$	$[CH_3C(O)]_2O$	$CsB_{10}H_8OC(O)C_6H_5 \cdot S(CH_3)_2$
$CsB_{10}H_8OH \cdot S(CH_3)_2$	$C_6H_5C(O)Cl$	$CsB_{10}H_8OC(O)C_6H_5 \cdot S(CH_3)_2$
$CsB_{10}H_8OH \cdot N_2$	$(C_2H_5)_3N$	$CsB_{10}H_8OH \cdot N(C_2H_5)_3$
$CsB_{10}Cl_2 \cdot N_2$	$(C_2H_5)_3P$	$CsB_{10}Cl_2P(C_2H_5)_3$
$N_2B_{10}H_8N(H) \cdot S(CH_3)_2$	C_6H_5NCO	$N_2B_{10}H_8N(H)C(O)N(C_6H_5) \cdot S(CH_3)_2$
$CsB_{10}H_8 \cdot HC(O)N(CH_3)_2$	$C_6H_5C_6H_4C(O)Cl$	$CsB_{10}H_8C(O)C_6H_4C_6H_5 \cdot HC(O)N(CH_3)_2$
$HB_{10}H_8 \cdot (CH_3)_2$	$CH_2=CH=CH_2$	$HB_{10}H_8C_3H_5 \cdot S(CH_3)_2$
$HB_{10}H_8 \cdot CH_3CN$	$C_6H_5CH=CH_2$	$HB_{10}H_8C_6H_4C_6H_5 \cdot CH_3CN$

to maintain a basic solution. More tetramethylammonium hydroxide can be added, if needed, to the isopropyl alcohol solution during this step to keep the solution basic. A tan-colored solid precipitates which is separated by filtration. The product, which is dried, is tetramethyl-

As further illustrations of procedures for obtaining compounds of the invention bearing X groups, fluorine-substituted products are prepared by reacting hydroxyl-bearing decaborates with hydrogen fluoride, e.g.,

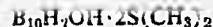

is reacted with HF to obtain $B_{10}H_7F_2S(CH_3)_2$; compounds bearing thiol groups ($-SH$) are obtained by reacting $B_{10}H_7N_2Z$ (where Z is defined as in Formula 1) with a metal azide, e.g., $B_{10}H_7N_2S(CH_3)_2$ is reacted with NaN_3 to obtain $NaB_{10}H_7N_2S(CH_3)_2$; compounds bearing thiol groups ($-SH$) are obtained by reacting



or $B_{10}H_7N_2Z$ with hydrogen sulfide, preferably under pressure, e.g., $B_{10}H_7N_2S(CH_3)_2$ is reacted with H_2S in a pressure vessel at autogenous pressure to obtain $HB_{10}H_7SH-S(CH_3)_2$. Thiol-substituted compounds can be oxidized to obtain products bearing a sulfo group ($-SO_2H$), e.g., $HB_{10}H_7SH-S(CH_3)_2$ can be oxidized with hydrogen peroxide to obtain

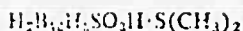

The processes illustrated in Examples 43-59 are generically applicable for the preparation of ionic compounds of the invention, represented by Formula 2. Compounds can be obtained having a wide range of X substituents, as described in earlier paragraphs for the non-ionic group. Thus, ionic compounds are obtained bearing such groups as carboxyl, halogens, nitro, amine, azo, sulfo, acyl (acetyl, capryl, methyl), alkoxy (methoxy, hexyloxy, phenoxy), hydrocarboxyloxy (propionyloxy, hexanoyloxy), cyano, hydroxy, and the like, by employing the reactions described earlier for the introduction of X groups and their modification.

The ionic compounds of the invention, i.e., compounds of Formula 2, are generally isolated in the form of salts of low solubility in water, e.g., cesium, tetramethylammonium, trimethylbutylammonium and like salts in which the cation has a large atomic volume. These salts are readily converted, as described earlier, to the free acid, i.e., to a compound of Formula 2 where M is H^+ or, in its hydrated form, $(H_3O)^+$, by contacting solutions of the salts with commercially available acid ion-exchange resins. The aqueous solutions are then neutralized with bases or salts of volatile anions, and the solutions are evaporated to dryness. This procedure is a versatile means of obtaining salts having any desired cation M. The following examples are illustrative of the process, the acid reactant being obtained as described above:

imparts a green color to fireworks, flare or rocket displays. Other components in the compounds of the invention, e.g., the cation M in the ionic species, the substituent X bonded to boron or the group Z, can impart other colors or permit a modification in the characteristics of the propellant composition and by proper choice of these components a broad range of color effects can be accomplished in this generic utility. The compounds of the invention are preferably employed for this use in combination with oxidizing agents, e.g., lithium perchlorate, sodium nitrate, potassium permanganate, strontium peroxide, manganese dioxide, and the like, to obtain the desired propulsive effect and color. The following combinations in which the boron-containing compound can be present in from about 5-25% by weight are illustrative of the compositions which can be used:

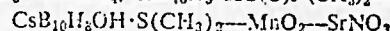
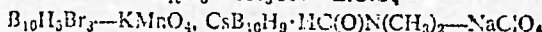
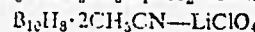
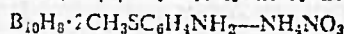
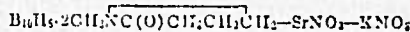
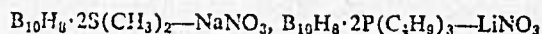

and the like. These examples are not limiting but are illustrative of the combinations which are possible for use in the above field.

The compounds of the invention are generically useful as impregnating agents for cellulosic materials in the preparation of resins. To illustrate, a section of cellulosic string is immersed in a saturated solution of $B_{10}H_7-2S(CH_3)_2$ in acetone for a short period and it is suspended in air until the solvent is evaporated. The dried string is ignited with an open flame and burns vigorously. There remains a self-supporting ash of substantially the same size and shape as the string. The residue, embedded in paraffin, has a resistance of about 3000-4000 ohms/inch. A section of string, treated as described above with a saturated solution of

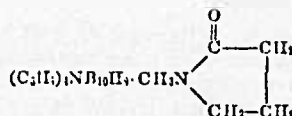

TABLE II

Polyborate salt	Derived acid	Neutralizing reagent	Product
$(CH_3)_4NEt_3B_{10}H_7S(CH_3)_2$	$HB_{10}H_7S(CH_3)_2$	C_2H_5N $Ba(OH)_2$	$C_2H_5NB_{10}H_7S(CH_3)_2$ $Ba(B_{10}H_7S(CH_3)_2)_2$
$(CH_3)_4NB_{10}H_7O_2SCH_2(CH_2)_2CH_2$	$HB_{10}H_7O_2SCH_2(CH_2)_2CH_2$	$((C_2H_5)_3SOH$ $(C_2H_5)_3POH$	$(CH_3)_4SB_{10}H_7O_2SCH_2(CH_2)_2CH_2$ $(C_2H_5)_3PB_{10}H_7O_2SCH_2(CH_2)_2CH_2$
$Cs_3B_{10}Cl_3HC(O)N(CH_3)_2$	$HB_{10}Cl_3HC(O)N(CH_3)_2$	$RbOH$ $C_2H_5N(CH_3)_3$ CaH_2NH_2	$RbB_{10}H_7Cl_3C(O)N(CH_3)_2$ $C_2H_5NB_{10}H_7Cl_3HC(O)N(CH_3)_2$ $CaH_2NB_{10}H_7Cl_3HC(O)N(CH_3)_2$
$(CH_3)_4NB_{10}H_7I-S(CH_3)_2$	$HB_{10}H_7I-S(CH_3)_2$	Ag_2O $CaCl_2$	$Ag_2B_{10}H_7I-S(CH_3)_2$ $CaB_{10}H_7I-S(CH_3)_2$
$Cs_3B_{10}H_7OH-S(CH_3)_2$	$HB_{10}H_7OH-S(CH_3)_2$	$Mg(OH)_2$ $Ca(OH)_2$	$Mg(OH)_2B_{10}H_7OH-S(CH_3)_2$ $Ca(OH)_2B_{10}H_7OH-S(CH_3)_2$
$Cs_3P_{10}H_7OC(O)H-S(CH_3)_2$	$HB_{10}H_7OC(O)H-S(CH_3)_2$	$Ni(OH)_2$ $FeCl_3$	$Ni(OH)_2B_{10}H_7OC(O)H-S(CH_3)_2$ $FeCl_3B_{10}H_7OC(O)H-S(CH_3)_2$
$(CH_3)_4NB_{10}H_7NO_2-2(CH_3)_2$	$H_2B_{10}H_7NO_2-2(CH_3)_2$	$HOCH_2CH_2NH_2$ CaH_2NH_2	$HOCH_2CH_2NH_2B_{10}H_7NO_2-2S(CH_3)_2$ $CaH_2NB_{10}H_7NO_2-2S(CH_3)_2$
$(CH_3)_4NB_{10}H_7C(O)C_6H_5-S(CH_3)_2$	$HB_{10}H_7C(O)C_6H_5-S(CH_3)_2$	NH_4Cl $NH_4ClCOOH$ $NH_4ClCOOH$ $H_2C_2O_4$ $CaH_2CH_2NH_2$	$NH_4B_{10}H_7C(O)C_6H_5-S(CH_3)_2$ $NH_4ClB_{10}H_7C(O)C_6H_5-S(CH_3)_2$ $H_2C_2O_4B_{10}H_7C(O)C_6H_5-S(CH_3)_2$ $CaH_2NB_{10}H_7C(O)C_6H_5-S(CH_3)_2$
$Cs_3B_{10}H_7SCN-S(CH_3)_2$	$HB_{10}H_7SCN-S(CH_3)_2$	$CaH_2CH_2NH_2$	$CaH_2NB_{10}H_7SCN-S(CH_3)_2$

Uses for compounds of the invention

The compounds of the invention, represented by Formula 1, are generically useful as combustible components of propellant compositions for fireworks, flares or rockets. Each of the compounds of the invention contains boron as a common element. The presence of this element

yields a shaped residue having a resistance of about 40,000 ohms/inch. The compounds of the invention, as exemplified in Examples 1-59, are useful in this field of application.

In the group of compounds which fall within the scope of Formula 2, the component M represents a range of groups which are readily interchangeable by metathetic

reactions as described earlier. All of the salts which fall within the scope of Formula 2 can be used to prepare the group of acids represented generically as $\text{HB}_{10}\text{H}_{9-y}\text{X}_y\cdot\text{Z}$, or, in aqueous solution, as $(\text{H}_3\text{O})\text{(B}_{10}\text{H}_{9-y}\text{X}_y\cdot\text{Z})$ by passing aqueous or alcoholic solutions of the salts through an acidic ion-exchange resin as described earlier. The acids of this group are strong acids and they are useful in industrial applications where it is desired to avoid contamination from sulfate, chloride, bromide, chlorate, phosphate, and like strong acid anions. Thus, the acids of Formula 2, where M is H (or H_3O^+) are useful for etching metals, such as steel, and for rust removal, for pickling, for scale removal and for similar metal processing operations.

The acids are useful as catalysts in the preparation of esters, e.g., in the reaction of alcohols and organic acids, to improve the yields of the desired esters. The acids of the invention are employed for this purpose in the same manner as p-toluenesulfonic acid, sulfuric acid or alcoholic hydrogen chloride.

The acids obtained from each of the compounds of Examples 43 through 59 are useful as described above.

The acids and many of the salts, particularly the alkali metal and alkaline earth metal salts, are useful as sequestering agents for heavy metals. Thus, a mixture of hydrocarbons in the boiling range of gasoline which contains a copper salt of an organic acid (copper stearate), is thoroughly agitated with aqueous ammoniacal solutions of any of the alkali metal or alkaline earth metal salts of the compounds of Formula 2, e.g., $\text{CsB}_{10}\text{H}_9\cdot\text{S}(\text{CH}_3)_2$, $\text{CsB}_{10}\text{H}_9\cdot\text{HCON}(\text{CH}_2)_2$, and the like. The hydrocarbon layer, which is separated from the aqueous reagent, is completely free of deleterious copper salt.

The new compounds, particularly the acids, alkali metal, alkaline earth metal and ammonia salts, are useful as sequestering agents for metals in aqueous media. Thus, copper, nickel, cobalt, zinc and cadmium are removed from aqueous solutions of salts containing these metals by mixing the solutions with ammoniacal solutions of the acids and alkali metal, alkaline earth metal and ammonium salts.

The substituted ammonium salts and, in general, all of the nitrogen-base salts as well as phosphonium and sulfonium salts are useful in the field of sequestering agents to remove undesirable metals from aqueous or hydrocarbon media, e.g.,

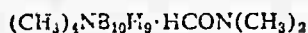

and the like.

The silver salts, i.e., the compounds of Formula 2, where M is Ag, are sensitive to light and they are useful in the photographic arts. To illustrate, the cesium salt, $\text{CsB}_{10}\text{H}_9\cdot\text{S}(\text{CH}_3)_2$, is reacted with silver nitrate to obtain $\text{AgB}_{10}\text{H}_9\cdot\text{S}(\text{CH}_3)_2$. An alcoholic solution of the silver salt is prepared in subdued light and a strip of pure cellulose sheet is immersed to half its length in the solution. The strip is removed and dried in the absence of light. When exposed to light the treated portion of the strip turns dark while the untreated portion is not affected.

The neutral or non-ionic group of compounds of the invention, which are represented by Formula 3, can be used as intermediates for the preparation of the ionic group of compounds which are represented by Formula 2. The use of ionic compounds as intermediates is illustrated in Examples 48 and 52.

Since many different embodiments of the invention may be made without departing from the spirit and scope thereof, it is to be understood that the invention is not limited by the specific illustrations except to the extent defined in the following claims.

The embodiments of the invention in which an exclu-

sive property or privilege is claimed are defined as follows:

1. A compound of the formula

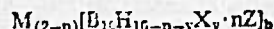

wherein M is a cation having a valence from 1 to 3; X is bonded to boron and is a monovalent group which is capable of bonding to nuclear carbon of a carbocyclic aromatic compound by replacement of hydrogen, and is (1) a group derived from an electrophilic reagent by direct attack on the boron cage, or (2) is a group derived by modification of a group in (1) by reduction, esterification, hydrolysis, dehydration, amidation and combinations thereof; Z is selected from the group consisting of organic sulfides, tertiary phosphines, tertiary amines, amides of carboxylic acids, organic sulfones and nitriles; n is a cardinal number of from 1 to 2, inclusive; (2-n) represents the number of M groups which are present in the compound; y is a cardinal number of from 0 to 20 (10-n), inclusive, and b is equal to the valence of M when n is 1 and b is 1 when n is 2.

2. A compound of the formula

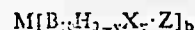

wherein M is a cation having a valence from 1 to 3; X is bonded to boron and is a monovalent group which is capable of bonding to nuclear carbon of a carbocyclic aromatic compound by replacement of hydrogen, and is (1) a group derived from an electrophilic reagent by direct attack on the boron cage, or (2) is a group derived by modification of a group in (1) by reduction, esterification, hydrolysis, dehydration, amidation and combinations thereof; Z is selected from the group consisting of organic sulfides, tertiary phosphines, tertiary amines, amides of carboxylic acids, organic sulfones and nitriles; y is a cardinal number of from 0 to 9, inclusive, and b is equal to the valence of M.

3. A compound of the formula

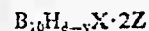

wherein X is bonded to boron and is a monovalent group which is capable of bonding to nuclear carbon of a carbocyclic aromatic compound by replacement of hydrogen, and is (1) a group derived from an electrophilic reagent by direct attack on the boron cage, or (2) is a group derived by modification of a group in (1) by reduction, esterification, hydrolysis, dehydration, amidation and combinations thereof; Z is selected from the group consisting of organic sulfides, tertiary phosphines, tertiary amines, amides of carboxylic acids, organic sulfones and nitriles; and y is a cardinal number of from 0 to 8, inclusive.

4. A compound of the formula



wherein M is a cation having a valence from 1 to 3; Z is selected from the group consisting of organic sulfides, tertiary phosphines, tertiary amines, amides of carboxylic acids, organic sulfones and nitriles; and b is equal to the valence of M.

5. A compound of the formula



wherein Z is selected from the group consisting of organic sulfides, tertiary phosphines, tertiary amines, amides of carboxylic acids, organic sulfones and nitriles.

6. A compound of the formula



wherein X is bonded to boron and is a monovalent group which is capable of bonding to nuclear carbon of a carbocyclic aromatic compound by replacement of hydrogen, and is (1) a group derived from an electrophilic reagent by direct attack on the boron cage, or (2) is a group derived by modification of a group in (1) by re-

duction, esterification, hydrolysis, dehydration, amidation and combinations thereof; Z is selected from the group consisting of organic sulfides, tertiary phosphines, tertiary amines, amides of carboxylic acids, organic sulfones and nitriles; and y is a cardinal number of from 1 to 8, inclusive.

7. A compound of the formula

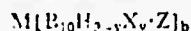

wherein M is a cation having a valence from 1 to 3; X is bonded to boron and is a monovalent group which is capable of bonding to nuclear carbon of a carbocyclic aromatic compound by replacement of hydrogen, and is (1) a group derived from an electrophilic reagent by direct attack on the boron cage, or (2) is a group derived by modification of a group in (1) by reduction, esterification, hydrolysis, dehydration, amidation and combinations thereof; Z is selected from the group consisting of organic sulfides, tertiary phosphines, tertiary amines, amides of carboxylic acids, organic sulfones and nitriles; y is a cardinal number of from 1 to 9, inclusive; and b is equal to the valence of M.

8. A compound of the formula

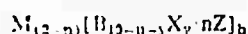

wherein M is a cation having a valence of from 1 to 3; X is a substituent selected from the class consisting of hydroxyl and halogen of atomic number of at least 17; Z is an organic sulfide; a is a cardinal number of from 1 to 2, inclusive; (2-n) represents the number of M groups present; y is a cardinal number of from 0 to (10-n), inclusive; and b is equal to the valence of M when n is 1 and b is 1 when n is 2.

9. A compound of claim 8 wherein Z is tertiary phosphine.

10. A compound of claim 8 wherein Z is tertiary amine.

11. A compound of claim 8 wherein Z is an amide of carboxylic acid.

12. A compound of claim 8 wherein Z is organic sulfone.

13. A compound of claim 8 wherein Z is nitrile.

14. Process for the formation of a compound selected from the class consisting of



wherein M is a cation having a valence from 1 to 3; Z is a member of the group consisting of organic sulfides, tertiary phosphines and tertiary amines and b is equal to the valence of M, which comprises treating a compound selected from the class consisting of $H_2B_{10}H_{10}$, $Na_2B_{10}H_{10}$, $K_2B_{10}H_{10}$, and $(NH_4)_2B_{10}H_{10}$, with a member of the group consisting of organic sulfoxides, phosphine oxides and amine oxides in the presence of a strong acid within a temperature range of $-20^\circ C.$ to $110^\circ C.$, isolating $B_{10}H_7\cdot 2Z$ from the reaction mixture, contacting the reaction mixture free of $B_{10}H_7\cdot 2Z$ with a salt containing the cation M, and separating therefrom the compound $M[B_{10}H_7\cdot Z]_b$.

15. Process for the formation of a compound of the formula



wherein M is a cation having a valence from 1 to 3; Z is selected from the class consisting of organic sulfones and amides of a carboxylic acid and b is equal to the valence of M, which comprises treating a compound selected from the class consisting of $H_2B_{10}H_{10}$, $Na_2B_{10}H_{10}$, $K_2B_{10}H_{10}$, and $(NH_4)_2B_{10}H_{10}$, with a compound selected from the class consisting of organic sulfones and amides of a carboxylic acid in the presence of a strong acid, and continuing the addition of acid until heat is no longer evolved, removing insoluble material by filtration, reacting the remaining filtrate with a salt containing the cation M, and separating therefrom the compound $M[B_{10}H_7\cdot Z]_b$.

16. Process for the formation of a compound of the formula



wherein Z is selected from the class consisting of organic sulfones and amides of a carboxylic acid which comprises treating $M_a\cdot(B_{10}H_{10})_b$ wherein M is a cation having a valence of from 1 to 3, a' and b' are positive whole numbers of 1 to 3, inclusive, and a' multiplied by the valence of M is equal to 2b', with a compound selected from the class consisting of organic sulfones and amides of a carboxylic acid in the presence of a strong acid, continuing the addition of said strong acid until heat is no longer evolved, applying heat and further addition of said strong acid, and isolating the resulting product.

17. Process for the formation of a compound selected from the class consisting of



wherein M is a cation having a valence from 1 to 3; Z is a member of the group consisting of organic sulfides, tertiary phosphines, tertiary amines, amides of carboxylic acids, organic sulfones and nitriles and b is equal to the valence of M, which comprises treating a compound selected from the class consisting of $B_{10}H_7\cdot 2N_2$ and $M(B_{10}H_7\cdot N_2)_b$ wherein M is a cation of valence b with a member of the group consisting of organic sulfides, tertiary amines, tertiary phosphines, amides of carboxylic acids, organic sulfones, and nitriles.

18. A process for preparing a compound of the formula

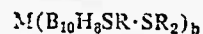

wherein M is a cation having a valence from 1 to 3, b is equal to the valence of M, and R is an organic radical bonded to the sulfur through carbon which comprises reacting a compound of the formula

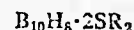

wherein R is defined as above and a compound selected from the class consisting of trisubstituted phosphine and an alkali metal phthalimide at a temperature of $140^\circ C.$ to $250^\circ C.$

19. Process for the formation of



wherein M is a cation having a valence from 1 to 3; Z is a member of the group consisting of organic sulfides, tertiary phosphines and tertiary amines and b is equal to the valence of M, which comprises treating a compound selected from the class consisting of $H_2B_{10}H_{10}$, $Na_2B_{10}H_{10}$, $K_2B_{10}H_{10}$, and $(NH_4)_2B_{10}H_{10}$, with a member of the group consisting of organic sulfoxides, phosphine oxides and amine oxides in the presence of a strong acid within a temperature range of $-20^\circ C.$ to $110^\circ C.$, and contacting the reaction mixture with a salt containing the cation M.

20. Process for the formation of



wherein Z is a member of the group consisting of organic sulfides, tertiary phosphines and tertiary amines, which comprises treating a compound selected from the class consisting of $H_2B_{10}H_{10}$, $Na_2B_{10}H_{10}$, $K_2B_{10}H_{10}$, and $(NH_4)_2B_{10}H_{10}$, with a member of the group consisting of organic sulfoxides, phosphine oxides and amine oxides in the presence of a strong acid within a temperature range of $-20^\circ C.$ to $110^\circ C.$, and isolating $B_{10}H_7\cdot 2Z$ from the reaction mixture.

21. A compound of claim 8 wherein the organic portion of the said organic sulfide is hydrocarbyl free of acetylenic unsaturation and of up to 13 carbon atoms.

No references cited.

JOHN D. RANDOLPH, *Primary Examiner.*

LEON D. ROSDOL, WALTER A. MODANCE,
J. W. WHISLER, H. I. MCATZ, *Assistant Examiners.*

1

3,328,422
**DERIVATIVES OF POLYHEDRAL
 DODECABORANES**

Walter H. Knoth, Jr., Mendenhall, Pa., assignor to E. I. du Pont de Nemours and Company, Wilmington, Del., a corporation of Delaware
 No Drawing. Filed Sept. 21, 1962, Ser. No. 225,966
 12 Claims. (Cl. 260-326.5)

This invention relates to new boron compounds and to processes for their preparation. More particularly, it relates to new boron compounds having a plurality of boron and hydrogen atoms and to their preparation.

Boron compounds, particularly boron hydrides, have achieved technical importance in recent years. For many potential applications most boron compounds, including boron hydrides, halides and alkyls, have been severely limited by hydrolytic, oxidative and other types of instability. To illustrate, diborane, chlorodiborane, pentaborane and trialkylboron compounds are spontaneously flammable in air. Diborane, pentaborane(9), chlorodiborane, boron trichloride, iododecaborane(14) and most other boron halides are rapidly hydrolyzed in water or alcohol. Other classes of boron compounds, e.g., the borazoles, are hydrolyzed by contact with water. Borazoles have poor thermal stability and they show reducing properties in chemical reactions, e.g., borazoles reduce silver nitrate. Even the most stable known boron hydride, i.e., decaborane(14) is hydrolyzed at a moderate rate in water. Known ionic boron hydrides, e.g., tetrahydroborates (NaBH₄ and the like), are similarly hydrolyzed at a rapid rate at 100° C.

This invention is directed to a broad class of boron compounds which have stability characteristics that are unusual among boron compounds. The compounds of the invention generally show hydrolytic, oxidative and chemical stabilities normally associated with aromatic compounds.

The novel compounds of the invention consist of 12 conjoined boron atoms of which at least 10 and at most 11 are bonded to hydrogen atoms, the compounds consisting further of at least one and at most two groups which are N,N-disubstituted amides of carboxylic acids, N,N-disubstituted amides of sulfonic acids, or organic sulfones, defined below in greater detail; any remaining component in said compounds being a cation, i.e., an atom or group of atoms which forms a positively charged ion in aqueous solution.

The novel compounds of the invention are obtained by heating dihydrogen dodecahydrododecaborate(-2), preferably in the form of a hydrate, with a compound which is an organic sulfone, an N,N-disubstituted carboxylic amide or an N,N-disubstituted sulfonamide defined below in greater detail, to a temperature at which hydrogen is released as a by-product, and, optionally, contacting the product so obtained with a solution containing a cation, i.e., a positively charged ion.

Description of the new compounds

The polyboron compounds of the invention are represented by the following generic formula:

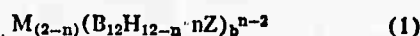

where M is a cation, i.e., an atom or group of atoms which in aqueous solution can form a positively charged ion; Z is an organic sulfone, an N,N-disubstituted amide of a carboxylic acid or an N,N-disubstituted sulfonamide defined below in greater detail; n is 1 or 2; (2-n) represents the number of M groups which are present in the compound; (n-2) represents the ionic charge or valence of the group in parentheses; b has a value of at least one and is otherwise equal to the valence of M.

2

Inspection of generic Formula 1 shows that the polyboron compounds fall into two broad groups which are based on the values for n. For compounds where n=1, the ionic charge [represented by (n-2)] of the group in parentheses becomes -1 and the number of cation-forming groups (M) also becomes 1. This subgeneric group is, therefore, represented by the following formula:



where M and Z are defined as in Formula 1 and b is equal to the valence of M.

For compounds where n=2, the ionic charge of the group in parentheses becomes zero, i.e., the boron entity is electrically neutral and the number of groups (M) also become zero. This subgeneric group is represented by the following formula:



where Z is defined as in Formula 1.

The novel compounds of the invention have in common a characteristic boron-containing component which in Formula 2 is the portion in brackets and in Formula 3 is the entire formula. The inventive feature of the novel compounds lies in this boron-containing component.

The common boron-containing unit contains 12 boron atoms which are deemed to be joined to form a skeleton-like unit or cage in which each boron atom is adjacent to at least four other boron atoms. The manner in which the boron atoms are linked is not known but the group of which the 12 boron atoms are a part functions as a unit in chemical reactions. The term "boron cage" will be used in the discussions to refer to the 12 conjoined boron atoms.

The ionic charge, represented in Formula 1 by (n-2) on the boron-containing component refers to a charge which is inherent in the boron-hydrogen cage structure.

With the above discussion in mind, it can be seen from formulas for the compounds of the invention that the boron-containing group can be electrically neutral, i.e., it can have an ionic charge of zero, as in Formula 3, or it can have a charge of -1, i.e., it can be a monovalent anion, as in Formula 2.

Both boron-containing compounds (neutral and monovalent anion) have at least two characteristics in common, viz., (1) the component Z and the manner in which it is bonded to the boron-containing group, and (2) remarkable and unexpected chemical behavior which resembles in many respects the substitution reactions which aromatic compounds undergo, i.e., a chemical behavior which is best described as "aromatic."

The group Z, as defined previously, is selected from organic sulfones, N,N-disubstituted amides of carboxylic acids and N,N-disubstituted amides of sulfonic acids. These groups have, as a common property, a structure containing an atom which is capable of donating a pair of electrons to the boron cage to form a stable covalent bond.

The groups which fall within the scope of Z can be represented by the following formulas:

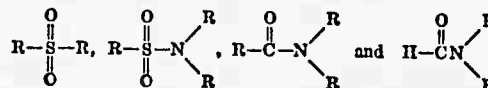

where the R groups, taken separately, represent monovalent hydrocarbon radicals which can be alike or different and which are bonded to the sulfur or nitrogen through carbon; and where two R groups, taken together, represent a divalent organic radical in which the terminal atoms are carbon, said divalent radical forming with at least one of the elements, sulfur and nitrogen, in the above formulas a ring of at most six members.

The nature of the R groups is not critical and these

groups can include a wide scope of organic radicals. Thus R groups can be aliphatic, cycloaliphatic, aryl, aralkyl, alkaryl, heterocyclic or combinations of these groups. The R groups can have chains consisting solely of carbon or they can be groups having oxygen-interrupted chains. The number of carbon atoms in each of the R groups is not critical.

Solely for reasons of availability of reactants, it is preferred that the R groups be aliphatically saturated hydrocarbon groups of up to 18 carbons. In the above description, "aliphatically saturated" means free of ethylenic and acetylenic carbon-to-carbon bonds; the term includes carbocyclic aromatic compounds.

Examples of sulfones which are within the scope of $RS(O)_2R$ are as follows: dimethyl sulfone, diethyl sulfone, dioctyl sulfone, didodecyl sulfone, dioctadecyl sulfone, diisobutyl sulfone, dicyclohexyl sulfone, di[4-(cyclohexyl)cyclohexyl]sulfone, diphenyl sulfone, dinaphthyl sulfone, propyl phenyl sulfone, anthryl dodecyl sulfone, pentamethylene sulfone, 3-oxa-pentamethylene sulfone, and the like.

Examples of sulfonamides which are within the scope of the formula $RS(O)_2NR_2$ are as follows: N,N-dimethylethanesulfonamide, N,N-dibutyloctanesulfonamide, N,N-dioctadecyl-2-ethylhexanesulfonamide, N,N-dicyclohexylcyclohexanesulfonamide, N,N-dipropylbenzenesulfonamide, N,N-dibutyltoluenesulfonamide, N,N-diphenylmethanesulfonamide, N,N-diethylnaphthalenesulfonamide, N,N-di(2-ethylhexyl)-4-phenylbenzenesulfonamide, N-benzenesulfonylmorpholine, and the like.

Examples of amides of carboxylic acids which fall within the scope of the formulas $HC(O)NR_2$ and $RC(O)NR_2$ are as follows: N,N-dimethylformamide, N,N-diethylformamide, N,N-diethylformamide, N,N-dicyclohexylformamide, N-methyl-N-dodecylformamide, N,N-dimethylacetamide, N,N-diisopropylacetamide, N,N-di(2-ethylhexyl)propionamide, N,N-didodecylcyclohexanecarboxylic amide, N,N-diphenylacetamide, N-(butyryl)morpholine, N-ethyl-N-octylbenzamide, N,N-dibenzyltoluamide, N,N-dicyclohexylphenylacetamide, N,N-dimethylstearamide, N-(phenylacetyl)morpholine, and the like.

Description of M

The compounds of Formulas 1 and 2 include the group M which is defined as a cation, i.e., an element or group of elements which forms a positively charged ion in aqueous solution. The group M preferably has a valence of at most 4, i.e., the valence of M is 1, 2, 3, or 4. In an especially preferred form of the invention, the valence of M is at most 3, i.e., 1, 2, or 3.

The sole function of M in the compounds of Formulas 1 and 2 is to provide a group with the necessary positive charge to combine with the boron-containing component in the event this component is a monovalent anion, as described for compounds of Formula 2. In other words, the sole purpose of M in the compounds is to provide a means for isolating the boron-containing anion. The properties of the group M are, therefore, not critical and M represents a broad range of elements or combinations of elements. To illustrate, M can be hydrogen, hydronium (H_3O^+), a metal, a metal-ammine complex, ammonium (NH_4^+), hydrazinium ($NH_2-NH_3^+$), N-substituted ammonium, N-substituted hydrazinium, S-substituted sulfonium, P-substituted phosphonium, and the like. To illustrate further, M can be lithium, sodium, cesium, beryllium, barium, magnesium, calcium, strontium, lanthanum, manganese, iron, cobalt, copper, zinc, mercury, aluminum, thallium, tin, lead, silver or any other metal. As further illustrations, M can be $R'NH_3^+$, $R'_2NH_2^+$, R'_3NH^+ , R'_4N^+ , $(R'NH-NH_3)^+$, $(R'_2N-NH_2)^+$, R'_3S^+ , R'_4P^+ ,

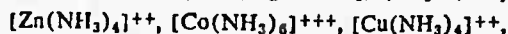

$[Cu(NH_2CH_2CH_2NH_2)_2]^{++}$, and the like. The substituents represented by R' in the above illustrations are organic groups whose character or nature is not a critical

feature of these cation groups. The substituents represented by R' can be open-chain or closed-chain, saturated or unsaturated or the substituents can be composed of heterocyclic rings of which the nitrogen is a component, e.g., pyridine, quinoline, morpholine, hexamethylenimine, and the like. Preferably, R' (for reasons of availability of reactants) is a hydrocarbon group of at most 18 carbons.

Nomenclature

No official system of naming boron compounds has been adopted at the present time. The nomenclature used herein follows the proposals made by a group of the Committee on Nomenclature of the American Chemical Society Division of Organic Chemistry. These proposals are discussed in (1) a paper presented by G. W. Schaeffer at the American Chemical Society Meeting, San Francisco, California, April 13-18 (1958), (2) a paper presented by K. L. Loening to the Division of Chemical Literature, American Chemical Society Meeting, Chicago, Illinois, September 7-12 (1958), and (3) a publication by Patterson, Chemical Engineering News 34, 560 (1956). The nomenclature is also in accordance with the system published in "Nomenclature of Inorganic Chemistry—1957," p. 72, International Union of Pure and Applied Chemistry, Butterworths Scientific Publications (London), 1959.

Names assigned to non-ionic boron compounds end in "ane" with the number of hydrogens bonded to boron in the parent compound shown in parentheses, e.g., $B_{10}H_{14}$ is tetradecahydrodecaborane(14) or, simply, decaborane(14), $B_{12}H_{10} \cdot 2CH_3C(O)N(CH_3)_2$ is bis(N,N-dimethylacetamido)decahydrodecaborane(10) or, more simply, bis(N,N-dimethylacetamido)dodecaborane(10). Names assigned to ionic boron compounds end in "ate" with the valence of the boron-containing ion designated in parentheses by numeral and charge sign. Thus,



is hydrazinium dimethylsulfone-undecahydrodecaborate (-1).

The terms for the captions "hydrogen" and "hydronium" are employed herein as defined on page 26 of "Nomenclature of Inorganic Chemistry—1957," which was referred to earlier.

Properties and characteristics of the new compounds

In physical properties the new compounds range from low melting products to high melting salt-like materials which are stable at conventional atmospheric temperatures and pressures. The products are normally colorless or white and they are usually crystalline. However, color and other physical characteristics are determined to some degree by the components M and Z.

Many of the compounds dissolve to some extent in water or hydroxylated solvents, e.g., alcohols, and to a more limited extent in ethers, e.g., tetrahydrofuran. The compounds fall into two groups in their behavior in water. The compounds of Formula 2 are ionic in character, i.e., they behave like salts and form ions in solution. The compounds of Formula 3 are neutral and non-ionic, i.e., they are not salt-like in character and they do not form ions. The ionic group of components generally show greater solubility in water than the non-ionic group of compounds and this difference in solubility is used to effect separation and purification of the groups.

The compounds of the invention are unusually stable thermally and chemically. They are stable, for example, in the presence of aqueous solutions of inorganic acids, a property which is unusual for boron compounds. The compounds undergo electrophilic substitution reactions in a manner resembling carbocyclic aromatic compounds to form a wide range of substituted products. This unusual behavior will be discussed more fully in paragraphs following the examples.

Examples of representative compounds are given be-

low solely to illustrate the invention and they are not to be considered as limiting the scope of operable compounds:

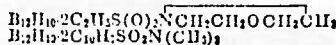
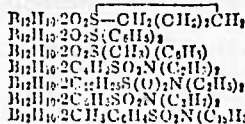
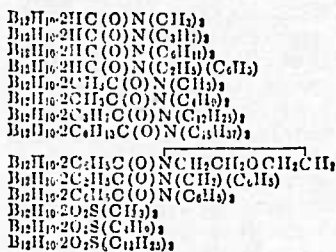

and the like. Further examples, particularly of compounds of Formula 2 are as follows:

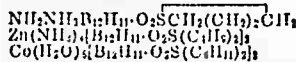
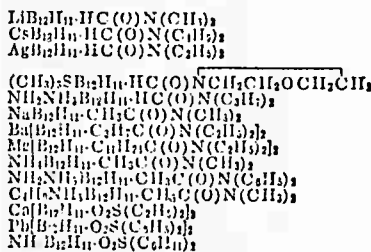

and the like.

The process

The compounds are obtained by employing as reactants (1) dihydrogen dodecahydrododecaborate(-2), preferably in the form of its hydrates, i.e.,

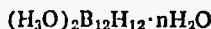

where n can have a value up to 18 or even higher, (2) a sulfone, an amide of a carboxylic acid or a sulfonamide which are represented by the formulas $RS(O)_2R$,



$HC(O)NR_2$ and $RS(O)_2NR_2$, wherein R is defined as described in a previous paragraph and, optionally, (3) a salt having the cation M . In the operation of the process, the reactant defined in (2) appears in toto in the final product as component Z , and the discussion given earlier for the Z groups applies in full to these reactants.

The dodecahydrododecaborate(-2) reactant can be prepared in situ, if desired, from a strong inorganic acid and a salt of the dodecahydrododecaborate(-2) anion. The dodecahydrododecaborate(-2) salts or the free acid are not readily available compounds and their preparation is described later in the examples.

The sulfones, amides or carboxylic acids and sulfonamides are well known and usually readily available materials. In the event they are not obtainable directly, the reactants can be prepared by conventional methods of organic chemistry.

The process is performed most conveniently and simply by contacting the boron-containing acid (or its precursors) and the Z reactant at a temperature sufficient to

release hydrogen and, optionally, contacting the resulting product with a salt having a cation M , where M is defined as in Formula 1.

As noted above, precursors of the hydrogen dodecahydrododecaborate(-2) can be used. The precursors are a strong mineral acid, e.g., concentrated aqueous solutions of HCl , H_3PO_4 , and the like, and a dodecahydrododecaborate(-2) of the formula $M_a(B_{12}H_{12})_b$, where M is a cation as defined in Formula 1 and a and b are the smallest positive whole numbers which satisfy the equation

$$b = \frac{a \times \text{valence of } M}{2}$$

15

The temperature to which the reaction mixture is heated to effect release of hydrogen is determined to some extent by the reactivity and physical properties of the components and by other conditions of operation, for example, pressure. The point at which onset of hydrogen evolution occurs is easily observed by the rapid formation of bubbles of gas in the mixture. In the initial phases of the reaction, water of hydration or adventitious moisture, if present, is removed after which evolution of hydrogen begins. In some instances, particularly for high boiling sulfones and sulfonamides, temperatures as low as 40° C. are sufficient. Temperatures up to 300° C., or higher can be used if necessary. In general, a temperature between about 50° C. and about 250° C. is sufficient for satisfactory operation.

The process can be conducted in a batch or continuous operation. In a batch process the reactants can be mixed initially at prevailing atmospheric temperature, if desired, and the mixture can be heated to the temperature at which hydrogen is released. In a continuous process the reactants can be fed into a vessel at the desired temperature and the reaction products can be removed continuously. The manner of operation, whether batch or continuous, is not a critical factor in the process.

The process can be operated at atmospheric pressure or at pressures which are higher or lower than atmospheric. Pressure can be used as a means of maintaining relatively low boiling reactants in mutual contact within the reaction zone, particularly when the rate of reaction is slow and a high temperature is desirable to effect release of hydrogen at a practical rate. Pressures below atmospheric can be employed when the reactants are high boiling and, consequently, do not volatilize at the low pressures. Atmospheric pressure is most conveniently employed for reactants which boil sufficiently high to remain in the reaction zone at the temperature of operation. Thus, the pressure at which the process is operated is a matter of convenience, based principally on the boiling points and volatility of the reactants. Pressure is not a critical factor in the process.

The mechanism of the reaction is not clearly established but it is evident from an inspection of the formulas of the reactants and the final products that one mole of hydrogen is released per mole of $H_2B_{12}H_{12}$ acid to obtain the compounds of Formula 2 and two moles of hydrogen are released per mole of $H_2B_{12}H_{12}$ acid to obtain compounds of Formula 3.

The mole ratio in which the reactants are used is not critical. Preferably, for maximum yield of desired products, the ratio of moles of Z compound to moles of dodecahydrododecaborate compound is at least 1 and it can be as high as 10 or even higher. In an especially preferred method of operation to obtain compounds of both Formulas 2 and 3, the mole ratio defined above is at least 2, i.e., it is preferable to use an excess of the Z reactant to assure maximum utilization of the boron-containing reactant.

In the operation of the process, a reaction vessel is used whose inner surfaces are made of corrosion-resistant material, i.e., commercially available stainless steels, plat-

75

inum, glass, and the like. Conventional vessels or pressure-resistant vessels can be employed.

The order in which the reactants are charged into the reaction vessel is not critical. Pressure in the vessel can be reduced to a low value, if desired, by conventional methods and heating of the reactants can be accomplished by any suitable means.

Mixing of the reactants during the operation of the process is desirable although not essential. Mixing can be accomplished by any suitable means, e.g., by mechanical stirring, shaking, and the like.

The time for completion of the reaction is not critical. In a batch process the time will generally lie between about 15 minutes and about 50 hours. In general, a reaction time of about 1-25 hours is sufficient for a batch operation. For a continuous process, much shorter reaction times can be used and unreacted components can be recirculated for further exposure in the reaction zone.

In an optional method of operation of the process, the reaction can be conducted in the presence of an inert solvent, i.e., a liquid which is not decomposed under the conditions of the reaction by the components of the process or by the products which are obtained. In many cases the Z component is a liquid at the temperature of the reaction and it can serve both as a solvent and reactant. The use of a solvent is not essential for operability and its use is based solely on convenience of operation. Solvents, in the event they are employed, are preferably liquids at the operating temperatures and they are, in most cases, liquids at prevailing atmospheric temperatures. Hydrocarbons are particularly useful as solvents for processes operating at atmospheric pressure, e.g., toluene, dodecane, and the like.

In the operation of the process, suitable provision should be made for disposition of the volatile by-products in view of their possible flammability or toxicity.

The crude product which remains in the reaction vessel after removal of volatile by-products is usually a syrup or pasty mass. It is processed by mixing with a hydroxylated compound, e.g., water, alcohol, and the like. Water is the preferred medium for processing the crude product. The non-ionic compounds of Formula 3 usually precipitate at this stage and they are separated by appropriate means, e.g., decantation or filtration.

The liquid portion remaining after separation of the non-ionic compound contains the ionic products of Formula 2. These products are isolated by contacting the solution with a salt having a cation M which forms a compound of Formula 1 of low solubility, e.g., a cesium salt or a tetra(lower alkyl)ammonium salt. These salts can be used as intermediate products for the preparation of a wide range of compounds of Formula 2 as described in the following paragraphs.

Metathetic reactions

Compounds of Formula 2 wherein M covers a wide range of cations are obtained by simple metathetic reactions employing, e.g., the cesium or tetraalkylammonium salts which are readily obtained by the processes described earlier. To illustrate, an aqueous solution of a compound of Formula 2 where M is Cs is contacted with a strong acid or with a strongly acidic ion-exchange resin to obtain the free acid, i.e., a compound of Formula 2 in which M is hydrogen or hydronium. The acid, generally in solution, is reacted with oxides of metals, hydroxides of metals, salts of metals (both organic and inorganic), nitrogen bases, sulfonium hydroxides or halides, phosphonium hydroxides or halides, aryldiazonium hydroxides or halides and similar types of compounds to obtain compounds of Formula 2 which have the desired cation M. In a process employing an ion-exchange resin, strongly acidic resins of the crosslinked polystyrenesulfonic acid variety are preferred because of availability of these resins in commercial markets. The acid, so obtained in aqueous solution, can be reacted with nitrates,

chlorides, bromides, acetates, benzoates and similar salts of metals or other bases to obtain salts of Formula 2.

Compounds of Formula 2 where M is an alkali or alkaline earth metal, e.g., Li, Na, K, Cs, Ca, Ba, Mg and Sr are especially useful in simple metathetic reactions with other salts to effect an exchange of cations. Thus, $\text{NaB}_{12}\text{H}_{11}\cdot\text{Z}$, where Z is defined as Formula 1 or 2, can be reacted in appropriate solvents with ammonium sulfate, benzenediazonium hydroxide, pyridinium chloride, morpholinium sulfate, poly(ethylenimine)hydrochloride, and the like to form compounds of Formula 2 having ammonium, benzenediazonium, pyridinium, morpholinium, poly(ethylenimine), and the like cations. These illustrations are not limiting and they demonstrate the breadth of metathetic reactions which can be used.

Compounds of the invention wherein M is a hydrogen ion are usually obtained as hydrates wherein the water is bound most closely with the proton to form hydronium ions.

Compounds of the invention in which the group M is a metal, particularly a transition metal, or a Werner-type complex also frequently contain solvent of crystallization when isolated by conventional methods. The solvent can be bound loosely in the lattices of the crystals or it can be associated by stronger bonds with the metal cation or Werner-type complex cation. Solvent of crystallization, e.g., water, entrapped in crystal lattices, is removed easily by well known procedures, e.g., by heating under reduced pressure. Solvent of crystallization which is associated with the cation is more difficult to remove, and for most applications, it is not necessary to remove completely this type of bound solvent.

The products of the invention and processes for obtaining them are illustrated in the following examples. Infra-red absorption spectra are determined on mulls of the compounds in mineral oil.

EXAMPLE A

A. A pressure vessel (capacity, 400 ml.) is charged with 19.0 g. of NaBH_4 and 75 ml. of dry triethylamine. The vessel is cooled in a solid carbon dioxide-acetone bath and the internal pressure is reduced to less than 1.0 mm. pressure by means of a vacuum pump. Diborane (36.0 g.) is introduced into the vessel which is then closed. The mixture is heated with agitation for 10 hours at 180° C. After cooling the vessel and venting to remove volatile products, there remains a solid residue which is washed from the vessel with glyme (1,2-dimethoxyethane). The solid is separated by filtration and it is again washed with glyme. The washed solid is dissolved in hot tetrahydrofuran and the solution is filtered to remove a small quantity of insoluble product. The filtrate is heated to boiling and glyme is added slowly until solid material begins to separate. The mixture is chilled and it is then filtered to separate the white crystals. These crystals are washed with glyme and dried at less than 0.001 mm. pressure at 90-100° C. to yield 43.9 g. of $\text{Na}_2\text{B}_{12}\text{H}_{12}$ containing glyme and water of solvation. Further treatment of the filtrate yields an additional 5.4 g. of the product.

The compounds can be obtained as its hydrate free of ether of solvation by dissolving the product in water and evaporating the solution to dryness. The product so obtained has the formula $\text{Na}_2\text{B}_{12}\text{H}_{12}\cdot\text{H}_2\text{O}$.

EXAMPLE B

An aqueous solution containing 0.43 g. of $\text{Na}_2\text{B}_{12}\text{H}_{12}\cdot\text{H}_2\text{O}$

is passed through a 0.5" diameter chromatography column containing 80 ml. of an acid ion-exchange resin of the crosslinked polystyrenesulfonic acid type. The strongly acid effluent from the column is evaporated to remove all materials volatile at less than 0.001 mm. at 45° C. There remains 0.38 g. of a white, crystalline, very hygroscopic solid which is a hydrate of dihydrogen dodecahydrododecaborate(-2).

9
EXAMPLE 1

(A) A mixture is prepared consisting of 20 g. of the dihydrate of $\text{Na}_2\text{B}_{12}\text{H}_{12}$, 150 ml. of N-methyl-2-pyrrolidone and 25 ml. of concentrated hydrochloric acid. The mixture is stirred and filtered to remove insoluble material. The clear filtrate is charged into a distillation unit and it is heated to boiling with removal of volatile material until the liquid temperature reaches 207°C . The solution is refluxed at this temperature for about 2 hours. It is cooled to atmospheric temperature and poured into 600 ml. of water. The solid product which forms is separated by filtration to obtain 5.3 g. of crude

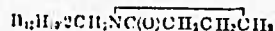

The filtrate is set aside for further work and it is designated as Solution A. The compound is dissolved in 100 ml. of CH_3CN and the solution is filtered into 400 ml. of ethanol. The precipitate is isolated and dried under reduced pressure.

The ultraviolet spectrum of the compound in acetonitrile solution shows maximum absorption at $219\text{m}\mu$ ($\epsilon=15,600$).

Anal.—Calc'd for

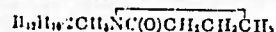

B, 38.4; C, 35.5; N, 3.3. Found: B, 37.80; C, 35.50; N, 3.27.

An aqueous solution of $(\text{C}_2\text{H}_5)_4\text{NOH}$ is added to solution A, obtained above, and



precipitates. It is separated and purified by crystallization from hot water.

(B) A reaction vessel is charged with the dihydrate of $\text{Na}_2\text{B}_{12}\text{H}_{12}$, N-methyl-2-pyrrolidone and concentrated hydrochloric acid. The mixture is filtered and the filtrate is refluxed for 2 hours at 210°C . and it is then poured into water. A white precipitate forms which is separated by filtration, washed and dried. The product is bis(N-methyl-2-pyrrolidone)decahydrododecaborane(10), i.e., a compound of the formula

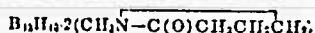

The identity of the compound is confirmed by its infrared absorption spectrum.

The filtrate from the above reaction mixture is separated into two portions. To one portion an aqueous solution of $(\text{CH}_3)_4\text{NCl}$ is added with stirring. The precipitate which forms is separated, washed and dried to yield



as a white crystalline product.

To the second portion of the filtrate an aqueous solution of $(\text{C}_2\text{H}_5)_4\text{NOH}$ is added with stirring. The white precipitate which forms is separated, washed and dried to yield



The identity of the tetraalkylammonium salts is confirmed by their infrared absorption spectra.

(C) A mixture is prepared which consists of 20 g. of $\text{Na}_2\text{B}_{12}\text{H}_{12}\cdot 2\text{H}_2\text{O}$, 200 ml. of N-methyl-2-pyrrolidone and 25 ml. of concentrated aqueous hydrochloric acid. The mixture is filtered to remove NaCl and the filtrate is heated to boiling to remove water until the pot temperature is 180°C . The mixture is refluxed for 3 hours at 180°C ., cooled and allowed to stand about 20 hours. It is then poured into 600 ml. of $\text{C}_2\text{H}_5\text{OH}$ and the solution which forms is added to a solution of 15 g. of CsOH in 200 ml. of $\text{C}_2\text{H}_5\text{OH}$. A precipitate forms and it is separated by

10

filtration. The product is crystallized from water to obtain 5.7 g. of

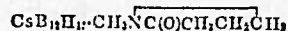

5 *Analysis.*—Calc'd for

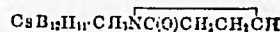

Cs, 35.6; B, 34.8; C, 16.1; H, 5.4; N, 3.8. Found: Cs, 32.6; B, 34.4; C, 15.3; H, 5.8; N, 3.9.

10 The process of Example 1 is generic to the preparation of compounds of Formula 1 where Z is an amide of a carboxylic acid. The process, as illustrated, employs a salt of $\text{B}_{12}\text{H}_{12}^{-2}$ anion in the presence of a strong mineral acid to prepare the dodecahydrododecaboric acid in situ.

15 The acid or its hydrates, e.g. $(\text{H}_2\text{O})_n\text{B}_{12}\text{H}_{12}\cdot n\text{H}_2\text{O}$, where n generally has a value of 4–18, can be employed directly. To illustrate, the hydrated boron-containing acid is reacted with $\text{CH}_3\text{C}(\text{O})\text{N}(\text{CH}_3)_2$ to obtain

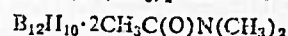

and, further with NH_4OH to obtain

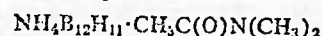

25 $\text{Na}_2\text{B}_{12}\text{H}_{12}$ (or any alkali metal salt of $\text{B}_{12}\text{H}_{12}^{-2}$) is reacted with $\text{C}_6\text{H}_5\text{C}(\text{O})\text{N}(\text{C}_6\text{H}_{17})_2$, in the presence of HCl to obtain $\text{B}_{12}\text{H}_{10}\cdot 2\text{C}_6\text{H}_5\text{C}(\text{O})\text{N}(\text{C}_6\text{H}_{17})_2$ and further with $(\text{CH}_3)_3\text{SOH}$ to obtain

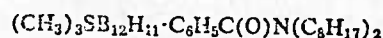

30 and $(\text{NH}_4)_2\text{B}_{12}\text{H}_{12}$ is reacted with



in the presence of HCl to obtain

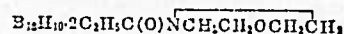

and further with tributylamine to obtain

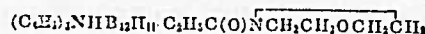

40 and $(\text{NH}_4)_2\text{B}_{12}\text{H}_{12}$ is reacted with $\text{HC}(\text{O})\text{N}(\text{CH}_3)_2$, preferably under pressure, to obtain $\text{B}_{12}\text{H}_{10}\cdot 2\text{HC}(\text{O})\text{N}(\text{CH}_3)_2$ and further with $(\text{CH}_3)_4\text{NCl}$ to obtain

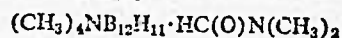

EXAMPLE 2

(A) A reaction vessel is charged with 1.6 g. of a hydrate of dihydrogen dodecahydrododecaborate of the approximate composition $(\text{H}_2\text{O})_2\text{B}_{12}\text{H}_{12}\cdot 5\text{H}_2\text{O}$, and 18 g. of tetrahydrothiophene-1,1-dioxide. The mixture is stirred to form a clear solution. The reaction vessel is then connected to a vacuum pump and pressure in the vessel is reduced to a very low value (less than 1.0 mm. of Hg). The solution, at prevailing atmospheric temperature (about 25°C .), gradually evaporates with removal at first of water vapor. Removal of water from the solution is followed by observing the intensity of the infrared absorption band for water (2.8μ) on an aliquot portion of the reaction mixture. As evaporation proceeds, the intensity of absorption at 2.8μ becomes very weak and the solution begins to evolve hydrogen. Evaporation under reduced pressure at atmospheric temperature is continued until evolution of hydrogen subsides. The clear residue is dissolved in about 100 ml. of water to form a clear solution which is divided into two portions, each of which are, of course, acidic. One portion is neutralized with a concentrated aqueous solution of CsOH and the second portion is neutralized with an aqueous solution of

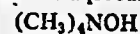

70 In each case a precipitate forms which is separated by filtration, washed and recrystallized from boiling water. The products are compounds of the formulas

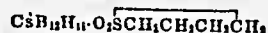

75 and

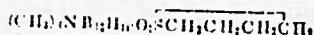

The identities of the compounds are confirmed by elemental analyses and by their infrared absorption spectra.

Analysis.—Calc'd for the Cs salt: Cs, 33.7; B, 32.95; C, 12.2; H, 4.86; S, 8.14. Found: Cs, 32.7; B, 32.64, C, 11.62; H, 5.05; S, 8.36.

Analysis.—Calc'd for the $(CH_3)_4N$ salt: N, 4.18; B, 38.75; C, 28.65; H, 9.33; S, 9.56. Found: N, 4.14; B, 38.36; C, 29.25; H, 9.45; S, 9.56.

The infrared absorption spectrum of the Cs salt shows strong absorption at 4.1μ (B-H stretch) and weaker absorption at 7.7, 7.8, 7.95, 8.1, 8.9, 9.1, 9.3, 9.5, 9.75, 9.9, 10.1, 11.0, 11.8, 11.9, and 13.25μ .

The infrared absorption spectrum of the tetramethylammonium salt shows absorption at all of the above bands for the cesium salt and, in addition, shows absorption at 10.5, 12.7, and 14.0μ .

(B) A quantity (9.11 g.) of

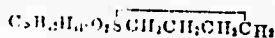

is dissolved in sufficient hot water to form a clear solution which is passed through a column filled with a commercial ion-exchange resin of the crosslinked polystyrene-sulfonic acid type. The aqueous effluent is a solution of the free acid, represented in its hydronium form as

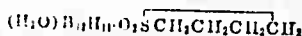

or, alternatively, as a hydrate of



The aqueous effluent is titrated to a pH value of 7 with a 0.1 N aqueous solution of sodium hydroxide to obtain an aqueous solution of

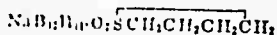

The equivalent weight of the salt employed as the initial reactant, i.e.,

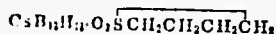

is thus determined to be 393 (calc'd value, 393).

The free acid can be isolated in crystalline form by evaporation of the aqueous effluent, obtained above, under reduced pressure. It is obtained preferably as a hydrate in which the number of moles of water is determined to a large extent by the duration and intensity of the drying period. For most purposes the acid is handled conveniently in aqueous solution.

The sodium salt, i.e.,



can also be isolated by evaporation of its aqueous solution. It can be obtained as a white crystalline compound, usually with water of hydration.

EXAMPLE 3

A reaction vessel is charged with 1.2 g. of a hydrate of dihydrogen dodecahydrododecaborate of the approximate composition $(H_2O)_2B_{12}H_{12} \cdot 5H_2O$, and 14.3 g. of tetrahydrothiophene-1,1-dioxide, i.e.,



The reaction vessel is connected to a vacuum pump and pressure in the vessel is reduced to a value of less than 1.0 mm. of Hg. The solution gradually evaporates and water vapor, which is released from the mixture, is removed. The extent of removal of water is estimated by periodic inspection of the infrared absorption spectrum of the mixture. When removal of water is substantially complete, hydrogen begins to evolve from the solution. The evaporation procedure is maintained at atmospheric temperature until evolution of hydrogen subsides. The mix-

ture, still under reduced pressure, is warmed to 95–100° C. and a further quantity of hydrogen is evolved. After hydrogen evolution at this temperature subsides, the reaction mixture is cooled to atmospheric temperature.

The mixture is diluted with water, an oil separates, and methanol is added. The oil changes to a crystalline mass which is separated by filtration. The product is recrystallized from aqueous acetone to obtain bis(tetrahydrothiophene-1,1-dioxide)dodecahydrododecaborane(10) containing acetone as solvent of crystallization. The identity of the product is confirmed by its infrared absorption spectrum and by elemental analysis.

Analysis.—Calc'd for

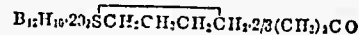

B, 31.05; C, 28.85; H, 28.85; O, 7.22; S, 15.32. Found: B, 31.28; C, 28.40; H, 7.37; S, 15.37.

The infrared spectrum of the compound shows absorption at the following wavelengths (expressed as microns): 4.0, 7.8, 8.1, 8.35, 8.45, 8.8, 8.9, 9.1, 9.3, 9.9, 10.0, 10.1, 11.0, and 12.25.

EXAMPLE 4

The procedure of Example 2 is followed employing 1.3 g. of the hydrate of dihydrogen dodecahydrododecaborate and 11.6 g. of di(n-propyl) sulfone, i.e., $(C_3H_7)_2SO_2$. The products obtained are $C_5B_{12}H_{11} \cdot O_2S(C_3H_7)_2$ and

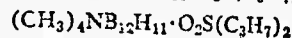

Analysis.—Calc'd for the Cs salt: C, 31.3; B, 30.6; O, 17.0; H, 5.94; S, 7.56. Found: C, 30.0; B, 30.7; O, 17.25; H, 6.31; S, 7.59.

Analysis.—Calc'd for the $(CH_3)_4N$ salt: N, 3.84; B, 35.5; C, 32.9; H, 10.2; S, 8.76. Found: N, 3.95; B, 35.72; C, 32.52; H, 10.02; S, 8.83.

The infrared absorption spectrum of the cesium salt shows absorption at the following principal wavelengths (expressed as microns): 4.0, 7.6, 7.8, 8.05, 8.4, 9.3, 9.4, 9.5, 9.8, 10.25, 11.9, and 13.9. The $(CH_3)_4N$ salt shows a similar infrared absorption spectrum and, further, includes absorption at a wavelength of 10.5.

The process of Examples 2, 3 and 4 is generic to the preparation of compounds of Formula (1) in which Z is a sulfone. To illustrate, hydrated dihydrogen dodecahydrododecaborate can be reacted with (1) diethyl sulfone to obtain $B_{12}H_{10} \cdot 2O_2S(C_2H_5)_2$ and, further, with NaOH to obtain $NaB_{12}H_{11} \cdot O_2S(C_2H_5)_2$, (2) ditolyl sulfone to obtain $B_{12}H_{10} \cdot 2O_2S(C_6H_4CH_3)_2$, and, further, with hydrazine to obtain $NH_2NH_2 \cdot B_{12}H_{11} \cdot O_2S(C_6H_4CH_3)_2$ (3) with ethyl cyclohexyl sulfone to obtain

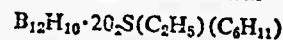

and, further, with $(CH_3)_2NNH_2$ to obtain

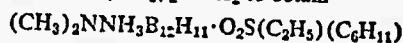

and (4) butyl naphthyl sulfone to obtain



and, further, with $Zn(NH_3)_4Cl_2$ to obtain

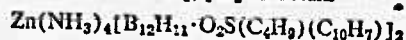

EXAMPLE 5

A reaction vessel is charged with 10.4 g. of hydrated dihydrogen dodecahydrododecaborate and 33 g. of N,N-diethyl-1-hexanesulfonamide. The vessel is connected to a vacuum pump and pressure in the vessel is reduced to a low value (less than 1 mm. of Hg). Water is released from the mixture and it is removed by evaporation. The acid dissolves during this step to form a clear solution. The components of the mixture can be stirred, if desired. The clear solution is heated to 40° C., evolution of hydrogen begins and the mixture is maintained at 40° C. until gas evolution subsides. The mixture at this point will be referred to as Solution A.

A portion (5.8 g.) of Solution A is added to about 20 ml. of ethyl alcohol and a sufficient quantity of an aque-

ous solution of $(\text{CH}_3)_4\text{NOH}$ is added to make the mixture basic. About 20 ml. of water is added to the reaction mixture and a white precipitate forms. The product is separated by filtration, washed and recrystallized from water to obtain tetramethylammonium (N,N-diethyl-1-hexanesulfonamide)undecahydrododecaborate(-1). The identity of the compound is confirmed by its infrared absorption spectrum and by elemental analysis.

Analysis.—Calc'd for

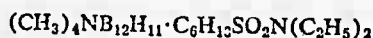

B, 29.8; N, 6.43; S, 7.35; C, 38.6; H, 10.7. Found, B, 29.73; N, 6.38; S, 7.27; C, 38.39; H, 10.57.

A second 5.8 g. portion of Solution A is reacted with an aqueous solution of CsOH and the resulting solution is processed as described in the preceding paragraph to obtain cesium (N,N-diethyl-1-hexanesulfonamide)undecahydrododecaborate(-1).

Analysis.—Calc'd for $\text{CsB}_{12}\text{H}_{11}\cdot\text{C}_6\text{H}_{13}\text{SO}_2\text{N}(\text{C}_2\text{H}_5)_2$: Cs, 26.8; B, 26.2; N, 2.82; S, 6.46; C, 24.2; H, 6.92. Found: Cs, 26.1; B, 25.2; N, 2.84; S, 6.28; C, 24.8; H, 7.19.

The infrared spectrum of the cesium salt shows absorption at the following wavelengths (expressed as microns): 4.05, 7.7, 8.6, 9.2, 9.5-10.0, 10.5, 12.0, 12.6, and 13.9.

EXAMPLE 6

A reaction vessel is charged with a few grams (ca. 3 g.) each of a hydrate of dihydrogen dodecahydrododecaborate(-2) and N,N-diethylbenzenesulfonamide. The components are mixed and heated under low pressure (less than 1 mm. of Hg) to 40° C. The mixture melts to a paste and the temperature is raised to 60° C. Hydrogen gas is evolved and the temperature is maintained at 60° C. until evolution of gas subsides. The mixture is cooled to atmospheric temperature, dissolved in ethyl alcohol and neutralized with aqueous CsOH . The precipitate which forms is separated by filtration and crystallized from water to obtain cesium (N,N-diethylbenzenesulfonamide)undecahydrododecaborate(-1).

Analysis.—Calc'd for $\text{CsB}_{12}\text{H}_{11}\cdot(\text{C}_2\text{H}_5)_2\text{NS}(\text{O})_2\text{C}_6\text{H}_5$: B, 26.65; N, 2.88; S, 6.58; C, 24.65; H, 5.38; Cs, 27.1. Found: B, 24.64; N, 3.04; S, 7.04; C, 22.71; H, 5.73; Cs, 26.3.

Operation of the process illustrated in Examples 5 and 6 at a temperature of about 90-100° C. permits the preparation of the non-ionic species of Formula 3. To illustrate, heating of the reaction mixture of Example 5 to about 100° C. will yield $\text{B}_{12}\text{H}_{10}\cdot 2\text{C}_6\text{H}_{13}\text{SO}_2\text{N}(\text{C}_2\text{H}_5)_2$; heating the reaction mixture of Example 6 to the same temperature will yield $\text{B}_{12}\text{H}_{10}\cdot 2\text{C}_6\text{H}_5\text{SO}_2\text{N}(\text{C}_2\text{H}_5)_2$.

The process of Examples 5 and 6 is generic to the preparation of compounds of Formula 1 where Z is a sulfonamide. To illustrate, hydrated dihydrogen dodecahydrododecaborate can be reacted with (1) N,N-dimethylethanesulfonamide to obtain $\text{B}_{12}\text{H}_{10}\cdot\text{C}_2\text{H}_5\text{SO}_2\text{N}(\text{CH}_3)_2$ and, further, with $(\text{CH}_3)_2\text{C}_6\text{H}_5\text{CH}_2\text{NOH}$ to obtain

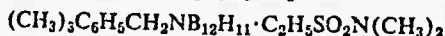

(2) with N-pentamethylenecyclohexanesulfonamide to obtain

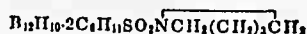

and, further, with $\text{Ca}(\text{OH})_2$ to obtain

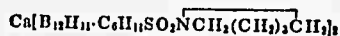

and (3) with N,N-dibutyl cyclobutanesulfonamide to obtain $\text{B}_{12}\text{H}_{10}\cdot 2\text{C}_4\text{H}_7\text{SO}_2\text{N}(\text{C}_4\text{H}_9)_2$ and, further, with N-methylquinoline to obtain N-methylquinolinium



Utility

The compounds of the invention are useful in many diverse fields. All of the compounds represented by Formula 1 are generically useful as combustible components

of fireworks compositions to impart a pleasing color and sparkle to the display.

The compounds of the invention are generically useful as impregnating agents for cellulosic products in the preparation of resistors. To illustrate, lengths of cotton string are immersed in (1) a nearly saturated acetone solution of

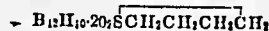

and (2) an aqueous acetone solution of

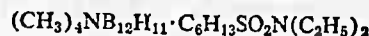

The lengths of string are withdrawn from the solutions and solvents are removed by air-drying. A free flame is applied to each of the dried strings and they burn freely. The residues from the impregnated strings, after burning, have a size and shape similar to the original section of string and the residual skeleton is of sufficient coherence to permit embedding in paraffin. The sections of residue, so treated, show resistances of about 11,300 ohms/inch and about 25,000 ohms/inch, respectively. The residue from a control unimpregnated section of string is very small and shapeless and it cannot be handled.

In the group of compounds which fall within the scope of Formula 2, the component M represents a range of groups which are readily interchangeable by metathetic reactions as described earlier. Thus, all of the salts can be used as intermediates in the preparation of acids which are represented generically as $\text{HB}_{12}\text{H}_{11}\cdot\text{Z}$, where Z is defined as in Formula 1, or in aqueous solution as $(\text{H}_3\text{O})\text{B}_{12}\text{H}_{11}\cdot\text{Z}\cdot n\text{H}_2\text{O}$, by passing aqueous or alcoholic solutions of the salts through an acidic ion-exchange resin as described earlier. The acids of this group are very strong acids and they are useful in industrial applications where it is desired to avoid contamination from sulfate, chloride, bromide, chlorate, phosphate, and like strong acid anions. Thus, the acids of Formula 2, where M is H or $(\text{H}_3\text{O})^+$ are useful for etching metals, such as steel, and for rust removal, for pickling, for scale removal and for similar metal processing operations.

The acids are useful as catalysts in the preparation of esters, e.g., in the reaction of alcohols and carboxylic acids, to improve the yields of the desired esters. The acids of this invention are employed for this purpose in the same manner as p-toluenesulfonic acid, sulfuric acid or alcoholic hydrogen chloride.

The compounds of Formula 4 are generically useful in the fields of application described above for the compounds of Formula 1.

As many apparently widely different embodiments of this invention may be made without departing from the spirit and scope thereof, it is to be understood that this invention is not limited to the specific embodiments thereof.

The embodiments of the invention in which an exclusive property or privilege is claimed are defined as follows:

1. A compound of the formula



wherein M is a cation; n is a cardinal number of from 1 to 2, inclusive; b is at least 1 and is otherwise equal to the valence of M; and Z is selected from the class consisting of

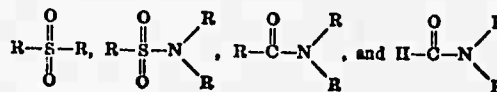

wherein each R taken separately is a monovalent hydrocarbyl group of up to 18 carbon atoms free of aliphatic ethylenic and acetylenic carbon-to-carbon bonds, and wherein any two R groups taken together represent a

15

divalent member of the class consisting of (a) alkylene of up to a total of 5 carbon atoms and (b)



2. A compound of claim 1 wherein n is 1.
3. A compound of claim 1 wherein n is 2.
4. A compound of claim 1 containing water of hydration.

5. A compound of claim 1 wherein the R groups each are monovalent hydrocarbyl groups of up to 18 carbon atoms free of aliphatic ethylenic acetylenic carbon-to-carbon bonds.

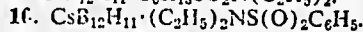
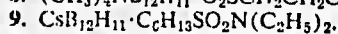
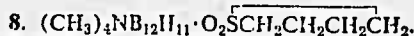
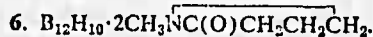

11. Process for preparing compounds of the formula

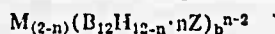

wherein M is a cation; Z is a group selected from the class consisting of

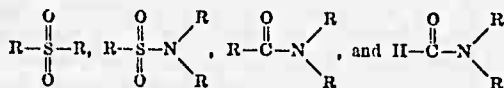

wherein each R taken separately is a monovalent hydrocarbyl group of up to 18 carbon atoms free of aliphatic ethylenic and acetylenic carbon-to-carbon bonds, and wherein any two R groups taken together represent a divalent group of the class consisting of (a) alkylene of up to a total of 5 carbon atoms, and (b)



16

n is a cardinal number of from 1-2, inclusive; and b is at least 1 and is otherwise the valence of M, which comprises reacting at a temperature of from about 40° C. to about 300° C.; a hydrate of $\text{H}_2\text{B}_{12}\text{H}_{12}$ with a compound selected from the class consisting of

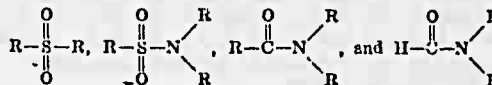

wherein R is defined as above; isolating from the reaction mixture any $\text{B}_{12}\text{H}_{10} \cdot 2\text{Z}$ formed, treating the remaining mixture with a salt whose cation is selected from the class consisting of cesium and tetra(lower alkyl)ammonium, isolating the resulting $\text{M}'(\text{B}_{12}\text{H}_{11} \cdot \text{Z})_b$ wherein M' is the aforesaid cesium and tetra(lower alkyl)ammonium, and subjecting said $\text{M}'(\text{B}_{12}\text{H}_{11} \cdot \text{Z})$ to a metathetical cation exchange reaction to obtain the compound $\text{M}(\text{B}_{12}\text{H}_{11} \cdot \text{Z})$.

12. Process of claim 11 wherein the hydrate of

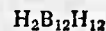

is formed in situ from $\text{Na}_2\text{B}_{12}\text{H}_{12}$ and a strong acid.

References Cited

- Karrer, Organic Chemistry, 2nd English ed., pp. 901-902, Elsevier Pub. Co., New York, 1956.
- 25 Knoth et al., J. Am. Chem. Soc., vol. 84, pp. 1056-1057 March 20, 1962.
- Knoth et al., J. Am. Chem. Soc., vol. 86, pp. 3973-3983 1964.
- 30 Redd, Chemistry of Carbon Compounds, vol. IA Aliphatic Compounds, page 221, Elsevier Pub. Co., New York, 1951.
- JOHN D. RANDOLPH, *Primary Examiner*.
- 35 C. DON QUARFORTH, *Examiner*.
- J. W. WHISLER, *Assistant Examiner*.

1

3,355,261

CHEMICAL PROCESS

Henry C. Miller, Wilmington, Del., and Earl L. Muctertics, West Chester, Pa., assignors to E. I. du Pont de Nemours and Company, Wilmington, Del., a corporation of Delaware

No Drawing. Filed Apr. 29, 1963, Ser. No. 276,652
12 Claims. (Cl. 23-362)

This invention relates to an improved process for preparing dodecahydrododecaborates. More specifically, it concerns an improved process for preparing alkali metal and alkaline earth metal dodecahydrododecaborates.

Dodecahydrododecaborates (2-) are salts of the $B_{12}H_{12}^{2-}$ anion which have been discovered only recently. The divalent anion is a polyhedral boron hydride which possesses unusual and unexpected stability. It undergoes many substitution reactions and is a versatile intermediate for the preparation of novel boron-containing products. Investigation and development of compounds containing the $B_{12}H_{12}^{2-}$ anion will be advanced by attractive processes for their preparation, particularly, processes which lead to good yields of products by economical routes.

In our copending U.S. Patent 3,328,134 it is shown that polyhydropolyborates having three or more boron atoms, including dodecahydrododecaborates, can be prepared by reacting diborane with an alkali metal or alkaline earth metal tetrahydroborate under at least 3 atmospheres pressure. We have now found a process whereby diborane and a tetrahydroborate can be reacted under selected conditions which do not require superatmospheric pressures to obtain dodecahydrododecaborates as the principal product in good yield.

Thus, it is an object of this invention to provide a process for the preparation of dodecahydrododecaborates which can be carried out at atmospheric pressure. It is another object to provide a process for the preparation of the above borates which will result in improved yields of said borates. Still other objects will become apparent from the following description.

The process of the invention comprises the preparation of alkali metal or alkaline earth metal dodecahydrododecaborates in a single step by reacting diborane with an alkali metal or alkaline earth metal tetrahydroborate at a temperature of at least 120° C. in the presence of a Lewis base which forms an adduct with diborane. The reaction proceeds at prevailing atmospheric pressures and thus no pressure equipment is needed. The reaction, preferably, is conducted in the substantial absence of oxygen (air) and moisture.

The essential components in the process are diborane, a tetrahydroborate and a Lewis base. These reactants are defined more fully in the paragraphs immediately following.

The tetrahydroborate reactant is a compound of the formula

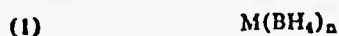

where M is an alkali metal or alkaline earth metal, and n is a positive whole number equal to the valence of M, i.e., n is 1 or 2. When M is an alkali metal, n has a value of 1; when M is an alkaline earth metal, n has a value of 2. Alkali metals and alkaline earth metals are elements of atomic numbers 3-56, inclusive, of Groups I-A and II-A of the Periodic Table. Thus, M in Formula 1 can be, e.g., lithium, sodium, potassium, rubidium, cesium, beryllium, magnesium, calcium, strontium and barium. Because of ready availability, sodium and potassium tetrahydroborates constitute a preferred group.

2

The Lewis base reactants are those of the following formulas:

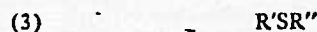
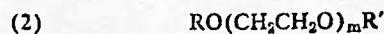

and



where R, R' and R'' are alkyl or cycloalkyl groups of up to 12 carbons and where R' and R'' can be bonded together to form a divalent hydrocarbon radical which forms a ring with the sulfur, nitrogen or phosphorus; m is a positive number of at least 2, i.e., m can be 2 or more, preferably m does not exceed 6. Tertiary amines of Formula 4 and polyethers of Formula 2 are particularly valuable for use in the process. The polyethers of Formula 2 may be viewed as alkoxy derivatives of glycol polyethers obtained from ethylene oxide.

Examples of the Lewis base reactant include those in which the hydrocarbyl groups (R, R' and R'') can be, for example, methyl, ethyl, propyl, isopropyl, butyl, isobutyl, octyl, 2-ethylhexyl, dodecyl, cyclopentyl, cyclohexyl, and the like. Specific examples of Lewis bases include, among others, methyl cyclohexyl sulfide, N,N-dimethylcyclohexylamine, N-methylpentamethyleneimine, N-methylpyrrolidine, cyclohexyldiethylphosphine, pentamethylene sulfide, and the like.

The diborane reactant is the compound having the formula B_2T_6 .

The reactants employed in the reaction are, in general, commercial grade materials. It is preferable the reactants be free of adventitious moisture in order to obtain higher yields, but in general, the commercial grade materials may be used without special purification.

For operation of the process of the invention, it is not essential that the reactants be charged into the vessel in any stated sequence. Whatever the sequence, the Lewis bases from adducts with the diborane. These adducts can be represented by the Formula 6 BH_3-Z (in which Z is the Lewis base defined previously) and serve as reservoirs of diborane at the temperature of the reaction.

The role of the Lewis base, as an essential component, may be explained by describing the formation of the adducts. The diborane (B_2H_6) behaves in many respects as if it were two loosely connected BH_3 groups, which can be fragmented to form BH_3 . The incomplete electron octet around the boron atom has a strong tendency to accept electrons and will form a coordination compound with an electron donor, and the Lewis bases, being electron donors, will combine reversibly with diborane to form the adducts. The formation of these adducts of B_2H_6 has been studied extensively in the literature and their properties are well-established. References which discuss these reversible combinations are:

Stone, Quarterly Reviews, 1955, 174-201 (particularly p. 184).

Sidgwick, "Chemical Elements and Their Compounds," vol. 1, p. 351 ff., Oxford University Press (1950).

Mosler, "Inorganic Chemistry," p. 780, John Wiley & Sons, Inc. (1942).

In addition, the Lewis base may aid, in some cases, in formation of a loose combination, not only with diborane, but with the tetrahydroborate and thus provide close reactive contact between the boron-containing reactants. However, the Lewis base does not enter into or form a part of the final product.

The adducts may be prepared outside the reaction zone and supplied in this preformed condition to the reaction zone. They may be prepared by simple mixing at any convenient temperature, e.g., -100° C. or lower or at

higher temperature, e.g., 50° C. The mixing temperature is not critical.

It is most convenient to prepare the adduct in the reaction zone, but however prepared, they are considered to be within the scope of the definition of the essential components of the reaction.

In general, a conventional vessel may be employed which, preferably, is lined with a corrosion-resistant material (e.g., stainless steel, platinum, glass, and the like). The vessel is preferably fitted with a gas inlet tube and a reflux condenser. The vessel is charged with the Lewis base and the tetrahydroborate of Formula 1, and an inert gas is passed into the vessel to remove adventitious moisture and to provide a non-oxidizing atmosphere. Suitable inert gases are nitrogen, argon, helium, and the like. Diborane is now passed into the reaction mixture, preferably by bubbling through the mixture to provide intimate contact between the reactants.

Alternatively, the Lewis base can be charged into the vessel initially and diborane passed into contact with the base to form an adduct. The tetrahydroborate can then be charged into the vessel. The reaction mixture can be stirred, if desired, during operation of the process by any suitable method, e.g., shaking or mechanical stirring.

The mole ratio in which the reactants are present is not critical. The diborane can be bubbled through slowly or rapidly and it is necessary only to have diborane present in sufficient quantity at any time to react with the tetrahydroborate. Moreover, the adducts formed from the Lewis base and diborane may boil at a temperature above the operating temperatures.

Heat is then applied slowly to the reaction vessel and the temperature of the reaction mixture is raised to a point where release of hydrogen gas begins. Heating may be continued to a higher temperature or it may be adjusted to maintain the temperature at a point at which a steady and controllable evolution of hydrogen takes place. When evolution of hydrogen ceases and is not renewed even with further heating, the reaction is complete and the flow of diborane is, therefore, stopped. The reaction mixture is cooled and processed by conventional procedures.

The process is generally operated at a temperature of at least 120° C. to permit release of free hydrogen and to obtain dodecahydrododecaborates as the principal product. Higher temperatures can be employed, for example, up to 400° C. or even higher, if desired, but excessively high temperatures offer no advantage. A convenient method of operation is simply to heat the reaction mixture to the temperature at which hydrogen is released and to maintain heating until no further release of hydrogen occurs. The preferred temperature range of operation is 120°-300° C.

The length of the reaction period is not critical. In a batch operation, release of hydrogen is generally rapid at the operating temperature. The mixture can be stirred mechanically to speed the reaction, or diborane can be introduced into the mixture through an inlet tube equipped with a porous plate to produce very small bubbles which provide a large surface area for reaction. Measurable amounts of the dodecahydrododecaborate salt are present in the reaction mixture within a short time after diborane is introduced, e.g., within one or two minutes. To obtain maximum yield of product, the reaction is preferably continued until no further release of hydrogen is noted but it is not essential for operability to conduct the process for this period of time.

The reaction proceeds readily at prevailing atmospheric pressure and this method of operation has obvious advantages of low cost and ease of manipulation. Pressure is not a critical variable for operability and fluctuations in pressure may occur during operations without affecting the process adversely. Similarly, the time of reaction is not critical.

The process can be operated by batch or continuous

methods, and procedures for these methods are well known in the engineering field.

Because diborane reacts readily with moisture and with oxygen, it is desirable to exclude these materials from the reaction zone.

Volatile by-products of the process can be collected in traps cooled, e.g., with liquid nitrogen, liquid helium and the like, although it is not essential to do so. However, since free hydrogen is obtained as a by-product, it is desirable to provide means for the safe disposition of the hydrogen. The formation of free hydrogen is a characteristic feature of the reaction, and the progress of the reaction can be followed, if desired, by measuring the amount of hydrogen which is released.

The principal product which is obtained directly in the reaction is a dodecahydrododecaborate of the formula

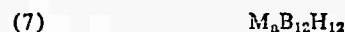

where M is an alkali metal or alkaline earth metal as defined in Formula 1, and a is a positive whole number which is equal to 2 divided by the valence of M, i.e., a is 2 when M is an alkali metal, and a is 1 when M is an alkaline earth metal. The objective of the process of this invention is the preparation of compounds of Formula 7.

The reaction product identified by Formula 7 is a salt which can be isolated directly from the reaction mixture by conventional methods, e.g., filtration, evaporation, crystallization, washing with non-solvents, and the like.

The dodecahydrododecaborate product may be isolated and purified by dissolving the alkali metal or alkaline earth metal salt in hydroxylated solvents or in ethers, e.g., water, alcohols, aqueous dioxane, aqueous 1,2-dimethoxyethane, and the like, followed by addition of a salt which has a cation of large atomic volume. Dodecahydrododecaborate salts of these cations have low solubility and can, therefore, be purified easily by one or more crystallizations. Examples of salts and bases with large cations which can be used to precipitate the dodecahydrododecaborates are quaternary ammonium salts and hydroxides [(CH₃)₄NCl, (C₂H₅)₄NOH], cesium salts and hydroxide (CsBr, CsOH), thallium salts and hydroxide (TlNO₃, TlOH), sulfonium salts and bases

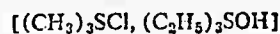

phosphonium salts

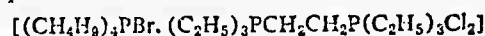

metal-ammine halides [Zn(NH₃)₄Cl₂, Co(NH₃)₆Cl₂] and related types of compounds.

The methods of isolation and purification are evident from the disclosure in the examples which illustrate the process of the invention.

The operation of the process of the invention is illustrated, but is not limited, by the examples which follow:

Example 1

(A) Triethylamine and diborane are contacted in a cooled reaction vessel under a blanket of nitrogen in sufficient quantities to provide 25 ml. of triethylamineborane adduct. The liquid adduct, under nitrogen gas, is stirred and 2.0 g. of NaBH₄ is added to form a slurry. Stirring is continued and B₂H₆ is bubbled through the mixture at a rate of about 1 g./hr. The mixture is heated slowly to 80° C. and no reaction is observed. At this point the NaBH₄ can be recovered unchanged. Heating is continued to 120° C. where evolution of hydrogen begins. After three hours at this temperature (i.e., 120° C.) the mixture is cooled and filtered to separate the solid product. A total quantity of 2.7 g. of crude product is obtained which is extracted with tetrahydrofuran. The insoluble portion (1.7 g.) is unreacted NaBH₄. The tetrahydrofuran extract is diluted with glyme and a white precipitate forms which is separated to obtain 2.3 g. of Na₂B₁₂H₁₂ containing glyme as solvent of crystallization.

5

(B) The process of Part A is repeated with the exception that diborane is bubbled through the reaction mixture at 190° C. for 1 hour and 45 minutes. The reaction mixture is processed as described in Part A to obtain 6.0 g. of $\text{Na}_2\text{B}_{12}\text{H}_{12}$ containing glyme as solvent of crystallization. No unreacted NaBH_4 is recovered.

Example 1 illustrates generically operation of the process employing a compound of Formula 4 as one component of the reaction mixture. It can, alternatively, be viewed as illustrating generically operation of the process in the presence of an adduct of Formula 6, where Z is a tertiary amine. The process can be operated with a broad range of tertiary amines, e.g., triisobutylamine, ethyldipropylamine, diethyloctylamine, diethylcyclohexylamine, methylcyclohexylamine, tricyclohexylamine, N-ethylpiperidine, and the like.

Example 2

(A) A reaction vessel is charged with 25 ml. of 1,11-dimethoxy-3,6,9-trioxaundecane



also called "tetraglyme"] and 2.0 g. of NaBH_4 . The reaction mixture is stirred under a blanket of nitrogen gas and B_2H_6 is bubbled through it at a rate of about 1 g./hr. The mixture is heated slowly and evolution of hydrogen gas begins initially at 106° C. At this temperature evolution of hydrogen gas continues for about 40 minutes and then subsides. A portion of the reaction mixture is removed, cooled and diluted with dioxane. A precipitate forms which is separated and identified as NaB_3H_9 containing dioxane as solvent of crystallization.

Heating of the remaining portion of the reaction mixture is continued with passage of B_2H_6 and at about 126° C. evolution of hydrogen begins again. A white solid precipitates and, after hydrogen evolution ceases, the solid is separated by filtration to obtain $\text{Na}_2\text{B}_{12}\text{H}_{12}$ containing tetraglyme as solvent of crystallization.

(B) The process of Part A is repeated except that 5.0 g. of B_2H_6 is passed through the reaction mixture in 50 minutes at 190° C. A total of 9.0 g. of $\text{Na}_2\text{B}_{12}\text{H}_{12}$ containing tetraglyme as solvent of crystallization is obtained (yield, 49%, based on the NaBH_4).

Example 2 illustrates generically operation of the process employing a compound of Formula 2 as one component of the reaction mixture. It can also be viewed as illustrating generically operation of the process in the presence of an adduct of Formula 6, where Z is a saturated hydrocarbyl polyether of Formula 2. The process can be operated with a broad range of polyethers, e.g., $\text{CH}_3\text{O}(\text{CH}_2\text{CH}_2\text{O})_2\text{CH}_3$, $\text{C}_2\text{H}_5\text{O}(\text{CH}_2\text{CH}_2\text{O})_4\text{C}_2\text{H}_5$,



and the like.

Example 3

A mixture of 2.0 g. of NaBH_4 and 25 ml. of di-n-butyl sulfide is blanketed with nitrogen gas, stirred and heated slowly to 195° C. Diborane (8.0 g.) is passed through the mixture over a period of 2 hours and 10 minutes at this temperature. Hydrogen gas is evolved and this gas together with some unreacted diborane passes out of the vessel with the off gases. The reaction mixture is cooled and tetrahydrofuran is added to it. Solids (about 1 g.) are removed from the mixture by filtration. The solid product is washed with fresh tetrahydrofuran, the filtrates are combined and diluted with two volumes of glyme. The white precipitate which forms is separated by filtration to obtain 2.4 g. of $\text{Na}_2\text{B}_{12}\text{H}_{12}$ containing solvent of crystallization (glyme). The solid is dissolved in water, an aqueous solution of CsCl is added and $\text{Cs}_2\text{B}_{12}\text{H}_{12} \cdot \text{CsCl}$ precipitates. It is separated by filtration, washed and dried.

The above process is repeated with the exception that no NaBH_4 is employed. The only product which is obtained is a yellow oil which contains no salt of the



6

anion. It is clear, therefore, that the tetrahydroborate is an essential component in the process of the invention to obtain salts of the $\text{B}_{12}\text{H}_{12}^{-2}$ anion.

Example 3 illustrates generically the operation of the process employing a compound of Formula 3 as one component of the reaction mixture. It can also be viewed as illustrating generically operation of the process in the presence of an adduct of Formula 6 where Z is an organic sulfide. The process is operable with a broad range of organic sulfides, e.g., dihexyl sulfide, methyl octyl sulfide, ethyl cyclohexyl sulfide, dicyclohexyl sulfide, and the like.

The process as illustrated in Examples 1-3 is generically operable with tertiary phosphines. To illustrate, tri-n-propylphosphine or tri-n-butylphosphine can be used in place of di-n-butyl sulfide in Example 3. Other phosphines which can be used include tri-cyclohexylphosphine, tri-n-hexylphosphine, ethyldibutylphosphine, and the like. Due caution should be observed in handling the phosphines in view of their known toxic and flammable properties.

In Examples 1-3, it is noted that the adducts of the liquid media and B_2H_6 are prepared directly in the reaction vessel. However, if sufficiently stable, they can be prepared separately and charged into the reaction vessel as needed. To illustrate, diborane and triethylamine can be reacted to form the liquid adduct $(\text{C}_2\text{H}_5)_3\text{N}-\text{BH}_3$ which is stored until needed. This modification in the process is illustrated in Example 4.

Example 4

A reaction vessel is employed which is fitted with a stirrer, a gas inlet tube, a reflux condenser and an oil bath heater. The vessel is connected to a liquid nitrogen trap which, in turn, is connected to a wet test meter.

The vessel is charged with 20 ml. of borane-triethylamine adduct $[(\text{C}_2\text{H}_5)_3\text{N}-\text{BH}_3$, prepared as described carrier], and 2.0 g. of NaBH_4 . The vessel is evacuated by means of a vacuum pump to a low pressure (less than 1.0 mm. of Hg) and sufficient B_2H_6 is passed into the vessel to restore the pressure to 1 atmosphere. The mixture is stirred at atmospheric pressure and heated gradually to 190-205° C. (oil bath temperature). Diborane (0.326 mole) is bubbled slowly through the mixture during this operation for a period of 1.75 hours. The volatile products are passed through the liquid nitrogen trap in which 0.21 mole of B_2H_6 condenses and 4.7 liters of non-condensable gas (hydrogen) passes through the wet test meter.

The reaction mixture is cooled to atmospheric temperature (about 25° C.). A small portion of the mixture is filtered to separate the solid product which is $\text{Na}_2\text{B}_{12}\text{H}_{12}$ containing a small quantity of NaBH_4 . The product is washed with petroleum ether and dried. Its identity is confirmed by its infrared absorption spectrum. The product is completely soluble in a small quantity of water. The product is, therefore, substantially free of



a salt which is highly insoluble in water. The high solubility of the product in water shows clearly that the process yields the sodium salt and that NaBH_4 is essential for its formation.

The aqueous solution of $\text{Na}_2\text{B}_{12}\text{H}_{12}$ is mixed with an aqueous solution of $(\text{CH}_3)_4\text{NCl}$ to form a white precipitate which is $[(\text{CH}_3)_4\text{N}]_2\text{B}_{12}\text{H}_{12}$. It is separated by filtration and its identity is confirmed by its infrared absorption spectrum.

The remaining bulk of the reaction mixture is mixed with an equal volume of tetrahydrofuran. A small amount of NaBH_4 is removed by filtration. The filtrate is diluted with 2-3 volumes of glyme and the precipitate which forms is separated, washed and dried to obtain 6.0 g. of white crystalline $\text{Na}_2\text{B}_{12}\text{H}_{12}$ containing glyme as solvent of crystallization.

A portion (0.15 g.) of the above sodium salt is dissolved in water and the aqueous solution is passed through

a column filled with a commercial acid ion-exchange resin of the crosslinked polystyrenesulfonic acid type. The eluent, which is an aqueous solution of $H_2B_{12}H_{12}$ [or $(H_2O)_2B_{12}H_{12}$], is titrated to a pH of 7 with aqueous 0.1 N NaOH solution of which 5.45 ml. is required. With these data, it is calculated that the conversion of $NaBH_4$ to $Na_2B_{12}H_{12}$ in the process of Example 4, is 40.8% of theory.

The processes of Examples 1-4 are generically operable with alkali metal and alkaline earth metal tetrahydroborates, including, e.g., $LiBH_4$, KBH_4 , $CsBH_4$, $Mg(BH_4)_2$, $Ca(BH_4)_2$, and $Ba(BH_4)_2$. The lithium, sodium and potassium salts, in particular the last two, are readily available and, therefore, preferred.

It is noted in Example 2, Part A, that NaB_3H_8 can be isolated from the reaction mixture as it is heated to the operating temperature of at least 120° C. The mechanism by which the reaction proceeds to the $B_{12}H_{12}^{2-}$ anion is not known but it is common in chemical reactions to pass through a range of intermediate products which vary widely in stability but which lead ultimately to desired products. The data in Example 2, Part A, suggest that the reaction proceeds through the formation initially of an $M(B_3H_8)_n$ compound [where M and n are defined as in Formula 1] and that with further heating in the presence of the Lewis base adduct and with further introduction of B_2H_6 , the $B_3H_8^{-1}$ anion reacts to form the $B_{12}H_{12}^{2-}$ anion.

One step in the process of the invention may, therefore, be viewed as the reaction of NaB_3H_8 (prepared in situ) and an adduct of Formula 6 in the presence of diborane at a temperature of at least 120° C. This mechanism, although not clearly established, is supported by the preparation of the $B_{12}H_{12}^{2-}$ anion directly from NaB_3H_8 and a trialkylamine- BH_3 adduct which is illustrated as follows:

A reaction vessel is charged with 6.1 g. of NaB_3H_8 (containing 3 moles of dioxane of crystallization) and 25 ml. of $(C_2H_5)_3N-BH_3$ adduct. The mixture is heated with stirring and forms a clear solution at 117° C. with no evidence of reaction. Heating and stirring is continued and at 133° C. hydrogen begins to be evolved and a solid separates from the mixture. Heating is continued for about 0.5 hour to a maximum temperature of 170° C. The reaction mixture is maintained at 170° C. for another 0.5 hour, i.e., until hydrogen evolution ceases. About 1.0 liter of gas is evolved, i.e., about 2.15 moles of hydrogen per mole of $B_3H_8^{-1}$ anion. The mixture is cooled and the solid is separated by filtration. The filtrate is unchanged $(C_2H_5)_3N-BH_3$ adduct and the solid is a mixture of $NaBH_4$ and $Na_2B_{12}H_{12}$ with dioxane of solvation. The mixture is stirred with tetrahydrofuran in which $Na_2B_{12}H_{12}$ is soluble and $NaBH_4$ is insoluble. The mixture is filtered to separate $NaBH_4$ and the filtrate is evaporated to obtain $Na_2B_{12}H_{12}$ with solvent of crystallization (dioxane).

In the above test no B_2H_6 is supplied to the reaction mixture during operation of the process. The test is repeated with B_2H_6 bubbling through the mixture and the sole product which is obtained and isolated in good yield is $Na_2B_{12}H_{12}$. Sodium trihydroborate (NaB_3H_8) when heated alone, i.e., in the absence of B_2H_6 and the trialkylamine-borane adduct, will yield $Na_2B_{12}H_{12}$ only when heated for long periods at a high temperature. Thus, NaB_3H_8 , after heating alone for 3 hours at 100° C. or for 10 hours at 150° C., yielded no $Na_2B_{12}H_{12}$. Only when NaB_3H_8 is heated for 10 hours at 200° C. is $Na_2B_{12}H_{12}$ found in the reaction product and it is present in admixture with $NaBH_4$.

Both diborane and the tetrahydroborate contribute to the boron content of the final product. The following illustrations provide further confirmation that each component is needed.

(A) A reaction vessel is charged with 25 ml. of $(C_2H_5)_3N-BH_3$ adduct, prepared as described earlier,

and 25 ml. of a saturated hydrocarbon of the kerosene boiling range. The mixture is stirred and heated to 180-200° C. Diborane (0.1 mole) is bubbled into the mixture at this temperature over a period of 1.5 hours. Volatile products are formed which include unreacted B_2H_6 and possibly a small amount of hydrogen. The reaction mixture is cooled and filtered. There is obtained a small quantity (ca. 0.6 g.) of a white solid which is



as shown by its infrared absorption spectrum. The yield is very low. In contrast, the yield of product obtained by the process of the invention and illustrated in the examples is high, demonstrating clearly the need for the presence of a tetrahydroborate in the mixture during reaction at atmospheric pressure.

(B) A reaction vessel is charged with 0.4 g. of $NaBH_4$ and 23 g. of $(C_2H_5)_3N-BH_3$, prepared as described earlier. The mixture is stirred and heated at 194-198° C. for 2 hours in the absence of B_2H_6 . The borane adduct $[(C_2H_5)_3N-BH_3]$ is then removed by distillation and the solid residue is examined for $B_{12}H_{12}^{2-}$ anion by infrared analysis and by reaction of an aqueous solution of the residue with an aqueous solution of $CsCl$. No salt of the $B_{12}H_{12}^{2-}$ anion is detected. This test shows that B_2H_6 is a necessary reactant in the process of the invention.

The importance of the Lewis base in obtaining reaction between diborane and the tetrahydroborate at atmospheric pressure by the methods described in Examples 1-4 is demonstrated in the following illustrations:

(C) A horizontal reaction tube is charged with 2.0 g. of $NaBH_4$ and the tetrahydroborate is heated to 200° C. Diborane (2.0 g.) is passed into the tube and over the $NaBH_4$ during a period of 0.5 hour. The exit gases are collected and 0.9 g. of B_2H_6 and 0.7 liter of hydrogen are recovered. No $Na_2B_{12}H_{12}$ is isolated; the product in the reactor is $NaBH_4$.

(D) A reaction vessel is charged with 2.0 g. of $NaBH_4$ and 25 ml. of saturated hydrocarbons of the kerosene boiling range. Diborane (2.0 g.) is bubbled through the stirred reaction mixture at 200° C. for 0.5 hour. The volatile products are collected and 1.33 g. of B_2H_6 and 1.37 liters of hydrogen are recovered. The solid reaction product is dissolved in water and an aqueous solution of $(CH_3)_4NCl$ is added. No precipitate forms and no $[(CH_3)_4N]_2B_{12}H_{12}$ is obtained. The solid product which is present in the vessel after reaction is principally $NaBH_4$.

It is evident from the above data that the process of the invention, employing a tetrahydroborate (or a trihydroborate formed in situ), diborane and a Lewis base as defined earlier, leads to maximum utilization of the boron components to obtain the desired product (a salt of the $B_{12}H_{12}^{2-}$ anion) in high yield.

The dodecahydrododecaborates obtained in the process of the invention are useful in many fields. They can be used as components of high energy fuels, e.g., rocket propellants, either alone or in combination with oxidizing agents. They can be used as components of compositions for flares and fireworks to impart a pleasing color and sparkle to the display.

The dodecahydrododecaborate salts are converted into the free acid, as described earlier in Example 4, by passage of an aqueous or alcohol solution of an alkali metal or alkaline earth metal salt through a column filled with an acid ion-exchange resin. The acid, which in aqueous solution has the formula $(H_2O)_2B_{12}H_{12}$, is useful in industrial applications, e.g., in absorption of noxious gases from the atmosphere or in situations where one desires to avoid contamination with sulfate, chlorine, bromide, chlorate, phosphate, and like strong acid anions. Thus, traces of lower alkyl amines [e.g., $(CH_3)_3N$] in air can be removed by bubbling the contaminated air through an aqueous solution of $H_2B_{12}H_{12}$. As a further illustration, the acid in aqueous solution is useful for etching metals,

such as steel, and for rust removal, for pickling, for scale removal and for similar metal processing operations.

The alkali metal and alkaline earth metal salts of the $B_{12}H_{12}^{-2}$ anion are useful as sequestering agents for metals, especially heavy metals. To illustrate, a mixture of hydrocarbons in the boiling range of gasoline, which contains in solution a copper salt of an organic acid (copper stearate), is thoroughly agitated with an aqueous ammoniacal solution of $Na_2B_{12}H_{12}$. The hydrocarbon layer, which is separated from the aqueous reagent, is completely free of the deleterious copper salt.

The foregoing detailed description has been given for clearness of understanding only and no unnecessary limitations are to be understood therefrom. As many apparently widely different embodiments of this invention may be made without departing from the spirit and scope thereof, it is to be understood that this invention is not limited to the specific embodiments thereof.

The embodiments of the invention in which an exclusive property or privilege is claimed are defined as follows:

1. A process for preparing alkali metal and alkaline earth metal dodecahydrododecaborates which comprises reacting

- (a) diborane,
- (b) a tetrahydroborate selected from the class consisting of alkali metal tetrahydroborates and alkaline earth metal tetrahydroborates, and
- (c) a compound selected from those of the formulas consisting of $RO(CH_2CH_2O)_mR'$, $R'SR''$, $RR'R''N$ and $RR'R''P$ wherein R , R' and R'' each are of up to 12 carbon atoms and are selected from the class consisting of alkyl and cycloalkyl, and R' and R'' can be joined together to form a ring with the hetero-

atom, and wherein m is a cardinal number of from 2 to 6 inclusive,

at a temperature of at least $120^\circ C.$ in the substantial absence of oxygen and water and at a pressure of about one atmosphere.

2. The process of claim 1 in which the temperature is from $120^\circ C.$ to $300^\circ C.$

3. The process of claim 1 in which the tetrahydroborate is an alkali metal tetrahydroborate.

4. The process of claim 1 in which the tetrahydroborate is an alkaline earth metal tetrahydroborate.

5. The process of claim 3 wherein the aliphatically saturated compound is an organic ether of the formula $RO(CH_2CH_2O)_mR'$ wherein m is a cardinal number of

from 2 to 6, inclusive, and R and R' each are selected from the class consisting of alkyl and cycloalkyl of up to 12 carbon atoms.

6. The process of claim 3 wherein the aliphatically saturated compound is a sulfide of the formula $R'SR''$ wherein R' and R'' each are selected from the class consisting of alkyl and cycloalkyl of up to 12 carbon atoms, and R' and R'' can be joined to form a ring with the sulfur.

7. The process of claim 3 wherein the aliphatically saturated compound is a tertiary amine of the formula $RR'R''N$ wherein R , R' and R'' each are selected from the class consisting of alkyl and cycloalkyl of up to 12 carbon atoms, and R' and R'' can be joined to form a ring with the nitrogen.

8. The process of claim 3 wherein the aliphatically saturated compound is a tertiary phosphine of the formula $RR'R''P$ wherein R , R' and R'' each are selected from the class consisting of alkyl and cycloalkyl of up to 12 carbon atoms, and R' and R'' can be joined to form a ring with the phosphorus.

9. The process of claim 1 wherein reactants (a) and (c) are premixed before contacting reactant (b).

10. A process for preparing $Na_2B_{12}H_{12}$ which comprises reacting B_2H_6 , $NaBH_4$, and $N(C_2H_5)_3$ at a temperature of from $120^\circ C.$ to $300^\circ C.$ in the substantial absence of oxygen and water and at a pressure of about one atmosphere.

11. A process for preparing $Na_2B_{12}H_{12}$ which comprises reacting B_2H_6 , $NaBH_4$ and $CH_3O(CH_2CH_2O)_4CH_3$ at a temperature of from $120^\circ C.$ to $300^\circ C.$ in the substantial absence of oxygen and water and at a pressure of about one atmosphere.

12. A process for preparing $Na_2B_{12}H_{12}$ which comprises reacting B_2H_6 , $NaBH_4$ and $S(C_2H_5)_2$ at a temperature of from $120^\circ C.$ to $300^\circ C.$ in the substantial absence of oxygen and water and at a pressure of about one atmosphere.

References Cited

UNITED STATES PATENTS

2,983,574 5/1961 Nigon ----- 23-14

OTHER REFERENCES

Baker et al.: "Journal of Inorganic and Nuclear Chemistry," vol. 23, pp. 41-44 (1961).

MILTON WEISSMAN, *Primary Examiner.*

1

3,365,275 POLYHYDROPOLYBORATES AND PROCESSES FOR PREPARING THEM

Earl J. Muehlethies, West Chester, Pa., assignor to E. I. du Pont de Nemours and Company, Wilmington, Del., a corporation of Delaware
No Drawing. Filed May 31, 1962, Ser. No. 199,573
19 Claims. (Cl. 23-204)

This invention relates to new compounds containing boron and to methods for preparing the compounds.

Boron compounds, principally salts of boric acid, have been in commercial use for many years. Recently other boron compounds, e.g., low molecular weight boron hydrides, have achieved technical importance in applications employing oxidizing and reducing agents. There are many potential applications, however, for which the available boron compounds are un-suited because of hydrolytic, oxidative or other types of instability. To illustrate, diborane, chlorodiborane, pentaborane(9) and trialkylboron compounds are spontaneously flammable in air. Diborane, pentaborane(9), chlorodiborane, boron trichloride, iododecaborane(14), and most other boron halides are hydrolyzed rapidly in water or alcohol. Even the most stable known borohydride, i.e., decaborane(14), is hydrolyzed at a moderate rate in water. Known ionic borohydrides, e.g., tetrahydroborates (NaBH_4 , and the like), are hydrolyzed at a rapid rate at 100°C .

A broad class of boron compounds has now been prepared which show good hydrolytic and oxidative stability.

The novel boron compounds of this invention are polyhydropolyborates which consist of (1) an anion-forming group of 20 conjoined boron atoms and 18 hydrogen atoms each bonded to boron, and (2) a cation which is hydrogen, hydronium, a metal, a metal-ammine complex of the Werner type, quaternary ammonium, aryldiazonium, S-substituted sulfonium and P-substituted phosphonium.

The compounds are defined also by the following formula:



where M is hydrogen (H^+) or, in its hydrated form, hydronium (H_3O^+), a metal, a metal-ammine, R_4N^+ , $\text{ArN}=\text{N}^+$, R_3S^+ , and R_3P^+ , where R represents an organic group and Ar represents an aryl group; *a* and *b* are the smallest whole numbers which satisfy the following equation:

$$b = \frac{a \times \text{valence of M}}{2} \quad (2)$$

The compounds of the invention are prepared by oxidizing a decahydrodecaborate(2^-), i.e., a compound containing the anion $\text{B}_{10}\text{H}_{10}^{2-}$. The resulting oxidized product can be contacted with a reactant containing the desired cation M and a compound of Formula 1 is isolated from the reaction mixture. Processes for obtaining the compounds of the invention are described more fully in later paragraphs.

The compounds of Formula 1 are composed of two principal components which are represented by M and ($\text{B}_{20}\text{H}_{18}$). Each of these groups will be discussed separately.

THE COMPONENT M

The component M can consist of one element or more than one element. To simplify the discussion, this component will also be referred to as a group. The group is ionically bonded to the $\text{B}_{20}\text{H}_{18}$ component and the primary function of the group is to provide the positive ionic charges needed to form a complete compound. The component M is a member of the group described previously for Formula 1 and each member of the group bears one or more positive ionic charges, i.e., each member has

2

a positive valence of at least one. The members of the group have the common property of forming cations in aqueous solution.

In its simplest form M is hydrogen, i.e., H^+ , which in aqueous solution is usually associated with one or more molecules of water to form a hydrated ion, e.g., the hydronium group (H_3O^+).

The group M can also be derived from any metal. The metals according to the Periodic Table in Deming's "General Chemistry," 5th ed., Chapter II, John Wiley & Sons, Inc., and in Lange's "Handbook of Chemistry," 9th ed., pp. 56-57, Handbook Publishers, Inc. (1956) are the elements of Groups I, II, VII, III-B, IV-B, V-B, VI-B, VII-B, and the elements of Groups III-A, IV-A, V-A, and VI-A which have atomic numbers above 5, 14, 33, and 52, respectively. The metals can be light or heavy metals. To illustrate, M can be lithium, sodium, potassium, cesium, beryllium, barium, lanthanum, manganese, iron, cobalt, copper, zinc, mercury, aluminum, thallium, tin, lead, silver or any other metal. Preferred metals are those whose valences are 1-3, inclusive.

An especially preferred group of metals from which M can be derived consists of elements of Groups I-A, II-A, I-B and II-B having atomic numbers up to and including 80. Most preferred metals are the alkali and alkaline earth metals, i.e., lithium, sodium, potassium, rubidium, cesium, beryllium, magnesium, calcium, strontium, and barium.

The group M can be a combination of a metal with ammonia or an amine, to form a Werner-type coordination group usually referred to as metal-ammines. Examples of cations of this type are as follows:

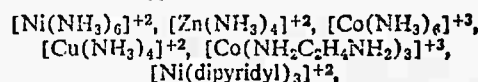

and the like.

The component M can be a group having the formula R_4N^+ , R_3S^+ or R_3P^+ , where R is an organic group bonded to nitrogen, sulfur or phosphorus. The R substituents are not critical features of these cation groups. Preferably R, for reasons of availability of reactants, contains at most 18 carbon atoms and can be alkyl, alkenyl, cycloalkyl, cycloalkenyl, aryl, alkaryl, aralkyl, cyanoalkyl, hydroxyalkyl or haloalkyl. To illustrate, R can be methyl, propyl, 2-ethylhexyl, octadecyl, allyl, cyclohexyl, cyclohexenyl, phenyl, naphthyl, anthryl, cyclohexylphenyl, diphenyl, benzyl, chloroethyl, ω -cyanoamyl, β -hydroxyethyl, p-hydroxyphenyl, and the like. In an especially preferred group, R is an aliphatically saturated hydrocarbon, i.e., a hydrocarbon free of olefinic and acetylenic bonds, of up to 12 carbons, e.g., ethyl, butyl, isobutyl, octyl, dodecyl, methylcyclohexyl, tolyl, ethylphenyl, and the like.

The group M can be aryldiazonium, i.e., a group of the formula ArN_2^+ , where Ar represents an aryl group, preferably a hydrocarbon aryl group of at most 12 carbons, e.g., phenyl, tolyl, xylyl, naphthyl, diphenyl, and the like.

The valence of the group (or cation) M will be between 1 and 3, i.e., M can have a valence of 1, 2 or 3. In most cases the valence of M will be 1 or 2. The group of compounds in which the valence of M is at most 2 are obtained from readily available reactants and thus form a preferred group.

THE GROUP ($\text{B}_{20}\text{H}_{18}$)

The novel and characterizing feature of the compounds of the invention is the polyhydropolyborate group ($\text{B}_{20}\text{H}_{18}$) $^{2-}$. The group is represented generically as having a negative ionic charge of 2 and the group, therefore, behaves in chemical reactions as a divalent anion. The group chemically is exceptionally stable. The boron cage is not easily decomposed by hydrolysis, oxidation or

reduction and it is resistant to thermal decomposition. The group is unchanged in simple metathetic reactions, a property which allows the preparation of a broad range of salts in which the cation is represented by M, as defined earlier. The group $(B_{10}H_{10})^{2-}$ undergoes electrophilic substitution reactions in a manner which resembles the behavior of carbocyclic aromatic compounds, e.g., benzene and naphthalene, to obtain compounds in which 1 to 13 hydrogens bonded to boron are replaced by monovalent substituents (organic and inorganic). The behavior of the boron-containing group is particularly surprising in view of the inorganic composition of the group. The stability of the group permits the preparation of a wide range of novel boron-containing compositions.

CHARACTERISTICS OF THE COMPOUNDS

The compounds are generally crystalline solids with the high-melting points which are characteristic of salts. They are stable under conventional storage conditions and can be kept for prolonged periods without decomposition.

The acid of the divalent anion and salts of colorless cations derived from the acid are yellow in color. The acid and salts are generally soluble in hydroxylated solvents, e.g., water, alcohol, and the like, to form intensely yellow solutions. These compounds show characteristic and identifying absorption bands in the infrared spectrum at approximately the following wave-lengths (expressed as microns): 11.3, medium; 11.5, strong; 12.1, strong; 12.8, medium; 13.4, strong; 13.7, medium shoulder; 14.4, strong; and 15.0, strong. Shifts in the characteristic bands can occur through the influence of the cation in the compound and some variation in the above values may, therefore, be noted.

The following examples illustrate the compounds of the invention:

$Li_2B_{10}H_{12}$, $K_2B_{10}H_{12}$, $MgB_{10}H_{12}$, $CaB_{10}H_{12}$, $SrB_{10}H_{12}$
 $BaB_{10}H_{12}$, $[C_2(H_2O)_2]_2(B_{10}H_{12})_3$, $Mn(H_2O)_6B_{10}H_{12}$
 $Fe(H_2O)_6B_{10}H_{12}$, $Co(H_2O)_6B_{10}H_{12}$, $Ni(H_2O)_6B_{10}H_{12}$
 $ZnB_{10}H_{12}$, $CdB_{10}H_{12}$, $HgB_{10}H_{12}$, $SnB_{10}H_{12}$, $PbB_{10}H_{12}$
 $Zn(NH_3)_6B_{10}H_{12}$, $[Co(NH_3)_6]_2(B_{10}H_{12})_3$
 $Cu(NH_3)_4B_{10}H_{12}$, $(CH_3)_2Si_2B_{10}H_{12}$, $[(C_6H_5)_4P]_2B_{10}H_{12}$
 $[(C_2H_5)_4N]_2B_{10}H_{12}$, $[(C_6H_5)_3N]_2B_{10}H_{12}$
 $[C_2H_5(CH_3)_2N]_2B_{10}H_{12}$, $(C_6H_5N=N)_2B_{10}H_{12}$
 $(CH_3C_6H_4N=N)_2B_{10}H_{12}$, $H_2B_{10}H_{12}$, $(H_3O)_2B_{10}H_{12}$

and the like.

PREPARATION OF THE COMPOUNDS

The compounds of Formula 1 are prepared by oxidizing a compound of the formula

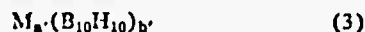

where M is a cation, i.e., a group which forms a positively charged ion in H_2O , preferably having a valence of 1-3 and a' and b' are defined as the smallest whole numbers which satisfy the equation:

$$2b' = a' \times \text{valence of M} \quad (4)$$

The compounds of Formula 3 which are employed as reactants are not commonly known and preparation of representative compounds is described in the examples. Any decahydrodecaborate (2^-) can be employed, i.e., compounds in which M is any group which can form a cation in water, are operable. For reasons of availability and cost, it is preferred to use decahydrodecaborates of Formula 3 in which M is hydrogen, hydronium, ammonium, substituted ammonium, an alkali metal or an alkaline earth metal. Specific illustrations of the classes of preferred reactants are $H_2B_{10}H_{10}$ and its hydrates, $Na_2B_{10}H_{10}$, $CaB_{10}H_{10}$, $K_2B_{10}H_{10}$, $Li_2B_{10}H_{10}$, $BaB_{10}H_{10}$, $CaB_{10}H_{10}$, $MgB_{10}H_{10}$, $(NH_4)_2B_{10}H_{10}$, $[(CH_3)_4N]_2B_{10}H_{10}$, $[(C_2H_5)_4N]_2B_{10}H_{10}$, $[(CH_3)_2NH_2]_2B_{10}H_{10}$, and the like. Hydrates of the salts can also be employed.

Oxidation of the decahydrodecaborate reactant is accomplished either chemically or electrolytically.

In chemical oxidation the oxidizing reagent or oxidant is a compound having as a characteristic component a metal of variable valence, which metal is in its highest valence state, said compound having an oxidation-reduction potential in acid solution of about -1.33 to about -1.61 volts. The oxidation-reduction potential of a compound is a recognized and measurable property for which values are found in readily available texts, e.g., "Oxidation Potentials," by W. G. Latimer, 2nd ed., Prentice-Hall, New York (1952), particularly p. 344. Examples of classes of compounds which are operable in the process are dichromates, aurates, higher oxides of lead, manganic salts, permanganates, higher oxides of bismuth and salts of tetravalent cerium.

The chemical oxidation process is conducted by simple and uncomplicated procedures in conventional equipment. A solvent is generally employed which preferably is hydroxylated, e.g., methanol, water, and the like. Water is most conveniently used and it is therefore the preferred solvent.

The ratio in which the reactants are employed is not a critical factor for operability. However, the use of an excess of oxidant may lead to a decrease in yield of the desired product. It is preferable to employ at most two oxidation equivalents of the oxidant (based on the metal) per mole of $B_{10}H_{10}^{2-}$ salt or acid used in the process. The preferred mole ratio of oxidant to polyhydrodecaborate can be determined by methods described in Handbook of Chemistry and Physics, 38th ed., p. 1588, Chemical Rubber Publishing Co. (1956).

Pressure is not a critical factor in the process and atmospheric pressure is normally used. However, if desired, pressures higher or lower than atmospheric can be employed. The temperature of the reaction is also not critical. Normally, the reaction is conducted at prevailing atmospheric temperature but temperatures as low as $0^\circ C.$ and as high as $100^\circ C.$ can be employed. Preferred temperatures of operation lie between about 10° and $75^\circ C.$

The reaction proceeds rapidly and a measurable quantity of product is obtained within a short time. Normally the reactants are maintained in contact for a sufficient period to assure maximum yield. The time of reaction can range from a few minutes to 24 hours or more.

In the operation of the process it is preferable (although not essential) to add the oxidant to the decaborate to reduce the vigor of the reaction and to obtain the maximum yield of desired product. Normally, therefore, the reaction vessel is charged with the solvent and the decahydrodecaborate. The chemical oxidant, which is conveniently handled in solution, is added gradually to the vessel at a rate which provides a controllable reaction. After all of the oxidant has been added, the reaction mixture can be stirred for a short period and a solution containing the desired cation (M) is added. The polyborate salt frequently precipitates at this point but, in the event precipitation does not occur, the solution is evaporated to a volume at which the solid separates. The product is purified by conventional procedures to obtain a salt of the divalent anion, $B_{10}H_{12}^{2-}$.

The electrolytic oxidation process is conducted by well known procedures which are described in texts, e.g., see Glasstone, "Introduction to Electrochemistry," Chapter XV, D. Van Nostrand Co., 5th ed. (1951). The decahydrodecaborate salt is dissolved in an aprotic solvent to provide a solution of satisfactory conductivity to which sufficient current is applied to release gas (hydrogen) at the cathode. An aprotic solvent is a liquid which has no tendency to release or to accept protons (see Moeller, "Inorganic Chemistry," p. 312 (1954), Wiley & Sons, Inc.).

The solvents employed in the process are usually polar organic liquids, e.g., nitriles, tertiary nitrogen bases, N,N-

disubstituted amides, and the like. Examples of suitable solvents are acetonitrile, pyridine, N,N-dimethylaniline, dimethylformamide, and combinations of these liquids. A current of at least one ampere and one volt is usually employed. These conditions are not critical and they are used solely to illustrate a satisfactory method of operation. The process is conducted conveniently at atmospheric temperature, i.e., about 25° C. although lower and higher temperatures can be used, e.g., as low as 0° C. or as high as 100° C. The preferred temperature range lies between 10° and 60° C.

The salt is isolated in the electrolytic oxidation process by methods described for the chemical oxidation process.

Metathetic reactions.—Compounds of Formula 1, wherein M includes the group of cations as defined for Formula 1 are obtained by simple metathetic reactions. To illustrate, an aqueous solution of a compound of Formula 1, where M is $(\text{CH}_3)_4\text{N}^+$ is contacted with a strong acid or with a strongly acidic cation exchange resin to obtain a free acid, i.e., a compound of Formula 1 in which M is H. The acid, generally in solution, is reacted with oxides of metals, hydroxides of metals, salts of metals (both organic and inorganic), quaternary nitrogen bases, sulfonium hydroxides or halides, phosphonium hydroxides or halides, arylidiazonium hydroxides or halides, and similar types of compounds to obtain products of Formula 1 which have the desired cation M. In a process employing an ion-exchange resin, strongly acidic resins of the sulfonic acid variety are preferred because of availability, e.g., "Amberlite" IR-120-H and "Dowex" 50. The acid, so obtained in aqueous solution, can be reacted with nitrates, chlorides, bromides, acetates, benzoates and similar salts of metals or other bases to obtain salts of Formula 1.

To illustrate, an aqueous solution of $\text{Cs}_2\text{B}_{20}\text{H}_{18}$ is passed through a column packed with a commercial cross-linked polyarylsulfonic acid to obtain in aqueous solution the acid $\text{H}_2\text{B}_{20}\text{H}_{18}$. The aqueous solution is evaporated under reduced pressure to obtain the crystalline acid generally as a solid hydrate having up to 12 or more molecules of water. The number of molecules of water present in the crystalline hydrated acid is not a critical factor in obtaining the free acid. However, for maximum stability in storage, a crystalline acid having at least 4 moles of water of hydration per mole of acid is preferred.

The acid is, in fact, most conveniently handled as a hydrate. In the hydrated form part of the water of hydration is considered to be associated with each ionizable proton and the crystalline acids can be represented as having hydrated protons, e.g., $(\text{H}_3\text{O})_2\text{B}_{20}\text{H}_{18}$,

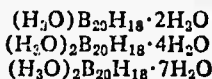

$(\text{H}_3\text{O})_2\text{B}_{20}\text{H}_{18} \cdot 10\text{H}_2\text{O}$, and the like.

For many purposes, it is not necessary to isolate the acid from solution. Solutions of the acid can be employed directly, for example, in metathetic reactions.

Metal salts of the invention can be prepared by neutralization of the acids, obtained as described above in aqueous or alcohol solution with an aqueous solution or suspension of an inorganic base, e.g., an alkali or alkaline earth metal hydroxide. The resulting aqueous solution of the metal salt of the $(\text{B}_{20}\text{H}_{18})^{-2}$ anion is concentrated by evaporation of water or alcohol until the salt crystallizes out. In many cases the salt may precipitate during its preparation and evaporation of the solution is not necessary. The crystalline salt is dried under reduced pressure, e.g., 0.1 mm. of mercury, and moderately elevated temperature, e.g., 50–100° C. The metal salts frequently contain water of hydration which can be removed by heating for several hours at a temperature of about 200° C. under low pressure, e.g., 0.1 mm. of mercury or lower. Specific examples of salts which can be

obtained by the process described above are: $\text{Na}_2\text{B}_{20}\text{H}_{18}$, $\text{K}_2\text{B}_{20}\text{H}_{18}$, $\text{Li}_2\text{B}_{20}\text{H}_{18}$, $\text{Cs}_2\text{B}_{20}\text{H}_{18}$, $\text{MgB}_{20}\text{H}_{18}$, $\text{BaB}_{20}\text{H}_{18}$, $\text{CaB}_{20}\text{H}_{18}$, and $\text{SrB}_{20}\text{H}_{18}$.

Water-insoluble heavy metal salts of the acids can be prepared by adding a water-soluble heavy metal salt, e.g., silver nitrate or mercuric nitrate, to an aqueous solution of $\text{H}_2\text{B}_{20}\text{H}_{18}$, whereupon the heavy metal salt of the anion precipitates out as a light colored solid. The salts formed in this procedure are usually anhydrous. Examples of heavy metal salts which can be prepared by this method are: $\text{HgB}_{20}\text{H}_{18}$, $\text{PbB}_{20}\text{H}_{18}$, and $\text{Ag}_2\text{B}_{20}\text{H}_{18}$. The procedure is generic to the preparation of metal salts of the compounds of the invention.

Nitrates, carbonates, chlorides or oxides of metals can be used to prepare the salts by the methods described earlier.

Light-sensitive salts, e.g., the silver salt, are preferably prepared under conditions providing minimum exposure to light although exclusion of light is not essential for operability.

Compounds of Formula 1, where M is an alkali or alkaline earth metal, e.g., Na, K, Cs, Ca, Ba, Mg, and Sr, can undergo simple metathetic reactions with other salts to effect an exchange of cations. Thus, $\text{Na}_2\text{B}_{20}\text{H}_{18}$ or $\text{K}_2\text{B}_{20}\text{H}_{18}$ can be reacted in aqueous solution with benzenediazonium hydroxide, trimethylsulfonium iodide, tetrabutylphosphonium chloride, and the like, to form compounds of Formula 1 having benzenediazonium, trimethylsulfonium, tetrabutylphosphonium, and the like, as cations. These illustrations are not limiting and they demonstrate the breadth of metathetic reactions which can be used.

Compounds of the invention in which the group M is a metal, particularly a transition metal, or a Werner-type complex, frequently contain solvent of crystallization when isolated by conventional methods. The solvent, e.g., water, can be bound loosely in the lattices of the crystals or it can be associated by stronger bonds with the metal cation or Werner-type complex cation. Solvent of crystallization, entrapped in crystal lattices, is removed easily by well-known procedures, e.g., heating under reduced pressure. Solvent of crystallization which is associated with the cation is more difficult to remove, and for most applications, it is not necessary to remove completely this type of bound solvent. Salts containing solvent of crystallization, in particular, salts with water of crystallization, are within the scope of the compounds of this invention.

The products of the invention and processes for obtaining them are illustrated in the following examples. The preparation of a representative compound of the type $\text{M}_n(\text{B}_{16}\text{H}_{16})_n$, which is employed as a principal reactant, is also illustrated.

Example A

(A) *Preparation of bis(dimethyl sulfide)decaborane (12).*—A reaction vessel having a capacity of about 365 g. of water is charged with 0.79 g. of decaborane(14), cooled in liquid nitrogen, and then evacuated to a pressure of 10 microns of mercury. Approximately 21 g. of dimethyl sulfide is condensed onto the decaborane in the reaction vessel. The reaction vessel is closed, allowed to warm to room temperature and stand for 4 days. During this time 6.6 millimoles of hydrogen is evolved. The reaction vessel is opened and excess dimethyl sulfide is removed by distillation, leaving a practically quantitative yield of white solid residue of $\text{B}_{10}\text{H}_{12} \cdot 2(\text{CH}_3)_2\text{S}$. The compound is recrystallized from ethyl acetate and it melts at 122–124° C. The compound is called bis(dimethyl sulfide)decaborane(12).

The above procedure is equally operable with other organic sulfides.

(B) *Preparation of $\text{M}_2\text{B}_{10}\text{H}_{10}$ (where M is NH_4).*—Bis(dimethyl sulfide)decaborane(12) (3.5 g.) is mixed with 50 ml. of liquid ammonia and stirred in a round-

bottom reaction vessel for 1 hour with the vessel being cooled to a temperature of about -50° C. by partial immersion in a bath of a mixture of solid carbon dioxide and acetone. The cooling bath is then removed and the excess ammonia is allowed to evaporate with stirring. The remaining traces of ammonia are removed by subjecting the residue to a high vacuum (0.01 mm. of mercury) at 25° C. There is obtained 5.6 g. of solid residue which is virtually a quantitative yield of $(\text{NH}_4)_2\text{B}_{10}\text{H}_{10}$.

Example I

(A) A reaction vessel is charged with 100 ml. of water and 1.46 g. of $(\text{NH}_4)_2\text{B}_{10}\text{H}_{10}$. The mixture is stirred and a solution of 5.4 g. of $\text{Ce}(\text{NH}_4)_2(\text{NO}_3)_6$ in 80 ml. of water is added gradually. Evolution of gas occurs and a deep blue-violet solution forms. A concentrated aqueous solution of $(\text{CH}_3)_4\text{NCl}$ is added to the reaction mixture with stirring and in sufficient amount to precipitate completely a violet-colored solid. The solid is separated by filtration and it is purified by crystallization from hot water to yield the yellow compound, bis(tetramethylammonium) octadecahydrocicosaborate(2-).

The compound is soluble in acetonitrile, hot methanol and hot water. The identity of the product is confirmed by elemental analysis.

Analysis.—Calcd. for $[(\text{CH}_3)_4\text{N}]_2\text{B}_{20}\text{H}_{18}$: C, 25.10; H, 11.06; N, 7.32; B, 56.54. Found: C, 26.28; H, 11.49; N, 7.55; B, 57.80.

The identity of the compound is further confirmed by measuring the number of moles of hydrogen obtained from the boron moiety ($\text{B}_{20}\text{H}_{18}$) upon complete hydrolysis to boric acid. The values for moles H_2 obtained per mole $[(\text{CH}_3)_4\text{N}]_2\text{B}_{20}\text{H}_{18}$ are as follows: Calcd., 40.0; found, 39.904 and 40.086.

(B) The above process is repeated employing the same quantity of reactants but the quantity of gas which evolves is measured. In two hours a total of 20 ml. of gas is released in the process. Aqueous $(\text{CH}_3)_4\text{NOH}$ solution is added to the reaction mixture to precipitate $[(\text{CH}_3)_4\text{N}]_2\text{B}_{20}\text{H}_{18}$. Elemental analysis of the product yields the following data: C, 23.92; H, 10.93; N, 7.04, 6.97; B, 56.88.

The infrared spectrum of $[(\text{CH}_3)_4\text{N}]_2\text{B}_{20}\text{H}_{18}$ in a Nujol mull shows many absorption bands of which the most representative are as follows (expressed as microns): 3.99, very strong; 4.05, very strong; 6.76, strong; 7.10, medium; 7.80, medium; 10.57, strong; 11.26, medium; 11.50, strong; 12.12, strong; 12.88, medium; 13.41, strong; 13.70, medium, shoulder; 14.41, strong, and 15.08, strong.

The ultraviolet spectrum of $[(\text{CH}_3)_4\text{N}]_2\text{B}_{20}\text{H}_{18}$ in solution in acetonitrile shows major absorption maxima at 292 $\text{m}\mu$ and 233 $\text{m}\mu$; the extinction coefficients are 8260 and 18,000, respectively.

X-ray single crystal data show that the tetramethylammonium salt has the monoclinic structure. The lattice constants for this salt are as follows: $a \sin \beta = 12.06$; $b = 15.85$, and $c = 13.50$. The cell weight constant corresponds to 4 molecules of $[(\text{CH}_3)_4\text{N}]_2\text{B}_{20}\text{H}_{18}$ per unit cell.

The magnetic susceptibility of solid $[(\text{CH}_3)_4\text{N}]_2\text{B}_{20}\text{H}_{18}$ is -0.64×10^{-6} E.M.U./g., showing that the compound is diamagnetic.

The electrical conductivity of the above salt is determined in aqueous solution at various concentrations and from the data a plot is made of the equivalent conductance of the solution as a function of the square root of the concentration of the salt. The data show that the compound is a 1-2 electrolyte.

Example II

A reaction vessel is charged with 7.7 g. of $(\text{NH}_4)_2\text{B}_{10}\text{H}_{10}$ and 350 ml. of water. The mixture is stirred and there is added gradually a solution consisting of 23 g. of $\text{Ce}(\text{NH}_4)_2(\text{SO}_4)_4 \cdot 2\text{H}_2\text{O}$, 250 ml. of water and 75 ml. of concentrated H_2SO_4 . The mixture is stirred overnight (ca. 15-20 hours) and it is then filtered. Aqueous

$(\text{CH}_3)_4\text{NOH}$ solution is added to the clear filtrate. The yellow precipitate which forms is separated and recrystallized from hot water to obtain pure $[(\text{CH}_3)_4\text{N}]_2\text{B}_{20}\text{H}_{18}$. Elemental analysis yields the following data: C, 24.13; H, 11.34; B, 56.39.

Examples I and II illustrate the process of the invention in which the mole ratio of the Ce^{+4} reactant to the $\text{B}_{10}\text{H}_{10}^{-2}$ reactant is about 1:1. The yields of desired $\text{B}_{20}\text{H}_{18}^{-2}$ under these conditions are generally not over 50% of the theoretical yield.

Example III

A reaction vessel is charged with 15.4 g. of $(\text{NH}_4)_2\text{B}_{10}\text{H}_{10}$ and 250 ml. of water. The mixture is stirred and a solution consisting of 126.4 g. of $\text{Ce}(\text{NH}_4)_2(\text{SO}_4)_4 \cdot 2\text{H}_2\text{O}$, 1000 ml. of water and 50 ml. of concentrated H_2SO_4 is added slowly over a period of 3 hours. During the addition the orange solution containing the Ce^{+4} ion is decolorized and a white solid precipitates. The precipitate is separated and it is shown by infrared analysis to be $\text{Ce}_2(\text{SO}_4)_3$.

The filtrate is stirred and a solution consisting of 25 g. of $(\text{CH}_3)_4\text{NOH}$ in 100 ml. of H_2O is added. A voluminous white precipitate forms which is separated by filtration. The solid is recrystallized from an acetonitrile-water solution to obtain 17.7 g. of yellow crystalline $[(\text{CH}_3)_4\text{N}]_2\text{B}_{20}\text{H}_{18}$. Elemental analysis yields the following average data: C, 24.46; H, 10.96; N, 7.23.

Example III illustrates the oxidation process in which the mole ratio of the Ce^{+4} reactant to the $\text{B}_{10}\text{H}_{10}^{-2}$ reactant is about 2:1. Under these conditions high yields of $\text{B}_{20}\text{H}_{18}^{-2}$ salts are obtained.

Example IV

A reaction vessel is charged with 100 ml. of water, 3 ml. of concentrated H_2SO_4 and 4.62 g. of $(\text{NH}_4)_2\text{B}_{10}\text{H}_{10}$. The mixture is stirred and a solution of 1.47 g. of $\text{K}_2\text{Cr}_2\text{O}_7$ in 50 ml. of water and 15 ml. of concentrated H_2SO_4 is added gradually at prevailing atmospheric temperature (about 25° C.). The color of the solution, which initially is yellow, changes through several shades to the greenish color of the trivalent chromium ion. The mixture is stirred vigorously for a short time and some gas evolves. An aqueous solution of $(\text{CH}_3)_4\text{NOH}$ is added and a flocculent precipitate forms. The precipitate, which is $[(\text{CH}_3)_4\text{N}]_2\text{B}_{20}\text{H}_{18}$, is separated and recrystallized from aqueous acetonitrile. There is obtained about 1 g. of bis(tetramethylammonium) octadecahydrocicosaborate(2-).

Example V

Using the procedure described in Example IV, a solution of 3.08 g. of $(\text{NH}_4)_2\text{B}_{10}\text{H}_{10}$ in 40 ml. of water is reacted with a solution of 0.63 g. of KMnO_4 in 40 ml. of water and 2 ml. of concentrated H_2SO_4 . The color of the solution changes from purple to colorless and gas is evolved. An aqueous solution of $(\text{CH}_3)_4\text{NOH}$ is added to the reaction mixture and the precipitate which forms is purified as described earlier to yield about 0.1 g. of $[(\text{CH}_3)_4\text{N}]_2\text{B}_{20}\text{H}_{18}$.

Example VI

A solution is prepared containing 1.0 g. of $(\text{NH}_4)_2\text{B}_{10}\text{H}_{10}$ in a small quantity of water. To this solution there is added 5 ml. of a suspension composed of 3 g. of PbO_2 , 30 ml. of water and 10 ml. of concentrated H_2SO_4 . Vigorous evolution of gas occurs and the color of the lead oxide changes from black to brown. An aqueous solution of $(\text{CH}_3)_4\text{NCl}$ is added and the precipitate which forms is separated. It is recrystallized as described in previous examples to obtain $[(\text{CH}_3)_4\text{N}]_2\text{B}_{20}\text{H}_{18}$.

Examples I-VI, inclusive, illustrate the process of chemical oxidation to obtain the compounds of the invention.

Example VII

A reaction vessel, fitted with two platinum electrodes, is charged with a solution consisting of 10 g. of $(\text{NH}_4)_2\text{B}_{10}\text{H}_{10}$, 300 ml. of acetonitrile and 100 ml. of pyridine. The solution is electrolyzed for 2 hours at 20 volts and an initial current of 1.4 amperes. The current gradually decreases to 0.8 ampere as the electrolysis progresses. A coating of an orange-colored gum forms on the anode and a gas is evolved at the cathode. The solution changes in color, becoming light yellow at first, then a deep yellow and finally a deep orange. After completion of the electrolysis step, water and excess

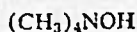

and $(\text{CH}_3)_4\text{NCl}$ are added to the solution. No precipitate forms and the solution is evaporated under reduced pressure to yield an orange solid. The solid is crystallized from hot water and from methanol to give yellow crystalline $[(\text{CH}_3)_4\text{N}]_2\text{B}_{20}\text{H}_{18}$. Data from elemental analysis are: C, 25.39, 25.44; H, 11.37, 11.60; N, 6.99, 6.73; B, 56.22.

Example VII illustrates the process to obtain the compounds of the invention by electrolytic oxidation.

Example VIII

(A) A solution of $[(\text{CH}_3)_4\text{N}]_2\text{B}_{20}\text{H}_{18}$ in methanol-water is passed through a column packed with a commercial acidic ion-exchange resin of the polysulfonic acid type. The effluent is a solution of the acid $\text{H}_2\text{B}_{20}\text{H}_{18}$, or, expressed in its hydrated form as a hydronium acid, $(\text{H}_3\text{O})_2\text{B}_{20}\text{H}_{18}$. The aqueous solution frequently is used without further processing to prepare salts of the acid.

(B) The solid acid is obtained by evaporating the aqueous solution, prepared as described above, to dryness at very low pressure (less than 0.1 mm. of mercury). The acid, which forms large intensely colored yellow crystals, contains 6 moles of water of hydration, of which 2 moles are considered to be associated with the proton cations. The identity of the compound is confirmed by elemental analysis.

Analysis.—Calcd. for $(\text{H}_3\text{O})_2\text{B}_{20}\text{H}_{18} \cdot 4\text{H}_2\text{O}$: H, 9.36; B, 62.80. Found: H, 8.91; B, 63.65.

The solid yellow crystals of the hydrated acid obtained above are very hygroscopic. They dissolve in water to form a clear yellow solution which, when mixed with an aqueous solution of $(\text{CH}_3)_4\text{NOH}$, forms the salt



A study of the acid strength of the dibasic acid in aqueous solution shows that it is a very strong acid, having only one inflection point in the titration curve.

Example VIII illustrates the preparation of the acid, dihydrogen octadecahydroicosaborate(2⁻) in the form of its hydrates. Any strong acid or acid ion-exchange resin can be employed to provide an acid environment. To illustrate, the $\text{B}_{20}\text{H}_{18}^{2-}$ salt can be mixed with an aqueous solution of a strong mineral acid, e.g., sulfuric, hydrochloric, and the like, to obtain the free acid which, in solution, is frequently referred to as $(\text{H}_3\text{O})_2\text{B}_{20}\text{H}_{18}$.

Example IX

A portion of an aqueous solution of the dibasic acid, prepared as described in Example VIII, part (A), is titrated with an aqueous solution of sodium hydroxide until the reaction mixture is neutral (pH=7). The resulting aqueous solution is yellow and its ultraviolet spectrum shows absorption in regions which are characteristic for salts of the $\text{B}_{20}\text{H}_{18}$ anion.

The yellow solution is evaporated to dryness under reduced pressure (less than 1 mm. of Hg) to obtain crude $\text{Na}_2\text{B}_{20}\text{H}_{18}$ as a tan-colored solid. The compound is purified by crystallization from methanol. The product so obtained contains water of crystallization.

Analysis.—Calcd. for $\text{Na}_2\text{B}_{20}\text{H}_{18} \cdot 2\text{H}_2\text{O}$: B, 68.34; H, 7.07. Found: B, 68.21; H, 7.25.

The compound can, if desired, be obtained free of solvent of crystallization by heating for a time at very low pressure. The molecular weight of the compound $\text{Na}_2\text{B}_{20}\text{H}_{18}$, determined by freezing point depression in aqueous solution gives the following values: 103, 99, 89, 88, i.e., an average mol. wt. of 95; calcd. value: 93.3.

The ultraviolet spectrum of the sodium salt in solution in acetonitrile shows major absorption maxima at 292 m μ and 233 m μ .

Example X

An aqueous solution of the dibasic acid, obtained as described in Example VIII, part (A), is mixed with an aqueous solution of CsF. The precipitate which forms is separated, washed and dried to obtain $\text{Cs}_2\text{B}_{20}\text{H}_{18}$ containing 1.5 moles of water of hydration. The salt is moderately soluble in water.

Analysis.—Calcd. for $\text{Cs}_2\text{B}_{20}\text{H}_{18} \cdot 1.5\text{H}_2\text{O}$: Cs, 50.4; B, 41.03. Found: Cs, 50.5; B, 41.93, 41.87.

The infrared spectrum of the above cesium salt in a Nujol mull shows absorption bands as follows (expressed as microns): 3.92, 3.99, 4.05, very strong; 10.51, strong; 11.28, very strong; 11.81, medium, shoulder; 12.05, very strong; 12.61, weak; 13.25, very strong; 13.65, 13.85, medium; 14.40, strong; and 14.88, very strong.

Example XI

(A) An aqueous solution of the dibasic acid, obtained as described in Example VIII, part (A), is mixed with an aqueous solution of AgNO_3 . The quantity of AgNO_3 used is equivalent to the amount of acid in the aqueous solution. The precipitate which forms is separated and dried to yield the silver salt of the acid as a hydrate.

Analysis.—Calcd. for $\text{Ag}_2\text{B}_{20}\text{H}_{18} \cdot 5\text{H}_2\text{O}$: Ag, 39.9; B, 40.1. Found: Ag, 40.1; B, 40.15.

(B) The process of part (A) is repeated, employing less than the equivalent amount of AgNO_3 in solution. The precipitate which forms became tan-colored during processing. It is, however, substantially pure silver salt, free of water of hydration.

Analysis.—Calcd. for $\text{Ag}_2\text{B}_{20}\text{H}_{18}$: Ag, 47.48; B, 43.13. Found: Ag, 47.91; B, 48.06.

In the process of Example XI, the use of excess silver nitrate solution results in reduction of the silver ion with formation of silver metal.

Example XII

A portion of an aqueous solution of the dibasic acid, prepared as described in Example VIII, part (A), is titrated with an aqueous solution of barium hydroxide until the reaction mixture is neutral (pH=7). The resulting solution of $\text{BaB}_{20}\text{H}_{18}$ is yellow and it shows absorption maxima at 292 m μ and 233 m μ .

The solid salt $\text{BaB}_{20}\text{H}_{18}$ can be isolated by evaporation of the solution as described in Example IX for the sodium salt.

Example XIII

An aqueous solution of the dibasic acid, prepared as described in Example VIII, part (A), is mixed with an aqueous solution of $(\text{C}_6\text{H}_5)_3\text{CH}_2\text{PI}$. The precipitate which forms is separated and recrystallized from benzene-acetonitrile-methanol mixture to obtain long needles of the bis(triphenylmethylphosphonium) salt.

Analysis.—Calcd. for $[(\text{C}_6\text{H}_5)_3\text{CH}_2\text{P}]_2\text{B}_{20}\text{H}_{18}$: C, 57.82; H, 6.90; P, 7.85; B, 27.41. Found: C, 57.69; H, 7.30; P, 7.92; B, 27.27.

A second preparation of the compound yields the following elemental analysis: C, 58.28; H, 7.42.

X-ray diffraction data on crystals of the compound show that the crystals are monoclinic where $a=11.96$, $b=15.42$, $c=12.37$ and $\beta=94^\circ$ C. The density is 1.167 and the observed molecular weight is 795 (calcd. value, 789).

Example XIV

A solution of the acid, prepared as described in Example VIII, part (A), is mixed with a hot methanol solution of $(C_6H_5CH_2)_4PBr$. The white precipitate which forms is separated and recrystallized from acetonitrile to yield the white crystalline bis(tetrabenzylphosphonium) salt.

Analysis.—Calcd. for $[(C_6H_5CH_2)_4P]_2B_{20}H_{18}$: C, 65.68; H, 7.27; P, 6.04; B, 21.10. Found: C, 61.97; H, 8.01; P, 5.86, B, 20.09.

Example XV

A solution of the acid, prepared as described in Example VIII, part (A), is mixed with an aqueous solution of $(CH_3)_3SI$. The precipitate which forms is separated, dried and purified by crystallization to obtain the bis(trimethylsulfonium) salt. Elemental analyses are: C, 18.77; H, 9.67.

The process is repeated to obtain a further quantity of the compound for confirmatory analysis.

Analysis.—Calcd. for $[(CH_3)_3S]_2B_{20}H_{18}$: C, 18.54; H, 9.33; S, 55.55; B, 16.49. Found: C, 18.93, 18.80; H, 9.80, 9.74; S, 55.16; B, 16.47.

The infrared spectrum of the above trimethylsulfonium salt in the 11-18 μ region is similar to the spectrum for $[(CH_3)_4N]_2B_{20}H_{18}$ described in Example I. The ultraviolet spectrum of the trimethylsulfonium salt in solution in acetonitrile shows the same maxima and extinction coefficients as the tetramethylammonium salt.

Examples X-XV, inclusive, illustrate the process of preparing compounds of the invention employing the dibasic acid, $H_2B_{20}H_{18}$, as a reactant. The process is generic to the preparation of a wide range of salts, e.g.,

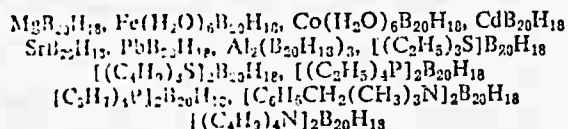

and the like, by neutralization of the acid with a base or salt having the appropriate cation. To illustrate briefly, the acid solution can be reacted with $MgCl_2$, $FeSO_4$, $CsCl_2$, $CdNO_3$, $Sr(OH)_2$, $PbCl_2$, $Al_2(SO_4)_3$, tri-substituted sulfonium iodides, tri-substituted sulfonium hydroxides, tetra-substituted phosphonium bromides, and the like.

Aryldiazonium salts can be obtained by reacting an aqueous solution of the acid with, e.g., an aryldiazonium chloride or hydroxide. To illustrate, an aqueous solution of benzenediazonium chloride is mixed with an aqueous solution of $H_2B_{20}H_{18}$ and the solution is evaporated, if necessary, to a point where the bis(benzenediazonium) octadecahydroeicosaborate(2-) precipitates. Similarly an aqueous solution of tolyldiazonium hydroxide is added in sufficient quantity to an aqueous solution of $H_2B_{20}H_{18}$ to form a neutral solution. The solution is evaporated until the bis(tolyldiazonium) salt separates, i.e.,



Metal-amine salts can be obtained by reacting a metal salt of the $B_{20}H_{18}^{2-}$ anion with a metal-amine salt, e.g., the chloride or nitrate, in solution in ammonium hydroxide. To illustrate, $ZnCl_2$ is dissolved in concentrated aqueous NH_4OH and $Na_2B_{20}H_{18}$ is added to the solution with stirring. The precipitate which forms is $Zn(NH_3)_4B_{20}H_{18}$. Cobalt-amine salts, copper-amine salts, and the like are prepared in a similar manner, employing cobalt nitrate and copper chloride in place of zinc chloride. The salts are isolated by filtration and dried by conventional methods.

Utility.—The invention provides a broad class of new boron compounds which find applications in many fields.

The compounds of the invention are generically useful as impregnating agents in the preparation of resistors. To illustrate, a section of a cotton string is immersed in a nearly saturated solution of $[(CH_3)_4N]_2B_{20}H_{18}$ in a mixture of acetonitrile and water. The string is withdrawn

from the solution and the solvent is removed by drying in air. A free flame is applied to the dried impregnated string and it burns to yield a coherent ash which in size and shape resembles the original string. The residual skeleton is of sufficient coherence to permit embedding in paraffin. The section of residue, so treated, shows a resistance in excess of 15,000 ohms/cm. The residue from a control section of string is very small and shapeless and it cannot be handled.

In the group of compounds which fall within the scope of Formula 1, the component M represents a range of groups which are readily interchangeable by metathetic reactions as described earlier. All of the salts which fall within the scope of Formula 1 can be used to prepare the acid, represented as $H_2B_{20}H_{18}$, in aqueous solution, as $(H_2O)_2B_{20}H_{18}$, by passing aqueous or alcoholic solutions of the salts through an acidic ion-exchange resin as described earlier. The acid (and its hydrates) is a strong acid and it is useful in industrial applications where it is desired to avoid contamination from sulfate, chloride, bromide, chlorate, phosphate, and like strong acid anions. Thus, the acid is useful for etching metals, such as steel, and for rust removal, for pickling, for scale removal and for similar metal processing operations.

The acid, described above, is useful as a catalyst in the preparation of esters, e.g., in the reaction of alcohols and organic carboxylic acids, to improve the yields of the desired esters. The acid of the invention is employed for this purpose in the same manner as p-toluenesulfonic acid, sulfuric acid or alcoholic hydrogen chloride.

Aqueous solutions of the acids are useful as agents for absorbing noxious basic materials from the air, e.g., traces of ammonia, lower alkyl amines, and the like. To illustrate, air contaminated with methylamines is passed through an aqueous solution of $H_2B_{20}H_{18}$ and the amines are removed.

All of the compounds of the invention are generically useful as components of fireworks compositions to impart a pleasing color and sparkle to the display, e.g., $Cs_2B_{20}H_{18}$, $[(CH_3)_3S]_2B_{20}H_{18}$, $[(C_6H_5)_3CH_3P]_2B_{20}H_{18}$, and like salts, such as the strontium, magnesium, cobalt and aryldiazonium salts, can be used in such compositions.

The silver salts, i.e., the compounds of Formula 1, where M is Ag, in the presence of an excess of silver ion, reduce the ion to metallic silver. These compounds are, therefore, useful in the photographic arts and in the preparation of printed circuits. To illustrate, a cellulose sheet is immersed for a few minutes in an aqueous solution of silver nitrate and dried in air. A solution of a compound of Formula 1, e.g., the tetramethylammonium salt, is applied to the dried impregnated sheet and a deposit of metallic silver forms on the sheet at the points of application. Further, a cellulose sheet is immersed for a few minutes in a solution of a salt of Formula 1, e.g., the cesium salt, and dried in air. A solution of $AgNO_3$ is applied to the dried sheet and a deposit of metallic silver forms on the sheet.

As many apparently widely different embodiments of this invention may be made without departing from the spirit and scope thereof, it is to be understood that this invention is not limited to the specific embodiments thereof except as defined in the appended claims.

The embodiments of this invention in which an exclusive property or privilege is claimed are defined as follows:

1. A compound of the general formula



wherein a and b are the smallest whole numbers which satisfy the equation

$$b = \frac{a \cdot \text{valence of M}}{2}$$

and M is a cation selected from the class consisting of hydrogen, hydronium, cation of a metal having a valence

13

of 1-3 selected from Group I, II, III-B, IV-B, V-B, VI-B, VII-B or VIII of the Periodic Table of elements, cation of a metal having a valence of 1-3 selected from Group III-A, IV-A, V-A, or VI-A of the Periodic Table of elements having atomic numbers above 5, 14, 33, or 52, respectively $[\text{Ni}(\text{NH}_3)_6]^{+2}$, $[\text{Zn}(\text{NH}_3)_4]^{+2}$,

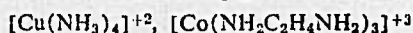
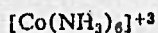

$[\text{Ni}(\text{dipyridyl})_3]^{+2}$; $\text{ArN}=\text{N}^+$ wherein Ar is a hydrocarbon aryl group of at most 12 carbon atoms, R_4N^+ , R_3S^+ , and R_4P^+ wherein R contains up to 18 carbon atoms and is a group selected from the class consisting of alkyl, cycloalkyl, alkenyl, cycloalkenyl, aryl, aralkyl, alkaryl, cyanoalkyl, hydroxyalkyl and haloalkyl.

2. A compound of claim 1 in the hydrated form.
3. $\text{H}_2\text{B}_{20}\text{H}_{18}$.
4. A compound of claim 3 in the hydrated form.
5. $[(\text{CH}_3)_4\text{N}]_2\text{B}_{20}\text{H}_{18}$.
6. A compound of claim 5 in the hydrated form.
7. $\text{Cs}_2\text{B}_{20}\text{H}_{18}$.
8. A compound of claim 7 in the hydrated form.
9. $(\text{CH}_3\text{C}_6\text{H}_4\text{N}_2)_2\text{B}_{20}\text{H}_{18}$.
10. A compound of claim 9 in the hydrated form.

14

References Cited

UNITED STATES PATENTS

2,606,183	8/1952	Hcad et al.	260-141
2,756,259	7/1956	Bragdon et al.	260-567.6
2,923,703	2/1960	Bruni et al.	260-141
3,018,160	1/1962	Miller	23-14
3,021,190	2/1962	McElroy et al.	23-14
3,108,139	10/1963	Larchar	260-567.6
3,148,939	9/1964	Knoth	23-358 X

OTHER REFERENCES

Schechter et al.: "Boron Hydrides and Related Compounds," prepared under contract NOa(s) 10992 by Callery Chemical Co. for Dept. of Navy, Bureau of Aeronautics, declassified Jan. 5, 1954, p. 59.

Lyscomb: "Proceeding of the National Academy of Sciences, U.S.A.," vol. 47, No. 11, pp. 1791-1795 (November 1961).

Kaczmarczyk et al.: "Proceedings of the National Academy of Sciences, U.S.A.," vol. 48, pp. 729-733 (May 1962).

MILTON WEISSMAN, *Primary Examiner.*

MAURICE A. BRINDISI, *Examiner.*

OSCAR R. VERTIZ, *Assistant Examiner.*

1

3,372,006
HALOGEN DERIVATIVES OF POLYHEDRAL BORON COMPOUNDS

Bertrand L. Chamberland, Wilmington, Del., and Earl L. Muettterties, West Chester, Pa., assignors to E. I. du Pont de Nemours and Company, Wilmington, Del., a corporation of Delaware
 No Drawing, Filed May 31, 1962, Ser. No. 199,574
 12 Claims (Cl. 23-358)

This invention relates to new compounds containing boron and to methods for preparing the compounds.

Boron compounds, principally salts of boric acid, have been in commercial use for many years. Recently other boron compounds, e.g., low molecular weight boron hydrides, have achieved technical importance in applications employing oxidizing and reducing agents. There are many potential applications, however, for which the available boron compounds are unsuited because of hydrolytic, oxidative or other types of instability. To illustrate, diborane, chlorodiborane, pentaborane(9) and trialkylboron compounds are spontaneously flammable in air. Diborane, pentaorane(9), chlorodiborane, boron trichloride, undecaborane(14), and most other boron halides are hydrolyzed rapidly in water or alcohol. Even the most stable known borohydride, i.e., decaborane(14), is hydrolyzed at a moderate rate in water. Known ionic borohydrides, e.g., tetrahydroborates (NBH_4^- and the like), are hydrolyzed at a rapid rate at 100° C.

A broad class of boron compounds has now been found which show good hydrolytic and oxidative stability.

The novel boron compounds of this invention are polyborates of the following generic formula:

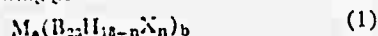

where M is an atom or group of atoms which make up a cation having a valence of 1/-3, inclusive; X is halogen; n is a positive whole number of 1 to 18, inclusive; a and b are the smallest positive whole numbers which satisfy the equation:

$$b = \frac{a \times \text{valence of M}}{2} \quad (2)$$

The substituent X is halogen, i.e., F, Cl, Br and I.

The compounds of Formula 1 are composed of two principal components which are represented by M and $(B_{20}H_{18-n}X_n)$. These two principal components are joined by electrovalent or salt-like bonds which are characteristic for ionizable inorganic compounds. Each of these components will be discussed separately.

THE COMPONENT M

In Formula 1 M is a component which can consist of one element or more than one element which is ionically bonded to the boron-containing moiety. The component M, for simplicity, will be referred to as a group although it may contain only one atom or element. The groups represented by M are cations, i.e., bear a positive ionic charge and they have in common the property of forming positively charged groups or cations in water. The properties of the group M are not critical and the group, therefore, represents a broad range of elements or combinations of elements. To illustrate, M can be hydrogen, which in aqueous solution forms a hydronium ion (H_3O^+), a metal ammonium (NH_4^+), hydrazonium (NH_2NH_2^+) (also called hydrazinium), N-substituted ammonium, N-substituted hydrazinium (NH_2NH_2^+), aryl-diazonium (ArN_2^+), sulfonium, phosphonium, metal-ammine, and the like.

The group M can be a metal of groups I-A, II-A, I-B

2

and II-B having atomic numbers up to and including 80. Most preferred metals are the alkali and alkaline earth metals, i.e., lithium, sodium, potassium, rubidium, cesium, beryllium, magnesium, calcium, strontium and barium.

The group M can be a combination of a metal and ammonia or a metal and an amine, i.e., a Werner-type coordination complex referred to as a metal-ammine group. To illustrate, M can be $[\text{Ni}(\text{NH}_3)_6]^{+2}$, $[\text{Zn}(\text{NH}_3)_4]^{+2}$,

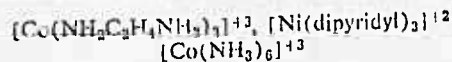

The group M can be aryl-diazonium, i.e., a group of the formula ArN_2^+ , where Ar represents an aryl group. To illustrate, Ar can be phenyl, tolyl, xylyl, naphthyl, and the like.

The group M can be an N-substituted ammonium group, an S-substituted sulfonium group and a P-substituted phosphonium groups, which groups have the formulas RNH_3^+ , R_2NH_2^+ , R_3NH^+ , R_4N^+ , R_2S^+ , and R_4P^+ . R represents an organic group bonded to the nitrogen, sulfur or phosphorus. The R groups are not critical features of these cation groups; thus, R can be open-chain, closed-chain, saturated or unsaturated hydrocarbon or substituted hydrocarbon groups. R can be a heterocyclic ring of which the nitrogen, sulfur or phosphorus atom is a component part. Thus, when M is a substituted ammonium group, R can be derived from pyridine, quinoline, morpholine, hexamethylenimine, and the like. Preferably R, for reasons of availability of reactants, contains at most 18 carbon atoms and can be alkyl, alkenyl, cycloalkyl, cycloalkenyl, aryl, aralkyl, alkaryl, cyanoalkyl or hydroxyalkyl. For example, R can be methyl, 2-ethylhexyl, octadecyl, allyl, cyclohexyl, cyclohexenyl, phenyl, naphthyl, anthryl, cyclohexyl-phenyl, diphenyl, benzyl, chloroethyl, α -cyanoamyl, β -hydroxyethyl, p-hydroxyphenyl, and the like.

The group M can also be an N-substituted hydrazonium (also called hydrazinium) radical having the formula $(\text{RNHNH}_2)^+$, $(\text{R}_2\text{NNH}_2)^+$, and the like, wherein R has the same definition as given in the preceding paragraph. To illustrate, the hydrazonium cation can be derived from phenylhydrazine, methylhydrazine, 1,1 - dimethylhydrazine, 1,2 - dimethylhydrazine, ethylhydrazine, 1,1-diethylhydrazine, and similar compounds.

The valence of the cation M will be between 1 and 3, i.e., M can have a valence of 1, 2, or 3. In most cases, the valence of M will be 1 or 2. This group of compounds in which the valence of M is at most 2, are readily preparable and so form a preferred group of compounds in this invention.

THE GROUP $(B_{20}H_{18-n}X_n)$

The novel and characterizing feature of the compounds of the invention is the polyborate group $(B_{20}H_{18-n}X_n)^{-2}$. The group is represented generically as having a negative ionic charge of 2 and it behaves in chemical reactions as a divalent anion. The group chemically is exceptionally stable. It is not easily decomposed by hydrolysis, oxidation or reduction and it is resistant to thermal decomposition. The group is unchanged in simple metathetic reactions, a property which allows the preparation of a broad range of salts in which the cation is represented by M.

A pertinent feature in the boron-containing group is the substituent X which is bonded to boron. The number of substituents which can be present is not less than 1 or more than 18 and they can be alike or different.

CHARACTERISTICS OF THE COMPOUNDS

The compounds are generally crystalline solids with the high-melting points which are characteristic of salts.

They are stable under conventional storage conditions and can be kept for prolonged periods without decomposition.

The compounds of the invention in which M forms a colorless cation, e.g., H, NH₄, the alkali metal or alkaline earth metal, are yellow in color. The acids and salts are generally soluble in hydroxylated solvents, e.g., water, alcohol, and the like, to form intensely yellow solutions.

The following examples illustrate the compounds of invention:

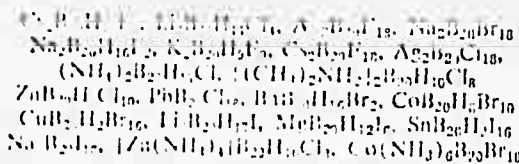

and the like. Representative compounds of the invention which are acids, i.e., compounds in which M is hydrogen or, in its hydrated form, hydronium (H₃O⁺), are as follows:

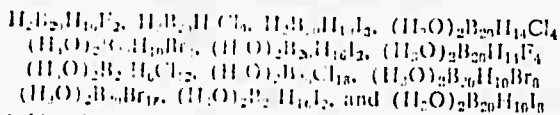

Acids of the type illustrated are frequently obtained as hydrates having up to 12 molecules of water, e.g.,

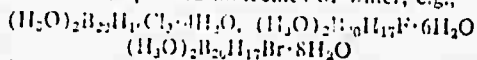

and the like.

PREPARATION OF THE COMPOUNDS

Compounds of Formula 1 are obtained by reacting a compound of the formula

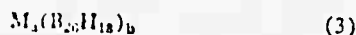

with a halogen. In Formula 3 M, *a* and *b* are defined as in Formula 1. Alternatively, *a* and *b* can be defined as the smallest whole numbers which satisfy the equation:

$$2b = a \times \text{valence of M} \quad (4)$$

The reactants of Formula 3 are not readily available compounds. For this reason, the preparation of a representative reactant is described in examples which are given later. Briefly, the reactants of Formula 3 are prepared by reacting a decahydrodecaborate(2⁻) with an oxidant containing a variable valence metal in its higher valence state, which oxidant has an oxidation-reduction potential in acid solution of about -1.33 to -1.61 volts, to obtain a product of Formula 3 in which the boron-containing group, B₂₀H₁₀, has a negative ionic charge or valence of 2.

The decahydrodecaborates(2⁻) employed as reactants to prepare compounds of Formula 3 have the general formula

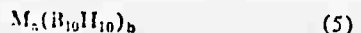

where M, *a* and *b* are defined as in Formulas 1 and 3.

The compounds of Formula 5 which are employed as reactants are not commonly known and the preparation of representative compounds is also described in the examples. Any decahydrodecaborate(2⁻) can be employed, i.e., compounds in which M is any group which can form a cation in water, are operable. For reasons of availability and cost, it is preferred to use decahydrodecaborates of Formula 5 in which M is hydrogen, hydronium, ammonium, substituted ammonium, an alkali metal or an alkaline earth metal. Specific illustrations of the classes of preferred reactants are H₂B₁₀H₁₀ and its hydrates,

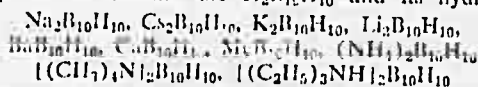

and the like. These and other salts of B₁₀H₁₀²⁻ are fully disclosed and claimed in U.S. Patents 3,148,938; 3,149,163 and 3,148,939.

The oxidizing reagent or oxidant is a compound having

as a characteristic component a metal of variable valence, which metal is in its highest valence state, said compound having an oxidation-reduction potential in acid solution of about -1.33 to about -1.61 volts. The oxidation-reduction potential of a compound is a recognized and measurable property for which values are found in readily available texts, e.g., "Oxidation Potentials," by W. C. Latimer, 2nd Ed., Prentice-Hall, New York (1952), particularly p. 344. Examples of classes of compounds which are operable in the process are dichromates, aurates, higher oxides of lead, manganic salts, permanganates, higher oxides of bismuth and salts of tetravalent cerium.

The oxidation process is conducted by simple and uncomplicated procedures in conventional equipment. A solvent is generally employed which preferably is hydroxylated, e.g., methanol, water, and the like. Water is most conveniently used and it is therefore the preferred solvent.

The ratio in which the reactants are employed is not a critical factor for operability. However, the use of an excess of oxidant may lead to a decrease in yield of the desired product. It is preferable to employ at most two oxidation equivalents of the oxidant (based on the metal) per mole of B₁₀H₁₀²⁻ salt or acid used in the process. The preferred mole ratio of oxidant to polyhydrodecaborate can be determined by methods described in Handbook of Chemistry and Physics, 38th Ed., p. 1588, Chemical Rubber Publishing Co. (1956).

Pressure is not a critical factor in the process and atmospheric pressure is normally used. However, if desired, pressures higher or lower than atmospheric can be employed. The temperature of the reaction is also not critical. Normally, the reaction is conducted at prevailing atmospheric temperature but temperatures as low as 0° C. and as high as 100° C. can be employed. Preferred temperatures of operation lie between about 10° and 75° C.

The reaction proceeds rapidly and a measurable quantity of product is obtained within a short time. Normally the reactants are maintained in contact for a sufficient period to assure maximum yield. The time of reaction can range from a few minutes to 24 hours or more.

In the operation of the process it is preferable (although not essential) to add the oxidant to the decaborate to reduce the vigor of the reaction and to obtain the maximum yield of desired product. Normally, therefore, the reaction vessel is charged with the solvent and the decahydrodecaborate. The chemical oxidant, which is conveniently handled in solution, is added gradually to the vessel at a rate which provides a controllable reaction. After all of the oxidant has been added, the reaction mixture can be stirred for a short period and a solution containing the desired cation (M) is added. The polyborate salt frequently precipitates at this point but, in the event precipitation does not occur, the solution is evaporated to a volume at which the solid separates. The product is purified by conventional procedures to obtain a salt of the divalent anion, B₂₀H₁₀²⁻.

Halogenation reactions.—Salts or the acid of the B₂₀H₁₀²⁻ anion can be employed for halogenations.

To obtain a halogenated divalent compound of Formula 1, i.e., a compound having the B₂₀H₁₀ⁿ⁻ anion, where *n* is at least 1, a salt of B₂₀H₁₀²⁻ is reacted with a mild halogenating agent, e.g., an N-halogenated amide, N-halogenated imide, N-halogenated sulfonamide, and the like. To illustrate, N-chloroacetamide, N-bromophthalimide, N-iodophthalimide, and like compounds can be used as halogenating agents.

To obtain fluorinated compounds, the divalent decaborate in aqueous solution can be reacted with elemental fluorine highly diluted with nitrogen gas.

The reaction is usually conducted in an aqueous medium containing a polar water-miscible solvent to facilitate solution of the reactants. A solution of a salt of a B₂₀H₁₀²⁻ anion is prepared and the halogenating agent is

added to it gradually. The organic halogenating agent, e.g., N-haloamide, is conveniently used in solution. The mode of addition is not critical and it is conducted by whatever method is most convenient. The reaction generally proceeds rapidly at prevailing atmospheric temperature; if desired, heating can be used to increase the rate.

The ratio of reactants is not critical but it is preferred to use the halogenating agent in sufficient quantity to obtain a product with the desired number of halogen substituents. The ratio, moles halogenating agent/mole $B_{20}H_{18}$ salt, usually lies between about 0.5 and 50; preferably, the ratio is from 1.0 to about 30.

Time, temperature and pressure are not critical factors in the process. The temperature can lie between about 10° C. and the boiling point of the solvent. The temperature generally does not exceed 150° C. The pressure is preferably atmospheric but it can be higher or lower than atmospheric.

Compounds of Formula 1, where the X groups are unlike, can be obtained by partially halogenating compounds of Formula 3 with one halogen, e.g., a reagent which will introduce chlorine, followed by further partial halogenation with a second halogen, e.g., a reagent which will introduce bromine, and if desired, halogenation with a third halogen, e.g., a reagent which will introduce iodine. The procedure can be modified to obtain whatever combination of halogens is desired in the products.

An optional method of obtaining the halogenated product is to halogenate the decahydrodecaborate salt prior to the oxidation step. To illustrate, the salt $M_a(B_{10}H_{10})_b$ can be reacted with a halogen to obtain $M_a(B_{10}H_{10-y}X_y)_b$, where M, X, a and b are defined as in Formula 1, and y is a positive whole number of 1-10, inclusive. Halogenation is conducted in the manner described in the preceding paragraphs for the $B_{20}H_{18}^{-2}$ salt. The halogenated salt is oxidized by the method described earlier. To illustrate, $(NH_4)_2B_{10}H_{10}$ is reacted with chlorine to yield $(NH_4)_2B_{10}Cl_{10}$; the latter compound is oxidized to form $(NH_4)_2B_{20}Cl_{10}$.

Metathetic reactions.—Compounds of Formula 1, wherein M covers a wide range of cations are obtained by simple metathetic reactions. To illustrate, an aqueous solution of a compound of Formula 1, where M is NH_4^+ , is contacted with a strong acid or with a strongly acidic cation exchange resin to obtain the free acid, i.e., a compound of Formula 1 in which M is H. The acid, generally in solution, is reacted with oxides of metals, hydroxides of metals, salts of metals (both organic and inorganic), nitrogen bases, sulfonium hydroxides or halides, phosphonium hydroxides or halides, aryldiazonium hydroxides or halides, and similar types of compounds to obtain products of Formula 1 which have the desired cation M. In a process employing an ion-exchange resin, strongly acidic resins of the sulfonic acid variety are preferred because of availability, e.g., "Amberlite" IR-120-H and "Dowex" 50. The acid, so obtained in aqueous solution, can be reacted with nitrates, chlorides, bromides, acetates, benzoates and similar salts of metals or other bases to obtain salts of Formula 1.

To illustrate, an aqueous solution of $Cs_2B_{20}H_{18}Cl_{10}$ is passed through a column packed with "Amberlite" IR-120-II to obtain in aqueous solution the acid $H_2B_{20}H_{18}Cl_{10}$. The aqueous solution is evaporated under reduced pressure to obtain the acid $H_2B_{20}H_{18}Cl_{10}$, generally as a solid hydrate having up to 12 molecules of water.

It is convenient to isolate the acids as hydrates. In the hydrated form part of the water of hydration is considered to be associated with the ionizable protons. In general, up to molecule of water is associated with each ionizable proton and the acids can be represented as having hydrated protons, e.g., $(H_2O)_2B_{20}H_{18}Cl_{10}$,

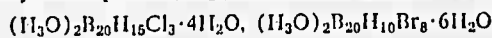

and the like. It is understood that when reference is made to the acids of $B_{20}H_{18-n}X_n^{-2}$ anions, the hydrates of

these acids are included. These hydrates generally have at most 12 molecules of water.

Examples of other acids which can be obtained and the salts from which they can be derived are as follows:

5	Compound:	Acid obtained
	$(NH_4)_2B_{20}H_{12}F_6$ -----	$H_2B_{20}H_{12}F_6$
	$Na_2B_{20}H_{14}Cl_4$ -----	$H_2B_{20}H_{14}Cl_4$
	$Cs_2B_{20}Cl_{10}$ -----	$H_2B_{20}Cl_{10}$
	$(NH_4)_2B_{20}H_{10}Br_8$ -----	$H_2B_{20}H_{10}Br_8$
10	$BaB_{20}H_{15}I_3$ -----	$H_2B_{20}H_{15}I_3$
	$CaB_{20}I_{13}$ -----	$H_2B_{20}I_{13}$
	$Na_2B_{20}H_{16}F_2$ -----	$H_2B_{20}H_{16}F_2$
	$Cs_2B_{20}H_{10}Cl_6$ -----	$H_2B_{20}H_{10}Cl_6$
	$MgB_{20}H_6Br_{12}$ -----	$H_2B_{20}H_6Br_{12}$
15	$[(CH_3)_4N]_2B_{20}Cl_{10}$ -----	$H_2B_{20}Cl_{10}$
	$(NH_4)_2B_{20}Br_{10}$ -----	$H_2B_{20}Br_{10}$
	$(CH_3NH_2)_2B_{20}H_2I_6$ -----	$H_2B_{20}H_2I_6$

Careful concentration of the solutions of the acids and intensive drying under low pressure and moderate temperature of the liquid residues yields the acids, generally as hydrates as discussed earlier. For many chemical reactions it is not necessary to isolate the acids from solution. The solutions of the acids can be employed directly, especially in metathetic reactions.

Metal salts of the invention can be prepared by neutralization of the acids, obtained as described above, in aqueous or alcohol solution with an aqueous solution or suspension of an inorganic base, e.g., an alkali or alkaline earth metal hydroxide. The resulting aqueous solution of the metal salt of the $B_{20}H_{18-n}X_n^{-2}$ anion is concentrated by evaporation of water or alcohol until the salt crystallizes out. In many cases the salt may precipitate during its preparation and evaporation of the solution is not necessary. The crystalline salt is dried under reduced pressure, e.g., 0.1 mm. of mercury, and moderately elevated temperature, e.g., 50-100° C. The metal salts frequently contain water of hydration which can be removed by heating for several hours at a temperature of about 200° C. under low pressure, e.g., 0.1 mm. mercury or lower. Specific examples of salts which can be obtained by the process described above are $Na_2B_{18}H_{10}Cl_8$,

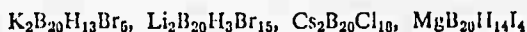

45 $BaB_{20}H_{13}Br_4, CaB_{20}H_9Cl_9,$ and $SrB_{20}H_{15}F_3.$

Water-insoluble heavy metal salts of the acids can be prepared by adding a water-soluble heavy metal salt, e.g., silver nitrate or mercuric nitrate, to an aqueous solution of the boron-containing acid whereupon the heavy metal salt of the anion precipitates out as a white or light colored solid. The salts formed in this procedure are usually anhydrous. Examples of heavy metal salts which can be prepared by this method from halo-substituted compounds are: $HgB_{20}H_2Cl_{16}, HgB_{20}H_5Br_{13},$

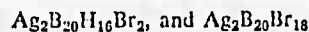

The procedure is generic to the preparation of metal salts of the compounds of the invention and it can be employed with compounds bearing a wide range of X groups.

Nitrates, carbonates, chlorides or oxides of metals can be used to prepare the salts by the methods described earlier.

Light-sensitive salts, e.g., the silver salt, are preferably prepared under conditions providing minimum exposure to light although exclusion of light is not essential for operability.

Compounds of Formula 1 where M is an alkali or alkaline earth metal, e.g., Na, K, Cs, Ca, Ba, Mg, and Sr, can undergo simple metathetic reactions with other salts to effect an exchange of cations. Thus, $Na_2B_{20}H_{15}Cl_3$ or $K_2B_{20}H_{12}F_6$ can be reacted in aqueous solution with ammonium sulfate, benzenediazonium hydroxide, pyridinium chloride, morpholinium sulfate, polyethylenimine hydrochloride, and the like, to form compounds of Formula 1 having ammonium, benzenediazonium, pyridin-

mixture is stirred and a solution containing 20.25 g. of N-iodosuccinimide, 75 ml. of CH_3CN and 50 ml. of CH_3OH is added with stirring. The solution is processed as described in Example II to obtain light yellow crystals of $[(\text{CH}_3)_4\text{N}]_2\text{B}_{20}\text{H}_9\text{I}_9$ associated with $(\text{CH}_3)_4\text{NI}$.

Analysis.—Calc'd for $[(\text{CH}_3)_4\text{N}]_2\text{B}_{20}\text{H}_9\text{I}_9 \cdot (\text{CH}_3)_4\text{NI}$: C, 8.39; H, 2.64; B, 12.60; I, 73.94. Found: C, 8.68; H, 2.77; B, 12.32; I, 73.87.

Examples I-III illustrate the preparation of compounds of the invention bearing a halogenated divalent anion, i.e., $(\text{B}_{20}\text{H}_{18-n}\text{X}_n)^{-2}$. The process is generic to the preparation of this class of compounds.

Compounds containing mixed halogens can be obtained by the processes of Examples I-III. To illustrate, the product of Example I can be used as a reactant in the process of Example III to obtain a compound having chlorine and bromine as substituents, e.g.,

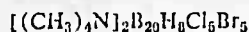

Compounds bearing fluorine as substituents can be obtained by passing a mixture of fluorine and nitrogen gas into a solution of an eicosaborate salt. To illustrate, the compound obtained in Example I can be fluorinated to form a fluorine-bearing salt, e.g.,



Aqueous or alcohol solutions of the compounds of Examples I-III can be passed through an acid ion-exchange resin to obtain free acids of the formulas $\text{H}_2\text{B}_{20}\text{H}_{12}\text{Cl}_6$, $\text{H}_2\text{B}_{20}\text{H}_{13}\text{Br}_5$ and $\text{H}_2\text{B}_{20}\text{H}_9\text{I}_9$. Solutions of the acids can be neutralized, e.g., with NaOH to obtain $\text{Na}_2\text{B}_{20}\text{H}_{12}\text{Cl}_6$, $\text{Na}_2\text{B}_{20}\text{H}_{13}\text{Br}_5$ and $\text{Na}_2\text{B}_{20}\text{H}_9\text{I}_9$, with HIOH to obtain the corresponding lithium salts or with KOH or CsOH to obtain the corresponding lithium and cesium salts. Other basic reactants can be employed in a similar manner, as described earlier, to obtain salts. Thus, aqueous solutions of the acids can be neutralized with solutions of zinc hydroxide in ammonia, cobalt hydroxide in ammonia or copper salts in ethylenediamine to obtain, e.g., $\text{Zn}(\text{NH}_3)_4\text{B}_{20}\text{H}_{12}\text{Cl}_6$, $\text{Co}(\text{NH}_3)_6\text{B}_{20}\text{H}_{13}\text{Br}_5$ and $\text{Cu}(\text{ethylene diamine})\text{B}_{20}\text{H}_9\text{I}_9$.

Aqueous solutions can be neutralized with ammonium hydroxide, isobutylamine, octadecylamine, allylamine, and the like to obtain, e.g., $(\text{NH}_4)_2\text{B}_{20}\text{H}_{12}\text{Cl}_6$,

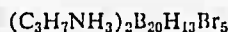

$\text{C}_{18}\text{H}_{37}\text{NH}_2)_2\text{B}_{20}\text{H}_9\text{I}_9$, $(\text{C}_3\text{H}_5\text{NH}_2)_2\text{B}_{20}\text{H}_{12}\text{Cl}_6$, and similar salts.

UTILITY

The invention provides a broad class of new boron compounds which find applications in many fields.

The compounds of the invention, particularly the less highly substituted products, are useful as impregnating agents in the preparation of resistors. To illustrate, a section of a cotton string is immersed in a nearly saturated solution of $[(\text{CH}_3)_4\text{N}]_2\text{B}_{20}\text{H}_{12}\text{Cl}_6$ in a mixture of acetonitrile and water. The string is withdrawn from the solution and the solvent is removed by drying in air. A free flame is applied to the dried impregnated string and it burns with difficulty to yield a coherent ash which in size and shape resembles the original string. The residual skeleton is of sufficient coherence to permit embedding in paraffin. The section of residue, so treated, shows a resistance on the order of 5000 ohms/cm. The residue from a control section of string is very small and shapeless and it cannot be handled.

In the group of compounds which fall within the scope of Formula 1, the component M represents a range of groups which are readily interchangeable by metathetic reactions as described earlier. All of the salts which fall within the scope of Formula 1 can be used to prepare the group of acids represented generically as $\text{H}_2(\text{B}_{20}\text{H}_{18-n}\text{X}_n)$ or, in aqueous solution, as $(\text{H}_3\text{O})_2\text{B}_{20}\text{H}_{18-n}\text{X}_n$ by passing

aqueous or alcoholic solutions of the salts through an acidic ion-exchange resin as described earlier. The acids of this group are strong acids and they are useful in industrial applications where it is desired to avoid contamination from sulfate, chloride, bromide, chlorate, phosphate, and like strong acid anions. Thus, the acids are useful for etching metals, such as steel, and for rust removal, for pickling, for scale removal and for similar metal processing operations.

The acids, described above, are useful as catalysts in the preparation of esters, e.g., in the reaction of alcohols and organic carboxylic acids, to improve the yields of the desired esters. The acids of the invention are employed for this purpose in the same manner as p-toluenesulfonic acid, sulfuric acid or alcoholic hydrogen chloride.

Aqueous solutions of the acids are useful as agents for absorbing noxious basic materials from the air, e.g., traces of ammonia, lower alkyl amines and the like. To illustrate, air contaminated with methylamines is passed through an aqueous solution of $\text{H}_2\text{B}_{20}\text{H}_{12}\text{Cl}_6$ or a solution of $\text{H}_2\text{B}_{20}\text{H}_{13}\text{Br}_5$ and the amines are removed.

All of the compounds of the invention are useful as components of fireworks compositions to impart a pleasing color and sparkle to the display, e.g., $[(\text{CH}_3)_4\text{N}]_2\text{B}_{20}\text{H}_{12}\text{Cl}_6$, $[(\text{CH}_3)_4\text{N}]_2\text{B}_{20}\text{H}_{13}\text{Br}_5$, and like salts, such as the strontium, magnesium and cobalt salts, can be used in such compositions.

The silver salts, i.e., the compounds of Formula 1, where M is Ag, in the presence of an excess of silver ion, reduce the ion to metallic silver. These compounds are, therefore useful in the photographic arts and in the preparation of printed circuits. To illustrate, a cellulose sheet is immersed for a few minutes in an aqueous solution of silver nitrate and dried in air. A solution of a compound of Formula 1, e.g., the tetramethylammonium salt of Example I, is applied to the dried impregnated sheet and a deposit of metallic silver forms on the sheet at the points of application. Further, a cellulose sheet is immersed for a few minutes in a solution of a salt of Formula 1, e.g., the compound of Example III, and dried in air. A solution of AgNO_3 is applied to the dried sheet and a deposit of metallic silver forms on the sheet.

As many apparently satisfactorily different embodiments of this invention may be made without departing from the spirit and scope thereof, it is to be understood that this invention is not limited to the specific embodiments thereof except as defined in the appended claims.

The embodiments of the invention in which an exclusive property or privilege is claimed are defined as follows:

1. A compound of the formula

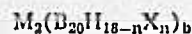

wherein M is a cation having a valence of 1-3, inclusive, and is selected from the class consisting of

hydrogen,
hydronium,
metal selected from Groups I and II of the Periodic Table having an atomic number of up to 80,
ammonium,
hydrazonium,

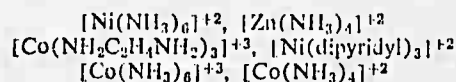

aryldiazonium of 6-10 carbon atoms,
S-substituted sulfonium,
P-substituted phosphonium,
N-substituted ammonium,
N-substituted hydrazinium

wherein the substituents on the S, P and N atoms are selected from the class consisting of alkyl, alkenyl, cycloalkyl, cycloalkenyl, aryl, aralkyl, alkaryl, cyanoalkyl and

ium, morpholinium, and the like, as cations. These illustrations are not limiting and they demonstrate the breadth of metathetic reactions which can be used.

Compounds of the invention in which the group M is a metal or a Werner-type complex frequently contain a solvent of crystallization when isolated by conventional methods. The solvent, e.g., water, can be bound loosely in the lattices of the crystals or it can be associated by stronger bonds with the metal cation or Werner-type complex cation. Solvent of crystallization, entrapped in crystal lattices, is removed easily by well-known procedures, e.g., heating under reduced pressure. Solvent of crystallization which is associated with the cation is more difficult to remove, and for most applications, it is not necessary to remove completely this type of bound solvent.

The products of the invention and processes for obtaining them are illustrated in the following examples. The preparation of a representative compound of the type $M_2(B_{10}H_{12})_6$, which is employed as a principal reactant, is also illustrated.

Example A

A. PREPARATION OF BIS(DIMETHYL SULFIDE) DECABORANE(12)

A reaction vessel having a capacity of about 365 g. of water is charged with 0.79 g. of decaborane(14), cooled in liquid nitrogen, and then evacuated to a pressure of 10 microns of mercury. Approximately 21 g. of dimethyl sulfide is condensed onto the decaborane in the reaction vessel. The reaction vessel is closed, allowed to warm to room temperature and stand for 4 days. During this time, 6.6 millimoles of hydrogen is evolved. The reaction vessel is opened and excess dimethyl sulfide is removed by distillation, leaving a practically quantitative yield of white solid residue of $B_{10}H_{12} \cdot 2(CH_3)_2S$. The compound is recrystallized from ethyl acetate and it melts at 122–124° C. The compound is called bis(dimethyl sulfide)decaborane(12).

B. PREPARATION OF $M_2B_{10}H_{12}$ (WHERE M IS NH₄)

Bis(dimethyl sulfide)decaborane(12) (8.5 g.) is mixed with 50 ml. of liquid ammonia and stirred in a round-bottom reaction vessel for 1 hour with the vessel being cooled to a temperature of about -50° C. by partial immersion in a bath of a mixture of solid carbon dioxide and acetone. The cooling bath is then removed and the excess ammonia is allowed to evaporate with stirring. The remaining traces of ammonia are removed by subjecting the residue to a high vacuum (0.01 mm. of mercury) at 25° C. There is obtained 5.6 g. of solid residue which is virtually a quantitative yield of $(NH_4)_2B_{10}H_{12}$.

Example B

A. A reaction vessel is charged with 100 ml. of water and 1.46 g. of $(NH_4)_2B_{10}H_{12}$. The mixture is stirred and a solution of 5.4 g. of $Ce(NH_4)_2(NO_3)_6$ in 80 ml. of water is added gradually. Evolution of gas occurs and a deep blue-violet solution forms. A concentrated aqueous solution of $(CH_3)_4NCl$ is added to the reaction mixture with stirring and in sufficient amount to precipitate completely a violet-colored solid. The solid is separated by filtration and it is purified by crystallization from hot water to yield the yellow compound, bis(tetramethylammonium)octadeca-hydroeicosaborate(2-).

The compound is soluble in acetonitrile, hot methanol and hot water. The identity of the product is confirmed by elemental analysis.

Analysis.—Calc'd for $[(CH_3)_4N]_2B_{20}H_{18}$: C, 25.10; H, 11.06; N, 7.32; B, 56.54; Eq. Wt., 191.4. Found: C, 26.28; H, 11.49; N, 7.55, 7.80; B, 54.28; Eq. Wt., 188, 204.

The identity of the compound is further confirmed by measuring the number of moles of hydrogen obtained from the boron moiety ($B_{20}H_{18}$) upon complete hydrolysis to boric acid. The values for moles H_2 obtained per

mole $[(CH_3)_4N]_2B_{20}H_{18}$, are as follows: Calc'd, 40.0. Found: 39.904 and 40.086.

B. A solution of $[(CH_3)_4N]_2B_{20}H_{18}$ in methanol-water is passed through a column packed with a commercial acidic ion-exchange resin of the polysulfonic acid type. The effluent is a solution of the acid $H_2B_{20}H_{18}$, or, expressed as a hydronium acid, $(H_3O)_2B_{20}H_{18}$. The aqueous solution is used without further processing to prepare salts of the acid.

C. A portion of an aqueous solution of the dibasic acid, prepared as described in Part A, is titrated with an aqueous solution of sodium hydroxide until the reaction mixture is neutral (pH=7). The resulting aqueous solution is yellow and its ultraviolet spectrum shows absorption in regions which are characteristic for salts of the $B_{20}H_{18}$ anion.

The yellow solution is evaporated to dryness under reduced pressure (less than 1 mm. of Hg) to obtain crude $Na_2B_{20}H_{18}$ as a tan-colored solid. The compound is purified by crystallization from methanol. The product so obtained contains water of crystallization.

Analysis.—Calc'd for $Na_2B_{20}H_{18} \cdot 2H_2O$: B, 68.34; H, 7.07. Found: B, 68.21; H, 7.25.

The compound can, if desired, be obtained free of solvent of crystallization by heating for a time at very low pressure. The molecular weight of the compound

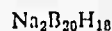

determined by freezing point depression in aqueous solution gives the following values: 103, 99, 89, 88, i.e., an average mol. wt. of 95; calc'd value: 93.3.

Example I

A reaction vessel is charged with 100 ml. of CH_3CN and 5.73 g. of $[(CH_3)_4N]_2B_{20}H_{18}$, prepared as described in Example B, Part A. The mixture is stirred and a solution consisting of 20.03 g. of N-chlorosuccinimide, 50 ml. of CH_3CN and 100 ml. of water is added with stirring. The mixture is heated to boiling for a period of time until a solid forms. The solution is cooled to about 25° C. and large yellow crystals form. The crystals are separated and recrystallized from acetonitrile-water solution to obtain $[(CH_3)_4N]_2B_{20}H_{12}Cl_6$. The identity of the product is confirmed by elemental analysis.

Analysis.—Calc'd for $[(CH_3)_4N]_2B_{20}H_{12}Cl_6$: C, 16.30; H, 6.16; B, 36.71; Cl, 36.08; N, 4.75. Found: C, 16.80, 16.70; H, 6.25, 6.36; B, 36.18, 36.10; Cl, 36.93, 36.75; N, 4.51, 4.64.

EXAMPLE II

A reaction vessel is charged with 3.82 g. of

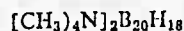

50 ml. of CH_3CN and 20 ml. of CH_3OH . The mixture is stirred and a solution consisting of 8.90 g. of N-bromo-succinimide, 50 ml. of CH_3CN and 20 ml. of CH_3OH is added. The reaction mixture is warmed on a hot plate until about half of the solution evaporates. Water is added to the solution and it is warmed again until the organic solvents are removed. The remaining aqueous solution is cooled to about 25° C. and a yellow solid precipitates. The solid is separated and it is recrystallized from acetonitrile-water solution to obtain

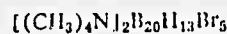

The ultraviolet spectrum of the compound in solution in CH_3CN shows absorption peaks at 242 m μ and 307 m μ .

Analysis.—Calc'd for $[(CH_3)_4N]_2B_{20}H_{13}Br_5$: C, 12.36; H, 4.86; B, 27.84; Br, 51.40. Found: C, 12.92; H, 5.15; B, 27.98; Br, 49.53.

EXAMPLE III

A reaction vessel is charged with 3.82g. of



50 ml. of CH_3CN and 20 ml. of CH_3OH . The reaction

11

hydroxyalkyl, wherein each of the immediately above groups contains at most 18 carbon atoms,

X is halogen, n is a positive number of 1-18, inclusive; and a and b are the smallest whole numbers which satisfy the equation

$$b = \frac{n \times \text{valence of M}}{2}$$

2. A compound of claim 1 in the hydrated form.
3. $\text{[(CH}_3)_3\text{N]}_n\text{B}_2\text{H}_2\text{Cl}_6$.
4. A compound of claim 3 in the hydrated form.
5. $\text{H}_2\text{B}_2\text{H}_2\text{Cl}_6$.
6. A compound of claim 5 in the hydrated form.
7. $\text{[(CH}_3)_3\text{N]}_n\text{B}_2\text{H}_2\text{Br}_6$.
8. A compound of claim 7 in the hydrated form.
9. $\text{Na}_2\text{B}_2\text{H}_2\text{Cl}_6$.
10. A compound of claim 9 in the hydrated form.
11. $\text{Zn}(\text{NH}_3)_4\text{B}_2\text{H}_2\text{Cl}_6$.
12. A compound of claim 11 in the hydrated form.

12

References Cited

UNITED STATES PATENTS

	2,756,259	7/1956	Bragdon et al.	260-567.6
	3,018,160	1/1962	Miller	23-14
6	3,021,190	2/1962	McElroy	23-14
	3,108,139	10/1963	Larchar	260-567.6
	3,148,938	9/1964	Knoth	23-358
	3,148,939	9/1964	Knoth	23-358 X
	3,149,163	9/1964	Knoth	260-583
10	3,166,378	1/1965	Knoth	23-361

OTHER REFERENCES

- 15 Kaczmarczyk et al., "Proceedings of the National Academy of Sciences, U.S.A.," vol. 48, pp. 729-733 (May 1962).
- Wiesboeck et al., "Journal of the American Chemical Society," vol. 83, pp. 4108-4109 (Oct. 5, 1961).
- 20 MILTON WEISSMAN, *Primary Examiner*.
- MAURICE A. BRINDISI, *Examiner*.

UNITED STATES PATENT OFFICE
CERTIFICATE OF CORRECTION

Patent No. 3,372,006 Dated March 5, 1968

Inventor(s) Bertrand L. Chamberland et al.

It is certified that error appears in the above-identified patent and that said Letters Patent are hereby corrected as shown below:

Column 1, line 37, "1f-3" should read -- 1-3 --; line 65, after "metal" insert a comma; Column 2, line 19, "groups" should read -- group --. Column 9, line 33, "IiOH" should read -- LiOH --. Column 10, line 51, " $M_2(B_{20}H_{18-n})_b$ " should read

-- $M_a(B_{20}H_{18-n})_b$ --.

Signed and sealed this 22nd day of February 1972.

(SEAL)
Attest:

EDWARD M. FLETCHER, JR.
Attesting Officer

ROBERT GOTTSCHALK
Commissioner of Patents

PO-1030
(3/69)

UNITED STATES PATENT OFFICE
CERTIFICATE OF CORRECTION

Patent No. 3,372,006 Dated March 5, 1968

Inventor(s) Bertrand L. Chamberland and Earl L. Muetterties

It is certified that error appears in the above-identified patent and that said Letters Patent are hereby corrected as shown below:

Col. 1, line 37, "1f-3" should be changed to
-- 1-3 --; line 65, insert a comma after "metal";

Col. 2, line 19, "groups" should be -- group --;

Col. 9, line 33, "LiOH" should be -- LiOH --; and

Signed and sealed this 14th day of September 1971.

(SEAL)
Attest:

EDWARD M. FLETCHER, JR.
Attesting Officer

ROBERT GOTTSCHALK
Acting Commissioner of Patents

Cont

1

3,373,202

METHOD OF PREPARING TETRAETHYLAMMONIUM DECAHYDRODECABORATES

Joseph M. Makhlouf, Mars, and Gerald T. Hefferman, Butler, Pa., assignors to Callery Chemical Company, Pittsburgh, Pa., a corporation of Pennsylvania
No Drawing. Filed Sept. 14, 1966, Ser. No. 579,198
3 Claims. (Cl. 260-567.6)

This invention relates to a new method of preparing decahydrodecaborates and more particularly to their preparation by the thermal decomposition of octahydro-

triborates. Meenterties and Knoth, Chemical and Engineering News, May 9, 1966, pages 88 to 98, in reviewing the extensive chemistry of the polyhedral boranes, which are of unusual interest because of their aromatic character, note the particular importance of the decahydrodecaborate(-2) ion, $B_{10}H_{10}^{2-}$. Heretofore, decahydrodecaborates have been prepared from decaborane, $B_{10}H_{14}$, which is an extremely expensive starting material. The preparation of decahydrodecaborates by pyrolysis of octahydrotriborates is disclosed in the co-pending application Ser. No. 579,220 of Makhlouf and Hough filed on even date herewith.

It is therefore an object of this invention to provide a simple and direct method of preparing compounds containing decahydrodecaborate(-2) ion. Another object is to provide a method of preparing tetraethylammonium decahydrodecaborate by pyrolysis of tetraethylammonium borohydride.

In accordance with this invention, tetraethylammonium borohydride $(C_2H_5)_4NBH_4$, is pyrolyzed at a temperature above its decomposition temperature, about 185° C., under an inert non-oxidizing atmosphere, suitably nitrogen or argon. It is preferred to use temperatures below about 220° C., because at higher temperatures significant amounts of dodecahydrododecaborates are produced. The pyrolysis reaction proceeds substantially quantitatively according to the equation:

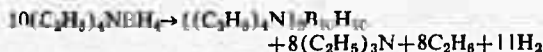

2

Illustrative of this reaction, 5.69 grams (39.2 millimols) of $(C_2H_5)_4NBH_4$ were placed under a nitrogen atmosphere in a 250 ml. steel cylinder reactor equipped with a vent for discharging gases through a mercury trap and a wet test meter. The reactor was heated slowly to 185° C. and after 18 hours at this temperature, off-gassing ceased. Two liters of methane and hydrogen were produced compared to 1.95 liters theoretically expected from the above stated equation and triethylamine distilled from the reaction into the bubbler. The solid residue in the reactor was vacuum dried to yield 1.44 grams (3.8 millimols) of $[(C_2H_5)_4N]_2B_{10}H_{10}$, a 97% yield. The infrared spectrum of the product was identical to that of an authentic sample of $[(C_2H_5)_4N]_2B_{10}H_{10}$ prepared by the method of the aforementioned co pending application of Makhlouf and Hough. The elemental analysis of the product was 29.51% B, 48.40% C, 13.79% H, and 7.21% N compared to the theoretical elemental content 28.54% B, 50.68% C, 13.3% H and 7.39% N.

According to the provisions of the patent statutes, we have explained the principle and mode of practice of our invention and have described what we now consider to represent its best embodiment. However, we desire to have it understood that, within the scope of the appended claims, the invention may be practiced otherwise than as specifically described.

We claim:

1. A method of preparing tetraethylammonium decahydrodecaborate comprising the steps of thermally decomposing tetraethylammonium borohydride under an inert non-oxidizing atmosphere and recovering the tetraethylammonium decahydroborate.

2. A method according to claim 1 in which the temperature is between about 180 and 220° C.

3. A method according to claim 1 in which the temperature is about 185° C.

No references cited.

CHARLES B. PARKER, Primary Examiner.
S. T. LAWRENCE III, Assistant Examiner.

1

3,373,203
PREPARATION OF DECAHYDRODECABORATES
Joseph M. Makhlouf, Mars, and William V. Hough,
Gibsonia, Pa., assignors to Callery Chemical Com-
pany, Pittsburgh, Pa., a corporation of Pennsylvania
No Drawing. Filed Sept. 14, 1966, Ser. No. 579,220
6 Claims. (Cl. 260-567.6)

This invention relates to a new method of preparing decahydrodecaborates and more particularly to their preparation by the thermal decomposition of octahydrotri- borates.

Meenterties and Knoth, Chemical and Engineering News, May 9, 1966, pages 88 to 98, in reviewing the extensive chemistry of the polyhedral boranes, which are of unusual interest because of their aromatic character, note the particular importance of the decahydrodecabo- rate (-2) ion, B₁₀H₁₀⁻². Heretofore, decahydrodecabo- rates have been prepared from decaborane, B₁₀H₁₄, which is an extremely expensive starting material.

It is therefore an object of this invention to provide a simple and direct method of preparing compounds con- taining decahydrodecaborate (-2) ion.

Another object of this invention is to provide a method of preparing decahydrodecaborate salts by pyrolysis of octahydrotriborate salts. Other objects will be apparent from the following description and claims.

In accordance with this invention, potassium octahydro- triborate, KB₃H₆, cesium octahydrotriborate, CsB₃H₆, tetramethylammonium octahydrotriborate,

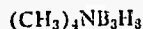

or tetraethylammonium octahydrotriborate,

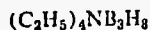

are pyrolyzed, or heated to a temperature at which they thermally decompose, to produce the corresponding deca- hydrodecaborate salt.

Tetramethylammonium octahydrotriborate thermally decomposes according to the equation:

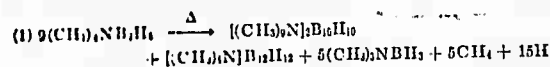

Potassium and cesium octahydrotriborates decompose primarily according to the equation:



where M represents K or Cs, although pyrolytic reactions giving other polyhedral boron compounds also occur simultaneously to some extent.

Tetraethylammonium octahydrotriborate is a much pre- ferred starting material as it decomposes, apparently by a different mechanism, to give substantially quantitative recovery of the boron as the decahydrodecaborate (-2) ion according to the equation:

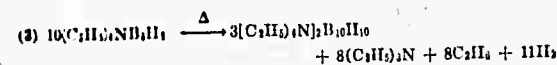

In the practice of this invention, the octahydrotriborate is heated to at least its decomposition temperature, about 160-165° C. for the potassium and cesium salts and about 180-185° C. for the tetramethylammonium and tetraethyl- ammonium salts, under an inert, non-oxidizing atmos- phere, suitably nitrogen, argon or other noble gas. Higher temperatures may be used but it is preferred to use tem- peratures below about 220° C. because at higher tempera- tures the pyrolysis reaction produces higher proportions of dodecahydrodecaborate (-2). The solid residue re- maining on removal of the volatile reaction products is substantially pure decahydrodecaborate (-2) salt when

2

using tetraethylammonium octahydrotriborate, or when using other octahydroborates, a mixture of decahydro- decaborate (-2) salt with other solid pyrolysis products from which it is separated by conventional means.

The following examples are illustrative of this inven- tion:

Example I

9.16 g. (53.64 millimols) of tetraethylammonium octa- hydrotriborate was placed under a nitrogen atmosphere in a 250 cc. steel cylinder provided with a vent discharg- ing through a mercury trap and a wet test meter. The temperature was slowly raised to and maintained at 185° for about 20 hours, until off-gasing ceased, at which time the vent was closed and the cylinder was cooled to room temperature. About 3.8 liters (STP) of ethane or hydro- gen were vented during the pyrolysis compared to 3.62 liters according to Equation 3, and 5.88 g. (96.5% yield according to Equation 3) of solid tetraethylammonium decahydrodecaborate was recovered for the reactor. Tri- ethylamine product was distilled from the reactor during the pyrolysis and collected in the mercury bubbler. Chem- ical elemental analysis of the product was 29.7% B, 48.72% C, 14.1% H and 7.27% N, compared to the theoretical elemental content for [(C₂H₅)₄N]₂B₁₀H₁₀ of 28.54% B, 50.68% C, 13.3% H and 7.39% N. A por- tion of this pyrolysis product was dissolved in acetonitrile, and about 2-3% by weight of the pyrolysis product was insoluble [(C₂H₅)₄N]₂B₁₂H₁₂ that was filtered out. Tetra- methylammonium octahydrotriborate was added to the solution to form tetraethylammonium decahydrodecabo- rate by the metathetic reaction:

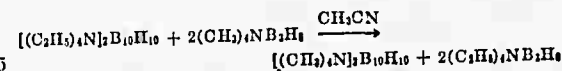

The infrared spectrum of the tetramethylammonium deca- hydrodecaborate was identical to that of an authentic tetramethylammonium decahydrodecaborate prepared by the method of Hawthorne and Pitochelli, J. Am. Chem. Soc., vol. 81, 5519 (1958).

The B¹¹ NMR spectrum of the solid pyrolysis product dissolved in acetonitrile, showed the expected two dou- blets. The high field doublet with a coupling constant of 128 cps., centered at 52 p.p.m., (CH₃O)₃B as ref. This corresponds with B¹¹ NMR values for the B₁₀H₁₀⁻² anion, reported by E. L. Meenterties et al. Inorg. Chem., vol. 3, 444 (1964).

Example II

Example I was repeated except that 5.36 g. (46.7 milli- mols) of tetramethylammonium octahydrotriborate was used in place of the tetraethylammonium octahydrotri- borate. The measured off-gas of hydrogen and methane was 2.58 liters as compared to 2.60 liters theoretical from Equation 1, and 4.68 g. of solid material was recovered from the reactor. Extraction of the solid product with methylene chloride yielded 1.68 grams of (CH₃)₃NBH₃ as the soluble fraction. The methylene insoluble fraction was extracted with water to yield a 1.33 g. of water in- soluble [(CH₃)₄N]₂B₁₂H₁₂ and 1.39 g. of water soluble [(CH₃)₄N]₂B₁₀H₁₀, a 95.5% yield based on Equation 1.

Example III

Example I was repeated except that 8.9 g. (112.0 milli- mols) of KB₃H₆ was used in place of the tetraethylam- monium octahydrotriborate. The measured hydrogen off- gas was 4.55 liters as compared to a theoretical 4.9 liters according to Equation 2. The residual solids, 8.23 grams, containing sodium decahydrodecaborate, was dissolved in an aqueous solution of (CH₃)₄NCl, leaving undissolved (CH₃)₄NBH₃ and a small amount of insoluble

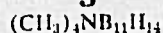

identified by infrared spectrum analysis. The water soluble material was primarily $(\text{CH}_3)_4\text{N}_2\text{B}_{10}\text{H}_{10}$.

Example IV

Example I was repeated except that 5.02 grams (29 millimols) of $\text{C}_2\text{B}_5\text{H}_9$ was used in place of the tetraethylammonium octahydrotriborate and 1.26 liters of hydrogen was evolved during the pyrolysis compared to theoretical of 1.27 liters according to Equation 2. The infrared absorption of the solid product, 4.95 grams, was substantially the same as that of the solid product from Example III: the absorption bands are at 2488, 2278, 2225 (shoulder), 1115, 1040-1025 (medium) and 730 cm^{-1} (broad and shallow).

According to the provisions of the patent statutes, we have explained the principle and mode of practice of our invention and have described what we now consider to represent its best embodiment. However, we desire to have it understood that, within the scope of the appended claims, the invention may be practiced otherwise than as specifically described.

We claim:

1. A method of preparing a decahydrodecaborate salt comprising thermally decomposing under an inert atmos-

phere an octahydrotriborate of the formula MB_3H_6 , where M is potassium, cesium, tetramethylammonium, or tetraethylammonium and recovering the decahydrodecaborate salt.

2. A method according to claim 1 in which the temperature is below about 220° C.

3. A method according to claim 1 in which the octahydrotriborate is tetraethylammonium octahydrotriborate.

4. A method according to claim 3 in which the temperature is below about 220° C.

5. A method according to claim 4 in which the temperature is about 185° C.

6. A method according to claim 1 in which the octahydrotriborate is tetramethylammonium octahydrotriborate and the pyrolysis product contains tetramethylammonium decahydrodecaborate, leaching said pyrolysis product with methylene chloride, and extracting the resultant solid residue with water to recover an aqueous solution of tetramethylammonium decahydrodecaborate.

No references cited.

CHARLES B. PARKER, *Primary Examiner.*

S. T. LAWRENCE III, *Assistant Examiner.*

1

3,383,399

SALTS OF BORON-HYDRIDE ANIONS AND BORON CONTAINING ORGANIC CATIONS AND METHOD OF THEIR PREPARATION

Stanley Frank Stafiej, Springdale, and Edward Andrew Takacs, South Norwalk, Conn., assignors to American Cyanamid Company, Stamford, Conn., a corporation of Maine

No Drawing, Filed Mar. 9, 1964, Ser. No. 351,586
7 Claims. (Cl. 260-453)

ABSTRACT OF THE DISCLOSURE

Salts of boron-containing cations and boron-containing anions, their method of preparation by the metathetical reaction of other salts of boron-containing cations with boron-hydride salts and their use as high energy solid rocket propellant ingredients, burning rate modifiers for rocket propellants, and boron-containing gasoline additives are disclosed.

This reaction may be represented by the following equation:

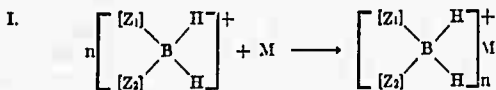

wherein $[Z_1]$ and $[Z_2]$ are each ligands selected from the group consisting of tertiary amines in which the nitrogen atom is bonded only to carbon atoms and not more than one nitrogen atom of another amine radical, nitriles, dialkyl sulfides, and tertiary phosphines in which the phosphorus is bonded only to carbon atoms; wherein M is a boron-hydride anion, such as $B_9H_{14}^-$, $B_3H_8^-$, $B_{10}H_{10}^-$, $B_{12}H_{12}^-$, $B_{10}H_{14}^-$, BH_4^- , $B_{10}H_{13} \cdot N_2H_4^-$, $B_{10}H_{13} \cdot NH_3^-$, and $B_{10}H_{13}C \equiv N^-$; and n is a positive integer equal to the valence of the boron-hydride anion.

The boron-containing cation useful for performing the reaction of the present invention may have associated with it any anion which will not interfere with the above reaction, such as the chloride, bromide, fluoride, nitrate, chlorate, sulphate, chloroplatinate, triiodide, hexafluorometantimonate, tetraphenylborate, tetrachloroborate and fluophosphate anions, although it is generally preferred that the anion be the fluoroborate or perchlorate anion since the fluoroborate and perchlorate of this cation can be prepared directly from readily available starting materials by the processes described and claimed in copending applications Ser. Nos. 351,583, now U.S. Patent No. 3,305,555, issued Feb. 21, 1967 and 351,582, now U.S. Patent No. 3,296,274, issued Jan. 3, 1967, filed concurrently herewith by Stafiej and Takacs, and Stafiej and Carvalho, respectively, and assigned to the assignee of the present application.

The boron-hydride anion useful for performing the reaction of the present invention may have associated with it any cation which will not interfere with the above reaction, such as potassium, sodium, lithium, ammonium, calcium, barium, zinc, tetramethylammonium, or triphenylmethylphosphonium, etc. Thus, illustrative of the boron-hydride salts useful in the process of this invention are the following: $(CH_3)_4NB_9H_{14}$, KB_3H_8 , $Ca(BH_4)_2$,

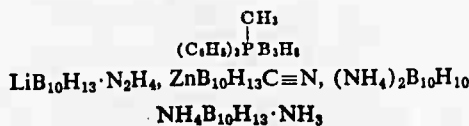

etc.

The nucleophiles or ligands $[Z_1]$ and $[Z_2]$ may be any of the ligands described in the aforesaid copending ap-

2

plications Ser. Nos. 351,583, now U.S. Patent No. 3,305,555, issued Feb. 21, 1967 and 351,582, now U.S. Patent No. 3,296,274, issued Jan. 3, 1967. Thus, the nucleophile or ligand may be a tertiary amine in which the nitrogen atom is bonded only to carbon atoms of hydrocarbon or substituted hydrocarbon radicals. The tertiary amine may have the formula



wherein R_1 , R_2 , and R_3 are the same or different hydrocarbon radicals or substituted hydrocarbon radicals. For example, they may be lower alkyl (e.g., methyl, ethyl, n-propyl, isopropyl, butyl, etc.), aryl (e.g., phenyl, biphenyl, naphthyl, etc.), aralkyl (e.g., benzyl, xylyl, etc.), alkaryl (e.g., tolyl, dimethyl-phenyl, ethyl-phenyl, cumenyl, etc.) or substituted forms thereof (e.g., containing one or more halogen, alkoxy, ester, thioether, etc. groups). Also, the tertiary amine may have the formula

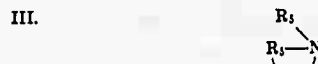

wherein R_4 and R_5 are hydrocarbon radicals or substituted hydrocarbon radicals. For example, R_4 may be the same as previously described for R_1 , R_2 , and R_3 and R_5 may be a bivalent radical which, when joined to the nitrogen atom by both valences, forms a heterocyclic ring (e.g., pyrrole, pyrrolidine, pyrroline, piperazine, piperidine, pipercoline, etc.). Further, the tertiary amine may have the formula



wherein R_8 is a hydrocarbon radical or substituted hydrocarbon radical which, in conjunction with the nitrogen atom, forms a heretocyclic ring (e.g., pyridine, naphthyridine, quinoline, pyrimidine, bipyridyl, etc.). Additionally, the tertiary amine may be a hydrazine derivative having the formula



wherein R_7 and R_8 may be the same as R_1 , R_2 , or R_3 above.

Also, the ligand can be any of the various nitriles, e.g., lower alkyl nitriles (acetonitrile, propionitrile, butyronitrile, etc.), cyanogen, lower alkylene dinitriles (malononitrile, succinonitrile, glutaronitrile, etc.). Further, the ligand can be a dialkyl sulfide, e.g., dimethyl sulfide, ethyl methyl sulfide, diethyl sulfide, substituted forms of the foregoing, etc.

Additionally, the ligand can be a tertiary phosphine in which the phosphorus atom is bonded only to carbon atoms of hydrocarbon or substituted hydrocarbon radicals and which may have any of the formulae

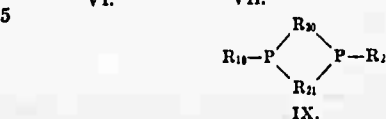
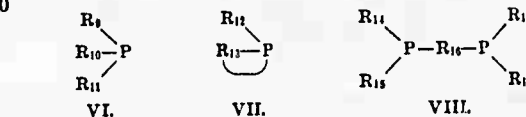

wherein R_9 , R_{10} , R_{11} , R_{12} , R_{14} , R_{15} , R_{17} , R_{18} , R_{19} , and R_{22} are monovalent hydrocarbon radicals which may be

the same or different in any given formula and R_{13} , R_{16} , R_{20} , and R_{21} are bivalent hydrocarbon radicals. These monovalent hydrocarbon radicals may be any of those previously described for R_1 , R_2 , or R_3 of Formula II. The bivalent hydrocarbon radical R_{13} can be any one which, when joined to the phosphorus atom by both valences, forms a heterocyclic ring (e.g., tetramethylene, pentamethylene, $-\text{CH}_2-\text{CH}_2-\text{O}-\text{CH}_2-\text{CH}_2-$,



etc.). The bivalent hydrocarbon radicals R_{16} , R_{20} , and R_{21} may be lower bivalent alkyl groups (e.g., methylene, ethylene, propylene, butylene, etc.) and, preferably, R_{20} and R_{21} together with two phosphorus atoms of Formula IX should add up to a five or six atom heterocyclic ring for maximum stability. R_{16} may also be a bivalent aryl, alkaryl, or aralkyl group (e.g., o-phenylene, m-phenylene, p-phenylene, o-xylylene, m-xylylene, p-xylylene, toluylene, naphthylene, etc.). Illustrative of ligands useful in the process of this invention are the following:

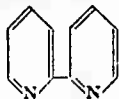
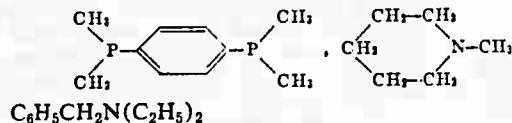
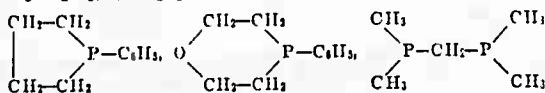
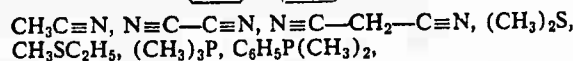

All of the foregoing nucleophiles or ligands have been listed in their simplest forms, but substituted forms thereof may also be used. Thus, they may contain fluorine, chlorine, bromine, or iodine atoms, ether linkages, ester linkages, alkoxy groups, thioether linkages, and other substituents attached thereto provided they do not adversely affect the desired reaction. Also, they may include additional nucleophilic portions providing a plurality of positions to which boron atoms can be secured by ligand linkages.

Also, the ligands can be those described in our copending application Ser. No. 351,584, now U.S. Patent No. 3,341,582, issued Sept. 12, 1967, filed concurrently herewith and assigned to the assignee of the present invention, which teaches reacting boron-containing cations containing nitrile groups with ethers and thioethers to produce a novel class of cations. Thus, the ligand may have the form

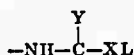

wherein Y represents a hydrocarbon or substituted hydrocarbon group, X represents $-\text{O}-$ or $-\text{S}-$, and L represents a hydrocarbon or substituted hydrocarbon group. For example, the ligand may be

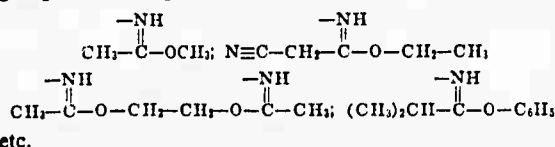

These boron-containing cations may be prepared from readily available starting materials in accordance with the teachings of the aforesaid copending applications

Ser. Nos. 351,583, now U.S. Patent No. 3,305,555, issued Feb. 21, 1967; 351,582, now U.S. Patent No. 3,296,274, issued Jan. 3, 1967; and 351,584, now U.S. Patent No. 3,341,582, issued Sept. 12, 1967.

In application Ser. No. 351,583, now U.S. Patent No. 3,305,555, issued Feb. 21, 1967, one method for preparing the boron-containing cations shown on the left side of Equation I above is taught wherein a tertiary amine-borane is reacted, under anhydrous conditions, with a trityl salt and a nucleophile or ligand. In application Ser. No. 351,582, now U.S. Patent No. 3,296,274, issued Jan. 3, 1967, another method for preparing such cations is taught wherein a borohydride salt is reacted, under anhydrous conditions with at least two equivalents of a trityl salt and at least two equivalents of a nucleophile or ligand. In application Ser. No. 351,584, now U.S. Patent No. 3,341,582, issued Sept. 12, 1967, yet another method of preparing such cations is taught wherein boron-containing cations containing at least one nitrole ligand are reacted under anhydrous conditions with alcohols or mercaptans.

The boron-hydride anions useful for performing the reaction of the present invention may be prepared from various starting materials by various processes. Illustrative of such preparations are the following:

The $\text{B}_9\text{H}_{14}^-$ anion can be prepared by reacting together at room temperature decaborane with an aqueous solution of at least two molar equivalents of an alkali-metal hydroxide to form an intermediate compound which can then be reacted at room temperature, while still in the solution wherein it was formed, with a mineral acid in an amount which is one molar equivalent less than the molar equivalents of base employed to produce the $\text{B}_9\text{H}_{14}^-$ anion as taught in pending application Ser. No. 219,367, filed Aug. 22, 1962 by Benjamin, Stafieji and Takacs and assigned to the assignee of the present application.

The B_3H_8^- anion can be prepared by reacting together pentaborane-9 with a basic material (such as an alkali-metal hydroxide, carbonate, methoxide, or ethoxide) in the presence of liquid water or alcohol as taught in pending application Ser. No. 343,173, filed Nov. 16, 1962 by Carvalho and Shust and assigned to the assignee of the present application.

The $\text{B}_{10}\text{H}_{10}^-$ anion can be prepared by the method described in letters by Hawthorne and Pitochelli, J.A.C.S., 81, 5519 (1959) and J.A.C.S., 82, 3228 (1960).

The $\text{B}_{12}\text{H}_{12}^-$ anion can be prepared by the method described in a letter by Pitochelli and Hawthorne, J.A.C.S. 82, 3228 (1960).

The $\text{B}_{10}\text{H}_{14}^-$ anion can be prepared by the method described by Muettterties in Inorg. Chem., 2, 647 (1963).

The BH_4^- anion is a commercially available product in the form of its alkali-metal salts.

The $\text{B}_{10}\text{H}_{13}\cdot\text{N}_2\text{H}_4^-$ anion can be prepared by reacting together, in an aqueous medium, decaborane, hydrazine, and a strong base (such as alkali-metal hydroxide, hydrazine, guanidine, and mono-, di-, and tri-amino-guanidine) as taught in application Ser. No. 214,797, now U.S. Patent No. 3,281,219, issued Oct. 25, 1966, filed Aug. 1, 1962, by Takacs and assigned to the assignee of the present application.

The $\text{B}_{10}\text{H}_{13}\cdot\text{NH}_3^-$ anion can be prepared by reacting together decaborane and a large excess of ammonium hydroxide (about 12 to about 15.2 moles of ammonium hydroxide per mole of decaborane) at reduced temperature (about -20°C . to about $+5^\circ\text{C}$.) as taught in abandoned application Ser. No. 220,590, filed Aug. 22, 1962 by Carvalho and assigned to the assignee of the present application.

The $\text{B}_{10}\text{H}_{13}\text{C}\equiv\text{N}^-$ anion can be prepared by the method described by Knoth and Muettterties in J. Inorg. and Nucl. Chem., 20, 66 (1961).

It is usually preferred to perform the reaction of this invention in the presence of an inert solvent which may be water, alcohol, etc. The reaction occurs easily and

rapidly at atmosphere pressure and at room temperature or below merely upon mixing the various ingredients together. However higher or lower temperatures and pressures may be used when desired. For example, this reaction can be performed at pressures of from about 100 mm. Hg to about five atmospheres and at temperatures of from about 78° C. to about 100° C.

The two reactants may be used in stoichiometrical proportions (i.e., one equivalent of boron-containing cation for each equivalent of boron-hydride anion) or an excess (0.1 to 100 mole percent or more) of either may be used.

Examples of products of the present invention are:

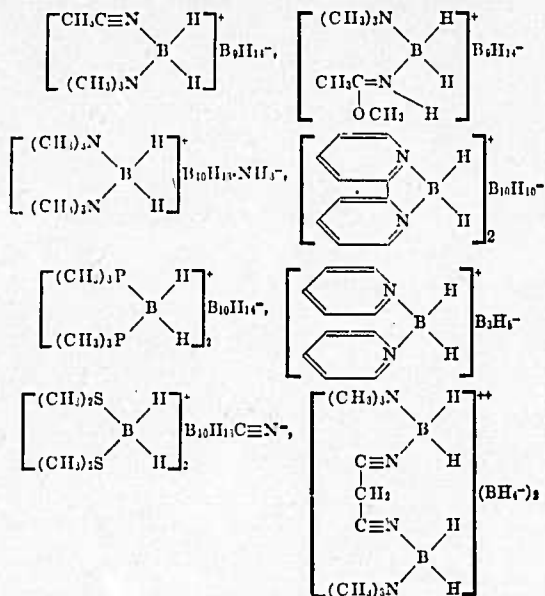

etc.

The compounds of this invention are useful as high energy solid rocket propellant ingredients, burning rate modifiers for rocket propellants, and as boron-containing gasoline additives.

For a clearer and more detailed understanding of the nature of the present invention, reference may be had to the following examples which are intended as illustrative only and not as limitations on the invention.

Example 1.—Preparation of

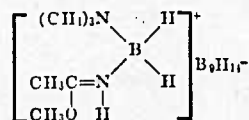

A solution of 186 mg. (1 mmole) of $(\text{CH}_3)_4\text{NB}_9\text{H}_{14}$ in 10 ml. of methanol was added to a solution of 232 mg. (1 mmole) of $[\text{CH}_3(\text{CH}_3\text{O})\text{C}=\text{NHBH}_2\text{N}(\text{CH}_3)_3]\text{BF}_4$ in 10 ml. of methanol. After a short induction period, white dandritic crystals of $(\text{CH}_3)_4\text{NBF}_4$ settled from solution. The solution was chilled in ice for 30 minutes and filtered to yield 120 mg. (75% yield) of material. Evaporation of the filtrate to dryness yielded 220 mg. (86% yield) of a light yellow solid, M.P. 85-96° C. Three recrystallizations from methanol-water raised the melting point to 97° C.

Analysis.—Calculated for $\text{C}_6\text{H}_{32}\text{N}_2\text{B}_{10}\text{O}$: C, 28.09; H, 12.57; N, 10.92; B, 42.18. Found: C, 28.48; H, 12.24; N, 11.10; B, 46.78.

Example 2.—Preparation of

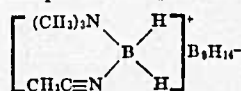

A solution of 400 mg. (2 mmoles) of



in 5 ml. of water was added to a solution of 820 mg. (2 mmoles) of $\text{KB}_9\text{H}_{14} \cdot \text{dioxanate}$ in 10 ml. of water. The white precipitate formed was filtered off and air dried to yield 360 mg. (80.2% yield) of product.

We claim:

1. A compound having the formula

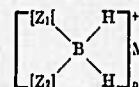

wherein $[\text{Z}_1]$ and $[\text{Z}_2]$ are each ligands of tertiary amines in which the nitrogen atom is bonded only to carbon atoms and not more than one nitrogen atom of another amine radical, nitriles, di-alkyl sulfides, or tertiary phosphines in which the phosphorous atom is bonded only to carbon atoms; wherein M is a boron-hydride anion; and n is a positive integer equal to the valence of said boron-hydride anion.

2. A compound as defined in claim 1 wherein M is a boron-hydride anion of $\text{B}_9\text{H}_{14}^-$, B_3H_8^- , $\text{B}_{10}\text{H}_{10}^-$, $\text{B}_{12}\text{H}_{12}^-$, $\text{B}_{10}\text{H}_{14}^-$, BH_4^- , $\text{B}_{10}\text{H}_{13} \cdot \text{N}_2\text{H}_4^-$, $\text{B}_{10}\text{H}_{13} \cdot \text{NH}_3^-$, or $\text{B}_{10}\text{H}_{13}\text{C}\equiv\text{N}^-$.

3.

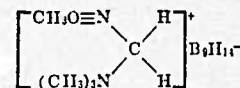

4.

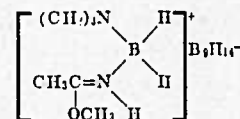

5. A process for preparing organic boron-hydride salts of boron-containing cations comprising reacting, at a pressure of about 100 mm. Hg to about 5 atmospheres and a temperature of from about -78° C. to about 100° C., a salt of a boron-containing cation with a salt of a boron-hydride anion.

6. A process for preparing boron-hydride salts of boron-containing cations comprising reacting, at a pressure of about 100 mm. Hg to about 5 atmospheres and a temperature of from about -78° C. to about 100° C., a salt of a boron-containing cation having the formula

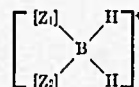

wherein $[\text{Z}_1]$ and $[\text{Z}_2]$ are each ligands of tertiary amines in which the nitrogen atom is bonded only to carbon atoms and not more than one nitrogen atom of another amine radical, nitriles, di-alkyl sulfides, or tertiary phosphines in which the phosphorous atom is bonded only to carbon atoms with a salt of a boron-hydride anion.

7. A process as defined in claim 6 wherein said boron-hydride anion is $\text{B}_9\text{H}_{14}^-$, B_3H_8^- , $\text{B}_{10}\text{H}_{10}^-$, $\text{B}_{12}\text{H}_{12}^-$, $\text{B}_{10}\text{H}_{14}^-$, BH_4^- , $\text{B}_{10}\text{H}_{13} \cdot \text{N}_2\text{H}_4^-$, $\text{B}_{10}\text{H}_{13} \cdot \text{NH}_3^-$ or $\text{B}_{10}\text{H}_{13}\text{C}\equiv\text{N}^-$.

References Cited

- Parry et al.: J.A.C.S., volume 80, 1958, pages 24 to 27.
 CHARLES B. PARKER, Primary Examiner.
 JOSEPH P. BRUST, Examiner.
 S. T. LAWRENCE III, Assistant Examiner.

1

3,411,890
CHEMICAL PRODUCTS AND PROCESSES
Joseph H. Balchis, Jr., Mendenhall, Pa., assignor to E. I. du Pont de Nemours and Company, Wilmington, Del.,
a corporation of Delaware
Filed July 11, 1962, Ser. No. 209,487
9 Claims. (Cl. 23-358)

ABSTRACT OF THE DISCLOSURE

Double salts of cobalt(III) and chromium(III) amines and decahydrodecaborate or dodecahydrododecaborate anions with a second anion which is oxidizing are useful as initiating explosives.

DESCRIPTION OF THE INVENTION

This invention relates to a new class of polyhydropolyborates and to processes for their preparation.

More particularly, the invention concerns salts comprising a cobalt or chromium ammine cation and anions of decahydrodecaborate or dodecahydrododecaborate and an inorganic oxidizing anion with a reduction potential of at least 0.5 volt.

Polyhydropolyborates are of increasing importance in the field of explosives, but there are no known polyhydropolyborates which can function in electric blasting caps simultaneously as a base charge, primer charge and/or ignition charge. Indeed, few compounds exhibit this combination of functions, for example, mercury fulminate. There have now been discovered a novel class of polyhydropolyborate salts having the desired combination of properties.

The products of this invention are salts containing:

(a) One of two ammine cations (cationic amines) of hexacoordinated, trivalent cobalt or chromium, with at least five of the six coordination positions of the cobalt or chromium being occupied by ammonia or amines bonded to the central metal atom through nitrogen, the remaining coordination position, if any, being occupied by water or an anion of the type defined in (c) below;

(b) One decahydrodecaborate or dodecahydrododecaborate anion; and

(c) At least one inorganic oxidizing anion having a reduction potential of 0.5 v. or greater. This anion, or one of these anions, can be coordinated to the cobalt or chromium as stated above.

The invention also includes hydrates of these salts.

The highest possible total positive charge (i.e., the sum of the positive charges on the cation or cations) of any one of the compounds defined above is six, this value being realized when there are two trivalent cations as described in (a) above. Since there is present in each compound one $B_{10}H_{10}^-$ or $B_{12}H_{12}^-$ anion, with a negative charge of two, and since the total positive and negative charges must be equal, it will be seen that the greatest possible number of anions described in (c) above is four, and this only when each of the four carries a single negative charge.

The compounds of the invention can be represented by the formula



where M is cobalt (III) or chromium (III), i.e., trivalent cobalt or chromium; L is a nitrogen-containing ligand bonded coordinately through nitrogen to M and defined in more detail below; A is an inorganic anion as defined in paragraph (c) above; n and p are 0 or 1 with the sum of n and p at most 1; s is 1 or 2; q is 10 or 12; and r is a cardinal whole number of 0-4, inclusive. The value of r

2

is determined by the number of cations (s), the number of anions A within the coordination sphere of each cation (p), and the valence of the anion A (a), the relationship being

$$r = \frac{s(3-pa) - 2}{a}$$

In the formula it is understood that the magnitude of the positive charge on each cation is (3-pa), the magnitude of the negative charge on the B_qH_q anion is 2, and the magnitude of the negative charge on the anion A is a.

The utility of the products of the invention is illustrated by the drawing which demonstrates the use of the products in blasting caps. The drawing will be more fully explained in the portion of the specification relating to utility.

COMPONENTS OF THE PRODUCTS

A. The ammine cation

One component of each of the products of this invention is a cobalt(III) or chromium(III) ammine cation of the type defined above. Cobalt(III) and chromium(III) ammine cations are a much-studied and well-recognized group, as are the nitrogen compounds that can function as ligands coordinated to the central metal atoms therein. See, for example, Mellor's "Comprehensive Treatise on Inorganic and Theoretical Chemistry," vol. XI, page 400, and vol. XIV, page 690 (Longmans, 1935), and Sidgwick's "Chemical Elements and Their Compounds," pages 1014, 1016, and 1399-1400 (Oxford, 1950). Nitrogen compounds that can function as ligands include ammonia; monoprimary amines (e.g., ethylamine, allylamine, benzylamine, and aniline); heterocyclic monoamines (e.g., pyridine); saturated acyclic 1,2- and 1,3-diprimary amines of 2-5 carbons (e.g., ethylenediamine, 1,2-propanediamine, 1,3-propanediamine, 2,3-butanediamine, and 2,4-pentanediamine); saturated alicyclic 1,2-diprimary amines (e.g., 1,2-cyclopentanediamine and 1,2-cyclohexanediamine); aromatic 1,2-diprimary amines (e.g., o-phenylenediamine); heterocyclic 1,2-ditertiary amines (e.g., 2,2'-bipyridyl and o-phenanthroline); and saturated, aliphatic, straight-chain polyamines (e.g., 1,2,3-propanetriamine and triethylenetetramine). More than one of the above species of ligands can be present in a single cobalt(III) or chromium(III) ammine cation, i.e., cations such as bis(ethylenediamine) (1,2-propanediamine)chromium(III), $(Cren_2pa)^{+++}$, and amminebis(ethylenediamine)pyridinecobalt(III),



are known. When one of the above diamines is present as a ligand, both amino groups can be bonded to the central metal atom in a chelate structure. Cobalt(III) and chromium(III) amines in which one coordination position is occupied by water or by an anion of the type defined under (c) above are well known. Examples are $[Co(NH_3)_5H_2O]^{+++}$ and $[Cr(NH_3)_5NO]^{+++}$.

Thus, L in the formula definition can be the same or different and represents ammonia, a monoprimary amine, or a heterocyclic monoamine; furthermore, any two L's can together represent a saturated acyclic 1,2- or 1,3-diprimary amine of 2-5 carbon atoms, a saturated alicyclic 1,2-diprimary amine, an aromatic 1,2-diprimary amine, or a heterocyclic 1,2-ditertiary amine; also any three L's can together represent a saturated, aliphatic, straight-chain triamine, and any four L's taken together can represent a saturated, aliphatic, straight-chain tetramine.

For reasons of availability of starting materials and stability, cations in which the coordinated nitrogen-containing ligands are ammonia, saturated acyclic 1,2-diprimary amines of 2-5 carbons, o-phenylenediamine, 2,2'-

5

wherein u and v are the smallest whole numbers that satisfy the equation

$$v = \frac{u(3-pa)}{2}$$

and the other terms are defined as previously) is reacted with a soluble salt containing as its only anion an ion of reduction potential of at least 0.5 v., e.g., an ammonium or alkali-metal salt, (M'_aA) in neutral or acidic aqueous solution. Again, hydrates of any of the reactants can be used.

Process I is preferred, because it does not require the preparation of a complex cobalt or chromium polyhydroxyborate as an intermediate. When the anion defined under (c) above is monovalent, Process I generally leads to a product containing two cobalt or chromium ammine cations when the nitrogen-containing ligand coordinated to the cobalt or chromium is ammonia, and to a product containing one cobalt or chromium ammine cation when the nitrogen-containing ligand is a larger molecule such as a 1,2-diamine. Process II generally leads to a product containing one cobalt or chromium ammine cation.

In neither process is the mole ratio of reactants, weight ratio of solvent to reactants, temperature, pressure, or reaction time critical. Usually the approximate mole ratio of reactants dictated by the stoichiometry of the reaction is used. Enough water to dissolve both reactants is ordinarily used. Since the solubility of the reactants varies considerably, solvent/reactant ratio may be as low as 1/1 or as high as 100/1 or even higher. Ordinarily, it is between 2/1 and 10/1. Alternatively, a partial solution of a reactant of relatively low solubility can be used.

The temperature is governed principally by the solubilities of the reactants and the stability of the product in the presence of water. For reactants with high solubilities and products stable to hot water, the temperature is limited only by the freezing point and the boiling point of water, with the preferred range being 20–90° C. For convenience, room temperature (20–30° C.) is ordinarily used. The solubilities of many reactants that are not highly soluble at room temperature, and the solubilities of many of the products, are increased advantageously by raising the temperature to 60–90° C. For products that react with hot water, e.g., compounds containing the $Cr(NH_3)_6^{+++}$ cation (Sidgwick, page 1017), relatively low temperatures are used if products containing all the original nitrogen-containing ligands, e.g., the six NH_3 groups of $Cr(NH_3)_6^{+++}$, in the cation are desired.

The products usually precipitate immediately when the reactants are mixed, or as soon as the reaction mixture is cooled to room temperature. In a few cases, the products may require several hours to crystallize from solution. The products can be separated by filtration or centrifugation and purified by recrystallization from water. Products that are obtained as hydrates can be partially or completely dehydrated by wellknown methods, e.g., heating under reduced pressure in the presence of a drying agent.

Properties of the products

The products are colored crystalline solids that explode on being struck or on being heated strongly. They are all at least slightly soluble in water and largely insoluble in organic solvents.

The following examples illustrate the products and processes of this invention.

EXAMPLE I

Hexamminecobalt(III) dodecahydrododecaborate nitrate dihydrate

An aqueous solution of $[Co(NH_3)_6](OH)_3$ was prepared by passing 0.13 molar $[Co(NH_3)_6]Cl_3$ ("Inorganic Syntheses, vol. II, p. 217 (McGraw-Hill, 1946)) through the hydroxide form of a strongly basic anion-exchange

6

resin. $[Co(NH_3)_6]_2(B_{12}H_{12})_2 \cdot 6H_2O$ was prepared by neutralizing an aqueous solution of the

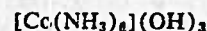

with 0.2-molar $H_3B_{12}H_{12}$, and concentrating the solution under reduced pressure at 25° C., whereupon the product crystallized. It was recrystallized from water at 60–65° C.

Analysis.—Calcd. for $[Co(NH_3)_6]_2(B_{12}H_{12})_2 \cdot 6H_2O$: B, 45.50; Co, 13.77; H, 9.89; N, 19.63. Found: B, 44.58; Co, 14.10, 14.14; H, 9.62; N, 20.14, 20.14.

A solution of 1.7 g. of $[Co(NH_3)_6]_2(B_{12}H_{12})_2 \cdot 6H_2O$ in 5 ml. of water was mixed with a solution of 0.34 g. of $NaNO_3$ in 1 ml. of water at room temperature. A solid precipitated immediately. It was dissolved by adding 7 ml. of water and heating the mixture to about 80° C. On cooling, orange crystals of hexamminecobalt(III) dodecahydrododecaborate nitrate dihydrate,

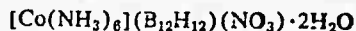

appeared, and were separated by filtration, washed with cold water, and dried. The yield was approximately one gram. The infrared absorption spectrum of the product (mineral-oil mull) had bands at 4.0 μ (B–H); 9.4 μ ($B_{12}H_{12}^{=}$); 3.0 μ , 6.2 μ , and 7.5 μ (NH_3); and 7.3–7.5 μ and 12.1 μ (NO_3^-). Recrystallization from 6.7 g. of water did not change the infrared absorption spectrum; the nitrogen content of the product was also essentially unchanged, being 24.34% before recrystallization and 24.27% after (calculated, 24.46%).

A second sample of the product prepared essentially as described above was analyzed more completely:

Analysis.—Calcd. for

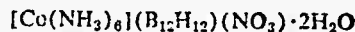

B, 32.37; Co, 14.69; N, 24.45. Found: B, 32.32; Co, 14.96; N, 24.58, 24.74.

The product exploded when struck sharply or when heated to several hundred degrees centigrade.

EXAMPLE II

Di[hexamminecobalt(III)] dodecahydrododecaborate tetranitrate tetrahydrate

$[Co(NH_3)_6](NO_3)_3$ was prepared by the method of "Inorganic Syntheses," vol. II, p. 218 (McGraw-Hill, 1946).

A solution of 8.96 g. of $Na_2B_{12}H_{12} \cdot 2H_2O$ in 10 ml. of water was added to a partial solution of 13.89 g. of $[Co(NH_3)_6](NO_3)_3$ in 100 ml. of water with stirring at 70° C. Addition of 35 ml. of water and heating to 90° C. gave a complete solution. The solution was cooled, and the orange crystals that formed were worked up by the method of Example I. The yield was 12.65 g. Two recrystallizations from water at 70° C. gave 6.83 g. of deep-orange, semitransparent needles of di[hexamminecobalt(III)] dodecahydrododecaborate tetranitrate tetrahydrate, $[Co(NH_3)_6]_2(B_{12}H_{12})(NO_3)_4 \cdot 4H_2O$.

Analysis.—Calcd. for

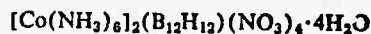

B, 16.56; Co, 15.03; N, 28.58. Found: B, 17.17; Co, 14.36, 14.45, 14.51; N, 29.30, 29.03.

The infrared absorption spectrum of the product had bands corresponding to NH_3 , H_2O , NO_3^- , and $B_{12}H_{12}^{=}$. The product exploded when struck by a hammer on a hard surface and flashed when dropped on a heated surface.

EXAMPLE III

Di[hexamminecobalt(III)] dodecahydrododecaborate tetranitrate dihydrate

$[Co(NH_3)_6]_2(B_{12}H_{12})(NO_3)_4 \cdot 4H_2O$ prepared in Example II was heated for 24 hours at 100° C. and 0.01–0.02 mm. pressure over phosphorus pentoxide. An essen-

7

tially quantitative yield of di[hexamminecobalt(III)] dodecahydrododecaborate tetranitrate dihydrate,

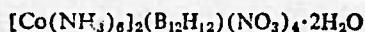

was realized (calculated weight loss, 4.59%; found, 4.35%). This product was qualitatively more sensitive to shock (exploded more readily when struck by a hammer) than the tetrahydrate.

EXAMPLE IV

Di[pentammineaquochromium(III)] dodecahydrododecaborate tetranitrate

$[\text{Cr}(\text{NH}_3)_5(\text{NO}_3)]_2$ was prepared by the method of "Inorganic Syntheses," vol. III, p. 153 (McGraw-Hill, 1950).

A mixture of 8.0 g. of $[\text{Cr}(\text{NH}_3)_5(\text{NO}_3)]_2$, 6.71 g. of $\text{Na}_2\text{B}_{12}\text{H}_{12} \cdot 2\text{H}_2\text{O}$, and 55 ml. of water was heated with agitation to 70° C., four drops of concentrated nitric acid being added during the process. At 70° C. a complete solution resulted. The crystals that formed on cooling were worked up by the method of Example I to give 5.78 g. of di[pentammineaquochromium(III)] dodecahydrododecaborate tetranitrate,

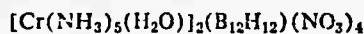

Recrystallization from 45 ml. of water at 60° C. gave 4.21 g. of the product in the form of orange-yellow crystals that exploded when struck sharply or when dropped onto a hot surface.

Analysis.—Calcd. for

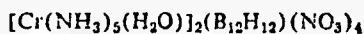

B, 18.54; Cr, 14.35; N, 28.00. Found: B, 17.96; Cr, 15.03, 15.38; N, 28.15, 28.34.

The corresponding $[\text{Cr}(\text{NH}_3)_6]^{+++}$ compound, di[hexamminechromium(III)] dodecahydrododecaborate tetranitrate, can be prepared by carrying out the reaction at room temperature in more dilute solution. Alternatively, the product of the foregoing example can be made directly from $[\text{Cr}(\text{NH}_3)_5(\text{H}_2\text{O})](\text{NO}_3)_3$ as the chromium-containing reactant.

EXAMPLE V

Di[hexamminecobalt(III)] decahydrododecaborate tetranitrate

A solution of 6.17 g. of $(\text{NH}_4)_2\text{B}_{10}\text{H}_{10}$ in 10 ml. of water was made acid with dilute nitric acid and added to a solution of 13.89 g. of $[\text{Co}(\text{NH}_3)_6](\text{NO}_3)_3$ in 155 ml. of water at 67° C. Warming the mixture to 75° C. gave a complete solution. On cooling, deep-orange, transparent crystals of di[hexamminecobalt(III)] decahydrododecaborate tetranitrate, $[\text{Co}(\text{NH}_3)_6]_2(\text{B}_{10}\text{H}_{10})(\text{NO}_3)_4$, precipitated and were worked up by the method of Example I. The yield was 11.55 g. Recrystallization from 130 ml. of water at 70° C. gave 8.03 g. of product, which was recrystallized once more from water for analysis.

Analysis.—Calcd. for $[\text{Co}(\text{NH}_3)_6]_2(\text{B}_{10}\text{H}_{10})(\text{NO}_3)_4$: B, 14.95; Co, 17.11; N, 32.74. Found: B, 14.73; Co, 16.96, 16.75; N, 31.65, 31.37.

The infrared absorption spectrum of the product (mineral-oil mull) remained essentially unchanged by the recrystallizations. The product exploded when struck by a hammer on a hard surface and flashed when dropped on a hot surface.

EXAMPLE VI

Di[nitratopentamminechromium(III)] decahydrododecaborate dinitrate

A solution of 6.17 g. of $(\text{NH}_4)_2\text{B}_{10}\text{H}_{10}$ in 10 ml. of water was acidified with 0.5 ml. of 1.6 N nitric acid and added to a solution of 13.61 g. of $[\text{Cr}(\text{NH}_3)_5](\text{NO}_3)_3$ in 140 ml. of water at 57° C. Adding 10 ml. of water and warming to 65° C. gave a complete solution. On cooling, transparent, orange-yellow, plate-like

8

crystals of di[nitratopentamminechromium(III)] decahydrododecaborate dinitrate

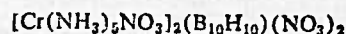

separated and were worked up by the method of Example I. The yield was 10.2 g. Recrystallization from 135 ml. of water at 60° C. gave 7.36 g. of product.

Analysis.—Calcd. for

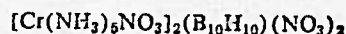

B, 16.89; Cr, 16.24; N, 30.61. Found: B, 17.40; Cr, 15.40, 15.20; N, 29.79, 29.48.

Hexacoordination of the chromium atoms in this product also may be attained by bridging of the chromium atoms through the $\text{B}_{10}\text{H}_{10}^{=}$ anion, in which case the product would be formulated as

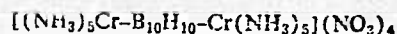

It is also possible that the chromium atoms are penta-coordinated, in which case the product would be formulated as $[\text{Cr}(\text{NH}_3)_5(\text{B}_{10}\text{H}_{10})(\text{NO}_3)]_2$.

The product exploded when struck sharply with a hammer on a hard surface or when dropped on a heated surface, and was sensitive to light.

EXAMPLE VII

Tris(ethylenediamine)cobalt(III) decahydrododecaborate nitrate dihydrate

$(\text{Coen}_3)(\text{NO}_3)_3$, a known compound, was prepared by air oxidation of an aqueous solution of cobalt(II) nitrate, ethylenediamine, and ethylenediamine nitrate. This is a well-known method for preparing complex cobalt(III) salts from cobalt(II) salts. See for example, "Inorganic Syntheses," vol. II, page 221 (McGraw-Hill, 1946).

A solution of 1.54 g. of $(\text{NH}_4)_2\text{B}_{10}\text{H}_{10}$ in 3 ml. of water was added to a solution of 4.25 g. of

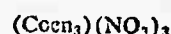

in 6 ml. of water at 80° C. On cooling, tris(ethylenediamine)cobalt(III) decahydrododecaborate nitrate dihydrate, $(\text{Coen}_3)(\text{B}_{10}\text{H}_{10})(\text{NO}_3) \cdot 2\text{H}_2\text{O}$, separated in yellow needles. The yield was 3.16 g. The product was recrystallized from 15 ml. of water at 80° C. for characterization.

Analysis.—Calcd. for

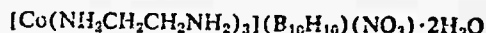

B, 23.75; Co, 12.94; N, 21.52. Found: B, 25.07; Co, 12.25, 12.01, 12.48, 12.10; N, 22.64, 22.88, 23.17.

The product exploded on contact with concentrated nitric acid. A piece of filter paper impregnated with the product from aqueous solution and dried flashed violently when touched with a free flame.

EXAMPLE VIII

Tris(ethylenediamine)cobalt(III) decahydrododecaborate nitrate monohydrate

$(\text{Coen}_3)(\text{B}_{10}\text{H}_{10})(\text{NO}_3) \cdot 2\text{H}_2\text{O}$ was prepared as described in Example VII and dehydrated for 16 hours over phosphorus pentoxide at 25° C. and less than 0.01 mm. pressure. This treatment resulted in a 3.8% loss in weight, corresponding to removal of one mole of water, to give tris(ethylenediamine)cobalt(III) decahydrododecaborate nitrate monohydrate.



Analysis.—Calcd. for

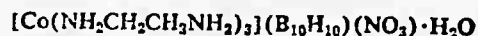

C, 16.47; H, 8.29; B, 24.73; Co, 13.47; N, 22.41. Found: C, 16.67, 16.19, 16.50; H, 8.85, 8.64, 8.10; B, 24.97, 24.79; Co, 13.61, 13.38; N, 23.41, 23.67.

Subsequent treatment of the product at 100° C. and less than 0.01 mm. pressure over phosphorus pentoxide for

23 hours did not remove any significant additional amount of water. The infrared absorption spectrum of the product was essentially the same as that of the dihydrate of Example VII. The product was more sensitive to shock, however, than the dihydrate, as judged by the ease with which it exploded when struck by a hammer.

EXAMPLE IX

Di[hexaminecobalt(III)] decahydrodecaborate bischromate

$[\text{Co}(\text{NH}_3)_6](\text{NO}_3)(\text{CrO}_4)$ was prepared by the method described for the preparation of $[\text{Co}(\text{NH}_3)_6]_2(\text{CrO}_4)_3$ in Gmelin's "Handbuch der Anorganischen Chemie," 8 Auflage 58, Bd. XVIII, p. 68. The product was recrystallized twice before analysis. It was shown to have the indicated structure, rather than that reported in Gmelin, by its analysis and infrared absorption spectrum.

Analysis.—Calcd. for $\text{Co}(\text{NH}_3)_6(\text{NO}_3)(\text{CrO}_4)$: Co, 17.38; Cr, 15.34; N, 28.91. Found: Co, 18.18, 18.06; Cr, 15.06, 14.95; N, 28.90, 28.88.

The presence of a nitrate group was confirmed by absorption in the vicinity of 7.3μ and sharp absorption at 12.1μ in the infrared.

A solution of 5.36 g. of $[\text{Co}(\text{NH}_3)_6](\text{NO}_3)(\text{CrO}_4)$ in 510 ml. of water was prepared by heating the water to 99°C . and then adding the cobalt compound. Addition of a solution of 1.05 g. of $(\text{NH}_4)_2\text{B}_{10}\text{H}_{10}$ in 5 ml. of water to the hot solution caused immediate precipitation of a shiny, orange-yellow solid, which was worked up by the method of Example I to give 5.39 g. of di[hexaminecobalt(III)] decahydrodecaborate bischromate, $[\text{Co}(\text{NH}_3)_6]_2(\text{B}_{10}\text{H}_{10})(\text{CrO}_4)_2$.

Analysis.—Calcd. for $[\text{Co}(\text{NH}_3)_6]_2(\text{B}_{10}\text{H}_{10})(\text{CrO}_4)_2$: B, 16.09; Co, 17.53; Cr, 15.47; N, 24.99. Found: B, 16.59; Co, 18.23, 18.44; Cr, 15.22, 15.20; N, 24.99, 24.92.

The product exploded when struck sharply with a hammer on a hard surface and flashed explosively when treated with concentrated nitric acid or dropped on a hot surface.

EXAMPLE X

Tris(2,2'-bipyridyl)cobalt(III) decahydrodecaborate perchlorate

$(\text{Cobipy}_3)(\text{ClO}_4)_3 \cdot 3\text{H}_2\text{O}$ (bipy=2,2' - bipyridyl) was

prepared by the method of Burstall and Nyholm, J. Chem. Soc. 1952, 3578.

A solution of 1.05 g. of $(\text{NH}_4)_2\text{B}_{10}\text{H}_{10}$ in 2 ml. of water was added to a solution of 6.0 g. of

$(\text{Cobipy}_3)(\text{ClO}_4)_3 \cdot 3\text{H}_2\text{O}$

in 55 ml. of water at 80°C . The hot solution was rapidly cooled, whereupon a reddish-brown solid precipitated. The latter was worked up by the method of Example I to give 4.92 g. of tris(2,2'-bipyridyl)cobalt(III) decahydrodecaborate perchlorate, $(\text{Cobipy}_3)(\text{B}_{10}\text{H}_{10})(\text{ClO}_4)_3$.

Analysis.—Calcd. for

$[\text{Co}(\text{C}_{10}\text{H}_8\text{N}_2)_3](\text{B}_{10}\text{H}_{10})(\text{ClO}_4)_3$

B, 14.52; Cl, 4.76; Co, 7.91; N, 11.28. Found: B, 12.54; Cl, 5.61, 5.68; Co, 7.08, 7.20; N, 10.88, 10.52.

The solid product exploded when struck a sharp blow by a hammer on a hard surface, when dropped on a heated surface, or when mixed with concentrated nitric acid.

The products and processes of this invention have been illustrated by the foregoing specific examples; however, the invention is generic to the products defined on pages 1-2 and the processes defined on pages 9-10. Additional examples of cobalt(III) and chromium(III) ammine polyhydroborate salts and the reactants from which they can be prepared are listed in Table I. The cobalt- and chromium-containing starting materials either are known compounds or can be prepared by modifications of procedures described in this application or in the literature. For convenience, all the reactants and products have been depicted in their anhydrous forms; it is to be understood, however, that hydrates of the reactants can be used, and that the products may be isolated from aqueous medium as hydrates.

A procedure somewhat similar to that of Example II may be used to prepare the products labeled XI-XVII in the table; while the general method of Example VII may be employed to obtain the products listed as XVIII-XXIV in the table. Product XXV is prepared by a method generally equivalent to that of Example X; and products XXVI-XXX may be produced by a process based on Example I.

TABLE I

Reactants	Product
XI..... $[\text{Co}(\text{NH}_3)_6](\text{NO}_3) + (\text{NH}_4)_2\text{B}_{10}\text{H}_{10}$	$[\text{Co}(\text{NH}_3)_6](\text{NO}_3)(\text{B}_{10}\text{H}_{10})$
XII..... $[\text{Co}(\text{NH}_3)_6](\text{BrO}_3) + \text{LiB}_{10}\text{H}_{10}$	$[\text{Co}(\text{NH}_3)_6](\text{BrO}_3)(\text{B}_{10}\text{H}_{10})$
XIII..... $[\text{Cr}(\text{NH}_3)_6](\text{NO}_3) + (\text{NH}_4)_2\text{B}_{10}\text{H}_{10}$	$[\text{Cr}(\text{NH}_3)_6](\text{NO}_3)(\text{B}_{10}\text{H}_{10})$
XIV..... $[\text{Co}(\text{NH}_3)_6](\text{NO}_3) + (\text{NH}_4)_2\text{B}_{10}\text{H}_{10}$	$[\text{Co}(\text{NH}_3)_6](\text{NO}_3)(\text{B}_{10}\text{H}_{10})$
XV..... $[\text{Co}(\text{NH}_3)_6](\text{IO}_3) + \text{NaB}_{10}\text{H}_{10}$	$[\text{Co}(\text{NH}_3)_6](\text{IO}_3)(\text{B}_{10}\text{H}_{10})$
XVI..... $[\text{Co}(\text{NH}_3)_6](\text{ClO}_4) + \text{K}_2\text{B}_{10}\text{H}_{10}$	$[\text{Co}(\text{NH}_3)_6](\text{ClO}_4)(\text{B}_{10}\text{H}_{10})$
XVII..... $[\text{Co}(\text{NH}_3)_6](\text{ClO}_4) + \text{K}_2\text{B}_{10}\text{H}_{10}$	$[\text{Co}(\text{NH}_3)_6](\text{ClO}_4)(\text{B}_{10}\text{H}_{10})$
XVIII..... $\left[\text{Co} \left(\begin{array}{c} \text{CH}_2 \\ \\ \text{CH}_2 - \text{CN} - \text{NH}_2 \\ \\ \text{CH}_2 - \text{CH} - \text{NH}_2 \end{array} \right) \right]_3 (\text{NO}_3)_3 + \text{Na}_2\text{B}_{10}\text{H}_{10}$	$\left[\text{Co} \left(\begin{array}{c} \text{CH}_2 \\ \\ \text{CH}_2 - \text{CN} - \text{NH}_2 \\ \\ \text{CH}_2 - \text{CH} - \text{NH}_2 \end{array} \right) \right]_3 (\text{B}_{10}\text{H}_{10})(\text{NO}_3)_3$
XIX..... $[\text{Cr}(\text{H}_2\text{NCH}_2\text{CH}_2\text{NH}_2)]_3(\text{NO}_3)_3 + (\text{NH}_4)_2\text{B}_{10}\text{H}_{10}$	$[\text{Cr}(\text{H}_2\text{NCH}_2\text{CH}_2\text{NH}_2)]_3(\text{B}_{10}\text{H}_{10})(\text{NO}_3)_3$
XX..... $[\text{Co}(\text{H}_2\text{NCH}_2\text{CH}_2\text{CH}_2\text{NH}_2)]_3(\text{NO}_3)_3 + \text{Na}_2\text{B}_{10}\text{H}_{10}$	$[\text{Co}(\text{H}_2\text{NCH}_2\text{CH}_2\text{CH}_2\text{NH}_2)]_3(\text{B}_{10}\text{H}_{10})(\text{NO}_3)_3$
XXI..... $[\text{Co}(\text{NH}_3)(\text{H}_2\text{NCH}_2\text{CH}_2\text{NH}_2)]_3(\text{H}_2\text{O})(\text{NO}_3)_3 + \text{Li}_2\text{B}_{10}\text{H}_{10}$	$[\text{Co}(\text{NH}_3)(\text{H}_2\text{NCH}_2\text{CH}_2\text{NH}_2)]_3(\text{H}_2\text{O})(\text{B}_{10}\text{H}_{10})(\text{NO}_3)_3$
XXII..... $\left[\text{Co} \left(\begin{array}{c} \text{H}_2\text{N} \\ \\ \text{H}_2\text{N} \end{array} \right) \right]_3 (\text{NO}_3)_3 + \text{K}_2\text{B}_{10}\text{H}_{10}$	$\left[\text{Co} \left(\begin{array}{c} \text{H}_2\text{N} \\ \\ \text{H}_2\text{N} \end{array} \right) \right]_3 (\text{B}_{10}\text{H}_{10})(\text{NO}_3)_3$
XXIII..... $[\text{Cr}(\text{H}_2\text{NCH}_2\text{CH}_2\text{NH}_2)]_3(\text{Cr}_2\text{O}_7)_2 + (\text{NH}_4)_2\text{B}_{10}\text{H}_{10}$	$[\text{Cr}(\text{H}_2\text{NCH}_2\text{CH}_2\text{NH}_2)]_3(\text{B}_{10}\text{H}_{10})(\text{Cr}_2\text{O}_7)_2$
XIV..... $[\text{Co}(\text{H}_2\text{NCH}_2\text{CH}_2\text{NH}_2)]_3(\text{NH}_3)_3(\text{MnO}_4)_2 + \text{Na}_2\text{B}_{10}\text{H}_{10}$	$[\text{Co}(\text{H}_2\text{NCH}_2\text{CH}_2\text{NH}_2)]_3(\text{NH}_3)_3(\text{B}_{10}\text{H}_{10})(\text{MnO}_4)_2$

TABLE I—Continued

Reactants	Product
XXV..... $\left[\text{Co} \left(\text{C}_{10}\text{H}_6\text{N}_2 \right) \right] (\text{NO}_3)_4 + \text{Li}_2\text{B}_{10}\text{H}_{12}$	$\left[\text{Co} \left(\text{C}_{10}\text{H}_6\text{N}_2 \right) \right] (\text{B}_{10}\text{H}_{10})(\text{NO}_3)_4$
XXVI.... $[\text{Cr}(\text{H}_2\text{NCH}_2\text{CH}_2\text{NH}_2)_2(\text{H}_2\text{NCH}_2\text{CH}_2\text{NH}_2)]_2(\text{B}_{10}\text{H}_{10}) + \text{KNO}_3$	$[\text{Cr}(\text{H}_2\text{NCH}_2\text{CH}_2\text{NH}_2)_2(\text{H}_2\text{NCH}_2\text{CH}_2\text{NH}_2)]_2(\text{B}_{10}\text{H}_{10})(\text{NO}_3)_4$
XXVII... $[\text{Co}(\text{H}_2\text{NCH}(\text{CH}_3)\text{CH}_2\text{NH}_2)]_2(\text{B}_{10}\text{H}_{10}) + \text{NH}_4\text{NO}_3$	$[\text{Co}(\text{H}_2\text{NCH}(\text{CH}_3)\text{CH}_2\text{NH}_2)]_2(\text{B}_{10}\text{H}_{10})(\text{NO}_3)_4$
XXVIII.. $[\text{Co}(\text{H}_2\text{NCH}_2\text{CH}_2\text{NH}_2)]_2(\text{B}_{10}\text{H}_{10}) + \text{Na}_2\text{Cr}_2\text{O}_7$	$[\text{Co}(\text{H}_2\text{NCH}_2\text{CH}_2\text{NH}_2)]_2(\text{B}_{10}\text{H}_{10})(\text{CrO}_3)_2$
XXIX.... $[\text{Cr}(\text{NH}_3)_3(\text{B}_{10}\text{H}_{10})] \text{FNaO}_4$	$[\text{Cr}(\text{NH}_3)_3(\text{B}_{10}\text{H}_{10})(\text{NO}_3)]_2$
XXX..... $[\text{Cr}(\text{NH}_3)_3(\text{B}_{10}\text{H}_{10})] \text{FNaClO}$	$[\text{Cr}(\text{NH}_3)_3(\text{B}_{10}\text{H}_{10})(\text{ClO})]_2$

Utility of the products

The products of this invention are useful as explosives. They are especially useful as one or more of the active components of electric blasting caps.

A typical cap is shown in the accompanying drawing. It is constructed and charged as follows: The cap comprises a bronze shell 11, of length 1/4 in., outer diameter 0.272 in., and average inner diameter 0.26 in. At the bottom of the shell, adjacent to the closed end, is loaded and pressed at 200 lbs. a base charge 12. Above the base charge is loaded and pressed at 200 lbs. a primer charge 13, and above the primer charge is inserted a loose (unpressed) ignition charge 14. A nickel/chromium (80/20) bridge wire 15 of resistance $1.37 \pm 0.50 \Omega$, soldered to and connecting the terminals of the lead wires 16, is embedded in the igniting charge. The shell is sealed with a rubber plug 17, which also holds the lead wires firmly in position. The lead wires are 1/8 in. apart and project 1/4 in. below the bottom of the rubber plug. Alternatively, other conventional shell-sealing means can be used. After the cap is charged and the plug is inserted, three peripheral crimps 18 are made in the shell wall to seal the plug.

The following examples illustrate the use of the products of this invention as components of electric blasting caps.

EXAMPLE A

The cap described above was loaded with four grains of pressed $[\text{Co}(\text{NH}_3)_6]_2(\text{B}_{10}\text{H}_{12})(\text{NO}_3)_4 \cdot 2\text{H}_2\text{O}$ as the base charge, four grains of pressed lead azide as the primer charge, and four grains of loose (unpressed) "50/25/25" commercial ignition mixture (50% by weight smokeless powder, 25% lead salt of dinitro-o-cresol, and 25% potassium chlorate) as the igniting charge. The cap was placed with its bottom (the integrally closed end) against a 1/8 in. lead plate and detonated by passage of a 5-ampere current through the lead wires and the bridge wire. The detonation blew a hole in the lead plate of a size and pattern corresponding to good explosive activity for the cobalt salt as a base charge. Essentially the same result was obtained when

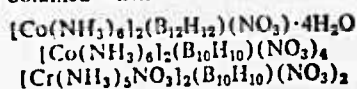

or $(\text{Coen}_3)(\text{B}_{10}\text{H}_{10})(\text{NO}_3) \cdot \text{H}_2\text{O}$ was substituted for

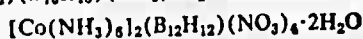

as the base charge in this test.

EXAMPLE B

The experiment of Example A was repeated, except that the cap was loaded with four grains of pressed PETN (pentaerythritol tetranitrate) as the base charge, four grains of pressed



as the primer charge, and four grains of the loose

"50/25/25" commercial ignition mixture of Example A as the igniting charge. The detonation blew a hole in the lead plate of essentially the size and shape of the bottom of the cap, which result showed that the chromium compound had good activity as a primer charge. Similar results were obtained when

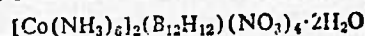

or

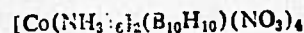

was substituted for

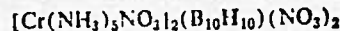

as the primer charge in this test.

EXAMPLE C

The experiment of Example A was repeated with four grains of pressed PETN as the cap base charge, four grains of pressed lead azide as the primer charge, and four grains of loose

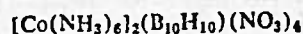

as the igniting charge. The detonation blew a hole in the lead plate similar to that described in Example B, showing that the cobalt compound had good activity as an igniting charge for the electric blasting cap.

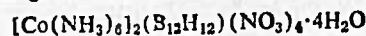

the corresponding dihydrate



and

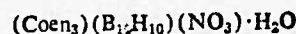

each gave essentially the same results when substituted for

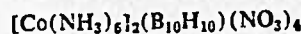

as the igniting charge in this test.

EXAMPLE D

The experiment of Example A was repeated, except that the cap contained four grains of pressed

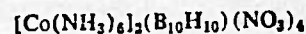

as the base charge, another four grains of the same compound (pressed) as the primer charge, and still another four grains of the same compound in loose form as the igniting charge. Detonation blew a hole in the lead plate of essentially the size and pattern of the one that resulted in Example A. Substitution of

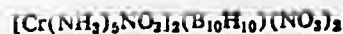

or

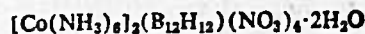

for

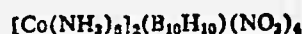

gave essentially the same result.

The results of Example D confirm what is shown by Examples A, B, and C, viz., that products of this inven-

tion not only are useful as explosives but moreover are exceptionally useful in electric blasting caps and other electrically actuated initiators and ignitors, in that they can function as base charges, primer charges, and/or ignition charges. This combination of functions is shown by only very few other compounds, e.g., mercury fulminate. It is significant that this combination of properties is not shown by complex cobalt and chromium ammine salts containing oxidizing anions but no polyhydropolyborate anions, e.g., $[\text{Cr}(\text{NH}_3)_6](\text{NO}_3)_3$, $[\text{Co}(\text{NH}_3)_6](\text{NO}_3)_3$, and $(\text{Coen}_3)(\text{NO}_3)_3$, which have long been known to be explosive under certain conditions (see, for example, Tomlinson et al., J. Am. Chem. Soc. 71, 375 (1949)). Furthermore, the cobalt and chromium ammine salts containing no polyhydropolyborate anions are much less powerful explosives than the products of the present invention when used as single components of blasting caps, i.e., as base chargers, primer charges, or ignition charges. This is shown conclusively by the fact that when

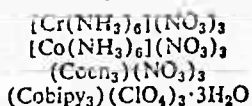

or

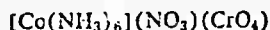

was used as the test compound in any of examples A, B, or C, no hole at all was blown in the lead plate when the cap was detonated.

As many apparently widely different embodiments of this invention may be made without departing from the spirit and scope thereof, it is to be understood that this invention is not limited to the specific embodiments thereof shown herein.

The embodiments of the invention in which an exclusive property or privilege is claimed are defined as follows:

1. Compounds selected from the class consisting of
- I. compounds of the formula

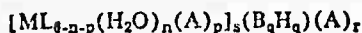

wherein

(1) the bracketed moiety represents a metal ammine cation in which M is selected from the class consisting of trivalent hexacoordinated cobalt and trivalent hexacoordinated chromium; L represents a ligand selected from the class consisting of ammonia, monoprimary amines, heterocyclic amines, saturated acyclic 1,2- and 1,3-diprimary amines of 2-5 carbon atoms, saturated alicyclic 1,2-diprimary amines, aromatic 1,2-diprimary amines, heterocyclic 1,2-ditertiary amines and saturated aliphatic straight-chain tri- and tetramines; n is a whole number of from 0 to 1, inclusive, and represents the number of coordinated water (H_2O) molecules in the cation; p is a whole number of from 0 to 1, inclusive, and represents the number of coordinated A anions in the cation; the sum of n and p at most is 1; and s is a whole number of 1 to 2, inclusive, and represents the number of cation entities present;

(2) the entity (B_qH_q) represents a divalent polyhydropolyborate anion in which q is a whole number selected from the class consisting of 10 and 12; and

(3) A represents an anion derived from an oxy-acid of an element selected from the groups of the Periodic Table consisting of Groups VA, VIB, VIIA and VIIB; and r represents the number of A groups in the compound outside the metal ammine cation and is a whole number of from 0 to four, inclusive, which is determined by the formula

$$r = \frac{s(3-pa) - 2}{a}$$

wherein a is the valence of the anion A and the remaining letters are defined as above, with the proviso that $(r+p)$ is greater than zero; and

II. hydrates thereof.

2. The compounds of claim I wherein L is selected from the class consisting of ammonia, saturated acyclic 1,2-diprimary amines of 2-5 carbons, o-phenylenediamine, 2,2'-bipyridyl and o-phenanthroline; and A is selected from the class consisting of nitrate, chromate, dichromate, permanganate, hypochlorite, chlorite, chlorate, bromate, iodate, perchlorate and periodate.
3. Hexamminecobalt(III) dodecahydrododecaborate nitrate dihydrate.
4. Tris(ethylenediamine)cobalt(III) decahydrodecaborate nitrate monohydrate.
5. Tris(2,2'-bipyridyl)cobalt(III) decahydrodecaborate perchlorate.
6. Di[hexamminecobalt(III)] decahydrodecaborate bischromate.
7. A product having the formula

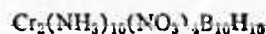

said product being formed by the process of reacting $[\text{Cr}(\text{NH}_3)_6](\text{NO}_3)_3$ with a salt selected from the class consisting of ammonium and alkali metal decahydrodecaborates and isolating the resulting product.

8. Process which comprises reacting a metal ammine salt in which the metal is selected from the class consisting of chromium and cobalt in the hexacoordinated trivalent state, wherein the ammine ligand is selected from the class consisting of ammonia and amines and the anions of said salt are oxidizing anions with a reduction potential of at least 0.5 v., with a polyhydropolyborate salt wherein the cation is selected from the class consisting of ammonium and alkali metal, and the anion is selected from the class consisting of $\text{B}_{10}\text{H}_{10}^-$ and $\text{B}_{12}\text{H}_{12}^-$ and isolating the resulting product consisting of a double salt having cations of a metal ammine, an anion selected from $\text{B}_{10}\text{H}_{10}^-$ and $\text{B}_{12}\text{H}_{12}^-$ and at least one oxidizing anion with a reduction potential of at least 0.5 v.

9. Process which comprises reacting a metal ammine salt wherein the metal is selected from the class consisting of chromium and cobalt in the hexacoordinated trivalent state, wherein the ammine ligand is selected from the class consisting of ammonia and amines and the anion of said salt is selected from the class consisting of $\text{B}_{10}\text{H}_{10}^-$ and $\text{B}_{12}\text{H}_{12}^-$, with a salt wherein the cation is selected from the class consisting of ammonium and alkali metal and the anion is an oxidizing anion with a reduction potential of at least 0.5 v., and isolating the resulting product consisting of a double salt having cations of a metal ammine, an anion selected from $\text{B}_{10}\text{H}_{10}^-$ and $\text{B}_{12}\text{H}_{12}^-$ and at least one oxidizing anion with a reduction potential of at least 0.5 v.

References Cited

UNITED STATES PATENTS

3,107,613	10/1963	Armstrong et al.	23-14 X
3,126,305	3/1964	Armstrong	23-14 X
3,148,939	9/1964	Knoth	23-14
3,169,045	2/1965	Miller et al.	23-14
3,184,286	5/1965	England	23-14
3,256,056	6/1966	Armstrong	23-361

FOREIGN PATENTS

70 613,367 1/1961 Canada.

OSCAR R. VERTIZ, Primary Examiner.

Nov. 19, 1968

J. H. BALTHIS, JR

3,411,890

CHEMICAL PRODUCTS AND PROCESSES

Filed July 11, 1962

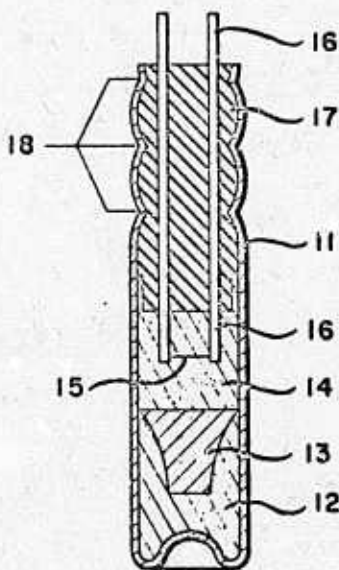

INVENTOR
JOSEPH H. BALTHIS, JR.

BY

C. Harold Allen
ATTORNEY

1

3,426,071
**METHOD OF PREPARING TETRAETHYLAM-
MONIUM DECAHYDRODECABORATE(2)**
Gerald T. Hefferan, Butler, Pa., assignor to Mine Safety
Appliances Company, a corporation of Pennsylvania
No Drawing. Filed Jan. 22, 1968, Ser. No. 699,363
U.S. Cl. 260-567.6 2 Claims
Int. Cl. C07f 5/02

ABSTRACT OF THE DISCLOSURE

Tetraethylammonium decahydrodecaborate (2) is made by pyrolyzing tetraethylammonium octahydrotriborate in triethylamine borane solvent.

The co-pending application of Makhlof and Hough, Ser. No. 579,220, now United States Patent No. 3,373,203 filed Sept. 14, 1966, of common ownership with this application, discloses the heating of tetraethylammonium octahydrotriborate to thermally decompose it to produce tetraethylammonium decahydrodecaborate.

In accordance with this invention, this thermal decomposition, or pyrolysis, is accomplished by heating a solution of tetraethylammonium octahydroborate in triethylamine. The use of the triethylamine borane solvent permits better temperature control as well as a somewhat lower reaction temperature than when pyrolyzing the solid salt. The solution pyrolysis, because the solution temperature is easily controlled and kept uniform throughout by conventional processing methods, is readily useable in large scale operations.

To illustrate this invention, 60.02 grams of

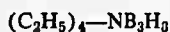

and 118.31 grams of $(C_2H_5)_3NBH_3$ were placed under a nitrogen atmosphere in a glass reactor equipped with a stirrer and having an outlet discharging through a Dry Ice condenser and a wet test meter. The mixture was heated with stirring to 170-173° C.; solution occurred at 100-106° C. with gas evolution and a solid again precipitated at about 168° C. The reaction mixture was kept at 170-173° C. for six hours until gas evolution ceased.

2

Pyrolysis by-product triethylamine (0.14 mole) was recovered in the Dry Ice condenser and 22.4 liters of gases, primarily hydrogen and ethane, discharged through the wet test meter. The reaction mixture was cooled to room temperature and triethylamine borane solvent was filtered from the solid pyrolysis products, residual solvent being recovered by pentane wash. All of the triethylamine borane (118.23 g.) was recovered. The solid products (41 g.) were treated with hot water to separate a soluble fraction (29.1 g.) identified as $[(C_2H_5)_4N]_2B_{10}H_{10}$ by infrared analysis. The elemental analysis of the product was: B, 25.9 milliatoms (mats.)/g.; C, 41.0 mats./g.; N, 6.85 mats./g.; and H, 134.1 mats./g. compared to theoretical values of B, 26.4 mats./g.; C, 42.3 mats./g.; N, 5.3 mats./g.; and H, 132 mats./g.

The pyrolysis occurs at temperatures above about 170° C. and it is generally preferred to use temperatures between 170° C. and 180° C. The amount of solvent used is not critical to the operability of the method, but it is preferred to use at least enough solvent to completely dissolve the octahydroborate, suitably at least about 2 parts by weight of triethylamine borane for each part by weight of tetraethylammonium octahydroborate.

According to the provisions of the patent statutes, I have explained the principle and mode of practice of my invention and have described what I now consider to represent its best embodiment. However, I desire to have it understood that, within the scope of the appended claims, the invention may be practiced otherwise than as specifically described.

I claim:

1. A method of preparing tetraethylammonium decahydrodecaborate (2) that comprises thermally decomposing a solution of tetraethylammonium octahydrotriborate in triethylamine borane.

2. A method according to claim 1 in which the temperature is between about 170 and 180° C.

References Cited

UNITED STATES PATENTS

3,373,202 3/1968 Makhlof et al. 260-567.6
3,373,203 3/1968 Makhlof et al. 260-567.6

CHARLES B. PARKER, *Primary Examiner*.

S. T. LAWRENCE III, *Assistant Examiner*.

field not high

1

2

3,431,089

REACTION PRODUCTS AND PROCESSES

Vaughn A. Engelhardt, Wilmington, Del., assignor to E. I. du Pont de Nemours and Company, Wilmington, Del., a corporation of Delaware
No Drawing. Filed May 31, 1962, Ser. No. 199,572
U.S. Cl. 23-358 11 Claims
Int. Cl. C01b 35/00, 21/00

This invention relates to new compounds containing boron and to methods for preparing the compounds.

Boron compounds, principally salts of boric acid, have been in commercial use for many years. Recently other boron compounds, e.g., low molecular weight boron hydrides, have achieved technical importance in applications employing oxidizing and reducing agents. There are many potential applications, however, for which the available boron compounds are unsuited because of hydrolytic, oxidative or other types of instability. To illustrate, diborane, chlorodiborane, pentaborane(9) and trialkylboron compounds are spontaneously flammable in air. Diborane, pentaborane(9), chlorodiborane, boron trichloride, iododecaborane(14), and most other boron halides are hydrolyzed rapidly in water or alcohol. Even the most stable known borohydride, i.e., decaborane(14), is hydrolyzed at a moderate rate in water. Known ionic borohydrides, e.g., tetrahydroborates (NaBH_4 , and the like), are hydrolyzed at a rapid rate at 100°C .

A broad class of boron compounds has now been found which show good hydrolytic and oxidative stability.

The novel boron compounds of this invention are polyhydropolyborates consisting of (1) a group of 20 cojoined boron atoms and 18 hydrogen atoms bonded to boron, and (2) a group selected from ammonium, N-monosubstituted ammonium, N-disubstituted ammonium, hydrazinium, N-monosubstituted hydrazinium, and N-disubstituted hydrazinium which groups form cations in aqueous or alcoholic solutions.

The compounds of the invention are further defined by the following generic formula:



where M is a cation selected from ammonium, mono-substituted ammonium, disubstituted ammonium, hydrazinium, monosubstituted hydrazinium and disubstituted hydrazinium groups; *a* and *b* are the smallest positive whole numbers which satisfy the equation:

$$b = \frac{a \times \text{valence of M}}{2} \quad (2)$$

Thus, M is a cation which is derived from ammonia, primary amines, secondary amines, hydrazine, mono-substituted hydrazines and disubstituted hydrazines. The primary amines and secondary amines can have more than one primary or secondary amine group, e.g., diaminoethane, 1,6-diaminohexane, 1,4-diaminocyclohexane, 1,5-diamino-3-azapentane, p-phenylenediamine, piperazine, and the like. Preferably the number of amine groups in the primary and secondary amines from which M is derived is at most three.

The cation groups which are within the scope of M can be represented as NH_4^+ , RNH_3^+ , R_2NH_2^+ , NH_2NH_3^+ , $\text{R}'\text{NHNH}_3^+$, $\text{R}'\text{NHNR}'\text{H}_2^+$, and $\text{R}'_2\text{NNH}_3^+$. R and R' are monovalent organic groups bonded to the nitrogen through carbon.

The characteristics of the R groups, which are bonded to the nitrogens of the cations derived from primary and secondary amines, are not critical features of these groups. Thus, the R groups can be open-chain, closed-chain, saturated or unsaturated hydrocarbon groups or substituted hydrocarbon groups. The R groups can be aliphatic, cycloaliphatic, aromatic or heterocyclic in

character. When two R groups are bonded to nitrogen, the groups can form a ring of which the nitrogen is a member, e.g., morpholine, thiamorpholine, hexamethyleneimine, piperidine, piperazine, and the like. Preferably, for reasons of availability of amines, the R group contains a chain of 1-18 carbons with at most one interrupting atom which is oxygen, nitrogen or sulfur, in which chain any aliphatic unsaturation (i.e., unsaturation other than aromatic) is at most one carbon to carbon double bond and any substituents, if present, are halogen, cyano, hydroxyl or amine (the last group shares in cation formation). In a more restricted sense the R groups can be alkyl, cycloalkyl, alkenyl, cycloalkenyl, aryl, aralkyl, alkaryl, and heterocyclic. To illustrate, R can be methyl, 2-ethylhexyl, octadecyl, allyl, crotyl, octadecenyl, cyclohexyl, cyclohexenyl, phenyl, naphthyl, anthryl, phenanthryl, cyclohexylphenyl, terphenyl, chloroethyl, fluoro-propyl, bromobutyl, β -hydroxyethyl, p-hydroxyphenyl, and the like.

R' groups bonded to hydrazinium cations are preferably alkyl or aryl groups of up to 8 carbons, e.g., methyl, ethyl, hexyl, octyl, phenyl, tolyl, xylyl, and the like. Thus, hydrazinium cations can be derived, e.g., from phenylhydrazine, methylhydrazine, 1,1-dimethylhydrazine, 1,2-dimethylhydrazine, ethylhydrazine, 1,1-diethylhydrazine, and similar compounds.

The valence of the cation M will be determined, of course, by the number of basic nitrogen groups which are present in the amine from which the cation is derived. To illustrate, cations from ammonia, hydrazines, mono- and disubstituted monoamines are monovalent, cations from diamino-substituted compounds are divalent, cations from triamino-substituted compounds are trivalent, and the like.

The group $(\text{B}_{20}\text{H}_{18})$

The novel and characterizing feature of the compounds of the invention is the polyhydropolyborate group $(\text{B}_{20}\text{H}_{18})^{-2}$. The group is represented generically as having a negative ionic charge of 2 and the group, therefore, behaves in chemical reactions as a divalent anion. The group, chemically, is exceptionally stable. It is not easily decomposed by hydrolysis, oxidation or reduction and it is resistant to thermal decomposition. The group is unchanged in simple metathetic reactions, a property which allows the preparation of a broad range of salts in which the cation is represented by M, as defined in Formula 1.

In addition to its exceptional stability, the $\text{B}_{20}\text{H}_{18}^{-2}$ anion undergoes electrophilic substitution reactions in a manner which resembles the behavior of carbocyclic aromatic compounds, e.g., benzene and naphthalene, to obtain compounds in which 1 to 18 hydrogens bonded to boron are replaced by monovalent substituents (organic and inorganic).

The behavior of the boron-containing group in substitution reactions is particularly surprising in view of the inorganic composition of the group.

Characteristics of the compound

The compounds are generally crystalline solids with the high-melting points which are characteristic of salts. They are stable under conventional storage conditions and can be kept for prolonged periods without decomposition. The salts are generally yellow in color and they are soluble in hydroxylated solvents, e.g., water, alcohol, and the like, to form intensely yellow solutions. The compounds show characteristic and identifying absorption bands in the infrared spectrum at approximately the following wavelengths (expressed as microns): 11.3, medium; 11.5, strong; 12.1, strong; 12.8, medium; 13.4, strong; 13.7, medium, shoulder; 14.4, strong; and 15.0, strong. Shifts in the characteristic bands can occur through the

influence of the cation in the compound and some variation in the above values may, therefore, be noted.

The following examples illustrate the compounds of the invention:

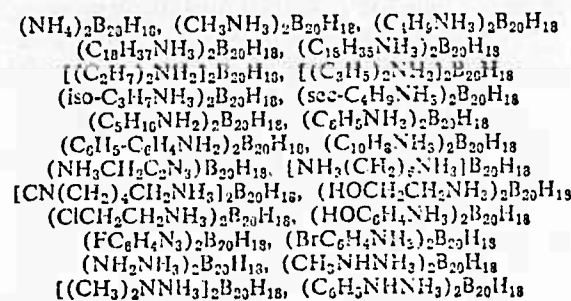

and the like.

Preparation of the compounds

The compounds of the invention are obtained by oxidizing a decahydrodecaborate(2-) salt, isolating a salt of the octadecaheptacosaborate(2-) from the reaction mixture and, optionally, contacting the salt so obtained with a salt having the cation M, and isolating a compound of Formula 1.

In the nomenclature used above the numbers in parenthesis, e.g., (2-), represent the valence of the anion.

The decahydrodecaborate salt employed as a reactant in the oxidation step is a compound of the following formula:



where M' is a cation, i.e., a group which bears a positive charge in aqueous solution, and a' and b' represent the smallest positive whole numbers which satisfy the equation

$$b' = \frac{a' \times \text{valence of M}'}{2} \quad (4)$$

The compounds of Formula 3 are not commonly known and preparation of a representative compound is described in the examples. Any decahydrodecaborate(2-) can be employed, i.e., compounds in which M' is any group which can form a cation in water, are operable. For reasons of availability and cost, it is preferred to use decahydrodecaborates of Formula 3 in which M is hydrogen, hydronium, ammonium, substituted ammonium, an alkali metal or an alkaline earth metal. Specific illustrations of the classes of preferred reactants are H₂B₁₀H₁₀ and its hydrates,

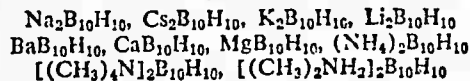

and the like.

Oxidation step to B₂₀H₁₀²⁻ compounds

Oxidation of the decahydrodecaborate reactant is accomplished either chemically or electrolytically.

In chemical oxidation the oxidizing reagent or oxidant is a compound having as a characteristic component a metal of variable valence, which metal is in its highest valence state, said compound having an oxidation-reduction potential in acid solution of about -1.33 to about -1.61 volts. The oxidation-reduction potential of a compound is a recognized and measurable property for which values are found in readily available texts, e.g., "Oxidation Potentials," by W. G. Latimer, 2nd ed., Prentice-Hall, New York (1952), particularly p. 344. Examples of classes of compounds which are operable in the process are dichromates, aurates, higher oxides of lead, manganese salts, permanganates, higher oxides of bismuth and salts of tetravalent cerium.

The chemical oxidation process is conducted by simple

and uncomplicated procedures in conventional equipment. A solvent is generally employed which preferably is hydroxylated, e.g., methanol, water, and the like. Water is most conveniently used and it is therefore the preferred solvent.

The ratio in which the reactants are employed is not a critical factor for operability. However, the use of an excess of oxidant may lead to a decrease in yield of the desired product. It is preferable to employ at most two oxidation equivalents of the oxidant (based on the metal) per mole of B₁₀H₁₀²⁻ salt or acid used in the process. The preferred mole ratio of oxidant to polyhydrodecaborate can be determined by methods described in Handbook of Chemistry and Physics, 38th ed., p. 1583, Chemical Rubber Publishing Co. (1956).

Pressure is not a critical factor in the process and atmospheric pressure is normally used. However, if desired, pressures higher or lower than atmospheric can be employed. The temperature of the reaction is also not critical. Normally, the reaction is conducted at prevailing atmospheric temperature but temperatures as low as 0° C. and as high as 100° C. can be employed. Preferred temperatures of operation lie between about 10° and 75° C.

The reaction proceeds rapidly and a measurable quantity of product is obtained within a short time. Normally the reactants are maintained in contact for a sufficient period to assure maximum yield. The time of reaction can range from a few minutes to 24 hours or more.

In the operation of the process it is preferable (although not essential) to add the oxidant to the decaborate to reduce the vigor of the reaction and to obtain the maximum yield of desired product. Normally, therefore, the reaction vessel is charged with the solvent and the decahydrodecaborate. The chemical oxidant, which is handled conveniently in solution, is added gradually to the vessel at a rate which provides a controllable reaction. After all of the oxidant has been added, the reaction mixture can be stirred for a short period and a solution containing a compound having a desired cation is added. At this stage in the process the solution which is added can contain a cation which falls within the scope of M as defined in Formula 1 or it can be any other cation-forming group. Frequently salts of alkali metals or of quaternary ammonium bases are employed. The selection of the cation at this point in the process is solely a matter of convenience and availability of reactants.

The polyborate salt may precipitate at this stage but, in the event precipitation does not occur, the solution is evaporated to a volume at which the solid separates. The product is purified by conventional procedures, e.g., crystallization, to obtain a salt of the divalent anion, B₂₀H₁₀²⁻ having a cation which falls within the scope of M in Formula 1 or within the broader scope of M' in Formula 3.

The electrolytic oxidation process is conducted by well known procedures which are described in texts, e.g., see Glasstone, "Introduction to Electrochemistry," Chap. XV, D. Van Nostrand Co., 5th ed. (1951). The decahydrodecaborate salt is dissolved in an aprotic solvent to provide a solution of satisfactory conductivity to which sufficient current is applied to release gas at the cathode. An aprotic solvent is a liquid which has no tendency to release or to accept protons (see Möeller, "Inorganic Chemistry," p. 312 (1954), John Wiley & Sons, Inc.).

The solvents employed in the process are usually polar organic liquids, e.g., nitriles, tertiary nitrogen bases, N,N-disubstituted amides, and the like. Examples of suitable solvents are acetonitrile, pyridine, N,N-dimethylaniline, dimethylformamide, and combinations of these liquids. A current of at least one ampere and one volt is usually employed. These conditions are not critical and they are used solely to illustrate a satisfactory method of operation. The process is conducted conveniently at atmospheric temperature, i.e., about 25° C. although lower and higher temperatures can be used, e.g., as low as 0° C. or

as high as 100° C. The preferred temperature range lies between 10° and 60° C.

The salt is formed in the electrolytic oxidation process by methods described for the chemical oxidation process.

In the event the salt of the $B_{20}H_{18}^{-2}$ anion, as isolated in the above processes, does not contain a cation M which falls within the scope of Formula 1 or in the event it is desired to obtain a salt with a different cation M, the octadecahydroicosaborate salt, as isolated from the process, can be reacted with a wide range of salts which have a cation which falls within the scope of the definition of M to obtain the compounds of the invention. This optional step in the process is simply a metathetic reaction of the kind which is well known in chemical work.

A second optional procedure which is convenient and of wide operability consists in contacting a solution of the $B_{20}H_{18}^{-2}$ salt, as isolated in the process, with a strong acid to obtain a solution of the acid $H_2B_{20}H_{18}$ [expressed also as $(H_3O)_2B_{20}H_{18}$]. To illustrate, a solution of a $B_{20}H_{18}^{-2}$ salt is contacted with a solution of hydrogen chloride or with a commercial acid ion-exchange resin of the cross-linked polystyrenesulfonic acid type. The solutions of the acid obtained in this manner can be neutralized with ammonia, primary and secondary amines, hydrazine and substituted hydrazines to obtain compounds of Formula 1, generally in solution. These solutions can be concentrated under reduced pressure to obtain the compounds of Formula 1 in a solid crystalline state.

The products of the invention and processes for obtaining them are illustrated in the following examples. The preparation of a representative compound of the type $M'_n(B_{20}H_{18})_m$, which is employed as a principal reactant, is illustrated in Example A and the preparation of the acid salt containing the $B_{20}H_{18}^{-2}$ anion, employed in metathetic reactions, is illustrated in Examples B through D.

EXAMPLE A

(A) Preparation of bis(dimethyl sulfide)decaborane (12)

A reaction vessel having a capacity of about 365 g. of water is charged with 0.79 g. of decaborane (14), cooled in liquid nitrogen, and then evacuated to a pressure of 10 microns of mercury. Approximately 21 g. of dimethyl sulfide is condensed onto the decaborane in the reaction vessel. The reaction vessel is closed, allowed to warm to room temperature and stand for 4 days. During this time, 6.6 millimoles of hydrogen is evolved. The reaction vessel is opened and excess dimethyl sulfide is removed by distillation, leaving a practically quantitative yield of white solid residue of $B_{10}H_{12} \cdot 2(CH_3)_2S$. The compound is recrystallized from ethyl acetate and it melts at 122–124° C. The compound is called bis(dimethyl sulfide)decaborane (12).

The above procedure is equally operable with other organic sulfides.

(B) Preparation of $M'_2B_{10}H_{10}$ (where M' is NH_4)

Bis(dimethyl sulfide)decaborane (12) (8.5 g.) is mixed with 50 ml. of liquid ammonia and stirred in a round-bottom reaction vessel for 1 hour with the vessel being cooled to a temperature of about -50° C. by partial immersion in a bath of a mixture of solid carbon dioxide and acetone. The cooling bath is then removed and the excess ammonia is allowed to evaporate with stirring. The remaining traces of ammonia are removed by subjecting the residue to a high vacuum (0.01 mm. of mercury) at 25° C. There is obtained 5.6 g. of solid residue which is virtually a quantitative yield of $(NH_4)_2B_{10}H_{10}$.

EXAMPLE B

A reaction vessel is charged with 100 ml. of water and 1.46 g. of $(NH_4)_2B_{10}H_{10}$. The mixture is stirred and a solution of 5.4 g. of $Ce(NH_4)_2(NO_3)_6$ in 80 ml. of water is added gradually. Evolution of gas occurs and a deep blue-violet solution forms. A concentrated aqueous solution of $(CH_3)_4NCl$ is added to the reaction mixture

with stirring and in sufficient amount to precipitate completely a violet-colored solid. The solid is separated by filtration and it is purified by crystallization from hot water to yield the yellow compound, bis(tetramethylammonium) octadecahydroicosaborate (2-).

The compound is soluble in acetonitrile, hot methanol and hot water. The identity of the product is confirmed by elemental analysis.

Analysis.—Calc'd for $[(CH_3)_4N]_2B_{20}H_{18}$: C, 25.10; H, 11.06; N, 7.32; B, 56.64; eq. wt., 191.4. Found: C, 26.28; H, 11.49; N, 7.55, 7.80; B, 54.28; eq. wt., 188, 204.

The identity of the compound is further confirmed by measuring the number of moles of hydrogen obtained from the boron moiety ($B_{20}H_{18}$) upon complete hydrolysis to boric acid. The values for moles H_2 obtained per mole $[(CH_3)_4N]_2B_{20}H_{18}$ are as follows: Calc'd, 40.0; found, 39.904 and 40.086.

EXAMPLE C

A solution of $[(CH_3)_4N]_2B_{20}H_{18}$ in methanol-water is passed through a column packed with a commercial acidic ion-exchange resin of the polyarylsulfonic acid type. The effluent is a solution of the acid $H_2B_{20}H_{18}$, or, expressed as a hydronium acid, $(H_3O)_2B_{20}H_{18}$. The aqueous solution is used without further processing to prepare salts of the acid.

The solid acid is obtained by evaporating the aqueous solution, prepared as described above, to dryness at very low pressure (less than 0.1 mm. of mercury). The acid, which forms large intensely colored yellow crystals, contains 6 moles of water of hydration, of which 2 moles are considered to be associated with the proton cations. The identity of the compound is confirmed by elemental analysis.

Analysis.—Calc'd for $(H_3O)_2B_{20}H_{18} \cdot 4H_2O$: H, 9.36; B, 62.80. Found: H, 8.91; B, 63.65.

The solid yellow crystals of the hydrated acid obtained above are very hygroscopic. They dissolve in water to form clear solutions.

EXAMPLE D

A portion of an aqueous solution of the dibasic acid, prepared as described in Example C, is titrated with an aqueous solution of sodium hydroxide until the reaction mixture is neutral (pH=7). The resulting aqueous solution is yellow and its ultraviolet spectrum shows absorption in regions which are characteristic for salts of the $B_{20}H_{18}$ anion.

The yellow solution is evaporated to dryness under reduced pressure (less than 1 mm. of Hg) to obtain crude $Na_2B_{20}H_{18}$ as a tan-colored solid. The compound is purified by crystallization from methanol. The product so obtained contains water of crystallization.

Analysis.—Calc'd for $Na_2B_{20}H_{18} \cdot 2H_2O$: B, 68.34; H, 7.07. Found: B, 68.21; H, 7.25.

The compound can, if desired, be obtained free of solvent of crystallization by heating for a time at very low pressure. The molecular weight of the compound $Na_2B_{20}H_{18}$, determined by freezing point depression in aqueous solution, gives the following values: 103, 99, 89, 88, i.e., an average mol. wt. of 95; calc'd value: 93.3.

The ultraviolet spectrum of the sodium salt in solution in acetonitrile shows major absorption maxima at 282 $m\mu$ and 233 $m\mu$.

The processes of Examples B through D illustrate generic methods of preparing salts and the acid of the $B_{20}H_{18}^{-2}$ anion. Compounds of Formula 1 can be obtained directly from the oxidation process by employing in the final step a salt which has the cation M as defined for Formula 1. To illustrate, in Example B, NH_4Cl , CH_3NH_3Cl , $C_6H_5NH_3Cl$, $C_6H_5(CH_3)NH_2Cl$, and the like can be used in place of $(CH_3)_4NCl$ to obtain $(NH_4)_2B_{20}H_{18}$, $(CH_3NH_3)_2B_{20}H_{18}$, $(C_6H_5NH_3)_2B_{20}H_{18}$, $(C_6H_5NH_2CH_3)_2B_{20}H_{18}$, and the like salts directly.

7

The acid of Example C can, of course, be neutralized with ammonium hydroxide or with any primary or secondary amine to obtain compounds of Formula 1. This procedure is illustrated in Examples I and VI, and it is also illustrated for an alkali metal hydroxide in Example D to obtain a metal salt for further metathetic reactions.

EXAMPLE I

An aqueous solution of $H_2B_{20}H_{18}$, prepared as described in Example C, is neutralized with an aqueous solution of NH_4OH to a pH value of 7. The solution, which is clear yellow, is evaporated to dryness, leaving

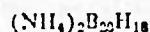

as a pale yellow solid residue. The identity of the compound is confirmed by its infrared absorption spectrum which shows bands at 3.08μ , 3.92μ , 4.0μ and 7.09μ and also in the 10-15 μ region.

Analysis.—Calc'd for $(NH_4)_2B_{20}H_{18} \cdot 1/2H_2O$: N, 10.02; H, 9.73; B, 77.40. Found: N, 10.09, 10.18; H, 9.55, 9.87; B, 77.74, 77.60.

The process of Example I illustrates the preparation of the compounds of the invention by neutralization of the acid, $H_2B_{20}H_{18}$, with a nitrogen base. The process is generic for the preparation of compounds of Formula 1. To illustrate, a solution of the acid $H_2B_{20}H_{18}$ is neutralized with $C_2H_5NH_2$ to obtain $(C_2H_5NH_3)_2B_{20}H_{18}$, with $C_3H_7NH_2$ to obtain $(C_3H_7NH_3)_2B_{20}H_{18}$, with $(CH_3)_3CNH_2$ to obtain $[(CH_3)_3CNH_3]_2B_{20}H_{18}$, and with $HOCH_2CH_2CH_2NH_2$ to obtain



EXAMPLE II

A quantity (ca. 1 ml.) of isopropylamine is neutralized with aqueous dilute hydrochloric acid. An aqueous solution containing an equivalent quantity of $Na_2B_{20}H_{18}$, prepared as described in Example D, is added to the solution with stirring. The solution is cooled with stirring and a flocculent precipitate forms. The precipitate is separated and dried in air to obtain di(isopropylammonium) octadecahydroeicosaborate(2-). The identity of the compound which has the formula



is confirmed by its infrared absorption spectrum.

The process of Example II illustrates the preparation of compounds of Formula 1 where M is derived from an aliphatic primary amine. It also illustrates the process in which the nitrogen base is employed in the form of a salt with a mineral acid. The process is generically applicable to the preparation of salts of this type by a simple metathetic reaction employing alkali metal salts of $B_{20}H_{18}$. To illustrate, $Na_2B_{20}H_{18}$ is reacted with the hydrochlorides of CH_3NH_2 to obtain $(CH_3NH_3)_2B_{20}H_{18}$, of $C_4H_9NH_2$ to obtain $(C_4H_9NH_3)_2B_{20}H_{18}$, of $C_{10}H_{21}NH_2$ to obtain $(C_{10}H_{21}NH_3)_2B_{20}H_{18}$, of $CH_3(CH_2)_2CH(C_2H_5)CH_2NH_2$ to obtain $[CH_3(CH_2)_2CH(C_2H_5)CH_2NH_3]_2B_{20}H_{18}$, of $C_{15}H_{37}NH_2$ to obtain $(C_{15}H_{37}NH_3)_2B_{20}H_{18}$, of



to obtain $(C_3H_7NH_3)_2B_{20}H_{18}$, of $C_{16}H_{35}NH_2$ to obtain $(C_{16}H_{35}NH_3)_2B_{20}H_{18}$, of $C_{10}H_{21}NH_2$ to obtain



of $C_6H_{11}NH_2$ to obtain $(C_6H_{11}NH_3)_2B_{20}H_{18}$, of



to obtain $(C_2H_5OC_2H_4NH_3)_2B_{20}H_{18}$, of $HOCH_2CH_2NH_2$ to obtain $(HOCH_2CH_2NH_3)_2B_{20}H_{18}$, of $ClCH_2CH_2NH_2$ to obtain $(ClCH_2CH_2NH_3)_2B_{20}H_{18}$, of



to obtain $(CH_2CH_2OCH_2CHNH_3)_2B_{20}H_{18}$, and with the

8

hydrochloride of $HOOC(CH_2)_2CH_2NH_2$ to obtain $[HOOCCH_2(CH_2)_2CH_2NH_3]_2B_{20}H_{18}$.

The hydrochlorides of amino acids, e.g., glycine, alanine, tyrosine, and the like can be reacted with an alkali metal salt of $B_{20}H_{18}^{2-}$ to obtain salts such as

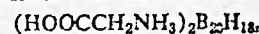

$[HOOCCH(CH_3)NH_3]_2B_{20}H_{18}$, and

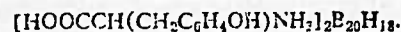

Hydrochlorides of diamines can be employed in the process, e.g., $Na_2B_{20}H_{18}$ can be reacted with the hydrochlorides of 1,2-diaminoethane to yield

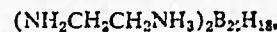

of 1,6-diaminohexane to yield $[NH_2(CH_2)_6NH_3]_2B_{20}H_{18}$, and the like.

Salts other than hydrochlorides can be employed, e.g., sulfate and phosphate salts of amines are operable.

EXAMPLE III

A reaction vessel is charged with about 1 ml. of aniline and dilute hydrochloric acid is added until the solution is slightly acid. An aqueous solution containing approximately an equivalent quantity of $Na_2B_{20}H_{18}$, prepared as described in Example D, is added gradually with stirring. The solution, which is clear at this point, is cooled and stirred. A precipitate forms which is separated by filtration and dried in air. The product so obtained is $(C_6H_5NH_3)_2B_{20}H_{18}$. Its identity is confirmed by its infrared absorption spectrum.

Example III illustrates the preparation of compounds of Formula 1 where M is derived from an aromatic primary amine, employing a simple metathetic reaction. It also illustrates the process employing the aromatic amine in the form of a salt with a mineral acid. The process is generic to the preparation of salts of this type. Any alkali metal or alkaline earth metal salt of $B_{20}H_{18}^{2-}$ can be employed, e.g., the Li, Na, K, Rb, Cs, Ba, Mg, and like salts. To illustrate, $Na_2B_{20}H_{18}$ can be reacted with the hydrochlorides of $ClC_6H_4NH_2$ to obtain

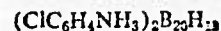

of $BrC_6H_4NH_2$ to obtain $(BrC_6H_4NH_3)_2B_{20}H_{18}$, of $FC_6H_4NH_2$ to obtain $(FC_6H_4NH_3)_2B_{20}H_{18}$, of $C_{10}H_7NH_2$ to obtain $(C_{10}H_7NH_3)_2B_{20}H_{18}$, of $HOC_6H_4NH_2$ to obtain $(HOC_6H_4NH_3)_2B_{20}H_{18}$, of $(C_6H_5)_2NH$ to obtain



of $CH_3C_6H_4NH_2$ to obtain $(CH_3C_6H_4NH_3)_2B_{20}H_{18}$, and of $C_{12}H_{25}C_6H_4NH_2$ to obtain $(C_{12}H_{25}C_6H_4NH_3)_2B_{20}H_{18}$. Hydrochlorides of aralkylamines are operable and can be employed, e.g., $C_6H_5CH_2NH_2 \cdot HCl$ and $Na_2B_{20}H_{18}$ yield $(C_6H_5CH_2NH_3)_2B_{20}H_{18}$. Hydrochlorides of aromatic amines with two or more amine groups can be employed, e.g., $Na_2B_{20}H_{18}$ reacts with the hydrochlorides of $NH_2C_6H_4NH_2$ to yield $(NH_2C_6H_4NH_3)_2B_{20}H_{18}$, of triaminobenzene to yield $[C_6H_3(NH_3)_3]_2(B_{20}H_{18})_2$, and the like.

The process is operable with other mineral acid salts of aromatic amines, e.g., sulfate and phosphate salts.

EXAMPLE IV

A reaction vessel is charged with approximately 1 ml. of dicyclohexylamine. Aqueous dilute hydrochloric acid is added gradually and a pale yellow solid forms. The solid is dissolved in hot aqueous methanol and an aqueous solution of $Na_2B_{20}H_{18}$, prepared as described in Example D, is added with stirring. The solution is cooled to about 25° C. and a yellow solid precipitates. The solid is separated and dried in air to obtain bis(dicyclohexylammonium) octadecahydroeicosaborate(2-) as a yellow crystalline compound. The identity of the compound, which has the formula $[(C_6H_{11})_2NH_3]_2B_{20}H_{18}$, is confirmed by its infrared absorption spectrum.

The process of Example IV illustrates the preparation of compounds of Formula 1 from secondary amines. The process is generically applicable to the preparation of compounds of this type. To illustrate, an alkali metal salt of $B_{20}H_{18}^{-2}$ will react with the hydrochlorides of $C_6H_{11}NHCH_3$ to obtain $(C_6H_{11}NH_2CH_3)_2B_{20}H_{18}$, of $CH_3NHCH_2C_6H_{17}$ to obtain $(CH_3NH_2C_6H_{17})_2B_{20}H_{18}$, of $(C_{12}H_{25})_2NH$ to obtain $[(C_{12}H_{25})_2NH_2]_2B_{20}H_{18}$, of $(C_3H_7)_2NH$ to obtain $[(C_3H_7)_2NH_2]_2B_{20}H_{18}$, of



to obtain $[(ClCH_2CH_2)_2NH_2]_2B_{20}H_{18}$, of $C_6H_5NHCH_3$ to obtain $(C_6H_5NH_2CH_3)_2B_{20}H_{18}$, of $C_{10}H_7NHC_2H_5$ to obtain $(C_{10}H_7NH_2C_2H_5)_2B_{20}H_{18}$, and of



to obtain $[(HOCH_2CH_2)_2NH_2]_2B_{20}H_{18}$.

Amine salts of other mineral acids, as described for earlier examples, can be used in the process of Example IV.

EXAMPLE V

A reaction vessel is charged with approximately 1 ml. of piperidine and diluted hydrochloric acid is added until the solution is slightly acid. An aqueous solution of $H_2B_{20}H_{18}$, prepared as described in Example C, is added gradually to the piperidinium hydrochloride solution until no further precipitation of a solid occurs. The precipitate is separated by filtration and dried in air to obtain substantially pure dipiperidinium octadecahydroeicosaborate as a yellow crystalline solid. The identity of the compound, which has the formula $(C_5H_{10}NH_2)_2B_{20}H_{18}$, is confirmed by its infrared absorption spectrum.

The process of Example V illustrates the compounds of the invention where M is a heterocyclic amine. The process is generic to compounds of this type. To illustrate, the acid $H_2B_{20}H_{18}$ will react with the hydrochlorides

of morpholine to form $(\overline{CH_2CH_2OCH_2CH_2NH_2})_2B_{20}H_{18}$,

of $\overline{NHCH_2CH_2NHCH_2CH_2}$ to yield



and of $\overline{CH_2CH_2NHCH_2CH_2}$ to yield



EXAMPLE VI

About 0.5 g. of the crystalline acid, dihydrogen octadecahydroeicosaborate(2-) containing 5-6 moles of water of hydration (prepared as described in Example C) is mixed with sufficient hydrazine (95%+ purity) to form a solution of $(NH_2NH_3)_2B_{20}H_{18}$ in hydrazine. The solution is yellow in color.

The dihydrazinium octadecahydroeicosaborate(2-) can be used in hydrazine solution or it can be isolated by careful evaporation of the solution at low temperatures (about 30° C. or less) under reduced pressure to form a crystalline, hygroscopic solid.

The dihydrazinium salt dissolves readily in hydrazine to form solutions which contain a high concentration of the $B_{20}H_{18}^{-2}$ anion. The solutions, preferably, are maintained at room temperature (ca. 25° C.) or lower. When the solutions are warmed, bubbles form and a gas is released.

The mixture now at this stage is a solution of



in hydrazine.

The solution is diluted with water and an aqueous solution of $TiNO_3$ is added. The precipitate which forms is separated and dried in air to yield $Ti_4B_{20}H_{18}$ as a hydrate. The compound is a white crystalline product whose identity is confirmed by its infrared absorption spectrum.

$(NH_2NH_3)_4B_{20}H_{18}$ is conveniently handled in solution in hydrazine from which it can be isolated, if desired, as a white crystalline solid, by evaporation of the hydrazine. Hydrazine solutions of $(NH_2NH_3)_4B_{20}H_{18}$ containing up to 50% or more by weight of the salt are stable compositions having a high boron content.

The process of Example VI illustrates the compounds of Formula 1 where M is derived from a hydrazine. The process is generic to compounds of this type. To illustrate, the acid $H_2B_{20}H_{18}$ will react with $(CH_3)_2NNH_2$ to form $[(CH_3)_2NNH_3]_2B_{20}H_{18}$, with $C_6H_5NHNH_2$ to form $(C_6H_5NHNH_3)_2B_{20}H_{18}$, and with $C_6H_5NHNH_2$ to form $(C_6H_5NHNH_3)_2B_{20}H_{18}$.

The invention provides a broad class of new boron compounds which find applications in many fields.

The compounds of the invention are useful as impregnating agents in the preparation of resistors. To illustrate, a section of a cotton string is immersed in a nearly saturated solution of $(NH_4)_2B_{20}H_{18}$ in water. The string is withdrawn from the solution and the solvent is removed by drying in air. A free flame is applied to the dried impregnated string and it burns freely and vigorously to yield a coherent ash which in size and shape resembles the original string. The residual skeleton is of sufficient coherence to permit embedding in paraffin. The section of residue, so treated, shows a resistance on the order of 700,000 ohms/cm. The residue from a control section of string is very small and shapeless and it cannot be handled.

All of the compounds of the invention are useful as components of fireworks compositions to impart a pleasing color and sparkle to the display, e.g., $(NH_4)_2B_{20}H_{18}$, $(C_6H_5NH_2)_2B_{20}H_{18}$, and like salts, such as the dicyclohexyl-ammonium and piperidinium salts, can be used in such compositions.

The compounds of the invention are useful as components for high energy fuels. Solutions of the hydrazine salts in a hydrazine, as well as solutions of other salts of Formula 1 in a hydrazine, are useful as propellant fuels, either alone or in combination with an oxidant.

As many apparently widely different embodiments of this invention may be made without departing from the spirit and scope thereof, it is to be understood that this invention is not limited to the specific embodiments thereof except as defined in the appended claims.

The embodiments of the invention in which an exclusive property or privilege is claimed are defined as follows:

1. A compound of the formula



wherein a and b are the smallest positive whole numbers which satisfy the equation

$$b = \frac{a \cdot \text{valence of } M}{2}$$

and M is a cation selected from the class consisting of

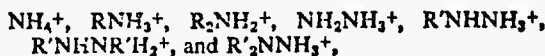

wherein R and R' are monovalent organic groups of up to 18 carbons bonded to the nitrogen through carbon.

2. A compound of claim 1 in the hydrated form.

3. A compound of claim 1 wherein R , taken separately, is a group of up to 18 carbon atoms and is selected from the class consisting of

alkyl, cycloalkyl, alkenyl, cycloalkenyl, aryl, aralkyl, and alkaryl, wherein any substituents on the above hydrocarbon radicals are selected from the class consisting of

hydrogen, halogen, cyano, hydroxyl, and amine, and, taken together, forms a heterocyclic group with nitrogen, and R' is a group of up to 8 carbon atoms selected from the class consisting of alkyl and aryl.

11

4. $(\text{NH}_4)_2\text{B}_{20}\text{H}_{18}$.
 5. A compound of claim 4 in the hydrated form.
 6. $[(\text{CH}_3)_2\text{C}(\text{I})\text{NH}_3]_2\text{B}_{20}\text{H}_{18}$.
 7. A compound of claim 6 in the hydrated form.
 8. $(\text{C}_6\text{H}_5\text{NH}_2)_2\text{B}_{20}\text{H}_{18}$.
 9. A compound of claim 8 in the hydrated form.
 10. $(\text{NH}_2\text{NH}_3)_2\text{B}_{20}\text{H}_{18}$.
 11. A compound of claim 10 in the hydrated form.

References Cited

UNITED STATES PATENTS

3,148,938	9/1964	Knoth	23—358
3,149,163	9/1964	Knoth	260—583
2,521,026	9/1950	Solomon	149—36 15

12

2,924,417	4/1960	Schulze	149—36
2,992,885	7/1961	Jackson et al.	23—14
3,051,546	8/1962	Miller	23—14

OTHER REFERENCES

- 5 Kaczmarczyk et al.: "Proceedings of The National Academy of Sciences, U.S.A.," volume 48, pp. 729-733 (May 1962).

EARL C. THOMAS, *Primary Examiner.*

10 H. S. MILLER, *Assistant Examiner.*

U.S. Cl. X.R.

1

3,446,604

ACID AND SALTS OF $B_{20}H_{18}^{-2}$ ION

Earl L. Muehlenberg, West Chester, Pa., assignor to E. I. du Pont de Nemours and Company, Wilmington, Del., a corporation of Delaware

No Drawing. Continuation-in-part of application Ser. No. 199,571, May 31, 1962. This application Oct. 9, 1963, Ser. No. 315,624

Int. Cl. C01b 6/08, 6/22

U.S. Cl. 23-354

16 Claims

ABSTRACT OF THE DISCLOSURE

The acid $H_4B_{20}H_{18}$ and salts thereof can be prepared by oxidizing a decahydrodecaborate (2^-) compound, and reducing the product. Cations can be exchanged by metathetical reaction. A hydroxyl group, a hydrocarbyloxy group or an amino group can be introduced by reacting $B_{20}H_{18}^{-2}$ anions with the appropriate base prior to reduction. The compounds have many uses such as the manufacture of resistive elements or can be used in the manufacture of fireworks.

DESCRIPTION OF THE INVENTION

This invention relates to new compounds containing boron and to methods for preparing the compounds.

This application is a continuation-in-part of my co-pending application, U.S. Ser. No. 199,571, filed May 31, 1962, now abandoned.

Boron compounds, principally salts of boric acid, have been in commercial use for many years. Recently other boron compounds, e.g., low molecular weight boron hydrides, have achieved technical importance in applications employing oxidizing and reducing agents. There are many potential applications, however, for which the available boron compounds are unsuited because of hydrolytic, oxidative or other types of instability. To illustrate, diborane, chlorodiborane, pentaborane(9) and trialkylboron compounds are spontaneously flammable in air. Diborane, pentaborane(9), chlorodiborane, boron trichloride, iododecaborane(14), and most other boron halides are hydrolyzed rapidly in water or alcohol. Even the most stable known borohydride, i.e., decaborane(14), is hydrolyzed at a moderate rate in water. Known ionic borohydrides, e.g., tetrahydroborates ($NaBH_4$, and the like), are hydrolyzed at a rapid rate at $100^\circ C$.

A class of boron compounds has now been obtained which show good hydrolytic and oxidative stability.

The novel compounds of the invention are the acid, $H_4B_{20}H_{18}$, salts of the acid and derivatives of either wherein one of the hydrogens bonded to boron in the $B_{20}H_{18}^{-4}$ anion is replaced by a substituent which can be hydroxyl ($-OH$), hydrocarbyloxy ($-OR$, where R is preferably an aliphatically saturated hydrocarbyl group), or amino ($-NH_2$).

The acid, $H_4B_{20}H_{18}$, and the acids of its substituted derivatives are tetrabasic acids in which the ionization constants for three of the acidic hydrogens are high and are in the class of strong mineral acids; while the ionization constant of the fourth hydrogen is low and approaches the value for organic acids. Because the ionization constant of the fourth acidic hydrogen is low, the formula $H_4B_{20}H_{18}$ may be written as $H_3(H^+B_{20}H_{18}^{-4})$ or alternatively as $H_2(H^+B_{20}H_{18}^{-3})$ or more simply



All of these alternative formulas denote the compound of the invention having the formula $H_4B_{20}H_{18}$ and it will be understood that said formula $H_4B_{20}H_{18}$ used herein is so defined.

2

Thus it is seen that when all four acidic hydrogens of $H_4B_{20}H_{18}$ are replaced by cations, neutral salts are formed. This usually occurs in the presence of a strong base. On the other hand, when a weak base is used, only the three strongly acidic hydrogens are replaced and the salt formed is an acid salt wherein the acid anion has the formula $(H^+B_{20}H_{18}^{-4})^{-3}$ or alternatively and more simply, $B_{20}H_{18}^{-3}$. Thus, salts of the acid anion can be viewed as salts of a tribasic anion or as acid salts of a tetrabasic anion.

Both neutral and acid salts of $H_4B_{20}H_{18}$ and the substitution products based thereon as defined earlier are included within the scope of this invention.

The novel products of the invention may be further defined as compounds of the formula



and hydrate thereof, where M is a cation, i.e., an atom or group of atoms which, in aqueous solution, can form one or more positively charged ions having a valence of 1 or more; X is $-OH$, $-OR$ (where R is a mono-valent hydrocarbyl group or radical), or $-NH_2$; n is a cardinal number of up to 1, i.e., 0-1, inclusive; a and b are the smallest whole numbers which satisfy the equation:

$$b = \frac{a \times \text{valence of M}}{4} \quad (2)$$

The divisor, i.e., 4, represents the valence of the anion.

Acids of the anion of Formula 1 are represented generically by the formula $H_4B_{20}H_{18-n}X_n$, wherein, as described earlier, three of the ionizable hydrogens are strongly acidic and the fourth is weakly acidic. Alternatively, acids of the anions of Formula 1 may be represented as $H_3(H^+B_{20}H_{18-n}X_n^{-4})$, $H_2(HB_{20}H_{18-n}X_n)$ or more simply as $H_2B_{20}H_{18-n}X_n$. Again, it will be understood that the formula $H_4B_{20}H_{18-n}X_n$ includes the alternatives in the previous sentence.

Salts of the acid anion, i.e., salts of $(HB_{20}H_{18-n}X_n)^3$ or more simply $(B_{20}H_{18-n}X_n)^{-3}$, fall within the scope of Formula 1 and they can be represented as a subgeneric group by the formula:

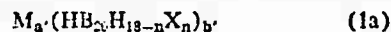

which can also be written conveniently as

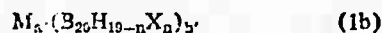

where M, X and n are defined as in Formula 1, and a' and b' are defined as the smallest whole numbers which satisfy the equation:

$$b' = \frac{a' \times \text{valence of M}}{3} \quad (2a)$$

The divisor, i.e., 3, represents the valence of the acid anion ($H^+B_{20}H_{18-n}X_n$ or $B_{20}H_{18-n}X_n$).

In an especially preferred form of the invention the group X in the above formulas is $-OH$ or $-OR$, where R is an aliphatically saturated hydrocarbyl group of up to 12 carbons (i.e., R is free of olefinic and acetylenic bonds; in other words, free of aliphatic unsaturation, but can contain aromatic unsaturation); and n is a cardinal number of up to 1, i.e., 0-1, inclusive. R, it is seen, covers alkyl, cycloalkyl, aryl, and aralkyl groups.

Compounds of Formulas 1 and 1a which are free of X groups (n=0) form an important subgeneric group which is represented by the following formula:

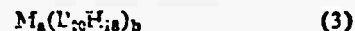

where M, a and b are defined as in Formula 1. Alternatively, a and b can be defined as the smallest whole numbers which satisfy the equation:

$$4b = a \times \text{valence of M} \quad (4)$$

The compounds of Formula 3, of course, include acid salts of the $B_{20}H_{18-n}X_n^{4-}$ anion as described for the compounds of generic Formula 1. The acid salts of the unsubstituted anion can be viewed, as described earlier, as salts of $(H_2B_2H_{18})^{-2}$ or $(B_2H_{18})^{-2}$. This subgeneric group of compounds is represented by the formula:

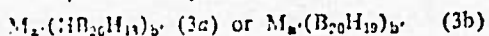

where M is defined as in Formula 1 and a' and b' are defined as in Formula 2a. Alternatively, a' and b' can be defined as the smallest whole numbers which satisfy the equation:

$$3b' = a'x \text{ valence of M} \quad (4a)$$

The compounds of the invention are obtained by oxidation or reduction processes or by combinations of these processes. Unsubstituted compounds of Formulas 3a and 3b are obtained by oxidation decahydrodecaborates(2-) (salt of the $B_{10}H_{12}^{-2}$ anion) or by reduction of octadecahydrodecaborates(2-) (salt of the $B_{20}H_{18}^{-2}$ anion). Compounds bearing X substituents are obtained by reaction of octadecahydrodecaborates(2-) with strong inorganic bases (NaOH, NaNH₂, etc.) or with metal salts of alcohols or phenols (Na ethoxide, K phenoxide, etc.). Methods of preparation will be described fully in later paragraphs.

The compounds of the invention are composed of two principal components which are represented by M and by the polyborate anion which in generic Formula 1 is $(B_{20}H_{18-n}X_n)^{4-}$. The component M and the polyborate anion, in its generic and subgeneric forms, will be discussed separately in the following paragraphs.

THE GROUP M

The group represented by M is a cation which can be composed of one or more than one element and which is ionically bonded to the boron-containing group. The group represented by M bear one or more positive ionic charges and may have in common the property of forming positively charged groups or cations in water. The sole function of the group M is to provide a component with the necessary positive charges which will combine with the negatively charged (or ionic) boron containing group in generic Formula 1 and thus permit isolation of the novel anion in the form of a compound. The properties of the group M are not critical and the group, therefore, represents a broad range of elements or combinations of elements. To illustrate, M can be hydrogen, which in aqueous solution forms a hydronium ion (H_3O^+), a metal, ammonium (NH_4^+), hydrazonium ($NH_2NH_3^+$) (also called hydrazinium), N-substituted ammonium, N-substituted hydrazinium, arylidiazonium (ArN_2^+), sulfonium, phosphonium, metal-amine, and the like.

The group M can be derived from any metal. The metals according to the Periodic Table in Deming's "General Chemistry," 5th ed., chap. II, John Wiley & Sons Inc., and in Lange's "Handbook of Chemistry," 9th ed., pp. 56-57, Handbook Publishers, Inc. (1956) are the elements of Groups I, II, VIII, III-B, IV-B, V-B, VI-B, VII-B, and the elements of Groups III-A, IV-A, V-A, and VI-A which have atomic numbers above 5, 14, 33, and 52, respectively. The metals can be light or heavy metals. To illustrate, M can be lithium, sodium, potassium, cesium, beryllium, barium, lanthanum, manganese, iron, cobalt, copper, zinc, mercury, aluminum, thallium, tin, lead, silver, or any other metal. Preferred metals are those whose valences are 1-3, inclusive.

An especially preferred group of metals from which M can be derived consists of elements of Groups I-A, II-A, I-B and II-B having atomic numbers up to and including 80. Most preferred metals are the alkali and alkaline earth metals, i.e., lithium, sodium, potassium, rubidium, cesium, beryllium, magnesium, calcium, strontium, and barium.

The group M can be a combination of a metal and ammonia or a metal and an amine, i.e., a Werner-type coordination complex referred to as a metal-amine group. To illustrate, M can be $[Ni(NH_3)_6]^{+2}$,

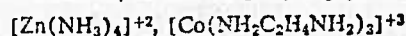

$[Ni(\text{pyridyl})_6]^{+2}$, $[Co(NH_3)_6]^{+3}$, $[Cu(NH_3)_4]^{+2}$, and the like. The group can be a metal with water of hydration, e.g., $[Cu(H_2O)_6]^{+2}$, $[Ni(H_2O)_6]^{+2}$, and the like.

The group M can be an N-substituted ammonium radical, an S-substituted sulfonium group and a P-substituted phosphonium group, having the formulas $R'NH_3^+$, $R'_2NH_2^+$, R'_3NH^+ , R'_4N^+ , R'_3S^+ , and R'_4P^+ . R' represents an organic group bonded to the nitrogen, sulfur or phosphorus. The R' groups are not critical features of these cation groups; thus, R' can be an open-chain, closed-chain, saturated or unsaturated hydrocarbon or substituted hydrocarbon group. R' can be an aliphatic, cycloaliphatic, aromatic or heterocyclic ring of which the nitrogen, sulfur or phosphorus atom is a component part. Thus, when M is a substituted ammonium group, R' can be derived from pyridine, quinoline, morpholine, hexamethylenimine, and the like. Preferably R' , for reasons of availability of reactants, contains at most 18 carbon atoms. For example, R' can be alkyl, alkenyl, cycloalkyl, cycloalkenyl, aryl, aralkyl, alkaryl, and the like. To illustrate specifically, R' can be methyl, 2-ethylhexyl, octadecyl, allyl, cyclohexyl, cyclohexenyl, phenyl, naphthyl, anthryl, cyclohexylphenyl, tolyl, xylyl, diphenyl, benzyl, chloroethyl, ω -cyanoamyl, β -hydroxyethyl, p-hydroxyphenyl, and the like.

The group M can be an N-substituted hydrazonium (also called hydrazinium) radical having the formula $(R'NHNH_2)^+$, $(R'_2NNH_2)^+$, and the like, wherein R' has the same definition as given in the preceding paragraph. To illustrate, the hydrazonium cation can be derived from phenylhydrazine, methylhydrazine, 1,1-dimethylhydrazine, 1,2-dimethylhydrazine, ethylhydrazine, 1,1-diethylhydrazine, and similar compounds.

The group M can yield one cation or more than one cation in aqueous solution, i.e., M can be a combination of cation-forming components. To illustrate, M can be composed of cations derived from sodium and potassium, cesium and ammonium, trimethylsulfonium and hydrogen, tetramethylammonium, ammonium and hydronium (hydronium), and the like. For mixed cations in which one of the cations is hydrogen, the compound is viewed, as described earlier, as a salt of the acid anion of Formula 3.

The cations "hydrogen" and "hydronium" are used herein as described on page 26 of "Nomenclature of Inorganic Chemistry—International Union of Pure and Applied Chemistry," published by Butterworth's Scientific Publications (1957).

The valence of the cation M will be between 1 and 4, i.e., M can have a valence of 1, 2, 3, or 4. In most cases the valence of M will be 1, 2, or 3. The group of compounds in which the valence of M is at most 3, are readily preparable and so form a preferred group of compounds of this invention.

THE GROUP $(B_{20}H_{18-n}X_n)^{4-}$

The novel and characterizing feature of the compounds of the invention is the polyhydrodecaborate group $(B_{20}H_{18-n}X_n)^{4-}$. The group is represented generically as having a negative ionic charge of 4 and in the presence of a strong base it behaves as a tetravalent anion. In the presence of a weak base or in neutral solution the anion is associated with a weakly acidic ionizable hydrogen to form an acid anion which can be viewed as having the formula $[H^+(B_{20}H_{18-n}X_n)^{4-}]$ and is written simply as $(B_{20}H_{19-n}X_n)^{-3}$.

The anionic group can be unsubstituted or it can bear one substituent designated as X. The substituent can be, as defined earlier, $-OH$, $-NH_2$, or $-OR$. The substitu-

ent is bonded to a boron atom of the B₂₀ unit and replaces a hydrogen atom bonded previously to the boron.

The anionic group, whether substituted or unsubstituted, or in neutral or acidic form, is exceptionally stable. The group is not easily decomposed by hydrolysis, oxidation or reduction and it is resistant to thermal decomposition. The group is unchanged in simple metathetic reactions, a property which permits the preparation of a broad range of neutral and acidic salts in which the cation is represented by M.

CHARACTERISTICS OF THE COMPOUNDS

The compounds are generally crystalline solids with the high-melting points which are characteristic of salts. They are stable under conventional storage conditions and can be kept for prolonged periods without decomposition.

The compounds of the neutral and acid anions, B₂₀H₁₈⁻⁴ and (H⁺B₂₀H₁₈⁻⁴)⁻³ or B₂₀H₁₉⁻³, and their substituted derivatives, in which the cation M contributes no color are usually white or colorless. The salts are appreciably soluble in water and hydroxylated solvents. In view of this property, the salts are readily separated from the less soluble salts of the divalent anion B₂₀H₁₈⁻² or its substituted derivatives, which may be present. The compounds of the invention are insoluble in oxygenated organic solvents such as acetone, ether, dimethylformamide, and the like.

Compounds of the unsubstituted tetravalent anion, i.e., B₂₀H₁₈⁻⁴, show characteristic and identifying absorption bands in the infrared spectrum at approximately the following wavelengths (expressed as microns): 4.1, very strong; 9.0, medium; 9.8, strong; and 12.6, very weak. Shifts in the characteristic bands can occur in view of the possible effect of the cation in the compounds.

Compounds of the unsubstituted acid anion show characteristic and identifying absorption bands in the infrared absorption spectrum at approximately the following wavelengths (expressed as microns): 4.0, strong; 5.4, medium; and 10.0, strong.

The properties of the acid salts, i.e., compounds of Formulas 1a and 3a, resemble closely the properties of the neutral salts. Salts of the acid anion (HB₂₀H₁₈⁻³ or B₂₀H₁₉⁻³) can be isolated readily in anhydrous form, i.e., free of solvent of crystallization. Salts of the neutral tetravalent anion (B₂₀H₁₈⁻⁴) are isolated most conveniently with solvent of crystallization. The salts of the acid anion may, therefore, be employed with advantage in fields where the presence of water or hydroxylated solvents is undesirable.

The acids of the anions of Formula 1 are readily soluble in water and their aqueous solutions are stable. The acids are conveniently handled in aqueous solutions and these solutions form a part of this invention. In the case of the acid derived from the anion bearing an —NH₂ substituent, one of the acidic protons can be associated firmly with the —NH₂ group, e.g., the acid derived from (B₂₀H₁₇NH₂)⁻⁴ may behave in aqueous solution in the presence of a weak base as an acid having the anion (B₂₀H₁₇NH₃)⁻³.

The following examples illustrate unsubstituted compounds of the invention:

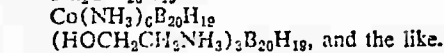
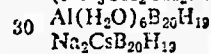
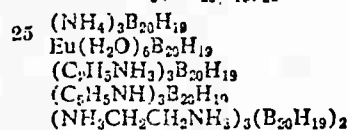
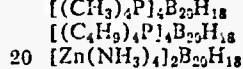
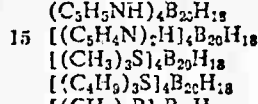
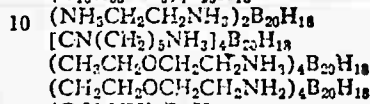
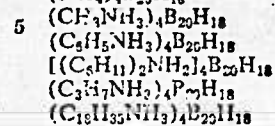
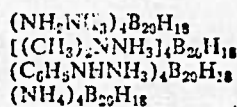
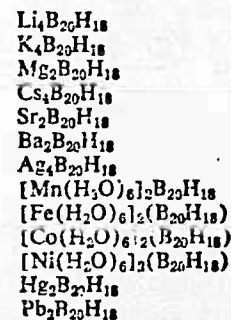

Compounds bearing hydroxyl substituents are represented generically by the formulas M_a(B₂₀H₁₇OH)_b (5) or M_a(B₂₀H₁₈CH)_b (5a) where M, a, b, a' and b' are defined as in formulas (1) and (1a). Representative examples of hydroxyl-substituted compounds are as follows:

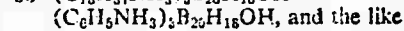
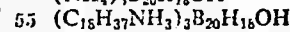
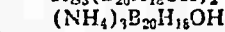
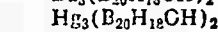
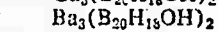
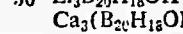
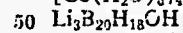
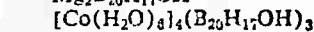
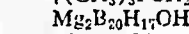
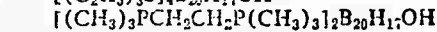
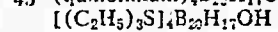
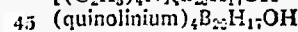
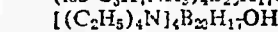
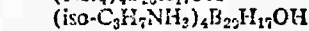
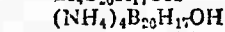
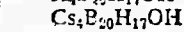
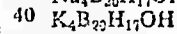
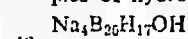

Compounds bearing hydrocarbyloxy substituents are represented generically by the formulas

M_a(B₂₀H₁₇OR)_b (6) or M_a(B₂₀H₁₈OR)_b (6a) where

60 M, a, b, a' and b' are defined as in Formulas 1 and 1a. Representative examples of hydrocarbyloxy-substituted compounds are as follows:

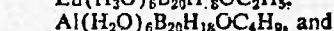
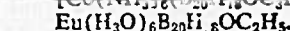
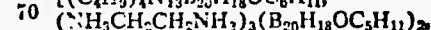
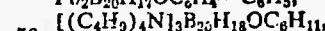
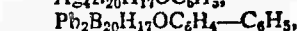
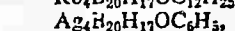
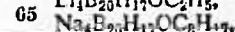
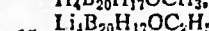
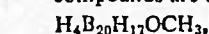

75 the like.

Compounds bearing amino substituents are represented generically by the formulas

$M_a(B_{20}H_{17}NH_2)_b$ (7) or $M_{a'}(B_{20}H_{18}NH_2)_{b'}$ (7a) where M, a, b, a' and b' are defined as in Formulas 1 and 1a. Representative examples of amino-substituted compounds are as follows:

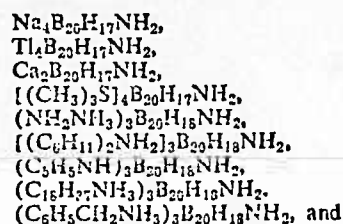

the like.

The cation M in the compounds can be hydrogen (H⁺) or, in its hydrated form, hydronium (H₃O⁺). These compounds are strong acids and they form an important group of the compounds of Formula 1. Illustrations of these acids are as follows:

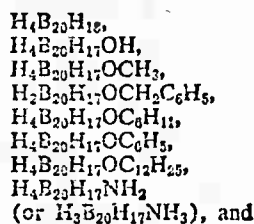

the like.

Acids of the tetravalent anions are generally obtained as hydrates having up to 12 or more molecules of water. In these hydrates up to 4 of the molecules of water are generally considered to be associated with the acid hydrogens. The hydrates of the acids are stable products and they form a preferred group of the acid derivatives. Illustrations of hydrates of acids are as follows:



$(H_3O)_4B_{20}H_{18} \cdot 6H_2O$, $(H_3O)_4B_{20}H_{18} \cdot 8H_2O$, and the like. Acids having only four molecules of water of hydration are illustrated by $(H_3O)_4B_{20}H_{17}OH$, $(H_3O)_4B_{20}H_{17}OCH_3$, and the like.

PREPARATION OF UNSUBSTITUTED COMPOUNDS

Compounds which are free of X substituents are preferably prepared by reducing a salt of the divalent eicosaborate anion of the following formula



where M is defined as in Formula 1, and a'' and b'' are the smallest whole numbers which satisfy the equation

$$2b'' = a'' \times \text{valence of M} \quad (8a)$$

The preparation of the reactions of Formula 8 is described fully in assignee's copending applications by V. A. Engelhardt, Ser. No. 199,572, filed May 31, 1962, and in my copending application, Ser. No. 199,573, filed May 31, 1962. Their preparation is also described briefly below and illustrated in the examples.

Acids and salts of the divalent octadecahydroeicosaborate anions of Formula 8 are obtained by oxidation of a decahydrodecaborate (2-) of the formula



where M is defined as in Formula 1, and a'' and b'' are defined as in Formulas 8 and 8a.

The process for preparing the unsubstituted compounds of the invention represented by Formula 8 can, therefore, be viewed as consisting of the following steps in which the intermediate products are not necessarily isolated prior to use in the succeeding step:

(a) oxidizing a decahydrodecaborate(2-) of Formula 9 to obtain a salt of the octadecahydroeicosaborate(2-) anion of Formula 8, and

(b) reducing the octadecahydroeicosaborate(2-) obtained in step (a) to obtain a salt which falls within the scope of Formula 3 and, optionally,

(c) reacting the product obtained in step (b) with an acid, base or salt containing a cation M which is desired in the final product, and isolating a compound of Formula 3.

Step (c) in the above procedure is optional and it is a simple metathetic reaction. A product which falls within the scope of Formula 3 can be isolated, if desired, directly from the reaction mixture in step (b).

Referring to step (a) in the above process, oxidation of the $B_{10}H_{10}^{2-}$ salt at conventional temperatures (e.g. 15°-30° C.) yields as the principal product a salt of the $B_{20}H_{18}^{2-}$ anion. In the event oxidation is conducted at low temperatures (e.g., 0° C. or lower), a product is obtained which is a mixture of salts of the $B_{20}H_{18}^{2-}$ and $B_{20}H_{19}^{3-}$ anions. Salts of the $B_{20}H_{19}^{3-}$ anion are, as stated earlier, acid salts represented by Formula 3a and they fall within the scope of Formula 1. It is possible, therefore, to combine oxidation and reduction of the $B_{10}H_{10}^{2-}$ anion in a single step to obtain as one product of the reaction a compound which falls within the scope of Formula 1.

The decahydrodecaborates, $M_{a''}(B_{10}H_{10})_{b''}$, are prepared by methods described fully in U.S. Patents 3,148,938; 3,148,939; and 3,149,163 to W. H. Knott, Jr. The preparation of representative compounds is described in the examples. Any decahydrodecaborate(2-) can be employed, i.e., compounds in which M is any atom or group of atoms which can form one or more cations in water, are operable. For reasons of availability and cost, it is preferred to use decahydrodecaborates of Formula 9 in which M is hydrogen, hydronium, ammonium, substituted ammonium, an alkali metal or an alkaline earth metal. Specific illustrations of the classes of preferred reactants are: $H_2B_{10}H_{10}$ and its hydrates, $Na_2B_{10}H_{10}$, $Cs_2B_{10}H_{10}$, $K_2B_{10}H_{10}$, $Li_2B_{10}H_{10}$, $BaB_{10}H_{10}$, $CaB_{10}H_{10}$, $MgB_{10}H_{10}$, $(NH_4)_2B_{10}H_{10}$, $[(CH_3)_4N]_2B_{10}H_{10}$, $[(C_2H_5)_3NH]_2B_{10}H_{10}$, $[(CH_3)_2NH_2]_2B_{10}H_{10}$, and the like.

Oxidation Step to $B_{20}H_{18}^{2-}$ Compounds—Oxidation of the decaborate reactant is accomplished either chemically or electrolytically.

In chemical oxidation the oxidizing reagent or oxidant is a compound having as a characteristic component a metal of variable valence, which metal is in its highest valence state, said compound having an oxidation-reduction potential in acid solution of about -1.33 to about -1.61 volts. The oxidation-reduction potential of a compound is a recognized and measurable property for which values are found in readily available texts, e.g., "Oxidation Potentials," by W. G. Latimer, 2nd ed., Prentice-Hall, New York (1952), particularly page 344. Examples of classes of compounds which are operable in the process are dichromates, aurates, higher oxides of lead, manganic salts, permanganates, higher oxides of bismuth and salts of tetravalent cerium.

The chemical oxidation process is conducted by simple and uncomplicated procedures in conventional equipment. A solvent is generally employed which preferably is hydroxylated, e.g., methanol, water, and the like. Water is most conveniently used and it is therefore the preferred solvent.

The ratio in which the reactants are employed is not a critical factor for operability. However, the use of an excess of oxidant may lead to a decrease in yield of the desired product. It is preferable to employ at most two oxidation equivalents of the oxidant (based on the metal) per mole of $B_{10}H_{10}^{2-}$ salt or acid used in the process. The preferred mole ratio of oxidant to polyhydroxyborate can be determined by methods described in "Handbook of Chemistry and Physics," 38th ed., p. 1588, Chemical Rubber Publishing Co. (1956).

Pressure is not a critical factor in the process and atmospheric pressure is normally used. However, if desired, pressures higher or lower than atmospheric can be employed.

The process is operable over a wide temperature range. However, as noted earlier, at low temperatures a salt of the $B_{20}H_{18}^{-2}$ anion may be obtained as well as a salt of the $B_{22}H_{19}^{-2}$ anion. At temperatures of 0° C. or below, the yield of $B_{22}H_{19}^{-2}$ salt may be 50% or higher. The formation of the $B_{20}H_{18}^{-2}$ salt diminishes at higher temperatures of operation and at about 20° C. or higher, the product is principally a salt of the $B_{20}H_{18}^{-2}$ anion. Normally the reaction is conducted at the prevailing atmospheric temperature but temperatures as low as -10° C. or lower and as high as 100° C. can be employed. Preferred temperatures of operation lie between about 0° and 50° C. The product obtained in the process, whether a mixture of salts of $B_{22}H_{19}^{-2}$ and $B_{20}H_{18}^{-2}$ anions or pure salts of the $B_{20}H_{18}^{-2}$ anion can be used in the reduction step designated as (b).

The reaction proceeds rapidly and a measurable quantity of product is obtained within a short time. Normally the reactants are maintained in contact for a sufficient period to assure maximum yield. The time of reaction can range from a few minutes to 24 hours or more.

In the operation of the process it is preferable (although not essential) to add the oxidant to the decaborate to reduce the vigor of the reaction and to obtain the maximum yield of desired product. Normally, therefore, the reaction vessel is charged with the solvent and the decahydrodecaborate. The chemical oxidant, which is conveniently handled in solution, is added gradually to the vessel at a rate which provides a controllable reaction. After all of the oxidant has been added, the reaction mixture can be stirred for a short period and a solution containing the desired cation M is added. The polyborate salt frequently precipitates at this point but, in the event precipitation does not occur, the solution is evaporated to a volume at which a solid separates. The salt of the divalent anion, $B_{22}H_{19}^{-2}$, generally precipitates first from the solution and is separated by filtration. Further evaporation of the filtrate leads to the precipitation of the acid salt of Formula 3a, if it is formed under the conditions of operation. The products are purified further, if desired, by conventional procedures.

The electrolytic oxidation process for obtaining salts of the $B_{20}H_{18}^{-2}$ anion from salts of the $B_{10}H_{10}^{-2}$ anion is described fully in my copending application, Serial No. 194,573, filed May 31, 1962.

Reduction step—Salts of the $B_{20}H_{18}^{-2}$ anion and of the acid anion are obtained by a reduction process which consists in reacting the acid of the $B_{20}H_{18}^{-2}$ anion (usually as a hydrate), e.g., $(H_2O)_2B_{20}H_{17}$ having up to 8 molecules of water, with an active metal, i.e., a metal which has a standard electrode potential at 25° C. of at least about 0.75 volt [cf., "Handbook of Chemistry and Physics," 38th ed. (1956-57), p. 1640, Chemical Rubber Publishing Co.].

The reaction is readily conducted in aqueous solution and for this reason metals are usually employed which react controllably in aqueous medium. Metals such as Zn, Mg, Al, and the like, are preferred. The acid of the $B_{20}H_{18}^{-2}$ anion or one of its hydrates, is dissolved in water and portions of metal (turnings, shavings, pellets, and the like) are added gradually. The reaction is vigorous and, as in the previous processes, a gas is evolved. The reaction can be controlled by appropriate means, e.g., cooling, dilution with water or very slow rate of addition of metal. When no further gas evolution occurs with addition of metal, unreacted solid material is separated and the clear solution is processed as described for the previous processes.

Preparation of substituted compounds—Compounds of Formula 1 in which X is -OH are obtained by reacting a salt of the $B_{20}H_{18}^{-2}$ anion with a strong base. The reaction is conveniently performed in water to which water-

miscible organic solvents can be added, if desired, to increase the solubility of the salts. The salt of the $B_{20}H_{18}^{-2}$ anion and the strong base is added to the solvent to form a clear solution which is heated and stirred until the solution is colorless. The solution is cooled and it is processed as described in the preparation of the unsubstituted salts to obtain a salt of the tetravalent anion.

Any salt of a $B_{20}H_{18}^{-2}$ anion can be used but, as a matter of convenience, the alkali metal, alkaline earth metal, ammonium or substituted ammonium salts are used. The term a strong base, as used herein, means a compound whose base strength is equivalent to an alkali metal hydroxide. The bases which are preferred for use in the process are the alkali metal hydroxides (LiOH, NaOH, KOH, CsOH), alkaline earth metal hydroxides ($Ca(OH)_2$, $Ba(OH)_2$, $Sr(OH)_2$), and quaternary ammonium hydroxides [R_4NOH , where R is aralkyl or lower alkyl, e.g., $(CH_3)_4NOH$, $(C_2H_5)_4NOH$, $(C_6H_5CH_2)(CH_3)_3NOH$, and the like].

The ratio in which the reactants are employed is not a critical factor. Sufficient base is employed to keep the solution alkaline, a condition which is readily determined by conventional methods, e.g., color indicators, potentiometric measurement, and the like. In general, the ratio, moles $B_{20}H_{18}^{-2}$ salt/moles strong base, lies between about 0.1 and 20.

The reaction is conducted readily at atmospheric pressure. It can be operated at pressures higher or lower than atmospheric but no advantages are found under these conditions of operation. The reaction proceeds at normal atmospheric temperatures but, to increase the speed of the reaction, the mixture is usually heated to the boiling point of the solution. The temperature of the reaction may lie between about 10° C. and about 100° C. The time of the reaction may be from a few minutes to 24 hours or more.

Compounds of Formula 1 in which X is -OR are obtained by reacting a salt of the $B_{20}H_{18}^{-2}$ anion with a metal alkoxide or phenoxide. The reaction is conducted in the manner described for the preparation of -OH substituted compounds and need not be repeated here. The preferred alkoxides or phenoxides are compounds of the formula $M''OR$, where M'' is sodium or potassium and R is defined as in Formula 1.

Compounds of Formula 1 in which X is -NH₂ are obtained by reacting a salt of the $B_{20}H_{18}^{-2}$ anion with an alkali metal amide of the formula $M''NH_2$, where M'' is, preferably sodium or potassium. The reaction is conveniently conducted in liquid ammonia as a solvent. Any salt of the $B_{20}H_{18}^{-2}$ anion can be used but the ammonium salt $(NH_4)_2B_{20}H_{18}$ is preferred. The reaction is conducted by conventional procedures wherein the decaborate and the alkali metal amide are simply mixed in liquid ammonia and the reaction is continued until all the liquid ammonia is removed by evaporation. The residue is processed in the usual manner, due care being exercised to destroy excess metal amide, if present, prior to working up the residue. The crude product is purified by conventional crystallization procedures as described in the preparation of -OH substituted compounds.

In all of the above processes for the preparation of unsubstituted or substituted compounds, the crude reaction products are purified by well-known and recognized procedures. Conventional crystallization procedures are used most frequently, employing water or inert organic solvents, e.g., benzene or alcohol. Solutions of the products can be treated with absorptive agents, e.g., activated carbon or silica gel, to absorb the major portion of the impurities.

Metathetic reactions—Compounds of Formula 1 wherein M covers a wide range of cations are obtained by simple metathetic reactions. To illustrate, an aqueous solution of a compound of Formula 1, where M is NH_4^+ , is contacted with a strong acid or with a strong acid ion-exchange resin to obtain the free acid, i.e., a compound of Formula 1 in which M is H. The acid, generally in solution, is reacted with oxides of metals, hydroxides of

metals, salts of metals (both organic and inorganic), nitrogen bases, sulfonium halides, phosphonium halides, aryltriminium hydroxides or oxides, and similar types of compounds to obtain products of Formula 1 which have the desired cation M. In a process employing an ion-exchange resin, strongly acidic resins of the sulfonic acid variety are preferred because of availability, e.g., "Amberlite" IR-120-H and "Dowex" 50. The acid, usually obtained in aqueous solution, can be reacted with nitrates, chlorides, bromides, acetates, benzoates, and similar salts of metals or other bases to obtain salts of Formula 1.

To illustrate, an aqueous solution of $C_3B_{20}H_{19}$ is passed through a column packed with "Amberlite" IR-120-H to obtain in aqueous solution the acid $H_3B_{20}H_{18}$. The aqueous solution is evaporated under reduced pressure to obtain the acid $H_3B_{20}H_{18}$ generally as a solid hydrate having up to 12 molecules of water. In the hydrated form part of the water of hydration is considered to be associated with the ionizable protons, e.g.,

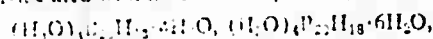

$(H_2O)_2(B_3H_7)_2 \cdot H_2O$, and the like. It is understood that when reference is made to acids of $B_nH_{19-n}X_n^{-4}$ anions, the hydrates of these acids are included.

Examples of other salts which can be obtained and the salts from which they can be derived are shown in Table I:

TABLE I

Compound:	Acid obtained (as hydrates)
$K_3B_{20}H_{19}$ -----	$H_3B_{20}H_{18}$
$(CH_3)_3Si(B_3H_7)_3$ -----	$H_3B_{20}H_{18}$
$Na_3B_{20}H_{19}$ -----	$H_3B_{20}H_{18}$
$(NH_4)_3B_{20}H_{19}OH$ -----	$H_3B_{20}H_{17}OH$
$(NH_4)_3B_{20}H_{17}NH_2$ -----	$H_3B_{20}H_{17}NH_2$
$C_3B_{20}H_{17}OC_2H_5$ -----	$H_3B_{20}H_{17}OC_2H_5$
$(C_2H_5)_3NH(B_3H_7)_3OC_2H_5$ -----	$H_3B_{20}H_{17}OC_2H_5$
$(C_2H_5)_3NH(B_3H_7)_3OC_2H_5$ -----	$H_3B_{20}H_{17}OC_2H_5$
$Na_3B_{20}H_{17}OH$ -----	$H_3B_{20}H_{17}OH$

Careful concentration of the solutions of the acids and intensive drying under low pressure and moderate temperature of the liquid residues yield the acids, generally as hydrates as described earlier. For many chemical reactions it is not necessary to isolate the acids from solution. The solutions of the acids can be employed directly, especially in metathetic reactions.

Metal salts of the invention can be prepared by neutralization of the acids, obtained as described above, in aqueous or alcohol solution with an aqueous solution or suspension of an inorganic base, e.g., an alkali or alkaline earth metal hydroxide. The resulting solution of the metal salt of the $(B_nH_{19-n}X_n)^{-4}$ anion or of the acid anion is concentrated by evaporation of water or alcohol until the salt crystallizes out. In many cases the salt may precipitate during its preparation and evaporation of the solution is not necessary. The crystalline salt is dried under reduced pressure, e.g., 0.1 mm. of mercury, or lower, and moderately elevated temperature, e.g., 50-100° C. The metal salts frequently contain water of hydration which can be removed by heating for several hours at a temperature of about 200° C. under low pressure, e.g., 0.1 mm. mercury or lower. Specific examples of salts which can be obtained by the process described above are:

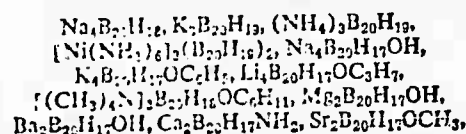

and the like.

Water-insoluble heavy metal salts of the acids can be prepared by adding a water-soluble heavy metal salt, e.g., silver nitrate or mercuric nitrate, to an aqueous solution of the boron-containing acid whereupon the heavy metal salt of the anion precipitates out as a white or light colored

solid. The salts formed in this procedure are usually anhydrous. Examples of heavy metal salts which can be prepared by this method are: $Ag_3B_{20}H_{18}$, $Pb_3(B_{20}H_{18})_2$, $Hg_2B_{20}H_{17}OC_2H_5$, $Hg_2B_{20}H_{17}OH$, and $Ag_2B_{20}H_{17}OCH_3$. The procedure is general to the preparation of metal salts of the compounds of the invention and it can be employed with unsubstituted and substituted compounds.

Nitrates, carbonates, chlorides or oxides of metals can be used to prepare the salts by the methods described earlier.

Light sensitive salts, e.g., the silver salts, are preferably prepared under conditions providing minimum exposure to light although exclusion of light is not essential for operability.

Compounds of Formula 1, where M is an alkali or alkaline earth metal, e.g., Na, K, Cs, Ca, Ba, Mg, and Sr, can undergo simple metathetic reactions with other salts to effect an exchange of cations. Thus, $Na_4B_{20}H_{18}$ or $K_4B_{20}H_{17}OH$ can be reacted in aqueous solution with ammonium sulfate, benzenediazonium hydroxide, pyridinium chloride, morpholinium sulfate, polyethyleneimine hydrochloride, and the like, to form compounds of Formula 1 having ammonium, benzenediazonium, pyridinium, morpholinium, and the like, as cations. These illustrations are not limiting and they demonstrate the breadth of metathetic reactions which can be used.

Compounds of the invention in which the group M is a metal, particularly a transition metal, or a Werner-type complex, frequently contain solvent of crystallization when isolated by conventional methods. The solvent, e.g., water, can be bound loosely in the lattices of the crystals or it can be associated by stronger bonds with the metal cation or Werner-type complex cation. Solvent of crystallization, entrapped in crystal lattices, is removed easily by well-known procedures, e.g., heating under reduced pressure. Solvent of crystallization which is associated with the cation is more difficult to remove, and for most applications it is not necessary to remove completely this type of bound solvent.

The products of the invention and processes for obtaining them are illustrated in the following examples. The preparation of a representative compound of the type $M_3(B_{10}H_{10})_6$, which is employed as a reactant, is also illustrated.

EXAMPLE A

(A) Preparation of Bis(dimethyl sulfide)decaborane(12).—A reaction vessel having a capacity of about 365 g. of water is charged with 0.79 g. of decaborane (14), cooled in liquid nitrogen, and then evacuated to a pressure of 10 microns of mercury. Approximately 21 g. of dimethyl sulfide is condensed onto the decaborane in the reaction vessel. The reaction vessel is closed, allowed to warm to room temperature and stand for 4 days. During this time 6.6 millimoles of hydrogen is evolved. The reaction vessel is opened and excess dimethyl sulfide is removed by distillation, leaving a practically quantitative yield of white solid residue of $B_{10}H_{12} \cdot 2(CH_3)_2S$. The compound is recrystallized from ethyl acetate and it melts at 122-124° C. The compound is called bis(dimethyl sulfide)decaborane(12).

The above procedure is equally operable with other organic sulfides.

(B) Preparation of $M_3B_{10}H_{10}$ (where M is NH_4).—Bis(dimethyl sulfide)decaborane(12) (8.5 g.) is mixed with 50 ml. of liquid ammonia and stirred in a round-bottom reaction vessel for 1 hour with the vessel being cooled to a temperature of about -50° C. by partial immersion in a bath of a mixture of solid carbon dioxide and acetone. The cooling bath is then removed and the excess ammonia is allowed to evaporate with stirring. The remaining traces of ammonia are removed by subjecting the residue to a high vacuum (0.01 mm. of mercury) at 25° C. There is obtained 5.6 g. of solid residue which is virtually a quantitative yield of $(NH_4)_3B_{10}H_{10}$.

Example B, which follows, illustrates the preparation of salts of the $B_{20}H_{18}^{-2}$ anion which are employed as reactants to prepare the compounds of the invention.

EXAMPLE B

(A) Preparation of $M_2B_{20}H_{18}$ (where M is a monovalent cation).—A reaction vessel is charged with 100 ml. of water and 1.46 g. of $(NH_4)_2B_{10}H_{10}$. The mixture is stirred and a solution of 5.4 g. of $Ce(NH_4)_2(NO_3)_6$ in 80 ml. of water is added gradually. Evolution of gas occurs and a deep blue-violet solution forms. A concentrated aqueous solution of $(CH_3)_4NCl$ is added to the reaction mixture with stirring and in sufficient amount to precipitate completely a violet-colored solid. The solid is separated by filtration and it is purified by crystallization from hot water to yield the yellow compound, bis-(tetramethylammonium) octadecahydroicosaborate(2-).

The compound is soluble in acetonitrile, hot methanol and hot water. The identity of the product is confirmed by elemental analysis.

Analysis.—Calc'd for $[(CH_3)_4N]_2B_{20}H_{18}$: C, 25.1; H, 11.1; N, 7.32; B, 56.5; Eq. Wt., 191.4. Found: C, 26.3; H, 11.5; N, 7.55; B, 54.3; Eq. Wt., 188, 204.

(B) A solution of $[(CH_3)_4N]_2B_{20}H_{18}$ in methanol-water is passed through a column packed with a commercial acidic ion-exchange resin of the polysulfonic acid type. The effluent is a solution of the acid $H_2B_{20}H_{18}$, or, expressed as a hydronium acid, $(H_3O)_2B_{20}H_{18}$. The aqueous solution is used without further processing to prepare salts of the acid. The solid acid is obtained by evaporating the aqueous solution, prepared as described above, to dryness at very low pressure (less than 0.1 mm. of mercury). The acid, which forms large intensely colored yellow crystals, contains 6 moles of water of hydration, of which 2 moles are considered to be associated with the proton cations. The identity of the compound is confirmed by elemental analysis.

Analysis.—Calc'd for $(H_3O)_2B_{20}H_{18} \cdot 4H_2O$: H, 9.36; B, 62.8. Found: H, 8.91; B, 63.7.

The solid yellow crystals of the hydrated acid obtained above are very hygroscopic. They dissolve in water to form a clear solution.

(C) A portion of an aqueous solution of the dibasic acid, prepared as described in Part B, is titrated with an aqueous solution of sodium hydroxide until the reaction mixture is neutral (pH=7). The resulting aqueous yellow solution is evaporated to dryness under reduced pressure (less than 1 mm. of Hg) to obtain crude $Na_2B_{20}H_{18}$ as a tan-colored solid. The compound is purified by crystallization from methanol. The product so obtained contains water of crystallization.

Analysis.—Calc'd for $Na_2B_{20}H_{18} \cdot 2H_2O$: B, 68.3; H, 7.07. Found: B, 68.2; H, 7.25.

The compound can, if desired, be obtained free of solvent of crystallization by heating for a time at very low pressure. The molecular weight of the compound $Na_2B_{20}H_{18}$, determined by freezing point depression in aqueous solution gives the following values: 103, 99, 89, 88, i.e., an average molecular weight of 95; calculated value: 93.3.

The compounds of Example B are characterized fully in my copending application, Ser. No. 199,573, filed May 31, 1962 and referred to in a preceding paragraph.

The preparation of compounds of Formula 1 which are free of X groups is illustrated in Examples 1-4.

EXAMPLE 1

Approximately 3.0 g. of magnesium turnings are added gradually and with stirring to about 50 ml. of an aqueous 0.2 M solution of $H_2B_{10}H_{10}$. A vigorous exothermic reaction sets in and gas is evolved. Water is added to abate the vigor of the reaction and the mixture is allowed to stand at about 25° C. for 24 hours. The solution, which is colorless, is filtered to separate the unreacted metal. The filtrate is neutralized with NH_4OH . The solution at

this stage contains $(NH_4)_2B_{20}H_{18}$. Aqueous $CsCl$ solution is added and the solution is stirred for several minutes. A green solid precipitates which is separated by filtration. The product is crystallized from hot water to obtain a colorless crystalline compound which is a hydrate of $Cs_2B_{20}H_{18}$. It is dried at 100° C. under very low pressure. *Analysis.*—Calc'd for $Cs_2B_{20}H_{18} \cdot H_2O$: Cs, 67.8; B, 27.6; H, 2.57. Found: Cs, 66.5; B, 27.4, 27.5; H, 3.23.

EXAMPLE 2

Zinc metal and an aqueous solution of $H_2B_{20}H_{18}$, prepared as described in Example B, Part B, are mixed until the acid solution becomes colorless and gas evolution ceases. The period of mixing is about 24 hours. The solution is decanted from excess metal and an aqueous solution of $(CH_3)_4NCl$ is added to the clear liquid. A white precipitate forms which is separated and recrystallized from acidified aqueous solution. The product is a mixture of hydrates of $[(CH_3)_4N]_2B_{20}H_{18}$ and

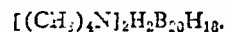

These compounds can also be written as

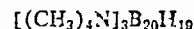

and $[(CH_3)_4N]_2HB_{20}H_{18}$. The elemental analysis of the product is as follows:

Analysis.—Calc'd for

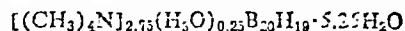

C, 24.5; H, 11.8; N, 7.15; B, 40.2. Found: C, 24.8; H, 10.4; N, 7.22; B, 40.2;

EXAMPLE 3

Magnesium turnings are added to a solution of $(NH_4)_2B_{20}H_{18}$, the mixture is stirred and dilute hydrochloric acid is added gradually. A gas is generated and, after all the acid is added, the solution is stirred for about 20 hours. The solution is now colorless and no more gas is evolved. The mixture is filtered and an aqueous solution of $(CH_3)_4NCl$ is added to the filtrate. The white precipitate which forms is separated, and recrystallized from water to obtain $[(CH_3)_4N]_2HB_{20}H_{18}$, which can also be viewed as $[(CH_3)_4N]_2B_{20}H_{18}$. The identity of the compound is confirmed by its infrared absorption spectrum.

Examples 1-3 illustrate the preparation of $B_{20}H_{18}^{-4}$ and $B_{20}H_{18}^{-3}$ salts by employing an active metal as the reducing agent. The process is generic to the preparation of $B_{20}H_{18}^{-4}$ and its acid salts. Metals such as Sr, Al, Fe, and the like can be employed. The solution can be neutralized with bases other than NH_4OH , as described in the paragraph following Example 1 to provide a broad range of salts of the invention. Similarly, halides other than $CsCl$ can be employed, e.g., $NaCl$, $CaCl_2$, $AlCl_3 \cdot 6H_2O$, $MgCl_2$, and the like can be used in the process to obtain salts of the formulas $Na_4B_{20}H_{18}$, $C_2B_{20}H_{18}$,

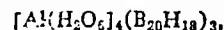

and $[Mg(H_2O)_6]_2B_{20}H_{18}$.

Any strong acid can be used in the process, e.g., sulfuric, trifluoroacetic, trichloroacetic, benzenesulfonic and benzenephosphonic acid. Acids which will react with metals to release hydrogen are generically useful.

EXAMPLE 4

(A) A cold aqueous solution of 12.6 g. of cerium ammonium sulfate is added slowly to an ice-water solution of 3.0 g. of $(NH_4)_2B_{10}H_{10}$. The reaction mixture is warmed to atmospheric temperature (ca. 25° C.) and a saturated aqueous solution of $(CH_3)_4NCl$ is added with stirring. A precipitate forms and it is separated by filtration, washed and dried. It is shown by infrared and ultraviolet absorption spectroscopy to be a mixture of $[(CH_3)_4N]_2B_{10}H_{10}$ and $[(CH_3)_4N]_2B_{20}H_{18}$, also written as

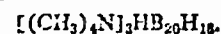

The mixture is stirred with acetonitrile and filtered. The

15

insoluble portion is $[(\text{CH}_3)_4\text{N}]_3\text{B}_{20}\text{H}_{19}$ and the filtrate contains the salt of the divalent anion. The yield of $[(\text{CH}_3)_4\text{N}]_2\text{B}_{20}\text{H}_{19}$ is 10%. The product is purified by recrystallization from hot water and dried under very low pressure at 100°C . to obtain a white, crystalline compound containing water of crystallization.

Analysis.—Calc'd for $[(\text{CH}_3)_4\text{N}]_3\text{B}_{20}\text{H}_{19} \cdot 0.5\text{H}_2\text{O}$: C, 30.9; H, 12.1; N, 9.00; B, 46.03. Found: C, 30.0, 29.9; H, 12.0, 12.0; N, 9.07, 9.13; B, 46.9, 46.7.

The above compound, heated to 300°C ., decomposes without fusion.

(B) The process of Part A is repeated except triethylammonium chloride is used in place of tetramethylammonium chloride to precipitate the product. The isolated product is dried under very low pressure at 100°C . to obtain anhydrous $[(\text{C}_2\text{H}_5)_3\text{NH}]_3\text{B}_{20}\text{H}_{19}$. The compound melts at $164\text{--}166^\circ\text{C}$. with decomposition.

Analysis.—Calc'd for $[(\text{C}_2\text{H}_5)_3\text{NH}]_3\text{B}_{20}\text{H}_{19}$: C, 39.9; H, 12.5; N, 7.75; B, 39.9; active H_2 , 1694 ml./g. Found: C, 40.2; H, 13.0; N, 7.63; B, 39.9; active H_2 , 1685 ml./g., 1653 ml./g.

The process of Example 4, which is a one-step oxidation-reduction process, is generic for the preparation of salts of the $\text{B}_{20}\text{H}_{19}^{-3}$ anion. A wide range of salts can be obtained by employing salts other than the trialkylammonium hydrochlorides in the final step, e.g., pyridine hydrochloride will yield $(\text{C}_5\text{H}_5\text{NH})_3\text{B}_{20}\text{H}_{19}$, glycine hydrochloride will yield

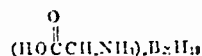

and $(\text{CH}_3)_3\text{SiCl}$ will yield $[(\text{CH}_3)_3\text{Si}]_3\text{B}_{20}\text{H}_{19}$.

The preparation of compounds of the invention which bear X substituents is illustrated in Examples 9-10.

EXAMPLE 5

(A) A reaction vessel is charged with 5.0 g. of

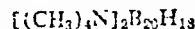

5.0 g. of $(\text{CH}_3)_4\text{NOH}$ and sufficient $\text{CH}_3\text{CN-H}_2\text{O}$ mixture (about 1:1 by volume) to form a clear solution. The solution is heated to boiling and acetonitrile is distilled from the mixture. The yellow color of the solution gradually disappears and a colorless solution remains. The solution is cooled to prevailing atmospheric temperature (ca. 25°C .) and a small quantity of solid product precipitates. The solid is separated and dried to yield a white crystalline hydrate of $[(\text{CH}_3)_4\text{N}]_2\text{B}_{20}\text{H}_{19} \cdot \text{OH}$.

(B) A reaction vessel is charged with 1000 ml. of water and 155 g. of $[(\text{CH}_3)_4\text{N}]_2\text{B}_{20}\text{H}_{19}$. The mixture is heated to boiling to form a solution and 61 g. of

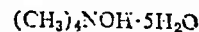

is added with stirring. The solution is stirred for 3 hours at the boiling point. The solution is filtered while hot and the filtrate is allowed to cool slowly to atmospheric temperature with intermittent filtration to remove the precipitate as it separates in stages. There is obtained as the first crop of crystals 151 g. of

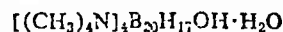

and, as the final crop of crystals at atmospheric temperature, 4 g. of the acid salt $[(\text{CH}_3)_4\text{N}]_3\text{B}_{20}\text{H}_{19}\text{OH}$. The latter compound is recrystallized from hot water and dried under reduced pressure. The infrared spectrum of the compound has a strong absorption band at 1800 cm^{-1} (5.4μ) showing a B—H—B bond.

Analysis.—Calc'd for $[(\text{CH}_3)_4\text{N}]_2\text{B}_{20}\text{H}_{19} \cdot \text{OH} \cdot \text{H}_2\text{O}$: C, 30.4; H, 11.4; N, 8.96; B, 44.4. Found: C, 30.5; H, 11.2; N, 9.15; B, 41.5.

EXAMPLE 6

The process of Example 5-A is repeated except that CsOH is employed in place of $(\text{CH}_3)_4\text{NOH}$. The product obtained is a hydrate of $\text{Cs}_2\text{B}_{20}\text{H}_{19} \cdot \text{OH}$, a white crystalline solid.

16

Analysis.—Calc'd for $\text{Cs}_2\text{B}_{20}\text{H}_{19} \cdot \text{OH} \cdot \text{H}_2\text{O}$: Cs, 66.3; B, 27.0. Found: Cs, 66.4, 65.0; B, 26.6.

EXAMPLE 7

(A) The process of Example 5-A is repeated except that KOH is employed in place of $(\text{CH}_3)_4\text{NOH}$. The product obtained is a hydrate of $\text{K}_2\text{B}_{20}\text{H}_{19} \cdot \text{OH}$, a white crystalline solid.

Analysis.—Calc'd for $\text{K}_2\text{B}_{20}\text{H}_{19} \cdot \text{OH} \cdot \text{H}_2\text{O}$: B, 48.6; H, 5.44. Found: B, 49.0; H, 5.14.

The infrared spectrum of the above potassium salt shows absorption at the following wavelengths (expressed in microns): 4.1, 9.0, 10.0, and 12.0.

(B) A solution is prepared consisting of 14.0 ml. of 0.157 M $(\text{H}_3\text{O})_2\text{B}_{20}\text{H}_{19}$ diluted to a volume of 50 ml. with water. This solution is added with stirring to a solution consisting of 50 ml. of water, 0.5 g. of KOH and 0.52 g. of NaBH_4 . Gas is evolved during this step. The solution is stirred for 2-3 hours and the yellow color disappears. An aqueous solution of $(\text{CH}_3)_4\text{NOH}$ is added and the small quantity of precipitate which forms is separated by filtration. The precipitate is by-product

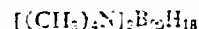

The clear filtrate is concentrated by evaporation until a solid separates in the form of colorless plates. The product is separated by filtration and it is dried to yield a hydrate of $[(\text{CH}_3)_4\text{N}]_2\text{B}_{20}\text{H}_{19} \cdot \text{OH}$. The compound is very hygroscopic.

Analysis.—Calc'd for $[(\text{CH}_3)_4\text{N}]_2\text{B}_{20}\text{H}_{19} \cdot 7\text{H}_2\text{O}$: C, 28.2; H, 12.2; B, 31.8. Found: C, 28.8, 29.1; H, 11.3, 11.0; B, 29.6

The electrical conductivity of the above salt is determined in aqueous solution at various concentrations and from the data a plot is made of the equivalent conductance of the solution as a function of the square root of the concentration of the salt. The data show that the compound is a 1-4 electrolyte.

(C) A reaction vessel is charged with an aqueous solution of $\text{Na}_2\text{B}_{20}\text{H}_{19}$ (equivalent to 9.44 g. of $\text{H}_2\text{B}_{20}\text{H}_{19}$) and a solution of 3.78 g. of NaBH_4 in 100 ml. of water containing 2 g. of NaOH is added with stirring. Several color changes in the solution are observed in this operation and a gas is evolved. The solution is stirred 16 hours at prevailing atmospheric temperature (ca. 25°C .). The solution is cooled to about 0°C . and an aqueous solution of $(\text{CH}_3)_4\text{NOH}$ is added. A white precipitate forms which is separated by filtration, washed and dried to obtain $[(\text{CH}_3)_4\text{N}]_2\text{B}_{20}\text{H}_{19} \cdot \text{OH}$.

A portion (0.5 g.) of the above compound is dissolved in water and 3 ml. of concentrated hydrochloric acid is added. The white precipitate which forms is separated, washed with water and methanol, and dried. The product is a mixture (approximately equimolar) of acid salts of the formulas $[(\text{CH}_3)_4\text{N}]_3\text{HB}_{20}\text{H}_{19} \cdot \text{OH}$ and

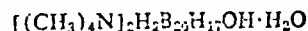

which can also be viewed as salts of

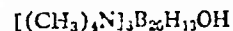

and $[(\text{CH}_3)_4\text{N}]_2(\text{H}_3\text{O})\text{B}_{20}\text{H}_{19}\text{OH}$. The group (H_3O) represents a hydronium ion or hydrated hydrogen ion.

Analysis.—Calc'd for

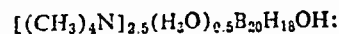

C, 25.9; H, 11.3; N, 7.5; B, 46.6. Found: C, 26.5, 26.3; H, 11.3, 11.1; N, 7.9, 8.0; B, 48.9, 48.9.

EXAMPLE 8

(A) A concentrated aqueous solution (10 ml.) of $\text{H}_2\text{B}_{20}\text{H}_{19}$ (approximately 15 moles of H_2O per mole of acid) is titrated with hydrazine hydrate ($\text{NH}_2\text{NH}_2 \cdot \text{H}_2\text{O}$) until the solution is basic. The solution becomes warm during the titration. It is cooled to prevailing atmospheric temperature (about 25°C .) and white crystals form. The crystals are separated and dried under reduced pressure

at 150° C. to obtain $(\text{NH}_2\text{NH}_2)_4\text{B}_{20}\text{H}_{17}\text{OH}$. The identity of the compound is confirmed by its infrared absorption spectrum and by elemental analysis.

Analysis.—Calc'd for $(\text{NH}_2\text{NH}_2)_4\text{B}_{20}\text{H}_{17}\text{OH}$: N, 29.3; H, 10.0; B, 56.5. Found: N, 28.8; H, 10.0; B, 56.8.

(B) Approximately 0.5 g. of $[(\text{C}_2\text{H}_5)_2\text{NH}]_2\text{B}_{20}\text{H}_{18}$ and 1 ml. of anhydrous hydrazine (99+ purity) are mixed in a vessel. The mixture is warmed under reduced pressure until the by-product triethylamine and excess hydrazine are removed. A white crystalline product remains which is $(\text{NH}_2\text{NH}_2)_4\text{B}_{20}\text{H}_{17}\text{OH}$, with hydrazine of crystallization.

(C) Approximately 0.5 g. of $[(\text{C}_2\text{H}_5)_2\text{NH}]_2\text{B}_{20}\text{H}_{18}$ (prepared as described in Example 4-B) is dissolved in 1.2-1.3 ml. of anhydrous hydrazine. The solution is processed as described in Part A above to obtain

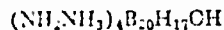

containing hydrazine and water of crystallization.

(D) Sufficient hydrazine (95%+) is added to a hydrate of the acid of the divalent anion $(\text{B}_{20}\text{H}_{18}^{--2})$, prepared as described in Example B, Part B, to form a solution. The solution is yellow and it is heated on a steam bath (70-100° C.). Bubbles form in the solution and the yellow color disappears in about 10 minutes. The mixture at this stage is a solution of $(\text{NH}_2\text{NH}_2)_4\text{B}_{20}\text{H}_{17}\text{OH}$ in hydrazine.

The solution is diluted with water and an aqueous solution of HNO_3 is added. The precipitate which forms is separated and dried in air to yield $\text{Ti}_4\text{B}_{20}\text{H}_{17}\text{OH}$. The compound is a white crystalline product whose identity is confirmed by its infrared absorption spectrum.

The compound $(\text{NH}_2\text{NH}_2)_4\text{B}_{20}\text{H}_{17}\text{OH}$ is conveniently isolated in solution in hydrazine from which it can be isolated, if desired, as a white crystalline solid, by evaporation of the hydrazine. The identity of the product is confirmed by elemental analysis.

Analysis.—Calc'd for $(\text{NH}_2\text{NH}_2)_4\text{B}_{20}\text{H}_{17}\text{OH}$: B, 56.3; N, 29.2; H, 10.1. Found: B, 56.9, 56.8; N, 28.7, 28.8; H, 10.0.

Hydrazine solutions of $(\text{NH}_2\text{NH}_2)_4\text{B}_{20}\text{H}_{17}\text{OH}$ containing up to 20% or more by weight of the salt are stable compositions having a high boron content.

Examples 5-8, inclusive, illustrate the preparation of salts of $\text{B}_{20}\text{H}_{18}\text{OH}^{--4}$ anion employing a strong base as the reactant. The process is generic to the preparation of $\text{B}_n\text{H}_{10}\text{OH}^{--4}$ salts, employing any strong base as the reducing and hydroxylating agent and any salt of a divalent eicosaborate anion, e.g., the salts of Example B, Parts A-C, inclusive. Operable bases include alkali metal hydroxides, a range of earth metal hydroxides, quaternary ammonium hydroxides, tri-substituted sulfonium hydroxides and tetra-substituted phosphonium hydroxides. In the operation of the process, the solution is preferably heated until the yellow color disappears, generally at a temperature of 50-150° C.

Example 9, which follows, illustrates an optional and indirect method for preparing compounds bearing a hydroxyl group. In this method compounds bearing an —OR substituent are reacted with aqueous HI solution to convert the —OR group into an —OH group.

EXAMPLE 9

The product from Example 10, Part B, is dissolved in water and aqueous hydrogen iodide solution is added. The mixture is heated to boiling for a short time, aqueous $(\text{CH}_3)_4\text{NCl}$ solution is added and the mixture is cooled. The precipitate which forms is separated, recrystallized from water and dried under reduced pressure to obtain a mixed cesium-tetramethylammonium acid salt which is principally $\text{Cs}[(\text{CH}_3)_4\text{N}]_2\text{HB}_{20}\text{H}_{17}\text{OH}$, or alternatively, $\text{Cs}[(\text{CH}_3)_4\text{N}]_2\text{B}_{20}\text{H}_{18}\text{OH}$. The identity of the compound is confirmed by its infrared absorption spectrum.

Example 10, which follows, illustrates the preparation of compounds of Formula 1 in which X is —OR.

EXAMPLE 10

(A) A reaction vessel, fitted with a reflux condenser and stirrer, is charged with 20 g. of $[(\text{CH}_3)_4\text{N}]_2\text{B}_{20}\text{H}_{18}$ and sufficient acetone:methanol mixture (1/1) to form a solution. The solution is heated to boiling and sodium methoxide is added in excess with stirring. An orange-colored gum forms, the solution is cooled and the gum is separated. The gum is dissolved in hot water, the solution is made acid, cooled and a white crystalline solid precipitates. The solid is separated, recrystallized again from acidified water and dried under reduced pressure to obtain the acid salt $[(\text{CH}_3)_4\text{N}]_2\text{B}_{20}\text{H}_{18}\text{CCH}_3$ which can also be viewed as $[(\text{CH}_3)_4\text{N}]_2\text{HB}_{20}\text{H}_{17}\text{CCH}_3$.

Analysis.—Calc'd for above salt: H, 11.8; N, 8.61; B, 44.3. Found: H, 11.7; N, 8.22; B, 45.8.

(B) Employing the procedure of Part A, $\text{Cs}_2\text{B}_{20}\text{H}_{18}$ is reacted in aqueous solution with sodium methoxide for 2-3 hours to obtain a pale orange-colored product. The product is purified by crystallizing from water to which a small quantity of CsCl is added. The compound is the acid salt $\text{Cs}_2\text{B}_{20}\text{H}_{18}\text{OCH}_3$.

The acid salts obtained in Parts A and B of Example 10 can be used to prepare solutions of the acid

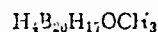

by processes which will be described later and the acid solutions can be neutralized completely with bases, e.g., $(\text{CH}_3)_4\text{NOH}$ or CsOH to obtain $[(\text{CH}_3)_4\text{N}]_2\text{B}_{20}\text{H}_{17}\text{OCH}_3$ and $\text{Cs}_2\text{B}_{20}\text{H}_{17}\text{CCH}_3$, respectively.

The process of Example 10 is generic for the preparation of compounds of Formula 1 in which X is —OR. To illustrate, $\text{Na}_2\text{B}_{20}\text{H}_{18}$ can be reacted with NaOC_2H_5 to obtain $\text{Na}_4\text{B}_{20}\text{H}_{17}\text{OC}_2\text{H}_5$; $\text{K}_2\text{B}_{20}\text{H}_{18}$ can be reacted with KOC_2H_5 to obtain $\text{K}_4\text{B}_{20}\text{H}_{17}\text{OC}_2\text{H}_5$; $\text{Na}_2\text{B}_{20}\text{H}_{18}$ can be reacted with $\text{NaOC}_6\text{H}_{13}$ to obtain $\text{Na}_4\text{B}_{20}\text{H}_{17}\text{OC}_6\text{H}_{13}$; $[(\text{CH}_3)_2\text{N}]_2\text{B}_{20}\text{H}_{18}$ can be reacted with NaOC_2H_5 to obtain $[(\text{CH}_3)_2\text{N}]_2\text{B}_{20}\text{H}_{17}\text{OC}_2\text{H}_5$; $\text{Li}_2\text{B}_{20}\text{H}_{18}$ can be reacted with $\text{LiOC}_{12}\text{H}_{25}$ to obtain $\text{Li}_4\text{B}_{20}\text{H}_{17}\text{OC}_{12}\text{H}_{25}$; and the like. The acid salts can be obtained as intermediate products as illustrated in Example 10, e.g., $\text{Na}_3\text{B}_{20}\text{H}_{18}\text{OC}_2\text{H}_5$, $\text{K}_3\text{B}_{20}\text{H}_{18}\text{OC}_2\text{H}_5$, $\text{Na}_2\text{B}_{20}\text{H}_{18}\text{OC}_6\text{H}_{13}$,

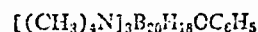

$\text{Li}_3\text{B}_{20}\text{H}_{18}\text{OC}_{12}\text{H}_{25}$, and the like.

Compounds of Formula 1 in which X is —NH₂ are obtained by reacting a salt of the divalent octadecahydro-eicosaborate, e.g., $(\text{NH}_4)_2\text{B}_{20}\text{H}_{18}$, with an alkali metal amide in liquid ammonia. The procedure is closely related to the process described in Example 8 for the preparation of —OH substituted compounds. To illustrate, a solution of NaNH_2 in liquid ammonia is prepared and



is added gradually with stirring. The solution is stirred until the liquid ammonia is substantially evaporated and the residue is warmed to dryness. Unreacted NaNH_2 is destroyed, for example, by careful addition of absolute ethanol, and the remaining crude product is processed by dissolving in water, adding $(\text{CH}_3)_4\text{NCl}$ and separating the precipitate which is $[(\text{CH}_3)_4\text{N}]_2\text{B}_{20}\text{H}_{17}\text{NH}_2$. The acid salt can also be obtained in the process, e.g.

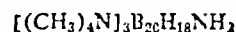

Acids of the formula $\text{H}_4\text{B}_{20}\text{H}_{17}\text{X}_n$, i.e., compounds of Formula 1, where M is hydrogen (or hydrogenium), are obtained by contacting salts of the trivalent or tetravalent eicosaborates with a strong acid, preferably an acid ion-exchange resin. To illustrate, an aqueous solution of

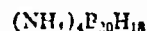

prepared as described in the first step of Example 1 is passed through a column filled with a commercial acid ion-exchange resin of the cross-linked polystyrene sulfonic acid type. The aqueous effluent is a solution of $\text{H}_4\text{B}_{20}\text{H}_{18}$

which can be evaporated to obtain a hydrate of the acid. The solution can be neutralized with a base, e.g., LiOH and evaporated to dryness to obtain a salt, e.g., Li₄B₂₀H₁₃. The process is described in more detail in Example 11 for the preparation of H₄B₂₀H₁₇OH. Both neutral and acid salts [Formula 1] can be used in the process to yield tetra-basic acids.

EXAMPLE 11

An aqueous solution of 1-(CH₃)₄Nf₄B₂₀H₁₇CH, prepared from the compound of Example 5, Part A, is passed through a column eluted with a commercial acid ion-exchange resin of the polystyrene sulfonic acid type. The eluent is an aqueous solution of H₂B₂₀H₁₇OH. The solution is mixed with an aqueous solution of CaCl₂ and the white precipitate which forms is separated by filtration. The product is crystallized from hot water to obtain tetra-calcium heptadeca-hydroxy-eicosaborate(4-).

Analysis.—Calcd for C₄H₂₀H₁₇OH: C, 67.8; B, 27.6; H, 2.57. Found: C, 67.5; B, 27.4; H, 2.70.

The titration curves for the acid H₄B₂₀H₁₇OH and H₄B₂₀H₁₇OH in aqueous solution show that in each acid three of the hydrogens are strongly acidic. The fourth hydrogen ionizes less readily than the other three and its ionization constant is in the range of a weak acid. The total volume of a standard sodium hydroxide solution used at the first inflection point (pH = 5) in a titration curve is three-fourths of the corresponding volume used at the second inflection point (pH = 9). Both neutral and acid salts of



anions can, therefore, be obtained by controlled neutralization of the acid. To illustrate, an aqueous solution of H₄B₂₀H₁₇ is titrated with an aqueous solution of CaOH until three of the hydrogen ions are neutralized, as shown by a titration curve. An aliquot portion of the solution is removed at this point and it is evaporated to dryness to obtain a hydrate of the acid salt Ca₃H₃B₂₀H₁₇, which can also be written conveniently as the hydrate of C₃H₃B₂₀H₁₇. The remaining portion of the solution can be titrated with an aqueous solution of a second base, if desired, e.g., (CH₃)₃NOH, to neutralize the fourth acidic hydrogen. The solution can be evaporated to dryness to obtain, as a hydrate, a salt of the formula C₃(CH₃)₃NB₂₀H₁₇.

Example 11 illustrates the preparation of the acid, H₄B₂₀H₁₇OH, and its conversion to acid and neutral salts by simple metathetic reactions. Neutralization of the acids of eicosaborates is a generic and versatile means of obtaining a broad range of salts. Table 2 illustrates representative salts which can be obtained from a typical acid of the invention, i.e., H₄B₂₀H₁₇ by reaction with the base or salt shown in the left column. Other acids of the invention bearing the generic anion of Formula 1 can be used with the base or salt reactant of Table 2 to obtain the corresponding salts.

TABLE 2—SALTS FROM H₄B₂₀H₁₇

Base or salt reactant	Polyborate salt
LiOH.....	Li ₄ B ₂₀ H ₁₇
RbOH.....	Rb ₄ B ₂₀ H ₁₇
MgO.....	Mg ₃ (H ₃ O) ₃ B ₂₀ H ₁₇
CaCO ₃	Ca ₃ (H ₃ O) ₃ B ₂₀ H ₁₇
LaCl ₃	La ₃ (H ₃ O) ₃ B ₂₀ H ₁₇
MnCl ₂	Mn ₃ (H ₃ O) ₃ B ₂₀ H ₁₇
CoCl ₂	Co ₃ (H ₃ O) ₃ B ₂₀ H ₁₇
NiCl ₂	Ni ₃ (H ₃ O) ₃ B ₂₀ H ₁₇
TiOH.....	Ti ₄ B ₂₀ H ₁₇
PbBr ₂	Pb ₄ B ₂₀ H ₁₇
Pyridine.....	(Pyridinium) ₄ B ₂₀ H ₁₇
Dipyridyl.....	(Dipyridinium) ₂ B ₂₀ H ₁₇
C ₁₀ H ₇ NH ₂	(C ₁₀ H ₇ N) ₄ B ₂₀ H ₁₇

TABLE 2—Continued

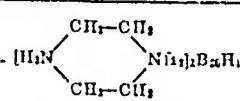
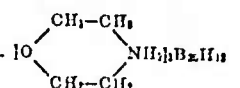
Base or salt reactant	Polyborate salt
5 Piperazine.....	
Morpholine.....	
10 C ₂ H ₅ NH ₂	(C ₂ H ₅ NH ₂) ₄ B ₂₀ H ₁₇
Zn(NH ₃) ₂ Cl ₂	(Zn(NH ₃) ₂) ₄ B ₂₀ H ₁₇
[Cr(NH ₃) ₆]Cl ₃	[Cr(NH ₃) ₆] ₄ B ₂₀ H ₁₇
[Co(NH ₃) ₆]Cl ₃	[Co(NH ₃) ₆] ₄ B ₂₀ H ₁₇
[Cu(NH ₃) ₄]SO ₄ ·H ₂ O.....	[Cu(NH ₃) ₄] ₄ B ₂₀ H ₁₇
15 (C ₆ H ₅) ₃ SiCl.....	(C ₆ H ₅) ₃ Si ₄ B ₂₀ H ₁₇
(C ₆ H ₅) ₃ PBr.....	(C ₆ H ₅) ₃ P ₄ B ₂₀ H ₁₇
(C ₆ H ₅) ₃ PCl ₂ ·H ₂ O.....	(C ₆ H ₅) ₃ P ₄ B ₂₀ H ₁₇
CH ₃ NH ₂	(CH ₃ NH ₂) ₄ B ₂₀ H ₁₇
(C ₆ H ₅) ₃ NH ₂ Cl.....	(C ₆ H ₅) ₃ NH ₂ ₄ B ₂₀ H ₁₇
CH ₃ NH ₂ CH ₃	(CH ₃ NHCH ₃) ₄ B ₂₀ H ₁₇
20 C ₆ H ₅ NH ₂	(C ₆ H ₅ NH ₂) ₄ B ₂₀ H ₁₇
(C ₆ H ₅) ₃ NOH.....	(C ₆ H ₅) ₃ N ₄ B ₂₀ H ₁₇
N,N'-C ₆ H ₄ (NH ₂) ₂	(N,N'-C ₆ H ₄ (NH ₂) ₂) ₄ B ₂₀ H ₁₇
HOC ₂ H ₄ NH ₂	(HOC ₂ H ₄ NH ₂) ₄ B ₂₀ H ₁₇
HOC ₃ H ₆ NH ₂	(HOC ₃ H ₆ NH ₂) ₄ B ₂₀ H ₁₇
25 H ₂ N(CH ₂) ₆ COOH.....	(H ₂ N(CH ₂) ₆ COOH) ₄ B ₂₀ H ₁₇
NH ₂ CH ₂ COOH.....	(NH ₂ CH ₂ COOH) ₄ B ₂₀ H ₁₇
Quantidine.....	(Quantidine) ₄ B ₂₀ H ₁₇
H ₂ N(CH ₂) ₆ NH ₂	(H ₂ N(CH ₂) ₆ NH ₂) ₄ B ₂₀ H ₁₇

30 The acids H₄B₂₀H₁₇OH, H₄B₂₀H₁₇NH₂, and H₄B₂₀H₁₇OR

where R is defined as in Formula 1, can be employed in place of H₄B₂₀H₁₇ in Table 2 to obtain the salts of the corresponding anions.

35 Metathetic reactions other than neutralization of the acids can be employed to obtain the compounds of the invention, as illustrated in Examples 10-19. To illustrate further, (CH₃)₃Si can be reacted with Na₄B₂₀H₁₇ to obtain [(CH₃)₃Si]₄B₂₀H₁₇; MgCl₂ can be reacted with H₄B₂₀H₁₇ to obtain [Mg(H₂O)₆]₄B₂₀H₁₇; (C₆H₅)₃CH₃P can be reacted with (NH₄)₄B₂₀H₁₇ to obtain

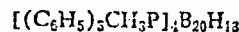

40 [(CH₃)₃CH₂CH₂P(CH₃)₃]₄ can be reacted with Na₄B₂₀H₁₇ to obtain [(CH₃)₃CH₂CH₂P(CH₃)₃]₄B₂₀H₁₇; ammoniacal ZnCl₂ can be reacted with C₃H₃B₂₀H₁₇OH to obtain [Zn(NH₃)₄]₃B₂₀H₁₇OH and the like.

45 Tetravalent eicosaborate anions of the formula (B₂₀H_{13-n}X_n)⁻⁴ form neutral and acid salts with naturally occurring nitrogen bases, e.g., lysine, aspartic acid, cysteine, asparagine, and the like. The acids of anions of the formula (B₂₀H_{13-n}X_n)⁻⁴ form neutral and acid salts with polymeric compositions containing basic nitrogen groups, e.g., poly(ethyleneimine), poly(p-amino-styrene), and the like.

UTILITY

The invention provides a broad class of new boron compounds which find applications in many fields.

50 The compounds of the invention are generically useful as impregnating agents in the preparation of resistors. To illustrate, a section of a cotton string is immersed in a nearly saturated aqueous solution of C₃H₃B₂₀H₁₇OH. The string is withdrawn from the solution and the solvent is removed by drying in air. A free flame is applied to the dried impregnated string and it burns to yield a coherent ash which in size and shape resembles the original string. The residual skeleton is of sufficient coherence to permit embedding in paraffin. The section of residue, so treated, shows a resistance of about 3000 ohms/cm. The residue from a control section of string is very small and shapeless and it cannot be handled. Residues showing a high resistance can be obtained from other compounds of the invention, e.g., [(CH₃)₃N]₄B₂₀H₁₇,

75 (NH₄)₄B₂₀H₁₇, Na₄B₂₀H₁₇, and K₄B₂₀H₁₇.

The hydrazine salts and their solutions in a hydrazine are useful as propellants in rocket propulsion motors. They can be used alone or in combination with oxidizing agents, e.g., nitric acid, fluorine oxide, and the like. To illustrate combinations can be employed which include (NH₂NH₂)₄B₂₀H₁₈ in hydrazine or in N,N-dimethylhydrazine, (NH₂NH₂)₃B₂₀H₁₈ in hydrazine, and the like. In compositions as described above, the eicosaborate salt can be present in from about 5-50% by weight of the solutions.

All of the salts which fall within the scope of Formula 1 can be used to prepare the group of acids represented generically as H₃B₂₀H_{18-n}X_n or, in aqueous solution, as (H₃O)₃B₂₀H_{18-n}X_n by passing aqueous or alcoholic solutions of the salts through an acidic ion-exchange resin as described earlier. The acids of this group are strong acids and they are generically useful in industrial applications where it is desired to avoid contamination from sulfate, chloride, bromide, chlorate, phosphate, and like strong acid anions. Thus, the acids are useful for etching metals, such as steel, and for rust removal, for pickling, for scale removal and for similar metal processing operations.

The acids, described above, are generically useful as catalysts in the preparation of esters, e.g., in the reaction of alcohols and organic carboxylic acids, to improve the yields of the desired esters. The acids of the invention are employed for this purpose in the same manner as p-toluenesulfonic acid, sulfuric acid or alcoholic hydrogen chloride.

Aqueous solutions of the acids are generically useful as agents for absorbing noxious basic materials from the air, e.g., traces of ammonia, lower alkyl amines, and the like. To illustrate, air contaminated with methylamines can be passed through an aqueous solution of H₃B₂₀H₁₈ and the amines are removed.

All of the compounds of the invention are generically useful as components of fireworks compositions to impart a pleasing color and sparkle to the display, e.g., (NH₄)₄B₂₀H₁₈, (NH₄)₃B₂₀H₁₈, Cs₄B₂₀H₁₈, and like salts, such as the strontium, magnesium and cobalt salts, can be used in such compositions. Each compound within the scope of Formula 1 contains an anion which has boron as a common component. The presence of this element imparts a green color to a fireworks, rocket or flare display. The compounds of the invention can have a wide range of cations, designated as M, and it is thus possible to provide a broad range of colors in any display or flare by choice of the appropriate cation. The compounds of the invention can be used in combination with oxidizing agents, e.g., lithium perchlorate, sodium nitrate, potassium permanganate, strontium peroxide, manganese dioxide, and the like, to provide the desired propulsive effect and color. The following combinations in which the boron-containing compounds of the invention can be from 5-25% by weight of the composition are illustrative of the compounds which can be used:

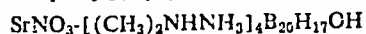
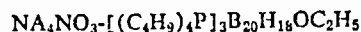
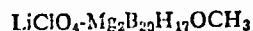
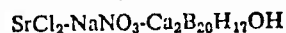
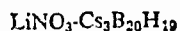

and the like.

As many apparently widely different embodiments of this invention may be made without departing from the spirit and scope thereof, it is to be understood that this invention is not limited to the specific embodiments thereof except as defined in the appended claims.

The embodiments of the invention in which an exclusive property or privilege is claimed are defined as follows:

1. A compound of the class consisting of H₃B₂₀H_{18-n}X_n and salts thereof, wherein X is bonded to boron and is of the class consisting of hydroxyl, aliphatically saturated hydrocarbyloxy, and amino; and n is a cardinal number of 0 to 1, inclusive.

2. A compound of the formula M_a(B₂₀H_{18-n}X_n)_b wherein M is a cation; X is of the class consisting of hydroxyl, aliphatically saturated hydrocarbyloxy of up to 12 carbon atoms, and amino; n is a cardinal number of 0 to 1, inclusive; and a and b are the smallest whole numbers satisfying the equation

$$b = \frac{ax \text{ valence of M}}{4}$$

3. A compound of claim 2 wherein M is hydrogen, a is 4 and b is 1.

4. A compound of claim 3 in hydrated form.

5. A compound of the formula M_{a'}(HB₂₀H₁₈X_n)_{b'} wherein M is a cation; X is bonded to boron and is of the class consisting of hydroxy, aliphatically saturated hydrocarbyloxy of up to 12 carbon atoms, and amino; n is a cardinal number of 0 to 1, inclusive; and a' and b' are the smallest whole numbers satisfying the equation

$$b' = \frac{a'x \text{ valence of M}}{3}$$

6. A compound of the formula M_a(B₂₀H₁₈)_b wherein M is a cation, and a and b are the smallest whole numbers satisfying the equation

$$b = \frac{ax \text{ valence of M}}{4}$$

7. A compound of claim 6 wherein M is hydrogen, a is 4, and b is 1.

8. A compound of claim 7 in hydrated form.

9. A compound of the formula M_{a'}(HB₂₀H₁₈)_{b'} wherein M is a cation, and a' and b' are the smallest whole numbers satisfying the equation

$$b' = \frac{a'x \text{ valence of M}}{3}$$

10. (NH₄)₄B₂₀H₁₈.

11. (NH₄)₃HB₂₀H₁₈.

12. Cs₄B₂₀H₁₈.

13. [(CH₃)₄N]₄B₂₀H₁₈.

14. [(CH₃)₄N]₃HB₂₀H₁₈.

15. A process for preparing a compound of the formula M_{a'}(HB₂₀H₁₈)_{b'} wherein M is a cation, and a' and b' are the smallest whole numbers satisfying the equation

$$b' = \frac{a'x \text{ valence of M}}{3}$$

which comprises reacting a compound of the formula M_{a''}(B₂₀H₁₈)_{b''} wherein M is defined as above, and a'' and b'' are the smallest whole numbers satisfying the equation

$$b'' = \frac{a''x \text{ valence of M}}{2}$$

with an oxidizing agent containing a variable valence metal in its highest valence state, said oxidizing agent having an oxidation-reduction potential in acid solution of about -1.33 to about -1.61 volts, in a hydroxylated solvent at a temperature below 20° C.

16. In a process for preparing a compound of the formula M_a(B₂₀H₁₈)_b wherein M is a cation and a and b are the smallest whole numbers satisfying the equation

$$b = \frac{ax \text{ valence of M}}{4}$$

the step which comprises treating a compound of the formula H₃(B₂₀H₁₈)₂ in an aqueous medium with a metal having a standard electrode potential at 25° C. of at least about 0.75 volts.

(References on following page)

References Cited

UNITED STATES PATENTS

3,148,939 9/1964 Knoth ----- 23-361

OTHER REFERENCES

Adams, Roy M.: Metallo-Boron Compound and Boranes, p. 487, Interscience Publishers, N.Y. 1964.

Hawthorne et al. (I), Journal of the American Chemical Society, vol. 85, p. 3704 (Nov. 20, 1963), Copy in Sci. Lib.

Hawthorne et al. (II), Journal of the American Chemical Society, vol. 85, pp. 3704-3705 (Nov. 20, 1963), Copy in Sci. Lib.

Kaczmarezyk et al., "Proceedings of the National Academy of Sciences, U.S.," vol. 48, pp. 729-733 (May, 1962), Copy in 23/361 in Group 110.

Pitochelli et al., Journal of the American Chemical Society, vol. 84, pp. 3026-3027 (Aug. 5, 1962), Copy in Sci. Lib.

E. C. THOMAS, *Primary Examiner.*

C. O. PETERS, *Assistant Examiner.*

U.S. Cl. X.R.

23-361; 260-606.5

1

3,455,661
**BIS-(HYDRAZINE)DECABORANE(12)
 COMPOUNDS**

William V. Hough, Gibsonia, and William J. Cooper, Butler, Pa., assignors to Mine Safety Appliances Company, a corporation of Pennsylvania
 No Drawing, Filed Aug. 9, 1965, Ser. No. 430,247
 Int. Cl. C01b 21/06, 21/16; C07H 5/02
 U.S. Cl. 23-358

6 Claims

ABSTRACT OF THE DISCLOSURE

Compounds of decaborane with hydrazines and lower alkyl substituted hydrazines are prepared in a reaction solvent consisting of a lower alkyl ether and an alcohol.

This invention relates to new compounds of decaborane with hydrazines and lower alkyl substituted hydrazines.

Decaborane reacts with hydrazine and lower alkyl hydrazines to form various compounds depending on the environment of the reaction. When the reactions are performed in hydrocarbon or ether solvents, the products are adducts of the hydrazine compound and decaborane having the general formula $(N_2R_4)_x(B_{10}H_{12})_y$, as is disclosed by Hough and Hashman in application Ser. No. 866,728, filed Apr. 15, 1959. When the reaction is performed in alcohol solvents, the products are tetradecahydrononoborate (-1) compounds, compounds having only nine boron atoms, as disclosed in the patent application of Hough and Hefferan, Ser. No. 312,783 filed Sept. 30, 1963.

It is the object of this invention to provide new bi-substituted hydrazine decaborane compounds. Another object is to provide a method of reacting decaborane with hydrazine or lower alkyl substituted hydrazines to produce bi-substituted hydrazine decaborane compounds. A further object is to provide new high energy fuels and methods for their preparation. Other objects will be apparent from the following description and claims.

The new compounds of this invention have the general formula

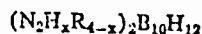

where R is hydrogen or a lower alkyl radical and x is an integer from 0 to 4. The compounds are bi-substituted decaboranes, that is two of the decaborane hydrogens are replaced by hydrazine or a lower alkyl substituted hydrazine. According to standard nomenclature practice, the compounds are designated as bis-(hydrazine) decaborane (12); for example $(N_2H_4)_2B_{10}H_{12}$ is named bis-(methylhydrazine)decaborane (12), $(CH_3N_2H_3)_2B_{10}H_{12}$ is named bis-(methylhydrazine)decaborane (12), and

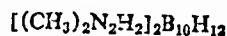

is named bis-(dimethylhydrazine)decaborane (12).

In accordance with this invention the reaction of decaborane with hydrazine or lower alkyl substituted hydrazines is directed to yield substantially only the new bis-(hydrazine)decaborane(12) compounds by (a) reacting decaborane and the hydrazine compound in an ether solvent containing a minor amount of alcohol to form an intermediate product, and (b) heating the inter-

2

mediate product under vacuum. The process can be represented by the equations:

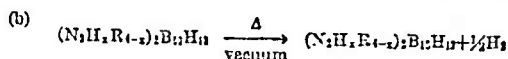
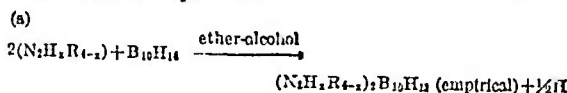

The reaction (a) is directed to form the desired intermediate by contacting the reactants in an ether solvent containing a small amount of an alcohol. Any aliphatic ethers are suitable for use, lower dialkyl ethers, e.g. diethyl ether, are preferred. Any alcohol may be used and lower aliphatic alcohol, such as, for example, methanol, ethanol and propanol, are preferred. Suitable mixed solvents contain from about 0.1 to 10% alcohol by volume, preferably between about 0.5 to 5% alcohol. The reaction is conveniently carried out at room temperature although higher or lower temperatures may be used if desired, suitably between about 0° C. and 40° C. The proportion of reactants is not critical, but it is generally preferred to use stoichiometric amounts or a slight excess of decaborane. The intermediate, which precipitates from the reaction mixture, has a fixed elemental content, or empirical formula; however, its structure has not been established. It may be a constant mixture of two or more decaborane compounds.

The intermediate solid material recovered from the reaction in the mixed ether-alcohol solvent very slowly loses hydrogen at ambient or slightly elevated temperatures to form a bis-(hydrazine)decaborane(12). In order to obtain practical hydrogen evolution rates, it is preferred to heat the intermediate, suitably to between about 50° C. and 150° C., under vacuum. A preferred method is to slurry the intermediate in an inert fluid, such as a hydrocarbon, and heat the slurry under vacuum or nitrogen.

Hydrazine or any lower alkyl substituted hydrazine i.e., having substituted alkyl groups containing no more than 6 carbon atoms, may be used in the method of this invention to prepare the corresponding bis-(hydrazine) decaborane. Suitable hydrazine compounds include hydrazine, monomethyl hydrazine, sym-dimethyl hydrazine, unsym-dimethyl hydrazine, trimethyl hydrazine, tetramethyl hydrazine, monoethyl hydrazine, triethyl hydrazine, mono-n-propyl hydrazine, sym-di-n-propyl hydrazine, and mono-n-butyl hydrazine.

In the following example that is illustrative of this invention, 23.4 mmoles of decaborane and 23.9 mmoles of monomethyl hydrazine were stirred at room temperature for 21 hours in 40 ml. of diethyl ether containing 5 drops of ethanol. Approximately 10 mmoles of hydrogen were evolved and a yellow-white precipitate formed. The solution was filtered and the product was dried in vacuo. Evaporation of ether from the filtrate left a large residue of unreacted decaborane. Analysis of the solid product were B, 47.1 mat./g. (milliatoms per gram); C, 8.7 mat./g.; N, 187 mat./g.; H, 117 mat./g., which corresponds to the theoretical analyses of

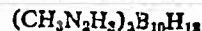

which are B, 46.8 mat./g.; C, 9.3 mat./g.; N, 18.7 mat./g.; H, 117 mat./g. 4.27 mmoles of the product mixture was added to 7 ml. of toluene, in which the product is insoluble, and heated in vacuo to 60° C. until no further

3

hydrogen was evolved. The hydrogen loss was 2.24 mmols. The product remaining in the solvent was filtered, washed and n-pentane and dried. The product was identified as bis-(monomethylhydrazine)decaborane (12) by elemental analysis, infra-red spectrum analysis and X-ray pattern analysis. The elemental analysis were B, 47.0 mat./g.; C, 10.3 mat./g.; N, 18.7 mat./g.; H, 11.1 mat./g.; corresponding to theoretical values of B, 47.1 mat./g.; C, 10.3 mat./g.; N, 18.7 mat./g. and H, 11.3 mat./g. The characteristic X-ray powder diffraction bands are 5.8 (very strong), 5.1 (very strong), 4.6 (weak), and 4.1 (very weak).

The bis-(monomethylhydrazine)decaborane(12) is a white crystalline solid. It is insoluble in ethers and hydrocarbons, slightly soluble in alcohols and soluble in water, with no evidence of hydrolysis. It is stable in vacuo to at least 200° C. and has a heat formation of 25° C. of about -80 Kcal./g. Other bis-(hydrazine)decaborane (12) compounds, e.g. bis-(hydrazine)decaborane(12), bis-(sym-dimethylhydrazine)decaborane(12) and bis-(unsym-dimethylhydrazine)decaborane(12) are like bis-(monomethylhydrazine)-decaborane(12) insoluble in ethers and hydrocarbon, slightly soluble in alcohols, soluble in water, with no evidence of hydrolysis, and thermally stable.

The bis-(hydrazine)decaborane(12) compounds of this invention are especially desirable for solid fuels because of their resistance to hydrolysis thermal stability and high heat of combustion. These compounds burn readily with conventional solid chemical oxidizers and are useful as fuel components in solid non-propellants when compounded with conventional oxidizers and binders. The compounds of this invention are also useful as intermediates in the synthesis of other compounds in which a decaborane-type structure is desired.

According to the provisions of the patent statutes, we have explained the principle and mode of practice of our invention and have described what we now consider to represent its best embodiment. However, we desire to have it understood that, within the scope of the appended claims, the invention may be practiced otherwise than as specifically described.

We claim:

1. A method of preparing a bis-(hydrazine)decaborane(12) comprising the steps of:
 - (a) contacting and reacting decaborane and a compound selected from the group consisting of hy-

4

drazine and lower alkyl substituted hydrazines in a reaction solvent consisting essentially of a lower alkyl ether and an alcohol, whereby a precipitate is formed;

- (b) recovering said precipitate; and
- (c) heating said precipitate, whereby hydrogen is evolved, to form said bis-(hydrazine)decaborane (12).

2. A method according to claim 1 in which the solvent contains from about 0.5 to 5% alcohol.

3. A method according to claim 1 in which the ether is diethyl ether and the alcohol is a lower aliphatic alcohol.

4. A method according to claim 1 in which step (a) is performed at about room temperature.

5. A method according to claim 1 in which step (c) is performed under vacuum.

6. A method of preparing a bis-(hydrazine)decaborane(12) that comprises the steps of:

- (a) contacting and reacting decaborane and a compound selected from the group consisting of hydrazine and lower alkyl substituted hydrazines at about room temperature in a reaction solvent consisting of diethyl ether containing about 0.5 and 5 ethanol, whereby a precipitate is formed;

(b) recovering said precipitate; and

- (c) slurring said precipitate in a hydrocarbon, heating said slurry under vacuum whereby hydrogen is evolved and recovering said bis-(hydrazine)decaborane(12) formed thereby.

References Cited

UNITED STATES PATENTS

35	3,148,938	9/1964	Knott	23-190 X
	3,149,010	9/1964	Armstrong	23-190 X
	3,153,567	10/1964	Fetter	23-358 X
	3,269,802	8/1966	Grafstein	23-358
	3,264,071	8/1966	Hough	23-358
40	3,298,799	1/1967	Hough et al.	23-358

OSCAR R. VERTIG, Primary Examiner

G. O. PETERS, Assistant Examiner

U.S. Cl. X.R.

23-190; 260-606.5

1

3,509,152

BIS-POLYQUATERNARY AMMONIUM DODECAHYDRODODECABORATES AND OCTAHYDROTRIBORATES

Robert Ehrlich, Morristown, and Phillip Shapiro, Succasunna, N.J., assignors to Thiokol Chemical Corporation, Bristol, Pa., a corporation of Delaware

No Drawing, Filed Apr. 23, 1966, Ser. No. 545,881

Int. Cl. C07d 51/64

U.S. Cl. 260-268

7 Claims

ABSTRACT OF THE DISCLOSURE

The invention relates to novel boron-containing polyquaternary ammonium compounds, particularly to bis-polyquaternary ammonium dodecahydrododecaborates and octahydrotriborates. The compounds are useful in rocket propellants and as reducing agents.

This invention concerns the preparation of a novel class of polyquaternary ammonium compounds containing substituents which include boron. More particularly, the invention pertains to polyquaternary ammonium borohydrides, dodecahydrododecaborates and octahydrotriborates useful as reducing agents, polymerization catalysts and flame temperature moderators in rocket propellants.

The novel compounds of this invention are included within the group consisting of:

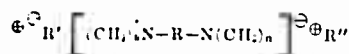

and

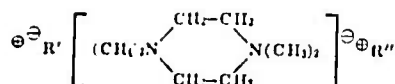

wherein R is selected from the group consisting of methylene, ethylene, and

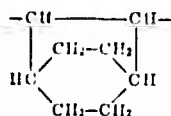

R' and R'' taken together are the $B_{12}H_{12}^{-2}$ radical and taken singly are selected from the group consisting of BH_4^{-1} and $B_3H_8^{-1}$ radicals; and n is one of the integers 1 through 3.

In a copending application, Ser. No. 545,843, filed in the United States Patent Office April 28, 1966, the preparation of polyquaternary ammonium thiophenoxides is described, which novel compounds are intermediates, in the preparation of a number of the subject compounds. Other intermediates, polyquaternary ammonium halides, are described in a copending application, Ser. No. 399,330, filed in the United States Patent Office on Sept. 25, 1964, now abandoned. The other reagents are commercially available or can be synthesized by known methods.

All of the subject compounds, except the alkylene-bis-compounds, have excellent hydrolytic and thermal stability and can be handled in air.

2

It is accordingly an object of this invention to provide novel compounds heretofore unreported in the literature.

A further object of this invention is to provide compounds useful as reducing agents, polymerization catalysts and the flame temperature moderators in rocket propellants.

Where the polyquaternary ammonium borohydrides of this invention are soluble in water, they are prepared by (1) contacting a bis(trimethylammonium thiophenoxide) with lithium borohydride in anhydrous tetrahydrofuran, (2) filtering to remove the solid product, and (3) drying the product. Where the polyquaternary ammonium borohydrides are soluble in dimethylformamide, they are prepared by (1) contacting a bis(trimethylammonium chloride) with sodium borohydride in dimethylformamide, (2) filtering to remove precipitated sodium chloride, (3) extracting with tetrahydrofuran, (4) removing the product by filtration, and (5) drying the product.

Polyquaternary ammonium dodecahydrododecaborates are prepared by (1) contacting a polyquaternary ammonium iodide with di-sodium dodecahydrododecaborate in aqueous solution, (2) filtering, and (3) washing the solid product with hot water. The di-sodium dodecahydrododecaborate is prepared by the method of R. M. Adams, A. R. Siedle and J. Grant, *Inorganic Chemistry* 3, 461 (1964).

The general method of preparing the polyquaternary ammonium octahydrotriborates is by (1) contacting a bis-iodide with potassium octahydrotriborate, and (2) recrystallizing the product from water.

By way of explanation, some specific examples illustrating the invention will be described. This is done solely by way of example, and is intended neither to delineate the scope of the invention nor limit the ambit of the appended claims.

EXAMPLE 1

Preparation of ethylene-bis(trimethylammonium borohydride)

(A) A suspension of 0.020 gram-mole of ethylene-bis(trimethylammonium thiophenoxide) in 100 milliliters of anhydrous tetrahydrofuran was added to 50 milliliters of a 4 molar solution of $LiBH_4$ in anhydrous tetrahydrofuran. The mixture was stirred at reflux for 15 hours, then the white, solid product was filtered, washed thoroughly with anhydrous tetrahydrofuran and dried. The yield was 2.91 grams of product having a melting point of 239-240° C., with decomposition. The solid was recrystallized by dissolving 5 grams in 75 milliliters of hot tetrahydrofuran, filtering the solution while hot, adding an equal volume of anhydrous tetrahydrofuran and cooling the solution. The long, white needles of the product melted at 192° C., with decomposition. The density was 0.837 g./cc. The theoretical and experimentally determined percentages by weight of elements in the product were as follows.



Theoretical—C, 54.61; H, 17.18; B, 12.29; N, 15.92 active II, 4.56

Experimental—C, 53.23; H, 17.97; B, 12.05; N, 15.03; active II, 4.49

(B) To a solution of 33 grams (0.15 gram-mole) of ethylene-bis(trimethylammonium chloride) in 1 liter of

3

dimethylformamide was added a solution of 12 grams of NaBH_4 in 10 milliliters of dimethylformamide. The solution was heated to 60°C . for 15 hours, followed by filtration of the precipitated NaCl . Approximately 150 milliliters of tetrahydrofuran were added to the filtrate, precipitating more NaCl . The solution was filtered and the filtrate tested for halogen. Fractional precipitation was repeated until the filtrate was halogen-free, after which 500 milliliters of anhydrous tetrahydrofuran were added. The mixture was allowed to stand for one hour, then the borohydride salt was isolated. The yield was 9.5 grams of product having a melting point of $189\text{--}190^\circ\text{C}$., with decomposition. The infrared spectrum was identical to that of the material prepared from the thiophenoxide.

EXAMPLE 2

Preparation of tetramethylpiperazinium bis-borohydride

Using the procedure described in Example 1(A), tetramethylpiperazinium bis-borohydride was prepared starting with 0.020 mole of tetramethylpiperazinium bis-thiophenoxide. The yield was 3.0 gram of product having a density of 0.914 g./cc. and a melting point of $185\text{--}190^\circ\text{C}$., with decomposition. The analysis was:

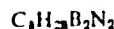

Theoretical—C, 55.23; H, 16.22; B, 12.45; active H, 4.64
Experimental—C, 54.81; H, 16.29; B, 12.40; active H, 4.56.

EXAMPLE 3

Preparation of N,N'-dimethyl-1,4-diazinabicyclo[2.2.2]octane bis-borohydride

Using the procedure described in Example 1(A), N,N'-dimethyl-1,4-diazinabicyclo[2.2.2]octane bis-borohydride was prepared starting with N,N'-dimethyl-1,4-diazinabicyclo[2.2.2]octane bis-thiophenoxide. The product decomposed above 240°C . Quantitative hydrolysis and elemental analysis confirmed the product composition.

EXAMPLE 4

Preparation of N,N,N',N'-tetramethylpiperazinium dodecahydrododecaborate

A solution of 2.90 grams of $\text{Na}_2\text{B}_{12}\text{H}_{12}$ (0.15 gram-mole dissolved in 200 milliliters of water was added to a solution of 5.97 grams of N,N,N',N'-tetramethylpiperazinium diiodide in 250 milliliters of hot water. A white precipitate formed immediately. The mixture was stirred at 70°C . for 30 minutes. The hot reaction mixture was filtered, after which the solid was washed with hot water. It is necessary to keep the water hot because the iodide is only slightly soluble in cold water. The white solid product was dried 3 hours at 80°C . in vacuo. The yield was 3.28 grams. The product density was 0.956 g./cc. and it did not decompose below 360°C . There was no weight loss to 268°C ., a 9% weight loss to 300°C ., a 12% weight loss to 400°C ., and a total of 27% loss by weight to 550°C . The analysis was:

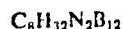

Theoretical—N, 9.79; B, 45.35.
Experimental—N, 9.47; B, 45.46; I, zero.

EXAMPLE 5

Preparation of N,N'-dimethyl-1,4-diazinabicyclo[2.2.2]octane dodecahydrododecaborate

Using the procedure described in Example 4, N,N'-dimethyl-1,4-diazinabicyclo[2.2.2]octane dodecahydrododecaborate was prepared starting with 0.01 gram-mole of N,N'-dimethyl-1,4-diazinabicyclo[2.2.2]octane diiodide in water. The product was a white, insoluble material weighing 3.10 grams, which did not appear to melt or decompose below 360°C . There was no weight loss to 225°C ., a 10% weight loss to 350°C ., a 28% weight

4

EXAMPLE 6

Preparation of methylene-bis(trimethylammonium) dodecahydrododecaborate

A solution of 1.88 grams of $\text{Na}_2\text{B}_{12}\text{H}_{12}$ (0.01 gram-mole) in 50 milliliters of water was added to a solution of 3.86 grams (0.01 gram-mole) of methylene-bis(trimethylammonium iodide) in 80 milliliters of water. Precipitation was immediate and 0.40 gram of salt was isolated and dried. The product decomposed above 240°C . without melting.

EXAMPLE 7

Preparation of ethylene-bis(trimethylammonium octahydrotriborate)

To a solution of 4.0 gram (0.01 gram-mole) of the bis-iodide in 10 milliliters of water was added a solution of 1.6 grams (0.02 gram-mole) of KB_3H_8 in 10 milliliters of water. A heavy white precipitate formed immediately and was filtered. The solid was recrystallized twice from hot water and dried in vacuo for 3 hours at 75°C ., yielding 1.75 gram of product which decomposed starting at 210°C . and complete at $300\text{--}310^\circ\text{C}$. The salt was stable in water at room temperature for 16 hours. The analysis was:



Theoretical—C, 42.27; H, 16.85; N, 12.32; B, 28.56.
Experimental—C, 42.86; H, 16.67; N, 12.52; B, 28.36; I, zero.

EXAMPLE 8

Preparation of methylene-bis(trimethylammonium octahydrotriborate)

Using the procedure described in Example 7, methylene-bis(trimethylammonium octahydrotriborate) was prepared. The white crystals changed color above 300°C . and did not melt below 360°C . The product was stable in water at room temperature for 16 hours.

EXAMPLE 9

Preparation of N,N,N',N'-tetramethylpiperazinium bis(octahydrotriborate)

A solution a 0.80 gram (0.002 gram-mole) of the bis-iodide in 10 milliliters of water was added to 0.32 gram (0.004 gram-mole) of KB_3H_8 dissolved in 5 milliliters of water. The insoluble, white octahydrotriborate salt was filtered and recrystallized from hot water. The yield was 0.35 gram of product which melted at $215\text{--}219^\circ\text{C}$., with decomposition. Product density was 0.878 g./cc. The salt was stable in water at room temperature for 16 hours. The analysis was:



Theoretical—C, 42.64; H, 16.10; N, 12.43; B, 28.83; active H, 7.61
Experimental—C, 43.40; H, 16.51; N, 12.20; B, 28.15; active H, 7.55

EXAMPLE 10

Preparation of N,N'-dimethyl-1,4-diazinabicyclo[2.2.2]octane bis-octahydrotriborate

Using the procedure described in Example 7, N,N'-dimethyl-1,4-diazinabicyclo[2.2.2]octane bis-octahydrotriborate was prepared starting with the bis-iodide. It decomposed without melting, beginning at 200°C . and continuing up to 350°C ., at which temperature it charred. Elemental analysis confirmed the synthesis. Again the compound was stable in water at room temperature for 16 hours.

What is claimed is:

1. N,N,N',N'-tetramethylpiperazinium dodecahydrododecaborate.
2. N,N'-dimethyl-1,4-diazinabicyclo[2.2.2]octane

3,509,152

5			6		
3. Methylene - bis(trimethylammonium)dodecahydro-	3,108,139	10/1963	Larchar	-----	260—567.6
dodecaborate.	3,127,404	3/1964	Mascoli	-----	260—268
4. Ethylene - bis(trimethylammonium octahydrotri-	3,219,699	11/1965	Elmlich et al.	-----	260—567.6
borate).	3,227,754	1/1966	Bragdon	-----	260—567.6
5. Methylene - bis(trimethylammonium octahydrotri-	3,228,814	1/1966	Jenkins et al.	-----	260—567.6
borate).	3,265,737	8/1966	Miller et al.	-----	260—268 X
6. N,N,N',N' - tetramethylpiperazinium bis(octahydro-	3,360,569	12/1967	Grafstein	-----	260—606.5
triborate).	3,365,275	1/1968	Muetterties	-----	260—567.6 X
7. N,N'-dimethyl - 1,4 - diazinebicyclo[2.2.2]octane	3,383,399	5/1968	Stafiej et al.	-----	260—268 X
bis-octahydrotriborate.					

10 DONALD G. DAUS, Primary Examiner

References Cited

UNITED STATES PATENTS

2,738,369	3/1956	Banus	-----	260—567.6
3,018,619	1/1962	Doss	-----	260—268 X

U.S. Cl. X.R.

260—567.6; 60—35.4; 252—188, 429

15

1

2

3,551,120

SUBSTITUTED DODECABORATES

Henry C. Miller, Wilmington, Del., and Earl L. Munter, West Chester, Pa., assignors to E. I. du Pont de Nemours and Company, Wilmington, Del., a corporation of Delaware

No Drawing. Continuation-in-part of applications Ser. No. 15,042, Mar. 15, 1960, Ser. No. 30,443, May 20, 1960, and Ser. No. 141,248, Sept. 25, 1961. This application Dec. 21, 1962, Ser. No. 246,636

Int. Cl. C01b 6/22

U.S. Cl. 23-358

35 Claims

This application is a continuation-in-part of our applications, Ser. No. 15,042, filed Mar. 15, 1960, and Ser. No. 30,443, filed May 20, 1960, both now abandoned and of our pending application, Ser. No. 141,248, filed Sept. 25, 1961, now abandoned.

This invention relates to new compounds containing boron and to methods for preparing the compounds.

Boron compounds, particularly boron hydrides, have achieved technical importance in recent years. However, there are many potential applications for which boron compounds including boron hydrides, halides and alkyls, cannot be used because of hydrolytic, oxidative and other types of instability. To illustrate, diborane, chlorodiborane, pentaborane(9) and trialkylboron compounds are spontaneously flammable in air. Diborane, pentaborane(9), chlorodiborane, boron trichloride, iododecaborane(14) and most other boron halides are hydrolyzed rapidly in water or alcohol. Even the most stable known borohydride, i.e., decaborane(14), is hydrolyzed at a moderate rate in water. Known ionic borohydrides, e.g., tetrahydroborates (NaBH_4 and the like), are hydrolyzed at a rapid rate at 100° C.

This invention is directed to a broad class of boron compounds which have stability characteristics that are unusual for boron compounds. The compounds of the invention generally show hydrolytic, oxidative and chemical stabilities normally associated with aromatic organic compounds.

The novel boron compounds are ionic in character and they are represented generically by the following formula:



M is a cation, i.e., an atom or group of atoms which forms a positively charged ion in aqueous solution, which cation has a positive ionic charge or valence of 1-4; $(B_{12}H_{12-y}X_y)$ is a group which forms a divalent anion in aqueous solution, i.e., an ion which carries a negative charge of 2; X is a monovalent group capable of bonding to carbon of a benzene nucleus by replacement of hydrogen bonded to said carbon; y is an integer, i.e., a positive whole number, of 1 through 12; a and b are positive whole numbers of 1 through 3 whose respective values are determined by the valence of M, i.e., a multiplied by the valence of M is equal to 2b. The X groups, when more than one is present, can be alike or different.

The novel compounds of this invention may also be defined as derivatives of the acid $H_2B_{12}I_{12}$ and its salts wherein at least one hydrogen of the $B_{12}H_{12}^{-2}$ anion is replaced by an X substituent. The component X comprises a broad group of substituents for which representative illustrations are given in the examples in later paragraphs.

In the compounds of Formula 1 the novel and characterizing component is the boron-containing group shown in parentheses, i.e., $(B_{12}H_{12-y}X_y)^{-2}$. This group behaves as a stable chemical entity in conventional reactions and it will be discussed more fully in later paragraphs with particular reference to the substituent X.

The group M

In generic Formula 1 M is a group which can be composed of one or more than one element and which is ionically bonded to the boron-containing group. The groups represented by M bear a positive ionic charge and they have in common the property of forming positively charged groups or cations in water.

The principal function of the group M is to provide an element or group of elements which bear the necessary positive charges to combine with the novel anion, i.e., $(B_{12}H_{12-y}X_y)^{-2}$, and thus permit its isolation as part of a stable compound.

The properties of the group M are not critical and the group therefore represents a broad range of elements or combinations of elements. To illustrate, M can be hydrogen, hydronium (H_3O^+), a metal, ammonium (NH_4^+), lydrazonium ($NH_2NH_3^+$) (also called hydrazinium), N-substituted ammonium, N-substituted hydrazinium ($CH_3NHNH_3^+$), aryl diazonium (ArN_2^+), sulfonium, phosphonium, metal-ammine, 2,2'-bipyridinium, quinolinium, phenazonium, N-alkylpyridinium, and the like.

The group M can be derived from any metal. The metals according to the Periodic Table in Deming's "General Chemistry," 5th ed., chap II, John Wiley & Sons, Inc., and in Lange's "Handbook of Chemistry," 9th ed., pp. 56-57, Handbook Publishers, Inc. (1956) are the elements of Groups I, II, VIII, III-B, IV-B, V-B, VI-B, VII-B, and the elements of Groups III-A, IV-A, V-A and VI-A which have atomic numbers above 5, 14, 33 and 52, respectively. The metals can be light or heavy metals. To illustrate, M can be lithium, sodium, potassium, cesium, beryllium, barium, lanthanum, zirconium, vanadium, manganese, iron, cobalt, copper, zinc, mercury, aluminum, thallium, tin, lead, antimony, bismuth, silver or any other metal. Preferred metals are those whose valences are 1-3, inclusive.

An especially preferred group of metals from which M can be derived consists of elements of Groups I-A, II-A, I-B and II-B having atomic numbers up to and including 80. Most preferred metals are the alkali and alkaline earth metals, i.e., lithium, sodium, potassium, rubidium, cesium, beryllium, magnesium, calcium, strontium and barium.

The group M can be a combination of a metal and ammonia or a metal and an amine, i.e., a Werner-type coordination complex referred to as a metal-ammine group. To illustrate M can be

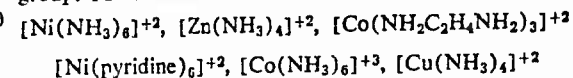

and the like. The group can be a metal with water of hydration, e.g., $[Cu(H_2O)_4]^{+2}$, $[Ni(H_2O)_6]^{+2}$, and the like.

The group M can be aryl diazonium, i.e., a group of the formula ArN_2^+ , where Ar represents an aryl group. To illustrate, Ar can be phenyl, tolyl, xylyl, naphthyl, and the like.

The group M can be an N-substituted ammonium radical, an S-substituted sulfonium group and a P-substituted phosphonium group of the formula RNH_3^+ , $R_2NH_2^+$, R_3NH^+ , R_4N^+ , R_3S^+ , and R_4P^+ . R represents an organic group bonded to the nitrogen, sulfur or phosphorus. The R groups are not critical features of these cation groups; thus, R can be open-chain, closed-chain, saturated or unsaturated hydrocarbon or substituted hydrocarbon groups. R can be a heterocyclic ring of which the nitrogen, sulfur or phosphorus atom is a component part. Thus, when M is a substituted ammonium group, R can be derived from pyridine, quinoline, morpholine, hexamethylenimine, and

3

the like. Preferably R, for reasons of availability of reactants, contains at most 18 carbon atoms. For example, R can be methyl, 2-ethylhexyl, octadecyl, allyl, cyclohexyl, cyclohexenyl, phenyl, naphthyl, antiryl, cyclohexylphenyl, diphenyl, benzyl, chloroethyl, α -cyanoamyl, β -hydroxyethyl, *p*-hydroxyphenyl, and the like.

The group M can be N-substituted hydrazonium (also called hydrazinium) radicals having the formulas $(RNHNH_2)^+$, $(R_2NHNH_2)^+$, and the like, wherein R has the same definition as given in the preceding paragraph. To illustrate, the hydrazonium cation can be derived from phenylhydrazine, methylhydrazine, 1,1-dimethylhydrazine, 1,2-dimethylhydrazine, ethylhydrazine, 1,1-diethylhydrazine, and similar compounds.

The valence of the cation M will be between 1 and 4, i.e., M can have a valence of 1, 2, 3, or 4. In most cases the valence of M will be 1 or 2 and this group of compounds in which the valence of M is at most 2 are readily preparable and so form a preferred group of compounds in this invention.

The group $(B_{12}H_{12-y}X_y)^{-2}$

The novel feature of the compounds of Formula 1 is the polyhydropolyborate group, $B_{12}H_{12-y}X_y$, which carries an ionic charge of -2 and which forms a divalent anion in aqueous solution. The values of a and b in generic Formula 1 are, therefore, determined by the valence of M and they are the smallest whole numbers which satisfy the following equation:

$$b = \frac{a \times \text{valence of M}}{2}$$

The pertinent feature in the novel group,

$(B_{12}H_{12-y}X_y)^{-2}$

is the substituent X, which is bonded to boron. The number of substituents which can be present in the group is not less than 1 or more than 12 and the substituents can be alike or different.

In its broadest aspects, X is a monovalent group which has the characterizing property of forming X—C bonds where C represents a carbon which is a nuclear member of a benzene ring and where the X—C bond is formed in place of an H—C bond. The property of forming X—C bonds, where C is nuclear carbon as defined above, is common to all the groups which are represented by X.

The group X can represent a substituent introduced into the $B_{12}H_{12}^{-2}$ anion by direct reaction or it can represent a substituent obtained by subsequent chemical modification of a group which has been introduced by direct reaction, e.g., a substituent obtained by reduction, esterification, hydrolysis or amidation of directly introduced groups.

Compounds of the invention are obtained by processes which employ as a principal reactant a salt or acid having the $B_{12}H_{12}^{-2}$ anion, i.e., a compound of the formula $M_a(B_{12}H_{12})_b$, where M, a and b have the meanings given in previous paragraphs.

The salts or acid having the $B_{12}H_{12}^{-2}$ anion (called dodecahydrododecaborates) are compounds whose infrared spectra consistently include strong absorption bands at $4.0\mu \pm 0.1$ and $9.35\mu \pm 0.1$. These bands are an identifying characteristic of dodecahydrododecaborate anions in which the absorption at $4.0\mu \pm 0.1$ is due to B—H stretching and at $9.35\mu \pm 0.1$ is due to the dodecaborate cage.

The dodecaborate anion is referred to above as a dodecaborate cage. The B^{11} nuclear magnetic resonance spectra of dodecahydrododecaborate salts have been determined and the data indicate that the dodecahydrododecaborate anion contains one and only one type of boron atom, i.e., all the borons are chemically equivalent. The data further indicate that each boron atom is bonded to only one hydrogen atom and that all the hydrogen atoms are chemically equivalent. These data are best explained by assigning to the dodecahydrododecaborate anion a

4

spatial configuration wherein the boron atoms form an icosahedron in which all the boron atoms are equal (in the same sense that all carbon atoms in benzene are equal) and each boron is bonded to one hydrogen. A complete analysis of infrared and Raman spectra show the dodecahydrododecaborate anion to have, in fact, I_h symmetry. The spatial configuration of this dodecahydrododecaborate anion can be described most aptly as an icosahedron of boron atoms.

One or more hydrogens in the $B_{12}H_{12}^{-2}$ anion can be replaced with groups or substituents to whatever degree desired. Substitution in the $B_{12}H_{12}^{-2}$ anion can, of course, lead to a shift in the absorption bands and the characteristic bands for the substituted B_{12} anion may vary from the wavelengths given earlier for the unsubstituted $B_{12}H_{12}^{-2}$ anion. Complete substitution of all 12 hydrogen atoms will, of course, result in the disappearance of the band at about 4.0μ which is due to B—H stretching.

The substituent X can be introduced directly or indirectly into the $B_{12}H_{12}^{-2}$ anion. One or more groups can be introduced by direct reaction and these groups can be modified by subsequent chemical reactions. Groups which can be introduced by conventional processes and which employ readily available reactants form a preferred class. In this preferred group of compounds of Formula 1, the group X represents one or more of the following substituents: halogens (F, Cl, Br, I), hydrocarbon, carboxyl

30

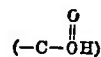

carbonyl and N-substituted carbonyl

35



halocarbonyl



where Y is F, Cl, Br, I, halomethyl ($-CH_2Y'$, $-CHY'_2$ and CY'_3 , where Y' is F, Cl, Br, I), hydroxy ($-OH$), hydrocarbonoxy ($-OR'$), monooxahydrocarbonoxy

$(R'OR''O-)$

acetal [$-CH(OR')_2$], ketal [$-CR'(OR')_2$], hydrocarboncarbonyloxy [$-OC(O)R'$], hydrocarbonoxycarbonyl [$-C(O)OR'$], isocyanate ($-NCO$), thiocyanate

$(-SCN)$

isothiocyanate ($-NCS$), hydrocarbonmercapto ($-SR'$), hydroxymethyl ($-CH_2OH$), hydrocarbonoxymethyl

$(-CH_2OR')$

aminomethyl ($-CH_2NH_2$, $-CH_2NHR'$ and $-CH_2NR'_2$), cyano ($-CN$), amino ($-NH_2$), substituted amino

$(-NHR', -NR'_2)$, thiol ($-SH$), azido ($-N_3$), acyl

formyl



nitro ($-NO_2$), nitroso ($-NO$), azo ($-N=N-Ar$), where Ar is an aromatic hydrocarbon group of up to 10 carbons), sulfo ($-SO_3H$), sulfonyl ($-SO_2R'$), and acetoxymercury

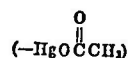

R' , where used in the above substituents, is a monovalent organic group which is preferably a hydrocarbon group (alkyl, cycloalkyl, alkenyl, cycloalkenyl, aryl, alkaryl, aralkyl, and the like) of at most 18 carbons, and R'' is a divalent hydrocarbon group of at most 18 carbons.

Many of the compounds of the invention are obtained by reacting the dodecahydrododecaborate(2-), i.e., the $B_{12}H_{12}^{2-}$ salt or acid, with an electrophilic reagent. Substituents introduced by this process into the anion are called hereinafter "electrophilic groups." Compounds of Formula 1 obtained by a process of electrophilic attack form a second preferred class of products of the invention. In this preferred group of compounds of Formula 1, X is defined as a monovalent group which is capable of bonding to carbon of a benzene nucleus by reaction of benzene or a substituted benzene with an electrophilic reagent.

An electrophilic group is a group which is deficient in electrons and which has a point of low electron density. Electrophilic groups and reagents which are employed to effect substitution of such groups for hydrogen on carbon of a benzene nucleus are described in conventional textbooks, of which the following are examples:

Remick, "Electronic Interpretations of Organic Chemistry," pp. 89-110, Wiley (1943).

Ingold, "Structure and Mechanism in Organic Chemistry," pp. 198-220, 269-304 (especially pp. 202, 211), Cornell University Press (1953).

Fuson, "Advanced Organic Chemistry," chap. 1, Wiley (1953).

Wheland, "Advanced Organic Chemistry," 2nd ed., p. 83, Wiley (1949).

Examples of electrophilic groups or substituents, represented by X in Formula 1, which are included in this preferred group are as follows: halogens (F, Cl, Br, I), hydrocarbon ($-R'$), carboxyl



N,N-disubstituted carbamyl

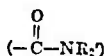

haloformyl



where Y is F, Cl, Br, I, cyano ($-\text{CN}$), trihalomethyl ($-\text{CCl}_3$, $-\text{CF}_3$, etc.), acyl



formyl



nitro ($-\text{NO}_2$), nitroso ($-\text{NO}$), azo ($-\text{N}=\text{N}-\text{R}'$), sulfo ($-\text{SO}_3\text{H}$), sulfonyl ($-\text{SO}_2\text{R}'$), hydrocarbonoxy ($-\text{OR}'$), hydrocarbonmercapto ($-\text{SR}'$), and mercuric acetyl

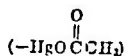

R' , where used in the above substituents is a monovalent organic group which is preferably a hydrocarbon group (alkyl, cycloalkyl, alkenyl, cycloalkenyl, aryl, alkaryl, aralkyl) of at most 18 carbons.

The number of substituents which can be present on the dodecahydrododecaborate(2-) anion is not less than 1 or more than 12. Thus, the anion $(B_{12}H_{12-y}X_y)^{2-}$, in the generic formula $M_a(B_{12}H_{12-y}X_y)_b$, can range from $(B_{12}H_{11}X)^{2-}$ through successively decreasing hydrogen content to $(B_{12}X_{12})^{2-}$.

Examples of the new compounds of the invention, illustrated by formulas, are as follows:

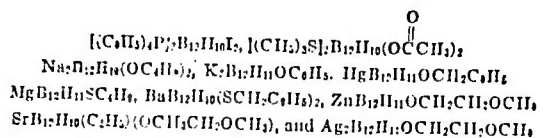
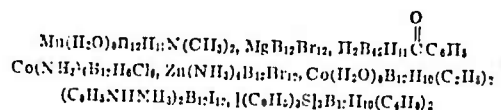
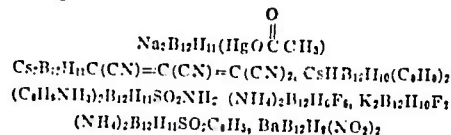
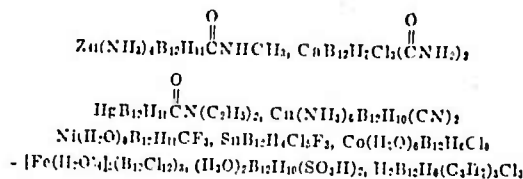
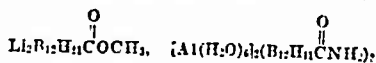
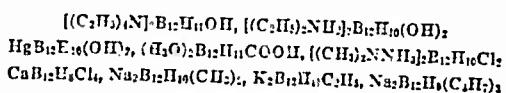

The invention includes within its scope compounds with two or more X groups which are unlike, e.g.,

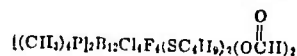
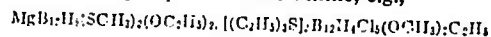

and the like.

The new compounds are usually solid products which are salt-like in character. Many of the compounds dissolve in water. The color of the compounds is dependent on the nature of the M group and of the electrophilic group bonded to boron. For example, the cupric ammonium salts are bright blue, alkali metal salts are usually white.

Most of the compounds are stable and usually can be handled in a conventional manner. Thus, compounds having halogen, alkyl or acyl substituents are stable and they can be kept in storage for prolonged periods in ordinary containers. However, the precautions usually followed in handling new compositions should be employed.

The scope of the monovalent groups encompassed by X in generic Formula 1 for the compounds of the invention can be understood more clearly by describing methods for obtaining the compounds.

The ionic charge of -2 on the boron-containing anion, which was discussed previously, refers to a charge which is inherent in the boron-hydrogen cage structure. The value of the ionic charge is independent of and does not take into consideration any ionic charge which may reside in the X substituents by virtue of ionizable functional groups. The ions which are formed by ionizable substituents are considered to be part of the X groups and are included within the scope of these groups. For example, carboxyl, sulfo, amino, thiol and like substituents will function as groups which possess acidic or basic properties which are independent of the boron cage structure.

Preparation of compounds

Electrophilic substitution.—In this method, which involves the direct substitution of hydrogen, two reactants are employed which are defined as follows:

(a) a boron-containing compound of the general formula $M_a(BH_2H_{12})_b$, wherein M, a and b have the meanings given earlier in generic Formula 1 for the novel compounds.

(b) a reagent capable of introducing an electrophilic group into a benzene nucleus by replacement of hydrogen bonded to a carbon of said nucleus. This second reactant is referred to as an electrophilic reagent.

The characteristics of each group of reactants are discussed in more detail in the following paragraphs.

The boron-containing reactant, $M_a(B_{12}H_{12})_b$, is a dibasic acid or a salt of a dibasic acid which has, as a characterizing group, a divalent anion, $(B_{12}H_{12})^{-2}$. This anion will be referred to as the "dodecahydrododecaborate(2-) anion" or, for simplicity, as "dodecahydrododecaborate(2-)."

At this point, it should be noted that the novelty of the compounds of the invention is such that no officially approved system of nomenclature has yet been established. The name "dodecahydrododecaborate(2-)" follows the lines recommended for naming other boron compounds and its use here permits the logical naming of a derivative of the $(B_{12}H_{12})^{-2}$ anion as a substituted "dodecaborate(2-)."

Dodecahydrododecaborate(2-) is an unusual species of divalent anion which has remarkable and unexpected chemical properties. In many respects it shows much

effect a substitution reaction in a benzene nucleus. These reagents, in view of the extensive work which has been done on substitution reactions in the benzene nucleus, form a well-known group of compounds.

Electrophilic reagents which are broadly operable in the process are reagents which will effect direct substitution of hydrogen bonded to carbon of a benzene nucleus, i.e., the hydrogen is replaced by a group derived from the electrophilic reagent. Electrophilic reagents are compounds which react by acquiring electrons or acquiring a share in electrons which previously belonged to a foreign molecule (see Ingold, *vide supra*, p. 201). Examples of electrophilic reagents which are within the scope of the above definition and which are operable in the process of the invention are given below, together with the substituent group which in the process is bonded to boron in the final product.

Electrophilic reagent	Electrophilic group bonded to boron
Halogens (F ₂ , Cl ₂ , Br ₂ , I ₂)	Halogen (F, Cl, Br, I)
Cyanogen halides (CNF, CNCl)	Nitrile (CN)
Sulfuric acid	-SO ₂ H
Nitric acid	-NO ₂
H ₂ NOSO ₃ H	-NH ₂
Olefins	-alkyl [e.g., -C ₂ H ₅ , -CH(CH ₃) ₂]
Acetylenes	Alkynyl (e.g., -CH=CH ₂ , -C≡CH)
$Hg(O\overset{O}{\parallel}CCH_3)_2$	$-HgO\overset{O}{\parallel}CCH_3$
$(CN)_2C=C(CN)_2$	$-(CN)C=C(CN)_2$
HNO ₂	-NO
CO/HCl	$-\overset{O}{\parallel}CH$
R''SO ₂ Cl	$-SO_2-R''$
$R_2''N\overset{O}{\parallel}CCl$	$-\overset{O}{\parallel}CNR_2''$
$(R''O)R''H + Cl^-$ (oxonium salt)	$-OR''$
$(R''OH)_2 + Cl^-$ (oxonium salt)	$-OH$
$(R''O)_2 + Cl^-$ (hydronium salt)	$-OH$
R''SR''	$-SR''$

greater chemical stability than any previous reported boron hydrides, whether neutral or bearing a charge. For example, the anion is inert to sodium methoxide in refluxing methanol and it does not hydrolyze in water. The anion forms salts with basic materials, e.g., amines and metals, and from these salts there can be obtained a strongly acidic hydronium compound by treatment with an ion exchange resin. Solutions of silver nitrate are not reduced by aqueous solutions containing the $B_{12}H_{12}^{-2}$ anion, a behavior which is in marked contrast to the behavior of other boron hydrides. The stability of the $B_{12}H_{12}^{-2}$ anion to strong bases, strong acids, and oxidizing agents is unique for boron hydride structures.

It is surprising, in view of the chemical stability described above, to find that the dodecahydrododecaborate(2-) anion undergoes a wide range of substitution reactions in a manner which resembles the behavior of a carbocyclic aromatic compound, e.g., benzene or naphthalene. More specifically, the hydrogens bonded to boron in the $B_{12}H_{12}^{-2}$ group are replaceable by substituents which can also replace hydrogen bonded to nuclear carbon in benzene or a substituted benzene such as toluene. This behavior of the dodecahydrododecaborate(2-) anion is particularly surprising in view of the completely inorganic composition of the anion. It is the previously unknown "aromatic character" of the dodecahydrododecaborate(2-) anion which forms the basis of the present invention leading to a broad range of novel substituted dodecaborates(2-).

It is evident from the above description of the chemistry of the dodecahydrododecaborate(2-) anion that the second reactant, i.e., the electrophilic reagent employed in preparing the novel compounds is a reagent which can

In the above groups, R'' is a monovalent organic radical, preferably hydrocarbon of at most 18 carbons, which can be alkyl, alkenyl, cycloalkyl, cycloalkenyl, aryl, alkaryl, aralkyl, and the like.

In the reactions employing some of the above electrophilic reagents, a catalyst may be used, e.g., aluminum trichloride, boron trifluoride and polyphosphoric acid. These catalysts are employed in the same manner as in the well-known procedures in organic chemistry. In some cases the boron compounds themselves function as catalysts, e.g., in alkylation of $(H_3O)_2B_{12}H_{12}$.

The electrophilic reagents employed in the process are materials which are usually readily available of which are obtained by conventional methods.

It is evident from the above discussion that a wide range of processes is available for the preparation of compounds of the invention. These processes are illustrated more fully in the examples which are given later in the discussion of the invention.

Processes which are employed to introduce one or more X groups on the boron cage are not necessarily identical with the processes employed to introduce the X groups on a benzene nucleus. Consideration must be given to differences in reactivity or in reaction mechanism between a completely inorganic system, as represented by the $B_{12}H_{12}^{-2}$ anion and an organic aromatic system represented by the benzene ring.

It is further noted that in the preparation of compounds of the invention by methods discussed earlier the substituent which ultimately is bonded to boron in the final product is not necessarily the substituent which would be obtained with a process employing a conventional carbocyclic aromatic reactant. To illustrate, reac-

tion of formaldehyde with a dodecahydrododecaborate(2⁻) yields a compound of Formula 1 in which X is —OCH₂ instead of —CH₂OH which might be obtained. Variations of this nature from conventional results are, as mentioned earlier, not unexpected in view of the completely inorganic character of the dodecahydrododecaborate(2⁻) anion. Such variations do not change the view of the basic aromatic character of the boron sphere or cage in the dodecaborate anion.

Differences in preparative procedures or variations in the types of substituents which may be obtained do not change in any way the common characteristics or property of all the X groups, i.e., the property of bonding to a nuclear carbon of a benzene ring.

It is surprising that, despite the inorganic nature of the boron-containing reactant, so many of the processes employed in aromatic chemistry are, in fact, operable in the present invention, e.g., the processes of halogenation, alkylation, acylation, amination and the like. Even more surprising and unexpected is the fact that the X groups bonded to boron in the dodecaborate(2⁻) anion exhibit a chemical behavior in subsequent reactions which resembles closely the behavior of the same X groups bonded to a nuclear carbon of an aromatic ring. This similarity in behavior permits the preparation of a broad range of X substituents bonded to the boron cage.

The boron hydride reactants of the formula

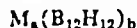

are materials which can be obtained by relatively simple methods from an alkali metal borohydride, e.g., NaBH₄, and diborane (B₂H₆). The preparation of representative dodecahydrododecaborates employed as reactants is illustrated in examples given in later paragraphs.

Reaction of the dodecahydrododecaborate(2⁻) salts to obtain the compounds of the invention is conducted in conventional vessels with corrosion-resistant inner surfaces, e.g., glass, platinum, poly(tetrafluoroethylene)resin, and the like. The dodecahydrododecaborate salt



and, optionally, an inert liquid solvent is charged into the reaction vessel. The electrophilic reactant is then supplied to the reaction vessel at a temperature and at a rate which will provide a controllable reaction and which will bring the reaction to completion within a reasonable time. When electrophilic reagents are employed which are hydrolytically stable, water or alcohols (methanol, ethanol) can be used conveniently as a solvent for the reaction. Other solvents can be used, for example, diethyl ether, benzene, heptane, carbon tetrachloride, carbon disulfide and the like.

The temperature at which the reaction is conducted will be determined largely by the reactivity of the electrophilic reagent. In general, the temperature will be between about -20° C. and 150° C. Preferably, the temperature will be between about 0° C. and about 100° C.

The time of reaction in a batch process will also depend to a considerable extent on the reactivity of the electrophilic reagent. The reaction generally proceeds rapidly and, with thorough mixing of the reactants, the time may be as low as 5 minutes or even less. Generally a reaction time between about 10 minutes and 5 hours is sufficient. It is desirable and advantageous to mix the reactants by any suitable means although mixing is not essential for operability. In some cases, e.g., with alkyl halides as the electrophilic reagent, catalysts are used in the process employing the technology of well-known organic aromatic chemistry.

The reaction can be conducted under pressure, if desired, but it is not essential to use pressure. In many cases, the reaction proceeds satisfactorily at atmospheric pressure.

The proportions in which the reactants are used are not critical. It is preferable, in order to obtain maximum yield of desired product, to use at least one mole of the elec-

trophilic reagent for each hydrogen which is to be replaced on the dodecaborate(2⁻) anion. It is not essential, however, that this ratio be used.

The compounds are purified by well-known and recognized procedures. For the majority of products, conventional crystallization procedures are used, employing water or alcohol as solvents. For products of limited solubility, solutions of the compounds can be treated with adsorptive agents, e.g., activated carbon or silica gel, to remove the impurities.

Indirect substitution.—The compounds of the invention can be obtained by processes which are conducted in two or more steps. These processes are generally employed to obtain compounds of Formula 1 in which X is hydroxyl, amine or substituted amine.

In one method of operation, a dodecahydrododecaborate salt, an amide of a carboxylic acid and an aqueous solution of a hydrogen halide, e.g., hydrogen chloride, are reacted, generally with heating. The product of the reaction is isolated as a metal salt and it is then reacted in a second step with an aqueous solution of an alkali metal hydroxide to obtain a compound of formula 1 in which X is —OH.

In a second method of operation, hydrates of metal salts of dodecahydrododecaborates are heated under reduced pressure over drying agents to obtain compounds of Formula 1 in which X is —OH. This method is especially useful for obtaining compounds which have a plurality of —OH groups.

Compounds of Formula 1 in which X is amine or a substituted amine are obtained by several methods. In one method a dodecaborate (2⁻), either as the acid or metal salts of the acid, is reacted with an hydroxylamine-O-sulfonic acid, generally in a neutral aqueous solution. The reaction proceeds readily at moderate temperatures and the amine-substituted compound is isolated by conventional procedures.

A second method of preparing compounds bearing amine groups consists in mixing a dodecaborate(2⁻) acid, e.g., H₂B₁₂H₁₂ or, in its hydronium form, (H₃O)₂B₁₂H₁₂, and an amide in aqueous solution. The solution is heated until water is removed completely and it is then refluxed. Dilution of the solution with an alcohol, e.g., CH₃OH, followed by addition of a salt having an appropriate cation leads to the isolation of a compound of generic Formula 1 in which X is —NH₂, —NHR' or —NR₂'.

A second group of products is obtained in this reaction which are compounds of Formula 1 in which X is formyl-oxy or hydrocarboncarbonyloxy, i.e., —OC(O)H or —OC(O)R'. To illustrate, with dimethylformamide as the reactant, compounds of Formula 1 are obtained in which X is —OC(O)H; with dimethylacetamide, compounds in which X is —OC(O)CH₃ are obtained. This group of compounds is also obtained readily by esterification of the hydroxyl-bearing compounds as described below.

The hydroxyl- and amine-substituted compounds can be used as intermediates for the preparation of compounds of the invention in which X is bonded to boron through oxygen or nitrogen. To illustrate, the hydroxyl-bearing compound is reacted with acids, acid halides or acid anhydrides to obtain compounds in which X represents an ester group [—OC(O)R', or —OC(O)H]; with isocyanates to obtain compounds in which X is —OC(O)NHR'; with olefins to obtain compounds in which X is —OR'; with acetylenic compounds to obtain products in which X is —OCH=CHR'; with sulfonyl halides to obtain products in which X is —OSO₂R', and the like. As a further illustration, the amine-bearing compounds can be acylated to give products having groups such as —NHC(O)R' and they can be reacted with isocyanates to obtain compounds having groups such as —NHC(O)NHR'. Amine-substituted (—NH₂) compounds can also be alkylated, e.g., with dialkyl sulfates, to obtain compounds bearing —NHR' and —NR₂' groups.

In the above description, R' has the meaning defined in an earlier paragraph. To illustrate, by using the ap-

appropriate amino-substituted polyborate and acid halide, there can be obtained

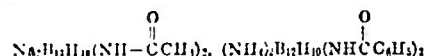

and the like.

Compounds bearing carboxy groups or esters and amides thereof are obtained by reacting the acid $\text{H}_2\text{B}_{12}\text{H}_{12}$, generally as a hydrate $[(\text{H}_3\text{O})_2\text{B}_{12}\text{H}_{12} \cdot n\text{H}_2\text{O}]$, where n has a value of up to 13] with carbon monoxide under super-atmospheric pressure. The product thus obtained is dissolved in water or in alcohols to obtain compounds bearing carboxyl groups or esterified carboxyl groups. The product of the carbon monoxide reaction can be reacted with ammonia or amines to obtain compounds bearing amide groups. The compounds are most conveniently isolated in the form of salts, e.g., metal or nitrogen base salts. Products bearing carbacyl halide groups (e.g., $-\text{COCl}$), can be obtained by reacting carboxy-substituted compounds with a halogenating agent, e.g., PCl_5 , AsCl_5 and the like.

X groups which are not alike.—The processes which have been described can be employed to obtain compounds having one or more X groups. These groups, if more than one is present, can be alike or different. To obtain compounds having two or more X groups which are unlike, the dodecahydrododecaborate is reacted with one electrophilic reagent until the desired number of substituents are introduced and the partially substituted product is then reacted with a second electrophilic reagent. The intermediate partially substituted product can, if desired, be isolated prior to reaction with the second electrophilic reagent. The process can be repeated with a third electrophilic reagent, or even further, until all hydrogens bonded to borons have been replaced. Further modification of various substituent groups can be accomplished by conventional methods to obtain compounds having a broad range of X groups.

To illustrate, compounds of the following formulas can be obtained by the methods described above:

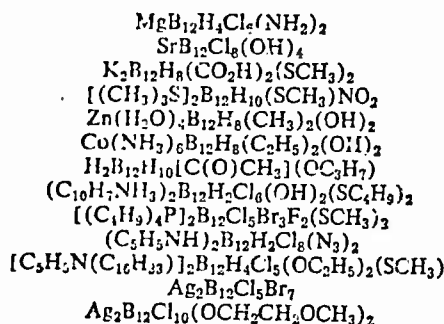

and the like.

In the processes described above, direct replacement of hydrogen bonded to boron by another element or group of elements can occur, i.e., substitution, or the substituent atom or group can be replaced wholly or in part by some other atom or group, i.e., displacement. Whether the reaction is substitution, replacement or displacement, there is no change in the geometry of the dodecaborate cage or dodecaborate moiety.

Metathetic reactions.—Compounds of Formula 1 wherein M covers a wide range of cations are obtained by simple metathetic reactions. To illustrate, an aqueous solution of a compound of Formula 1 where M is NH_4^+ is contacted with a strong acid or with a strongly acidic cation exchange resin to obtain the free acid, i.e., a compound of Formula 1 in which M is H. The acid, generally in solution, is reacted with metals, oxides of metals, hydroxides of metals, salts of metals (both organic and inorganic), nitrogen bases, sulfonium hydroxides or halides,

phosphonium hydroxides or halides, aryldiazonium hydroxides or halides, and similar types of compounds to obtain products of Formula 1 which have the desired cation M. In a process employing an ion-exchange resin, strongly acidic resins of the sulfonic acid variety are preferred because of availability, e.g., "Amberlite IR-120H" and "Dowex" 50. The acid, so obtained in aqueous solution, can be reacted with nitrates, chlorides, bromides, acetates, benzoates and similar salts of metals or other bases to obtain salts of Formula 1.

To illustrate, an aqueous solution of $\text{Cs}_2\text{B}_{12}\text{H}_{12}\text{Cl}_{10}$ is passed through a column packed with "Amberlite IR-120H" to obtain in aqueous solution the acid $\text{H}_2\text{B}_{12}\text{H}_2\text{Cl}_{10}$. The aqueous solution is evaporated under reduced pressure to obtain the concentrated acid, either as a hydrate of the formula $(\text{H}_2\text{O})_2\text{B}_{12}\text{H}_2\text{Cl}_{10}$ or as the free acid $\text{H}_2\text{B}_{12}\text{H}_2\text{Cl}_{10}$. Examples of other acids which can be obtained and the salts from which they can be derived are as follows:

Compound	Acid obtained
$\text{Na}_2\text{B}_{12}\text{H}_4\text{Cl}_8$	$\text{H}_2(\text{B}_{12}\text{H}_4\text{Cl}_8)$
$[(\text{CH}_3)_3\text{N}]_2\text{B}_{12}\text{H}_{10}\text{Br}_2$	$\text{H}_2(\text{B}_{12}\text{H}_{10}\text{Br}_2)$
$\text{K}_2\text{B}_{12}\text{H}_8\text{Cl}_6$	$\text{H}_2(\text{B}_{12}\text{H}_8\text{Cl}_6)$
$\text{Li}_2\text{B}_{12}\text{Cl}_8$	$\text{H}_2\text{B}_{12}\text{Cl}_8$
$[(\text{CH}_3)_3\text{N}]_2\text{B}_{12}\text{H}_{10}\text{I}_2$	$\text{H}_2\text{B}_{12}\text{H}_{10}\text{I}_2$
$\text{Na}_2\text{B}_{12}\text{H}_{10}(\text{NO}_2)_2$	$\text{H}_2\text{B}_{12}\text{H}_{10}(\text{NO}_2)_2$
$\text{K}_2\text{B}_{12}\text{H}_{10}\text{CN}$	$\text{H}_2\text{B}_{12}\text{H}_{10}\text{CN}$
$\text{Na}_2\text{B}_{12}\text{H}_{10}(\text{C}_6\text{H}_5)_2$	$\text{H}_2\text{B}_{12}\text{H}_{10}(\text{C}_6\text{H}_5)_2$
$[(\text{CH}_3)_3\text{N}]_2\text{B}_{12}\text{H}_8\text{Cl}_2(\text{OH})_2$	$\text{H}_2\text{B}_{12}\text{H}_8\text{Cl}_2(\text{OH})_2$
$\text{Cs}_2\text{B}_{12}\text{H}_{10}(\text{SO}_2\text{C}_6\text{H}_5)_2$	$\text{H}_2\text{B}_{12}\text{H}_{10}(\text{SO}_2\text{C}_6\text{H}_5)_2$
$\text{Cs}_2\text{B}_{12}\text{H}_{10}[\text{CH}(\text{CH}_3)]_2$	$\text{H}_2\text{B}_{12}\text{H}_{10}[\text{CH}(\text{CH}_3)]_2$

Compounds of Formula 1 where M is an alkali or alkaline earth metal, e.g., Na, K, Cs, Ca, Ba, Mg, and Sr, can undergo simple metathetic reactions with other salts to effect an exchange of cations. Thus, $\text{Na}_2\text{B}_{12}\text{H}_{10}\text{Cl}_2$ or $\text{K}_2\text{B}_{12}\text{H}_8(\text{OH})_4$ can be reacted in aqueous solution with ammonium sulfate, benzenediazonium hydroxide, pyridinium chloride, morpholinium sulfate, polyethyleneimine hydrochloride, and the like, to form compounds of Formula 1 having ammonium, benzenediazonium, pyridinium, morpholinium, and the like, as cations. These illustrations are not limiting and they demonstrate the breadth of metathetic reactions which can be used.

Compounds of the invention in which the group M is a metal, particularly a transition metal, or a Werner-type complex, frequently contain solvent of crystallization when isolated by conventional methods. The solvent, e.g., water, can be bound loosely in the lattices of the crystals or it can be associated by stronger bonds with the metal cation or Werner-type complex cation. Solvent of crystallization, entrapped in crystal lattices, is removed easily by well-known procedures, e.g., heating under reduced pressure. Solvent of crystallization which is associated with the cation is more difficult to remove, and for most applications, it is not necessary to remove completely this type of bound solvent.

The products of the invention and processes for obtaining them are illustrated in the following examples.

Preparations of representative dodecahydrododecaborates, and a bis(carbonyl)dodecaborane (10), are illustrated in Examples A, B, C, D and E. The products as obtained, are used as reactants to prepare the compounds of the invention.

EXAMPLE A

A pressure vessel of 400 ml. capacity is charged with 9.5 g. of sodium hydroborate and 75 ml. of 1,2-dimethoxyethane, also called "glyme." The vessel is closed, cooled to -80°C . and evacuated to a pressure of about 0.001 mm. of mercury. Diborane (14.0 g.) is charged into the vessel which is then sealed and heated with agitation under autogenous pressure for 10 hours at 120°C . The molar ratio of NaBH_4 to B_2H_6 in this reaction is 1:2. The reactor is cooled, the volatile products are released by venting and the content of the tube are washed into a receiver with glyme. A suspension of a white solid in

a yellow liquid is formed from which the solid is separated by filtration. The solid is dissolved in hot tetrahydrofuran and the solution is filtered to remove a trace of unreacted sodium hydroborate. The hot filtrate is diluted with glyme and chilled to yield 14.0 g. of disodium polyhydroxyborate(2-) as long, glistening white needles. The compound crystallizes with 1,2-dimethoxyethane and water. The compound has the following infrared absorption frequencies: 2.8 μ , sharp, medium; 3.9 μ with 4.02 μ shoulder, sharp, strong; 6.2, 7.5 and 8.4 μ , sharp, medium; 9.3 μ , medium, sharp, strong; 10.9 μ , sharp, strong; and 13.9 μ , broad, weak. The compound shows the absorption bands which are characteristic of the dodecahydrododecaborate anion. It has the following elemental analysis: Analysis found—C, 14.33; H, 7.09; B, 45.08; Na, 16.1.

The compound therefore is a solvate of disodium dodecahydrododecaborate having the following composition: $\text{Na}_2\text{B}_{12}\text{H}_{12} \cdot 0.86\text{C}_4\text{H}_{10}\text{O}_2 \cdot 1.25\text{H}_2\text{O}$.

The compound can be obtained as its hydrate, free of ether of solvation, by recrystallization from a large quantity of diethyl ether or tetrahydrofuran/diethyl ether mixtures, followed by drying under reduced pressure. The ether-free hydrate has infrared absorption characteristics as follows: 2.8 μ , sharp, medium; 3.9 μ , sharp, strong; 6.2 μ , sharp, medium; 9.25 μ , sharp, medium; and 13.9 μ , broad, medium. The elemental analysis is as follows: Found—H, 6.56; B, 62.02; Na, 20.5.

The compound is therefore a monhydrate of disodium dodecahydrododecaborate, i.e., $\text{Na}_2\text{B}_{12}\text{H}_{12} \cdot \text{H}_2\text{O}$ (calculated analysis: H, 6.85; B, 63.05; Na, 22.32).

The dihydrate, $\text{Na}_2\text{B}_{12}\text{H}_{12} \cdot 2\text{H}_2\text{O}$, is obtained in the above process by less intensive drying of the crystals.

EXAMPLE B

An aqueous solution of 3.2 g. of $\text{Na}_2\text{B}_{12}\text{H}_{12}$ (with water and 1,2-dimethoxyethane as solvents of crystallization), obtained as described in Example A, is mixed with an aqueous solution of 12 g. of cesium fluoride. A heavy white precipitate forms which dissolves in the reaction mixture on warming. On cooling, fine white crystals form which are separated by filtration and dried. There is obtained 3.2 g. of cesium dodecahydrododecaborate(2-) with 1,2-dimethoxyethane as solvent of crystallization.

EXAMPLE C

An aqueous solution containing 0.43 g. of the hydrate of disodium dodecahydrododecaborate(2-) is passed through a 0.5" diameter chromatography column containing 80 ml. of the ion-exchange resin of the cross-linked polystyrenesulfonic acid type. The strongly acid effluent from the column is evaporated to remove all materials volatile at less than 0.001 mm. at 45° C. There remains 0.38 g. of a very white, crystalline, very hygroscopic solid which is a hydrate of dihydrogen dodecahydrododecaborate(2-). The acid titrates as a very strong acid, having an equivalence point at a pH of 7. The infrared absorption spectrum of the acid, which has the formula $\text{H}_2\text{B}_{12}\text{H}_{12}$, shows strong absorption at 3.9 μ and 9.3 μ . The crystalline acid, as normally obtained, contains from 2 to 10 or more moles of water of hydration. Two moles of water of hydration are considered to be associated with the hydrogen ions and the various hydrates can, therefore, be written as $(\text{H}_3\text{O})_2\text{B}_{12}\text{H}_{12}$, $(\text{H}_3\text{O})_2\text{B}_{12}\text{H}_{12} \cdot 8\text{H}_2\text{O}$, and the like.

EXAMPLE D

(A) An aqueous solution containing 0.3 g. of the hydrate of disodium dodecahydrododecaborate is mixed with an aqueous solution containing an equal weight of tetramethylammonium chloride. A white precipitate forms immediately. The mixture is heated to boiling and sufficient methanol is added to form a clear solution. The solution is chilled and white crystals from which are separated by filtration, washed and dried at very low pressure at 90° C. There is obtained 0.14 g. of bis(tetra-

methylammonium) dodecahydrododecaborate(2-). The compound can be purified by recrystallization from water.

The infrared absorption spectrum of the compound is as follows, using a Nujol mull: 3.95 μ , sharp, strong; fine structure at 4.9–6.5 μ , weak; 7.8 μ , sharp, medium; 9.4 μ , sharp, strong; and [for the $(\text{CH}_3)_4\text{N}^+$ cation], 10.5 μ , sharp, strong.

(B) An aqueous solution of the free acid ($\text{H}_2\text{B}_{12}\text{H}_{12}$) obtained from $\text{Na}_2\text{B}_{12}\text{H}_{12}$ is neutralized by treatment with cesium hydroxide. A white solid precipitates which is separated by filtration and dried as described above. The product, which is $\text{Cs}_2\text{B}_{12}\text{H}_{12}$, is sparingly soluble in water and it is characterized by the following infrared absorption bands: 3.9 μ , 9.35 μ , sharp, strong; 14.0 μ , sharp, medium; 13.3 μ , medium broad, weak.

(C) An aqueous solution of $\text{H}_2\text{B}_{12}\text{H}_{12}$, obtained from $\text{Na}_2\text{B}_{12}\text{H}_{12}$, is stirred with an excess of nickelous carbonate (NiCO_3) until no further solution of the carbonate is observed. The excess reagent is removed by filtration and the filtrate is evaporated by gentle warming at 25 mm. pressure. The residual solid is dried at about 25° C. and at a final pressure of 25 microns. There is obtained a pale green, very water-soluble hydrated nickel dodecahydrododecaborate(2-).

Analysis.—Calc'd for $\text{NiB}_{12}\text{H}_{12} \cdot 6/4\text{H}_2\text{O}$ (percent): Ni, 18.74; B, 41.45; H, 7.88. Found (percent): Ni, 18.72, 18.68; B, 41.18, 41.44; H, 8.05, 9.01.

(D) An aqueous solution of $\text{H}_2\text{B}_{12}\text{H}_{12}$ is neutralized with an aqueous solution of KOH. The solution is evaporated to dryness under reduced pressure to obtain a hydrate of $\text{K}_2\text{B}_{12}\text{H}_{12}$ as a solid crystalline product. The degree of hydration is not critical and the compound is employed in reactions as obtained above.

EXAMPLE E

Preparation of $\text{B}_{12}\text{H}_{10} \cdot 2\text{CO}$

A silver-lined shaker tube (capacity, 400 ml.) is charged with 20 g. of a hydrate of $\text{H}_2\text{B}_{12}\text{H}_{12}$ containing 4–6 moles of water per mole of acid. The tube is sealed and evacuated to a low pressure. The tube is attached to a shaker, heated cautiously and carbon monoxide is admitted under pressure in several stages until a temperature of 80° C. and a pressure of 1000 atmospheres is reached. The tube is shaken for 5 hours at 80° C. and 975–1000 atmospheres with repressuring with CO as necessary. At the end of this time the tube is cooled to atmospheric temperature (ca. 25° C.) and it is vented to remove unreacted carbon monoxide.

A portion of the semisolid reaction product is dried under reduced pressure in a sublimation apparatus and the dried material is heated at 100° C./1 mm. Hg pressure. The compound $\text{B}_{12}\text{H}_{10} \cdot 2\text{CO}$, which can also be written as $\text{B}_{12}\text{H}_{10}(\text{CO})_2$, is collected as a crystalline sublimate.

Analysis.—Calc'd for $\text{B}_{12}\text{H}_{10} \cdot 2\text{CO}$ (percent): C, 12.2; H, 5.1; B, 66.1. Found (percent): C, 13.0; H, 5.5; B, 65.4.

A second portion of the product from the shaker tube is dried at 25° C./1 mm. pressure in the presence of P_2O_5 and extracted with hot benzene. The benzene extract is cooled and $\text{B}_{12}\text{H}_{10} \cdot 2\text{CO}$ precipitates as a crystalline solid. It is separated by filtration and dried.

The infrared absorption spectrum of the compound in a mineral oil mull shows strong bands at 3.9 μ and 4.55 μ ; somewhat weaker bands at 9.3 μ and 13.8 μ ; and weaker bands at 9.1 μ , 9.8 μ , 11.7 μ and 13.5 μ .

The procedures described in Example D are generic for the preparation of salts of the $\text{B}_{12}\text{H}_{12}^{2-}$ anion. The procedures described in Parts B and C are particularly useful, employing as one reactant, a base with the desired cation, i.e., group M, to neutralize the acid $\text{H}_2\text{B}_{12}\text{H}_{12}$. The solution can be evaporated to dryness in the event the salt is soluble and does not precipitate. Any salt which is

desired for use as a reactant in substitution reactions can, therefore, be prepared by the above process.

The compounds of the invention are further illustrated by reference to the following examples:

EXAMPLE 1

(A) A corrosion-resistant reaction vessel is charged with 1 g. of $\text{Cs}_2\text{B}_{12}\text{H}_{11}\text{OH}$, prepared as described in Example 8, Part A. The vessel is cooled to 0°C . and 15 ml. of anhydrous HF is added. The mixture is agitated for 1 hour at 0°C . and it is then warmed to about 25°C . to volatilize unreacted HF. The solid crystalline product which remains is principally $\text{Cs}_2\text{B}_{12}\text{H}_{11}\text{F}$. It contains 5.98% fluorine and the infrared spectrum shows substantially no absorption bands for the hydroxyl group.

(B) A corrosion-resistant pressure vessel is cooled in solid carbon dioxide and it is flushed with nitrogen. The vessel is charged with 25 g. of anhydrous HF and 5.0 g. of hydrated $\text{H}_2\text{B}_{12}\text{H}_{12}$. It is closed and the mixture is heated with agitation under autogenous pressure for 4 hours at $85\text{--}100^\circ\text{C}$. The mixture is cooled to about 25°C . vented into a corrosion-resistant container, and flushed with nitrogen to remove all unreacted hydrogen fluoride. The residue is removed and it is neutralized with aqueous 50% cesium hydroxide solution. The precipitate is separated by filtration and it is crystallized from water to obtain a white crystalline product which is a mixture of about 80% $\text{Cs}_2\text{B}_{12}\text{H}_8\text{F}_4$ and 20% $\text{Cs}_2\text{B}_{12}\text{H}_7\text{F}_5$.

Analysis.—Calc'd for the above mixture (percent): B, 25.1; F, 16.5. Found (percent): B, 25.1, 25.0; F, 16.5, 16.3.

The process is repeated, using twice the quantities given above. There is obtained a white crystalline solid which is a mixture of about 30% $\text{Cs}_2\text{B}_{12}\text{H}_8\text{F}_4$ and 70%

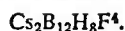

Analysis.—Calc'd for the above mixture (percent): F, 14.8. Found (percent): F, 14.87.

(C) The process of Part B is repeated again and there is obtained in pure form the tetrafluoro derivative.

Analysis.—Calc'd for $\text{Cs}_2\text{B}_{12}\text{H}_8\text{F}_4$ (percent): B, 27.0; F, 15.7. Found (percent): B, 27.0; F, 15.7.

(D) A mixture of 10 g. of the monohydrate of $\text{Na}_2\text{B}_{12}\text{H}_{12}$ and 40 g. of anhydrous HF is heated in a corrosion-resistant pressure vessel at 90°C . for 5 hours under autogenous pressure. The vessel is cooled, vented and nitrogen gas is bubbled through it vigorously for 4 hours at about 25°C . to remove unreacted HF. The residual reaction mixture is removed and it is neutralized with aqueous 50% CsOH solution. The cesium salt which precipitates is separated and recrystallized three times from water to obtain 16 g. of a mixture of about 80% $\text{Cs}_2\text{B}_{12}\text{H}_8\text{F}_4$ and 20% $\text{Cs}_2\text{B}_{12}\text{H}_7\text{F}_5$.

Analysis.—Calc'd for $\text{Cs}_2\text{B}_{12}\text{H}_7.8\text{F}_{4.2}$ (percent): B, 25.1; F, 16.5; Cs, 55.0. Found (percent): B, 24.34; F, 16.4; Cs, 57.5.

(E) The process of Part D is repeated except that the temperature of the reaction is increased to 150°C . The compound obtained is $\text{Cs}_2\text{B}_{12}\text{H}_6\text{F}_6$. The infrared spectrum of the compound shows absorption at the following wavelengths: 4.0, 8.5 (strong), 9.4 (weak), 10.2 (strong), 10.7, 11.6, 12.1 and 13.8μ .

Analysis.—Calc'd for $\text{Cs}_2\text{B}_{12}\text{H}_6\text{F}_6$ (percent): B, 25.0; F, 22.1. Found (percent): B, 24.5; F, 21.6.

(F) Anhydrous $\text{K}_2\text{B}_{12}\text{H}_{12}$ and HF are reacted at 150°C . under the conditions described for Part D. The product, isolated as the cesium salt, is the pentafluoro derivative.

Analysis.—Calc'd for $\text{Cs}_2\text{B}_{12}\text{H}_7\text{F}_5$ (percent): B, 25.9; F, 19.1. Found (percent): B, 25.3; F, 18.6.

(G) The process of Part D is repeated employing 21.5 g. of $\text{Na}_2\text{B}_{12}\text{H}_{12} \cdot 6\text{H}_2\text{O}$ and 30 g. of anhydrous HF. The mixture is heated 5 hours at 90°C . The product, isolated as the cesium salt, is a mixture of $\text{Cs}_2\text{B}_{12}\text{H}_{10}\text{F}_2$ and $\text{Cs}_2\text{B}_{12}\text{H}_9\text{F}_3$. The analysis is as follows: F, 10.33%; B, 25.21%.

(H) A reaction vessel is charged with 40 ml. of water and 2.5 g. of hydrated $\text{NiB}_{12}\text{H}_{12}$, prepared as described in Example D, Part C. A stream of gas containing one part fluorine to ten parts of nitrogen is passed into the reaction mixture for 7 hours. Passage of the gas mixture is stopped and the reaction mixture is neutralized with NH_4OH . Incipient precipitation of $\text{Ni}(\text{NH}_3)_4\text{B}_{12}\text{F}_{11}\text{OH}$ occurs. At this point addition of NH_4OH is stopped and the solution is filtered. Traces of the BF_4^- ion are removed as the cesium and rubidium salts and the solution which remains is mixed with $(\text{CH}_3)_4\text{NCl}$ to precipitate tetramethylammonium cesium undecafluorohydroxydecaborate(2-). The infrared spectrum shows absorption bands as follows (expressed as cm^{-1}): 1215, strong; 725, strong, broad; 1080, 770 and 705, weak. Absorption bands, characteristic of the B—H bonding, are absent.

Analysis.—Calc'd for $(\text{CH}_3)_4\text{NCsB}_{12}\text{F}_{11}\text{OH}$ (percent): C, 8.53; H, 2.31; B, 23.0; F, 37.1. Found (percent): C, 8.72; H, 2.33; B, 22.5; F, 35.6.

(I) A reaction vessel of poly(tetrafluoroethylene) resin is charged with 200 ml. of water and 8.8 g. of crystalline hydrated $\text{K}_2\text{B}_{12}\text{H}_{12}$. The mixture is stirred to form a solution and it is cooled to about 0°C . Fluorine diluted with nitrogen (about 5 parts nitrogen to 1 part fluorine) is bubbled into the solution at a rate of 90 ml./min. for 50 hours. The temperature is maintained at about 0°C . during the operation. Flow of fluorine is stopped and the reaction mixture is filtered. The filtrate is evaporated in a platinum vessel at $90\text{--}100^\circ\text{C}$. (steam bath temperatures) to obtain 11.9 g. of a viscous mass which solidifies on cooling. The mass is neutralized with 8 ml. of 7 N aqueous KOH and the mixture is filtered. An aqueous solution of 6 g. of Cs^+ in 6 ml. of water is added to the filtrate with stirring to precipitate $\text{Cs}_2\text{B}_{12}\text{F}_{11}\text{OH}$. The precipitate is separated by filtration and the filtrate is partially concentrated to obtain an additional quantity of product. Total yield of $\text{Cs}_2\text{B}_{12}\text{F}_{11}\text{OH}$ is 9.8 g. The product is recrystallized three times from slightly more than its weight in water and dried under reduced pressure at 100°C . The infrared spectrum of the compound shows a band at $2.71\text{--}2.73\mu$ (doublet).

Analysis.—Calc'd for $\text{Cs}_2\text{B}_{12}\text{F}_{11}\text{OH}$ (percent): Cs, 42.8; B, 20.9; F, 33.6. Found (percent): Cs, 42.4; B, 21.3; F, 33.5.

EXAMPLE 2

(A) A corrosion-resistant pressure vessel is cooled in solid carbon dioxide and flushed with nitrogen gas. It is charged with 20 g. of anhydrous HCl and 11 g. of hydrated $\text{H}_2\text{B}_{12}\text{H}_{12}$ prepared as described in Example C. The vessel is closed and the mixture is heated with agitation for 4 hours at 85°C . The vessel and contents are cooled to about 25°C . and volatile products are removed by venting. These products include unreacted HCl. The crude product remaining in the vessel is removed by washing with ice water and the aqueous solution is neutralized with aqueous $(\text{CH}_3)_4\text{NOH}$. The solid which forms is separated by filtration and it is purified by recrystallization from water. The compound is bis(tetramethylammonium) monochloroundecafluorododecaborate(2-). It is a white, crystalline product whose infrared spectrum, taken in a Nujol mull, shows absorption at the following wavelengths (expressed as microns, exclusive of bands coincident with Nujol): strong at 4.0, 9.6, 10.6 and 12.0; weaker at 7.8 and 12.4. The identity of the compound is confirmed by elemental analyses.

Analysis.—Calc'd for $[(\text{CH}_3)_4\text{N}]_2\text{B}_{12}\text{H}_{11}\text{Cl}$ (percent): N, 8.6; Cl, 11.1. Found (percent): N, 8.22; Cl, 11.56.

(B) A mixture of 5.0 g. of $\text{NaB}_{12}\text{H}_{12} \cdot \text{H}_2\text{O}$ and 36.5 g. of anhydrous HCl is heated in a pressure vessel with agitation at 90°C . for 5 hours under autogenous pressure. The reaction mixture is processed as described in Example 1, Part D, for the preparation of the fluorinated derivative, except that $(\text{CH}_3)_4\text{NOH}$ is employed in place of CsOH. The product obtained is $[(\text{CH}_3)_4\text{N}]_2\text{B}_{12}\text{H}_{11}\text{Cl}$. Elemental analyses are as follows: N, 7.4; Cl, 11.8.

(C) A reaction vessel is charged with 100 ml. of water and 10 g. of the hydrate of $H_2B_{12}Cl_{12}$. The mixture is cooled to about 0° C. and chlorine gas is bubbled through the solution until the color of chlorine persists. Passage of gas is stopped, the solution is evaporated to a small volume and it is neutralized with NH_4OH . An aqueous solution of $(CH_3)_4NCl$ is added to the neutral solution and the precipitate which forms is separated by filtration. The compound, which is bis(tetramethylammonium) hexachlorohexahydrododecaborate(2-), is purified by crystallization from water. It is a white crystalline solid which, in a Nujol mull, shows the following principal characterizing absorption bands in the infrared spectrum (expressed as cm^{-1}): 1060, strong; 1025, shoulder; 950, strong; 885, strong; 850-790, strong, broad; 715, strong, broad.

Analysis.—Calc'd for $[(CH_3)_4N]_2B_{12}H_6Cl_6$ (percent): H, 6.1; C, 19.25; B, 26.1; Cl, 42.7. Found (percent): H, 5.70; C, 18.60; B, 25.7; Cl, 43.16.

(D) A reaction vessel is charged with 100 ml. of water and 1.9 g. of $Cs_2B_{12}H_{12}C_4H_{10}O_2$, prepared as described in Example B. Chlorine gas is passed into the solution at prevailing atmospheric temperature (about 25° C.) until the solution is saturated and passage of chlorine is continued for 2.5 hours. The resulting clear solution is evaporated under reduced pressure to obtain a white crystalline solid as a residue. The infrared absorption spectrum of the product shows that it is free of solvent, i.e., no dimethoxyethane (glyme) is present. The infrared spectrum further shows strong absorption at 9.5 μ and at 11.7 μ .

The solid is recrystallized from aqueous solution to give fine white crystals whose infrared absorption spectrum shows a greatly reduced B—H absorption band at 4.0 μ . The compound is again crystallized from water and the fine white crystals are dried at 65° C. at 0.02 mm. pressure for 3 hours. Elemental analysis of the product and the infrared absorption spectrum show that the compound is dicesium decachlorodihydrododecaborate(2-), i.e., $Cs_2B_{12}H_2Cl_{10}$.

Analysis.—Calc'd for $Cs_2B_{12}H_2Cl_{10}$ (percent): Cs, 35.4; B, 17.3; Cl, 47.2. Found (percent): Cs, 35.6; B, 17.69; Cl, 45.15.

(E) A glass reaction vessel is charged with 40 g. of $Na_2B_{12}H_{12} \cdot 2H_2O$ and 320 ml. of water. The mixture is stirred, cooled to 13-20° C. and chlorine gas is passed into it at this temperature for 2-3 hours. The cooling bath is removed and passage of chlorine gas is continued for 2 hours at 20-63° C. The mixture is now warmed to steam bath temperature and chlorine gas is passed through it for 2 hours. An aliquot portion of the reaction mixture is removed and mixed with an aqueous solution of $(CH_3)_4NCl$. The precipitate which forms is separated and it is crystallized from water to obtain

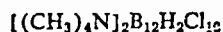

The infrared absorption spectrum shows characterizing absorption bands at 4.0 μ (weak), 9.4-9.8 μ (strong), and 11.4 μ (strong).

(F) The solution remaining from the reaction of Part E is divided into two equal parts. Each portion is charged into a silver-lined pressure vessel (400 ml. capacity) and 50 g. of chlorine is added to each vessel. The reaction mixtures are heated for 2 hours at 150° C. under autogenous pressure. The vessels are cooled and vented to remove volatile products. The residual liquids are filtered and the combined filtrates are subjected to low pressure (water pump vacuum) to remove dissolved chlorine. The liquid is neutralized with about 120 ml. of 10 N potassium hydroxide and it is filtered again. A concentrated aqueous cesium fluoride solution is added to the filtrate with stirring. The precipitate which forms is separated by filtration to obtain $Cs_2B_{12}Cl_{12}$ as a white crystalline solid. The compound is crystallized from about 2.8 parts of hot water to obtain 117.5 g. of product, i.e., dicesium dodecachlorododecaborate(2-) as the monohydrate.

Analysis.—Calc'd for $Cs_2B_{12}Cl_{12} \cdot H_2O$ (percent): Cs, 31.68; B, 15.47; Cl, 50.70. Found (percent): Cs, 31.20; B, 15.58; Cl, 50.42.

(G) A reaction vessel is charged with 120 ml. of water and 20 g. of the monohydrate of $Na_2B_{12}H_{12}$. The solution is cooled in a mixture of ice and water and chlorine gas is bubbled through the solution until no further absorption of chlorine is evident. The solution is warmed to about 30° C. and passage of chlorine gas is continued until no further uptake of chlorine occurs. The reaction mixture and 50 g. of chlorine is now charged into a corrosion-resistant pressure vessel and the mixture is heated under autogenous pressure at 150° C. for 2 hours. The vessel is cooled, vented to the air and the reaction mixture is washed out with water. Some corrosion of the reaction vessel occurs and the mixture contains iron and other heavy metals as salts. The solution is neutralized with NH_4OH and the precipitated metal hydroxides are separated by filtration. The filtrate is divided into three equal parts which are treated as follows:

(1) Aqueous CsF solution is added to one part and the white precipitate which forms is separated. The precipitate is crystallized several times from hot water to yield pure dicesium dodecachlorododecaborate(2-). This salt is moderately soluble in water. The infrared absorption spectrum of a Nujol mull of the compound shows the following bands (expressed as cm^{-1}): 1040, very strong; 1005, weak; 725, weak, broad.

Analysis.—Calc'd for $Cs_2B_{12}Cl_{12}$ (percent): Cs, 32.4; B, 15.7; Cl, 51.8. Found (percent): Cs, 30.2; B, 15.8; Cl, 51.2.

(2) A second part is mixed with an aqueous solution of $RbCl$ and the white precipitate, which is dirubidium dodecachlorododecaborate(2-), is separated by filtration. The salt is very water-soluble and it is purified by crystallization from water. The infrared absorption spectrum of a Nujol mull of the compound shows the following bands (expressed as cm^{-1}): 1050, very strong; 1005, weak; 950 and 970, very weak; 890, very weak; 725, weak, broad.

Analysis.—Calc'd for $Rb_2B_{12}Cl_{12}$ (percent): B, 17.7; Cl, 58.7. Found (percent): B, 18.1; Cl, 59.7.

(3) The third part is mixed with an aqueous solution of $(CH_3)_4NCl$. The precipitate is treated as described above to obtain bis(tetramethylammonium) dodecachlorododecaborate(2-) as a white, crystalline product which has very low solubility in water. The infrared absorption spectrum of a Nujol mull of the compound shows the following bands (expressed as cm^{-1}): 1040, very strong; 1005, weak; 950, strong; 725, weak, broad.

Analysis.—Calc'd for $[(CH_3)_4N]_2B_{12}Cl_{12}$ (percent): C, 13.9; H, 3.48; N, 4.03; B, 18.8; Cl, 61.2. Found (percent): C, 13.9; H, 3.97; N, 4.07; B, 18.1; Cl, 61.1.

The above compound is crystallized from solution in aqueous 1,2-dimethoxyethane to yield the monoetherate.

Analysis.—Calc'd for

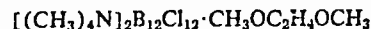

(percent): C, 18.2; H, 4.60; B, 16.6; Cl, 53.6. Found (percent): C, 18.0; H, 4.35; B, 16.2; Cl, 52.5.

(H) A portion of the product $[(CH_3)_4N]_2B_{12}Cl_{12}$, obtained in Part G, is dissolved in water and the aqueous solution is passed through a column packed with an acidic ion-exchange resin. The eluate is evaporated under reduced pressure at 25° C. to obtain the hydrate of the free acid, $H_2B_{12}Cl_{12}$, as a crystalline hygroscopic white solid.

Analysis.—Calc'd for $(H_3O)_2B_{12}Cl_{12} \cdot 6H_2O$ (percent): B, 18.5; Cl, 60.6; N.E., 350.8. Found (percent): B, 18.0; Cl, 59.9; N.E., 342.

A solution of 80 g. of $Cs_2B_{12}Cl_{12} \cdot H_2O$, obtained as described in Part F, is dissolved in 800 ml. of water and the warm solution is passed through a column, containing 753.5 g. of an acidic ion-exchange resin. The eluate is

evaporated under reduced pressure to obtain $H_2B_{12}Cl_{12}$ containing 7.5 moles of water.

Analysis.—Calc'd for $(H_2O)_2B_{12}Cl_{12} \cdot 5\frac{1}{2}H_2O$ (percent): B, 18.75; Cl, 61.44. Found (percent): B, 18.73; Cl, 61.10.

The above hydrated acid is further dried under reduced pressure at $100^\circ C.$ over P_2O_5 in an Abderholden unit for 22 hours to remove 5 moles of water of hydration.

Analysis.—Calc'd for $(H_2O)_2B_{12}Cl_{12} \cdot \frac{1}{2}H_2O$ (percent): B, 21.56; Cl, 70.63. Found (percent): B, 21.19; Cl, 70.99.

The infrared absorption spectrum of a Nujol mull of each of the above acidic compounds shows strong absorption at 9.7μ with a "sharp" shoulder at 10.0μ and no absorption at 4.0μ .

(I) An aqueous 0.086 M solution of $H_2B_{12}Cl_{12}$, prepared as described in Part H, is neutralized to a pH value of 7 with 1 N sodium hydroxide solution. The solution is evaporated under reduced pressure at $25^\circ C.$ to obtain the disodium salt as a white crystalline solid.

Analysis.—Calc'd for $Na_2B_{12}Cl_{12} \cdot 2\frac{1}{2}H_2O$ (percent): Na, 7.11; B, 20.09; Cl, 65.83. Found (percent): Na, 7.60; B, 19.60; Cl, 65.97.

(J) An aqueous 0.086 M solution of $H_2B_{12}Cl_{12}$, prepared as described in Part H, is stirred about 18 hours with excess nickel carbonate. The solution is filtered to remove unreacted nickel carbonate and the filtrate is processed as described in Part I. The nickel salt is obtained as a pale green crystalline solid.

Analysis.—Calc'd for $NiB_{12}Cl_{12} \cdot 8H_2O$ (percent): Ni, 7.74; B, 17.13; Cl, 56.12. Found (percent): Ni, 7.81; 7.85; B, 16.82; Cl, 58.32.

The above salt is dried under reduced pressure over P_2O_5 at $100^\circ C.$ for 31 hours to obtain the nickel salt as a tetrahydrate, a yellow crystalline product which dissolves readily in water.

Analysis.—Calc'd for $NiB_{12}Cl_{12} \cdot 4H_2O$ (percent): Ni, 8.55; B, 18.93; Cl, 62.02; H_2O , 10.50. Found (percent): Ni, 8.55, 8.45; B, 18.89; Cl, 62.81; H_2O , 9.72, 9.67.

The nickel salt is further dried 42 hours at $148^\circ C.$ in the manner described above to obtain $NiB_{12}Cl_{12} \cdot 2H_2O$. Continued drying at $207.5^\circ C.$ under reduced pressure yields the anhydrous salt, $NiB_{12}Cl_{12}$.

(K) An aqueous 0.086 M solution of $H_2B_{12}Cl_{12}$ is swirled with Ag_2O until reaction is complete. The mixture is filtered and the filtrate is evaporated under reduced pressure at $25^\circ C.$ to obtain the silver salt. The product is white and water-soluble.

Analysis.—Calc'd for $Ag_2B_{12}Cl_{12}$ (percent): Ag, 27.98; Cl, 55.18; B, 16.84. Found (percent): Ag, 27.72; Cl, 54.61; B, 16.51.

(L) An aqueous solution of the silver salt of Part K is mixed with NH_4OH . The white precipitate which forms is separated to obtain $[Ag(NH_3)_2]_2B_{12}Cl_{12}$ as a crystalline solid.

(M) Excess cerium carbonate is stirred overnight with an aqueous solution of $H_2B_{12}Cl_{12}$ (0.0841 mole). The solution is filtered and the filtrate is evaporated under reduced pressure at less than $50^\circ C.$ to obtain hydrated $Ce_2(B_{12}Cl_{12})_3$ as a colorless, water-soluble salt.

Analysis.—Calc'd for $Ce_2(B_{12}Cl_{12})_3 \cdot 22H_2O$ (percent): Ce, 12.0; B, 16.7; Cl, 54.5. Found (percent): Ce, 11.0; B, 18.7; Cl, 54.8.

(N) An aqueous solution of $H_2B_{12}Cl_{12}$ (0.1035 mole) is stirred overnight with excess europium oxide. The reaction mixture is filtered and the filtrate is evaporated in a rotary drier under reduced pressure at less than $40^\circ C.$ It is further dried under reduced pressure at about $25^\circ C.$ over P_2O_5 to obtain a hydrate of $Eu_2(B_{12}Cl_{12})_3$ as a yellow-green solid.

Analysis.—Calc'd for $Eu_2(B_{12}Cl_{12})_3 \cdot 18H_2O$ (percent): Eu, 13.3; Cl, 55.6. Found (percent): Eu, 14.0; Cl, 55.9.

(A) A mixture consisting of 9 g. of hydrated $H_2B_{12}H_{12}$ (crystalline) and 36 g. of anhydrous HBr is heated in a corrosion-resistant pressure vessel under autogenous pressure for 4 hours at $100-105^\circ C.$ The reaction vessel is cooled, vented and the reaction mixture is neutralized with $(CH_3)_4NOH$. The solid product is separated and recrystallized twice from water to obtain a compound which is principally the acid salt, $(CH_3)_4NHB_{12}H_{11}Br$.

Analysis.—Calc'd for $(CH_3)_4NHB_{12}H_{11}Br$ (percent): C, 16.3; H, 8.2; Br, 27.0. Found (percent): C, 19.9; H, 8.4; Br, 25.4.

The tetramethylammonium acid salt, obtained above, is dissolved in water and the solution is passed through a column filled with a sodium ion-exchange resin. The aqueous effluent is a solution of $Na_2B_{12}H_{11}Br$. Sufficient $CsOH$ is added to the effluent to precipitate the compound as the cesium salt. It is separated, washed and crystallized twice from water to obtain the cesium salt as a dihydrate.

Analysis.—Calc'd for $Cs_2B_{12}H_{11}Br \cdot 2H_2O$ (percent): B, 24.9; Br, 15.3. Found (percent): B, 24.2; Br, 14.0.

(B) A solution of 8.4 g. of an etherate (glyme) of disodium dodecahydrododecaborate(2-) in aqueous methanol is chilled to $0-10^\circ C.$ Bromine is added dropwise until it is no longer rapidly absorbed. Approximately 6.5 ml. of bromine is used. Bromine addition is continued until a total of 8.5 ml. is used. A small amount of solid forms and it is separated by filtration and discarded.

The filtrate is evaporated to dryness at 10 mm. and $80^\circ C.$ to leave a white solid suspended in an oil. This residue is taken up in a little water, made alkaline with sodium hydroxide and evaporated again to dryness at 10 mm. and $80^\circ C.$ to leave a white solid. This residue is extracted with warm tetrahydrofuran. The insoluble portion, sodium bromide, is discarded. The tetrahydrofuran solution, clarified by filtration, is diluted with dioxane to precipitate while solid disodium hexabromohexahydrododecaborate(2-) which is washed with dioxane and dried.

Analysis.—Calc'd for $Na_2B_{12}H_6Br_{10} \cdot C_4H_8O_2 \cdot 2H_2O$ (percent): C, 16.17; H, 3.53; B, 13.15; Na, 4.66; Br, 48.56. Found (percent): C, 16.61; H, 3.86; B, 13.43; Na, 4.3; Br, 47.56.

(C) A solution is prepared consisting of 200 ml. of 50% aqueous methanol and 22 g. of $Na_2B_{12}H_{12} \cdot 2H_2O$. The solution is cooled to about $5^\circ C.$ and it is brominated as described in Part B, employing 32.2 ml. of liquid bromine. The reaction mixture is processed as described in Part B to obtain a solution of $Na_2B_{12}H_6Br_6$ in tetrahydrofuran. The solution is evaporated to dryness, leaving 91 g. of a syrup-like residue which contains tetrahydrofuran as solvent of crystallization. The residue is dissolved in 250 ml. of water and the solution is evaporated to dryness to remove the tetrahydrofuran. The residue solidifies at prevailing atmospheric temperature to yield the sodium salt containing about 6 moles of water of hydration, i.e. $Na_2B_{12}H_6Br_6 \cdot 6H_2O$.

(D) An aqueous methanolic solution containing 0.25 g. of disodium dodecahydrododecaborate(2-) is cooled to $0^\circ C.$ and liquid bromine is added dropwise with vigorous stirring until the color of bromine persists in the solution. Aqueous tetramethylammonium chloride is added with stirring to the solution and the white solid which forms is separated by filtration. It is recrystallized from aqueous methanol to obtain 0.32 g. of product in the first crop. A second crop of 0.23 g. of crystals is obtained from the filtrate. The crystals are a mixture of bis(tetramethylammonium) hexabromohexahydrododecaborate(2-), i.e., $[(CH_3)_4N]_2B_{12}H_6Br_6$, and bis(tetramethylammonium) pentabromoheptahydrododecaborate(2-), i.e., $[(CH_3)_4N]_2B_{12}H_7Br_5$.

Elemental analyses of the two crops of crystals are as follows:

First crop

Analysis.—Calc'd for $(C_4H_{12}N)_2B_{12}H_6Br_{5.5}$ (percent): C, 13.26; H, 4.24; B, 17.92; N, 3.87; Br, 60.66. Found (percent): C, 14.14; B, 4.55; N, 17.69; Br, 3.83; Br, 59.65.

Second crop

Analysis.—Calc'd for $(C_4H_{12}N)_2B_{12}H_6Br_{5.6}$ (percent): C, 13.12; H, 4.19; B, 17.73; N, 3.83; Br, 61.13. Found (percent): C, 12.69; H, 3.98; B, 17.50; N, 3.95; Br, 60.5.

These brominated polyhydrododecaborates are characterized by infrared absorption bands at 3.9μ , sharp, strong; 11.9μ , 12.4μ , 12.7μ , and 13.0μ , broad, strong; 9.6μ , medium sharp, medium; and 10.5μ , sharp, strong [for the $(CH_3)_4N^+$ ion].

(E) A portion (3.3 g.) of $Na_2Br_{12}H_6Br_6 \cdot 6H_2O$, obtained in Part C, is dissolved in about 5 ml. of water. The solution is mixed with a concentrated solution containing 3.3 g. of CsCl. The white crystals which form are separated and they are recrystallized twice from hot water. The product is dried to obtain the dicesium salt as a monohydrate.

Analysis.—Calc'd for $Cs_2B_{12}H_6Br_6 \cdot H_2O$ (percent): B, 14.45; Br, 53.3; H, 0.9; Cs, 29.55. Found (percent): B, 14.54; Br, 52.64; H, 1.25, 1.07; Cs, 29.4.

(F) A portion (9.2 g.) of the compound of Part C, i.e., $Na_2B_{12}H_6Br_6 \cdot 6H_2O$, is dissolved in a minimum quantity of water. The solution is passed through a column packed with an acidic ion exchange resin and the column is flushed with water. The washings and eluate are combined to yield a solution of the acid $H_2B_{12}H_6Br_6$ which, in solvated form, is also written as $(H_3O)_2B_{12}H_6Br_6$.

The process is repeated employing 5.2 g. of hydrated $Na_2B_{12}H_6Br_6$. The acid effluent is evaporated to dryness and the white residue is held under reduced pressure at $70-80^\circ C$. until the vapor pressure is less than 1 micron. The dried product, $H_2B_{12}H_6Br_6$, is a tough amber glass at atmospheric temperature. It is soluble in water, 1,2-dimethoxyethane, ethanol, benzenemethanol mixtures, and cold tetrahydrofuran. It is insoluble in benzene, chloroform, ether, dioxan and hot tetrahydrofuran. The titration curve, employing NaOH, shows a sharp break at $pH=7$.

(G) About 25 ml. of the acid solution, obtained in Part F, is neutralized with an aqueous solution of

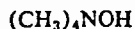

The white tetramethylammonium salt precipitates but it is not isolated. The crude aqueous reaction mixture is heated to boiling and it is diluted with water to a volume of about 40 ml. to obtain a clear solution. The solution is chilled and white crystals form which are separated by filtration. The crystals are further purified by two crystallizations from boiling water to obtain 0.44 g. of anhydrous $[(CH_3)_4N]_2B_{12}H_6Br_6$.

Analysis.—Calc'd for above compound (percent): B, 17.0; Br, 62.8; C, 12.58; H, 3.96; N, 3.67. Found (percent): B, 18.57; Br, 62.84; C, 12.71, 12.99; H, 4.13, 4.06; N, 3.75, 3.77.

The infrared absorption spectrum of a Nujol mull of the compound shows the following bands characteristic for the anion: 3.95μ , strong; 9.65μ , strong; 10.6μ , strong; 11.8μ , strong; 12.75μ , strong with shoulders at 12.4μ and 13.0μ ; and the following bands characteristic for the cation: 7.1μ , weak; 7.8μ , weak; and 10.55μ , strong.

(H) About 50 ml. of the acid solution, obtained in Part F, is neutralized with aqueous NaOH solution. Excess aqueous $(CH_3)_3Si$ solution is added and the reaction mixture in which a white precipitate is present, is heated to boiling and diluted with water to a total volume of about 100 ml. to yield a clear solution. The hot solution is cooled and the white crystals which form are separated.

They are recrystallized twice from hot water to yield 1.04 g. of bis(trimethylsulfonium) hexabromohexahydrododecaborate(2-).

Analysis.—Calc'd for $[(CH_3)_3S]_2B_{12}H_6Br_6$ (percent): B, 16.88; Br, 62.3; C, 9.36; H, 3.14; S, 8.32. Found (percent): B, 16.73; Br, 62.21; C, 10.07, 10.25; H, 3.34, 3.31; S, 8.35.

(I) The process of Part H is repeated, employing an aqueous solution of $(C_2H_5)_3NHCl$ in place of an aqueous solution of the sulfonium iodide. There is obtained 0.69 g. of the triethylammonium salt.

Analysis.—Calc'd for $[(C_2H_5)_3NH]_2B_{12}H_6Br_6$ (percent): B, 15.9; Br, 58.7; C, 16.65; H, 4.44; N, 3.43. Found (percent): B, 14.78, 16.70; Br, 59.99; C, 17.16, 17.14; H, 4.65, 4.65; N, 3.34, 3.36.

(J) About 50 ml. of the acid solution, obtained in Part F, is neutralized with aqueous NaOH solution. Concentrated NH_4OH (about 10 ml.) is then added to the solution with stirring after which an excess of an ammoniacal solution of $ZnCl_2$ is added. The white precipitate which forms is separated and it is recrystallized twice from boiling water. There is obtained 0.24 g. of tetraaminozinc hexabromohexahydrododecaborate(2-).

Analysis.—Calc'd for $Zn(NH_3)_4B_{12}H_6Br_6$ (percent): B, 17.32; Br, 64.1; H, 2.42; N, 7.48. Found (percent): B, 17.82; Br, 65.0; H, 2.62; N, 7.31, 7.17.

(K) The process of Part J is repeated employing ammoniacal $CuCl_2$ in place of the ammoniacal $ZnCl_2$ solution. The deep blue precipitate which forms is separated and it is crystallized twice from dilute NH_4OH . The product is tetraaminocopper(II) hexabromohexahydrododecaborate(2-).

Analysis.—Calc'd for $Cu(NH_3)_4B_{12}H_6Br_6$ (percent): B, 17.4; Br, 64.2; H, 2.43; N, 7.51; Cu, 8.52. Found (percent): B, 17.11; Br, 63.32; H, 3.11, 2.86; N, 7.52, 7.56; Cu, 8.53.

(L) A solution is prepared containing 10 g. of $(H_3O)_2B_{12}H_6 \cdot 8H_2O$ in 150 ml. of water. Liquid bromine is added dropwise to the solution with stirring and the temperature rises rapidly to $90-100^\circ C$. The rate of addition of bromine is adjusted to maintain this temperature. After 59 g. of bromine is added, the rate of bromine uptake decreases sharply. An additional 20 g. of bromine is added and the mixture is held at $80-90^\circ C$. for 1 hour. The reaction mixture is concentrated to a small volume under reduced pressure and it is separated into two portions. To one part an aqueous solution of CsF is added and to the second part an aqueous solution of $(CH_3)_4NCl$ is added. The white precipitates in each reaction are separated by filtration and they are recrystallized from hot water. The compounds are dicesium and bis(tetramethylammonium) decabromodihydrododecaborates(2-).

Analysis.—Calc'd for $Cs_2B_{12}H_2Br_{10} \cdot 4H_2O$ (percent): B, 10.2; Br, 63.1; Cs, 21.0. Found (percent): B, 10.3; Br, 62.5; Cs, 22.1. Calc'd for $[(CH_3)_4N]_2B_{12}H_2Br_{10}$ (percent): C, 8.88; H, 2.23; B, 12.0; Br, 74.1. Found (percent): C, 8.89; H, 2.36; B, 11.6; Br, 74.4.

(M) A solution is prepared containing 20 g. of $Na_2B_{12}H_{12} \cdot 2H_2O$, 100 ml. of water and 100 ml. of methanol. It is cooled to $5-15^\circ C$. and bromine is added dropwise with stirring. After 30 ml. is added, the bromine uptake decreases sharply and an additional 30 ml. of bromine is added in one portion. A fast stream of chlorine gas is passed into the solution. The temperature of the reaction mass rises to $50^\circ C$. during this step. The solution is placed in a vessel equipped with a water aspirator and the solution is evaporated until excess bromine and the hydrogen chloride and hydrogen bromide formed in the reaction are removed, as shown by the absence of color due to chlorine or bromine. The solution is neutralized with NH_4OH and it is divided into two portions.

To one part an aqueous solution of CsF is added with stirring and the precipitate is separated by filtration. The

salt, dicesium dodecabromododecaborate(2-), is purified by crystallization from water.

Analysis.—Calc'd for $\text{Cs}_2\text{B}_{12}\text{Br}_{12}$ (percent): Cs, 19.6; B, 9.56; Br, 70.8. Found (percent): Cs, 18.1; B, 9.57; Br, 71.3.

The compound is also obtained readily as a monohydrate by crystallization from water.

Analysis.—Calc'd for $\text{Cs}_2\text{B}_{12}\text{Br}_{12}\cdot\text{H}_2\text{O}$ (percent): Cs, 19.4; B, 9.46; Br, 69.9. Found (percent): Cs, 18.5; B, 9.58; Br, 70.1.

To a second part of the neutralized solution an aqueous solution of $(\text{CH}_3)_4\text{NCl}$ is added with stirring. The precipitate is processed as described earlier to obtain bis(tetramethylammonium) dodecabromododecaborate(2-).

Analysis.—Calc'd for $[(\text{CH}_3)_4\text{N}]_2\text{B}_{12}\text{Br}_{12}$ (percent): C, 7.77; H, 1.94; B, 10.5; Br, 77.6. Found (percent): C, 8.29; H, 2.66; B, 10.6; Br, 77.7.

The infrared absorption spectrum of the $\text{B}_{12}\text{Br}_{12}^{2-}$ salts shows a band which is a doublet centered at 990 cm^{-1} .

(N) A portion of the cesium salt obtained in Part M is dissolved in water and the solution is passed through a column packed with an acidic ion-exchange resin. The acidic eluate is evaporated under reduced pressure at 25°C . to give a hydrate of dihydrogen dodecabromododecaborate(2-) as a white crystalline solid.

Analysis.—Calc'd for $(\text{H}_3\text{O})_2\text{B}_{12}\text{Br}_{12}\cdot 6\text{H}_2\text{O}$ (percent): B, 10.5; Br, 77.6 (N.E., 617.8). Found (percent): B, 10.3; Br, 77.9 (N.E., 613).

(O) Operating in a photographic dark room, a solution of AgNO_3 (0.006 mole) in water (25 ml.) is added with stirring to a solution of $\text{Cs}_2\text{B}_{12}\text{Br}_{12}\cdot\text{H}_2\text{O}$ (0.003 mole) in water (200 ml.). The compound, $\text{Ag}_2\text{B}_{12}\text{Br}_{12}$, is precipitated in almost quantitative yield as a white solid which is separated, washed and dried. The infrared spectrum of the compound shows strong absorption bands at 10.05 and 10.17μ with a feeble spur at 10μ .

Analysis.—Calc'd for $\text{Ag}_2\text{B}_{12}\text{Br}_{12}$ (percent): B, 9.95. Found (percent): B, 9.92.

The acid, obtained in Part N, can be reacted in aqueous solution with salts, e.g., carbonates, chlorides, nitrates and the like, to obtain a wide range of products. To illustrate, ZnCl_2 reacts with the acid to form $\text{ZnB}_{12}\text{Br}_{12}$; CuCl_2 reacts with the acid to form the copper salt as a pale green hydrate, $\text{Cu}(\text{H}_2\text{O})_4\text{B}_{12}\text{Br}_{12}$ which upon dehydration at 90°C . under low pressure becomes purple.

EXAMPLE 4

(A) A reaction vessel is charged with 22.4 g. of $\text{Na}_2\text{B}_{12}\text{H}_{12}\cdot 2\text{H}_2\text{O}$, 50 ml. of water and 150 ml. of methanol. The solution is stirred and a solution of 25.4 g. of iodine in 200 ml. of methanol is added gradually. The iodine color disappears immediately and a slight rise in temperature occurs. The solution is neutralized with NH_4OH and an aqueous solution of $(\text{CH}_3)_4\text{NCl}$ is added with stirring. The precipitate which forms is separated and it is crystallized several times from water. The product is bis(tetramethylammonium) iodoundecahydrododecaborate(2-).

Analysis.—Calc'd for $[(\text{CH}_3)_4\text{N}]_2\text{B}_{12}\text{H}_{11}\text{I}$ (percent): C, 23.1; H, 8.42; B, 31.3; I, 30.5. Found (percent): C, 23.6; H, 8.73; B, 30.8; I, 30.4.

The infrared absorption spectrum shows the following characteristic bands (expressed as cm^{-1}): 1280, weak; 1050, strong; 950, strong; ca. 800, strong, broad; and 720, strong.

(B) A solution containing 10 g. of $\text{Na}_2\text{B}_{12}\text{H}_{12}\cdot 2\text{H}_2\text{O}$ in a minimum amount of water is passed through a column packed with an acidic ion-exchange column. The column is washed to remove all of the acid and 200 ml. of an acidic eluate is obtained. There is added to this solution 200 ml. of $\text{C}_2\text{H}_5\text{OH}$ and 11.34 g. of iodine. The mixture is permitted to stand 2 hours at about 25°C . at which time the iodine color is gone. Tetramethylammonium chloride (15 g.) is added to the solution with stirring and the precipitate which forms is processed as

described in Part A to obtain $(\text{CH}_3)_4\text{N}]_2\text{B}_{12}\text{H}_{11}\text{I}$. Analysis of the compound shows 22.2% C, 8.23% H, 29.1% B and 23.6% I.

Passage of an aqueous solution of $[(\text{CH}_3)_4\text{N}]_2\text{B}_{12}\text{H}_{11}\text{I}$ through a column filled with a commercial acid ion-exchange resin yields an aqueous solution of the acid $\text{H}_2\text{B}_{12}\text{H}_{11}\text{I}$. Evaporation of the solution yields a hydrate of the crystalline acid which is viewed as $(\text{H}_3\text{O})_2\text{B}_{12}\text{H}_{11}\text{I}$. Optionally, the acid effluent from the ion-exchange column is neutralized with an aqueous solution of NaOH and the neutral solution is evaporated to dryness to obtain $\text{Na}_2\text{B}_{12}\text{H}_{11}\text{I}$ as a crystalline compound.

(C) The procedure of Part A is repeated except that 50.8 g. of iodine is employed and cesium fluoride is used instead of the tetramethylammonium chloride. The product obtained is mixed salt containing CsI and

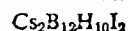

in equimolar proportions.

Analysis.—Calc'd for $\text{Cs}_2\text{B}_{12}\text{H}_{10}\text{I}_2\cdot\text{CsI}$ (percent): Cs, 43.7; B, 14.1; I, 41.4. Found (percent): Cs, 42.9; B, 14.0; I, 41.8.

The infrared absorption spectrum shows the following characteristic bands (expressed as cm^{-1}): 1060, weak; 1045, medium; 955, strong, slightly broad; 835, weak; 815, medium; 785, strong; 760, weak; 738, medium and 720, weak.

(D) An aqueous solution of $\text{H}_2\text{B}_{12}\text{H}_{12}$ is prepared as described in Part B from 50 g. of $\text{Na}_2\text{B}_{12}\text{H}_{12}\cdot 2\text{H}_2\text{O}$. The acidic eluate is mixed with 114 g. of iodine and the mixture is allowed to stand at about 25°C . until reaction is complete. An aqueous solution of CsOH is added with stirring and the precipitate is processed as described in previous parts.

Analysis.—Calc'd for $\text{Cs}_2\text{B}_{12}\text{H}_{10}\text{I}_2$ (percent): B, 19.7; I, 38.5; H, 1.52; Cs, 40.3. Found (percent): B, 16.2; I, 38.1; H, 1.48; Cs, 41.2.

(E) A solution is prepared which consists of 25 ml. of water and 2.1 g. of $\text{Na}_2\text{B}_{12}\text{H}_{12}\cdot\text{H}_2\text{O}$. The solution is swirled at atmospheric temperature (about 25°C .) while portions of a solution of 6 g. of iodine in 100 ml. of ethyl alcohol are added. Decolorization occurs fairly rapidly until 40 ml. of the iodine solution is added. Another 40 ml. is added and the dark mixture is allowed to stand at atmospheric temperature for 1 hour. The mixture is then evaporated under reduced pressure and a tacky light yellow solid is obtained as a residue. The solid, which is the sodium salt of diiodododecahydrododecaborate, is dissolved in 15 ml. of water and excess aqueous 50% cesium fluoride solution is added with stirring. The precipitate which forms is separated by filtration and it is recrystallized from 10 ml. of water. Large white crystals are obtained which are dried at 65°C . at 0.1 mm. pressure for 3 hours. The product is dicesium diiodododecahydrododecaborate(2-), i.e., $\text{Cs}_2\text{B}_{12}\text{H}_{10}\text{I}_2$. The identity of the compound is confirmed by its infrared absorption spectrum and by elemental analysis. The infrared spectrum shows strong bands at 10.5μ , 12.3μ , 12.7μ , 13.6μ and 13.8μ , in addition to the characteristic B—H and B_{12} skeletal bands at 4.0μ and 9.7μ , respectively.

Analysis.—Calc'd for $\text{Cs}_2\text{B}_{12}\text{H}_{10}\text{I}_2$ (percent): B, 19.68; I, 38.49. Found (percent): B, 19.33; I, 39.00.

(F) One-half of the quantity of $\text{Cs}_2\text{B}_{12}\text{H}_{10}\text{I}_2\cdot\text{CsI}$ obtained in Part C is added to a solution of 115 g. of ICl in 150 ml. of CCl_4 . The mixture is heated at 80°C . for 8 hours with stirring. It is filtered and the solid product is extracted with CS_2 to remove free iodine and unreacted ICl . The solid residue is dissolved in water and an aqueous solution of CsCl is added to form a cream-colored precipitate. The product is separated and crystallized twice from water to yield dicesium dodecaiodododecaborate(2-).

Analysis.—Calc'd for $\text{Cs}_2\text{B}_{12}\text{I}_{12}$ (percent): Cs, 13.8; B, 6.76; I, 79.4. Found (percent): Cs, 13.2; B, 6.67; I, 78.7.

PASSAGE of an aqueous solution of $Cs_2B_{12}I_{12}$ through a column filled with a commercial ion-exchange resin yields an aqueous solution of $H_2B_{12}I_{12}$. Neutralization of this solution with an aqueous solution of NaOH and evaporation of the reaction mixture yields $Na_2B_{12}I_{12}$, generally as the dihydrate or hexahydrate, i.e., $Na_2B_{12}I_{12} \cdot 2H_2O$ or $Na_2B_{12}I_{12} \cdot 6H_2O$.

(G) Operating in a photographic dark room, a solution of $AgNO_3$ (0.68 g.) in water (20 ml.) is added to a stirred solution of $Na_2B_{12}I_{12} \cdot 6H_2O$ (3.61 g.) in water (100 ml.). The precipitate which forms is separated, washed and dried to obtain $Ag_2B_{12}I_{12}$ as an off-white product weighing 3.63 g.

Analysis.—Calc'd for $Ag_2B_{12}I_{12}$ (percent): Ag, 11.6; B, 6.95; I, 81.5. Found (percent): Ag, 10.7; B, 7.03; I, 76.7.

The similarity in chemical behavior of the dodecaborate moiety and a benzene nucleus, previously referred to as "aromaticity," is shown by the dehalogenation of the iodine-substituted dodecaborates to yield the parent dodecahydrododecaborate. To illustrate, 5.0 g. of

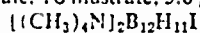

prepared as described in Example 4, Part A, is mixed with 200 ml. of liquid ammonia and potassium metal (ca. 0.5 g.) is added in small pieces until the blue color of free potassium persists. The liquid ammonia is evaporated and the white residue is crystallized from water to obtain $[(CH_3)_4N]_2B_{12}H_{12}$. In like manner, 4.55 g. of $Cs_2B_{12}H_{10}I_2$, obtained as described in Example 4, Part D, is dissolved in 25 ml. of liquid ammonia and treated with 1.2 g. of potassium to obtain $Cs_2B_{12}H_{12}$.

EXAMPLE 5

(A) A solution is prepared containing 6 g. of the hydrate of $Na_2B_{12}H_4Br_8$ (see Example 3, Part C) in 50 ml. of water. The solution is cooled to about $-30^\circ C$. and chlorine gas is passed into it until the gas is no longer absorbed. The solution is neutralized with NH_4OH and a concentrated solution of CsCl is added. A precipitate forms and the mixture is heated until a clear solution is obtained. The solution is cooled and the crystals which form are collected. They are recrystallized from water to yield dicesium hexabromotrichlorotrihydrododecaborate(2-) as a dihydrate.

Analysis.—Calc'd for $Cs_2B_{12}H_3Br_6Cl_3 \cdot 2H_2O$ (percent): B, 12.7; Br, 47.0; Cl, 10.4. Found (percent): B, 12.7; Br, 46.7; Cl, 10.1.

The infrared absorption spectrum of the compound shows the following characteristic bands (expressed as cm^{-1}): 2560, medium; 1630, medium; 1040, very sharp; 860, strong, broad; and 730–705, medium, broad.

(B) A solution is prepared containing 10 g. of $Cs_2B_{12}H_4F_8$ (see Example 1, Part C) in 30 ml. of water. The solution is heated almost to boiling and 8 ml. of bromine is added dropwise and with stirring. The solution is now heated to boiling, chlorine is passed into the mixture and four portions of 2 ml. each of bromine are added gradually. The solution is cooled and the solid which precipitates is separated. It is redissolved in hot water, a small quantity of aqueous CsOH is added to assure that the solution is basic and the mixture is cooled. The crystals which form are separated and recrystallized from hot water to obtain dicesium octabromotetrafluorododecaborate(2-).

Analysis.—Calc'd for $Cs_2B_{12}Br_8F_4$ (percent): B, 11.8; F, 6.8; Br, 57.0. Found (percent): B, 12.9; F, 6.74; Br, 57.06.

(C) A reaction mixture consisting of 14 g. of hydrated $(H_3O)_2B_{12}I_{11}I$ and 30 g. of anhydrous HF is heated with agitation under autogenous pressure at $90^\circ C$. for 4 hours. The reaction vessel is cooled, vented and swept with a stream of nitrogen gas. The reaction mixture is neutralized with CsOH and the cesium salt which precipitates is purified as described in earlier examples by

crystallization from water to obtain a product which is principally $Cs_2B_{12}H_8F_3I$.

Analysis.—Calc'd for $Cs_2B_{12}H_8F_3I$ (percent): I, 21.5; F, 9.7. Found (percent): I, 20.9; F, 10.1.

Examples 1 through 5 illustrate compounds of the invention in which X is halogen and methods for their preparation. The processes are generic to the preparation of halogen-bearing compounds and can be employed to obtain compounds having a wide range of halogen substituents, both as to number and kind. To illustrate, the processes can be employed to obtain compounds having combinations of F, Cl, Br, and I substituents, e.g., $(NH_4)_2B_{12}Cl_5I_7$, $[Zn(NH_4)_4]B_{12}F_3Br_3I_6$,

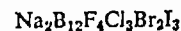

and the like. In examples given later, it is shown that dodecaborates bearing X groups other than halogens can be employed as reactants to obtain compounds having mixed substituents, e.g.,

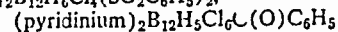
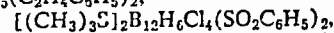
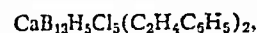

and the like.

EXAMPLE 6

(A) A small portion of the compound obtained as described in Example A, i.e., disodium dodecahydrododecaborate(2-), is dissolved in a few cc. of water and the solution is added carefully to a few cc. of ice-cold concentrated nitric acid to form a clear amber solution. The solution is allowed to warm to about $25^\circ C$. and it is made alkaline with aqueous sodium hydroxide. An aqueous solution of tetramethylammonium chloride is added and a white precipitate forms which is the tetramethylammonium salt of a nitrated dodecaborate anion. The infrared absorption spectrum of the product, which is bis(tetramethylammonium) nitroundecahydrododecaborate(2-), shows absorption bands at 6.35μ and 7.74μ (characteristic for the nitro group) and at 3.9μ and at 9.25μ .

Analysis.—Calc'd for $[(CH_3)_4N]_2B_{12}H_{11}NO_2 \cdot H_2O$ (percent): C, 26.52; H, 10.30; B, 35.84; N, 14.08. Found (percent): C, 26.3; H, 10.34; B, 37.99; N, 11.02.

(B) A solution consisting of about 5 g. of $Na_2B_{12}H_{12}$ (containing water of hydration) in 5 ml. of water is added dropwise with stirring to 10 ml. of 70% HNO_3 , cooled in an ice-salt bath. The temperature is kept at $20-25^\circ C$. during the addition. The dark green solution is cooler and neutralized slowly with 8 ml. of aqueous 50% NaOH. The mixture is extracted with tetrahydrofuran several times. The extracts are combined and blown with air to remove the tetrahydrofuran. An oil (3.5 g.) remains to which 2 ml. of aqueous 50% CsF solution is added. A precipitate forms which is separated and recrystallized from water twice to give brownish-yellow crystals of dicesium nitroundecahydrododecaborate. The crystals ignite readily on a hot plate but they do not explode when struck with a hammer.

Analysis.—Calc'd for $Cs_2B_{12}H_{11}NO_2$ (percent): Cs, 58.7; B, 28.7; H, 3.4; N, 3.1. Found (percent): Cs, 51.5; B, 28.25; H, 3.10; N, 3.37.

(C) A solution is prepared which contains 3 ml. of water and 1.65 g. of disodium dodecahydrododecaborate. The solution is added dropwise and with stirring to 15 ml. of concentrated nitric acid which is cooled in ice. The reaction mixture is allowed to warm to atmospheric temperature (about $25^\circ C$.) and it is then made basic by adding 23 ml. of a 30% aqueous sodium hydroxide solution. The reaction mixture is evaporated to dryness under reduced pressure to obtain a solid yellow residue. The solid is extracted with tetrahydrofuran to dissolve the nitrated polyhydroxyborate. The solution is filtered and dioxane is added to the filtrate. The filtrate is concentrated under reduced pressure until a yellow solid precipitates. The solid is collected on a filter; it is washed

with dioxane and dried at low pressure at 90° C. to give 0.47 g. of disodium monohydroxyundecaborate containing two moles of dioxane of solvation. The identity of the compound, which has the formula,



is confirmed by its infrared absorption spectrum and by elemental analysis. The infrared absorption spectrum shows bands at 4.0 μ and 9.3 μ , characteristic of the polyhydroxyundecaborate anion, and bands at 6.35 μ and 7.75 μ , characteristic of the nitro group. This compound is not shock-sensitive.

Analysis.—Calc'd for $\text{Na}_2\text{C}_4\text{H}_{10}\text{B}_{12}\text{NO}_8$ (percent): Na, 11.2; C, 23.5; H, 6.65; B, 31.75; N, 3.32. Found (percent): Na, 10.3; C, 22.6; H, 6.23; B, 31.1; N, 3.46.

Example 6 illustrates compounds of the invention in which X is a nitro group.

Compounds having a plurality of nitro groups on the dodecaborate ion, e.g., 2, 3, 4, or more nitro groups, can be obtained by employing a higher concentration of nitric acid in the reaction and by operating at temperatures higher than atmospheric, e.g., at 40° C. or higher. Nitration can also be conducted in several steps to obtain a higher degree of substitution.

The compounds of Example 6 can be converted by simple metathetic reactions to a broad range of compounds, e.g.,

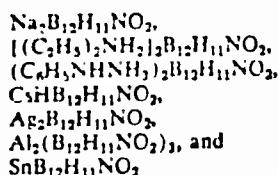

The process of Example 5 illustrates broadly the preparation of nitro-substituted dodecaborates. The process can be used with dodecaborates bearing substituents other than $-\text{NO}_2$ groups to obtain compounds of the invention having both $-\text{NO}_2$ groups and other groups. The broad process can be used to prepare, for example,

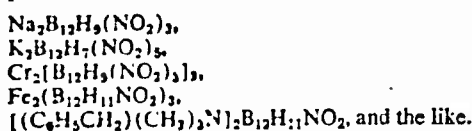

It can be used to prepare $\text{Cs}_2\text{B}_{12}\text{H}_9(\text{C}_6\text{H}_{11})(\text{NO}_2)_2$ from $\text{Cs}_2\text{B}_{12}\text{H}_{11}(\text{C}_6\text{H}_{11})$; $\text{Na}_2\text{B}_{12}\text{H}_4(\text{C}_{10}\text{H}_{21})(\text{NO}_2)_2$ from

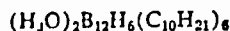

and

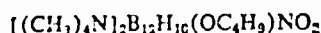

from $\text{Cs}_2\text{B}_{12}\text{H}_{11}\text{OC}_4\text{H}_9$. The halogen-bearing compounds obtained by the processes of Examples 1-5 can be nitrated by the process of Example 6 to obtain halogenated nitro-substituted compounds, e.g.,

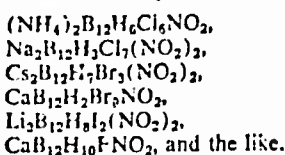

A solution is prepared which contains 1.8 g. of the solvated sodium polyhydroxyundecaborate obtained as described in Example A (i.e., disodium dodecahydroxyundecaborate), 25 ml. of water and 0.54 g. of sodium nitrite (NaNO_2). The solution is chilled to below 5° C. and it is acidified with dilute sulfuric acid. The solution is clear yellow in color at low temperatures and it becomes deep green or warming to atmospheric temperature (about 25° C.). An aqueous solution of cesium hydroxide is added to the green solution with stirring and a yellow solid precipitates which is separated by filtration. The solid is recrystallized twice from water, and it is dried at about

25° C. under very low pressure (less than 0.01 mm.). There is obtained 1.0 g. of dicesium nitrosoundecahydroxyundecaborate (2-), i.e., $\text{Cs}_2\text{B}_{12}\text{H}_{11}\text{NO}$. The infrared absorption spectrum of the compound shows bands at 4.0 μ , 7.3 μ and 9.5 μ .

Example 7 illustrates compounds of the invention in which the substituent X is nitroso and their preparation. The process is broadly operable for introducing $-\text{NO}$ groups into dodecaborates. It can be used to prepare, for example,

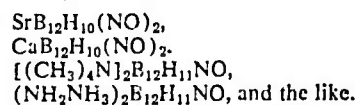

Dodecaborates can be employed as reactants which bear substituents other than $-\text{NO}$ groups. To illustrate,

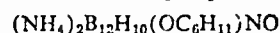

can be obtained from $\text{Cs}_2\text{B}_{12}\text{H}_{11}\text{OC}_6\text{H}_{11}$

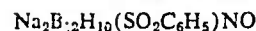

can be obtained from $\text{Cs}_2\text{B}_{12}\text{H}_{11}\text{SO}_2\text{C}_6\text{H}_5$, and the like.

EXAMPLE 8

(A) A reaction vessel is charged with a solution consisting of 20 g. of $\text{Na}_2\text{B}_{12}\text{H}_{12} \cdot 2\text{H}_2\text{O}$ and 200 ml. of N-methyl-2-pyrrolidone. The solution is stirred and 25 ml. of hydrochloric acid is added. The mixture is filtered and the filtrate is distilled until the pot temperature reaches 180° C. The mixture is held at this temperature for 3 hours and it is then poured into 600 ml. of alcohol. The resulting clear solution is mixed with a solution of 15 g. of CsOH in 200 ml. of alcohol. A white precipitate forms which is separated by filtration. The solid is crystallized from water to obtain 5.7 g. of product (designated as Product A). A portion (4.5 g.) of the solid is added to 25 ml. of 2.5% aqueous NaOH solution and the mixture is refluxed for 2 hours. The mixture is filtered and a solution of CsOH in ethanol is added with stirring. The precipitate which forms is separated and crystallized from water to yield dicesium monohydroxyundecahydroxyundecaborate (2-).

Analysis.—Calc'd for $\text{Cs}_2\text{B}_{12}\text{H}_{11}\text{OH}$ (percent): B, 30.6; H, 2.8; Cs, 62.8. Found (percent): B, 30.1; H, 2.8; Cs, 61.8.

Crystallization of the compound from aqueous cesium bromide solution yields the double salt

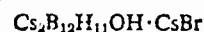

(B) A pressure vessel is charged with a solution of 5 g. of the hydrate of $\text{H}_2\text{B}_{12}\text{H}_{12}$ in 25 ml. of water. The vessel is closed and the solution is heated under autogenous pressure for 5 hours at 200° C. The vessel is opened and aqueous cesium fluoride is added to the reaction mixture. The precipitate which forms is processed as described in Part A to yield $\text{Cs}_2\text{B}_{12}\text{H}_{11}\text{OH}$.

(C) Hydrated $\text{H}_2\text{B}_{12}\text{H}_{12}$ (29 g.; N.E., 194) is added slowly and with stirring to 100 ml. of acetone which is cooled with ice to keep the temperature at 20-25° C. The reaction mixture is stirred for 15 minutes at 25° C., 15 ml. of 50% aqueous NaOH solution is added, followed by 60 g. of aqueous 50% CsF solution. The precipitate which forms is separated to obtain 29 g. of $\text{Cs}_2\text{B}_{12}\text{H}_{11}\text{OH}$. The compound is purified by recrystallization from water.

(D) A mixture of 5 g. of $\text{Cs}_2\text{B}_{12}\text{H}_{11}\text{OCH}(\text{CH}_3)_2$, prepared as described in Example 13, Part B, and 25 ml. of 48% hydrogen bromide is refluxed for a short time. Excess hydrogen bromide is removed by blowing the mixture with air and sufficient 50% NaOH is added to make the solution basic. The precipitate which forms is processed as described in Part A to yield the double salt, $\text{Cs}_2\text{B}_{12}\text{H}_{11}\text{OH} \cdot \text{CsBr}$.

An aqueous solution of the double salt



is passed through a column packed with an acid ion-exchange resin to obtain the acid $H_2B_{12}H_{11}OH$ in solution. The acidic eluate is neutralized with NaOH and the solution is evaporated to obtain $NaB_{12}H_{11}OH \cdot NaBr$. An aqueous solution of this sodium salt is mixed with an aqueous solution of $(CH_3)_4NCl$ to precipitate the tetramethylammonium salt in pure form.

Analysis.—Calc'd for $[(CH_3)_4N]_2B_{12}H_{11}OH$ (percent): B, 42.5; C, 31.47; H, 11.8; N, 9.1. Found (percent): B, 43.7; C, 27.8; H, 11.4; N, 8.2.

(E) A reaction vessel is charged with 3.0 g. of hydrated $H_2B_{12}H_{12}$ (N.E., 154) and 1.75 g. of oxalic acid. The vessel is placed in a boiling water bath and the mixture is stirred for 5 minutes. An exothermic reaction sets in and the temperature rises to a maximum of $120^\circ C$. with vigorous bubbling. The mixture is cooled to about $25^\circ C$. and 5 ml. of water is added. The solution is neutralized with aqueous CsOH solution to phenolphthalein end point. A precipitate forms and the reaction mixture is heated to boiling with addition of the minimum amount of water needed to dissolve the precipitate at the boiling point. The solution is cooled in an ice-water bath and the crystals which form are separated. They are crystallized from hot water to obtain 1.6 g. of $Cs_2B_{12}H_{11}OH$.

(F) A mixture of 8.75 g. of oxalic acid and 3.0 g. of hydrated $H_2B_{12}H_{12}$ is heated at $150^\circ C$. for 15 minutes. The reaction mixture is processed as described in Part E to obtain $Cs_2B_{12}H_{10}(OH)_2$.

(G) A reaction vessel is charged with a solution consisting of 20 g. of $Na_2B_{12}H_{12} \cdot 2H_2O$ and about 200 ml. of N-methyl-2-pyrrolidone. The solution is stirred and 25 ml. of hydrochloric acid is added. The mixture is filtered and the filtrate is distilled until a pot temperature of $205^\circ C$. is reached. The mixture is held at this temperature for 4 hours and it is then poured into 600 ml. of ethyl alcohol. The precipitate which forms is separated by filtration. It is purified by dissolving in acetonitrile and reprecipitating with ethanol. The product (7.8 g.) so obtained (which is

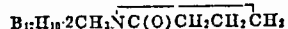

and is designated as Product B) is mixed with 50 ml. of 6% aqueous NaOH solution, the mixture is refluxed for 4 hours and then allowed to cool.

A portion of the above reaction mixture is added with stirring to a solution of 6 g. of $(CH_3)_4NOH$ in 400 ml. of ethyl alcohol. The mixture is evaporated to dryness, leaving a syrupy residue. The residue is mixed with 150 ml. of isopropyl alcohol and forms an oil. The oil is crystallized from solution in aqueous ethyl alcohol to yield bis(tetramethylammonium) dihydroxydecahydrododecaborate(2-).

Analysis.—Calc'd for $[(CH_3)_4N]_2B_{12}H_{10}(OH)_2$ (percent): B, 40.3; C, 29.8; H, 11.2. Found (percent): B, 40.4; C, 26.1; H, 10.8.

The remaining portion of the reaction mixture is evaporated to a small volume and a concentrated solution of CsOH is added. The precipitate which forms is separated, recrystallized twice from water and dried 15 hours at $56^\circ C$. under very low pressure.

Analysis.—Calc'd for $Cs_2B_{12}H_{10}(OH)_2$ (percent): B, 28.4; H, 3.1; Cs, 58.1. Found (percent): B, 28.23, 28.31; H, 3.38; Cs, 58.25.

(H) A concentrated aqueous solution of

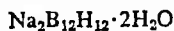

is passed through a column filled with an acidic ion exchange resin. The eluate is an aqueous solution of $H_2B_{12}H_{12}$. A portion of this solution containing 0.12 mole of the acid is reacted with the exact equivalent quantity of aluminum metal. The reaction proceeds rapidly with evolution of hydrogen and an aqueous solution of $Al_2(B_{12}H_{12})_3$ forms. The solution is evaporated to dryness and the residue is dried intensively over P_2O_5 at $25^\circ C$.

to obtain the salt with sixteena moles of water of hydration.

Analysis.—Calc'd for $Al_2(B_{12}H_{12})_3 \cdot 16H_2O$ (percent): Al, 6.86; B, 49.56; H, 8.97. Found (percent): Al, 6.61; B, 50.6; H, 9.36

A portion of the above hydrated aluminum salt is heated at very low pressure for 44.5 hours at $148^\circ C$. over P_2O_5 . A portion of the dry residue (8.58 g.) is mixed with 100 ml. of water and 80 ml. of 0.912 N aqueous CsOH solution is added with stirring. The mixture is filtered to remove insoluble $Al(OH)_3$ and the filtrate is evaporated to dryness to obtain the solid cesium trihydroxynonahydrododecaborate(2-).

Analysis.—Calc'd for $Cs_2B_{12}H_9(OH)_3$ (percent): B, 28.49; H, 2.65; Cs, 58.32. Found (percent): B, 31.4; H, 3.08, 2.93; Cs, 57.63, 55.2.

A second portion (18.5 g.) of the above hydrated aluminum salt is heated at very low pressure for 83 hours at $148^\circ C$ over P_2O_5 . Water and hydrogen are released and a 20.9% loss in weight is noted. The residue (14.7 g.) is dissolved in 100 ml. of 1.44 N hydrochloric acid and the solution is diluted to a volume of 720 ml. The diluted solution is passed through a column filled with an acidic ion exchange resin and the eluate is neutralized with $(CH_3)_4NOH$ to obtain an aqueous solution of

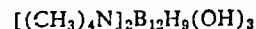

Neutralization of the eluate with NH_4OH yields

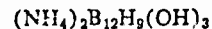

(I) An aqueous solution of $H_2B_{12}H_{12}$ is neutralized with the exact quantity of $Be(OH)_2$ to provide a neutral solution of $BeB_{12}H_{12}$. The solution is evaporated to dryness and the residue is dried intensively over P_2O_5 to obtain the tetrahydrate of the beryllium salt.

Analysis.—Calc'd for $BeB_{12}H_{12} \cdot 4H_2O$ (percent): B, 58.22; Be, 4.04; H, 6.04. Found (percent): B, 60.26; Be, 4.12, 3.94; H, 8.73.

A quantity (9.93 g.) of the above beryllium salt is heated under very low pressure over P_2O_5 for 52 hours at $148^\circ C$. The dried product, which shows a weight loss of 9.83%, is suspended in 100 ml. of water, 90 ml. of 1 N NH_4OH is added with stirring, and the mixture is filtered to remove $Be(OH)_2$. The filtrate is evaporated to dryness to yield the solid $(NH_4)_2B_{12}H_9(OH)_3$.

(J) A reaction vessel is charged with 70 ml. of tert-butanol and 6 g. of $(H_3O)_2B_{12}H_{12} \cdot 6H_2O$. The mixture is refluxed for 2 hours and water is added. The solution is boiled to remove the butanol as an azeotrope with water. The remaining solution contains the acid

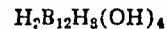

A portion of the above solution is neutralized with ammonia hydroxide to obtain $(NH_4)_2B_{12}H_8(OH)_4$ in solution and an aqueous solution of CsF is added. The solution is concentrated to a small volume from which the cesium salt crystallizes on cooling. The compound, which is very water-soluble, is purified by recrystallization from water.

Analysis.—Calc'd for $Cs_2B_{12}H_8(OH)_4 \cdot 2H_2O$ (percent): B, 25.0; H, 3.16; Cs, 51.6. Found (percent): B, 25.0; H, 3.10; Cs, 55.8.

The infrared absorption spectrum of a Nujol mull of the compound shows the following principal bands (expressed as cm^{-1}): 3580, strong; 3330, medium; 1630, medium; 1015, very strong, broad; 1025, very strong; 985, weak; 882, strong; and 740-725, very strong, broad.

A portion of the above solution is neutralized with ammonium hydroxide and there is then added an aqueous solution of $(CH_3)_4NCl$ to obtain the tetramethylammonium salt of $B_{12}H_8(OH)_4^{2-}$. The compound is recrystallized from water.

Analysis.—Calc'd for $[(CH_3)_4N]_2B_{12}H_8(OH)_4$ (percent): B, 36.7; H, 10.3; C, 27.1; N, 7.92. Found (percent): B, 37.6; H, 10.5; C, 27.1; N, 8.90.

The infrared absorption spectrum of a Nujol mull of the compound shows the following principal bands, expressed as cm^{-1} : 3330, medium; 1140, medium; 1070, weak; 1050, weak; 1025, strong; 980, medium; 950, strong; 900, weak; and 725, strong, broad.

(K) Compounds bearing $-\text{OH}$ substituents are also obtained by heating a hydrate of $\text{H}_2\text{B}_{12}\text{H}_{12}$ with SO_2 . Thus, a mixture consisting of 20 g. of crystalline hydrated $\text{H}_2\text{B}_{12}\text{H}_{12}$ and 50 g. of sulfur dioxide is heated in a stainless steel pressure vessel with agitation under autogenous pressure at 60°C . for 5 hours. The vessel is cooled and vented to remove unreacted sulfur dioxide. The process is repeated three more times and the four crude reaction products are combined. The mixture is neutralized with $(\text{CH}_3)_4\text{NOH}$ and the precipitate which forms is separated, washed and dried to obtain 43 g. of

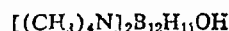

The compound is further purified by recrystallization from water. Its infrared spectrum shows absorption bands at 2.8, 4.0, 7.8, 8.8, 9.2, 9.5, 9.7, 10.55, 11.1, 12.5, and 13.9μ .

(L) A solution is prepared which consists of 1.8 g. of $\text{H}_2\text{B}_{12}\text{H}_{12}$ (calculated on an anhydrous basis from hydrated $\text{H}_2\text{B}_{12}\text{H}_{12}$) in 110 ml. of water. To this solution at room temperature (ca. 25°C .) 30.8 ml. of 30% aqueous H_2O_2 is added with stirring. The mixture is allowed to stand at room temperature for 4 days and the solution is then evaporated to dryness under reduced pressure at about 25°C . in a rotating evaporation unit. This operation is conducted behind suitable protective shielding. The residue is dried 18 hours over P_2O_5 and there is obtained 3.08 g. of $\text{H}_2\text{B}_{12}\text{H}_6(\text{OH})_6$. Titration of an aqueous solution of this acid shows that it is a strong acid, i.e., an acid in the class of strong mineral acids. The infrared absorption spectrum of the acid in a mineral oil mull show the following absorption bands: 2.8, 4.0, 9.0, and 10.6μ .

Analysis.—Calc'd for $\text{H}_2\text{B}_{12}\text{H}_6(\text{OH})_6$ (percent): B, 54.2; H, 5.83 (N.E., 120). Found (percent): B, 54.8; H, 6.14 (N.E., 125).

(M) An aqueous solution of the acid of part L is mixed with thallium carbonate and the precipitate which forms is separated. It is recrystallized from water, washed and dried to obtain the diethallium salt.

Analysis.—Calc'd for $\text{Tl}_2\text{B}_{12}\text{H}_6(\text{OH})_6$ (percent): Tl, 63.2; B, 20.0; H, 1.85. Found (percent): Tl, 62.1; B, 19.5; H, 2.23.

(N) An aqueous solution of the acid of Part L is reacted with CsF to obtain a salt which is very soluble in water. The product is a hydrated double salt of

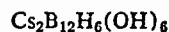

and CsF whose infrared absorption spectrum shows the following bands: 4.1, 6.1, 8.8, 10.25, and 11.35μ .

Analysis.—Calc'd for $\text{Cs}_2\text{B}_{12}\text{H}_6(\text{OH})_6 \cdot \text{CsF} \cdot 4\text{H}_2\text{O}$ (percent): Cs, 54.8; B, 17.86; H, 2.75. Found (percent): Cs, 55.2; B, 17.41; H, 2.45.

(O) Irradiation equipment employed in this process consists of a quartz tube (about 3 cm. x 30 cm.) surrounded by a mercury vapor coil. The tube is charged with 60 ml. of an aqueous solution (0.1035 molar) of $\text{H}_2\text{B}_{12}\text{Cl}_{12}$. The solution is irradiated for 24 hours and the blue suspension which forms is filtered. The solids are set aside and the filtrate is irradiated again for 68 hours. The suspension is filtered and the solids from both filtrations are combined to obtain 1.45 g. of hydrated $\text{H}_2\text{B}_{12}(\text{OH})_{12}$ containing some unreacted $\text{H}_2\text{B}_{12}\text{Cl}_{12}$. In the operation of the process, 90 ml. of hydrogen is evolved and substantially all of the chlorine is recovered as chloride ion (AgCl) in the filtrate.

The above process is repeated employing 100 ml. of a 0.1035 molar solution of $\text{H}_2\text{B}_{12}\text{Cl}_{12}$. There is obtained 3.19 g. of hydrated $\text{H}_2\text{B}_{12}(\text{OH})_{12}$ containing some unreacted starting compound.

The product, as isolated in several runs, ranged in color from white to blue. The product is insoluble in water and conventional organic solvents. It is washed repeatedly with water and ethanol and dried under reduced pressure over P_2O_5 . The product is hydrated $\text{H}_2\text{B}_{12}(\text{OH})_{12}$, also written as $(\text{H}_3\text{O})_2\text{B}_{12}(\text{OH})_{12}$, containing a minor quantity of product which bears chlorine bonded to boron. The composition of the product can be represented as $(\text{H}_3\text{O})_2\text{B}_{12}(\text{OH})_{11.5}\text{Cl}_{0.7}$.

Analysis.—Calc'd for the above mixture (percent): B, 33.7; Cl, 6.47; H, 4.49; O, 55.2. Found (percent): B, 33.6, 33.7; Cl, 6.36, 6.49; H, 4.82, 4.78; O, 51.1.

The acid is insoluble in concentrated sulfuric acid at 25°C . but it dissolves on warming the acid to 90°C . On cooling the sulfuric acid solution, no precipitation occurs. The product in sulfuric acid solution is a compound bearing $-\text{OH}$ and $-\text{OSO}_3\text{H}$ groups, i.e., it can be represented as $\text{H}_2\text{B}_{12}(\text{OH})_n(\text{OSO}_3\text{H})_{12-n}$ where n has a value of 1–12.

The free acid, dihydrogen dodecahydroxydodecaborate, which is usually obtained in hydrated form, is a white solid that is unchanged by heating up to 310°C . The acid is substantially insoluble in water, methanol, ethanol and other lower alkanols, dimethylformamide, dimethylsulfone, benzene, 1,2-dimethoxyethane, acetic acid and pyridine. It dissolves in basic solvents upon the addition of water and it also dissolves in dilute solutions of inorganic bases. Although substantially insoluble in water, sufficient acid does dissolve to give a strongly acid reaction to the water, as determined by pH test papers.

(P) A solution of 5.0 g. of $\text{Cs}_2\text{B}_{12}\text{Br}_{12}$ in 200 ml. of water is irradiated for 20 hours in the unit described in Part O. The solid is separated by filtration to obtain 0.764 g. of $(\text{H}_3\text{O})_2\text{B}_{12}(\text{OH})_{12}$. The product is suspended in water and aqueous CsOH solution is added until the solution is neutral. The acid dissolved during this step in the process. The solution is concentrated by evaporation until crystals of $\text{Cs}_2\text{B}_{12}(\text{OH})_{12}$ appear. The solid crystals are separated and recrystallized twice from water. Some $\text{Cs}_2\text{B}_{12}\text{Br}_{12}$ is present as an impurity.

Analysis.—Calc'd for $\text{Cs}_2\text{B}_{12}(\text{OH})_{12}$ (percent): Cs, 44.3; B, 21.7; H, 2.00. Found (percent): Cs, 38.2; B, 20.36; H, 2.21; Br, 3.75.

The process of Part P is repeated employing 10 g. of $\text{Cs}_2\text{B}_{12}\text{Br}_{12}$ in 200 ml. of water and 1.36 g. of product is isolated. The products obtained in these runs are combined to obtain 20 g. of $\text{Cs}_2\text{B}_{12}(\text{OH})_{12}$. The combined product is purified by dissolving it in water and irradiating the solution for 4 hours. The amount of bromine present in the compound is substantially reduced to obtain a product of the following analysis: Cs, 40.9; B, 20.4; H, 3.16; Br, 0.52.

(Q) Salts of the $\text{B}_{12}(\text{OH})_{12}^{-2}$ anion are obtained by neutralization of the acid obtained in Part P, employing the appropriate base and an aqueous suspension of the acid. The ammonium, methylammonium, and tert-butylammonium salts are prepared by this method. The ammonium salt is purified by crystallization from water, the methylammonium and tert-butylammonium salts by crystallization from aqueous ethanol.

Analysis.—Calc'd for $(\text{NH}_4)_2\text{B}_{12}(\text{OH})_{12}$ (percent): H, 5.41; B, 35.1; N, 7.58; O, 51.9. Found (percent): H, 5.80; B, 34.5; N, 6.58; O, 46.2.

Analysis.—Calc'd for $(\text{CH}_3\text{NH}_2)_2\text{B}_{12}(\text{OH})_{12}$ (percent): H, 6.04; B, 32.7; N, 7.04; O, 48.2; C, 6.04. Found (percent): H, 6.54; B, 32.7; N, 6.04; O, 35.5; C, 5.86.

Analysis.—Calc'd for $[(\text{CH}_3)_3\text{CNH}_2]_2\text{B}_{12}(\text{OH})_{12}$ (percent): H, 7.48; B, 27.0; N, 5.83; O, 39.9; C, 20.0. Found (percent): H, 7.79; B, 27.6; N, 5.96; O, 31.1; C, 19.6.

The cesium, ammonium and tert-butylammonium salts are moderately soluble in water. The cesium salt turns yellow at surfaces exposed to light.

Neutralization of an aqueous suspensions of

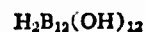

with $(\text{CH}_3)_4\text{NOH}$ yields $\{(\text{CH}_3)_4\text{N}\}_2\text{B}_{12}(\text{OH})_{12}$. The salt is very soluble in water and it is not readily isolated in solid form.

Example 8 illustrates the compounds of the invention in which X is hydroxyl and methods for their preparation. The processes of Example 8 are generic to the preparation of hydroxyl-bearing dodecaborates and these processes are operable with reactants bearing substituents other than hydroxyl. To illustrate, compounds can be obtained of the formulas $\text{BaB}_{12}\text{H}_{10}(\text{OCH}_3)(\text{OH})$, $\text{CuB}_{12}\text{H}_9(\text{C}_6\text{H}_{11})(\text{OH})_2$, $\text{K}_2\text{P}_3[\text{C}(\text{CH}_3)_3](\text{OH})_3$, and the like by employing as reactants dodecaborates having as substituents $-\text{OC}_2\text{H}_5$, $-\text{C}_6\text{H}_{13}$ and $-\text{C}(\text{CH}_3)_3$, respectively.

EXAMPLE 9

A reaction vessel is charged with 2.0 g. of

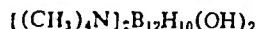

prepared as described in Example 8, Part G, and 10 ml. of glacial formic acid. The mixture is heated at 90–100° C. for 3 minutes and it is then poured into water. The solution is filtered and the filtrate is mixed with an aqueous solution of $(n\text{-C}_7\text{H}_{17})_4\text{NI}$. The precipitate which forms is separated and it is recrystallized from 50% aqueous ethyl alcohol. The product is bis(tetra-*n*-propylammonium) diformoxydodecahydrododecaborate(2-).

Analysis.—Calcd for $\{(\text{C}_7\text{H}_{17})_4\text{N}\}_2\text{B}_{12}\text{H}_{10}(\text{O}_2\text{CH})_2$ (percent): B, 21.6; C, 51.8; H, 11.4; N, 4.6. Found (percent): B, 21.6; C, 49.6; H, 11.1; N, 4.56.

(B) A reaction vessel is charged with 25 ml. of formic acid (98–100% purity) and 0.65 g. of $\text{Cs}_2\text{B}_{12}\text{H}_{10}\text{OH}$. The solid dissolves and the solution is heated at steam bath temperatures for 15 minutes. It is then allowed to stand at atmospheric temperature (ca. 25° C.) for about 18 hours. The reaction mixture is evaporated in a Rinco rotary drier under reduced pressure at 60° C. or less. There is obtained 0.67 g. of dicesium formoxyundecafluorododecaborate(2-), i.e., $\text{Cs}_2\text{B}_{12}\text{F}_{11}\text{OC}(\text{O})\text{H}$. The infrared spectrum of the compound contains bands as follows (expressed as microns): 5.8 (strong), 10.22 (weak), 12.0 (weak), and 15.45 (moderately strong).

(C) A small platinum tube is charged with 1 g. of $\text{Cs}_2\text{B}_{12}\text{F}_{11}\text{OH}$ and the vessel and contents are cooled in liquid nitrogen. Pressure in the tube is reduced to a low value and 1.0 g. of carbonyl fluoride (COF_2) is added. The tube is sealed, placed in a pressure reactor and heated under 400 atmospheres pressure at 150° C. for 16 hours. It is cooled, opened and allowed to warm to atmospheric temperature. Unreacted COF_2 escapes during this stage of the processing. A white solid, weighing 1.07 g., remains which is dicesium fluoroformoxyundecafluorododecaborate(2-), i.e., $\text{Cs}_2\text{B}_{12}\text{F}_{11}\text{OC}(\text{O})\text{F}$. The infrared spectrum of the compound displays very strong bands at 5.5 ($=\text{O}$) and 10.3 μ [$-\text{C}(\text{O})\text{F}$].

The compound hydrolyzes readily in water, releasing CO_2 .

EXAMPLE 10

A solution consisting of 5 g. of hydrated $\text{H}_2\text{B}_{12}\text{H}_{12}$ and 25 ml. of glacial acetic acid is stirred for 3 hours at about 25° C. It is then heated for 24 hours at steam bath temperatures (90–100° C.) The solution is cooled and it is mixed with an aqueous 50% solution of CsF . The precipitate which forms is separated by filtration and it is recrystallized from water to obtain 6.4 g. of dicesium monoacetoxundecafluorododecaborate(2-), i.e.,

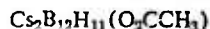

Examples 9 and 10 illustrate the compounds of the invention in which X is an ester group, i.e., $-\text{OC}(\text{O})\text{R}$. Two generic processes are exemplified which are as follows: (1) reaction of hydroxyl-substituted dodecaborates with anhydrous organic acids or their equivalents (acid anhydrides and acid halides), and (2) reaction of polyhydrododecaborates with an anhydrous organic acid. In either process any organic acid can be employed. For

example, $\text{H}_2\text{B}_{12}\text{H}_9(\text{OH})_3$ can be reacted with butyric acid to yield $\text{H}_2\text{B}_{12}\text{H}_9(\text{O}_2\text{CC}_4\text{H}_7)_3$; $\text{H}_2\text{B}_{12}\text{H}_{11}\text{OH}$ can be reacted with methacrylic acid to yield

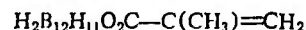

$\text{H}_2\text{B}_{12}\text{H}_{10}(\text{OH})_2$ can be reacted with benzoyl chloride to yield $\text{H}_2\text{B}_{12}\text{H}_{10}(\text{O}_2\text{CC}_6\text{H}_5)_2$; $\text{H}_2\text{B}_{12}\text{H}_{10}(\text{OH})_2$ can be reacted with octadecanoyl chloride to yield

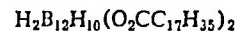

$\text{H}_2\text{B}_{12}\text{H}_{10}(\text{OH})_2$ can be reacted with propionic acid to yield $\text{H}_2\text{B}_{12}\text{H}_{10}(\text{O}_2\text{CC}_2\text{H}_5)_2$. Similarly, $\text{H}_2\text{B}_{12}\text{H}_{12}$ can be reacted with propionic acid to yield $\text{H}_2\text{B}_{12}\text{H}_{11}(\text{O}_2\text{CC}_2\text{H}_5)$, with hexahydrobenzoic acid to yield

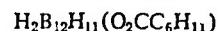

and with dodecanoic acid to yield $\text{H}_2\text{B}_{12}\text{H}_{11}(\text{O}_2\text{CC}_{11}\text{H}_{23})$.

In the processes of Examples 9 and 10, dodecaborates can be employed as reactants which bear not only $-\text{OH}$ groups but other substituent groups as well. To illustrate, $\text{H}_2\text{B}_{12}\text{H}_{10}(\text{C}_2\text{H}_4\text{C}_6\text{H}_5)\text{OH}$ can be reacted with propionic acid to yield $\text{H}_2\text{B}_{12}\text{H}_{10}(\text{C}_2\text{H}_4\text{C}_6\text{H}_5)(\text{O}_2\text{CCH}_2\text{CH}_3)$; $\text{H}_2\text{B}_{12}\text{Cl}_8(\text{OH})_4$ can be reacted with acetic acid to yield $\text{H}_2\text{B}_{12}\text{Cl}_8(\text{O}_2\text{CCH}_3)_4$; $\text{H}_2\text{B}_{12}\text{H}_8(\text{OCH}_3)_2(\text{OH})_2$ can be reacted with formic acid to yield



and $\text{H}_2\text{B}_{12}\text{B}_9(\text{OH})_3$ can be reacted with trifluoroacetic acid to yield $\text{H}_2\text{B}_{12}\text{B}_9(\text{O}_2\text{CCF}_3)_3$. Further,



can be reacted with formic acid to yield

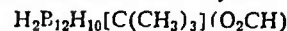

$\text{H}_2\text{B}_{12}\text{H}_{10}(\text{SO}_2\text{C}_6\text{H}_5)_2$ can be reacted with acetic acid to yield $\text{H}_2\text{B}_{12}\text{H}_9(\text{SO}_2\text{C}_6\text{H}_5)_2(\text{O}_2\text{CCH}_3)$, and the like.

The dodecaborate acids can be neutralized with organic and inorganic bases to yield a wide range of salts and the compounds are usually isolated in this manner, as illustrated in the examples.

EXAMPLE 11

(A) A solution of 7.5 g. of $\text{Na}_2\text{B}_{12}\text{H}_{12}\cdot\text{H}_2\text{O}$ in 50 ml. of water is passed through a column packed with an acid ion-exchange resin, as described in Example C. The acidic eluate and washings are collected and heated under reduced pressure until the volume is about 50 ml. The solution contains the acid $\text{H}_2\text{B}_{12}\text{H}_{12}$.

The acid solution obtained above is mixed with 10 ml. of 37% formaldehyde solution. The mixture becomes slightly warm but no color change occurs. The mixture is heated on a steam bath for about 1 hour and the solution becomes pink in color. The solution is cooled and it is evaporated under reduced pressure to yield a faintly pink tacky solid.

The solid obtained above is mixed with a solution of 5.0 g. of NaHCO_3 in about 25 ml. of hot water. The solution is cooled and filtered. An aqueous solution of cesium fluoride is added with stirring to the filtrate to form a white precipitate. The precipitate is separated and dried. Elemental analysis of the compound shows that it has the formula $\text{Cs}_2\text{B}_{12}\text{H}_{11}\text{X}$, where X consists of one oxygen, one carbon and three hydrogens. The infrared absorption spectrum shows that X is $-\text{OCH}_3$ and that the compound is, therefore, $\text{Cs}_2\text{B}_{12}\text{H}_{11}\text{OCH}_3$.

Analysis.—Calcd for $\text{Cs}_2\text{B}_{12}\text{H}_{11}\text{O}$ (percent): C, 2.74; H, 3.22. Found (percent): C, 3.16; H, 2.20.

(B) Crystalline hydrated $\text{H}_2\text{B}_{12}\text{H}_{12}$ (5.0 g.) is added slowly to 15 ml. of 37% formaldehyde with stirring and cooling to keep the temperature at about 25° C. The solution is stirred for a few minutes after addition of the acid is completed and 10 ml. of aqueous 50% CsF solution is added. The precipitate which forms is separated by filtration and it is recrystallized from hot water to obtain $\text{Cs}_2\text{B}_{12}\text{H}_{11}\text{OCH}_3$.

Analysis.—Calcd for $\text{Cs}_2\text{B}_{12}\text{H}_{11}\text{O}$ (percent): Cs, 60.6; B, 29.7; C, 2.74; H, 3.22. Found (percent): Cs, 55.3; B, 26.4; C, 2.6; H, 3.1.

(C) A portion (5 g.) of the crystalline hydrate of $H_2B_{12}H_{12}$ is dissolved in 25 ml. of 99% formic acid. The solution is heated on a steam bath for 3 hours, cooled and an aqueous 50% solution of CsF is added. The precipitate is processed as described in Part B to obtain 3.4 g. of $Cs_2B_{12}H_{11}OCH_3$.

(D) A mixture of 2.0 g. of the crystalline hydrate of $H_2B_{12}H_{12}$ (N.E., 174) and 10 ml. of CH_3OH is heated in a pressure vessel under autogenous pressure for 15 hours at steam bath temperatures. Volatile products formed in the reaction consist of H_2 and CH_4 . The liquid reaction product is mixed with aqueous 50% CsF solution and the precipitate is processed as described in Part B to obtain the methoxy-substituted compound.

Analysis.—Calc'd for $Cs_2B_{12}H_{11}OCH_3$ (percent): B, 29.6; C, 2.7; H, 3.2. Found (percent): B, 25.6; C, 3.1; H, 3.1.

(E) A mixture of 20 g. of CH_3OCH_3 and 12 g. of the crystalline hydrate of $H_2B_{12}H_{12}$ is heated in a pressure vessel under autogenous pressure at 90° C. for 2 hours. The reaction mixture is divided into two equal parts.

To one part an aqueous solution of CsOH is added until the mixture is neutral. The precipitate is processed as described in Part B to obtain a crystalline product which is a compound of about 40% $Cs_2B_{12}H_{11}OCH_3$ and 60% $Cs_2B_{12}H_{10}(OCH_3)_2$.

Analysis.—Calc'd for above product (percent): Cs, 59.0; B, 28.8; C, 3.7; H, 3.3. Found (percent): Cs, 56.9; B, 29.0; C, 3.6; H, 3.6.

To the second part, aqueous $(CH_3)_4NOH$ is added until the solution is neutral and the precipitate is processed as described in Part B to obtain a crystalline product which is about 40% $[(CH_3)_4N]_2B_{12}H_{11}OCH_3$ and 60%



Analysis.—Calc'd for above product (percent): C, 25.1; H, 10.7; N, 5.4. Found (percent): C, 25.6; H, 11.0; N, 5.4.

(F) A mixture of 50 g. of CH_3OCH_3 and 15 g. of the crystalline hydrate of $H_2B_{12}H_{12}$ is heated in a pressure vessel under autogenous pressure at 110° C. for 1 hour. The reaction mixture is neutralized with aqueous CsOH solution and the precipitate is processed as described in Part B to obtain a dodecaborate bearing two methoxy groups.

Analysis.—Calc'd for $Cs_2B_{12}H_{10}(OCH_3)_2$ (percent): B, 27.7; C, 5.1; H, 3.4. Found (percent): B, 27.1; C, 4.8; H, 3.5.

EXAMPLE 12

(A) A mixture of 5 g. of the crystalline hydrate of $H_2B_{12}H_{12}$ and 25 ml. of $C_2H_5OC_2H_5$ is heated in a pressure vessel under autogenous pressure at 60° C. for 10 hours. The reaction mixture, so obtained, is stirred with 10 ml. of aqueous 50% CsF solution. The crystalline Cs salt (1.9 g.) which precipitates is processed as described in Example 11, Part B to obtain cesium hydrogen ethoxyundecahydrododecaborate(2-) with one mole of ethanol as solvent of crystallization.

Analysis.—Calc'd for $CsHB_{12}H_{11}OC_2H_5 \cdot C_2H_5OH$ (percent): Cs, 32.6; B, 35.5; C, 13.2. Found (percent): Cs, 39.6; B, 36.8; C, 13.2.

(B) A mixture of 5 g. of the crystalline hydrate of $H_2B_{12}H_{12}$ and 25 ml. of ethanol is heated in a pressure vessel under autogenous pressure for 4 hours at 100° C. Volatile products formed in the reaction contain 83 ml. of hydrogen and 160 ml. of ethane. The non-volatile reaction product is neutralized with aqueous NaOH solution following which an aqueous solution of CsF is added. The precipitate is processed as described in Example 11, Part B, to obtain $Cs_2B_{12}H_{11}OC_2H_5$. The identity of the compound is confirmed by its infrared absorption spectrum.

(C) Acetaldehyde (25 ml.) is cooled in an ice bath and 5 g. of crystalline hydrated $H_2B_{12}H_{12}$ is slowly added with stirring. After addition is completed, the solution is

stirred a short period and 10 ml. of 50% aqueous CsF is added. The precipitate is processed as described earlier to obtain the monoethoxy derivative.

Analysis.—Calc'd for $Cs_2B_{12}H_{11}OC_2H_5$ (percent): Cs, 58.7; B, 28.7; C, 5.3; H, 3.5. Found (percent): Cs, 55.2; B, 23.9; C, 5.3; H, 3.5.

(D) A solution of 10 g. of crystalline hydrated $H_2B_{12}H_{12}$ (N.E., 222) in 20 ml. of glacial acetic acid is heated for 15 hours at steam bath temperatures. Excess acid is removed in a rotary evaporator and the syrupy residue is diluted with 25 ml. of water. The solution is neutralized with aqueous 50% sodium hydroxide and 30 ml. of aqueous 50% CsF is added. The precipitate is separated and crystallized repeatedly to obtain

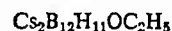

A second product isolated from the reaction mixture is $Cs_2B_{12}H_{11}OH$

(E) Acetaldehyde (25 ml.) is cooled in an ice bath and 5 g. of crystalline hydrated $H_2B_{12}H_{12}$ is added with stirring. An exothermic reaction sets in and subsides in a short time. Aqueous 50% CsF solution (10 ml.) is added to the mixture and the precipitate which forms is processed as described in Example 11 Part B to obtain the diethoxy-substituted derivative.

Analysis.—Calc'd for $Cs_2B_{12}H_{10}(OC_2H_5)_2$ (percent): Cs, 53.5; B, 26.2; C, 9.7; H, 4.0. Found (percent): Cs, 49.1; B, 29.3; C, 8.1; H, 4.4.

EXAMPLE 13

(A) A mixture of 2.0 g. of crystalline hydrated $H_2B_{12}H_{12}$ (N.E., 174) and 10 ml. of n-propyl alcohol is heated in a pressure vessel under autogenous pressure at steam bath temperature (90–100° C.) for 15 hours. The vessel is cooled to about -196° C. and it is opened. Volatile products which are collected are hydrogen and, by warming to 0° C., propane. The liquid residue is mixed with aqueous 50% CsF solution and the



(3.7 g.) which precipitates is purified by processes described earlier.

Analysis.—Calc'd for $Cs_2B_{12}H_{11}OC_3H_7$ (percent): B, 27.8; C, 7.7; H, 3.9. Found (percent): B, 27.5; C, 7.8; H, 4.1.

(B) A solution of 28 g. of crystalline hydrated $H_2B_{12}H_{12}$ (N.E., 160) in 100 ml. of isopropyl alcohol is allowed to stand 18–20 hours at about 25° C. The solution is then refluxed at steam bath temperature for about 100 hours. It is neutralized with 50% aqueous NaOH solution and 60 g. of aqueous 50% CsF solution is added. The precipitate is separated and crystallized from water to yield 33.6 g. of $Cs_2B_{12}H_{11}OCH(CH_3)_2$. The infrared absorption spectrum of the compounds shows a broad peak with three fingers at 8.55, 8.70, and 8.95 μ , a large peak at 9.6 μ with a shoulder at 9.4 μ , small peaks at 10.5 and 11.1 μ and a very small peak at 12 μ .

Analysis.—Calc'd for $Cs_2B_{12}H_{11}OCH(CH_3)_2$ (percent): Cs, 57.0; B, 27.8; C, 7.7; H, 3.9. Found (percent): Cs, 55.4; B, 29.0; C, 7.1; H, 3.6.

The reaction is repeated employing 26.4 g. of hydrated $H_2B_{12}H_{12}$ (N.E., 163) and 100 ml. of isopropyl alcohol. The mixture is refluxed 98 hours, neutralized with 50% NaOH solution, evaporated and mixed with a solution of 40 g. of $(CH_3)_4NCl$ in 20 ml. of water. The precipitate is separated and dried at 100° C. in vacuo to yield 44 g. of the bis(tetramethylammonium) salt.

Analysis.—Calc'd for $[(CH_3)_4N]_2B_{12}H_{11}OCH(CH_3)_2$ (percent): B, 37.3; C, 38.0; H, 12.1; N, 8.0. Found (percent): B, 37.8; C, 32.6; H, 11.3; N, 6.6.

(C) A mixture consisting of 11 g. of di(tertbutyl)peroxide and 2 g. of $Na_2B_{12}H_{12} \cdot 2H_2O$ is heated in an oil bath at 105° C. for 18 hours. The disodium salt does not dissolve appreciably in the liquid. The reaction mixture is dissolved in water and aqueous 50% CsF solution is

added. The precipitate is separated, washed and redissolved in water from which it is again crystallized. These crystals are $\text{Cs}_2\text{B}_{12}\text{H}_{12}$. The mother liquor from this crystallization is concentrated and more crystals separate. These crystals, obtained in low yield, are

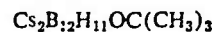

The infrared spectrum of this compound shows strong absorption in the 8.5–8.9 μ wavelengths.

Analysis.—Calc'd for $\text{Cs}_2\text{B}_{12}\text{H}_{11}\text{OC}(\text{CH}_3)_3$ (percent): C, 10.0; H, 4.2. Found (percent): C, 9.2; H, 4.5.

(D) A pressure vessel is charged with 2 g. of a hydrate of $\text{H}_2\text{B}_{12}\text{H}_{12}$ (N.E., 174) and 10 ml. of 2,2,2-trifluoroethanol. The mixture is heated under autogenous pressure for 15 hours at 100° C. The reaction mixture is processed as described in Part B to obtain 3.4 g. of dicesium (2,2,2-trifluoroethoxy)undecahydrododecaborate(2⁻). The compound is recrystallized from solution in 3.3 ml. of hot water to obtain 2.0 g. of pure product. The identity of the compound is confirmed by its infrared absorption spectrum. It has the formula $\text{Cs}_2\text{B}_{12}\text{H}_{11}\text{OCH}_2\text{CF}_3$.

(E) The reaction described in Part D is repeated employing 2 g. of the hydrate of $\text{H}_2\text{B}_{12}\text{H}_{12}$ and 10 ml. of 2H-hexafluoropropanol-2. There is obtained 2.2 g. of dicesium 2H-hexafluoroisopropoxyundecahydrododecaborate(2⁻). The compound is crystallized from water and it has the formula $\text{Cs}_2\text{B}_{12}\text{H}_{11}\text{OCH}(\text{CF}_3)_2$.

EXAMPLE 14

(A) A mixture of 2.0 g. of hydrated $\text{H}_2\text{B}_{12}\text{H}_{12}$ (N.E., 174) and 10 ml. of n-C₄H₉OH is heated in a pressure vessel under autogenous pressure at steam bath temperature for 15 hours. The vessel is cooled to -196° C. and opened. Volatile products obtained are hydrogen and, on warming to 0° C., n-butane. The liquid residue is mixed with 5 ml. of aqueous 50% CsF solution and the precipitate which forms is processed as described in previous examples to obtain 3.6 g. of $\text{Cs}_2\text{B}_{12}\text{H}_{11}\text{X}$, where X is $-\text{OCH}_2\text{CH}_2\text{CH}_2\text{CH}_3$.

Analysis.—Calc'd for $\text{Cs}_2\text{B}_{12}\text{H}_{11}\text{OC}_4\text{H}_9$ (percent): B, 27.1; C, 10.0; H, 4.2. Found: B, 26.9; C, 9.8; H, 4.3.

(B) A mixture of 210 g. of hydrated $\text{H}_2\text{B}_{12}\text{H}_{12}$ (N.E., 174) and 10 ml. of (n-C₄H₉)₂O is heated and processed as described in Part A. The product obtained is $\text{Cs}_2\text{B}_{12}\text{H}_{11}\text{OC}_4\text{H}_9$ with $\text{Cs}_2\text{B}_{12}\text{H}_{11}\text{OH}$ as a by-product.

EXAMPLE 15

(A) A portion (5 g.) of crystalline hydrated $\text{H}_2\text{B}_{12}\text{H}_{12}$ is added slowly to 15 ml. of diethyl ketone. The temperature of the reaction mixture is maintained at 20–25° C. during this step. When addition is complete, the mixture is stirred and 10 ml. of aqueous CsF solution is added. The precipitate is separated and purified as described earlier to obtain 4.7 g. of the compound $\text{Cs}_2\text{B}_{12}\text{H}_{11}\text{X}$, where X is $-\text{OCH}(\text{C}_2\text{H}_5)_2$.

Analysis.—Calc'd for $\text{Cs}_2\text{B}_{12}\text{H}_{11}\text{OC}_2\text{H}_5$ (percent): Cs, 53.8; B, 26.3; H, 4.5. Found (percent): Cs, 57.2; B, 27.1; H, 3.9.

(B) The procedure of Part A is repeated employing 5 g. of crystalline hydrated $\text{H}_2\text{B}_{12}\text{H}_{12}$ and 15 ml. of cyclohexanone. The product obtained consists of 4.9 g. of dicesium cyclohexyloxyundecahydrododecaborate(2⁻).

Analysis.—Calc'd for $\text{Cs}_2\text{B}_{12}\text{H}_{11}\text{OC}_6\text{H}_{11}$ (percent): Cs, 52.5; B, 25.6; H, 4.3. Found (percent): Cs, 54.3; B, 24.5; H, 3.8.

EXAMPLE 16

(A) Crystalline hydrated $\text{H}_2\text{B}_{12}\text{H}_{12}$ (10.0 g.) and 150 ml. of 1,2-dimethoxyethane are stirred to form a solution. Ethyl acetoacetate (7.23 g.) is added to the solution and the mixture is stirred for 17 hours at about 25° C. The solution is evaporated and the oil which remains is dissolved in 50 ml. of water. The solution is made basic with 20 g. of (CH₃)₄NOH and the solution is poured into a large excess of ethyl alcohol. The alcohol solution is evaporated to dryness and the remaining white solid

is crystallized from a 20:1 mixture of CH₃OH and water. The product is $[(\text{CH}_3)_4\text{N}]_2\text{B}_{12}\text{H}_{11}\text{OCH}_2\text{CH}_2\text{OCH}_3$. Reaction in the process occurs between $\text{H}_2\text{B}_{12}\text{H}_{12}$ and 1,2-dimethoxyethane.

The infrared spectrum of the compound shows absorption at the following characteristic wavelengths (expressed as microns): 4.1, very strong; 6.8, strong; 7.1, shoulder; 7.4, shoulder; 7.8, medium; 8.1, weak; 8.5, shoulder; 8.55, shoulder; 9.0, strong; 9.35, strong; 9.6, shoulder; 9.8, strong; 10.55, strong; 10.8, shoulder; 11.5, weak; 11.6, weak; 11.8, weak; 13.4, very weak; 13.9, strong.

Analysis.—Calc'd for

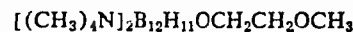

percent: B, 35.64; N, 7.69; C, 36.26; H, 11.62. Found (percent): B, 36.61; N, 7.48, 7.64; C, 35.85; H, 11.57, 11.81.

(B) A solution consisting of 6.34 g. of hydrated $\text{H}_2\text{B}_{12}\text{H}_{12}$ in 100 ml. of 1,2-dimethoxyethane is stirred at about 25° C. for 96 hours and at 80° C. for 12 hours. The clear solution is evaporated to dryness in a rotary evaporator, the residue is dissolved in 50 ml. of water and 9.0 g. of CsF is added to the solution. The precipitate which forms is crystallized from aqueous ethanol to obtain dicesium bis(2-methoxyethoxy)decahydrododecaborate(2⁻) as a white solid.

The infrared spectrum of the compound shows absorption at the following characteristic wavelengths (expressed as microns): 2.8, weak; 4.1, very strong; 6.2, weak; 7.2, very weak; 7.4, medium; 7.5, very weak; 7.85, weak; 8.1, weak; 8.35, shoulder; 8.5, shoulder; 8.65, strong; 9.0, strong; 9.4, strong; 9.75, strong; 10.05, medium; 10.8, weak; 11.3, weak; 11.65, weak; 11.9, weak; 13.7, broad.

Analysis.—Calc'd for $\text{Cs}_2\text{B}_{12}\text{H}_{10}(\text{OCH}_2\text{CH}_2\text{OCH}_3)_2$ (percent): Cs, 46.32; B, 22.62; C, 12.56; H, 4.57. Found (percent): Cs, 45.20; B, 22.77; C, 12.96; H, 4.59.

(C) A mixture consisting of 10 g. of hydrated crystalline (H_3O)₂B₁₂H₁₂ and 40 ml. of HOCH₂CH₂Cl is heated at steam bath temperatures (90–100° C.) for 20 hours. The mixture is cooled and concentrated by evaporation (employing a Rinko unit). The residue is neutralized with aqueous cesium hydroxide solution and the cesium salt which precipitates is separated. It is recrystallized from water to obtain $\text{Cs}_2\text{B}_{12}\text{H}_{11}\text{OCH}_2\text{CH}_2\text{Cl}$.

Analysis.—Calc'd for $\text{Cs}_2\text{B}_{12}\text{H}_{11}\text{OCH}_2\text{CH}_2\text{Cl}$ (percent): Cl, 7.8; C, 4.9; H, 3.1. Found (percent): Cl, 8.1; C, 4.5; H, 3.1.

EXAMPLE 17

(A) A solution of 2.9 g. (0.013 mole) of

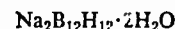

in 10 ml. of water is passed through a column filled with a commercial acid ion-exchange resin. The aqueous effluent, which is a solution of $\text{H}_2\text{B}_{12}\text{H}_{12}$, or written in the hydronium form (H_3O)₂B₁₂H₁₂, is evaporated under reduced pressure at less than 25° C. to obtain a solid residue. The residue is dissolved in 20 ml. of 1,2-dimethoxyethane (glyme), the solution is cooled in an ice bath, and a solution of 2.4 g. of epichlorohydrin (0.026 mole) is added to it dropwise. The solvent is then removed under reduced pressure and the residue is dissolved in ethanol. To this solution there is added a solution of 3.9 g. (0.026 mole) of CsF in 10 ml. of a 1:1 mixture of absolute ethanol and glyme. The precipitate which forms is separated, washed and dried to obtain a compound of Formula 1 bearing a chloropropoxy and a methoxyethoxy substituent.

Analysis.—Calc'd for



(percent): C, 12.5; H, 4.0; B, 22.7; Cl, 6.3. Found (percent): C, 11.27; H, 3.86; B, 20.67; Cl, 6.67.

39

(B) The procedure of Part A is repeated employing styrene oxide as the oxirane reactant. The product which is obtained is $\text{Cs}_2\text{B}_{12}\text{H}_{10}(\text{OCH}_2\text{CH}_2\text{C}_6\text{H}_5)_2$.

Analysis.—Calc'd for above compound (percent): C, 29.6; H, 4.5; B, 20.0. Found (percent): C, 27.22; H, 4.70; B, 18.49.

(C) The procedure of Part A is repeated employing dicyclopentadiene dioxide as the reactant. The product which is obtained is a tetraesium salt of the formula

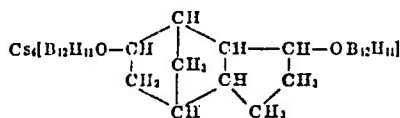

This compound can be viewed as a product of Formula 1 in which the X group carries a negative charge of -2 (inherent in the second $\text{B}_{12}\text{H}_{11}$ cage) and two of the four cesium ions are, therefore, part of the X group.

(D) Employing the process of Part A up to the addition of CsF, an oxirane of the formula

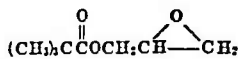

is reacted with $\text{H}_2\text{B}_{12}\text{H}_{12}$ to obtain

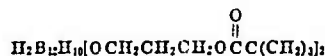

40

(percent): C, 7.5; H, 3.7; B, 27.0. Found (percent): C, 9.05; H, 3.79; B, 22.87.

(E) A solution of 22.4 g. of $\text{Na}_2\text{B}_{12}\text{H}_{12}\cdot 2\text{H}_2\text{O}$ (0.1 mole) in 40 ml. of water is passed through a column filled with an acid ion-exchange resin. The effluent is evaporated under reduced pressure at 20°C . to obtain a hydrate of $\text{H}_2\text{B}_{12}\text{H}_{12}$ as a solid residue. The hydrated acid is dissolved in 60 ml. of glyme and 22.8 g. (0.2 mole) of 3,4-epoxy-4-methyl-2-pentanol is added dropwise and with stirring. The solvent (glyme) is evaporated from the reaction mixture under reduced pressure to obtain the solvated acid

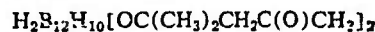

A solution of 30.4 g. (0.2 mole) of CsF in 30 ml. of ethanol is added to the residue and the precipitate which forms is separated and recrystallized from ethanol-water mixture to obtain a compound of the formula

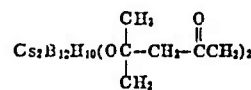

By employing the procedure of Example 17, hydrated $\text{H}_2\text{B}_{12}\text{H}_{12}$ is reacted with the oxiranes shown in Table I at the indicated temperature to obtain, as cesium salts, the products shown in the last column of the table:

TABLE I

Oxirane	Temperature, °C.	Product
3,4-epoxycyclohexane carbonitrile.....	<30	$\text{Cs}_2\text{B}_{12}\text{H}_{10} \left[\begin{array}{c} \text{CH}_3 \\ \\ \text{O}-\text{CH} \quad \text{CH}_2 \\ \quad \\ \text{H}_2\text{C} \quad \text{CH}_2 \\ \\ \text{CH} \\ \\ \text{CN} \end{array} \right]_2$
3,4-epoxy-tetrahydrothiophene-1,1-dioxide.....	<36	$\text{Cs}_2\text{B}_{12}\text{H}_{10} \left[\begin{array}{c} \text{O}-\text{CH}-\text{CH}_3 \\ \quad \\ \text{H}_2\text{C} \quad \text{CH}_2 \\ \\ \text{S O}_2 \end{array} \right]_2$
1,2-epoxy-3-phenoxypropane.....	<30	$\text{Cs}_2\text{B}_{12}\text{H}_{10}(\text{OCH}_2\text{CH}_2\text{CH}_2\text{OC}_6\text{H}_5)_2$
Dipentene monoxide.....	<0	$\text{Cs}_2\text{B}_{12}\text{H}_{10} \left[\begin{array}{c} \text{CH}_3 \\ \\ \text{O}-\text{HC} \quad \text{CH}_2 \\ \quad \\ \text{H}_2\text{C} \quad \text{CH}_2 \\ \\ \text{CH} \\ \\ \text{C}=\text{CH}_2 \end{array} \right]_2$
1,2-epoxy-3-(4-chlorophenoxy)propane.....	<30	$\text{Cs}_2\text{B}_{12}\text{H}_{10}(\text{OCH}_2\text{CH}_2\text{CH}_2\text{OC}_6\text{H}_4\text{Cl})_2$
1,2-epoxy-3-methoxypropane.....	<30	$\text{Cs}_2\text{B}_{12}\text{H}_{10}(\text{OCH}_2\text{CH}_2\text{CH}_2\text{OCCH}_3)_2$
Methyl phenylglycidate.....	<30	$\text{Cs}_2\text{B}_{12}\text{H}_{10}[\text{OCH}(\text{C}_6\text{H}_5)\text{C}(\text{O})\text{CH}_2]_2$
	30	$\text{Cs}_2\text{B}_{12}\text{H}_{10}(\text{OC}_6\text{H}_5)_2$
	30	$\text{Cs}_2\text{B}_{12}\text{H}_{10} \left[\begin{array}{c} \text{H} \quad \text{CH} \\ \quad \\ \text{O}-\text{C} \quad \text{CH} \\ \quad \\ \text{H}_2\text{C} \quad \text{CH} \\ \quad \\ \text{CH} \quad \text{CH}_2 \\ \\ \text{C}=\text{O} \\ \\ \text{O C O C H}_3 \end{array} \right]_2$
	55	$\text{Cs}_2\text{B}_{12}\text{H}_{10}[\text{O}(\text{CH}_2)_4\text{CH}_3]_2$

in solution. The compound is hydrolyzed in acid solution by conventional methods to obtain a solution of



This solution is mixed with an aqueous solution of CsF to obtain $\text{Cs}_2\text{B}_{12}\text{H}_{10}[\text{OCH}_2\text{CH}_2\text{CH}_2\text{OH}]_2$. The product is purified as described in Part A.

Analysis.—Calc'd for $\text{Cs}_2\text{B}_{12}\text{H}_{10}[\text{OCH}_2\text{CH}_2\text{CH}_2\text{OH}]_2$

Examples 11-17, inclusive, illustrate compounds of the invention in which X is an $-\text{OR}$ group and their preparation. The processes which employ, as one reactant, an acid of a polyhydrododecaborate and, as a second reactant, a member of the group consisting of aldehydes, ketones, alcohols, ethers, and oxiranes, are generic to the preparation of compounds bearing $-\text{OR}$ groups. Optionally, in the process for preparing com-

pounds having —OCH₃ groups, formic acid can be used in place of formaldehyde. The generic process is illustrated further as follows: H₂B₁₂H₁₂ can be reacted with butyraldehyde to yield H₂B₁₂H₁₁OC₄H₉, with dioctyl ether to yield H₂B₁₂H₁₀(OC₈H₁₇)₂, with 2,2'-dichlorodiethyl ether to yield H₂B₁₂H₁₁OCH₂CH₂Cl, and with 2-phenylethanol to yield H₂B₁₂H₁₁OCH₂CH₂C₆H₅. Dodecaborates which bear other substituents can be employed as reactants. To illustrate, H₂B₁₂H₁₀(SO₂C₆H₅)₂ can be reacted with dipropyl ether to yield

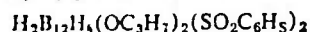

H₂B₁₂H₁₁C₆H₁₁ can be reacted with heptyl alcohol to yield H₂B₁₂H₁₀(C₇H₁₅)₂, H₂B₁₂H₁₁CH(CH₃)₂ can be reacted with 1,2-dimethoxyethane to yield

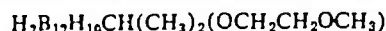

H₂B₁₂H₁₀(SCH₃)₂ can be reacted with diethyl ether to yield H₂B₁₂H₉(SCH₃)₂(OC₂H₅)₂; and



can be reacted with 1,2-diethoxyethane to yield

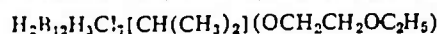

The dodecaborate acids are customarily neutralized with bases and the compounds are isolated as salts.

EXAMPLE 18

(A) A mixture of 10 g. of crystalline hydrated

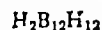

and 20 g. of CH₃SSCH₃ is stirred at 25–35° C. until it becomes homogeneous (ca. 0.5 hour). It is then stirred an additional 18 hours at prevailing atmospheric temperature (ca. 25° C.). Methyl mercaptan is evolved in the process and the mercaptan is preferably collected in a cooled trap. The reaction mixture is neutralized with aqueous 10% NaOH solution and the resulting solution is steam distilled to remove the last portions of methyl mercaptan. The liquid is evaporated to a mushy solid which is mixed with aqueous 50% CsF solution. The precipitated material is crystallized repeatedly from water to form two main fractions which are Cs₂B₁₂H₁₁SCH₃ (referred to as Fraction 1) and Cs₂B₁₂H₁₀(SCH₃)₂ (referred to as Fraction 2).

The infrared spectrum of Fraction 1 shows characterizing absorption bands (wavelengths expressed as microns) at 4, 9.3, 10.2, 10.4, 11.5, 11.8, and 12.1. The infrared spectrum for Fraction 2 is similar although there are intensity differences. In perchlorobutadiene mulls, the infrared spectra of both fractions showed a characterizing band at 3.4μ (saturated C—H).

Analysis.—Calc'd for Cs₂B₁₂H₁₁SCH₃ (percent): C, 2.70; H, 3.1. Found (percent): C, 3.12; H, 3.60. Calc'd for Cs₂B₁₂H₁₀(SCH₃)₂ (percent): C, 4.80; H, 3.20; S, 12.3. Found (percent): C, 4.29; H, 3.36; S, 10.06.

(B) The reaction of Part A is repeated except that the mixture is heated 8 hours at 35° C. and it is then allowed to stand about 18 hours at atmospheric temperature with nitrogen gas bubbling through it. The mixture is processed as described in Part A. The disubstituted compound

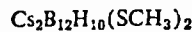

which is more soluble than the monosubstituted compound, is obtained in larger amount. *Analysis:* C, 4.83; H, 3.65; S, 13.53; B, 25.20.

Example 18 illustrates the compounds of Formula 1

in which X is a —SR group. The process described is generic to the preparation of these compounds and it can be employed to prepare a wide range of compounds by use of the appropriate disulfide reactant. To illustrate, H₂B₁₂H₁₂ can be reacted with dibenzyl disulfide to yield H₂B₁₂H₁₀(SCH₂C₆H₅)₂, with dioctyl disulfide to yield

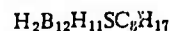

and with diallyl disulfide to yield H₂B₁₂H₁₀(SC₃H₅)₂. Substituted dodecaborates can be employed as reactants as described for other procedures. For example, dimethyl disulfide can be reacted with H₂B₁₂H₁₁C₆H₁₁ to yield



with H₂B₁₂H₉F₄ to obtain H₂B₁₂H₇F₄(SCH₃)₂, with

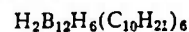

to yield H₂B₁₂H₄(C₁₀H₂₁)₆(SCH₃)₂. Any disulfide can be employed in the process and dimethyl disulfide is used above solely by way of illustration. The dodecaborate acids are customarily converted to salts, as described earlier.

EXAMPLE 19

(A) A reaction vessel is charged with a mixture of 18 g. of the crystalline hydrate of H₂B₁₂H₁₂ and 12 g. of benzenesulfonyl chloride. Nitrogen is bubbled through the mixture to provide agitation. Within a few minutes an exothermic reaction sets in and the mixture forms a uniformly soft solid. The reaction mixture is neutralized with an aqueous solution of CsOH and the precipitate which forms is separated. The precipitate is boiled with water and the mixture of solid and liquid is filtered. The filtrate is cooled and the crystals which form are collected. The crystals are a mixture of about 30% of

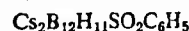

and 70% of Cs₂B₁₂H₁₀(SO₂C₆H₅)₂. The infrared absorption spectrum of a Nujol mull of the product shows the following characteristic bands (expressed as microns): 4.0, 6.3, 7.6, 8.5, 8.9, 9.3, 9.7, 9.9, 10.4, 12.6, and 13.7.

Analysis.—Calc'd for the above mixture (percent): C, 15.90; H, 2.90; S, 7.05. Found (percent): C, 15.56; H, 3.53; S, 7.01.

(B) A mixture consisting of 20 g. of benzenesulfonyl chloride and 10 g. of hydrated crystalline (H₃O)₂B₁₂H₁₂ is stirred at 35° C. for 24 hours in a current of nitrogen. The reaction mixture is processed as described in Part A and the product, which is recrystallized three or four times from water, is substantially pure Cs₂B₁₂H₁₁SO₂C₆H₅.

Analysis.—Calc'd for Cs₂B₁₂H₁₁SO₂C₆H₅ (percent): S, 5.8; C, 13.1; H, 2.9; B, 23.6. Found (percent): S, 5.7; C, 13.3; H, 3.8; B, 24.3.

Example 19 illustrates compounds of the invention in which the substituent is an RSO₂— group. The process is generic to the preparation of this class of compounds. It employs as one reactant a sulfonyl halide (preferably a chloride) and, as the second reactant, a dodecaborate acid, i.e., H₂B₁₂H₁₂ or derivatives thereof having substituents bonded to boron. The process proceeds readily and heating is not required, although heat can be applied if needed to speed the process. It can be used to prepare a wide range of compounds by appropriate choice of reactants. Table II which follows illustrates products (shown in column 3) which can be obtained by reacting H₂B₁₂H₁₂ with the sulfonyl chlorides shown in column 1, employing the reaction conditions of Example 19. A reagent to supply an appropriate cation is shown in column 2.

TABLE II

Sulfonyl chloride	Cation reactant	Product
Cyclohexylbenzene-SO ₂ Cl	NaOH	Na ₂ B ₁₂ H ₁₁ SO ₂ C ₆ H ₁₁
Diphenyl-SO ₂ Cl	Pyridine	(C ₆ H ₅) ₂ B ₁₂ H ₁₁ SO ₂ C ₆ H ₅
Naphthalene-SO ₂ Cl	Aniline	(C ₆ H ₅) ₂ B ₁₂ H ₁₁ SO ₂ C ₁₀ H ₇
Anthracene-SO ₂ Cl	(CH ₃) ₂ NOH	(CH ₃) ₂ NB ₁₂ H ₁₁ SO ₂ C ₁₄ H ₉
Phenanthrene-SO ₂ Cl	CsOH	Cs ₂ B ₁₂ H ₁₁ SO ₂ C ₁₄ H ₉
C ₁₀ H ₇ SO ₂ Cl	TiOH	TiB ₁₂ H ₁₁ (SO ₂ C ₁₀ H ₇) ₂
C ₁₀ H ₇ SO ₂ Cl	(CH ₃) ₂ SOH	(CH ₃) ₂ SB ₁₂ H ₁₁ SO ₂ C ₁₀ H ₇
Cyclohexane-SO ₂ Cl	(C ₂ H ₅) ₂ POH	(C ₂ H ₅) ₂ PB ₁₂ H ₁₁ (SO ₂ C ₆ H ₁₁) ₂
Dodecyl dodecylbenzene-SO ₂ Cl		2[(C ₂ H ₅) ₂ PB ₁₂ H ₁₁ SO ₂ C ₁₂ H ₂₅]

The free acids are, of course, obtained in the process prior to the neutralization step and the acids can, if desired, be isolated directly. To illustrate briefly,

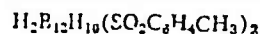

can be obtained from $\text{H}_2\text{B}_{12}\text{H}_{12}$ and $\text{CH}_3\text{C}_6\text{H}_4\text{SO}_2\text{Cl}$,
 $\text{H}_2\text{B}_{12}\text{H}_{11}(\text{SO}_2\text{C}_6\text{H}_4\text{OC}_6\text{H}_5)$ can be obtained from

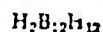

and $\text{C}_6\text{H}_5\text{OC}_6\text{H}_4\text{SO}_2\text{Cl}$;

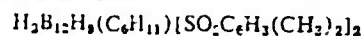

can be obtained from $\text{H}_2\text{B}_{12}\text{H}_{12}$, C_6H_{11} and



and the like.

Compounds of Formula 1 in which one or more X groups are carbacyl [KC(O)—] are obtained conveniently by (1) reaction of $\text{B}_{12}\text{H}_{10}\cdot 2\text{CO}$ or

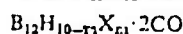

(where X is defined as in Formula 1 and m is 1-10) with substituted aryl compounds as described and illustrated in Example 42, or (2) reaction of $\text{B}_{12}\text{H}_{10}\cdot 2\text{CO}$ with organomercurials as described in Examples 43-44.

EXAMPLE 20

(A) A solution of 4.4 g. of *p*-methoxybenzenediazonium tetrafluoroborate is prepared in 50 ml. of water and it is filtered to remove insoluble material. The filtrate is cooled in an ice bath and a solution of 10 g. of the monohydrate of disodium dodecahydrododecaborate is added with stirring. A heavy white precipitate forms which is separated by filtration. A portion of the precipitated material is dried on a porous plate and its infrared absorption spectrum is determined. The infrared spectrum shows the characteristic B—H and B_{12} skeletal bands at 4.0μ and 9.4μ , a band at 4.4μ which is due to the diazonium function and bands at 6.3μ , 9.1μ , and 11.9μ , which are due to the aromatic system. The compound is bis(*p*-methoxybenzenediazonium) dodecahydrododecaborate(2-), i.e., a salt of the formula



The salt is dried at 25°C . and 0.02 mm. for 20 hours. When placed on a metal block and struck with a hammer, it detonates with a flash of light and forms much black ash. It also detonates in a combustion chamber used for elemental analysis.

Analysis.—Calc'd for $\text{C}_{14}\text{H}_{26}\text{B}_{12}\text{N}_4\text{O}_2$ (percent): C, 40.79; H, 6.36. Found (percent): C, 38.86; H, 6.26.

(B) A suspension of the diazonium salt obtained in Part A in 2 ml. of ethanol is warmed on a steam bath to form a violet solution. The solution is evaporated to yield a tacky, purple solid which is slightly soluble in water to form a strongly acid solution. The compound is the dihydrate of dihydrogen bis(*p*-methoxyphenylazo)-dodecahydrododecaborate(2-), i.e.,

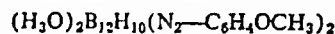

The identity of the compound is confirmed by its infrared absorption spectrum which shows bands at 3.2μ , 6.25μ , 4.0μ , and 9.25μ .

Example 20 illustrates compounds of Formula 1 in which X is an arylazo group, i.e., $\text{ArN}=\text{N}-$, and a method for their preparation. The process is generic to the preparation of this class of compounds and it is usually conducted in two steps. In the first step an aryl-diazonium salt of $\text{B}_{12}\text{H}_{12}^{2-}$ is prepared and, in the second step, the salt is rearranged to form the arylazosubstituted dodecaborate acid. A wide range of products can be obtained by employing the appropriate diazonium tetrafluoroborate and the appropriate dodecaborate which can contain substituents. By way of illustration, the following compounds can be obtained: $\text{H}_2\text{B}_{12}\text{H}_{11}(\text{N}_2-\text{C}_6\text{H}_5)$,

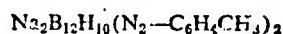

$\text{BaB}_{12}\text{H}_{10}[\text{N}_2\text{C}_6\text{H}_3(\text{CH}_3)_2]_2$, $\text{CaB}_{12}\text{H}_9\text{F}_4(\text{N}_2\text{C}_6\text{H}_5)_2$,
 $[(\text{CH}_3)_3\text{S}]_2\text{B}_{12}\text{H}_9(\text{OCH}_3)(\text{N}_2\text{C}_6\text{H}_5\text{OCH}_3)_2$
 and the like.

EXAMPLE 21

A mixture of 25 g. of crystalline hydrated $\text{H}_2\text{B}_{12}\text{H}_{12}$ and 30 g. of propylene is agitated in a pressure vessel under autogenous pressure at $24-25^\circ\text{C}$. for 2.5 days. The vessel is vented to remove unreacted propylene and the non-volatile residue is neutralized with aqueous CsOH solution. The precipitate which forms is separated. On attempted recrystallization from water, it forms a gel which is broken by addition of methanol. The product is crystallized a second time from water to obtain pure dicesium isopropylundecahydrododecaborate(2-).

Analysis.—Calc'd for $\text{C}_8\text{H}_{12}\text{B}_{12}\text{CH}(\text{CH}_3)_2$ (percent): C, 8.00; H, 4.00; B, 28.8. Found (percent): C, 8.39; H, 4.35; B, 28.01.

The above process is repeated at 35°C . and at 45°C . to obtain the isopropyl-substituted dicesium salt.

EXAMPLE 22

(A) A suspension is prepared by stirring 0.3 g. of $\text{H}_2\text{B}_{12}\text{H}_{12}\cdot 2\text{H}_2\text{O}$, or $(\text{H}_3\text{C})_2\text{B}_{12}\text{H}_{12}$, in 40 ml. of 1,2-dimethoxyethane. Isobutylene is bubbled through the suspension at about 25°C . for 40 minutes at a rate of about 50 ml./minute. The temperature rises rapidly to 31°C . and remains at this point for 30 minutes. The temperature then drops to about 28°C . and the solution becomes clear. The solution is concentrated under reduced pressure to yield an oily residue which contains the free alkylated acid. The residue is dissolved in a small quantity of water and 1 ml. of aqueous 50% cesium fluoride solution is added with stirring. A white crystalline solid forms which is separated by filtration. The infrared absorption spectrum and elemental analysis show that the product is the monohydrate of cesium hydrogen tert-butylundecahydrododecaborate(2-), i.e., $\text{CsHB}_{12}\text{H}_{11}\text{C}(\text{CH}_3)_3\cdot\text{H}_2\text{O}$ or, as an optional method of representation,

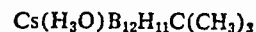

Analysis.—Calc'd for $\text{C}_4\text{H}_{23}\text{B}_{12}\text{CsO}$ (percent): C, 13.70; H, 6.57; B, 37.1. Found (percent): C, 13.75; H, 5.73; B, 34.07.

Solubility of the product in water is limited and its aqueous solution is strongly acidic, showing the presence of the hydrogen cation.

(B) A mixture of 2.5 g. of $(\text{H}_3\text{O})_2\text{B}_{12}\text{H}_{12}$ and 3.1 g. of isobutylene is charged into a pressure vessel and agitated under autogenous pressure for 2.5 days at about 25°C . A portion of the reaction mixture is processed as described in Part A to obtain $\text{Cs}_2\text{B}_{12}\text{H}_{11}\text{C}(\text{CH}_3)_3$ as a colloidal salt. A second portion is reacted with aqueous TlNO_3 solution to obtain the very insoluble $\text{Tl}_2\text{B}_{12}\text{H}_{11}\text{C}(\text{CH}_3)_3$ as a double salt with thallium nitrate.

EXAMPLE 23

A mixture of 5 g. of crystalline hydrated $\text{H}_2\text{B}_{12}\text{H}_{12}$ and 25 g. of decene-1 is agitated in a pressure vessel under autogenous pressure at atmospheric temperature for 4.5 days. The mixture, which originally forms two phases, is a substantially homogeneous oil at the end of this period. It is washed with aqueous 2% NaOH solution in which the mixture is insoluble. The oily layer is dissolved in ether and washed with water. The ether solution is dried and the solvent is removed by evaporation to obtain the hydrate of dihydrogen hexa(decyl)hexahydrododecaborate(2-) in substantially pure form. The compound is an oil at ordinary temperatures.

Analysis.—Calc'd for $(\text{H}_3\text{O})_2\text{B}_{12}\text{H}_6(\text{C}_{10}\text{H}_{21})_6$ (percent): C, 70.60; H, 13.50; B, 12.70. Found (percent): C, 69.99; H, 12.84; B, 10.85.

EXAMPLE 24

(A) An aqueous solution containing 6.1 g. of disodium polyhydropolyborate of Example A is passed

through a column (1" x 40") packed with an ion-exchange resin, "Amberlite" IR-120-H, to obtain the free acid in solution. The acidic solution is evaporated under reduced pressure to yield the free acid in the form of a hydrate as a white crystalline solid.

(B) The acid hydrate of Part A is mixed with 5 ml. of cyclohexene and 5 ml. of 1,2-dimethoxyethane. The mixture is heated to boiling under a reflux condenser for 20 hours to form a colorless homogeneous solution. The solution is evaporated under reduced pressure and there is obtained a solvated dihydrogen monocyclohexylundecahydrododecaborate. The compound is a colorless, viscous liquid whose structure is confirmed by the infrared absorption spectrum and by elementary analysis to be $H_2B_{12}H_{11}(C_6H_{11}) \cdot (H_2O)_5 \cdot C_4H_{10}O_2$.

Analysis.—Calc'd for $C_{10}H_{44}B_{12}O_7$ (percent): C, 29.56; B, 31.96; H, 10.92; O (by difference), 27.56. Found (percent): C, 30.73; B, 30.73; H, 8.8; O (by difference), 29.88.

(C) A portion of the acid from Part B is dissolved in 20 ml. of aqueous 5% potassium hydroxide solution. To this solution, which contains $K_2B_{12}H_{11}(C_6H_{11})$, there is added with stirring 10 ml. of aqueous 50% cesium fluoride solution. A white sticky precipitate forms which is separated by filtration and dried under reduced pressure to yield a cesium salt of a cyclohexyl-substituted polyhydrodopolyborate. The infrared absorption spectrum of the compound shows the characteristic bands for $B_{12}H_{12}$ anion (4.0 μ and 9.3 μ) and bands for cycloaliphatic C—H, methyl groups and ether functions. Data from the infrared absorption spectrum and elemental analysis show that the compound is dicesium monocyclohexylundecahydrododecaborate with 1 mole of 1,2-dimethoxyethane as solvent of crystallization, i.e.,



Analysis.—Calc'd for $C_{10}H_{32}B_{12}Cs_2O_2$ (percent): C, 20.70; H, 5.70; B, 22.40. Found (percent): C, 19.71; H, 5.27; B, 20.52.

The salt is soluble in water and it forms a neutral solution, i.e., the pH of the solution is 7.

(D) A mixture of the hydrate of $H_2B_{12}H_{12}$ (about 0.08 mole) and cyclohexene (0.16 mole) in 100 ml. of 1,2-dimethoxyethane is refluxed for 2 hours. The mixture is cooled to atmospheric temperature, neutralized with concentrated aqueous NaOH solution and evaporated to dryness. The solid is dissolved in tetrahydrofuran, the solution is filtered and the filtrate is again evaporated to dryness. The yellow syrup which remains is dissolved in water and the solution is steam-distilled. The aqueous solution is mixed with aqueous 50% CsF solution to precipitate $Cs_2B_{12}H_{11}C_6H_{11}$. The white solid is crystallized from water to obtain the pure product as fine white crystals.

The infrared absorption spectrum shows characteristic bands at wavelengths (expressed as microns) of 4.05, 3.45 and 6.9.

Analysis.—Calc'd for $Cs_2B_{12}H_{11}C_6H_{11}$ (percent): C, 14.71; H, 4.53. Found (percent): C, 14.16; H, 3.75.

EXAMPLE 25

(A) A homogeneous solution is prepared consisting of 5.0 g. of the hydrate of $H_2B_{12}H_{12}$ and 5 g. of styrene in 2-propanol. The solution is held at 0–5° C. for 18 hours and at atmospheric temperature (about 25° C.) for 5 hours. The reaction mixture is neutralized with aqueous CsOH solution and the precipitate which form is separated. It is crystallized from aqueous 50% isopropyl alcohol to obtain a product which is a mixture of compounds having from one to four $C_6H_5C_2H_4$ — groups as substituents. These compounds, which are not separated by crystallization, have the formula $Cs_2B_{12}H_{12-n}(C_2H_4C_6H_5)_n$, where n is 1–4.

Analysis.—Calc'd for $Cs_2B_{12}H_{8.8}(C_2H_4C_6H_5)_{3.2}$ (percent): C, 41.30; H, 5.10; B, 17.50. Found (percent): C, 41.62; H, 5.26; B, 17.56.

(B) The process of Part A is repeated employing 29 g. of the hydrate of $H_2B_{12}H_{12}$ and 15 g. of styrene. There is obtained a product whose average composition is $Cs_2B_{12}H_{10.6}(C_2H_4C_6H_5)_{1.4}$.

Analysis.—Calc'd for above composition (percent): C, 24.30; H, 4.20; B, 23.40; Cs, 37.90. Found (percent): C, 24.33; H, 4.65; B, 23.34; Cs, 45.10.

(C) A reaction vessel is charged with 21 g. of 2-propanol and cooled to 0–5° C. Hydrated crystalline

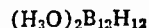

(12 g.) is added with stirring. The solution is maintained at 0–5° C. and 10 g. of p-chlorostyrene is added dropwise with stirring. The reaction mixture is allowed to warm to atmospheric temperature (about 25° C.) and then heated to 35° C. for 20 hours with stirring. The solution becomes clear. It is cooled to atmospheric temperature and then poured onto a small amount of chopped ice. The mixture is neutralized with aqueous CsOH solution and the cesium salt which precipitates is separated and recrystallized from water to obtain

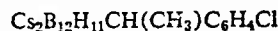

The infrared spectrum shows absorption at 2.8, 4.0, 6.3, 8.6, 8.9, 9.4, and 9.7 μ .

Analysis.—Calc'd for $Cs_2B_{12}H_{11}CH(CH_3)C_6H_4Cl$ (percent): C, 17.6; H, 3.5; B, 23.8; Cl, 6.5. Found (percent): C, 15.7; H, 4.1; B, 24.9; Cl, 5.0.

Fluoroalkyl-substituted dodecaborates are obtained by reacting a dodecahydrododecaborate salt with a fluoroolefin. To illustrate, 2 g. of a trihydrate of $Na_2B_{12}H_{12}$, 10 g. of tetrafluoroethylene, 40 ml. of deoxygenated water and 0.5 g. of potassium persulfate are charged into a pressure vessel and the mixture is heated gradually from 31–82° C. under 605–800 p.s.i. pressure for 4.5 hours. The reaction mixture thus obtained is mixed with an excess of aqueous 50% CsF solution and the precipitate which forms is separated. It is a mixture of $Cs_2B_{12}H_{12}$ (i.e., unreacted $B_{12}H_{12}^{2-}$ anion) and $Cs_2B_{12}H_{11}CF_2-CF_2H$. Elementary analysis of the mixture shows 2.42% C, 3.15% H, and 7.87% F. The infrared absorption spectrum shows characterizing bands at 4.0, 8.6, 9.0 and 9.4 μ . The fluoroalkyl-substituted compound can be obtained in pure form by repeated crystallization from hydroxylated solvents.

EXAMPLE 26

(A) A pressure vessel is charged with 5.0 g. of hydrated dihydrogen dodecahydrododecaborate, i.e., hydrated $(H_2O)_2B_{12}H_{12}$, and 50 ml. of 1,2-dimethoxyethane containing a small quantity of water. The vessel is flushed with nitrogen, closed and cooled in a solid carbon dioxide bath to –80° C. Pressure in the vessel is reduced to less than 10 mm. of mercury by means of a vacuum pump and 1.8 g. (0.05 mole) of acetylene is injected into the vessel. The reaction mixture is heated with agitation under autogeneous pressure (45 p.s.i.) at 80° C. for 4 hours. The vessel is cooled to atmospheric temperature and the reaction mixture is poured into a glass container. The mixture, which is homogeneous, is evaporated under reduced pressure (20–30 mm.) at about 40° C. to yield 6.5 g. of reaction product. The infrared absorption spectrum of the product shows that it is a mixture of dihydrogen polyhydrododecaborates bearing substituents which are saturated and unsaturated hydrocarbon groups of at most 2 carbons and monooxahydrocarboxy groups of the type $-OCH_2CH_2OCH_3$. The elemental analysis is as follows: C, 26.92; H, 8.74.

(B) The acid, obtained as described in Part A, is neutralized with aqueous potassium hydroxide to form the dipotassium salt in aqueous solution. This solution is reacted with aqueous cesium fluoride to precipitate the dicesium compound which is separated by filtration. The compound is dried and its elemental analysis is as follows: C, 9.80; H, 3.97.

EXAMPLE 27

(A) A reaction vessel is charged with 5.0 g. of the hydrate of dihydrogen dodecahydrododecaborate, i.e., hydrated $H_2B_{12}H_{12}$, and 50 ml. of 1,2-dimethoxyethane containing a small quantity of water. The reaction vessel is fitted with a reflux condenser and means of introducing nitrogen to provide an inert atmosphere. Phenylacetylene (2.5 g.) is added to the reaction mixture which is then heated to mild refluxing for 1 hour in the nitrogen atmosphere. The mixture is cooled and the solvent is removed by heating the mixture under about 1 mm. pressure at 35–40° C. There is obtained 8.1 g. of a viscous residue which is shown by elemental analysis and the infrared absorption spectrum to be dihydrogen monostyrylundeca-hydrododecaborate dihydrate.

Analysis.—Calc'd for $(H_2O)_2B_{12}H_{11}(C_2H_2C_6H_5)$ (percent): C, 34.10; H, 8.5. Found (percent): C, 34.09; H, 9.96.

(B) The product of Part A is neutralized with aqueous potassium hydroxide to form an aqueous solution of $K_2B_{12}H_{11}(C_2H_2C_6H_5)$. The solution is reacted with aqueous cesium fluoride to precipitate the dicesium salt. The salt is separated by filtration and dried. The identity of the compound, which is dicesium monostyrylundeca-hydrododecaborate, is confirmed by elemental analysis.

Analysis.—Calc'd for $Cs_2B_{12}H_{11}(C_2H_2C_6H_5)$ (percent): C, 18.70; H, 3.50. Found (percent): C, 18.27; H, 3.97.

(C) A reaction vessel is charged with 4.0 g. of the crystalline hydrate of $H_2B_{12}H_{12}$ and 4 g. of cold CH_3OH . The solution is chilled to 0° C. and 2 g. of phenylacetylene is added with agitation. The mixture is maintained at 0° C. for 1 hour and then at about 25° C. for 16 hours. A portion is neutralized with $CsOH$ solution to form the insoluble cesium salt which gels in water. A second portion is neutralized with aqueous $TiOH$ to precipitate the very insoluble thallium salt. The thallium compound is extracted with water in a Soxhlet extractor and the product is dried to obtain $Tl_2B_{12}H_{11}(C_2H_2C_6H_5)$ as a white crystalline product. The infrared absorption spectrum shows that the product contains some $Tl_2B_{12}H_{11}CH(CH_3)C_6H_5$.

Analysis.—Calc'd for $Tl_2B_{12}H_{11}(C_2H_2C_6H_5)$ (percent): C, 14.7; H, 2.8; B, 19.8. Found (percent): C, 14.9; H, 3.4; B, 19.2.

(D) The process of Part C is repeated, employing five times the quantities of reactants by weight. The reaction mixture is neutralized with aqueous $CsOH$ and the gel which forms is broken up with methanol. The white crystalline product is a mixture of mono- and di-substituted dicesium polyhydrododecaborates having an average composition of 1.3 phenylacetylene units per dodecaborate anion, e.g., 70% of $Cs_2B_{12}H_{11}C_2H_2C_6H_5$ and 30% of $Cs_2B_{12}H_{10}(C_2H_2C_6H_5)_2$.

Analysis.—Calc'd for above composition (percent): C, 23.20—H, 3.70; B, 23.90. Found (percent): C, 23.51; H, 4.14; B, 22.76.

EXAMPLE 28

A reaction vessel is charged with 10 g. of the crystalline hydrate of $H_2B_{12}H_{12}$ and 11.7 g. of propiolic acid is added to it slowly over a period of 2 hours with stirring. The temperature of the reaction mass is maintained at 35–40° C. The mixture is neutralized with aqueous $NaOH$ solution and an excess of aqueous 50% CsF solution is added. The precipitate which forms is separated and recrystallized three times from water to obtain

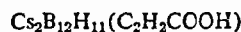

as a white crystalline salt. The compound contains a carboxyl group which can also form a cesium salt and the compound contains a small quantity of this tricesium salt.

Analysis.—Calc'd for $Cs_2B_{12}H_{11}(C_2H_2COOH)$ (percent): Cs, 55.5; H, 2.96; C, 7.55. Found (percent): Cs, 56.7; H, 3.40; C, 4.20.

Examples 21 through 28 illustrate the compounds of

Formula 1 in which X is a substituted or unsubstituted hydrocarbon group. The substituent X can be saturated or unsaturated, open-chain or cyclic. The process, which is generic to the preparation of this class of compounds, employs (1) a reactant which has olefinic or acetylenic bonds

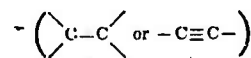

and (2) an acid of a dodecaborate which can have substituents. The unsaturated reactant preferably has at most two unsaturated bonds, i.e., at most two olefinic or two acetylenic bonds. The number of carbons in this reactant is not critical but, in general, unsaturated reactants of up to 18 carbons are preferred. Examples of compounds which can be obtained by the process are:

$H_2B_{12}H_{10}(C_6H_{13})_2$ from hexene-1 and $H_2B_{12}H_{12}$, $H_2B_{12}H_{11}(C_2H_4COOH)$ from acrylic acid and $H_2B_{12}H_{12}$, $H_2B_{12}H_{10}C(CH_3)_3(C_6H_{11})$ from cyclohexene and $H_2B_{12}H_{11}C(CH_3)_3$, and

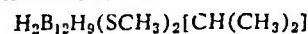

from propylene and $H_2B_{12}H_{10}(SCH_3)_2$.

Compounds of Formula 1 in which at least one X group is alkynyl can be obtained from derivatives bearing open chain acyl groups by reaction with a halogenating agent followed by dehydrohalogenation. To illustrate,

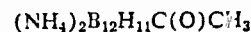

can be reacted with PCl_5 to obtain

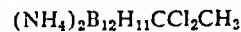

This compound can then be dehydrohalogenated with, e.g., aqueous KOH solution, to obtain $(NH_4)_2B_{12}H_{11}C \equiv CH$.

Compounds of Formula 1 in which at least one X group is methyl are obtained by treating $B_{12}H_{10} \cdot 2CO$ with a reducing agent, e.g., lithium aluminum hydride. To illustrate, $B_{12}H_{10} \cdot 2CO$ is dissolved in diethyl ether and this solution is added slowly and with stirring to a solution of $LiAlH_4$ in ether. After addition is complete, the mixture is gently refluxed for a few hours and then allowed to cool. Excess $LiAlH_4$ is destroyed by adding ether saturated with water slowly to the solution and finally water is added. The ether layer separates and is removed by decantation. The water layer is filtered and the filtrate is acidified with hydrochloric acid. The filtrate can, if desired, be divided into separate portions. To one portion an aqueous solution of Cs^+ can be added to precipitate $Cs_2B_{12}H_{10}(CH_3)_2$; to a second portion $(C_2H_5)_4NOH$ can be added to precipitate $[(C_2H_5)_2N]_2B_{12}H_{10}(CH_3)_2$, and to a third portion $TiNO_3$ can be added to precipitate $Ti_2B_{12}H_{10}(CH_3)_2$. The precipitated compounds can be isolated and purified by recrystallization as described in previous examples. Optionally, the acidified filtrate obtained from the reaction can be subjected to further purification to obtain hydrated $H_2B_{12}H_{10}(CH_3)_2$ or it can be neutralized with a wide range of basic compounds, e.g., NH_2NH_2 , NH_4OH , pyridine, dicyclohexylamine, dimethylaniline, and the like to obtain, e.g.,

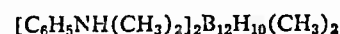
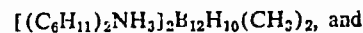
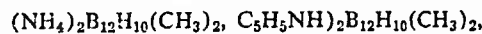
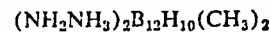

Compounds of Formula 1 in which at least one X group is hydroxymethyl can be obtained by reducing $B_{12}H_{10} \cdot 2CO$ with a borohydride, e.g., $LiBH_4$. To illustrate, a solution is prepared of $LiBH_4$ in 1,2-dimethoxyethane (glyme). The solution is stirred under an inert atmosphere, e.g., nitrogen, and to it there is added dropwise a solution of $B_{12}H_{10} \cdot 2CO$ in 1,2-dimethoxyethane. After addition is completed the mixture is reduced gently for about 30 minutes. The mixture is cooled and the glyme is removed by evaporation or, in the event two layers are

present, by decantation. The residue is dissolved in water and the solution can be divided, if desired, into several portions. These portions are mixed with a salt or base having the desired cation M to obtain salts of the anion $B_{12}H_{10}(CH_2OH)_2^{-2}$. For example, one portion can be mixed with an aqueous solution of TlOH to obtain $Tl_2B_{12}H_{10}(CH_2OH)_2$, a second portion can be mixed with RbCl to obtain $Rb_2B_{12}H_{10}(CH_2OH)_2$, and a third portion can be mixed with CsCl to obtain

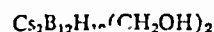

Aqueous solutions of these salts can be contacted with an acid ion-exchange resin to obtain a pure aqueous solution of $H_2B_{12}H_{10}(CH_2OH)_2$. The acid solution can be neutralized with any desired organic or inorganic base to obtain a compound of Formula 1 bearing $-CH_2OH$ groups.

The compounds described above in which at least one X is $-CH_2OH$ can be reacted with hydrohalogenic acids to obtain compounds of Formula 1 in which at least one X is CH_2Y (where Y is F, Cl, Br or I). To illustrate, $H_2B_{12}H_{10}(CH_2OH)_2$ can be reacted with HF to obtain $H_2B_{12}H_{10}(CH_2F)_2$, with HCl to obtain

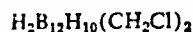

with HBr to obtain $H_2B_{12}H_{10}(CH_2Br)_2$, and with HI to obtain $H_2B_{12}H_{10}(CH_2I)_2$. These acids can be employed, as described earlier, to prepare a wide range of salts.

Compounds bearing $-CH_2OH$ groups can be reacted with organic acids, anhydrides or acid halides to obtain products bearing $-CH_2OC(O)R$ groups, where R has the meanings defined in a previous paragraph. To illustrate, $H_2B_{12}H_{10}(CH_2OH)_2$ can be reacted with acetic anhydride to obtain $H_2B_{12}H_{10}[CH_2OC(O)CH_3]_2$, with benzoyl chloride to obtain $H_2B_{12}H_{10}[CH_2OC(O)C_6H_5]_2$, with methacrylic anhydride to obtain

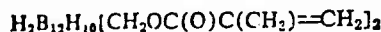

and the like.

EXAMPLE 29

(A) A quantity (20 g.) of $[(CH_3)_4N]_2B_{12}H_{11}OH$, obtained as described in Example 8, Part D, is mixed with 50 ml. of water. The mixture is heated to refluxing and chlorine gas is passed into it for 40 minutes. The mixture is cooled and the precipitate is separated. It is recrystallized from 50% aqueous CH_3CN to obtain 18 g. of a pentachloromonohydroxy derivative.

Analysis.—Calc'd for $[(CH_3)_4N]_2B_{12}H_6Cl_5OH$ (percent): C, 19.9; H, 6.5; Cl, 37.0; N, 5.8. Found (percent): C, 19.4; H, 6.5; Cl, 37.9; N, 5.7.

An aqueous solution of the above compound is passed through a column filled with an acid ion-exchange resin and the aqueous effluent, which contains $H_2B_{12}H_6Cl_5OH$, is neutralized with cesium hydroxide to obtain



(B) Sufficient water is added to 1 g. of $Cs_2B_{12}H_{11}OH$, prepared as described in Example 8, Part C, to form a clear solution at 90° C. Chlorine gas is bubbled through the solution at this temperature for one hour. The product which is formed is sparingly soluble and water is added as needed to maintain a clear hot solution during passage of the gas. Flow of chlorine is stopped and the solution is chilled. White crystals form which are separated, recrystallized from hot water and dried. The product is the monohydrate of $Cs_2B_{12}HCl_{10}OH$.

Analysis.—Calc'd for $Cs_2B_{12}HCl_{10}OH \cdot H_2O$ (percent): Cs, 33.8; B, 16.5; H, 0.5; Cl, 45.1. Found (percent): Cs, 32.5, 32.8; B, 16.5, 16.5; H, 0.7, 0.6; Cl, 45.3, 45.6.

The above process is repeated employing

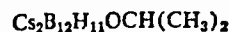

of Example 13, Part B, and $Cs_2B_{12}H_{11}OC_6H_{11}$ of Example 75

15, Part C, in place of $Cs_2B_{12}H_{11}OH$. The product obtained with either reactant is $Cs_2B_{12}HCl_{10}OH$ as a hydrate.

(C) A reaction vessel is charged with 60 g. of

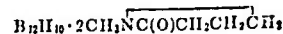

obtained as described in Example 8, Part G, and a solution of 28 g. of NaOH in 300 ml. of water. The mixture is refluxed for one hour. It is cooled and sufficient concentrated hydrochloric acid is added to form a neutral solution. The solution is heated to slow refluxing and chlorine gas is passed through it for 1.5 hours. The solution is cooled and neutralized with aqueous NaOH solution. It is stirred and 50 g. of $(CH_3)_4NOH \cdot 5H_2O$ is added. The solution is cooled in ice and the precipitate which forms is separated to obtain $[(CH_3)_4N]_2B_{12}Cl_9H_2(OH)_2$. The filtrate is set aside for further processing. The compound is further purified by recrystallization from 50% aqueous acetonitrile to obtain 27 g. of product.

Analysis.—Calc'd for $[(CH_3)_4N]_2B_{12}Cl_9H_2(OH)_2$ (percent): C, 15.9; H, 4.7; Cl, 47.4. Found (percent): C, 16.4; H, 4.9; Cl, 46.6.

The filtrate from the above process is allowed to evaporate for two days at atmospheric temperature. Crystals form which are separated and dried to obtain 14.5 g. of

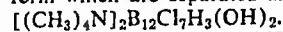

Analysis.—Calc'd for $[(CH_3)_4N]_2B_{12}Cl_7H_3(OH)_2$ (percent): C, 17.0; H, 5.1; Cl, 43.8. Found (percent): C, 17.5; H, 5.4; Cl, 43.6.

(D) An aqueous solution of $[(CH_3)_4N]_2B_{12}H_9(OH)_3$ is prepared as described in Example 8, Part H, and it is evaporated to a volume of 200 ml. The solution is cooled to 5° C., chlorine gas is bubbled through it and the temperature is raised gradually to 95° C. Excess chlorine is then swept from the solution with a stream of nitrogen and the solution is evaporated to dryness under reduced pressure. There is obtained 57.7 g. of a gummy residue which is mixed with 55 ml. of water. The mixture is made neutral with aqueous $(CH_3)_4NOH$ solution and it is filtered. The filtrate is added to 480 ml. of absolute ethyl alcohol and a white crystalline solid precipitates which is $[(CH_3)_4N]_2B_{12}Cl_9(OH)_3$. The crystals are separated, washed with absolute alcohol and dried under reduced pressure to yield 33.3 g. of product. The compound is further purified by dissolving in water and precipitating again with alcohol.

Analysis.—Calc'd for $[(CH_3)_4N]_2B_{12}Cl_9(OH)_3$ (percent): N, 4.32; C, 14.82; H, 4.20; B, 20.03; Cl, 49.22. Found (percent): N, 4.35, 4.19; C, 15.33; H, 4.60; B, 20.93; Cl, 49.45.

(E) A solution of 6.13 g. of $(NH_4)_2B_{12}H_9(OH)_3$, prepared as described in Example 8, Part I, is chlorinated as described above to obtain the trihydroxynonachlorododecaborate salt, i.e., $(NH_4)_2B_{12}Cl_9(OH)_3$.

(F) An aqueous solution of $H_2B_{12}H_8(OH)_4$, prepared as described in Example 8, Part J, is warmed to 50–60° C. and chlorine gas is bubbled through it until no further absorption of the gas is observed. The reaction mixture is cooled and neutralized with NH_4OH . It is divided into two portions. One portion is mixed with an aqueous solution of $(CH_3)_4NCl$ and the second portion is mixed with an aqueous solution of $(n-C_3H_7)_4NI$. In each case the white precipitate which forms is separated, recrystallized from water and dried. The compounds are salts of the tetrahydroxooctachlorododecaborate anion.

Analysis.—Calc'd for $[(CH_3)_4N]_2B_{12}Cl_8(OH)_4$ (percent): B, 20.7; C, 15.2; H, 4.13; Cl, 45.2. Found (percent): B, 20.7; C, 15.3; H, 4.73; Cl, 46.2.

Analysis.—Calc'd for $[(C_3H_7)_4N]_2B_{12}Cl_8(OH)_4$ (percent): B, 15.2; C, 33.7; H, 7.50; Cl, 53.2. Found (percent): B, 13.3; C, 24.8; H, 6.05; Cl, 33.8.

The infrared spectrum of the tetramethylammonium salt shows characteristic absorption bands at the following wavelengths (expressed as cm^{-1}): 3600, medium; 3100, medium; 1200, medium; 1080, weak; 1025, strong, broad; 940, strong; 850, strong, broad; and 720, strong, broad.

EXAMPLE 30

(A) A mixture is prepared consisting of 20 ml. of water and 1 g. of $Cs_2B_{12}H_{11}OCH(CH_3)_2$, obtained as described in Example 13, Part B. Liquid bromine is added dropwise to the solution with stirring. The reaction is exothermic and the solution refluxes. Water is added as needed during the process to maintain a clear solution. When bromine is no longer absorbed, the solution is heated to maintain refluxing and chlorine gas is bubbled through the solution while bromine is added dropwise for 5 minutes. The solution is then evaporated partially, filtered and the filtrate is cooled. A precipitate forms which is separated, washed with water and dried under reduced pressure to obtain 1.7 g. of $Cs_2B_{12}Br_{11}OH$.

Analysis.—Calc'd for $Cs_2B_{12}Br_{11}OH$ (percent): Cs, 20.6; B, 10.1; Br, 68.0. Found (percent): Cs, 19.3; B, 9.8; Br, 68.4.

(B) Bromination of $[(CH_3)_4N]_2B_{12}H_{11}OCH(C_2H_5)_2$, obtained as described in Example 15, is conducted as described in Part A to obtain 2.2 g. of

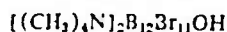

Analysis.—Calc'd for $[(CH_3)_4N]_2B_{12}Br_{11}OH$ (percent): B, 11.0; C, 8.2; H, 2.1; Br, 74.8. Found (percent): B, 10.9; C, 8.5; H, 2.2; Br, 74.9.

(C) Bromination of 1.0 g. of $[(CH_3)_4N]_2B_{12}H_{11}OH$ (see Example 8, Part D), as described in Part A, yields 2.2 g. of $[(CH_3)_4N]_2B_{12}Br_{11}OH$. Similarly bromination of 2.0 g. of $Cs_2B_{12}H_{11}OH$ (see Example 8, Part B) yields 2.0 g. of $Cs_2B_{12}Br_{11}OH$.

(D) A portion (5.5 g.) of product B, obtained as described in Example 8, Part G, is mixed with 30 ml. of water and 2 g. of NaOH. The mixture is refluxed for 2.5 hours and then cooled to atmospheric temperature. It is diluted with 20 ml. of water and liquid bromine is added dropwise with stirring. The reaction is exothermic and proceeds rapidly. Bromine addition is continued until the color of bromine persists for 10 minutes. The mixture is then made basic by addition of solid NaOH. Aqueous $(CH_3)_2NCl$ solution is added with stirring until precipitation of a white solid is complete. The solid is separated and crystallized from hot water to obtain 3.5 g. of white crystalline $[(CH_3)_4N]_2B_{12}Br_{10}(OH)_2$.

Analysis.—Calc'd for $[(CH_3)_4N]_2B_{12}Br_{10}(OH)_2$ (percent): B, 11.70; C, 9.50; H, 2.30; Br, 71.80; N, 2.50. Found (percent): B, 11.82; C, 9.21, 9.02; H, 2.76, 3.03; Br, 71.60, 72.03; N, 2.47, 2.59.

(E) A solution consisting of 100 ml. of water and 10 g. of $Cs_2B_{12}H_9(OH)_3$, prepared as described in Example 8, Part H, is cooled to about 8° C. Liquid bromine is added dropwise with stirring and the solution temperature is maintained at 8–32° C. until the rate of bromine absorption decreases. An excess of liquid bromine is added at this time and chlorine gas is bubbled through the solution as the temperature is raised from 32° to 83° C. When no further reaction is evident, addition of chlorine is stopped and nitrogen gas is passed into the mixture to sweep out excess chlorine and bromine. The solution is evaporated at 55° C. under reduced pressure to yield 25.12 g. of solids. The solids are divided into two portions.

One portion is dissolved in water and neutralized with aqueous CsOH solution. The precipitate which forms is separated and crystallized twice from water to obtain $Cs_2B_{12}Br_9(OH)_3$ as a white, crystalline solid.

Analysis.—Calc'd for $Cs_2B_{12}Br_9(OH)_3$ (percent): Cs, 22.82; B, 11.06; Br, 61.74. Found (percent): Cs, 22.10; B, 12.40, 12.14; Br, 63.48, 63.26.

The second portion of solids is dissolved in water and the solution is passed through a column packed with a strong acid ion-exchange resin. The effluent is neutralized with $(C_2H_5)_4NOH$ and evaporated under reduced pressure at 35° C. to obtain $[(CH_3)_4N]_2B_{12}Br_9(OH)_3$. The compound is further purified by crystallization from 50% aqueous alcohol.

EXAMPLE 31

Analysis.—Calc'd for $[(CH_3)_4N]_2B_{12}Br_9(OH)_3$ (percent): B, 12.39; N, 2.67; C, 9.16; H, 2.60; Br, 68.60. Found (percent): B, 12.36; N, 2.69, 2.27; C, 8.40; H, 2.82; Br, 68.65.

Sufficient water is added to 2.0 g. of $Cs_2B_{12}H_{11}OCH_3$, prepared as described in Example 11, Part B, to form a clear solution at 90° C. Chlorine gas is passed into the solution at this temperature and water is added as needed to maintain a clear solution. Passage of chlorine is continued until reaction is complete and the solution is then cooled. White crystals of hydrated $Cs_2B_{12}HCl_{10}OCH_3 \cdot H_2O$ precipitate. The crystals are separated and crystallized from water.

Analysis.—Calc'd for $Cs_2B_{12}HCl_{10}OCH_3 \cdot H_2O$ (percent): Cs, 33.2; B, 16.2; C, 1.5; H, 0.75; Cl, 44.4. Found (percent): Cs, 32.9; B, 16.4; C, 1.3; H, 0.96; Cl, 44.1.

EXAMPLE 32

A suspension is prepared consisting of 150 ml. of methanol and 3.5 g. of $[(CH_3)_4N]_2B_{12}H_{11}OCH_2CH_2OCH_3$, obtained as described in Example 17, Part A. The suspension is cooled to 10° C. and this temperature is maintained while a solution of 27.8 g. of bromine in 40 ml. of methanol is added dropwise with stirring. The reaction mixture is allowed to warm to atmospheric temperature and it is stirred for 11 hours. The solution is concentrated on a rotary evaporator and $(CH_3)_4NBr$ separates. The mixture is filtered and the filtrate is evaporated to dryness. A gray solid form which is crystallized from water to obtain crystalline white



Analysis.—Calc'd for the above product (percent): B, 13.04; Br, 64.22; C, 13.27; H, 3.44; N, 2.81. Found (percent): B, 12.62; Br, 64.39; C, 12.62; H, 3.03; N, 2.19, 2.13.

EXAMPLE 33

Chlorine gas is bubbled through a mixture of acetonitrile and $Cs_2B_{12}H_{11}CH(CH_3)_2$, obtained as described in Example 21. The temperature of the reaction mixture is maintained at 25–40° C. during the process and passage of gas is continued until no further absorption occurs. The solution is evaporated to dryness and the solid residue is recrystallized from water to obtain

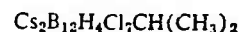

Analysis.—Calc'd for above compound (percent): C, 5.10; H, 1.60; Cl, 36.20. Found (percent): C, 4.64; H, 1.56; Cl, 35.47.

EXAMPLE 34

A portion of the product, whose average composition is $Cs_2B_{12}H_{10.6}(C_2H_4C_6H_5)_{1.4}$, which is obtained as described in Example 25, Part B, is mixed with acetonitrile and the mixture is chlorinated as described in Example 33. The reaction mixture is processed to obtain the cesium salt which is shown by elemental analysis to have the average composition $Cs_2B_{12}Cl_{10.6}(C_2H_4C_6H_5)_{1.4}$.

Analysis.—Calc'd for above composition (percent): C, 16.40; H, 1.50; Cl, 46.10. Found (percent): C, 17.46; H, 1.98; Cl, 46.41.

The acid $H_2B_{12}H_{12}$ (and its hydrates) reacts with nitriles, e.g., acetonitrile, propionitrile, benzonitrile, to form dodecaborates having nitrogen-containing substituents whose structure has not been determined exactly. The substituted compounds can be reacted with halogens, e.g., bromine, to obtain dodecaborates bearing both bromine and nitrogen-containing substituents. The preparation of these compounds is illustrated in Example 35.

EXAMPLE 35

(A) A mixture of 100 ml. of CH_3CN and 24 g. of hydrated $H_2B_{12}H_{12}$ (N.E., 186) is refluxed on a steam

bath for about 9.5 days. The solution is divided into two equal parts.

Aqueous CsOH solution is added to one part and aqueous $(\text{CH}_3)_4\text{NOH}$ is added to the second part. The precipitates which form are separated to obtain the cesium and tetramethylammonium salts of substituted dodecaborates. The infrared absorption spectrum of the cesium salt shows a sharp band at 3.0μ and a broad band at 6.3μ . The elemental analyses of each of the salts is as follows:

Cs salt: Cs, 48.1; B, 36.6; C, 3.20; H, 4.40; N, 3.2.

$(\text{CH}_3)_4\text{N}$ salt: B, 52.9; C, 19.0; H, 11.5; N, 9.8.

Portions of each of the salts are refluxed in concentrated aqueous HBr for a short period and the solutions are neutralized with base. The salts are separated and have the following elemental analysis:

Cs salt: Cs, 55.9; B, 25.1; C, 2.0; H, 3.2; N, 3.3.

$(\text{CH}_3)_4\text{N}$ salt: B, 55.6; C, 19.7; H, 11.2; N, 10.7.

Portions of each of the salts are boiled in concentrated aqueous HBr for a short period and they are then treated with liquid bromine as described in Example 3, Part L. The salts are isolated and they show the following elemental analyses:

Cs salt: Cs, 15.3; B, 10.8; C, 2.5; H, 0.9; Br, 67.7; N, 1.2.

$(\text{CH}_3)_3\text{N}$ salt: B, 13.3; C, 5.9; H, 2.5; Br, 76.0; N, 2.9.

(B) A mixture of 100 ml. of propionitrile and 24.5 g. of hydrated $\text{H}_2\text{B}_{12}\text{H}_{12}$ (N.E., 190) is refluxed for about 9.5 days. The reaction mixture is processed in the manner described in Part A, including refluxing with HBr and perbromination. The infrared absorption spectrum of the cesium salt, as obtained initially, shows a characteristic double peak at 9.5μ . Elemental analyses of the Cs and $(\text{CH}_3)_4\text{N}$ salts are as follows:

Cs salt: Cs, 49.0; B, 34.7; C, 5.0; H, 4.5; N, 3.3.

$(\text{CH}_3)_4\text{N}$ salt: B, 45.3; C, 26.6; H, 11.3; N, 13.6.

After treatment with refluxing HBr solution, the elemental analyses are:

Cs salt: Cs, 34.7; B, 23.8; C, 2.3; H, 3.2; N, 3.3.

$(\text{CH}_3)_4\text{N}$ salt: B, 53.2; C, 21.8; H, 11.4; N, 9.1.

After treatment with refluxing HBr solution and with liquid bromine, the elemental analyses are:

Cs salt: Cs, 15.1; B, 10.8; C, 3.6; H, 1.3; Br, 67.0; N, 1.5.

$(\text{CH}_3)_4\text{N}$ salt: B, 12.9; C, 8.0; H, 2.6; Br, 74.5; N, 3.0.

EXAMPLE 36

(A) A mixture consisting of 10 g. of hydrated crystalline $(\text{H}_2\text{O})_2\text{B}_{12}\text{H}_{12}$ and 20 g. of hydrogen sulfide is heated in a pressure vessel under autogenous pressure with agitation for 4 hours at 100°C . The vessel is cooled, vented and flushed with nitrogen. The reaction mixture is neutralized with cesium hydroxide and the precipitate which forms is separated and recrystallized twice from water. The product is $\text{Cs}_2\text{B}_{12}\text{H}_{11}\text{SH}$ whose infrared spectrum (mineral oil mull) shows slight absorption at 2.8 and 6.3μ ; strong absorption at 4.0μ ; moderate absorption at 9.5, 10.3, 11.9 and 13.9μ .

Analysis.—Calc'd for $\text{Cs}_2\text{B}_{12}\text{H}_{11}\text{SH}$ (percent): B, 29.7; S, 7.3; H, 2.7; Cs, 60.5. Found (percent): B, 30.1; S, 7.5; H, 2.8; Cs, 60.0.

(B) The cesium salt obtained above is dissolved in CH_3CN and chlorine gas is passed into the solution at $25\text{--}32^\circ\text{C}$. for 15 minutes. The solution is evaporated and the solid residue is recrystallized from water to obtain a product whose analysis agrees fairly well for the composition $\text{Cs}_2\text{B}_{12}\text{H}_4\text{Cl}_7\text{SH}$ or the closely related disulfide $[\text{Cs}_2\text{B}_{12}\text{H}_4\text{Cl}_7\text{S}]_2$. The infrared absorption spectrum shows bands at 2.8, 5.2 and 9.5μ (strong); and weak bands at 10.5, 11.2, 11.7 and 13.8μ .

Analysis.—Calc'd for $\text{Cs}_2\text{B}_{12}\text{H}_4\text{Cl}_7\text{SH}$ (percent): Cl, 36.5; S, 4.7; B, 19.1. Found (percent): Cl, 35.5; S, 4.7; B, 19.0.

EXAMPLE 37

(A) A weighed portion (1.1 g.) of crude



prepared as described in Example 41, is heated under very low pressure to a maximum of 410°C . for a period of one hour. The residue is cooled and is dissolved in a few milliliters of water. An equal volume of aqueous 50% CsCl is added and the solution is chilled to precipitate $\text{Cs}_2\text{B}_{12}\text{H}_{10}(\text{CN})_2$. The precipitate is separated, washed and dried to obtain 0.3 g. of product. The infrared spectrum of the product shows major absorption bands at the following wavelengths (expressed as cm^{-1}): 2500, 2190, 1260, 1040, 1020, 850 and 725.

Analysis.—Calc'd for $\text{Cs}_2\text{B}_{12}\text{H}_{10}(\text{CN})_2$ (percent): C, 5.2; H, 2.2; B, 28.4; N, 6.1; Cs, 58.0. Found (percent): C, 5.1; H, 2.6; B, 27.6; N, 4.8; Cs, 55.4.

(B) A mixture consisting of 10 g. of a crystalline hydrate of $(\text{H}_2\text{O})_2\text{B}_{12}\text{H}_{12}$ and 15 g. of cyanogen chloride (CNCl) is reacted in a pressure vessel at 225 psi. pressure and at $25\text{--}26^\circ\text{C}$. for 4 hours. The product is a friable mass. It is dissolved in dilute aqueous NaOH solution and to this solution is added an aqueous 50% CsF solution. The precipitate which forms is separated and recrystallized from water. The product is principally



Its infrared absorption spectrum includes the following bands: 2.75, 2.9, 3.95, 4.5, 6.2 (broad), 10.3 (shoulder at 9.9), 12.2 and 13.7μ (broad).

Analysis.—Calc'd for $\text{Cs}_2\text{B}_{12}\text{H}_6\text{Cl}_2(\text{CN})_4$ (percent): C, 8.3; H, 2.1; Cl, 12.2; N, 9.7. Found (percent): C, 7.5; H, 4.2; Cl, 13.7; N, 10.3.

EXAMPLE 38

(A) The crude reaction product obtained from

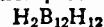

and CO, as described in Example E, is dissolved in water and aqueous CsF is added to the solution. The precipitate which forms is extracted repeatedly with water and the least water-soluble fraction is isolated. This fraction is $\text{Cs}_2\text{B}_{12}\text{H}_{11}(\text{COOH})$. The infrared absorption spectrum shows strong absorption at 6.0μ , i.e., for the $-\text{C}(\text{O})\text{OH}$ group.

Analysis.—Calc'd for $\text{Cs}_2\text{B}_{12}\text{H}_{11}(\text{COOH})$ (percent): C, 2.4; H, 2.4; B, 28.8. Found (percent): C, 2.6; H, 2.5; B, 27.6.

(B) A portion of the above salt is dissolved in excess aqueous NaOH solution to form $\text{Na}_2\text{B}_{12}\text{H}_{11}(\text{COONa})$ in solution. This solution is added to a large excess of aqueous TINO_3 solution and the precipitate which forms is isolated. It is $\text{Ti}_2\text{B}_{12}\text{H}_{11}(\text{COOTI})$. The infrared spectrum shows absorption bands at 6.8μ , i.e., for the $-\text{C}(\text{O})\text{OTI}$ group.

(C) Sufficient $\text{B}_{12}\text{H}_{10}\cdot 2\text{CO}$ is added gradually and carefully to a quantity of water to form a solution containing about 10% by weight of the dicarbonyl compound. The $\text{B}_{12}\text{H}_{10}\cdot 2\text{CO}$ reacts vigorously with the water during addition and the compound formed in solution is dihydrogen dicarboxydecahydrododecaborate(2^-), i.e.,

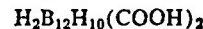

In its hydronium form the compound is



The acid is dehydrated easily to the bis(carbonyl) compound and, for this reason, the acid is preferably kept in aqueous solution. The solutions are stable and can be stored in conventional equipment customarily used for strong inorganic acids.

The identity of the acid is confirmed by the nuclear magnetic resonance spectrum of its aqueous solution. The B_{11} resonance shows two peaks, the more intense of which is displaced $+39.4$ p.p.m. and the weaker peak $+47.4$ p.p.m. from trimethyl borate.

55

(D) An aqueous solution of CsF is added to a portion of the solution of the acid obtained in Part C. The precipitate which forms is separated and it is recrystallized fractionally from water to obtain $\text{Cs}_2\text{B}_{12}\text{H}_{10}(\text{COOH})_2$.

The infrared absorption spectrum of a mineral oil mull of the compound shows the following bands: 2.65, 3.9, 5.9, 7.9, 9.3, 9.6, 10.8, 13.8 (broad) and 14.4 μ .

Analysis.—Calc'd for $\text{Cs}_2\text{B}_{12}\text{H}_{10}(\text{COOH})_2$ (percent): C, 4.7; H, 2.9; B, 26.0; Cs, 53.6. Found (percent): C, 4.7; H, 2.9; B, 25.9; Cs, 52.7.

(E) An excess of aqueous NaOH solution is added to a second portion of the acid solution of Part C to obtain a solution of $\text{Na}_2\text{B}_{12}\text{H}_{10}(\text{COONa})_2$. This solution is added to a large excess of an aqueous thallium nitrate solution and the precipitate which forms is separated to obtain $\text{Tl}_2\text{B}_{12}\text{H}_{10}(\text{COOTl})_2$.

The infrared spectrum of a mineral oil mull shows absorption at 4.0, 7.5, 9.7, 10.0, 10.6, 13.2, and 13.9 μ .

Analysis.—Calc'd for $\text{Tl}_2\text{B}_{12}\text{H}_{10}(\text{COOTl})_2$ (percent): C, 2.3; H, 1.0; B, 12.4. Found (percent): C, 2.7; H, 1.1; B, 12.8.

EXAMPLE 39

(A) Gaseous chlorine is bubbled through a solution consisting of 0.5 g. of $\text{B}_{12}\text{H}_{10}\cdot 2\text{CO}$ and 25 ml. of water. An exothermic reaction occurs and the temperature of the solution rises to a maximum of about 50° C. before subsiding. The solution is now heated to 90–100° C. and passage of chlorine gas is continued until the solution shows the color of excess chlorine. The reaction mixture is now cooled and an excess of an aqueous solution of $(\text{CH}_3)_4\text{NCl}$ is added. A white precipitate forms which redissolves when the solution is heated. The hot solution is cooled and the crystalline solid which forms is separated by filtration to obtain 1.5 g. of

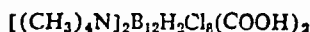

The infrared spectrum of the compound shows major absorption bands at the following wavelengths (expressed as microns): 5.95; 6.05, 6.75, 7.8, 9.6, 10.55, 11.65 and 13.85.

Analysis.—Calc'd for $[(\text{CH}_3)_4\text{N}]_2\text{B}_{12}\text{H}_{10}\text{Cl}_8(\text{COOH})_2$ (percent): C, 18.4; H, 4.0; N, 4.3; B, 20.0; Cl, 43.5. Found (percent): C, 17.7; H, 4.2; N, 4.4; B, 19.5; Cl, 44.7.

(B) A reaction vessel is charged with 0.5 g. of $\text{B}_{12}\text{H}_{10}\cdot 2\text{CO}$

and 25 ml. of water. A solution forms and to it 4.5 g. of iodine is added with stirring. The solution is refluxed for 2 hours, cooled to atmospheric temperature and filtered to remove undissolved iodine. The filtrate is heated to boiling and nitrogen gas is bubbled through it to remove unreacted dissolved iodine. A small quantity of mercury is added to the solution followed by a small quantity of zinc dust to remove the last traces of unreacted iodine. The solution which is nearly colorless is filtered and an aqueous solution of $(\text{CH}_3)_4\text{NCl}$ is added to the filtrate. A white solid is formed which redissolves on heating the solution to boiling. The solution is now chilled and the crystals which form are separated. The crystalline product is redissolved in a minimum amount (about 30 ml.) of hot water to form a clear solution. On cooling to atmospheric temperature a small quantity (0.2 g.) of $(\text{CH}_3)_4\text{NI}$ separates which is removed by filtration. The filtrate is chilled to about 0° C. or less and the solid which forms is separated, washed and dried to yield a mixture of $[(\text{CH}_3)_4\text{N}]_2\text{B}_{12}\text{H}_{10}(\text{COOH})_2$ and $(\text{CH}_3)_4\text{NI}$ in a molar ratio of 1:2.5. The infrared spectrum shows major absorption bands (expressed as cm^{-1}) at 2500, 1650, 1250, 1050, and 940.

Analysis.—Calc'd for

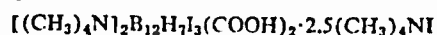

(percent): C, 19.1; H, 5.1; B, 10.3; N, 5.0; I, 55.5. Found (percent): C, 18.7; H, 5.1; B, 9.9; N, 4.0; I, 54.8.

56

EXAMPLE 40

A reaction vessel is charged with 10 ml. of methanol and 0.5 g. of $\text{B}_{12}\text{H}_{10}\cdot 2\text{CO}$ is added with stirring. The reaction is exothermic and a solution forms. The solution is warmed to incipient refluxing for about 30 minutes. A solution consisting of 1.0 g. of $(\text{CH}_3)_4\text{NCl}$ in 20 ml. of methanol is added with stirring and a solid product forms. The solid does not redissolve on heating even with the addition of more methanol. The slurry is chilled and the solid product is separated by filtration. It is washed and dried to obtain 0.9 g. of

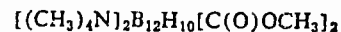

The infrared spectrum of the compounds shows absorption bands at the following wavelengths (expressed as cm^{-1}): 2500, 1660, 1480, 1200, 1070, 1040, 1000–1015, 950, 885, 760, and 730.

Analysis.—Calc'd for

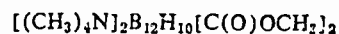

(percent) C, 35.5; H, 9.9; B, 32.0; N, 6.9. Found (percent): C, 35.1; H, 10.0; B, 31.9; N, 7.0.

EXAMPLE 41

(A) A reaction vessel is charged with 1 g. of $\text{B}_{12}\text{H}_{10}\cdot 2\text{CO}$

and the vessel and contents are cooled to about –80° C. Pressure in the vessel is reduced to a very low value and about 25 ml. of liquid ammonia is condensed into the vessel. A white slurry forms and it is allowed to warm gradually to permit excess ammonia to evaporate. A white solid remains which is $(\text{NH}_4)_2\text{B}_{12}\text{H}_{10}[\text{C}(\text{O})\text{NH}_2]_2$. The solid is held under a reduced pressure of about 10⁻² mm. Hg at prevailing atmospheric temperature to remove the last traces of unreacted ammonia. The infrared spectrum of the compound shows characterizing bands at the following wavelengths (expressed as cm^{-1}): 3450, 3300, 3200, 2500, 1525, 1500, 1430, 1400, 1100, 1050, 1010, 865, 815, 725 and 670. The ammonium salt is very soluble in water.

Analysis.—Calc'd for $(\text{NH}_4)_2\text{B}_{12}\text{H}_{10}[\text{C}(\text{O})\text{NH}_2]_2$ (percent): B, 49.2; N, 21.2; C, 9.1; H, 8.4. Found (percent): B, 48.8; N, 21.2; C, 9.4; H, 8.5.

The ammonium salt is dissolved in water and the aqueous solution is passed through a column filled with an acid ion-exchange resin to obtain the acid,



Aqueous solutions of this acid are reacted with CsOH, $(\text{CH}_3)_4\text{NOH}$ and $(\text{CH}_3)_3\text{SOH}$ to form, respectively, $\text{Cs}_2\text{B}_{12}\text{H}_{10}[\text{C}(\text{O})\text{NH}_2]_2$, $[(\text{CH}_3)_4\text{N}]_2\text{B}_{12}\text{H}_{10}[\text{C}(\text{O})\text{NH}_2]_2$ and $[(\text{CH}_3)_3\text{S}]_2\text{B}_{12}\text{H}_{10}[\text{C}(\text{O})\text{NH}_2]_2$. The salts are white, crystalline, highly water-soluble compounds.

(B) A portion of the ammonium salt obtained in Part A is dissolved in a small quantity of water. The solution is made basic by addition of a small quantity of NH_4OH and an aqueous solution of CsCl is added in excess. Crude $\text{Cs}_2\text{B}_{12}\text{H}_{10}[\text{C}(\text{O})\text{NH}_2]_2$ precipitates and it can be separated if desired. Alternatively, the mixture is heated to boiling for a few minutes and the solution is chilled. A white crystalline product then separates which is a hydrate of $\text{Cs}_2\text{B}_{12}\text{H}_{10}[\text{C}(\text{O})\text{OH}][\text{C}(\text{O})\text{NH}_2]$. The compound is called dicesium monocarboxymonocarboxylatedodecaborate(2⁻). Its infrared spectrum contains the following characteristic absorption bands (wavelengths expressed as cm^{-1}): 3600, 3500, 3400, 1640, 1600, 1575, 1525, 1340, 1260, 1200, 1060, 1010, 910, 850, 735, and 695.

Analysis.—Calc'd for $\text{Cs}_2\text{B}_{12}\text{H}_{10}(\text{COOH})(\text{CONH}_2)\cdot \text{H}_2\text{O}$ (percent): Cs, 51.8; B, 25.4; H, 2.9; C, 4.7; N, 2.7. Found (percent): Cs, 51.0; B, 25.8; H, 3.0; C, 5.1; N, 2.9.

(C) A reaction vessel is charged with 0.5 g. of

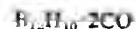

and 10 ml. of anhydrous benzene. The mixture is stirred and 3.0 ml. of freshly dried and distilled piperidine is added. A mildly exothermic reaction occurs and a white solid separates which does not redissolve on heating even after a further addition of 10 ml. of benzene. The mixture is now chilled, the solid is separated by filtration, washed with benzene and dried to obtain di(piperidinium) di(N-pentamethylenecarbonyl) dodecaborate (2⁻). The compound is further purified by recrystallization from aqueous ethanol. The infrared spectrum of the compound shows major absorption bands at the following wavelengths (expressed as cm.⁻¹): 2500, 1610, 1480, 1250, 1160, 1035, 1025, 980, and 685.

Analysis.—Calc'd for

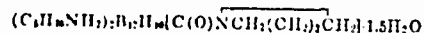

(percent): C, 46.9; H, 10.2; B, 23.0; N, 10.0. Found (percent): C, 43.5; H, 10.3; B, 23.0; N, 10.0.

EXAMPLE 42

A solution is prepared consisting of 0.5 g. of

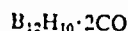

and 10 ml. of anhydrous CH₃CN. To this solution is added with stirring 2 ml. of freshly dried C₆H₅N(CH₃)₂. This solution is warmed to incipient reflux temperature for 30 minutes and it becomes yellow, then green and finally orange in color. Acetonitrile is removed by evaporation and the oil which remains is dissolved in aqueous ethanol. A small quantity of aqueous NaOH solution is added to make the mixture strongly basic. An aqueous solution of CsF is added in excess and the solution is chilled. Tan needles of Cs₂B₁₂H₁₀[C(O)C₆H₄N(CH₃)₂]₂ form which are separated and recrystallized from water. The infrared spectrum of the compound shows absorption bands at the following wavelengths (expressed as cm.⁻¹): 2500, 1600, 1560, 1530, 1300, 1250, 1185, 1170, 1120, 1060, 1035, 945, 920, 845, 820, 746, and 725.

Analysis.—Calc'd for

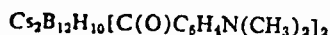

(percent): Cs, 37.8; B, 18.5; H, 4.3; C, 30.8; N, 4.0. Found (percent): Cs, 35.4; B, 18.2; H, 4.5; C, 30.8; N, 4.1.

EXAMPLE 43

(A) A reaction vessel is charged with 20 ml. of dry xylene and 0.5 g. of B₁₂H₁₀(CO)₂. The solution is stirred and 0.53 ml. of diethyl mercury is added gradually. The clear solution which forms is heated to refluxing and a white solid, which is (C₂H₅Hg)₂B₁₂H₁₀[C(O)C₂H₅]₂, separates. The suspension of solid and liquid is maintained at incipient reflux temperature for 30 minutes and the mixture is then allowed to cool to about 25° C. The solid is separated and washed thoroughly with dry xylene and dry ether. The washed product is dried at very low pressure (about 10⁻³ mm. Hg) at atmospheric temperature to obtain pure (C₂H₅Hg)₂B₁₂H₁₀[C(O)C₂H₅]₂. The infrared spectrum of the compound shows absorption bands at the following wavelengths (expressed as cm.⁻¹): 2450, 1550, 1330, 1160, 1100, 1070, 940, and 710.

Analysis.—Calc'd for (C₂H₅Hg)₂B₁₂H₁₀[C(O)C₂H₅]₂ (percent): Hg, 56.2; B, 18.2. Found (percent): Hg, 54.0; B, 19.3.

(B) A portion of the mercury salt of Part A is suspended in aqueous alcohol and the suspension is heated to refluxing. Hydrogen sulfide is bubbled through the hot liquid and mercury sulfide precipitates. The mixture is filtered and the filtrate is partially evaporated. The residual liquid is mixed with an excess of aqueous (CH₃)₄NCl solution and the solution is concentrated to a small volume. Chilling of the solution results in precipitation of [(CH₃)₄N]₂B₁₂H₁₀[C(O)C₂H₅]₂. The product is separated by filtration and dried as described in Part A. The infrared spectrum of the compound shows absorption bands at the following wavelengths (expressed as cm.⁻¹): 2500, 1630, 1490, 1400, 1160, 1075, 950, and 725.

(C) A second portion of the mercury salt of Part A is suspended in about 20 ml. of ethanol. Liquid bromine is added dropwise and with stirring. The reaction is exothermic and care is exercised during the addition of the bromine. When the vigor of the reaction subsides the mixture is heated to reflux temperature and addition of bromine is continued until an excess of bromine is present as shown by the color of the solution. Chlorine gas is now bubbled through the refluxing solution for 30 minutes after which nitrogen gas is bubbled through the mixture to remove unreacted halogens. An excess of aqueous (CH₃)₄NCl solution is added, the mixture is heated to boiling and portions of alcohol and water are added in sufficient amount to form a clear solution. The solution is chilled and a solid product precipitates. It is separated, dried, extracted with boiling alcohol and then with boiling water. The residue is suspended in hot aqueous alcohol and hydrogen sulfide is passed into the suspension to precipitate mercury as the sulfide. The hot solution is filtered and the filtrate is chilled to precipitate

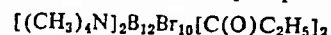

The infrared spectrum of the compound shows absorption bands at the following wavelengths (expressed as cm.⁻¹): 1650, 1150, 1110, 1055, 990, 950, 880, 845, and 720.

EXAMPLE 44

(A) The procedure of Example 43, Part A, is repeated employing a solution of 0.5 g. of B₁₂H₁₀(CO)₂ in 20 ml. of dry xylene and 2.0 g. of (C₆H₅)₂Hg. The mercury salt which is obtained has the formula

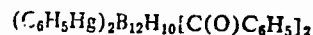

The infrared spectrum of the compound comprises the following absorption bands (expressed as cm.⁻¹): 2500, 1590, 1525, 1250, 1180, 1025, 845, 765, and 690.

(B) The mercury salt of Part A is processed as described in Example 43, Part C to obtain

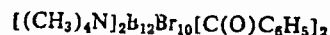

The infrared spectrum of the compound contains absorption bands at the following wavelengths (expressed as cm.⁻¹): 1620, 1280, 1185, 990, 950, 850, 770, and 705.

The process illustrated in Examples 43 and 44 is generic for the preparation of compounds of Formula 1 in which X is a carbacyl group, i.e., RC(O). By employing the appropriate mercurials and B₁₂H₁₀(CO)₂, compounds such as (NH₄)₂B₁₂H₁₀[C(O)C₆H₁₁]₂,

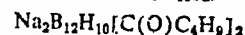

Cs₂B₁₂H₁₀[C(O)C₆H₄CH₃]₂, and the like can be obtained. Modifications of the process can be made, e.g., other organometallics can be employed in place of the organomercurials as reactants.

EXAMPLE 45

(A) A solution is prepared consisting of 5.6 g. of Na₂B₁₂H₁₂ · H₂O (.025 mole), 2.82 g. of H₂NOSO₃H (.025 mole), and 50 ml. of water. The solution is neutralized to a pH of 7 with aqueous NaOH solution, and it is then refluxed for 1.5 hours. The solution is evaporated under reduced pressure and the residue is mixed with an aqueous solution of (CH₃)₄NCl. A white solid forms which is separated to obtain 3 g. of crude

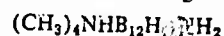

which can also be written as (CH₃)₄NB₁₂H₁₁NH₂ to show the close association of the acidic proton with the —NH₂ substituent. The product is recrystallized four times from water and is obtained as beautiful white plates. The infrared spectrum shows characterizing absorption bands at 3240 and 1580 cm.⁻¹ as well as other characterizing bands for the dodecaborate cage.

Analysis.—Calc'd for (CH₃)₄NHB₁₂H₁₁NH₂ (percent): C, 20.8; H, 11.3; B, 55.9; N, 12.7. Found (percent): C, 20.2; H, 11.2; B, 55.2; N, 12.2.

(B) An aqueous solution $C_5B_{12}H_{11}COOH$ (see Example 38, Part A) is prepared and there is added to it with stirring an excess of an aqueous solution of H_2NOSO_2H . Gas evolves spontaneously from the reaction mixture. After gas evolution ceases, the mixture is chilled and colorless needles separate from the solution. The needles are removed by filtration, washed and dried to obtain $C_5HB_{12}H_{11}NH_2$ in pure form. The infrared spectrum of the product shows characterizing absorption bands as follows (expressed as microns): 3.05, 4.0, 6.3, 7.1, 9.4, 9.8, and 13.8. The compound can also be written as

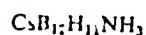

containing reactant of column 1 and the hydroxylamino-O-sulfonic acid of column 2, neutralized with the base of column 3, are reacted preferably in aqueous solution at a temperature between about 60° C. and 100° C., to give the product or products of column 4. When both monoaminated and diaminated compounds are possible products, i.e., when either one or two amino groups (NRR') can be introduced, the major product is determined by the ratio of the reactants. The acids of the diamino-substituted anions shown in column 4 are obtained by passing the salts, bearing cations of the bases shown in column 3 through an acid ion-exchange resin, as described earlier.

TABLE III

Column 1 Boron-containing reactant	Column 2 Hydroxylamino-O-sulfonic acid	Column 3 Neutralizing agent	Column 4 Product or products
$H_2B_{12}H_{11}Cl_4$	H_2NOSO_2H	NaOH	$\{NaHB_{12}H_{11}Cl_4NH_2\}$ $\{H_2B_{12}H_{11}Cl_4(NH_2)_2\}$
$CaB_{12}H_{11}$	CH_3NHOSO_2H	$Ca(OH)_2$	$\{Ca_2H_{12}B_{24}H_{22}N_2(CH_3)_4\}$ $\{H_2B_{12}H_{11}(NHCH_3)_2\}$
$(NH_4)_2B_{12}H_{11}C_2H_5$	H_2NOSO_2H	NH_4OH	$\{NH_4HB_{12}H_{11}(C_2H_5)NH_2\}$ $\{C_2H_5B_{12}H_{11}(C_2H_5)(NH_2)_2\}$
$BaB_{12}H_{11}OC_2H_5$	$C_4H_9NHOSO_2H$	$Ba(OH)_2$	$\{BaH_{12}B_{12}H_{11}(OC_2H_5)_2(C_4H_9)_2N_2\}$ $\{H_2B_{12}H_{11}OC_2H_5(C_4H_9)(NH_2)\}$
$MgB_{12}H_{11}SC_2H_5$	$C_4H_9NHOSO_2H$	NaOH	$\{MgH_{12}B_{12}H_{11}(SC_2H_5)(C_4H_9)(NH_2)_2\}$ $\{NaHB_{12}H_{11}(SC_2H_5)(C_4H_9)(NH_2)\}$
$Na_2B_{12}H_{11}C_2H_5$	H_2NOSO_2H	Na_2CO_3	$\{Na_2H_{12}B_{12}H_{11}(C_2H_5)_2(NH_2)_2\}$ $\{H_2B_{12}H_{11}(C_2H_5)_2(NH_2)\}$
$(NH_4)_2B_{12}H_{11}OC_2H_5$	$(C_2H_5)_2NOSO_2H$	NH_4OH	$\{NH_4HB_{12}H_{11}(OC_2H_5)(N(C_2H_5)_2)\}$ $\{H_2B_{12}H_{11}(OC_2H_5)(N(C_2H_5)_2)_2\}$

to show the close association of the acidic proton with the $-NH_2$ group.

(C) A solution of 67 g. of $Na_2B_{12}H_{12} \cdot 2H_2O$ and 100 g. of H_2NOSO_2H in 250 ml. of water is neutralized by adding, at a temperature below 25° C. a solution of 36 g. of sodium hydroxide in 100 ml. of water. The solution is heated cautiously until an exothermic reaction begins (at about 70° C.) The mixture is then cooled to moderate the reaction which continues for about 30 minutes. The solution is now cooled to about 5° C. and the precipitate which forms is separated to obtain 9 g. of $H_2B_{12}H_{10}(NH_2)_2$ as a white crystalline solid. Concentration of the filtrate to about one-half of its original volume and cooling yields an additional 7 g. of product (referred to as the second fraction).

The first fraction is recrystallized twice from water to obtain a very sparingly soluble crystalline product.

Analysis.—Cal'd for $H_2B_{12}H_{10}(NH_2)_2$ (percent): B, 74.6; H, 9.3; N, 16.1. Found (percent): B, 74.8; H, 9.2; N, 15.8.

The second fraction of crystals are recrystallized from a relatively small volume of water to obtain a more soluble crystalline product.

Analysis.—Found (percent): B, 74.6; H, 8.5; N, 15.3.

The two fractions isolated and purified as described above are isomeric forms of $H_2B_{12}H_{10}(NH_2)_2$. The two isomers differ in their solubility in water. The compound can also be written as $B_{12}H_{10}(NH_2)_2$ to show the close association of the protons with the amine substituents.

(D) An aqueous solution of $H_2B_{12}H_{10}(COOH)_2$ is mixed with an aqueous solution of hydroxylamine-O-sulfonic acid. A gas (CO_2) is evolved and a solid precipitates which is separated by filtration. It is washed and dried to obtain $H_2B_{12}H_{10}(NH_2)_2$. The identity of the compound is confirmed by its infrared absorption spectrum which shows characterizing bands at 9.4 μ and 10.5 μ . The intensities of these bands are reversed from the intensities of the corresponding bands of the compounds obtained in Part C, showing a different distribution of isomers in the products made by the two methods.

Additional examples of products of the invention which can be obtained by the amination procedure of Example 45, are given in Table III. In each instance the boron-

The NH_2 -substituted compounds can be N-alkylated by reaction with alkyl sulfates to obtain compounds of Formula 1 in which X is $-NR_2$. To illustrate, a mixture of $(CH_3)_4NHB_{12}H_{11}NH_2$ and water is heated to reflux temperature. Dialkyl sulfate [e.g., $(CH_3)_2SO_4$] and an aqueous NaOH solution are added to the mixture to form a slightly basic solution and the mixture is heated again to reflux temperature. Aqueous NaOH solution and dialkyl sulfate are added at intervals about every 15 minutes during the period of refluxing. Finally, sufficient aqueous NaOH solution is added to make the solution alkaline and the mixture is refluxed again for about one hour. The mixture is cooled and the solvent is removed for evaporation. The residue can, if desired, be divided into several portions. The portions are mixed with aqueous solution of salts, e.g. $(CH_3)_4NCl$, CSF_5 , $TiNO_3$ and the like, to precipitate salts of the anion $B_{12}H_{11}NR_2^{-2}$. Examples of salts which can be obtained by the above procedure are $(CH_3)_4NHB_{12}H_{11}N(CH_2)_3$.

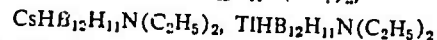

and the like. These acid salts can be dissolved in aqueous alkaline solutions (e.g., NaOH) and the alkaline solutions can then be treated with a further quantity of the salts illustrated above to obtain normal salts.

EXAMPLE 46

(A) A mixture consisting of 10 g. of crystalline hydrated $(H_2O)_2B_{12}H_{12}$ and 25 g. of HCN is heated in a pressure vessel under autogenous pressure at 100° C. for 4 hours. The vessel is cooled, vented and the reaction mixture is blown with nitrogen to remove unreacted HCN. The viscous residue is neutralized with aqueous CsOH solution, and the cesium salt which precipitates is separated. It is recrystallized repeatedly from water to obtain a product whose elemental analysis shows that 1-2 moles of HCN have combined with each mole of $B_{12}H_{12}^{-2}$ anion. The analyses are: C, 4.31; H, 5.22; N, 4.59. The infrared spectrum of the product shows absorption at 2.8, 3.1, 4.0, 6.15, 6.7 and 9.5 μ .

(B) The process of part A is repeated five times, employing 15.0 g. of hydrated crystalline $(H_2O)_2B_{12}H_{12}$ and 30 g. HCN. The first batch is heated at 100° C. for 4 hours, the remaining batches at 110° C. for 4 hours.

The non-volatile residues of the five runs are combined and the combined product is processed as described in Part A to obtain 99 g. of product whose infrared spectrum shows absorption at 2.7, 3.1, 4.0, 6.1, 6.6, 7.5, 8.0, 9.5, 9.8, 11.2, 12.0 and 13.9 μ . Elemental analyses are as follows: C, 5.6; H, 4.3; N, 5.3; B, 36.6. The product is a mixture containing $C_5H_{12}B_{12}H_{10}(N=CH_2)_2$.

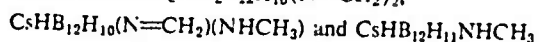

(C) A portion of the product obtained in Part A is dissolved in water and an aqueous solution of $(CH_2)_3SI$ is added with stirring. The precipitate which forms is separated and recrystallized to give a product which is predominantly $(CH_3)_3SHB_{12}H_{11}NHCH_3$. The acidic proton is closely associated with the methylamino group and the compound can also be written as

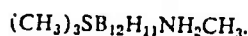

Analysis.—Calcd. for $(CH_3)_3SHB_{12}H_{11}NHCH_3$ (percent): C, 19.2; H, 10.0; S, 12.8; N, 5.7. Found (percent): C, 18.2; H, 9.5; S, 12.9; N, 6.5.

(D) A second portion of the product obtained in part A is dissolved in water and an aqueous solution of $TiNO_3$ is added with stirring. The precipitate is purified as described in part C to obtain $TiHB_{12}H_{11}NHCH_3$ or (to show the association of the acidic proton with the amine substituent) $TiB_{12}H_{11}NH_2CH_3$.

Analysis.—Calcd. for $TiHB_{12}H_{11}NHCH_3$ (percent): C, 3.2; H, 4.2; N, 3.8. Found (percent): C, 3.9; H, 3.6; N, 4.4.

(E) A mixture of 10 g. of hydrated crystalline $(H_2O)_2B_{12}H_{12}$ and 20 g. of HCN is heated in a pressure vessel under autogenous pressure for 4 hours at 80–83° C. The reaction mixture is processed as described in part A with the exception that it is neutralized with dilute aqueous NaOH solution. An aqueous 50% CsF solution is added to the neutralized solution and the cesium salt which separates is purified by crystallization from water. Elemental analyses suggest that the compound is principally $CsHB_{12}H_{11}N=CH_2$.

Analysis.—Calcd. for $CsHB_{12}H_{11}N=CH_2$ (percent): C, 4.0; H, 3.1; N, 4.6. Found (percent): C, 4.3; H, 4.4; N, 4.1.

(F) A portion of the above product is dissolved in water and the solution is passed through a column filled with a sodium ion-exchange resin. The aqueous effluent is mixed with $(CH_3)_4NCl$ and $(CH_3)_4NOH$. The precipitate is separated and purified as described earlier to obtain the tetramethylammonium acid salt.

Analysis.—Calcd. for $(CH_3)_4NHB_{12}H_{11}N=CH_2$ (percent): C, 25.8; H, 10.0; N, 13.5. Found (percent): C, 26.1; H, 10.9; N, 11.6.

EXAMPLE 47

(A) A solution of 1.4 g. of $B_{12}H_{10} \cdot 2CO$ in 30 ml. of acetonitrile is added with stirring to a solution of 1.5 g. of sodium azide in 50 ml. of acetonitrile. Nitrogen gas (350 ml.) is evolved rapidly. After gas evolution has ceased, the reaction mixture is filtered and the filtrate is evaporated by a stream of air until a viscous syrup remains. The syrup is diluted with water and an aqueous solution of $(CH_3)_4NCl$ is added with stirring. A white precipitate forms which is separated to obtain

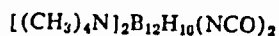

The product is recrystallized from water to yield 2.3 g. of white crystalline compound of Formula 1 bearing isocyanate substituents.

Analysis.—Calcd. for $[(CH_3)_4N]_2B_{12}H_{10}(NCO)_2$ (percent): B, 34.88; C, 32.26; H, 9.21; N, 15.05. Found (percent): B, 34.79; C, 32.23; H, 9.14; N, 15.23.

The infrared absorption spectrum of the compound shows a strong band at 4.33 μ , characteristic of the —NCO group.

(B) Gaseous chlorine is bubbled through an aqueous

solution of 0.5 g. of $B_{12}H_{10} \cdot 2CO$ as described in Example 39. After chlorination is complete, the solution is evaporated to dryness in a sublimation unit and the residue is sublimed at 0.003 mm. Hg pressure to obtain 0.92 g. of sublimate on the water cooled condenser. A portion (0.5 g.) of the sublimate is dissolved in 5 ml. of dry CH_3CN and a suspension of 0.5 g. of NaN_3 in 5 ml. of CH_3CN is added to the solution with stirring. A mild exothermic reaction occurs and a gas is evolved. The mixture is heated to incipient reflux temperature for 1 hour and it is then evaporated to dryness. The residue is dissolved in water and an aqueous solution of $(CH_3)_4NCl$ is added in excess. The precipitate which forms is separated and heated to boiling with 60 ml. of water. The solid dissolves partially and the hot mixture is filtered. The filtrate is chilled and a total of 0.45 g. of a solid precipitates. The compound, which is

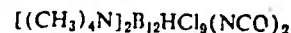

is separated, washed and dried. Its infrared spectrum shows major absorption bands at the following wavelengths (expressed as cm^{-1}): 2300, 1700, 1480, 1280, 1060, 945, 855, and 725.

Analysis.—Calcd. for $[(CH_3)_4N]_2B_{12}HCl_9(NCO)_2$ (percent): C, 17.6; H, 3.7; B, 19.1; Cl, 46.8; N, 8.2. Found (percent): C, 17.6; H, 4.1; B, 19.2; Cl, 45.6; N, 7.0.

EXAMPLE 48

A suspension of $[(CH_3)_4N]_2B_{12}H_{10}(NCO)_2$ in absolute ethanol is saturated with dry hydrogen chloride. Heat is evolved and the solid dissolves. After the heat of the reaction subsides, the clear solution is evaporated to dryness and the residue is dissolved in water. Sufficient aqueous solution of $(CH_3)_4NOH$ is added to the clear solution to form a neutral mixture. The mixture is evaporated to dryness and the solid residue is dissolved in hot ethanol containing a small quantity of water. The hot solution is chilled to obtain a crystalline product which is separated to yield 0.5 g. of

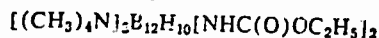

The infrared spectrum of the compound shows major absorption bands at the following wavelengths (expressed as cm^{-1}): 3380, 2460, 1700, 1460, 1330, 1300, 1280, 1205, 1160, 1090, 1055, 1020, 1010, 965, 950, 890, 870, 825, 795, 780, 725 and 860.

Analysis.—Calcd. for

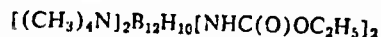

(percent): C, 36.2; H, 10.1; B, 27.9; N, 12.1. Found (percent): C, 36.3; H, 10.4; B, 28.2; N, 12.2.

The preceding examples illustrate broadly the substitution, replacement and metathetic reactions which the $B_{12}H_{12}^{-2}$ anion undergoes, employing techniques which are in many cases appropriate for effecting replacement of hydrogen bonded to carbon of a benzene nucleus. The substitution reactions used for carbocyclic aromatic compounds may be employed or modifications of these reactions can be used. Versatile intermediates, illustrated in the examples, are employed in many cases. Thus, dodecaborate derivatives bearing sulfo groups ($-SO_3H$) may be obtained by reacting dihydrogen dodecahydrododecaborate ($2-$) with a sulfonating agent, e.g., chlorosulfonic acid, liquid sulfur trioxide, fuming sulfuric acid and the like. The sulfo-substituted products, e.g.,



can be neutralized with bases or basic salts (NaOH, Na_2CO_3 , NH_4OH , NH_2NH_2 , and the like) to obtain salts such as $Na_2B_{12}H_{11}SO_3Na$, $(NH_4)_2B_{12}H_{11}SO_3NH_4$, and $(NH_2NH_2)_2B_{12}H_{11}SO_3NH_2NH_2$. Compounds bearing sulfonic groups can be reacted with phosphorus halides, e.g., PCl_5 , to obtain products bearing sulfonyl chloride groups, as illustrated by the compound $H_2B_{12}H_{11}SO_2Cl$. The sulfonyl chlorides can be reacted with ammonia or

amines to obtain products bearing sulfamyl groups, e.g., $(\text{NH}_4)_2\text{B}_{12}\text{H}_{11}\text{SO}_2\text{NH}_2$ and



Compounds bearing amine, hydroxyl and isocyanate groups have been described in the examples. The substituent groups in these compounds, i.e., the $-\text{NH}_2$, $-\text{OH}$, and $-\text{NCO}$ groups, undergo the same or similar types of reactions as their counterparts in organic chemistry. Thus, the organic chemistry of aromatic amines, phenols and isocyanates can be applied to the corresponding boron compounds to obtain a broad range of products bearing desired substituents. To illustrate, a compound bearing $-\text{NH}_2$ groups can be reacted with (1) an isocyanate to form products having ureido or ureylene substituents, e.g., $\text{Na}_2\text{B}_{12}\text{H}_{10}(\text{NH}_2)_2$ is reacted with $\text{C}_6\text{H}_5\text{NCO}$ to form $\text{Na}_2\text{B}_{12}\text{H}_{10}[\text{NHC}(\text{O})\text{NHC}_6\text{H}_5]_2$, (2) with isothiocyanates to obtain products bearing thioureido or thioureylene groups, $\text{Na}_2\text{B}_{12}\text{H}_{10}(\text{NH}_2)_2$ can be reacted with $\text{C}_3\text{H}_5\text{NCS}$ to obtain $\text{Na}_2\text{B}_{12}\text{H}_{10}[\text{NHC}(\text{S})\text{NHC}_3\text{H}_5]_2$, (3) with sulfonyl chlorides to obtain products which bear sulfamino groups, e.g., $\text{Na}_2\text{B}_{12}\text{H}_{10}(\text{NH}_2)_2$ can be reacted with

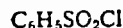

to obtain $\text{Na}_2\text{B}_{12}\text{H}_{10}(\text{NHSO}_2\text{C}_6\text{H}_5)_2$, and (4) with oxiranes to obtain hydroxyl-substituted dodecaborate compounds, e.g., $\text{Na}_2\text{B}_{12}\text{H}_{10}(\text{NH}_2)_2$ can be reacted with glycidol to obtain $\text{Na}_2\text{B}_{12}\text{H}_{10}[\text{NHCH}_2\text{CH}(\text{OH})\text{CH}_2\text{OH}]_2$.

The amino-substituted dodecaborates can be reacted, as described earlier, with acid anhydrides or carbacyl halides to form compounds having amide groups bonded through the nitrogen to the dodecaborate anion. To illustrate, $\text{H}_2\text{B}_{12}\text{H}_{10}(\text{NH}_2)_2$ can be reacted with acetic anhydride to form $\text{H}_2\text{B}_{12}\text{H}_{10}[\text{NHC}(\text{O})\text{CH}_3]_2$, with



to form $\text{H}_2\text{B}_{12}\text{H}_{10}[\text{NHC}(\text{O})\text{C}_6\text{H}_5]_2$ and the like.

As further illustrations, compounds of the invention which bear $-\text{OH}$ groups can be reacted, as described above for the amine-substituted compounds, with isocyanates, isothiocyanates, carbacyl halides, carbamyl halides, sulfonyl halides and oxiranes to obtain products which bear, e.g., N-substituted carbamoyloxy groups

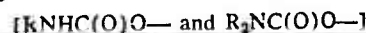

N-substituted thiocarbamoyloxy groups $[\text{RNHC}(\text{S})\text{O}-$ and $\text{R}_2\text{NC}(\text{S})\text{O}-]$, hydrocarboxyloxy groups



sulfonyloxy groups $[\text{RS}(\text{O})_2\text{O}-]$ and hydroxyl-bearing ether groups. To illustrate, by reacting $\text{Cs}_2\text{B}_{12}\text{H}_{11}\text{OH}$ (1) with $\text{C}_6\text{H}_5\text{NCO}$, the compound $\text{Cs}_2\text{B}_{12}\text{H}_{11}\text{OC}(\text{O})\text{NHC}_6\text{H}_5$ can be obtained, (2) with $\text{C}_6\text{H}_5\text{NCS}$, the compound $\text{Cs}_2\text{B}_{12}\text{H}_{11}\text{OC}(\text{S})\text{NHC}_6\text{H}_5$ can be obtained, (3) with acetyl chloride, the compound $\text{Cs}_2\text{B}_{12}\text{H}_{11}\text{OC}(\text{O})\text{CH}_3$ can be obtained (4) with $\text{CH}_3\text{C}_6\text{H}_4\text{SO}_2\text{Cl}$, the compound



can be obtained and (5) with ethylene oxide, the compound $\text{Cs}_2\text{B}_{12}\text{H}_{11}\text{OCH}_2\text{CH}_2\text{OH}$ can be obtained.

The preparation of compounds bearing from 1-12 hydroxyl groups was illustrated earlier in the examples. These products provide a fertile source of reagents to obtain compounds of Formula 1 bearing from 1-12 substituents by reactions which have been described above.

Compounds of Formula 1 in which X represents one or more $-\text{NCO}$ groups can be reacted with alcohols, mercaptans, ammonia, amines, and the like to obtain products bearing $-\text{NHC}(\text{O})\text{OR}$, $-\text{NHC}(\text{O})\text{SR}$, $-\text{NHC}(\text{O})\text{NH}_2$, $-\text{NHC}(\text{O})\text{NHR}$, $-\text{NHC}(\text{O})\text{NR}_2$, and like substituents.

The nitro-substituted dodecaborate compounds can be reduced with hydrogen to amino-substituted dodecaborates, i.e., compounds of the general formula $\text{M}_a[\text{B}_{12}\text{H}_{12-y}(\text{NH}_2)_y]_b$, where M, a, b and y are defined as in Formula 1. Conventional processes employing iron and a mineral acid are satisfactory for use in the reduc-

tion step. To illustrate, by reduction of the appropriate nitro derivative, there can be obtained

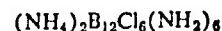

$\text{Na}_2\text{B}_{12}\text{H}_6(\text{NH}_2)_6$, $\text{Cs}_2\text{B}_{12}\text{H}_3(\text{NH}_2)_2$, $[\text{C}(\text{CH}_3)_4]_2\text{H}_{11}\text{NH}_2$, and the like.

Acids of the formula $\text{H}_2\text{B}_{12}\text{H}_{12-y}\text{X}_y$ are obtained as described earlier, most conveniently by contacting an aqueous solution of a dodecaborate (2^-) salt with an acid ion-exchange resin. The hydrogen ions, i.e., $(\text{H}^+)_2$, are considered to be hydrated in aqueous solution and they are generally referred to as hydronium ions, i.e., $(\text{H}_3\text{O}^+)_2$. The terms "hydrogen ion" and "hydronium ion," are employed herein in their generic sense as defined on p. 26 of "Nomenclature of Inorganic Chemistry—International Union of Pure and Applied Chemistry" which was referred to earlier.

In the operation of this process for preparing acids, aqueous or methanol solutions of dodecaborate (2^-) salts are passed through a column filled with an acid ion-exchange resin of the crosslinked polystyrenesulfonic acid type, these resins are available commercially. The aqueous or alcoholic effluents are solutions of the free acids. Careful concentration of the solutions and intensive drying of the liquid residues under low pressures and at moderate temperatures usually yields the acids as crystalline hydrates. However, for most purposes, it is convenient to use the acid in aqueous or alcoholic solutions and the acids are preferably stored in solution. By using the process as described above, the following acids can be obtained from the named representative dodecaborate salts.

Dodecaborate salt:	Acid obtained in aqueous solution
$[(\text{CH}_3)_4\text{N}]_2\text{B}_{12}\text{H}_3\text{Cl}_7$	$\text{H}_2\text{B}_{12}\text{H}_3\text{Cl}_7(\text{OH})_2$
$[(\text{CH}_3)_4\text{N}]_2\text{B}_{12}\text{Cl}_7(\text{OH})_2$	$\text{H}_2\text{B}_{12}\text{Cl}_7(\text{OH})_2$
$\text{Cs}_2\text{B}_{12}\text{H}_{10}(\text{OC}_3\text{H}_7)_2$	$\text{H}_2\text{B}_{12}\text{H}_{10}(\text{OC}_3\text{H}_7)_2$
$\text{Cs}_2\text{B}_{12}\text{H}_{11}\text{SO}_2\text{C}_6\text{H}_5$	$\text{HB}_{12}\text{H}_{11}\text{SO}_2\text{C}_6\text{H}_5$
$\text{Cs}_2\text{B}_{12}\text{H}_4\text{Cl}_2(\text{CN})_4$	$\text{H}_2\text{B}_{12}\text{H}_4\text{Cl}_2(\text{CN})_4$
$\text{Cs}_2\text{B}_{12}\text{H}_4\text{Cl}_2\text{SH}$	$\text{H}_2\text{B}_{12}\text{H}_4\text{Cl}_2\text{SH}$
$\text{Cs}_2\text{B}_{12}\text{H}_6\text{F}_4$	$\text{H}_2\text{B}_{12}\text{H}_6\text{F}_4$
$[(\text{CH}_2)_4\text{N}]_2\text{B}_{12}\text{H}_{11}\text{Cl}$	$\text{H}_2\text{B}_{12}\text{H}_{11}\text{Cl}$
$\text{Cs}_2\text{B}_{12}\text{Cl}_{12}$	$\text{H}_2\text{B}_{12}\text{Cl}_{12}$
$[(\text{CH}_3)_3\text{S}]_2\text{B}_{12}\text{H}_6\text{Br}_6$	$\text{H}_2\text{B}_{12}\text{H}_6\text{Br}_6$
$\text{Cs}_2\text{B}_{12}\text{Br}_{11}\text{OH}$	$\text{H}_2\text{B}_{12}\text{Br}_{11}\text{OH}$
$[(\text{CH}_3)_4\text{N}]_2\text{B}_{12}\text{Br}_{12}$	$\text{H}_2\text{B}_{12}\text{Br}_{12}$
$\text{Cs}_2\text{B}_{12}\text{I}_{12}$	$\text{H}_2\text{B}_{12}\text{I}_{12}$
$\text{Cs}_2\text{B}_{12}\text{H}_{11}\text{SCH}_3$	$\text{H}_2\text{B}_{12}\text{H}_{11}\text{SCH}_3$
$\text{Cs}_2\text{B}_{12}\text{H}_{11}\text{C}_6\text{H}_{11}$	$\text{H}_2\text{B}_{12}\text{H}_{11}\text{C}_6\text{H}_{11}$
$\text{Cs}_2\text{B}_{12}\text{H}_{10}[\text{C}(\text{O})\text{NH}_2]_2$	$\text{H}_2\text{B}_{12}\text{H}_{10}[\text{C}(\text{O})\text{NH}_2]_2$
$[(\text{CH}_3)_4\text{N}]_2\text{B}_{12}\text{Cl}_{10}(\text{COOH})_2$	$\text{H}_2\text{B}_{12}\text{Cl}_{10}(\text{COOH})_2$
$[(\text{CH}_3)_4\text{N}]_2\text{B}_{12}\text{H}_{10}[\text{C}(\text{O})\text{OCH}_3]_2$	$\text{H}_2\text{B}_{12}\text{H}_{10}[\text{C}(\text{O})\text{OCH}_3]_2$
$\text{Cs}_2\text{B}_{12}\text{H}_{10}(\text{CN})_2$	$\text{H}_2\text{B}_{12}\text{H}_{10}(\text{CN})_2$
$\text{Cs}_2\text{B}_{12}\text{H}_{10}(\text{NH}_2)_2$	$\text{H}_2\text{B}_{12}\text{H}_{10}(\text{NH}_2)_2$
$\text{Cs}_2\text{B}_{12}\text{H}_{10}[\text{N}(\text{CH}_3)_2]_2$	$\text{H}_2\text{B}_{12}\text{H}_{10}[\text{N}(\text{CH}_3)_2]_2$
$\text{Cs}_2\text{B}_{12}\text{H}_2\text{Br}_{10}$	$\text{H}_2\text{B}_{12}\text{H}_2\text{Br}_{10}$

Metal salts of the invention can be prepared by neutralization of the acids, obtained as described above, in aqueous or alcohol solution with an aqueous solution or suspension of an inorganic base, e.g., an alkali or alkaline earth metal hydroxide. The resulting aqueous solution of the metal salt of the $(\text{B}_{12}\text{H}_{12-y}\text{X}_y)^{2-}$ anion is concentrated by evaporation of water or alcohol until the salt crystallizes out. In many cases the salt may precipitate during its preparation and evaporation of the solution is not necessary. The crystalline salt is dried under reduced pressure, e.g., 0.1 mm. of mercury, and moderately elevated temperature, e.g., 50-100° C. The metal salts frequently contain water of hydration which can be removed by heating for several hours at a temperature of about 200° C. under low pressure, e.g., 0.1 mm. of mercury or lower.

65

Water-insoluble heavy metal salts of the acids can be prepared by adding a water-soluble heavy metal salt, e.g., silver nitrate or mercuric nitrate, to an aqueous solution of the boron-containing acid. Silver salts can also be obtained by shaking aqueous solutions of the acids with freshly prepared silver oxide. The heavy metal salts precipitate as white or light-colored solids. The salts thus obtained are usually anhydrous.

Nitrates, carbonates, chlorides, or oxides of metals can be used to prepare the salts by the methods described earlier. Organic bases, e.g., an tetra-substituted ammonium hydroxides, phosphonium hydroxides, sulfonium hydroxides, arsonium hydroxides or halides, stibonium hydroxides or halides, aryl diazonium hydroxides or halides, amino acids (e.g., glycine), esters of amino acids, and similar types of bases can be employed. Heterocyclic bases, e.g., pyridine, quinoline, α,α' -dipyridyl, piperazine, pyrrolidine, phenazine, morpholine, thiamorpholine and the like, are operable to form salts.

The following table illustrates representative salts which can be obtained by neutralizing the acids with a base or an appropriate salt in aqueous solution (Table IV):

TABLE IV

Acid	Neutralizing agent	Product
H ₂ B ₁₂ H ₁₀ (NH) ₂	LiOH	Li ₂ B ₁₂ H ₁₀ (NH) ₂
H ₂ B ₁₂ H ₁₀ (NH) ₂	Ba(OH) ₂	Ba ₂ B ₁₂ H ₁₀ (NH) ₂
H ₂ B ₁₂ H ₁₀ (OH) ₂	MgCO ₃	Mg ₂ B ₁₂ H ₁₀ (OH) ₂
H ₂ B ₁₂ H ₁₀ (OH) ₂	Li ₂ CO ₃	Li ₂ B ₁₂ H ₁₀ (OH) ₂
H ₂ B ₁₂ H ₁₀ (OH) ₂	Al(OH) ₃	Al ₂ (OH) ₄ B ₁₂ H ₁₀ (OH) ₂
H ₂ B ₁₂ H ₁₀ (OH) ₂	FeCl ₃	Fe ₂ (OH) ₄ B ₁₂ H ₁₀ (OH) ₂
H ₂ B ₁₂ H ₁₀ (OH) ₂	Cu(OH) ₂	Cu ₂ (OH) ₄ B ₁₂ H ₁₀ (OH) ₂
H ₂ B ₁₂ H ₁₀ (OH) ₂	Ni(OH) ₂	Ni ₂ (OH) ₄ B ₁₂ H ₁₀ (OH) ₂
H ₂ B ₁₂ H ₁₀ (OH) ₂	Ag ₂ O	Ag ₂ B ₁₂ H ₁₀ (OH) ₂
H ₂ B ₁₂ H ₁₀ (OH) ₂	CuO	Cu ₂ (OH) ₄ B ₁₂ H ₁₀ (OH) ₂
H ₂ B ₁₂ H ₁₀ (OH) ₂	ZnCl ₂	Zn ₂ (OH) ₄ B ₁₂ H ₁₀ (OH) ₂
H ₂ B ₁₂ H ₁₀ (OH) ₂	HgCl ₂	Hg ₂ B ₁₂ H ₁₀ (OH) ₂
H ₂ B ₁₂ H ₁₀ (OH) ₂	AlCl ₃ ·6H ₂ O	Al ₂ (OH) ₄ (B ₁₂ H ₁₀) ₂
H ₂ B ₁₂ H ₁₀ (OH) ₂	SnCl ₄	Sn ₂ B ₁₂ H ₁₀ (OH) ₂
H ₂ B ₁₂ H ₁₀ (OH) ₂	PbCl ₂	Pb ₂ B ₁₂ H ₁₀ (OH) ₂
H ₂ B ₁₂ H ₁₀ (OH) ₂	EuCl ₃	[Eu ₂ (H ₂ O) ₁₂ (B ₁₂ H ₁₀) ₂ ·4H ₂ O]
H ₂ B ₁₂ H ₁₀ (OH) ₂	NH ₄ SCN	(NH ₄) ₂ B ₁₂ H ₁₀ (OH) ₂
H ₂ B ₁₂ H ₁₀ (OH) ₂	(C ₆ H ₅) ₃ NNH ₂	(C ₆ H ₅) ₃ NNH ₂ B ₁₂ H ₁₀ (OH) ₂
H ₂ B ₁₂ H ₁₀ (OH) ₂	(C ₆ H ₅) ₃ NH ₂	(C ₆ H ₅) ₃ NH ₂ B ₁₂ H ₁₀ (OH) ₂
H ₂ B ₁₂ H ₁₀ (OH) ₂	(C ₆ H ₅) ₃ N	(C ₆ H ₅) ₃ NB ₁₂ H ₁₀ (OH) ₂
H ₂ B ₁₂ H ₁₀ (OH) ₂	C ₁₀ H ₇ N (quinoline)	(C ₁₀ H ₇ N) ₂ B ₁₂ H ₁₀ (OH) ₂
H ₂ B ₁₂ H ₁₀ (OH) ₂	ZnO	Zn ₂ (OH) ₄ B ₁₂ H ₁₀ (OH) ₂
H ₂ B ₁₂ H ₁₀ (OH) ₂	Zn(NH ₄) ₂ Cl ₂	Zn ₂ (NH ₄) ₂ (OH) ₄ B ₁₂ H ₁₀ (OH) ₂
H ₂ B ₁₂ H ₁₀ (OH) ₂	(H ₃ C) ₃ SOH	(C ₃ H ₇) ₃ SOB ₁₂ H ₁₀ (OH) ₂
H ₂ B ₁₂ H ₁₀ (OH) ₂	(H ₃ C) ₃ NCl	(C ₃ H ₇) ₃ NB ₁₂ H ₁₀ (OH) ₂
H ₂ B ₁₂ H ₁₀ (OH) ₂	(C ₆ H ₅) ₃ PCl	(C ₆ H ₅) ₃ PB ₁₂ H ₁₀ (OH) ₂
H ₂ B ₁₂ H ₁₀ (OH) ₂	Ni ₂ C ₁₀ H ₁₆ COOH	(Ni ₂ C ₁₀ H ₁₆ COOH) ₂ B ₁₂ H ₁₀ (OH) ₂
H ₂ B ₁₂ H ₁₀ (OH) ₂	CrCl ₃	(Cr ₂ (OH) ₄) ₂ B ₁₂ H ₁₀ (OH) ₂
H ₂ B ₁₂ H ₁₀ (OH) ₂	C ₁₀ H ₇ N(C ₁₂ H ₁₁)	(C ₁₀ H ₇ N)(C ₁₂ H ₁₁) ₂ B ₁₂ H ₁₀ (OH) ₂
H ₂ B ₁₂ H ₁₀ (OH) ₂	(C ₆ H ₅) ₃ Cl	(C ₆ H ₅) ₃ ClB ₁₂ H ₁₀ (OH) ₂
H ₂ B ₁₂ H ₁₀ (OH) ₂	(C ₆ H ₅) ₃ As	(C ₆ H ₅) ₃ AsB ₁₂ H ₁₀ (OH) ₂
H ₂ B ₁₂ H ₁₀ (OH) ₂	AgNO ₃	Ag ₂ B ₁₂ H ₁₀ (OH) ₂

*en = ethylene-caraine.

The process described above and illustrated in the examples are generic for the preparation of compounds of the invention as defined by Formula 1. The processes can be used alone or in combination to obtain the desired products. For example, H₂S can be reacted, as described in Example 36; with hydrated H₂B₁₂H₁₀Cl₄ to obtain H₂B₁₂H₁₀Cl₄(SH)₂, with H₂B₁₂H₁₀(OH)₄ to obtain a mixture of thiol-substituted compounds, e.g.

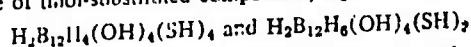

with H₂B₁₂H₁₀F to obtain H₂B₁₂H₁₀F(SH)₂ and with H₂B₁₂H₁₀(OC₁₁)₂ to obtain H₂B₁₂H₁₀(SH)₂(OCH₂)₂. Similarly, hydrated H₂B₁₂H₁₀ can be reacted as described in Example 13, parts D and E, with long chain α,α' -hydro- and ω,α,α' -trihydroperfluoroalkanol, e.g.

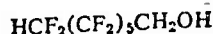
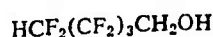
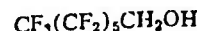

and

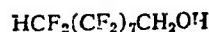

to obtain fluoroalkoxy substituted dodecaborates, e.g.,

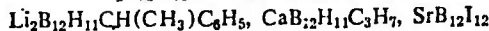
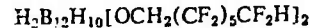
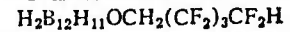

and



Polychloropolyfluoroalkanol can be employed in the reaction, e.g., ClF₂CCF₂CFCICF₂CF₂CH₂OH, to obtain H₂B₁₂H₁₁OCH₂CF₂CF₂CFCICF₂CF₂Cl. Mono-cyano substituted compounds can be obtained by contacting the crude reaction product obtained in Example E with liquid ammonia to prepare Cs₂B₁₂H₁₁C(O)NH₂ and dehydrating the monoamide, as described in Example 37, part A, to obtain Cs₂B₁₂H₁₁CN. Reaction of this compound with C₆H₅CH₂SSCH₂C₆H₅, as described in Example 8, part A, will yield Cs₂B₁₂H₉(SCH₂C₆H₅)₂CN, a compound which can then be brominated as described in Example 3, part C, to obtain Cs₂B₁₂H₉Br₂(SCH₂C₆H₅)₂CN.

Further examples which illustrate the products obtained by the described processes are

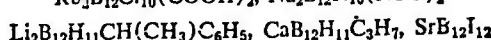
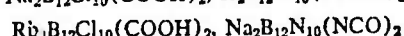
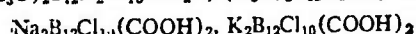
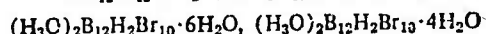
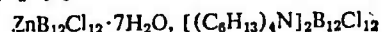

and

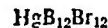

The illustrations in the preceding paragraphs demonstrate the generic nature of the processes and their versatility to obtain a wide range of products which fall within the scope of the compounds of the invention.

Utility

The invention provides a broad class of new boron compounds which find applications in many fields.

75

The compounds of the invention are generically useful as components of fireworks compositions to impart a pleasing color and sparkle to the display.

Each compound within the scope of Formula 1 contains an anion which has boron as a common component. The presence of this element imparts a green color to a fireworks, rocket or flare display. The compounds of the invention can have a wide range of cations, designated as M, and it is thus possible to provide a broad range of colors in any display or flare by choice of the appropriate cation. The compounds of the invention can be used in combination with oxidizing agents, e.g., lithium perchlorate, sodium nitrate, potassium permanganate, strontium peroxide, manganese dioxide, and the like, to provide the desired propulsive effect and color. The following combinations, in which the boron-containing compounds can be from 5-25% by weight of the composition, are illustrative of compositions which can be used:

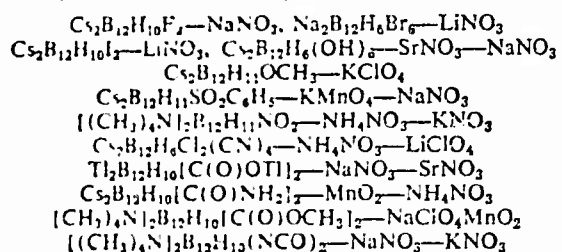

and the like. These examples are not limiting but are illustrative of types of compositions which are possible for use in the above field. Other ingredients can be and frequently are present in these combinations, e.g., carbon and sulfur.

The compounds of the invention are useful in the field of high energy fuels. For this purpose, partially substituted compounds are preferred, i.e., compounds having one to five substituents on the dodecaborate anion. The compounds can be used in combination with oxidizing agents, e.g., nitric acid, fluorine oxide and the like. They can be used in solution in hydrazine or N,N-dialkyl hydrazines, e.g., N,N-dimethylhydrazine. To illustrate, combinations which can be employed include $\text{H}_2\text{B}_{12}\text{H}_{10}[\text{C}(\text{O})\text{NH}_2]_2$ in N,N-dimethylhydrazine, $(\text{NH}_2\text{NH}_2)_2\text{B}_{12}\text{H}_{11}\text{OH}$ in hydrazine and the like. The acids in the above examples form hydrazinium salts in solution and they are not present as the free acids. In compositions as described above the dodecaborate salt can be present in from about 5-50% by weight of the solutions.

The compounds of the invention, exclusive of the fully halogenated products, are useful as impregnating agents in the preparation of resistors. To illustrate, a section of a cotton string is immersed in a nearly saturated solution of $\text{Na}_2\text{B}_{12}\text{H}_{11}\text{CH}(\text{CH}_3)_2$ in aqueous alcohol. The string is withdrawn from the solution and the solvent is removed by drying in air. A free flame is applied to the dried impregnated string and it burns to yield a coherent ash which in size and shape resembles the original string. The residual skeleton is of sufficient coherence to permit embedding in paraffin. The section of residue, so treated, shows a resistance of about 300 ohms/cm. The residue from the control section of string is very small and shapeless and it cannot be handled.

Highly halogenated compounds, e.g., the salts of $\text{B}_{12}\text{Br}_{12}$ anion, are useful as impregnating agents for retarding the combustion of cellulosic products. To illustrate, filter paper which has been treated with an aqueous solution of $(\text{NH}_4)_2\text{B}_{12}\text{Br}_{12}$ and dried, does not burn freely when touched with a free flame.

The nitrated and nitroso-substituted compounds are useful as explosives or detonating agents.

In the group of compounds which fall within the scope of Formula 1, the component M represents a range of groups which are readily interchangeable by metathetic

reactions as described earlier. All of the salts which fall within the scope of Formula 1 can be used to prepare the group of acids represented generically as

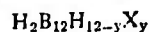

or, in aqueous solution, as $(\text{H}_3\text{O})_2\text{B}_{12}\text{H}_{12-y}\text{X}_y$ by passing aqueous or alcoholic solutions of the salts through an acidic ion-exchange resin as described earlier. The acids of this group, exclusive of compounds in which X is an amine group, are strong acids and they are useful in industrial applications where it is desired to avoid contamination from sulfate, chloride, bromide, chlorate, phosphate, and like strong acid anions. Thus, the acids are useful for etching metals, such as steel, and for rust removal, for pickling, for scale removal and for similar metal processing operations.

The acids, described above, are useful as catalysts in the preparation of esters, e.g., in the reaction of alcohols and organic carboxylic acids, to improve the yields of the desired esters. The acids of the invention are employed for this purpose in the same manner as p-toluene-sulfonic acid, sulfuric acid or alcoholic hydrogen chloride.

Aqueous solutions of the acids are generically useful as agents for absorbing noxious basic materials from the air, e.g., traces of ammonia, lower alkyl amines and the like. To illustrate, air contaminated with methylamines is passed through an aqueous solution of $\text{H}_2\text{B}_{12}\text{H}_{12}(\text{OH})_2$, $\text{H}_2\text{B}_{12}\text{H}_{10}(\text{OCH}_3)_2$, $\text{H}_2\text{B}_{12}\text{Cl}_{12}$, and the like, and the amines are removed.

The acids and many of the salts, particularly the alkali metal and alkaline earth metal salts, are useful as sequestering agents for heavy metals. Thus, a mixture of hydrocarbons in the boiling range of gasoline which contains a copper salt of an organic acid (copper stearate), is thoroughly agitated with aqueous ammoniacal solutions of any of the alkali metal or alkaline earth metal salts of the anion $(\text{B}_{12}\text{H}_{12-y}\text{X}_y)^{-2}$, e.g., $\text{C}_{52}\text{B}_{12}\text{H}_{11}\text{SO}_2\text{C}_6\text{H}_5$,

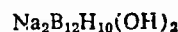

The new compounds, particularly the acids, alkali and the like. The hydrocarbon layer, which is separated from the aqueous reagent, is completely free of deleterious copper salt.

The new compound, particularly the acids, alkali metal, alkaline earth metal and ammonia salts, are useful as sequestering agents for metals in aqueous media. Thus, copper, nickel, cobalt, zinc and cadmium are removed from aqueous solutions of salts containing these metals by mixing the solutions with ammoniacal solutions of the acids and alkali metal, alkaline earth metal and ammonium salts.

The substituted ammonium salts and, in general, all of the nitrogen-base salts as well as phosphonium and sulfonium salts are useful in the field of sequestering agents to remove undesirable metals from aqueous or hydrocarbon media.

To illustrate, a mixture of hydrocarbons in the boiling range of gasoline, which contains in solution a copper salt of an organic acid (copper stearate), is thoroughly agitated with an aqueous ammoniacal solution of



The hydrocarbon layer, which is separated from the aqueous reagent, is completely free of the deleterious copper salt. Similar results can be obtained employing

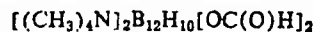

$\text{C}_{52}\text{B}_{12}\text{H}_{11}\text{OCH}_2\text{CH}_2\text{OCH}_3$, and the like.

The compounds of the invention, especially in the form of salts, are useful as surface-active agents, particularly as wetting agents. To illustrate, a glass surface coated with a film of a silicone is not wetted when brought into contact with water. The addition of a small quantity of dicesium cyclohexylundecahydrododecaborate to the water results in immediate wetting of the glass surface, i.e., the treated water spreads rapidly over the surface of the glass.

The silver salts, i.e., the compounds of Formula 1, where M is Ag, are sensitive to light and they are useful in the photographic arts. To illustrate, the cesium salt, $Cs_2B_{12}H_{11}OC(O)H$, is reacted with silver nitrate to obtain $Ag_2B_{12}H_{11}OC(O)H$. An alcoholic solution of the silver salt is prepared in subdued light and a strip of pure cellulose sheet is immersed to half its length in the solution. The strip is removed and dried in the absence of light. When exposed to light, the treated portion of the strip turns dark, while the untreated portion is not affected.

The foregoing detailed description has been given for clearness of understanding only and no unnecessary limitations are to be understood therefrom. The invention is not limited to the exact details shown and described, for obvious modifications will occur to those skilled in the art.

The embodiments of the invention in which an exclusive property or privilege is claimed are defined as follows:

1. A compound of the formula $M_a(B_{12}H_{12-y}X_y)_b$ wherein M is a cation having a valence of 1-4; X is a monovalent element other than hydrogen, or a radical, said X being capable of bonding to the carbon of a benzene nucleus by replacement of a hydrogen bonded to said carbon; and when more than one X group is present the X's can be different; y is a positive whole number of 1 through 12, inclusive; and a and b are positive whole numbers of 1 through 3, inclusive.
2. A compound of claim 1 wherein X comprises halogen.
3. A compound of claim 1 wherein X comprises hydrocarbon.
4. A compound of claim 1 wherein X comprises acyl.
5. A compound of claim 1 wherein X comprises nitro.
6. A compound of claim 1 wherein X comprises amino.
7. A compound of claim 1 wherein X comprises hydroxyl.
8. A compound of claim 1 wherein X comprises carboxyl.
9. A compound of claim 1 wherein X comprises isocyanato.
10. A compound of claim 1 wherein X comprises hydrocarbyloxy.
11. A compound of claim 1 wherein X comprises halo-hydrocarbyloxy.
12. A compound of claim 1 wherein X comprises hydrocarbyloxyhydrocarbyloxy.
13. A compound of claim 1 wherein X comprises hydroxylhydrocarbyloxy.
14. A compound of claim 1 wherein X comprises hydrocarboncarbonyloxy.
15. A compound of claim 1 wherein X comprises cyano.
16. A compound of claim 1 wherein X comprises hydrocarbyloxy-carbonyl.
17. A compound of claim 1 wherein X comprises carbamyl.
18. A compound of claim 1 wherein X comprises thiol.
19. A compound of claim 1 wherein X comprises hydrocarbylmercapto.
20. A compound of the formula $M_a[B_{12}H_{10}(COOH)_2]_b$ wherein M is a cation selected from the class consisting of hydrogen, alkali metals, and tetramethylammonium.

21. A compound of the formula $M_2[B_{12}H_{10}(NH_2)_2]$ wherein M is a cation selected from the class consisting of hydrogen, alkali metals, and tetramethylammonium.

22. A compound of the formula $M_2B_{12}Cl_{12}$ wherein M is a cation selected from the class consisting of hydrogen, alkali metals, and tetramethylammonium.

23. A compound of the formula $M_2B_{12}(OH)_{12}$ wherein M is selected from the class consisting of hydrogen, alkali metals, ammonium and tetramethylammonium.

24. A compound of the formula $M_2B_{12}H_{10}(NCO)_2$ wherein M is selected from the class consisting of alkali metals and tetramethylammonium.

25. A compound selected from the class consisting of $H_2B_{12}Cl_{12}$ and hydrates thereof.

26. A compound selected from the class consisting of $H_2B_{12}Br_{12}$ and hydrates thereof.

27. A compound selected from the class consisting of $H_2B_{12}I_{12}$ and hydrates thereof.

28. The compound of the formula $Ag_2B_{12}Cl_{12}$.

29. The compound of the formula $Ag_2B_{12}Br_{12}$.

30. The compound of the formula $Ag_2B_{12}I_{12}$.

31. The compound of the formula

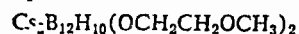

32. The compound of the formula $C_5B_{12}H_{10}(SCH_3)_2$.

33. The compound of the formula

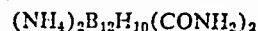

34. The compound of the formula

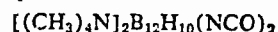

35. A compound of the formula $M_a(B_{12}H_{12-y}X_y)_b$ wherein M is a cation having a valence of 1-4; X is a monovalent substituent selected from the group consisting of halogen, hydrocarbon, acyl, nitro, amino, hydroxyl, carboxyl, isocyanato, hydrocarbyloxy, halo-hydrocarbyloxy, hydrocarbyloxyhydrocarbyloxy, hydroxyhydrocarbyloxy, hydrocarboncarbonyloxy, cyano, hydrocarbyloxy-carbonyl and carbamyl; and when more than one X group is present the X's can be different; y is a positive whole number of 1 through 12, inclusive; and a and b are positive whole numbers of 1 through 3, inclusive.

References Cited

UNITED STATES PATENTS

3,148,938	9/1964	Knoth, Jr.	23-358
3,166,514	1/1965	Parshall	23-358X
3,189,580	6/1965	Dawes	23-361X
3,228,814	1/1966	Jenkins et al.	23-358X
3,148,939	9/1964	Knoth, Jr.	23-361X
3,169,045	2/1965	Miller et al.	23-358
3,390,966	7/1968	Knoth, Jr.	23-361

OTHER REFERENCES

Hawthorne et al.: "Journal of the American Chemical Society," vol. 82, p. 3228 (June 1960).

Knoth, et al.: "Journal of the American Chemical Society," vol. 84, pp. 1056-1057 (Mar. 20, 1962).

OSCAR R. VERTIZ, Primary Examiner

G. O. PETERS, Assistant Examiner

U.S. Cl. X.R.

23-361; 260-606.5

United States Patent [19]

Hough et al.

[11] 3,961,017

[45] June 1, 1976

- [54] PRODUCTION OF
DODECAHYDRODODECABORATE (2-)
- [75] Inventors: William Vernon Hough, Evans City;
Clarence Robert Guibert, Mars;
Gerald Thomas Hefferan, Butler, all
of Pa.
- [73] Assignee: Mine Safety Appliances Company,
Pittsburgh, Pa.
- [22] Filed: Mar. 24, 1975
- [21] Appl. No.: 561,283

- [52] U.S. Cl. 423/286
- [51] Int. Cl.² C01B 35/18
- [58] Field of Search 423/286; 260/606.5 B

- [56] References Cited
UNITED STATES PATENTS
- 3,328,134 6/1967 Miller et al. 423/286
- 3,882,037 5/1975 Brown 260/606.5 B

OTHER PUBLICATIONS

Adams, R. M., *Boron Metallo-Boron Compounds and Boranes*, Interscience Publishers, N.Y., 1964, p. 386.
Hughes, R. I. et al., *Production of the Boranes and Related Research*, Academic Press, N.Y., 1967, pp. 102-103.

Primary Examiner--G. O. Peters

[57] ABSTRACT

This invention relates to the preparation of dodecahydrododecaborate (2-) anions and particularly to the preparation of alkali metal dodecahydrododecaborates such as $\text{Na}_2\text{B}_{12}\text{H}_{12}$. The process of the invention involves the reaction of an alkali metal borohydride with dimethylsulfideborane, at a temperature and for a time sufficient, to yield the alkali metal dodecahydrododecaborate. The reaction may be conducted at atmospheric pressure.

10 Claims, No Drawings

PRODUCTION OF
DODECAHYDRODODECABORATE (2-)

STATE OF THE ART

Previous methods for the synthesis of dodecahydrododecaborates (2-) anions involve either reactions of diborane or pyrolysis of base borane, e.g.,



Because of the volatility of starting materials, the above methods have been conducted in sealed bombs or autoclaves such that all materials were contained with no losses of boron-containing materials. Scale-up of these procedures to provide production quantities of $\text{B}_{12}\text{H}_{12}^{2-}$ is difficult and expensive since extremely large vessels are needed to contain the large quantities of hydrogen evolved.

U.S. Pat. No. 3,169,045 and Miller et al., *Inorganic Chemistry*, Vol. 3, 1964, pages 1456-1463, describe dodecahydrododecaborate salts and a method of their preparation.

DESCRIPTION OF THE INVENTION

It has now been found that $\text{B}_{12}\text{H}_{12}^{2-}$ can be prepared at atmospheric pressure in a process which does not result in the loss of appreciable boron-containing materials. The hydrogen formed by the reaction can be removed as it is formed.

The process of the invention comprises the reaction of an alkali metal hydride or borohydride with dimethylsulfideborane. The chemical reactions involved can be represented by the following equations:

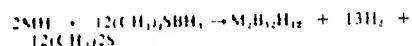

or

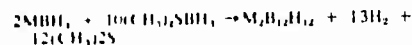

where M is an alkali metal, for example, lithium, sodium, potassium, rubidium or cesium, preferably sodium.

In general, commercial grades of materials are satisfactory. However, it is highly desirable that the reactants be as free of water as is practicable, since moisture, if present, will reduce the yield of the desired product.

The reaction is conducted at atmospheric pressure, pressures other than atmospheric may be employed but merely make the process equipment more costly and complex. The reaction is conducted in an inert atmosphere, for example, under a nitrogen blanket in the substantial absence of moisture, at the desired temperature until the product is formed.

Conveniently, the reaction is conducted in a corrosion resistant vessel, such as stainless steel, having a steam jacket for heating, stirring means, temperature sensing means, means for providing an inert gas atmosphere, and suitable material supply and removal means. The reactor is further equipped with a condenser operated to pass H_2 and dimethylsulfide, but to retain other materials. Conveniently, the reactor is connected to a receiver vessel to which the reaction

mixture can be transferred for purification. The receiver is preferably further connected to a filter or vacuum kettle for final product isolation. All steps in the sequence are preferably conducted in an inert atmosphere and the substantial absence of water.

Mixing of the reactants is highly desirable, but not essential and mixing can be accomplished by any suitable means.

While the reaction is primarily described herein as a batch reaction, the process can also be conducted as a continuous process with or without recycle of unreacted materials, in whole or in part.

The molar ratio of the reactants is not critical. It is preferable to use the reactant in about stoichiometric proportions, i.e., about 10 mols of dimethylsulfideborane for every 2 mols of alkali metal borohydride. Where an excess of one reactant is present, it is desirable that the dimethylsulfideborane be in excess. It is not necessary, however, to use these ratios to obtain at least some quantity of the desired dodecahydrododecaborates.

The reaction to form the dodecahydrododecaborates is conducted at a temperature of between about 95°C. and about 200°C. and preferably, between about 100°C. and 150°C. Conveniently the reaction is conducted at about 130°C.-140°C. While not necessary, it is most preferable that the reaction mixture be gradually raised, for example, incrementally during the course of the reaction, to the ultimately desired reaction temperature for more control over the reaction and to allow for relatively constant controlled evolution of hydrogen.

Likewise, since the reaction mixture will in most instances contain some small amount of reactive impurities, it is desirable to allow these to be reacted at moderate temperature before the desired reaction is commenced.

In a preferred embodiment, the reaction between the alkali metal borohydride and the dimethylsulfideborane is conducted in the presence of an inert liquid reaction media, i.e. a liquid which is unreactive under the conditions of the reaction with the reactants and the product. Ethers and sulfides are suitable reaction media. The reaction media should be liquid at room temperature and liquid at the desired maximum reaction temperature. The preferred reaction medium comprises diglyme, i.e. the dimethyl ether of diethylene glycol. Other suitable reaction media include other glycol ethers such as monomethyl-, trimethyl and tetramethyl ethers of diethylene glycol, dioxane and lower dialkylsulfides, such as diethylsulfide and dibutylsulfide. The inert liquid dispersant should be as free of moisture as possible. Infrared analysis for hydroxyl is an expedient safeguard prior to use.

The time of the reaction is not critical. The reaction time will generally be between about 5 to about 25 hours in a batch process, although shorter or longer times can be employed, dependent upon equipment limitations to accommodate hydrogen evolution.

The reaction products can be separated from the reaction mixture by conventional procedures, such as filtration, crystallization, solution chromatography and the like.

The alkali metal salts prepared in accordance with this invention are solid products which are salt-like in character and dissolve in water and polar solvents, such as hydroxylate solvents. The compounds, as obtained, frequently contain solvent of crystallization. Solvents

3

of crystallization are readily removed, by conventional procedures, for example, recrystallization, heating under reduced pressure and the like.

The tendency of the salts to crystallize with solvents of crystallization or water of hydration complicates elemental analysis. However, identity of the compounds can be confirmed by strong characteristic absorption bands of the $B_2H_4^-$ anion in the infrared absorption spectrum which appear at $4.0\mu \pm 0.1$ and $9.35\mu \pm 0.1$. The absorption band at 4.0μ in some instances appears as a doublet in which there is a shoulder at 4.0μ band at about 4.1μ .

The alkali metal dodecahydrododecaborates undergo metathetic reaction with other salts, in aqueous or non aqueous solvents, to yield other dodecahydrododecaborate salts having as cations Li, Na, K, Rb, Cs, Be, Mg, Ca, Sr, Ba, Cu, Ag, Zn, Cd, and Hg, ammonium, hydrazonium, N substituted ammonium, N-substituted hydrazonium, substituted phosphonium, and diazonium, and the like.

Compounds containing the dodecahydrododecaborate (2-) anions are useful as sequestering agents to remove metals, such as copper, nickel, cobalt, zinc and cadmium, from aqueous and non-aqueous solutions; lithium dodecahydrododecaborate is useful in modifying the combustion characteristics of hydrocarbon fuels, silver dodecahydrododecaborate is useful in the field of light-sensitive chemicals employed in photography, and mercury dodecahydrododecaborate is useful in biochemical applications for which mercury compounds are frequently employed.

Illustrating the invention is the following examples, which, however, are not to be considered as limiting the invention to their details. All parts and percentages are by weight, unless otherwise specified. All temperatures are degrees Centigrade, unless otherwise specified.

EXAMPLE

The following process and workup was conducted in a dry nitrogen atmosphere.

Into a one gallon stainless steel reactor, equipped with stirrer, temperature sensing means, means for providing an inert gas atmosphere, an external heating means, a condenser, and means for adding reactants and removing reaction product, was charged 75 grams (2 mols) of sodium borohydride and 1800 ml of diglyme. The mixture stirred for 10-15 minutes to allow for possible interaction.

There was then added 800 grams (10 mols BH_3) of dimethylsulfideborane. The dimethylsulfideborane was added to the reaction in small increments to allow reaction of small amounts of hydroxyl impurities with the evolution of hydrogen. The condenser was maintained at $35^\circ-40^\circ C$, so that dimethylsulfide and hydrogen evolved were removed while entrained dimethylsulfideborane was returned to the reaction with negligible dissociation.

The reactor jacket was brought to $105^\circ C$, and rapid evolution of hydrogen was noted. The temperature of the reaction mixture was $95^\circ-100^\circ C$. After about five hours the temperature of the reactor jacket was increased in $10^\circ C$ increments as hydrogen evolution decreased until $140^\circ C$ was reached after two hours. The reaction mixture was then maintained at $135^\circ C$, until hydrogen evolution was very slow (i.e. 3-4 liters/hour), at least about 12 hours. The total hydrogen evolved was about 105 percent of theory based on wet test meter readings.

4

There was added to the reaction mixture 700 ml of diglyme, an amount equivalent to the dimethylsulfide removed during the reaction, and the reaction mixture cooled to $50^\circ C$. The product $Na_2B_{12}H_{12}$ was in solution.

To a receiver was charged 1500 ml of hexane and then the reactor pressurized with nitrogen and the reaction mixture transferred to the receiver under nitrogen pressure. The resultant slurry was stirred in the receiver for one hour and the liquid was then removed from the slurry. The remaining solids were similarly washed with hexane two additional times. To the remaining solids there was then added 1725 ml of 1,4 dioxane and the resultant slurry stirred for two hours. The fluid portion was removed and the solids were slurried with hexane and the fluid portion then removed. The remaining solids were again slurried in hexane and transferred to a vacuum pot where the hexane was removed by stirrer distillation.

The resultant solid product was $Na_2B_{12}H_{12}$ containing two to three moles of associated diglyme and/or 1,4 dioxane, mostly diglyme. The material was hygroscopic and was handled with minimum air exposure and stored in air tight containers.

The product was measured for boron content by carbonate fusion to determine the total boron present.

The product was titrated for boron content to determine the presence of BH_4^- and $B_3H_8^-$.

Infra-red analysis was also performed.

On three repetitions of the above, the following results were obtained:

	Recovery	Boron Content	Yield of $Na_2B_{12}H_{12}$ Base on Total Boron Charge
Run 1	518g	21.3	91.3%
Run 2	420.2g	21.4	90.4%
	78g	23.9	
Run 3	471.4g	23.3	91%

The boron analyses were run by carbonate fusion and may be low but not more than 5 percent low. Actual yields may have been 95-96 percent.

The process of the invention is operable to provide a desired product with substantial variation of the above examples, for example, by substituting other alkali metal borohydrides, such as described hereinabove, or by varying the ratio of the reactants, the reaction times, temperatures, or other process variables within the limits discussed above.

According to the provisions of the Patent Statutes, there is described above the invention and what are now considered its best embodiments; however, within the scope of the appended claims, it is understood that the invention can be practiced otherwise than as specifically described.

We claim:

1. A process for preparing an alkali metal dodecahydrododecaborate which comprises reacting at a temperature between about $90^\circ C$ and about $200^\circ C$, in an inert atmosphere and at substantially atmospheric pressure, an alkali metal borohydride or alkali metal hydride with dimethylsulfideborane for a time and at a temperature sufficient to form alkali metal dodecahydrododecaborate and removing hydrogen and dimethylsulfide from said reaction as they are formed.

2. A process, as in claim 1, wherein the reaction is conducted in the presence of an inert liquid dispersant.

5

3. A process, as in claim 2, wherein the reaction is conducted at a temperature between about 100°C. and about 150°C.

4. A process, as in claim 3, wherein the temperature of the reaction is raised incrementally during the course of the reaction.

5. A process, as in claim 2, wherein the alkali metal borohydride and the dimethylsulfideborane are reacted in about stoichiometric proportions.

6. A process, as in claim 2, wherein the alkali metal borohydride is sodium borohydride.

6

7. A process, as in claim 2, wherein the inert dispersant comprises diglyme.

8. A process, as in claim 7, wherein the process is conducted at substantially atmospheric pressure at a temperature between about 100°C. and about 150°C.

9. A process, as in claim 8, wherein the temperature of the reaction is raised incrementally during the course of the reaction.

10. A process, as in claim 2, wherein the inert liquid dispersant comprises diglyme.

* * * * *

15

20

25

30

35

40

45

50

55

60

65

United States Patent [19]

[11] **4,002,681**

Goddard

[45] **Jan. 11, 1977**

[54] **BIS-GUANIDINIUM
DECAHYDRODECABORATE AND A
PROCESS FOR ITS PREPARATION**

[75] Inventor: **Terrence P. Goddard, Aptos, Calif.**

[73] Assignee: **Teledyne McCormick Selph, an
operating division of Teledyne
Industries, Inc., Hollister, Calif.**

[22] Filed: **June 10, 1976**

[21] Appl. No.: **694,627**

[52] U.S. Cl. **260/564 D; 149/18**

[51] Int. Cl.² **C07C 129/00**

[58] Field of Search **260/564 D**

[56] **References Cited**
OTHER PUBLICATIONS
Chemical Abstracts, vol. 42, column 7498(a) (1948).

Primary Examiner—Gerald A. Schwartz
Attorney, Agent, or Firm—David H. Semmes; Warren
E. Olsen

[57] **ABSTRACT**
This invention relates to a novel boron-containing salt. Specifically, the guanidinium salt of decahydrodecaboric acid, and a process for preparing same.

1 Claim, No Drawings

BIS-GUANIDINIUM DECAHYDRODECABORATE AND A PROCESS FOR ITS PREPARATION

BACKGROUND AND BRIEF DESCRIPTION OF THE INVENTION

Boron hydride salts, in particular the nonmetal salts of decahydrodecaboric acid, have been discovered to have particular utility in the field of high energy fuels. They may be used as constituents of pyrotechnic compositions, and in rocket propellants. The present invention teaches a new nonmetal salt of decahydrodecaboric acid, which exhibits stable physical properties and exhibits several unusual pyrotechnic properties, in that the material deflagrates at a very rapid rate without the deflagration becoming a detonation.

A particular objective in preparing compounds suitable for certain types of pyrotechnic usage is to achieve a high gas output and low molecular weight combustion products, when the fuel is burned with a suitable oxidizing agent. Combustion products such as hydrogen (H₂) and nitrogen (N₂) gas fulfill this requirement. In preparing salts useful as pyrotechnic fuels from an anion such as decahydrodecaborate (-2) (B₁₀H₁₀⁻²), it is therefore advantageous to use a cation containing a high weight fraction of atomic nitrogen and hydrogen. The guanidinium ion, chemical formula C(NH₂)₃⁺¹ has been found to be such a cation. In addition, the corresponding Bronsted base of the ion, free guanidine, is a strong base, which imparts to the cation, and thus the salt, a high degree of chemical stability.

DETAILED DESCRIPTION OF INVENTION

the guanidinium salt of the decahydrodecaborate (-2) ion is represented by the chemical formula (C(NH₂)₃)₂B₁₀H₁₀. The salt is prepared by reacting one mole of guanidine carbonate, (C(NH₂)₃)₂CO₃, with one mole decahydrodecaboric acid, H₂B₁₀H₁₀, (or, as the hydronium form) (H₃O⁺)₂B₁₀H₁₀⁻², in aqueous solution.

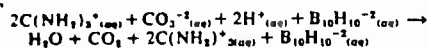

at room temperature and pressure (e.g., 20° C and 760 mm Hg). The resulting neutral solution is evaporated to dryness (which also removes carbon dioxide) to yield crystalline solid, melting point 273°-280° C. The preparation is essentially stoichiometric. The first crop yield may be further purified by recrystallization. The particle size of the resulting crystals may be controlled by the rate of crystallization.

An alternate preparation of bis-guanidinium decahydrodecaborate (-2) is accomplished by neutralizing an aqueous solution of decahydrodecaboric acid to pH 7.0 with free guanidine base (usually available as a 25% solution in ethanol), and evaporating the resulting neutral solution to dryness. The solution of free guanidine is not particularly stable, however, and the former preparative method is preferred.

The aqueous decahydrodecaboric acid used as a starting material for the process of this invention is conveniently prepared by passing an amine or metal salt of the decahydrodecaborate (-2) ion through a column containing a strongly acidic ion exchange resin of the sulfonic acid type, such as a DUOLITE type C-20, manufactured by the Diamond Shamrock Corporation. Preferred starting salts are bis (triethylammonium) decahydrodecaborate (-2) and disodium

decahydrodecaborate (-2). The preparation and properties of the aqueous acid itself are known, and reference may be made to U.S. Pat. No. 3,148,939 for further detail.

The salt described by this invention is useful as a moderate-to-high energy fuel for use in pyrotechnic compounds and rocket and gun propellants. Pyrotechnic compositions and propellants based on the bis-guanidinium decahydrodecaborate salt fill an important gap in the energy output and combustion product stoichiometry available from compositions based on other decahydrodecaboric salts. Such compositions make use of the unique decomposition properties of the decahydrodecaborate (-2) ion, a bicapped square antiprism polyhedral ion with unusual stability; the ion is believed to be kinetically rather than thermodynamically stabilized. The anion demonstrates an unusually fast decomposition upon oxidation, which is believed to proceed through the labile apical hydrogen atoms bonded to the cage. Pyrotechnic compositions based on a physical blend of certain metallic salts of this anion with various inorganic oxidizers have been recognized by ARMSTRONG, U.S. Pat. No. 3,126,305 as providing a wide range of confined burning rates. Physical blends of nonmetallic salts of the decahydrodecaborate ion, including the particular novel salt taught herein are useful to produce extremely fast deflagration rates, and various applications are described in a copending application of common assignment, entitled IGNITION AND PYROTECHNIC COMPOSITIONS, Ser. No. 694,625, filed on even date and in copending application, entitled COPRECIPITATED PYROTECHNIC COMPOSITION PROCESS AND RESULTANT PRODUCTS, Ser. No. 694,626, filed on even date.

Pyrotechnic compositions and propellants, based on the novel compound of this invention exhibit unique behavior. Despite the fact that a high energy fuel is being used, the reaction does not propagate to a detonation, as is true with most commonly used high energy fuels such as commercial and military explosive compositions.

This unusual property is due to the fact that the reaction mechanism is kinetically rather than thermodynamically controlled, i.e., the deflagration occurs in such a manner that much heat is generated in the reaction without said heat accelerating the reaction to the point of detonation. The distinction between deflagration and detonation is used in the common sense, whereby in deflagration, the chemical change or "burning" of the fuel occurs in advance of the compression front caused by the expanding gases. By contrast, in detonation the chemical reaction occurs after the compression or shock wave propagates through the composition medium. A more detailed explanation of this phenomenon may be found in a text on explosives such as C. H. Johansson and P. S. Persson "Detonics of High Explosives," Academic Press, NY., 1970.

The product of this invention, Bis-guanidinium Decahydrodecaborate, and the inventive process for making this new product is illustrated by the following example.

EXAMPLE I

6.9 liters of approximately 0.3 normal decahydrodecaboric acid is neutralized with 197 grams (1.1 moles) guanidine carbonate. The reaction is accompanied by evolution of carbon dioxide gas. The solution is

evaporated on a flash evaporator until a slush remains in the rotary flask. The crystals are filtered. A second crop is recovered by evaporating the filtrate to dryness. 249 grams (1.05 moles) of a pure white crystalline powder is recovered after vacuum drying (yield 95%). The dried powder exhibits a moisture content of 0.11%, a melting point of 279° C, a crystal (true) density of 1.11 grams per cubic centimeter, and an average particle size of 46 microns. Calculated boron content of product: 45.4%; found 41.2%.

The infrared spectrum of the compound confirms the identity of the functional groups present in the compound. the NH_2 + stretch at $3200\text{--}3500\text{ cm}^{-1}$ and N-H

an exemplary, though non-limiting, application for the product taught by the present invention.

EXAMPLE II

Hand blended mixes of the bis-guanidinium decahydrodecaborate (-2) from Example I are made with various concentrations of the following inorganic oxidizing agents: potassium nitrate, guanidine nitrate, and ammonium perchlorate. The resulting mixes are ignited in an adiabatic calorimeter, and the heat generated by the resulting deflagration is measured. The results are summarized in Table I, over a range of representative, stable burning concentrations.

TABLE I

OXIDIZER	RANGE OF CONCENTRATION, % -by-weight, bis-GUANIDINIUM DECAHYDRODECABORATE(-2)	RANGE OF HEAT OF REACTION, CALORIES/GRAM
Potassium nitrate	15% -30%	1250-1375
guanidine nitrate	8% -30%	860-990
ammonium perchlorate	14% -30%	1890-1780

bending band at 500 cm^{-1} , and the double bonded $\text{C}=\text{N}$ stretching frequencies at $1,620$ and $1,800\text{ cm}^{-1}$ confirm the presence of the guanidium ion. The B-H stretching frequency near 2500 cm^{-1} and the $\text{B}_{10}\text{H}_{10}^{-2}$ cage modes at 1030 , 1070 and 670 cm^{-1} confirm the presence of the decahydrodecaborate (-2) ion.

The utility of the product of this process may be now appreciated by the following example which illustrates

Obvious modifications and equivalents in the present invention will be evident to those skilled in the art, and the scope of the present invention is to be defined solely by the appended claims.

I claim:

1. The bis-guanidinium salt of decahydrodecaboric acid, having the formula $(\text{C}(\text{NH}_2)_2)_2\text{B}_{10}\text{H}_{10}$.

* * * * *

35

40

45

50

55

60

65

- [54] HIGH SPEED IGNITER DEVICE
- [75] Inventors: Terrence P. Goddard, Aptos; Samuel D. Webb; Donald N. Thatcher, both of Hollister, all of Calif.
- [73] Assignee: Teledyne McCormick Selph, Hollister, Calif.
- [21] Appl. No.: 738,763
- [22] Filed: Nov. 4, 1976
- [51] Int. Cl.² F42B 3/10
- [52] U.S. Cl. 102/70 R; 102/27 R; 149/22
- [58] Field of Search 149/22; 102/27 R, 70 R
- [56] References Cited

U.S. PATENT DOCUMENTS

3,041,914	7/1962	Gurton et al.	102/27 R
3,107,613	10/1963	Armstrong et al.	149/61
3,320,882	5/1967	Schulz	102/27 R
3,389,659	6/1968	Cassidy et al.	102/27 R
3,667,391	6/1972	Amiable	102/70
3,851,586	12/1974	Eller et al.	102/70 R
3,903,800	9/1975	Kilmer	102/27 R
3,945,322	3/1976	Carlson et al.	102/27 R

4,023,493	5/1977	Austin et al.	102/27 R
4,024,817	5/1977	Calder et al.	102/27 R

Primary Examiner—Edward A. Miller
 Attorney, Agent, or Firm—David H. Semmes; Warren E. Olsen

[57] ABSTRACT

An ignition device in the form of a linear member which has an internal linear propagation characteristic of a detonation, but a radial heat and gas evolution characteristic of a very fast deflagrating pyrotechnic material not accompanied by a shock or detonation wave. The device uses a central core containing an encapsulated explosive with a surrounding layer, or discrete layers, of a metal-clad pyrotechnic material that is significantly characterized by a class of compounds that are specific simple decahydrodecaborate salts containing the common anion $B_{10}H_{10}^{-2}$. The outer cladding materials themselves do not functionally ensure a radial deflagration; rather the specific pyrotechnic materials employed ensure a radial deflagration. There are taught specific relationships for components, and a necessary radial compaction.

64 Claims, 6 Drawing Figures

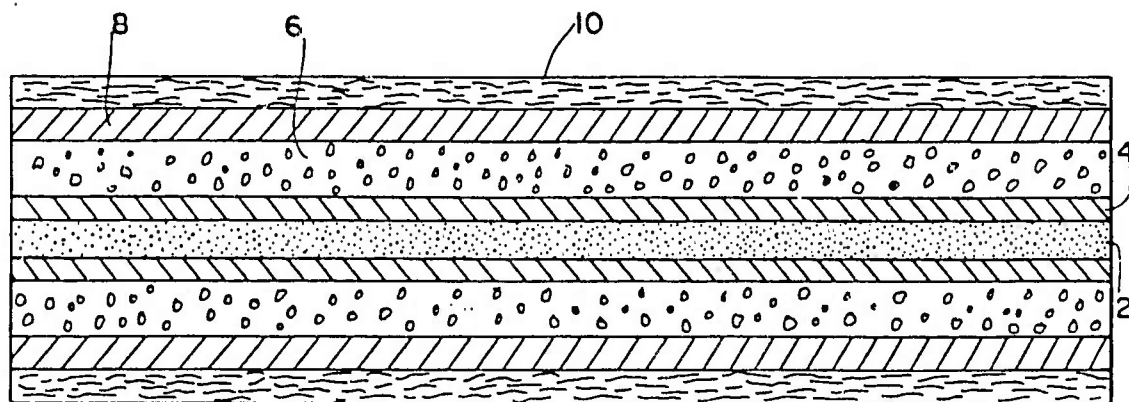

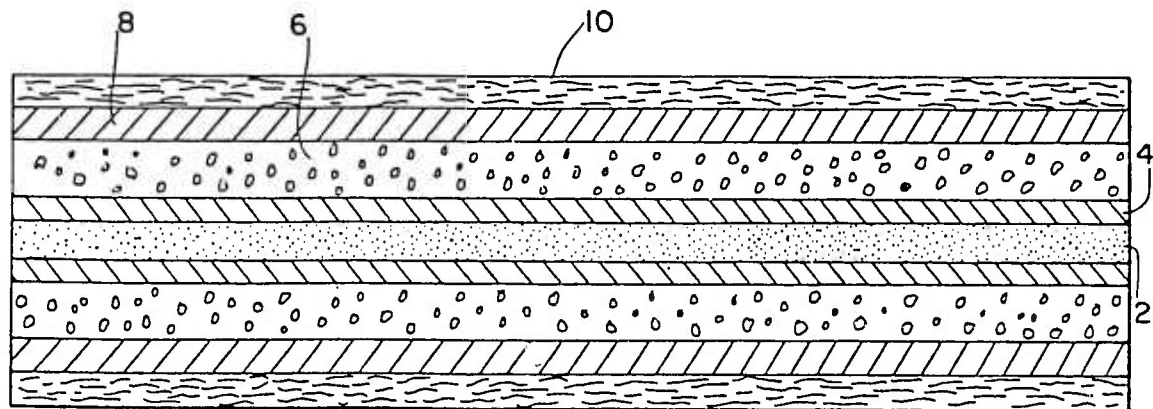

FIG. 1

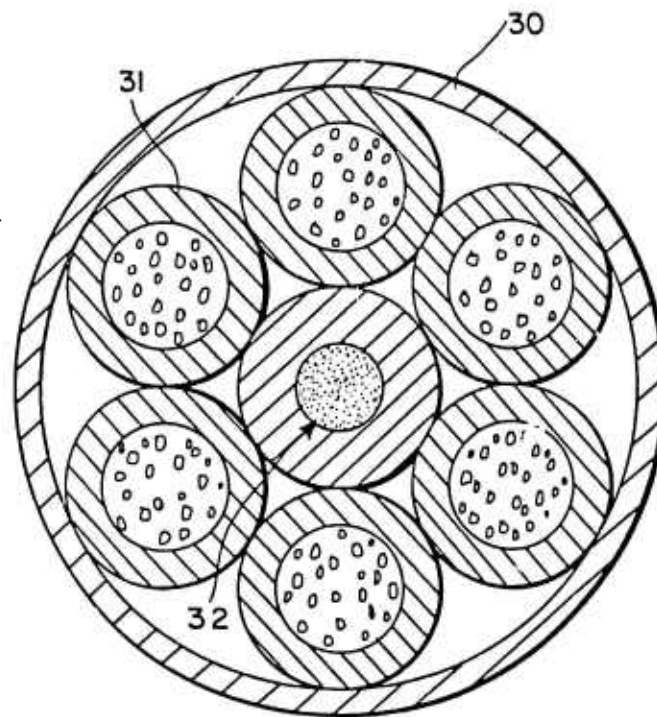

FIG. 4

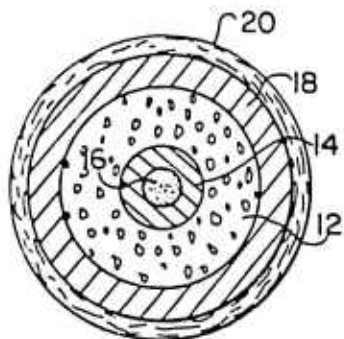

FIG. 2

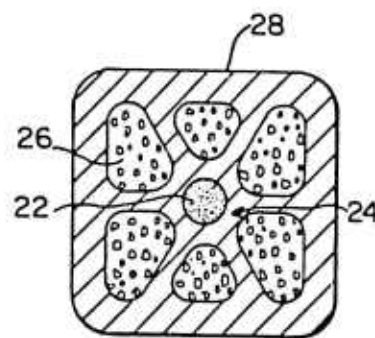

FIG. 3

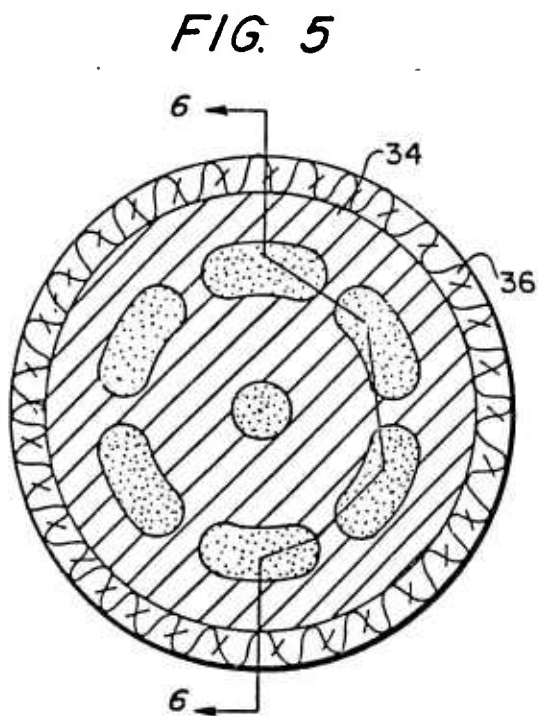

FIG. 5

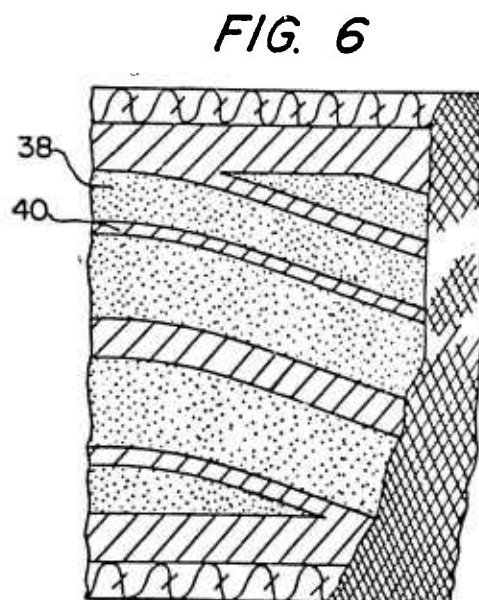

FIG. 6

HIGH SPEED IGNITER DEVICE

BACKGROUND AND SUMMARY OF THE INVENTION

For many applications, it is necessary to nearly simultaneously apply heat and gas over an extended area, for example, in the ignition of a mass of propellant or over a surface to accomplish mechanical work. This near simultaneous ignition is best accomplished by a source with a very fast propagating speed, that is, by a stimulus with a propagating velocity characteristic of a detonation. 5000 to 8000 meters per second. For the same applications, however, it is often required that the source of heat and gas which actually performs the function, for example, ignites the propellant or provides a force against a surface, be a "soft" or nondetonating stimulus. Although a detonation might provide adequate heat and gas to accomplish the intended purpose, the accompanying detonation wave cannot be tolerated because of the mechanical impulse applied to the surrounding volume. For example, many commonly used rocket or gun propellants are fashioned into complex geometric shapes termed "grains" in order to control the overall burning rate of the propellant mass. A detonation wave impinging on such grains will shatter the grain structure, thus destroying the physical configuration which is necessarily designed into the grain. What is needed, then, for these types of applications, is a device which is capable of transferring a stimulus over an extended region with a very high speed, but whose outward stimulus at the point of ignition or gas evolution is characteristic of a fast deflagration, without an accompanying shock or detonation wave.

BRIEF DESCRIPTION OF THE DRAWINGS

FIG. 1 schematically illustrates a first embodiment of the invention;

FIG. 2 schematically illustrates a second embodiment of the invention;

FIG. 3 schematically illustrates a third and preferred embodiment of the invention;

FIGS. 4 and 5 schematically illustrate compaction and area reduction according to the principles of the present invention;

FIG. 6 schematically illustrates, in partial section, a spiral pyrotechnic configuration after the area reduction.

DETAILED DESCRIPTION OF THE INVENTION

The subject invention consists basically of a central cord of explosive, that is, material capable of undergoing a detonation, surrounded by an outer layer of a rapidly burning pyrotechnic material, in particular, certain types of compounds based on salts of decahydrodecaboric acid, and manufactured in such a manner that the function of the resulting device accomplishes the desired purpose.

A linear cross sectional view of a first embodiment of the invention is shown in FIG. 1. A central core of a detonating explosive, 2, is surrounded by a sheath, 4, which may be metal or one or more layers of fiber or plastic. The central explosive core is surrounded by a pyrotechnic material, 6, selected from a class of salts of decahydrodecaboric acid blended, or coprecipitated with a suitable oxidizer. The pyrotechnic layer is in turn surrounded by a metal cladding 8. The entire assembly

is encapsulated by an outer covering, 10, which may consist of metal, plastic, or fabric.

The overall cross-sectional area of the subject device may be of virtually any geometry and depends on the exact method of manufacture. The internal cross-sectional structure may also assume a variety of forms, two of which are represented in FIGS. 2 and 3. In the second embodiment of FIG. 2 a single annulus of pyrotechnic material, 12, surrounds a sheath, 14, which contains a centrally disposed high explosive, 16. A metal cladding, 18, surrounds the pyrotechnic material 12 to allow the cross-sectional area of the entire device to be reduced by a swaging operation. After the intimate compaction of the device, as by swaging, a final outer encapsulation, 20, may be added.

In the third, and preferred, embodiment of FIG. 3, a plurality of individual metal-clad pyrotechnic cords are illustrated to have been compacted over a central explosive cord and into an overall square cross-section, such as by drawing through a succession of square dies. Alternatively, a single wagonwheel spaced metal matrix may have been employed to initially define the central high explosive and the surrounding discrete pyrotechnic sections. In either case, the overall cross-section must be reduced by swaging or drawing in order to ensure an intimate compaction of pyrotechnic with respect to the outer sheath of the detonating cord. In this third embodiment, the explosive core, 22, is sheathed by a concentrically spaced metal region, 24, with each pyrotechnic material segment 26 shown with its cladding, 28, intimately fused to the detonating cord sheathing 24.

In the embodiment of FIG. 3, the fused metal cladding 28 may also function as the encapsulating layer for the device or, optionally, a further metallic, braided or plastic encapsulation may be applied after the area reduction step.

The principle of the device function is that the central cord is detonated with a suitable source, i.e., one which will impart sufficient stimulus to the explosive material to induce a high order detonation in the material. Suitable detonators are conventional in the art, as illustrated hereinafter, and further illustration is not considered necessary to an understanding of the present invention. This stimulus propagates linearly along the central portion of the device with a speed characteristic of the detonating velocity of the detonating explosives preferred for this device, i.e., 5000 to 8000 meters per second. The explosive stimulus ignites the pyrotechnic material as it passes down the center of the cord, by the shock induced into the pyrotechnic material or the flame associated with the hot gases behind the detonation wave, or both.

Pyrotechnic materials useful in the subject device consist of a certain class of decahydrodecaboric acid salts with various oxidizers. They have a very fast deflagration mechanism, but will not detonate. The pyrotechnic material, after being ignited by the detonating stimulus, burns and the hot gases and particles from this deflagration propagate outward in a radial direction with an effective velocity less than that characteristic of a detonation, typically 10,000 inches per second. The shock wave associated with the detonating stimulus is completely absorbed by the cladding and encapsulating layers around the pyrotechnic material, so that a source outside the device experiences only the effects of the deflagrating pyrotechnic, and does not witness a shock wave associated with the detonation. The effective rate

of propagation of the deflagrating stimulus in the linear direction, however, is very fast, i.e., that of the detonation front.

The method of manufacturing the devices is critical in that the final geometrical configuration of the device must allow an efficient ignition of the pyrotechnic material. This condition may be stated as a criterion that the pyrotechnic material and the cladding around it be intimately juxtapositioned with the detonating explosive material, through intimate contact with and around the central detonating member. This condition may be achieved if the layers of pyrotechnic material, explosive material, and successive layers of encapsulment are first assembled in loose form and then the cross-sectional area of the loose assembly is reduced until the components are tightly squeezed together.

The device may be further appreciated by a consideration of its significant components, and their interactions, as follows.

DETONATING HIGH EXPLOSIVE CORD

The function of the central explosive cord is to propagate the explosive stimulus at a high linear velocity, and simultaneously ignite the pyrotechnic decahydrodecaborate composition surrounding the cord. In order to accomplish the latter, the explosive must possess sufficient force to shatter the metal separating it from the pyrotechnic, and have sufficient heat output to ignite the pyrotechnic composition.

A convenient method of packaging the said explosive in a cord form to accomplish the intended purpose is to surround the linear explosive in a metal sheath, such as lead, silver, or aluminum, and draw or swage the resulting assembly through a series of dies until the desired distribution of explosive in the resulting cord is obtained. Such a swaging procedure is well known to those practiced in the art. The distribution of explosive is normally measured by the weight of explosives in grains per linear foot of cord; the ratio of the weight of sheathing metal to the weight of explosive per linear foot may be conveniently defined as the "mass ratio." The requirements of the explosive to propagate at the desired speed and ignite the pyrotechnic composition place certain restrictions on the type of explosive, the core load, and mass ratio preferred for the explosive cords useful in this invention.

Preferred explosive materials for the cords incorporated in this invention are materials which have a brisance equal to at least 90% that of trinitrotoluene (TNT), and a heat of explosion in excess of 600 calories per gram. The term brisance reference to the shattering power of the explosive and the heat of explosion refers to the self-contained energy released when the subject material undergoes a detonation; these definitions are elaborated upon in any common reference work on explosives, such as Basil T. Fedoroff, "Encyclopedia of Explosives and Related Items." Representative high explosive materials which have properties satisfactory for the present invention, and which can be readily incorporated into the detonating cords, are cyclotri-methylenetrinitramine (RDX), cyclotetramethylenetetranitramine (beta-HMX), pentaerythritol (PETN), hexanitrostilbene (HNS), and dipicramid (DIPAM).

Preferred sheathing metals for the forementioned explosives are aluminum, silver, and lead, the lead material being especially preferred for the cords useful in this invention. Preferred limits on the explosive distributions and mass ratios of the forementioned explosives in

lead sheathed cords useful in this invention are given in Table I.

In general, the higher mass ratios correspond to the lower limits of core load. The mass ratio for a detonating cord does not change during a swaging operation that reduces the core loading, i.e., the detonating cord is elongated, but the total ratio of lead to explosive remains substantially constant for any final outer diameter given to the detonating cord.

TABLE I

Explosive	Explosive Distribution (Core Load) Grains per linear foot	Mass Ratio (Ratio of weight of lead to weight of explosive)
RDX	2 - 6	50 - 12
HMX	2 - 6	50 - 12
PETN	2 - 6	50 - 12
DIPAM	4 - 10	50 - 15
HNS	4 - 10	50 - 15

An alternate embodiment of encapsulation on the explosive particles herein is a flexible, extruded cord consisting of an explosive, with the forementioned properties, bonded with a viscoelastic binder such as nitrile rubber or nitrocellulose. An example of such a flexible cord is described by Evans in U.S. Pat. No. 3,338,764. The core loads of the said explosive in a flexible form are as given in Table I; preferred flexible-type cords for use in this invention may also contain an additional form of explosive encapsulation through a further outer layer of a flexible inert material.

Decahydrodecaborate Compounds

The pyrotechnic compositions taught for use in the present invention consist either of an intimate blend, or a coprecipitate, of certain simple salts of decahydrodecaboric acid with an oxidizing agent, and may optionally include small amounts of other materials such as finely divided metals or small amounts of binder. The key ingredient is a simple decahydrodecaborate salt of a certain class, and these distinguish the pyrotechnic compositions within this invention from other pyrotechnic or incendiary compositions.

The pyrotechnic materials taught for this invention are unusual in that the subject class of pyrotechnic compositions do not exhibit a detonation upon confinement. Normally, the burning of any composition containing a high energy component, such as those employing nitroglycerine or other commercial explosives, black powder, and compositions employing a free metal and oxidizer, such as aluminum and potassium perchlorate, results in a transformation to a detonation under even mild confinement conditions, making them unsuitable for ignition purposes. The compounds of this invention, however, can be formulated to deflagrate uniformly with a very fast rate, but not detonate. Thus, the advantages of extremely high heat and gas output, without the accompanying detonation shock effects, are achieved in the present invention.

The simple decahydrodecaborate salts taught for use herein are compounds of the general chemical formula:



where M is a cation or complex cation incorporating hydrogen, nitrogen, carbon, or metals, or some combination thereof, and is chosen from the list given below; x is the number of M ions; and y is equal to:

(x times the valence of the M ion)/2

The compounds may further be defined as certain salts of decahydrodecaboric acid, and thus contain, as a common ion the decahydrodecaborate (-2) anion $B_{10}H_{10}^{-2}$.

The cation M is herein defined by the following classes:

A. ammonium, NH_4^+ , wherein the salt has the formula $(NH_4)_x B_{10}H_{10}$ and is described by KNOTH U.S. Pat. No. 3,148,938.

B. hydrazinium, $NH_2NH_3^+$, wherein the salt has the formula $(NH_2NH_3)_x B_{10}H_{10}$ and is described by KNOTH U.S. Pat. No. 3,148,938.

C. substituted ammonium cations, wherein the salt has the general formula $(R_3NH)_x B_{10}H_{10}$, where R can be hydrogen (H) or alkyl radical (preferred radicals contain less than six (6) carbon atoms). The R's in the preceding formula may represent different alkyl groups. Compounds with two or three hydrogen radicals are described by KNOTH U.S. Pat. No. 3,149,163. Typical cations are methylammonium $(CH_3)NH_3$, dimethylammonium $(CH_3)_2NH_3$, trimethylammonium $(CH_3)_3NH$, and triethylammonium $(CH_3CH_2)_3NH$.

D. substituted hydrazinium cations, wherein the salt has the general formula $(R_2NNR_2H)_x B_{10}H_{10}$, where R can be hydrogen (H) or an alkyl radical (preferred radicals contain less than six (6) carbon atoms), and the substituted alkyl groups can be symmetric or asymmetric with respect to the $N=N$ linkage. Symmetric substituted cations are described by KNOTH U.S. Pat. No. 3,149,163. An example of an unsymmetric substituted cation is (1,1) dimethylhydrazinium. The R's in the preceding formula may be mixed alkyl radicals.

E. quaternary ammonium salts of the general formula $(R_4N)_x B_{10}H_{10}$, where R is an alkyl radical; the R's in the preceding formula may represent mixed alkyl groups. Examples of typical cations are tetramethylammonium $(CH_3)_4N^+$ and tetraethylammonium $(CH_3CH_2)_4N$.

F. aryl containing cations, such as pyridinium, bipyridinium, or substituted aryl cations, such as aryl-diazonium cations.

G. guanidinium ion, $C(NH_2)_3^+$, wherein the salt has the formula $(C(NH_2)_3)_x B_{10}H_{10}$ and is further described in a copending application of common assignment entitled BIS-GUANDINIUM DECAHYDRODECABORATE, filed June 10, 1976, with Ser. No. 694,627.

H. metal ions, derived from metals defined by a Periodic Table such as that in the "Handbook of Chemistry and Physics," 54th Edition, inside front cover, by the elements in Groups 1, 2, 8, 3b, 4b, 5b, 6b and 7b, and the elements of Groups 3a, 4a, 5a, and 6a with atomic numbers greater than 5, 14, 33, and 52 respectively. These metal decahydrodecaborate salts are further described by KNOTH U.S. Pat. No. 3,148,939. Representative examples of such metal salts are $Cs_2B_{10}H_{10}$ and $K_2B_{10}H_{10}$, the simple cesium and potassium salts of decahydrodecaborate acid.

These simple salts of the decahydrodecaborate (-2) ion (chemical formula $B_{10}H_{10}^{-2}$) are conveniently prepared by stoichiometrically reacting an aqueous solution of the parent acid, dihydrogen decahydrodecaborate, $H_2B_{10}H_{10}$ with

1. a soluble hydroxide of the desired cation, such as ammonium hydroxide,

2. the conjugate Bronsted base of the desired cation, such as a free amine, or

3. a soluble salt of the desired cation, such that the salt anion is destroyed during the reaction, such as guanidine carbonate. A Bronsted base is any substance capable of accepting a proton in a reaction; the definition is elaborated upon in any elementary chemistry text, such as Dickerson, Gray and Haight, "Chemical Principles, 2nd Edition," 1974, pg. 135.

The aqueous solutions of the salts, prepared above, may be evaporated to dryness to recover the crystalline salt. Alternately, some salts may be precipitated from the aqueous solution by a nonsolvent that is miscible with water. The salts may be purified by recrystallization.

The aqueous decahydrodecaboric acid used as a starting material for the process of this invention is conveniently prepared by passing an amine or metal salt of the decahydrodecaborate (-2) ion through a column containing a strongly acidic ion exchange resin of the sulfonic acid type, such as "Duolite" type "C-20", acid form (Diamond Shamrock Corporation). Preferred starting salts are bis (triethylammonium) decahydrodecaborate (-2) and disodium decahydrodecaborate (-2). The preparation and properties of the aqueous acid and additional preparative methods for metallic salts are described in more detail in U.S. Pat. No. 3,148,939.

The compositions of this invention make use of the unique decomposition properties of the decahydrodecaborate (-2) ion, a bicapped square antiprism polyhedral ion with unusual stability; the ion is believed to be kinetically rather than thermodynamically stabilized. The ion demonstrates an unusually fast decomposition upon oxidation, which is believed to proceed through the labile apical hydrogen atoms bonded to the cage.

The pyrotechnic compositions contemplated for use within the present invention are conveniently further divisible into two classes, said classes being distinguished by the method of combining the simple decahydrodecaborate salt with the oxidizer.

Class (1)

The compositions of Class (1) consist of intimate physical mixtures of a decahydrodecaborate salt, selected from the forementioned list of such salts, with a finely divided oxidizing agent.

The compositions of this invention are prepared by intimately mixing the finely divided constituents by hand or in conventional mixing equipment. A liquid carrier such as butyl acetate or trichloroethylene may be employed to facilitate mixing or addition of binder; the liquid is subsequently evaporated to yield the dry composition.

The particle size of such decahydrodecaborate (-2) salts are controlled during their preparation of the reaction conditions, method of recrystallization, speed of recrystallization, and optionally, by subsequently grinding and/or sieving, with or without a liquid carrier. The particle size of the oxidizing agent is controlled commonly by grinding to the prescribed particle size, with subsequent sieving. The sieve size for both decahydrodecaborate salt and oxidizer is normally between the limits 40 mesh and 325 mesh (which specifies only the maximum particle size in the mix).

Non-metallic pyrotechnic compositions of Class (1) are further described in detail in a copending application of common assignment entitled IGNITION AND PYROTECHNIC COMPOSITIONS, filed June 10,

1976 and assigned Ser. No. 694,625, which is incorporated herein by reference. Metallic pyrotechnic compositions included within class (1) are further described in Armstrong, U.S. Pat. No. 3,126,305.

Class (2)

The compositions of Class (2) are comprised of an intimate blend of a decahydrodecaborate salt, selected from the preceding list, with an oxidizing agent, in a manner such that a chemically and physically different product is obtained from the starting materials.

The process by which the compositions of this class are prepared produces a very intimate blend of decahydrodecaborate (-2) ion with the oxidizer and makes the compositions so prepared chemically and physically unique from physical blends of decahydrodecaborates (-2) salts with oxidizer or pyrotechnic compositions incorporating decahydrodecaborate (-2) salts produced by other means. In general, the process consists of dissolving, in a suitable solvent, a decahydrodecaborate (-2) salt, as described above, and also dissolving, in the same solution, an oxidizing agent, as described above. The subject composition is recovered by precipitating the composite ingredients of the solution with a suitable nonsolvent. The resulting solid, after filtration and drying, comprises an intimate mixture of the decahydrodecaborate (-2) anion with the oxidizing cation or substance, in a form that is chemically and physically different than the starting materials.

The process may be properly called a "cocrystallization" or "coprecipitation" and the resulting produce a "cocrystallate" or "coprecipitate."

The materials of Class (2) and process for preparing them is described in more detail in a copending application of common assignment entitled COPRECIPI-TATED PYROTECHNIC COMPOSITION PRO-CESSSES AND RESULTANT PRODUCTS, filed June 10, 1976 as Ser. No. 694,626, which is incorporated herein by reference.

The essential component of both Class (1) and Class (2) compositions is an oxidizing agent i.e., a material that will readily react or burn when mixed with the decahydrodecaborate (-2) salt. Any solid oxidizing agent which will yield oxygen upon decomposition will fulfill this role; solid oxygen containing metal or non-metal salts are preferred because of their availability, stability, and ease of incorporation into the composition. Solid oxidizing agents useful in Class (2) must meet certain solubility criteria, as listed in the referenced description of the coprecipitation process.

In general, solid oxidizing agents include ammonium, substituted ammonium, guanidine, substituted guanidine, alkali and alkaline-earth salts of oxygen containing acids such as nitric, perchloric, permanganic, manganic, chromic, and dichromic acids. Preferred species for this invention, which gave good thermal stability and low hygroscopicity include ammonium nitrate, potassium nitrate, potassium perchlorate, ammonium perchlorate, guanidine nitrate, triaminoguanidine nitrate, potassium permanganate, sodium chromate, barium nitrate, barium chromate, barium manganate, sodium dichromate, tetramethylammonium nitrate and cesium nitrate. Other solid oxidizing agents which could be used if the appropriate solvent/nonsolvent system were used include ammonium, substituted ammonium, guanidine, substituted guanidine, alkali and alkaline-earth salts of other oxygen-containing acids such as chloric, persulfuric, thiosulfuric, periodic, iodic and bromic acids. Other

stable oxidizers include lead thiocyanate, the oxides and peroxides of the light and heavy metals and nonmetals, such as barium peroxide, lead peroxide (PbO_2), lithium peroxide, ferric oxide, red lead (Pb_3O_4), cupric oxide, tellurium dioxide, antimonite oxide, etc., and nonionic substances such as nitrocellulose, nitroguanidine, and cyclotetramethylenetetranitramine (HMX). Mixtures of the aforementioned oxidizing agents can also be used.

Optionally, additives to both Class (1) and (2) compositions may be employed to alter the processing, handling, or other properties of the mix. These may include binders such as caesin, gum arabic, dextrans, waxes, polymeric materials such as polyurethanes, epoxies, natural or synthetic rubbers, copolymers of a rubber and plastic such as styrene-butadiene, methyl cellulose, and nitrocellulose. Polyethylene glycol of average molecular weight 4000 is a preferred species. These optional ingredients would commonly be used in concentrations up to 8% by weight of the total weight of the pyrotechnic materials used as taught herein.

The pyrotechnic compounds taught herein preferably have the particular salts of decahydrodecaboric acid constituting from between approximately 6-30% by weight of the total pyrotechnic compound. With respect to the simple nonmetallic salts, critical mole ratios of salt to oxidizer have been discovered, as further elaborated upon in the copending application Ser. No. 694,625, previously incorporated by reference herein.

A convenient method of packaging the decahydrodecaborate salt pyrotechnic compositions for incorporation into the subject ignition devices is to first clad the pyrotechnic composition within a metal tube to form a linear cord, in a manner identical with that described for sheathing the high explosive detonating cords. Multiple cords of the pyrotechnic material can then be used to fabricate the subject device, by laying or spiraling the pyrotechnic cords around the central explosive cord. Lead is a preferred cladding metal; pyrotechnic core loads between 3 and 80 grains of composition per linear foot and mass ratios between 8 and 35 are preferred for pyrotechnic cords taught for the subject ignition devices.

As has been noted, the present invention significantly requires an intimate juxtapositioning of the subject pyrotechnics around the sheathed detonating high explosive cord. Hence, a consideration of an exemplary manufacturing procedure is helpful to a further understanding of the present invention.

Manufacture of Ignition Devices

The method of manufacturing the subject ignitor devices is critical to their successful function. The principle of operation of the device requires that the explosive stimulus shatter the layer or layers of sheathing materials separating the explosive materials from the pyrotechnic material, and either by shock or flame stimulus, ignite the pyrotechnic materials. This requirement can be embodied in a cord in which the successive layers of material — central explosive composition, layer or layers of sheathing material, and pyrotechnic composition are in intimate contact, and the sheathing layer is thin enough to shatter or effectively transmit the explosive shock and accompanying flame to the pyrotechnic material.

A preferred method of manufacturing the subject devices which fulfills the aforementioned requirement consists of first assembling a bundle consisting of a central explosive cord, which may be of an extruded or

metal sheathed configuration, as described above, and surrounding it with several cords, consisting of metal clad decahydrodecaborate pyrotechnic materials as defined above. The pyrotechnic cords may be extended in a linear form along the central explosive cord. The number of cords is not critical, but the number must be sufficient to incorporate the desired distribution of pyrotechnic in the final device; in general, for ease of handling, more than three and less than 13 cords are preferred. The method of assembling the pyrotechnic cords around the central core is determined somewhat by the diameters of the pyrotechnic cords and the central cord, and it is essential that each of the pyrotechnic cords be in intimate contact with the explosive along its full length. This requirement eliminates, for example, such configurations as those made by braiding the pyrotechnic cords around the central cord.

The critical manufacturing step in this and other methods of manufacturing the subject devices consists in achieving a cross-sectional area reduction on the assembled bundle, so that the pyrotechnic cladding and explosive cord sheath are brought into very intimate contact, in essence, fused together. FIG. 4 illustrates that a convenient way of bringing about the area reduction is to place a number of metal clad pyrotechnic cords 31 about sheathed detonating cord 32, and fit this bundle inside a tightly fitting outer tube of a metal, such as lead, aluminum, or silver, as shown at 30. The pyrotechnic cords 31 are preferably spiraled about cord 32. The tube and bundle assembly is then swaged or drawn through a series of dies such that the cross-sectional area of the assembly is reduced, for example to the configuration 34 shown in FIG. 5. The area reduction results in deformation and elongation of the bundle inside the tube, bringing the respective explosive sheathing layer and pyrotechnic cladding layers into very tight contact. Preferred area reductions which will accomplish the required compaction and deformation are 10 to 60%. The configuration 34 may include the tube 30, or the tube 30 may be removed to leave a metallic matrix of the sheathing, cladding, explosive and pyrotechnic.

An alternate method of providing the required area reduction consists of drawing or swaging the assembled cord bundle through a series of dies without using a metal tube as an additional outer cladding cover. In this form, a layer of glass or fabric, such as 36 in FIG. 5, may then be braided over the external surface of the finished device, or alternately, an extruded plastic layer may be applied on the outer surface. Such an outer covering or encapsulment is required only to protect or hold the assembly together; the radial deflagration phenomenon derives from the unique pyrotechnic materials themselves. This latter method of manufacture is preferred when a low metal content is desired for the finished device, such as for use in large caliber gun ignitors or where light weight in the device is a system requirement.

FIG. 6 illustrates, in a sectional view, spirals of pyrotechnic, 38, around the sheathed detonating cord, with metallic cladding 40 fused between respective spirals.

The cross-sectional configuration of the finished device is not critical, and can be altered by the cross-sectional configuration of the dies used to produce the final device. Examples of geometric cross-sectional shapes which are satisfactory for the subject devices include round, square, oval, or hexagonal.

Other methods of manufacture of the subject devices which bring about the required intimacy of the individual components will be evident to those practiced in the art of assembly of linear and cord explosive and pyrotechnic devices, and the above method of manufacture is not intended to be limiting. For example, the subject devices could alternatively be manufactured by suspending the explosive central cord concentrically in a metal tube whose inside diameter is larger than the outside diameter of the central cord, and the void formed by these surfaces filled with the decahydrodecaborate pyrotechnic material. Spacers inserted at intervals, as the pyrotechnic material is loaded, could serve to support the central cord and improve uniformity of the pyrotechnic loading. The loaded assembly would then be capped and drawn through a series of dies until the desired compaction and area reduction is achieved.

Alternately, one could start with a metal tube whose cross-sectional area resembles a wagon wheel, i.e., with a central "hub" or enclosed aperture into which the explosive material is introduced with a series of outer apertures, mutually separated from each other by the "spokes" into which the pyrotechnic material is loaded. The assembly is capped and the area reduced in the same manner as described above, in order to achieve the required intimate compaction of all the components within the resultant matrix defining the present invention.

It should be noted that the area reduction is considered necessary for all configurations and embodiments, and specific examples now follow to further illustrate manufacturing principles and resultant ignition functions according to the various embodiments of the present invention.

Through the following examples, the significant parameters of the present invention are illustrated. In each example the detonating cords and pyrotechnic cords are referenced to their respective linear distributions and mass ratios. It should be noted that the initial outer diameters of the various high explosive detonating cords, and the initial outer diameters and numbers of concentrically arranged pyrotechnic cords are not particularly critical.

In the following examples, the detonating cords had initial outer diameters of approximately 0.080 inches. The metal-clad pyrotechnic cords had initial outer diameters in the range 0.080 to 0.125 inches. Of course, the definition of either component by linear distribution, of explosive or pyrotechnic material, and its associated mass ratio practically defines the approximate outer diameters. During the mechanical forming manufacturing step, the metal cladding is radically compressed upon the respective crystalline explosive and pyrotechnic components, increasing their respective densities, without effecting the overall mass ratios of each component at all. The area reduction mechanism is the results in the filling of any initial voids to create an intimate metallic matrix around substantially compacted explosive and pyrotechnic volumes.

EXAMPLE I

A bundle consisting of one central denoting high-explosive cord of lead sheathed RDX, 2.5 grains per linear foot and mass ratio 42, is surrounded by 6 lead clad pyrotechnic cords containing 25%-by-weight cesium decahydrodecaborate coprecipitated with 75%-by-weight potassium nitrate, 12.5 grains per linear foot

and of mass ratio 15. The pyrotechnic cords are positioned linearly along the explosive cord length and inserted inside a lead tube of outside diameter 0.628 inches, simply, to act as a further outer encapsulment for the assembly. The cord and tube assembly is swaged to an outside diameter of 0.532 inches, corresponding to an area reduction of 28%. The finished assembly inside the tube is approximately 18 inches long, with 8 inch leads of all the cords protruding from both ends. The above-noted linear distributions of explosive and pyrotechnic materials remained substantially constant through the area reduction.

The unit is securely mounted on a test stand. The pyrotechnic cords on one end of the unit are capped and shielded from the explosive cord ends by an aluminum plate, such that the uncapped end of the explosive cord protrudes through a hole in the plate while the pyrotechnic cords remain behind the plate. The purpose of the plate is to shield the pyrotechnic lines from the detonator and explosive cord flash, to demonstrate that the lines ignited inside the swaged tube by the confined explosive impetus. A number 8 detonating cap is attached to the protruding explosive cord.

The unit is functioned by remotely detonating the cap. High speed motion picture photography demonstrates that the unit has a linear propagation in excess of 5400 meters per second, characteristic of the RDX detonation front speed, and has a radial expansion of approximately 250 meters per second (9800 inches per second), characteristic of the decahydrodecaborate deflagration speed. Post fire examination of the remains show that all the pyrotechnic cords have completely ignited. Several small fragments of the outer encapsulating tube remain.

EXAMPLE II

A bundle consisting of one central detonating high-explosive cord of lead sheathed RDX, 2.4 grains per linear foot and mass ratio 42, is surrounded by 5 lead clad pyrotechnic cords containing 15%-by-weight bis-tetramethylammonium decahydrodecaborate coprecipitated with 85%-by-weight potassium nitrate, 15 grains per linear foot and of mass ratio 12. The pyrotechnic cords are spiraled around the explosive cord length and inserted inside a lead tube of outside diameter 0.455 inches which serves as an outer encapsulment. The cord and tube assembly is swaged to an outside diameter of 0.348 inches, corresponding to an area reduction of 42%. The finished assembly inside the outer tube is approximately 18 inches long, with 8 inch leads of all the cords protruding from both ends.

The unit is tested in a manner identical with Example I. All pyrotechnic cords function completely. Several small fragments of the outer encapsulation remain. The event is characterized audially by a loud "crack," indicating to those practiced in the art that the effective event was a deflagration rather than a detonation.

EXAMPLE III

A bundle consisting of one central detonating high-explosive cord of lead sheathed RDX, 2.5 grains per linear foot and mass ratio 42, is surrounded by 6 lead clad pyrotechnic cords containing 25%-by-weight cesium decahydrodecaborate coprecipitated with 75%-by-weight potassium nitrate, 12.5 grains per linear foot and of mass ratio 15. The pyrotechnic cords are arranged linearly along the explosive cord length and inserted inside an encapsulment tube of aluminum, of

outer diameter 0.500 inches. The cord and tube assembly is swaged to an outside diameter of 0.401 inches, corresponding to an area reduction of 36%. The finished assembly inside the tube is approximately 12 inches long, with 8 inch leads of all the cords protruding from both ends.

The unit is tested in a manner identical with Example I. All pyrotechnic cords function completely. The outer aluminum encapsulating layer is ruptured. High speed motion picture photography indicates the linear propagation speed is that characteristic of a detonation.

EXAMPLE IV

A bundle consisting of one central detonating high-explosive cord of lead sheathed HNS, 4.1 grains per linear foot and mass ratio 44, is surrounded by 5 lead-clad pyrotechnic cords, each containing 15%-by-weight bis-tetramethylammonium decahydrodecaborate coprecipitated with 75%-by-weight potassium nitrate, 27 grains per linear foot and mass ratio 8. The pyrotechnic cords are spiraled around the central cord explosive length and held in place with tape. The finished assembly is drawn through a square die to a dimension 0.200 inch on a side. The area reduction is 48%. The drawn assembly is then braided over its exterior surface with a tight braid of fiberglass in a loose (open) weave. This form of outer encapsulment is used merely to protect the igniter configuration. Eight inches of each of the cords protrudes from the end of the finished assembly, which is approximately 18 inches long.

The unit is mounted in a test fixture in a manner identical with Example I except that a chicken wire screen envelopes the entire assembly to capture any fragments that may remain after function.

The unit is tested in a manner identical with Example I. High speed motion picture photography confirms that the longitudinal propagation velocity is in excess of 6000 meters per second and the radial expansion approximately 250 meters per second. No fragments of any kind remain in the test setup, indicating that the unit functioned completely, vaporizing the lead matrix as well as all of the outer encapsulating materials. This example illustrates functioning of the preferred embodiment of the invention, as illustrated in FIG. 3 of the drawings.

EXAMPLE V

A 36 inch length of lead sheathed RDX, 2.5 grains per foot and mass ratio 42, is taped tightly on an aluminum plate against an aluminum clad pyrotechnic cord containing 25%-by-weight cesium decahydrodecaborate coprecipitated with 75%-by-weight potassium nitrate, 12 grains per linear foot and mass ratio 14. The ends of the pyrotechnic cord are coated with an epoxy and shielded from the ends of the explosive cord. A number 8 detonating cap is attached to the explosive cord and detonated.

The detonating cap is functioned remotely. The explosive cord functions completely. The pyrotechnic cord fails to ignite. The test demonstrates that the explosive and pyrotechnic cords must be brought into intimate contact by a drawing or swaging process as a requirement for successful manufacture of the devices taught by the present invention.

EXAMPLE VI

A bundle consisting of one central cord of lead sheathed HNS, 4.1 grains per linear foot and mass ratio

42, is surrounded by 6 lead-clad pyrotechnic cords containing 15%-by-weight bis-tetramethylammonium decahydrodecaborate which has been coprecipitated with 85%-by-weight potassium nitrate as taught herein. Each cord has a pyrotechnic distribution of 7.3 grains per linear foot and a mass ratio of 35. The pyrotechnic cords are spiraled around the explosive cord length and inserted inside a lead tube of outside diameter 0.628 inches. The cord and tube assembly is swaged to an outside diameter of 0.532 inches, corresponding to an area reduction of 28%. The finished assembly inside the tube is approximately 18 inches long, with 8 inch leads of all the cords protruding from both ends.

The unit is tested in a manner identical with Example 1. Four of the pyrotechnic lines fail to function and the lead tube fails to rupture. The test places an upper limit on the mass ratio of the pyrotechnic cord and a lower limit on the distribution of explosive HNS material.

EXAMPLE VII

A bundle consisting of one central cord of lead sheathed RDX, 2.5 grains per linear foot and mass ratio 42, is surrounded by 6 lead-clad pyrotechnic cords containing 15%-by-weight bis-tetramethylammonium coprecipitated with 85%-by-weight potassium nitrate, 7.3 grains per linear foot and of mass ratio 35. The pyrotechnic cords are braided around the explosive cord length and inserted inside a lead tube of outside diameter 0.750 inches. The cord and tube assembly is swaged to an outside diameter of 0.532 inches, corresponding to an area reduction of 49%. The finished assembly inside the tube is approximately 18 inches long, with 8 inch leads of all the cords protruding from both ends.

The unit is tested in a manner identical with Example 1. Two of the pyrotechnic cords fail to function completely. In several locations the lead tube ruptures. In one rupture, examination of the functioned unit reveals that all six pyrotechnic lines have been ignited at one point but one has failed to propagate. The break in the pyrotechnic cord was at a point on the cord braid where the failed line overlapped another (functioned) line, i.e., the pyrotechnic line was not in intimate contact with the explosive cord at the failure point.

The test demonstrates that the pyrotechnic line must be in intimate contact with the explosive cord over its entire length.

Having described various embodiments of our invention, it is understood that the invention is to be limited only by the scope of the appended claims.

We claim:

1. In an igniter device comprising a centrally disposed high explosive which is linearly encapsulated, the improvement comprising a linear distribution of metal clad pyrotechnic material about said encapsulation and in intimate contact therewith, wherein said pyrotechnic material includes an oxidizing agent combined with a simple decahydrodecaborate salt, having the common anion $B_{10}H_{10}^{-2}$ wherein the cation is selected from the group consisting of:

- i. ammonium, wherein the salt has the formula $(NH_4)_2B_{10}H_{10}$;
- ii. hydrazinium, wherein the salt has the general formula $(NH_2NH_2)_2B_{10}H_{10}$;
- iii. substituted ammonium cations, wherein the salt has the general formula $(R_3NH)_2B_{10}H_{10}$, wherein further R is selected from the group consisting of hydrogen and alkyl radicals containing less than six carbon atoms;

iv. substituted hydrazinium cations, wherein the salt has the general formula $(R_2NNR_2H)_2B_{10}H_{10}$ wherein further R is selected from the group consisting of hydrogen and alkyl radicals containing less than six atoms.

2. In an igniter device comprising a centrally disposed high explosive which is linearly encapsulated, the improvement comprising a linear distribution of metal clad pyrotechnic material about said encapsulation and in intimate contact therewith, wherein said pyrotechnic material includes an oxidizing agent combined with a simple decahydrodecaborate salt, having the common anion $B_{10}H_{10}^{-2}$ wherein the cation is selected from the group consisting of:

- i. tetramethylammonium $(CH_3)_4N^+$, tetraethylammonium $(CH_3CH_2)_4N^+$, and quaternary ammonium cations having the general formula R_4N^+ where R is an alkyl radical;
- ii. pyridinium, bipyridinium aryl-diazonium, aryl containing cations and substituted aryl containing cations.

3. In an igniter device comprising a centrally disposed high explosive which is linearly encapsulated, the improvement comprising a linear distribution of metal clad pyrotechnic material about said encapsulation and in intimate contact therewith, wherein said pyrotechnic material includes an oxidizing agent combined with a simple decahydrodecaborate salt, having the anion $B_{10}H_{10}^{-2}$, wherein the cation is guanidinium, and the salt has the formula $(C(NH_2)_3)_2B_{10}H_{10}$.

4. In an igniter device comprising a centrally disposed high explosive which is linearly encapsulated, the improvement comprising a linear distribution of metal clad pyrotechnic material about said encapsulation and in intimate contact therewith, wherein said pyrotechnic material includes an oxidizing agent combined with a simple metallic decahydrodecaborate salt, having the common anion $B_{10}H_{10}^{-2}$, wherein the cation is selected from the group consisting of:

- i. metal ions derived from the elements in Groups 1, 2, 8, 3b, 4b, 5b, 6b, 7b, and the elements of Groups 3a, 4a, 5a, and 6a which have atomic numbers respectively greater than 5, 14, 33 and 52.

5. An igniter device as in claim 1 wherein said device has a final configuration which is the resultant product of a process wherein an initial cross-sectional area of said igniter is radially reduced by a mechanical forming step which compacts said metal cladding radially inwardly to define a final cross-sectional area for said device which is reduced approximately 10-60 percent from said initial cross-sectional area.

6. An igniter device as in claim 5 wherein said metal cladding on said pyrotechnic is one selected from the group consisting of lead, aluminum and silver, and said simple decahydrodecaborate salt selected comprises approximately 6-30% by weight of said pyrotechnic material.

7. An igniter device as in claim 6 wherein said centrally disposed high explosive is selected from the group consisting of cyclotrimethylenetrinitramine (RDX), cyclotetramethylenetetranitramine (beta-HMX), pentaerythritol (PETN), hexanitrostilbene (HNS), and dipicramid (DIPAM), and said linear encapsulation comprises a sheath around said explosive.

8. An igniter device as in claim 7 wherein said high explosive sheath, and said metal cladding on said pyrotechnic material, are of lead, and said detonating cord has a distribution of high explosive of between approxi-

mately 2 to 6 grains per lineal foot and a mass ratio of lead to high explosive of between approximately 50 to 12, by weight.

9. An igniter device as in claim 5 wherein said pyrotechnic material includes an oxidizer selected from the group consisting of ammonium nitrate, potassium nitrate, potassium perchlorate, ammonium perchlorate, guanidine nitrate, triaminoguanidine nitrate, potassium permanganate, sodium chromate, barium nitrate, barium chromate, barium manganate, sodium dichromate, tetramethylammonium nitrate and cesium nitrate.

10. An igniter device as in claim 5 wherein said device further comprises a plurality of individual metal-clad pyrotechnic cords concentrically arranged about, and linearly extending along, said encapsulated explosive wherein said individual metal clad pyrotechnic cords are fused into a metallic matrix around said high explosive by said forming step.

11. An igniter device as in claim 5 wherein said pyrotechnic material is further the resultant product of a coprecipitation of one of said group of simple decahydrodecaborate salts, and said solid oxidizing agent, by the process of:

- i. dissolving both the decahydrodecaborate (-2) salt and the solid oxidizing agent in a mutually soluble solvent, at a temperature sufficiently high to maintain said salt and said oxidizing agent in solution;
- ii. forming a pressurized stream of said solution and brining said solution stream together with a pressurized stream of a miscible nonsolvent, under conditions of extreme turbulence within a mixing chamber, to effect a substantially complete coprecipitation;
- iii. recovering the coprecipitated product by filtering the effluent from said mixing chamber, and washing said product with an inert and nonsolvent fluid;
- iv. drying the product to remove all remaining liquid.

12. An igniter device as in claim 11 wherein said coprecipitated oxidizing agent is selected from the group consisting of ammonium nitrate, potassium nitrate, potassium perchlorate, ammonium perchlorate, guanidine nitrate, triaminoguanidine nitrate, potassium permanganate, sodium chromate, barium nitrate, barium chromate, barium manganate, sodium dichromate, tetramethylammonium nitrate and cesium nitrate.

13. An igniter device as in claim 12 wherein said device further comprises a plurality of individual metal-clad pyrotechnic cords concentrically arranged about, and linearly extending along, said encapsulated explosive wherein said individual metal clad pyrotechnic cords are fused into a metallic matrix around said high explosive by said forming step.

14. An igniter device as in claim 10 wherein said plurality of metal clad pyrotechnic cords is between 3 and 13.

15. An igniter device as in claim 13 wherein said plurality of metal clad pyrotechnic cords is between 3 and 13.

16. An igniter device as in claim 14 wherein said linear encapsulation comprises an outer sheath, and said sheath and said metal cladding on each of said pyrotechnic cords are of lead, wherein further said detonating cord has a distribution of high explosive of between approximately 2 to 6 grains per lineal foot and a mass ratio of lead to high explosive of between approximately 50 to 12, by weight, and each pyrotechnic cord has a distribution of said pyrotechnic of between approximately 3 to 80 grains per lineal foot and a mass

ratio of lead to pyrotechnic material of between approximately 3 to 35, by weight.

17. An igniter device as in claim 6 wherein said centrally disposed and linearly encapsulated explosive comprises a flexible extended cord of explosive particles within a viscoelastic binder.

18. An igniter device as in claim 17 wherein said flexible extruded cord further includes an additional sheathing defined by a separate outer layer of plastic material.

19. An igniter device as in claim 6 wherein said initial cross section of said igniter is further defined by an additional layer of an encapsulating material as an outer covering.

20. An igniter device as in claim 2 wherein said device has a final configuration which is the resultant product of a process wherein an initial cross-sectional area of said igniter is radially reduced by a mechanical forming step which compacts said metal cladding radially inwardly to define a final cross-sectional area for said device which is reduced approximately 10-60 percent from said initial cross-sectional area.

21. An igniter device as in claim 20 wherein said metal cladding on said pyrotechnic is one selected from the group consisting of lead, aluminum and silver, and said simple decahydrodecaborate salt selected comprises approximately 6-30% by weight of said pyrotechnic material, and the cation is further selected from the group consisting of tetramethyl ammonium, tetraethyl ammonium, pyridinium and aryl-diazonium cations.

22. An igniter device as in claim 21 wherein said centrally disposed high explosive is selected from the group consisting of cyclotrimethylenetrinitramine (RDX), cyclotetramethylenetetranitramine (beta-HMX), pentaerythritol (PETN), hexanitrostilbene (HNS), and dipicramid (DIPAM), and said linear encapsulation comprises a sheath around said explosive.

23. An igniter device as in claim 22 wherein said high explosive sheath, and said metal cladding on said pyrotechnic material, are of lead, and said detonating cord has a distribution of high explosive of between approximately 2 to 6 grams per lineal foot and a mass ratio of lead to high explosive of between approximately 50 to 12, by weight.

24. An igniter device as in claim 20 wherein said pyrotechnic material includes an oxidizer selected from the group consisting of ammonium nitrate, potassium nitrate, potassium perchlorate, ammonium perchlorate, guanidine nitrate, triaminoguanidine nitrate, potassium permanganate, sodium chromate, barium nitrate, barium chromate, barium manganate, sodium dichromate, tetramethylammonium nitrate and cesium nitrate.

25. An igniter device as in claim 20 wherein said device further comprises a plurality of individual metal-clad pyrotechnic cords concentrically arranged about, and linearly extending along, said encapsulated explosive wherein said individual metal clad pyrotechnic cords are fused into a metallic matrix around said high explosive by said forming step.

26. An igniter device as in claim 20 wherein said pyrotechnic material is further the resultant product of a coprecipitation of one of said group of simple decahydrodecaborate salts, and said solid oxidizing agent, by the process of:

- i. dissolving both the decahydrodecaborate (-2) salt and the solid oxidizing agent in a mutually soluble

- solvent, at a temperature sufficiently high to maintain said salt and said oxidizing agent in solution;
- ii. forming a pressurized stream of said solution and brining said solution stream together with a pressurized stream of a miscible nonsolvent, under conditions of extreme turbulence within a mixing chamber, to effect a substantially complete coprecipitation;
 - iii. recovering the coprecipitated product by filtering the effluent from said mixing chamber, and washing said product with an inert and nonsolvent fluid;
 - iv. drying the product to remove all remaining liquid.

27. An igniter device as in claim 26 wherein said coprecipitated oxidizing agent is selected from the group consisting of ammonium nitrate, potassium nitrate, potassium perchlorate, ammonium perchlorate, guanidine nitrate, triaminoguanidine nitrate, potassium permanganate, sodium chromate, barium nitrate, barium chromate, barium manganate, sodium dichromate, tetramethylammonium nitrate and cesium nitrate.

28. An igniter device as in claim 27 wherein said device further comprises a plurality of individual metal-clad pyrotechnic cords concentrically arranged about, and linearly extending along, said encapsulated explosive wherein said individual metal clad pyrotechnic cords are fused into a metallic matrix around said high explosive by said forming step.

29. An igniter device as in claim 25 wherein said plurality of metal clad pyrotechnic cords is between 3 and 13.

30. An igniter device as in claim 28 wherein said plurality of metal clad pyrotechnic cords is between 3 and 13.

31. An igniter device as in claim 29 wherein said linear encapsulation comprises an outer sheath, and said metal cladding on each of said pyrotechnic cords, are of lead, wherein further said detonating cord has a distribution of high explosive of between approximately 2 to 6 grains per lineal foot and a mass ratio of lead to high explosive of between approximately 50 to 12, by weight, each pyrotechnic cord has a distribution of said pyrotechnic of between approximately 33 to 80 grains per lineal foot and a mass ratio of lead to pyrotechnic material of between approximately 8 to 35, by weight.

32. An igniter device as in claim 21 wherein said centrally disposed and linearly encapsulated explosive comprises a flexible extruded cord of explosive particles within a viscoelastic binder.

33. An igniter device as in claim 32 wherein said flexible extruded cord further includes an additional sheathing defined by a separate outer layer of plastic material.

34. An igniter device as in claim 21 wherein said initial cross section of said igniter is further defined by an additional layer of an encapsulating material as an outer covering.

35. An igniter device as in claim 3 wherein said device has a final configuration which is the resultant product of a process wherein an initial cross-sectional area of said igniter is radially reduced by a mechanical forming step which compacts said metal cladding radially inwardly to define a final cross-sectional area for said device which is reduced approximately 10-60 percent from said initial cross-sectional area.

36. An igniter device as in claim 35 wherein said metal cladding on said pyrotechnic is one selected from the group consisting of lead, aluminum and silver, and said simple decahydrodecaborate salt selected com-

prises approximately 6-30% by weight of said pyrotechnic material.

37. An igniter device as in claim 36 wherein said centrally disposed high explosive is selected from the group consisting of cyclotrimethylenetrinitramine (RDX), cyclotetramethylenetetranitramine (beta-HMX), pentaerythritol (PETN), hexanitrostilbene (HNS), and dipicramid (DIPAM), and said linear encapsulation comprises a sheath around said explosive.

38. An igniter device as in claim 37 wherein said high explosive sheath, and said metal cladding on said pyrotechnic material, are of lead, and said detonating cord has a distribution of high explosive of between approximately 2 to 6 grains per lineal foot and a mass ratio of lead to high explosive of between approximately 50 to 12, by weight.

39. An igniter device as in claim 35 wherein said pyrotechnic material includes an oxidizer selected from the group consisting of ammonium nitrate, potassium nitrate, potassium perchlorate, ammonium perchlorate, guanidine nitrate, triaminoguanidine nitrate, potassium permanganate, sodium chromate, barium nitrate, barium chromate, barium manganate, sodium dichromate, tetramethylammonium nitrate and cesium nitrate.

40. An igniter device as in claim 35 wherein said device further comprises a plurality of individual metal-clad pyrotechnic cords concentrically arranged about, and linearly extending along, said encapsulated explosive wherein said individual metal clad pyrotechnic cords are fused into a metallic matrix around said high explosive by said forming step.

41. An igniter device as in claim 35 wherein said pyrotechnic material is further the resultant product of a coprecipitation of one of said group of simple decahydrodecaborate salts, and said solid oxidizing agent, by the process of:

- i. dissolving both the decahydrodecaborate (-2) salt and the solid oxidizing agent in a mutually soluble solvent, at a temperature sufficiently high to maintain said salt and said oxidizing agent in solution;
- ii. forming a pressurized stream of said solution and brining said solution stream together with a pressurized stream of a miscible nonsolvent, under conditions of extreme turbulence within a mixing chamber, to effect a substantially complete coprecipitation;
- iii. recovering the coprecipitated product by filtering the effluent from said mixing chamber, and washing said product with an inert and nonsolvent fluid;
- iv. drying the product to remove all remaining liquid.

42. An igniter device as in claim 41 wherein said coprecipitated oxidizing agent is selected from the group consisting of ammonium nitrate, potassium nitrate, potassium perchlorate, ammonium perchlorate, guanidine nitrate, triaminoguanidine nitrate, potassium permanganate, sodium chromate, barium nitrate, barium chromate, barium manganate, sodium dichromate, tetramethylammonium nitrate and cesium nitrate.

43. An igniter device as in claim 42 wherein said device further comprises a plurality of individual metal-clad pyrotechnic cords concentrically arranged about, and linearly extending along, said encapsulated explosive wherein said individual metal clad pyrotechnic cords are fused into a metallic matrix around said high explosive by said forming step.

44. An igniter device as in claim 40 wherein said plurality of metal clad pyrotechnic cords is between 3 and 13.

45. An igniter device as in claim 43 wherein said plurality of metal clad pyrotechnic cords is between 3 and 13.

46. An igniter device as in claim 44 wherein said linear encapsulation comprises an outer said sheath and said metal cladding on each of said pyrotechnic cords, are of lead, wherein further said detonating cord has a distribution of high explosive of between approximately 2 to 6 grains per lineal foot and a mass ratio of lead to high explosive of between approximately 50 to 12, by weight, and each pyrotechnic cord has a distribution of said pyrotechnic of between approximately 3 to 80 grains per lineal foot and a mass ratio of lead to pyrotechnic material of between approximately 8 to 35, by weight.

47. An igniter device as in claim 36 wherein said centrally explosive disposed and linearly encapsulated explosive comprises a flexible extruded cord of explosive particles within a viscoelastic binder.

48. An igniter device as in claim 47 wherein said flexible extruded cord further includes an additional sheathing defined by a separate outer layer of plastic material.

49. An igniter device as in claim 36 wherein said initial cross section of said igniter is further defined by an additional layer of an encapsulating material as an outer covering.

50. An igniter device as in claim 4 wherein said device has a final configuration which is the resultant product of a process wherein an initial cross-sectional area of said igniter is radially reduced by a mechanical forming step which compacts said metal cladding radially inwardly to define a final cross-sectional area for said device which is reduced approximately 10-60 percent from said initial cross-sectional area.

51. An igniter device as in claim 50 wherein said metal cladding on said pyrotechnic is one selected from the group consisting of lead, aluminum and silver, wherein the metallic salt is selected from the group consisting of cesium decahydrodecaborate, $Cs_2B_{10}H_{10}$, and potassium decahydrodecaborate, $K_2B_{10}H_{10}$, and comprises approximately 6-30% by weight of said pyrotechnic material.

52. An igniter device as in claim 51 wherein said centrally disposed high explosive is selected from the group consisting of cyclotrimethylenetrinitramine (RDX), cyclotetramethylenetetranitramine (beta-HMX), pentaerythritol (PETN), hexanitrostilbene (HNS), and dipicramid (DIPAM), and said linear encapsulation comprises a sheath around said explosive.

53. An igniter device as in claim 52 wherein said high explosive sheath, and said metal cladding on said pyrotechnic material, are of lead, and said detonating cord has a distribution of high explosive of between approximately 2 to 6 grains per lineal foot and a mass ratio of lead to high explosive of between approximately 50 to 12, by weight.

54. An igniter device as in claim 50 wherein said pyrotechnic material includes an oxidizer selected from the group consisting of ammonium nitrate, potassium nitrate, potassium perchlorate, ammonium perchlorate, guanidine nitrate, triaminoguanidine nitrate, potassium permanganate, sodium chromate, barium nitrate, barium chromate, barium manganate, sodium dichromate, tetramethylammonium nitrate and cesium nitrate.

55. An igniter device as in claim 50 wherein said device further comprises a plurality of individual metal-clad pyrotechnic cords concentrically arranged about, and linearly extending along, said encapsulated explo-

sive wherein said individual metal clad pyrotechnic cords are fused into a metallic matrix around said high explosive by said forming step.

56. An igniter device as in claim 50 wherein said pyrotechnic material is further the resultant product of a coprecipitation of one of said group of simple decahydrodecaborate salts, and said solid oxidizing agent, by the process of:

- i. dissolving both the decahydrodecaborate (-2) salt and the solid oxidizing agent in a mutually soluble solvent, at a temperature sufficiently high to maintain said salt and said oxidizing agent in solution;
- ii. forming a pressurized stream of said solution and brining said solution stream together with a pressurized stream of a miscible nonsolvent, under conditions of extreme turbulence within a mixing chamber, to effect a substantially complete coprecipitation;
- iii. recovering the coprecipitated product by filtering the effluent from said mixing chamber, and washing said product with an inert and nonsolvent fluid;
- iv. drying the product to remove all remaining liquid.

57. An igniter device as in claim 56 wherein said coprecipitated oxidizing agent is selected from the group consisting of ammonium nitrate, potassium nitrate, potassium perchlorate, ammonium perchlorate, guanidine nitrate, triaminoguanidine nitrate, potassium permanganate, sodium chromate, barium nitrate, barium chromate, barium manganate, sodium dichromate, tetramethylammonium nitrate and cesium nitrate.

58. An igniter device as in claim 57 wherein said device further comprises a plurality of individual metal-clad pyrotechnic cords concentrically arranged about, and linearly extending along, said encapsulated explosive wherein said individual metal clad pyrotechnic cords are fused into a metallic matrix around said high explosive by said forming step.

59. An igniter device as in claim 55 wherein said plurality of metal clad pyrotechnic cords is between 3 and 13.

60. An igniter device as in claim 58 wherein said plurality of metal clad pyrotechnic cords is between 3 and 13.

61. An igniter device as in claim 59 wherein said linear encapsulation comprises an outer sheath, and said sheath and said metal cladding on each of said pyrotechnic cords, are of lead, wherein further said detonating cord has a distribution of high explosive of between approximately 2 to 6 grains per lineal foot and a mass ratio of lead to high explosive of between approximately 50 to 12, by weight, each pyrotechnic cord has a distribution of said pyrotechnic of between approximately 3 to 80 grains per lineal foot and a mass ratio of lead to pyrotechnic material of between approximately 8 to 35, by weight.

62. An igniter device as in claim 51 wherein said centrally disposed and linearly encapsulated explosive comprises a flexible extruded cord of explosive particles within a viscoelastic binder.

63. An igniter device as in claim 62 wherein said flexible extruded cord further includes an additional sheathing defined by a separate outer layer of plastic material.

64. An igniter device as in claim 51 wherein said initial cross section of said igniter is further defined by an additional layer of an encapsulating material as an outer covering.

• • • • •

United States Patent [19]

Goddard et al.

[11] 4,089,716

[45] May 16, 1978

[54] IGNITION ENHANCING PROPELLANT COATINGS

[75] Inventors: Terrence P. Goddard, Aptos; Donald N. Thatcher, Hollister; Charles G. Garrison, San Jose, all of Calif.

[73] Assignee: Teledyne McCormick-Selph, an operating division of Teledyne Industries, Inc., Hollister, Calif.

[21] Appl. No.: 795,477

[22] Filed: May 10, 1977

[51] Int. Cl.² C06B 45/28

[52] U.S. Cl. 149/10; 149/9;
149/11; 149/22

[58] Field of Search 149/22, 9, 10, 11;
260/564 D

[56] References Cited

U.S. PATENT DOCUMENTS

4,002,681 1/1977 Goddard 260/564 D

Primary Examiner—Stephen J. Lechert, Jr.

Attorney, Agent, or Firm—David H. Semmes; Warren E. Olsen

[57] ABSTRACT

This invention teaches preparation of individual and uncoated propellant grains by incorporating a coating or integral layer of ignition compound, specifically simple salts of decahydrodecaboric acid and coprecipitates of these salts with an oxidizer. The resulting propellant grains so prepared exhibit substantially improved ignition capability, virtually independent of ambient conditioning temperature conditions at the time of use.

23 Claims, No Drawings

IGNITION ENHANCING PROPELLANT COATINGS

CROSS-REFERENCES TO RELATED APPLICATIONS

This application incorporates by reference a copending application of common assignment entitled CO-PRECIPIATED PYROTECHNIC COMPOSITION PROCESSES AND RESULTANT PRODUCTS, Ser. No. 694,626, filed June 10, 1976, which is a continuation-in-part of the application entitled HIGH BURN PROPELLANT COMPOSITIONS, Ser. No. 585,216, filed June 6, 1975, now abandoned.

This application is also a related case to another copending application of common assignment entitled ACTIVE BINDER PROPELLANTS INCORPORATING BURNING RATE CATALYSTS, Ser. No. 696,324, filed June 15, 1976, which related to uniform nitrocellulose-containing propellant compositions, employing the same decahydrodecaborate (-2) compounds which are employed herein. In distinction, the present invention is categorically concerned with treating of individual grains of existing types of nitrocellulose-based propellant, and creating a product which is usable directly in place of the untreated forms of such granular propellants, for example in gun applications.

Our copending application entitled CONSOLIDATED CHARGES INCORPORATING INTEGRAL IGNITION COMPOUNDS, filed May 10, 1977, and assigned Ser. No. 795,473, employs the same ignition compounds employed herein as a matrix between consolidated grain-to-grain boundaries while the present invention teaches a new ignition structure for each grain, without reliance upon a matrix between individual grains.

BACKGROUND AND BRIEF DESCRIPTION OF INVENTION

The purpose of this invention is to describe propellant grains which demonstrate significantly better ignition characteristics than state-of-the-art propellant grains.

In the design of devices incorporating a propellant, and particularly those devices that use the burning propellant gases to accomplish mechanical work, such as gun ammunition, a controlled amount of gas and heat must be released within a specified time period by the burning propellant.

With existing propellants, for example those based on nitrocellulose, nitrocellulose/nitroglycerine, and nitrocellulose/nitroglycerine/nitroguanidine, and better known to those practices in the art as "single base", "double base", and "triple base" propellants, respectively, the burning rate of the propellant is fixed within rather narrow limits by the formulation; a major change in propellant formulation is required to significantly alter such characteristics as burning rate. As a result, to control the release of heat and gas in a device such as a rocket motor chamber, gun chamber, or other gas generating device, the propellant is configured into a sometimes complicated three dimensional geometry, known as a "grain", so that the amount of surface burning at a given time is controlled. The inherent burning rate of the propellant and the grain size and geometry determine the burning rate or "quickness" of the propellant mass. In many instances, a substance is used in the outer layer of the grain to retard the initial burning rate, and is known as a "deterrent layer." Additionally, most

propellant grains designed for use in guns incorporate an outer layer of graphite glazed onto the propellant surface; needed to protect the grain and reduce the handling hazards due to friction and static electricity.

The function sequence of the propellant burning can be discussed in terms of two events: (1) ignition of the exterior surface of the grain, and (2) regressive burning of the propellant grain. The first event, ignition, depends on the propagation of a flame front, generated by a priming source and burning of the propellant ignited first, through the propellant bed or along a monolithic grain. In a loosely packed bed of individual propellant grains, this gaseous flame front propagates easily through the interstitial voids in the bed. However, due to the deterrents and coatings on the grain, and in some cases, the nature of the propellant itself, the actual ignition of the propellant matrix by the hot gas is retarded, particularly at low temperature. It is additionally believed by those practiced in the art that a certain amount of hot particles, i.e., condensed chemical species in the flame, contribute substantially to the ignition event, in addition to the hot gases; the propagation of such hot particles through a propellant bed is difficult compared to the gas propagation.

This invention describes propellant grains otherwise similar to state-of-the-art propellant grains, but fabricated to incorporate an ignition compound or burning rate enhancing layer as a coating or as a chemically bound surface layer on each propellant grain, and thus dispersed uniformly along each monolithic grain that comprises a propellant bed. The burning rate enhancer, specifically consisting of selected compounds based on certain decahydrodecaborate (-2) salts, greatly facilitates propagation of the initiating flame front along the propellant surface, and/or through the propellant bed. The propellants described by this invention demonstrate significantly better ignition and burning characteristics than similar state-of-the-art propellant grains at ambient temperature; the improvement is even more marked at low temperature.

DETAILED DESCRIPTION OF THE INVENTION

The present invention describes a method, and resultant product, of manufacturing or treating propellant grains to incorporate a coating of an integral ignition composition, specifically ignition compounds that are themselves, or contain, certain salts of decahydrodecaboric acid.

The manufacture of coated propellants according to the present invention consists, firstly, of obtaining a suitable propellant in grain or spherical configuration with a range of burning properties and chemical composition which will give the desired rate of gas evolution and composition of combustion products for the intended purpose, such as accelerating a projectile in a gun. Commonly used propellants for this purpose are "single", "double", or "triple base" propellants (as they are commonly known by those practiced in the art), and these propellants may incorporate one or more layers on the grain surface, such as various types of polymers (known as a "deterrent" layer), to aid in modifying initial ignition characteristics. The propellant may be configured in spherical or ellipsoidal shapes, representative diameters or average diameters of 0.01 inch to 0.05 inch or more and known as "ball propellant," or cylindrical shapes with one or more longitudinal perfora-

tions, with characteristic web dimensions 0.009 inches to 0.03 inches or more.

For the purpose of this invention, it is critical that the starting propellant grains do not have a graphite layer on the grain surface, as a graphite layer, if desired, must be applied during or after the subject ignition enhancer is added to the grain. The method and principle of incorporating the ignition compound into the propellant grain is general to any of the types of commonly used individual grain nitrocellulose base propellants, and the classes listed and examples presented are not intended to be limiting, except as noted.

According to the present invention, the decahydrodecaborate compound is conveniently applied to existing propellant grains by means of a solvent or fluid carrier. The decahydrodecaborate compound, depending on the class as delineated below, may be soluble or insoluble in this solvent or carrier. The geometry and thickness of the ignition enhancing layer is determined by the solvating power of the solvent or vehicle on the propellant, and the solubility of the decahydrodecaborate compound in the fluid. For example, a solvent such as acetone, with high solvating power on a typical propellant, would carry a dissolved decahydrodecaborate compound deeply into the propellant matrix, resulting in a new propellant composition with a gradient of decahydrodecaborate compound in a typical cross section across the propellant web. In contrast, a solvent with low solvating ability, such as isopropanol, used as a carrier for an insoluble decahydrodecaborate compound would, when applied to a typical propellant, result in essentially a surface layer of adhering and highly concentrated decahydrodecaborate ignition enhancer. The methods and types of solvents and decahydrodecaborate compounds described in this invention encompass a range of coating or layering options between the extremes.

The ignition compounds useful in this invention are from two general classes; the first, Class (1), being simple salts of decahydrodecaboric acid, and the second, Class (2), being coprecipitates of salts from Class (1) with a suitable oxidizing agent.

The two classes of decahydrodecaborate compounds are defined as follows:

Class (1)

The simple decahydrodecaborate salts used in this invention are compounds of the general chemical formula:

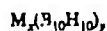

where M is a cation or complex cation incorporating hydrogen, nitrogen, carbon, or metals, or some combination thereof, and is chosen from the list given below; x is the number of M ions; and y is equal to:

$$\frac{x \text{ times the valence of the } M \text{ ion}}{2}$$

The compounds may further be defined as certain salts of decahydrodecaboric acid, and thus contain as a common ion the decahydrodecaborate (-2) anion $B_{10}H_{10}^{-2}$.

The cation M is chosen from the classes:

- a. ammonium, NH_4^+ , wherein the salt has the formula $(NH_4)_x(B_{10}H_{10})_y$ and is described by KNOTH U.S. Pat. No. 3,148,938.

- b. hydrazinium, $NH_2NH_3^+$, wherein the salt has the formula $(NH_2NH_3)_x(B_{10}H_{10})_y$ and is described by KNOTH U.S. Pat. No. 3,148,938.

- c. substituted ammonium cations, wherein the salt has the general formula $(R_xNH)_x(B_{10}H_{10})_y$ where R can be hydrogen (H) or alkyl radical (preferred radicals contain less than six carbon atoms). The R's in the preceding formula may represent different alkyl groups. Compounds with two or three hydrogen radicals are described by KNOTH U.S. Pat. No. 3,149,163. Typical cations are methylammonium $(CH_3)NH_3^+$, dimethylammonium $(CH_3)_2NH_2^+$, trimethylammonium $(CH_3)_3NH^+$, and triethylammonium $(CH_3CH_2)_3NH^+$.

- d. substituted hydrazinium cations, wherein the salt has the general formula $(R_xNNR_xH)_x(B_{10}H_{10})_y$ where R can be hydrogen (H) or an alkyl radical (preferred radicals contain less than six carbon atoms), and the substituted alkyl groups can be symmetric or asymmetric with respect to the N=N linkage. Symmetric substituted cations are described by KNOTH U.S. Pat. No. 3,149,163. An example of an unsymmetric substituted cation is (1,1) dimethylhydrazinium. The R's in the preceding formula may be mixed alkyl radicals.

- e. quaternary ammonium salts of the general formula $(R_xN)_x(B_{10}H_{10})_y$ where R is an alkyl radical; the R's in the preceding formula may represent mixed alkyl groups. Examples of typical cations are tetramethylammonium $(CH_3)_4N^+$ and tetraethylammonium $(CH_3CH_2)_4N^+$.

- f. aryl containing cations, such as pyridinium, bipyridinium, or substituted aryl cations, such as aryl diazonium cations.

- g. guanidinium ion, $C(NH_2)_3^+$, wherein the salt has the formula $(C(NH_2)_3)_x(B_{10}H_{10})_y$ and is described in an application of common assignment, entitled BISGUANIDINIUM DECAHYDRODECABORATE AND A PROCESS FOR ITS PREPARATION, filed June 10, 1976 and now U.S. Pat. No. 4,002,681.

- h. metal ions, derived from metals defined by a Periodic Table such as that in the "Handbook of Chemistry and Physics", 54th Edition, inside front cover, by the elements in Groups 1, 2, 8, 3b, 4b, 5b, 6b and 7b, and the elements of Groups 3a, 4a, 5a and 6a with atomic numbers greater than 5, 14, 33, and 52, respectively. The metal decahydrodecaborate salts are further described by KNOTH U.S. Pat. No. 3,148,939. Examples of such metal salts are $Cs_2B_{10}H_{10}$ and $K_2B_{10}H_{10}$, the cesium and potassium salts of decahydrodecaboric acid, which are representative of alkali metal salts preferred for the compositions described in this invention.

Class (2)

An intimate blend of the compounds described in Class (1) above, with an oxidizing agent, in a manner that a chemically and physically different product is obtained than the starting materials.

The process by which the compositions of this class are prepared produces a very intimate blend of decahydrodecaborate (-2) ion with the oxidizer and makes the compositions so prepared chemically and physically unique from physical blends of decahydrodecaborate (-2) salts with oxidizer or pyrotechnic compositions incorporating decahydrodecaborate (-2) salt, as described above, and also dissolving, in the same solution,

an oxidizing agent, as described above. The subject composition is recovered by precipitating the composite ingredients of the solution with a suitable nonsolvent. The resulting solid, after filtration and drying, comprises an intimate mixture of the decahydrodecaborate (-2) anion with the oxidizing cation or substance, in a form that is chemically and physically different than the starting materials.

The process may be properly called a "cocrystallization" or "coprecipitation" and the resulting produce a "cocrystallate" or "coprecipitate."

These unique coprecipitated Class (2) salts, containing the $B_{10}H_{10}^{-2}$ anion, and the process for their creation, are themselves further disclosed and the above-referenced copending patent application of common assignment entitled COPRECIPITATED PYROTECHNIC COMPOSITION PROCESSES AND RESULTANT PRODUCTS.

The ignition compounds may be soluble or insoluble in the solvent or liquid carrier. The solvent or liquid carriers used in coating grains are of such a type that the propellant ingredients will not react with the contracting liquid. The purpose of the solvent or carrier is to provide a softening and/or solvating of the propellant surfaces in order that the decahydrodecaborate compound will adhere to the grain surface or be chemically or physically incorporated into the propellant matrix. For this purpose, a wide variety of chemically pure solvents and vehicles or mixtures of these solvents and vehicles may be used by those practiced in the art to control the solvating ability. Preferred solvents and vehicles which are compatible with common propellant ingredients include those with functional organic groups such as ketones (acetone, methyl ethyl ketone, methyl isobutyl ketone); alcohols (methanol, ethanol, isopropanol, butyl alcohols, diacetone alcohol), esters (butyl acetate, ethyl acetate, dibutylphthalate), ethers (ethyl ether, isopropyl ether). Other solvents and vehicles which would meet specific solubility, nonreactivity, and volatility requirements are available, and the above list is not meant to be limiting. Mixtures of the forementioned solvents are commonly used to control one or more critical parameters. Some mixtures may contain a small amount of adhesive such as collodion (4 grams pyroxylin (chiefly nitrocellulose) in 100 ml of a mixture of 1 volume ethanol and 3 volumes ethyl ether).

The ignition compositions, depending on the class, which are the key elements in this invention, may be soluble or insoluble in the solvent or carrier used in the coating process, and the choice of solvent or carrier system depends somewhat on the type of ignition compound to be used.

The simple decahydrodecaborate salts, represented by Class (1) of the preceding list of the specific ignition aids, may be soluble or insoluble in the solvent or vehicle system used. A critical requirement of the use of these simple salts is an intimate contact with the propellant ingredients of each grain (particularly nitrocellulose with or without nitroglycerine), which ingredients must act as oxidizers to combust the salt, which acts as a fuel. The result of the intimate interface of binder oxidizer and fuel is a layer which will have a faster burning rate than the original propellant composition, and one which lies on the exterior surface of each of the original propellant grains.

To achieve the required intimate contact between propellant oxidizer and decahydrodecaborate salt, it is necessary that the salt either be dissolved in the solvent

or vehicle, or be of a very fine particle size that is suspended in the fluid. Ten microns average diameter is a preferred upper limit on the average diameter of undissolved salt crystals.

Representative examples of Class (1) decahydrodecaborate salts dissolved in a solvent and carrier system are bisammonium decahydrodecaborate in acetone/ethanol or isopropanol, and dipotassium decahydrodecaborate in acetone/ethanol. The solubility of the decahydrodecaborate salts in solvent systems varies considerably, and must be considered separately for each individual case. In general, the decahydrodecaborate salts with relatively small cations, as represented by Class 1(a) and 1(b) and certain members of Classes 1(c) (such as methylammonium or dimethylammonium), 1(d) and 1(h) such as sodium or potassium, are more likely to be soluble in selected members from the list of solvents than salts with larger molecular weight cations, for example, cesium or tetramethylammonium. It is desirable to initially dry; i.e., remove water, from the prepared solutions by, for example, letting the prepared solutions stand over calcium sulfate, in order to avoid introducing excess moisture into the individual coated propellant grains.

Examples of useful decahydrodecaborate salts insoluble in most solvents and carriers are tetramethylammonium decahydrodecaborate and dicesium decahydrodecaborate, which may be incorporated into a surface layer by suspending them in a carrier which has some solvent ability on the propellant as for example, butyl acetate/ethanol, acetone/ethanol, or ether/acetone mixtures. The solvent with the suspended decahydrodecaborate salt is applied to the propellant in the same manner as the pure solvent.

The decahydrodecaborate compounds of Class (2), i.e., decahydrodecaborate salts coprecipitated with an oxidizer, must be insoluble in the coating fluid, in order that the intimate crystalline structure of the coprecipitate is not degraded. As with the insoluble simple salts, the Class (2) compounds may be suspended in the propellant solvent or vehicle. In contrast to the insoluble simple salts of Class (1), the Class (2) coprecipitates are self combusting, and do not require the oxidative ingredients of the propellants to achieve ignition enhancement. They may thus be applied in an outer layer in such a manner that the propellant solvent/suspended ignition carrier system does not penetrate as deeply into the surface of the propellant grains as that for the Class (1) compounds, for example, by using a carrier such as isopropanol, which does not have appreciable solvent ability on typical propellants, but which will soften the propellant surface sufficiently for the Class (2) ignition compounds to adhere to the surface forming an outer layer. Examples of Class (2) ignition composition and acceptable solvent carriers are the coprecipitate of 25-parts-by-weight cesium decahydrodecaborate and 75 parts-by-weight potassium nitrate with isopropanol, butyl acetate/ethanol, acetone/ethanol, or ether/ethanol carriers and the coprecipitate of 15-parts-by-weight tetramethylammonium decahydrodecaborate and 85-parts-by-weight potassium nitrate with the same carriers.

The coating process preferably consists of initially dissolving or suspending the decahydrodecaborate compound in a predetermined concentration in the solvent or carrier. The amount of propellant solvent fluid preferred for the coating process is between 0.010 and 0.300 milliliters of fluid (for solution or suspension

of the salt compound), per gram of propellant. The preferred limits on decahydrodecaborate compounds are, as follows:

Class (1) soluble: 0.1 to 1.0% of the total propellant weight;

Class (1) insoluble: 0.3 to 2.0% of the total propellant weight; Class (2): 0.5 to 4.0% of the total propellant weight.

The required concentration of the ignition compound in the coating fluid may be calculated for each case from the amount of fluid to be used and the percent concentration of the ignition compound desired.

The propellant is wetted with the requisite amount of the solution or suspension and mixed well. In the case of a solvent with substantial solvating power, a lesser amount of solution is preferred, and the solution or suspension is rapidly absorbed by the propellant. In the case of a fluid with low solvating power, the propellant may be tumbled in the fluid for a longer time, allowing a suspended decahydrodecaborate solid to adhere to the softened surface, or a dissolved salt to penetrate into a thin surface layer. The containing device may be any convenient flask, for example, a stainless steel beaker, or, in the case where a tumbling action is preferred, a rotating drum of nearly circular cross section, known affectionately to those practiced in the art as a "sweetie barrel."

Consequently, the ignition compositions remain in a surface layer of variable thickness (depending on the solvent power of the coating fluid) on the surfaces of the individual grain. This new layer provides a fast burning channel which aids in uniform flame front propagation over each of the grain surfaces. The decahydrodecaborate salt may be considered a burning rate catalyst or ignition enhancer seeded into the propellant surface, or alternately, the coating layer may be considered to have created a new propellant composition with a burn rate higher than the propellant initially present in the grain, the two interpretations being one and the same, and physically equivalent.

As with most commonly used propellants, it is often desirable to apply a layer or coating of graphite to the exterior surface, to aid in safe handling of the propellant. Within this invention, the use of an optional graphite coating is preferably applied as a last, outer coating, to protect the decahydrodecaborate coating or layers. This graphite coating is conveniently applied by adding to the decahydrodecaborate coated or impregnated propellant—while it is still wetted or softened with the coating solvent—a loose graphite layer, and then tumbling, vibrating, or rolling the coated grains until a shiny or glazed appearance is obtained, as commonly practiced by those experienced in the art.

The coated propellants prepared by this method, after a suitable drying period, exhibit substantially better ignition properties than untreated units. The effect of the introduction of the ignition composition directly into the propellant surface is to place the ignition stimulus in very intimate contact with, in fact, as part of, the propellant surface, so as to achieve a direct heat input to the surface.

The ignition enhancement is illustrated by the following example.

EXAMPLE I

A typical uncoated single base propellant, consisting of approximately 93.3% nitrocellulose (of nitrogen content 13.15%), 4.8% ethylcentralite as stabilizer and

deterrent, 0.8% diphenylamine, 0.8% lead carbonate, 0.3% potassium sulfate, and 1.3% residual moisture and volatiles, such as can be purchased as Canadian Industries Limited SPDN 1462, is chosen as representative of the class of uncoated single, double and triple base propellants considered as starting materials in this invention. Any propellant so chosen is necessarily procured without an initial graphite glaze present on the surface of each grain.

A series of ignition enhancing coatings or layers of decahydrodecaborate compounds are applied according to Table I. Two control propellants, incorporating as a glaze layer 0 and 1.9% graphite, and denoted as A and B respectively, are prepared and subjected to the same conditioning and history as the decahydrodecaborate coated propellants.

A solvent and carrier consisting of 65%-by-volume ethanol and 35%-by-volume acetone is chosen as representative of the manifold of solvents available.

Propellant B is prepared by wetting the uncoated propellant with 0.17 milliliters solvent per gram propellant, and tumbling the wetted propellant in a cup containing approximately 0.25 grams of graphite (of such a particle size so as to pass through a 325 mesh screen) per gram propellant. The coated propellant grains with the adhering graphite powder is vibrated on a screen to remove excess (loose) graphite until, via the grain-to-grain rubbing action, a smooth glazed appearance is obtained. The propellant is dried to constant weight in vacuo at 35° C, 48 hours being a sufficient drying time.

Propellants C and D are coated with decahydrodecaborate compounds soluble in the chosen solvent and carrier, as delineated on Table I. Solutions consisting of 0.125 grams of the decahydrodecaborate compounds per milliliter of solution are prepared and dried over calcium sulfate. The uncoated propellant is placed in a cup and wetted with 0.10 to 0.13 milliliters solution per gram propellant and stirred until the grains are uniformly coated. Then 0.25 grams graphite per gram propellant is added to the cup and stirring continued until the grains have a dry appearance. A small amount of residual graphite and powder remains in the cup. The coated propellant is placed on a dried screen and vibrated and then dried in a manner identical with Propellant B. The actual coating percentages-by-weight, as given on Table I, are derived by simultaneously treating and drying identical batches of (a) uncoated propellant and (b) propellant coated only with decahydrodecaborate compound, weighing all three samples, and computing the appropriate coating weights.

TABLE I

Propellant Designation	Decahydrodecaborate Type	Compound %	Graphite %
A (Control)	—	0	0
B (Graphite glaze control)	—	0	1.9
C	Ammonium decahydrodecaborate (Class Ia) ¹	1.0	1.0
D	Potassium decahydrodecaborate (Class Ib) ¹	1.0	1.1
E	15% tetramethylammonium decahydrodecaborate coprecipitated with 85% potassium nitrate	0.9	1.1
F	(Class II) ²	2.7	1.1

¹soluble in the solvent used
²insoluble in the solvent used

Propellants E and F are prepared by suspending 0.086 grams per milliliter, and 0.20 grams per milliliter, respectively, of the Class (2) decahydrodecaborate compound in the solvent carrier, and applying 0.15 milliliters of the resulting suspension per gram of propellant to the dry propellant. Graphite coating and computation of the coating weights are accomplished in a manner identical with that used for Propellants C and D.

The control and coated propellants are tested by loading 0.20 grams of the applicable propellant into a 0.38 special caliber cartridge case primed with a No. 500 small pistol primer; a stainless steel wire screen (60 mesh) is pressed over the load. The cartridge is mounted in a chamber and breech assembly with a firing pin, and fired into a 10 cc closed bomb. Pressure is measured as a function of time with a high speed transducer and recorded on an oscillograph. Tests at low temperature were performed by conditioning the entire test assembly to -65° F and firing the unit.

The primary criteria, as shown in Table II, for comparison between control units and decahydrodecaborate compounds is the ignition time, defined as the first measurable deviation from the starting pressure baseline to 10% of the peak pressure. Other criteria, also shown on Table II, are the peak pressures obtained, the time between deviation from baseline and peak pressure, and the slope of the curve between the 10% and 90% $(dP/dt)_{0.10-0.90}$ of peak pressure points.

TABLE II

Propellant	Temp. $^{\circ}$ F	Ignition Time (msec)	Peak Pressure (psi)	Time to Peak Pressure (msec)	$(dP/dt)_{0.10-0.90}$ (psi/msec)
A	70	10-16	1150-1340	38-56	29-49
	-65	6-37	975-1435	39-75	32-38
B	70	20-28	1355-1475	50-58	44-52
	-65	12-35 ¹	1215-1405 ¹	47-75 ¹	31-39 ¹
C	70	10.5-14	1320-1495	42-46	43-55
	-65	10.3-14	960-1300	46-54	28-41
D	70	4.4-6.4	1310-1370	30-33	49-57
	-65	9.5-14	1130-1310	40-48	33-45
E	70	6.2-7.9	1345-1370	33-38	57-56
	-65	11.9-15.0	1230-1245	46-50	37-39
F	70	3.5-8.1	1280-1380	30-38	43-54
	-65	5.4-12.3	960-1170	38-48	26-40

¹ fail to ignite; primer functioned properly.

The derived data of Table II illustrate the range of ignition properties that can be obtained by varying the type and amount of decahydrodecaborate compound. In all cases, the ignition time and variation in ignition times is lower than the graphite coated control. Propellant C shows a significant property in that the ignition time is virtually independent of ambient (conditioning) temperature, which is a very important property for devices incorporating propellant, such as automatic cannon, which depend on a reproducible ignition. Propellants D, E and F, in addition to short and reproducible ignition times, incorporate an inherent flask reducer in the form of the potassium content of the decahydrodecaborate compounds.

In summary, the present invention involves the coating of individual grains of nitrocellulose-based propellants, in order to provide an ignition layer completely

surrounding each volume of propellant. The types of decahydrodecaborate compounds employed commonly have the $B_{10}H_{10}(-2)$ anion, which is an anion believed to be kinetically, rather than thermodynamically stabilized upon thermal decomposition. The present invention involves applying individual layers upon each of the propellant grains, so that these individual layers will act as ignition aids to the propellant material which they surround. Granular propellants are commonly used in gun applications, and the present invention allows for preformulated propellants to be treated after manufacture, by the novel teachings of the present invention. Such granular propellants present unusual handling problems, and are normally coated with a graphite layer, for the purposes herein before described. According to the present invention any such graphite layer must necessarily be applied after the ignition layer has been applied, and if such an optional graphite layer is used the resultant propellant granules or grains may be handled as easily as conventional gun propellants which have also been treated with graphite layers. Accordingly, the present invention allows the incorporation of an ignition aid layer directly upon the exterior surfaces of each grain, and if a subsequent graphite layer is employed the handling problems are no greater than they would be with conventional propellant grains having such a graphite layer.

The products derived from the process of the present invention may of themselves be considered unique new forms of granular propellants, since they contain distinguishable cores of propellant materials surrounded by an identifiable covering layer of the ignition aid. It should be emphasized that all of the propellant aids taught herein take advantage of the unique decomposition properties of the $B_{10}H_{10}(-2)$ anion, and regardless of the choices for a cation in the salt the ignition times become virtually independent of the ambient conditioning temperatures to which the granular propellants are exposed prior to ignition. The present invention, therefore, teaches a new process for producing granular nitrocellulose-based propellant grains, and a resultant product, which will significantly allow reproducible ignition times, a requirement particularly important in such gun applications as the automatic cannon.

Having described and illustrated representative embodiments of both classes of the decahydrodecaborate compounds contemplated according to the teachings of the present invention, it is to be understood that the invention is to be defined solely by the scope of the appended claims.

We claim:

1. A process for incorporating an ignition compound comprised of certain decahydrodecaborate compounds directly upon exterior surfaces of uncoated nitrocellulose-based propellant grains, through the steps of:

(A) wetting uncoated, loose propellant grains on their exterior surfaces with a coating fluid having a solvating effect on said grains, the coating fluid being in the range of approximately 0.010 to 0.100 milliliters of fluid per gram of propellant,

(B) introducing a layer of decahydrodecaborate compound onto the exterior surfaces of said grains as the result of the wetting effect of said coating fluid, wherein said compound is in the range of approximately 0.1 to 4.0% of the total propellant weight, wherein said compound further includes a salt selected from the class of salts having the common

anion $B_{10}H_{10}^{-2}$, and a cation selected from the group consisting of:

- (i) ammonium, wherein the salt has the formula $(NH_4)_2B_{10}H_{10}$;
- (ii) hydrazinium, wherein the salt has the general formula $(NH_2NH_2)_2B_{10}H_{10}$;
- (iii) metal ions derived from the elements in Groups 1, 2, 8, 3b, 4b, 5b, 6b, 7b, and the elements of Groups 3a, 4a, 5a, and 6a which have atomic numbers respectively greater than 5, 14, 33 and 52; and,

(C) drying the thusly coated propellant grains until the exterior surface of each grain presents a dry appearance.

2. The process according to claim 1 wherein the decahydrodecaborate compound selected is soluble in the coating fluid, and the step of introducing said compound further consists of first dissolving said compound in said fluid, and wetting the exteriors of said propellant grains with the solution in order to form said layer on each grain.

3. The process according to claim 1 wherein the decahydrodecaborate compound selected is insoluble in the coating fluid, and the step of introducing said compound further consists of first suspending compound particles of approximately ten microns average diameter in said fluid, and wetting the exterior of said propellant grains with the suspension in order to form said layer on each grain.

4. The process according to claim 1 wherein said compound is insoluble in said fluid and is the resultant product of a coprecipitation of one of said salts with a solid oxidizing agent by the steps of:

- (i) dissolving both the decahydrodecaborate (-2) salt and the oxidizing agent in a mutually soluble solvent, at a temperature sufficiently high to maintain said salt and said oxidizing agent in solution;
- (ii) forming a pressurized stream of said solution and bringing said solution stream together with a pressurized stream of a miscible nonsolvent, under conditions of extreme turbulence within a mixing chamber, to effect a substantially complete coprecipitation;
- (iii) recovering the coprecipitated product by filtering the effluent from said mixing chamber, and washing said product with an inert and nonsolvent fluid;
- (iv) drying the product to remove all remaining liquid.

5. A process according to claim 1 wherein the step of drying the coated grains further comprises tumbling the wetted and coated propellant grains in a container containing fine particle graphite powder, thereafter vibrating the coated grains with the adhering graphite powder to create a glazed appearance, as the result of grain-to-grain rubbing action, and drying the glazed grains to a dry appearance.

6. The process according to claim 1 wherein said uncoated granular nitrocellulose based propellant is selected from the group consisting of nitrocellulose, nitrocellulose/nitroglycerine and nitrocellulose/nitroglycerine/nitroguanidine based gun propellants.

7. The process according to claim 1 wherein the coating fluid having a solvating effect on said uncoated propellant grains includes one or more members from the group consisting of:

- acetone,
- methyl ethyl ketone,
- methyl isobutyl ketone,

methanol,
ethanol,
isopropanol,
butyl alcohols,
diacetone alcohol,
butyl acetate,
dibutylphthalate,
ethyl ether and
isopropyl ether.

8. The process according to claim 1 wherein said decahydrodecaborate compound selected is bisammonium decahydrodecaborate, said coating fluid is a mixture of approximately 65% by volume ethanol and 35% by volume acetone, and said introducing step further consists of first dissolving approximately 0.125 gram of said salt per milliliter of said fluid prior to said wetting step.

9. The product of a coated granular propellant according to the process of claim 8.

10. A process according to claim 1 wherein the decahydrodecaborate compound selected is a simple metallic salt selected from the group consisting of cesium decahydrodecaborate, $Cs_2B_{10}H_{10}$, potassium decahydrodecaborate $K_2B_{10}H_{10}$, and the simple metallic decahydrodecaborates salts of the alkaline and alkaline earth metals of Groups 1a and 2a having an atomic number less than 87.

11. The process according to claim 10 wherein said decahydrodecaborate compound selected is bispotassium decahydrodecaborate, said coating fluid is a mixture of approximately 65% by volume ethanol and 35% by volume acetone, and said introducing step further consists of first dissolving approximately 0.125 gram of said salt per milliliter of said fluid prior to said wetting step.

12. The product of a coated granular propellant according to the process of claim 11.

13. A process for incorporating an ignition compound comprised of certain decahydrodecaborate compounds directly upon exterior surfaces of uncoated nitrocellulose-based propellant grains, through the steps of:

- (A) wetting uncoated, loose propellant grains on their exterior surfaces with a coating fluid having a solvating effect on said grains, the coating fluid being in the range of approximately 0.010 to 0.100 milliliters of fluid per gram of propellant, and
- (B) introducing a layer of decahydrodecaborate compound onto the exterior surfaces of said grains as the result of the wetting effect of said coating fluid, wherein said compound is in the range of approximately 0.1 to 4.0% of the total propellant weight, wherein said compound further includes a salt selected from the class of salts having the common anion $B_{10}H_{10}^{-2}$, and a cation selected from the group consisting of:

- (i) substituted ammonium cations, wherein the salt has the general formula $(R_3NH)_2B_{10}H_{10}$ wherein further R is selected from the group consisting of hydrogen and alkyl radicals containing less than six carbon atoms;
- (ii) substituted hydrazinium cations, wherein the salt has the general formula $(R_2NHR_2H)_2B_{10}H_{10}$ wherein further R is selected from the group consisting of hydrogen and alkyl radicals containing less than six atoms;
- (iii) tetramethylammonium, $(CH_3)_4N^+$, tetraethylammonium, $(CH_3CH_2)_4N^+$, and quaternary

13

ammonium cations having the general formula R_4N^+ where R is an alkyl radical;

(iv) pyridinium, bipyridinium aryl-diazonium, aryl containing cations and substituted aryl containing cations.

(v) the guanidinium cation, $C(NH_2)_3^+$; and

(D) drying the thusly coated propellant grains until the exterior surface of each grain presents a dry appearance.

14. The process according to claim 13 wherein the decahydrodecaborate compound selected is soluble in the coating fluid, and the step of introducing said compound further consists of first dissolving said compound in said fluid, and wetting the exteriors of said propellant grains with the solution in order to form said layer on each grain.

15. The process according to claim 13 wherein the decahydrodecaborate compound selected is insoluble in the coating fluid, and the step of introducing said compound further consists of first suspending compound particles of approximately ten microns average diameter in said fluid, and wetting the exterior of said propellant grains with the suspension in order to form said layer on each grain.

16. The process according to claim 13 wherein said compound is insoluble in said fluid and is the resultant product of a coprecipitation of one of said salts with a solid oxidizing agent by the steps of:

(i) dissolving both the decahydrodecaborate (-2) salt and the oxidizing agent in a mutually soluble solvent, at a temperature sufficiently high to maintain said salt and said oxidizing agent in solution;

(ii) forming a pressurized stream of said solution and bringing said solution stream together with a pressurized stream of a miscible nonsolvent, under conditions of extreme turbulence within a mixing chamber, to effect a substantially complete coprecipitation;

(iii) recovering the coprecipitated product by filtering the effluent from said mixing chamber, and washing said product with an inert and nonsolvent fluid;

(iv) drying the product to remove all remaining liquid.

17. A process according to claim 13 wherein the step of drying the coating grains further comprises tumbling the wetted and coated propellant grains in a container containing fine particle graphite powder, thereafter vibrating the coated grains with the adhering graphite powder to create a glazed appearance, as the result of

14

grain-to-grain rubbing action, and drying the glazed grains to a dry appearance.

18. The process according to claim 13 wherein said uncoated granular nitrocellulose based propellant is selected from the group consisting of nitrocellulose, nitrocellulose/nitroglycerine and nitrocellulose/nitroglycerine/nitroguanidine based gun propellants.

19. The process according to claim 13 wherein the coating fluid having a solvating effect on said uncoated propellant grains includes one or more members from the group consisting of:

acetone,
methyl ethyl ketone,
methyl isobutyl ketone,
methanol,
ethanol,
isopropanol,
butyl alcohols,
diacetone alcohol,
butyl acetate,
dibutylphthlate,
ethyl ether and
isopropyl ether.

20. The process according to claim 13 wherein said decahydrodecaborate compound selected is bisammonium decahydrodecaborate, said coating fluid is a mixture of approximately 65% by volume ethanol and 35% by volume acetone, and said introducing step further consists of first dissolving approximately 0.125 gram of said salt per milliliter of said fluid prior to said wetting step.

21. The product of a coated granular propellant according to the process of claim 20.

22. The process according to claim 16 wherein the coprecipitated decahydrodecaborate compound is approximately 15 to 25% by weight ammonium decahydrodecaborate and the remainder an oxidizing agent selected from the group consisting of ammonium nitrate, potassium nitrate, potassium perchlorate, ammonium perchlorate, guanidine nitrate, triaminoguanidine nitrate, potassium permanganate, sodium chromate, barium nitrate, barium chromate, barium manganate, sodium dichromate, tetramethylammonium nitrate and cesium nitrate, wherein further the coating fluid includes one or more members selected from the group consisting of isopropanol, butylacetate/ethanol, acetone/ethanol, and ether/ethanol.

23. The product of a coated granular propellant according to the process of claim 22.

* * * * *

55

60

65

[54] CONSOLIDATED CHARGES
INCORPORATING INTEGRAL IGNITION
COMPOUNDS

[75] Inventors: Terrence P. Goddard, Aptos; Donald
N. Thatcher, Hollister; Charles G.
Garrison, San Jose, all of Calif.

[73] Assignee: Teledyne McCormick Selph, an
operating division of Teledyne
Industries, Inc., Hollister, Calif.

[21] Appl. No.: 795,473

[22] Filed: May 10, 1977

[51] Int. Cl.² C06B 45/28

[52] U.S. Cl. 149/10; 149/9;
149/11; 149/22

[58] Field of Search 260/564 D; 149/22, 9,
149/10, 11

[56]

References Cited

U.S. PATENT DOCUMENTS

4,002,681 1/1977 Goddard 260/564 D

Primary Examiner—Stephen J. Lechert, Jr.
Attorney, Agent, or Firm—David H. Semmes; Warren E.
Olsen

[57]

ABSTRACT

This invention teaches a method and the resultant product of preparing consolidated propellant charges that incorporate an integral ignition compound, specifically certain simple salts of decahydrodecaboric acid and coprecipitates of these salts with an oxidizer. The charges so prepared exhibit substantially improved ignition and breakup compared to untreated charges, especially at low temperature, because each of the individual consolidated grains are surrounded by the salts taught herein.

19 Claims, No Drawings

CONSOLIDATED CHARGES INCORPORATING INTEGRAL IGNITION COMPOUNDS

CROSS-REFERENCES TO RELATED APPLICATIONS

This application incorporates by reference a copending application of common assignment entitled CO-PRECIPI-TATED PYROTECHNIC COMPOSITION PROCESSES AND RESULTANT PRODUCTS, Ser. No. 694,626, filed June 10, 1976, which is a continuation-in-part of the application entitled HIGH BURN PROPELLANT COMPOSITIONS, Ser. No. 585,216, filed June 6, 1975, now abandoned.

This application is also a related case to another copending application of common assignment entitled ACTIVE BINDER PROPELLANTS INCORPORATING BURNING RATE CATALYSTS, Ser. No. 696,324, filed June 15, 1976, which related to uniform nitrocellulose-containing propellant compositions, employing the same decahydrodecaborate (-2) compounds which are employed herein. The present invention, in distinction, is not a uniform propellant composition, but is categorically directed to the consolidation of individual grains of an existing propellant composition.

BACKGROUND AND BRIEF DESCRIPTION OF INVENTION

The purpose of this invention is to describe consolidated grain propellant charges which demonstrate significantly better ignition characteristics than state-of-the-art consolidated grain charges. In the design of devices incorporating a propellant, and particularly those devices that use the burning propellant gases to accomplish mechanical work, such as gun ammunition, a controlled amount of gas and heat must be released within a specified time period by the burning propellant. With existing propellants, for example, those based on nitrocellulose, nitrocellulose/nitroglycerine, and nitrocellulose/nitroglycerine/nitroguanidine, and better known to those practiced in the art as "single base," "double base," and "triple base" propellants, respectively, the burning rate of the propellant is fixed within rather narrow limits by the formulation; a major change in propellant formulation is required to significantly alter such characteristics as the basic burning rate. As a result, to control the release of heat and gas in a device such as a rocket motor chamber, gun chamber, or other gas generating device, the propellant is configured into a sometimes complicated three dimensional geometry, known as a "grain," so that the amount of surface burning at a given time is controlled. The inherent burning rate of the propellant and the grain size and geometry determine the burning rate or "quickness" of the propellant mass. The function sequence of the propellant bed burning can be discussed in terms of two events: (1) ignition of the exterior surface of the grain, and (2) regressive burning of the propellant grain. The first event, ignition, depends on the propagation of a flame front, generated by a priming source and burning of those propellant grains ignited first, through the propellant bed. In a loosely packed bed of individual propellant grains, this flame front propagates easily through the interstitial voids in the bed. Often, however, in the design of devices incorporating such packed granular propellants, it becomes very desirable to package the maximum amount of usable chemical energy (in the

form of the unburned propellant) into a minimum amount of space. This reduces the overall volume and therefore packaging weight and space of the device. Toward this end, a method has been developed by those practiced in the art, of consolidating a loosely packed propellant bed into an integral grain, thus reducing the overall volume of the propellant mass. The resulting grain is commonly known as a molded charge, "consolidated charge" or "consolidated grain." The amount of interstitial void volume is, of course, reduced in the volume reduction process, thus rendering it more difficult for the initiating flame front to penetrate the deformed, individual grains comprising the propellant mass. The successful ignition of the individual grains, therefore, critically depends on breakup of the consolidated grain and passage of the flame front through the disintegrating mass. With a consolidated charge, it is desirable to have the consolidated or densified propellant burn as effectively as a loosely packed propellant bed. This invention described consolidated charges, fabricated in a manner analogous to state-of-the-art consolidation procedures, though unique in that they incorporate a burning rate enhancing layer as an initial coating, or as a chemically bound surface layer, on the individual propellant grains, which layer is then dispersed as a uniform matrix throughout the consolidated grain mass. The burning rate enhancer, specifically consisting of selected compounds based on decahydrodecaborate (-2) salts, greatly facilitates propagation of the initiating flame front through the propellant mass and breakup of the consolidated grain. The specific burn-rate enhancers taught herein have been found to be unusually effective in promoting the break-up of the individual grains which were deformed together by the consolidation. The charges described by this invention therefore demonstrate significantly better ignition and burning characteristics than similar state-of-the-art consolidated grains at ambient temperature; the improvement is even more marked at low temperature.

DETAILED DESCRIPTION OF THE INVENTION

The present invention describes a method, and resultant product, of manufacturing consolidated propellant charges that incorporate individual grains surrounded by a matrix of an integral ignition composition, specifically ignition compounds that are themselves, or contain, certain salts of decahydrodecaboric acid.

The manufacture of a consolidated charge consists, firstly, of obtaining a suitable propellant in grain or spherical configuration with a range of burning properties and chemical composition of combustion products for the intended purpose, such as accelerating a projectile in a gun. Commonly used granular propellants for this purpose are "single," "double," or "triple base" propellants as known by those practiced in the art, and these propellants may incorporate one or more layers on the grain surface, such as graphite or polymer (known as a "deterrent" layer), to aid in handling or modifying initial ignition characteristics. The individual propellant grains may be configured in spherical or ellipsoidal shapes, representative diameters or average diameters of 0.01 inch to 0.05 inch or more and known as "ball propellant," or cylindrical shapes with one or more longitudinal perforations, with characteristic web dimensions 0.009 inches to 0.03 inches or more. The method taught herein for incorporating the ignition compound into the resulting consolidated grain is gen-

eral to any of the types of commonly used propellants, and the classes listed and examples presented are not intended to be limiting.

The known consolidation process consists, in general, of applying a solvent or liquid to the desired quantity of loose propellant, placing the wetted propellant in a press mold, and pressing the loose propellant to a set pressing pressure or density. The final charge configuration may be any geometry for which a mold can be fabricated and reasonably uniform density attained during pressing. In normal consolidation procedures, it is desirable to control the propellant and mold temperature between 20° and 60° C. The type and amount of solvent or liquid, the pressing pressure and density, and the temperature at pressing are all dependent on the type of propellant used and the properties and geometry desired of the end configuration. The incorporation of ignition composition is compatible with the preferred ranges of these variables as described herein.

The ignition composition is conveniently introduced into the present consolidation process at the point where the loose propellant is wetted by the solvent or liquid carrier. The compositions useful as ignition aids may be either soluble or insoluble in the solvent or carrier being used, the solubility being dependent on the solvent or carrier type, the ignition composition type and the consolidating temperature.

The ignition compounds useful in this invention are from two general classes; the first, Class (1), being simple salts of decahydrodecaboric acid, and the second, Class (2), being coprecipitates of salts from Class (1) with a suitable oxidizing agent.

The two classes of decahydrodecaborate compounds are defined as follows:

CLASS (1)

The simple decahydrodecaborate salts used in this invention are compounds of the general chemical formula:



where M is a cation or complex cation incorporating hydrogen, nitrogen, carbon, or metals, or some combination thereof, and is further chosen from the list given below; x is the number of M ions; and y is equal to:

x times the valence of the M ion/2

The compounds may further be defined as certain salts of decahydrodecaboric acid, and thus contain as a common ion the decahydrodecaborate (-2) anion $B_{10}H_{10}^{-2}$. The cation M is chosen from the classes:

- ammonium, NH_4^+ , wherein the salt has the formula $(NH_4)_2B_{10}H_{10}$ and is described by KNOTH U.S. Pat. No. 3,148,938.
- hydrazinium, $NH_2NH_3^+$, wherein the salt has the formula $(NH_2NH_3)_2B_{10}H_{10}$ and is described by KNOTH U.S. Pat. No. 3,148,938.
- substituted ammonium cations, wherein the salt has the general formula $(R_3NH)_2B_{10}H_{10}$ where R can be hydrogen (H) or alkyl radical (preferred radicals contain less than six (6) carbon atoms). The R's in the preceding formula may represent different alkyl groups. Compounds with two or three hydrogen radicals are described by KNOTH U.S. Pat. No. 3,149,163. Typical cations are methylammonium $(CH_3)NH_3^+$, dimethylammonium

$(CH_3)_2NH_2^+$, trimethylammonium $(CH_3)_3NH^+$, and triethylammonium $(CH_3CH_2)_3NH^+$.

- substituted hydrazinium cations, wherein the salt has the general formula $(R_2NNR_2H)_2B_{10}H_{10}$, where R can be hydrogen (H) or an alkyl radical (preferred radicals contain less than six (6) carbon atoms), and the substituted alkyl groups can be symmetric or asymmetric with respect to the N-N linkage. Symmetric substituted cations are described by KNOTH U.S. Pat. No. 3,149,163. An example of an unsymmetric substituted cation is (1,1) dimethylhydrazinium. The R's in the preceding formula may be mixed alkyl radicals.
- quaternary ammonium salts of the general formula $(R_4N)_2B_{10}H_{10}$, where R is an alkyl radical; the R in the preceding formula may represent mixed alkyl groups. Examples of typical cations are tetramethylammonium $(CH_3)_4N^+$ and tetraethylammonium $(CH_3CH_2)_4N^+$.
- aryl containing cations, such as pyridinium, bipyridinium, or substituted aryl cations, such as aryl diazonium cations.
- guanidinium ion, $C(NH_2)_3^+$, wherein the salt has the formula $(C(NH_2)_3)_2B_{10}H_{10}$ and is described in an application of common assignment, entitled BIS-GUANIDINIUM DECAHYDRODECABORATE AND A PROCESS FOR ITS PREPARATION, filed June 10, 1976 and now U.S. Pat. No. 4,002,681.
- metal ions, derived from metals defined by a Periodic Table such as that in the "Handbook of Chemistry and Physics", 54th Edition, inside front cover, by the elements in Groups 1, 2, 8, 3b, 4b, 5b, 6b and 7b, and the elements of Groups 3a, 4a, 5a and with atomic numbers greater than 5, 14, 33, and respectively. The metal decahydrodecaborate salts are further described by KNOTH U.S. Pat. No. 3,148,939. Examples of such metal salts are $Cs_2B_{10}H_{10}$ and $K_2B_{10}H_{10}$, the cesium and potassium salts of decahydrodecaboric acid, which are representative of alkali metal salts preferred for the compositions described in this invention.

CLASS (2)

An intimate blend of the compounds described in Class (1) above, with an oxidizing agent, in a manner that a chemically and physically different product is obtained than the starting materials.

The process by which the compositions of this class are prepared produces a very intimate blend of decahydrodecaborate (-2) ion with the oxidizer and makes the compositions so prepared chemically and physically unique from physical blends of decahydrodecaborate (-2) salts with oxidizer or pyrotechnic compositions incorporating decahydrodecaborate (-2) salt, as described above, and also dissolving, in the same solution, an oxidizing agent, as described above. The subject composition is recovered by precipitating the composite ingredients of the solution with a suitable non-solvent. The resulting solid, after filtration and drying, comprises an intimate mixture of the decahydrodecaborate (-2) anion with the oxidizing cation or substance, in a form that is chemically and physically different than the starting materials.

The process may be properly called a "cocrystallization" or "coprecipitation" and the resulting product a "cocrystallate" or "coprecipitate."

These unique coprecipitated Class (2) salts, containing the $B_{10}H_{10}^{-2}$ anion, and the process for their creation, are themselves further disclosed in a copending patent application of common assignment entitled, "COPRECIPITATED PYROTECHNIC COMPOSITION PROCESSES AND RESULTANT PRODUCTS," filed June 10 1976, assigned Ser. No. 694,626, which is incorporated herein by reference.

The ignition compounds may be soluble or insoluble in the solvent or liquid carrier. The solvent or liquid carriers used in consolidating grains are of such a type that the propellant ingredients will not react with the contacting liquid. The purpose of the solvent or carrier is to provide a softening and/or wetting of the propellant surfaces in order that the individual grains will readily compact during the consolidating process and remain sealed together to form an integral charge after consolidation. For this purpose, a wide variety of chemically pure solvents and vehicles or mixtures of these solvents and vehicles may be used by those practiced in the consolidating process, to control such various terminal parameters as charge density and grain-to-grain structural integrity, or gross grain physical properties. Preferred solvents and vehicles which are compatible with common propellant ingredients include those with functional organic groups such as ketones (acetone, methyl ethyl ketone, methyl isobutyl ketone); alcohols (methanol, ethanol, isopropanol, butyl alcohols, diacetone alcohol), esters (butyl acetate, ethyl acetate, dibutylphthalate); ethers (ethyl ether, isopropyl ether). Other solvents and vehicles which meet the solubility, nonreactivity, and volatility requirements to achieve consolidation are available, and the above list is not meant to be limiting. Mixtures of the forementioned solvents are commonly used to control one or more critical parameters. Some mixtures may contain a small amount of adhesive to improve grain-to-grain integrity, such as collodion (4 grams pyroxylin (chiefly nitrocellulose) in 100 ml of a mixture of 1 volume ethanol and 3 volumes ethyl ether). It should be noted that some solvents, in particular those containing dibutylphthalate act so as to achieve a deterring layer at the grain-grain interface, thus reducing ignition efficiency (which may be desirable for some applications).

The ignition compositions, depending on the class, which are the key elements in the process and product taught by this invention, may be soluble or insoluble in the solvent or carrier used in the consolidating process, and furthermore the choice of solvent or carrier system depends somewhat on the type of ignition compound to be used.

The simple decahydrodecaborate salts, represented by Class (1) of the preceding list of the specific ignition aides, may be soluble or insoluble in the solvent or vehicle system used. A critical requirement of the use of these simple salts is an intimate contact with the individual propellant grain ingredients (particularly nitrocellulose with or without nitroglycerine), which must act as oxidizers to combust the salt, which acts as a fuel. The result of the intimate interface of binder oxidizer and fuel is a layer which will have a faster burning rate than the original propellant composition, and one which lies both on the exterior surface of the original propellant grains and forms a matrix between the grain-to-grain boundaries.

To achieve the required intimate contact between propellant oxidizer and decahydrodecaborate salt, it is preferable that the salt either be dissolved in the sol-

vent or vehicle, or be of a very fine particle size that is suspended in the solvent fluid. Ten microns average diameter is a preferred upper limit on the average diameter of undissolved salt crystals.

Representative examples of Class (1) decahydrodecaborate salts dissolved in a solvent carrier system are bis-ammonium decahydrodecaborate in acetone/ethanol or isopropanol, and dipotassium decahydrodecaborate in acetone/ethanol. The solubility of the decahydrodecaborate salts in solvent systems varies considerably, and must be considered separately for each individual case. In general, the decahydrodecaborate salts with relatively small cations, as represented by Class 1(a) and 1(b) and certain members of Classes 1(c) (such as methylammonium or dimethylammonium), 1(d) and 1(h) (such as sodium or potassium), are more likely to be soluble in selected members from the list of solvents than salts with larger molecular weight cations, for example, cesium or tetramethylammonium. It is desirable to initially dry, i.e., remove water, from the prepared solutions by, for example, letting the prepared solutions stand over calcium sulfate, or other drying agent, in order to avoid introducing excess moisture into the consolidated charges.

Examples of useful decahydrodecaborate salts insoluble in most solvents and carriers are tetramethylammonium decahydrodecaborate and dicesium decahydrodecaborate, which may be incorporated into a surface layer by suspending them in a carrier which has some solvent ability on the propellant as for example, butyl acetate/ethanol, acetone/ethanol, or ether/acetone mixtures. The solvent with the suspended decahydrodecaborate salt is applied to the propellant in the same manner as the pure solvent. In either case, a distinguishable layer of the salt is formed around the individual propellant grains.

It should now be emphasized that the decahydrodecaborate compounds of Class 2, i.e., decahydrodecaborate salts coprecipitated with an oxidizer, must be insoluble in the consolidation fluid, in order that the intimate crystalline structure of the coprecipitate is not degraded. As with the insoluble simple salts, the Class 2 compounds may be suspended in the propellant solvent or vehicle. In contrast to the insoluble simple salts of Class 1, the Class 2 coprecipitates are self combusting, and do not require interface with the oxidative ingredients of the propellants to achieve ignition enhancement. They may thus be applied in an outer layer in such a manner that the propellant solvent/suspended ignition carrier system does not penetrate as deeply into the surface of the individual propellant grains as that for the Class 1 compounds, for example by using a carrier such as isopropanol, which does not have appreciable solvent ability on typical propellants, but which will soften the propellant surface sufficiently for the Class 2 ignition compounds to adhere to the surface, forming an outer layer. Examples of Class 2 ignition composition and acceptable solvent carriers are the coprecipitate of 25-parts-by-weight cesium decahydrodecaborate and 75-parts-by-weight potassium nitrate with isopropanol, butyl acetate/ethanol, acetone/ethanol, or ether/ethanol carriers and the coprecipitate of 15-parts-by-weight tetramethylammonium decahydrodecaborate and 85-parts-by-weight potassium nitrate with the same carriers.

The consolidation process may first include dissolving or suspending the decahydrodecaborate compound in a predetermined concentration in the solvent

or carrier. The amount of propellant solvent fluid preferred for the consolidation process is between 0.010 and 0.100 milliliters of fluid (for solution or suspension of the salt compounded) per gram of propellant. The preferred limits on decahydrodecaborate compounds are, as follows:

Class 1 soluble: 0.1 to 1.0% of the total propellant weight;

Class 1 insoluble: 0.3 to 2.0% of the total propellant weight;

Class 2: 0.5 to 4.0% of the total propellant weight.

The required concentration of the ignition compound in the consolidating fluid may be calculated for each case from the amount of fluid to be used and the percent concentration of the ignition compound desired.

The propellant is wetted with the requisite amount of the solution or suspension and mixed well; in normal practice the solution or suspension is rapidly absorbed by the propellant to give a dry appearance. The propellant is then consolidated in the accepted fashion, at which time the individual wetted grains are fused into a charge with the desired density. The ignition compositions remain in a surface layer of variable thickness (depending on the solvent power of the consolidating fluid) on the exterior surfaces remaining on the individual grains or encompassed between the fused grain-to-grain boundaries formed during the consolidation. This new matrix layer formed provides a fast burning channel through the consolidated charge bed, which aids in flame front propagation and charge breakup, and, as well, aids the propellant ignition uniformly over the individual grain surfaces. The decahydrodecaborate salt may be considered a burning rate catalyst or ignition enhancer seeded into the propellant surface or, alternatively, the layer may be considered as a new propellant composition with a burn rate higher than the propellant initially present in the grain, the two interpretations being one and the same, and physically equivalent.

The consolidated charge assemblies prepared by this method, after a suitable drying period, exhibit substantially better ignition properties than untreated units. The effect of the introduction of the ignition composition directly into the consolidated charge is to place the ignition stimulus in very intimate contact with, in fact, as part of, the propellant surface, so as to achieve a direct heat input into the surface of each individual grain. The fast transfer of the ignition impetus throughout the consolidated charge facilitates grain breakup, which is quite necessary for proper overall propellant charge function.

The ignition enhancement is illustrated by the following examples.

EXAMPLE I

A typical single base propellant, consisting of approximately 91.85% nitrocellulose, 0.5% diphenylamine, 0.15% potassium sulfate, 5.6% methyl centralite as a

deterrent coating, 0.4% graphite as a glazed layer, and 1.5% residual moisture and volatiles, such as can be purchased as Canadian Industries Ltd. (CIL) #5479, is chosen as representative of the class of single, double and triple base granular propellants considered in this invention. A consolidation process is employed whereby the propellant grains are treated with a mixture of 65%-by-volume of ethanol and 35%-by-volume of acetone, in the ratio 0.05 milliliters of solution per gram of propellant. The wetted, loose propellant grains are placed in a die maintained at 30° centigrade and pressed at 13,000-15,000 pounds per square inch for 30-60 seconds. The die used in these examples has a diameter of 0.50 inches; two grams of propellant are used, giving a consolidated pellet of length approximately 0.50 inches.

The present invention involves introducing the decahydrodecaborate compound into the process as the propellant is being wetted and prepared for pressing; as by tumbling the wetted propellant grains in the required amount of decahydrodecaborate compound powder. In this example, a decahydrodecaborate compound consisting of 15%-by-weight tetramethylammonium decahydrodecaborate (-2) coprecipitated with 85%-by-weight potassium nitrate, which is representative of decahydrodecaborate compounds of Class (2), is used. This compound is insoluble in the solvent mixture, and deposits in a solid coating on the individual grain surfaces. A series of pellets consisting of pure propellant (control samples) and varying amounts of the decahydrodecaborate compound is prepared according to Table I.

The pellets are tested by mounting the pellet in a closed bomb of approximately 100 cc free volume pressured to 1,000 pounds per square inch gauge. A small area of the pellet is placed in contact with a nichrom wire. A current of several amps applied to the wire ignites the pellet. Pressure-vs-time for the ignition and burning sequence is recorded on a fast oscillograph.

The primary criteria, as shown in Table I, for comparison between control units and decahydrodecaborate compounds is the ignition time, defined as the first measurable deviation from the starting pressure baseline to 10% of the peak pressure. The propellant grain incorporating the decahydrodecaborate compound show a marked improvement in the ignition time. Moreover, the pressure traces show a much better defined deviation from baseline than control units. Other significant criteria, also shown on Table I, are the peak pressures obtained, the time between deviation from baseline and peak pressure, and the slope of the curve between the 10% and 90% $((dP/dt)_{10-90})$ of peak pressure points. The pellets incorporating the decahydrodecaborate compound are superior to the control units in all respects, except that the $(dp/dt)_{10-90}$ of the unit having 4.9% decahydrodecaborate compound is lower than the control units. This establishes an upper limit to the concentration of compound in the pellet.

Table I

Pellet Type	Decahydrodecaborate Compound %	Ignition Time Milliseconds	Peak Pressure pounds per square Inch Gauge	Time to peak Pressure	$(\frac{dP}{dt})_{10-90}$ (PSI/MSEC)
A (Control) (Units A-1) (and A-2)	0	9.8/11.0	2113/2063	36.0/37.4	91.9/90.7
B	1.4	5.6	2400	30.0	102.1
C	2.3	6.2	2200	31.2	101.1
D	3.1	7.4	2275	30.1	112.4

Table I-continued

Pellet Type	Decahydrodecaborate Compound %	Ignition Time Milliseconds	Peak Pressure pounds per square Inch Gauge	Time to peak Pressure	$(\frac{dP}{dt})_{10-90}$ (PSI/MSEC)
E	4.9	1.2	2125	35.6	83.0

EXAMPLE II

A series of pellets, using the same propellant as Example I are pressed, incorporating decahydrodecaborate compounds as described in Table II. The control units F, and the units G containing 15%-by-weight tetra-

incorporating decahydrodecaborate compounds from both Class I and II demonstrate significantly improved ignition characteristics over that of the control at this low temperature. The ignition time, as defined in Example I, is faster than the control units at ambient temperature, and are as shown in Table III.

TABLE II (70° F)

Pellet Type	Decahydrodecaborate Compound %	Ignition Time (MSEC)	Peak Pressure (PSI)	Time to Peak Pressure (MSEC)	$(\frac{dP}{dt})_{10-90}$ (PSI/MSEC)
F (Control)	0	14	1600	47	63.5
G	2.0 ⁽¹⁾	4.0	1855	27.0	92.8
H	0.44 ⁽²⁾	3.5	1763	29.0	110.2

⁽¹⁾Decahydrodecaborate, Class II

⁽²⁾Decahydrodecaborate, Class Ia

TABLE III (-65° F)

Pellet Type	Decahydrodecaborate Compound %	Ignition Time (MSEC)	Peak Pressure	Time to Peak Pressure (MSEC)	$(\frac{dP}{dt})_{1-9}$ (PSI/MSEC)
F (Control)	0	25-30	850-1000	55-67	32-40
G	2.0-3.0 ⁽¹⁾	2-5	1040-1200	35-39	47-59
H	0.44 ⁽²⁾	6-9	950-1060	34-36	44-54

⁽¹⁾Decahydrodecaborate, Class II

⁽²⁾Decahydrodecaborate, Class I(a)

methylammonium decahydrodecaborate coprecipitated with 85%-by-weight potassium nitrate, are manufactured in a manner identical with Example I.

A third set of units -H- incorporates bisammonium decahydrodecaborate, a pure simple salt from Class I(a) which is representative of salts and decahydrodecaborate compounds which are soluble in the consolidating solvent. In this procedure, the decahydrodecaborate salt is dissolved in the solvent at the desired concentration, in this case 0.9g salt per 100 ml solution, and the consolidation process done in a manner otherwise identical with Example I.

Representative pellets are tested at ambient temperature (circa 70° F) in a manner identical to Example I, except that the bomb volume is slightly larger, 125 cc (thus peak pressures are lower than Example I). The critical parameters of the pressure-vs-time traces are shown in Table II. The control units F, as well as the G units, exhibit behavior similar to that as found in Example I. The soluble Class I(a) decahydrodecaborate compounds, units H, also demonstrate a pronounced igni-

EXAMPLE III

A single base propellant, consisting of approximately 91.0% nitrocellulose, 0.7% diphenylamine, 0.3% potassium sulfate, 5.2% ethylene dimethacrylate and 0.4% graphite as a coating, and 2.5% residual moisture and volatiles, such as can be purchased as DuPont smokeless powder 8472-1, is chosen as a representative propellant which is relatively difficult to ignite.

A consolidation process identical with Examples I and II is used to fabricate pellets containing 0 and specified amounts of decahydrodecaborate compounds of Class I and Class II as represented in Table IV. The pellets are ignited, at ambient and low temperature, with parameters measured and recorded in Table IV, in an identical manner with Example II. The critical parameters of the pressure-vs-time traces for each event are shown in TABLE IV.

As with Example II, the units incorporating decahydrodecaborate compounds show marked ignition enhancement, especially at reduced temperatures.

TABLE IV

Pellet Type	Decahydrodecaborate Compound %	Temperature at Ignition	Ignition Time (MSEC)	Peak Pressure (PSI)	Time to Peak Pressure (MSEC)	$(\frac{dP}{dt})_{1-9}$ (PSI/MSEC)
I	0	70° F	10.5	1790	31	143
		-65° F	60-104	800-1025	141-180	11-23
J	1.7-2.7 ⁽¹⁾	70° F	1.5	1780	19	142
		-65° F	1-1.5	920-1090	40-48	22-38
K	0.44 ⁽²⁾	70° F	4	1730	19	173
		-65° F	7-12	750-960	40-55	21-36

⁽¹⁾Decahydrodecaborate Compound, Class II.

⁽²⁾Decahydrodecaborate Compound, Class I(a).

tion enhancement.

Additional units of configuration F, G and H are fired in the identical closed bomb except that the bomb and pellet are conditioned to -65° F at firing. The units

In summary, the above representative examples illustrate the synergistic results obtainable when a process of

consolidating a granular nitrocellulose-base propellant includes the novel step of incorporating a layer of specific decahydrodecaborate compounds, on the exterior of each grain before the consolidation step. The decahydrodecaborate compound specified herein may normally be thought of as a high energy fuel, however, the small percentages of them in the instant process do not explain the unexpected enhanced ignition which have been shown by the representative examples. Rather, the present invention involves the synergistic combination of an additional fuel upon the propellant grains, despite the fact that the propellants themselves are known to be fuel-rich. The present invention critically depends upon the decahydrodecaborate anion, which is believed to be kinetically, rather than thermodynamically stabilized. There is no critical distinction between whether or not the cation of the salt is organic, or inorganic, since any degradation present in a heavy cation is far outweighed by the energetic activity of the decahydrodecaborate anion, when it is proximate the grain-to-grain boundaries between the compacted propellant grains. The fact that the ignition layer resulting from the process taught herein is not simply a fuel is manifestly illustrated by the illustrations in Table I, which unexpectedly show an upper limit to the concentration of representative ignition compounds according to the present invention.

While specific embodiments of an improved process for consolidating charges of nitrocellulose-based granular propellants have been illustrated herein, together with unique products obtainable according to this process, it is understood that the illustrative examples are merely representative, and that subject matter in which an exclusive property or privilege is claimed is to be defined solely by the scope of the appended claims, as follows.

We claim:

1. In a process for consolidating a charge of nitrocellulose-based propellant grains, the improvement of incorporating an ignition compound matrix comprised of certain decahydrodecaborate compounds, through the steps of:

(A) wetting loose propellant grains on their exterior surfaces with a consolidating fluid having a solvating effect on said grains, the consolidating fluid being in the range of approximately 0.010 to 0.100 milliliters of fluid per gram of propellant, and,

(B) introducing a layer of decahydrodecaborate compound onto the exterior surfaces of said grains as the result of the wetting effect of said consolidating fluid, wherein said compound is in the range of approximately 0.1% to 4.0% of the total propellant weight, wherein said compound further includes a salt selected from the class of salts having the common anion $B_{10}H_{10}^{-2}$, and a cation selected from the group consisting of:

- (i) ammonium, wherein the salt has the formula $(NH_4)_2B_{10}H_{10}$;
- (ii) hydrazinium, wherein the salt has the general formula $(NH_2NH_3)B_{10}H_{10}$;
- (iii) metal ions derived from the elements in Groups 1, 2, 8, 3b, 4b, 5b, 6b, 7b, and the elements of Groups 3a, 4a, 5a, and 6a which have atomic numbers respectively greater than 5, 14, 33 and 52; and

(C) consolidating the thusly wetted propellant grains into a consolidated charge by a compaction step, wherein the decahydrodecaborate compound layer

on each grain becomes a matrix between the grain-to-grain boundaries of the consolidated charge.

2. The process according to claim 1 wherein the decahydrodecaborate compound selected is soluble in the consolidating fluid, and the step of introducing said compound further consists of first dissolving said compound in said fluid, and wetting the exteriors of said propellant grains with the solution in order to form said layer on each grain.

3. The process according to claim 1 wherein the decahydrodecaborate compound selected is insoluble in the consolidating fluid, and the step of introducing said compound further consists of first suspending compound particles of approximately ten microns average diameter in said fluid, and wetting the exterior of said propellant grains with the suspension in order to form said layer on each grain.

4. The process according to claim 1 wherein said compound is insoluble in said fluid and is the resultant product of a coprecipitation of one of said salts with a solid oxidizing agent by the steps of:

- (i) dissolving both the decahydrodecaborate (-2) salt and the oxidizing agent in a mutually soluble solvent, at a temperature sufficiently high to maintain said salt and said oxidizing agent in solution;
- (ii) forming a pressurized stream of said solution and bringing said solution stream together with a pressurized stream of a miscible nonsolvent, under conditions of extreme turbulence within a mixing chamber, to effect a substantially complete coprecipitation;
- (iii) recovering the coprecipitated product by filtering the effluent from said mixing chamber, and washing said product with an inert and nonsolvent fluid;
- (iv) drying the product to remove all remaining liquid.

5. The process according to claim 1 wherein the step of introducing said compound further consists of first wetting the propellant grains and then tumbling the wetted grains in a powder of said compound in order to form said layer in each grain.

6. The process according to claim 1 wherein said granular nitrocellulose based propellant is selected from the group consisting of nitrocellulose, nitrocellulose/nitroglycerine, and nitrocellulose/nitroglycerine/nitroguanidine based gun propellants.

7. The process according to claim 1 wherein the consolidating fluid having a solvating effect on said propellant includes one or more members from the group consisting of:

- acetone,
- methyl ethyl ketone,
- methyl isobutyl ketone,
- methanol,
- ethanol,
- isopropanol,
- butyl alcohols,
- diacetone alcohol,
- butyl acetate,
- dibutylphthalate,
- ethyl ether and
- isopropyl ether.

8. The process according to claim 6 wherein the granular propellant selected is nitrocellulose based, said decahydrodecaborate compound selected is bisammonium decahydrodecaborate, said consolidation fluid is a mixture of approximately 65% by volume ethanol

and 35% by volume acetone, and said introducing step further consists of first dissolving approximately 0.9 gram of said salt per 100 milliliter of said fluid prior to said wetting step.

9. The product of a consolidated charge according to the process of claim 8.

10. A process according to claim 4 wherein the decahydrodecaborate compound selected is a simple metallic salt selected from the group consisting of cesium decahydrodecaborate, $Cs_2B_{10}H_{10}$, potassium decahydrodecaborate $K_2B_{10}H_{10}$, and the simple metallic decahydrodecaborate salts of the alkaline and alkaline earth metals of Groups 1a and 2a having an atomic number less than 87.

11. In a process for consolidating a charge of nitrocellulose-based propellant grains, the improvement of incorporating an ignition compound matrix comprised of certain decahydrodecaborate compounds, through the steps of:

(A) wetting loose propellant grains on their exterior surfaces with a consolidating fluid having a solvating effect on said grains, the consolidating fluid being in the range of approximately 0.010 to 0.100 milliliters of fluid per gram of propellant; and,

(B) introducing a layer of decahydrodecaborate compound onto the exterior surfaces of said grains as the result of the wetting effect of said consolidating fluid, wherein said compound is in the range of approximately 0.1% to 4.0% of the total propellant weight, wherein said compound further includes a salt selected from the class of salts having the common anion $B_{10}H_{10}^{-2}$, and a cation selected from the group consisting of:

(i) substituted ammonium cations, wherein the salt has the general formula $(R_3NH)_2B_{10}H_{10}$, wherein further R is selected from the group consisting of hydrogen and alkyl radicals containing less than six carbon atoms;

(ii) substituted hydrazinium cations, wherein the salt has the general formula $(R_2NNR_2H)_2B_{10}H_{10}$ wherein further R is selected from the group consisting of hydrogen and alkyl radicals containing less than six atoms;

(iii) tetramethylammonium, $(CH_3)_4N^+$, tetraethylammonium, $(CH_2CH_3)_4N^+$, and quaternary ammonium cations having the general formula R_4N^+ where R is an alkyl radical;

(iv) pyridinium, bipyridinium aryl-diazonium, aryl containing cations and substituted aryl containing cations.

(v) the guanidinium cation, $C(NH_2)_3^+$; and,

(C) consolidating the thusly wetted propellant grains into a consolidated charge by a compaction step, wherein the decahydrodecaborate compound layer on each grain becomes a matrix between the grain-to-grain boundaries of the consolidated charge.

12. The process according to claim 11 wherein the decahydrodecaborate compound selected is soluble in the consolidating fluid, and the step of introducing said compound further consists of first dissolving said compound in said fluid, wetting the exteriors of said propellant grains with the solution in order to form said layer on each grain.

13. The process according to claim 11 wherein the decahydrodecaborate compound selected is insoluble in the consolidating fluid, and the step of introducing said compound further consists of first suspending compound particles of approximately ten microns average

diameter in said fluid, and wetting the exteriors of said propellant grains with the suspension in order to form said layer on each grain.

14. The process according to claim 11, wherein said compound is insoluble in said fluid and is the resultant product of a coprecipitation of one of said salts with a solid oxidizing agent by the steps of:

(i) dissolving both the decahydrodecaborate (-2) salt and the oxidizing agent in a mutually soluble solvent, at a temperature sufficiently high to maintain said salt and said oxidizing agent in solution;

(ii) forming a pressurized stream of said solution and bringing said solution stream together with a pressurized stream of a miscible nonsolvent, under conditions of extreme turbulence within a mixing chamber, to effect a substantially complete coprecipitation;

(iii) recovering the coprecipitated product by filtering the effluent from said mixing chamber, and washing said product with an inert and nonsolvent fluid;

(iv) drying the product to remove all remaining liquid.

15. The process according to claim 11 wherein the step of introducing said compound further consists of first wetting the propellant grains and then tumbling the wetted grains in a powder of said compound in order to form said layer on each grain.

16. The process according to claim 11 wherein said granular nitrocellulose based propellant is selected from the group consisting of nitrocellulose, nitrocellulose/nitroglycerine, and nitrocellulose/nitroglycerine/nitroguanidine based gun propellants.

17. The process according to claim 11 wherein the consolidating fluid having a solvating effect on said propellant includes one or more members from the group consisting of:

acetone,
methyl ethyl ketone,
methyl isobutyl ketone,
methanol,
ethanol,
isopropanol,
butyl alcohols,
diacetone alcohol,
butyl acetate,
dibutylphthalate,
ethyl ether and
isopropyl ether.

18. The process according to claim 14 wherein the coprecipitated decahydrodecaborate compound is approximately 15% to 25% by weight tetramethylammonium decahydrodecaborate and the remainder an oxidizing agent selected from the group consisting of ammonium nitrate, potassium nitrate, potassium perchlorate, ammonium perchlorate, guanidine nitrate, triaminoguanidine nitrate, potassium permanganate, sodium chromate, barium nitrate, barium chromate, barium manganate, sodium dichromate, tetramethylammonium nitrate and cesium nitrate, wherein further the consolidating fluid includes one or more members selected from the group consisting of isopropanol, butylacetate/ethanol, acetone/ethanol, and ether/ethanol.

19. The product of a consolidated charge according to the process of claim 18.

• • • • •

[54] NOVEL TRIAMINOGUANIDINE NITRATE PROPELLANTS

[75] Inventor: Terrence P. Goddard, Aptos, Calif.

[73] Assignee: Teledyne McCormick Selph, an operating division of Teledyne Industries, Inc., Hollister, Calif.

[21] Appl. No.: 853,917

[22] Filed: Nov. 22, 1977

Related U.S. Application Data

[63] Continuation-in-part of Ser. No. 762,229, Jan. 24, 1977.

[51] Int. Cl.² C06B 45/10

[52] U.S. Cl. 149/19.3; 149/19.1; 149/19.8; 149/22; 260/564 D

[58] Field of Search 149/22, 19.3, 18, 19.1, 149/19.8; 260/564 D

[56] References Cited

U.S. PATENT DOCUMENTS

4,002,681 1/1977 Goddard 149/18

Primary Examiner—Stephen J. Lechert, Jr.
Attorney, Agent, or Firm—David H. Semmes; Warren E. Olsen

[57] ABSTRACT

This invention describes pyrotechnic compositions made by suitably combining, preferably by coprecipitation, triaminoguanidine nitrate with bis-triaminoguanidinium decahydrodecaborate. Propellants comprising these compounds are also included.

4 Claims, 2 Drawing Figures



NOVEL TRIAMINOGUANIDINE NITRATE PROPELLANTS

CROSS-REFERENCE TO RELATED APPLICATIONS

This application is a continuation-in-part of my earlier copending application of common assignment entitled BIS-TRIAMINOGUANIDINE DECAHYDRODECABORATE AND A PROCESS FOR ITS PREPARATION, filed Jan. 24, 1977, and assigned Ser. No. 762,229.

BACKGROUND AND BRIEF DESCRIPTION OF THE INVENTION

The present invention describes a family of new and unique pyrotechnic compositions, propellants based on them, and a method of preparing same. The basic compositions consist of mixtures or coprecipitates of bis-triaminoguanidinium decahydrodecaborate and triaminoguanidine nitrate, in any proportions.

A particular objective in preparing compounds suitable for certain types of pyrotechnic usage is to achieve a high gas output and low molecular weight combustion products, when the compound is burned. Combustion products such as hydrogen (H₂) and nitrogen (N₂) gas fulfill this requirement. In preparing salts useful as pyrotechnic monopropellants and oxidizers from an anion such as decahydrodecaborate (-2) (B₁₀H₁₀⁻²) or nitrate (NO₃⁻), it has been found advantageous to use a cation containing a high weight fraction of atomic nitrogen and hydrogen. The triaminoguanidinium ion, chemical formula C(NHNH₂)₃⁺, has been found to be such a cation. In addition, the corresponding Brønsted base of the ion, free triaminoguanidine, is a strong base, which imparts to the cation, and thus the salt, a high degree of chemical stability.

Triaminoguanidine nitrate, (NHNH₂)₃CNO₃, also known to those practiced in the art as TAGN, has been found to have particular usefulness as an oxidizer in certain classes of propellants. It is by itself a slow, cool burning monopropellant with high gas output. One of the most serious drawbacks with the use of TAGN is the control of burning rate of the neat material, as well as propellants containing it.

This invention describes compositions employing TAGN as a starting material that have pyrotechnic performance superior to pure TAGN, in terms of energy and gas output and burning rate control. In particular, very fast burning, high energy propellants can be manufactured from them. The subject compositions consist of very intimate blends or coprecipitates of an ultrafast deflagrating monopropellant, namely the triaminoguanidinium salt of decahydrodecaboric acid, with TAGN. The resulting compositions, which can be prepared over a wide range of the constituent anion content, have pyrotechnic properties wholly unlike the starting salts.

Historically, boron hydride salts, in particular the non-metal salts of decahydrodecaboric acid, has been discovered to have particular utility in the field of high energy fuels. They may be used as constituents of pyrotechnic compositions and in propellants. For example, non-metallic salts of the decahydrodecaborate ion, and exemplary uses, are disclosed in the copending application of common assignment entitled IGNITION AND PYROTECHNIC COMPOSITIONS, Ser. No. 694,625, filed June 10, 1976. For these compositions, in

general, the ratio of decahydrodecaborate fuel to oxidizer was fixed within certain defined limits in order to achieve acceptable pyrotechnic performance.

The particular decahydrodecaborate salt used in this invention is the fully amino-substituted compound, which is disclosed in my copending patent application of common assignment entitled BIS-TRIAMINOGUANIDINIUM DECAHYDRODECABORATE AND A PROCESS FOR ITS PREPARATION, Ser. No. 762,229, filed Jan. 24, 1977, incorporated herein by reference. In contrast to other simple decahydrodecaborate salts, the triaminoguanidine salt is a powerful monopropellant; i.e., combusts by itself releasing internal energy, without need of additional oxidizer materials. The compound is very unusual in that it contains only boron, nitrogen, carbon and hydrogen, but no oxygen.

The advantage of the chemical system formed by combining the two monopropellants is that they can be mixed in any proportion and, as well, both possess the triaminoguanidine ion as a common cation.

The preferred method of preparing a compound with a given stoichiometry consists of dissolving the two starting salts in water and rapidly precipitating the constituent ions simultaneously with a nonsolvent such as isopropanol. The detailed methodology for this process, known as "coprecipitation," has been disclosed in my copending application entitled COPRECIPITATED PYROTECHNIC COMPOSITION PROCESSES AND RESULTANT PRODUCTS, Ser. No. 694,626, filed June 10, 1976. This process for preparing the subject compositions makes use of the triaminoguanidinium cation which is common to both starting salts, and coprecipitates of the two salts result in very intimate mixing of the B₁₀H₁₀⁻² and NO₃⁻ anions which helps impart to the resulting compositions very reproducible pyrotechnic performance.

DETAILED DESCRIPTION OF THE INVENTION

General Information

The compositions of this invention are described by the general chemical formula

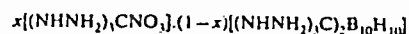

where x can vary between 0.01 and 0.99. Preferred compositions have $0.5 < x < 0.99$.

The subject compositions are prepared by blending or combining the starting salts:

(a) bis-triaminoguanidinium decahydrodecaborate (-2), [(NHNH₂)₃C]₂B₁₀H₁₀, and

(b) triaminoguanidine nitrate (TAGN), (NHNH₂)₃CNO₃, in such a manner as to achieve very intimate mixing. A coprecipitation process, as will be described below, is a preferred method of preparing the compositions.

TAGN

The triaminoguanidine nitrate, which is classified for shipping purposes as "Explosive, Class A," can be obtained from several commercial sources, but may be conveniently prepared in the laboratory according to the reaction:

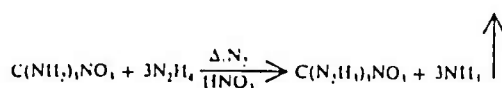

In this method, 1 part-by-weight guanidine nitrate [(NH₂)₃CNO₂], 2.3 parts-by-weight hydrazine hydrate (N₂H₄·H₂O), 2.4 parts-by-weight water, and 0.5 parts-by-weight nitric acid (HNO₃, 90%) are combined in a suitable vessel and heated to 80°-85° C. Heating is maintained for two hours, with dry nitrogen (N₂) bubbled through the mixture. The solution is cooled and allowed to stand for 8 hours, after which period the triaminoguanidine nitrate is recovered as a white precipitate. The product may be purified by recrystallization.

Bis-triaminoguanidinium Decahydrodecaborate

The bis-triaminoguanidine decahydrodecaborate salt may be prepared by neutralizing one mole of aqueous decahydrodecaboric acid, H₂B₁₀H₁₀ (or as the hydronium form, (H₃O⁺)₂B₁₀H₁₀⁻²), with two moles of the aqueous free base [C(NHNH₂)₃]₂(NNH₂).

The aqueous decahydrodecaboric acid used as a starting material for the process of this invention is conveniently prepared by passing an amine or metal salt of the decahydrodecaborate (-2) ion through a column containing a strongly acidic ion exchange resin of the sulfonic acid type, such as a DUOLITE type C-20, manufactured by the Diamond Shamrock Corporation. Preferred starting salts are bis (triethylammonium) decahydrodecaborate (-2) and disodium decahydrodecaborate (-2). The preparation and properties of the aqueous acid itself are known, and reference may be made to KNOTH, U.S. Pat. No. 3,148,939, for further detail.

The free base of triaminoguanidine may be prepared by passing a chloride, nitrate, or other water soluble salt of triaminoguanidine through a column containing a strongly basic ion exchange resin of the polystyrene type, such as DOWEX® 2-X8, manufactured by the Dow Chemical Company of Midland, Mich.

The neutralization preparation where the concentrations of the reacting aqueous solutions are approximately 0.3 molar, results in an immediate precipitation of the desired product. Upon filtering, washing with cold water, purification by recrystallization or reprecipitation in isopropanol, and washing with butyl acetate (to aid in drying) a brilliant white powder with a prilled appearance is recovered, which can be demonstrated to be the subject compound of a purity exceeding 97%.

Other preparative methods employing simple metathesis are obvious. For example, the product could be recovered by mixing aqueous solutions of salts containing the substituent ions, such as aqueous triethylammonium decahydrodecaborate and aqueous triaminoguanidine hydrochloride, such that the desired product precipitates and the undesired ions remain in solution.

The detailed preparation and properties of the bis triaminoguanidine decahydrodecaborate salt, which is by itself useful as a pyrotechnic monopropellant, are given in my copending patent application Ser. No. 762,229, as referenced above.

Preparation of Subject Compositions via Physical Blending

The compositions of this invention may be prepared by intimately mixing the finely divided constituents by hand or in conventional mixing equipment. A liquid carrier such as butyl acetate or trichloroethylene may be employed to facilitate mixing or addition of binder; the liquid is subsequently evaporated to yield the dry composition. The physical blending process, in general, and as applicable to other decahydrodecaborate salts and oxidizers, is described further in the copending application of common assignment, Ser. No. 694,625, as referenced above.

General Description of the Coprecipitation Process

In general, the physical blends of oxidizer with the decahydrodecaboric acid salts, as described in the copending application Ser. No. 694,625, noted above, suffer from several deficiencies inherent in the physical blend properties and processing technique. When used as a confined column delay, in a lead sheath, for example, the burn rates may be unreproducible, and the column fails to propagate below a certain critical distribution of the mixture in the tube. The stoichiometry of a physical blend is always subject to point-to-point variations due to blending techniques, settling and separation of the separate ingredients, and particle size distributions of the constituent materials.

A method is thereby needed to produce a composition with very uniform composition, in which the fuel anion and oxidizer are in very intimate contact, and which is very reproducible in manufacturing techniques from lot to lot. It has been discovered that such an intimate mixture can be obtained if the decahydrodecaborate (-2) anion is mixed in the crystal lattice with the oxidizing agent, in this case a nitrate ion, and if crystals containing the respective ions and oxidizing agents are intimately intertwined.

The process by which the compositions of the referenced invention are prepared produces a very intimate blend of decahydrodecaborate (-2) ion with the oxidizer, and makes the compositions so prepared chemically and physically unique from physical blends of decahydrodecaborate (-2) salts with oxidizer or pyrotechnic compositions incorporating decahydrodecaborate (-2) salts produced by other means. In general, the process consists of dissolving, in a suitable solvent, a decahydrodecaborate (-2) salt, and also dissolving, in the same solution, the oxidizing agent. The subject composition is recovered by precipitating the composite ingredients of the solution with a suitable nonsolvent. The resulting solid, after filtration and drying, comprises an intimate mixture of the decahydrodecaborate (-2) anion with the oxidizing cation or substance, in a form that is chemically and physically different than the starting materials.

The process may be properly called a "cocrystallization" or "coprecipitation" and the resulting product a "cocrystallate" or "coprecipitate". The detailed requirements and description of the process is given in the copending application of common assignment, entitled COPRECIPIATED PYROTECHNIC COMPOSITION PROCESSES AND RESULTANT PRODUCTS, filed June 10, 1976 and assigned Ser. No. 694,626, and is incorporated herein by reference.

Preparation of Subject Compositions via Coprecipitation

The coprecipitation process is a preferred method of preparing compounds of this invention. In the general method, the requisite quantities of the salts (a) bis-triaminoguanidinium decahydrodecaborate (-2), and (b) TAGN, are dissolved in hot water at approximately 70° C. A preferred solution concentration is approximately 0.3-0.1 molar in $B_{10}H_{10}^{-2}$, due to the relatively low solubility of the salt (a). The ions in the hot solution are precipitated by rapidly mixing one part-by-volume of the hot solution with five parts-by-volume isopropanol (anhydrous), in an apparatus and via the method described in the above-noted application Ser. No. 694,626. The resulting precipitate is filtered, washed in butyl acetate, and dried, to yield a white, fluffy powder. Where small quantities of the subject compositions are desired, for example 150 grams or less, satisfactory results can be obtained by effecting the rapid precipitation by hand, i.e., slowly pouring the hot solution into a pot containing rapidly stirred isopropanol.

The resulting product contains stoichiometrically the substituent ions from starting salts (a) and (b), but in different chemical environments than in the starting salts. Specifically, there is interlattice and intercrystalline mixing of the substituents, notably the $B_{10}H_{10}^{-2}$ and NO_3^- ions, a chemical state not obtainable by physical blending. This state mixing results in compositions with more uniform and predictable burning than compositions obtained by other methods of combining the ingredients.

The choice of the ratio of starting salt (a) to starting salt (b) depends on the application requirements. A unique and exceptionally useful feature of the subject compositions is that salts (a) and (b) may be combined in virtually any proportions, although compositions containing 50% or more by weight triaminoguanidine nitrate are preferred for economic reasons. The pyrotechnic performance and utility of the composition system is illustrated by FIG. 1, which shows the heat of explosion of the subject compositions as a function of the decahydrodecaborate salt (a) content. This curve (FIG. 1) was generated by preparing physical blends of salts (a) and (b) in the proportions indicated, and igniting a sample of the composition in a closed Parr bomb in an argon atmosphere. The heat of reaction, or more commonly termed by those practiced in the art "heat of explosion," is derived by measuring the temperature rise in a water bath surrounding the reaction vessel. This heat of explosion as a function of decahydrodecaborate salt (a) content is a smooth, monotonically increasing function to at least 50% by-weight salt (a), starting at 940 cal/g (pure TAGN) and approaching 1325 cal/gram (pure bis-triaminoguanidinium decahydrodecaborate). Coprecipitates of salts (a) and (b), as indicated on FIG. 1, have heats of explosion very near that derived for physical blends, indicating that no significant change in burning mechanism accompanies the coprecipitation process.

Application of The Subject Compositions

The subject compositions can be used per se as ignition compounds mixed with other ingredients, or manufactured into propellants. Other additives may be employed to alter the processing, handling, or other properties of the mix. These are known, per se, and may include binders such as caesin, gum arabic, dextrin,

waxes, polymeric materials such as polyurethanes, epoxies, natural or synthetic rubbers, copolymers or a rubber and plastic such as styrenebutadiene, methyl cellulose, and nitrocellulose. Polyethylene glycol of average molecular weight 4000 is a preferred known additive. These ingredients are commonly used in concentrations up to 8% by weight.

A major usage of the subject compositions is in ultra high burn rate propellants, where the coprecipitated composition is used as a major fraction of the solids content of the propellant. These propellants and methods for their preparation are further described in the copending application of common assignment entitled HIGH BURNING RATE PROPELLANTS WITH COPRECIPITATED SALTS OF DECAHYDRODECABORIC ACID, Ser. No. 707,810, filed July 22, 1976. When used in accordance with the formulations taught in the aforementioned disclosure, the subject propellants would have the general formula:

	Probable Range, % by Wt.
1. Polymeric binder system	8-15
2. Curing, polymerizing, or cross-linking agents	0-10
3. Plasticizing agents	0-25
4. Pure decahydrodecaborate salts	0-25
5. Coprecipitated triaminoguanidine nitrate/bis triaminoguanidinium decahydrodecaborate	35-90
6. Energetic fuels, such as, but not limited to, finely divided aluminum	0-10
7. Oxidizer or mixture of oxidizers to supplement (5)	0-15
8. Other inert ingredients, such as colorants, stabilizers.	0-10

The unique products of this invention, and representative usages are further illustrated by the following Examples.

EXAMPLE I

1.5 Grams bis-triaminoguanidinium decahydrodecaborate and 8.5 grams triaminoguanidine nitrate are dissolved in 100 milliliters deionized water at 50° C. The ingredients are rapidly precipitated by pouring into 500 ml stirred anhydrous isopropanol. A white powder precipitates immediately, and is recovered by filtration, washed in the filter with n-butyl acetate, and dried in an oven at 60° C.

A series of standard pyrotechnic characterization tests are run on the dried powder; results are summarized in Table I.

TABLE I

PARAMETER	Ex. I	Ex. II	Ex. III
method of manufacture	hand	lab coprecipitator	hand
% bis-triaminoguanidinium decahydrodecaborate	15	15	25
heat of explosion, cal/gram ¹	1129	1089	1159
impact sensitivity, cm ²	8	6	—
electrostatic sensitivity, millijoules ²	—	>225	—
autoignition temperature, ° C ⁴	250	240	247
true density (g/cc)	1.46	1.38	1.60

¹Parr Bomb under argon

²Enclosed Bureau of Mines tool, 1 kg drop, no grit

³2 electrode, 0.020 inch gap, open cup, 500 pF capacitor, no resistor.

⁴See Woods metal bath.

EXAMPLE II

22.5 Grams bis-triaminoguanidine decahydrodecaborate and 125.4 grams triaminoguanidine nitrate are dis-

solved in 250 ml deionized water at 50° C. The hot solution was charged into a laboratory model coprecipitator, as described in application Ser. No. 694,626. The product is obtained by precipitation with 5 times the solution volume of anhydrous isopropanol; flow rates of 200 cc/min of the solution and 1000 cc/min isopropanol, with a mixing head gap of 0.030 inches are used. The resulting product is recovered in a filter, washed with butyl acetate, dried at 60° C, and spatulated.

Pyrotechnic characteristics of the resulting composition are also given in Table I, above.

EXAMPLE III

28.3 Grams bis-triaminoguanidinium decahydrodecaborate and 85 grams triaminoguanidine nitrate are dissolved in 1000 ml deionized water at 60° C. The hot solution is poured slowly into a stainless pot containing 5000 ml anhydrous isopropanol agitated with a high speed stirring apparatus. The resulting precipitate is filtered, washed with butyl acetate in the filter, dried 24 hours at 125° F, and spatulated.

Pyrotechnic characteristics of the resulting compositions are also given in Table I, above.

EXAMPLE IV

A free energy minimization thermochemical analysis, as commonly performed by those practiced in the art, is run on a hypothetical composition comprising 15%-by-weight bis-triaminoguanidinium decahydrodecaborate and 85%-by-weight triaminoquinidine nitrate, representative of the compositions produced as Examples I and II. Representative combustion parameters of the composition burning in a chamber at 1000 psi and exhausted through a nozzle are given in Table II. The propellant has low flame temperature and very high gas output.

TABLE II

PARAMETER	Combustion Parameters of 15%-By-Weight Bis-Triaminoguanidinium Decahydrodecaborate And 85%-By-Weight Triaminoquinidine Nitrate	
	1000 psi	EXPANDED
Specific impulse (ft-lb/lb)	0	245
Specific impulse (vacuum, ft-lb/lb)	0	264
Flame temperature (isobaric, ° K)	2103	986
Gamma	1.26	1.28
Flame temperature (isochoric, ° K)	2650	1262
Gas output (moles/100g)	5.66	5.45
Gas molecular weight	15.9	15.5
Product molecular weight	17.7	18.4

Used as a gun propellant, the impetus of the system (without binder) is 416,000 (ft-lb/lb), which is substantially higher than either nitramine propellants currently known or, as well, nitrocellulose propellants. Primary combustion products after expansion are, (in units of moles/100g):

H₂: 2.5
N₂: 2.1
CO: 0.5
H₂O: 0.23
B₂O₃: 0.22

EXAMPLE V

The utility of the subject compositions as very high pressure-producing compositions is illustrated by loading approximately 100 milligrams of the subject compositions into a closed pressure cartridge of a well-known type as shown in FIG. 2, and firing the pressure cartridge in a 10 cc closed bomb. The pressure in the bomb

is measured by a fast response transducer and recorded as a function of time. The pressure cartridge consists of an exploding bridgewire mounted in a suitable cartridge case. The bridgewire is primed with a 53 mg of an initiating pyrotechnic powder. The subject composition is loaded into the cartridge over the priming load, and the cartridge closed with a crimped or welded cap. The function time of the compositions is taken as the time between the application of current to the bridgewire to the peak pressure.

When tested in this manner, 96 mg of the composition from Example II produces a peak pressure of 1600 psi in 4 milliseconds. By contrast, to produce a comparable pressure rise, 120 g of a commonly used high speed composition, [consisting of 22 parts-by-weight finely divided zirconium, 17.5 parts-by-weight potassium perchlorate, 1.7 parts-by-weight binder, and 58 parts-by-weight "Hi Temp" (Hercules Powder Co., an RDX/wax composition)] is required.

EXAMPLE VI

The utility of the subject compositions when used in a propellant described in the copending application of common assignment entitled HIGH BURNING RATE PROPELLANTS WITH COPRECIPITATED SALTS OF DECAHYDRODECABORIC ACID, filed July 22, 1976 and assigned Ser. No. 707,810, is illustrated by preparing a propellant with the following formulation:

Composition from Example II: 70%
Nitrocellulose (12.6%N): 17%
Dinitrotoluene: 7%
Acetyl Tributyl Citrate: 6%

The propellant ingredients are slurried in a 75%-by-volume ethanol/25%-by-volume butyl acetate solvent and charged into a one-pint Baker Perkins sigma blade dough mixer. The solvent is removed under vacuum at 120° F and a thick dough obtained. The dough is extruded into ¼ inch diameter burning rate strands using a 6-inch air operated press and 1-inch barrel extruder. Further drying at 120° F for several weeks follows.

The strands are fired in a closed bomb strand burner, as commonly used by those practiced in the art. A burning rate of 475 inches per second is measured with the bomb pressurized to 2000 psi, which represent burning rates wholly unachievable with state-of-the-art propellants.

A free energy minimization program is run on this propellant to assess its utility as a gun or rocket propellant; parameters are summarized in Table III. The derived impulse of 360,000 ft-lb/lb is typical of that achievable with single base propellants. This value can be raised substantially by reducing the plasticizer content of the propellant, or, for rocket propellants, adding aluminum.

TABLE III

PARAMETER	Combustion Parameters of Propellant Containing Coprecipitated Product	
	1000 psi	EXPANDED
Specific Impulse (lb-sec/lb)	—	226
Specific Impulse (vacuum, lb-sec/lb)	—	246
Flame Temperature (isobaric, ° K)	1815	967
Gamma	1.27	1.27
Flame Temperature (isochoric, ° K)	2305	1228
Gas Output (moles/100g)	5.63	5.14
Gas Molecular Weight	15.9	16.8
Product Molecular Weight	17.8	19.45

PARAMI
Impulse (f

While
have be
to be un

the scop
I claim

1. A p

(A) a

perc

(B) cu

(C) p

(D) a

TABLE III-continued

Combustion Parameters of Propellant Containing Coprecipitated Product	
PARAMETER	1000 psi EXPANDED
Impulse (ft-lb/lb)	360,000

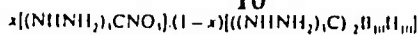

wherein the value of x is between 0.01 and 0.99, in the range 35-90 percent.

2. A propellant according to claim 1 wherein further said composition is a coprecipitate and the substituents $B_{10}F_{10}^{-2}$ and NO_2^- are intimately intertwined through interlattice and intercrystalline mixing.

3. A propellant according to claim 2 wherein said polymeric binder system is an active binder which is selected from the group consisting of nitrocellulose, oxygen containing binders and fluorine containing binders, and the value of x is between 0.5 and 0.99.

4. A propellant according to claim 3 wherein the active binder is nitrocellulose, with a nitrogen content between 12.5% and 13.3%, by weight, wherein the oxidizer component is substantially supplied by said coprecipitate composition.

• • • • •

While various examples of the subject composition have been given, and preparatory methods taught, it is to be understood that the invention is to be defined by the scope of the appended claims.

I claim:

1. A propellant comprising, by weight:

(A) a polymeric binder system, in the range 8-35 percent;

(B) curing agents, in the range 0-10 percent;

(C) plasticizing agents, in the range 0-25 percent;

(D) a composition having the general formula

5

10

15

20

25

30

35

40

45

50

55

60

65

id recorded
nsists of
tal cartridge
ing of an initi-
composition is
oad, and the
id cap. The
as the time
dgewire to
e composition
e of 1600 psi in
a comparable
e high speed
weight finely
potassium per-
8 parts by
der Co., an

when used in
application of
NING RATE
CIPITATED
KIC ACID,
o. 707,810, is
f: following

in a 75%-by-
c rate solvent
s sigma blade
der vacuum at
ough is ex-
ands using a
rrel extruder.
ks follows.

s and burner,
he rt. A burn-
sued with the
resent burning
th art propel-

is run on this
rocket propel-
e. The de-
al of that
his value can
lasticizer con-
elents, adding

EXPANDED
226
246
967
127
1228
5.14
16.8
19.45

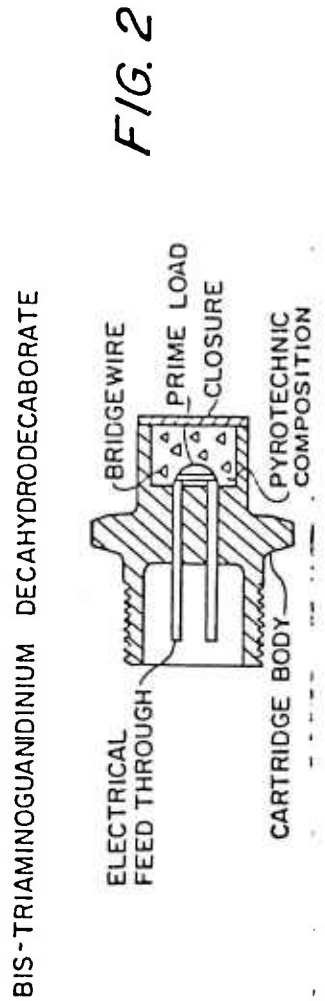
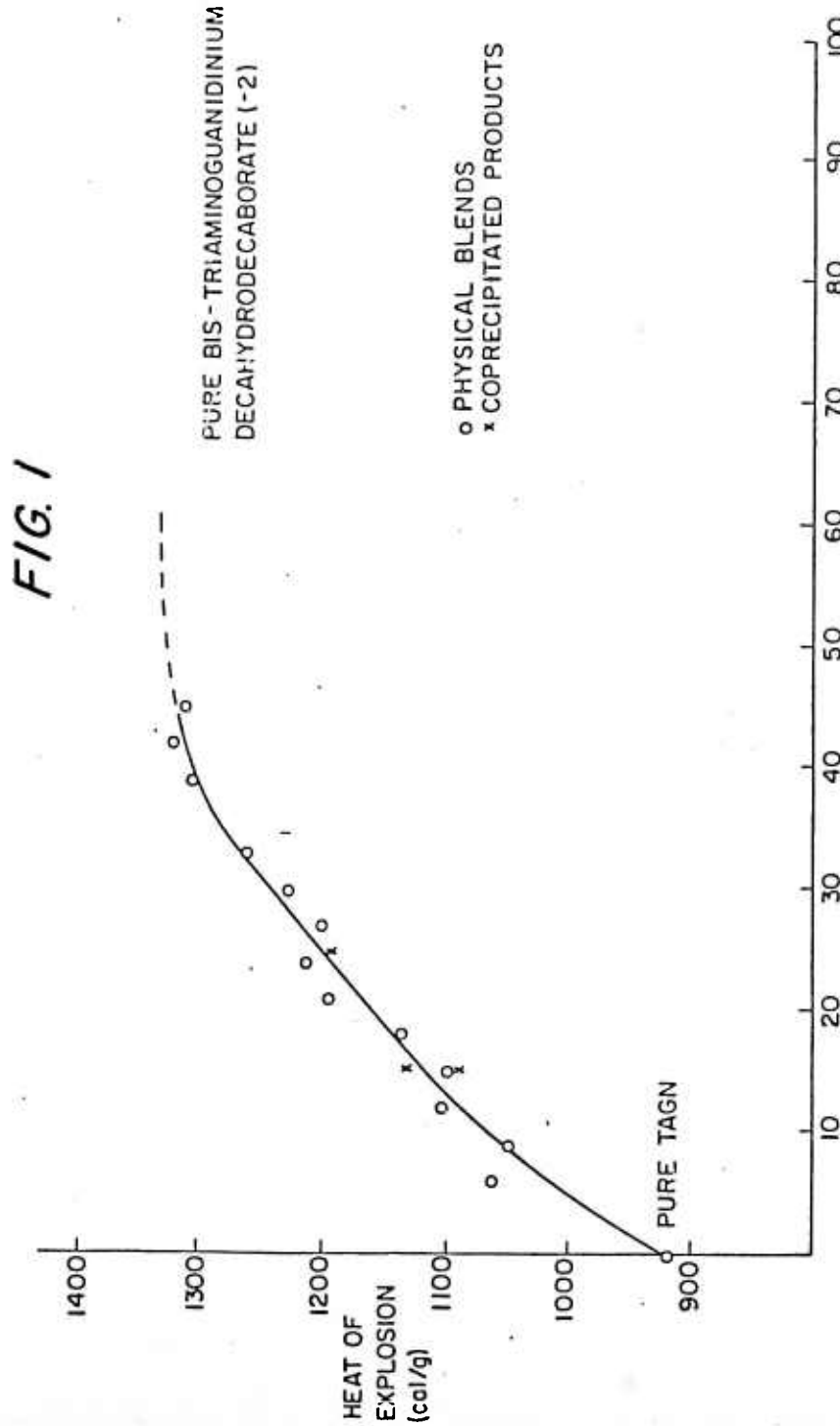

United States Patent [19]

Goddard

[11] 4,130,585

[45] Dec. 19, 1978

[54] BIS-TRIAMINOGUANIDINE
DECAHYDRODECABORATE, PROCESS
FOR PREPARATION, AND HIGH ENERGY
PROPELLANT

[75] Inventor: Terrence P. Goddard, Aptos, Calif.

[73] Assignee: Teledyne McCormick Selph, an
operating division of Teledyne
Industries, Inc., Hollister, Calif.

[21] Appl. No.: 762,229

[22] Filed: Jan. 24, 1977

[51] Int. Cl.² C07C 123/00

[52] U.S. Cl. 260/564 D; 149/22

[58] Field of Search 149/18, 22; 260/564 D

[56] References Cited

U.S. PATENT DOCUMENTS

4,002,681 1/1977 Goddard 149/18

Primary Examiner—Stephen J. Lechert, Jr.
Attorney, Agent, or Firm—David H. Semmes, Warren E.
Olsen

[57] ABSTRACT

This invention relates to bis-triaminoguanidine decahy-
drodecaborate, which is a novel boron salt that has
been found to have particular utility as a high energy
monopropellant. The invention includes the
triaminoguanidinium salt of decahydrodecaboric acid,
and as a product of a preferred process for preparing
same.

5 Claims, No Drawings

**BIS-TRIAMINO GUANIDINE
DECAHYDRODECABORATE, PROCESS FOR
PREPARATION, AND HIGH ENERGY
PROPELLANT**

**BACKGROUND AND BRIEF DESCRIPTION OF
THE INVENTION**

Boron hydride salts, in particular the nonmetal salts of decahydrodecaboric acid, had been discovered to have particular utility in the field of high energy fuels. They may be used as constituents of pyrotechnic compositions and in propellants. For example, non-metallic salts of the decahydrodecaborate ion, and exemplary uses, are disclosed in the co-pending applications of common assignment entitled "Ignition and Pyrotechnic Compositions," Ser. No. 694,625, filed June 10, 1976 and "Coprecipitated Pyrotechnic Composition Processes and Resultant Products," Ser. No. 694,626, filed June 10, 1976.

The present invention teaches a new non-metal salt of decahydrodecaboric acid, which exhibits stable physical properties, and is of itself a high energy monopropellant. The compound is very unusual in that it contains only boron, nitrogen, carbon, and hydrogen, but no oxygen.

A particular objective in preparing compounds suitable for certain types of pyrotechnic usage is to achieve a high gas output and low molecular weight combustion products, when the compound is burned. Combustion products such as hydrogen (H_2) and nitrogen (N_2) gas fulfill this requirement. In preparing salts useful as pyrotechnic fuels from an anion such as decahydrodecaborate (-2)($B_{10}H_{10}^{-2}$), it has been found advantageous to use a cation containing a high weight fraction of atomic nitrogen and hydrogen. The triaminoguanidinium ion, chemical formula $C(NHNH_2)_3^{+1}$ has been found to be such a cation. In addition, the corresponding Brønsted base of the ion, free triaminoguanidine, is a strong base, which imparts to the cation, and thus the salt, a high degree of chemical stability.

Other decahydrodecaborate (-2) salts employing guanidine chemistry have been previously investigated by the present inventor. The simple guanidine salt is disclosed in my earlier application "Bis-Guanidinium Decahydrodecaborate and a Process of Its Preparation," Ser. No. 694,627, filed June 10, 1976, which is now U.S. Pat. No. 4,002,681. This simple salt was found to be useful as a high energy pyrotechnic fuel, and was by itself thermochemically stable; i.e., has a substantial negative heat of formation as commonly defined by those practiced in the art. The compound which is the subject of the present invention, by contrast, combusts by itself releasing internal energy, without need of an additional oxidizing material, which suggests the presently taught compound has a substantial positive heat of formation. As a result, the compound taught herein is useful as a monopropellant in its own right, or alternatively, can be used with additional oxidizer to modify its combustion properties. Specifically, such inorganic oxidizing agents as potassium nitrate, guanidine nitrate and ammonium perchlorate may advantageously be employed, in concentrations from 0-90%, by weight.

**DETAILED DESCRIPTION OF THE
INVENTION**

The triaminoguanidine salt of the decahydrodecaborate (-2) ion is represented by the chemical formula

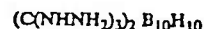

and more accurately by the structural formula:

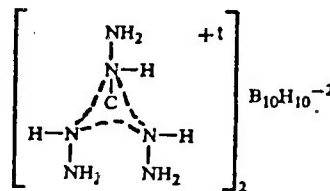

which illustrates the resonance stabilization achieved by protonating the free substituted guanidine base to form the unipositive ion.

The salt is relatively insoluble in cold water, which makes preparation by a variety of metathesis reactions feasible. A preferred method of preparation is to stoichiometrically neutralize one mole of aqueous decahydrodecaboric acid, $H_2B_{10}H_{10}$, (or as the hydronium form, $(H_3O^+)_2B_{10}H_{10}^{-2}$), with two moles of the aqueous free base $(C(NHNH_2)_3)_2$ (NNH_2).

The aqueous decahydrodecaboric acid used as a starting material for the process of this invention is conveniently prepared by passing an amine or metal salt of the decahydrodecaborate (-2) ion through a column containing a strongly acidic ion exchange resin of the sulfonic acid type, such as a DUOLITE type C-20, manufactured by the Diamond Shamrock Corporation. Preferred starting salts are bis (triethylammonium) decahydrodecaborate (-2) and disodium decahydrodecaborate (-2). The preparation and properties of the aqueous acid itself are known, and reference may be made to Knoth U.S. Pat. No. 3,148,939, for further detail.

The free base of triaminoguanidine may be prepared by passing a chloride, nitrate, or other water soluble salt of triaminoguanidine through a column containing a strongly basic ion exchange resin of the polystyrene type, such as DOWEX® 2-X8, manufactured by the Dow Chemical Company of Midland, Mich.

The neutralization preparation where the concentrations of the reacting aqueous solutions are approximately 0.3 molar, results in an immediate precipitation of the desired product. Upon filtering, washing with cold water, purification by recrystallization or reprecipitation in isopropanol, and washing with butyl acetate (to aid in drying) a brilliant white powder with a prilled appearance is recovered, which can be demonstrated to be the subject compound of a purity exceeding 97%.

Other preparative methods employing simple metathesis are obvious. For example, the product could be recovered by mixing aqueous solutions of salts containing the substituent ions, such as aqueous triethylammonium decahydrodecaborate and aqueous triaminoguanidine hydrochloride, such that the desired product precipitates and the undesired ions remain in solution. The first method, however, may be preferred where high purities are required, because the process of obtaining the free acid and free base forms of

the desired ions by ion exchange results in an added purification step.

The subject of this invention is useful as a high energy monopropellant in such devices as electric initiators or squibs, or as an ingredient to enhance burning rates. The compound may be mixed with additional materials with oxidative power to modify the combustion properties, for use in such devices as pyrotechnic deflagrating cords.

Specific reference should be had to the above-noted copending application entitled "Ignition and Pyrotechnic Compositions," Ser. No. 694,625, incorporated herein by reference, for examples of suitable and preferred species of oxidizing agents which are useful for creating a pyrotechnic mixture with the particular boron-containing salt taught herein. While the $B_{10}H_{10}^{-2}$ anion, a bicapped square antiprism polyhedral ion, has unusual stability, it is significant that the present compound achieves a resonance stabilization by protonating a free substituted guanidine base to form the unipositive ion comprising the cation. Of greater, and perhaps related, significance is the unexpected result that the simple salt bis-guanidinium decahydrodecaborate, had a substantial negative heat of formation, making the simple salt useful as a high energy pyrotechnic fuel, while the present invention exhibits a compound having a substantial positive heat of formation. Hence, the compound taught herein is useful alone, as a monopropellant, or optionally is capable of use as a component in a pyrotechnic material, through mixture with an oxidizing agent, to take further advantage of the unique decomposition properties of the decahydrodecaborate (-2) anion.

The unique product of this invention, bis-triaminoguanidinium decahydrodecaborate, is further illustrated by reference to the following example.

Example I

Fourteen hundred milliliters of aqueous free triaminoguanidine, obtained by passing a 2N solution of triaminoguanidine hydrochloride through a column containing DOWEX® 2-X8 exchange resin, is neutralized to pH7 with approximately 800 ml of 0.3M aqueous decahydrodecaboric acid at room temperature. A white precipitate forms immediately during the neutralization. The precipitate is recovered and washed with cold water. A small second crop of product is obtained by reducing the volume of filtrate on a rotary evaporator and chilling to 0° C.

The product is purified by dissolving the precipitate in 800 ml deionized water at 80° C. and slowly adding the hot solution to 4000 ml reagent grade isopropanol, with vigorous stirring, where the product reprecipitates. The precipitate is filtered, washed in butyl acetate, refiltered, and dried in vacuo at 140° F.

63 grams of a fluffy, brilliant white powder with a prilled appearance is obtained after drying.

Analysis: The $B_{10}H_{10}^{-2}$ in a small sample of the compound is oxidized at 80° C. with platinum black in aqueous solution to boric acid. The boric acid content of the degraded product is determined by titration against sodium hydroxide in mannitol solution. Boron content found: 32.2%. Theoretical content: 32.9%.

The infrared spectrum is obtained in a KBr pellet incorporating the compound. The spectrum between 4000 and 800 cm^{-1} is virtually a superposition of spectra of triaminoguanidine hydrochloride and metallic salts of decahydrodecaboric acid with some minor shifting due to lattice effects. The characteristic peaks from the triaminoguanidinium ion are found at 3450, 3320, 1690, 1600, 1350, 1130 and 960 cm^{-1} ; the characteristic decahydrodecaborate (-2) ion peaks are found at 2470,

1080 and 1030 cm^{-1} . No other major features are evident.

An analysis of solution conductivity vs. solution concentration gives a conductivity of 222 $ohm^{-1} cm^2 mole^{-1}$ at infinite dilution, which is characteristic of a compound containing three ions, one species being an organic cation. The above analyses demonstrate that the recovered product is the desired subject of the invention.

Characteristics: The pyrotechnic utility of the subject composition is demonstrated by subjecting the material to several standard tests used to characterize explosives and pyrotechnics.

A sample of the compound, having a density of 1.22 grams/c.c., is subjected to an impact drop test, consisting of placing a 5 milligram sample of the powder on a 400 grit paper disc, and releasing a 2 kilogram weight from a calibrated height. An anvil on the weight strikes the powder sample. The sample fails to ignite 10 times in succession when the weight is released from a height of 3 centimeters. This test indicates the compound is very slightly less impact sensitive than primary explosives such as lead styphnate or lead azide (2 cm). the "fire" event is characterized by a fireball several centimeters in diameter, indicating that the igniting compound has a very high gas output.

The heat of explosion of the compound is measured by igniting a sample of the compound in a closed calorimeter bomb under argon, and measuring the temperature rise in a water bath surrounding the bomb. The heat of explosion is 1367 calories per gram of sample, which is approximately 3 times that of commonly used initiating explosives such as lead azide or lead styphnate.

The autoignition temperature of the compound is measured by recording the temperature at which the compound will not spontaneously ignite within 5 seconds when placed in contact with a hot reservoir. The measured autoignition temperature is 252° C., which illustrates the good thermal stability of the subject composition.

Obvious modifications and equivalents in the present invention will be evident to those skilled in the art, and the scope of the present invention is to be defined solely by the appended claims.

I claim:

1. The triaminoguanidinium salt of decahydrodecaboric acid, having the formula $(C(NHNH_2)_3)_2 B_{10}H_{10}$.

2. A product having the formula

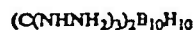

said product being formed by the process of neutralizing one mole of aqueous decahydrodecaboric acid, $H_2B_{10}H_{10}$ with two moles of the aqueous free base of triaminoguanidine, $(C(NHNH_2)_3)_2(NNH_2)$.

3. The product according to the process of claim 2, wherein the concentrations of the reacting aqueous solutions are approximately 0.3 molar, whereby said product is precipitated, and then said product is filtered, washed with cold water and washed with butyl acetate.

4. A high energy monopropellant consisting essentially of the triaminoguanidinium salt of decahydrodecaboric acid, having the formula $(C(NHNH_2)_3)_2 B_{10}H_{10}$.

5. A pyrotechnic mixture consisting essentially of the salt according to claim 1, with an oxidizing agent, wherein said salt comprises from 10% and up to 100%, by weight, of said mixture.

• • • • •

[54] COPRECIPITATED PYROTECHNIC COMPOSITION PROCESSES AND RESULTANT PRODUCTS

[75] Inventors: **Terrence P. Goddard**, Aptos; **Donald N. Thatcher**, Hollister, both of Calif.

[73] Assignee: **Teledyne McCormick Selph**, Hollister, Calif.

[21] Appl. No.: 694,626

[22] Filed: **Jun. 10, 1976**

Related U.S. Application Data

[63] Continuation-in-part of Ser. No. 585,216, Jun. 6, 1975, abandoned.

[51] Int. Cl.² C06B 31/00; C06B 43/00

[52] U.S. Cl. 149/22; 149/108.6; 149/109.2

[58] Field of Search 149/22, 108.6, 109.2

[56] **References Cited**
U.S. PATENT DOCUMENTS

3,107,613	10/1963	Armstrong et al.	149/61 X
3,126,305	3/1964	Armstrong	149/61 X
3,148,938	9/1964	Knoth	149/22 X
3,149,163	9/1964	Knoth	149/22 X
3,256,056	6/1966	Armstrong	149/22 X
3,617,403	11/1971	Johnson	149/22 X
3,706,608	12/1972	Geisler	149/22 X
3,976,521	8/1976	Boyd et al.	149/22 X
4,002,681	1/1977	Goddard	260/564 D

Primary Examiner—Edward A. Miller
Attorney, Agent, or Firm—David H. Semmes; Warren E. Olsen

[57] **ABSTRACT**

This invention relates to novel pyrotechnic materials useful in pyrotechnic, incendiary, and propellant compositions, and a method of their preparation. The process is characterized by being a cocrystallization of certain salts of decahydrodecaboric acid and certain oxidizing agents, the resulting coprecipitates are compositions chemically and physically distinct from the starting materials.

26 Claims, 5 Drawing Figures

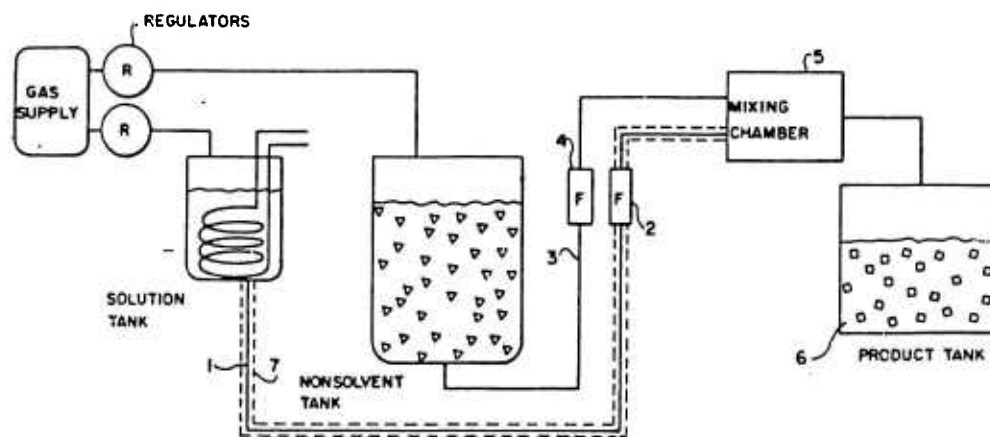

COPRECIPITATED PYROTECHNIC
COMPOSITION PROCESSES AND RESULTANT
PRODUCTS

CROSS-REFERENCES TO RELATED
APPLICATIONS

This application is a continuation-in-part of copending application, Ser. No. 585,216, filed June 6, 1975, entitled HIGH BURN PROPELLANT COMPOSITIONS, now abandoned. Certain specific applications of the subject invention are taught in our copending applications ACTIVE BINDER PROPELLANTS INCORPORATING BURNING RATE CATALYSTS filed June 15, 1976 and HIGH BURNING RATE PROPELLANTS WITH COPRECIPITATED SALTS OF DECAHYDROCECABORIC ACID, Ser. No. 707,810, filed July 22, 1976.

BACKGROUND AND SUMMARY OF THE
INVENTION

The present invention describes a family of new and unique pyrotechnic compositions and a method of preparing them. The compositions consist of selected metallic and nonmetallic salts of decahydrodecaboric acid, in combination with certain oxidizing agents. The method of preparing the compositions results in chemical substances in which there is intercrystalline mixing of the substituents, in a chemical state not obtainable by physical blending.

The unique character of the new compositions is produced by the method of manufacture. In the process, the decahydrodecaborate (-2) salt and oxidizer are dissolved in a suitable solvent. The solution containing the salt and oxidizer are pumped under pressure through a nozzle into a mixing chamber containing a high flow rate of a suitable nonsolvent. The dissolved ingredients are rapidly precipitated into very fine intertwined crystals containing the original constituents in a different physical and chemical environment than the starting crystals.

The physical, thermochemical, and kinetic properties of the new compositions are radically different than the corresponding physical blends of the starting ingredients. The pyrotechnic performance of the new compositions is wholly unpredicted by studies of the corresponding physical blends. Analysis of the infrared spectra of the subject compositions reveals that the critical ingredients, in particular the decahydrodecaborate (-2) ion, are in different chemical environments than the starting ingredients. In addition, the particles produced by the rapid precipitation are of smaller and more uniform particle size than the starting ingredients. These facts demonstrate that the decahydrodecaborate (-2) ion is in very intimate contact with the oxidizing species, which results in far more uniform and predictable burning than is obtainable by other means of combining the ingredients.

The compositions of this invention are very useful for a variety of purposes. They are excellent ignition materials for other pyrotechnic, incendiary, or propellant compositions, such as gun and rocket propellants. Confined in a metal sheath, they exhibit a range of burn rates and stability unobtainable by any other compositions. They can be incorporated as burn rate catalysts into rocket and gun propellants. A rocket or gun propellant can be made from the subject compositions by combining them with a suitable binder and other pyrotechnic

ingredients and stabilizers; the propellants made by this method exhibit a fast burn rate wholly unobtainable by using physical blends of oxidizers and fuels in a similar binder.

The most significant property of the final compositions is that, despite a very high energy content, they do not detonate when confined, but burn at a steady and predictable rate.

BRIEF DESCRIPTION OF THE DRAWINGS

FIG. 1 is a schematic representation of a coprecipitation sequence according to the present invention;

FIGS. 2 and 3 are schematic representations of a first form of coprecipitation apparatus usable according to the present invention;

FIG. 4 is a schematic representation of a second form of coprecipitation apparatus usable according to the present invention;

FIG. 5 is a schematic illustration of a cartridge testing setup for the products of the present invention.

DETAILED DESCRIPTION OF THE
INVENTION

The simple decahydrodecaborate salts used as a starting material according to this invention are compounds of the general chemical formula:

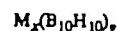

where M is a cation or complex cation incorporating hydrogen, nitrogen, carbon, or metals, or some combination thereof, and is chosen from the list given below; x is the number of M ions; and y is equal to:

$$\frac{x \text{ times the valence of the } M \text{ ion}}{2}$$

The compounds may further be defined as salts of decahydrodecaboric acid, and thus contain as a common ion the decahydrodecaborate (-2) anion $B_{10}H_{10}^{-2}$.

The cation M is chosen from the classes:

a. ammonium, NH_4^+ , wherein the salt has the formula $(NH_4)_x B_{10}H_{10}$, and is described by KNOTH U.S. Pat. No. 3,148,938.

b. hydrazinium, $NH_2NH_3^+$, wherein the salt has the formula $(NH_2NH_3)_x B_{10}H_{10}$, and is described by KNOTH U.S. Pat. No. 3,148,938,

c. substituted ammonium cations, wherein the salt has the general formula $(R_3NH)_x B_{10}H_{10}$, where R can be hydrogen (H) or an alkyl radical (preferred radicals contain less than six (6) carbon atoms). The R's in the preceding formula may represent different alkyl groups. Compounds with two or three hydrogen radicals are described by KNOTH U.S. Pat. No. 3,149,163. Typical cations are methylammonium $(CH_3)NH_3^+$, dimethylammonium $(CH_3)_2NH_2^+$, trimethylammonium $(CH_3)_3NH^+$, and triethylammonium $(CH_3CH_2)_3NH^+$.

d. substituted hydrazinium cations, wherein the salt has the general formula $(R_2NNR_2H)_x B_{10}H_{10}$, where R can be hydrogen (H) or an alkyl radical (preferred radicals contain less than six (6) carbon atoms), and the substituted alkyl groups can be symmetric or asymmetric with respect to the N-N linkage. Symmetric substituted cations are described by KNOTH U.S. Pat. No. 3,149,163. An example of an unsymmetric substituted cation is

- (1,1) dimethylhydrazinium. The R's in the preceding formula may be mixed alkyl radicals.
- e. quaternary ammonium salts of the general formula $(R_4N)_2B_{10}H_{10}$ where R is an alkyl radical; the R, s in the preceding formula may represent mixed alkyl groups. Examples of typical cations are tetramethylammonium $(CH_3)_4N^+$ and tetraethylammonium $(CH_3CH_2)_4N^+$.
- f. aryl containing cations, such as pyridinium, bipyridinium, or substituted aryl cations, such as aryl-diazonium cations.
- g. guanidinium ion, $C(NH_2)_3^+$, wherein the salt has the formula $(C(NH_2)_3)_2B_{10}H_{10}$, and is described in the copending application of common assignment, entitled **BIS-GUANIDINIUM DECAHYDRODECABORATE AND A PROCESS FOR ITS PREPARATION**, filed June 10, 1976, and now U.S. Pat. No. 4,002,681.
- h. metal ions, derived from metals defined by a Periodic Table such as that in the "Handbook of Chemistry and Physics", 54th Edition, inside front cover, by the elements in Groups 1, 2, 8, 3b, 4b, 5b 6b and 7b, and the elements of Groups 3a, 4a, 5a, and 6a with atomic numbers greater than 5, 14, 33, and 52 respectively. The metal decahydrodecaborate salts are further described by KNOTH U.S. Pat. No. 3,148,939. Examples of such metal salts are $Cs_2B_{10}H_{10}$ and $K_2B_{10}H_{10}$, the cesium and potassium salts of decahydrodecaboric acid. The cesium salt is a particularly preferred metal decahydrodecaborate salt for the compositions described in this invention.

The salts of the decahydrodecaborate (-2) ion (Chemical formula $B_{10}H_{10}^{-2}$) are conveniently prepared by stoichiometrically reacting an aqueous solution of the parent acid, dihydrogen decahydrodecaborate, $H_2B_{10}H_{10}$, with (1) a soluble hydroxide of the desired cation, such as ammonium hydroxide, (2) the conjugate Brønsted base of the desired cation, such as a free amine, or (3) a soluble salt of the desired cation, such as the salt anion is destroyed during the reaction, such as guanidine carbonate. A Brønsted base is any substance capable of accepting a proton in a reaction; the definition is elaborated upon in any elementary chemistry text, such as Dickerson, Gray and Haight, "Chemical Principles, 2nd Edition," 1974, page 135.

The aqueous solutions of the salts, prepared above, may be evaporated to dryness to recover the crystalline salt. Alternatively, some salts may be precipitated from the aqueous solution by a nonsolvent that is miscible with water. The salts may be purified by recrystallization.

The aqueous decahydrodecaboric acid used as a starting material for the process of this invention is conveniently prepared by passing an amine or metal salt of the decahydrodecaborate (-2) ion through a column containing a strongly acidic ion exchange resin of the sulfonic acid type, such as a DUOLITE type "C-20", acid form by the Diamond Shamrock Corporation. Preferred starting salts are bis(triethylammonium) decahydrodecaborate (-2) and disodium decahydrodecaborate (-2). The preparation and properties of the aqueous acid, and additional preparative methods for metallic salts, are described in more detail in U.S. Pat. No. 3,148,939.

The second essential component of the subject pyrotechnic compositions is an oxidizing agent, i.e., a material that will readily react or burn when mixed with the

decahydrodecaborate (-2) salt. Any solid oxidizing agent which will yield oxygen upon decomposition will fulfill this role; solid oxygen containing metal or non-metal salts are preferred because of their availability, stability, and ease of incorporation into the composition.

Solid oxidizing agents useful in this invention must meet certain criteria, such as listed in the description of the coprecipitation process. In general, solid oxidizing agents include ammonium, substituted ammonium, guanidine, substituted guanidine, alkali and alkaline-earth salts of oxygen containing acids such as nitric, perchloric, permanganic, manganic, chromic, and dichromic acids. Preferred species for this invention, which gave good thermal stability and low hygroscopicity include ammonium nitrate, potassium nitrate, potassium perchlorate, ammonium perchlorate, guanidine nitrate, triaminoguanidine nitrate, potassium permanganate, sodium chromate, barium nitrate, barium chromate, barium manganate, sodium dichromate, tetramethylammonium nitrate and cesium nitrate. Other solid oxidizing agents which could be used if the appropriate solvent/nonsolvent system were used include ammonium, substituted ammonium, guanidine, substituted guanidine, alkali and alkaline-earth salts of other oxygen-containing acids such as chloric, persulfuric, thiosulfuric, periodic, iodic and bromic acids. Other stable oxidizers include lead thiocyanate, the oxides and peroxides of the light and heavy metals and nonmetals, such as barium peroxide, lead peroxide (PbO_2), lithium peroxide, ferric oxide, red lead (Pb_3O_4), cupric oxide, tellurium dioxide, antimonite oxide, etc. and nonionic substances such as nitrocellulose, nitroguanidine, and cyclotetramethylenetetranitramine (HMX). Mixtures of the aforementioned oxidizing agents also can be used.

The compositions of this invention make use of the unique decomposition properties of the decahydrodecaborate (-2) ion, a bicapped square antiprism polyhedral ion with unusual stability; the ion is believed to be kinetically rather than thermodynamically stabilized. The ion demonstrates an unusually fast decomposition upon oxidation, which is believed to proceed through the labile apical hydrogen atoms bonded to the cage. Pyrotechnic compositions based on a physical blend of the metallic salts of this ion with various inorganic oxidizers have been recognized by ARMSTRONG, U.S. Pat. No. 3,126,305 as providing a wide range of confined burning rates. Physical blends of non-metallic salts of the decahydrodecaborate ion which produce extremely fast deflagration rates and high heat and gas outputs are described in our copending application entitled **IGNITION AND PYROTECHNIC COMPOSITIONS**, filed June 10, 1976, as Ser. No. 694,625.

The compositions of this invention, as well as those taught in our above-noted copending application, are unique in that, despite the fact that a high energy fuel, namely those decahydrodecaborate (-2) salts represented by the cation classes (a) through (g) is being used, the reaction does not propagate to a detonation, as is true with most commonly used high energy compositions such as commercial and military explosives. This unusual property is due to the fact that the reaction mechanism is kinetically rather than thermodynamically controlled, i.e., the deflagration occurs in such a manner that much heat is generated in the reaction without this heat accelerating the reaction to the point of detonation. The distinction between deflagration and

detonation is used in the common sense, whereby in deflagration, the chemical change or "burning" of the fuel occurs in advance of compression front caused by the expanding gases whereas in detonation the chemical reaction occurs after the compression or shock wave propagates through the composition medium. A more detailed explanation of this phenomenon may be found in a text on explosives such as C. H. Johansson and P. A. Persson "Detonics of High Explosives", (Academic Press, N.Y., 1970).

A critical factor in obtaining reproducible and uniform burning a composition containing the decahydrodecaborate (-2) is recognized by those practiced in the art to be an intimate contact between the decahydrodecaborate (-2) ion and the specific ion or oxidizing species which effects the initial oxidative step which leads to the breakup of the borane ion. This intimate contact is attempted in common practice by physically blending very finely ground or prepared powders of the decahydrodecaborate (-2) salt with the oxidizing agent.

The physical blends of oxidizer with the decahydrodecaboric acid salts, as described in our copending application noted above, suffer from several deficiencies inherent in the physical blend properties and processing technique. When used as a confined column delay, in a lead sheath, for example, the burn rates may be unreproducible, and the column fails to propagate below a certain critical distribution of the mixture in the tube. The stoichiometry of a physical blend is always subject to point-to-point variations due to blending techniques, settling and separation of the separate ingredients, and particle size distributions of the constituent materials.

A method is thereby needed to produce a composition with very uniform composition, in which the fuel anion and oxidizer are in very intimate contact, and which is very reproducible in manufacturing techniques from lot to lot. It has been discovered that such an intimate mixture can be obtained if the decahydrodecaborate (-2) anion is mixed in the crystal lattice with the oxidizing agent, such as a nitrate ion, and if crystals containing the respective ions and oxidizing agents are intimately intertwined.

The process by which the compositions of this invention are prepared produces a very intimate blend of decahydrodecaborate (-2) ion with the oxidizer, and makes the compositions so prepared chemically and physically unique from physical blends of decahydrodecaborate (-2) salts with oxidizer or pyrotechnic compositions incorporating decahydrodecaborate (-2) salts produced by other means. In general, the process consists of dissolving, in a suitable solvent, a decahydrodecaborate (-2) salt, as described above, and also dissolving, in the same solution, an oxidizing agent, as described above. The subject composition is recovered by precipitating the composite ingredients of the solution with a suitable nonsolvent. The resulting solid, after filtration and drying, comprises an intimate mixture of the decahydrodecaborate (-2) anion with the oxidizing cation or substance, in a form that is chemically and physically different than the starting materials.

The process may be properly called a "cocrystallization" or "coprecipitation" and the resulting product a "cocrystallate" or "coprecipitate".

In order to successfully coprecipitate the decahydrodecaborate (-2) salt with the oxidizing agent, three criteria on the composite system must be met:

- a. Both the decahydrodecaborate (-2) salt and the oxidizing agent must be soluble in the same solvent.
- b. The resulting coprecipitate must be insoluble in the solvent/nonsolvent fluid resulting from the mixing process.
- c. Solvent and nonsolvent must be miscible in all proportions.

Examples of solvent/nonsolvent systems which meet the last criteria, and, depending on the individual ingredients' solubility, can be used to produce certain of the subject compositions, include water/acetone, water/isopropyl alcohol, methanol/toluene and methanol/butyl acetate. Other solvents and/or nonsolvents include but are not limited to ethanol, t-butyl alcohol, ethylene glycol, ethylene glycol butyl ether, diacetone alcohol, methylisobutyl ketone, diisobutylketone, methyl ethyl ketone, dimethylformamide, tetrahydrofuran, glycerol, xylenes, dimethylsulfoxide, and n-methyl pyrrolidinone.

A general requirement for the preparative process is that the mixing between solution and nonsolvent be rapid, in order that the precipitating ingredients may be intimately mixed. A slow crystal growth in which the various anions and cations or constituents in the crystal lattice are well ordered is avoided in the rapid precipitation process. A mixing generally known in the chemical processing industry as "rapid mixing" or "static mixing" can be specially adapted to produce the desired compositions.

A general schematic diagram of an apparatus suitable for producing a sufficiently rapid and complete precipitation of the composition ingredients is shown in FIG. 1. The essential subsystems include 1, a storage tank and plumbing to deliver a specified flow rate of solution into a mixing chamber; 2, a means to carefully control the forementioned flow rate; 3, a storage tank and plumbing to deliver the nonsolvent to the mixing chamber; 4, a means of controlling the nonsolvent flow rate; 5, a mixing chamber with fluid dynamic behavior suitable for achieving the required mixing conditions; 6, a means of collecting the effluent containing the coprecipitated composition; 7, a means of maintaining an adequate temperature in the solution flow path. In operation, the solution of the desired decahydrodecaborate (-2) salt and oxidizer is placed in the "solvent" tank, which may be heated by internal coils or an external steam or water jacket. The solution is pumped to the mixing chamber by pressurizing the storage tank; the line through which the solution flows may be heated by a steam or water jacket or heating tapes. The flow rate may be regulated by introducing into the solution line a flowmeter with an adequate flow adjustment, or alternately, by controlling the driving pressure in the tank such that the pressure in the tank such that the pressure in conjunction with the nozzle aperture resistance results in the desired flow. The nonsolvent is placed in a storage tank of adequate capacity, and likewise pumped under pressure into the mixing chamber.

The mixing chamber design and resulting dynamics of fluid mixing in the chamber is critical to the successful coprecipitation of the subject composition. It is essential in the precipitation process that the solvent and nonsolvent be brought together very rapidly and under conditions of extreme turbulence, in order to produce the requisite intermingling of the solution and nonsol-

vent which effects the actual precipitation. Two designs which successfully accomplish this rapid precipitation are shown in FIGS. 2 and 3.

FIGS. 2 and 3 show an apparatus suitable for producing the subject compositions on a 50 to 500 gram laboratory scale. The solution is pumped through a moveable nozzle 10 consisting of an array of small apertures into the mixing chamber 12. The nozzle aperture and pattern are designed to optimize flow rates and turbulence for a fluid of particular viscosity; aperture diameters between 0.005 and 0.025 inches and equally spaced on a circle between 0.020 and 0.075 inch diameter are preferred. A useful configuration consists of 8 0.010 inch diameter holes equally spaced on a 0.060 diameter circle. The mixing chamber volume is controlled by movement of the nozzle in block 14. The nozzle is moved by micrometer 16 mounted in block 18 sliding on rails 20; block 22 is held against the micrometer by springs 24. A sliding seal 26 prevents leakage from the mixing chamber. Thermocouple 28 monitors the effluent temperature. Distance or "gap" between the nozzle tip and chamber wall may be varied between 0 and 0.300 inches in order to provide a variable back pressure on the nonsolvent flow. The range 0.015 and 0.050 inches is preferred for optimum mixing when a fluid with a viscosity similar to water is the non-solvent. The nonsolvent is pumped directly into the mixing chamber, as shown. The edge of the nozzle assembly 10 creates the necessary turbulence for effective mixing. The coprecipitate is carried by the effluent stream out to an outflow port, and thence to a catch tank. As shown in FIG. 1, flows are controlled by flowmeters in the input lines. Flows on the solvent line may be varied between 30 and 600 cubic centimeters per minute for a fluid with viscosity similar to water. Tank capacities are 2 liters solution and 20 liters nonsolvent. Filtration and drying of the precipitate in the catch tank recovers the desired product.

FIG. 4 shows a second mixer for FIG. 1, suitable for producing larger quantities of the subject compositions. The solution is pumped through nozzle 30 into mixing chamber 32, of internal dimensions on the order of 2 inches. The nonsolvent flows through nozzle 34 into the same chamber at right angles to nozzle 30. The nozzles may be standard spray nozzles such as those purchased from the Spray Engineering Company, Burlington, Mass. The coprecipitated effluent from the mixing chamber flows through a tube 34 containing curved sheet like elements 36 within the tube; the tube mixing device itself is known and described for example in ARMENIADES, U.S. Pat. No. 3,286,992. In this apparatus the majority of coprecipitation occurs at the intersection of the spray nozzles. The tube element 36 is merely an auxiliary mixer that assures complete and rapid precipitation of any product not precipitated in the main chamber. Flow rates on this apparatus are controlled by the driving pressure behind the nozzles, which generates the required constriction in the flow. The range of preferred driving pressure is 10 to 150 pounds per square inch gauge, for each of the process streams.

While crystalline size may be affected by choosing the Apparatus of FIGS. 2 or 4, for the purposes of this invention this is irrelevant. Regardless of coprecipitated particle size, the chemical natures of these coprecipitates are indistinguishable, as evidenced by pyrotechnic performance tests.

The concentrations of decahydrodecaborate (-2) salt and oxidizer in the starting solution, the operating

temperature of the solution flowing in the apparatus and the ratio of flow rates of solution to nonsolvent must be chosen individually for each decahydrodecaborate (-2) salt and oxidizer combination desired. Practically speaking, the solution concentrations are preferred to be within a factor of 5 of the saturation concentrations at the operating temperature used, in order to minimize nonsolvent usage and therefore cost. Sparingly soluble oxidizers or decahydrodecaborate (-2) salts may be dissolved at elevated temperature; the elevated temperature must be maintained in the coprecipitator storage tanks and flow lines in order to prevent a drop in the fluid temperature with accompanying premature precipitation of the constituents before reaching the mixing chamber. The solution/nonsolvent flow ratio must be sufficiently small to assure complete precipitation of the desired product. Alternately, the initial concentrations of the salt and oxidizer in the solution may be adjusted so that the desired stoichiometric product is obtained for a fixed solution/nonsolvent ratio.

The subject compositions are recovered by filtering and washing the precipitate. A washing with an inert and nonsolvent fluid after filtration is an essential step in recovering a useful product. A preferred washing fluid is butyl acetate. The washing is necessary to give a product that can be readily broken up into a fluffy powder after the drying process. A preferred drying process consists of allowing the washed powder to dry for 18 to 30 hours in open air, followed by subsequent forced air oven drying for 48 hours minimum at 60 to 80 degrees Centigrade.

The products recovered from the filtration and washing, after drying, are very fine, fluffy powders with a relatively low bulk density, indicating that the effective particle size of the material is very small. Viewed under a microscope, the powders consist of agglomerates of very small intertwined crystals.

The crystal density of the compositions, as measured by tightly compressing a sample of the powders, differs markedly from what is calculated for the crystal density by summing the contributions from the starting crystals. The deviations have been found to be as much as 30%, and may be either higher or lower than the calculated density. These types of data normally indicate that the crystal compositions and structure are different than a physical blend of the starting ingredients.

Significantly, the IR spectra of the subject compositions are found to differ substantially from a superposition of the spectra of the starting materials. A particularly useful spectral feature for analysis of the chemical species is the boron-hydrogen stretching frequency in the vicinity of 2500 cm^{-1} ; this feature is a characteristic of the decahydrodecaborate (-2) ion, and substructure on the region can be used to compare chemical and crystal environments of different compositions containing the ion. It is recognized by those practiced in the art, and as further explained by Kazuo Nakamoto in "Infrared Spectra of Inorganic and Coordination Compounds", 2nd Edition, p. 61, that inorganic crystal spectra in the high frequency region, which includes the 2500 cm^{-1} region, consists of combination bands of crystal lattice mode frequencies with fundamental mode characteristic frequencies. In addition, peak splittings are often caused by the occupation of more than one unique crystal lattice site by an ion, or by destruction of degeneracies in the gas phase molecular frequency by crystal lattice effects. The differences in substructure in

a fundamental peak such as that of the 2500 cm^{-1} band characteristic of the $\text{B}_{10}\text{H}_{10}^{-2}$ ion can thus be attributed to changes in the chemical and crystal environment of the ion.

The IR spectra of the subject compositions in the 2500 cm^{-1} region show in general, and as shown in detail by the various examples to follow, that the chemical and crystal environment of the decahydrodecaborate (-2) ion is different than the starting environment, which demonstrates further that the subject coprecipitated compositions are differentiated chemically, as well as physically from their physical blend counterparts.

The pyrotechnic performance of the presently taught coprecipitated compositions is also markedly different from that of the counterpart physical blends. In general, the heat of reaction obtained by combusting the mixture in an adiabatic calorimeter under an inert gas such as argon is different from that obtained by preparing and similarly testing a simple physical blend with the exact same stoichiometry. The heat of reaction may be greater than, or less than, that displayed by the physical blend. Such behavior is in general indicative of a different burning mechanism for the subject composition than for a simple blend, which is, in part, caused by different arrangement of the chemical species.

The above general features of the subject compositions demonstrate that the chemical species initially present in the separated decahydrodecaborate (-2) salt and oxidizer before dissolution have recombined in the presently taught coprecipitation process to yield products in which the constituents originally present are arranged differently in the final crystal environment. Furthermore, and as is illustrated more particularly in Example I, the decahydrodecaborate (-2) anion, which is the critical ingredient for the unique performance of the compositions, is mixed in the crystal lattice in close proximity to the oxidizing anion, which effectively promotes an extremely efficient and uniform oxidation, and therefore improved pyrotechnic performance.

EXAMPLE I

One hundred thirty-five grams of purified cesium decahydrodecaborate (-2) ($\text{Cs}_2\text{B}_{10}\text{H}_{10}$) and 405 grams potassium nitrate are dissolved in 1260 milliliters deionized water at 60° Centigrade. The solution is filtered hot to remove a trace of insoluble residue. The solution is placed into a precipitating system shown in FIG. 1 and pumped to a mixing apparatus, as depicted in FIG. 2. Acetone is used as a nonsolvent. The product is precipitated over a period of several minutes using a solution flow rate of 90 cubic centimeters per minute, a nonsolvent flow rate of 1800 cubic centimeters per minute and a mixing chamber gap of 0.030 inches. A 50° Centigrade temperature is maintained in the solution tank and flow lines during the process. 4000 ml effluent and precipitate are collected.

The resulting product is filtered, washed with butyl acetate in the filter, and dried, first 24 hours in open air and finally 48 hours at 60° Centigrade. 59 grams of pure white precipitate is recovered.

The heat of reaction of the coprecipitated composition is 690 calories per gram. The measured crystal density is 2.25 grams per cubic centimeter. By contrast, the heat of reaction of a corresponding physical blend is measured at 825 calories per gram, and the calculated crystal density is 2.16 grams per cubic centimeter. This

demonstrates that for the same apparent stoichiometry significantly altered pyrotechnic characteristics are experienced.

The precipitation is repeated with the remaining solution at (a) 20:1 nonsolvent/solution ratios and mixing chamber gaps of 0.015 and 0.045 inches; at (b) 10:1 nonsolvent/solution volume ratio and 0.030 and 0.145 inch gaps; and (c) 5:1 nonsolvent/solution ratio at a 0.030 gap (FIG. 2). The precipitates are recovered as in the previous example. The measured heat of reaction for the additional coprecipitated samples are within 1.5% of the original value, and the crystal densities are within 2% of the original value. The latter test indicates that the composition has precipitated completely in the first test, and the stoichiometry of the composition is identical with that of the corresponding physical blend tested.

Infrared spectra of the precipitated materials show an altered absorption region near 2500 cm^{-1} . The peak in the 2500 cm^{-1} region for pure cesium decahydrodecaborate (-2) shows a major peak at 2470 cm^{-1} with a prominent red-shifted sideband at 2418 cm^{-1} and a small blue-shifted sideband at 2540 cm^{-1} . The precipitated material shows a major peak at 2455 cm^{-1} with two prominent blue-shifted peaks at 2520 cm^{-1} and 2572 cm^{-1} and a minor red shifted peak at 2410 cm^{-1} . The spectrum closely resembles that of a known double salt of cesium decahydrodecaborate (-2) and a cesium nitrate (reference ARMSTRONG, U.S. Pat. No. 3,107,613) which shows a major peak at 2450 cm^{-1} , two prominent blue-shifted peaks at 2520 and 2575 cm^{-1} and a minor red-shifted peak at 2420 cm^{-1} . The double salt is known to have the nitrate and decahydrodecaborate (-2) anions in a one-to-one ratio in the crystal lattice. This evidence demonstrates that in all probability, the precipitate obtained from the forementioned process has the nitrate and decahydrodecaborate (-2) ions mixed in the lattice, i.e., the chemical species have been rearranged chemically during the process. Needless to say, the stoichiometry of the double salt and the coprecipitations taught herein are widely dissimilar.

EXAMPLE II

Six hundred seventy-five grams cesium decahydrodecaborate (-2) and 2025 grams potassium nitrate are dissolved in 6300 milliliters deionized water at 45° Centigrade. The solution is filtered hot to remove a trace of insoluble material. The solution is placed into a precipitating system as shown in FIG. 1 and pumped to a mixing apparatus depicted in FIG. 4. The solution spray nozzle is a Sprayco $\frac{1}{2}$ GG 1.5 (Spray Engineering Co., Burlington, Mass.). Acetone is used as a nonsolvent, and is pumped into the chamber through a Sprayco $\frac{1}{2}$ GG 3030 nozzle. The flow rates are controlled by the pressures applied to the solution and nonsolvent tanks, 25 and 89 PSIG respectively. A flow ratio of 19.8 acetone-to-solution is achieved with these pressures. The product is precipitated in two increments with several minutes operating time for each increment. A temperature of 37° Centigrade is maintained in the solution tank and flow lines throughout the process.

The resulting product is filtered, washed with butyl acetone in the filter, and dried, first 25 hours in open air and finally 48 hours minimum at 50° Centigrade. 2415 grams of a white fluffy powder (yield 89%) is recovered. The product has a heat reaction of 712 calories per gram.

EXAMPLE III

The material from Example II is confined in a lead or aluminum sheath, by loading the powder into a tube and drawing or swaging the loaded and sealed tube through a series of dies until the desired distribution of material in the sheath is reached. This distribution is normally measured in grains of powder per linear foot of the sheathed cord, and is called "core load". A lead jacketed cord exhibits a linear propagation rate of 15,300 inches per second at 25 grains per foot loading, 11,600 inches per second at 12.5 grains per foot loading and 9600 inches per second at 1 grain per foot. The material will propagate reliably at core loads of 0.15 grains per foot. An aluminum jacketed cord exhibits a linear burning rate of approximately 12,000 inches per second at 6 to 12 grains per foot loading. By contrast, comparable physical blend consisting of 25% 10 micron or smaller cesium decahydrodecaborate (-2) and 200 mesh potassium nitrate in a lead sheath exhibits a burning rate of 5300 to 7900 inches per second at 19 grains per foot, 6300 inches per second at 7.3 grains per foot, and 7400 to 8600 inches per second at 2.2 grains per foot. Importantly, physically blended material does not propagate reliably below this critical level. The subject coprecipitated composition, prepared in Example II, thus displays faster and more uniform propagation than the corresponding physical blend.

EXAMPLE IV

Seventy-six grams bis-tetramethylammonium decahydrodecaborate (-2), representative of class (e) of the preceding list of cations, and 429 grams potassium nitrate are dissolved in 2500 milliliters deionized water at ambient temperature. The solution is filtered to remove a trace of residue. The solution is placed in a precipitating apparatus as shown in FIG. 1 and pumped to a mixing apparatus as depicted in FIG. 2. Isopropyl alcohol is used as nonsolvent. The product is precipitated over a period of several minutes using a solution flow rate of 115 milliliters per minute and a nonsolvent flow rate of 1180 milliliters per minute. The mixing chamber gap is 0.030 inches. The precipitate is recovered and dried in a manner identical with Example I.

Four hundred seventeen grams of a fluffy white powder is recovered (yield 83%). The powder has a heat of reaction of 1348 calories per gram. A physical blend of the starting materials with identical stoichiometry has a heat of reaction of 1220 calories per gram. The infrared spectrum of the pure starting material, bis-tetramethylammonium decahydrodecaborate (-2), shows a single broad peak at 2470 cm^{-1} .

By contrast, the infrared spectrum of the recovered product in the vicinity of 2500 cm^{-1} shows a sharp major peak coprecipitated at 2475 cm^{-1} , a prominent blue-shifted peak at 2530 cm^{-1} , and two major red shifted peaks at 2410 and 2435 cm^{-1} . The additional peaks and shift indicate that the decahydrodecaborate (-2) ion is in a different crystallographic environment than in the pure salt, i.e., the constituents have been chemically rearranged during the precipitation process.

EXAMPLE V

Three hundred seventy-eight grams of bis-tetramethylammonium decahydrodecaborate (-2) and 2144 grams of potassium nitrate are dissolved in 13 liters deionized water at ambient temperature. The solution is filtered to remove a trace of insoluble residue. The

solution is placed into a precipitating system as shown in FIG. 1 and pumped to a mixing apparatus as shown in FIG. 4. The solution spray nozzle is a Sprayco $\frac{1}{2}$ GG 1.5 (Spray Engineering Co., Burlington, Mass.). Isopropanol is used as a nonsolvent, and is pumped into the chamber through a Sprayco $\frac{1}{2}$ GG 3030 nozzle. The flow rates are controlled by the pressures applied to the solution and nonsolvent tanks, 25 and 26 PSIG respectively. A flow rate of 10:1 isopropanol-to-solution is achieved with these pressures. Product is precipitated in 5 runs with approximately one minute per increment required.

The resulting product is filtered, washed and dried in a manner identical with Example II. 2522 grams of white, fluffy powder is recovered (yield 86%). The product has a heat of reaction of 1339 calories per gram and a crystal density of 1.85 grams per cubic centimeter. A physical blend with identical stoichiometry has a heat of reaction of 1220 calories per gram and a calculated crystal density of 1.93 grams per cubic centimeter.

EXAMPLE VI

22.5 grams bis-guanidinium decahydrodecaborate (-2) specified at class (g) of the preceding list of cations, and 127.5 grams guanidine nitrate are dissolved in 1500 milliliters methanol at 60° Centigrade. The solution is filtered to remove a trace of residue. The solution is placed in a precipitating apparatus as shown in FIG. 1 and pumped to a mixing apparatus as depicted in FIG. 2. Butyl acetate is used as nonsolvent. The product is precipitated over a period of several minutes using a solution flow rate of 216 milliliters per minute and a nonsolvent flow rate of 1142 milliliters per minute. The mixing chamber gap is 0.030 inches. The precipitate is recovered and dried in a manner identical with Example I.

A fluffy white powder is recovered. The powder has a heat of reaction of 849 calories per gram and a crystal density of 1.48 grams per cubic centimeter. A physical blend of the starting materials with identical stoichiometry has a heat of reaction of 900 calories per gram and a calculated crystal density of 1.02 grams per cubic centimeter.

EXAMPLE VII

Thirty grams bis-dimethylammonium decahydrodecaborate (-2), representative of class (c) of the preceding list of cations, and 120 grams potassium nitrate are dissolved in 500 milliliters deionized water at ambient temperature. The solution is filtered to remove a trace of residue. The solution is placed in a precipitating apparatus as shown in FIG. 1 and pumped to a mixing apparatus as depicted in FIG. 2. Isopropanol is used as nonsolvent. The product is precipitated over a period of several minutes using a solution flow rate of 116 milliliters per minute and a nonsolvent flow rate of 1218 milliliters per minute. The mixing chamber gap is 0.030 inches. The precipitate is recovered and dried in a manner identical with Example I.

A fluffy white powder is recovered. The powder has a heat of reaction of 1411 calories per gram and a crystal density of 1.72 grams per cubic centimeter. A physical blend of the starting materials with identical stoichiometry has a heat of reaction of 1325 calories per gram and a calculated crystal density of 1.98 grams per cubic centimeter.

EXAMPLE VIII

37.5 grams bis-ammonium decahydrodecaborate (-2), representative of class (a) of the preceding list of cations, and 112.5 grams ammonium nitrate are dissolved in 1500 milliliters methanol at ambient temperature. The solution is filtered to remove a trace of residue. The solution is placed in a precipitating apparatus as shown in FIG. 1 and pumped to a mixing apparatus as depicted in FIG. 2. Butyl acetate is used as nonsolvent. The product is precipitated over a period of several minutes using a solution flow rate of 216 milliliters per minute and a nonsolvent flow rate of 1142 milliliters per minute. The mixing chamber gap is 0.030 inches. The precipitate is recovered and dried in a manner identical with Example I.

A fluffy white powder is recovered. The powder has a heat of reaction of 1826 calories per gram and a crystal density of 1.53 grams per cubic centimeter. A physical blend of the starting materials with identical stoichiometry has a heat of reaction of 1775 calories per gram and a calculated crystal density of 1.55 grams per cubic centimeter.

EXAMPLE IX

The powders from Examples V and VII are incorporated into sheathed cord as described in Example III. The deflagration rates as a function of material distribution in the cord is shown in Table I. The data illustrates the range of pyrotechnic burning rate performance that can be achieved by the subject compositions.

TABLE I

COMPOSITION	CORE LOAD (GRAINS/FT)	LINEAR BURNING RATE (IN/SEC)
Example VI	1.3	7,140
	6.1	8,400
	10.5	10,330
	13.3	11,130
Example VII	24.8	11,130
	1.7	10,600
	12.0	14,240
	19.6	11,540

EXAMPLE X

The speed of ignition is determined by loading approximately 100 milligrams of the subject compositions into a closed pressure cartridge similar to that shown in FIG. 5, and firing the pressure cartridge in a 5cc closed bomb. The pressure in the bomb is measured by a fast response transducer and recorded as a function of time. The pressure cartridge consists of an exploding bridgewire mounted in a suitable cartridge case. The bridgewire is primed with 5mg of an initiating pyrotechnic powder. The subject composition is loaded into the cartridge over the priming load, and the cartridge closed with a crimped aluminum cap. The ignition time of the compositions is taken as the time between the application of current to the bridgewire to first detectable increase in the pressure. The burning time is taken as the time elapsed between the first detectable increase in the pressure to the peak pressure. Examples of the subject compositions tested in this manner are given in Table II.

The data demonstrates the very fast function times attainable in devices incorporating the subject compositions, which makes the compositions useful as gun ignitors and in pressure cartridges and squibs.

Comparable data for black powder of classification FFFG granular size, is shown in Table II for comparison purposes.

TABLE II

Composition	Ignition Time (Milli-seconds)	Burning Time (Milli-seconds)	Peak Pressure Pounds Per Square Inch Gauge
25% $C_{10}H_{10}B_{10}$ coprecipitated with 75% KNO_3	0.75	0.75	712
15% $((CH_3)_4N)_2 B_{10}H_{10}$ coprecipitated with 85% KNO_3	1.2	0.8	1,100
FFFG Black Powder	1.2	4	600

The processes, and the resulting specific compositions, disclosed herein in which an exclusive property or privilege is claimed are to be defined, as follows

We claim:

1. A process for preparing a coprecipitated composition of a solid oxidizing agent and certain simple decahydrodecaborate salts, having the common anion $B_{10}H_{10}^{-2}$ wherein the cation is selected from the group consisting of:

A. ammonium, wherein the salt has the formula $(NH_4)_2 B_{10}H_{10}$;

B. hydrazinium, wherein the salt has the formula $(NH_2NH_3) B_{10}H_{10}$;

C. substituted ammonium cations, wherein the salt has the general formula $(R_3NH)_2 B_{10}H_{10}$, wherein further R is selected from the group consisting of hydrogen and alkyl radicals containing less than six carbon atoms;

D. substituted hydrazinium cations, wherein the salt has the general formula $(R_2NNR_2H)_2 B_{10}H_{10}$ wherein further R is selected from the group consisting of hydrogen and alkyl radicals containing less than six carbon atoms, comprising the steps of:

i. dissolving both the decahydrodecaborate (-2) salt and the oxidizing agent in a mutually soluble solvent, at a temperature sufficiently high to maintain said salt and said oxidizing agent in solution;

ii. forming a pressurized stream of said solution and bringing said solution stream together with a pressurized stream of a miscible nonsolvent, under conditions of extreme turbulence within a mixing chamber, to effect a substantially complete coprecipitation;

iii. recovering the coprecipitated product by filtering the effluent from said mixing chamber, and washing said product with an inert and nonsolvent fluid;

iv. drying the product to remove all remaining liquid.

2. A process for preparing a coprecipitated composition of a solid oxidizing agent and certain simple decahydrodecaborate salts, having the common anion $B_{10}H_{10}^{-2}$, and the cation selected from the group consisting of:

A. tetramethylammonium, $(CH_3)_4N^+$, tetraethylammonium, $(CH_3 CH_2)_4N^+$, and quaternary ammonium cations having the general formula R_4N^+ where R is an alkyl radical;

B. pyridinium, bipyridinium aryl-diazonium, aryl containing cations and substituted aryl containing cations, comprising the steps of:

- i. dissolving both the decahydrodecaborate (-2) salt and the oxidizing agent in a mutually soluble solvent, at a temperature sufficiently high to maintain said salt and said oxidizing agent in solution;
 - ii. forming a pressurized stream of said solution and bringing said solution stream together with a pressurized stream of a miscible nonsolvent, under conditions of extreme turbulence within a mixing chamber, to effect a substantially complete coprecipitation;
 - iii. recovering the coprecipitated product by filtering the effluent from said mixing chamber, and washing said product with an inert and nonsolvent fluid;
 - iv. drying the product to remove all remaining liquid.
3. A process for preparing a coprecipitated composition of a solid oxidizing agent and a simple decahydrodecaborate salt, having the anion $B_{10}H_{10}^{-2}$, wherein the cation is guanidinium, and the salt has the formula $(C(NH_2)_3)_2 B_{10}H_{10}$, comprising the steps of:
- i. dissolving both the decahydrodecaborate (-2) salt and the oxidizing agent in a mutually soluble solvent, at a temperature sufficiently high to maintain said salt and said oxidizing agent in solution;
 - ii. forming a pressurized stream of said solution and bringing said solution stream together with a pressurized stream of a miscible nonsolvent, under conditions of extreme turbulence within a mixing chamber, to effect a substantially complete coprecipitation;
 - iii. recovering the coprecipitated product by filtering the effluent from said mixing chamber, and washing said product with an inert and nonsolvent fluid;
 - iv. drying the product to remove all remaining liquid.
4. A process for preparing a coprecipitated composition of a solid oxidizing agent and a simple metallic decahydrodecaborate salt, having the common anion $B_{10}H_{10}^{-2}$, wherein the cation is selected from the group consisting of:
- A. metal ions derived from the elements in Groups 1, 2, 8, 3b, 4b, 5b, 6b, 7b, and the elements of Groups 3a, 4a, 5a, and 6a which have atomic numbers respectively greater than 5, 14, 33 and 52, comprising the steps of:
 - i. dissolving both the decahydrodecaborate (-2) salt and the oxidizing agent in a mutually soluble solvent, at a temperature sufficiently high to maintain said salt and said oxidizing agent in solution;
 - ii. forming a pressurized stream of said solution and bringing said solution stream together with a pressurized stream of a miscible nonsolvent, under conditions of extreme turbulence within a mixing chamber, to effect a substantially complete coprecipitation;
 - iii. recovering the coprecipitated product by filtering the effluent from said mixing chamber, and washing said product with an inert and nonsolvent fluid;
 - iv. drying the product to remove all remaining liquid.
5. A process for preparing a coprecipitated composition of a solid oxidizing agent and a simple metallic decahydrodecaborate salt, having the common anion $B_{10}H_{10}^{-2}$, wherein the metallic salt is selected from the group consisting of cesium decahydrodecaborate,

- $Cs_2B_{10}H_{10}$ and potassium decahydrodecaborate, $K_2B_{10}H_{10}$, comprising the steps of:
- i. dissolving both the decahydrodecaborate (-2) salt and the oxidizing agent in a mutually soluble solvent, at a temperature sufficiently high to maintain said salt and said oxidizing agent in solution;
 - ii. forming a pressurized stream of said solution and bringing said solution stream together with a pressurized stream of a miscible nonsolvent, under conditions of extreme turbulence within a mixing chamber, to effect a substantially complete coprecipitation;
 - iii. recovering the coprecipitated product by filtering the effluent from said mixing chamber, and washing said product with an inert and nonsolvent fluid;
 - iv. drying the product to remove all remaining liquid.
6. A process according to claim 1 wherein the simple decahydrodecaborate salt selected is bis-ammonium decahydrodecaborate, and said solid oxidizer is selected from the group consisting of ammonium nitrate, potassium nitrate, potassium perchlorate, ammonium perchlorate, guanidine nitrate, triaminoguanidine nitrate, potassium permanganate, sodium chromate, barium nitrate, barium chromate, barium manganate, sodium dichromate, tetramethylammonium nitrate and cesium nitrate.
7. The coprecipitation product of bis-ammonium decahydrodecaborate and a solid oxidizer, according to the process of claim 6.
8. A process according to claim 2 wherein the simple decahydrodecaborate salt selected is bis-tetramethylammonium decahydrodecaborate, and said solid oxidizer is selected from the group consisting of ammonium nitrate, potassium nitrate, potassium perchlorate, ammonium perchlorate, guanidine nitrate, triaminoguanidine nitrate, potassium permanganate, sodium chromate, barium nitrate, barium chromate, barium manganate, sodium dichromate, tetramethylammonium nitrate and cesium nitrate.
9. The coprecipitation product of bis-tetramethylammonium decahydrodecaborate and a solid oxidizer, according to the process of claim 8.
10. A process according to claim 3 where said solid oxidizer is selected from the group consisting of ammonium nitrate, potassium nitrate, potassium perchlorate, ammonium perchlorate, guanidine nitrate, triaminoguanidine nitrate, potassium permanganate, sodium chromate, barium nitrate, barium chromate, barium manganate, sodium dichromate, tetramethylammonium nitrate and cesium nitrate.
11. The coprecipitation product of bis-guanidinium decahydrodecaborate and a solid oxidizer, according to the process of claim 10.
12. A process according to claim 5 wherein the simple metallic decahydrodecaborate salt selected is cesium decahydrodecaborate and said solid oxidizer is selected from the group consisting of ammonium nitrate, potassium nitrate, potassium perchlorate, ammonium perchlorate, guanidine nitrate, triaminoguanidine nitrate, potassium permanganate, sodium chromate, barium nitrate, barium chromate, barium manganate, sodium dichromate, tetramethylammonium nitrate and cesium nitrate.
13. The coprecipitation product of cesium decahydrodecaborate and a solid oxidizer, according to the process of claim 12.

17

14. A process according to claim 6 wherein said oxidizer is ammonium nitrate, said solvent is methanol and said nonsolvent stream is butyl acetate.

15. The coprecipitation product of bis-ammonium decahydrodecaborate and ammonium nitrate, according to the process of claim 14.

16. A process according to claim 8 wherein said oxidizer is potassium nitrate, said solvent is water and said nonsolvent stream is isopropanol.

17. The coprecipitation product of bis-tetramethylammonium decahydrodecaborate and potassium nitrate, according to the process of claim 16.

18. A process according to claim 10 wherein said oxidizer is guanidine nitrate, said solvent is methanol, and said nonsolvent stream is butyl acetate.

19. The coprecipitation product of bis-guanidinium decahydrodecaborate and guanidine nitrate, according to the process of claim 18.

18

20. A process according to claim 12 wherein said oxidizer is potassium nitrate, said solvent is water, and said nonsolvent stream is acetone.

21. The coprecipitation product of cesium decahydrodecaborate and potassium nitrate, according to the process of claim 20.

22. A process according to claim 1, wherein said step of washing with an inert and nonsolvent fluid comprises washing with butyl acetate.

23. A process according to claim 2, wherein said step of washing with an inert and nonsolvent fluid comprises washing with butyl acetate.

24. A process according to claim 3, wherein said step of washing with an inert and nonsolvent fluid comprises washing with butyl acetate.

25. A process according to claim 4, wherein said step of washing with an inert and nonsolvent fluid comprises washing with butyl acetate.

26. A process according to claim 5, wherein said step of washing with an inert and nonsolvent fluid comprises washing with butyl acetate.

• • • • •

25

30

35

40

45

50

55

60

65

FIG. 1

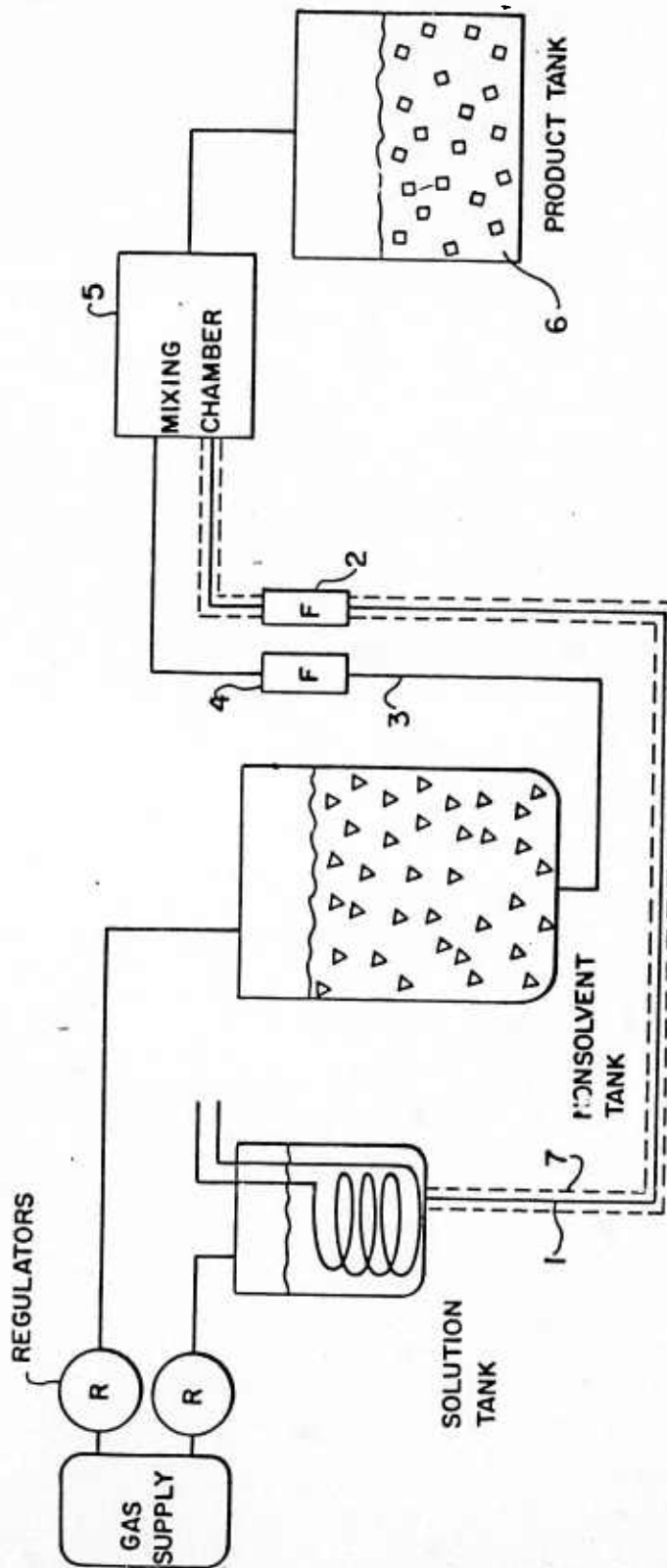

FIG. 2

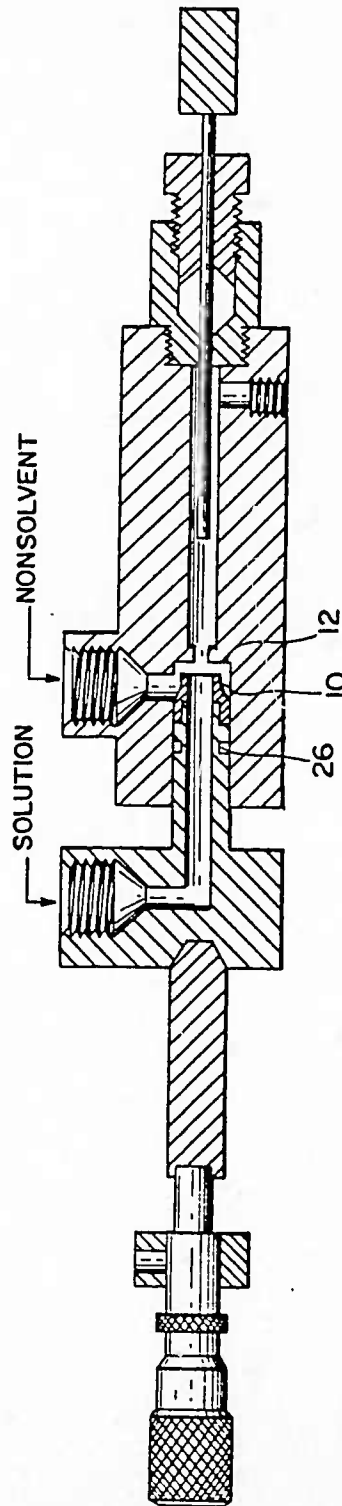
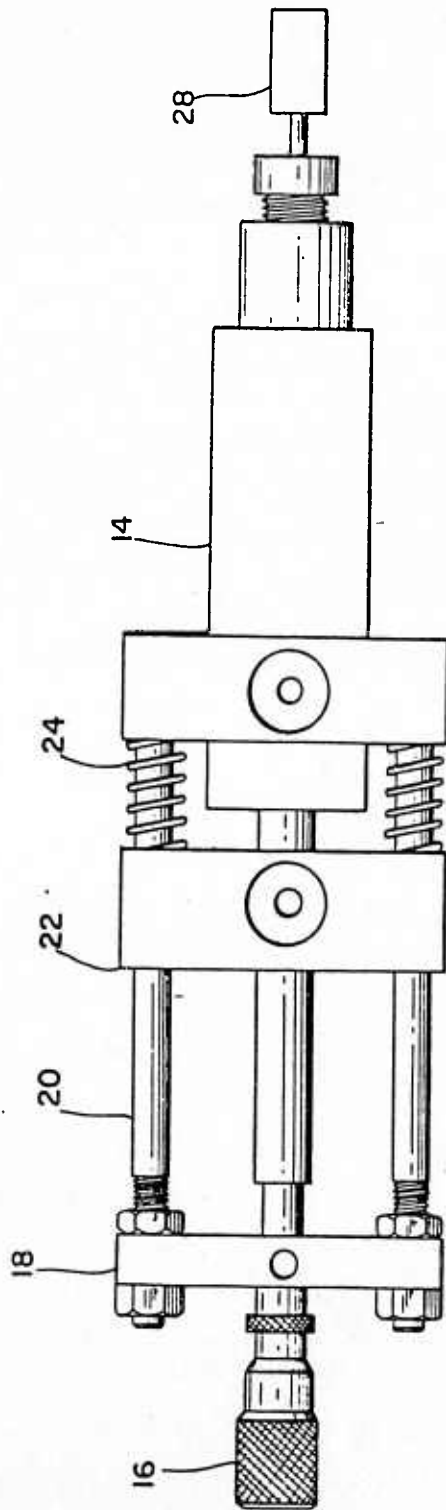
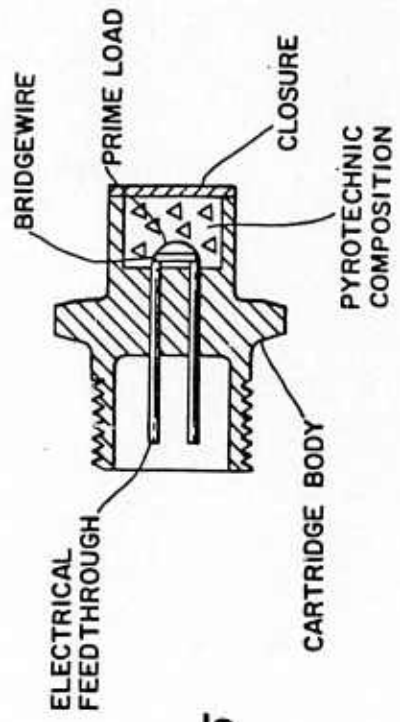
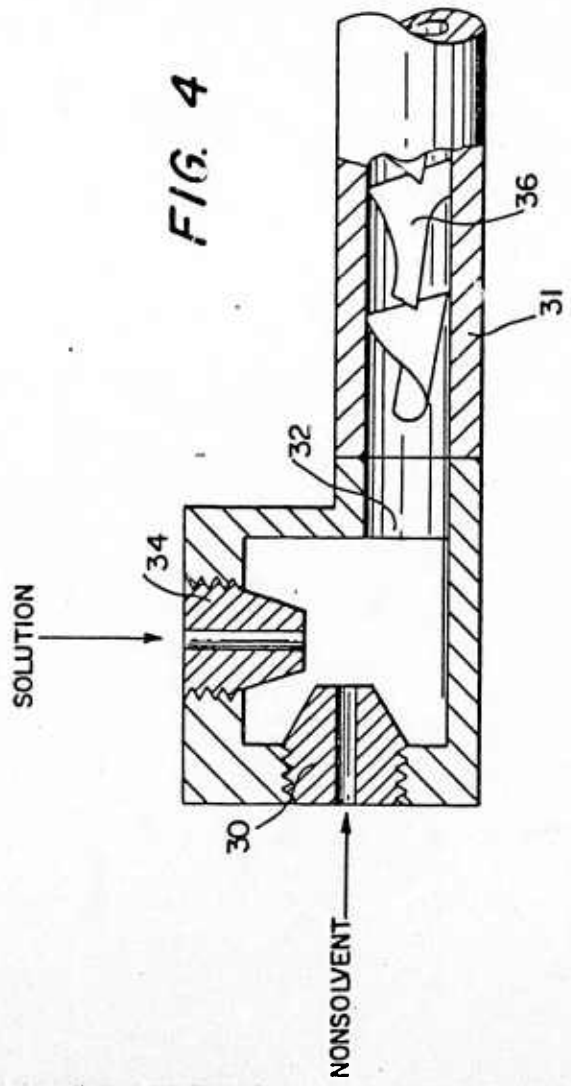

FIG. 3



[54] HIGH BURNING RATE PROPELLANTS WITH COPRECIPIATED SALTS OF DECAHYDRODECABORIC ACID

[75] Inventors: Terrence P. Goddard, Aptos; Donald N. Thatcher, Hollister, both of Calif.

[73] Assignee: Teledyne McCormick Selph, Hollister, Calif.

[*] Notice: The portion of the term of this patent subsequent to Jan. 23, 1996, has been disclaimed.

[21] Appl. No.: 707,810

[22] Filed: Jul. 22, 1976

Related U.S. Application Data

[63] Continuation-in-part of Ser. No. 694,626, Jun. 10, 1976, which is a continuation-in-part of Ser. No. 585,216, Jun. 6, 1975, abandoned.

[51] Int. Cl.² C01B 45/10

[52] U.S. Cl. 149/19.8; 149/19.1; 149/19.3; 149/19.9; 149/22

[58] Field of Search 149/19.2, 19.8, 19.9, 149/22, 19.1, 19.3, 19.4, 19.5, 19.6, 19.91

[56] References Cited

U.S. PATENT DOCUMENTS

3,126,305	3/1964	Armstrong	149/61 X
3,148,938	9/1964	Knoth	149/22 X
3,149,163	9/1964	Knoth	149/22 X
3,256,056	6/1966	Armstrong	149/22 X
3,617,403	11/1971	Johnson	149/22 X
3,689,331	9/1972	Pierce	149/22 X
4,002,681	1/1977	Goddard	260/564 D

Primary Examiner—Edward A. Miller
Attorney, Agent, or Firm—David H. Semmes; Warren E. Olsen

[57] ABSTRACT

A class of high burning propellants, useful as gun or rocket propellants, gas generators or specialized application where a very high burning rate is required, characterized by replacing the normally found oxidizer used in various propellants with certain coprecipitated salts of decahydrodecaboric acid and certain oxidizing agents. The resultant propellants employ such a coprecipitate as the major fraction of the solids loading, and optionally may further include certain simple decahydrodecaborate salts for further enhancement of the burning rates in the thusly formulated and composed propellants.

53 Claims, No Drawings

HIGH BURNING RATE PROPELLANTS WITH
COPRECIPITATED SALTS OF
DECAHYDRODECABORIC ACID

CROSS-REFERENCES TO RELATED
APPLICATIONS

This application is a continuation-in-part of our copending application COPRECIPITATED PYROTECHNIC COMPOSITION PROCESSES AND RESULTANT PRODUCTS, Ser. No. 694,626, filed June 10, 1976, which in turn is a continuation-in-part of the application entitled HIGH BURN PROPELLANT COMPOSITIONS, Serial No. 585,216, filed June 6, 1975, and now abandoned.

This application is also a related case to our copending applications COMPOSITE PROPELLANTS INCORPORATING BURNING RATE ENHANCERS, Ser. No. 696,323, filed June 15, 1976, and ACTIVE BINDER PROPELLANTS INCORPORATING BURNING RATE CATALYSTS, Ser. No. 696,324, filed June 15, 1976.

BACKGROUND AND SUMMARY OF THE
INVENTION

The present invention describes a class of propellants useful as gun or rocket propellants, gas generators, or specialized applications where a very high burning rate is required. The key ingredient of the propellant compositions is a coprecipitate of selected metallic and nonmetallic salts of decahydrodecaboric acid, in combination with certain oxidizing agents. The method of preparing the coprecipitates results in chemical substances in which there is intercrystalline mixing of the substituents, in a chemical state not obtainable by physical blending.

The forementioned coprecipitates replace the oxidizer normally found in typical compositions such as composite propellants, and are responsible for the high burning rates. Other simple decahydrodecaborate salts of selected types, and either soluble or insoluble in the propellant resins or extending solvents, may optionally be additionally used to further enhance the burning rate.

The subject propellants have the general formula as follows:

	Probable Range, % by Wt.
1. Polymeric binder system	8-35
2. Curing, polymerizing, or cross-linking agents	0-10
3. Plasticizing agents	0-25
4. Decahydrodecaborate compounds Class (1)	0-25
5. Decahydrodecaborate compounds Class (2)	35-90
6. Energetic fuels, such as, but not limited to, finely divided aluminum	0-10
7. Oxidizer or mixture of oxidizers to supplement (5)	0-15
8. Other inert ingredients, such as colorants, stabilizers.	0-10

The ingredients, selected from items (3) through (8) in the above list, are combined in a suitable manner with a binder system selected from items (1) and (2) to form a nonporous propellant with desired physical properties. The key ingredient which distinguishes the subject propellants from other state-of-the-art propellants is the use of decahydrodecaborate compounds (item 5) of class (2), as further defined and described hereinafter. The optional and additional use of decahydrodecaborate compounds of class (1), as defined hereinafter, to

enhance burning rate when used with certain "active," that is, oxygen or fluorine containing binders, is also unique.

The two classes of decahydrodecaborate compounds as defined as follows:

Class 1

The simple decahydrodecaborate salts used according to the first class of burn rate enhancers within the present invention are compounds of the general chemical formula:

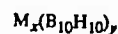

where M is a cation or complex cation incorporating hydrogen, nitrogen, carbon, or metals, or some combination thereof, and is chosen from the list given below; x is the number of M ions; and y is equal to:

$$\frac{x \text{ times the valence of the } M \text{ ion}}{2}$$

The compounds may further be defined as salts of decahydrodecaboric acid, and thus contain as a common ion the decahydrodecaborate (-2) anion $B_{10}H_{10}^{-2}$.

The cation M is chosen from the classes:

(a) ammonium, NH_4^+ , wherein the salt has the formula $(NH_4)_2B_{10}H_{10}$, and is described by KNOTH U.S. Pat. No. 3,148,938.

(b) hydrazinium, $NH_2NH_3^+$, wherein the salt has the formula $(NH_2NH_3)_2B_{10}H_{10}$, and is described by KNOTH U.S. Pat. No. 3,148,938.

(c) substituted ammonium cations, wherein the salt has the general formula $(R_3NH)_2B_{10}H_{10}$, where R can be hydrogen (H) or an alkyl radical (preferred radicals contain less than six (6) carbon atoms). The R's in the preceding formula may represent different alkyl groups. Compounds with two or three hydrogen radicals are described by KNOTH U.S. Pat. No. 3,149,163. Typical cations are methylammonium $(CH_3)NH_3^+$, dimethylammonium $(CH_3)_2NH_2^+$, trimethylammonium $(CH_3)_3NH^+$, and triethylammonium $(CH_3CH_2)_3NH^+$.

(d) substituted hydrazinium cations, wherein the salt has the general formula $(R_2NNR_2H)_2B_{10}H_{10}$, where R can be hydrogen (H) or an alkyl radical (preferred radicals contain less than six (6) carbon atoms), and the substituted alkyl groups can be symmetric or asymmetric with respect to the N-N linkage. Symmetric substituted cations are described by KNOTH U.S. Pat. No. 3,149,163. An example of an unsymmetric substituted cation is (1,1) dimethylhydrazinium. The R's in the preceding formula may be mixed alkyl radicals.

(e) quaternary ammonium salts of the general formula $(R_4N)_2B_{10}H_{10}$, where R is an alkyl radical; the R's in the preceding formula may represent mixed alkyl groups. Examples of typical cations are tetramethylammonium $(CH_3)_4N^+$ and tetraethylammonium $(CH_3CH_2)_4N^+$.

(f) aryl containing cations, such as pyridinium, bipyridinium, or substituted aryl cations, such as aryl-diazonium cations.

(g) guanidinium ion, $C(NH_2)_3^+$, wherein the salt has the formula $(C(NH_2)_3)_2B_{10}H_{10}$, and is described in the copending application of common assignment, entitled BIS-GUANIDINIUM DECAHYDRODECABORATE AND A PROCESS FOR ITS PREPARA-

TION, filed June 10, 1976, and assigned Ser. No. 694,627.

(h) metal ions, derived from metals defined by a Periodic Table such as that in the "Handbook of Chemistry and Physics", 54th Edition, inside front cover, by the elements in Groups 1, 2, 8, 3b, 4b, 5b, 6b and 7b, and the elements of Groups 3a, 4a, 5a, and 6a with atomic numbers greater than 5, 14, 33, and 52 respectively. The metal decahydrodecaborate salts are further described by KNOTH U.S. Pat. No. 3,148,939. Examples of such metals salts are $\text{Cs}_2\text{B}_{10}\text{H}_{10}$ and $\text{K}_2\text{B}_{10}\text{H}_{10}$, the cesium and potassium salts of decahydrodecaboric acid, which are representative of alkaline metal decahydrodecaborate salts, having atomic numbers less than 87, preferred for the compositions described in this invention.

The salts of the decahydrodecaborate (-2) ion (Chemical formula $\text{B}_{10}\text{H}_{10}^{-2}$) are conveniently prepared by stoichiometrically reacting an aqueous solution of the parent acid, dihydrogen decahydrodecaborate, $\text{H}_2\text{B}_{10}\text{H}_{10}$, with (1) a soluble hydroxide of the desired cation, such as ammonium hydroxide, (2) the conjugate Bronsted base of the desired cation, such as a free amine, or (3) a soluble salt of the desired cation, such that the salt anion is destroyed during the reaction, such as guanidine carbonate. A Bronsted base is any substance capable of accepting a proton in a reaction; the definition is elaborated upon in any elementary chemistry text, such as Dickerson, Gray and Haight, "Chemical Principles, 2nd Edition," 1974, page 135.

The aqueous solutions of the salts, prepared above, may be evaporated to dryness to recover the crystalline salt. Alternatively, some salts may be precipitated from the aqueous solution by a nonsolvent that is miscible with water. The salts may be purified by recrystallization.

The aqueous decahydrodecaboric acid used as a starting material for the process of this invention is conveniently prepared by passing an amine or metal salt of the decahydrodecaborate (-2) ion through a column containing a strongly acidic ion exchange resin of the sulfonic acid type, such as a DUOLITE type "C-20", acid form by the Diamond Shamrock Corporation. Preferred starting salts are bis(triethylammonium) decahydrodecaborate (-2) and disodium decahydrodecaborate (-2). The preparation and properties of the aqueous acid, and additional preparative methods for metallic salts, are described in more detail in U.S. Pat. No. 3,148,939.

CLASS 2

An intimate blend of the compounds described in Class (1) above, with an oxidizing agent, in a manner that a chemically and physically different product is obtained than the starting materials.

The process by which the compositions of this class are prepared produces a very intimate blend of decahydrodecaborate (-2) ion with the oxidizer and makes the compositions so prepared chemically and physically unique from physical blends of decahydrodecaborate (-2) salts with oxidizer or pyrotechnic compositions incorporating decahydrodecaborate (-2) salts produced by other means. In general, the process consists of dissolving, in a suitable solvent, a decahydrodecaborate (-2) salt, as described above, and also dissolving, in the same solution, an oxidizing agent, as described above. The subject composition is recovered by precipitating the composite ingredients of the solution with a suitable nonsolvent. The resulting solid, after filtration

and drying, comprises an intimate mixture of the decahydrodecaborate (-2) anion with the oxidizing cation or substance, in a form that is chemically and physically different than the starting materials.

The process may be properly called a "cocrySTALLIZATION" or "coprecipitation" and the resulting product a "cocrySTALLATE" or "coprecipitate".

An essential component of Class (2) compounds is an oxidizing agent; i.e., a material that will readily react or burn when mixed with the decahydrodecaborate (-2) salt. Any solid oxidizing agent which will yield oxygen upon decomposition will fulfill this role; solid oxygen containing metal or nonmetal salts are preferred because of their availability, stability, and ease of incorporation into the composition.

In general, solid oxidizing agents include ammonium, substituted ammonium, guanidine, substituted guanidine, alkali and alkaline-earth salts of oxygen containing acids such as nitric, perchloric, permanganic, manganic, chromic, and dichromic acids. Preferred species for this invention, which gave good thermal stability and low hygroscopicity include ammonium nitrate, potassium nitrate, potassium perchlorate, ammonium perchlorate, guanidine nitrate, triaminoguanidine nitrate, potassium permanganate, sodium chromate, barium nitrate, barium chromate, barium manganate, sodium dichromate, tetramethylammonium nitrate and cesium nitrate. Other solid oxidizing agents which could be used if the appropriate solvent/nonsolvent system were used include ammonium, substituted ammonium, guanidine, substituted guanidine, alkali and alkaline-earth salts of other oxygen-containing acids such as chloric, persulfuric, thiosulfuric, periodic, iodic and bromic acids. Other stable oxides include lead thiocyanate, the oxides and peroxides of the light and heavy metals and nonmetals, such as barium peroxide, lead peroxide (PbO_2), lithium peroxide, ferric oxide, red lead (Pb_3O_4), cupric oxide, tellurium dioxide, antimonite oxide, etc., and nonionic substances such as nitrocellulose, nitroguanidine, and cyclotetramethylenetetranitramine (HMX). Mixtures of the aforementioned oxidizing agents also can be used.

These unique coprecipitated Class 2 salts, containing the $\text{B}_{10}\text{H}_{10}^{-2}$ anion, and the process for their creation, are themselves further disclosed in our copending patent application entitled COPRECIPITATED PYROTECHNIC COMPOSITION PROCESSES AND RESULTANT PRODUCTS, filed June 10, 1976, assigned Ser. No. 694,626, which is incorporated herein by reference.

The compositions of this invention make use of the unique decomposition properties of the decahydrodecaborate (-2) ion, a bicapped square antiprism polyhedral ion with unusual stability; the ion is believed to be kinetically rather than thermodynamically stabilized. The ion demonstrates an unusually fast decomposition upon oxidation, which is believed to proceed through the labile apical hydrogen atoms bonded to the cage. When incorporated into a composition such as a propellant, the decahydrodecaborate (-2) ion acts in such a manner as to control the overall burning rate of the propellant, so that the overall composition exhibits an accelerated, and in some cases, a stabilized burning rate.

The propellant binder system may be of a polymeric type which requires a post formulation cure, such as polyester, polybutadiene system, or alternatively, may be a polymer, such as nitrocellulose, which requires no additional crosslinking to give the desired properties.

Polymeric binder systems requiring a cure may be based on, but are not limited to, resins of the following types:

polyester, polyacrylate, epoxy, polysulfide, polyurethane, the copolymer of butadiene and acrylic acid (PBAA), the terpolymer of butadiene, acrylic acid, and acrylonitrile (PBAN), carboxy-terminated polybutadiene (CTPB), hydroxy-terminated polybutadiene (HTPB).

Nitrocellulose binder does not require a post formulation cure. Nitrocellulose of nitrogen content between 12.5 and 13.3% nitrogen content is preferred. The nitrocellulose binder system is an example of an "active binder", that is, one which is self-combusting and contributes per se to the overall performance.

As used herein, a nitrocellulose binder would be used in such relatively low percentages, e.g., 8% to less than 35%, as noted above, that it would not constitute a "single base" propellant. Unlike our copending Ser. No. 696,324, ACTIVE BINDER PROPELLANTS INCORPORATING BURNING RATE CATALYSTS, noted hereinbefore, the present invention substantially replaces the normally found oxidizer component in a propellant with the coprecipitate of an oxidizer and a decahydrodecaborate salt. Hence, the present invention is distinguished in that the coprecipitation of a decahydrodecaborate salt with an oxidizer becomes substantially all the oxidizer necessary in the subject propellants.

As used hereinabove, the well known term "cure" includes a chemical reaction wherein monomers are either cross-linked or end-linked. Of course, nitrocellulose is a natural polymer that does not require any type of cure.

Binders incorporating fluorine are also preferred species for the subject invention. Examples of suitable resins are the copolymer of hexafluoropropylene and vinylidene fluoride, and the copolymer of chlorotrifluoroethylene and vinylidene. The former copolymer is an example of a fluorine containing binder which may be used with or without a curing agent; a suitable curing system consists of 5 to 10 parts-by-weight zinc oxide, 5 to 10 parts-by-weight dibasic lead phosphate, and 1.5 to 3.0 parts-by-weight benzoyl peroxide or 3 parts-by-weight polyamine such as hexamethylenediamine to 100 parts-by-weight copolymer resin.

Other ingredients useful, but not essential, in the subject invention, include fuels, such as finely divided aluminum, to enhance the flame temperature of the burning propellant, additional oxidizer, such as ammonium or potassium perchlorate, to achieve more complete combustion of the binder; plasticizers, such as difunctional or trifunctional epoxy resins (uncured) and organic esters, which modify the resulting physical properties of the propellant; and other additives such as colorants, stabilizers, etc. All of the forementioned ingredients and their usage are practiced and known to those experienced in the art.

The method of manufacture and subsequent processing of the propellant to the desired configuration, is dependent upon the specific formulation and configuration desired for an intended usage. In general, the formulations of this invention may be cast, extruded, or pressed, depending on the end-of-mix (before curing, if any) properties.

Representative formulations according to the principles of the present invention are detailed, as follows:

Example I illustrates the invention with a propellant binder that is representative of "composite" propellants,

as known in the art and also defined in our copending application COMPOSITE PROPELLANTS INCORPORATING BURNING RATE ENHANCERS, Ser. No. 696,323, filed June 15, 1976. Example I further illustrates a coprecipitation compound which is representative of the coprecipitation of a class (1) metallic salt of decahydrodecaborate acid with an oxidizer. The coprecipitate of cesium decahydrodecaborate with potassium nitrate is intended to be representative of most class (2) metallic salt coprecipitations with appropriate and conventional oxidizers.

EXAMPLE I

33.8 grams of a hydroxy-terminated polybutadiene polymer resin (R45M, Arco Chemical Co., Lakewood, CA), 20.0 grams of isodecyl pelargonate (Emery 2911, Emery Industries, Inc., Cincinnati, Ohio) and 25.0 grams powdered aluminum are charged into a Baker Perkins 1 pint sigma blade mixer, and degassed under vacuum at 190° F. for 1 hour. The temperature is reduced to 140° F. 182.5 grams of the coprecipitate of 25 parts-by-weight cesium decahydrodecaborate and 75 parts-by-weight potassium nitrate is added to the mixer in 5 increments; mixing under vacuum is continued for a minimum of 10 minutes after each addition. 2.87 grams of the curing agent toluene diisocyanate is added and mixing continued for 10 minutes.

A tough rubbery nonporous material is obtained after a 24 hour ambient cure. Burning rate strands $\frac{1}{4}$ inch square and $1\frac{1}{2}$ inches long are cut from slabs of the propellant.

The cured strands are inhibited with a single layer of carboxy-terminated polybutadiene rubber, and cured at 190° F. for 24 hours minimum. A second layer of 35% Shell Epon 828 epoxy resin and 65% polyamine curing agent is added over the CTPB inhibitor, and cured for a minimum of 2 hours at 190° F.

The cured and inhibited strands are tested as follows: The burn rate strands are trimmed to a length of approximately $1\frac{1}{2}$ inches. A nichrome ignition wire is inserted through a $\frac{1}{16}$ inch hole drilled $\frac{1}{4}$ inch from one end of the strand.

Two lacquer-coated solder breakwires are inserted through $\frac{1}{16}$ inch holes spaced 1 inch apart and $\frac{1}{4}$ inch from the ignition wire; the breakwires are potted into place with nitrocellulose cement. The strand with attached wires is securely fastened with phenolic tie-downs to a phenolic plate, and electrical connections to the wires made. The phenolic plate is mounted in a pressure bomb; electrical connections are made through a feedthrough mounted in the bomb flange. For testing, a sealed bomb is first pressurized to 1000, and then another test is made at 2000 psi. A 28V pulse applied to the ignition wire ignites the strand. Time between successive breakwire breaks is recorded, as well as pressure rise in the bomb as a function of time. The reciprocal of the time between successive wire breaks is the burn rate in inches per second. The average of the burn rates over the manifold of data points for several strands of the propellant is taken as the burn rate for the propellant.

When tested in the above manner, the propellant exhibits a linear burning rate of 12.1 ± 0.7 inches per second at 1000 psi and 16.3 ± 1.9 inches per second at 2000 psi.

The next example, Example II, illustrates the performance of the same representative class (2) metallic coprecipitate, cesium decahydrodecaborate with potassium nitrate, with a nitrocellulose binder. The nitrocel-

lulose binder typifies an "active" binder, and the effects of varying the relative weights of an active binder and a representative coprecipitate is illustrated.

EXAMPLE II

Propellants incorporating coprecipitated cesium decahydrodecaborate and potassium nitrate in a nitrocellulose binder are prepared according to Table I, in nominal 100-200 gram batch sizes, as follows:

TABLE I

Ingredient	By Weight		
	Propellant 2	Propellant 3	Propellant 4
Nitrocellulose (12.6% N)	17.0	12.8	13.0
Dinitrotoluene	12.0	14.5	6.5
Acetyl tributyl citrate	10.0	8.6	5.5
Coprecipitate of cesium decahydrodecaborate and potassium nitrate, 25/75 ratio, parts-by-weight	61.0	64.1	75.0

Nitrocellulose, of nitrogen content 12.6%, and corresponding to that material specified as MIL-N-244A, Grade A Type I, is dissolved in reagent grade acetone, in the approximate ratio of 1 part nitrocellulose to 5 parts acetone using a magnetic stirrer and teflon spin bar. The dinitrotoluene and acetyl tributyl citrate are added to the nitrocellulose/acetone solution and mixing continued until the ingredients are completely mixed, 10 minutes being an adequate period.

The resulting solution is charged into a Baker Perkins 1 pint sigma blade mixer at 60° C. The coprecipitate of cesium decahydrodecaborate and potassium nitrate is added in three equal increments, with a minimum of 10 minute mixing between additions. Mixing is continued until a uniform slurry of mixed ingredients is obtained. Vacuum is applied (28 inches mercury minimum) to the mixer and mixing continued, usually for several hours, until the material has a tough, rubbery consistency.

Burning rate strands are prepared from the warm propellant by placing into a small extruder and extruding a 1/8 inch strand with the help of an air operated press. The material can also be rolled into thin sheets, or pressed into a variety of grain configurations.

The 1/8 inch O.D. strands are dried for two days minimum in an oven at 60° C. to remove residual acetone.

A sample of the propellants are subjected to an impact or "drop" test consisting of dropping a 2 kg weight from a calibrated height onto a small (20 milligram) sample of propellant placed on a grit base. The propellant cannot be ignited in 10 trials when the weight is released from a height of 10 cm, which is indicative that the propellant is relatively insensitive and quite safe to handle.

The dried burning rate strands are coated with a single layer of flexible epoxy, simply to inhibit surface burning. The inhibited burn rate strands are cut to a length of approximately 3 1/2 inches. A nichrome ignition wire is inserted through a 1/16 inch hole drilled 1/2 inch from one end of the strand. Three lacquer-coated solder breakwires are inserted through 1/16 inch holes spaced at 1 inch intervals from the ignition wire; the breakwires are potted into place with a nitrocellulose base cement such as Duco brand. The strand with attached wires is securely fastened with phenolic tiedowns to a phenolic plate, and electrical connections to the wires made.

The phenolic plate is mounted in a pressure bomb; electrical connections are made through a feedthrough mounted in the bomb flange. The sealed bomb is first pressurized to 1000, and then to 2000 psi. A 28V pulse

applied to the ignition wire ignited the strand. Time between successive breakwire breaks is recorded, as well as pressure rise in the bomb as a function of time. The reciprocal of the time between successive wire breaks is the burn rate in inches per second. The average of these burn rates (2 data points per strand) over the manifold of data points for all strands of a particular propellant is taken as the burn rate for that propellant.

The burning rates obtained are as follows:

	Linear Burning Rate Inches per Second	
	1000 psi	2000 psi
Propellant 2	2.7	5.1
Propellant 3	3.2	—
Propellant 4	3.9	7.3

The data indicate the control that can be achieved by varying the concentration of the decahydrodecaborate coprecipitate. The pressure exponent of the propellant is approximately 0.9.

The next example, Example III, illustrates the same representative active binder of nitrocellulose, of a 12.6% nitrogen content, with a representative class 2 metallic coprecipitate, as in Example II and also with a representative class 2 nonmetallic salt of decahydrodecaborate acid which has been coprecipitated with an oxidizer. Propellant 6 employs tetramethylammonium decahydrodecaborate and typifies the results expectable when a simple nonmetallic salt, from class 1, as above-defined, is coprecipitated with potassium nitrate, or any equivalent oxidizer material.

EXAMPLE III

Propellants incorporating coprecipitated decahydrodecaborates and potassium nitrate, an acetone soluble simple decahydrodecaborate salt, and a nitrocellulose binder, are prepared according to Table II, in nominal 100g batches, as follows:

TABLE II

Ingredients	% by weight	
	Propellant 5	Propellant 6
nitrocellulose (12.6% N)	17.0	17.0
dinitrotoluene	12.0	12.0
acetyl tributyl citrate	10.0	10.0
potassium decahydrodecaborate	16.0	16.0
coprecipitate of cesium decahydrodecaborate and potassium nitrate, 25/75 ratio, parts-by-weight	45.0	
coprecipitate of tetramethylammonium decahydrodecaborate and potassium nitrate, 15/85 ratio, parts-by-weight.		45.0

The nitrocellulose, of nitrogen content 12.6%N, and corresponding to that material specified by MIL-N-244A, Grade A Type I, is dissolved in reagent grade acetone, in the approximate ratio 10 parts-by-weight acetone to 1 part nitrocellulose in a Waring blender operated at moderate speed. The potassium decahydrodecaborate salt is dried in vacuum for a minimum of 24 hours at 100° C. and dissolved in acetone in the approximate ratio 5 parts acetone to 1 part salt. The salt/acetone solution, dinitrotoluene, and acetyl tributyl citrate, are added to the blender and mixed for a minimum of 5 minutes, until a uniform fluid is obtained. The decahydrodecaborate coprecipitate is added to the

blender in 3 increments, with blending of 5 minutes between additions, until a uniform slurry is obtained.

The resulting slurry is charged into a Baker Perkins 1 pint sigma blade mixer at 60° C. Vacuum is applied, and mixing started, to remove the acetone carrier. Mixing is continued, usually for a period of 4-8 hours, until a tough, rubbery dough is obtained.

Burning rate strands are prepared from the warm propellant by placing into a small extruder and extruding a 1/4 inch strand with the help of an air operated press. The material can also be rolled into thin sheets, or pressed into a variety of grain configurations.

The 1/4 inch O.D. strands are dried for two days minimum in an oven at 60° C. to remove residual acetone.

A sample of the propellants are subjected to an impact or "drop" test consisting of dropping a 2 kg weight from a calibrated height onto a small (20 milligram) sample of propellant placed on a grit base. The propellant cannot be ignited in 10 trials when the weight is released from a height of 7 cm, which is indicative that the propellant is relatively insensitive and quite safe to handle.

The dried burning rate strands are coated with a single layer of flexible epoxy to inhibit surface burning.

The inhibited burn rate strands are cut to a length of approximately 3 1/2 inches. A nichrome ignition wire is inserted through a 1/16 inch hole drilled 1/2 inch from one end of the strand. Three lacquer-coated solder breakwires are inserted through 1/16 inch holes spaced at 1 inch intervals from the ignition wire; the breakwires are potted into place with a nitrocellulose base cement. The strand with attached wires is securely fastened with phenolic tiedowns to a phenolic plate, and electrical connections to the wires made. The phenolic plate is mounted in a pressure bomb; electrical connections are made through a feedthrough mounted in the bomb flange. The sealed bomb is pressurized, first to 1000, and then to 2000 psi. A 28V pulse applied to the ignition wire ignites the strand. Time between successive breakwire breaks is recorded, as well as pressure rise in the bomb as a function of time. The reciprocal of the time between successive wire breaks is the burn rate in inches per second. The average of these burn rates (2 data points per strand) over the manifold of data points for all strands of a particular propellant is taken as the burn rate for that propellant.

The burning rates obtained are as follows:

	Linear Burning Rate Inches Per Second	
	1000 psi	2000 psi
Propellant 5	10.3	15.9
Propellant 6	5.9	—

The data illustrates the burning rate enhancement that can be achieved by the addition of a soluble decahydrodecaborate salt to the propellant. Propellant 5 exhibits a pressure exponent of 0.6.

The following example, Example IV, illustrates the performance level of an active binder propellant according to the present invention, together with an optional, additional ingredient for burn rate enhancement. The optional use of certain simple salts of decahydrodecaboric acid, defined earlier herein as class (1) compounds, has been found useful with active binders in formulations as taught herein.

EXAMPLE IV

A propellant incorporating a coprecipitated decahydrodecaborate compound with oxidizer, a soluble simple decahydrodecaborate salt, and a fluorine containing polymeric binder is prepared according to Table III. The fluorine containing polymer is an example of a high energy binder, which contributes substantially to the speed and output of the overall reaction. No curing agent is used in this particular example, but a curing system utilizing a peroxide or amine cure, and comprising approximately 5% by weight of the total propellant weight, could be used to improve the physical properties of the propellant.

The copolymer of hexafluoropropylene and vinylidene fluoride is dissolved in reagent grade acetone, in the approximate ratio 5 parts-by-weight acetone to 1 part-by-weight copolymer in a Waring blender. The potassium decahydrodecaborate salt is dried in vacuo for a minimum of 24 hours at 100° C., and dissolved in acetone in the approximate ratio 5 parts acetone to 1 part salt. The salt/acetone solution is added to the blender and mixed for several minutes until a homogenous mix is obtained. The decahydrodecaborate coprecipitate is added to the blender in 3 increments, with blending of 5 minutes between additions, until a uniform slurry is obtained.

TABLE III

Ingredient	% By Weight
	Propellant 7
Copolymer of hexafluoropropylene and vinylidene fluoride (1)	25.0
Coprecipitate of cesium decahydrodecaborate and potassium nitrate, 25/75 parts-by-weight	65.0
Potassium decahydrodecaborate	10.0

(1) "Fluorel" Brand Elastomer FC-2175 (3M Company, St. Paul, Minn.)

The resulting slurry is charged into a Baker Perkins 1 pint sigma blade mixer at 60° C. Vacuum is applied, and mixing started, to remove the acetone carrier. Mixing is continued, usually for a period of 4-8 hours, until a tough, rubbery dough is obtained.

Burning rate strands are prepared from the warm propellant by placing into a small extruder and extruding a 1/4 inch strand with the help of an air operated press. The material can also be rolled into thin sheets, or pressed into a variety of grain configurations.

The 1/4 inch O.D. strands are dried for two days minimum in an oven at 60° C. to remove residual acetone.

The dried burning rate strands are coated with a single layer of flexible epoxy to inhibit surface burning. The inhibited burn rate strands are cut to a length of approximately 3 1/2 inches. A nichrome ignition wire is inserted through a 1/16 inch hole drilled 1/2 inch from one end of the strand. Three lacquer-coated solder breakwires are inserted through 1/16 inch holes spaced at 1 inch intervals from the ignition wire; the breakwires are potted into place with a nitrocellulose base cement.

The strand with attached wires is securely fastened with phenolic tiedowns to a phenolic plate, and electrical connections to the wires made. The phenolic plate is mounted in a pressure bomb; electrical connections are made through a feedthrough mounted in the bomb flange. The sealed bomb is pressurized to 1000 psi. A 28V pulse applied to the ignition wire ignites the strand. Time between successive breakwire breaks is recorded, as well as pressure rise in the bomb as a function of time.

The reciprocal of the time between successive wire breaks is the burn rate in inches per second. The average of these burn rates (2 data points per strand) over the manifold of data points for all strands of a particular propellant is taken as the burn rate for that propellant.

When tested in the above manner, propellant 7 gives a burning rate of 16.7 inches per second at 1000 psi.

Though representative examples have been given to illustrate our invention, the scope of our invention is to be defined by the appended claims.

We claim:

1. A propellant composition wherein substantially all the oxidizer is physically intertwined by a coprecipitation with certain simple decahydrodecaborate salts, comprising, by weight:

(A) a polymeric binder system, in the range 8-35 percent;

(B) curing agents, in the range 0-10 percent;

(C) plasticizing agents, in the range 0-25 percent;

(D) the resultant product, in the range 35-90 percent, of a process wherein a solid oxidizing agent is coprecipitated with certain simple decahydrodecaborate salts, having the common anion $B_{10}H_{10}^{-2}$, wherein the cation is selected from the group consisting of:

(a) ammonium, wherein the salt has the formula $(NH_4)_2B_{10}H_{10}$;

(b) hydrazinium, wherein the salt has the formula $(NH_2NH_2)_2B_{10}H_{10}$;

(c) substituted ammonium cations, wherein the salt has the general formula $(R_3NH)_2B_{10}H_{10}$, wherein further R is selected from the group consisting of hydrogen and alkyl radicals containing less than six carbon atoms;

(d) substituted hydrazinium cations, wherein the salt has the general formula $(R_2NNR_2H)_2B_{10}H_{10}$ wherein further R is selected from the group consisting of hydrogen and alkyl radicals containing less than six carbon atoms, wherein said process comprises the steps of:

(i) dissolving both the decahydrodecaborate (-2) salt and the oxidizing agent in a mutually soluble solvent, at a temperature sufficiently high to maintain said salt and said oxidizing agent in solution;

(ii) forming a pressurized stream of said solution and bringing said solution stream together with a pressurized stream of a miscible nonsolvent, under conditions of extreme turbulence within a mixing chamber, to effect a substantially complete coprecipitation;

(iii) recovering the coprecipitated product by filtering the effluent from said mixing chamber, and washing said product with an inert and nonsolvent fluid;

(iv) drying the product to remove all remaining liquid.

2. A propellant composition wherein substantially all the oxidizer is physically intertwined by a coprecipitation with certain simple decahydrodecaborate salts, comprising, by weight:

(A) a polymeric binder system, in the range 8-35 percent;

(B) curing agents, in the range 0-10 percent;

(C) plasticizing agents, in the range 0-25 percent;

(D) the resultant product, in the range 35-90 percent, of a process wherein a solid oxidizing agent is coprecipitated with certain simple decahydrodecaborate salts,

having the common anion $B_{10}H_{10}^{-2}$, wherein the cation is selected from the group consisting of:

(a) tetramethylammonium, $(CH_3)_4N^+$, tetraethylammonium, $(CH_3CH_2)_4N^+$, and quaternary ammonium cations having the general formula R_4N^+ where R is an alkyl radical;

(b) pyridinium, bipyridinium aryl-diazonium, aryl containing cations and substituted aryl containing cations, wherein said process comprises the steps of:

(i) dissolving both the decahydrodecaborate (-2) salt and the oxidizing agent in a mutually soluble solvent, at a temperature sufficiently high to maintain said salt and said oxidizing agent in solution;

(ii) forming a pressurized stream of said solution and bringing said solution stream together with a pressurized stream of a miscible nonsolvent, under conditions of extreme turbulence within a mixing chamber, to effect a substantially complete coprecipitation;

(iii) recovering the coprecipitated product by filtering the effluent from said mixing chamber, and washing said product with an inert and nonsolvent fluid;

(iv) drying the product to remove all remaining liquid.

3. A propellant composition wherein substantially all the oxidizer is physically intertwined by a coprecipitation with certain simple decahydrodecaborate salts, comprising, by weight:

(A) a polymeric binder system, in the range 8-35 percent;

(B) curing agents, in the range 0-10 percent;

(C) plasticizing agents, in the range 0-25 percent;

(D) the resultant product, in the range 35-90 percent, of a coprecipitation of a solid oxidizing agent with a simple decahydrodecaborate salt, having the anion $B_{10}H_{10}^{-2}$, wherein the cation is guanidinium, and the salt has the formula $(C(NH_2)_3)_2B_{10}H_{10}$, comprising the steps of:

(i) dissolving both the decahydrodecaborate (-2) salt and the oxidizing agent in a mutually soluble solvent, at a temperature sufficiently high to maintain said salt and said oxidizing agent in solution;

(ii) forming a pressurized stream of said solution and bringing said solution stream together with a pressurized stream of a miscible nonsolvent, under conditions of extreme turbulence within a mixing chamber, to effect a substantially complete coprecipitation;

(iii) recovering the coprecipitated product by filtering the effluent from said mixing chamber, and washing said product with an inert and nonsolvent fluid;

(iv) drying the product to remove all remaining liquid.

4. A propellant composition wherein substantially all the oxidizer is physically intertwined by a coprecipitation with certain simple decahydrodecaborate salts, comprising, by weight:

(A) a polymeric binder system, in the range 8-35 percent;

(B) curing agents, in the range 0-10 percent;

(C) plasticizing agents, in the range 0-25 percent;

(D) the resultant product, in the range 35-90 percent, of a process wherein a solid oxidizing agent is coprecipitated with certain simple decahydrodecaborate salts,

having the common anion $B_{10}H_{10}^{-2}$, wherein the cation is selected from the group consisting of metal ions derived from the elements in Groups 1, 2, 8, 3b, 4b, 5b, 6b, 7b, and the elements of Groups 3a, 4a, 5a, and 6a which have atomic numbers respectively greater than 5, 14, 33 and 52, wherein said process comprises the steps of:

- (i) dissolving both the decahydrodecaborate (--2) salt and the oxidizing agent in a mutually soluble solvent, at a temperature sufficiently high to maintain said salt and said oxidizing agent in solution;
- (ii) forming a pressurized stream of said solution and bringing said solution stream together with a pressurized stream of a miscible nonsolvent, under conditions of extreme turbulence within a mixing chamber, to effect a substantially complete coprecipitation;
- (iii) recovering the coprecipitated product by filtering the effluent from said mixing chamber, and washing said product with an inert and nonsolvent fluid;
- (iv) drying the product to remove all remaining liquid.

5. A propellant composition wherein substantially all the oxidizer is physically intertwined by a coprecipitation with certain simple decahydrodecaborate salts, comprising, by weight:

- (A) a polymeric binder system, in the range 8-35 percent;
- (B) curing agents, in the range 0-10 percent;
- (C) plasticizing agents, in the range 0-25 percent;
- (D) the resultant product, in the range 35-90 percent, of a process wherein a solid oxidizing agent is coprecipitated with certain metallic salts, selected from the group consisting of cesium decahydrodecaborate, $Cs_2B_{10}H_{10}$, and potassium decahydrodecaborate, $K_2B_{10}H_{10}$, wherein said process comprises the steps of:

- (i) dissolving both the decahydrodecaborate (-2) salt and the oxidizing agent in a mutually soluble solvent, at a temperature sufficiently high to maintain said salt and said oxidizing agent in solution;
- (ii) forming a pressurized stream of said solution and bringing said solution stream together with a pressurized stream of a miscible nonsolvent, under conditions of extreme turbulence within a mixing chamber, to effect a substantially complete coprecipitation;
- (iii) recovering the coprecipitated product by filtering the effluent from said mixing chamber, and washing said product with an inert and nonsolvent fluid;
- (iv) drying the product to remove all remaining liquid.

6. A propellant composition according to claim 1 wherein said resultant coprecipitation process product further comprises said solid oxidizer being selected from the group consisting of ammonium nitrate, potassium nitrate, potassium perchlorate, ammonium perchlorate, guanidine nitrate, triaminoguanidine nitrate, potassium permanganate, sodium chromate, barium nitrate, barium chromate, barium manganate, sodium dichromate, tetramethylammonium nitrate and cesium nitrate.

7. A propellant composition according to claim 2 wherein said resultant coprecipitation process product further comprises said solid oxidizer being selected from the group consisting of ammonium nitrate, potas-

sium nitrate, potassium perchlorate, ammonium perchlorate, guanidine nitrate, triaminoguanidine nitrate, potassium permanganate, sodium chromate, barium nitrate, barium chromate, barium manganate, sodium dichromate, tetramethylammonium nitrate and cesium nitrate.

8. A propellant composition according to claim 3 wherein said resultant coprecipitation process product further comprises said solid oxidizer being selected from the group consisting of ammonium nitrate, potassium nitrate, potassium perchlorate, ammonium perchlorate, guanidine nitrate, triaminoguanidine nitrate, potassium permanganate, sodium chromate, barium nitrate, barium chromate, barium manganate, sodium dichromate, tetramethylammonium nitrate and cesium nitrate.

9. A propellant composition according to claim 4 wherein said resultant coprecipitation process product further comprises said solid oxidizer being selected from the group consisting of ammonium nitrate, potassium nitrate, potassium perchlorate, ammonium perchlorate, guanidine nitrate, triaminoguanidine nitrate, potassium permanganate, sodium chromate, barium nitrate, barium chromate, barium manganate, sodium dichromate, tetramethylammonium nitrate and cesium nitrate.

10. A propellant composition according to claim 5 wherein said resultant coprecipitation process product further comprises said solid oxidizer being selected from the group consisting of ammonium nitrate, potassium nitrate, potassium perchlorate, ammonium perchlorate, guanidine nitrate, triaminoguanidine nitrate, potassium permanganate, sodium chromate, barium nitrate, barium chromate, barium manganate, sodium dichromate, tetramethylammonium nitrate and cesium nitrate.

11. A propellant composition as in claim 6 wherein said polymeric binder system is a composite propellant requiring a post-formulation cure and is selected from the group consisting of:

- polyester
- polyacrylate,
- epoxy,
- polysulfide,
- polyurethane,
- the copolymer of butadiene and acrylic acid (PBAA),
- the terpolymer of butadiene,
- acrylic acid,
- acrylonitrile (PBAN)
- carboxy-terminated polybutadiene (CTPB) and
- hydroxy-terminated polybutadiene (HTPB)

12. A propellant composition as in claim 7 wherein said polymeric binder system is a composite propellant requiring a post-formulation cure and is selected from the group consisting of:

- polyester
- polyacrylate,
- epoxy,
- polysulfide,
- polyurethane,
- the copolymer of butadiene and acrylic acid (PBAA),
- the terpolymer of butadiene,
- acrylic acid,
- acrylonitrile (PBAN)
- carboxy-terminated polybutadiene (CTPB) and
- hydroxy-terminated polybutadiene (HTPB)

13. A propellant composition as in claim 8 wherein said polymeric binder system is a composite propellant

requiring a post-formulation cure and is selected from the group consisting of:

polyester
polyacrylate,
epoxy,
polysulfide,
polyurethane,
the copolymer of butadiene and acrylic acid (PBAA),
the terpolymer of butadiene,
acrylic acid,
acrylonitrile (PBAN)
carboxy-terminated polybutadiene (CTPB) and
hydroxy-terminated polybutadiene (HTPB)

14. A propellant composition as in claim 9 wherein said polymeric binder system is a composite propellant requiring a post-formulation cure and is selected from the group consisting of:

polyester
polyacrylate,
epoxy,
polysulfide,
polyurethane,
the copolymer of butadiene and acrylic acid (PBAA),
the terpolymer of butadiene,
acrylic acid,
acrylonitrile (PBAN)
carboxy-terminated polybutadiene (CTPB) and
hydroxy-terminated polybutadiene (HTPB)

15. A propellant composition as in claim 10 wherein said polymeric binder system is a composite propellant requiring a post-formulation cure and is selected from the group consisting of:

polyester
polyacrylate,
epoxy,
polysulfide,
polyurethane,
the copolymer of butadiene and acrylic acid (PBAA),
the terpolymer of butadiene,
acrylic acid,
acrylonitrile (PBAN)
carboxy-terminated polybutadiene (CTPB) and
hydroxy-terminated polybutadiene (HTPB)

16. A propellant composition as in claim 6 wherein said polymeric binder system is selected from the group consisting of nitrocellulose, oxygen containing binders, and fluorine containing binders.

17. A propellant composition as in claim 7 wherein said polymeric binder system is selected from the group consisting of nitrocellulose, oxygen containing binders, and fluorine containing binders.

18. A propellant composition as in claim 8 wherein said polymeric binder system is selected from the group consisting of nitrocellulose, oxygen containing binders, and fluorine containing binders.

19. A propellant composition as in claim 9 wherein said polymeric binder system is selected from the group consisting of nitrocellulose, oxygen containing binders, and fluorine containing binders.

20. A propellant composition as in claim 10 wherein said polymeric binder system which is selected from the group consisting of nitrocellulose, oxygen containing binders, and fluorine containing binders.

21. A propellant composition as in claim 6 wherein said polymeric binder is an active binder selected from the group consisting of nitrocellulose, the copolymer of hexafluoropropylene and vinylidene fluoride, and the

copolymer of chlorotrifluoroethylene and vinylidene fluoride.

22. A propellant composition as in claim 7 wherein said polymeric binder is an active binder selected from the group consisting of nitrocellulose, the copolymer of hexafluoropropylene and vinylidene fluoride, and the copolymer of chlorotrifluoroethylene and vinylidene fluoride.

23. A propellant composition as in claim 8 wherein said polymeric binder is an active binder selected from the group consisting of nitrocellulose, the copolymer of hexafluoropropylene and vinylidene fluoride, and the copolymer of chlorotrifluoroethylene and vinylidene fluoride.

24. A propellant composition as in claim 9 wherein said polymeric binder is an active binder selected from the group consisting of nitrocellulose, the copolymer of hexafluoropropylene and vinylidene fluoride, and the copolymer of chlorotrifluoroethylene and vinylidene fluoride.

25. A propellant composition as in claim 10 wherein said polymeric binder is an active binder selected from the group consisting of nitrocellulose, the copolymer of hexafluoropropylene and vinylidene fluoride, and the copolymer of chlorotrifluoroethylene and vinylidene fluoride.

26. A propellant composition according to claim 16 wherein said propellant composition further comprises from 0.01-25 percent, by weight, certain simple salts having the common anion $B_{10}H_{10}^{-2}$ wherein the cation is selected from the group consisting of:

(i) ammonium, wherein the salt has the formula $(NH_4)_2B_{10}H_{10}$;

(ii) hydrazinium, wherein the salt has the general formula $(NH_2NH_3) B_{10}H_{10}$;

(iii) substituted ammonium cations, wherein the salt has the general formula $(R_3NH)_2B_{10}H_{10}$, wherein further R is selected from the group consisting of hydrogen and alkyl radicals containing less than six carbon atoms;

(iv) substituted hydrazinium cations, wherein the salt has the general formula $(R_2NNR_2H)_2B_{10}H_{10}$ wherein further R is selected from the group consisting of hydrogen and alkyl radicals containing less than six atoms;

(v) tetramethylammonium $(CH_3)_4N^+$, tetraethylammonium $(CH_3CH_2)_4N^+$, and quaternary ammonium cations having the general formula R_4N^+ where R is an alkyl radical;

(vi) pyridinium, bipyridinium aryl-diazonium, aryl containing cations and substituted aryl containing cations;

(vii) guanidinium, wherein the salt has the formula $(C(NH_2)_3)_2B_{10}H_{10}$;

(viii) metal ions derived from the elements in Groups 1, 2, 8, 3b, 4b, 5b, 6b, 7b, and the elements of Groups 3a, 4a, 5a, and 6a which have atomic numbers respectively greater than 5, 14, 33 and 52.

27. A propellant composition according to claim 17 wherein said propellant composition further comprises from 0.01-25 percent, by weight, certain simple salts having the common anion $B_{10}H_{10}^{-2}$ wherein the cation is selected from the group consisting of:

(i) ammonium, wherein the salt has the formula $(NH_4)_2B_{10}H_{10}$;

(ii) hydrazinium, wherein the salt has the general formula $(NH_2NH_3) B_{10}H_{10}$;

- (iii) substituted ammonium cations, wherein the salt has the general formula $(R_3NH)_2B_{10}H_{10}$, wherein further R is selected from the group consisting of hydrogen and alkyl radicals containing less than six carbon atoms;
- (iv) substituted hydrazinium cations, wherein the salt has the general formula $(R_2NNR_2H)_2B_{10}H_{10}$ wherein further R is selected from the group consisting of hydrogen and alkyl radicals containing less than six atoms;
- (v) tetramethylammonium $(CH_3)_4N^+$, tetraethylammonium $(CH_3CH_2)_4N^+$, and quaternary ammonium cations having the general formula R_4N^+ where R is an alkyl radical;
- (vi) pyridinium, bipyridinium aryl-diazonium, aryl containing cations and substituted aryl containing cations;
- (vii) guanidinium, wherein the salt has the formula $(C(NH_2)_3)_2B_{10}H_{10}$;
- (viii) metal ions derived from the elements in Groups 1, 2, 8, 3*b*, 4*b*, 5*b*, 6*b*, 7*b*, and the elements of Groups 3*a*, 4*a*, 5*a*, and 6*a* which have atomic numbers respectively greater than 5, 14, 33 and 52.
28. A propellant composition according to claim 18 wherein said propellant composition further comprises from 0.01-25 percent, by weight, certain simple salts having the common anion $B_{10}H_{10}^{-2}$ wherein the cation is selected from the group consisting of:
- (i) ammonium, wherein the salt has the formula $(NH_4)_2B_{10}H_{10}$;
- (ii) hydrazinium, wherein the salt has the general formula $(NH_2NH_3) B_{10}H_{10}$;
- (iii) substituted ammonium cations, wherein the salt has the general formula $(R_3NH)_2B_{10}H_{10}$, wherein further R is selected from the group consisting of hydrogen and alkyl radicals containing less than six carbon atoms;
- (iv) substituted hydrazinium cations, wherein the salt has the general formula $(R_2NNR_2H)_2B_{10}H_{10}$ wherein further R is selected from the group consisting of hydrogen and alkyl radicals containing less than six atoms;
- (v) tetramethylammonium $(CH_3)_4N^+$, tetraethylammonium $(CH_3CH_2)_4N^+$, and quaternary ammonium cations having the general formula R_4N^+ where R is an alkyl radical;
- (vi) pyridinium, bipyridinium aryl-diazonium, aryl containing cations and substituted aryl containing cations;
- (vii) guanidinium, wherein the salt has the formula $(C(NH_2)_3)_2B_{10}H_{10}$;
- (viii) metal ions derived from the elements in Groups 1, 2, 8, 3*b*, 4*b*, 5*b*, 6*b*, 7*b*, and the elements of groups 3*a*, 4*a*, 5*a*, and 6*a* which have atomic numbers respectively greater than 5, 14, 33 and 52.
29. A propellant composition according to claim 19 wherein said propellant composition further comprises from 0.01-25 percent, by weight, certain simple salts having the common anion $B_{10}H_{10}^{-2}$ wherein the cation is selected from the group consisting of:
- (i) ammonium, wherein the salt has the formula $(NH_4)_2B_{10}H_{10}$;
- (ii) hydrazinium, wherein the salt has the general formula $(NH_2NH_3) B_{10}H_{10}$;
- (iii) substituted ammonium cations, wherein the salt has the general formula $(R_3NH)_2B_{10}H_{10}$, wherein further R is selected from the group consisting of

- hydrogen and alkyl radicals containing less than six carbon atoms;
- (iv) substituted hydrazinium cations, wherein the salt has the general formula $(R_2NNR_2H)_2B_{10}H_{10}$ wherein further R is selected from the group consisting of hydrogen and alkyl radicals containing less than six atoms;
- (v) tetramethylammonium $(CH_3)_4N^+$, tetraethylammonium $(CH_3CH_2)_4N^+$, and quaternary ammonium cations having the general formula R_4N^+ where R is an alkyl radical;
- (vi) pyridinium, bipyridinium aryl-diazonium, aryl containing cations and substituted aryl containing cations;
- (vii) guanidinium, wherein the salt has the formula $(C(NH_2)_3)_2B_{10}H_{10}$;
- (viii) metal ions derived from the elements in Groups 1, 2, 8, 3*b*, 4*b*, 5*b*, 6*b*, 7*b*, and the elements of Groups 3*a*, 4*a*, 5*a*, and 6*a* which have atomic numbers respectively greater than 5, 14, 33 and 52.
30. A propellant composition according to claim 20 wherein said propellant composition further comprises from 0.01-25 percent, by weight, certain simple salts having the common anion $B_{10}H_{10}^{-2}$ wherein the cation is selected from the group consisting of:
- (i) ammonium, wherein the salt has the formula $(NH_4)_2B_{10}H_{10}$;
- (ii) hydrazinium, wherein the salt has the general formula $(NH_2NH_3) B_{10}H_{10}$;
- (iii) substituted ammonium cations, wherein the salt has the general formula $(R_3NH)_2B_{10}H_{10}$, wherein further R is selected from the group consisting of hydrogen and alkyl radicals containing less than six carbon atoms;
- (iv) substituted hydrazinium cations, wherein the salt has the general formula $(R_2NNR_2H)_2B_{10}H_{10}$ wherein further R is selected from the group consisting of hydrogen and alkyl radicals containing less than six atoms;
- (v) tetramethylammonium $(CH_3)_4N^+$, tetraethylammonium $(CH_3CH_2)_4N^+$, and quaternary ammonium cations having the general formula R_4N^+ where R is an alkyl radical;
- (vi) pyridinium, bipyridinium aryl-diazonium, aryl containing cations and substituted aryl containing cations;
- (vii) guanidinium, wherein the salt has the formula $(C(NH_2)_3)_2B_{10}H_{10}$;
- (viii) metal ions derived from the elements in Groups 1, 2, 8, 3*b*, 4*b*, 5*b*, 6*b*, 7*b*, and the elements of Groups 3*a*, 4*a*, 5*a*, and 6*a* which have atomic numbers respectively greater than 5, 14, 33 and 52.
31. A propellant composition according to claim 11 wherein said polymeric composite propellant binder selected is hydroxy-terminated polybutadiene.
32. A propellant composition according to claim 12 wherein said polymeric composite propellant binder selected is hydroxy-terminated polybutadiene.
33. A propellant composition according to claim 13 wherein said polymeric composite propellant binder selected is hydroxy-terminated polybutadiene.
34. A propellant composition according to claim 14 wherein said polymeric composite propellant binder selected is hydroxy-terminated polybutadiene.
35. A propellant composition according to claim 15 wherein said polymeric composite propellant binder selected is hydroxy-terminated polybutadiene.

- 36. A propellant composition as in claim 21 wherein said binder selected is nitrocellulose.
- 37. A propellant composition as in claim 22 wherein said binder selected is nitrocellulose.
- 38. A propellant composition as in claim 23 wherein said binder selected is nitrocellulose.
- 39. A propellant composition as in claim 24 wherein said binder selected is nitrocellulose.
- 40. A propellant composition as in claim 25 wherein said binder selected is nitrocellulose.
- 41. A propellant composition as in claim 26 wherein said binder selected is nitrocellulose.
- 42. A propellant composition as in claim 27 wherein said binder selected is nitrocellulose.
- 43. A propellant composition as in claim 28 wherein said binder selected is nitrocellulose.
- 44. A propellant composition as in claim 29 wherein said binder selected is nitrocellulose.
- 45. A propellant composition as in claim 30 wherein said binder selected is nitrocellulose.
- 46. A propellant composition as in claim 40 wherein said resultant product is the coprecipitate of cesium decahydrodecaborate with potassium nitrate.
- 47. A propellant composition as in claim 46 wherein said coprecipitate is cesium decahydrodecaborate, ap-

- proximately 25 parts by weight, and potassium nitrate, approximately 75 parts by weight.
- 48. A propellant composition as in claim 35 wherein said resultant product is the coprecipitate of cesium decahydrodecaborate with potassium nitrate.
- 49. A propellant composition as in claim 48 wherein said coprecipitate is cesium decahydrodecaborate, approximately 25 parts by weight, and potassium nitrate, approximately 75 parts by weight.
- 50. A propellant composition as in claim 37 wherein said resultant product is the coprecipitate of tetramethylammonium decahydrodecaborate with potassium nitrate.
- 51. A propellant composition as in claim 50 wherein said coprecipitate is tetramethylammonium decahydrodecaborate, approximately 15 parts by weight and potassium nitrate, approximately 85 parts by weight.
- 52. A propellant composition as in claim 30 wherein said binder contains fluorine and is the copolymer of hexafluoropropylene and vinylidene fluoride, said resultant product is the coprecipitate of cesium decahydrodecaborate with potassium nitrate, and said simple salt selected is potassium decahydrodecaborate.
- 53. A propellant composition as in claim 52 wherein, by weight, said binder is approximately 25 percent, said coprecipitate is approximately 65 percent, and said simple salt is approximately 10 percent.

* * * * *

30

35

40

45

50

55

60

65

United States Patent [19]

Goddard et al.

[11] 4,139,404

[45] * Feb. 13, 1979

[54] **ACTIVE BINDER PROPELLANTS
INCORPORATING BURNING RATE
CATALYSTS**

[75] Inventors: Terrence P. Goddard, Aptos; Donald
N. Thatcher, Hollister, both of Calif.

[73] Assignee: Teledyne McCormick Selph,
Hollister, Calif.

[*] Notice: The portion of the term of this patent
subsequent to Jan. 23, 1996, has been
disclaimed.

[21] Appl. No.: 696,324

[22] Filed: Jun. 15, 1976

Related U.S. Application Data

[63] Continuation-in-part of Ser. No. 592,449, Jul. 2, 1975,
abandoned, which is a continuation-in-part of Ser. No.
585,216, Jun. 6, 1975, abandoned.

[51] Int. Cl.² C06B 45/10

[52] U.S. Cl. 149/19.2; 149/19.8;
149/22; 149/96

[58] Field of Search 149/22, 19.2, 19.8,
149/96

[56]

References Cited

U.S. PATENT DOCUMENTS

3,107,613	10/1963	Armstrong et al.	149/61 X
3,126,305	3/1964	Armstrong	149/61 X
3,148,938	9/1964	Knoth	149/22 X
3,149,163	9/1964	Knoth	149/22 X
3,256,056	6/1966	Armstrong	149/22 X
3,689,331	9/1972	Pierce	149/22 X
3,808,061	4/1974	Pierce	149/22 X
4,002,681	1/1977	Goddard	250/564 D

Primary Examiner—Edward A. Miller

Attorney, Agent, or Firm—David H. Semmes; Warren E.
Olsen

[57]

ABSTRACT

New propellant compositions characterized by the ad-
dition of certain simple salts and double salts, both me-
tallic and non-metallic, having the $B_{10}H_{10}^{-2}$ anion in
common, are taught herein to function as a class of burn
rate catalysts, and not as fuels, when combined with a
category of propellants known as nitrocellulose base
propellants. Additionally, unique forms of the simple
salts, created by coprecipitation of the simple salt with
an oxidizer, constitute a third class of burn rate enhanc-
ers herein.

17 Claims, No Drawings

**ACTIVE BINDER PROPELLANTS
INCORPORATING BURNING RATE CATALYSTS
CROSS REFERENCE TO RELATED
APPLICATIONS**

This application is a continuation-in-part of copending application METHOD FOR PREPARING A HIVELITE HIGH BURN PROPELLANT COMPOSITION, Ser. No. 592,449, filed July 2, 1975, now abandoned, which in turn is a continuation-in-part of Ser. No. 585,216, filed June 6, 1975 and entitled HIGH BURN PROPELLANT COMPOSITIONS, now abandoned.

**BACKGROUND AND SUMMARY OF THE
INVENTION**

The purpose of this invention is to describe propellants with a controllable burning rate and a process for preparing them. The propellants comprise a class of nitrocellulose base materials that incorporate a burning rate enhancer chosen from any of three classes of compounds based on decahydrodecaborate salts.

The present invention describes a class of propellants that are useful as gun or rocket propellants and in pyrotechnic devices such as gas generators. In these types of applications, a controlled amount of gas and heat must be released within a specified time period by the burning propellant. With existing propellants based on nitrocellulose, nitrocellulose/nitroglycerine, and nitrocellulose/nitroglycerine/nitroguanidine, and better known to those practiced in the art as "single base," "double base," and "triple base" propellants, respectively, the burning rate of the propellant is fixed within rather narrow limits by the formulation; a major change in propellant formula is required to significantly alter such characteristics as burning rate. As a result, to control the release of heat and gas in a device such as a rocket motor chamber, gun chamber, or other gas generating device, the propellant is configured into a sometimes complicated three dimensional geometry, known as a "grain," so that the amount of surface burning at a given time is controlled, rather than the actual regressive burning rate of the propellant matrix. In addition, the manufacturing lot-to-lot variations in characteristics such as burning rate are somewhat difficult to control for certain classes of these propellants.

This invention describes propellants in which the burning rate is easily controlled, by the addition of a burning rate catalyst into the propellant matrix. An important feature of the invention is that the burning rate catalyst can be added to numerous existing propellant formulations to derive the subject propellants, with the effect that the range of burning rates available from the manifold of tested and qualified propellants can be greatly enhanced. The method of adding the burning rate catalyst is not critical: it can be added during the manufacturing process, or alternatively, after the nitrocellulose base propellant has been completely processed, or even formed into a grain. The new propellants incorporating the burning rate catalyst into the entire bulk of the propellant to alter the burning characteristics throughout the grain, or by "seeding" the catalyst into a surface layer of an existing grain, so that the grain is effectively coated with a surface layer of the new propellant composition, thereby altering the initial burning rate of the grain.

The end product of the subject invention is a nitrocellulose base propellant that enables the grain designer a much broader range of burning rate options, which can in turn be used simply with existing grains or perform more sophisticated functions with new designs.

**DETAILED DESCRIPTION OF THE
INVENTION**

The compositions of this invention consist of propellants incorporating nitrocellulose as the primary binder, and other ingredients including plasticizers, such as nitroglycerin, monopropellants such as nitroguanidine, stabilizers such as triacetin, and other additives to alter physical or thermochemical characteristics, and most important, a burning rate catalyst chosen from one of three classes of compounds based on decahydrodecaborate salts. The compositions, less the decahydrodecaborate salts, may be any composition known to those practiced in the art, as "single base," "double base," or "triple base" propellants, which have as a common ingredient nitrocellulose as the primary binder.

The general propellant formula may be described as follows:

COMPONENT	PROBABLE RANGE, WEIGHT %
1. Binder (Nitrocellulose)	8-99.9
2. Decahydrodecaborate compound	0.01-20
3. Oxidizer or monopropellant	0-60
4. Other additives, such as energetic plasticizers, coloring agents	0-40

The three classes of decahydrodecaborate compounds are further defined as follows:

Class 1

The simple decahydrodecaborate salts used according to the first class of burn rate enhancers within the present invention are compounds of the general chemical formula:



where M is a cation or complex cation incorporating hydrogen, nitrogen, carbon, or metals, or some combination thereof, and is chosen from the list given below; x is the number of M ions; and y is equal to:

$$x \text{ times the valence of the M ion}/2$$

The compounds may further be defined as salts of decahydrodecaboric acid, and thus contain as a common ion the decahydrodecaborate (-2) anion $B_{10}H_{10}^{-2}$.

The cation M is chosen from the classes:

(a) ammonium, NH_4^+ , wherein the salt has the formula $(NH_4)_2B_{10}H_{10}$, and is described by KNOTH U.S. Pat. No. 3,148,938.

(b) hydrazinium, $NH_2NH_3^+$, wherein the salt has the formula $(NH_2NH_3)_2B_{10}H_{10}$, and is described by KNOTH U.S. Pat. No. 3,148,938,

(c) substituted ammonium cations, wherein the salt has the general formula $(R_3NH)_2B_{10}H_{10}$, where R can be hydrogen (H) or an alkyl radical (preferred radicals contain less than six (6) carbon atoms). The R's in the preceding formula may represent different alkyl groups. Compounds with two or three hydrogen radicals are described by KNOTH U.S. Pat. No. 3,149,163.

Typical cations are methylammonium $(\text{CH}_3)\text{NH}_3^+$, dimethylammonium $(\text{CH}_3)_2\text{NH}_2^+$, trimethylammonium $(\text{CH}_3)_3\text{NH}^+$, and triethylammonium $(\text{CH}_3\text{CH}_2)_3\text{NH}^+$.

(d) substituted hydrazinium cations, wherein the salt has the general formula $(\text{R}_2\text{NNR}_2\text{H})_2\text{B}_{10}\text{H}_{10}$, where R can be hydrogen (H) or an alkyl radical (preferred radicals contain less than six (6) carbon atoms), and the substituted alkyl groups can be symmetric or asymmetric with respect to the N—N linkage. Symmetric substituted cations are described by KNOTH U.S. Pat. No. 3,149,163. An example of an unsymmetric substituted cation is (1,1) dimethylhydrazinium. The R's in the preceding formula may be mixed alkyl radicals.

(e) quaternary ammonium salts of the general formula $(\text{R}_4\text{N})_2\text{B}_{10}\text{H}_{10}$, where R is an alkyl radical; the R's in the preceding formula may represent mixed alkyl groups. Examples of typical cations are tetramethylammonium $(\text{CH}_3)_4\text{N}^+$ and tetraethylammonium $(\text{CH}_3\text{CH}_2)_4\text{N}^+$.

(f) aryl containing cations, such as pyridinium, bipyridinium, or substituted aryl cations, such as aryl-diazonium cations.

(g) guanidinium ion, $\text{C}(\text{NH}_2)_3^+$, wherein the salt has the formula $(\text{C}(\text{NH}_2)_3)_2\text{B}_{10}\text{H}_{10}$, and is described in the copending application of common assignment, entitled **BIS-GUANIDINIUM DECAHYDRODECABORATE AND A PROCESS FOR ITS PREPARATION**, filed Jan. 10, 1976, and now U.S. Pat. No. 4,002,681.

(h) metal ions, derived from metals defined by a Periodic Table such as that in the "Handbook of Chemistry and Physics," 54th Edition, inside front cover, by the elements in Groups 1, 2, 8, 3b, 4b, 5b, 6b and 7b, and the elements of Groups 3a, 4a, 5a, and 6a with atomic numbers greater than 5, 14, 33, and 52 respectively. The metal decahydrodecaborate salts are further described by KNOTH U.S. Pat. No. 3,148,939. Examples of such metal salts are $\text{Cs}_2\text{B}_{10}\text{H}_{10}$ and $\text{K}_2\text{B}_{10}\text{H}_{10}$, the cesium and potassium salts of decahydrodecaboric acid, which are representative of alkaline metal decahydrodecaborate salts, having atomic numbers less than 87, preferred for the compositions described in this invention.

The salts of the decahydrodecaborate (-2) ion (Chemical formula $\text{B}_{10}\text{H}_{10}^{-2}$) are conveniently prepared by stoichiometrically reacting an aqueous solution of the parent acid, dihydrogen decahydrodecaborate, $\text{H}_2\text{B}_{10}\text{H}_{10}$, with (1) a soluble hydroxide of the desired cation, such as ammonium hydroxide, (2) the conjugate Brønsted base of the desired cation, such as a free amine, or (3) a soluble salt of the desired cation, such that the salt anion is destroyed during the reaction, such as guanidine carbonate. A Brønsted base is any substance capable of accepting a proton in a reaction; the definition is elaborated upon in any elementary chemistry text, such as Dickerson, Gray and Haight, "Chemical Principles, 2nd Edition," 1974, page 135.

The aqueous solutions of the salts, prepared above, may be evaporated to dryness to recover the crystalline salt. Alternatively, some salts may be precipitated from the aqueous solution by a nonsolvent that is miscible with water. The salts may be purified by recrystallization.

The aqueous decahydrodecaboric acid used as a starting material for the process of this invention is conveniently prepared by passing an amine or metal salt of the decahydrodecaborate (-2) ion through a column containing a strongly acidic ion exchange resin of the sulfonic acid type, such as a DUOLITE type "C-20," acid

form by the Diamond Shamrock Corporation. Preferred starting salts are bis(triethylammonium) decahydrodecaborate (-2) and disodium decahydrodecaborate (-2) . The preparation and properties of the aqueous acid, and additional preparative methods for metallic salts, are described in more detail in U.S. Pat. No. 3,148,939.

The simple non-metallic decahydrodecaborate salts themselves are capable of further utility within pyrotechnic compositions, as disclosed in another copending application entitled **IGNITION AND PYROTECHNIC COMPOSITIONS**, filed June 10, 1976, and assigned Ser. No. 694,625, also as a continuation-in-part of the above-noted parent applications.

Class (2)

Double salts of the formula $\text{M}_x(\text{B}_{10}\text{H}_{10})_y \cdot \text{N}_z\text{P}_t$, where M, x, and y are as described in (1), N is a cation or complex cation incorporating hydrogen, metals, or non-metals, or some combination thereof, z is the number of N ions, P is an oxidizing anion, composed of oxygen and a nonmetal, in some combination thereof, and t is equal to:

$$\frac{z \text{ times the valence of the N ion}}{\text{valence of the P ion}}$$

The ratio (x/z) is a ratio of small whole numbers.

The compounds may further be defined as double salts that include a cation, M_x , as defined above, the decahydrodecaborate (-2) ion $(\text{B}_{10}\text{H}_{10}^{-2})$, together with an additional oxidizing anion such as nitrate or dichromate. Preferred salts in this category include the double salt of cesium decahydrodecaborate and cesium nitrate, chemical formula $(\text{Cs}_2\text{B}_{10}\text{H}_{10})\text{CsNO}_3$, and the double salt of cesium decahydrodecaborate and cesium dichromate, chemical formula $(\text{Cs}_2\text{B}_{10}\text{H}_{10})_2\text{Cs}_2\text{Cr}_2\text{O}_7$, which salts themselves are further described in U.S. Pat. No. 3,107,613, and U.S. Pat. No. 3,265,056, respectively.

Class 3

An intimate blend of the compounds described in Class (1) above, with an oxidizing agent, in a manner that a chemically and physically different product is obtained than the starting materials.

The process by which the compositions of this class are prepared produces a very intimate blend of decahydrodecaborate (-2) ion with the oxidizer and makes the compositions so prepared chemically and physically unique from physical blends of decahydrodecaborate (-2) salts with oxidizer or pyrotechnic compositions incorporating decahydrodecaborate (-2) salts produced by other means. In general, the process consists of dissolving, in a suitable solvent, a decahydrodecaborate (-2) salt, as described above. The subject composition is recovered by precipitating the composite ingredients of the solution with a suitable nonsolvent. The resulting solid, after filtration and drying, comprises an intimate mixture of the decahydrodecaborate (-2) anion with the oxidizing cation or substance, in a form that is chemically and physically different than the starting materials.

The process may be properly called a "cocrystallization" or "coprecipitation" and the resulting produce a "cocrystallate" or "coprecipitate."

An essential component of Class (3) compounds is an oxidizing agent; i.e., a material that will readily react or

burn when mixed with the decahydrodecaborate (-2) salt. Any solid oxidizing agent which will yield oxygen upon decomposition will fulfill this role; solid oxygen containing metal or nonmetal salts are preferred because of their availability, stability, and ease of incorporation into the composition.

Solid oxidizing agents useful in this invention must meet certain criteria, as listed in the description of the coprecipitation process. In general, solid oxidizing agents include ammonium, substituted ammonium, guanidine, substituted guanidine, alkali and alkaline-earth salts of oxygen containing acids such as nitric, perchloric, permanganic, manganic, chromic, and dichromic acids. Preferred species for this invention, which gave good thermal stability and low hygroscopicity include ammonium nitrate, potassium nitrate, potassium perchlorate, ammonium perchlorate, guanidine nitrate, triaminoguanidine nitrate, potassium permanganate, sodium chromate, barium nitrate, barium chromate, barium manganate, sodium dichromate, tetramethylammonium nitrate and cesium nitrate. Other solid oxidizing agents which would be used if the appropriate solvent/nonsolvent system were used include ammonium, substituted ammonium, guanidine, substituted guanidine, alkali and alkaline-earth salts of other oxygen-containing acids such as chloric, persulfuric, thiosulfuric, periodic, iodic and bromic acids. Other stable oxides include lead thiocyanate, the oxides and peroxides of the light and heavy metals and nonmetals, such as barium peroxide, lead peroxide (PbO_2), lithium peroxide, ferric oxide, red lead (Pb_3O_4), cupric oxide, tellurium dioxide, antimonic oxide, etc., and nonionic substances such as nitrocellulose, nitroguanidine, and cyclotetramethylenetetranitramine (HMX). Mixtures of the aforementioned oxidizing agents also can be used.

These unique coprecipitated Class 3 salts, containing the $B_{10}H_{10}^{-2}$ anion, and the process for their creation, are themselves further disclosed in our copending application entitled COPRECIPITATED PYPOTECHNIC COMPOSITION PROCESSES AND RESULTANT PRODUCTS, filed June 10, 1976, assigned Ser. No. 694,626, which is incorporated herein by reference.

The compositions of this invention make use of the unique decomposition properties of the decahydrodecaborate (-2) anion, a bicapped square antiprism polyhedral ion with unusual stability; the ion is believed to be kinetically rather than thermodynamically stabilized. The ion demonstrates an unusually fast decomposition upon oxidation, which is believed to proceed through the labile apical hydrogen atoms bonded to the cage. When incorporated into a nitrocellulose base propellant, the decahydrodecaborate (-2) ion acts in such a manner as to control the overall burning rate of the propellant, so that the overall composition exhibits an accelerated, and in some cases a stabilized burning rate.

In the subject propellant compositions, a decahydrodecaborate (-2) compound, from the forementioned three classes, is used in a catalytic amount, i.e., from 0.01% to an upper limit of 20%. The effect of the incorporation of the decahydrodecaborate ion into the propellant matrix is profound; the intrinsic burning rate of a typical double base propellant can be doubled with as little as 5% by weight of the decahydrodecaborate catalyst.

The method of incorporating the decahydrodecaborate (-2) compound into the propellant is not critical, and may be accomplished by a variety of means. The advantage of this invention is that previously formu-

lated nitrocellulose base propellants can be used as one ingredient in the subject propellants. The decahydrodecaborate (-2) compound may be incorporated with the preformulated propellants during the manufacturing phase, by adding the decahydrodecaborate (-2) compound along with other ingredients to a nitrocellulose in a solvent slurry form, or alternatively by starting with a previously manufactured propellant and adding the decahydrodecaborate by softening the propellant matrix and mixing the decahydrodecaborate compound with the softened material.

The decahydrodecaborate (-2) compounds are amenable to incorporation into the subject propellants either dissolved in a suitable solvent, such as acetone or acetone/alcohol mixtures, which is also a solvent for the nitrocellulose based propellant, or alternatively, carried as an undissolved suspension in a liquid such as butyl acetate, which is a solvent or softening agent for the preformulated propellant.

Examples of acetone or acetone/ethanol soluble decahydrodecaborates are bis-ammonium decahydrodecaborate (-2) and potassium decahydrodecaborate (-2), representatives of Class (1)a and Class (1)h, respectively. Examples of decahydrodecaborates insoluble in acetone or butyl acetate are cesium decahydrodecaborate (-2), bis-tetramethylammonium decahydrodecaborate (-2), and cesium nitrate, and the coprecipitate of cesium decahydrodecaborate (-2) with potassium nitrate, which are representatives from Classes (1)h, (1)e, (2), and (3), respectively.

A convenient method of preparation of the subject propellants is to obtain the precured or preformulated propellant as a slurry or softened using a method commonly practiced for the particular material, for example with heat, by solvent swelling, or solvent dissolving. The solid or dissolved ingredients are blended with the softened or slurried binder in a suitable mixing apparatus, usually under vacuum, until the mixture is of adequate uniformity. The order of addition of ingredients and details of the blending cycle may vary with the specific formulation. After blending, the soft propellant is formed into the final configuration, commonly by casting or extruding, and allowed to harden, for example by loss of solvent or loss of heat.

EXAMPLE I

A quantity of a typical propellant consisting of 48% by weight nitroglycerine, 12.05% triacetin, 5% cellulose acetate, 2% nitrodiphenylamine, 2% lead 2-ethyl hexoate, and 0.05% candilla wax, simply and well-known in this art by the identifier "X-9 double base propellant," is obtained in a sheet form of approximate thickness $\frac{1}{4}$ inch. This X-9 double base propellant is a typical double base propellant, and results obtained with this material are representative of the magnitude of effectiveness of the compositions that are the subject of this invention.

100g of X9 propellant is softened with approximately 250 ml butyl acetate over a period of 24 to 72 hours. The softened material is charged into a Baker-Perkins sigma blade mixer at 100° F. and degased for 30 minutes at a vacuum of 28" Hg minimum. Two (2) grams of bis-ammonium decahydrodecaborate (-2) is added to the mixer, and blending at 100° F. under vacuum is continued for an additional 30 minutes. The resulting blend, after the mixing cycle, is a uniform mass with a very thick consistency.

Propellant burn rate strands are made by extruding the blend propellant to the desired dimensions, using an extruder barrel and ram mounted in an air operated press, in a well-known manner.

The strands are dried at ambient temperature and pressure, for a minimum of three days, and thereafter under a vacuum of 28" Hg minimum for a minimum of two days. During the drying period, the outside cross sectional dimensions may shrink to $\frac{1}{4}$ inch, from a $\frac{1}{2}$ inch initial dimension, due to the evaporation of butyl acetate.

The dried strands inhibited with three or four layers of ethyl cellulose by dipping in a solution of ethyl cellulose dissolved in 60% ethyl lactate and 40% butyl acetate. After coating is complete, the inhibited strands are dried for 72 hours minimum at 110° F.

A similar batch of X9 propellant is processed in an identical manner as described above, except that no bis-ammonium decahydrodecaborate (-2) is added, to serve as a control or "standard" to determine the effects of adding the decahydrodecaborate salts.

The inhibited burn rate strands are cut to a length of approximately 3 $\frac{1}{2}$ inches. A nichrome ignition wire is inserted through a 1/16 inch hole drilled $\frac{1}{2}$ inch from one end of the strand. Three lacquer-coated solder breakwires are inserted through 1/16 inch holes spaced at 1 inch intervals from the ignition wire; the breakwires are potted into place with Duco cement. The strand with attached wires is securely fastened with phenolic tiedowns to a phenolic plate, and electrical connections to the wires made. The phenolic plate is mounted in a pressure bomb; electrical connections are made through a feedthrough mounted in the bomb flange. The sealed bomb is pressurized to 1000 psi. A 28V pulse applied to the ignition wire ignites the strand. Time between successive breakwire breaks is recorded, as well as pressure rise in the bomb as a function of time. The reciprocal of the time between successive wire breaks is the burn rate in inches per second. The average of these burn rates (2 data points per strand) over the manifold of data points for all strands of a particular propellant is taken as the burn rate for that propellant. The standard deviation is computed by normal procedures, when at least 10 data points are obtained.

The burning rates so obtained are:
control: 0.145 \pm 0.024 inches per second
2% bis-ammonium decahydrodecaborate: 0.235 \pm 0.021 inches per second,
or a burning rate increase of 61%.

EXAMPLE II

Additional blends of decahydrodecaborate compounds with the typical and representative active binder "X9" propellant are made and tested in a manner identical to Example I. Decahydrodecaborate compounds representative of each of the three forementioned classes are tested. These results are shown in Table I.

TABLE I

Decahydrodecaborate Compound	Class	Wt. %	Burning Rate Inches per Second
None (control)	—	—	0.145 \pm .024
Cesium decahydrodecaborate (Cs ₂ B ₁₀ H ₁₀)	1 (h)	1	0.168 \pm .010
		2	0.185 \pm .008
		4	0.212 \pm .007
bis-ammonium decahydrodecaborate (From Example I) (NH ₄) ₂ B ₁₀ H ₁₀	1 (a)	2	0.235 \pm .021
Double salt of cesium decahydrodecaborate (-2)	2	1	0.201 \pm .021
		2	0.187 \pm .022

TABLE I-continued

Decahydrodecaborate Compound	Class	Wt. %	Burning Rate Inches per Second
and cesium nitrate		4	0.217 \pm .022
Coprecipitate of cesium decahydrodecaborate (-2) and potassium nitrate	3	2	0.234 \pm .053

The data show that the decahydrodecaborate compounds universally increase the burning rates of the propellants incorporating them over that of the control propellant. Furthermore, in the case of propellants incorporating cesium decahydrodecaborate (-2), the burning rates are stabilized, which is a highly desirable feature.

The embodiments of the specific nitrocellulose base propellant compositions disclosed herein, in which an exclusive property or privilege is claimed, are to be defined, as follows.

We claim:

1. An active binder propellant composition comprising, by weight:
 - (A) a nitrocellulose binder in the range 8-99.9 percent;
 - (B) oxidizer or monopropellant in the range 0-60 percent; and
 - (C) a burn rate catalyst, in the range 0.01-20 percent, which consists of certain decahydrodecaborate salts, having the common anion B₁₀H₁₀⁻² wherein the cation is selected from the group consisting of:
 - (i) ammonium, wherein the salt has the formula (NH₄)₂B₁₀H₁₀;
 - (ii) hydrazinium, wherein the salt has the general formula (NH₂NH₃)B₁₀H₁₀;
 - (iii) substituted ammonium cations, wherein the salt has the general formula (R₃NH₂)₂B₁₀H₁₀, wherein further R is selected from the group consisting of hydrogen and alkyl radicals containing less than six carbon atoms;
 - (iv) substituted hydrazinium cations, wherein the salt has the general formula (R₂NNR₂H)₂B₁₀H₁₀ wherein further R is selected from the group consisting of hydrogen and alkyl radicals containing less than six atoms,
 wherein said burn rate catalyst is further the resultant product of a coprecipitation of one of said group of decahydrodecaborate salts, and a solid oxidizing agent, by the process of:
 - (i) dissolving both the decahydrodecaborate (-2) salt and the solid oxidizing agent in a mutually soluble solvent, at a temperature sufficiently high to maintain said salt and said oxidizing agent in solution;
 - (ii) forming a pressurized stream of said solution and bringing said solution stream together with a pressurized stream of a miscible non-solvent under conditions of extreme turbulence within a mixing chamber, to effect a substantially complete coprecipitation;
 - (iii) recovering the coprecipitated product by filtering the effluent from said mixing chamber, and washing said product with an inert and non-solvent fluid;
 - (iv) drying the product to remove all remaining fluid.
2. An active binder propellant composition comprising, by weight:

- (A) a nitrocellulose binder in the range 8-99.9 percent;
- (B) oxidizer or monopropellant in the range 0-60 percent; and
- (C) a burn rate catalyst, in the range 0.01-20 percent, which consists of certain decahydrodecaborate salts, having the common anion $B_{10}H_{10}^{-2}$, and a cation selected from the group consisting of:
- tetramethylammonium, $(CH_3)_4N^+$, tetraethylammonium, $(CH_3CH_2)_4N^+$, and quaternary ammonium cations having the general formula R_4N^+ wherein R is an alkyl radical;
 - pyridinium, bipyridinium aryl-diazonium, aryl containing cations and substituted aryl containing cations,

wherein said burn rate catalyst is further the resultant product of a coprecipitation of one of said group of decahydrodecaborate salts, and a solid oxidizing agent, by the process of:

- dissolving both the decahydrodecaborate (-2) salt and the solid oxidizing agent in a mutually soluble solvent, at a temperature sufficiently high to maintain said salt and said oxidizing agent in solution;
- forming a pressurized stream of said solution and bringing said solution stream together with a pressurized stream of a miscible nonsolvent, under conditions of extreme turbulence within a mixing chamber, to effect a substantially complete coprecipitation;
- recovering the coprecipitated product by filtering the effluent from said mixing chamber, and washing said product with an inert and non-solvent fluid;
- drying the product to remove all remaining liquid.

3. An active propellant composition comprising, by weight:

- a nitrocellulose binder in the range 8-99.9 percent;
- oxidizer or monopropellant in the range 0-60 percent; and
- a burn rate catalyst, in the range 0.01-20 percent, which consists of a decahydrodecaborate salt, having the anion $B_{10}H_{10}^{-2}$, wherein the cation is guanidinium, and the salt has the formula $(C(NH_2)_3)_2B_{10}H_{10}$.

wherein said burn rate catalyst is further the resultant product of a coprecipitation of bis guanidinium decahydrodecaborate, and a solid oxidizing agent, by the process of:

- dissolving both the decahydrodecaborate (-2) salt and the solid oxidizing agent in a mutually soluble solvent, at a temperature sufficiently high to maintain said salt and said oxidizing agent in solution;
- forming a pressurized stream of said solution and bringing said solution stream together with a pressurized stream of a miscible nonsolvent, under conditions of extreme turbulence within a mixing chamber, to effect a substantially complete coprecipitation;
- recovering the coprecipitated product by filtering the effluent from said mixing chamber, and washing said product with an inert and non-solvent fluid;
- drying the product to remove all remaining liquid.

4. An active binder propellant composition comprising, by weight:

- a nitrocellulose binder in the range 8-99.9 percent;
- oxidizer or monopropellant in the range 0-60 percent; and
- a burn rate catalyst, in the range 0.01-20 percent, which consists of a metallic decahydrodecaborate salt, having the common anion $B_{10}H_{10}^{-2}$, wherein the cation is selected from the group consisting of:
 - metal ions derived from the elements in Groups 1, 2, 8, 3b, 4b, 5b, 6b, 7b, and the elements of Groups 3a, 4a, 5a, and 6a which have atomic numbers respectively greater than 5, 14, 33 and 52,

wherein said burn rate catalyst is further the resultant product of a coprecipitation of one of said group of decahydrodecaborate salts, and a solid oxidizing agent, by the process of:

- dissolving both the decahydrodecaborate (-2) salt and the solid oxidizing agent in a mutually soluble solvent, at a temperature sufficiently high to maintain said salt and said oxidizing agent in solution;
- forming a pressurized stream of said solution and bringing said solution stream together with a pressurized stream of a miscible nonsolvent, under conditions of extreme turbulence within a mixing chamber, to effect a substantially complete coprecipitation;
- recovering the coprecipitated product by filtering the effluent from said mixing chamber, and washing said product with an inert and non-solvent fluid;
- drying the product to remove all remaining liquid.

5. An active binder propellant composition according to claim 1 wherein said nitrocellulose base binder is selected from the group consisting of nitrocellulose, nitrocellulose/nitroglycerine, and nitrocellulose/nitroglycerine/nitroguanidine.

6. An active binder propellant composition according to claim 2 wherein said nitrocellulose base binder is selected from the group consisting of nitrocellulose, nitrocellulose/nitroglycerine, and nitrocellulose/nitroglycerine/nitroguanidine.

7. An active binder propellant composition according to claim 3 wherein said nitrocellulose base binder is selected from the group consisting of nitrocellulose, nitrocellulose/nitroglycerine, and nitrocellulose/nitroglycerine/nitroguanidine.

8. An active binder propellant composition according to claim 4 wherein said nitrocellulose base binder is selected from the group consisting of nitrocellulose, nitrocellulose/nitroglycerine, and nitrocellulose/nitroglycerine/nitroguanidine.

9. A nitrocellulose base propellant composition according to claim 5 wherein said oxidizing agent is selected from the group consisting of ammonium nitrate, potassium nitrate, potassium perchlorate, ammonium perchlorate, guanidine nitrate, triaminoguanidine nitrate, potassium permanganate, sodium chromate, barium nitrate, barium chromate, barium manganate, sodium dichromate, tetramethylammonium nitrate and cesium nitrate.

10. A nitrocellulose base propellant composition according to claim 6 wherein said oxidizing agent is se-

11

12

lected from the group consisting of ammonium nitrate, potassium nitrate, potassium perchlorate, ammonium perchlorate, guanidine nitrate, triaminoguanidine nitrate, potassium permanganate, sodium chromate, barium nitrate, barium chromate, barium manganate, sodium dichromate, tetramethylammonium nitrate and cesium nitrate

11. A nitrocellulose base propellant composition according to claim 7 wherein said oxidizing agent is selected from the group consisting of ammonium nitrate, potassium nitrate, potassium perchlorate, ammonium perchlorate, guanidine nitrate, triaminoguanidine nitrate, potassium permanganate, sodium chromate, barium nitrate, barium chromate, barium manganate, sodium dichromate, tetramethylammonium nitrate and cesium nitrate.

12. A nitrocellulose base propellant composition according to claim 8 wherein said oxidizing agent is selected from the group consisting of ammonium nitrate, potassium nitrate, potassium perchlorate, ammonium perchlorate, guanidine nitrate, triaminoguanidine nitrate, potassium permanganate, sodium chromate, barium nitrate, barium chromate, barium manganate, so-

dium dichromate, tetramethylammonium nitrate and cesium nitrate.

13. An active binder propellant composition according to claim 12 wherein the metallic salt selected is cesium decahydrodecaborate, said solid oxidizing agent is potassium nitrate, said solvent is water, and said non-solvent stream is acetone.

14. An active binder propellant composition according to claim 13 wherein said propellant binder selected is of the double base type, comprising nitrocellulose/nitroglycerine.

15. An active binder propellant composition according to claim 14 wherein said double base propellant further comprises approximately, by weight, 48% nitroglycerine, 12.05% triactin, 5% cellulose acetate, 2% nitrodiphenylamine, 2% lead 2-ethyl hexoate and 0.05% candilla wax.

16. An active binder propellant composition according to claim 14 wherein said burn rate catalyst is in the range 0.01-10 percent.

17. An active binder propellant composition according to claim 15 wherein said burn rate catalyst is present in the range 0.01-10 percent.

* * * * *

25

30

35

40

45

50

55

60

65

United States Patent [19]

Goddard

[11] 4,164,513

[45] Aug. 14, 1979

[54] AMINO-SUBSTITUTED GUANIDINE SALTS
OF DECAHYDRODECABORIC ACID

[75] Inventor: Terrence P. Goddard, Aptos, Calif.

[73] Assignee: Teledyne McCormick Selph, an
operating div. of Teledyne Ind., Inc.,
Hollister, Calif.

[21] Appl. No.: 853,918

[22] Filed: Nov. 22, 1977

[51] Int. Cl.¹ C07C 123/00

[52] U.S. Cl. 260/564 D; 149/22

[58] Field of Search 260/564 D; 149/109.4,
149/22

[56]

References Cited

U.S. PATENT DOCUMENTS

4,002,681 1/1977 Goddard 149/22 X
4,094,712 6/1978 Goddard et al. 149/22 X

Primary Examiner—Stephen J. Lechert, Jr.
Attorney, Agent, or Firm—David H. Semmes; Warren E. Olsen

[57]

ABSTRACT

This invention relates to amino-substituted guanidine decahydrodecaborates, which are shown to be novel boron-containing salts that have particular utility as high energy monopropellants. The invention includes the diamino-guanidinium and monoaminoguanidinium salts of decahydrodecaboric acid, and as preferred products of processes for preparing same.

4 Claims, No Drawings

AMINO-SUBSTITUTED GUANIDINE SALTS OF DECAHYDRODECABORIC ACID

CROSS-REFERENCE TO RELATED APPLICATIONS

This is a related application to my copending application of common assignment entitled BIS-TRIAMINOGUANIDINE DECAHYDRODECABORATE AND A PROCESS FOR ITS PREPARATION, filed Jan. 24, 1977 and assigned Ser. No. 762,229.

BACKGROUND AND BRIEF DESCRIPTION OF THE INVENTION

Boron hydride salts, in particular the non-metal salts of decahydrodecaboric acid, had been discovered to have particular utility in the field of high energy fuels. They may be used as constituents of pyrotechnic compositions and in propellants. For example, non-metallic salts of the decahydrodecaborate ion, and exemplary uses, are disclosed in the copending applications of common assignment entitled IGNITION AND PYROTECHNIC COMPOSITIONS, Ser. No. 694,625, filed June 10, 1976, and COPRECIPITATED PYROTECHNIC COMPOSITION PROCESSES AND RESULTANT PRODUCTS, Ser. No. 694,626, filed June 10, 1976.

The present invention teaches new non-metal salts of decahydrodecaboric acid, which exhibits stable physical properties, and are themselves high energy monopropellants. The compounds are very unusual in that they contain only boron, nitrogen, carbon and hydrogen,

No. 4,002,681. This simple salt was found to be useful as a high energy pyrotechnic fuel, and was by itself thermochemically stable; i.e., it has a substantial negative heat of formation as commonly defined by those practiced in the art. The fully amino-substituted compound is disclosed in my copending application of common assignment entitled BIS-TRIAMINOGUANIDINIUM DECAHYDRODECABORATE AND A PROCESS FOR ITS PREPARATION, Ser. No. 762,229, filed Jan. 24, 1977. In contrast to the simple guanidine salt, the triaminoguanidine salt is a powerful monopropellant; i.e., combusts by itself releasing internal energy, without need of additional oxidizer materials.

The subject of the present invention is the mono- and diamino substituted guanidine salts, which like the triaminoguanidine salts, have been discovered to be monopropellants. As a result, the compounds taught herein are useful as monopropellants in their own right, or alternatively, can be used with additional oxidizer to modify combustion properties. Specifically, such inorganic oxidizing agents as potassium nitrate, guanidine nitrate, triaminoguanidine nitrate and ammonium perchlorate may advantageously be employed, in concentrations from 0-90%, by weight.

DETAILED DESCRIPTION OF THE INVENTION

The aminoguanidine^(A) and diaminoguanidine^(B) salts of the decahydrodecaborate (-2) ion are represented by the chemical formulae $(\text{CNHNH}_2(\text{NH}_2)_2)_2\text{B}_{10}\text{H}_{10}$ and $(\text{C}(\text{NH}_2)_2\text{NH})_2\text{B}_{10}\text{H}_{10}$ respectively, or more accurately by the structural formulae:

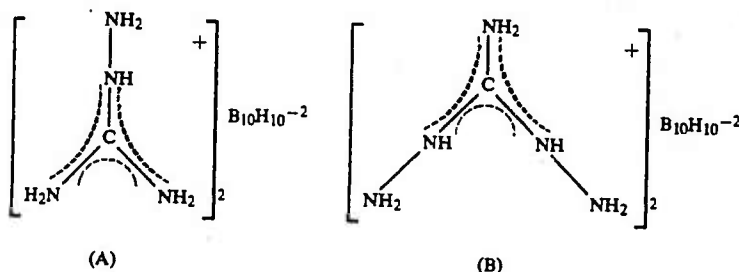

but no oxygen.

A particular objective in preparing compounds suitable for certain types of pyrotechnic usage is to achieve a high gas output and low molecular weight combustion products, when the compound is burned. Combustion products such as hydrogen (H₂) and nitrogen (N₂) gas fulfill this requirement. In preparing salts useful as pyrotechnic fuels from an anion such as decahydrodecaborate (-2) (B₁₀H₁₀⁻²), it has been found advantageous to use a cation containing a high weight fraction of atomic nitrogen and hydrogen. Cations of the general formula C(NHR)₃ where R may be hydrogen (H) or an amino radical (-NH₂) are found to be such cations. In addition, the corresponding Bronsted bases of the free ions are strong bases, thus imparting to the cations and therefore the salts a high degree of chemical stability.

Other decahydrodecaborate (-2) salts employing guanidine chemistry have been previously investigated by the present inventor. The simple guanidine salt is disclosed in my earlier application BIS-GUANIDINIUM DECAHYDRODECABORATE AND A PROCESS OF ITS PREPARATION, Ser. No. 694,627, filed June 10, 1976, which is now U.S. Pat.

which illustrate the resonance stabilization achieved by protonating the free bases to form the unipositive ions.

Both of the salts may be conveniently prepared by neutralizing one mole of aqueous decahydrodecaboric acid H₂B₁₀H₁₀, with two moles of the free base corresponding to the desired cation, or with a salt, such as a carbonate, of the cation, which is degraded during the neutralization.

The aqueous decahydrodecaboric acid used as a starting material for the process of this invention is conveniently prepared by passing an amine or metal salt of the decahydrodecaborate (-2) ion through a column containing a strongly acidic ion exchange resin of the sulfonic acid type, such as a DUOLITE type C-20, manufactured by the Diamond Shamrock Corporation. Preferred starting salts are bis (triethylammonium) decahydrodecaborate (-2) and disodium decahydrodecaborate (-2). The preparation and properties of the aqueous acid itself are known, and reference may be made to Knoth, U.S. Pat. No. 3,148,939, for further detail.

The free base of the desired cation may be prepared by passing a chloride, nitrate, or other water soluble salt of the cation through a column containing a strongly basic ion exchange resin of the polystyrene type, such as DOWEX® 2-X8.

The neutralization reaction yields the constituent ions in aqueous solution. The salt may be recovered by a variety of standard methods, for example by evaporating the solution to near saturation and chilling, or by precipitating the salt from solution with a nonsolvent.

The subjects of this invention are useful as high energy monopropellants in such devices as electric initiators or squibs, or as ingredients to enhance burning rates. The compounds may be mixed with additional materials with oxidative power to modify the combustion properties, for use in such devices as pyrotechnic deflagrating cords.

Specific reference should be had to the above-noted copending application entitled IGNITION AND PYROTECHNIC COMPOSITIONS, Ser. No. 694,625, incorporated herein by reference, for examples of suitable and preferred species of oxidizing agents which are useful for creating a pyrotechnic mixture with the particular boron-containing salt taught herein. While the $B_{10}H_{10}^{-2}$ anion, a bicapped square antiprism polyhedral ion, has unusual stability, it is significant that the present compounds achieve a resonance stabilization by protonating a free substituted guanidine base to form the unipositive ion comprising the cation. Of greater, and perhaps related, significance is the unexpected result that the simple salt bis-guanidinium decahydrodecaborate, had a substantial negative heat of formation, making the simple salt useful as a high energy pyrotechnic fuel, while the present invention exhibits compounds having substantial internal energy. Hence, the compounds taught herein are useful alone, as monopropellants, or optionally are capable of use as components in a pyrotechnic material, through mixture with an oxidizing agent, to take further advantage of the unique decomposition properties of the decahydrodecaborate (-2) anion.

The unique products of this invention, mono and di-amino substituted guanidinium decahydrodecaborates, are further illustrated by reference to the following examples:

EXAMPLE I

Bis-Aminoguanidinium Decahydrodecaborate (-2)

Preparation

One hundred fifty (150) milliliters of aqueous decahydrodecaboric acid, approximately 0.25 M, is neutralized directly to pH 7 with solid aminoguanidine bicarbonate. Vigorous evolution of carbon dioxide is apparent. The resulting solution is slowly poured into 8 parts-by-volume isopropanol, with vigorous stirring. A white, fluffy solid precipitates immediately. The precipitate is filtered and washed with butyl acetate. The salt is oven dried at 60° C., at the end of which it is a pink color. Overall yield of the reaction is 90%.

Analysis

The $B_{10}H_{10}^{-2}$ in a small sample of the compound is oxidized at 80° C. with platinum black in aqueous solution to boric acid. The boric acid content of the degraded product is determined by titration against so-

dium hydroxide in mannitol solution. Boron content found: 38.9%. Theoretical content: 40.3%.

The infrared spectrum is obtained in a KBr pellet incorporating the compound. The spectrum between 4000 and 800 cm^{-1} is compared with spectra of aminoguanidinium nitrate dihydrate and metallic salts of decahydrodecaboric acid. The characteristic peaks from the aminoguanidinium ion are found at 3400, 1700, 1200 and 900 cm^{-1} ; the characteristic decahydrodecaborate (-2) ion peaks are found at 2470, 1080 and 1030 cm^{-1} .

An analysis of solution conductivity vs. solution concentration gives a conductivity of 262 $ohm^{-1} cm^2 mole^{-1}$ at infinite dilution, which is characteristic of a compound containing three ions, one species being an organic cation. The above analyses demonstrate that the recovered product is the desired subject of the invention.

EXAMPLE II

Bis N,N'Diaminoguanidinium Decahydrodecaborate (-2)

Preparation

One hundred forty (140) milliliters of aqueous decahydrodecaboric acid, approximately 0.25 M, is neutralized directly to pH 7 with N,N'diaminoguanidine free base. The aqueous free base is obtained by passing a 0.8 M solution of N,N'diaminoguanidine hydrochloride through a column containing DOWEX® 2-X8 strongly basic ion exchange resin. The resulting solution is slowly poured into 8 parts-by-volume isopropanol, with vigorous stirring. A white precipitate forms immediately. The precipitate is filtered and washed with butyl acetate, and oven dried at 60° C. A white, fluffy powder is recovered, yield approximately 80%.

Analysis

The $B_{10}H_{10}^{-2}$ in a small sample of the compound is oxidized at 80° C. with platinum black in aqueous solution to boric acid. The boric acid content of the degraded product is determined by titration against sodium hydroxide in mannitol solution. Boron content found: 36.2%. Theoretical content: 35.9%.

The infrared spectrum is obtained in a KBr pellet incorporating the compound. The spectrum between 4000 and 800 cm^{-1} is virtually a superposition of spectra of N,N'diaminoguanidine hydrochloride and metallic salts of decahydrodecaboric acid with some minor shifting due to lattice efforts. The characteristic peaks from the triaminoguanidinium ion are found at 3300, 1700, 1390, 1200, 1000, and 960 cm^{-1} ; the characteristic decahydrodecaborate (-2) ion peaks are found at 2470, 1080 and 1030 cm^{-1} .

An analysis of solution conductivity vs. solution concentration gives a conductivity of 280 $ohm^{-1} cm^2 mole^{-1}$ at infinite dilution, which is characteristic of a compound containing three ions, one species being an organic cation. The above analyses demonstrate that the recovered product is the desired subject of the invention.

EXAMPLE III

Pyrotechnic Characteristics

The pyrotechnic utility of the subject compositions is demonstrated by subjecting the materials to several standard tests used to characterize explosives and pyrotechnics. Results are summarized in Table I.

MATERIAL	"NO FIRE" IMPACT (cm)	HEAT OF EXPLOSION (cal/g)	AUTOIGNITION (°C.)
guanidinium decahydrodecaborate	16	1228	292
N,N'-diaminoguanidinium decahydrodecaborate	1	1556	273

TABLE I
PYROTECHNIC CHARACTERISTICS

A sample of the compound, is subjected to an impact drop test, consisting of placing a 5 milligram sample of the powder on a 400 grit paper disc, and releasing a 2 kilogram weight from a calibrated height. An anvil on the weight strikes the powder sample. The release height at which the sample fails to ignite 10 times in succession is recorded as the impact sensitivity "no fire."

The heat of explosion of the compound is measured by igniting a sample of the compound in a closed calorimeter bomb under argon, and measuring the temperature rise in a water bath surrounding the bomb. The results are customarily reported in calories of heat liberated per gram of explosive.

The autoignition temperature of the compound is measured by recording the temperature at which the compound will not spontaneously ignite within 5 seconds when placed in contact with a hot reservoir.

The data in Table I show that the aminoguanidine decahydrodecaborate salt is a relatively sensitive pyrotechnic composition with good heat output; it is useful as a transfer material in pyrotechnic trains or as a burning rate modified in propellants. The N,N'-diaminoguanidinium decahydrodecaborate salt is very sensitive, with caloric output over four times that of a conventional initiating explosive such as lead azide. It is useful as a new type of initiating (priming) explosive, and as well, could be used as a propellant burning rate modifier when suitably combined with oxidizer. Both compounds are stable in excess of 200° C. as evidenced by differential scanning calorimeter studies, which is of substantial benefit to high temperature explosive applications.

Obvious modifications and equivalents within the present invention will appear to those of ordinary skill

in the art, and the present invention is to be defined solely by the scope of the appended claims.

I claim:

1. The monoaminoguanidinium salt of decahydrodecaboric acid, having the formula $(\text{CNHNH}_2(\text{NH}_2)_2)_2\text{B}_{10}\text{H}_{10}$.

2. The monoaminoguanidine salt of the decahydrodecaborate (-2) ion as represented by the structural formula:

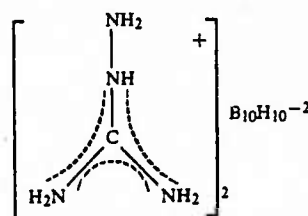

wherein resonance stabilization is achieved by protonating a free guanidine base to form the unipositive ion.

3. The diaminoguanidine salt of decahydrodecaboric acid, having the formula $(\text{C}(\text{NHNH}_2)_2(\text{NH}_2)_2)_2\text{B}_{10}\text{H}_{10}$.

4. The diaminoguanidine salt of the decahydrodecaborate (-2) ion as represented by the structural formula:

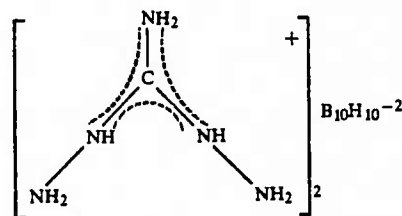

wherein resonance stabilization is achieved by protonating a free substituted guanidine base to form the unipositive ion.

* * * * *

55

60

65

[54] COMPOSITIONS OF
BIS-TRIAMINOGUANIDINE
DECAHYDRODECABORATE AND TAGN

[75] Inventor: Terrence P. Goddard, Aptos, Calif.

[73] Assignee: Teledyne McCormick Selph, an
operating Division of Teledyne
Industries, Inc., Hollister, Calif.

[*] Notice: The portion of the term of this patent
subsequent to Dec. 19, 1995, has been
disclaimed.

[21] Appl. No.: 882,829

[22] Filed: Mar. 2, 1978

Related U.S. Application Data

[60] Division of Ser. No. 853,917, Nov. 22, 1977, Pat. No.
4,108,697, which is a continuation-in-part of Ser. No.
762,229, Jan. 24, 1977, Pat. No. 4,130,585.

[51] Int. Cl.² C06B 43/00

[52] U.S. Cl. 149/22; 149/92

[58] Field of Search 149/22, 36, 92

[56] References Cited

U.S. PATENT DOCUMENTS

3,126,305	3/1964	Armstrong	149/22
3,668,873	6/1972	Bauman	149/22
4,002,681	1/1977	Goddard	149/18
4,080,902	3/1978	Goddard et al.	149/22
4,108,697	8/1978	Goddard	149/22
4,130,585	12/1978	Goddard	149/22

Primary Examiner—Edward A. Miller

Attorney, Agent, or Firm—David H. Semmes; Warren E. Olsen

[57] ABSTRACT

This invention describes pyrotechnic compositions made by suitably combining, preferably by coprecipitation, triaminoguanidine nitrate with bis-triaminoguanidinium decahydrodecaborate. Propellants comprising these compounds are also included.

8 Claims, 2 Drawing Figures

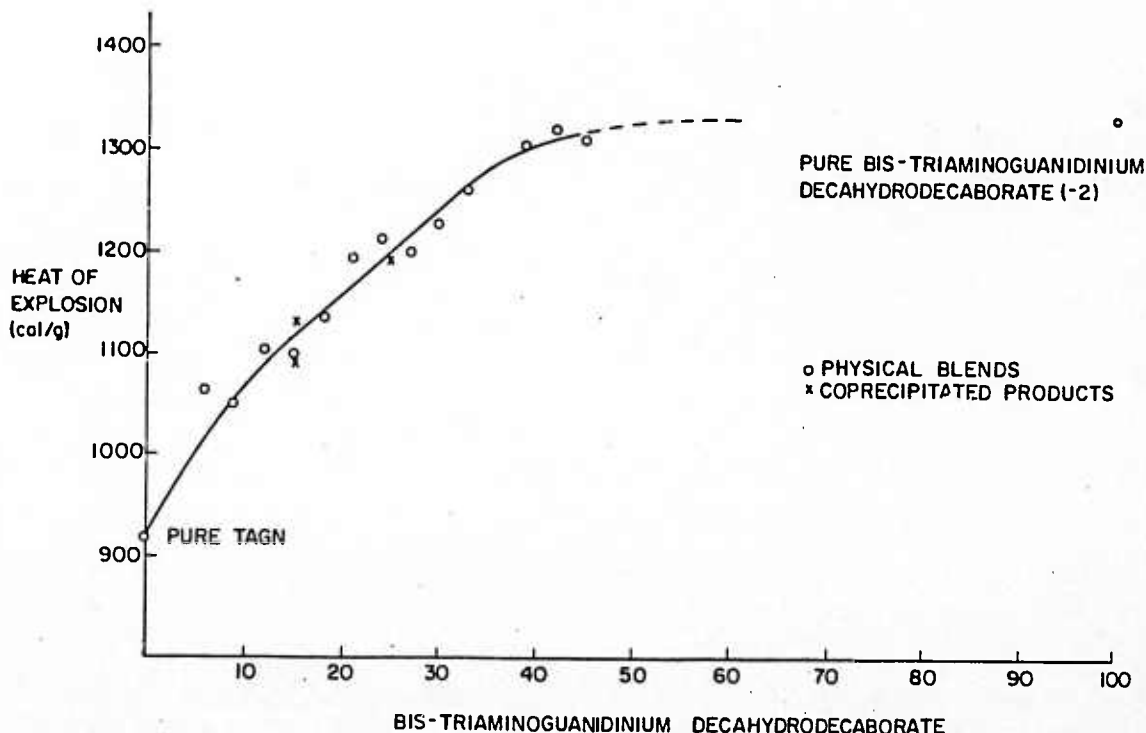

FIG. 1

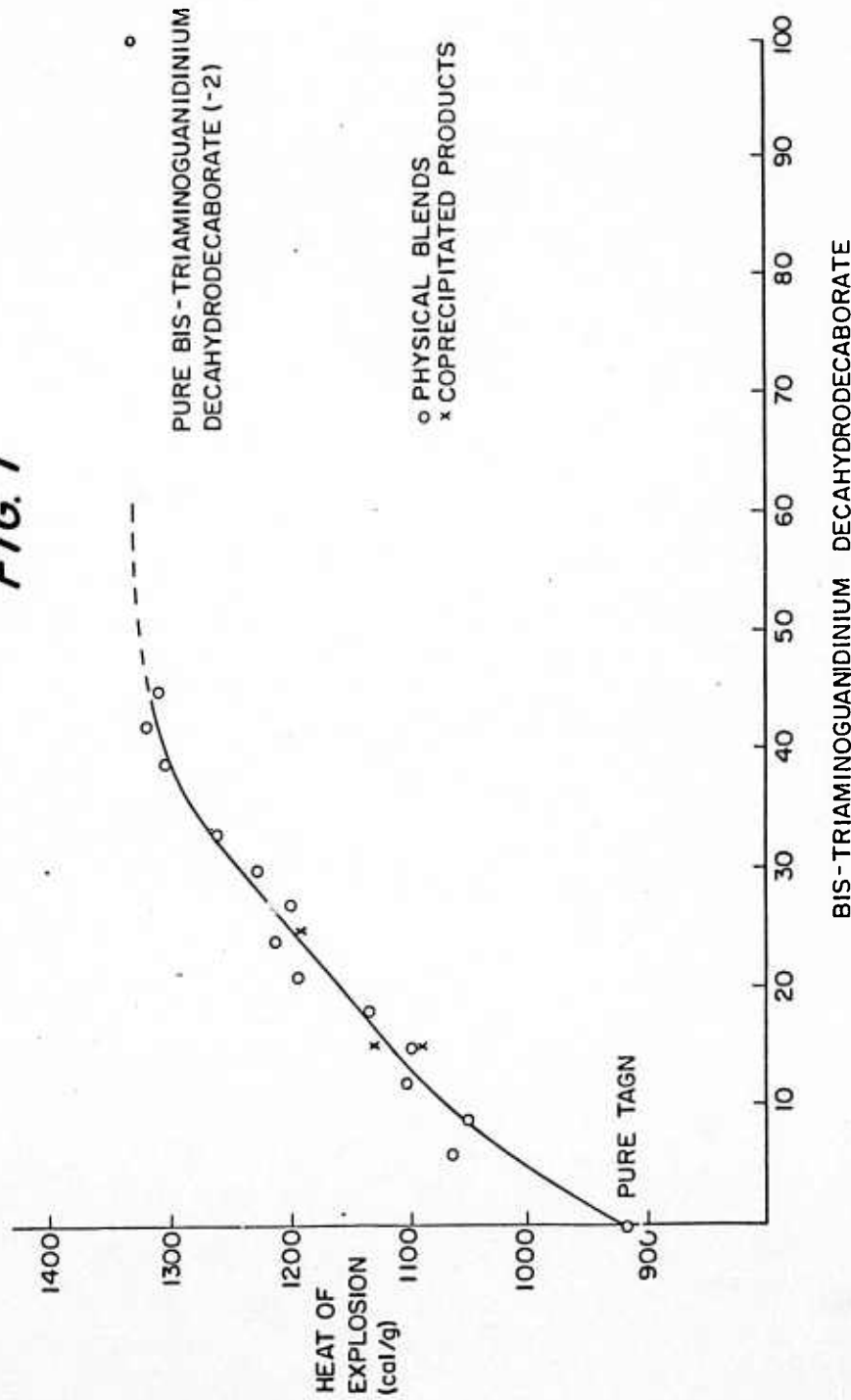
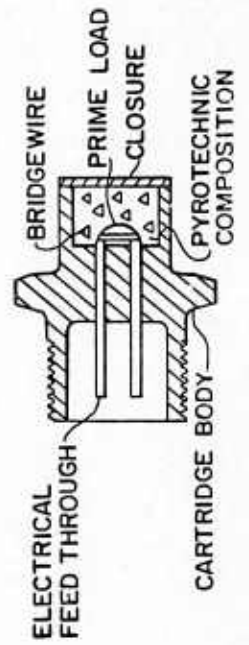

FIG. 2



COMPOSITIONS OF BIS-TRIAMINO GUANIDINE
DECAHYDRODECABORATE AND TAGN

CROSS-REFERENCE TO RELATED
APPLICATIONS:

This application is a division of my application entitled NOVEL TRIAMINO GUANIDINE NITRATE PROPELLANTS AND IGNITION COMPOUNDS, Ser. No. 853,917, filed Nov. 22, 1977, now U.S. Pat. No. 4,103,697, which in turn is a continuation-in-part of my earlier copending application of common assignment entitled BIS-TRIAMINO GUANIDINE DECAHYDRODECABORATE AND A PROCESS FOR ITS PREPARATION, filed January 24, 1977, Ser. No. 762,229, and now U.S. Pat. No. 4,130,585.

BACKGROUND AND BRIEF DESCRIPTION OF
THE INVENTION

The present invention describes a family of new and unique pyrotechnic compositions, propellants based on them, and a method of preparing same. The basic compositions consist of mixtures or coprecipitates of bis-triaminoguanidinium decahydrodecaborate and triaminoguanidine nitrate, in any proportions.

A particular objective in preparing compounds suitable for certain types of pyrotechnic usage is to achieve a high gas output and low molecular weight combustion products, when the compound is burned. Combustion products such as hydrogen (H₂) and nitrogen (N₂) gas fulfill this requirement. In preparing salts useful as pyrotechnic monopropellants and oxidizers from an anion such as decahydrodecaborate (-2) (B₁₀H₁₀⁻²) or nitrate (NO₃⁻), it has been found advantageous to use a cation containing a high weight fraction of atomic nitrogen and hydrogen. The triaminoguanidinium ion, chemical formula C (NHNH₂)₃⁺¹, has been found to be such a cation. In addition, the corresponding Brønsted base of the ion, free triaminoguanidine, is a strong base, which imparts to the cation, and thus the salt, a high degree of chemical stability.

Triaminoguanidine nitrate, (NHNH₂)₃CNO₃, also known to those practiced in the art as TAGN, has been found to have particular usefulness as an oxidizer in certain classes of propellants. It is by itself a slow, cool burning monopropellant with high gas output. One of the most serious drawbacks with the use of TAGN is the control of burning rate of the neat material, as well as propellants containing it.

This invention describes compositions employing TAGN as a starting material that have pyrotechnic performance superior to pure TAGN, in terms of energy and gas output and burning rate control. In particular, very fast burning, high energy propellants can be manufactured from them. The subject compositions consist of very intimate blends or coprecipitates of an ultrafast deflagrating monopropellant, namely the triaminoguanidinium salt of decahydrodecaboric acid, with TAGN. The resulting compositions, which can be prepared over a wide range of the constituent anion content, have pyrotechnic properties wholly unlike the starting salts.

Historically, boron hydride salts, in particular the nonmetal salts of decahydrodecaboric acid, has been discovered to have particular utility in the field of high energy fuels. They may be used as constituents of pyrotechnic compositions and in propellants. For example, non-metallic salts of the decahydrodecaborate ion, and

exemplary uses, are disclosed in the copending application of common assignment entitled IGNITION AND PYROTECHNIC COMPOSITIONS, Ser. No. 694,625, filed June 10, 1976, now abandoned. For these compositions, in general, the ratio of decahydrodecaborate fuel to oxidizer was fixed within certain defined limits in order to achieve acceptable pyrotechnic performance.

The particular decahydrodecaborate salt used in this invention is the fully amino-substituted compound, which is disclosed in my copending patent application of common assignment entitled BIS-TRIAMINO GUANIDINIUM DECAHYDRODECABORATE AND A PROCESS FOR ITS PREPARATION, U.S. Pat. No. 4,130,585, incorporated herein by reference. In contrast to other simple decahydrodecaborate salts, the triaminoguanidine salt is a powerful monopropellant; i.e., combusts by itself releasing internal energy, without need of additional oxidizer materials. The compound is very unusual in that it contains only boron, nitrogen, carbon and hydrogen, but no oxygen.

The advantage of the chemical system formed by combining the two monopropellants is that they can be mixed in any proportion and, as well, both possess the triaminoguanidine ion as a common cation.

The preferred method of preparing a compound with a given stoichiometry consists of dissolving the two starting salts in water and rapidly precipitating the constituent ions simultaneously with a nonsolvent such as isopropanol. The detailed methodology for this process, known as "coprecipitation", has been disclosed in my copending application entitled COPRECIPITATED PYROTECHNIC COMPOSITION PROCESSES AND RESULTANT PRODUCTS, Ser. No. 694,626, filed June 10, 1976 now U.S. Pat. No. 4,135,956. This process for preparing the subject compositions makes use of the triaminoguanidinium cation which is common to both starting salts, and coprecipitates of the two salts result in very intimate mixing of the B₁₀H₁₀⁻² and NO₃⁻ anions which helps impart to the resulting compositions very reproducible pyrotechnic performance.

BRIEF DESCRIPTION OF THE DRAWINGS

FIG. 1 is a graph showing the heat of explosion of the subject composition as a function of the decahydrodecaborate salt content.

FIG. 2 illustrates a conventional pressure cartridge for testing the material, as according to Example V.

DETAILED DESCRIPTION OF THE
INVENTION:

General Information

The compositions of this invention are described by the general chemical formula

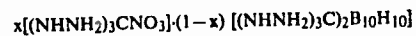

where x can vary between 0.01 and 0.99. Preferred compositions have $0.5 < x < 0.99$.

The subject compositions are prepared by blending or combining the starting salts:

- (a) bis-triaminoguanidinium decahydrodecaborate (-2), [(NHNH₂)₃C]₂B₁₀H₁₀, and
- (b) triaminoguanidine nitrate (TAGN), (NHNH₂)₃CNO₃

in such a manner as to achieve very intimate mixing. A coprecipitation process, as will be described below, is a preferred method of preparing the compositions.

TAGN

The triaminoguanidine nitrate, which is classified for shipping purposes as "Explosive, Class A", can be obtained from several commercial sources, but may be conveniently prepared in the laboratory according to the reaction:

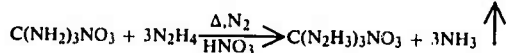

In this method, 1 part-by-weight guanidine nitrate $[(\text{NH}_2)_3\text{CNO}_3]$, 2.3 parts-by-weight hydrazine hydrate $(\text{N}_2\text{H}_4 \cdot \text{H}_2\text{O})$, 2.4 parts-by-weight water, and 0.5 parts-by-weight nitric acid $(\text{HNO}_3, 90\%)$ are combined in a suitable vessel and heated to $80^\circ\text{--}85^\circ\text{C}$. Heating is maintained for two hours, with dry nitrogen (N_2) bubbled through the mixture. The solution is cooled and allowed to stand for 8 hours, after which period the triaminoguanidine nitrate is recovered as a white precipitate. The product may be purified by recrystallization.

Bis-triaminoguanidinium Decahydrodecaborate

The bis-triaminoguanidine decahydrodecaborate salt may be prepared by neutralizing one mole of aqueous decahydrodecaboric acid, $\text{H}_2\text{B}_{10}\text{H}_{10}$, (or as the hydronium form, $(\text{H}_3\text{O}^+)_2\text{B}_{10}\text{H}_{10}^{-2}$), with two moles of the aqueous free base $[\text{C}(\text{NHNH}_2)_2(\text{NNH}_2)]$.

The aqueous decahydrodecaboric acid used as a starting material for the process of this invention is conveniently prepared by passing an amine or metal salt of the decahydrodecaborate (-2) ion through a column containing a strongly acidic ion exchange resin of the sulfonic acid type, such as a DUOLITE type C-20, manufactured by the Diamond Shamrock Corporation. Preferred starting salts are bis (triethylammonium) decahydrodecaborate (-2) and disodium decahydrodecaborate (-2) . The preparation and properties of the aqueous acid itself are known, and reference may be made to KNOTH, U.S. Pat. No. 3,148,939, for further detail.

The free base of triaminoguanidine may be prepared by passing a chloride, nitrate, or other water soluble salt of triaminoguanidine through a column containing a strongly basic ion exchange resin of the polystyrene type, such as DOWEX^R2-X8, manufactured by the Dow Chemical Company of Midland, Michigan.

The neutralization preparation where the concentrations of the reacting aqueous solutions are approximately 0.3 molar, results in an immediate precipitation of the desired product. Upon filtering, washing with cold water, purification by recrystallization or reprecipitation in isopropanol, and washing with butyl acetate (to aid in drying) a brilliant white powder with a prilled appearance is recovered, which can be demonstrated to be the subject compound of a purity exceeding 97%.

Other preparative methods employing simple metathesis are obvious. For example, the product could be recovered by mixing aqueous solutions of salts containing the substituent ions, such as aqueous triethylammonium decahydrodecaborate and aqueous triaminoguanidine hydrochloride, such that the desired

product precipitates and the undesired ions remain in solution.

The detailed preparation and properties of the bis triaminoguanidine decahydrodecaborate salt, which is by itself useful as a pyrotechnic monopropellant, are given in my copending patent application, U.S. Pat. No. 4,130,585, as referenced above.

Preparation of Subject Compositions via Physical Blending

The compositions of this invention may be prepared by intimately mixing the finely divided constituents by hand or in conventional mixing equipment. A liquid carrier such as butyl acetate or trichloroethylene may be employed to facilitate mixing or addition of binder; the liquid is subsequently evaporated to yield the dry composition. The physical blending process, in general, and as applicable to other decahydrodecaborate salts and oxidizers, is described further in the copending application of common assignment, Ser. No. 694,625, as referenced above.

General Description of the Coprecipitation Process

In general, the physical blends of oxidizer with the decahydrodecaboric acid salts, as described in the copending application, Ser. No. 694,625, noted above, suffer from several deficiencies inherent in the physical blend properties and processing technique. When used as a confined column delay, in a lead sheath, for example, the burn rates may be unreproducible, and the column fails to propagate below a certain critical distribution of the mixture in the tube. The stoichiometry of a physical blend is always subject to point-to-point variations due to blending techniques, settling and separation of the separate ingredients, and particle size distributions of the constituent materials.

A method is thereby needed to produce a composition with very uniform composition, in which the fuel anion and oxidizer are in very intimate contact, and which is very reproducible in manufacturing techniques from lot to lot. It has been discovered that such an intimate mixture can be obtained if the decahydrodecaborate (-2) anion is mixed in the crystal lattice with the oxidizing agent, in this case a nitrate ion, and if crystals containing the respective ions and oxidizing agents are intimately intertwined.

The process by which the compositions of the referenced invention are prepared produces a very intimate blend of decahydrodecaborate (-2) ion with the oxidizer, and makes the compositions so prepared chemically and physically unique from physical blends of decahydrodecaborate (-2) salts with oxidizer or pyrotechnic compositions incorporating decahydrodecaborate (-2) salts produced by other means. In general, the process consists of dissolving, in a suitable solvent, a decahydrodecaborate (-2) salt, and also dissolving, in the same solution, the oxidizing agent. The subject composition is recovered by precipitating the composite ingredients of the solution with a suitable nonsolvent. The resulting solid, after filtration and drying, comprises an intimate mixture of the decahydrodecaborate (-2) anion with the oxidizing cation or substance, in a form that is chemically and physically different than the starting materials.

The process may be properly called a "cocrystallization" or "coprecipitation" and the resulting product a "cocrystallate" or "coprecipitate". The detailed requirements and description of the process is given in the

copending application of common assignment, entitled COPRECIPIATED PYROTECHNIC COMPOSITION PROCESSES AND RESULTANT PRODUCTS, filed June 10, 1976 and now U.S. Pat. No. 4,135,956, and is incorporated herein by reference.

Preparation of Subject Compositions via Coprecipitation

The coprecipitation process is a preferred method of preparing compounds of this invention. In the general method, the requisite quantities of the salts (a) bis-triaminoguanidinium decahydrodecaborate (-2), and (b) TAGN, are dissolved in hot water at approximately 70°C . A preferred solution concentration is approximately 0.3-0.1 molar in $\text{B}_{10}\text{H}_{10}^{-2}$, due to the relatively low solubility of the salt (a). The ions in the hot solution are precipitated by rapidly mixing one part-by-volume of the hot solution with five parts-by-volume isopropanol (anhydrous), in an apparatus and via the method described in the above-noted U.S. Pat. No. 4,135,956. The resulting precipitate is filtered, washed in butyl acetate, and dried, to yield a white, fluffy powder. Where small quantities of the subject compositions are desired, for example 150 grams or less, satisfactory results can be obtained by effecting the rapid precipitation by hand, i.e., slowly pouring the hot solution into a pot containing rapidly stirred isopropanol.

The resulting product contains stoichiometrically the substituent ions from starting salts (a) and (b), but in different chemical environments than in the starting salts. Specifically, there is interlattice and intercrystalline mixing of the substituents, notably the $\text{B}_{10}\text{H}_{10}^{-2}$ and NO_3^- ions, a chemical state not obtainable by physical blending. This state mixing results in compositions with more uniform and predictable burning than compositions obtained by other methods of combining the ingredients.

The choice of the ratio of starting salt (a) to starting salt (b) depends on the application requirements. A unique and exceptionally useful feature of the subject compositions is that salts (a) and (b) may be combined in virtually any proportions, although compositions containing 50% or more by weight triaminoguanidine nitrate are preferred for economic reasons. The pyrotechnic performance and utility of the composition system is illustrated by FIG. 1, which shows the heat of explosion of the subject compositions as a function of the decahydrodecaborate salt (a) content. This curve (FIG. 1) was generated by preparing physical blends of salts (a) and (b) in the proportions indicated, and igniting a sample of the composition in a closed Parr bomb in an argon atmosphere. The heat of reaction, or more commonly termed by those practiced in the art "heat of explosion", is derived by measuring the temperature rise in a water bath surrounding the reaction vessel. This heat of explosion as a function of decahydrodecaborate salt (a) content is a smooth, monotonically increasing function to at least 50% byweight salt (a), starting at 940 cal/g (pure TAGN) and approaching 1325 cal/gram (pure bis-triaminoguanidinium decahydrodecaborate). Coprecipitates of salts (a) and (b), as indicated on FIG. 1, have heats of explosion very near that derived for physical blends, indicating that no significant change in burning mechanism accompanies the coprecipitation process.

Application of The Subject Compositions

The subject compositions can be used per se as ignition compounds mixed with other ingredients, or manufactured into propellants. Other additives may be employed to alter the processing, handling, or other properties of the mix. These are known, per se, and may include binders such as casein, gum arabic, dextrans, waxes, polymeric materials such as polyurethanes, epoxies, natural or synthetic rubbers, copolymers or a rubber and plastic such as styrenebutadiene, methyl cellulose, and nitrocellulose. Polyethylene glycol of average molecular weight 4000 is a preferred known additive. These ingredients are commonly used in concentrations up to 8% by weight.

A major usage of the subject compositions is in ultra high burn rate propellants, where the coprecipitated composition is used as a major fraction of the solids content of the propellant. These propellants and methods for their preparation are further described in the copending application of common assignment entitled HIGH BURNING RATE PROPELLANTS WITH COPRECIPIATED SALTS OF DECAHYDRODECABORIC ACID, Ser. No. 707,810, now U.S. Pat. No. 4,138,282. When used in accordance with the formulations taught in the aforementioned disclosure, the subject propellants would have the general formula:

	Probable Range, % by Wt.
1. Polymeric binder system	8-35
2. Curing, polymerizing, or cross-linking agents	0-10
3. Plasticizing agents	0-25
4. Pure decahydrodecaborate salts	0-25
5. Coprecipitated triaminoguanidine nitrate/bis triaminoguanidinium decahydrodecaborate	35-90
6. Energetic fuels, such as, but not limited to, finely divided aluminum	0-10
7. Oxidizer or mixture of oxidizers to supplement (5)	0-15
8. Other inert ingredients, such as colorants, stabilizers.	0-10

The unique products of this invention, and representative usages are further illustrated by the following Examples.

EXAMPLE I

1.5 grams bis-triaminoguanidinium decahydrodecaborate and 8.5 grams triaminoguanidine nitrate are dissolved in 100 milliliters deionized water at 50°C . The ingredients are rapidly precipitated by pouring into 500 ml stirred anhydrous isopropanol. A white powder precipitates immediately, and is recovered by filtration, washed in the filter with n-butyl acetate, and dried in an oven at 60°C .

A series of standard pyrotechnic characterization tests are run on the dried powder; results are summarized in Table I.

TABLE I

PARAMETER	EX. I	EX. II	EX. III
method of manufacture	hand	lab coprecipitator	hand
% bis-triaminoguanidinium decahydrodecaborate	15	15	25
heat of explosion, cal/gram ¹	1129	1089	1159

TABLE I-continued

PARAMETER	EX. I	EX. II	EX. III
impact sensitivity, cm ²	8	6	—
electrostatic sensitivity, millijoules ³	—	>225	—
autoignition temperature, °C. ⁴	250	240	247
true density (g/cc)	1.46	1.38	1.60

¹Parr Bomb under argon.²Enclosed Bureau of Mines tool, 1 kg drop, no grit.³2 electrode, 0.020 inch gap, open cup, 500 pF capacitor, no resistor.⁴5 sec Woods metal bath.

EXAMPLE II

22.5 grams bis-triaminoguanidine decahydrodecaborate and 126.4 grams triaminoguanidine nitrate are dissolved in 250 ml deionized water at 50° C. The hot solution was charged into a laboratory model coprecipitator, as described in application Ser. No. 694,626. The product is obtained by precipitation with 5 times the solution volume of anhydrous isopropanol; flow rates of 200 cc/min of the solution and 1000 cc/min isopropanol, with a mixing head gap of 0.030 inches are used. The resulting product is recovered in a filter, washed with butyl acetate, dried at 60° C., and spatulated.

Pyrotechnic characteristics of the resulting composition are also given in Table I, above.

EXAMPLE III

28.3 grams bis-triaminoguanidinium decahydrodecaborate and 85 grams triaminoguanidine nitrate are dissolved in 1000 ml deionized water at 60° C. The hot solution is poured slowly into a stainless pot containing 5000 ml anhydrous isopropanol agitated with a high speed stirring apparatus. The resulting precipitate is filtered, washed with butyl acetate in the filter, dried 24 hours at 125° F., and spatulated.

Pyrotechnic characteristics of the resulting composition are also given in Table I, above.

EXAMPLE IV

A free energy minimization thermochemical analysis, as commonly performed by those practiced in the art, is run on a hypothetical composition comprising 15%-by-weight bis-triaminoguanidinium decahydrodecaborate and 85%-by-weight triaminoguanidine nitrate, representative of the compositions produced as Examples I and II. Representative combustion parameters of the composition burning in a chamber at 1000 psi and exhausted through a nozzle are given in Table II. The propellant has low flame temperature and very high gas output.

TABLE II

PARAMETER	COMBUSTION PARAMETERS OF 15%-BY-WEIGHT BIS-TRIAMINO GUANIDINIUM DECAHYDRODECABORATE AND 85%-BY-WEIGHT TAGN	
	1000 psi	EXPANDED
Specific impulse (ft-lb/lb)	0	245
Specific impulse (vacuum, ft-lb/lb)	0	264
Flame temperature (isobaric, °K.)	2103	986
Gamma	1.26	1.28
Flame temperature (isochoric, °K.)	2650	1262
Gas output (moles/100g)	5.66	5.45
Gas molecular weight	15.9	15.5
Product molecular weight	17.7	18.4

Used as a gun propellant, the impetus of the system (without binder) is 416,000 (ft-lb/lb), which is substan-

tially higher than either nitramine propellants currently known or, as well, nitrocellulose propellants. Primary combustion products after expansion are (in units of moles/100g):

H₂: 2.5N₂: 2.1

CO: 0.5

H₂O: 0.23B₂O₃: 0.22

EXAMPLE V

The utility of the subject compositions as very high pressure-producing compositions is illustrated by loading approximately 100 milligrams of the subject composition into a closed pressure cartridge of a well-known type as shown in FIG. 2, and firing the pressure cartridge in a 10 cc closed bomb. The pressure in the bomb is measured by a fast response transducer and recorded as a function of time. The pressure cartridge consists of an exploding bridgewire mounted in a suitable cartridge case. The bridgewire is primed with a 53 mg of an initiating pyrotechnic powder. The subject composition is loaded into the cartridge over the priming load, and the cartridge closed with a crimped or welded cap. The function time of the compositions is taken as the time between the application of current to the bridgewire to the peak pressure.

When tested in this manner, 96 mg of the composition from Example II produces a peak pressure of 1600 psi in 4 milliseconds. By contrast, to produce a comparable pressure rise, 120 g of a commonly used high speed composition, [consisting of 22 parts-by-weight finely divided zirconium, 17.5 parts-by-weight potassium perchlorate, 1.7 parts-by-weight binder, and 58 parts-by-weight "Hi Temp" (Hercules Powder Co., an RDX/wax composition)] is required.

EXAMPLE VI

The utility of the subject compositions when used in a propellant described in the copending application of common assignment entitled HIGH BURNING RATE PROPELLANTS WITH COPRECIPITATED SALTS OF DECAHYDRODECABORIC ACID, filed July 22, 1976 and assigned Ser. No. 707,810, is illustrated by preparing a propellant with the following formulation:

Composition from Example II	: 70%
Nitrocellulose (12.6%N)	: 17%
Dinitrotoluene	: 7%
Acetyl Tributyl Citrate	: 6%

The propellant ingredients are slurried in a 75%-by-volume ethanol/25%-by-volume butyl acetate solvent and charged into a one-pint Baker Perkins sigma blade dough mixer. The solvent is removed under vacuum at 120° F. and a thick dough obtained. The dough is extruded into 1/4 inch diameter burning rate strands using a 6-inch air operated press and 1-inch barrel extruder. Further drying at 120° F. for several weeks follows.

The strands are fired in a closed bomb strand burner, as commonly used by those practiced in the art. A burning rate of 475 inches per second is measured with the bomb pressurized to 2000 psi, which represent burning rates wholly unachievable with state-of-the-art propellants.

A free energy minimization program is run on this propellant to assess its utility as a gun or rocket propellant; parameters are summarized in Table III. The derived impulse of 360,000 ft-lb/lb is typical of that achievable with single base propellants. This value can be raised substantially by reducing the plasticizer content of the propellant, or, for rocket propellants, adding aluminum.

TABLE III

COMBUSTION PARAMETERS OF PROPELLANT CONTAINING COPRECIPITATED PRODUCT		
PARAMETER	1000 psi	EXPANDED
Specific Impulse (lb-sec/lb)	—	226
Specific Impulse (vacuum, lb-sec/lb)	—	246
Flame Temperature (adiabatic, °K.)	1815	967
Gamma	1.27	1.27
Flame Temperature (isochoric, °K.)	2305	1228
Gas Output (moles/100g)	5.63	5.14
Gas Molecular Weight	15.9	16.8
Product Molecular Weight	17.8	19.45
Impulse (ft-lb/lb)		360,000

While various examples of the subject compositions have been given, and preparatory methods taught, it is to be understood that the invention is to be defined by the scope of the appended claims.

I claim:

1. The composition having the general formula

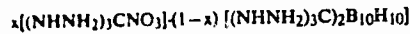

wherein the value of x is between 0.01 and 0.99.

2. The composition of claim 1 wherein the value of x is between 0.5 and 0.99.

3. A mixture comprising an intimate physical blend of the triaminoguanidinium salt of decahydrodecaborate acid, $(\text{C}(\text{NHNH}_2)_3)_2\text{B}_{10}\text{H}_{10}$ and triaminoguanidine nitrate, $(\text{NHNH}_2)_3\text{CNO}_3$, wherein said nitrate comprises from between approximately 1% and 99%, by weight, of said mixture.

4. A product having the formula:

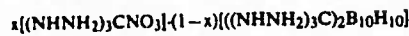

wherein the value of x varies between 0.01 and 0.99 said product being formed by a coprecipitation process between the triaminoguanidinium salt of decahydrodecaboric acid and triaminoguanidinium nitrate by the steps of:

(A) dissolving both said decahydrodecaborate salt and said nitrate in a mutually soluble solvent, at a temperature sufficiently high to maintain said salt and said nitrate in solution;

(B) forming a pressurized stream of said solution and bringing said solution stream together with a pressurized stream of a miscible nonsolvent, under conditions of extreme turbulence within a mixing chamber, to effect a substantially complete coprecipitation;

(C) recovering the coprecipitated product by filtering the effluent from said mixing chamber, and washing said product with an inert and nonsolvent fluid;

(D) drying the product to remove all remaining liquid.

5. The product of claim 4 wherein said mutually soluble solvent is water and said solution concentration is approximately 0.3 to 0.1 molar in $\text{B}_{10}\text{H}_{10}^{2-}$, wherein said coprecipitation step further comprises rapidly mixing approximately one part-by-volume of said solution with five parts-by-volume of said miscible nonsolvent.

6. The composition of claim 1 wherein further the composition is a coprecipitate and the substituent ions $\text{B}_{10}\text{H}_{10}^{2-}$ and NO_3^- are intimately intertwined through interlattice and intercrystalline mixing.

7. The coprecipitate of claim 6 wherein the value of x is between 0.5 and 0.99, and said coprecipitate is the product of a process comprising the steps of dissolving the triaminoguanidinium salt of decahydrodecaboric acid and triaminoguanidinium nitrate in water to form a solution and simultaneously precipitating the constituent ions by adding said solution to a miscible nonsolvent.

8. A compositions according to claim 1 wherein x is approximately 0.85 and 0.75.

* * * * *

45

50

55

60

65