

AD-F 250004

ST 17-1-1

US ARMY

AD A115857

ARMOR REFERENCE DATA

IN THREE VOLUMES

VOLUME III

DIVISION 86 ORGANIZATIONS

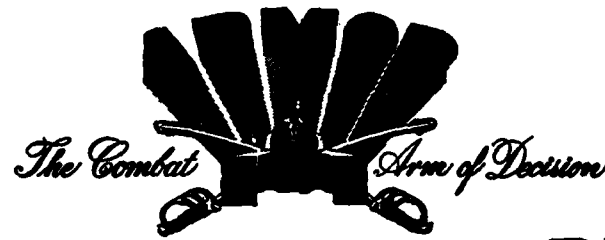

This document has been approved
for public release and sale; its
distribution is unlimited.

DTIC
SELECTE
JUN 13 1982
S D
F

COMPLIMENTS
OF
THE ARMOR SCHOOL LIBRARY
GAFFEY HALL
624-6231

US ARMY ARMOR SCHOOL
FORT KNOX, KENTUCKY



82 05 28 015

DTIC FILE COPY

INTRODUCTION

The purpose of this text is to provide a reference handbook for students and instructors of the US Army Armor School, nonresident students, instructors at other service schools, and US Army advisors to Armor units in the field. It contains data on organizations, details of equipment, and tables pertinent to armor operations.

The text reflects organizations of division level and below, as listed in Department of the Army Tables of Organization and Equipment, with changes available at time of preparation.

The **ARMOR REFERENCE DATA** has been prepared by the US Army Armor School. It reflects the current thought of this School and conforms to published Department of Army doctrine as closely as possible. Comments/recommendations concerning this special text should be forwarded to the Directorate of Training Developments, US Army Armor School, ATTN: ATZK-CSD, Fort Knox, Kentucky 40121.

ADF250004

SECURITY CLASSIFICATION OF THIS PAGE (When Data Entered)

REPORT DOCUMENTATION PAGE		READ INSTRUCTIONS BEFORE COMPLETING FORM
1. REPORT NUMBER	2. GOVT ACCESSION NO. AD A115 857	3. RECIPIENT'S CATALOG NUMBER
4. TITLE (and Subtitle) US Army Armor Reference Data In Three Volumes Volume III Division 86 Organizations		5. TYPE OF REPORT & PERIOD COVERED Special Text
7. AUTHOR(s)		6. PERFORMING ORG. REPORT NUMBER ST 17-1-1
9. PERFORMING ORGANIZATION NAME AND ADDRESS Army Armor School Fort Knox, KY		8. CONTRACT OR GRANT NUMBER(s)
11. CONTROLLING OFFICE NAME AND ADDRESS		10. PROGRAM ELEMENT, PROJECT, TASK AREA & WORK UNIT NUMBERS
14. MONITORING AGENCY NAME & ADDRESS (if different from Controlling Office)		12. REPORT DATE 1981
		13. NUMBER OF PAGES 211
		15. SECURITY CLASS. (of this report) Unclassified
16. DISTRIBUTION STATEMENT (of this Report)		15a. DECLASSIFICATION/DOWNGRADING SCHEDULE
<div style="border: 1px solid black; padding: 5px; width: fit-content; margin: 0 auto;"> This document has been approved for public release and its distribution is unlimited. </div>		
17. DISTRIBUTION STATEMENT (of the abstract entered in Block 20, if different from Report)		
18. SUPPLEMENTARY NOTES		
19. KEY WORDS (Continue on reverse side if necessary and identify by block number)		
20. ABSTRACT (Continue on reverse side if necessary and identify by block number)		

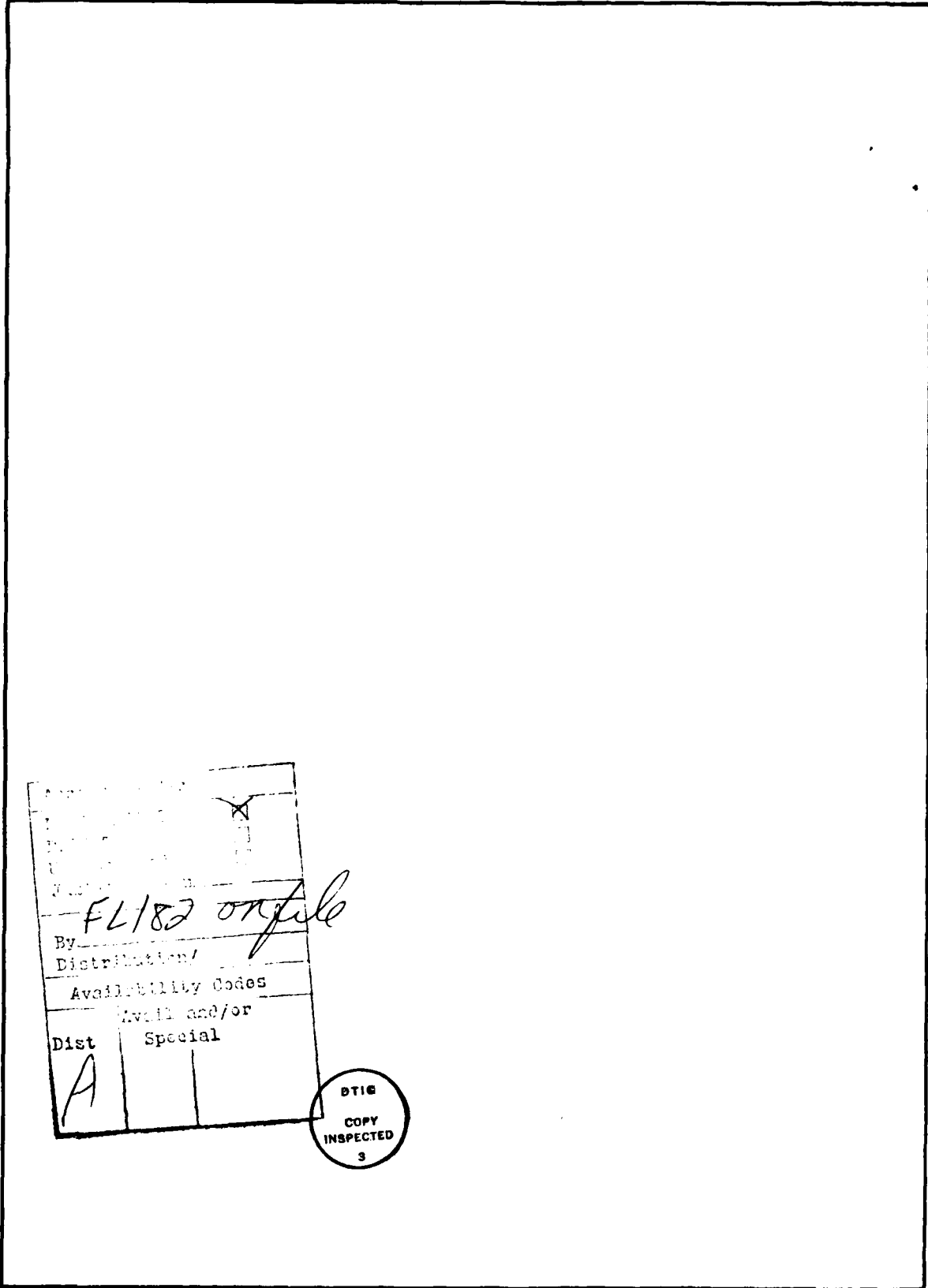

By _____	
Distribution/ _____	
Availability Codes	
Dist	Avail and/or Special
A	

FL182 on file

DTIC
COPY
INSPECTED
3

INDIVIDUAL WEAPONS

Each Table of Organization and Equipment (TOE) provides that the personnel of the unit are to be armed with the rifle, 5.56mm unless otherwise indicated. Entries in the remarks column of Section II of the TOE designate specific individuals to be armed with a weapon, or weapons, other than the rifle. Rifle mounted grenade launchers, however, are authorized the squad, section, etc, in bulk for use as desired by the commander.

In this text, the following abbreviations are used to indicate the specific weapon(s) authorized each individual. Rifle grenade launchers have been included as an example of how this weapon may be distributed within the unit.

AR	Rifle, 5.56mm with bipod
GL	Launcher, grenade, M203
MG	Machinegun, 7.62mm M60
P	Pistol, caliber .45
R	Rifle, 5.56mm
Rev	Revolver, caliber .38
S	Submachinegun, caliber .45
SAW	Squad Automatic Weapon

SILHOUETTE IDENTIFICATION



Armored Reconnaissance/Airborne Assault Vehicle M551A1



Bridge and Launcher, AVLB CL60



Carrier Ambulance M113A1



Carrier Cargo M548



Carrier CP M577A1



Carrier Guided Missile ADA SP Chaparral M730



Carrier Guided Missile TOW XM233E1



Carrier Improved TOW Vehicle M901



Carrier Gun 20 mm ADA SP Vulcan M741



Carrier Mortar 4.2 inch M106 or Carrier Mortar 81 mm M125



Carrier Cavalry Fighting Vehicle M3



Carrier Personnel M113A1



Carrier Infantry Fighting Vehicle M2



Chassis Trailer 2-ton w/Generator

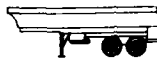

Semitrailer Tank Fuel Suc 5000 Gal M1314K

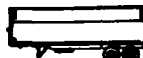

Semitrailer Van Cargo 12-ton M128A2C



Semitrailer Van Supply 12-ton M129A1



Semitrailer Shop Act Maint Tool Crib B-1



Semitrailer and Trailer Shop Set Act Maint Elec B-2

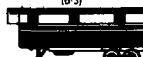

Semitrailer Shop Set Act Maint Sheet Metal B-3



Semitrailer Shop Set Act Maint Mach and Eng B-4



Semitrailer Shop Set Act Maint Prop and Rotor B-5



Semitrailer Shop Van Repair Parts 6-ton M750



Tank Combat 105 mm Gun M60A1



Tank Combat 105mm Gun M1



Truck Cargo 1-ton 6X6 M561



Truck Cargo Tac 1-ton 4X4 M880



Truck Cargo Tac 1-ton 4X4 W/60 AMP Kit W/E M881



Truck Cargo Tac 1-ton 4X4 W/60 AMP Comm Kit W/E M882



Truck Cargo Tac 1-ton 4X4 W/60 AMP Comm Shelter Kit W/E M883



Truck Cargo Tac 1-ton 4X4 W/100 AMP Comm Shelter Kit W/E M884



Truck Cargo Tac 1-ton 4X4 W/Comm Shelter Kit W/E M885



Truck Cargo 2-ton M35A2



Truck Cargo 5-ton 8X8 M656



Truck Cargo 10-ton 8x8

















Truck Cargo 8-ton 4X4 M520

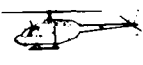

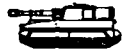



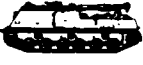







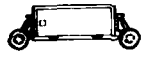

Truck Dump 5-ton 6X6 M817



Truck Guided Missile TOW XM232E1

-  Combined Engineer Vehicle, M728
-  Crate Wheel Mtd 3 ton, M63
-  Crate Wheel Mtd 20 ton
-  Crawler Road Mtd, Mv 63A
-  Helicopter Attack, AH-1S
-  Helicopter, Attack, AH-64
-  Helicopter Observation, OH-58A
-  Helicopter Utility, UH-1H
-  Helicopter, Utility, UH-60A
-  Howitzer 155 mm SP, M109A1
-  Howitzer 8 inch SP, M110A1
-  Loader Scoop Type 2 4 Cu Yds
-  Recovery Vehicle Light, M578
-  Recovery Vehicle Medium, M88
-  Semi-trailer Low Bed 25-ton, M172A1

-  Semi-trailer Stake 12-ton, M127A2C
-  Tractor Whe. Ind. W/Backhoe and Loader Case 9480
-  Tractor Full Track DSL MDM HD 168
-  Tractor Full Track DSL W/Ripper
-  Trailer ACR Mount Ambul
-  Trailer Ammunition, M332
-  Trailer 4-ton, M416
-  Trailer, Field Kitchen
-  Trailer 4-ton, M101A1
-  Trailer 1 1/2-ton, M105A2
-  Trailer Flatbed 10-ton, M345
-  Trailer, Shop Set Ach Maint, Paint, B-6
-  Trailer Tank Water 400 gal, M149A1
-  Truck Ambulance 4-ton, M718
-  Truck Ambulance 1 1/4-ton, 636 M792

















-  Truck Ambulance Tac 1 1/4-ton, 434, M886
-  Truck Guided Missile Equip, TOW, XM236
-  Truck Platform Utility (Mule) 1-ton, M274A5
-  Truck Shop Equip Contact, Trk Mtd
-  Truck Tank Fuel Servicing 2-ton, M89A2C
-  Truck Tank Fuel Servicing 2500 gal, 434, M259
-  Truck Tractor 10-ton, M123A1C
-  Truck Tractor Wrecker 5 1/4-ton, M819
-  Truck Utility 4-ton, M151A2
-  Truck Utility 4-ton, Mounberg, 7.62 mm mg
-  Truck Van Expandable 5-ton, 636, M820
-  Truck Van Shop 2 1/2-ton, M109A3
-  Truck Wrecker 2 1/2-ton, M860
-  Truck Wrecker 5-ton, M816
-  Truck Wrecker 10-ton, 434, M553
-  Water Purification Set, Trk Mtd, 1500 GPH

TABLE OF CONTENTS
VOLUME III

<i>TOE</i>	<i>Title</i>	<i>Page</i>
CHAPTER 8.	Divisional Units, Division 86.....	451-512
	Armor Battalion	452
	Headquarters and Headquarters Company	454
	Tank Company	464
	Mechanized Infantry Battalion.....	470
	Headquarters and Headquarters Company	472
	Rifle Company.....	484
	Anti-Armor Company.....	488
	Armored Cavalry Squadron	492
	Headquarters and Headquarters Troop	494
	Armored Cavalry Troop.....	506
	Air Cavalry Troop	512
CHAPTER 9.	Armored Cavalry Regiment, Corps 86	515-551
	Armored Cavalry Regiment	516
	Headquarters and Headquarters Troop	520
	Armored Cavalry Squadron	526
	Headquarters and Headquarters Troop	528
	Armored Cavalry Troop	536
	Tank Company	542
	Combat Aviation Squadron	548
	Headquarters and Headquarters Troop	550
	Air Cavalry Troop	558
	Attack Helicopter Company	562
	Regimental Support Aviation Troop	566
	Field Artillery Battalion	570
	Headquarters and Headquarters Battery	572
	Field Artillery Battery	578
	Service Battery	582
	CEWI Company	588
	Engineer Company	592
	Air Defense Artillery Battery	598
	NBC Defense Company	602
	Support Squadron.....	606
	Headquarters and Headquarters Troop	608
	Administration Company	612
	Medical Company.....	616
	Supply and Transport Troop	620
	Maintenance Troop	624
CHAPTER 10.	TABLES.....	628-646
TABLES 1.	Authorized TOE Equipment, Tank Platoon, Armored Cavalry Platoon, Scout Platoon	628
2.	Characteristics of Illumination Means	632
3.	Characteristics of Tank and Light Armor Vehicle Weapons	633
4.	Characteristics of Vehicles	634
5.	Characteristics of Individual and Crew-Served Weapons	635
6.	Characteristics of Antitank Weapons	637
7.	Characteristics of Mines	638
8.	Characteristics of Field Artillery and Air Defense Weapons	641
9.	Characteristics of Army Aircraft	642
	a. Characteristics of Army Airplanes	643
	b. Characteristics of Army Helicopters	644
10.	Characteristics of Helicopter Armament	645
11.	Standard Tactical Missions of Field Artillery	646
CHAPTER 11.	Troop List	647-656

CHAPTER 8

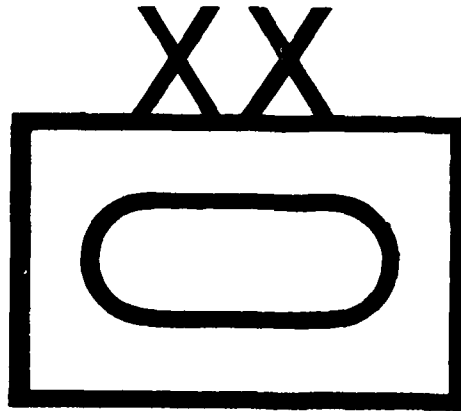

DIVISION—86
HEAVY DIVISION

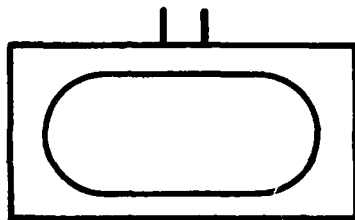

0	WO	EM	AGG
39	2	538	579

452

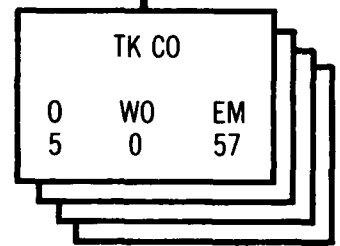
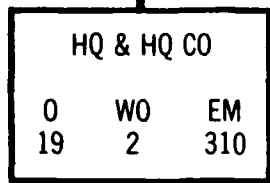

SUMMARY OF EQUIPMENT

WEAPONS

BAYONET-KNIFE: W/SCABBARD FOR M16A1 RIFLE.....	541
LAUNCHER GRENADE SMOKE: M243	2
LAUNCHER GRENADE SMOKE: M257	1
LAUNCHER GRENADE 40 MILLIMETER: SGLE SOT RIFLE MTD DITCHBLE W/E...	16
LAUNCHER GRENADE SMOKE: SCREENING RP M250.....	58
LAUNCHER ROCKET: 66MM 4-TUBE.....	4
MACHINE GUN CALIBER .50: HEAVY FIXED TURRET TYPE.....	58
MACHINE GUN CALIBER .50: HB FLEXIBLE VEHICLE MTD.....	8
MACHINE GUN 7.62 MILLIMETER: FIXED.....	31
MACHINE GUN 7.62 MILLIMETER: LIGHT FLEXIBLE.....	6
MORTAR 81 MILLIMETER: ON MOUNT.....	7
PISTOL CALIBER .45 AUTOMATIC.....	278
RIFLE 5.56 MILLIMETER: W/E.....	411
SUBMACHINE GUN 5.56 MILLIMETER: PORT FIRING M231.....	1
SUBMACHINE GUN CALIBER .45.....	14
MACHINE GUN 7.62MM: FIXED 4240C RH FEED F/PVS.....	116
MACHINE GUN 7.62MM MILLIMETER: FIXED.....	1

VEHICLES

INFANTRY FIGHTING VEHICLE M2.....	1
CARRIER FIGHTING VEHICLE: M3.....	6
CARRIER 81 MILLIMETER MORTAR: FULL TRACKED (LESS MORTAR).....	6
CARRIER COMMAND POST: LIGHT TRACKED.....	6
CARRIER PERSONNEL FULL TRACKED: ARMORED.....	13
RECOVERY VEHICLE FULL TRACKED: MEDIUM.....	7
TRAILER CARGO: 1/4 TON 2 WHEEL W/E.....	11
TRAILER CARGO: 3/4 TON 2 WHEEL W/E.....	3
TRAILER CARGO: 1-1/2 TON 2 WHEEL W/E.....	30
TRAILER TANK: WATER 400 GALLON 1-1/2 TON 2 WHEEL W/E.....	5
TRUCK CARGO: TACTICAL 1-1/4 TON 4X4 W/E.....	2
TRUCK CARGO: TACTICAL 1-1/4 TON 4X4 W/60 AMP-COMM KITS W/E.....	2
TRUCK CARGO: 1-1/4 TON 6X6 W/E.....	1
TRUCK CARGO: 2-1/2 TON 6X6 W/E.....	9
TRUCK CARGO: DROP SIDE 2/1/2 TON 6X6 W/E.....	5
TRUCK CARGO: 2-1/2 TON 6X6 W/WINCH W/E.....	9
TRUCK CARGO: 5 TON 6X6 LWB W/WINCH W/E.....	2

TRUCK CARGO: 5 TON 8X8 W/E.....	1
TRUCK CARGO: 5 TON 6X6 LWB W/WINCH W/E.....	22
TRUCK UTILITY: 1/4 TON 4X4 W/E.....	1
TRUCK WRECKER: 5 TON 8X8 W/WINCH W/E.....	12
MOTORCYCLE: 2 WHEEL.....	58
TANK COMBAT FULL TRACKED: 105MM GUN M1.....	10
TRUCK CARGO: 10 TON 8X8 HIGH MOBILITY XM 977.....	1
TRUCK RECOVERY: TACTICAL 10 TON 8X8 HIGH MOBILITY.....	11
TRUCK VAN: SHOP 2-1/2 TON 6X6 W/E.....	2

NBC

ALARM CHEMICAL AGENT AUTOMATIC: PORTABLE MANPACK.....	28
ALARM CHEMICAL AGENT AUTOMATIC: PTBL W/PWR SUP F/TRK UTIL 1/4TON.....	10
ALARM CHEMICAL AGENT AUTOMATIC: PTBL W/PWR SUP F/TRK 2-1/2 TON...	1
DECONTAMINATING APPARATUS POWER DRIVER SKID MOUNTED: MULTIPURPOSE	1
CHARGER RADIAC DETECTOR: PP-4370/PD.....	5
MASK CBR: HEADMOUNT PROTECTIVE.....	10
RADIAC METER: IM-185/UD.....	50

MISCELLANEOUS EQUIPMENT

DEMOLITION SET EXPLOSIVE: INITIATING ELECTRIC AND SEMI ELECTRIC..	1
LASER INFRARED OBSERVATION SET: AN/GVS-5.....	6
NIGHT VISION GOGGLES: AN/PVS-5.....	120
NIGHT VISION SIGHT CREW SERVED WEAPON: AN/TVS-5.....	22
NIGHT VISION SIGHT INDIVIDUAL SERVED WEAPON: AN/PVS-4.....	15
NIGHT VISION SIGHT INFRARED: AN/TAS-6.....	2
NIGHT VISION SIGHT TRIPOD MOUNTED: AN/TVS-4.....	1
PLATOON EARLY WARNING SYSTEM: AN/TRS-2(V).....	14
VIEWER INFRARED: AN/PAS-7.....	2
COMBAT VEHICLE HEADING REFERENCE UNIT (CV-HRU):.....	56
DETECTING SET MINE: VEHICULAR.....	1
DETECTOR RADAR SIGNAL: AN/PSS-10.....	6
MEDICAL EQUIPMENT SET BATTALION AID STATION:.....	1
PLRS BASIC USER UNIT.....	1
PLRS SURFACE VEHICLE INSTALLATION KIT:.....	1

TANK BATTALION DIVISION 86

HH

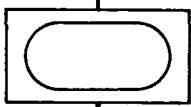

0	WO	EM	AGG
19	2	310	331

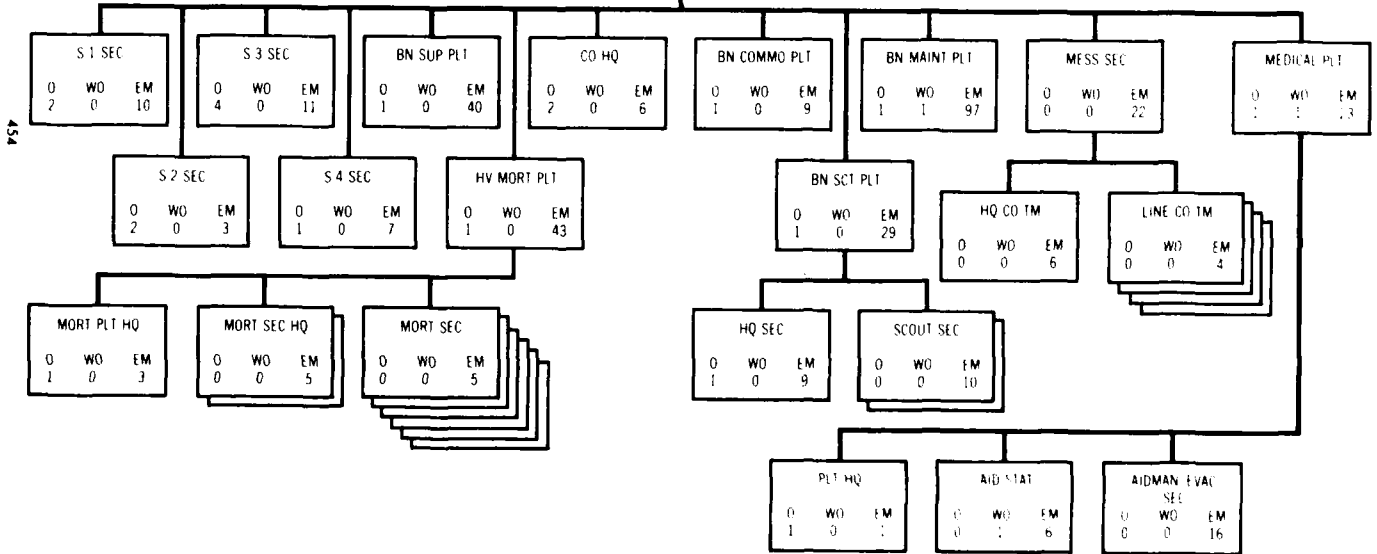
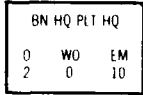

SUMMARY OF EQUIPMENT

WEAPONS			
BAYONET-KNIFE: W/SCABBARD FOR M16A1 RIFLE.....	293	TRUCK CARGO: 5 TON 6X6 LWB W/E.....	1
LAUNCHER GRENADE SMOKE: M257.....	1	TRUCK CARGO: 5 TON 8X8 W/E.....	2
LAUNCHER GRENADE 40 MILLIMETER: SGLE SHOT RIFLE MTD DITCHBLE W/E..	8	TRUCK UTILITY: 1/4 TON 4X4 W/E.....	14
LAUNCHER GRENADE SMOKE: SCREENING M243.....	2	TRUCK VAN: SHOP 2-1/2 TON 6X6 W/E.....	2
LAUNCHER GRENADE SMOKE: SCREENING RP M250.....	2	TRUCK WRECKER: 5 TON 8X8 W/WINCH W/E.....	1
MACHINE GUN CALIBER .50: HEAVY FIXED TURRET TYPE.....	2	MOTORCYCLE: 2 WHEEL.....	4
MACHINE GUN CALIBER .50: HB FLEXIBLE VEHICLE MTD.....	4	TANK COMBAT FULL TRACKED: 105MM GUN XM1.....	2
MACHINE GUN CALIBER .50: HB FLEXIBLE FOR GROUND USE.....	31	TRUCK CARGO: 10 TON 8X8 HIGH MOBILITY XM977.....	10
MACHINE GUN 7.62 MILLIMETER: FIXED.....	6	TRUCK RECOVERY: TACTICAL 10 TON 8X8 HIGH MOBILITY.....	1
MACHINE GUN 7.62 MILLIMETER: LIGHT FLEXIBLE.....	7	TRUCK TANK: FUEL SERVICING 2500 GAL 8X8 H MO W/WINCH.....	11
MACHINE GUN 7.62MM: FIXED M240C RH FEED F/EVS.....	4		
MACHINE GUN 7.62 MILLIMETER: FIXED.....	1	NBC	
MORTAR 81 MILLIMETER: ON MOUNT.....	6	ALARM CHEMICAL AGENT AUTOMATIC: PORTABLE MANPACK.....	4
PISTOL CALIBER .45 AUTOMATIC.....	46	ALARM CHEMICAL AGENT AUTOMATIC: PTBL W/PWR SUP E/TRK UTIL 1/4TON.	2
RIFLE 5.56 MILLIMETER: W/E.....	275	ALARM CHEMICAL AGENT AUTOMATIC: PTBL W/PWR SUP E/TRUCK 2-1/2 TON.	1
SUBMACHINE GUN 5.56 MILLIMETER: PORT FIRING M231.....	1	DECONTAMINATING APPARATUS POWER DRIVEN SKID MOUNTED: MULTIPURPOS.	2
SUBMACHINE GUN CALIBER .45.....	14	MASK CBR: HEADWOUND PROTECTIVE.....	10
		MASK CHEMICAL-BIOLOGICAL: MULTIPURPOSE.....	317
VEHICLES		CHARGER RADIAC DETECTOR: PP-4370/PD.....	1
CAVALRY FIGHTING VEHICLE: M3.....	6	RADIACMETER: IM-185/UD.....	22
CARRIER 81 MILLIMETER MORTAR: FULL TRACKED (LESS MORTAR).....	6		
CARRIER COMMAND POST: LIGHT TRACKED.....	6	MISCELLANEOUS EQUIPMENT	
CARRIER PERSONNEL FULL TRACKED: ARMORED.....	13	DEMOLITION SET EXPLOSIVE: INITIATING ELECTRIC AND SEMI ELECTRIC..	1
INFANTRY FIGHTING VEHICLE: M2.....	1	DETECTING SET MINE: VEHICULAR.....	1
RECOVERY VEHICLE FULL TRACKED: MEDIUM.....	7	DETECTOR RADAR SIGNAL: AN/PSS-10.....	6
TRAILER CARGO: 1/4 TON 2 WHEEL W/E.....	11	MEDICAL EQUIPMENT SET BATTALION AID STATION.....	1
TRAILER CARGO: 3/4 TON 2 WHEEL W/E.....	3	NET CONTROL DEVICE NCO: KIX-15/TSBC.....	6
TRAILER CARGO: 1-1/2 TON 2 WHEEL W/E.....	26	NIGHT VISION GOGGLES: AN/PVS-5.....	52
TRAILER TANK: WATER 400 GALLON 1/1-2 TON 2 WHEEL W/E.....	5	NIGHT VISION SIGHT CREW SERVED WEAPON: AN/TVS-5.....	22
TRUCK CARGO: TACTICAL 1-1/4 TON 4X4 W/E.....	2	NIGHT VISION SIGHT INDIVIDUAL SERVED WEAPON: AN/PVS-4.....	7
TRUCK CARGO: TACTICAL 1-1/4 TON 4X4 W/60 AMP-COMM KITS W/E.....	2	NIGHT VISION SIGHT INPRARED: AN/TAS-6.....	2
TRUCK CARGO: 1-1/4 TON 6X6 W/E.....	1	NIGHT VISION SIGHT TRIPOD MOUNTED: AN/TVS-4.....	1
TRUCK CARGO: 2-1/2 TON 6X6 W/E.....	12	PLRS BASIC USER UNIT.....	1
TRUCK CARGO: DROP SIDE 2-1/2 TON 6X6 W/E.....	5	PLRS SURFACE VEHICLE INSTALLATION KIT.....	1
TRUCK CARGO: 2-1/2 TON 6X6 W/WINCH W/E.....	9	VIEWER INPRARED: AN/PAS-7.....	2

455

HEADQUARTERS AND HEADQUARTERS COMPANY TANK BATTALION DIVISION 86

BATTALION HEADQUARTERS

BN HQ PLT HQ



1 LTC 12800 (Bn Cdr) P
1 PFC 19L10 (Dvr) P



1 MAJ 12800 (XO) P
1 CSM 00250 (CSM) P
1 PFC 19L10 (Dvr) P



1 SSG 19K30 (Tk Cdr) P
1 SGT 19K20 (Sr Gunner) P
1 SGT 19L20 (Sr Tk Dvr) P, R
1 SP4 19K10 (Loader) P, R



1 SSG 19K30 (Tk Cdr) P
1 SP4 19K10 (Gunner) P
1 SP4 19L10 (Tk Dvr) P, R
1 PFC 19K10 (Loader) P, R

S-1 SECTION



1 CPT 56A00 (Chaplain)
1 SP4 71M10 (Chap Asst) R



1 CPT 12A41 (S-1) R
1 SFC 75240 (PAC Supv) R
1 SSG 75230 (Per Staff NCO) R
1 SGT 71D20 (Legal Clerk) R
1 SGT 75B20 (PAC Clerk) R
1 SP4 71L10 (Clerk Typ) R
1 SP4 75B10 (PAC Clerk) R
1 PFC 75B10 (PAC Clerk-Dvr) R
1 PFC 75B10 (PAC Cln) R

S-2 SECTION



1 CPT 35A00 (S-2) R
1 LT 35A00 (Tac Intel Off) R
1 MSG 19Z50 (Intel NCO) R
1 SSG 19B30 (Sr Intel Anal) R
1 SP4 19F1U (Per Carr Dvr) P

S-3 SECTION



1 MAJ 12800 (S-3) P
1 SP4 05B10 (RTO Dvr) R



1 LT 12C00 (LNO) R
1 SP4 19K10 (Dvr) R



1 MSG 19Z50 (Op NCO) R
1 SFC 19K40 (Mast Gnr) R
1 SGT 19K20 (Op Asst) R
1 SP4 19K10 (Dvr) R



1 CPT 12B00 (S-3 Air) R
1 LT 74A00 (Asst S-3/Cml Off) R
1 SFC 19K40 (Asst Op NCO) R
1 SGT 54E20 (NBC NCO) R
1 SP4 19K1U (Dvr) P



1 SGT 19D20 (Gunner) R
1 SP4 19K1U (Dvr) P

* ALO Vehicle

S-4 SECTION



1 CPT 12B92 (S-4) R
1 SP4 76Y10 (Supply Sp-Dvr) R

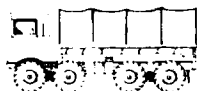

1 SSG 76Y30 (Asst Supply SGT) R
1 SP4 76Y10 (Supply Sp-Dvr) R



1 SGT (Gen Supply SGT) R
1 PFC 76Y10 (Supply Sp-Dvr) R



1 SFC 76Y40 (Supply NCO) R
1 SP4 19K10 (Dvr) P

HEADQUARTERS & HEADQUARTERS COMPANY

HHC HQ SECTION



1 MAJ 12B00 (Cdr) P
1 PFC 19E10 (Dvr) R



1 CPT 12B00 (XO) R
1 PFC 19E10 (Dvr) R



1 ISG 1925M (ISG) R
1 SSG 76Y30 (Supply NCO) R
1 SP4 76Y10 (Armorer-Dvr) R



1 SP4 54E10 (Decon Sp-Dvr) R

457

BN COMMO PLT



1 CPT 25A00 (C E Off) R
1 SP4 36K10 (Wire Sp-Dvr) R



**



1 SP4 36K10 (Wire Sp) R
1 PFC 36K10 (Wire Sp-Dvr) R



**



1 SP4 36C10 (Switch Bd Op) R
1 PFC 36K10 (Wire Sp-Dvr) R

**



1 SFC 31V40 (Tac Com Chiet) R
1 SP4 05B10 (RTO) R
1 SP4 36K1U (Dvr) P
1 PFC 36C10 (Switch Bd Op) R

* W/Winch & Skid Mtd Decon Apparatus Utilized For Msgr Service

BATTALION SCOUT PLT

SCT PLT HQ

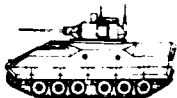

1 LT 12C00 (Plt Ldr) R
1 SP4 19D10 (Gunner) R
1 SP4 19D10 (Sct) R
1 SP4 19D10 (Sct) R
1 PFC 19D1U (Dvr) R



1 SFC 19D40 (Plt SGT) R
1 SP4 19D10 (Gunner) R
1 SP4 19D10 (Sct) R
1 SP4 19D10 (Sct) R
1 PFC 19D1U (Dvr) R

1ST SCT SEC



1 SSG 19D30 (Sec Ldr) R
1 SSG 19D30 (Sqd Ldr) R
2 SGT 19D20 (Gunner) R
2 SP4 19D10 (Sct) R
2 PFC 19D1U (Dvr) GL

2D SCT SEC



1 SSG 19D30 (Sec Ldr) R
1 SSG 19D30 (Sqd Ldr) R
2 SGT 19D20 (Gunner) R
2 SP4 19D10 (Sct) R
2 PFC 19D1U (Dvr) GL

BN HV MORT PLT

HV MORT PLT HQ



1 LT 12B00 (Plt Ldr) R
1 PFC 11C10 (RTO-Dvr) R



1 SFC 11C40 (Plt Sct) R
1 PFC 11C10 (Dvr) R

MORT SEC HQ



1 SSG 11C30 (Sec Ldr) R
2 SGT 11C20 (FDC) R
1 SP4 11C10 (Dvr) R
1 PFC 11C1U (RTO) R



1 SSG 11C30 (Sec Ldr) R
2 SGT 11C20 (FDC) R
1 SP4 11C10 (Dvr) R
1 PFC 11C1U (RTO) R

6 MORTAR SQUADS



1 SGT 11C20 (Sqd Ldr) R
1 SP4 11C10 (Gnr) P
1 SP4 11C1U (Dvr) R
1 PFC 11C10 (Asst Gnr) P
1 PFC 11C10 (Ammo Br) R



1 SGT 11C20 (Sqd Ldr) R
1 SP4 11C10 (Gnr) P
1 SP4 11C1U (Dvr) R
1 PFC 11C10 (Asst Gnr) P
1 PFC 11C10 (Ammo Br) R



1 SSG 11C30 (Sqd Ldr) R
1 SP4 11C10 (Gnr) P
1 SP4 11C1U (Dvr) R
1 PFC 11C10 (Asst Gnr) P
1 PFC 11C10 (Ammo Br) R



1 SSG 11C30 (Sqd Ldr) R
1 SP4 11C10 (Gnr) P
1 SP4 11C1U (Dvr) R
1 PFC 11C10 (Asst Gnr) P
1 PFC 11C10 (Ammo Br) R



1 SSG 11C30 (Sqd Ldr) R
1 SP4 11C10 (Gnr) P
1 SP4 11C1U (Dvr) R
1 PFC 11C10 (Asst Gnr) P
1 PFC 11C10 (Ammo Br) R



1 SSG 11C30 (Sqd Ldr) R
1 SP4 11C10 (Gnr) P
1 SP4 11C1U (Dvr) R
1 PFC 11C10 (Asst Gnr) P
1 PFC 11C10 (Ammo Br) R

BN SUPPORT PLATOON

HQ SEC



1 LT 12B92 (Plt Ldr Asst S-4) R
1 PFC 19K10 (Dvr) R

HHT MESS TM



1 SFC 94B40 (Food Svc SGT) R
1 SSG 94B30 (1st Cook) R
1 SGT 94B20 (Cook) R
2 SP4 94B10 (Cook) R
1 PFC 64B10 (Cook Veh Dvr) R

4 CO MESS TM'S



4 SFC 94B40 (Food Svc SGT) R
4 SGT 94B20 (1st Cook) R
4 SP4 94B10 (Cook Dvr) R
4 PFC 94B10 (Cook) R

TRANS SEC



1 SFC 64C40 (Trk Mstr) R
1 SGT 64C20 (Dvr) R
1 SP4 64C10 (Dvr Ammo Hdlr) R



1 SSG 64C30 (Ammo Sec SGT) R
1 SGT 64C20 (Dvr) R
1 SP4 64C10 (Dvr Ammo Hdlr) R

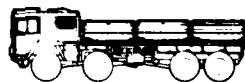

1 SGT 64C20 (Dvr) R
1 SP4 19K10 (Ammo Sp) R
1 SP4 64C10 (Dvr Ammo Hdlr) R

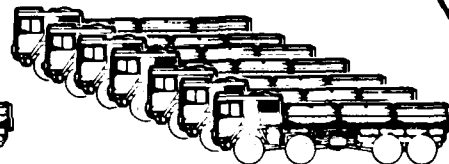

1 SGT 64C20 (Dvr) R
1 SP4 64C10 (Dvr Ammo Hdlr) R

POL SEC*



1 SSG 64C30 (POL Sec SGT) R
1 SGT 64C20 (Dvr) R



1 SGT 64C20 (Dvr) R

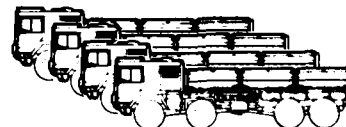

1 SGT 64C20 (Dvr) R
1 PFC 64C10 (Asst Dvr) R

* NOTE: POL Section will have PODS on the vehicles
The PODS are not shown.

BN MEDICAL PLATOON

PLT HQ



* 1 CPT 62A00 (Physician) R
1 SFC 91B40 (PSG) R
1 SGT 91B20 (Med Aidman Dvr) R

AID STATION SEC



1 WO 011A0 (PA) P
1 SSG 91C30 (Prac Nurse) R
1 SP4 91B1U (Amb Dvr) P



1 SSG 91C30 (Prac Nurse) R
1 SGT 91B20 (Med Aidman) R
1 SP4 91B1U (Amb Dvr) P

AIDMAN EVAC SEC

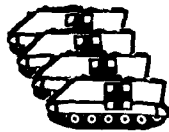

1 SGT 91B20 (Sr Med Aidman) R
1 SP4 91B1U (Amb Dvr) R
1 PFC 91B10 (Amb Attendant Dvr) P



1 SP4 91B1U (Amb Dvr) R
1 PFC 91B10 (Amb Attendant Dvr) P

* Also acts as Plt Ldr

BN MAINT PLT

BN MAINT PLT HQ



1 CPT 12B77 (Bn Maint Off) P
1 SP4 71L10 (Reports Clerk-Dvr) R



1 WO 630A0 (Auto Maint Tech) R
1 MSG 63250 (Bn Motor SGT) R

INSP/QUAL CON SEC



1 SFC 63C40 (Sec SGT) R
2 SSG 63C30 (Trk Veh Insp) R
1 SSG 63C30 (Auto Veh Insp) R
2 SSG 45K30 (Turret Insp) R
1 SSG 31V30 (Tac Comm Insp) R

MAINT ADMIN SEC



1 SSG 76D30 (Sec SGT) R
1 SP4 76D10 (PLL Clerk-Dvr) R



1 SGT 76D20 (Co PLL Clerk) R
1 PFC 76D10 (Equip Maint Clerk-Dvr) R



1 SGT 76D20 (Co PLL Clerk Dvr) R



1 SP4 76D10 (Equip Maint Clerk Dvr) R

461

RECOV SPT SEC



1 SSG 63F30 (Sec SGT) P
1 PFC 44B10 (Welder Dvr) R

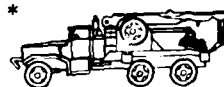

*
1 SP4 63F10 (Wrecker Op) R
1 SP4 63F10 (Wrecker Op Dvr) R

* W Winch

RECOV SPT SEC

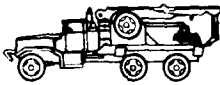

1 SGT 44B20 (Welder) R

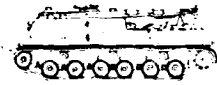

1 SGT 63F20 (Recov Veh Op) P S
1 PFC 63F10 (Recov Veh Op Dvr) P S



1 SGT 63F20 (Recov Veh Op) P S
1 PFC 63F10 (Recov Veh Op Dvr) P S



1 SGT 63F20 (Recov Veh Op) P S
1 PFC 63F10 (Recov Veh Op Dvr) P S

MAINT SVC SEC



1 SFC 63C40 (Sec SGT) R
1 PFC 63C10 (Trk Veh Mech Dvr) R



1 SGT 63C20 (Trk Veh Mech) R
1 SP4 63C10 (Trk Veh Mech) R
1 SP4 63C1U (Trk Veh Mech Dvr) R
1 PFC 63C1U (Trk Veh Mech Dvr) R



1 SGT 63C20 (Trk Veh Mech) R
2 SP4 63C10 (Trk Veh Mech) R
2 PFC 63C10 (Trk Veh Mech Dvr) R



1 SGT 31V20 (Tac Comm Mech) R
1 SP4 45N10 (Tk Trt Mech) R
1 SP4 63C1U (Trk Veh Mech Dvr) R



1 SP4 63B10 (Pwr Gen Mech) R
1 SP4 63C1U (Trk Veh Mech) R
1 PFC 63B10 (Pwr Gen Mech Dvr) R



1 SGT 45N20 (Tk Trt Mech) R
2 SP4 63C10 (Trk Veh Mech) R
1 PFC 63C10 (Trk Veh Mech Dvr) R

* W/Winch

TK CO MAINT TM



1 SFC 63C40 (Tm Chief) R
1 PFC 63C10 (Trk Veh Mech-Dvr) R



1 SFC 63C40 (Tm Chief) R
1 PFC 63C10 (Trk Veh Mech-Dvr) R



1 SFC 63C40 (Tm Chief) R
1 PFC 63C10 (Trk Veh Mech-Dvr) R



1 SFC 63C40 (Tm Chief) R
1 PFC 63C10 (Trk Veh Mech-Dvr) R



1 SP4 63C10 (Trk Veh Mech) R
1 PFC 45N10 (Tk Trt Mech) R
1 PFC 63C10 (Trk Veh Mech-Dvr) R



1 SP4 63C10 (Trk Veh Mech) R
1 PFC 45N10 (Tk Trt Mech) R
1 PFC 63C10 (Trk Veh Mech-Dvr) R



1 SP4 63C10 (Trk Veh Mech) R
1 PFC 45N10 (Tk Trt Mech) R
1 PFC 63C10 (Trk Veh Mech-Dvr) R



1 SP4 63C10 (Trk Veh Mech) R
1 PFC 45N10 (Tk Trt Mech) R
1 PFC 63C10 (Trk Veh Mech-Dvr) R



1 SGT 45N20 (Tk Trt Mech) R
1 SGT 63C20 (Trk Veh Mech) R
1 SP4 31V10 (Tac Comm Mech) R
1 SP4 46N10 (Tk Trt Mech-Dvr) R



1 SGT 45N20 (Tk Trt Mech) R
1 SGT 63C20 (Trk Veh Mech) R
1 SP4 31V10 (Tac Comm Mech) R
1 SP4 46N10 (Tk Trt Mech-Dvr) R



1 SGT 45N20 (Tk Trt Mech) R
1 SGT 63C20 (Trk Veh Mech) R
1 SP4 31V10 (Tac Comm Mech) R
1 SP4 46N10 (Tk Trt Mech-Dvr) R



1 SGT 45N20 (Tk Trt Mech) R
1 SGT 63C20 (Trk Veh Mech) R
1 SP4 31V10 (Tac Comm Mech) R
1 SP4 46N10 (Tk Trt Mech-Dvr) R

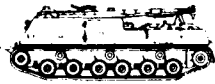

1 SGT 63F20 (Recov Veh Op) P, S
1 SP4 63F10 (Recov Veh Op-Dvr) P, S



1 SGT 63F20 (Recov Veh Op) P, S
1 SP4 63F10 (Recov Veh Op-Dvr) P, S

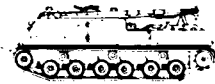

1 SGT 63F20 (Recov Veh Op) P, S
1 SP4 63F10 (Recov Veh Op-Dvr) P, S



1 SGT 63F20 (Recov Veh Op) P, S
1 SP4 63F10 (Recov Veh Op-Dvr) P, S

* W-Winch

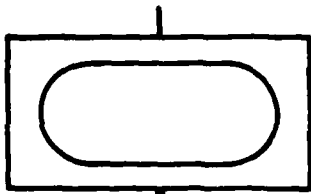

0	WO	EM	AGG
5	0	57	62

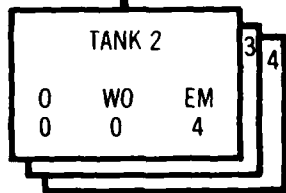
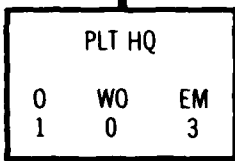
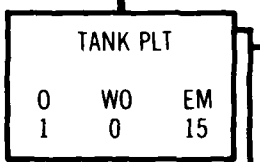
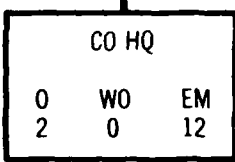

464

SUMMARY OF EQUIPMENT

	WEAPONS		NBC EQUIPMENT	
	RAYONET-KNIFE: W/SCABBARD FOR M16A1 RIFLE.....	62	ALARM CHEMICAL AGENT AUTOMATIC: PORTABLE MANPACK.....	6
	LAUNCHER GRENADE 40 MILLIMETER: SGLE SHOT RIPLE MTD DITCHBLE W/E..	2	ALARM CHEMICAL AGENT AUTOMATIC: PTBL W/PWR SUP F/TRK UTIL 1/4TON.	2
	LAUNCHER GRENADE SMOKE: SCREENING RP M250.....	14	RADIAC SET: AN/VDR-1.....	5
	LAUNCHER ROCKET: 66MM 4-TUBE.....	1	CHARGER RADIAC DETECTOR: PP-4370/PD.....	1
	MACHINE GUN CALIBER .50: HEAVY FIXED TURRET TYPE.....	14	MASK CHEMICAL-BIOLOGICAL: MULTI PURPOSE.....	62
	PISTOL CALIBER .45 AUTOMATIC.....	58		
	RIFLE 5.56 MILLIMETER: W/E.....	34		
	MACHINE GUN 7.62MM: FIXED M240C RH FEED F/PVS.....	28		
405	MACHINE GUN .50 CAL .50 MB FLEX.....	1		
	VEHICLES		MISCELLANEOUS EQUIPMENT	
	TRAILOR CARGO: 1-1/2 TON 2 WHEEL W/E.....	1	BINOCULAR: MODULAR CONSTRUCTION MIL SCALE RETICLE 7X50MM W/F.....	16
	TRUCK CARGO: 2-1/2 TON 6X6 W/E.....	1	NIGHT VISION GOGGLES: AN/PVS-5.....	17
	TRUCK UTILITY: 1/4 TON 4X4 W/E.....	2	NIGHT VISION SIGHT INDIVIDUAL SERVED WEAPON: AN/PVS-4.....	2
	MOTORCYCLE: 2 WHEEL.....	2	PLATOON EARLY WARNING SYSTEM: AN/TRS-2 (V).....	3
	TANK COMBAT FULL TRACKED: 105MM GUN XM1.....	14	COMBAT VEHICLE HEADING REFERENCE UNIT (CV-HRU).....	14

TANK COMPANY (DIVISION 86)

TANK COMPANY

HQ SEC



1 CPT 1,800 (Car) P
1 SGT 54E20 (NB) Ops NC01 GL



1 LT 1,800 (OO) P
1 SSG 1975M (First Sergeant) R



1 SSG 76Y30 (Supply Sergeant) P
1 SP4 76T10 (Armorer/Driver) GL



HQ TK SEC



1 SSG 19K30 (Tank Commander) P
1 SGT 19K20 (Sr Gunner) P
1 SP4 19K10 (Loader) P, R
1 SP4 19L10 (Tank Driver) P, R

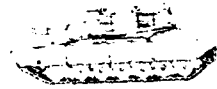

1 SSG 19K30 (Tank Commander) P
1 SP4 19K10 (Gunner) P
1 SP4 19L10 (Tank Driver) P, R
1 PFC 19K10 (Loader) P, R

* Used when necessary for messenger service

1ST TANK PLATOON

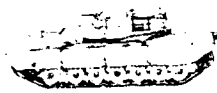

1 LT 19K10 (Plt Ldr) P
1 SGT 19K20 (Sr Gnr) P
1 SGT 19L20 (Sr Dvr) P R
1 SP4 19K10 (Loader) P R

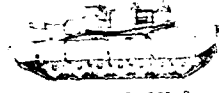

1 SFC 19K30 (Plt SGT) P
1 SGT 19K20 (Sr Gnr) P
1 SP4 19L10 (Dvr) P R
1 SP4 19K10 (Loader) P R

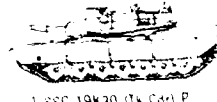

1 SSG 19K30 (Tn Cdr) P
1 SGT 19K20 (Sr Gnr) P
1 PFC 19L10 (Dvr) P R
1 PFC 19K10 (Loader) P R

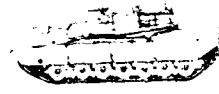

1 SSG 19K30 (Tn Cdr) P
1 SP4 19K10 (Gnr) P
1 SP4 19L10 (Dvr) P R
1 PFC 19K10 (Loader) P R

2D TANK PLATOON

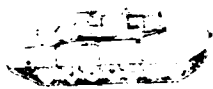

1 LT 19B00 (Plt Ldr) P
1 SGT 19K20 (Sr Gnr) P
1 SGT 19L20 (Sr Dvr) P R
1 SP4 19K10 (Loader) P R

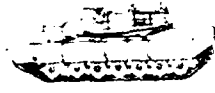

1 SFC 19K30 (Plt SGT) P
1 SGT 19K20 (Sr Gnr) P
1 SP4 19L10 (Dvr) P R
1 SP4 19K10 (Loader) P R

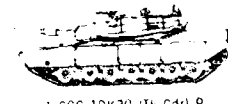

1 SSG 19K30 (Tn Cdr) P
1 SGT 19K20 (Sr Gnr) P
1 PFC 19L10 (Dvr) P R
1 PFC 19K10 (Loader) P R



1 SSG 19K30 (Tn Cdr) P
1 SP4 19K10 (Gnr) P
1 SP4 19L10 (Dvr) P R
1 PFC 19K10 (Loader) P R

3D TANK PLATOON



1 LT 12B00 (Pit Ldr) P
1 SGT 19K20 (Sr Gnr) P
1 SGT 19L20 (Sr Dvr) P R
1 SP4 19K10 (Loader) P R

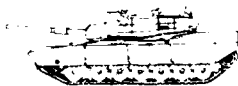

1 SFC 19K40 (Plt SGT) P
1 SGT 19K20 (Sr Gnr) P
1 SP4 19L10 (Dvr) P R
1 SP4 19K10 (Loader) P R

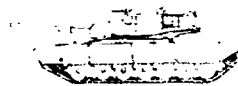

1 SSG 19K30 (Tn Cdr) P
1 SGT 19K20 (Sr Gnr) P
1 PFC 19L10 (Dvr) P R
1 PFC 19K10 (Loader) P R

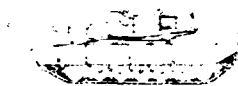

1 SSG 19K30 (Tn Cdr) P
1 SP4 19K10 (Gnr) P
1 SP4 19L10 (Dvr) P R
1 PFC 19K10 (Loader) P R

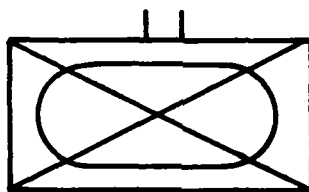

0	WO	EM	AGG
45	2	822	869

HQ & HQ CO		
0	WO	EM
20	2	334

ANTITANK CO		
0	WO	EM
5	0	64

RIFLE CO		
0	WO	EM
5	0	106

470

SUMMARY OF EQUIPMENT

WEAPONS			
BAYONET-KNIFE: W/SCABBARD FOR M16A1 RIFLE.....	826	TRAILER CARGO 3/4 TON 2 WHEEL.....	3
LAUNCHER GRENADE 40MM.....	147	TRAILER CARGO 1-1/2 TON 2 WHEEL.....	34
LAUNCHER RKT 66MM.....	21	TRAILER TANK: WATER 400 GALS.....	5
LAUNCHER TUBULAR GUIDED MISSILE (TOW).....	12	TRUCK CARGO TAC 1-1/4 TON 4X4 W/E.....	2
MACHINE GUN CAL .50 HB FLEX VEH MTD.....	1	TRUCK CARGO TAC 1-1/4 TON 4X4 W/60 AMP COMM KITS.....	2
MACHINE GUN CAL .50 HB FLEX GRD USE.....	41	TRUCK CARGO 1-1/4 TON 6X6 W/E.....	3
MACHINE GUN 7.62MM - FIXED.....	6	TRUCK CARGO 2-1/2 TON 6X6 W/E.....	22
MACHINE GUN 7.62MM - LIGHT FLEXIBLE.....	55	TRUCK CARGO DROPSIDE 2-1/2 TON 6X6 W/E.....	6
MORTAR 4.2 IN.....	6	TRUCK CARGO 2-1/2 TON 6X6 W/WINCH W/E.....	10
PISTOL CAL .45 AUTO.....	175	TRUCK CARGO 5 TON 6X6 LWB W/E.....	14
RIFLE 5.56MM W/E.....	630	TRUCK CARGO 5 TON 6X6 LWB W/WINCH W/E.....	1
SUBMACHINE GUN CAL .45.....	22	TRUCK UTILITY 1/4 TON 4X4 W/E.....	20
SUBMACHINE GUN 5.56MM: PORT FIRING M231.....	330	TRUCK WRBCKER 5 TON 6X6 W/WINCH W/E.....	2
MACHINE GUN 7.62MM: FIXED M240C RH FEED F/VIS.....	12	TRUCK CARGO: 10 TON 8X8 HIGH MOBILITY XM977.....	4
MACHINE GUN 5.56MM: (SAW).....	72	TRUCK TANK: FUEL SERVICEING 2500 GAL 8X8 HMO W/WINCH.....	5
MACHINE GUN 7.62MM: FIXED.....	55		
NBC EQUIPMENT		MISCELLANEOUS EQUIPMENT	
ALARM CHEMICAL AGENT AUTO - PORTABLE MANPACK.....	21	LASER INFRARED OBSERVATION SET: AN/GVS-5.....	2
DECON APPARATUS - PWR DRIVEN SKID MTD: MULTIPURPOSE.....	1	NIGHT VISION GOGGLES: AN/PVS-5.....	198
MASK CBR: HEADWOUND PROTECTIVE.....	10	NIGHT VISION SIGHT CREW SERVED WPN: AN/TVS-5.....	27
RADIAC SET: AN/VDR-1.....	50	NIGHT VISION SIGHT INDIVIDUAL SERVED WPN: AN/PVS-4.....	185
CHARGER RADIAC DETECTOR: PP-4370/PD.....	13	NIGHT VISION SIGHT INFRARED: AN/TAS-4.....	12
MASK CHEM-BIO: MULTI PURPOSE.....	869	NIGHT VISION SIGHT INFRARED: AN/TAS-6.....	9
RADIACMETER: IM-185/UD.....	82	PLATOON EARLY WARNING SYSTEM: AN/TRS-2(V).....	14
VEHICLES		TARGET DESIGNATOR LASER: AN/PAQ-1.....	2
CAVALRY FIGHTING VEHICLE: M3.....	7	TANK AND PUMP UNIT LIQUID DISPENSING TRUCK MTDING.....	1
CARRIER 107MM MORTAR.....	6	TANK AND LIQUID DISPENSING TRAILER MTDING.....	1
CARRIER CMD POST LIGHT TRACKED.....	8	COMPUTER INDICATOR: CP-696/UD.....	5
CARRIER PERSONNEL FULL TRACKED.....	20	COMPUTER BALLISTICS: MORTAR XM23.....	4
CBT VEHICLE ANTI-TANK: IMPROVED TOW VEHICLE.....	12	DEMOLITION SET EXPLOSIVE.....	5
INFANTRY FIGHTING VEH: M2.....	54	DETECTING SET MINE: PTBL METALLIC AND NON-METALLIC.....	1
RECOVERY VEHICLE FULL TRACKED: MEDIUM.....	7	DETECTING SET MINE: PTBL METALLIC (AN/PSS-11).....	3
TRAILER CARGO 1/4 TON 2 WHEEL W/E.....	19	PLRS BASIC USER UNIT.....	34
MOTORCYCLE: 2 WHEEL.....	4	PLRS MANPACK UNIT INSTALLATION KIT.....	23
		PLRS SURFACE VEHICLE INSTALLATION KIT.....	34

INFANTRY BATTALION MECHANIZED (DIVISION 86)

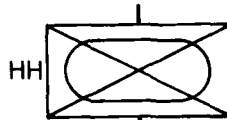

BN HQ PLT			
0	WO	EM	AGG
45	2	822	869
0	WO	EM	
3	0	9	

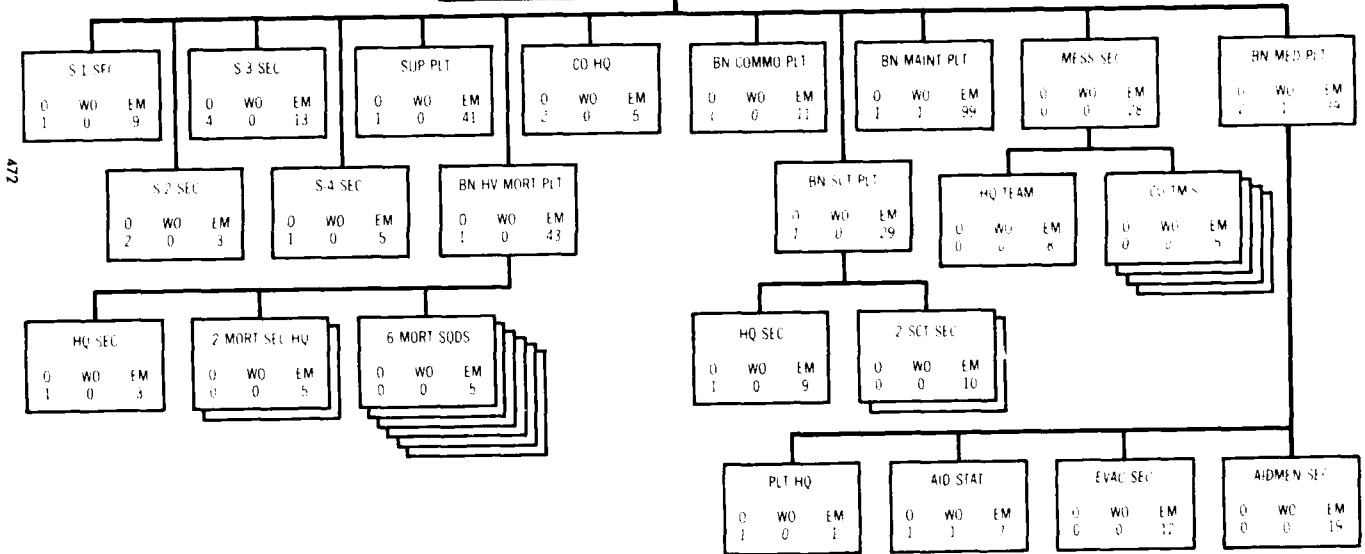

477

SUMMARY OF EQUIPMENT

WEAPONS			
RAYONET-KNIFE: W/SCABBARD FOR M6A1 RIFLE.....	314	TRUCK CARGO: TACTICAL 1-1/4 TON 4X4 W/E.....	7
LAUNCHER GRENADE 40 MILLIMETER: SGL SHOT RIFLE NTD DITCHBLE W/E..	15	TRUCK CARGO: TACTICAL 1-1/4 TON 4X5 W/60 AMP-COMM KITS W/E.....	7
LAUNCHER ROCKET: 66MM 4-TUBE.....	9	TRUCK CARGO: 1-1/4 TON 6X6 W/E.....	3
MACHINE GUN CALIBER .50: HB FLEXIBLE FOR GROUND USE.....	30	TRUCK CARGO: 2-1/2 TON 6X6 W/E.....	12
MACHINE GUN 7.62 MILLIMETER: FIXED.....	6	TRUCK CARGO: DROP SIDE 2-1/2 TON 6X6 W/E.....	7
MACHINE GUN 7.62 MILLIMETER: LIGHT FLEXIBLE.....	19	TRUCK CARGO: 2-1/2 TON 6X6 W/WINCH W/E.....	10
M1 MORTAR 4.2 INCH: ON MOUNT.....	6	TRUCK CARGO: 5 TON 6X6 LWB W/E.....	14
RIFLE 5.56 MILLIMETER: W/E.....	254	TRUCK CARGO: 5 TON 6X6 LWB W/WINCH W/E.....	1
PISTOL CALIBER .45 AUTOMATIC.....	110	TRUCK UTILITY: 1/4 TON 4X4 W/E.....	15
SUBMACHINE GUN 5.56 MILLIMETER: PORT FIRING M231.....	18	TRUCK WRACKER: 5 TON 8X8 W/WINCH W/E.....	7
SUBMACHINE GUN CALIBER .45.....	14	MOTORCYCLE: 2 WHEEL.....	4
MACHINE GUN 7.62 MILLIMETER: FIXED.....	3	TRUCK CARGO: 10 TON 8X8 HIGH MOBILITY XM977.....	4
		TRUCK TANK: FUEL SERVICING 2500 GAL 8X8 H MO W/WINCH.....	5
NBC EQUIPMENT		MISCELLANEOUS EQUIPMENT	
ALARM CHEMICAL AGENT AUTOMATIC: PORTABLE MANPACK.....	2	DEMOLITION SET EXPLOSIVE: INITIATING ELECTRIC AND SEMI ELECTRIC..	1
MASK CBR: HEAD/SHOULDER PROTECTIVE.....	10	DETECTING SET MINE: PTBL METALLIC AND NON METALLIC.....	1
RADIAC SET: AN/VDR-1.....	21	DETECTING SET MINE: PTBL METALLIC (AN/PSS-11).....	3
CHARGER RADIAC DETECTOR: PP-4370/PD.....	6	PLATOON EARLY WARNING SYSTEM: AN/TRS-2(V).....	7
MASK CHEMICAL-BIOLOGICAL: MULTI PURPOSE.....	356	TARGET DESIGNATOR LASER: AN/PAQ-1.....	7
RADIAC METER: IM-185/UD.....	30	PLRS BASIC USER UNIT.....	14
DECONTAMINATING APPARATUS POWER DRIVEN SKID MOUNTED: MULTIPURPOS.	1	PLRS MANPACK UNIT INSTALLATION KIT(MUPIK).....	7
		PLRS SURFACE VEHICLE INSTALLATION KIT.....	14
VEHICLES AND VEHICLE EQUIPMENT		TANK AND PUMP UNIT LIQUID DISPENSING TRUCK MOUNTING.....	1
CAVALRY FIGHTING VEHICLE: M3.....	7	TANK UNIT LIQUID DISPENSING TRAILER MOUNTING.....	1
CARRIER 107 MILLIMETER MORTAR: SELF PROPELLED (LESS MORTAR).....	6	COMPUTER INDICATOR: CP-696/UD.....	1
CARRIER COMMAND POST: LIGHT TRACKED.....	8	COMPUTER BALLISTICS: MORTAR XM21.....	4
CARRIER PERSONNEL FULL TRACKED: ARMORED.....	17	LASER INFRARED OBSERVATION SET.....	2
INFANTRY FIGHTING VEHICLE: M2.....	2	NIGHT VISION GOGGLES: AN/PVS-5.....	49
RECOVERY VEHICLE FULL TRACKED: MEDIUM.....	7	NIGHT VISION SIGHT CREW SERVED WEAPON: AN/PVS-5.....	22
TRAILER CARGO: 1/4 TON 2 WHEEL W/E.....	14	NIGHT VISION SIGHT INDIVIDUAL SERVED WEAPON: AN/PVS-4.....	9
TRAILER CARGO: 3/4 TON 2 WHEEL W/E.....	3	NIGHT VISION SIGHT INFRARED: AN/TAS-5.....	2
TRAILER CARGO: 1-1/2 TON 2 WHEEL W/E.....	24		
TRAILER TANK: WATER 400 GALLON 1-1/2 TON 2 WHEEL W/E.....	5		

HEADQUARTERS AND HEADQUARTERS COMPANY INFANTRY BATTALION — MECHANIZED (DIVISION 86)

473

BN HQ SEC



1 LTC 11C00 (Bn Cdr) P
1 PFC 11B10 (RTO Dvr) R



1 MAJ 11C00 (XO) P
1 CSM 00Z50 (CSM) R
1 PFC 11B10 (RTO Dvr) R



1 CPT 56A00 (Chap)
1 SP4 71M10 (Chap Asst) (Dvr) R



1 SGT 11H20 (Sec SGT) R
1 SGT 11H20 (IFV Gunner) P
1 SP4 11H10 (Veh Cdr) P
1 SP4 11H10 (Veh Dvr) P
1 PFC 05B10 (RTO) R

S-1



1 CPT 11C41 (S 1) R
1 SFC 75Z40 (PAC Supv) R
1 SSG 75Z30 (Pers Staff NCO) R
1 SGT 71D20 (Legal Clerk) R
1 SGT 75B20 (PAC Clerk) R
1 SP4 71L10 (Clerk Typ) R
1 SP4 75B10 (PAC Clerk) R
1 SP4 11B1U (Dvr) P
2 PFC 75B10 (PAC Clerk) R

S-2



1 CPT 35A00 (S 2) R
1 LT 35A00 (Tac Intel Off) R
1 MSG 11B50 (Intel SGT) R
1 SSG 99B30 (Sr Intel Anal) R
1 SP4 11B10 (Carr Dvr) P

S-4



1 CPT 11C92 (S 4) R
1 SP4 76Y10 (Sup Sp Dvr) R

S-3 SEC



1 MAJ 11A00 (S 3) P
1 PFC 11B10 (Dvr) R



1 LT 74A00 (Asst S 3 Cml Off) R
1 PFC 11B10 (Dvr) R



1 LT 11C00 (Ln Off) R
1 SP4 05B10 (RTO-Dvr) R



1 MSG 11B50 (Op SGT) R
1 SP4 71L10 (Clerk Typist) R



1 CPT 11C00 (S 3 Arr) R
1 SFC 11B40 (Op SGT) R
1 SSG 54E30 (NBC SGT) R
1 SP4 05B10 (RTO) R
1 SP4 11B1U (Dvr) P



1 SGT 11B20 (IFV Gnr) R
1 SP4 11B1U (IFV Dvr) P



*
1 SGT 11B20 (IFV Gnr) R
1 SP4 11B1U (IFV Dvr) P

* ALO Vehicle

CO HQ SEC



1 MAJ 11C00 (Cdr) P
1 PFC 11B10 (RTO-Dvr) GL



1 CPT 11C00 (XO) R
1 PFC 11B10 (RTO-Dvr) GL



1 ISG 11B40 (ISG) R
1 SSG 76Y30 (Supply Sgt) R
1 SGT 76Y20 (Armorer Dvr) GL

BN COMMO PLT



1 CPT 25A00 (C.E. Off) R
1 PFC 11B10 (Dvr) R



1 SGT 36K20 (Wire Tm Chief) R
1 PFC 11B10 (Dvr) R



1 SGT 36K20 (Wire Tm Ch) R
2 SP4 36K10 (Wire Op Sp Dvr) R
2 SP4 36K10 (Wire Op Sp) R



1 SFC 31V40 (Com Chief) R
1 SGT 05B20 (RTO) R
1 PFC 05B10 (RTO Dvr) R

475

BN SCOUT PLT

HQ SEC



1 LT 11C00 (Plt Ldr) R
1 SGT 19D20 (IFV Gnr) R
1 SP4 19D10 (Sct) R
1 PFC 19D10 (Sct) R
1 PFC 19D1U (Dvr) R



1 SFC 19D40 (Plt SGT) R
1 SGT 19D20 (IFV Gnr) R
1 SP4 19D10 (Sct) R
1 PFC 19D10 (Sct) R
1 PFC 19D1U (Dvr) R

1ST SCT SEC

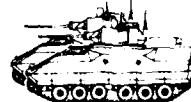

1 SSG 19D30 (Sec Ldr) R
1 SSG 19D30 (Sqd Ldr) R
2 SGT 19D20 (IFV Gnr) R
2 SP4 19D10 (Sct) R
2 SP4 19D1U (Dvr) GL
2 PFC 19D10 (Sct) R

2D SCT SEC



1 SSG 19D30 (Sec Ldr) R
1 SSG 19D30 (Sqd Ldr) R
2 SGT 19D20 (IFV Gnr) R
2 SP4 19D10 (Sct) R
2 SP4 19D1U (Dvr) GL
2 PFC 19D10 (Sct) R

* Used for Msgr Svc

BN SPT PLT

HQ SEC **TRANS SEC**



1 LT 11C92 (Plt Ldr. Asst S-4) R
1 PFC 11B10 (Dvr) R



*
1 SFC 11B40 (Ammo Chief) R
1 PFC 54E10 (Decon Equip Handler) R
1 PFC 64C10 (Dvr) R



1 SSG 64C30 (Sqd Ldr) R
1 PFC 64C10 (Dvr) R

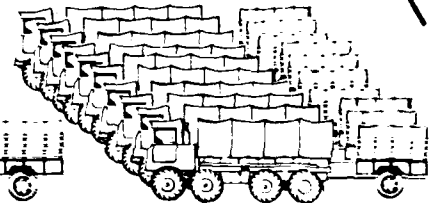

1 PFC 11B10 (Ammo Hd'r) Dvr. R

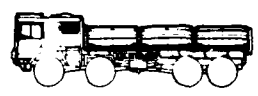

1 SSG 64C30 (Sr Hv Veh Dvr) R
1 SP4 64C10 (Veh Dvr) P
1 PFC 11B10 (Ammo Handler) R



1 SGT 64C20 (Hv Veh Dvr) R
1 SP4 64C10 (Hv Veh Dvr) R
1 PFC 11B10 (Ammo Handler) R



2 SP4 64C10 (Hv Veh Dvr) R

POL SEC



W/Winch
1 SSG 64C30 (Sqd Ldr) R
1 SP4 76W10 (Petro Veh Op) R
1 SP4 64C10 (Veh Dvr) P



W/Winch
1 SGT 76W20 (Petro Veh Op) R
1 SP4 76W10 (Petro Veh Op) R
1 SP4 64C10 (Veh Dvr) P

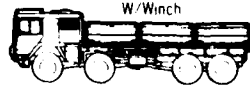

W/Winch
2 SP4 76W10 (Petro Veh Op) R
1 SP4 64C10 (Veh Dvr) P



W/Winch
1 SP4 76W10 (Petro Veh Op) R
1 SP4 64C10 (Veh Dvr) P

S-4 TRANS SECTION



1 SFC 76Y40 (Sup SGT) R
1 PFC 76Y10 (Sup Sp/Dvr) R



1 SGT 76Y20 (Sup Sp) R
1 SP4 76Y10 (Sup Sp/Dvr) R

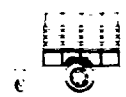

* W/Winch & Skid Mtd Decon Apparatus

MESS SECTION

HQ CO TM



- 1 SFC 94B40 (Food Svc SGT) R
- 1 SSG 94B30 (1st Cook) R
- 1 SGT 94B20 (Cook) R
- 2 SP4 94B10 (Cook Dvr) R
- 3 PFC 94B10 (Cook) R

4 CO MESS TMS



- 1 SSG 94B30 (Food Svc SGT) R
- 1 SGT 94B20 (1st Cook) R
- 2 SP4 94B10 (Cook Dvr) R
- 1 PFC 94B10 (Cook) R

HV MORTAR PLATOON

MORT PLT HQ



1 LT 11A00 (Plt Ldr) R
1 PFC 11C10 (RTO Dvr) R



1 SFC 11C40 (Plt SGT) R
1 PFC 11C10 (Dvr) R

MORT SEC HQ



1 SSG 11C30 (Sec Ldr) R
2 SGT 11C20 (FDC) R
1 SP4 11C1U (Dvr) P
1 PFC 11C10 (RTO) R



1 SSG 11C30 (Sec Ldr) R
2 SGT 11C20 (FDC) R
1 SP4 11C1U (Dvr) P
1 PFC 11C10 (RTO) R

MORTAR SQUADS



1 SGT 11C20 (Sqd Ldr) R
1 SP4 11C1U (Dvr) P
1 SP4 11C10 (Gnr) P
1 PFC 11C10 (Ammo Br) R
1 PFC 11C10 (Asst Gnr) P



1 SGT 11C20 (Sqd Ldr) R
1 SP4 11C1U (Dvr) P
1 SP4 11C10 (Gnr) P
1 PFC 11C10 (Ammo Br) R
1 PFC 11C10 (Asst Gnr) P



1 SGT 11C20 (Sqd Ldr) R
1 SP4 11C1U (Dvr) P
1 SP4 11C10 (Gnr) P
1 PFC 11C10 (Ammo Br) R
1 PFC 11C10 (Asst Gnr) P



1 SGT 11C20 (Sqd Ldr) R
1 SP4 11C1U (Dvr) P
1 SP4 11C10 (Gnr) P
1 PFC 11C10 (Ammo Br) R
1 PFC 11C10 (Asst Gnr) P



1 SGT 11C20 (Sqd Ldr) R
1 SP4 11C1U (Dvr) P
1 SP4 11C10 (Gnr) P
1 PFC 11C10 (Ammo Br) R
1 PFC 11C10 (Asst Gnr) P



1 SGT 11C20 (Sqd Ldr) R
1 SP4 11C1U (Dvr) P
1 SP4 11C10 (Gnr) P
1 PFC 11C10 (Ammo Br) R
1 PFC 11C10 (Asst Gnr) P

BN MEDICAL PLT

PLT HQ



1 LT 67B00 (Plt Ldr) P
1 SFC 91B40 (Plt SGT) P

AID STATION



1 CPT 62A00 (Physician) P
1 SSG 91C30 (Prac Nur) P
1 SP4 91B1U (Dvr) P
1 PFC 91C10 (Patient Care Sp) P



1 WO 011A0 (PA) P
1 SGT 91B20 (Med Aidman) P
1 SP4 91B10 (Med Aidman) P
1 SP4 91B1U (Dvr) P
1 PFC 91B10 (Med Aidman) P

EVACUATION SEC



1 SSG 91B30 (Sec SGT) R
1 SP4 91B1U (Amb Dvr) P



1 SGT 91B20 (Med Aidman) P
1 SP4 91B1U (Amb Dvr) P



1 SP4 91B10 (Med Aidman) P
1 SP4 91B1U (Amb Dvr) P



1 SP4 91B10 (Med Aidman) P
1 SP4 91B1U (Amb Dvr) P



1 PFC 91B10 (Med Aidman) P
1 SP4 91B1U (Amb Dvr) P



1 PFC 91B10 (Med Aidman) P
1 SP4 91B1U (Amb Dvr) P

BN MAINT PLATOON

MAINT PLT HQ



1 CPT 11C91 (Bn Maint Off) R
1 SP4 71L10 (Reports Clerk RTO Dvr) R

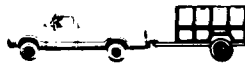

1 WO 630A0 (Autmv Maint Tech) R



1 MSG 63750 (EVS ITV Maint Supv) R

INSPECTION/Q-C SEC



1 SFC 63140 (Section Chief) R
1 SSG 63B30 (Automotive Insp RTO/Dvr) R
1 SSG 63130 (ITV IFV CFV Insp) R
1 SSG 31V30 (Tac Comm Sys Insp) R



1 SSG 76P30 (Section Chief) R
1 PFC 76C10 (Eq Records Clerk Dvr) R



1 SSG 76P30 (Sec Chief) R
1 SGT 76C20 (Eq Rcd Clerk Pt Sp Dvr) R



1 SGT 76C20 (Eq Rcd Clerk Pt Sp Dvr) R



1 SGT 76C20 (Eq Rcd Clerk Pt Sp Dvr) R



1 SGT 76C20 (Eq Rcd Clk Pt Sp Dvr) R



1 SGT 76C20 (Eq Rcd Clk Pt Sp Dvr) R



1 SGT 76C20 (Eq Rcd Clk Pt Sp Dvr) R
1 PFC 76C10 (Eq Rcds Clk Dvr) R

SUPPORT SECTION



1 SSG 63T30 (Section Chief) R
1 PFC 44B10 (Welder) Dvr) R

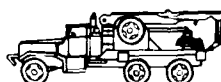

1 SGT 63T20 (Recov Veh Op) P
1 PFC 44B10 (Welder) Dvr) R

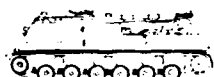

1 SGT 63T20 (Recovery Veh Op) RT0) P
1 SP4 63T10 (Recovery Veh Op) RT0) P, S
1 PFC 63T10 (Recovery Veh Op) Dvr) P, S

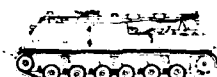

1 SP4 63T10 (Recovery Veh Op) RT0) P, S
1 PFC 63T10 (Recovery Veh Op) Dvr) P, S

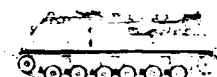

1 SP4 63T10 (Recovery Veh Op) RT0) P, S
1 PFC 63T10 (Recovery Veh Op) Dvr) P, S

MAINT/SVC SECTION

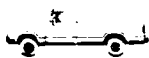

1 SFC 63T40 (FVS) (TV Maint Supv) R
1 PFC 63B10 (Lt W Veh) Pwr Gen Mech) Dvr) R



1 SGT 31V20 (Tac Comm Sys Op Mech) R
3 PFC 31V10 (Tac Comm Sys Op Mech) Dvr) R



1 SGT 63S20 (Hv Wht Veh Mech) R
1 SGT 63B20 (Lt W Veh) Pwr Gen Mech) R
1 SP4 63B10 (Lt W Veh) Pwr Gen Mech) R
1 PFC 63T10 (Hv Wht Veh Mech) Dvr) R



1 SGT 63T20 (ITV) (IFV) (CFV) (Auto Mech) R
2 SP4 63T10 (ITV) (IFV) (CFV) (Auto Mech) Dvr) R
1 SP4 45T10 (IFV) (CFV) (Turret Mech) R



1 SGT 63T20 (ITV) (IFV) (CFV) (Auto Mech) R
2 SP4 63T10 (ITV) (IFV) (CFV) (Auto Mech) Dvr) R
1 PFC 45T10 (IFV) (CFV) (Turret Mech) R



1 SGT 63T20 (ITV) (IFV) (CFV) (Auto Mech) R
2 SP4 63T10 (ITV) (IFV) (CFV) (Auto Mech) Dvr) R
1 SP4 63T10 (ITV) (IFV) (CFV) (Auto Mech) R



1 SGT 63T20 (ITV) (IFV) (CFV) (Auto Mech) R
3 SP4 63T10 (ITV) (IFV) (CFV) (Auto Mech) Dvr) R
1 SP4 63T10 (ITV) (IFV) (CFV) (Auto Mech) R

* W Winch

4 RIFLE CO MAINT TMS



1 SFC 63140 (FVS (TV Maint Supv) R
 1 SP4 31V10 (Tac Comm Sys Op Mech) P
 1 PFC 63110 (ITV (FV (FV Auto Mech Dvr) GL



1 SFC 63140 (FVS (TV Maint Supv) R
 1 SP4 31V10 (Tac Comm Sys Op Mech) P
 1 PFC 63110 (ITV (FV (FV Auto Mech Dvr) GL



1 SFC 63140 (FVS (TV Maint Supv) R
 1 SP4 31V10 (Tac Comm Sys Op Mech) R
 1 PFC 63110 (ITV (FV (FV Auto Mech Dvr) GL



1 SFC 63140 (FVS (TV Maint Supv) R
 1 SP4 31V10 (Tac Comm Sys Op Mech) R
 1 PFC 63110 (ITV (FV (FV Auto Mech Dvr) GL

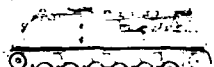

1 SGT 63120 (Recovery Veh Op) P
 1 SP4 63110 (Recovery Veh Op Dvr) P

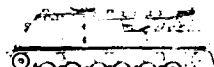

1 SGT 63120 (Recovery Veh Op) P
 1 SP4 63110 (Recovery Veh Op Dvr) P

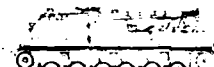

1 SGT 63120 (Recovery Veh Op) P
 1 SP4 63110 (Recovery Veh Op Dvr) P

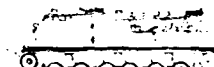

1 SGT 63120 (Recovery Veh Op) P
 1 SP4 63110 (Recovery Veh Op Dvr) P

481



1 SGT 45120 (IFV (FV Turret Mech) P
 1 SP4 45110 (IFV (FV Turret Mech) Dvr) P



1 SGT 45120 (IFV (FV Turret Mech) P
 1 SP4 45110 (IFV (FV Turret Mech) P
 1 PFC 45110 (IFV (FV Turret Mech) Dvr) R



1 SGT 45120 (IFV (FV Turret Mech) P
 1 SP4 45110 (IFV (FV Turret Mech) P
 1 PFC 45110 (IFV (FV Turret Mech) Dvr) R



1 SGT 45120 (IFV (FV Turret Mech) P
 1 SP4 45110 (IFV (FV Turret Mech) P
 1 PFC 45110 (IFV (FV Turret Mech) Dvr) R



1 SGT 63120 (ITV (FV (FV Auto Mech) R
 1 SP4 6311U (ITV (FV (FV Auto Mech) Dvr) R



1 SGT 63120 (ITV (FV (FV Auto Mech) R
 1 SP4 6311U (ITV (FV (FV Auto Mech) Dvr) R



1 SGT 63120 (ITV (FV (FV Auto Mech) R
 1 SP4 6311U (ITV (FV (FV Auto Mech) Dvr) R



1 SGT 63120 (ITV (FV (FV Auto Mech) R
 1 SP4 6311U (ITV (FV (FV Auto Mech) Dvr) R

ANTIARMOR CO MAINT TM



- 1 SFC 63T40 (FVS/ITV Maint Supervisor) R
- 1 PFC 45T10 (IFV/CFV Turret Mech) R
- 1 Pfc 63T10 (ITV/IFV/CFV Auto Mech-Dvr) R



- 1 SGT 63T20 (ITV/IFV/CFV Auto Mech) R
- 1 SP4 45T10 (IFV/CFV Turret Mech) R
- 1 SP4 63T10 (ITV/IFV/CFV Auto Mech) R
- 1 SP4 31V10 (Tac Comm Sys Op Mech-Dvr) GL

Notes:

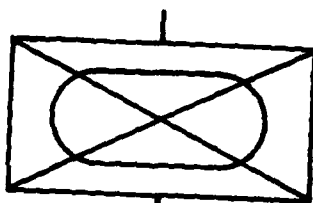

0	WO	EM	AGG
5	0	106	111

484

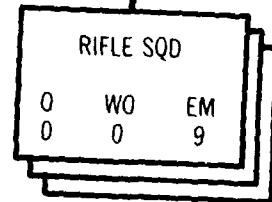
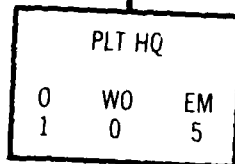
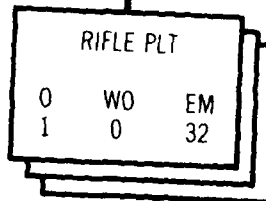
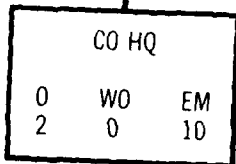

SUMMARY OF EQUIPMENT

	WEAPONS			
485	RAYONET-KNIFE W/SCABBARD FOR WEAPONS.....	111		
	LAUNCHER GRENADE 40 MILLIMETER: SGLE SHOT RIFLE MTD DITCHBLE W/E..	30		
	LAUNCHER ROCKET: 66MM 4-TUBE.....	3		
	MACHINE GUN CALIBER .50: HB FLEXIBLE FOR GROUND USE.....	2		
	MACHINE GUN 7.62 MILLIMETER: LIGHT FLEXIBLE.....	9		
	PISTOL CALIBER .45 AUTOMATIC.....	10		
	RIFLE 5.56 MILLIMETER: W/E.....	83		
	SUBMACHINE GUN 5.56 MILLIMETER: PORT FIRING M231.....	78		
	SUBMACHINE GUN CALIBER .45.....	2		
	MACHINE GUN 5.56 MILLIMETER: (SAW).....	18		
	MACHINE GUN 7.62 MILLIMETER: FIXED.....	13		
	VEHICLES			
	CARRIER PERSONNEL FULL TRACKED: ARMORED.....	1		
	INFANTRY FIGHTING VEHICLE: M2.....	13		
	TRAILER CARGO: 1/4 TON 2 WHEEL W/E.....	1		
	TRAILER CARGO: 1-1/2 TON 2 WHEEL W/E.....	2		
	TRUCK CARGO: 2-1/2 TON 6X6 W/E.....	2		
	TRUCK UTILITY: 1/4 TON 4X4 W/E.....	1		
			NBC	
			ALARM CHEMICAL AGENT AUTOMATIC: PORTABLE MANPACK.....	4
			CHARGER RADIAC DETECTOR: PP-4370/PD.....	1
			MASK CHEMICAL-BIOLOGICAL: MULTI PURPOSE.....	111
			RADIAC METER: IM-185/UD.....	8
			RADIAC SET: AN/VDR-1.....	3
			MISCELLANEOUS EQUIPMENT	
			DEMOLITION SET EXPLOSIVE: INITIATING ELECTRIC AND SEMI ELECTRIC..	1
			KIT VEHICLE NIGHT VISION SIGHT: M113A1/TAS-6.....	1
			NIGHT VISION GOGGLES: AN/PVS-5.....	30
			NIGHT VISION SIGHT CREW SERVED WEAPON: AN/TVS-5.....	1
			NIGHT VISION SIGHT INDIVIDUAL SERVED WEAPON: AN/PVS-4.....	38
			NIGHT VISION SIGHT INFRARED: AN/TAS-6.....	1
			PLATOON EARLY WARNING SYSTEM: AN/TRS-2(V).....	3
			PLRS BASIC USER UNIT.....	4
			PLRS MANPACK UNIT INSTALLATION KIT (MPUIK).....	4
			PLRS SURFACE VEHICLE INSTALLATION KIT:.....	4
			TRACKER INFRARED GUIDED MISSILE SU-36 (XO-1)/P: (DRAGON).....	9
			VIEWER INFRARED: AN/PAS-7.....	3

RIFLE COMPANY MECHANIZED BATTALION (DIVISION 86)

CO HQ SECTION

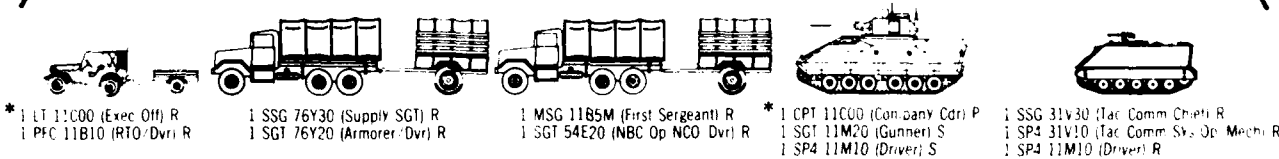

- * 1 LT 11C00 (Exec Off) R
1 PFC 11B10 (RTO/Dvr) R
- 1 SSG 76Y30 (Supply SGT) R
1 SGT 76Y20 (Armorer/Dvr) R
- 1 MSG 11B5M (First Sergeant) R
1 SGT 54E20 (NBC Op NCO/Dvr) R
- * 1 CPT 11C00 (Company Cdr) P
1 SGT 11M20 (Gunner) S
1 SP4 11M10 (Driver) S
- 1 SSG 31V30 (Tac Comm Chpt) R
1 SP4 31V10 (Tac Comm Sv Op Mach) R
1 SP4 11M10 (Driver) R

1ST RIFLE PLATOON

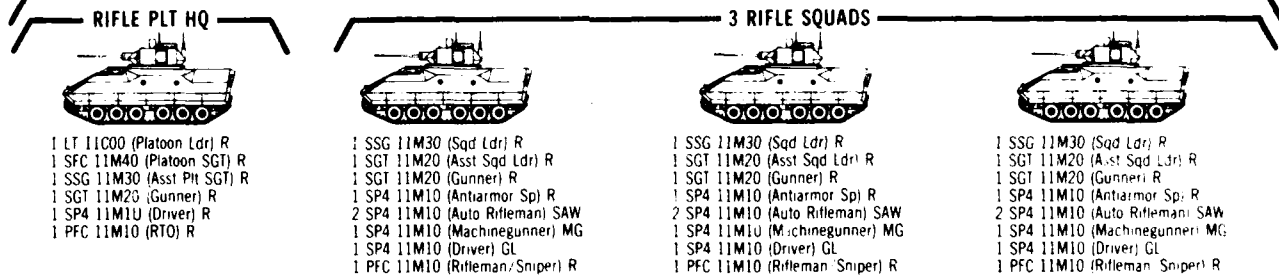

RIFLE PLT HQ

- 1 LT 11C00 (Platoon Ldr) R
- 1 SFC 11M40 (Platoon SGT) R
- 1 SSG 11M30 (Asst Plt SGT) R
- 1 SGT 11M20 (Gunner) R
- 1 SP4 11M1U (Driver) R
- 1 PFC 11M10 (RTO) R

3 RIFLE SQUADS

- 1 SSG 11M30 (Sqd Ldr) R
- 1 SGT 11M20 (Asst Sqd Ldr) R
- 1 SGT 11M20 (Gunner) R
- 1 SP4 11M10 (Antiarmor Sp) R
- 2 SP4 11M10 (Auto Rifleman) SAW
- 1 SP4 11M10 (Machinegunner) MG
- 1 SP4 11M10 (Driver) GL
- 1 PFC 11M10 (Rifleman/Sniper) R

- 1 SSG 11M30 (Sqd Ldr) R
- 1 SGT 11M20 (Asst Sqd Ldr) R
- 1 SGT 11M20 (Gunner) R
- 1 SP4 11M10 (Antiarmor Sp) R
- 2 SP4 11M10 (Auto Rifleman) SAW
- 1 SP4 11M10 (Machinegunner) MG
- 1 SP4 11M10 (Driver) GL
- 1 PFC 11M10 (Rifleman/Sniper) R

- 1 SSG 11M30 (Sqd Ldr) R
- 1 SGT 11M20 (Asst Sqd Ldr) R
- 1 SGT 11M20 (Gunner) R
- 1 SP4 11M10 (Antiarmor Sp) R
- 2 SP4 11M10 (Auto Rifleman) SAW
- 1 SP4 11M10 (Machinegunner) MG
- 1 SP4 11M10 (Driver) GL
- 1 PFC 11M10 (Rifleman/Sniper) R

486

2D RIFLE PLATOON

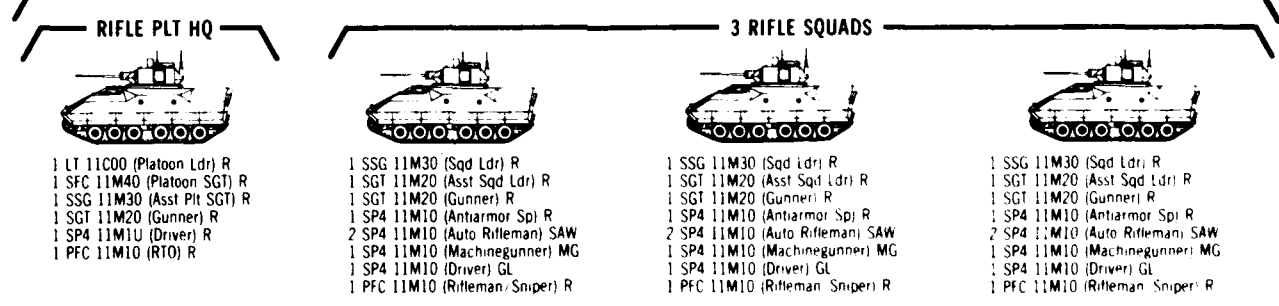

RIFLE PLT HQ

- 1 LT 11C00 (Platoon Ldr) R
- 1 SFC 11M40 (Platoon SGT) R
- 1 SSG 11M30 (Asst Plt SGT) R
- 1 SGT 11M20 (Gunner) R
- 1 SP4 11M1U (Driver) R
- 1 PFC 11M10 (RTO) R

3 RIFLE SQUADS

- 1 SSG 11M30 (Sqd Ldr) R
- 1 SGT 11M20 (Asst Sqd Ldr) R
- 1 SGT 11M20 (Gunner) R
- 1 SP4 11M10 (Antiarmor Sp) R
- 2 SP4 11M10 (Auto Rifleman) SAW
- 1 SP4 11M10 (Machinegunner) MG
- 1 SP4 11M10 (Driver) GL
- 1 PFC 11M10 (Rifleman/Sniper) R

- 1 SSG 11M30 (Sqd Ldr) R
- 1 SGT 11M20 (Asst Sqd Ldr) R
- 1 SGT 11M20 (Gunner) R
- 1 SP4 11M10 (Antiarmor Sp) R
- 2 SP4 11M10 (Auto Rifleman) SAW
- 1 SP4 11M10 (Machinegunner) MG
- 1 SP4 11M10 (Driver) GL
- 1 PFC 11M10 (Rifleman/Sniper) R

- 1 SSG 11M30 (Sqd Ldr) R
- 1 SGT 11M20 (Asst Sqd Ldr) R
- 1 SGT 11M20 (Gunner) R
- 1 SP4 11M10 (Antiarmor Sp) R
- 2 SP4 11M10 (Auto Rifleman) SAW
- 1 SP4 11M10 (Machinegunner) MG
- 1 SP4 11M10 (Driver) GL
- 1 PFC 11M10 (Rifleman/Sniper) R

* Interchangeable

3D RIFLE PLATOON

RIFLE PLT HQ

3 RIFLE SQUADS



- 1 LT 11C00 (Platoon Ldr) R
- 1 SFC 11M40 (Platoon SGT) R
- 1 SSG 11M30 (Asst Plt SGT) R
- 1 SGT 11M20 (Gunner) R
- 1 SP4 11M1U (Driver) R
- 1 PFC 11M10 (RTO) R

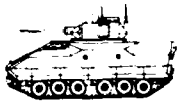

- 1 SSG 11M30 (Squad Leader) R
- 1 SGT 11M20 (Asst Squad Leader) R
- 1 SGT 11M20 (Gunner) R
- 1 SP4 11M10 (Antiarmor Sp) R
- 2 SP4 11M10 (Auto Rifleman) SAW
- 1 SP4 11M10 (Machinegunner) MG
- 1 SP4 11M10 (Driver) GL
- 1 PFC 11M10 (Rifleman Sniper) R



- 1 SSG 11M30 (Squad Leader) R
- 1 SGT 11M20 (Asst Squad Leader) R
- 1 SGT 11M20 (Gunner) R
- 1 SP4 11M10 (Antiarmor Sp) R
- 2 SP4 11M10 (Auto Rifleman) SAW
- 1 SP4 11M10 (Machinegunner) MG
- 1 SP4 11M10 (Driver) GL
- 1 PFC 11M10 (Rifleman Sniper) R



- 1 SSG 11M30 (Squad Leader) R
- 1 SGT 11M20 (Asst Squad Leader) R
- 1 SGT 11M20 (Gunner) R
- 1 SP4 11M10 (Antiarmor Sp) R
- 2 SP4 11M10 (Auto Rifleman) SAW
- 1 SP4 11M10 (Machinegunner) MG
- 1 SP4 11M10 (Driver) GL
- 1 PFC 11M10 (Rifleman Sniper) R

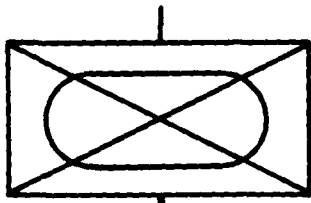

0	WO	EM	AGG
5	0	64	69

488

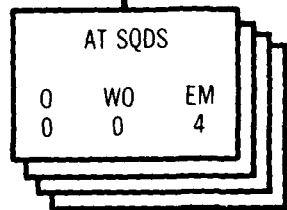
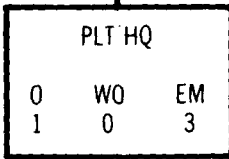
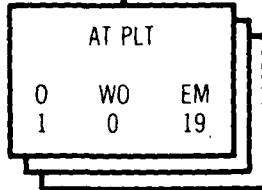
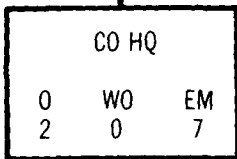

SUMMARY OF EQUIPMENT

WEAPONS	
BAYONET-KNIFE: W/SCABBARD FOR M16A1 RIFLE.....	68
LAUNCHER GRENADE 40 MILLIMETER: SGL SHOT RIFLE MTD DITCHBLE W/E..	12
LAUNCHER TUBULAR GUIDED MISSILE: (TOW).....	12
MACHINE GUN CALIBER .50: HB FLEXIBLE VEHICLE MTD.....	1
MACHINE GUN CALIBER .50: HB FLEXIBLE FOR GROUND USE.....	3
PISTOL CALIBER .45 AUTOMATIC.....	25
RIFLE 5.56 MILLIMETER: W/E.....	44
MACHINE GUN 7.62MM: FIXED M240C RH FEED F/EVS.....	12
VEHICLES	
CARRIER PERSONNEL FULL TRACKED: ARMORED.....	4
COMBAT VEHICLE ANTI-TANK: IMPROVED TOW VEHICLE (W/O TOW WEAPON)..	12
TRAILER CARGO: 1/4 TON 2 WHEEL W/E.....	1
TRAILER CARGO: 1-1/2 TON 2 WHEEL W/E.....	2
TRUCK CARGO: 2-1/2 TON 6X6 W/E.....	2
TRUCK UTILITY: 1/4 TON 4X4 W/E.....	1
NBC EQUIPMENT	
ALARM CHEMICAL AGENT AUTOMATIC: PORTABLE MANPACK.....	3
RADIAC SET: AN/VDR-1.....	17
MASK CHEMICAL-BIOLOGICAL: MULTI PURPOSE.....	69
RADIACMETER: IM-185/LD.....	20
CHARGER RADIAC DETECTOR: PP-4370/PD.....	3
MISCELLANEOUS EQUIPMENT	
BINOCULAR: MODULAR CONSTRUCTION MIL SCALE RETICLE 7X50MM W/E.....	20
COMPASS MAGNETIC UNMOUNTED: MIL GRADUATIONS.....	15
NIGHT VISION GOGGLES: AN/PVS-5.....	29
NIGHT VISION SIGHT CREW SERVED WEAPON: AN/TVS-5.....	1
NIGHT VISION SIGHT INDIVIDUAL SERVED WEAPON: AN/PVS-4.....	24
NIGHT VISION SIGHT INFRARED: AN/TAS-4.....	12
NIGHT VISION SIGHT INFRARED: AN/TAS-6.....	3

ANTI-ARMOR COMPANY MECHANIZED BATTALION (DIVISION 86)

ANTIARMOR CO HQ SECTION



1 CPT 11A00 (Company Cdr) P
1 PFC 11B10 (RTO/Dvr) R



1 MSG 11B5M (First SGT) R
1 SGT 54E20 (NBC NCO/Dvr) R



1 SSG 76Y30 (Supply SGT) R
1 SGT 76Y20 (Armorer/Dvr) R



1 LT 11C00 (Executive Officer) R
1 SGT 31V20 (Fac Comm Chief) R
1 SP4 11B1U (RTO/Dvr) R

1ST AT PLT

AT PLT HQ



1 LT 11C00 (Plt Ldr) R
1 SFC 11H40 (Plt SGT) R
1 SP4 11H1U (Dvr) R
1 PFC 11H10 (RTO) R



1 SGT 11H20 (Sqd Ldr) R
1 SP4 11H10 (Gunner) P
1 SP4 11H1U (Dvr) GL
1 PFC 11H10 (Asst Gnr) P



1 SGT 11H20 (Sqd Ldr) R
1 SP4 11H10 (Gunner) P
1 SP4 11H1U (Dvr) GL
1 PFC 11H10 (Asst Gnr) P



1 SGT 11H20 (Sqd Ldr) R
1 SP4 11H10 (Gunner) P
1 SP4 11H1U (Dvr) GL
1 PFC 11H10 (Asst Gnr) P



1 SGT 11H20 (Sqd Ldr) R
1 SP4 11H10 (Gunner) P
1 SP4 11H1U (Dvr) GL
1 PFC 11H10 (Asst Gnr) P

490

4 AT SQUADS

2D AT PLT

AT PLT HQ



1 LT 11C00 (Plt Ldr) R
1 SFC 11H40 (Plt SGT) R
1 SP4 11H1U (Dvr) R
1 PFC 11H10 (RTO) R



1 SGT 11H20 (Sqd Ldr) R
1 SP4 11H10 (Gunner) P
1 SP4 11H1U (Dvr) GL
1 PFC 11H10 (Asst Gnr) P



1 SGT 11H20 (Sqd Ldr) R
1 SP4 11H10 (Gunner) P
1 SP4 11H1U (Dvr) GL
1 PFC 11H10 (Asst Gnr) P



1 SGT 11H20 (Sqd Ldr) R
1 SP4 11H10 (Gunner) P
1 SP4 11H1U (Dvr) GL
1 PFC 11H10 (Asst Gnr) P



1 SGT 11H20 (Sqd Ldr) R
1 SP4 11H10 (Gunner) P
1 SP4 11H1U (Dvr) GL
1 PFC 11H10 (Asst Gnr) P

4 AT SQUADS

3D AT PLT

AT PLT HQ

4 AT SQUADS



1 LT 11C00 (Plt Ldr) R
1 SFC 11H40 (Plt SGT) R
1 SP4 11H1U (Dvr) R
1 PFC 11H10 (RTO) R



1 SGT 11H20 (Sqd Ldr) R
1 SP4 11H10 (Gunner) P
1 SP4 11H1U (Dvr) GL
1 PFC 11H10 (Asst Gnr) P



1 SGT 11H20 (Sqd Ldr) R
1 SP4 11H10 (Gunner) P
1 SP4 11H1U (Dvr) GL
1 PFC 11H10 (Asst Gnr) P



1 SGT 11H20 (Sqd Ldr) R
1 SP4 11H10 (Gunner) P
1 SP4 11H1U (Dvr) GL
1 PFC 11H10 (Asst Gnr) P



1 SGT 11H20 (Sqd Ldr) R
1 SP4 11H10 (Gunner) P
1 SP4 11H1U (Dvr) GL
1 PFC 11H10 (Asst Gnr) P

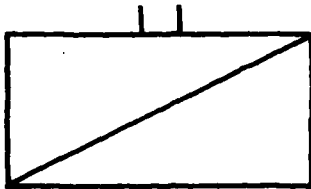

0	WO	EM	AGG
40	27	563	630

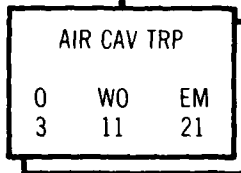
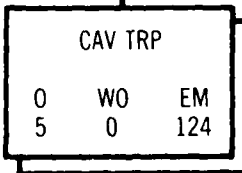
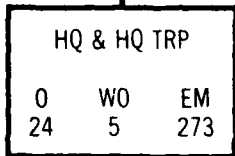

492

SUMMARY OF EQUIPMENT

	WEAPONS				AIRCRAFT
ARMAMENT SUBSYSTEM HELICOPTER 7.62MM MG.....	1		HELICOPTER OBSERVATION: OH-58C.....	12	
GUN AUTOMATIC 20MM: HIGH RATE THREE BARREL.....	8		HELICOPTER ATTACK: TOM MISSILE.....	9	
LAUNCHER GRENADE SMOKE: M257.....	3		HELICOPTER UTILITY: UH-60A.....	1	
LAUNCHER GRENADE 40MM.....	44				
LAUNCHER ROCKET AIRCRAFT: 2.75 INCH.....	16		COMMUNICATIONS AND ELECTRONICS		
MACHINE GUN CALIBER .50: HB FLEX VEHICLE MTD.....	21		LASER INFRARED OBSERVATION SET: AN/GVS-5.....	2	
MACHINE GUN CALIBER .50: HB FLEX FOR GROUND USE.....	25		MESSAGE DEVICE DIGITAL: AN/PSG-2.....	2	
MACHINE GUN 7.62MM: AIRCRAFT LIGHT DOOR MTD.....	2		RADIO SET: AN/GRC-106.....	5	
MACHINE GUN 7.62MM: LIGHT FLEXIBLE.....	38		RADIO SET: AN/PRC-90.....	46	
MORTAR 81MM: ON MOUNT.....	6		RADIO SET: AN/VRC-24.....	1	
PISTOL CALIBER .45 AUTOMATIC.....	97		RADIO SET CONTROL GROUP: AN/GRA-39.....	19	
REVOLVER CALIBER .38 SPECIAL: 4 IN BARREL.....	48		RANGE FINDER FIRE CONTROL: W/E (LASER).....	13	
RIFLE 5.56MM: W/E.....	474		RADIO SET: AN/PRC-70.....	1	
SUBMACHINE GUN 5.56MM: PORT FIRING M231.....	1		SPEECH SECURITY EQUIPMENT: TSEC/KY-47.....	181	
SUBMACHINE GUN CALIBER .45.....	8		SPEECH SECURITY EQUIPMENT 28V RED: TSEC/KY-58.....	42	
MACHINE GUN 7.62MM: FIXED M240C RH FEED.....	40		TARGET DESIGNATOR LASER: AN/PAQ-1.....	2	
BAYONET-KNIFE: W/SCABBARD.....	599		TARGET DESIGNATOR SET ELECTRO OPTICAL.....	2	
			SWITCHBOARD TELEPHONE MANUAL: SB-22/PT.....	4	
			SWITCHBOARD TELEPHONE MANUAL: SB-99/GT.....	1	
			TELEPHONE SET: TA-312/PT.....	31	
			RADIO SET: AN/PRC-68.....	63	
			SPEECH SECURITY EQUIPMENT TACTICAL: TSEC/KY-65.....	5	
VEHICLES			MISCELLANEOUS EQUIPMENT		
CAVALRY FIGHTING VEHICLE: M3.....	41		ALARM CHEMICAL AGENT AUTO: PORTABLE MANPACK.....	4	
CARRIER 81MM MORTAR: FULL TRACKED.....	6		ALARM CHEMICAL AGENT AUTO: PTBL F/FULL TRKD.....	33	
CARRIER COMMAND POST: LIGHT TRACKED.....	9		ALARM CHEMICAL AGENT AUTO: PTBL W/PWR SUP MH VEH.....	7	
CARRIER PERSONNEL FULL TRACKED: ARMORED.....	16		BINOCULAR: MIL SCALE RETICLE 7X50MM.....	60	
CRANE WHEEL MTD: SELF-PROPELLED.....	1		CHARGER RADIAC DETECTOR: PP-1578/PD.....	2	
RECOVERY VEHICLE FULL TRACKED: MEDIUM.....	4		COMPASS MAGNETIC UNMOUNTED: MIL GRADUATIONS.....	10	
TRAILER ACFT MAINT AIRMOBILE: 4 WHEELED.....	1		DECONTAMINATING APPARATUS POWER DRIVEN SKID MOUNTED.....	1	
TRAILER AMMUNITION: 1-1/2 TON 2 WHEELED.....	4		DEMOLITION SET EXPLOSIVE: INITIATING NONMETALLIC.....	18	
TRAILER CARGO: 1/4 TON.....	13		DETECTING SET MINE: PTBL METALLIC AND NONMETALLIC.....	13	
TRAILER CARGO: 3/4 TON.....	2		DETECTING SET MINE: PTBL METALLIC (AN/PSS-111).....	13	
TRAILER CARGO: 1-1/2 TON.....	41		DRUM FABRIC COLLAPSIBLE: LIQUID FUEL 500 GAL CAP.....	6	
TRAILER TANK: WATER 400 GAL 1-1/2 TON.....	4		FORWARD AREA REFUELING EQUIPMENT: (FARE).....	2	
TRUCK AMBULANCE: TACTICAL 1-1/4 TON.....	1		NIGHT VISION GOGGLES: AN/PVS-5.....	114	
TRUCK CARGO: TACTICAL 1-1/4 TON.....	2		NIGHT VISION SIGHT CREW SERVED WEAPON: AN/TVS-5.....	23	
TRUCK CARGO: TACTICAL 1-1/4 TON W/60 AMP-COMM.....	1		NIGHT VISION SIGHT INDIVIDUAL SERVED WEAPON: AN/PVS-4.....	42	
TRUCK CARGO: 1-1/4 TON 6X6 W/E.....	2		NIGHT VISION SIGHT INFRARED: AN/TAS-4.....	2	
TRUCK CARGO: 2-1/2 TON 6X6 W/E.....	19		TANK AND PUMP UNIT LIQUID DISPENSING TRUCK MOUNTING.....	9	
TRUCK CARGO: 2-1/2 TON 6X6 W/WINCH W/E.....	6		TANK UNIT LIQUID DISPENSING TRAILER MOUNTING.....	8	
TRUCK CARGO: 5 TON 6X6 LMB W/E.....	9		DETECTING SET MINE: VEHICULAR.....	2	
TRUCK CARGO: 5 TON 6X6 LMB W/WINCH W/E.....	1		DETECTING SET RADAR SIGNAL: AN/APR-39(V)1.....	21	
TRUCK CARGO: DROP SIDE 5 TON 6X6 W/WINCH.....	19		DETECTING SET RADAR SIGNAL: AN/APR-39(V)2.....	21	
TRUCK LIFT PORK: 6000 LB CAP.....	2		DETECTOR RADAR SIGNAL: AN/PSS-10.....	18	
TRUCK UTILITY: 1/4 TON 4X4 W/E.....	22		MASK CHEMICAL-BIOLOGICAL: MULTI PURPOSE.....	618	
TRUCK VAN: SHOP 2-1/2 TON 6X6 W/E.....	1		NIGHT VISION IMAGING SYSTEM AVIATOR.....	42	
TRUCK WRECKER: 5 TON 6X6 W/WINCH.....	4				
FIRE SUPPORT TEAM VEHICLE: FORWARD OBSERVER ARTY.....	2				
MOTORCYCLE: 2 WHEEL.....	13				

CAVALRY SQUADRON DIVISIONAL CAVALRY (DIVISION 86)

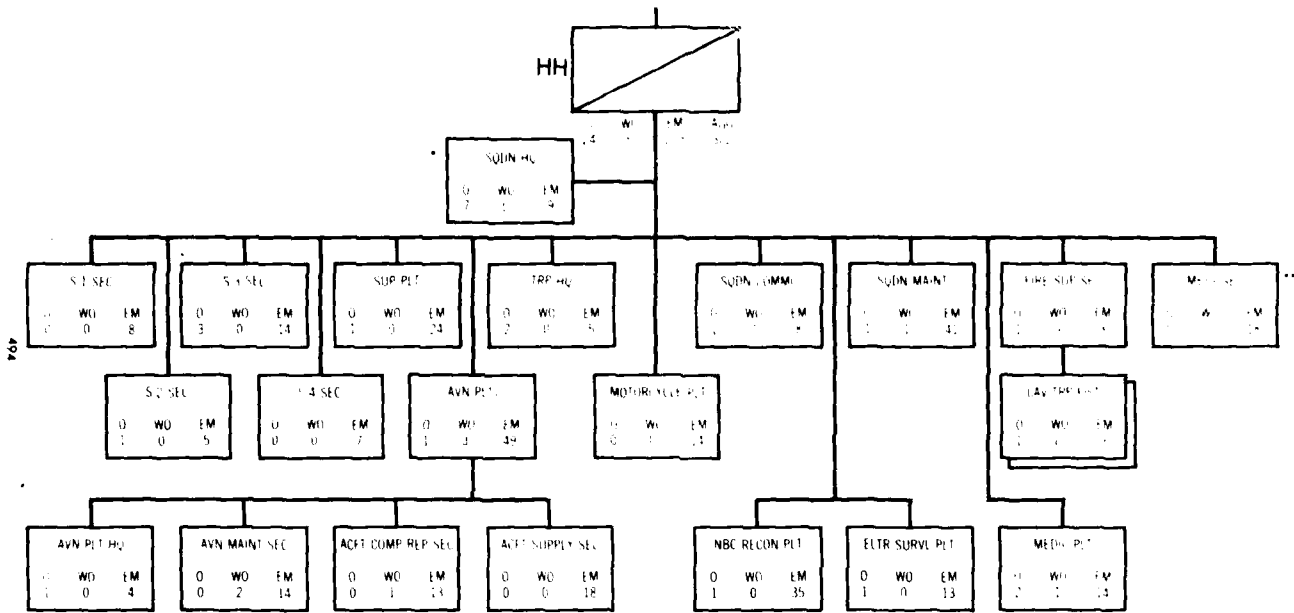

* Includes principle staff officers - S1, S2, S3, S4 & Chaplain
 ** HQ Mess. Trn also serves Air Cav Trps

SUMMARY OF EQUIPMENT

WEAPONS			
MACHINE GUN 7.62MM: FIXED M240C RH FEED F/EVS.....	2	FIRE SUPPORT TEAM VEHICLE: FORWARD OBSERVER ARTILLERY.....	2
SUBMACHINE GUN 5.56 MILLIMETER: PORT FIRING M231.....	1	RECOVERY VEHICLE FULL TRACKED: MEDIUM.....	3
ARMAMENT SUBSYSTEM HELICOPTER 7.62MM MG: LIGHT W/O WEAPONS W/E..	1	CAVALRY FIGHTING VEHICLE: M3.....	3
LAUNCHER GRENADE SMOKE: M257.....	3	CARRIER COMMAND POST LIGHT TRACKED.....	7
LAUNCHER GRENADE 40 MILLIMETER: SGL SHOT RIFLE MTD DITCHBLE W/E..	4	CARRIER PERSONNEL FULL TRACKED: ARMORED.....	14
MACHINE GUN CALIBER .50: HB FLEXIBLE VEHICLE MTD.....	15	CRONE WHEEL MOUNTED: SELF-PROPELLED.....	1
MACHINE GUN CALIBER .50: HB FLEXIBLE FOR GROUND USE.....	23		
MACHINE GUN 7.62 MILLIMETER: AIRCRAFT LIGHT DOOR MTD.....	2	AIRCRAFT	
MACHINE GUN CALIBER .50: HB FLEXIBLE FOR GROUND USE.....	2	HELICOPTER UTILITY: UH-60A.....	1
MACHINE GUN 7.62 MILLIMETER: LIGHT FLEXIBLE.....	2		
MORTAR 81 MILLIMETER: ON MOUNT.....	10	NBC	
REVOLVER CALIBER .38 SPECIAL: 3IN BARREL.....	258	DECONTAMINATING APPARATUS POWER DRIVEN SKID MOUNTED: MULTIPURPOSE	1
RIFLE 5.56 MILLIMETER: W/E.....	277	ALARM CHEMICAL AGENT AUTOMATIC: PORTABLE MANPACK.....	4
BAYONET-KNIFE: W/SCABBARD FOR M16A1 RIFLE.....	29	ALARM CHEMICAL AGENT AUTOMATIC: PTBL F/FULL TRKD APC AND ARV....	3
PISTOL CALIBER .45 AUTOMATIC.....	29	ALARM CHEMICAL AGENT AUTOMATIC: PTBL W/PWR SUP F/TRK UTIL 1/4TON	4
LAUNCHER ROCKET AIRCRAFT: 2.75 INCH.....	2	ALARM CHEMICAL AGENT AUTOMATIC: PTBL W/PWR SUP F/TRUCK 2 1/2 TON	1
GUN AUTOMATIC 20 MILLIMETER: HIGH RATE THREE BARREL W/E.....	2	CHARGER RADIAC DETECTOR: PP-4370/PD.....	1
		MASK CBR: HEADMOUNT PROTECTIVE.....	10
		RADIAC METER: IM-185/UD.....	26
		MASK CHEMICAL-BIOLOGICAL: MULTI PURPOSE.....	296
VEHICLES		MISCELLANEOUS EQUIPMENT	
TRAILER ACFT MAINT AIRMOBILE: 4 WHEELED 30/48 IN TRP RAIL SYSTEM	1	DETECTING SET RADAR SIGNAL: AN/APR-39(V)1.....	1
TRAILER AMMUNITION: 1-1/2 TON 2 WHEEL W/E.....	4	DETECTING SET RADAR SIGNAL: AN/APR-39(V)2.....	1
TRAILER CARGO: 3/4 TON 2 WHEEL W/E.....	2	DETECTING SET MINE: PTBL METALLIC AND NONMETALLIC.....	1
TRAILER CARGO: 1-1/2 TON 2 WHEEL W/E.....	35	DETECTING SET MINE: PTBL METALLIC (AN/PSS-11).....	1
TRAILER TANK: WATER 400 GALLON 1-1/2 TON W WHEEL W/E.....	4	DETECTING SET MINE: VEHICULAR.....	2
TRANSPORTER AIRMOBILE: HYD LIFT FOR SHELTER AND X-4 CONTAINER...	2	NIGHT VISION GOGGLES: AN/PVS-5.....	27
TRUCK AMBULANCE: TACTICAL 1-1/4 TON 4X4 W/E.....	1	NIGHT VISION SIGHT CREW SERVED WEAPON: AN/PVS-5.....	17
TRUCK CARGO: TACTICAL 1-1/4 TON 4X4 W/E.....	2	NIGHT VISION SIGHT INDIVIDUAL SERVED WEAPON: AN/PVS-4.....	2
TRUCK CARGO: TACTICAL 1-1/4 TON 4X5 W/60 AMP-COMM KITS W/E.....	1	NIGHT VISION SIGHT INFRARED: AN/TAS-4.....	2
TRUCK CARGO: 1-1/4 TON 6X6 W/E.....	2	KIT VEHICLE NIGHT VISION SIGHT: M113A1/TAS-6.....	17
TRUCK CARGO: 2-1/2 TON 6X6 W/WINCH W/E.....	4	TARGET DESIGNATOR LASER: AN/PAQ-1.....	2
TRUCK CARGO: 5-TON 6X6 LWB W/E.....	9	TANK AND PUMP UNIT LIQUID DISPENSING TRUCKMOUNTING.....	8
TRUCK CARGO: DROP SIDE 5-TON 6X6 W/WINCH W/E.....	19	TANK UNIT LIQUID DISPENSING TRAILER MOUNTING.....	8
TRUCK CARGO: 5-TON 6X6 LWB W/WINCH W/E.....	1	COMPASS MAGNETIC UNMOUNTED: MIL GRADUATIONS.....	4
TRUCK LIFT FORK: DSL DRVN 5000 LB CAP ROUGH TERRAIN.....	2	FORWARD AREA REFUELING EQUIPMENT: (FARE).....	2
TRUCK CARGO: 2-1/2 TON 6X6 W/E.....	15	NAVIGATION SET DOPPLER: AN/ASN-128.....	1
MOTORCYCLE: 2 WHEEL.....	13	NIGHT VISION IMAGING SYSTEM AVIATOR.....	20
TRUCK LIFT FORK: DSL DRVN 5000 LB CAP ROUGH TERRAIN.....	2	LASER INFRARED OBSERVATION SET: AN/GVS-5.....	2
TRUCK UTILITY: 1/4 TON 4X4 W/E.....	16		
TRUCK VAN: SHOP 2-1/2 TON 6X6 W/E.....	1		
TRUCK WRECKER: 5-TON 6X6 W/WINCH W/E.....	4		

HEADQUARTERS AND HEADQUARTERS TROOP DIVISIONAL CAVALRY SQUADRON

SQDN HQ SEC



1 LTC 12C00 (Cdr) P
* 1 PFC 19D10 (Dvr) R



1 MAJ 15B00 (XO) P
1 CSM 00Z50 (CSM) R
1 PFC 19D10 (Dvr) R



1 SSG 19D30 (Veh Cdr) R
1 SP4 19D10 (Gnr) R
1 SP4 19D10 (Dvr) P



1 SSG 19D30 (Veh Cdr) R
1 SP4 19D10 (Gnr) R
1 SP4 19D10 (Dvr) P

* Listed on TO&E as Set for CV's

S-1 SEC



1 CPT 56A00 (Chaplain)
1 SP4 71M10 (Chap Asst) R



1 CPT 12A40 (S 1) R
1 SFC 75Z40 (PAC Supv) R
1 SSG 75Z30 (Pers Staff NCO) R
1 SGT 75B20 (Liaison Clerk) R
1 SGT 75B20 (PAC Clerk) R
1 SP4 75B10 (PAC Clerk) R
1 SP4 71L10 (Clerk Typist) R
1 PFC 75B10 (PAC Clerk) R

S-2 SEC



1 CPT 35A00 (S 2) R
1 LT 35A00 (Tac Intel Off) R
1 MSG 19Z50 (Intel SGT) R
1 SGT 96B20 (Sr Intel Anal) R
1 SGT 96B20 (Intel Anal) R
1 SP4 19D10 (Intel Asst) R
1 SP4 19D1U (Carr Dvr) P

967

S-3 SEC



1 MAJ 12C00 (S 3) R
1 PFC 19D10 (RTO Dvr) R



1 LT 12C00 (Liaison Off) R
1 PFC 19D10 (Liaison Agt) R



1 LT 15B00 (Fit Ops Off) R
1 MSG 19Z50 (Op SGT) R
1 SFC 71P40 (Fit Ops SGT) R
1 SSG 71P30 (Asst Fit Op SGT) R
1 SP4 71L10 (Clerk Typist/Dvr) R
1 SP4 71P10 (Fit Op Sp) R



1 CPT 12C00 (S 3 Air) R
1 SFC 19D40 (Asst Op SGT) R
1 SGT 19D20 (Op Asst) R
1 SGT 54E20 (NBC NCO) R
1 SP4 19D1U (Dvr) R
1 SP4 05B10 (RTO) R

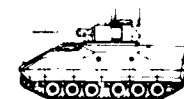

1 SGT 19D20 (Veh Cdr) R
1 SP4 19D1U (Dvr) R

S-4 SEC



1 CPT 12C92 (S A) R
1 PFC 76Y10 (Sup Sp) R



1 SP4 76Y10 (Sup Sp) R



1 SP4 76Y10 (Sup Sp) R



1 SP4 54E10 (Driver Sp) R



1 SFC 76Y40 (Sup SGT) R
1 SGT 76Y20 (Asst Sup SGT) R
1 SP4 19D10 (Dvr) P

* W/Winch
** Carries 1 skid mounted 120mm mortar

HHT HQ SEC



1 MAJ 12C00 (Cdr) P
1 PFC 19D10 (Dvr) GI



1 CPT 12C00 (XO) R



1 SSG 1975M (ISG) R



1 SSG 76Y30 (Sup SGT) R
1 SP4 76Y10 (Armored) GI
1 PFC 76Y10 (Sup Sp Dvr) GI

SQDN COMMO PLT



1 CPT 25A00 (C E Off) R
1 PFC 36K10 (Wire Op Sp Dvr) R



2 SP4 36K10 (Wire Op Sp) R
1 PFC 31V10 (Comm Sys Mech) R



1 SFC 31V40 (Comm Ch) R
1 SP4 31V10 (Comm Sys Mech) R
1 SP4 36K10 (Dvr) P
1 PFC 05B10 (RTG) R

SQDN SUPPORT PLATOON

PLT HQ



1 SFC 19D10 (Plt Ldr) R
1 PFC 19D10 (Dvr) R

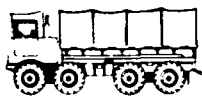

1 SFC 64C40 (Trk Master) R
1 SP4 64C10 (Dvr) R



1 SGT 64C20 (Ammo Sec SGT) R
1 SP4 64C10 (Dvr) R

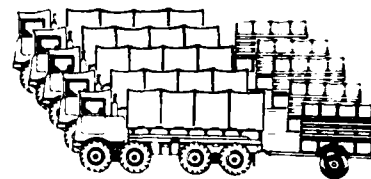

1 PFC 64C10 (Veh Dvr) R
1 PFC 64C10 (Asst Veh Dvr) R



1 SP4 19D10 (Ammo Sp) R
1 PFC 64C10 (Dvr) R

TRANS SECTION

POL SECTION



1 SGT 64C20 (POL Sec SGT) R
1 SP4 64C10 (Dvr) R



1 SP4 64C10 (Dvr) R

HHT/AIR CAV MESS TM



1 SFC 94B40 (Food Svc SGT) R
1 SGT 94B20 (Cook) R
1 PFC 94B10 (Cook) R
1 PFC 94B10 (Cook Dvr) R



1 SSG 94B30 (1st Cook) R
2 SP4 94B10 (Cook) R
1 PFC 94B10 (Cook/Dvr) R



1 SFC 94B40 (Food Serv SGT) R
1 SGT 94B20 (1st Cook) R
2 SP4 94B10 (Cook/Dvr) R
1 PFC 94B10 (Cook) R

CAV TRP MESS TM



1 SFC 94B40 (Food Svc SGT) R
1 SGT 94B20 (1st Cook) R
2 SP4 94B10 (Cook) (Dvr) R
1 PFC 94B10 (Cook) R

SQDN MEDICAL PLT

PLT HQ



* 1 CPT 62A00 (Phys Plt Ldr) R
1 SFC 91B40 (PSG) R

AID STATION



1 LT 67B00 (Fld Med Asst) P
1 SSG 91C30 (Prac Nur) R
1 SP4 91B10 (Med Aide) R
1 PFC 91B1U (Amb Dvr) P



1 WO 011A0 (PA) R
1 SGT 91B20 (Med Aide) R
1 PFC 91B1U (Amb Dvr) P

EVAC/SEC



1 SP4 91B10 (Med Aide) R
1 SP4 91B10 (Amb Dvr) R



2 SGT 91B20 (Troop Aidman) P
2 SP4 91B1U (Amb Dvr) P
2 PFC 19B10 (Med Aide) P

* Also acts as Platoon Leader

SQDN MAINT PLT

PLT HQ



1 CPT 12A77 (Maint Off) R
1 WO 630A0 (Auto Maint Tech) R
1 MSG 63Z50 (Motor SGT) R
1 SP4 71L10 (Reps Clk Dvr) R

INSP/QUAL CON SEC



1 SFC 63T40 (Sec SGT) R
2 SSG 63T30 (CFV Systems Mech) R
1 SSG 63T30 (CFV Arm Sys Mech Dvr) R

REC/ADMIN SECTION



1 SGT 76V20 (Sec SGT) R
1 SP4 76V10 (Equip Rec Parts Sp Dvr) R

RECOVERY SEC

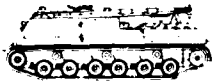

1 SP4 63T10 (Recov Veh Op) P. S
1 PFC 63T10 (Recov Veh Op) P. S

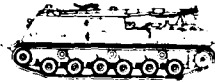

1 SP4 63T10 (Recov Veh Op) P. S
1 PFC 63T10 (Recov Veh Op) P. S

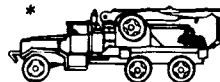

1 SSG 63T30 (Recov Sec SGT) P
1 SP4 63S10 (Recov Veh Op Dvr) R

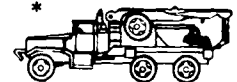

1 SGT 63T20 (Recov Veh Opi) R

MAINT/SVC SEC

500



1 SFC 63T40 (CFV Maint Supv) R
1 SGT 63T20 (CFV Auto Mech) R
1 PFC 63T10 (CFV Auto Mech/Dvr) R



2 SGT 63B20 (L1 W Veh/Gen Mech) R
2 SP4 63B10 (L1 W Veh/Gen Mech) R
2 PFC 63B10 (L1 W Veh/Gen Mech) R



1 SGT 63T20 (CFV Auto Mech) R
2 SP4 63T10 (CFV Auto Mech) R
1 SP4 44B10 (Welder) R
1 PFC 63T10 (CFV Auto Mech) R



1 SGT 63T20 (CFV Auto Mech) R
1 SP4 63T10 (CFV Auto Mech) R
1 SP4 45T10 (CFV Turret Mech) R
2 PFC 63T10 (CFV Auto Mech) R



1 SGT 63T20 (CFV Auto Mech) R
1 SP4 63T10 (CFV Auto Mech) R
1 PFC 63T10 (CFV Auto Mech) R
1 PFC 45T10 (CFV Auto Mech) R



1 SGT 63T20 (CFV Auto Mech) R
1 SP4 63T10 (CFV Auto Mech) R
1 PFC 63T10 (CFV Auto Mech) R

* W/Winch

NBC RECON PLT



1 LT 74A00 (Plt Ldr) R
 1 SGT 54E20 (Recon NCO) R
 1 SP4 54E10 (NBC Sct) (Dvr) R
 1 PFC 54E10 (NBC Sct) R



1 SFC 54E40 (Plt SGT) R
 1 SGT 54E20 (Recon NCO) R
 1 SP4 54E10 (NBC Sct) (Dvr) R
 1 PFC 54E10 (NBC Sct) R



1 SSG 54E30 (Sqd Ldr) R
 1 SGT 54E20 (Recon NCO) R
 1 SP4 54E10 (NBC Sct) (Dvr) R
 1 PFC 54E10 (NBC Sct) R



1 SSG 54E30 (Sqd Ldr) R
 1 SGT 54E20 (Recon NCO) R
 1 SP4 54E10 (NBC Sct) (Dvr) R
 1 PFC 54E10 (NBC Sct) R

ELTR SURVL PLT

ELTR SURVL
 PLT HQ



1 LT 35C00 (Plt Ldr) R
 1 PFC 19D10 (Dvr) R

REMOTE SENSOR
 SECTION



1 SGT 17M20 (Tm Ch) R
 1 SP4 17M10 (Grd Sens Sp) R
 1 SP4 17M10 (Grd Sens Sp Dvr) R
 1 PFC 17M10 (Grd Sens Sp) R

501

AVIATION PLATOON

PLT HQ & AVUM MAINT SEC



1 WO 100B6 (Actl Maint Tech) Rev
 1 WO 100BE (Pilot) Rev
 1 SGT 67T20 (Crew Ch) Rev



1 CPT 71A00 (Plt Cdr) Rev
 1 SFC 67Z40 (Plt SGT) R
 1 PFC 67V10 (Hel Rprman Dvr) R



1 SGT 35K20 (Avionics Repr) R
 1 SP4 35K10 (Avionics Repr Dvr) R

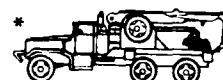

1 SP4 63B10 (Recov Veh Opi) R



1 SGT 76C20 (Sup Sp) R
 1 SP4 76C10 (Sup Sp) R
 1 PFC 76C10 (Sup Sp/Dvr) R



2 SSG 67Y3F (Atk Hel Tech Insp) Rev
 1 SGT 67Y20 (Atk Hel Reprman) R
 2 SP4 67Y10 (Atk Hel Reprman) R



1 SFC 67Z4F (Sec SGT) Rev
 1 SSG 67Y3F (Sct Hel Tech Insp) Rev
 1 SP4 67Y10 (Sct Hel Reprman Dvr) R
 1 PFC 67V10 (Sct Hel Reprman) R

* W/Winch

ACFT COMP REP SEC



1 WO 160A0 (Actt Maint Tech) Rev
1 PFC 68G10 (Actt Struct Rep Dvr) R



*
1 SFC 68K40 (Actt Comp Repr Sp) R
1 PFC 68F10 (Actt Elec Dvr) R



*
1 SSG 67W3F (Actt Qual Con) Rev
1 SP4 76C10 (Mat Sup Sp Dvr) R



*
1 SP4 68J10 (Actt Ms Sys Repr) R
1 PFC 68J10 (Hst Ms Sys Rep Dvr) R



503



1 SGT 68G20 (Actt Struct Repr) R
1 SP4 68G10 (Actt Struct Repr) R



1 SP4 68B10 (Actt Pw Ptt Repr) R

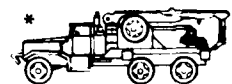

1 SP4 68D10 (Actt Pw Ptt Repr) R



1 SP4 68D10 (Actt Pw Ptt Repr Dvr) R

Note Truck Lift Fork, Dsl Drvn 6,000 lb Cap Rough Terrain

1 PFC 68H10 (Actt Pneu Repr Dvr) R

* W Winch

ACFT SUP SEC



1 SSG 76W30 (Shl SGT) R
1 PFC 68M10 (Weap Sys Mech Dvr) R



1 SGT 68M20 (Hel Weap Sys Reprman) R
1 SP4 68M10 (Hel Weap Sys Reprman Dvr) R



1 SP4 68M10 (Hel Weap Sys Reprman) R
1 PFC 68M10 (Hel Weap Sys Reprman Dvr) R



1 SGT 55B20 (Ammo Sp) R
1 PFC 64C10 (Dvr) R



1 SP4 64C10 (Veh Dvr) R



1 SP4 64C10 (Veh Dvr) R



1 SP4 64C10 (Veh Dvr) R

504



1 SGT 76W20 (Actt Fuel Hldr) R
1 PFC 76W10 (Actt Fuel Hldr Dvr) R



1 SP4 76W10 (Actt Fuel Hldr Dvr) R



1 SGT 76W20 (Actt Fuel Hldr) R
1 PFC 76W10 (Actt Fuel Hldr Dvr) R

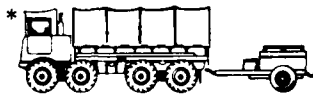

1 SP4 76W10 (Actt Fuel Hldr Dvr) R

Note Truck Lift Fork, Dsl Drvn 6,000-lb Cap Rough Terrain

1 PFC 64C10 (Dvr) R

* W Winch

FIRE SUPPORT SEC



1 CPT 13E00 (FSO) P
1 SP4 13F10 (Dvr) R



1 SFC 16F40 (Fire Sup NCO) R
1 SP4 13F1U (Carr Dvr) GL

CAV TRP FIST TM



1 LT 13A00 (Fire Sup Tm Chief) R
1 SSG 13F30 (Fire Sup SGT) R
1 SP4 13F10 (Fire Sup Sp) R
1 PFC 13F10 (RTO Dvr) R

MOTORCYCLE PLT

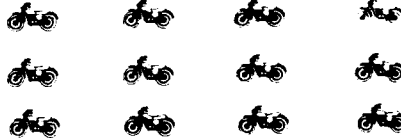

1 SFC 19D40 (PSG) R
1 PFC 19D10 (Sct/Dvr) R



4 SGT 19D20 (Sqd Ldr) R
4 SP4 19D10 (Sct) R
4 PFC 19D10 (Sct) R

505

*To be carried with 1 1/2-Ton Trk

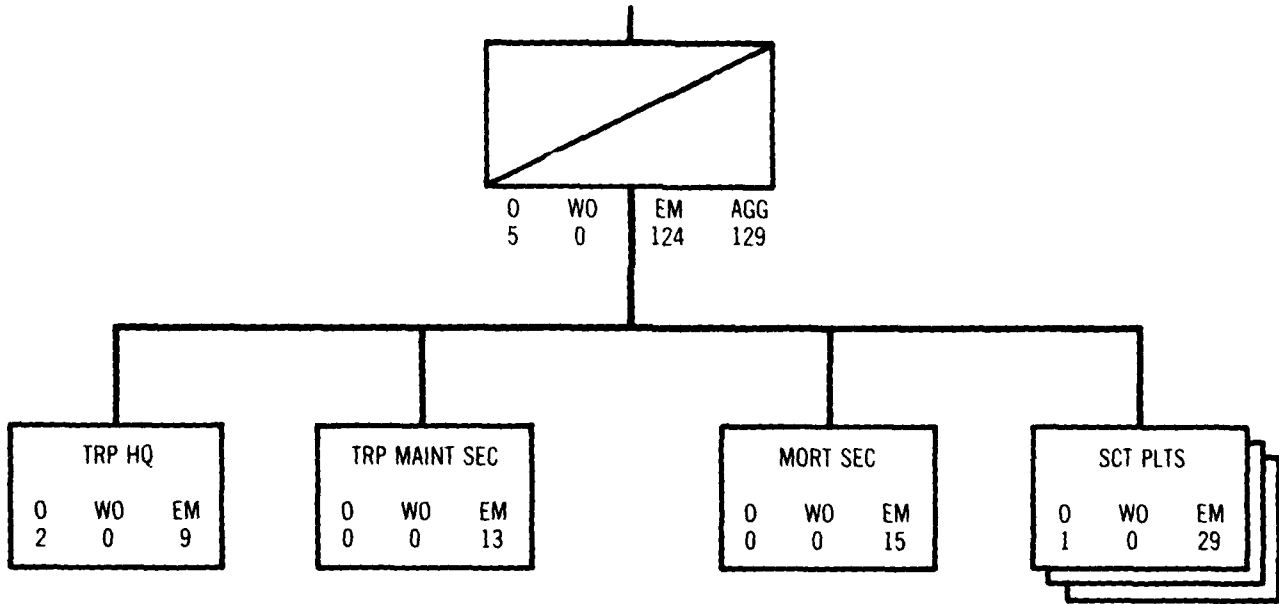

SUMMARY OF EQUIPMENT

WEAPONS			
RAYONET-KNIFE: W/SCABBORD FOR M16A1 RIFLE.....	129	CARRIER 81 MILLIMETER MORTAR: FULL TRACKED (LESS MORTAR).....	3
PISTOL CALIBER .45 AUTOMATIC.....	34	CARRIER COMMAND POST: LIGHT TRACKED.....	1
RIFLE 5.56 MILLIMETER: W/E.....	95	CARRIER PERSONNEL FULL TRACKED: ARMORED.....	1
LAUNCHER GRENADE 40 MILLIMETER: SGLE SHOT RIFLE MTD D7CHEBLE W/E..	20	RPCOVERY VEHICLE FULL TRACKED: MEDIUM.....	1
MACHINE GUN CALIBER .50: HB FLEXIBLE VEHICLE MTS.....	3	TRAILOR CARGO: 1-1/2 TON 2 WHEEL W/E.....	2
MACHINE GUN CALIBER .50: HB FLEXIBLE FOR GROUND USE.....	1	TRUCK CARGO: 2-1/2 TON 6X6 W/E.....	1
MACHINE GUN 7.62 MILLIMETER: LIGHT FLEXIBLE.....	19	TRUCK CARGO: 2-1/2 TON 6X6 W/WINCH W/E.....	1
MORTAR 81 MILLIMETER: ON MOUNT.....	3	TRUCK UTILITY: 1/4 TON 4X4 W/E.....	2
SUBMACHINE GUN CALIBER .45.....	4		
MACHINE GUN 7.62MM: FIXED M240C RH FEED F/PVS.....	19		
NBC EQUIPMENT		MISCELLANEOUS EQUIPMENT	
ALARM CHEMICAL AGENT AUTOMATIC: PTBL F/FULL TRKD APC AND ARV.....	12	TELESCOPE STRAIGHT: MILITARY.....	9
ALARM CHEMICAL AGENT AUTOMATIC: PTBL w/PWR SUP F/TRK UTIL 1/4TON.	1	DETECTOR RADAR SIGNAL: AN/PSS-10.....	9
CHARGER RADIA* DETECTOR: PPP-4370/PD.....	2	DEMOLITION SET EXPLOSIVE: INITIATING NON ELECTRIC.....	9
MASK CHEMICAL-BIOLOGICAL: MULTI PURPOSE.....	129	DETECTING SET MINE: PTBL METALLIC AND NON METALLIC.....	6
RADIACMETER: IM-1R5/UD.....	14	DETECTING SET MINE: PTBL METALLIC (AN/PSS-11).....	6
VEHICLES AND VEHICLE EQUIPMENT		NIGHT VISION GOGGLES: AN/PVS-5.....	45
CAVALRY FIGHTING VEHICLE: M3.....	19	NIGHT VISION SIGHT CREW SERVED WEAPON: AN/TVS-5.....	3
		NIGHT VISION SIGHT INDIVIDUAL SERVED WEAPON: AN/PVS-4.....	20
		PLRS BASIC USER UNIT.....	12
		PLRS SURFACE VEHICLE INSTALLATION KIT.....	94

507

CAVALRY TROOP DIVISIONAL CAVALRY SQUADRON

CAV TRP HQ SEC



1 CPT 12C00 (Cdr) P



1 ISG 19Z5M (ISG) R
 1 SSG 76Y30 (Sup SGT) R
 1 SP4 76Y10 (Armorer/Dvr) R



1 LT 12C00 (XO) R
 1 SSG 31V30 (Comm Ch) R
 1 SP4 05B10 (RTO) R
 1 SP4 19D1U (Dvr) P, GL



1 SSG 19D30 (CFV Cdr) P, S
 1 SP4 19D10 (Gnr) R
 1 SP4 19D10 (Dvr) P, S

508

MORTAR SEC



1 SSG 11C3U (Sec Ldr) R
 1 SP4 11C10 (Gnr) P
 1 SP4 11C1U (Dvr) P
 1 PFC 11C10 (Ammo Br) R
 1 PFC 11C10 (Asst Gnr) R



1 SGT 11C20 (Sqd Ldr) R
 1 SP4 11C10 (Gnr) P
 1 SP4 11C1U (Dvr) P
 1 PFC 11C10 (Ammo Br) R
 1 PFC 11C10 (Asst Gnr) R



1 SGT 11C20 (Sqd Ldr) R
 1 SP4 11C10 (Gnr) P
 1 SP4 11C1U (Dvr) P
 1 PFC 11C10 (Ammo Br) R
 1 PFC 11C10 (Asst Gnr) R

1ST SCT PLT



- 1 LT 12C00 (Plt Ldr) P
- 1 SP4 19D10 (Gnr) R
- 1 SP4 19D1U (Dvr) P. GL
- 1 SP4 19D10 (Sct) R
- 1 PFC 19D10 (Sct) R



- 1 SFC 19D40 (Plt SGT) R
- 1 SP4 19D10 (Gnr) R
- 1 SP4 19D1U (Dvr) P. GL
- 1 SP4 19D10 (Sct) R
- 1 PFC 19D10 (Sct) R



- 1 SSG 19D3U (Sqd Ldr) R
- 1 SP4 19D10 (Gnr) R
- 1 SP4 19D1U (Dvr) P. GL
- 1 SP4 19D10 (Sct) R
- 1 PFC 19D10 (Sct) R



- 1 SGT 19D20 (Crew Ldr) R
- 1 SP4 19D10 (Gnr) R
- 1 SP4 19D1U (Dvr) P. GL
- 1 SP4 19D10 (Sct) R
- 1 PFC 19D10 (Sct) R

2D SCT PLT



- 1 LT 12C00 (Plt Ldr) P
- 1 SP4 19D10 (Gnr) R
- 1 SP4 19D1U (Dvr) P. GL
- 1 SP4 19D10 (Sct) R
- 1 PFC 19D10 (Sct) R



- 1 SFC 19D40 (Plt SGT) R
- 1 SP4 19D10 (Gnr) R
- 1 SP4 19D1U (Dvr) P. GL
- 1 SP4 19D10 (Sct) R
- 1 PFC 19D10 (Sct) R



- 1 SSG 19D30 (Sqd Ldr) R
- 1 SP4 19D10 (Gnr) R
- 1 SP4 19D1U (Dvr) P. GL
- 1 SP4 19D10 (Sct) R
- 1 PFC 19D10 (Sct) R



- 1 SGT 19D20 (Crew Ldr) R
- 1 SP4 19D10 (Gnr) R
- 1 SP4 19D1U (Dvr) P. GL
- 1 SP4 19D10 (Sct) R
- 1 PFC 19D10 (Sct) R

3D SGT PLT

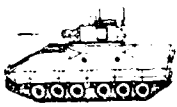

1 LT 12C00 (Pit Ldr) P
 1 SP4 19D10 (Gnr) R
 1 SP4 19D1U (Dvr) P GL
 1 SP4 19D10 (Sct) R
 1 PFC 19D10 (Sct) R



1 SFC 19D40 (Plt SGT) R
 1 SP4 19D10 (Gnr) R
 1 SP4 19D1U (Dvr) P GL
 1 SP4 19D10 (Sct) R
 1 PFC 19D10 (Sct) R



1 SSG 19D30 (Sqd Ldr) R
 1 SP4 19D10 (Gnr) R
 1 SP4 19D1U (Dvr) P GL
 1 SP4 19D10 (Sct) R
 1 PFC 19D10 (Sct) R



1 SGT 19D20 (Crew Ldr) R
 1 SP4 19D10 (Gnr) R
 1 SP4 19D1U (Dvr) P GL
 1 SP4 19D10 (Sct) R
 1 PFC 19D10 (Sct) R

510

TRP MAINT SEC



1 SFC 63T40 (Maint Supv) R
 1 PFC 63T10 (CFV Auto Mech Dvr) R



1 SGT 76C20 (PLL Ck) R
 1 SP4 63T10 (CFV Auto Mech) R
 1 PFC 45N10 (CFV Turret Mech Dvr) R
 1 PFC 63B10 (Lt Veh/Gen Mech) R



1 SGT 63T-0 (CFV Auto Mech) R
 1 SP4 63T10 (CFV Auto Mech Dvr) GL
 1 SP4 45T10 (CFV Turret Mech) R
 1 SP4 31V10 (Comm Sys Mech) P
 1 PFC 63T10 (CFV Auto Mech) R



1 SP4 63T10 (Recov Veh Op) P S
 1 SP4 63T10 (Recov Veh Op) P S

Notes: _____

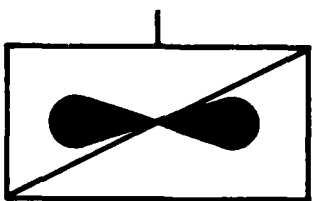

0	WO	EM	AGG
3	11	21	35

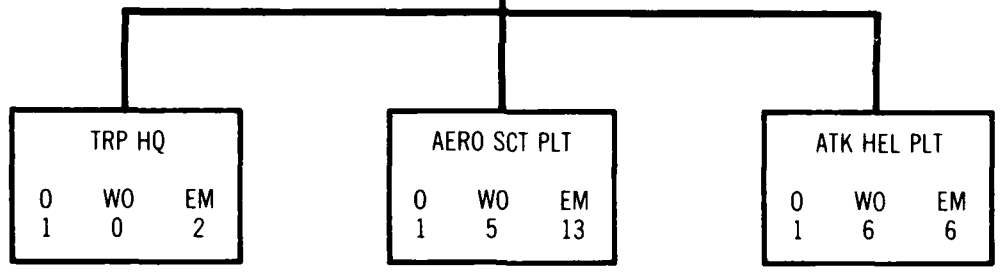

512

SUMMARY OF EQUIPMENT

WEAPONS	
REVOLVER CALIBER .38 SPECIAL: 4IN BARREL.....	19
RIFLE 5.56 MILLIMETER: W/E.....	13
LAUNCHER ROCKET AIRCRAFT: 2.75 INCH.....	8
GUN AUTOMATIC 20 MILLIMETER: HIGH RATE THREE BARREL W/E.....	4
BAYONET-KNIFE: W/SCABBARD FOR M16A1 RIFLE.....	32

VEHICLES	
TRAILER CARGO: 1/4 TON 2 WHEEL W/E.....	1
TRAILER CARGO: 1-1/2 TON 2 WHEEL W/E.....	1
TRUCK CARGO: 2-1/2 TON 6X6 W/E.....	1
TRUCK UTILITY: 1/4 TON 4X4 W/E.....	1

AIRCRAFT	
HELICOPTER OBSERVATION: OH-58C.....	6
HELICOPTER ATTACK: TOW MISSILE.....	4

NBC EQUIPMENT	
MASK CHEMICAL-BIOLOGICAL: MULTI PURPOSE.....	32

MISCELLANEOUS EQUIPMENT	
DETECTING SET RADAR SIGNAL: AN/APR-39 (V) 1.....	10
DETECTING SET RADAR SIGNAL: AN/APR-39 (V) 2.....	10
NIGHT VISION IMAGING SYSTEM AVIATOR:.....	20

AIR CAVALRY TROOP DIVISIONAL CAVALRY SQUADRON

AERO-RECON TRP HQ



1 CPT 15B00 (Cdr) Rev
1 SP4 19D10 (Dvr) R



1 ISG 67Z5M (ISG) Rev

AERO-SCOUT PLT



1 LT 15B00 (Pit Ldr) Rev
1 SFC 67Z40 (Pit SGT) R
1 SGT 67V20 (Sct/Obs/Repairman) R
1 SGT 19D2F (Sct) Rev



1 WO 100BC (Inst Pilot) Rev
1 SGT 67Y20 (Hel Repairman) R
1 SGT 19D2F (Sct) Rev



2 WO 100BH (Pilot) Rev
2 SP4 67V10 (Hel Repairman) R
2 SGT 19D2F (Sct) Rev



1 WO 100BH (Pilot) Rev
1 SGT 67V20 (Hel Rep) Rev
1 SP4 67V10 (Hel Rep) R



1 WO 100BH (Pilot) Rev
1 SGT 67V10 (Hel Rep) Rev
1 PFC 67V10 (Hel Rep) R

514

ATTACK HEL PLT



1 LT 15B00 (Pit Ldr) Rev
1 SFC 67V40 (Pit SGT) R
1 SGT 67Y20 (Hel Repairman) R
1 PFC 67Y10 (Hel Repairman) R



2 WO 100E0 (Pilot) Rev
1 SGT 67Y20 (Hel Repairman) R



2 WO 100E0 (Pilot) Rev
1 SP4 67Y10 (Hel Repairman) R



2 WO 100E0 (Pilot) Rev
1 SP4 67Y10 (Hel Repairman) R

CHAPTER 9

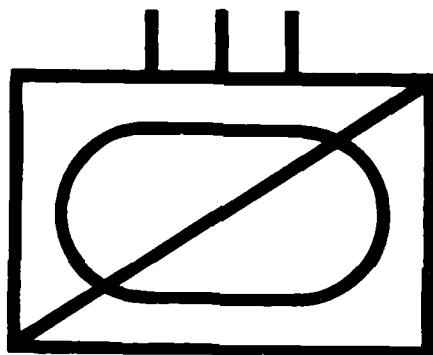

CORPS—86
ARMORED CAVALRY REGIMENT

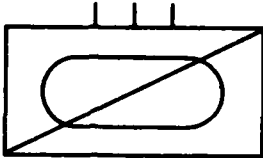

0	WO	EM	AGG
330	161	4624	5115

516

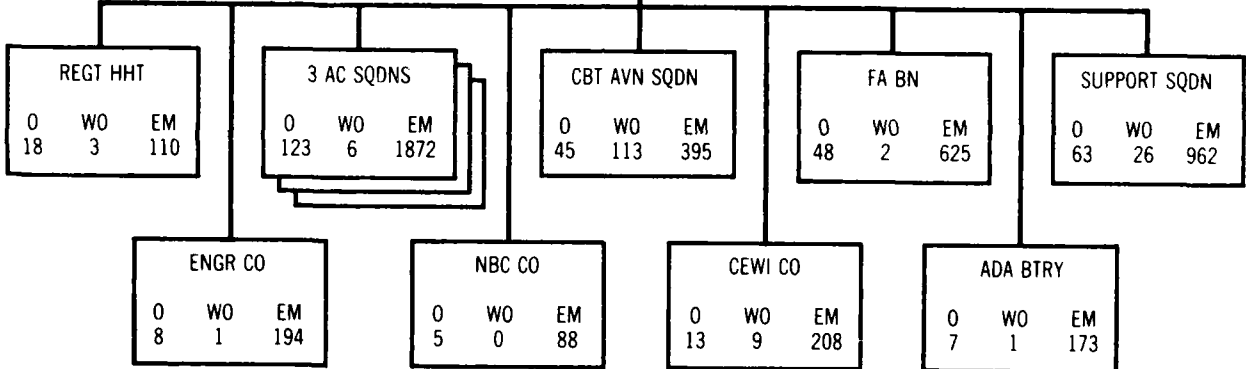

SUMMARY OF EQUIPMENT

WEAPONS

BAYONET KNIFE W/SCABBARD FOR M16A1 RIFLE.....	4,700
LAUNCHER GRENADE 40MM: SGL SHOT RIFLE MTD DTOMBLE W/E.....	265
LAUNCHER GRENADE SMOKE: SCREENING RED PHOSPHORUS M239.....	15
LAUNCHER GRENADE SMOKE: SCREENING RP M250.....	126
LAUNCHER ROCKET AIRCRAFT: 2.75 INCH.....	52
LAUNCHER ROCKET AIRCRAFT: 66MM 4 TUBE.....	3
MACHINE GUN CALIBER .50: HEAVY FIXED TURRET TYPE.....	129
MACHINE GUN CALIBER .50: MB FLEXIBLE VEHICLE MTD.....	210
MACHINE GUN CALIBER .50: MX FLEXIBLE FOR GROUND USE.....	137
MACHINE GUN CALIBER .50: VEHICLE HEAVY FIXED.....	3
MACHINE GUN CALIBER 7.62MM: AIRCRAFT LIGHT DOOR MTD.....	50
MACHINE GUN CALIBER 7.62MM: LIGHT FLEXIBLE.....	184
MORTAR 4.2 INCH: ON MOUNT.....	18
PISTOL CALIBER .45 AUTOMATIC.....	981
REVOLVER CALIBER: 38 SPECIAL: 4 INCH BARREL.....	210
RIFLE 5.56MM: W/E.....	4,395
SUBMACHINE GUN 5.56MM: PORT FIRING M231.....	1
SUBMACHINE GUN CALIBER .45.....	96
MACHINE GUN 7.62MM: FIXED M240C RH FEED F/PVS.....	366
MACHINE GUN 5.56MM: (SAW).....	20
MACHINE GUN 7.62MM: FIXED.....	1

VEHICLES

CARRIER 107MM MORTAR: SELF-PROPELLED (LESS MORTAR).....	18
CARRIER CARGO: TRACKED 6 TON.....	49
CARRIER COMMAND POST: LIGHT TRACKED.....	48
CARRIER PERSONNEL FULL TRACKED: ARMORED.....	82
CHASSIS TRAILER: GENERATOR PURPOSE 3 1/2 TON 2 WHEEL W/E.....	2
CAVALRY FIGHTING VEHICLE: M3.....	111
CHASSIS TRAILER: GENERATOR 2 1/2 TON 2 WHEEL W/E.....	2
COMBAT ENGINEER VEHICLE FULL TRACKED.....	3
CRANE WHEEL MTD: 20 TON W/BOOM CRANE.....	1
CRANE WHEEL MTD: SP ARMY AIRCRAFT MAINTENANCE.....	1
HELICOPTER OBSERVATION: OH-58C.....	18
HELICOPTER ATTACK: TOW MISSILE.....	12
HELICOPTER OBSERVATION: OH-58A.....	6
HELICOPTER UTILITY: UH-60A.....	25
HOMITZER MEDIUM SP: 155MM.....	24
KITCHEN FIELD TRAILER MOUNTED: MTD OR M103A3 TRAILER.....	11
LAUNCH M60 SERIES TANK CHASSIS TRNSPTG: 60FT BRIDGE.....	15
LOADER SCOOP TYPE DSL 4 WHL 2 1/2 CO YD.....	1
RECOVERY VEHICLE FULL TRACKED: LIGHT ARMORED.....	3
RECOVERY VEHICLE FULL TRACKED: MEDIUM.....	30
SEMITRAILER LOW BED: BREAKBULK/CONTAINER TRANSPORTER 22 1/2 TON.....	13
SEMITRAILER LOW BED: HEAVY EQUIPMENT TRANSPORTER 60-TON.....	3
SEMITRAILER STAKE: 12 TON 4 WHEEL W/E.....	9
SEMITRAILER TANK: 5000 GAL FUEL DISPENSING AUTOMOTIVE.....	18

SEMITRAILER VAN: REPAIR PARTS STORAGE 6 TON 4 WHEEL W/E.....	7
SEMITRAILER VAN: SUPPLY 12 TON 4 WHEEL W/E.....	8
TRUCK LIFT FORK: DSL DRVN 10,000 LBS CAP ROUGH TERRAIN.....	8
MMNV-WPNS CARRIER.....	2
DIVAD GUN AIR DEFENSE ARTILLERY SP.....	17
HELICOPTER ATTACK ADVANCED: (AAH).....	14
MOTORCYCLE: 2 WHEEL.....	20
TRUCK CARGO: 10 TON 8X8 HIGH MOBILITY M9977.....	64
TRUCK RECOVERY: TACTICAL 10 TON 8X8 HIGH MOBILITY.....	5
TRUCK ROCKET RESUPPLY: 5 TON 6X6 W/WHE (SLAFAB).....	2
TRUCK TANK: FUEL SERVICING 2500 GAL 8X8 W/WINCH.....	37
TRUCK UTILITY: 1 1/4 TON 4X4 W/C MMNV.....	38
WELDING SHOP TRAILER MOUNTED: OXY-ACETYLENE.....	1
TRACTOR FULL TRND HIGH SPD: ARMORED DOZER.....	6
TRACTOR WHEEL IND: DSL W/BACKHOE W/LOADER.....	2
TRAILER ACFT MAINT AIRMOBILE: 4 WHLD.....	2
TRAILER AMMUNITION: 1 1/2 TON 2 WHL W/E.....	6
TRAILER CARGO: 1/4 TON 2 WHEEL W/E.....	149
TRAILER CARGO: 3/4 TON 2 WHEEL W/E.....	39
TRAILER CARGO: 1 1/2 TON 2 WHEEL W/E.....	208
TRAILER TANK: WATER 400 GALLON 1 1/2 TON 2 WHL W/E.....	34
TRUCK AMBULANCE: TACTICAL 1 1/4 TON 4X4 W/E.....	3
TRUCK AMBULANCE: 1 1/4 TON 6X6 W/E.....	14
TRUCK CARGO: TACTICAL 1 1/4 TON 4X4 W/E.....	27
TRUCK CARGO: TACTICAL 1 1/4 TON 4X4 W/COMMO SHELTER KIT W/E.....	1
TRUCK CARGO: TACTICAL 1 1/4 TON 4X4 W/60 AMP KIT W/E.....	1
TRUCK CARGO: TACTICAL 1 1/4 TON 4X4 W/60 AMP COMP KIT W/E.....	36
TRUCK CARGO: TACTICAL 1 1/4 TON 4X4 W/60 AMP COMP SHELTER KIT W/E.....	17
TRUCK CARGO: 1 1/4 TON 6X6 W/E.....	31
TRUCK CARGO: 2 1/2 TON 6X6 W/E.....	137
TRUCK CARGO: DROP SIDE 2 1/2 TON 6X6 W/E.....	11
TRUCK CARGO: 2 1/2 TON 6X6 W/WINCH W/E.....	44
TRUCK CARGO: DROP SIDE 2 1/2 TON 6X6 W/WINCH W/E.....	1
TRUCK CARGO: 2 1/2 TON 6X6 XLWB W/E.....	11
TRUCK CARGO: DROP SIDE 5 TON 6X6 W/E.....	23
TRUCK CARGO: 5 TON 6X6 LWB W/E.....	28
TRUCK CARGO: DROP SIDE 5 TON 6X6 W/WINCH W/E.....	10
TRUCK CARGO: 5 TON 6X6 LWB W/WINCH W/E.....	6
TRUCK CARGO: 5 TON 8X8 W/E.....	6
TRUCK DUMP: 5 TON 6X6 W/E.....	2
TRUCK DUMP: 5 TON 6X6 W/WINCH W/E.....	1
TRUCK LIFT FORK: DSL DRVN 6,000 LBS CAP ROUGH TERRAIN.....	5
TRUCK LIFT FORK: DSL DRVN 10,000 LBS CAP ROUGH TERRAIN.....	1
TRUCK LIFT FORK: LIMITED ROUGH TERRAIN 4,000 LBS.....	4
TRUCK TANK: WATER 1,000 GAL 2 1/2 TON 6X6 W/E.....	1
TRUCK TRACTOR: 5 TON 6X6 W/E.....	51
TRUCK TRACTOR: 5 TON 6X6 W/WINCH W/E.....	2
TRUCK TRACTOR WRECKER: 5 TON 6X6 W/WINCH W/E.....	1

ARMORED CAVALRY REGIMENT

SUMMARY OF EQUIPMENT (Continued)

VEHICLES

TRUCK UTILITY: 1/4 TON 4X4 W/E.....	191
TRUCK TRACTOR HET 22 1/2 TON 8X8 W/DUAL MISHIP WINCH.....	3
TRUCK VAN EXPANSIBLE 5 TON 6X6 (ARMY).....	9
TRUCK VAN SHOP 2 1/2 TON 6X6 W/E.....	24
TRUCK VAN SHOP 2 1/2 TON 6X6 W/WINCH W/E.....	3
TRUCK WRECKER: 5 TON 6X6 W/WINCH W/E.....	16

NBC EQUIPMENT

ALARM CHEMICAL AGENT AUTOMATIC: PTBL MANPACK.....	80
ALARM CHEMICAL AGENT AUTOMATIC: FIXED EMPLACED.....	12
ALARM CHEMICAL AGENT AUTOMATIC: PTBL F/TRK UTILITY 1/4 TON.....	4
ALARM CHEMICAL AGENT AUTOMATIC: PTBL F/TRK UTILITY 2 1/2 TON.....	12
ALARM CHEMICAL AGENT AUTOMATIC: PTBL F/FULL TKD APC & ARV.....	72
ALARM CHEMICAL AGENT AUTOMATIC: PTBL F/CARRIER CMD & RECON ARV.....	7
ALARM CHEMICAL AGENT AUTOMATIC: PTBL W/PWR SUP F/TRK UTILITY 1/4 TON	43
ALARM CHEMICAL AGENT AUTOMATIC: PTBL W/PWR SUP F/TRK UTILITY 3/4 TON	1
ALARM CHEMICAL AGENT AUTOMATIC: PTB W/PWR SUP F/TRK UTILITY 2 1/2 TON	5
ALARM UNIT CHEMICAL AGENT AUTOMATIC ALARM.....	1
CHARGER RADIAC DETECTOR PP-1578/PD.....	26
DECONTAMINATING APPARATUS PWR DRWN SKID MOUNTED.....	9
MASK CBR: HEADWOUND PROTECTIVE.....	90
MASK CBR: PROTECTIVE FIELD.....	858
RADIAC SET: AN/PDR-27.....	8
RADIAC SET: AN/PDR-56(F).....	5
RADIAC METER: IM-91PD.....	2
RADIAC METER: IM-93/UD.....	37
RADIAC METER: IM-74/PD.....	24
RADIAC SET: AN/VDR-1.....	178
CHARGER-RADIAC DETECTOR: PP-4370/PD.....	58
MASK-CHEMICAL-BIOLOGICAL.....	4,368
MASK-CHEMICAL-BIOLOGICAL: PROTECTIVE COMBAT VEH.....	21
RADIAC METER: IM-185/PD.....	383
MASK-CHEMICAL-BIOLOGICAL PROTECTIVE FIELD M30.....	60

ARMORED CAVALRY REGIMENT

Notes: _____

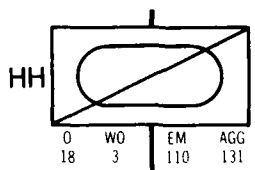

0	WO	EM	AGG
18	3	110	131

REGT HQ			
0	WO	EM	
8	0	1	

520

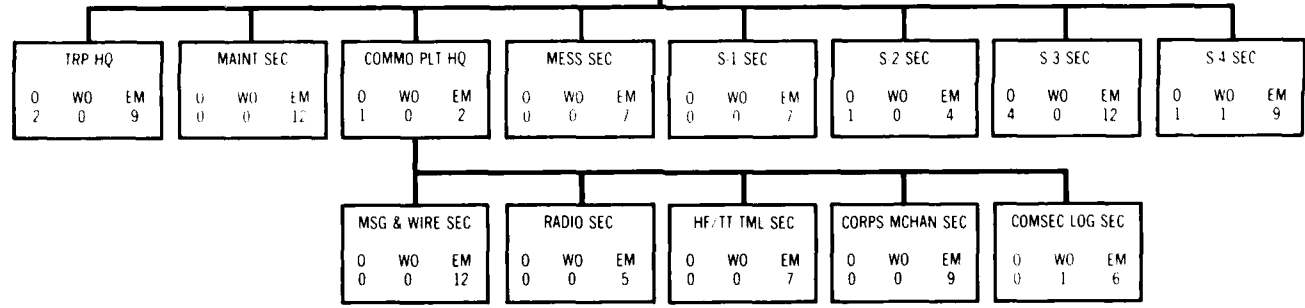

SUMMARY OF EQUIPMENT

WEAPONS

BAYONET-KNIFE: W/SCABBARD FOR M16A1 RIFLE.....	35
LAUNCHER GRENADE 40 MILLIMETER: SGL SHOT RIFLE MTD DITCHBLE W/E.....	1
MACHINE GUN 7.62 MILLIMETER: FIXED.....	1
MACHINE GUN CALIBER .50: HB FLEXIBLE VEHICLE MTD.....	1
MACHINEGUN CALIBER .50: HB FLEXIBLE FOR GROUND USE.....	4
MACHINE GUN 7.62 MILLIMETER: LIGHT FLEXIBLE.....	2
PISTOL CALIBER .45 AUTOMATIC.....	37
REVOLVER CALIBER .38 SPECIAL: 4-INCH BARREL.....	50
RIFLE 5.56 MILLIMETER: W/E.....	143
SUBMACHINE GUN 5.56 MILLIMETER: PORT FIRING M231.....	1

VEHICLES

CARRIER COMMAND POST: LIGHT TRACKED.....	4
CARRIER PERSONNEL FULL TRACKED: ARMORED.....	3
TRAILER CARGO: 1/4 TON 2 WHEEL W/E.....	9
TRAILER CARGO: 3/4 TON 2 WHEEL W/E.....	3
TRAILER CARGO: 1-1/2 TON 2 WHEEL W/E.....	8
TRAILER TANK: WATER 400 GALLON 1-1/2 TON 2 WHEEL W/E.....	2
TRUCK AMBULANCE: 1-1/4 TON 6X6 W/E.....	1
TRUCK CARGO: TACTICAL 1-1/4 TON 4X4 W/E.....	1
TRUCK CARGO: TACTICAL 1-1/4 TON 4X4 W/100 COMM SHELTER KT W/E.....	2
TRUCK CARGO: TACTICAL 1-1/4 TON W/100 AMP-COMM SHELTER KT W/E.....	3
TRUCK CARGO: 1-1/4 TON 6X6 W/E.....	5
TRUCK CARGO: 2-1/2 TON 6X6 W/E.....	10

TRUCK CARGO: 5 TON 6X6 LWB W/E.....	1
TRUCK CARGO: DROP SIDE 5 TON 6X6 W/WINCH W/E.....	1
TRUCK UTILITY: 1/4 TON 4X4 W/E.....	15
TRUCK WRECKER: 5 TON 6X6 W/WINCH W/E.....	1
RECOVERY VEHICLE FULL TRACKED: MEDIUM.....	1

NBC EQUIPMENT

ALARM CHEMICAL AGENT AUTOMATIC: PORTABLE MANPACK.....	4
ALARM CHEMICAL AGENT AUTOMATIC: PTBL W/PWR SUP F/TRK UTIL 1/4 TON..	1
ALARM CHEMICAL AGENT AUTOMATIC: PTBL W/PWR SUP F/TRUCK 2 1/2 TON..	1
CHARGER RADIAC DETECTOR: PP-157R/PD.....	3
CHARGER RADIAC DETECTOR: PP-4370/PD.....	2
DECONTAMINATING APPARATUS POWER DRIVEN SKID MOUNTED: MULTIPURPOS.....	1
MASK CHEMICAL-BIOLOGICAL: MULTIPURPOSE.....	261
RADIAC METER: IM-185/AD.....	2
RADIAC SET: AN/VDR-1.....	2

MISCELLANEOUS EQUIPMENT

BINOCULAR: MODULAR CONSTRUCTION MIL SCALE RETICLE 7X50MM W/E.....	10
MOUNT GUN: RING CAL .50.....	5
MOUNT TRIPOD MACHINE GUN: 7.62 MILLIMETER.....	2
NIGHT VISION GOGGLES: AN/PVS-5.....	10
NIGHT VISION SIGHT CREW SERVED WEAPON: AN/PVS-5.....	1

HEADQUARTERS AND HEADQUARTERS TROOP ARMORED CAVALRY REGIMENT

*REGIMENTAL HQ



1 COL 12C00 (Cdr) P



1 LTC 12C00 (XO) P



1 CSM 00Z50 (CSM) R

S-1/ADMIN SEC



* 1 MAJ 41A00 (S 1) P
1 PFC 75B10 (PAC Clerk) R



1 MSG 71L50 (Admin NCO) R



1 SFC 75Z40 (Pers Staff NCO) R



* 1 MAJ 56A00 (Chaplain)
1 SSG 71M30 (Sr Chapel Act Sp) R

S-1/ADMIN SEC



1 SGT 71D20 (Legal Clerk) R



1 SP4 71L10 (Clerk Typ) R



1 SP4 75B10 (PAC Clerk) R



* 1 MAJ 35A00 (S 2) P
1 CPT 35A00 (Asst S 2) R
1 MSG 19Z50 (Intell SGT) R
1 SFC 19D40 (Asst Intell SGT) R
1 SP4 19D10 (Dvr) R
1 SP4 71L10 (Clerk Typ) R

S-2 SEC

S-3 SEC



* 1 MAJ 12C00 (S 3) P
1 PFC 19D10 (Dvr) R

* With Regimental HQ



1 CPT 12C00 (LO) R
1 PFC 19D10 (Dvr) R



1 MSG 19Z50 (Ops SGT) R
1 SP4 19D10 (Ops Asst) R
1 PFC 05B10 (RTO) R



1 CPT 12C00 (Asst S 3) R
1 CPT 12C00 (Asst S 3 Air) R
1 LT 12C00 (LO) R
1 SP4 19D10 (Dvr) P
1 SP4 05B10 (RTO) R



1 CPT 12C00 (Asst S 3) R
1 MSG 19Z50 (Asst Ops SGT) R
1 SGT 05B20 (Chief RTO) R
1 SP4 19D10 (Dvr) R
1 SP4 71L10 (Clerk Typ) R

S-4 SEC



* 1 MAJ 92B00 (S 4) P
1 PFC 05B10 (RTO) Dvr) R

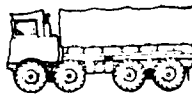

1 WO 041A0 (Food Svc Tech) R
1 MSG 94B50 (Food Svc Supv) R
1 SGT 76Y20 (Asst Supply SGT) R
1 SP4 71L10 (Clerk Typist) Dvr) R
1 PFC 76Y10 (Gen Supplyman) R



1 CPT 92B00 (Asst S 4) R
1 MSG 76Z5K (Chief Supply SGT) R
1 SP4 76Y10 (Gen Supplyman) R
1 SP4 19D10 (Dvr) R
1 SP4 05B10 (RTO) R

TRP HQ



1 MAJ 12C00 (Trp Cdr) P
1 SP4 64C10 (Dvr) R



1 CPT 12C00 (XO) R
1 PFC 64C10 (Dvr) R



1 SSG 19Z50 (1SG) R
1 PFC 64C10 (Dvr) R



1 SSG 76Y30 (Supply SGT) R
1 SP4 76Y10 (Armor Dvr) R
1 PFC 76Y10 (Gen Supplyman) R



** 1 SP4 54E10 (Decon Equip Op) R
1 PFC 54E10 (Decon Equip Op) R

523

COMMO PLT

COMMO PLT HQ



* 1 MAJ 25A00 (C E Off) P
1 MSG 31V50 (Com Chief) R
1 PFC 36K10 (Msgr) Dvr) R

* With Regimental HQ



1 LT 25A00 (Plt Ldr) R
1 SSG 31V30 (Com Chief) R
1 PFC 36K10 (Wire Op Sp Swbd) Dvr) R



1 SP4 36K10 (Wire Op Sp Swbd) R
1 SP4 36K10 (Wire Op Sp Wire) R
1 PFC 36K10 (Wire Op Sp Swbd) Dvr) R



1 SGT 36K20 (Wire Ops Tm Chief) R
1 SP4 72E10 (Telecom Center Op) Dvr) R
2 PFC 36K10 (Wire Op Sp Wire) R

** W/Winch

RADIO SECTION



1 SGT 05C20 (RATT Ops Tm Chief) R
1 PFC 31V70 (Commo Sys Op Mech Dvtr) R



1 PFC 31V10 (Commo Sys Op Mech Dvtr) R



1 SP4 05C10 (RTO) R
1 PFC 05C10 (RTO Dvtr) R

CORPS HF/TT TML SEC



1 SSG 05C30 (Sec Chief) R
1 SGT 05C20 (RATT Op Tm Chief) R
1 SP4 05B10 (RTO) R

1 SGT 05C20 (RATT Op Tm Chief) R
1 SP4 05B10 (RTO) R

COMSEC LOG SEC



1 WO 290AL (Commo Sec Chief) R
1 SGT 75E20 (Crypto Mat Sp) R



1 SSG 31S30 (Fld Gen COMSEC Supv) R
1 SGT 31T10 (Fld Gen COMSEC Repr) R
1 SP4 31T10 (Fld Gen COMSEC Repr) R
1 SP4 31S10 (Fld Gen COMSEC Repr) R
1 PFC 31T10 (Fld Gen COMSEC Repr) R

CORPS MECH SEC



(M885)
1 SSG 31M30 (Mech Tml Sec Chief) R
1 SGT 31M20 (Mech Tml Tm Chief) R
1 SP4 31M10 (Mech Tml Eq Op) R
1 PFC 31M10 (Mech Tml Eq Op) R

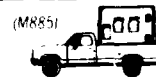

(M885)
1 SGT 31M20 (Mech Tml Tm Chief) R
1 SP4 31M10 (Mech Tml Eq Op) R
1 PFC 31M10 (Mech Tml Eq Op) R

HHT MESS TEAM



1 SFC 94B40 (Food Svc SGT) R
1 SGT 74B20 (Cook) R
1 PFC 94B10 (Cook Dvtr) R



1 SSG 94B30 (First Cook) R
2 SP4 94B10 (Cook) R
1 PFC 94B10 (Cook Dvtr) R

HHT MAINT SEC



1 SFC 63140 (Motor SGT) R
1 PFC 63110 (TAC Comm Sp Op Mech Dvr) R



1 SGT 76020 (PLI Clerk) R
1 SP4 45110 (CFV Turnst Mech) R
1 SP4 76010 (Eq Repl Parts Sp Dvr) R



1 SGT 63120 (APC Auto Mech) R
1 SP4 63110 (APC Auto Mech) R
2 PFC 63110 (APC Auto Mech Dvr) R

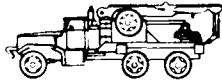

1 SP4 63110 (Recv Vch Op Dvr) R

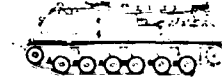

1 SGT 63120 (Recv Vch Op) P
1 PFC 63110 (Recv Vch Op Dvr) P

MED SEC



1 WO 01140 (PA) P
1 SSG 91E30 (Prac Nurse) R
1 SGT 91B20 (Aidman) P
1 PFC 91B10 (Med Aide Dvr) P



1 SSG 91B30 (Sec SGT) R
1 SGT 91B20 (Aidman) P
1 SGT 91B20 (Med Aide) P
1 SP4 91B10 (Aidman) P
1 SP4 91B10 (Med Aide) P
1 PFC 91B10 (Amb Attend Dvr) R

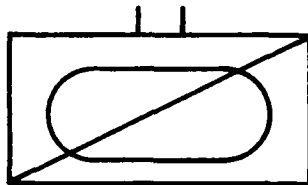

0	WO	EM	AGG
41	2	624	667

HHT		
0	WO	EM
18	2	189

3 CAV TRPS		
0	WO	EM
6	0	122

TANK CO		
0	WO	EM
5	0	69

SUMMARY OF EQUIPMENT

WEAPONS

BAYONET-KNIFE W/SCABBARD FOR M16A1 RIFLE.....	573
LAUNCHER GRENADE 40 MILLIMETER: SLE SHOT RIFLE MTD DITCHBLE W/E.....	47
LAUNCHER GRENADE SMOKE: SCREENING RED PHOSPHOROUS M239.....	2
LAUNCHER GRENADE SMOKE: SCREENING RP M250.....	42
LAUNCHER ROCKET: 66MM 4-TUBE.....	1
MACHINE GUN CALIBER .50: HEAVY FIXED TURRET TYPE.....	43
MACHINE GUN CALIBER .50: HB FLEXIBLE VEHICLE MTD.....	37
MACHINE GUN CALIBER .50: HB FLEXIBLE FOR GROUND USE.....	32
MACHINE GUN 7.62 MILLIMETER: LIGHT FLEXIBLE.....	37
MACHINE GUN 7.62MM: FIXED M240C RH FEED F/PVS.....	122
MACHINE GUN 7.62 MILLIMETER: FIXED.....	1
MORTAR 4.2 INCH: ON MOUNT.....	6
PISTOL CALIBER .45 AUTOMATIC.....	240
RIFLE 5.56 MILLIMETER: W/E.....	510
SUBMACHINE GUN CALIBER .45.....	14

VEHICLES AND EQUIPMENT

CAVALRY FIGHTING VEHICLE: M3.....	37
CARRIER 107 MILLIMETER MORTAR: SELF PROPELLED (LESS MORTAR).....	6
CARRIER COMMAND POST: LIGHT TRACKED.....	9
CARRIER PERSONNEL FULL TRACKED: ARMORED.....	15
LAUNCH M60 SERIES TANK CHASS TRANSPIT: 40 AND 60 FT. BRIDGE TY CL60, BRIDE.....	3
MOTORCYCLE: 2 WHEEL.....	6
RECOVERY VEHICLE FULL TRACKED: MEDIUM.....	7
TRAILER CARGO: 1/4 TON 2 WHEEL W/E.....	8
TRAILER CARGO: 3/4 TON 2 WHEEL W/E.....	2
TRAILER CARGO: 1-1/2 TON 2 WHEEL W/E.....	28
TRAILER TANK: WATER 400 GALLON 1-1/2 TON 2 WHEEL W/E.....	5
TRUCK CARGO: TACTICAL 1-1/4 TON 4X4 W/E.....	2
TRUCK CARGO: TACTICAL 1-1/4 TON W/60 AMP-COMM KITS W/E.....	2
TRUCK CARGO: 2-1/2 TON 6X6 W/E.....	14
TRUCK CARGO: 2-1/2 TON 6X6 W/WINCH W/E.....	8
TRUCK CARGO: 5 TON 6X6 LWB W/E.....	6
TRUCK CARGO: 5 TON 6X6 LWB W/WINCH W/E.....	1
TRUCK CARGO: 5 TON 8X8 W/E.....	2
TRUCK UTILITY: 1/4 TON 4X4 W/E.....	17
TRUCK VAN: SHOP 2-1/2 TON 6X6 W/E.....	2

TRUCK VAN: SHOP 2-1/2 TON 6X6 W/WINCH W/E.....	1
TRUCK WRECKER: 5 TON 6X6 W/WINCH W/E.....	1
TRUCK CARGO: 10 TON 8X8 HIGH MOBILITY XM977.....	8
TRUCK RECOVERY: TACTICAL 10 TON 8X8 HIGH MOBILITY.....	1
TRUCK TANK: FUEL SERVICING 2500 GAL 8X8 H MO W/WINCH.....	9
TANK COMBAT FULL TRACKED: 105MM GUN M1.....	43

NBC EQUIPMENT

ALARM CHEMICAL AGENT AUTOMATIC: PORTABLE MANPACK.....	22
ALARM CHEMICAL AGENT AUTOMATIC: PTBL F/FULL TRKD APC AND ARV.....	24
ALARM CHEMICAL AGENT AUTOMATIC: PTBL W/PWR SUP F/TRK UTIL 1/4 TON..	7
ALARM CHEMICAL AGENT AUTOMATIC: PTBL W/PWR SUP F/TRUCK 2 1/2 TON...	1
CHARGER RADIAC DETECTOR: PP-1578/PD.....	3
CHARGER BATTERY: PP-7387/TAS.....	4
CHARGER RADIAC DETECTOR: PP-4370/PD.....	8
MASK CBR: HEADMOUND PROTECTIVE.....	10
MASK CHEMICAL-BIOLOGICAL: MULTI PURPOSE.....	681
RADIAC METER: IM-93/UD.....	4
RADIAC METER: IM-174/PD.....	4
RADIAC SET: AN/VDR-1.....	28
RADIAC METER: IM-185/UD.....	67

MISCELLANEOUS EQUIPMENT

SELF-CONTAINED LAND NAVIGATION SUBSYSTEM.....	38
RADAR SET: AN/PPS-5 LESS POWER.....	4
RADAR SET: AN/PPS-15 LESS POWER.....	18
PLATOON EARLY WARNING SYSTEM: AN/TRS-2(V).....	15
NIGHT VISION GOGGLES: AN/PVS-5.....	161
NIGHT VISION SIGHT CREW SERVED WEAPON: AN/PVS-5.....	20
NIGHT VISION SIGHT INDIVIDUAL SERVED WEAPON: AN/PVS-4.....	43
DEMOLITION SET EXPLOSIVE: INITIATING NON ELECTRIC.....	18
DETECTING SET MINE: PTBL METALLIC AND NON METALLIC.....	10
DETECTING SET MINE: PTBL METALLIC (AN/PSS-11).....	10
BINOCULAR: MODULAR CONSTRUCTION MIL SCALE RETICLE 7X50MM W/E.....	95
DETECTING SET MINE: VEHICULAR.....	2
DETECTOR RADAR SIGNAL: AN/PSS-10.....	18

ARMORED CAVALRY SQUADRON ARMORED CAVALRY REGIMENT

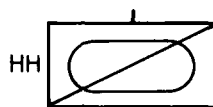

0 WO EM AGG
18 7 189 209

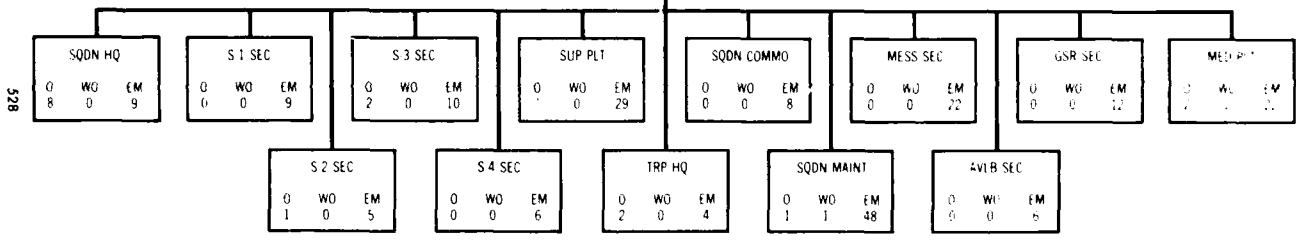

528

SUMMARY OF EQUIPMENT

WEAPONS

LAUNCHER GRENADE 40 MILLIMETER: SGL SHOT RIFLE MTD DITCHBLE W/E...	3
LAUNCHER GRENADE SMOKE: SCREENING RED PHOSPHOROUS M239.....	2
LAUNCHER GRENADE SMOKE: SCREENING RP M250.....	1
MACHINE GUN CALIBER .50: HB FLEXIBLE VEHICLE MTD.....	6
MACHINE GUN CALIBER .50: HB FLEXIBLE FOR GROUND USE.....	24
MACHINE GUN 7.62 MILLIMETER: LIGHT FLEXIBLE.....	1
MACHINE GUN 7.62MM: FIXED M240C RH FEED F/PVS.....	4
MACHINE GUN 7.62 MILLIMETER: FIXED.....	1
PISTOL CALIBER .45 AUTOMATIC.....	38
RIFLE 5.56 MILLIMETER: W/E.....	179

TRUCK CARGO: 5 TON 6X6 LWB W/E.....	6
TRUCK CARGO: 5 TON 6X6 LWB W/WINCH W/E.....	1
TRUCK CARGO: 5 TON 8X8 W/E.....	2
TRUCK UTILITY: 1/4 TON 4X4 W/E.....	11
TRUCK VAN: SHOP 2-1/2 TON 6X6 W/E.....	2
TRUCK VAN: SHOP 2-1/2 TON 6X6 W/WINCH W/E.....	1
TRUCK WRECKER: 5 TON 6X6 W/WINCH W/E.....	1
TRUCK CARGO: 10 TON 8X8 HIGH MOBILITY XM977.....	8
TRUCK RECOVERY: TACTICAL 10 TON 8X8 HIGH MOBILITY.....	1
TRUCK TANK: FUEL SERVICING 2500 GAL 8X8 H MO W/WINCH.....	9

VEHICLES

CAVALRY FIGHTING VEHICLE: M3.....	1
CARRIER COMMAND POST: LIGHT TRACKED.....	6
CARRIER PERSONNEL FULL TRACKED: ARMORED.....	11
LAUNCH M60 SERIES TANK CHASS TRNSPTS: 40 AND 60 FT BRGE TY CL60/W BRIDGE.....	3
MOTORCYCLE: 2 WHEEL.....	4
RECOVERY VEHICLE FULL TRACKED: MEDIUM.....	3
TANK COMBAT FULL TRACKED: 105MM GUN M1.....	2
TRAILER CARGO: 1/4 TON 2 WHEEL W/E.....	7
TRAILER CARGO: 3/4 TON 2 WHEEL W/E.....	2
TRAILER CARGO: 1-1/2 TON 2 WHEEL W/E.....	7
TRAILER CARGO: 1-1/2 TON 2 WHEEL W/E.....	10
TRAILER TANK: WATER 400 GALLON 1-1/2 TON 2 WHEEL W/E.....	5
TRUCK CARGO: TACTICAL 1-1/4 TON 4X4 W/E.....	1
TRUCK CARGO: TACTICAL 1-1/4 TON 4X4 W/E.....	1
TRUCK CARGO: TACTICAL 1-1/4 TON 4X4 W/60 AMP-COMM KITS W/E.....	2
TRUCK CARGO: 2-1/2 TON 6X6 W/E.....	10
TRUCK CARGO: 2-1/2 TON 6X6 W/WINCH W/E.....	1

NBC EQUIPMENT

ALARM CHEMICAL AGENT AUTOMATIC: PORTABLE MANPACK.....	4
ALARM CHEMICAL AGENT AUTOMATIC: PTBL W/PWR SUP F/TRK UTIL 1/4 TON.....	2
ALARM CHEMICAL AGENT AUTOMATIC: PTBL W/PWR SUP F/TRUCK 2 1/2 TON.....	1
CHARGER RADIA DETECTOR: PP-4370/PD.....	1
DECONTAMINATING APPARATUS POWER DRIVEN SKID MOUNTED: MULTIPURPOS.....	1
MASK CBR: HEADMOUNT PROTECTIVE.....	13
MASK CHEMICAL-BIOLOGICAL: MULTI PURPOSE.....	217
RADIAC METER: IM-185/UD.....	18
RADIAC SET: AN/VDR-1.....	8

MISCELLANEOUS

BAYONET-KNIFE: W/SCABBARD FOR M16A1 RIFLE.....	217
BINOCULAR: MODULAR CONSTRUCTION MIL SCALE RETICLE 7X50MM W/E.....	7
BRIDGE ARMOR VEH LAUNCH SCISSOR TY: CL 60 ALUM 60 FT LG OF SPAN.....	3
NIGHT VISION GOGGLES: AN/PVS-5.....	22
NIGHT VISION SIGHT CREW SERVED WEAPON: AN/PVS-5.....	12
NIGHT VISION SIGHT INDIVIDUAL SERVED WEAPON: AN/PVS-4.....	2
RADAR SET: AN/PVS-5 LESS POWER.....	4

HEADQUARTERS AND HEADQUARTERS TROOP ARMORED CAVALRY SQUADRON ARMORED CAVALRY REGIMENT

SQDN HQ SEC



* 1 LTC 12C00 (Cdr) P



* 1 MAJ 12C00 (XO) P
1 CSM 19250 (CSM) R

* Also Lt Veh Dvr



1 SSG 19K30 (Tank Cdr) P
1 SP4 19K10 (Gnr) P
1 SP4 19K10 (Dvr) P, S
1 PFC 19K10 (Loader) P, S



1 SSG 19K30 (Tank Cdr) P
1 SP4 19K10 (Gnr) P
1 SP4 19K10 (Dvr) P, S
1 PFC 19K10 (Loader) P, S

S-1 SEC



1 CPT 56A00 (Chaplain)
1 SP4 71M10 (Chap Act Sp) R



1 CPT 12A41 (S-1) R
1 SFC 75240 (PAC Super) R
1 SSG 75230 (Personnel Staff NCO) R
1 SGT 71D20 (Legal Clk) R
1 SGT 75B20 (PAC Clk) R
1 SP4 19D10 (Pers Carr Dvr) P
1 SP4 71L10 (Clk Typ) R
1 SP4 75B10 (PAC Clk) R
1 PFC 75B10 (PAC Clk) R

S-2 SEC



1 CPT 35A00 (S-2) R
1 LT 35A00 (TAC Intel Off) R
1 MSG 19250 (Intel Anal) R
1 SSG 96B30 (Sr Intel Anal) R
1 SGT 96B20 (Intel Anal) R
1 SP4 19D10 (Intel Asst) R
1 SP4 19D10 (Dvr) P

530

S-3 SECTION



1 MAJ 12C00 (S-3) P
1 PFC 19D10 (Dvr) R



1 LT 12C00 (Liaison Off) R
1 PFC 19D10 (Liaison Agent-Dvr) R



1 MSG 19250 (Op SGT) R
1 SGT 19D20 (Asst Op SGT) R
1 SP4 71L10 (Clk Typ-Dvr) R



1 CPT 12C00 (S-3 Air) R
1 SFC 19D40 (Asst Op SGT) R
1 SP4 05B10 (RTO) R
1 SP4 19D10 (Dvr) P



1 SP4 19D10 (Gnr) R
1 SP4 19D10 (Dvr) P
(TACP)

S-4 SECTION

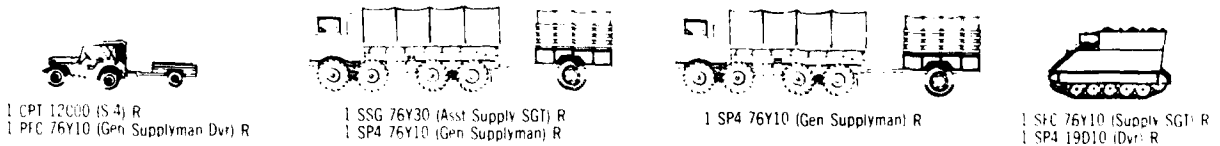

HHT HQ SECTION

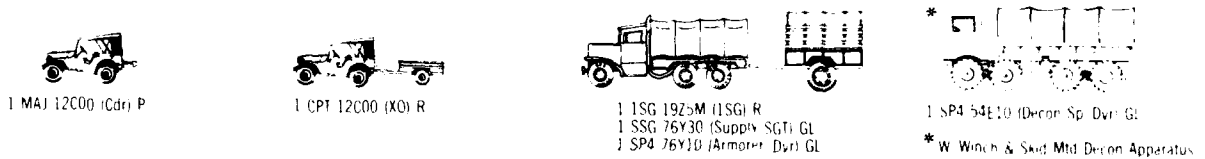

SQDN COMMO SEC

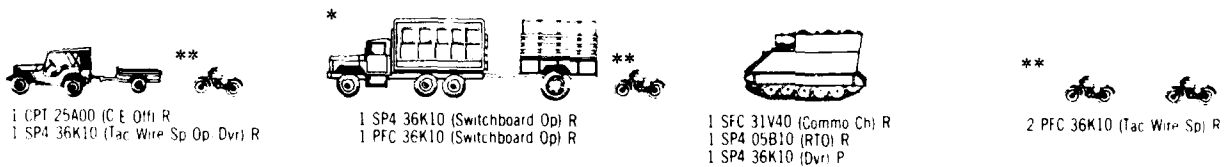

* W Winch
** Also Used For Mstr Service

SQDN SUPPORT PLATOON

SQDN SPT PLT HQ



1 LT 12C00 (Plt Ldr) R
1 PFC 64C10 (Dvr) R



1 SSG 64C30 (POL Sec SGT) R
1 SP4 64C10 (Hv Veh Dvr) R

TRANS SEC

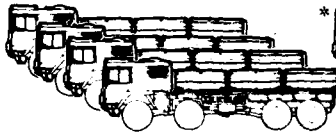

1 SGT 64C20 (Hv Veh Dvr) R

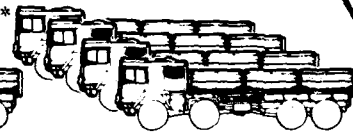

1 SP4 64C10 (Hv Veh Dvr) R
1 PFC 64C10 (Hv Veh Dvr) R

POL SEC



1 SFC 64C40 (Trk Mstr) R
1 SP4 64C10 (Hv Veh Dvr) R



1 SSG 64C30 (Ammo Sec SGT) R
1 SP4 64C10 (Hv Veh Opt) R



1 SGT 64C20 (Hv Veh Opt) R
1 SP4 64C10 (Ammo Sp) R



1 SGT 64C20 (Hv Veh Dvr) R

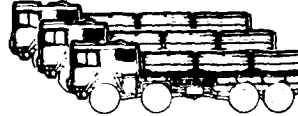

1 SP4 64C10 (Hv Veh Dvr) R
1 PFC 64C10 (Hv Veh Dvr) R

HHT MESS SEC



1 SFC 94B40 (Food Serv SGT) R
1 SSG 94B30 (1st Cook) R
1 SGT 94B20 (Cook) R
2 SP4 94B10 (Cook) R
1 PFC 94B10 (Cook) (Dvr) R

4 CAV TRP MESS TRP



1 SFC 94B40 (Food Serv SGT) R
1 SGT 94B20 (1st Cook) R
1 SP4 94B10 (Cook - Dvr) R
1 PFC 94B10 (Cook) R

* W/Winch

SQDN MEDICAL PLATOON

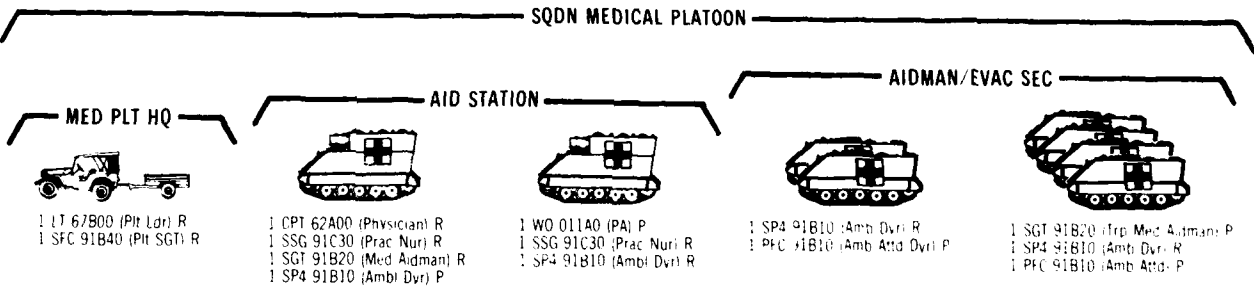

BN MAINT PLATOON

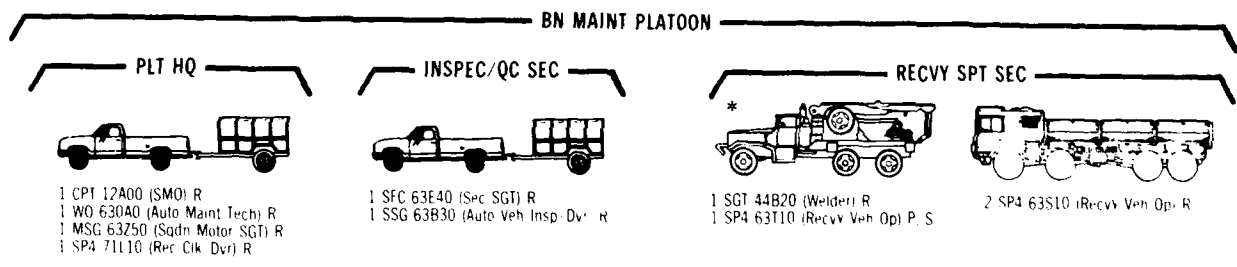

RECOVERY SPT SEC

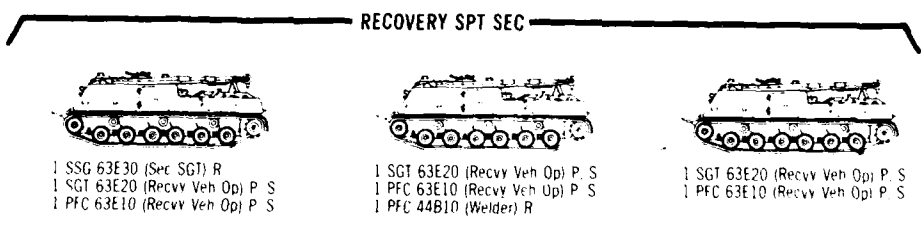

* W Winch

INSP/QUAL CONTROL SECTION
ADMIN/RECORD SECTION

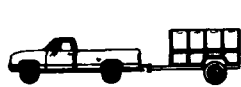

1 SSG 76Y30 (Sec SGT) R
1 PFC 76C10 (Equip Rec/Part Sp/Dvr) R



1 SP4 76C10 (Equip Rec/Parts Sp) R
** 1 PFC 63T10 (CFV Auto Mech) R



* 1 SSG 31V30 (Com Sys Insp) R
** 1 PFC 63T10 (CFV Auto Mech) R



* 1 SSG 63T30 (Tk Veh Insp) R
** 1 PFC 63T10 (CFV Auto Mech) R



* 1 SSG 45K30 (Turret Insp) R
** 1 PFC 63B10 (Lt Veh/Gen Mech) R



* 1 SSG 63T30 (Tk Veh Insp) R
** 1 SP4 63B10 (Lt Veh/Gen Mech) R



* 1 SSG 45K30 (Turret Insp) R
* 1 SP4 63B10 (Lt Veh/Gen Mech) R

534

* From Qual Control Sec
** From Maint Svc Sec

MAINT/SERVICE SEC



1 SGT 63T20 (CFV Auto Mech) R
1 SP4 63S10 (Hv Wheel Veh Mech) R
1 SP4 45T10 (CFV Turret Mech) R
1 SP4 63E10 (M1 Auto Mech) R
1 SP4 45E10 (M1 Auto Mech) R



1 SGT 63B20 (Lt Veh/Gen Mech) R
1 SP4 63T10 (CFV Auto Mech) R
1 PFC 63B10 (Lt Veh/Gen Mech) R



1 SFC 63T40 (Maint Supv) R
1 SGT 63E20 (M1 Auto Mech) R

MAINT/SVC SEC CONT



1 SGT 63T20 (CFV Auto Mech) R
1 PFC 63E10 (M1 Tk Auto Mech) R



1 SGT 31V20 (Comm Sys Mech) R
1 SP4 63B10 (Hv Wh Veh Mech) R



1 SGT 63E20 (M1 Auto Mech) R
1 PFC 63B10 (CFV Auto Mech) R



1 SP4 63T10 (CFV Auto Mech) R
1 PFC 63B10 (M1 Auto Mech) R

AVLB SEC

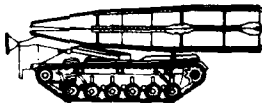

1 SSG 19K30 (Sec Ch) R
1 SP4 19L10 (AVLB Dvr) R

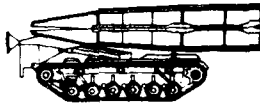

1 SGT 19K20 (AVLB Cdr) R
1 SP4 19L10 (AVLB Dvr) R

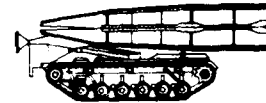

1 SGT 19K20 (AVLB Cdr) R
1 SP4 19L10 (AVLB Dvr) R

GSR SEC



1 SSG 17K30 (Sec Ch) R
1 SP4 17K10 (GSR Crewman) R
1 PFC 17K10 (GSR Crewman/Dvr) R



1 SGT 17K20 (Tm Ch) R
1 SP4 17K10 (GSR Crewman) R
1 PFC 17K10 (GSR Crewman/Dvr) R



1 SGT 17K20 (Tm Ch) R
1 SP4 17K10 (Crewman) R
1 PFC 17K10 (GSR Crewman/Dvr) R

* W Winch

536

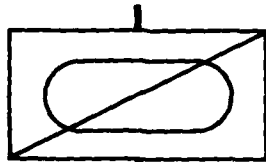

0	WO	EM	AGG
6	0	129	135

HQ SEC			
0	WO	EM	
2	0	11	

2 MORT SEC			
0	WO	EM	
0	0	11	

*TOTAL FOR BOTH SECS.

2 SCT PLTS			
0	WO	EM	
1	0	29	

2 TANK PLTS			
0	WO	EM	
1	0	15	

MAINT SEC			
0	WO	EM	
0	0	12	

SUMMARY OF EQUIPMENT

WEAPONS			
BAYONET-KNIFE: W/SCABBARD FOR M16A1 RIFLE.....	94	TRUCK CARGO: 2-1/2 TON 6X6 W/WINCH W/E.....	2
LAUNCHER GRENADE 40 MILLIMETER: SLE SHOT RIFLE MTD DITCHBLE W/E....	14	TRUCK UTILITY: 1/4 TON 4X4 W/E.....	1
LAUNCHER GRENADE SMOKE: SCREENING RP M250.....	9		
MACHINE GUN CALIBER .50: HEAVY FIXED TURRET TYPE.....	9	NBC EQUIPMENT	
MACHINE GUN CALIBER .50: HB FLEXIBLE VEHICLE MTD.....	11	ALARM CHEMICAL AGENT AUTOMATIC: PORTABLE MANPACK.....	4
MACHINE GUN CALIBER .50: HB FLEXIBLE FOR GROUND USE.....	2	ALARM CHEMICAL AGENT AUTOMATIC: PTBL F/FULL TRKD APC AND ARV.....	8
MACHINE GUN 7.62 MILLIMETER: LIGHT FLEXIBLE.....	12	ALARM CHEMICAL AGENT AUTOMATIC: PTBL W/FWR SUP F/TRK UTIL 1/4 TON.	1
MORTAR 4.2 INCH: ON MOUNT.....	2	MASK CHEMICAL-BIOLOGICAL: MULTI PURPOSE.....	130
RIFLE 5.56 MILLIMETER: W/E.....	98	RADIAC METER: IM-93/AJD.....	1
PISTOL CALIBER .45 AUTOMATIC.....	47	RADIAC METER: IM-174/PD.....	1
SUBMACHINE GUN CALIBER .45.....	4	CHARGER RADIAC DETECTOR: PP-4370/PD.....	2
MACHINE GUN 7.62MM: FIXED M240C RH FEED F/FVS.....	30	RADIAC SET: AN/VDR-1.....	5
		MISCELLANEOUS EQUIPMENT	
		DEMOLITION SET EXPLOSIVE: INITIATING NON ELECTRIC.....	6
		DETECTING SET MINE: PTBL METALLIC AND NON METALLIC.....	3
		DETECTING SET MINE: PTBL METALLIC (AN/PSS-11).....	3
		NIGHT VISION GOGGLES: AN/PVS-5.....	40
		NIGHT VISION SIGHT CREW SERVED WEAPON: AN/TVS-5.....	2
		NIGHT VISION SIGHT INDIVIDUAL SERVED WEAPON: AN/PVS-4.....	13
		PLATOON EARLY WARNING SYSTEM: AN/TRS-2(V).....	4
		BINOCULAR: MODULAR CONSTRUCTION MIL SCALE RETICLE 7X50MM W/E.....	24

537

VEHICLES

TANK COMBAT FULL TRACKED: 105MM GUN M1.....	9
CAVALRY FIGHTING VEHICLE: M3.....	12
CARRIER 107 MILLIMETER MORTAR: SELF PROPELLED (LESS MORTAR).....	2
CARRIER COMMAND POST: LIGHT TRACKED.....	1
CARRIER PERSONNEL FULL TRACKED: ARMORED.....	1
RECOVERY VEHICLE FULL TRACKED: MEDIUM.....	1
TRAILER CARGO: 1-1/2 TON 2 WHEEL W/E.....	3
TRUCK CARGO: 2-1/2 TON 6X6 W/E.....	1

**ARMORED CAVALRY TROOP
ARMORED CAVALRY SQUADRON
ARMORED CAVALRY REGIMENT**

HQ SECTION



1 CPT 12C00 (Cdr) P
1 SP4 05B10 (RTO Dvr) R



1 SSG 19Z5M (1SG) R
1 SSG 76Y30 (Supply SGT) R
1 SP4 76Y10 (Armorer/Dvr) R



1 LT 12C00 (XO) R
1 SSG 31V30 (Com Ch) R
1 SSG 19030 (Veh Cdr) P
1 SP4 19010 (Carr Dvr) GL



1 SSG 19K30 (Tk Cdr) P
1 SGT 19K20 (Gnr) P
1 SP4 19K10 (Dvr) P, S
1 PFC 19K10 (Loader) P, S

MORTAR SEC

MORTAR SQD



1 SSG 11C30 (Sec Ldr) R
1 SGT 11C20 (Sqd Ldr) R
1 SP4 11C10 (Dvr) R
1 SP4 11C10 (Gnr) P
1 PFC 11C10 (Ammo Br) R
1 PFC 11C10 (Asst Gnr) R

MORTAR SQD



1 SGT 11C20 (Sqd Ldr) R
1 SP4 11C10 (Dvr) P
1 SP4 11C10 (Gnr) R
1 PFC 11C10 (Ammo Br) R
1 PFC 11C10 (Asst Gnr) R

1ST SCOUT PLATOON



1 LT 12C00 (Plt Ldr) P
1 SP4 19D10 (Gnr) R
1 SP4 19D10 (Dvr) R
1 SP4 19D10 (Sct) R
1 PFC 19D10 (Sct) R



1 SFC 19040 (Plt SGT) P
1 SP4 19D10 (Gnr) R
1 SP4 19D10 (Dvr) R
1 SP4 19D10 (Sct) R
1 PFC 19D10 (Sct) R



1 SSG 19D30 (Sqd Ldr) R
1 SP4 19D10 (Gnr) R
1 SP4 19D10 (Dvr) R
1 SP4 19D10 (Sct) R
1 SP4 19D10 (Sct) R



1 SGT 19020 (Crew Ldr) R
1 SP4 19D10 (Gnr) R
1 SP4 19D10 (Dvr) R
1 SP4 19D10 (Sct) R
1 SP4 19D10 (Sct) R

2D SCOUT PLT



1 LT 12C00 (Plt Ldr) P
 1 SP4 19D10 (Gnr) R
 1 SP4 19D10 (Dvr) R
 1 SP4 19D10 (Sct) R
 1 PFC 19D10 (Sct) R



1 SFC 19D40 (Plt SGT) P
 1 SP4 19D10 (Gnr) R
 1 SP4 19D10 (Dvr) R
 1 SP4 19D10 (Sct) R
 1 PFC 19D10 (Sct) R



1 SSG 19D30 (Sqd Ldr) R
 1 SP4 19D10 (Gnr) R
 1 SP4 19D10 (Dvr) R
 1 SP4 19D10 (Sct) R
 1 PFC 19D10 (Sct) R



1 SGT 19D20 (Crew Ldr) R
 1 SP4 19D10 (Gnr) R
 1 SP4 19D10 (Dvr) R
 1 SP4 19D10 (Sct) R
 1 PFC 19D10 (Sct) R

1ST TANK PLATOON

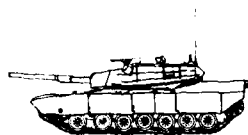

1 LT 12B00 (Plt Ldr) P
 1 SGT 19K20 (Gnr) R
 1 SP4 19K10 (Dvr) R
 1 PFC 19K10 (Loader) R



1 SFC 19K40 (Plt SGT) P
 1 SGT 19K20 (Gnr) R
 1 SP4 19K10 (Dvr) R
 1 PFC 19K10 (Loader) R



1 SSG 19K30 (Tk Cdr) R
 1 SGT 19K20 (Gnr) R
 1 SP4 19K10 (Dvr) R
 1 PFC 19K10 (Loader) R

2D TANK PLATOON



1 LT 12B00 (Pit Ldr) P
 1 SGT 19K20 (Gnr) R
 1 SP4 19K10 (Dvr) R
 1 PFC 19K10 (Loader) R



1 SFC 19K40 (Pit Sct) P
 1 SGT 19K20 (Gnr) R
 1 SP4 19K10 (Dvr) R
 1 PFC 19K10 (Loader) R

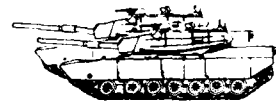

1 SSG 19K30 (Tk Cdr) R
 1 SGT 19K20 (Gnr) R
 1 SP4 19K10 (Dvr) R
 1 PFC 19K10 (Loader) R

TRP MAINT SECTION



1 SFC 63T40 (CFV Maint Sup) R
 1 SP4 76C10 (Eq Rds/Parts Sp) R



1 SGT 76C20 (PLL Clerk) R
 1 PFC 45T10 (CFV Turret Mech) R
 1 PFC 63E10 (M1 Auto Mech) R



1 SGT 63T20 (CFV Auto Mech) R
 1 SP4 31V10 (Com Sys Mech) P
 1 SP4 63E10 (M1 Auto Mech) P
 1 SP4 45E10 (M1 Turret Mech) R
 1 PFC 45T10 (CFV Turret Mech/Dvr) GL



1 SGT 63T20 (Revy Veh Op) P, S
 1 SP4 63E10 (Revy Veh Op) P, S

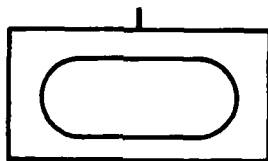

0 WO EM AGG
5 0 69 74

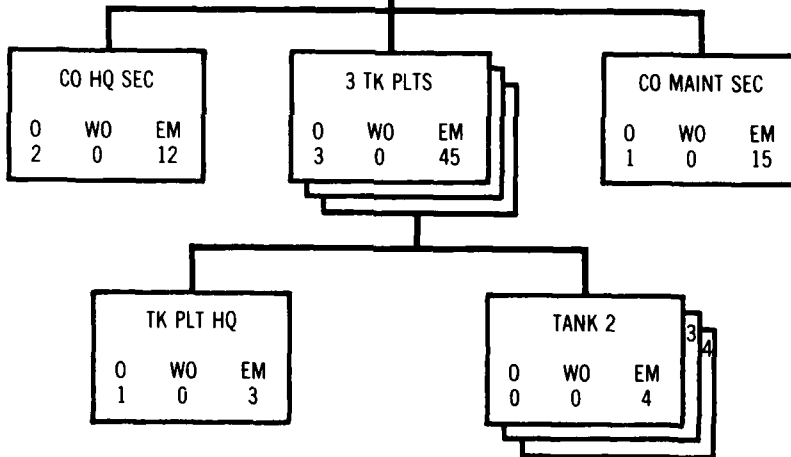

542

SUMMARY OF EQUIPMENT

WEAPONS		NBC EQUIPMENT	
BAYONET-KNIFE: W/SCABBARD FOR M16A1 RIFLE.....	74	ALARM CHEMICAL AGENT AUTOMATIC: PORTABLE MANPACK.....	6
LAUNCHER GRENADE 40 MILLITER: SGLE SHOT RIFLE MTD DITCHBLE W/E.....	2	ALARM CHEMICAL AGENT AUTOMATIC: PTBL W/PWR SUP F/TRK UTIL 1/4 TON..	2
LAUNCHER GRENADE SMOKE: SCREENING RP M250.....	14	MACK CHEMICAL-BIOLOGICAL: MULTI PURPOSE.....	74
LAUNCHER ROCKET: 66MM 4-TUBE.....	1	RADIACMETER: IM-185/UD.....	7
MACHINE GUN CALIBER .50: HEAVY FIXED TURRET TYPE.....	14	RADIACMETER: IM-93/UD.....	1
MACHINE GUN CALIBER .50: HB FLEXIBLE FOR GROUND USE.....	2	RADIACMETER: IM-174/PD.....	1
MACHINE GUN 7.62MM: FIXED M240C RH FEED F/PVS.....	28	RADIAC SET: AM/VDR-1.....	5
SUBMACHINE GUN CALIBER .45.....	2	CHARGER RADIAC DETECTOR: PP-4370/PD.....	1
RIFLE 5.56 MILLIMETER: W/E.....	37		
PISTOL CALIBER .45 AUTOMATIC.....	61		
VEHICLES			
TANK COMBAT FULL TRACKED: 105MM GUN M1.....	14	MISCELLANEOUS EQUIPMENT	
CARRIER PERSONNEL FULL TRACKED: ARMORED.....	1	BINOCULAR: MODULAR CONSTRUCTION MIL SCALE RETICLE 7X50MM W/E.....	16
RECOVERY VEHICLE FULL TRACKED: MEDIUM.....	1	COMBAT VEHICLE HEADING REFERENCE UNIT (CV-HRU).....	14
TRAILER CARGO: 1/4 TON 2 WHEEL W/E.....	1	PLATOON EARLY WARNING SYSTEM: AN/TRS-2(V).....	3
TRAILER CARGO: 1-1/2 TON 2 WHEEL W/E.....	2	SELF-CONTAINED LAND NAVIGATION SUBSYSTEM.....	5
TRUCK CARGO: 2-1/2 TON 6X6 W/E.....	1	NIGHT VISION GOGGLES: AN/PVS-5.....	19
TRUCK CARGO: 2-1/2 TON 6X6 W/INCH W/E.....	1	NIGHT VISION SIGHT CREW SERVED WEAPON: AN/PVS-5.....	2
TRUCK UTILITY: 1/4 TON 4X4 W/E.....	3	NIGHT VISION SIGHT INDIVIDUAL SERVED WEAPON: AN/PVS-4.....	2
MOTORCYCLE: 2 WHEEL.....	2		

TANK COMPANY ARMORED CAVALRY SQUADRON ARMORED CAVALRY REGIMENT

TANK CO HQ SEC



* 1 CPT 12B00 (Cdr) P



1 LT 12B00 (XO) P
1 SP4 19K10 (Dvr) P, GL



1 ISG 19Z5M (ISG) R
1 SSG 76Y30 (Supply SGT) R
1 SP4 76Y10 (Armorer/Dvr) GL



** Used by ISG & XO when necessary for Msgr service

* Drives own vehicle. When mtd in Tk
Displaced crew member will drive vehicle.



1 SSG 19K30 (Tank Cdr) P
1 SGT 19K20 (Sr Gunner) P
1 SGT 19K20 (Sr Tk Dvr) P, R
1 SP4 19K10 (Loader) P, R



1 SSG 19K30 (Tank Cdr) P
1 SP4 19K10 (Gunner) P
1 SP4 19K10 (Dvr) P, R
1 PFC 19K10 (Loader) P, R

1ST TANK PLATOON



1 LT 12B00 (Pit Ldr) P
1 SGT 19K20 (Sr Gnr) P
1 SP4 19K10 (Dvr) P, R
1 SP4 19K10 (Loader) P, R



1 SFC 19K40 (Pit SGT) P
1 SGT 19K20 (Sr Dvr) P, R
1 SP4 19K10 (Gnr) P
1 SP4 19K10 (Loader) P, R



1 SSG 19K30 (Tk Cdr) P
1 SGT 19K20 (Sr Gnr) P
1 PFC 19K20 (Dvr) P, R
1 PFC 19K10 (Loader) P, R

2D TANK PLATOON

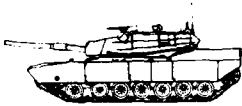

1 LT 12B00 (Plt Ldr) P
1 SGT 19K20 (Sr Gnr) P
1 SP4 19K10 (Dvr) P, R
1 SP4 19K10 (Loader) P, R



1 SFC 19K40 (Plt SGT) P
1 SGT 19K20 (Sr Dvr) P, R
1 SP4 19K10 (Gnr) P
1 SP4 19K10 (Loader) P, R



1 SSG 19K30 (Tk Cdr) P
1 SGT 19K20 (Sr Gnr) P
1 PFC 19K20 (Dvr) P, R
1 PFC 19K10 (Loader) P, R

3D TANK PLATOON



1 LT 12B00 (Plt Ldr) P
1 SGT 19K20 (Sr Gnr) P
1 SP4 19K10 (Dvr) P, R
1 SP4 19K10 (Loader) P, R



1 SFC 19K40 (Plt SGT) P
1 SGT 19K20 (Sr Dvr) P, R
1 SP4 19K10 (Gnr) P
1 SP4 19K10 (Loader) P, R



1 SSG 19K30 (Tank Cdr) P
1 SGT 19K20 (Sr Gnr) P
1 PFC 19K20 (Dvr) P, R
1 PFC 19K10 (Loader) P, R

CO MAINT SEC



1 SFC 63E40 (Motor SGT) R
1 PFC 63E10 (Tr Veh Mech) P



1 SGT 76C20 (PLL Clerk) R
1 SGT 45E20 (Turret Mech) R
1 PFC 76C10 (Rec/Parts Sp) R
1 PFC 45E10 (Turret Mech) R



1 SGT 63E10 (Tr Veh Mech) R
1 SP4 31V10 (Com Mech) R
1 SP4 45E10 (Turret Mech/Dvr) R
1 SP4 63E10 (Tr Veh Mech) P



1 SGT 63E20 (Recvy Veh Op) P, S
1 SP4 63E10 (Recvy Veh Op-Dvr) P, S

Notes:

(The following area contains multiple horizontal lines for writing notes, but no text is present.)

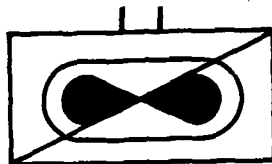

O	WO	EM	AGG
45	113	403	561

HHT		
O	WO	EM
22	7	227

REGT SUP AVN TRP		
O	WO	EM
8	43	75

ATK HEL CO		
O	WO	EM
3	15	19

AIR CAV TRP		
O	WO	EM
3	11	21

SUMMARY OF EQUIPMENT

WEAPONS

BAYONET-KNIFE: W/SCABBARD FOR M16A1 RIFLE.....	578
GUN AUTOMATIC 20MM: HIGH RATE THREE BARREL W/E.....	26
LAUNCHER GRENADE 40MM: SGL SHOT RIFLE MTD DITCHBLE W/E.....	9
MACHINE GUN CALIBER .50: MB FLEXIBLE FOR GRD USE.....	12
LAUNCHER ROCKET AIRCRAFT: 2.75 INCH.....	52
MACHINE GUN 7.62MM: AIRCRAFT LIGHT DOOR MTD.....	50
MACHINE GUN 7.62MM: LIGHT FLEXIBLE.....	4
PISTOL CALIBER .45 AUTOMATIC.....	29
REVOLVER CALIBER .38 SPECIAL: 4-INCH BARREL.....	167
RIFLE 5.56MM: W/E.....	402

VEHICLES

CARRIER COMMAND POST: LIGHT TRACKED.....	2
CRANE WHEEL MOUNTED: SP ARMY AIRCRAFT MAINTENANCE.....	1
HELICOPTER OBSERVATION: OH-58C.....	18
HELICOPTER ATTACK: TOW MISSILE.....	12
HELICOPTER OBSERVATION: OH-58C.....	6
HELICOPTER UTILITY: UH-50A.....	25
TRAILER ACFT MAINT AIRMOBILE: 4 WHLD.....	2
TRAILER AMMUNITION: 1 1/2 TON 2 WHEEL W/E.....	6
TRAILER CARGO: 1 1/4 TON 2 WHEEL W/E.....	23
TRAILER CARGO: 3/4 TON 2 WHEEL W/E.....	7
TRAILER CARGO: 1 1/2 TON 2 WHEEL W/E.....	27
TRAILER TANK: WATER 400 GALLON 1 1/2 TON 2 WHEEL W/E.....	3
TRUCK AMBULANCE: TACTICAL 1 1/4 TON 4X4 W/E.....	3
TRUCK CARGO: TACTICAL 1 1/4 TON 4X4 W/E.....	4

TRUCK CARGO: TACTICAL 1 1/4 TON 4X4 W/100 AMP-COMM SHELTER KIT W/E.....	1
TRUCK CARGO: 1 1/4 TON 4X4 W/E.....	5
TRUCK CARGO: 2 1/2 TON 6X6 W/E.....	19
TRUCK CARGO: 2 1/2 TON 6X6 W/WINCH W/E.....	3
TRUCK CARGO: 5 TON 6X6 LWB W/E.....	3
TRUCK LIPT FORK: DSL DRVN 6,000 LBS CAP ROUGH TERRAIN.....	4
TRUCK UTILITY: 1/4 TON 4X4 W/E.....	27
TRUCK VAN: EXPANSIBLE 5 TON 6X6 (ARMY).....	4
TRUCK VAN: SHOP 2 1/2 TON 6X6 W/E.....	2
TRUCK WRECKER: 5 TON 8X8 W/WINCH W/E.....	3
HELICOPTER ATTACK ADVANCED: (AAH).....	14
HELICOPTER OBSERVATION: OH-58C.....	8
TRUCK CARGO: 10 TON 8X8 HIGH MOBILITY XM 977.....	6
TRUCK TANK: FUEL SERVICING 2500 GAL 8X8MM W/WINCH.....	8

NBC EQUIPMENT

ALARM CHEMICAL AGENT AUTOMATIC: PTBL MANPACK.....	2
ALARM CHEMICAL AGENT AUTOMATIC: W/PWR SUP F/TRK 1/4 TON.....	6
ALARM CHEMICAL AGENT AUTOMATIC: W/PWR SUP F/TRK 2 1/2 TON.....	1
CHARGER RADIAC DETECTOR: PP-1578/PD.....	5
MASK-CBR: HEADMOUND PROTECTIVE.....	10
RADIAC SET: AN/VDR-1.....	33
CHARGER RADIAC DETECTOR: PP-4370/PD.....	6
MASK-CHEMICAL-BIOLOGICAL.....	597
RADIACMETER: IM-185/UD.....	55

COMBAT AVIATION SQUADRON ARMORED CAVALRY REGIMENT

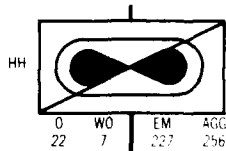

550

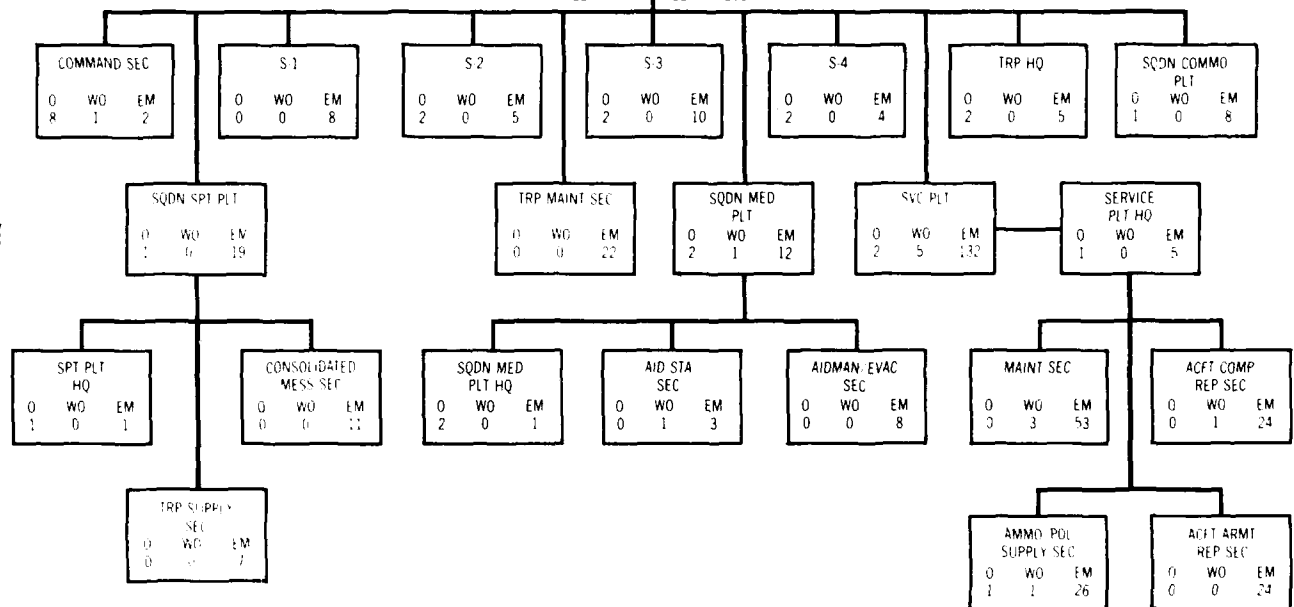

SUMMARY OF EQUIPMENT

WEAPONS

BAYONET KNIFE: W/SCABBARD FOR M16A1 W/E.....	277
LAUNCHER GRENADE 40MM: SGLE SHOT RIFLE MTD DITCHBLE W/E.....	3
MACHINE GUN CALIBER .50: HB FLEXIBLE FOR GROUND USE.....	12
MACHINE GUN 7.62MM: AIRCRAFT LIGHT DOOR MTD.....	8
PISTOL CALIBER .45 CALIBER.....	29
REVOLVER CALIBER .38 SPECIAL: 4 IN BARREL.....	10
RIFLE 5.56MM: W/E.....	258

VEHICLES

CARRIER COMMAND POST: LIGHT TRACKED.....	2
CRANE WHEEL MTD: SP ARMY AIRCRAFT MAINTENANCE.....	1
HELICOPTER UTILITY: UH-60A.....	4
TRAILER ACPT MAINT AIRMOBILE: 4 WHEELED.....	2
TRAILER AMMUNITION: 1-1/2 TON 2 WHEEL W/E.....	6
TRAILER CARGO: 1/4 TON 2 WHEEL W/E.....	12
TRAILER CARGO: 3/4 TON 2 WHEEL W/E.....	4
TRAILER CARGO: 1-1/2 TON 2 WHEEL W/E.....	20
TRAILER TANK WATER 400 GALLONS 1-1/2 TON 2 WHEELED W/E.....	3
TRUCK AMBULANCE: TACTICAL 1-1/4 TON 4X4 W/E.....	3
TRUCK CARGO: TACTICAL 1-1/4 TON 4X4 W/E.....	1
TRUCK CARGO: TACTICAL 1-1/4 TON 4X4 W/100 AMP-COMM SHELTER KIT W/E.....	1
TRUCK CARGO: 1-1/4 TON 6X6 W/E.....	5
TRUCK CARGO: 2-1/2 TON 6X6 W/E.....	11
TRUCK CARGO: 2-1/2 TON 6X6 W/WINCH W/E.....	3
TRUCK CARGO: 5 TON 6X6 LWB W/E.....	3
TRUCK LIPT FORK: DSL DRVN 6,000 LBS CAP ROUGH TERRAIN.....	4
TRUCK UTILITY: 1/4 TON 4X4 W/E.....	16

TRUCK VAN: EXPANSIBLE 5 TON 6X6 (ARMY).....	3
TRUCK VAN: SHOP 2-1/2 TON 6X6 W/E.....	2
TRUCK WRECKER: 5 TON 6X6 W/WINCH W/E.....	2
TRUCK CARGO: 10 TON 8X HIGH MOBILITY M977.....	6
TRUCK TANK: FUEL SERVICING 2500 GAL 8X8 W/WINCH.....	8

NBC EQUIPMENT

ALARM CHEMICAL AGENT AUTOMATIC: PTBL W/PWR SUP F/TRK 1/4 TON.....	5
ALARM CHEMICAL AGENT AUTOMATIC: PTBL W/PWR SUP F/TRK 1-1/2 TON.....	1
RADIAC SET: AN/VDR-1.....	1
CHARGER RADIAC DETECTOR: PP-4370/PD.....	1
MASK CHEMICAL-BIOLOGICAL: MULTI-PURPOSE.....	296
RADIAC METER IM-185/UD.....	8
MASK CBR: HEADWOUND PROTECTIVE.....	10

MISCELLANEOUS EQUIPMENT

BINOCULAR: MODULAR CONSTRUCTION MIL SCALE RETICLE 7X50MM W/E.....	3
FIRE DIRECTION SET ARTILLERY: 30000 METER MAX RANGE.....	1
NIGHT VISION GOGGLES: AN/PVS-5.....	5
NIGHT VISION SIGHT INDIVIDUAL SERVED WEAPON: AN/PVS-4.....	1
RADIO-SET: AN/GRC-106.....	3
RADIO-SET: AN/GRC-90.....	10
RADIO-SET: AN/GRC-24.....	1
RADIO-SET CONTROL GROUP: AN/GRA-39.....	7
RADIO-SET: AN/PRC-70.....	1

HEADQUARTERS AND HEADQUARTERS TROOP COMBAT AVIATION SQUADRON ARMORED CAVALRY REGIMENT

COMMAND SECTION



1 LTC 15B00 (Sgdn Cdr) Rev
1 SP4 64C10 (Veh Dvr) R



1 MAJ 15B00 (XO) Rev
1 CSM 00Z50 (CSM) R



* 1 CPT 41A00 (S-1) R
1 PFC 75B10 (PAC Clerk Dvr) R



* 1 CPT 56A00 (Chaplain)
1 SP4 71M10 (Chaplain Asst) R



1 SFC 75Z40 (PAC Supvrt) R
1 SSG 75Z30 (Pers Staff NCO) R
1 SGT 71D20 (Legal Clerk) R
1 SGT 75B20 (PAC Clerk) R
1 SP4 71L10 (Clerk Typist) R
1 SP4 75B10 (PAC Clerk Dvr) R

SQUADRON S-2 SEC



* 1 CPT 35A00 (S-2) R
1 PFC 96B10 (Intel Analy) R



1 LT 35A00 (Asst S-2) R
1 LT 35A00 (Tac Intel Off) R
1 SFC 96B40 (Intel SGT) R
1 SSG 96B30 (Intel SGT) R
1 SGT 96B20 (Intel Analy) R
1 SP4 96B10 (Intel Analy) R

S-3 SEC



1 CPT 13A00 (Fire Spt Off) R
1 SP4 13F10 (Fire Spt Sp) R



* 1 MAJ 15B00 (S-3) Rev
1 SP4 08510 (RTO-Dvr) R



* 1 WO 100BB (Fit Safety Tech) Rev
1 SSG 71P30 (Fit Ops SGT) R
1 SP4 71P10 (Fit Ops Sp) R
1 PFC 71P10 (Fit Ops Sp Dvr) R

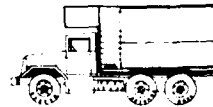

1 CPT 15B00 (Asst S-3) Rev
1 SFC 19D40 (Ops Chiet) R
1 SFC 13F40 (Fire Spt SGT) R
1 PFC 05B10 (RTO/Dvr) R



** 1 SGT 67I2F (Crew Chiet) Rev
1 SP4 67I1F (Door Gunner) R

SQUADRON S-4 SECTION



* 1 MAJ 92B00 (S-4) R
1 SP4 71L10 (Clerk Typist) R



1 CPT 71A00 (Avn Mat Staff Off) R
1 SFC 67Z40 (Actt Maint Sr SGT) R



1 SGT 76Y20 (Supply SGT) R



1 LT 92B00 (Asst S-4) R
1 SFC 76Y40 (S-4 SGT) R

* From Sgdn Command Sec
** Piloted by S-3 or Asst S-3

TROOP HQ



1 MAJ 12C00 (Tro Cdr) P
1 PFC 19D10 (Dvr) GL



1 CPT 12C00 (XO) R
1 PFC 76Y10 (Supply Sp Dvr) GL



1 ISG 19Z5M (ISG) R



1 SSG 76Y30 (Supply SGT) R
1 PFC 76Y10 (Supply Sp) GL

SQUADRON COMMO PLT



* 1 CPT 25A15 (C E Off) R
1 SP4 36C10 (Wire Sys Instr) R



1 CPT 25A00 (Plt Ldr) R
1 PFC 31V10 (Commo Sys Op) R



1 SSG 31V30 (Commo Chief) R
1 PFC 36K10 (Tac Wire Ops Sp) R



1 SGT 31V20 (Tac Comm Sys Op) R
1 SP4 31V10 (Comm Sys Op) R



1 SP4 36K10 (Tac Wire Ops Sp) R

553

SQDN SUPPORT PLATOON HQ



1 LT 12C92 (Plt Ldr) R
1 PFC 19D10 (Dvr) R

TROOP SUPPLY SEC



1 SFC 76Y40 (Supply SGT) R
1 SGT 76Y20 (Supply Sp) R
1 SP4 76Y10 (Armor) R
1 PFC 76Y10 (Supply Sp Dvr) R



1 SSG 76Y30 (Asst Supply SGT) R
1 SP4 76Y10 (Armor) R
1 PFC 76Y10 (Supply Sp Dvr) R

CONSOLIDATED MESS SEC



1 SFC 94B40 (Food Svc SGT) R
1 SP4 94B10 (Cook) R
1 PFC 94B10 (Cook/Dvr) R



1 SSG 94B30 (1st Cook) R
1 SP4 94B10 (Cook) R
1 PFC 94B10 (Cook/Dvr) R



1 SGT 94B20 (Cook) R
1 SP4 94B10 (Cook) R
1 PFC 94B10 (Cook/Dvr) R

* From Sqdn Command Sec

SQDN MED PLT HQ



1 CPT 61N00 (Flt Surgeon) R
1 LT 67B00 (Fid Med Asst) P
1 SFC 91B40 (PSG) R

AID STATION SEC



1 WO 011A0 (PA) R
1 SP4 91B10 (Med Aide) R



1 SSG 91C30 (Prac Nurse) R
1 SGT 91B10 (Med Aide) R

AIDMAN/EVAC SEC



2 SGT 91B20 (Trp Aidman) P
1 PFC 91B10 (Ambi Attd/Dvr) R



2 SGT 91B20 (Trp Aidman) P
1 PFC 91B10 (Ambi Attd/Dvr) R



1 SGT 91B20 (Trp Aidman) P
1 PFC 91B10 (Ambi Attd/Dvr) R

SERVICE PLT HQ/MAINTENANCE SEC



1 CPT 71A00 (Plt Cdr) Rev
1 SFC 67Z40 (PSG) R
1 PFC 67Y10 (Attack Hel Repairman/Dvr) R



1 WO 100EG (Actt Maint Tech) Rev
2 SSG 67W3F (Actt QC Supv) Rev
2 SGT 76C20 (Eq Rcds & Pts Sp) R
9 PFC 67T10 (Utility Hel Rpmn-Dvr) R
2 SP4 76C10 (Eq Rcds & Pts Sp) R



1 SFC 67Z4F (Sec Chief) Rev
5 SSG 67Y3F (Attack Hel Tech Insp) Rev
6 SGT 67Y20 (Attack Hel Rpmn) R
2 SP4 67Y10 (Attack Hel Rpmn) R
1 PFC 67Y10 (Attack Hel Rpmn-Dvr) R



1 SSG 67T30 (Maint Supv) R
5 SSG 67V3F (Obsn./Sct Hel Tech Insp) Rev
8 SP4 67T10 (Utility Hel Rpmn) R
2 SP4 67Y10 (Attack Hel Rpmn) R
1 PFC 67Y10 (Attack Hel Rpmn-Dvr) R



SERVICE PLT HQ/MAINT SEC



1 SSG 67Y30 (Maint Supv) R
 6 SSG 67T3F (Utility Hel Tech Insp) Rev
 8 SGT 67T20 (Utility Hel Rpmn) R
 1 PFC 67Y10 (Attack Hel Rpmn Dvr) R

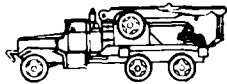

1 SP4 63B10 (Wrecker Op) R



1 WO 100BF (Pilot) Rev
 1 SGT 67T2F (Crew Chief) Rev
 1 SP4 67T1F (Door Gnr) Rev
 1 SP4 67V10 (Obs Sct) R



1 WO 100BE (Pilot) Rev
 1 SGT 67T2F (Crew Chief) Rev
 1 SP4 67T1F (Door Gnr) Rev
 1 PFC 67V10 (Obs Sct) R

ACFT COMP REP SEC



1 WO 160A00 (Acft Maint Tech) Rev
 1 SP4 68B10 (Acft Pwr Plant Rep Dvr) R



1 SFC 68K40 (Acft Comp Rep Supv) R
 1 PFC 68H10 (Acft Pseud Rep) R
 2 PFC 68G10 (Acft Struc Rep Dvr) R



1 SSG 68G30 (Acft Struc Rep Supv) R
 3 SP4 68G10 (Acft Struc Rep) R
 1 PFC 68G10 (Acft Struc Rep Dvr) R



1 SGT 76C20 (Eq Rcds & Pts Sp) R
 1 SP4 76C10 (Eq Rcds & Pts Sp Dvr) R
 2 PFC 76C10 (Eq Rcds & Pts Sp) R



1 SGT 68D20 (Acft Pwrtrain Rep) R
 1 PFC 68F10 (Acft Electrician) R
 1 PFC 68D10 (Acft Pwrtrain Rep) R
 3 PFC 68B10 (Acft Pwrplant Rep Dvr) R

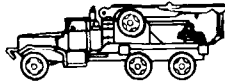

2 SGT 68G20 (Acft Struc Rep) R

1 Crane Wheel Mid SP
 Army Aircraft Maint

1 SP4 68D10 (Acft Pwrtrain Rep) R

Truck Lift Fork, Dsl Drvn
 6,000 lb Cap Rough Terrain

1 SP4 68D10 (Acft Pwrtrain Rep) R

* W Winch

AMMO / POL SUPPLY SEC



1 LT 15B00 (Sec Ldr) Rev
1 SP4 55B10 (Ammo Hdlr Dvr) R



1 SFC 76Y40 (PSG) R
1 PFC 55B10 (Ammo Hdlr Dvr) R



2 SGT 55B20 (Ammo Spl) R

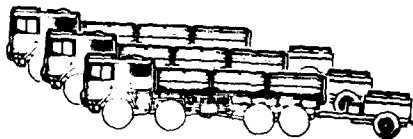

3 SP4 55B10 (Ammo Hdlr Dvr) R

556



1 SSG 76W30 (Sec SGT) R
1 SP4 76W10 (Acft Fuel Hdlr Dvr) R

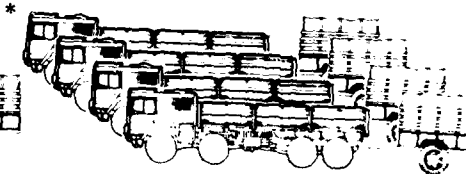

4 SGT 76W10 (Acft Fuel Hdlr) R
4 PFC 76W10 (Acft Fuel Hdlr Dvr) R

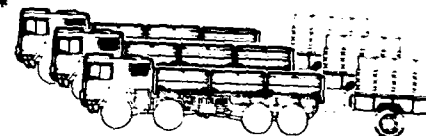

3 SP4 76W10 (Acft Fuel Hdlr Dvr) R



1 WO 100B0 (Pilot) Rev
1 SGT 6712F (Crew Chief) R
1 SP4 6711F (Door Gnr) Rev

Note: 3 Truck Lift Fork, Dsl Drvn
6,000-lb. Cap. Rough Terrain

3 PFC 55B10 (Ammo Hdlr Dvr) R

* W/POL Pods

ACFT ARMT REP SEC



1 SFC 68K40 (Acft Armt Rep Supv) R
1 SP4 76C10 (Eq Rcds & Parts Sp Dvtr) R
6 PFC 68J10 (Fire Control Rep) R



1 SSG 68J30 (Fire Control Sup) R
3 SGT 68J20 (Fire Control Rep) R
4 SP4 68J10 (Fire Control Rep Dvtr) R



1 SSG 68M30 (Wpns Sys Rep Supv) R
2 SGT 68M20 (Wpns Sys Rep) R
2 SP4 68M10 (Wpns Sys Rep Dvtr) R
3 PFC 68M10 (Wpns Sys Rep) R

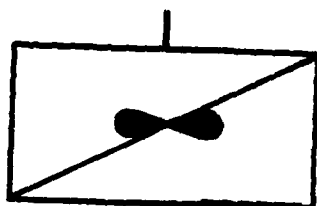

0	WO	EM	AGG
3	11	21	35

558

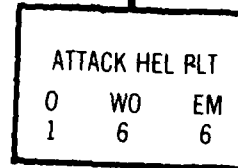
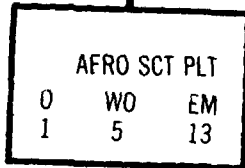
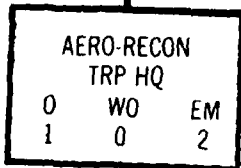

SUMMARY OF EQUIPMENT

WEAPONS

BAYONET-KNIFE: W/SCABBARD FOR M16A1 RIFLE.....	32
GUN AUTOMATIC 20MM: HIGH RATE THREE BARREL W/E.....	4
LAUNCHER ROCKET AIRCRAFT: 2.75 INCH.....	8
REVOLVER CALIBER .38 SPECIAL: 4 INCH BARREL.....	19
RIFLE 5.56MM W/E.....	13

VEHICLES

HELICOPTER ATTACK: TOW MISSILE.....	4
TRAILER CARGO: 1/4 TON 2 WHEEL W/E.....	1
TRAILER CARGO: 1-1/2 TON 2 WHEEL W/E.....	1
TRUCK CARGO: 2-1/2 TON 6X6 W/E.....	1
TRUCK UTILITY: 1/4 TON 4X4 W/E.....	1

NBC EQUIPMENT

MASK-CHEMICAL-BIOLOGICAL: MULTIPURPOSE.....	32
---	----

MISCELLANEOUS EQUIPMENT

RADIO SET: AN/PRC-90.....	21
DETECTING SET RADAR SIGNAL: AN/APR-39 (V1).....	10
DETECTING SET RADAR SIGNAL: AN/APR-39 (V2).....	10
NAVIGATION SET DOPPLER: AN/ASN-128.....	16
NIGHT VISION IMAGINE SYSTEM AVIATOR.....	20
RADIO SET: AN/GRC- ()-(V5).....	2
RADIO SET: AN/PRC-68.....	7

AIR CAV TROOP COMBAT AVIATION SQUADRON ARMORED CAVALRY REGIMENT

AERO-RECON TRP HQ



1 CPT 15B00 (Trp Cdr) Rev
1 SP4 64C10 (Dvr) R



1 ISG 67Z5M (ISG) Rev

AERO SCOUT PLT

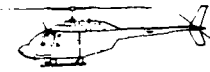

1 LT 15B00 (Plt Ldr) Rev
1 SFC 67Z40 (Plt SGT) R
1 SGT 67V20 (Sct/Hel Rep) R
1 SGT 19D2F (Scout Obs) Rev



1 WO 100BC (Instr Pilot) Rev
1 SGT 67V20 (Sct/Hel Rep) R
1 SGT 19D2F (Scout Obs) Rev



3 WO 100BH (Pilot) Rev
3 SGT 19D2F (Scout Obs) Rev
3 SP4 67V10 (Sct/Hel Rep) R

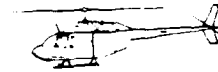

1 WO 100BH (Pilot) Rev
1 SGT 19D2F (Scout Obs) Rev
1 PFC 67V10 (Sct/Hel Rep) R

ATTACK HEL PLT



1 LT 15B00 (Plt Ldr) Rev
1 WO 100E0 (Pilot) Rev
1 SFC 67Z40 (PSG) R

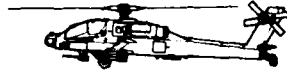

2 WO 100E0 (Pilot) Rev
2 SGT 67Y20 (Atk Hel Rep) R



2 WO 100E0 (Pilot) Rev
2 SP4 67Y10 (Atk Hel Rep) R



1 WO 100E0 (Pilot) Rev
1 PFC 67Y10 (Atk Hel Rep) R

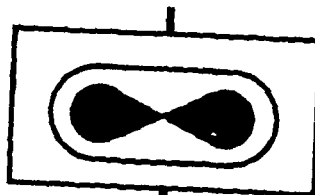

0	WO	EM	AGG
3	15	19	37

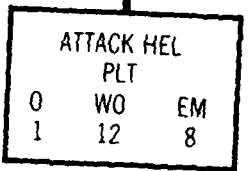
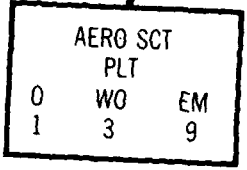
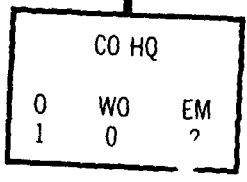

562

SUMMARY OF EQUIPMENT

WEAPONS

BAYONET-KNIFE: W/SCABBARD FOR M16A1 RIFLE.....	37
GUN AUTOMATIC 20MM: HIGH RATE THREE BARREL W/E.....	7
LAUNCHER ROCKET AIRCRAFT: 2.75 INCH.....	14
REVOLVER CALIBER .38 SPECIAL: 4 INCH BARREL.....	25
RIFLE 5.56MM: W/E.....	12

VEHICLES

HELICOPTER ATTACK ADVANCED: (AAH).....	7
HELICOPTER OBSERVATION: OH-59C.....	4
TRAILER CARGO: 1/4 TON 2 WHEEL W/E.....	1
TRAILER CARGO: 1-1/2 TON 2 WHEEL W/E.....	1
TRUCK CARGO: 2-1/2 TON 6X6 W/E.....	1
TRUCK UTILITY: 1/4 TON 4X4 W/E.....	1

NBC EQUIPMENT

MASK-CHEMICAL-BIOLOGICAL: MULTIPURPOSE.....	37
---	----

MISCELLANEOUS EQUIPMENT

RADIO SET: AN/PRC-90.....	23
DETECTING SET RADAR SIGNAL: AN/APR-39 (V) 1.....	11
DETECTING SET RADAR SIGNAL: AN/APR-39 (V) 2.....	11
NAVIGATION SET DOPPLER: AN/ASN-128.....	11
NIGHT VISION IMAGING SYSTEM AVIATOR.....	22
RADIO SET AN/GRC- () - (V5).....	2
RADIO SET: AN/PRC-68.....	5

**ATTACK HELICOPTER COMPANY
COMBAT AVIATION SQUADRON
ARMORED CAVALRY REGIMENT**

ATTACK HEL CO



1 CPT 15B00 (Cdr) Rev
1 SP4 64C10 (Dvr) R



1 ISG 67Z5M (ISG) Rev

AERO SCOUT PLT



1 LT 15B00 (Pilot) Rev
1 SFC 67Z40 (PSG) Rev
1 CPT 67V20 (Sct Hel Repl) R
1 SGT 1902F (Sct Obs) Rev



1 WO 100BC (Instr Pilot) Rev
1 SSG 67V30 (Sr Sct Hel Repl) R
1 SGT 1902F (Sct Obs) Rev



1 WO 100BH (Pilot) Rev
1 SGT 1902F (Sct Obs) Rev
1 SP4 67V10 (Sct Hel Repl) R



1 WO 100RM (Pilot) Rev
1 SGT 1902F (Sct Obs) Rev
1 PFC 67V10 (Sct Hel Repl) R

ATTACK HEL PLT



1 LT 15B12 (Plt Ldr) Rev
1 SFC 67Z40 (PSG) R
1 SSG 67Y30 (Sr AH Repl) R



1 WO 100EE (Pilot) Rev
1 WO 100EO (Pilot) Rev
1 SGT 67Y20 (AH Repl) R

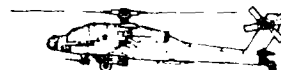

1 WO 100EE (Pilot) Rev
1 SGT 67Y20 (AH Repl) R



4 WO 100EO (Pilot) Rev
2 SP4 67Y10 (AH Repl) R



4 WO 100EO (Pilot) Rev
2 PFC 67Y10 (AH Repl) R

Notes:

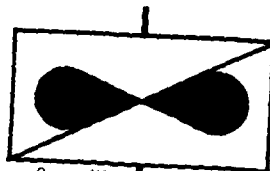

0	WO	EM	AGG
8	43	75	126

566

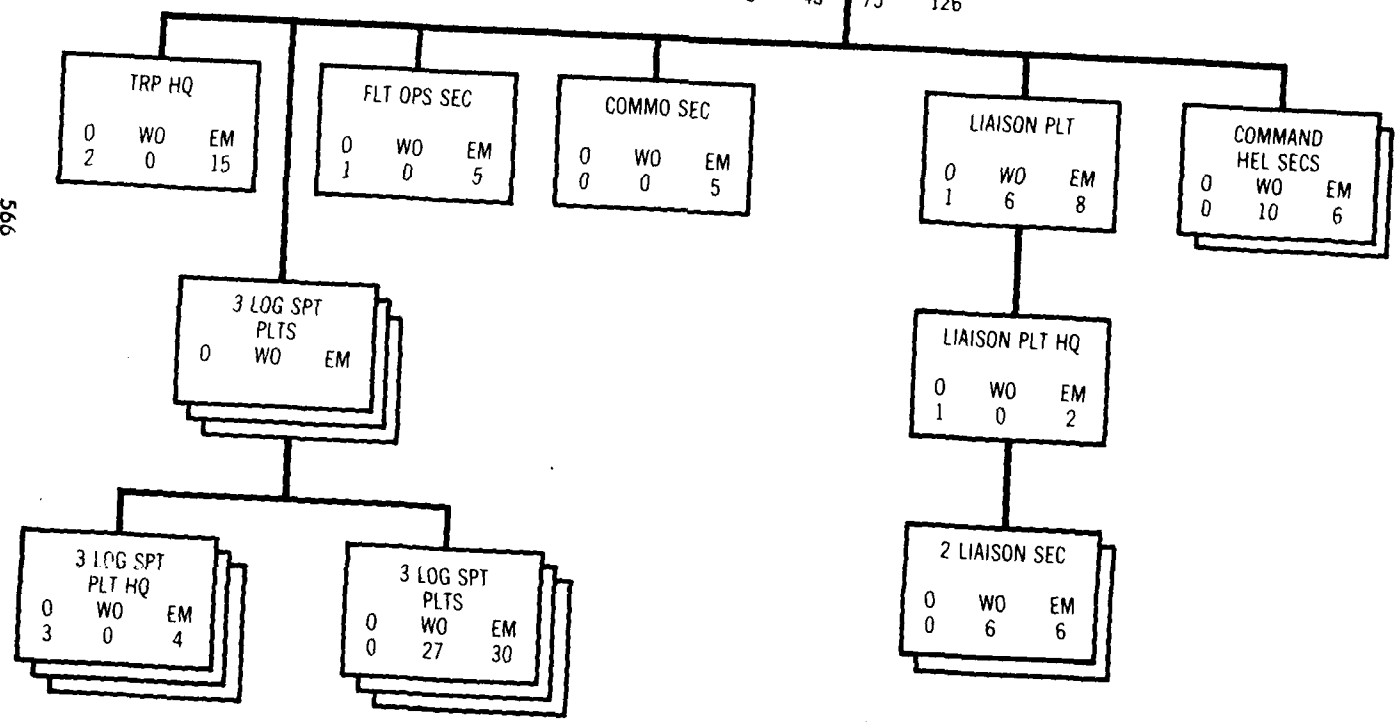

SUMMARY OF EQUIPMENT

WEAPONS

BAYONET-KNIFE: W/SCABBARD FOR M16A1 RIFLE.....	131
LAUNCHER GRENADE 40MM: SGLE SHOT RIFLE MTD DTCHBLE W/E.....	6
MACHINE GUN 7.62MM: AIRCRAFT LIGHT DOOR MTD.....	42
MACHINE GUN 7.62MM: LIGHT FLEXIBLE.....	4
REVOLVER CALIBER .38 SPECIAL: 4 INCH BARREL.....	50
RIFLE 5.56MM: W/E.....	81

VEHICLES

HELICOPTER OBSERVATION-OH-58A.....	6
HELICOPTER UTILITY: UH-60A.....	21
TRAILER CARGO: 1/4 TON 2 WHEEL W/E.....	6
TRAILER CARGO: 3/4 TON 2 WHEEL W/E.....	3
TRAILER CARGO: 1-1/2 TON 2 WHEEL W/E.....	2
TRUCK CARGO: TACTICAL 1-1/4 TON 4X4 W/E.....	3
TRUCK CARGO: 2-1/2 TON 6X6 W/E.....	2
TRUCK UTILITY: 1/4 TON 4X4 W/E.....	6
TRUCK VAN: EXPENSIBLE 5 TON 6X6 (ARMY).....	1
TRUCK WRECKER: 5 TON 6X6 W/WINCH W/E.....	1

NBC EQUIPMENT

ALARM CHEMICAL AGENT AUTOMATIC: PTBL MANPACK.....	2
ALARM CHEMICAL AGENT AUTOMATIC: PTBL W/PWR SUP F/TRK 1/4 TON.....	1
CHARGER RADIAC DETECTOR: PP-1578/PD.....	5
RADIAC SET: AN/VDR-1.....	32
CHARGER RADIAC DETECTOR: PP-4370/PD.....	5
MASK CHEMICAL-BIOLOGICAL: MULTIPURPOSE.....	131
RADIACMETER IM-185/UD.....	47

MISCELLANEOUS EQUIPMENT

BINOCULAR MODULAR CONSTRUCTION: MIL SCALE RETICLE 7X50MM W/E.....	131
NIGHT VISION GOGGLES: AN/PVS-5.....	96
NIGHT VISION SIGHT INDIVIDUAL SERVED WEAPON: AN/PVS-4.....	2
RADIO SET: AN/ARC-102.....	21
RADIO SET: AN/PRC-90.....	96
RADIO SET CONTROL GROUP: AN/GRA-39.....	8
RECEIVER-TRANSMITTER CONTROL GROUP: AN/GRA-39.....	1

REGIMENTAL SUPPORT AVIATION TROOP COMBAT AVIATION SQUADRON ARMORED CAVALRY REGIMENT

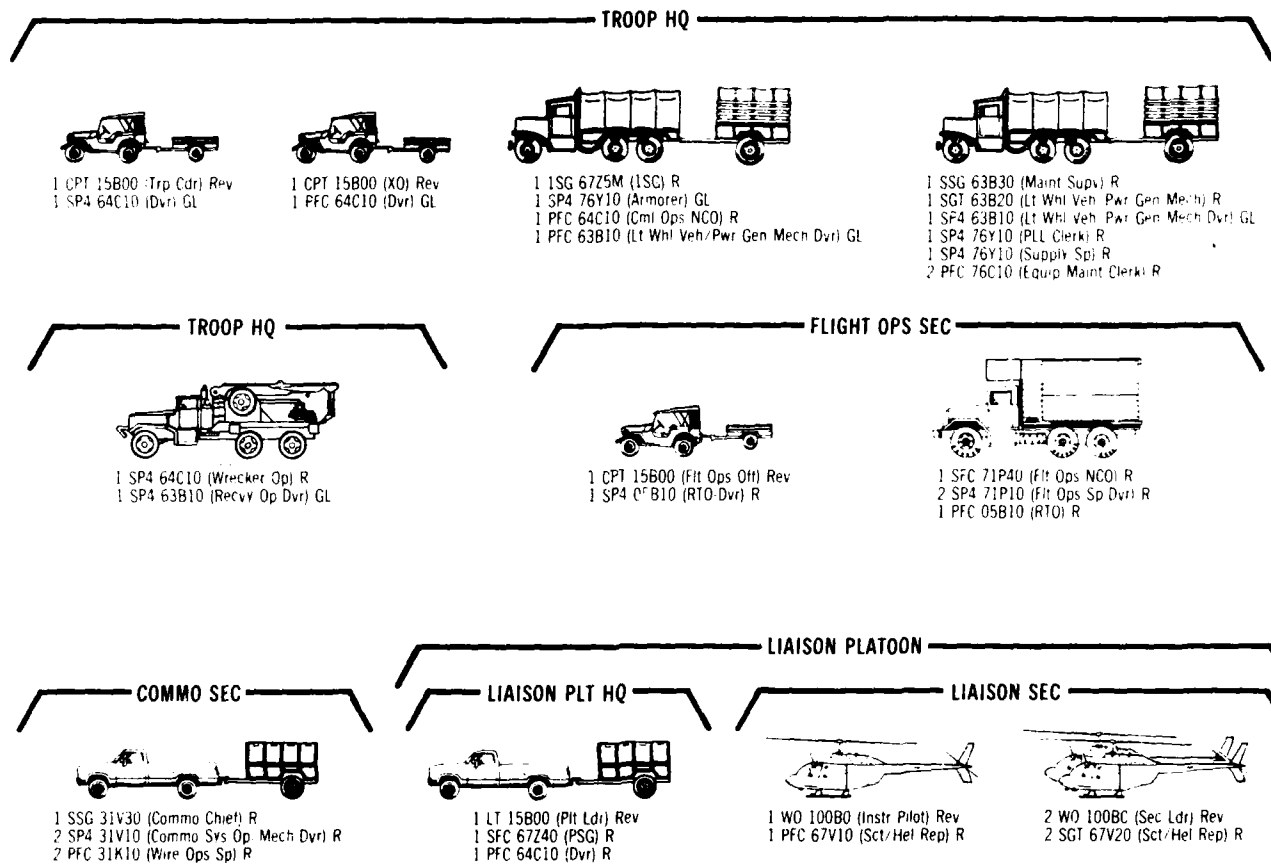

2 LIAISON SECS

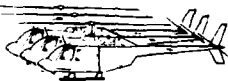

3 WO 100BC (Pilot) Rev
3 SP4 67V10 (Sct-Hel Rep) R

COMMAND HEL SEC



1 WO 100B0 (Sec Ldr) Rev
1 WO 100BC (Instr Pilot) Rev
1 SSG 67T3F (Sr Crew Chief) Rev



4 WO 100BC (Pilot) Rev
2 SGT 67T2F (Crew Chief) Rev

COMMAND HEL SEC



1 WO 100BF (Instr Exam) Rev
1 WO 100BB (Fit Safety Tech) Rev
1 SGT 67T2F (Crew Chief) Rev



2 WO 100B0 (Pilot) Rev
2 SGT 67T2F (Crew Chief) Rev

3 LOG SPT PLT HQ



3 LT 15B00 (Plt Ldr) Rev
3 SSG 67T3F (PSG) Rev
1 PFC 64C10 (Dvr) R

3 LOG SPT PLTS

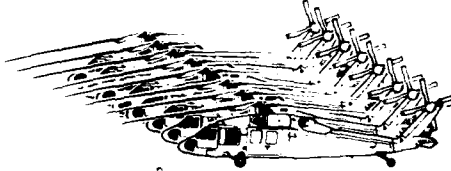

16 WO 100B0 (Pilot) Rev
8 SGT 67T2F (Crew Chief) Rev
8 SP4 67T1F (Door Gnr) Rev

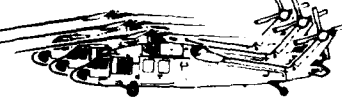

3 WO 100B0 (Pilot) Rev
3 SGT 67T2F (Crew Chief) Rev
3 SP4 67T1F (Door Gnr) Rev



1 WO 100BB (Fit Safety Tech) Rev
1 WO 100BC (Instr Exam) Rev
1 SGT 67T2F (Crew Chief) Rev
1 SP4 67T1F (Door Gnr) Rev



3 WO 100B0 (Spec Ldr) Rev
3 WO 100BC (Instr Pilot) Rev
3 SGT 67T2F (Crew Chief) Rev
3 SP4 67T1F (Door Gnr) Rev

C2 PLT HQ



1 LT 15B00 (Plt Ldr) Rev
1 SFC 67Z40 (PSG) R
1 SP4 64C10 (Dvr) R

570

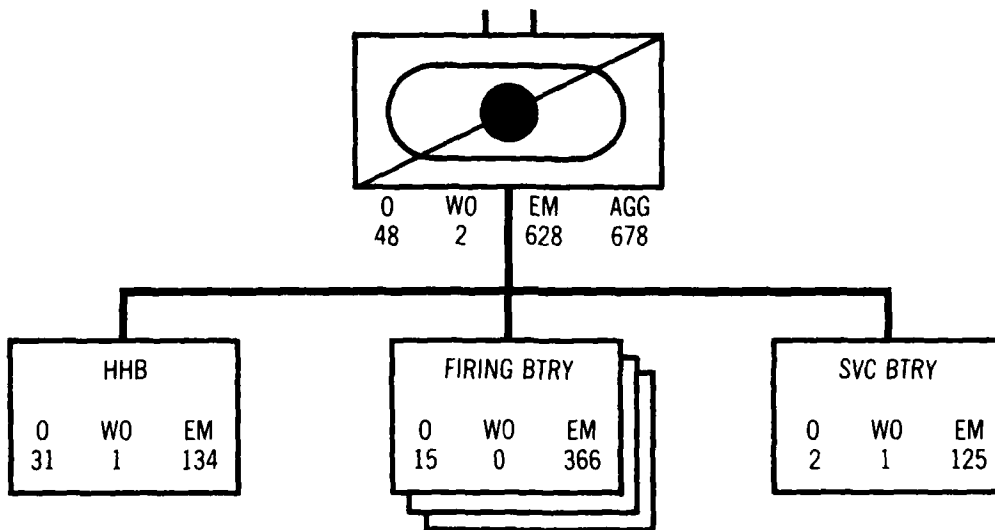

SUMMARY OF EQUIPMENT

WEAPONS

BAYONET-KNIFE: W/SCABBARD FOR M16A1 RIFLE.....	736
LAUNCHER GRENADE 40MM: SGL SHOT RIFLE MTD DITCHBLE W/E.....	49
MACHINE GUN CALIBER .50: HB FLEXIBLE VEHICLE MTD.....	62
MACHINE GUN 7.62MM: LIGHT FLEXIBLE.....	29
PISTOL CALIBER .45 AUTOMATIC.....	30
RIFLE 5.56MM: W/E.....	724
SUBMACHINE GUN CALIBER .45:.....	4

VEHICLES

CARRIER CARGO: TRACKED 6 TON.....	24
CARRIER COMMAND POST: LIGHT TRACKED.....	13
HOWITZER MEDIUM SP: 155MM.....	24
KITCHEN FIELD TRAILER MOUNTED: MTD ON M103A3 TRAILER.....	5
RECOVERY VEHICLE FULL TRACKED: LIGHT ARMORED.....	3
SEMITRAILER VAN: REPAIR PARTS STORAGE 6 TON 4 WHL W/E.....	1
TRAILER CARGO: 1/4 TON 2 WHEEL W/E.....	28
TRAILER CARGO: 3/4 TON 2 WHEEL W/E.....	2
TRAILER CARGO: 1-1/2 TON 2 WHEEL W/E.....	18
TRUCK TANK: WATER 400 GALLON 1-1/2 TON 2 WHL W/E.....	5
TRUCK AMBULANCE: 1-1/4 TON 6X6 W/E.....	1
TRUCK CARGO: TACTICAL 1-1/4 TON 4X4 W/100 AMP-COMM SHELTER KIT W/E...	2

TRUCK CARGO: 1-1/4 TON 6X6 W/E.....	11
TRUCK CARGO: 2-1/2 TON 6X6 W/E.....	24
TRUCK CARGO: 2-1/2 TON 6X6 W/WINCH W/E.....	5
TRUCK CARGO: 5 TON 6X6 LWB W/E.....	5
TRUCK CARGO: 5 TON 6X6 W/WINCH W/E.....	1
TRUCK TRACTOR: 5 TON 6X6 W/E.....	1
TRUCK UTILITY: 1/4 TON 4X4 W/E.....	31
TRUCK WRECKER: 5 TON 6X6 W/WINCH W/E.....	1
MOTORCYCLE: 2 WHEEL.....	2
TRUCK RECOVERY: TACTICAL 10 TON 8X8 HIGH MOBILITY.....	1
TRUCK CARGO: 10 TON 8X8 HIGH MOBILITY XM977.....	32

NBC EQUIPMENT

ALARM CHEMICAL AGENT AUTOMATIC: PTBL F/CARRIER CMD.....	7
ALARM CHEMICAL AGENT AUTOMATIC: PTBL W/PWR SUP F/TRK 1/4 TON.....	5
ALARM CHEMICAL AGENT AUTOMATIC: PTBL W/PWR SUP F/TRK 3/4 TON.....	1
DECONTAMINATING APPARATUS PWR DRVN SKID MTD.....	1
MASK CBR: HEADMOUND PROTECTIVE.....	10
CHARGER RADIAC DETECTOR: PP-4370/PD.....	5
MASK CHEMICAL-BIOLOGICAL.....	751
RADIACMETER: IM-185/UD.....	25

FIELD ARTILLERY BATTALION ARMORED CAVALRY REGIMENT

572

HH

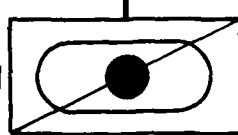

0	WO	EM	AGG
31	1	134	166

BN HQ

0	WO	EM
8	0	3



BTRY HQ

0	WO	EM
1	0	11

PAC SEC

0	WO	EM
0	0	9

OPS/INTEL PLT

0	WO	EM
4	0	19

SURVEY PLT

0	WO	EM
1	0	11

COMMO PLT

0	WO	EM
1	0	20

MEDICAL SEC

0	WO	EM
0	1	13

MVR BDE

FIRE SUP SEC

0	WO	EM
1	0	3

MVR BN

FIRE SUP SEC

0	WO	EM
3	0	9

(3)

CAVALRY

FIST TMS

0	WO	EM
12	0	36

(12)

OPS/INTEL

PLT HQ

0	WO	EM
1	0	10

INTEL SEC

0	WO	EM
2	0	3

OPS/FD

SEC

0	WO	EM
1	0	6

SUMMARY OF EQUIPMENT

WEAPONS

BAYONET-KNIFE: W/SCABBARD FOR M16A1 RIFLE.....	218
LAUNCHER GRENADE 40MM: SGL SHOT RIFLE MTD DITCHBLE W/E.....	10
MACHINE GUN CALIBER .50: HB FLEXIBLE VEHICLE MTD.....	12
MACHINE GUN 7.62MM: LIGHT FLEXIBLE.....	3
PISTOL CALIBER .45 AUTOMATIC.....	22
RIFLE 5.56MM: W/E.....	210

VEHICLES

CARRIER COMMAND POST: LIGHT TRACKED.....	7
KITCHEN FIELD TRAILER MOUNTED: MTD ON M103A3 TRAILER.....	1
TRAILER CARGO: 1/4 TON 2 WHEEL W/E.....	12
TRAILER CARGO: 3/4 TON 2 WHEEL W/E.....	1
TRAILER CARGO: 1-1/2 TON 2 WHEEL W/E.....	1
TRUCK TANK: WATER 400 GALLON 1-1/2 TON 2 WHL W/E.....	1
TRUCK AMBULANCE: 1-1/4 TON 6X6 W/E.....	1
TRUCK CARGO: TACTICAL 1-1/4 TON 4X4 W/100 AMP-COMM SHELTER KIT W/E....	2
TRUCK CARGO: 1-1/4 TON 6X6 W/E.....	4
TRUCK CARGO: 2-1/2 TON 6X6 W/E.....	4
TRUCK CARGO: 5 TON 6X6 LWB W/E.....	2
TRUCK CARGO: 5 TON 6X6 W/WINCH W/E.....	1
TRUCK UTILITY: 1/4 TON 4X4 W/E.....	14
MOTORCYCLE: 2 WHEEL.....	2

NBC EQUIPMENT

ALARM CHEMICAL AGENT AUTOMATIC: PTBL F/CARRIER CMD.....	1
ALARM CHEMICAL AGENT AUTOMATIC: PTBL W/PWR SUP F/TRK 1/4 TON.....	16
DECONTAMINATING APPARATUS PWR DRVN SKID MTD MULTIPURPOSE.....	1
MASK CBR: HEADWOUND PROTECTIVE.....	10
MASK CHEMICAL-BIOLOGICAL: MULTI-PURPOSE.....	233
RADIACMETER: IM-185/UD.....	8

MISCELLANEOUS EQUIPMENT

BINOCULAR MODULAR CONSTRUCTION: MIL SCALE RETICLE 7X50MM W/E.....	36
DETECTING SET MINE: PTBL METALLIC & NON-METALLIC.....	2
DETECTING SET MINE: PTBL METALLIC & (AN-PSS-11).....	2
FIRE DIRECTION SET ARTILLERY: 3000 METER MAXIMUM RANGE.....	2
NIGHT VISION GOGGLES: AN/PVS-5.....	18
NIGHT VISION SIGHT CREW SERVED WEAPON: AN/TVS-5.....	12
NIGHT VISION SIGHT INDIVIDUAL SERVED WEAPON: AN/PVS-4.....	4
NIGHT VISION SIGHT INFRARED: AN/TAS-4.....	12
NIGHT VISION SIGHT INFRARED: AN/TAS-6.....	1
RANGEFINDER FIRE CONTROL: W/E (LASER).....	1

HEADQUARTERS, HEADQUARTERS BATTERY FIELD ARTILLERY BATTALION ARMORED CAVALRY REGIMENT

BN HQ



1 LTC 13E00 (Bn Cdr) P
1 PFC 13B10 (RTO Dvr) R



1 MAJ 13E00 (XO) P
1 CSM 00250 (CSM Dvr) R



1 CPT 56A00 (Chaplain)
1 SP4 71M10 (Chap Act Sp Dvr) R

BATTERY HQ



1 CPT 13X00 (Btry Cdr) P
1 PFC 13B10 (Dvr) R



1 ISG 13Y5M (ISG) R
1 SSG 76Y30 (Sup SGT) R
1 SP4 76Y10 (Armorer Dvr) R
1 PFC 76Y10 (Gen Sup Sp) R



1 SFC 94B40 (Food Serv SGT) R
1 SSG 94B30 (1st Cook) R
1 SGT 94B20 (Cook) R
2 SP4 94B10 (Cook Dvr) R
1 PFC 94B10 (Cook) R

OPS INTEL PLT

OPS INTEL PLT HQ



* 1 MAJ 13E00 (S 3) P
1 SP4 71L10 (Clerk Typist-Dvr) GL



**
1 SSG 54E30 (NBC NCO) R
1 SP4 54E10 (Decon Sp-Dvr) R



1 CPT 13E00 (Plans Op- Oth) R
1 MSG 13Y50 (Ops SGT) R
1 SFC 13E40 (Asst Ops SGT) R
1 SP4 36K10 (Tac Wire Ops Sp Dvr) R

1 SP4 13E10 (Tac Ops Sp RTO) R
1 SP4 71L10 (Clerk Typist) R
2 SP4 13E10 (Ops Sp) R

OPS-FD SEC



1 CPT 13E00 (FD Oth) R
1 SP4 13E10 (TF Ops Sp, RTO-Dvr) R
1 SP4 13E10 (TF Ops Sp, RTO) R



2 SSG 13E00 (FD SGT) R
2 SGT 13E20 (TF Equip Sp-Dvr) R

INTEL SEC



* 1 CPT 13E35 (S 2) R
1 CPT 13E35 (Target Off Asst S 2) R
1 LT 35A00 (Intel Oth) R
1 MSG 13W50 (Intel SGT) R
1 SSG 96B30 (Cbt Intel Anal) R
1 SP4 17C1U (TF Intel Sp RTO-Dvr) R

* From Bn Staff
** W/Winch & Skid Mtd Decon Apparatus

SURVEY PLT

SURVEY PLATOON HQ



1 LT 13D35 (Recon-Survey Off) R
1 SFC 82C40 (Chief Surveyor) R
1 PFC 82C10 (Dvr RTO) R

CONVL SURVEY SEC



1 SSG 82C30 (Sec Chief) R
1 PFC 82C10 (Rod-Tapeman-Dvr) GL



1 SGT 82C20 (Survey Comp/Rec) R
1 SGT 82C20 (Survey Computer) R
1 SP4 82C10 (Instr Op/ RTO Dvr) R

2 PADS SURVEY SEC



2 SSG 82C30 (Chief of PADS Sec) R
2 SP4 82C10 (Instr Op/ RTO Dvr) GL

COMMO PLT

COMMO PLT HQ



* 1 CPT 25A00 (C-E Off) R
** 2 SP4 36K10 (Wire Ops Sp/Dvr) R
1 PFC 36K10 (Dvr RTO) GL



1 LT 25A00 (Plt Ldr/Btry XO) R
1 MSG 31V50 (Commo Chief) R
2 SGT 31V20 (Commo Sys Op/Mech) R
4 PFC 31V10 (Commo Sys Op/Mech) R
** 3 PFC 36K10 (Wire Op Sp/Dvr) R

RADIO TT SEC



1 SSG 05C30 (RATT Ops Supv) R
1 SGT 05C20 (RATT Ops Tm Chief) R
1 SP4 05C10 (Radio TT Op) R
1 PFC 05C10 (Radio TT Op Dvr) R



1 SGT 05C20 (RATT Ops Tm Chief) R
1 SP4 05C10 (Radio TT Op) R
1 PFC 05C10 (Radio TT Op Dvr) R

MEDICAL SEC



1 WO 011A0 (PA) P
1 SGT 91B20 (Med Aidman) R
1 PFC 91B10 (Ambi Dvr) R



1 SSG 91B30 (Sec SGT) R
1 SP4 91B10 (Med Aidman) R



1 SSG 91C30 (Prac Nurse) R
7 SP4 91B10 (RATT Aidman) P
1 PFC 91B10 (Med Aidman-Dvr) R

* From Bn Staff
** Also Motorcycle Messenger

PERS/ADMIN CEN (PAC)



* 1 PT 13E41 (S I) R
 1 SGT 71020 (PAC Clerk) P
 1 SP4 71110 (Clerk Typ St) R
 1 PFC 13B10 (RTO Dvr) R



1 SFC 75240 (PAC Supv) R
 1 SSG 75230 (Pers Admin Staff NCO) R
 1 SGT 75B20 (PAC Clerk) R
 1 SP4 75B10 (PAC Clerk) R
 2 PFC 75B10 (PAC Clerk Dvr) R

MVR BOE FIRE SPT SEC



1 MAJ 13E10 (F S Dvr) P
 1 SP4 13F10 (F S Sp Dvr) GL



1 SFC 13F40 (F S SGT) R
 1 SP4 13F11 (F S Sp RTO Dvr) R

3 MVR BN FS SEC



3 CPT 13F00 (F S Dvr) P
 3 SP4 13F10 (F S Sp Dvr) GL



3 SFC 13F40 (F S SGT) R
 3 SP4 13F11 (F S Sp RTO Dvr) R

12 CAVALRY TANK FIST



12 LT 13A00 (F S Trn Ch) R
 12 SSG 13F30 (F S SGT RTO) R
 12 SP4 13F11 (F S Sp RTO Dvr) R
 12 PFC 13F10 (RTO) R

* From Bn Staff

Notes:

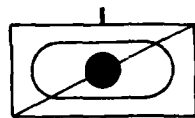

0	WO	EM	AGG
5	0	133	138

FIRING PLT			
0	WO	EM	
2	0	25	

BTRY HQ			
0	WO	EM	
1	0	11	

FIRING PLT			
0	WO	EM	
2	0	49	

COMMO SEC			
0	WO	EM	
0	0	5	

PLT HQ			
0	WO	EM	
1	0	3	

FDC SEC			
0	WO	EM	
1	0	6	

AMMO SEC			
0	WO	EM	
0	0	8	

HOW SEC			
0	WO	EM	
0	0	32	

PLT HQ			
0	WO	EM	
1	0	3	

FDC SEC			
0	WO	EM	
1	0	6	

AMMO SEC			
0	WO	EM	
0	0	2	

HOW SEC			
0	WO	EM	
0	0	32	

578

SUMMARY OF EQUIPMENT

WEAPONS

BAYONET-KNIFE: W/SCABBARD FOR M16A1 RIFLE.....	130
LAUNCHER GRENADE 40MM: SGLE SHOT RIFLE MTD DTCHBLE W/E.....	8
MACHINE GUN CALIBER .50: HB FLEXIBLE VEHICLE MTD.....	16
MACHINE GUN 7.62MM: LIGHT FLEXIBLE.....	5
PISTOL CALIBER .45 AUTOMATIC.....	1
RIFLE 5.56MM: W/E.....	129

VEHICLES

CARRIER CARGO: TRACKED 6 TON.....	8
CARRIER COMMAND POST: LIGHT TRACKED.....	2
HOWITZER MEDIUM SP: 155MM.....	8
KITCHEN FIELD TRAILER MOUNTED: MTD ON M103A3 TRAILER.....	1
TRAILER CARGO: 1/4 TON 2 WHEEL W/E.....	5
TRAILER CARGO: 1-1/2 TON 2 WHEEL W/E.....	3
TRUCK TANK: WATER 400 GALLON 1-1/2 TON 2 WHL W/E.....	1
TRUCK CARGO: 1-1/4 TON 6X6 W/E.....	2
TRUCK CARGO: 2-1/2 TON 6X6 W/E.....	4
TRUCK UTILITY: 1/4 TON 4X4 W/E.....	5
TRUCK CARGO: 10 TON 8X8 HIGH MOBILITY XM977.....	4

NBC EQUIPMENT

ALARM CHEMICAL AGENT AUTOMATIC: PTBL F/CARRIER CMD.....	2
ALARM CHEMICAL AGENT AUTOMATIC: PTBL W/PWR SUP F/TRK 1/4 TON TRK.....	1
MASK-CHEMICAL-BIOLOGICAL: MULTIPURPOSE.....	130
RADIACMETER: IM-185/UD.....	5

MISCELLANEOUS EQUIPMENT

BINOCULAR MODULAR CONSTRUCTION: MIL SCALE RETICLE 7X50MM W/E.....	7
FIRE DIRECTION SET ARTILLERY: 3000 METER MAX RANGE.....	2
NIGHT VISION GOGGLES: AN/PVS-5.....	9
NIGHT VISION SIGHT INDIVIDUAL SERVED WEAPON: AN/PVS-4.....	4
PLRS BASIC USER UNIT.....	4
PLRS MANPACK UNIT INSTALLATION KIT (MPUIK).....	5
PLRS SURFACE VEHICLE INSTALLATION KIT.....	5

**FIELD ARTILLERY BATTERY
FIELD ARTILLERY BATTALION
ARMORED CAVALRY REGIMENT**

BATTERY HQ



1 CPT 13A00 (Btry Cdr) P
1 PFC 13B10 (RTO Dvr) GL



1 ISG 13Y5M (ISG) R



1 SSG 76Y30 (Supply SGT) R
1 SGT 54E20 (NBC NCO) R
1 SP4 76Y10 (Armorer Dvr) R



1 SSG 94B30 (Food Sv. SGT) R
1 SGT 94B20 (1st Cook) R
2 SP4 94B10 (Cook Dvr) R
2 PFC 94B10 (Cook Dvr) R

COMMO SEC



1 SSG 31V30 (Commo Ch. H) R
1 SGT 36K20 (Wire Ops Chief) R
2 SP4 36K10 (Wire Ops Sp) R
1 PFC 36K10 (Wire Ops Sp Dvr) GL

2 FIRING PLTS

FIRING PLT HQ



1 LT 14A00 (Plt Ldr) R
1 PFC 14B20 (RTO Dvr) GL



1 SFC 13B40 (Plt SGT) R



1 PFC 13B10 (RTO Dvr) R

FIRE DIRECTION CENTER



1 LT 14A00 (F. D. Op) R
1 SSG 13E30 (F. D. SGT) R
2 SGT 13E20 (BCS Op) R
2 SP4 13E10 (Char. Op. RTO) R
1 SP4 13E10 (Dvr) GL

2 FIRING PLTS (Cont.)

4 HOWITZER SECTIONS

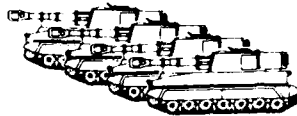

1 SSG 15B10 Sp. Ch. Pt. R
1 SGT 15B11 Gunner R
1 SP4 15B12 Asst. Gunner R
1 SP4 15B13 Cannonier Asst. Mble R
1 SP4 15B14 Cannonier Drive R



1 SP4 15B15 Gun Drive R
1 PLT 15B16 Cannonier Drive R

AMMUNITION SEC



1 SGT 15B17 Sp. Ch. Pt. R
1 PLT 15B18 Ammo Hdr. Drive Gt



1 SP4 15B19 Ammo Sp. R
1 PLT 15B20 Ammo Hdr. Drive R

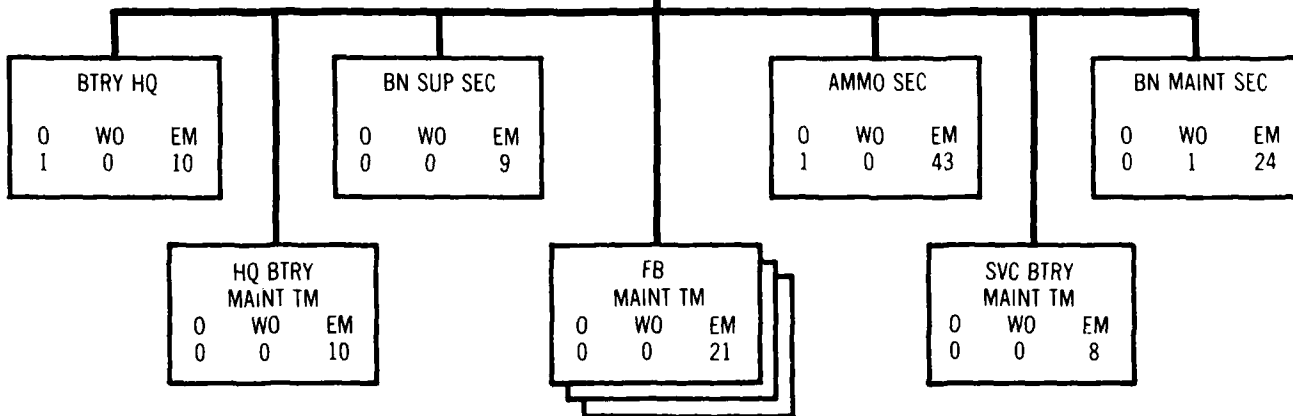
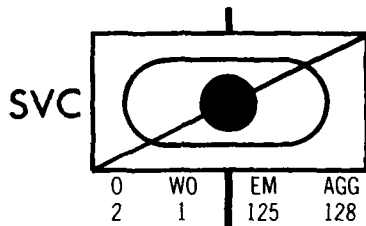

582

SUMMARY OF EQUIPMENT

WEAPONS

BAYONET-KNIFE: W/SCABBARD FOR M16A1 RIFLE.....	128
LAUNCHER GRNADAE 40MM: SGL SHOT RIFLE MTD DITCHBLE W/E.....	15
MACHINE GUN CALIBER .50: HB FLEXIBLE VEHICLE MTD.....	2
MACHINE GUN 7.62MM: LIGHT FLEXIBLE.....	11
PISTOL CALIBER .45 AUTOMATIC.....	5
RIFLE 5.56MM: W/E.....	127
SUBMACHINE GUN CALIBER .45.....	4
LAUNCHER GRNADAE 40MM: SGL SHOT RIFLE MTD DITCHBLE W/E.....	15

VEHICLES

KITCHEN FIELD TRAILER MOUNTED: MTD ON M103A3 TRAILER.....	1
RECOVERY VEHICLE FULL TRACKED: LIGHT ARMORED.....	3
SEMITRAILER VAN: REPAIR PORTS STORAGE 6 TON 4 WHEEL W/E.....	1
TRAILER CARGO: 1/4 TON 2 WHEEL W/E.....	1
TRAILER CARGO: 3/4 TON 2 WHEEL W/E.....	1
TRAILER CARGO: 1-1/2 TON 2 WHEEL W/E.....	8
TRUCK TANK: WAT. 100 GALLON 1-1/2 TON 2 WHL W/E.....	1
TRUCK CARGO: 1-1/4 TON 6X6 W/E.....	1
TRUCK CARGO: 2-1/2 TON 6X6 W/E.....	8
TRUCK CARGO: 2-1/2 TON 6X6 W/WINCH W/E.....	5
TRUCK CARGO: 5 TON 6X6 LWB W/E.....	3
TRUCK TRACTOR: 5 TON 6X6 W/E.....	1

TRUCK UTILITY: 1/4 TON 4X4 W/E.....	2
TRUCK WRECKER: 5 TON 6X6 W/WINCH W/E.....	1
TRUCK CARGO: 10 TON 8X8 HIGH MOBILITY M9977.....	20
TRUCK RECOVERY: TACTICAL 10 TON 8X8 HIGH MOBILITY.....	1

NBC EQUIPMENT

ALARM CHEMICAL AGENT: PTBL W/PWR SUPPLY P/1/4 TON TRK.....	1
ALARM CHEMICAL AGENT: PTBL W/PWR SUPPLY P/1/4 TON TRK.....	1
RADIOMETER: IM-185/VD.....	2
MASK-CHEMICAL-BIOLOGICAL: MULTIPURPOSE.....	128

MISCELLANEOUS EQUIPMENT

BINOCULAR: MODULAR CONSTRUCTION MIL SCALE RETICLE 7X50MM W/E.....	1
DEMOLITION SET EXPLOSIVE: INITIATING ELEC & SEMI-ELEC.....	1
DETECTING SET MINE: PTBL METALLIC AND NON-METALLIC.....	1
DETECTING SET MINE: PTBL METALLIC (AN/PSS-11).....	1
NIGHT VISION GOGGLES: AN/PVS-5.....	5
NIGHT VISION SIGHT CREW SERVED WEAPON: AN/TVS-5.....	2
NIGHT VISION SIGHT INDIVIDUAL SERVED WEAPON AN/PVS-4.....	3
NIGHT VISION SIGHT INFRARED: AN/TAS-6.....	1

SERVICE BATTERY FIELD ARTILLERY BATTALION ARMORED CAVALRY REGIMENT

BATTERY HQ



1 CPT 13A9? (Btry Cdr) p****
1 PFC 13B10 (RTO Dvr) GL



1 ISG 13Y5M (ISG) R
1 SSG 76Y30 (Supply SGT) R
1 SGT 54E20 (NBC NCO) R
1 SP4 76Y10 (Armorer Dvr) R
1 SP4 36K10 (Wire Ops Sp) R



1 SSG 94B30 (Food Svc SGT) R
1 SGT 94B20 (1st Cook) R
1 SP4 94B10 (Cook Dvr) R
1 PFC 94B10 (Cook) R

BN SUPPLY SEC



1 SFC 76Y40 (Supply SGT) R
1 SP4 76Y10 (Gen Supply Sp) R



1 SGT 76Y20 (Gen Supply Sp) R
1 PFC 76Y10 (Gen Supply Sp) R



1 SP4 76Y10 (Gen Supply Sp) R
1 PFC 76Y10 (Gen Supply Sp) R



3 PFC 76W10 (POL Dvr) R

BN MAINT SEC



*** 1 CPT 13E77 (Motor Off) R
1 PFC 63D10 (Trk Veh Mech/Dvr) GL



1 WU 63C40 (Auto Maint Tech) R
3 SGT 63D20 (Trk Veh Mech) R
3 PFC 63D10 (Trk Veh Mech/Dvr) R



1 MSG 63Z50 (Motor Maint SGT) R
1 SGT 63D20 (Pwr Gen & W/Veh Mech) R
3 SP4 44B10 (Welder) R
4 SP4 63D10 (Trk Veh Mech) R



1 SP4 63D10 (Wrecker Opt) R

* W POL Pods
** W Winch
*** From Bn Staff
**** Also S4

BN MAINT SEC

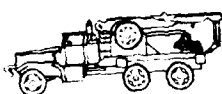

1 SP4 63D10 (Wreckr Op) R



1 SSG 63D30 (Sr Recvy Veh Op) P
1 PFC 63D10 (Recvy Veh Op/RTD Dvr) P



1 SP4 63D10 (Recvy Veh Op) P
1 PFC 63D10 (Recvy Veh Op/RTD Dvr) P

AMMO TRAIN HQ



1 LT 13A00 (Ammo Off Asst S-4 Btry XO) R
1 SFC 13B40 (Ammo SGT) R
1 SP4 71L10 (Ammo Clerk Dvr) GL
1 SP4 13B10 (Ammo Sp/RTD) R

4 AMMO SEC



1 SSG 13B30 (Sec Chieft) R
1 SP4 13B10 (Ammo Sp Dvr) GL



1 SP4 13B10 (Ammo Sp) R
1 PFC 13B10 (Ammo Hqr Dvr) R

HQ BTRY MAINT TM



1 SFC 63D40 (Tm Chieft) R
1 SGT 63B20 (Pwr Gen & W Veh Mech) R
1 SGT 63D20 (Trk Veh Mech) R
1 SP4 76C10 (Equip Maint Clerk) R
2 SP4 63B10 (Pwr Gen & W Veh Mech) R
1 SP4 63D10 (Trk Veh Mech) R
2 PFC 63B10 (Pwr Gen & W Veh Mech) GL
1 PFC 63D10 (Trk Veh Mech) GL

3 FB MAINT TMS



1 SFC 63D40 (Tm Chieft) R
1 SGT 63D20 (Trk Veh Mech) R
1 SP4 76C10 (Equip Maint Clerk) R
1 SP4 63B10 (Pwr Gen & W Veh Mech) R
1 SP4 63D10 (Trk Veh Mech) R
1 PFC 63B10 (Pwr Gen & W Veh Mech) R
1 PFC 63D10 (Trk Veh Mech Dvr) GL

SVC BTRY MAINT TEAM/QUALITY CONTROL/PLL SEC



1 SSG 63D30 (Tm Chieft) R
1 PFC 63D10 (Pwr Gen & W Veh Mech Dvr) GL



1 SSG 45L30 (Arm Maint Insp) R
1 SP4 76C10 (Equip Maint Clerk Dvr) R

*W Wmth

SVC BTRY MAINT TEAM/QUALITY CONTROL/PLL SEC



1 SP4 63D10 (Pwr Gen & W/Veh Mech) R
1 PFC 63D10 (Pwr Gen & W/Veh Mech) R

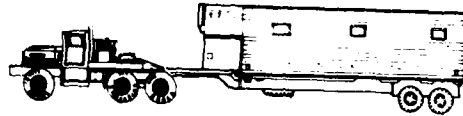

1 SSG 63H30 (Tech Insp) R
1 SGT 63D20 (Pwr Gen & W/Veh Mech-Dvr) R

888

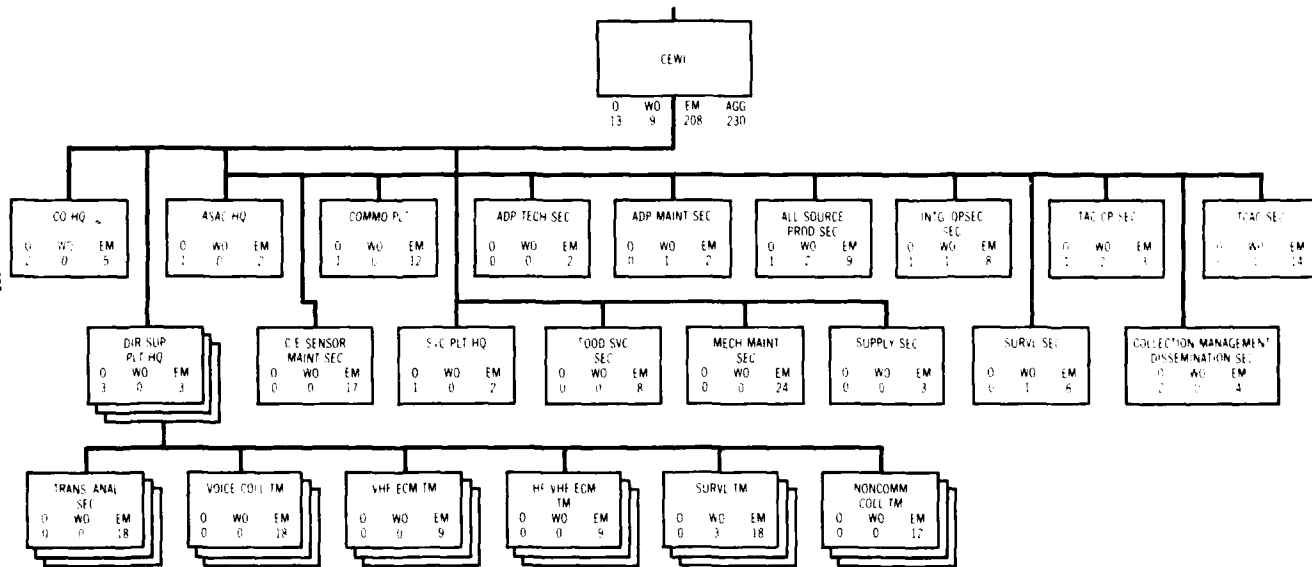

SUMMARY OF EQUIPMENT

WEAPONS

BAYONET-KNIFE: W/SCABBARD FOR M16A1 RIFLE.....	240
LAUNCHER GRENADE 40MM: SGL SHOT RIFLE MTD DOUBLE W/E.....	7
MACHINE GUN 7.62MM: LIGHT FLEXIBLE.....	4
PISTOL CALIBER .45 AUTOMATIC.....	5
RIFLE 5.56MM: W/E.....	235

VEHICLES

CARRIER CARGO: TRACKED 5 TON.....	16
CARRIER COMMAND POST: LIGHT TRACKED.....	2
CARRIER PERSONNEL FULL TRACKED: ARMORED.....	3
TRAILER CARGO: 1/4 TON 2 WHEEL W/E.....	23
TRAILER CARGO: 3/4 TON 2 WHEEL W/E.....	3
TRAILER CARGO: 1-1/2 TON 2 WHEEL W/E.....	7
TRAILER TANK: WATER 400 GAL 1-1/2 TON 2 WHEEL W/E.....	1
TRUCK CARGO: TACTICAL 1-1/4 TON 4X4 W/50 AMP KIT W/E.....	1
TRUCK CARGO: TACTICAL 1-1/4 TON 4X4 W/50 AMP-COMM KITS W/E.....	2
TRUCK CARGO: 2-1/2 TON 6X6 W/E.....	16
TRUCK CARGO: 5 TON 6X6 LWB W/E.....	1
TRUCK TRACTOR: 5 TON 6X6 W/E.....	1
TRUCK UTILITY: 1/4 TON 4X4 W/E.....	23
TRUCK VAN: EXPENSIBLE 5 TON 6X6 (ARMY).....	2
TRUCK WRBECKER: 5 TON 6X6 W/WINCH W/E.....	1

NBC EQUIPMENT

ALARM CHEMICAL AGENT AUTOMATIC: PIRL MANPACK.....	1
CHARGER RADIAC DETECTOR: PP-1578/PD.....	2
MASK CBR: PROTECTIVE FIELD.....	240
RADIAC SET: AN/PDR-27.....	1
RADIAC METER: IM-93/UD.....	7
RADIAC METER: IM-174/PD.....	3
RADIAC SET: AN/VDR-1.....	6
CHARGER RADIAC DETECTOR: PP-4370/PD.....	6
RADIAC METER: IM-185/VD.....	28

MISCELLANEOUS EQUIPMENT

BINOCULAR: MODULAR CONSTRUCTION MIL SCALE RETICLE 7X50MM W/E.....	1
DATA ANALYSIS CENTRAL: AN/TYO-5/V/3.....	3
DATA ANALYSIS CENTRAL: AN/TYO-5/V/4.....	1
ELECTRONIC KEY GENERATOR HIGH SPEED TACTICAL.....	7
COUNTER ELECTRONIC DIGITAL READOUT: AN/VSM-207.....	3
COUNTERMEASURES SET: AN/TLO-17.....	3
COUPLER DIRECTIONAL: CU-209/V.....	1
COMMUNICATIONS TERMINAL: AN/JGC-74A(V)3.....	2
DATA ANALYSIS CENTRAL: AN/TYK-10A.....	3

685

**CEWI COMPANY
ARMORED CAVALRY REGIMENT**

INTELLIGENCE/OPERATIONS SECURITY SECTION

1 LT	CI OFFICER.....	
1 WO	CI PSYCHIAT.....	
1 SFC	OPERATIONS SERGEANT.....	
1 SFC	SIGNAL SECURITY SERGEANT.....	
1 SSG	INTERROGATOR.....	
2 SGT	SIGNAL SECURITY SP.....	
1 SGT	IMAGERY INTERPRETER.....	
1 SGT	INTERROGATOR.....	
1 SP4	INTERROGATOR.....	
1 SP4	SIGNAL SECURITY SP.....	
	CARRIER CARGO: TRACKED 5 TON.....	1
	TRAILER, CARGO: 1/4 TON 2 WHEEL W/E.....	1
	TRUCK UTILITY: 1/4 TON 4X4 W/E.....	1

TAC OP SECTION

1 LT	TACTICAL INTELLIGENCE ANALYST.....	
1 SSG	SENIOR INTELLIGENCE ANALYST.....	
1 SGT	INTELLIGENCE ANALYST.....	
1 SP4	INTELLIGENCE ANALYST.....	
	CARRIER COMMAND POST: LIGHT TRACKED.....	1

TOAC SECTION

1 WO	TRAFFIC ANALYST TECHNICIAN.....	
1 SSG	EW/SIGNAL INTELLIGENCE MORSE INTCP.....	
1 SSG	EW/SIGNAL INTELLIGENCE NCOMM ANALYST.....	
1 SSG	TRAFFIC ANALYST.....	
1 SGT	EW/SIGNAL INTELLIGENCE NCOMM ANALYST.....	
3 SGT	TRAFFIC ANALYST.....	
1 SGT	INTELLIGENCE ANALYST.....	
1 SP4	INTELLIGENCE ANALYST.....	
3 SP4	TRAFFIC ANALYST.....	
2 PFC	TRAFFIC ANALYST.....	
	CARRIER CARGO: TRACKED 5 TON.....	2

SURVEILLANCE TM SECONDARY GS

1 WO	OB TECHNICIAN.....	
1 SSG	TEAM CHIEF.....	
2 SGT	IMAGE INTERPRETER.....	
2 SP4	IMAGE INTERPRETER.....	
1 PFC	IMAGE INTERPRETER.....	
	TRUCK CARGO: 2-1/2 TON 6X6 W/E.....	1

CEWI COMPANY (Continued)
ARMORED CAVALRY REGIMENT CORPS 86

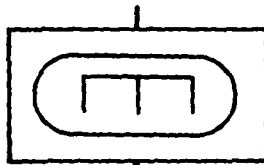

0	WO	EM	AGG
8	1	194	203

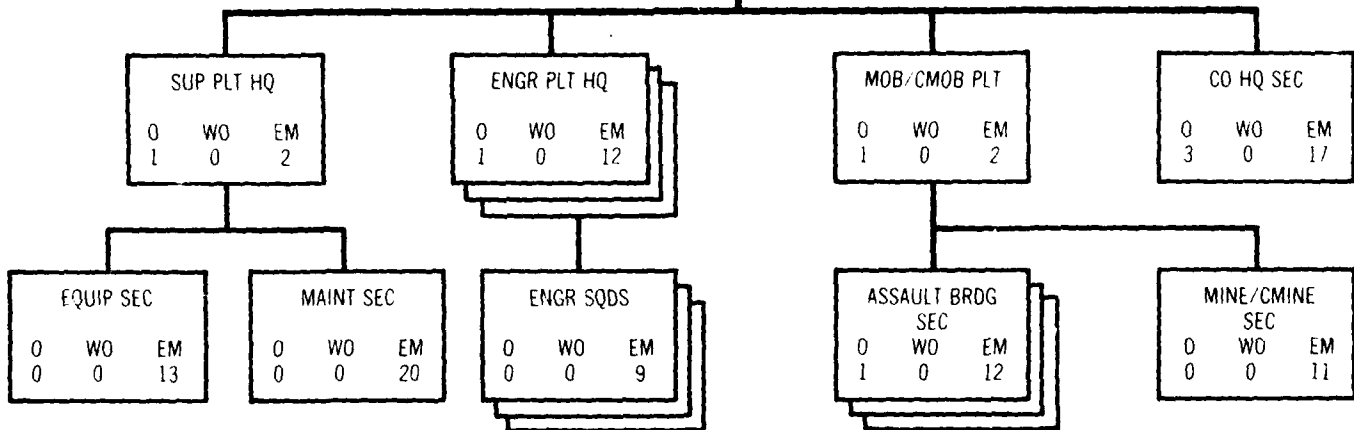

592

SUMMARY OF EQUIPMENT

WEAPONS

BAYONET-KNIFE: W/SCABBARD FOR M16A1 RIFLE.....	203
LAUNCHER GRENADE 40MM: SGL SHOT RIFLE MTD DITCHBLE W/E.....	18
LAUNCHER GRENADE SMK: SCREENING RED PHOSPHOROUS M239.....	3
MACHINE GUN CALIBER .50: HB FLEXIBLE MTD.....	16
MACHINE GUN CALIBER .50: HB FLEXIBLE FOR GRD USE.....	1
MACHINE GUN CALIBER .50: VEHICLE HVY FIXED.....	3
PISTOL CALIBER .45 AUTOMATIC.....	63
RIFLE 5.56MM: W/E.....	138
MACHINE GUN 5.5MM: (SAW).....	9

VEHICLES

CARRIER CARGO: TRACKED 5 TON.....	3
CARRIER PERSONNEL FULL TRACKED: ARMORED.....	13
COMBAT ENGINEER VEHICLE FULL TRACKED.....	3
CRANE WHEEL MTD: 20 TON W/BOOM CRANE 30 FT.....	1
KITCHEN FIELD TRAILER MOUNTED: MTD ON M103A1 TRAILER.....	1
LAUNCH M40 SERIES TANK CHASSIS.....	6
LOADER SCOOP TYPE: DSL 4 WHELS 2-1/2 CU YD.....	1
RECOVERY VEHICLE FULL TRACKED: MEDIUM.....	1
TRACTOR FULL TRACKED HIGH SPEED: ARMORED DOZER.....	6
TRACTOR WHEELED IND: DSL W/BACKHOE W/LOADER.....	2
TRAILER CARGO: 1/4 TON 2 WHEEL W/E.....	4
TRAILER CARGO: 1-1/2 TON 2 WHEEL W/E.....	13
TRAILER TANK: WATER 400 GAL 1-1/2 TON TRAILER W/E.....	1
TRUCK CARGO: 1-1/4 TON 6X6 W/E.....	8

TRUCK CARGO: 2-1/2 TON 6X6 W/E.....	7
TRUCK CARGO: 2-1/2 6X6 W/WINCH W/E.....	1
TRUCK DUMP: 5 TON 6X6 W/E.....	2
TRUCK DUMP: 5 TON 6X6 W/WINCH W/E.....	1
TRUCK UTILITY: 1/4 TON 4X4 W/E.....	1
DISPENSER MINE: GROUND VEHICLE XM128.....	1
TRUCK RECOVERY: TACTICAL 10 TON 8X8 HIGH MOBILITY.....	1
TRUCK ROCKET RESUPPLY: 5 TON 6X6 W/MHE (SLUPAE).....	2
TRUCK TANK: FUEL SERVICING 2500 GAL 8X8 W/WINCH.....	2

NBC EQUIPMENT

ALARM CHEMICAL AGENT AUTOMATIC: PTBL FIXED EMPLACEMENT.....	3
ALARM CHEMICAL AGENT AUTOMATIC: PTBL P/TRUCK 1/4 TON.....	3
RADIAC SET: AN/VDR-1.....	6
CHARGER RADIAC DETECTOR: PP-4370/PD.....	4
MASK CHEMICAL-BIOLOGICAL.....	203

MISCELLANEOUS EQUIPMENT

NIGHT VISION GOGGLES: AN/PVS-5.....	29
NIGHT VISION SIGHT CREW SERVED WEAPON: AN/PVS-5.....	16
NIGHT VISION SIGHT INDIVIDUAL SERVED WEAPON: AN/PVS-4.....	9
DEMOLITION SET EXPLOSIVE: INITIATING ELBC & SEMI-ELBC.....	12
DETECTING SET MINE: PTBL METALLIC & NON-METALLIC.....	10
DETECTING SET MINE: PTBL METALLIC (AN/PSS-11).....	10

ENGINEER COMPANY ARMORED CAVALRY REGIMENT

CO HQ

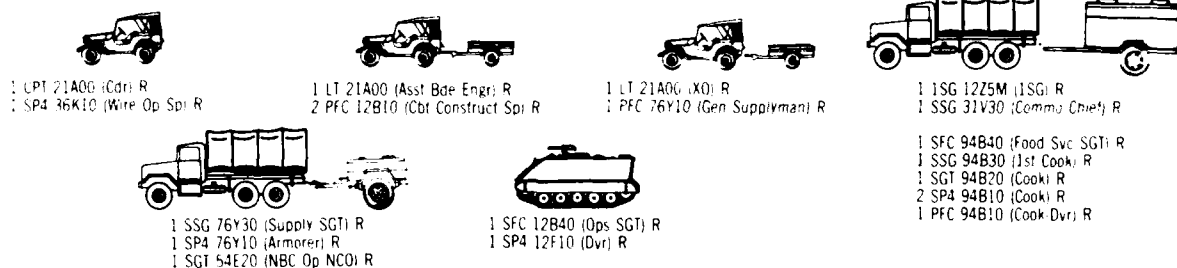

3 ENGR PLT

ENGR PLT HQ

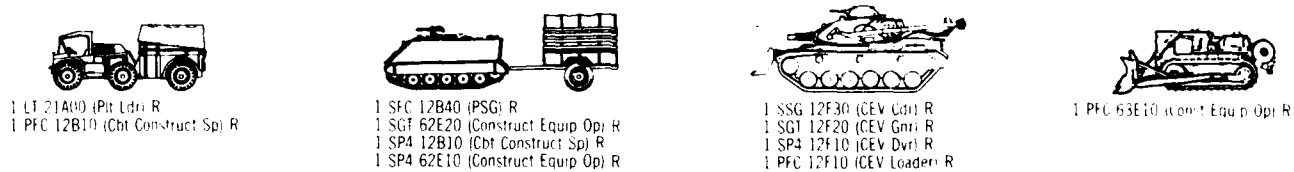

3 ENGR SQD

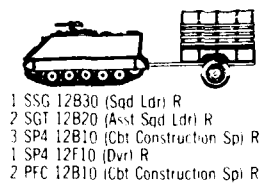

SPT PLT
SPT PLT HQ



1 LT 21A00 (Pit Ldr) R
1 PFC 62J10 (Dvr) R



1 SFC 62N40 (PSG) R

EQUIP SEC

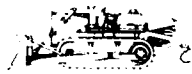

1 PFC 62E10 (Const Equip Op) R



1 SSG 62N30 (Const Equip Supv) R
1 SGT 62F20 (Lift Load Equip Opi) R
1 SP4 62J10 (Gen Mach Op) R
3 SP4 62F10 (Lift Load Equip Opi) R



1 PFC 62J10 (Gen Mach Op) R



1 PFC 62J10 (Gen Mach Op) R



2 SP4 62J10 (POL Opi) R

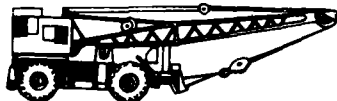

1 SGT 62J20 (Gen Mach Op) R

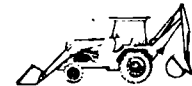

1 PFC 62E10 (Const Equip Op) R

MAINT SEC



1 WO 621A0 (Engr Equip Rep Tech) R
1 SGT 62B20 (Const Equip Mech) R
2 SP4 62B10 (Const Equip Mech) R
1 PFC 62B10 (Const Equip Mech) R
2 PFC 63Y10 (Trk Veh Mech) R



1 SFC 63B10 (Motor SGT) R
1 SGT 63Y20 (Trk Mech) R
1 SP4 63B10 (Lt W/Veh & Pwr Gen Mech) R
3 SP4 63Y10 (Trk Veh Mech) R
1 SP4 76C10 (Equip Maint Clerk) R
1 SP4 76C10 (PLL Clerk) R
2 PFC 63B10 (Lt W/Veh & Pwr Gen Mech) R



2 SP4 63Y10 (Recvy Veh Op) R



1 SP4 62B10 (Wrecker Op) R

MOB/CMOB PLT

MOB/CMOB PLT HQ



1 LT 21A00 (Pit Ldr) R
1 PFC 12F10 (Dvr) R



1 SFC 12F40 (PSG) R



1 SFC 12F40 (Assault Bridge Sp) R

3 ASSAULT BRIDGE SEC

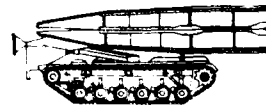

1 SSG 12F30 (AVLB Cdr Trn Chief) R
1 SP4 12F10 (AVLB Dvr) R

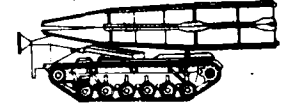

1 SGT 12F20 (AVLB Cdr) R
1 SP4 12F10 (AVLB Dvr) R

* W/POL Pods
** W/Winch

MINE/CMINE SEC

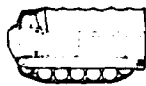

1 SP4 12F10 (M548 Dvr) R

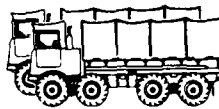

1 SSG 12F30 (SLV Crew Chief) R
1 SGT 12F20 (SLV Launch Op) R
1 SP4 12F10 (SLV Crewman) R
1 PFC 12F10 (RSV Dvr) R



1 SP4 12F10 (GEMMS Opl) R

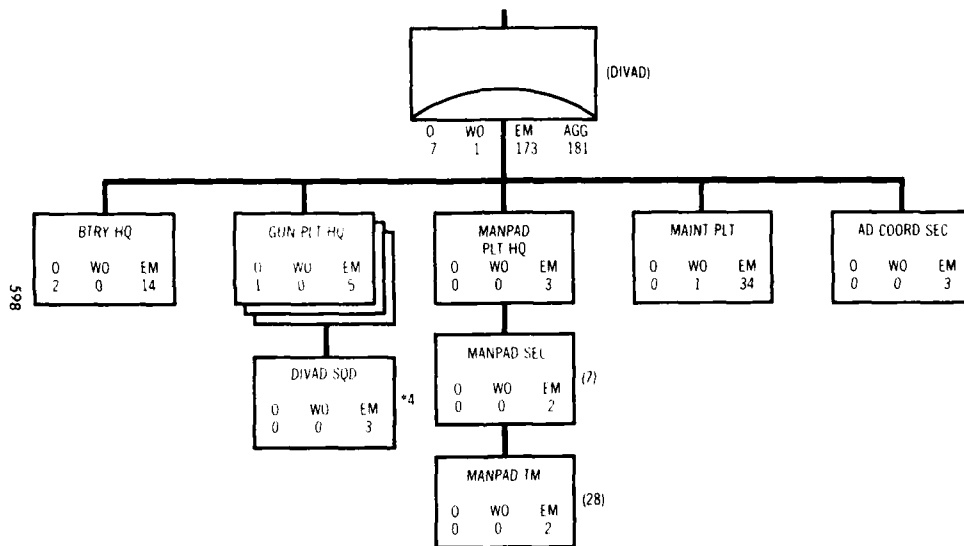

SUMMARY OF EQUIPMENT

WEAPONS

BAYONET-KNIFE: W/SCABBARD FOR M16A1 RIFLE.....	181
LAUNCHER GRENADE 40MM: SGL SHOT RIFLE MTD D/DOUBLE W/E.....	4
MACHINE GUN CALIBER .50: HB FLEXIBLE VEHICLE MTD.....	10
MACHINE GUN 7.62MM: LIGHT FLEXIBLE.....	4
PISTOL CALIBER .45 AUTOMATIC.....	49
RIFLE 5.56MM W/E.....	120
SUBMACHINE GUN CALIBER .45.....	38
MACHINE GUN 5.56MM (SAW).....	12

TRUCK CARGO: 5 TON 6X6 LWB W/WINCH W/E.....	2
TRUCK UTILITY: 1/4 TON 4X4 W/E.....	5
TRUCK VAN: SHOP 2/12 TON 6X6 W/E.....	3
TRUCK WRECKER: 5 TON 6X6 W/WINCH W/E.....	1
DIVAD GUN AIR DEFENSE ARTILLERY SP.....	12
TRUCK CARGO: 10 TON 8X8 HIGH MOBILITY XM977.....	2
TRUCK UTILITY: 1-1/4 TON 4X4 W/E HMMWV.....	37

VEHICLES

605 CARRIER CARGO: TRACKED 6 TON.....	6
CARRIER PERSONNEL FULL TRACKED: ARMORED.....	5
CHASSIS TRAILER: GENERATOR 2 1/2 TON 2 WHEEL W/E.....	1
KITCHEN FIELD TRAILER MTD: MTD ON M103A3 TRAILER.....	1
RECOVERY VEHICLE FULL TRACKED: MEDIUM.....	1
TRAILER CARGO: 1/4 TON 2 WHEEL W/E.....	5
TRAILER CARGO: 3/4 TON 2 WHEEL W/E.....	2
TRAILER CARGO: 1-1/2 TON 2 WHEEL W/E.....	4
TRAILER TANK: WATER 400 GAL 1-1/2 TON 2 WHEEL W/E.....	1
TRUCK CARGO: TACTICAL 1-1/4 TON 4X4 W/50 AMP-COMM KITS W/E.....	2
TRUCK CARGO: 2-1/2 TON 6X6 W/E.....	4

NBC EQUIPMENT

ALARM CHEMICAL AGENT AUTOMATIC: PTBL W/PWR SUPPLY F/1/4 TON TRUCK...	6
RADIAC SET: AN/VDR-1.....	18
CHARGER RADIAC DETECTOR: PP-4370/PD.....	1
MASK-CHEMICAL-BIOLOGICAL: MULTI-PURPOSE.....	181
RADIACMEER: IM-195/JD.....	9

MISCELLANEOUS EQUIPMENT

BINOCULAR: MODULAR CONSTRUCTION MIL SCALE RETICLE 7X50MM W/E.....	80
MOUNT GUN: RING CAL .50.....	2
NIGHT VISION GOGGLES: AN/PVS-5.....	12
NIGHT VISION SIGHT CREW SERVED WEAPON: AN/TVS-5.....	7
NIGHT VISION SIGHT INDIVIDUAL SERVED WEAPON: AN/PVS-4.....	1

ADA BATTERY ARMORED CAVALRY REGIMENT

HQ SEC

AD COORD SEC



1 CPT 14B00 (Btry Cdr) P
1 SGT 54E10 (Chem Ops SGT) R



1 SSG 16Z5M (ISG) R
1 SSG 76Y3G (Supply SGT) R
1 SP4 76Y10 (Armorer/Dvr) GL



1 SSG 94B30 (Food Svc SGT) R
1 SGT 94B20 (1st Cook) R
2 SP4 94B10 (Cook) R
1 PFC 94B10 (Cook-Dvr) R



1 LT 14B00 (AD Coord Off) R
1 SSG 16H30 (AD Coord SGT) R
1 PFC 16H10 (RTO-Dvr) R



1 LT 14B00 (XO) R
1 SP4 16R10 (Dvr) GL



1 SSG 16R30 (Ammo Sqd Ldr) R
1 PFC 16R10 (Ammo Hldr-Dvr) GL



1 SP4 16R10 (Ammo Hldr) R
1 PFC 16R10 (Ammo Hldr-Dvr) GL

009

MAINT PLT



1 WO 224B0 (Sp Maint Tech) R
1 SP4 52C10 (Util Equip Rep) R



1 SFC 24M40 (Ch Sys Mech) R
4 SP4 24M10 (Sys Mech-Dvr) R



1 SFC 63B40 (Maint Supv) R
1 SP4 76C10 (PLL Clerk) R



1 PFC 76W10 (Petro Veh Op) R



1 PFC 76W10 (Petro Veh Op) R



1 SSG 31V30 (Commo Chief) R
1 PFC 31V10 (Commo Sys Rep) R
1 PFC 52C10 (Util Equip Rep) R



1 SGT 63B20 (Lt W Veh/Pwr Gen Mech) R
1 SP4 63B10 (Lt W Veh/Pwr Gen Mech) R
1 PFC 63Y10 (Trk Veh Mech Dvr)

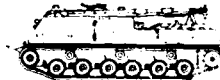

1 SGT 63Y20 (Recvr Veh Op) P
1 SP4 63Y10 (Recvr Veh Op) P

* W/POL Pods

MAINT PLT



1 SSG 24M30 (Sys Mech) R
2 SGT 24M20 (Sys Mech) R

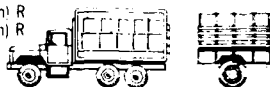

1 SSG 63B30 (Sr W Veh/Pwr Gen Mech) R
1 SP4 63B10 (Lt W Veh/Pwr Gen Mech) R
2 PFC 63Y10 (Trk Veh Mech) R



1 SGT 63B20 (Lt W Veh/Pwr Gen Mech) R
1 SGT 63Y20 (Trk Veh Mech) R
2 SP4 63Y10 (Trk Veh Mech) R



1 SGT 63Y20 (Trk Veh Mech) R
3 PFC 63B10 (Lt W Veh/Pwr Gen Mech) R

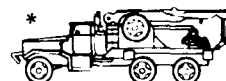

1 SP4 63Y10 (Recvy Veh Op) P

3 GUN PLT

GUN PLT HQ



1 LT 14B00 (Plt Ldr) R
1 PFC 16R10 (RTO Dvr) R



1 SFC 16R40 (PSG) R
1 SP4 16R10 (Dvr) P

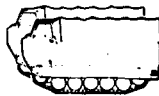

1 SP4 16R10 (Dvr) R
1 PFC 16R10 (Ammo Hdtr) R

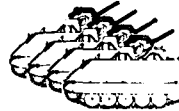

1 SSG 16R30 (Sgd Ldr) R
1 SGT 16R20 (Sr Gnr) R
1 SP4 16R10 (Dvr) R

109

MANPAD PLT

MANPAD PLT HQ



1 LT 14B00 (Plt Ldr) R
1 SFC 16S40 (Plt SGT) R
1 PFC 16S10 (RTO/Dvr) R



1 SGT 16S20 (MANPADS Crewman) R
1 PFC 16S10 (MANPADS Crewman) R

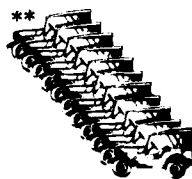

1 SP4 16S10 (MANPADS Crewman) R
1 PFC 16S10 (MANPADS Crewman) R



2 SP4 16S10 (MANPADS Crewman) R



1 SSG 16S30 (Sp. Chft) R
1 PFC 16S10 (Dvr RTO) R

(MANPADS Tms Assign to Ssg Based on MSN)

* W/Winch
** Truck Utility 1 + Ton
4x4 W/E HMMWV

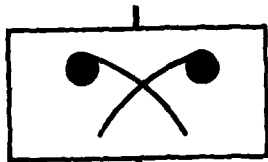

0	WO	EM	AGG
5	0	83	88

602

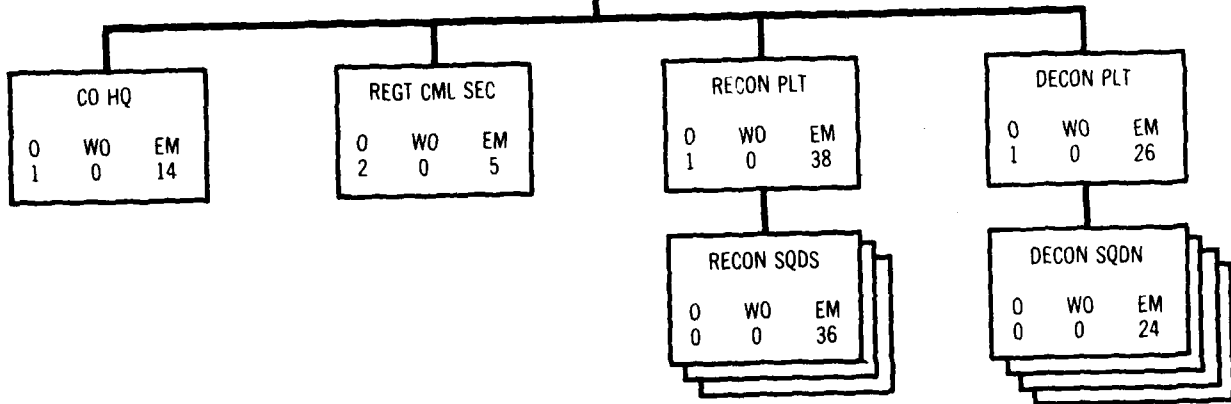

SUMMARY OF EQUIPMENT

WEAPONS		NBC EQUIPMENT	
BAYONET-KNIFE: W/SCABBARD FOR M16A1 RIFLE.....	91	ALARM CHEMICAL AGENT AUTOMATIC: PTBL MANPACK.....	1
LAUNCHER GRENADE 40MM: SGL SHOT RIFLE MTD DITCHBLE W/E.....	10	ALARM CHEMICAL AGENT AUTOMATIC: PTBL F/TRK 2-1/2 TON.....	12
MACHINE GUN CALIBER .50: HB FLEXIBLE VEHICLE MTD.....	10	DECONTAMINATING APPARATUS PWR DRVN SKID MOUNTED.....	4
MACHINE GUN CALIBER .50: HB FLEXIBLE FOR GRD USE.....	1	RADIAC SET AN/PDR-56(P).....	5
MACHINE GUN CALIBER 7.62MM: LIGHT FLEXIBLE.....	10	CHARGER RADIAC DETECTOR: PP-4370/PD.....	5
PISTOL CALIBER .75 AUTOMATIC.....	1	RADIAC SET: AN/VDR-1.....	18
RIFLE 5.56MM: W/E.....	80	MASK CHEMICAL-BIOLOGICAL: PROTECTIVE FIELD XM11.....	60
		MASK CHEMICAL-BIOLOGICAL: PROTECTIVE COMBAT VEH XM14.....	21
		RADIAC METER: IM-195/UD.....	21
		CHARGER RADIAC DETECTOR: PP-4370/PD.....	5
VEHICLES		MISCELLANEOUS EQUIPMENT	
CARRIER PERSONNEL FULL TRACKED: ARMORED.....	10	BINOCULAR: MODULES CONSTRUCTION MIL SCALE RETICLE 7X50MM W/E.....	11
TRAILER CARGO: 1/4 TON 2 WHEEL W/E.....	1	PLATOON EARLY WARNING SYSTEM: AN/TRS-2(V).....	12
TRAILER CARGO: 3/4 TON 2 WHEEL W/E.....	3	RADIO SET: AN/PDR-56(P).....	5
TRAILER CARGO: 1-1/2 TON 2 WHEEL W/E.....	16	COMPUTER INDICATOR: CP-696/UD.....	5
TRUCK CARGO: TACTICAL 1-1/4 TON 4X4 W/E.....	1	TANK FABRIC COLLAPSIBLE: WATER 500 GAL.....	4
TRUCK CARGO: 2-1/2 TON 6X6 W/WINCH W/E.....	6	TANK FABRIC COLLAPSIBLE: WATER 3000 GAL.....	4
TRUCK CARGO: DROPSIDE 5 TON 6X6 W/WINCH W/E.....	4	RADIO SET: AN/GRC- () - (V3).....	13
TRUCK TANK: WATER 1,000 GAL 2-1/2 TON 6X6 W/E.....	4	RADIO SET: AN/GRC- () - (V5).....	4
TRUCK UTILITY: 1/4 TON 4X4 W/E.....	1		
TRUCK WRECKER: 5 TON 6X6 W/WINCH W/E.....	1		
HMVV-WEAPONS CARRIER.....	2		
TRUCK UTILITY: 1-1/4 TON 4X4 W/E HMVV.....	1		

603

NBC COMPANY ARMORED CAVALRY REGIMENT

COMPANY HQ

1 CPT	COMPANY CDR.....	11
1 SFC	FIRST SERGEANT.....	
1 SSG	MAINTENANCE SUPERVISOR.....	
1 SFC	DEPUTY SERGEANT.....	
1 SGT	LT WVEH/PWR GEN MECH.....	GL
1 SGT	UNIT CLERK.....	
1 SGT	ANYONE.....	GL
1 SGT	CONSTRUCTION EQUIP MECH.....	GL
1 SGT	ENGINE BCD AND PARTS SPECIALIST.....	GL
1 SGT	LT WVEH/PWR GEN MECH.....	GL
1 SGT	QUARTERMASTER/CML EC RPMN.....	GL
1 SGT	TAC COMM SYSTEM OP/MECH.....	GL
2 PFC	LT WVEH/PWR GEN MECH.....	GL
	TRAILER CARGO: 3/4 TON 2 WHEEL W/E.....	2
	TRAILER CARGO: 1-1/2 TON 2 WHEEL W/E.....	2
	TRUCK CARGO: 2-1/2 TON 6X6 W/WINCH W/E.....	2
	TRUCK WRECKER: 5 TON 6X6 W/WINCH W/E.....	1
	TRUCK UTILITY: 1-1/4 TON 4X4 W/E HMMWV.....	1

REGIMENTAL CML SEC

1 MAJ	CHEMICAL OFFICER.....	11
1 CPT	ASST CHEMICAL OFFICER.....	
1 SFC	NBC OPNS/STAFF NCO.....	
1 SSG	PLOTTER.....	
1 SGT	COMPUTER.....	
1 SGT	NBC OPNS NCO.....	
1 SP4	CLERK-TYPIST.....	
	TRAILER CARGO: 1/4 TON 2 WHEEL W/E.....	1
	TRAILER CARGO: 3/4 TON 2 WHEEL W/E.....	1
	TRUCK CARGO: TACTICAL 1-1/4 TON 4X4 W/E.....	1
	TRUCK UTILITY: 1/4 TON 4X4 W/E.....	1

1 DECON PLATOON HQ

1 LT	PLATOON LEADER.....	
1 SFC	PLATOON SERGEANT.....	
1 SP4	DRIVER.....	
	HMMWV-WEACONS CARRIER.....	1
	TRAILER CARGO: 1-1/2 TON 2 WHEEL W/E.....	1

4 DECON SQUADS

4 SSG	SQUAD LEADERS.....	
4 SGT	DECON NCO.....	
8 SP4	DECON SPECIALIST.....	
8 PFC	DECON SPECIALIST.....	
	TRAILER CARGO: 1-1/2 TON 2 WHEEL W/E.....	12
	TRUCK CARGO: 2-1/2 TON 6X6 W/WINCH W/E.....	4
	TRUCK CARGO: DROP SIDE 5 TON 6X6 W/WINCH W/E.....	4
	TRUCK TANK: WATER 10000 GALLON 2-1/2 TON 6X6 W/E.....	4

1 RECON PLATOON HQ

1 LT	PLATOON LEADER.....	
1 SFC	PLATOON SERGEANT.....	
1 SP4	DRIVER.....	
	CARRIER PERSONNEL FULL TRACKED: ARMORED.....	1
	TRAILER CARGO: 1-1/2 TON 2 WHEEL W/E.....	1

3 RECON SQUADS

3 SSG	SQUAD LEADER.....	
6 SGT	NBC RECON NCO.....	
12SP4	NBC SCOUT.....	
15PFC	NBC SCOUT.....	
	CARRIER PERSONNEL FULL TRACKED: ARM RED.....	9

NBC COMPANY
ARMORED CAVALRY REGIMENT CORPS 86

Notes:

406

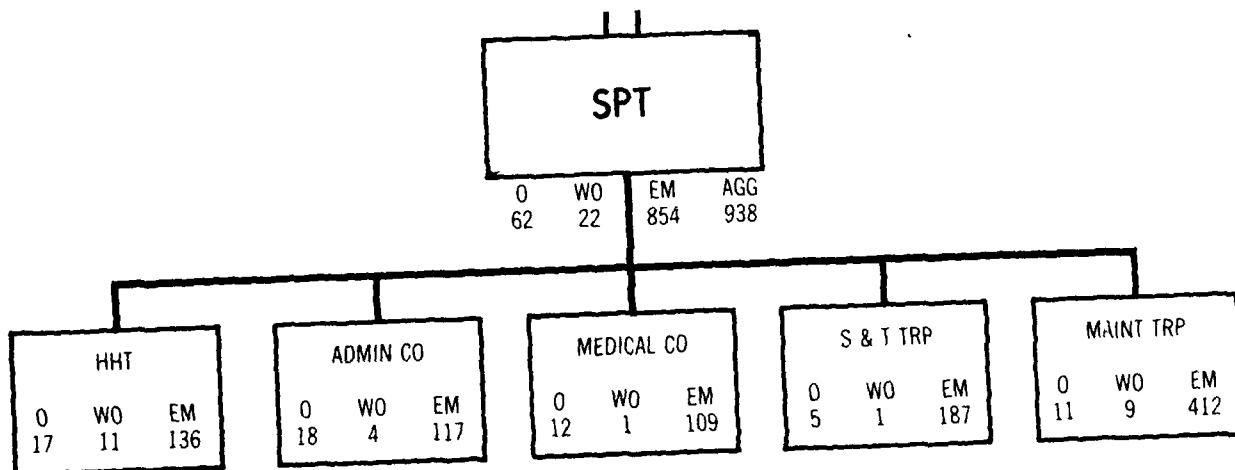

SUMMARY OF EQUIPMENT

WEAPONS

BAYNET-KNIFE: W/CABARD FOR MISAL RIFLE.....	927
LAUNCHER GRENADE 40MM: SINGLE SHOT RIFLE MTD DITCHBLE W/E.....	26
LAUNCHER GRENADE SMOKE: SCREENING RED PHOSPHOROUS M733.....	6
MACHINE GUN CALIBER .50: HB FLEXIBLE FOR GRO USE.....	23
MACHINE GUN 7.62MM: LIGHT FLEXIBLE.....	20
PISTOL CALIBER .45 AUTOMATIC.....	47
RIFLE 5.56MM: W/E.....	1003
SUBMACHINE GUN CALIBER .45.....	12

VEHICLES

CARRIER PERSONNEL FULL TRACKED: ARMORED.....	3
CHASSIS TRAILER: GP 3 1/2 TON 2 WHEEL W/E.....	2
CHASSIS TRAILER: GENERATOR 2 1/2 TON 2 WHEEL W/E.....	1
KITCHEN FIELD TRAILER MOUNTED: MTD ON M103A3 TRAILER.....	4
RECOVERY VEHICLE FULL TRACKED: MEDIUM.....	6
SEMITRAILER LOW BED: BREAKBULK/CONT TRANSPORTER.....	13
SEMITRAILER LOW BED: HEAVY EQUIPMENT AND TRANSPORTER.....	3
SEMITRAILER STAKE: 12 TON 4 WHEEL W/E.....	9
SEMITRAILER TANK: 5000 GAL FUEL DISPENSING.....	18
SEMITRAILER VAN: REPAIR PARTS STORAGE 6 TON 4 WHL W/E.....	1
SEMITRAILER VAN: SUPPLY 12 TON 4 WHL W/E.....	9
TRUCK LIFTFORK: DEL DRVN 10,000 LB CAP ROUGH TERRAIN.....	8
TRUCK AMBULANCE: 1-1/4 TON 6X6 W/E.....	12
TRUCK CARGO: TACTICAL 1-1/4 TON 4X4 W/E.....	10
TRUCK CARGO: TACTICAL 1-1/4 TON 4X4 W/50 AMP-COMM KITS W/E.....	26
TRUCK CARGO: TACTICAL 1-1/4 TON 4X4 W/50 AMP-COMM SHELTER KIT W/E.....	4
TRUCK CARGO: TACTICAL 1-1/4 TON 4X4 W/100 AMP-COMM SHELTER KIT W/E.....	2
TRUCK CARGO: 1-1/4 TON 6X6 W/E.....	2
TRUCK CARGO: 2-1/2 TON 6X6 W/E.....	21
TRUCK CARGO: DROP SIDE 2-1/2 TON 6X6 W/E.....	11
TRUCK CARGO: 2-1/2 TON 6X6 W/WINCH W/E.....	5
TRUCK CARGO: DROP SIDE 2-1/2 TON 6X6 W/WINCH W/E.....	1
TRUCK CARGO: 2-1/2 TON 6X6 LWB W/E.....	11
TRUCK CARGO: DROP SIDE 5 TON 6X6 W/E.....	23

TRUCK CARGO: DROP SIDE 5 TON 6X6 W/WINCH W/E.....	4
TRUCK MEND PLATFORM: 1000 LB CAP.....	2
TRUCK MEND PLATFORM: 2500 LB CAP WOOD.....	2
TRUCK LIFT FORK: DEL DRVN 6000 LB CAP ROUGH TERRAIN.....	1
TRUCK LIFT FORK: DEL DRVN 10,000 LB CAP ROUGH TERRAIN.....	1
TRUCK LIFT FORK: LIMITED ROUGH TERRAIN 4000 LB.....	1
TRUCK TRACTOR: 5 TON 6X6 W/E.....	49
TRUCK TRACTOR: 5 TON 6X6 W/WINCH W/E.....	2
TRUCK TRACTOR WRECKER: 5 TON 6X6 W/WINCH W/E.....	1
TRUCK UTILITY: 1/4 TON 4X4 W/E.....	32
TRUCK TRACTOR: HET 22 1/2 TON 8X8 W/DUAL MIDSHIP WINCH.....	3
TRUCK VAN: EXPANSIBLE 5 TON 6X6 (ARMY).....	3
TRUCK VAN: SHOP 2-1/2 TON 6X6 W/E.....	13
TRUCK WRECKER: 5 TON 6X6 W/WINCH W/E.....	5
WELDING SHOP TRAILER MOUNTED: OXY-ACETYLENE/ELECT STICK.....	1

NBC EQUIPMENT

ALARM CHEMICAL AGENT AUTOMATIC: PTBL MANPACK.....	5
ALARM CHEMICAL AGENT AUTOMATIC: PTBL FIXED EMPLACEMENT.....	9
ALARM CHEMICAL AGENT AUTOMATIC: PTBL F/TRK 1/4 TON.....	1
ALARM CHEMICAL AGENT AUTOMATIC: PTBL W/PWR SUP F/TRK 1/4 TON.....	4
ALARM UNIT CHEMICAL AGENT AUTOMATIC ALARM.....	2
CHARGER RADIAC DETECTOR: PP-1578/PD.....	7
MASK CBR: HEAD/SHOULDER PROTECTIVE.....	40
MASK CBR: PROTECTIVE FIELD.....	618
RADIAC SET: AN/PDR-27.....	7
RADIAC METER: IM-9/PD.....	2
RADIAC METER: IM-93/UD.....	18
RADIAC METER: IM-174/PD.....	9
RADIAC SET: AN/VDR-1.....	11
CHARGER RADIAC DETECTOR: PP-4370/PD.....	2
MASK-CHEMICAL-BIOLOGICAL.....	432
RADIAC METER: IM-185/UD.....	23

SUPPORT SQUADRON ARMORED CAVALRY REGIMENT CORPS 86

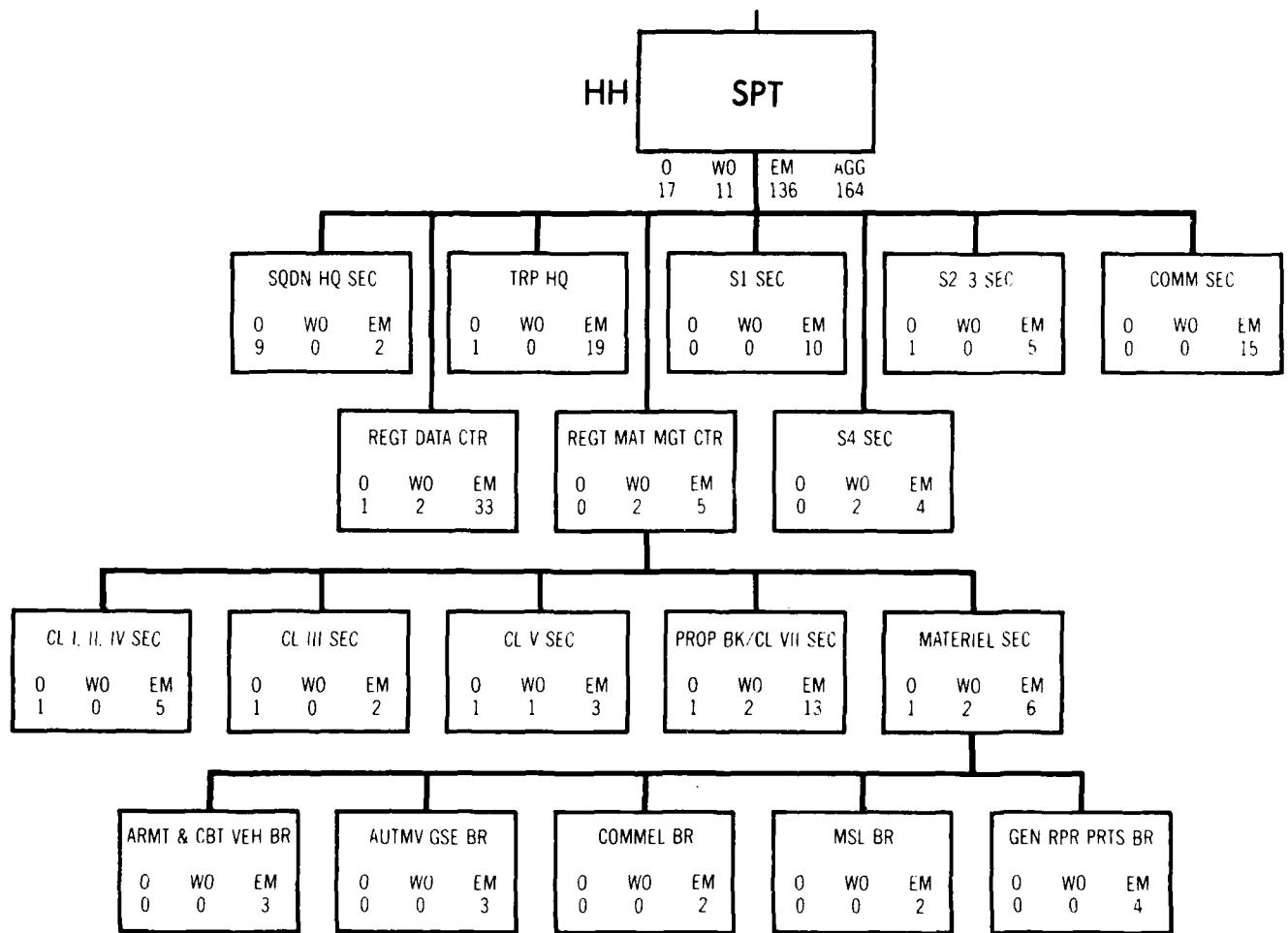

SUMMARY OF EQUIPMENT

WEAPONS		NBC EQUIPMENT	
BAY NET-KNIFE: W/STANDARD FOR M16A1 RIFLE.....	164	ALARM CHEMICAL AGENT AUTOMATIC: PTBL MANPACK.....	3
LAUNCHER GRENADE 40MM: ONE SHOT RIFLE MTD DOUBLE W/E.....	2	CHARGER RADIAC DETECTOR: PP-1578/PD.....	2
MACHINE GUN 7.62MM: LIGHT FLEXIBLE.....	4	MASK ORG: PROTECTIVE FIELD.....	164
PISTOL CALIBER .45 AUTOMATIC.....	6	RADIAC SET: AN/PDR-27.....	1
RIFLE 5.56MM: W/E.....	159	RADIAC METER: IM-93 AD.....	1
		RADIAC METER: IM-174/PD.....	1
VEHICLES			
TRAILER CARGO: 1/4 TON 2 WHEEL W/E.....	9		
TRAILER CARGO: 3/4 TON 2 WHEEL W/E.....	8		
TRAILER CARGO: 1-1/2 TON 2 WHEEL W/E.....	2		
TRAILER TANK: WATER 400 GALLON 1-1/2 TON 2 WHEEL W/E.....	1		
TRUCK CARGO: TACTICAL 1-1/4 TON 4X4 W/E.....	4		
TRUCK CARGO: TACTICAL 1-1/4 TON 4X4 W/50 AMP-COMM KIT W/E.....	6		
TRUCK CARGO: TACTICAL 1-1/4 TON 4X4 W/100 AMP-COMM SHELTER KIT W/E.....	1		
TRUCK CARGO: 2-1/2 TON 6X6 W/E.....	2		
TRUCK CARGO: 2-1/2 TON 6X6 W/MINCH W/E.....	1		
TRUCK TRACTOR: 5 TON 6X6 W/E.....	2		
TRUCK UTILITY: 1/4 TON 4X4 W/E.....	9		
TRUCK VAN: SHOP 2 1-2 TON 6X6 W/E.....	2		
TRUCK VAN: EXPENSIBLE 5 TON 6X6 (ARMY).....	1		
		MISCELLANEOUS EQUIPMENT	
		MOBILE MAINTENANCE SHOP FACILITY.....	1
		RADIO SET: AN/GRC-126.....	1
		RADIO SET: AN/GRC-160.....	1
		RADIO SET: AN/VRC-46.....	12
		RADIO TELETYPEWRITER SET: AN/GRC-142.....	1
		STORAGE FACILITY MOBILE.....	1
		RADIO SET CONTROL GROUP: AN/GRA-39.....	9
		RECEIVER-TRANSMITTER CONTROL GROUP: AN/GRA-6.....	1
		RECORDER-REPRODUCER SOUND SET: AN/UNH-10.....	2

609

HEADQUARTERS, HEADQUARTERS TROOP SUPPORT SQUADRON ARMORED CAVALRY REGIMENT CORPS 86

PS

0 WO EM AGG
18 4 117 139

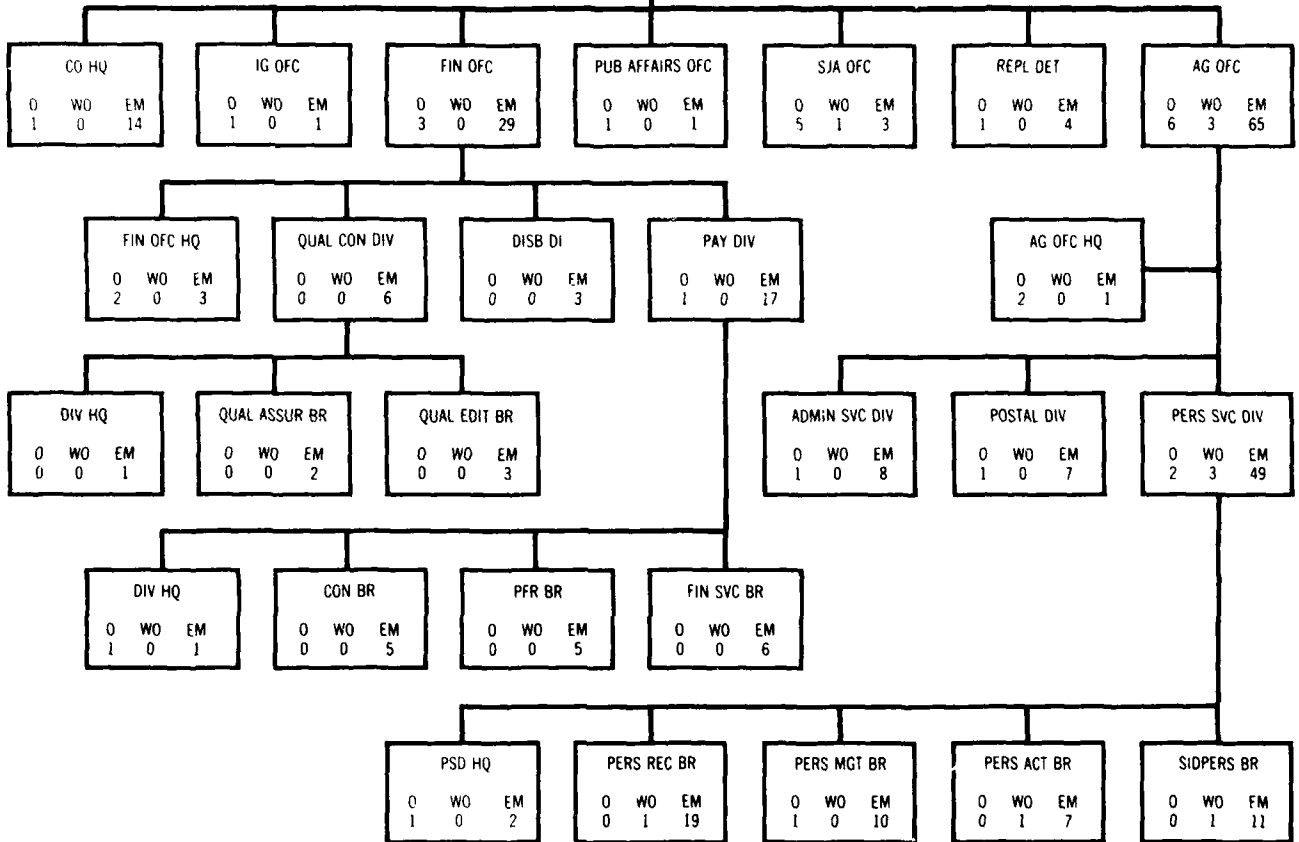

SUMMARY OF EQUIPMENT

WEAPONS

BAYONET-KNIFE: W/SCABBARD FOR M16A1 RIFLE.....	138
LAUNCHER GRENADE 40MM: SGL SHOT RIFLE MTD DITCHBLE W/E.....	5
MACHINE GUN 7.62MM: LIGHT FLEXIBLE.....	4
PISTOL CALIBER: .45 AUTOMATIC.....	12
RIFLE 5.56MM: W/E.....	126

VEHICLES

KITCHEN FIELD TRAILER MOUNTED: MTD ON M103A3 TRAILER.....	1
TRAILER CARGO: 1/4 TON 2 WHEEL W/E.....	7
TRAILER TANK: WATER 400 GALLON 1-1/2 TON 2 WHEEL W/E.....	1
TRUCK CARGO: TACTICAL 1-1/4 TON 4X4 W/E.....	2
TRUCK CARGO: 2 1/2 TON 6X6 W/E.....	1
TRUCK UTILITY: 1/4 TON 4X4 W/E.....	7
TRUCK VAN: EXPENSIBLE 5 TON 6X6 (ARMY).....	1
TRUCK VAN: SHOP 2-1/2 TON 6X6 W/E.....	1

NBC EQUIPMENT

ALARM CHEMICAL AGENT AUTOMATIC: PTBL FIXED EMPLACEMENT.....	2
CHARGER RADIAC DETECTOR: PP-1578/PD.....	1
MASK CBR: PROTECTIVE FIELD.....	138
RADIAC SET: AN/PDR-27.....	1
RADIACMETER: IM-93/UD.....	2
RADIACMETER: IM-174/PD.....	1

MISCELLANEOUS EQUIPMENT

CAMERA SET STILL PICTURE: K5-19.....	1
CAMERA SET STILL PICTURE: K5-99.....	1
DRAFTING EQUIPMENT SET BATTALION.....	1
DUPLICATING MACHINE OFFSET PROCESS.....	1
DUPLICATING MACHINE STENCIL PROCESS.....	2
CARD PUNCH MACHINE: ADP.....	1
DATA CONVERTER: ADPE ANALOG TO DIGITAL ETC.....	1
DISPLAY EQUIPMENT: ADPE.....	1
SORTER CARD: ADPE.....	1

ADMINISTRATIVE COMPANY SUPPORT SQUADRON ARMORED CAVALRY REGIMENT

COMPANY HQ	
1 PVT COMPANY COMMANDER.....	11
1 SGT FIRST SERGEANT.....	
1 SGT SECOND SERGEANT.....	
1 SGT THIRD SERGEANT.....	
1 SGT ADMINISTRATIVE SUPERVISOR.....	GL
1 SGT PAY SP.....	GL
1 SGT QUALITY ASSURANCE SP.....	GL
1 SGT QUALITY EDITING BRANCH.....	GL
1 SGT SENIOR PAY SP.....	GL
1 SGT PAY SP.....	GL
1 SGT DISBURSING DIVISION.....	GL
1 SGT PAY DIVISION.....	GL
1 SGT CONTROL BRANCH.....	GL
1 SGT PFR BRANCH.....	GL
1 SGT FINANCIAL SERVICES BRANCH.....	GL
1 SGT ADJUTANT GENERAL OFFICE.....	GL
1 SGT ADMINISTRATIVE SERVICES DIVISION.....	GL
INSPECTOR GENERAL OFFICE	
1 SGT INSPECTOR GENERAL.....	11
1 SGT ADMINISTRATIVE SUPERVISOR.....	
TRAILER CARGO: 1/4 TON 2 WHEEL W/E.....	1
TRUCK UTILITY: 1/4 TON 4X4 W/E.....	1
STAFF LEGAL ADVOCATE OFFICE	
1 SGT STAFF LEGAL ADVOCATE.....	11
1 SGT ASSISTANT STAFF LEGAL ADVOCATE.....	
1 SGT LEGAL RESPONSE TRAINING.....	
1 SGT LEGAL ADMINISTRATIVE TRAINING.....	
1 SGT LEGAL CLERK.....	
1 SGT CLERK TYPIST.....	
1 SGT CLERK.....	
TRAILER CARGO: 1/4 TON 2 WHEEL W/E.....	1
TRUCK UTILITY: 1/4 TON 4X4 W/E.....	1
PUBLIC AFFAIRS OFFICE	
1 PVT PUBLIC AFFAIRS OFFICER.....	
1 SGT PUBLIC AFFAIRS SUPERVISOR.....	
TRAILER CARGO: 1/4 TON 2 WHEEL W/E.....	1
TRUCK UTILITY: 1/4 TON 4X4 W/E.....	1
FINANCE OFFICE	
1 MAJ FINANCE OFFICER.....	11
1 PVT SENIORITY FINANCIAL OFFICER.....	11
1 SGT FINANCIAL ADMINISTRATIVE SUPERVISOR.....	
1 SGT FINANCIAL OPERATIONS SUPERVISOR.....	
1 SGT CLERK TYPIST.....	
1 SGT CLERK.....	
TRAILER CARGO: 1/4 TON 2 WHEEL W/E.....	1
TRUCK UTILITY: 1/4 TON 4X4 W/E.....	1

QUALITY CONTROL DIVISION	
1 SGT DIVISION CHIEF.....	
QUALITY ASSURANCE BRANCH	
1 SGT QUALITY ASSURANCE SGT.....	
1 SGT QUALITY ASSURANCE SP.....	
QUALITY EDITING BRANCH	
1 SGT SENIOR PAY SP.....	
1 SGT PAY SP.....	
1 SGT PAY SP.....	
DISBURSING DIVISION	
1 SGT DISBURSING ACCOUNTANT.....	
1 SGT CASHIER.....	11
1 SGT DISBURSING SP.....	11
PAY DIVISION	
1 LT MILITARY PAY OFFICER.....	
1 SGT PAY DIVISION CHIEF.....	
CONTROL BRANCH	
1 SGT BRANCH CHIEF.....	
1 SGT SENIOR PAY SP.....	
2 SGT PAY SP.....	
1 PFC PAY SP.....	
PFR BRANCH	
1 SGT BRANCH CHIEF.....	
1 SGT PAY SP.....	
2 SGT PAY SP.....	
1 SGT PAY SP.....	
1 PFC PAY SP.....	
FINANCIAL SERVICES BRANCH	
1 SGT BRANCH CHIEF.....	
1 SGT PAY SP.....	
1 SGT TRAVEL SP.....	
1 SGT PAY SP.....	
1 PFC PAY SP.....	
ADJUTANT GENERAL OFFICE	
1 MAJ ADJUTANT GENERAL.....	11
1 PVT EXECUTIVE OFFICER.....	
1 SGT CLERK TYPIST.....	
1 SGT CLERK.....	
TRUCK CARGO: TYPICAL 1-1/4 TON 4X4 W/E.....	1
ADMINISTRATIVE SERVICES DIVISION	
1 LT ADMINISTRATIVE SERVICES OFFICER.....	
1 SGT ADMINISTRATIVE SUPERVISOR.....	
1 SGT ADMINISTRATIVE SP.....	
2 SGT CLERK TYPIST.....	
1 SGT CLERK TYPIST.....	
1 SGT PERFORMING ARTS SP.....	
1 SGT PHYSICAL ACTIVITIES SP.....	

POSTAL DIVISION	
1 LT POSTAL OFFICER.....	
1 SGT POSTAL OFFICER.....	
1 SGT SENIOR CLERK.....	
1 SGT SENIOR CLERK.....	
1 SGT POSTAL CLERK.....	
1 SGT POSTAL CLERK.....	
TRUCK VAN: TYPICAL 1/4 TON 4X4 W/E.....	1
PERSONNEL DIVISION	
1 LT PERSONNEL OFFICER.....	
1 SGT PERSONNEL OFFICER.....	
1 SGT CLERK TYPIST.....	
1 SGT CLERK TYPIST.....	
PERSONNEL MANAGEMENT BRANCH	
1 SGT UNIT PERSONNEL TRAINING.....	
1 SGT PERSONNEL MANAGEMENT SUPERVISOR.....	
1 SGT SENIOR PERSONNEL MANAGEMENT SP.....	
1 SGT PERSONNEL MANAGEMENT SP.....	
1 PFC PERSONNEL MANAGEMENT SP.....	
PERSONNEL MANAGEMENT BRANCH	
1 LT PERSONNEL MANAGEMENT OFFICER.....	
1 SGT PERSONNEL MANAGEMENT SUPERVISOR.....	
1 SGT SENIOR PERSONNEL MANAGEMENT SP.....	
1 SGT PERSONNEL MANAGEMENT SP.....	
1 PFC PERSONNEL MANAGEMENT SP.....	
PERSONNEL ATTENTION BRANCH	
1 SGT UNIT PERSONNEL TRAINING.....	
1 SGT PERSONNEL ATTENTION SUPERVISOR.....	
1 SGT SENIOR PERSONNEL ATTENTION SP.....	
1 SGT PERSONNEL ATTENTION SP.....	
1 PFC PERSONNEL ATTENTION SP.....	
GENERAL INSTRUMENTS BRANCH	
1 SGT UNIT PERSONNEL TRAINING.....	
1 SGT DATA PROCESSING OFFICER.....	
1 SGT ADMINISTRATIVE SP.....	
2 SGT DATA ANALYST SP.....	
1 SGT CLERK TYPIST.....	
1 SGT CLERK TYPIST.....	
2 SGT DATA ANALYST TYPIST.....	
1 SGT TRANSLATOR EQUIPMENT SPECIALIST.....	
1 PFC CLERK TYPIST.....	
1 PFC DATA ANALYST SP.....	
TRUCK CARGO: 1/4 TON 2 WHEEL W/E.....	1
TRUCK UTILITY: 1/4 TON 4X4 W/E.....	1
TRUCK VAN: EXPANSIBLE 1/4 TON 4X4 W/E.....	1
REPLACEMENT MANAGEMENT	
1 LT COMMANDER.....	
1 SGT DATA TYPIST SERGEANT.....	
1 PFC TYPIST.....	
1 SGT UNIT CLERK.....	
1 SGT SUPPLY SP.....	
1 SGT SUPPLY SP.....	
TRAILER CARGO: 1/4 TON 2 WHEEL W/E.....	1
TRUCK UTILITY: 1/4 TON 4X4 W/E.....	1

**ADMINISTRATIVE COMPANY
SUPPORT SQUADRON
ARMORED CAVALRY REGIMENT CORPS 86**

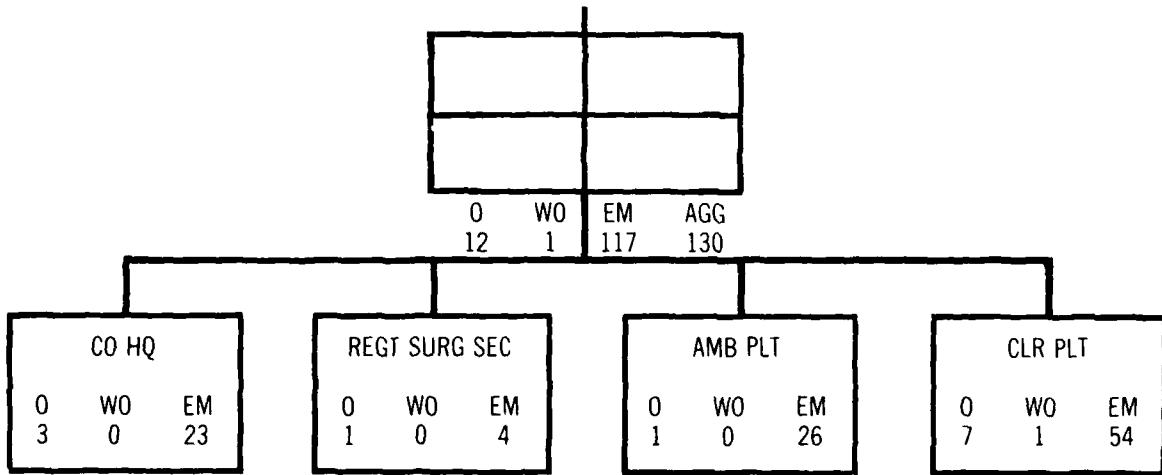

SUMMARY OF EQUIPMENT

WEAPONS			
PISTOL CALIBER .45 AUTOMATIC.....	9	MASK CBR: HEADWOUND PROTECTIVE.....	40
RIFLE 5.56MM: W/E.....	114	MASK CBR: PROTECTIVE FIELD.....	123
VEHICLES		RADIAC SET: AN/PDR-27.....	2
KITCHEN FIELD TRAILER MOUNTED: MTD ON M103A3 TRAILER.....	1	RADIACMETER: IM-93/PD.....	2
TRAILER CARGO: 1-1/2 TON 2 WHEEL W/E.....	6	RADIACMETER: IM-93/UD.....	5
TRAILER CARGO: 1-1/2 TON 2 WHEEL W/E.....	6	RADIACMETER: IM-174/PD.....	1
TRAILER TANK: W/TAR 100 GALLON 1-1/2 TON 2 WHEEL W/E.....	2	SHELTER SYSTEM COLLECT PROTECT: CHEMICAL-BIOLOGICAL 10 MEN.....	2
TRUCK AMBULANCE: 1-1/4 TON 6X6 W/E.....	12	MISCELLANEOUS EQUIPMENT	
TRUCK CARGO: 1-1/4 TON 6X6 W/E.....	1	CHEST MEDICAL INSTRUMENT AND SUPPLY SET.....	1
TRUCK CARGO: 2-1/2 TON 6X6 W/E.....	7	DENTAL EQUIPMENT SET GENERAL DENTISTRY FIELD.....	1
TRUCK CARGO: 2-1/2 TON 6X6 W/WINCH W/S.....	1	ENTOMOLOGICAL COLLECTING KIT FIELD.....	1
TRUCK UTILITY: 1/4 TON 4X4 W/E.....	6	MEDICAL EQUIPMENT SET CLEARING STATION.....	1
NBC EQUIPMENT		MEDICAL EQUIPMENT SET PHYSICAL EXAMINATION.....	1
ALARM CHEMICAL AGENT AUTOMATIC: PTBL FIXED EMPLACEMENT.....	3	REFRIGERATOR MECH BIOLOGICAL: WHOLE BLD PTBL.....	1
ALARM CHEMICAL AGENT AUTOMATIC: PTBL P/TRK 1/4 TON.....	1	RESUSCITATOR-ASPIRATOR: INTERMITTENT POSITIVE PRESS.....	12
ALARM UNIT CHEMICAL AGENT: AUTOMATIC.....	1	STERILIZER SURGICAL DRESSING.....	2
CHARGER RADIAC DETECTOR: PP-1574/PD.....	2	SURGICAL INSTRUMENT AND SUPPLY SET FLT SURGEON.....	1
		SURGICAL INSTRUMENT AND SUPPLY SET HOSPITAL WARD.....	2
		SURGICAL INSTRUMENT AND SUPPLY SET INDIVIDUAL.....	32

617

MEDICAL COMPANY SUPPORT SQUADRON ARMORED CAVALRY REGIMENT CORPS 86

COMPANY HQ

1 MAJ COMPANY CDR..... 11
 1 CPT EXECUTIVE OFFICER.....
 1 LT HEALTH SERVICE MATERIAL OFFICER.....
 1 SGT FIRST SERGEANT.....
 1 SPC FOOD SERVICE SERGEANT.....
 1 SSG MEDICAL SUPPLY SERGEANT.....
 1 SSG MAINTENANCE/RECOVERY SUPERVISOR.....
 1 SSG SUPPLY SERGEANT.....
 1 SSG FIRST COOK.....
 1 SSG BIOMEDICAL EQUIPMENT SP ADV.....
 1 SGT COOK.....
 1 SP4 ARMORER.....
 1 SP4 CLERK TYPIST.....
 2 SP4 COOK.....
 1 SP4 EQUIPMENT RECORDS & PARTS SP.....
 1 SGT LT W VEH/POWER GENERATOR MECHANIC.....
 1 SP4 MEDICAL SUPPLY SPECIALIST.....
 2 SP4 LT W VEH/POWER GENERATOR MECHANIC.....
 1 PFC GENERAL CLERK.....
 1 PFC LT W VEH/POWER GENERATOR MECHANIC.....
 2 PFC COOK.....
 2 SGT NBC NCO.....
 TRAILER CARGO: 1/4 TON 2 WHEEL W/E..... 3
 TRAILER CARGO: 1-1/2 TON 2 WHEEL W/E..... 3
 TRAILER TANK: WATER 400 GAL 1-1/2 TON 2 WHEEL W/E..... 1
 TRUCK CARGO: 1-1/4 TON 6X6 W/E..... 1
 TRUCK CARGO: 2-1/2 TON 6X6 W/E..... 3
 TRUCK CARGO: 2-1/2 TON 6X6 W/WINCH W/E..... 1
 TRUCK UTILITY: 1/4 TON 4X4 W/E..... 3

816

RESUMEVICAL SURGEON SECTION

1 CPT PWMT MEDICAL OFFICER..... 11
 1 SFC MEDICAL NCO.....
 1 SP4 PATIENT ADMINISTRATIVE SP.....
 1 SGT ENVIRONMENTAL HEALTH SP.....
 1 SP4 ENVIRONMENTAL HEALTH SP.....
 TRAILER CARGO: 1/4 TON 2 WHEEL W/E..... 1
 TRUCK UTILITY: 1/4 TON 4X4 W/E..... 1

AMBULANCE PLATOON

1 LT PLATOON LEADER.....
 1 SPC PLATOON SERGEANT.....
 3 SGT SENIOR MEDICAL AIDE.....
 21 SP4 AMBULANCE DRIVER.....
 1 PFC VEHICLE DRIVER.....
 TRAILER CARGO: 1/4 TON 2 WHEEL W/E..... 1
 TRUCK AMBULANCE: 1-1/4 TON 6X6 W/E..... 12
 TRUCK UTILITY: 1/4 TON 4X4 W/E..... 1

CLEARING PLATOON

1 MAJ PLATOON COMMANDER..... 11
 1 MAJ INTERNIST..... 11
 1 CPT DENTAL OFFICER..... 11
 3 CPT GENERAL MEDICAL OFFICER..... 11
 1 LT FIELD MEDICAL ASSISTANT.....
 1 SPC PLATOON SERGEANT.....
 1 SPC WARDMASTER.....
 2 SSG SECTION SERGEANT.....
 1 SSG PRACTICAL NURSE.....
 2 SGT PATIENT CARE SP.....
 1 SGT DENTAL ASSISTANT.....
 1 SP4 MEDICAL LAB SP.....
 1 SGT OPERATING ROOM SP.....
 1 SGT PHARMACY SP.....
 4 SGT MEDICAL AIDE.....
 1 SGT BEHAVIORAL SCIENTIST SP.....
 1 SGT X-RAY SP.....
 1 SP4 DENTAL ASSISTANT.....
 5 SP4 MEDICAL AIDE.....
 1 PFC MEDICAL LAB SP.....
 1 SP4 PATIENT ADMINISTRATIVE SP.....
 4 SP4 LITTER BEARER.....
 4 PFC VEHICLE DRIVER.....
 12 PFC LITTER BEARER.....
 2 SP4 PATIENT CARE.....
 3 PFC MEDICAL AIDE.....
 1 PFC PATIENT CARE SP.....
 1 SP4 TAC WIRE OPERATIONS SP.....
 2 PFC RADIO OPERATOR.....
 1 WO PHYSICIAN ASSISTANT.....
 TRAILER CARGO: 1/4 TON 2 WHEEL W/E..... 1
 TRAILER CARGO: 1-1/2 TON 2 WHEEL W/E..... 3
 TRAILER TANK: WATER 400 GAL 1-1/2 TON 2 WHL W/E..... 1
 TRUCK CARGO: 2-1/2 TON 6X6 W/E..... 4
 TRUCK UTILITY: 1/4 TON 4X4 W/E..... 1

MEDICAL COMPANY
 SUPPORT SQUADRON
 ARMORED CAVALRY REGIMENT
 CORPS 86

620

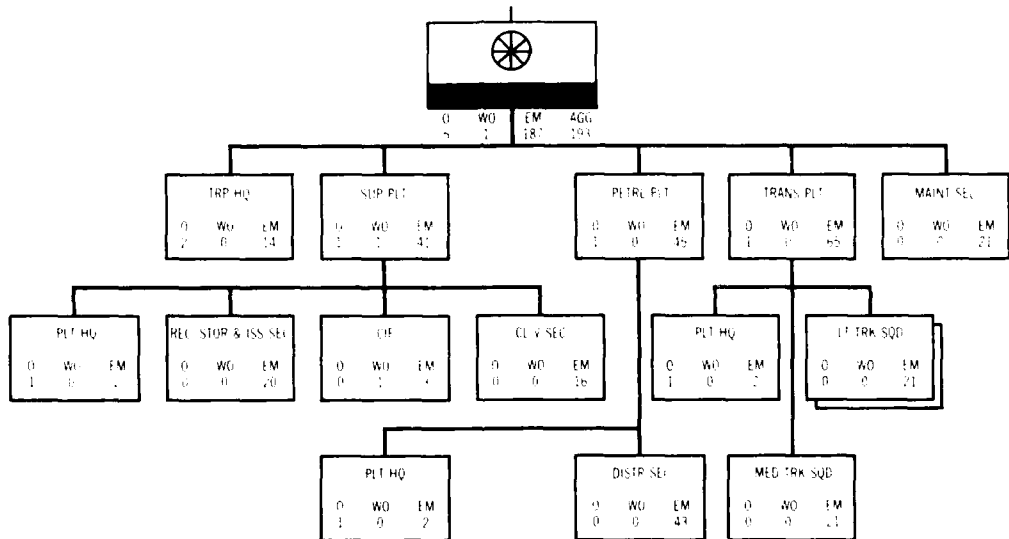

SUMMARY OF EQUIPMENT

WEAPONS	
BAYONET-KNIFE: W/SCABBARD FOR M16A1 RIFLE.....	193
LAUNCHER GRENADE 40MM: SGL SHOT RIFLE MTD DITCHBLE W/E.....	6
MACHINE GUN CALIBER .50 MB FLEXIBLE FOR GRD USE.....	4
MACHINE GUN 7.62MM: LIGHT FLEXIBLE.....	8
PISTOL CALIBER .45 AUTOMATIC.....	1
RIFLE 5.56MM: W/E.....	192
VEHICLES	
SEMITRAILER LOW BED.....	10
SEMITRAILER TANK: 5000 GAL FUEL DISPENSING.....	18
TRUCK LIFT FORK: DSL DRVN 1000 LB CAP ROUGH TERRAIN.....	8
TRAILER CARGO: 1/4 TON 2 WHEEL W/E.....	3
TRAILER CARGO: 3/4 TON 2 WHEEL W/E.....	2
TRAILER CARGO 1-1/2 TON 2 WHEEL W/E.....	5
TRAILER TANK WATER: 400 GALLON 1-1/2.....	1
TRUCK CARGO: TACTICAL 1-1/4 TON 4X4 W/E.....	1
TRUCK CARGO: TACTICAL 1-1/4 TON 4X4 W/50 AMP-COMM KITS W/E.....	2
TRUCK CARGO: TACTICAL 2-1/2 TON 6X6 W/E.....	4
TRUCK CARGO: TACTICAL DROPSIDE 5 TON 6X6 W/E.....	22
TRUCK CARGO: TACTICAL DROPSIDE 5 TON 6X6 W/WINCH W/E.....	2
TRUCK LIFT FORK: LIMITED ROUGH TERRAIN 4000 LB.....	1
TRUCK TRACTOR: 5 TON 6X6 W/E.....	28
TRUCK TRACTOR WRECKER: 5 TON 6X6 W/WINCH W/E.....	1
TRUCK UTILITY: 1/4 TON 4X4 W/E.....	3
NBC EQUIPMENT	
ALARM CHEMICAL AGENT AUTOMATIC PTBL FIXED EMPLACEMENT.....	4
CHARGER RADIAC DETECTOR: PP-1579/PD.....	2
MASK CBR: PROTECTIVE FIELD.....	193
RADIAC SET: AN/PDR-27.....	3
RADIAC METER: IM-93/UD.....	10
RADIAC METER: IM-174/PD.....	6
MISCELLANEOUS EQUIPMENT	
NIGHT VISION GOGGLES: AN/PVS-5.....	50
RADIO SET: AN/GRC-160.....	5
RADIO SET: AN/PRC-77.....	2
RADIO SET: AN/VRC-46.....	6
RADIO SET: CONTROL GROUP: AN/GRA-39.....	5

S & T TROOP SUPPORT SQUADRON ARMORED CAVALRY REGIMENT

Notes: _____

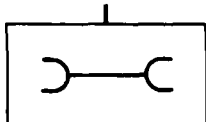

0	WO	EM	AGG
11	9	412	432

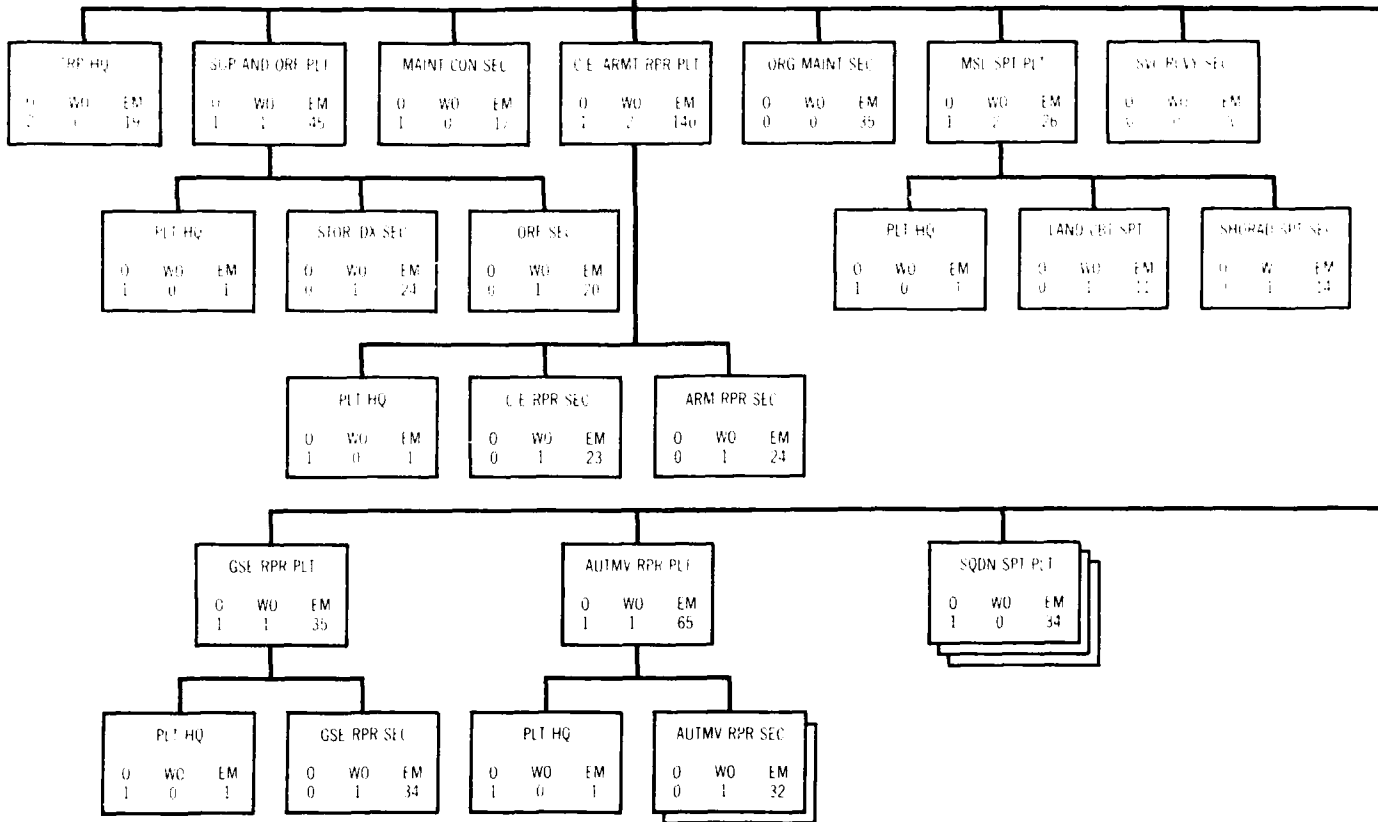

024

SUMMARY OF EQUIPMENT

WEAPONS

BAYONET-KNIFE W/SCABBARD FOR M16A1 RIFLE.....	432
LAUNCHER GRENADE 40MM: SGL SHOT RIFLE MTD DTORBLE W/E.....	13
LAUNCHER GRENADE SMOKE: SCREENING RED PHOSPHORUS M239.....	6
MACHINE GUN CALIBER .50: HB FLEXIBLE FOR GROUND USE.....	19
PISTOL CALIBER .45 AUTOMATIC.....	19
MACHINE GUN 7.62MM: LIGHT FLEXIBLE.....	4
RIFLE 5.56MM: W/E.....	413
SUBMACHINE GUN CALIBER .45.....	12

VEHICLES

CARRIER PERSONNEL FULL TRACKED: ARMORED.....	3
CHASSIS TRAILER: GP 3-1/2 TON 2 WHEEL W/E.....	2
CHASSIS TRAILER: GENERATOR 2-1/2 TON 2 WHEEL W/E.....	1
KITCHEN FIELD TRAILER MOUNTED: MTD ON M103A3 TRAILER.....	2
RECOVERY VEHICLE FULL TRACKED: MEDIUM.....	6
SEMITRAILER LOW BED: BREAKBULK/CONT TRANSPORTER 22-1/2 TON.....	3
SEMITRAILER LOW BED: HEAVY EQUIP TRANSPORTER 60 TON.....	3
SEMITRAILER STAKE: 12 TON 4 WHEEL W/E.....	9
SEMITRAILER VAN: REPAIR PARTS STORAGE 6 TON 4 WHL W/E.....	1
SEMITRAILER VAN: SUPPLY 12 TON 4 WHL W/E.....	8
TRAILER CARGO: 1/4 TON 2 WHEEL W/E.....	7
TRAILER CARGO: 3/4 TON 2 WHEEL W/E.....	3
TRAILER CARGO: 1-1/2 TON 2 WHEEL W/E.....	18
TRAILER CARGO: WATER 400 GAL 1-1/2 TON 2 WHEEL W/E.....	1
TRUCK CARGO: TACTICAL 1-1/4 TON 4X4 W/E.....	3
TRUCK CARGO: TACTICAL 1-1/4 TON 4X4 W/50 AMP-COMM KITS W/E.....	18
TRUCK CARGO: TACTICAL 1-1/4 TON 4X4 W/100 AMP-COMM SHELTER KIT W/E.....	4

TRUCK CARGO: TACTICAL 1-1/4 TON 4X4 W/100 AMP-COMM SHELTER KIT W/E.....	1
TRUCK CARGO: 1-1/4 TON 6X6 W/E.....	1
TRUCK CARGO: 2-1/2 TON 6X6 W/E.....	1
TRUCK CARGO: DROP SIDE 2-1/2 TON 6X6 W/E.....	1
TRUCK CARGO: 2-1/2 TON 6X6 W/WINCH W/E.....	1
TRUCK CARGO: DROP SIDE 2-1/2 TON 6X6 W/WINCH W/E.....	1
TRUCK CARGO: 2-1/2 TON 6X6 XLWB W/E.....	1
TRUCK CARGO: DROP SIDE 5 TON 6X6 W/E.....	1
TRUCK CARGO: DROP SIDE 5 TON 6X6 W/WINCH W/E.....	1
TRUCK LIFT FORK: DSL DRVN 6000 LB CAP ROUGH TERRAIN.....	1
TRUCK LIFT FORK: DSL DRVN 10,000 LB CAP ROUGH TERRAIN.....	1
TRUCK TRACTOR: 5 TON 6X6 W/E.....	19
TRUCK TRACTOR: 5 TON 6X6 W/WINCH W/E.....	2
TRUCK UTILITY: 1/4 TON 4X4 W/E.....	1
TRUCK TRACTOR: HET 22-1/2 TON 9X8 W/DUAL MIDSHIP.....	1
TRUCK VAN: EXPENSIBLE 5 TON 6X6 (ARMY).....	1
TRUCK VAN: SHOP 2-1/2 TON 6X6 W/E.....	19
TRUCK WRECKER: 5 TON 6X6 W/WINCH W/E.....	1
WELDING SHOP TRAILER MOUNTED: OXY-ACETYLENE/ELECT.....	1
RECOVERY VEHICLE FULL TRACKED: MEDIUM.....	6

NBC EQUIPMENT

ALARM CHEMICAL AGENT AUTOMATIC: PTBL MANPACK.....	1
ALARM CHEMICAL AGENT AUTOMATIC: PTBL W/PWR SUP F/TRK 1/4 TON.....	4
RADIAC SET: AN/VOR-1.....	11
MASK CHEMICAL-BIOLOGICAL.....	132
RADIACMETER: IM-195/JD.....	23

MAINTENANCE TROOP SUPPORT SQUADRON ARMORED CAVALRY REGIMENT

SUPPLY AND REE PLATOON	
1 LT	PLATOON LEADER.....
1 SFC	PLATOON SERGEANT.....

STORAGE/DM SECTION	
1 WO	SUPPORT SUPPLY TECHNICIAN.....
1 SSG	MATERIEL STORAGE AND HANDLING SUPERVISOR.....
1 SGT	DM CONTROL CLERK.....
2 SGT	HEAVY VEHICLE DRIVER.....
1 SP4	DM CONTROL CLERK.....
4 SP4	HEAVY VEHICLE DRIVER.....
1 SP4	I/O CLERK.....
1 SP4	MATERIEL CONTROL AND ACCOUNTING SP.....
4 SP4	MATERIEL STORAGE AND HANDLING SP.....
1 SP4	PACKING-CRATING SP.....
1 SP4	SHOP CLERK.....
1 PFC	DM CONTROL CLERK.....
1 PFC	HIGH PRIORITY CLERK.....
1 PFC	I/O CLERK.....
3 PFC	MATERIEL STORAGE AND HANDLING SP.....
1 PFC	PACKING-CRATING SP.....

SEMITRAILER TRAKE	12 TON 4 WHEEL W/E.....	3
SEMITRAILER VAN	SUPPLY 12 TON 4 WHEEL W/E.....	9
TRUCK CARGO	DROPSIDE 2-1/2 TON 6X6 WINCH W/E.....	7
TRUCK HAND PLATFORM	1000 LB CAP.....	1
TRUCK HAND PLATFORM	2500 LB CAP WOOD.....	3
TRUCK LIFT FORK	DSL DRW 6000LB CAP ROUGH TERRAIN.....	1
TRUCK LIFT FORK	DSL DRW 10000 LB CAP ROUGH TERRAIN.....	1
TRUCK TRACTOR	5 TON 6X6 W/E.....	16

REP SECTION		
1 WO	AUTOMOTIVE REPAIR TECHNICIAN.....	
1 SFC	MAINTENANCE SERGEANT.....	
2 SGT	WVEN/POWER GENERATOR MECHANIC.....	
1 SGT	TRACKED VEHICLE MECHANIC.....	
1 SP4	EQUIPMENT MAINTENANCE/PL CLERK.....	
3 SP4	LT WVEN/POWER GENERATOR MECHANIC.....	
1 SP4	TACTICAL COMM SYSTEM SP.....	
1 SP4	TANK TURRET MECHANIC.....	
2 SP4	TRACKED VEHICLE MECHANIC.....	
3 PFC	WVEN/POWER GENERATOR REPAIRMAN.....	
3 PFC	TRACKED VEHICLE MECHANIC.....	
1 PFC	CONSTRUCTION EQUIPMENT MECHANIC.....	
1 PFC	DM CHEMICAL EQUIPMENT REPRESENTATIVE.....	
TRAILER CARGO	TARP 1-1/2 TON 2 WHEEL W/E.....	1
TRUCK CARGO	DROPSIDE 2-1/2 TON 6X6 W/E.....	2

ORGANIZATIONAL MAINTENANCE SECTION		
1 SFC	MOTOR SERGEANT.....	
6 SSG	LT WVEN/POWER GENERATOR MECHANIC.....	
1 SGT	TRACK VEHICLE MECHANIC.....	
1 SGT	EQUIPMENT MAINTENANCE CLERK.....	
1 SP4	CONSTRUCTION EQUIPMENT MECHANIC.....	
1 SP4	EQUIPMENT MAINTENANCE CLERK.....	
7 SP4	LT WVEN/POWER GENERATOR MECHANIC.....	
1 SP4	UTILITIES EQUIPMENT MECHANIC.....	
9 PFC	LT WVEN/POWER GENERATOR MECHANIC.....	
4 PFC	FILL CLERK.....	
1 PFC	TRACK VEHICLE MECHANIC.....	
1 SGT	HEAVY WHEELED VEHICLE MECHANIC.....	
1 SP4	HEAVY WHEELED VEHICLE MECHANIC.....	
1 PFC	CONSTRUCTION EQUIPMENT MECHANIC.....	
1 PFC	HEAVY WHEELED VEHICLE MECHANIC.....	
1 PFC	UTILITIES EQUIPMENT MECHANIC.....	
TRAILER CARGO	1-1/2 TON 2 WHEEL W/E.....	2
TRUCK CARGO	TACTICAL 1-1/4 TON 4X4 W/E.....	1
TRUCK CARGO	2-1/2 TON 6X6 W/E.....	1
TRUCK CARGO	2-1/2 TON 6X6 W/MINCH W/E.....	1

3 SQUADRON SUPPORT PLATOONS		
3 LT	PLATOON LEADER.....	
3 SFC	AUTOMOTIVE REPAIRMAN EMM.....	
3 SGT	TANK TURRET REPAIRMAN.....	
6 SGT	TRACK VEHICLE REPAIRMAN.....	
3 SGT	WHEELED VEHICLE REPAIRMAN.....	
3 SP4	MATERIEL CONTROL AND ACCOUNTING SP.....	
3 SP4	RECOVERY VEHICLE OPERATOR.....	
6 SP4	TANK TURRET REPAIRMAN.....	
9 SP4	TRACK VEHICLE REPAIRMAN.....	
3 SP4	WHEELED VEHICLE REPAIRMAN.....	
3 PFC	RECOVERY VEHICLE OPERATOR.....	
6 PFC	TANK TURRET REPAIRMAN.....	
18 PFC	TRACK VEHICLE REPAIRMAN.....	
3 PFC	WHEELED VEHICLE REPAIRER.....	
3 SGT	FIELD RADIO REPAIRMAN.....	
3 SP4	FC INSTRUMENT REPAIRMAN.....	
3 SP4	SMALL ARMS REPAIRMAN.....	
3 SP4	RECOVERY VEHICLE OPERATOR.....	
3 PFC	FIELD RADIO REPAIRMAN.....	
3 SGT	POWER GENERATOR EQUIPMENT REPAIRMAN.....	
3 SP4	ARTILLERY REPAIRMAN.....	
3 SP4	FC COMPUTER REPAIRMAN.....	
3 PFC	POWER GENERATOR EQUIPMENT REPAIRMAN.....	
3 SSG	AUTOMOTIVE REPAIRMAN SUPERVISOR.....	
3 SSG	TANK TURRET REPAIRMAN SUPERVISOR.....	
CORNER PERSONNEL FULL TRACKED	ARMORED.....	3
INSTRUMENT REPAIR SHOP TRUCK	2-1/2 TON 6X6 W/E.....	3
RECOVERY VEHICLE FULL TRACKED	MEDIUM.....	3
TRAILER CARGO	1/4 TON 2 WHEEL W/E.....	3
TRAILER CARGO	1-1/2 TON 2 WHEEL W/E.....	3
TRUCK CARGO	DRIP SHOE 5 TON 6X6 WINCH W/E.....	3
TRUCK UTILITY	1/4 TON 4X4 W/E.....	3
TRUCK WRECKER	5 TON 6X6 W/MINCH W/E.....	3

MAINTENANCE TROOP (Continued)
SUPPORT SQUADRON
ARMORED CAVALRY REGIMENT
CORPS 86

627

CHAPTER 10
TABLES

TABLE 1
AUTHORIZED TOE EQUIPMENT
TANK PLATOON

PLATOON HEADQUARTERS, No. 1 Tank

2 alarm OML agent M8
4 bayonet-knife w/scabbard for M16A1 rifle
1 binocular: modular construction mil scale reticle 7x50-mm w/e
3 cable telephone: wd-1/TT DR-8 1,320 feet
1 launcher grenade tank mtd M239
1 machinegun cal .50 M85
1 machinegun 7.62-mm fixed
4 mask: protective tank
1 night vision goggles AN/PVS-5
4 pistol caliber .45 automatic
1 radiometer IM-93/UD
1 radiometer IM-174/PD
1 radio set: AN/VRC-12 mounted in tank combat full track 105-mm gun
1 radio set control group AN/GRA-39
1 reeling machine cable hand RL-39
1 searchlight infrared AN/VSS-3
2 submachinegun caliber .45
1 tank combat full track 105-mm gun
1 telephone set TA-1/PT

No. 2 Tank

4 bayonet-knife w/scabbard for M16A1 rifle
1 binocular: modular construction mil scale reticle 7x50-mm w/e
1 launcher grenade tank mtd M239
1 machinegun cal .50 M85
1 machinegun 7.62-mm fixed
4 mask: protective tank
1 night vision goggles AN/PVS-5
4 pistol caliber .45 automatic
1 radio set: AN/VRC-64 mounted in tank combat full track 105-mm gun
1 searchlight infrared AN/VSS-3
2 submachinegun caliber .45
1 tank combat full track 105-mm gun

No. 3 Tank

4 bayonet-knife w/scabbard for M16A1 rifle
1 binocular: modular construction mil scale reticle 7x50-mm w/e
1 launcher grenade tank mtd M239
1 machinegun cal .50 M85
1 machinegun 7.62-mm fixed
4 mask: protective tank
1 night vision goggles AN/PVS-5
4 pistol caliber .45 automatic
1 radio set: AN/VRC-64 mounted in tank combat full track 105-mm gun
1 searchlight infrared AN/VSS-3
2 submachinegun caliber .45
1 tank combat full track 105-mm gun

No. 4 Tank

4 bayonet-knife w/scabbard for M16A1 rifle
1 binocular: modular construction mil scale reticle 7x50-mm w/e
1 launcher grenade tank mtd M239
1 machinegun cal .50 M85
1 machinegun 7.62-mm fixed
4 mask: protective tank
1 night vision goggles AN/PVS-5
4 pistol caliber .45 automatic
1 radiometer IM-93/UD
1 radio set: AN/VRC-12 mounted in tank combat full track 105-mm gun
1 searchlight infrared AN/VSS-3
2 submachinegun caliber .45
1 tank combat full track 105-mm gun

No. 5 Tank

4 bayonet-knife w/scabbard for M16A1 rifle
1 binocular: modular construction mil scale reticle 7x50-mm w/e
1 launcher grenade tank mtd M239
1 machinegun cal .50 M85
1 machinegun 7.62-mm fixed
4 mask: protective tank
1 night vision goggles AN/PVS-5
4 pistol caliber .45 automatic
1 radio set: AN/VRC-64 mounted in tank combat full track 105-mm gun
1 searchlight infrared AN/VSS-3
2 submachinegun caliber .45
1 tank combat full track 105-mm gun

TABLE I (continued)
AUTHORIZED TOE EQUIPMENT
ARMORED CAVALRY PLATOON
(TOE 17-307H)

PLATOON HEADQUARTERS

1 alarm OML agent M-14
4 bayonet-knife w/scabbard for M16A1 rifle
1 binocular: modular construction mil scale reticle 7x50-mm w/e
2 cable telephone: WD-1/TT DR-8 1320 feet
1 carrier personnel full track armored
1 machinegun cal .50 HB flex
1 machinegun 7.62-mm light flex
4 mask: protective tank
1 mount tripod machinegun 7.62-mm
2 night vision goggles AN/PVS-5
1 night vision sight crew-served weapon AN/TVS-5
1 night vision sight tripod mounted AN/TVS-4
1 pistol caliber .45 automatic
1 radio set AN/PRC-77
1 radio set: AN/VRC-12 mounted in carrier personnel FTA
1 radio set control group AN/GRA-39
1 reel equipment CE-11
3 rifle 5.56-mm w/e
1 telephone set TA-312/PT
1 telescope straight military

SCOUT SECTION

2 alarm OML agent M-14
2 antenna AT-784/PRC
4 binocular: modular construction mil scale reticle 7x50-mm w/e
4 cable telephone: WD-1/TT DR-8 1320 feet
2 carrier guided missile equipment: less weapon (TOV)
2 carrier personnel full track armored
2 demolition set explosive: initiating nonelectric
1 detecting set mine: ptbl metallic and nonmetallic AN/PRS-7
2 detecting set mine: ptbl metallic AN/PSS-11
4 launcher grenade M203
2 launcher tubular guided missile: (TOV)

TOE 17-307H

4 machinegun 7.62-mm light flexible
8 mask: protective tank
12 mask CBR: protective field
2 mount tripod machinegun cal .50
3 night vision goggles AN/PVS-5
4 night vision sight crew-served weapon AN/TVS-5
4 night vision sight individual-served weapon AN/PVS-4
2 radiacmeter IM-93/UD
4 radiacmeter IM-174/PD
4 radio set AN/PRC-77
2 radio set: AN/VRC-46 mounted in carrier personnel FTA
2 radio set: AN/VRC-64 mounted in carrier personnel FTA
2 range finder fire control: w/e (laser)
4 reel equipment CE-11
20 rifle 5.56-mm w/e
2 telescope straight military
2 tracker infrared guided missile SU-35: (Dragon)

TANK SECTION

4 binocular: modular construction mil scale reticle 7x50-mm w/e
1 cable telephone: WD-1/TT DR-8 1320 feet
4 launcher grenade tank mtd M239
4 machinegun cal .50 fixed M85
4 machinegun 7.62-mm fixed
12 mask: protective tank
4 night vision goggles AN/PVS-5
1 radio set: AN/VRC-12 mounted in tank combat full track 105-mm gun
3 radio set: AN/VRC-64 mounted in tank combat full track 105-mm gun
1 radio set control group AN/GRA-39
1 reel equipment CE-11
16 pistol caliber .45 automatic
4 searchlight infrared AN/VSS-3
8 submachinegun caliber .45
4 tank combat full track: 105-mm gun

TABLE I (continued)
 AUTHORIZED TOE EQUIPMENT
 ARMORED CAVALRY PLATOON
 (TOE 17-107H)

PLATOON HEADQUARTERS

- 2 bayonet-knife w/scabbard for M16A1 rifle
- 1 binocular: modular construction mil scale reticle 7x50-mm w/e
- 4 cable telephone: WD-1/TT DR-8 1320 feet
- 1 carrier personnel full track armored
- 1 machinegun cal .50 HB flex
- 2 mask: protective tank
- 1 night vision goggles AN/PVS-5
- 1 night vision sight crew-served weapon AN/TVS-5
- 1 night vision sight tripod-mounted AN/TVS-4
- 1 pistol caliber .45 automatic
- 1 radio set: AN/VRC-12 mounted in carrier personnel PTA
- 1 radio set control group AN/GRA-39
- 1 reeling machine cable hand RL-39
- 1 rifle 5.56-mm w/e
- 2 telephone set TA-1/PPT
- 1 telescope straight military

Scout Section

- 2 alarm OML agent M-14
- 2 antenna AT-79A/PRC
- 12 bayonet-knife w/scabbard for M16A1 rifle
- 4 binocular: modular construction mil scale reticle 7x50-mm w/e
- 4 carrier personnel full track armored
- 4 launcher grenade M203
- 4 machinegun cal .50 HB flex
- 4 machinegun 7.62-mm light flexible
- 12 mask: protective tank
- 9 night vision goggles AN/PVS-5
- 4 night vision sight crew-served weapon AN/TVS-5
- 4 night vision sight individual-served weapons AN/PVS-4
- 4 pistol caliber .45 automatic
- 2 radiometer IM-93/UD
- 1 radiometer IM-174/PD
- 2 radio set: AN/VRC-160 mounted in carrier personnel PTA
- 2 radio set: AN/VRC-45 mounted in carrier personnel PTA
- 3 rifle 5.56-mm w/e
- 2 telescope straight military

Light Armor Section

- 3 armored reconnaissance/airborne assault vehicle
- 12 bayonet-knife w/scabbard for M16A1 rifle
- 3 binocular: modular construction mil scale reticle 7x50-mm w/e
- 1 machinegun cal .50 HB flex
- 1 machinegun 7.62-mm fixed
- 12 mask: protective tank
- 3 night vision goggles AN/PVS-5
- 3 night vision sight crew-served weapon AN/TVS-5
- 12 pistol caliber .45 automatic
- 1 radiometer IM-93/UD
- 1 radio set: AN/VRC-12 mounted in arm'd recon/abn aslt veh
- 2 radio set: AN/VRC-54 mounted in arm'd recon/abn aslt veh
- 1 searchlight infrared AN/VIS-3
- 6 submachinegun caliber .45

Rifle Squad

- 1 antenna AT-784/PRC
- 11 bayonet-knife w/scabbard for M16A1 rifle
- 1 binocular: modular construction mil scale reticle 7x50-mm w/e
- 2 bipod rifle: 5.56-mm w/carrying case f/M16A1 rifle
- 1 cable telephone: WD-1/TT DR-8, 1320 feet
- 1 carrier personnel full track armored
- 1 demolition set explosive: initiating nonelectric
- 1 detecting set mine: ptbl metallic and nonmetallic AN/PRC-7
- 1 detecting set mine: ptbl metallic AN/PSS-11
- 2 launcher grenade M203
- 1 launcher rocket 56-mm 4-tube M202
- 1 machinegun cal .50 HB flex
- 1 machinegun 7.62-mm light flexible
- 2 mask: protective tank
- 9 mask CBR: protective field
- 1 mount tripod machinegun 7.62-mm
- 2 night vision goggles AN/PVS-5
- 1 night vision sight crew-served weapon AN/TVS-5
- 2 night vision sight individual-served weapon AN/PVS-4
- 1 pistol caliber .45 automatic
- 1 radiometer IM-93/UD
- 1 radio set AN/PRC-77
- 1 radio set AN/VRC-64 mounted in carrier personnel PTA
- 1 reel equipment CE-11
- 10 rifle 5.56-mm w/e
- 1 viewer infrared AN/PVS-7

Mortar Squad

- 5 bayonet-knife w/scabbard for M16A1 rifle
- 1 binocular: modular construction mil scale reticle 7x50-mm w/e
- 1 carrier 4.2-inch mortar: self-propelled (less mortar)
- 1 compass unmounted magnetic: mil graduations
- 1 machinegun cal .50 HB flex
- 2 mask: protective tank
- 3 mask CBR: protective field
- 1 mortar 4.2-inch: on mount
- 1 night vision goggles AN/PVS-5
- 1 night vision sight crew-served weapon AN/TVS-5
- 3 pistol caliber .45 automatic
- 1 plotting board indirect-fire: azimuth
- 1 radiometer IM-93/UD
- 1 radio set: AN/VRC-64 mounted in carrier 4.2-inch mortar SP
- 1 range fixer fire control: w/e (laser)
- 2 rifle 5.56-mm w/e

TOE 17-107H

TABLE 1 (continued)
 AUTHORIZED TOE EQUIPMENT
 SCOUT PLATOON
 (TOE 17-39R)

PLATOON HEADQUARTERS

- 2 bayonet-knife w/scabbard for M16A1 rifle
- 1 binocular: modular construction mil scale retical 7x50-mm w/e
- 1 cable telephone: WD-1/TT DR-8 1320 feet
- 1 carrier personnel full track armored
- 1 demolition set explosive: initiating nonelectric
- 1 launcher grenade M203
- 1 machinegun cal .50 HB flex
- 2 mask: protective tank
- 1 mask CBR: protective field
- 1 mount tripod for cal .50 machinegun
- 2 night vision goggles AN/PVS-5
- 1 night vision sight crew-served weapon AN/TVS-5
- 1 night vision sight tripod mounted AN/TVS-4
- 1 pistol caliber .45 automatic
- 1 radiometer IM-93/UD
- 1 radiometer IM-174/PD
- 1 radio set: AN/PRC-77
- 1 radio set: AN/VRC-12 mounted in carrier personnel PTA
- 1 rangefinder fire control (LASER)
- 1 reel equipment CE-11
- 2 rifle 5.56-mm w/e
- 1 speech scty equipment TSEC/KY-38
- 1 telephone set TA-312/PT
- 1 telescope straight military

TOE 17-39R (020P79)

(3) SCOUT SECTION

- 2 alarm OML agent M-14
- 2 antenna AT-784/PRC
- 9 bayonet-knife w/scabbard for M16A1 rifle
- 2 binocular: modular construction mil scale reticle 7x50-mm w/e
- 2 cable telephone: WD-1/TT DR-P 1320 feet
- 1 carrier personnel full track armored
- 1 combat vehicle anti-tank (ITV)
- 1 launcher grenade M203
- 1 launcher tubular guided missile (TGM)
- 1 machinegun cal .50 HB flex
- 2 machinegun 7.62mm light
- 4 mask: protective tank
- 3 mask CBR: protection field
- 1 mount tripod for cal .50 mg
- 4 night vision goggles AN/PVS-5
- 1 night vision sight crew-served weapon AN/TVS-5
- 2 night vision sight individual-served weapon AN/PVS-4
- 2 pistol caliber .45 automatic
- 2 radiometer IM-93/UD
- 1 radiometer IM-174/PD
- 2 radio set: AN/PRC-77
- *1 radio set: AN/VRC-46 mounted in carrier personnel PTA
- 1 radio set: AN/VRC-64 mounted in combat vehicle antitank (ITV)
- 1 rangefinder fire control (LASER)
- 2 reel equipment CE-11
- 7 rifle 5.56-mm w/e
- 2 telescope straight military
- **1 viewer infrared AN/PAS-7

*PSC gets AN/VRC-47 in lieu of AN/VRC-46
 **only two sections equipped with AN/PAS-7

TABLE 2
CHARACTERISTICS OF ILLUMINATION MEANS

TYPE	RANGE	RATE OF DESCENT	BURNING TIME	CONTINUOUS ILLUMINATION	DIAMETER OF ILLUMINATED AREA ¹
ARTILLERY/MORTAR FLARES					
81mm/M301A3	3,300m	6m/sec	60 sec	2 rd/min	1,200m
4.2-in/M335A2	5,500m	5m/sec	90 sec	2 rd/min	1,500m
105mm how/M314A1E2	8,500m	35 ft/sec	60 sec	2 rd/min	1,000m
155mm how/M118	11,600m	35 ft/sec	60 sec	2 rd/min	1,000m
155mm how/M485	14,000m	15 ft/sec	120 sec	1 rd/min	2,000m
AIRCRAFT FLARES ^{1&2}					
MK 45	Rg of Acft	7.5 ft/sec	180 to 210 sec	20 rd/hr	750m
M8A1	Rg of Acft	8.0 ft/sec	165 to 195 sec	27 rd/hr	700m
MK 24	Rg of Acft	7.5 ft/sec	150 to 180 sec	40 rd/hr	750m
TYPE	RANGE IR	RANGE VISIBLE SPREAD/FOCUSED	CANDLEPOWER	OPERATIONAL LIMITATIONS	
XENON SEARCHLIGHTS					
15 inch (AN/VSS-3)	1000m/1500m	1500m	75 million	Limited penetration of fog and smoke.	
23 inch (AN/VSS-1)	1000m	1500m	100 million	Limited penetration of fog and smoke.	
30 inch	10,000m/7500m	10,000/15,000m	400-1000 million	Weight, noise, terrain, mobility, limited penetration of fog and smoke.	

¹Artillery and aircraft flares are vulnerable to changes in wind directions and velocity. Diameter of illuminated area will be reduced by rain, fog, dust, and smoke.

²Aircraft flares are less accurate than artillery flares. Vulnerability of delivery means must be considered in planning.

TABLE 3
CHARACTERISTICS OF TANK AND LIGHT ARMOR VEHICLE WEAPONS

Weapons	Ammunition Stowage			Type Ammunition (Standard)	Maximum Open Direct Fire Range	Secondary Armament	Primary Sighting Equipment	Firing Table
	76-mm 65(a)	Cal .50 630	Cal .30 5,000					
76-mm Gun Tank M41 Series	76-mm 65(a)	Cal .50 630	Cal .30 5,000	AP-T HEAT-T HE-T WP-T TP-T Cannister HVAP-T	AP-T 2,000m HEAT-T 2,000m HE-T WP-T 4,400m Cannister 274m	M2--Cal .50 M37--Cal .30	M41-M20 Periscope	FT 76-1-1
90-mm Gun Tank M48A2 M48A2C M48A3 M48A1	90-mm 64 64 62 60	Cal .50 1,365 1,365 600	Cal .30 5,950 5,950 5,900 (7.62-mm)	HEAT-T HE-T WP-T TP-T Cannister AP-T HVAP-T	HEAT-T 2,000m HE-T WP-T 3,000m Cannister=274m	M2--Cal .50 (Mod) M37--Cal .30 M48A3 has M219--7.62-mm	M48A2-M31 Periscope M48A2C-M31 Periscope M48A3-M32 Periscope M48A1-M20 Periscope	FT 90-N-2 FT 90-L-1
105-mm Gun Tank M60 M60A1 M60A3 M48A5	105-mm 57 63 63 54	Cal .50 900 900 900	7.62-mm 5,950 5,950 5,950 5,400	APDS-T HEAT-T HEP-T APFSDS-T TP-T WP-T APERS-T	APDS-T 4,400m HEAT-T 4,400m HEP-T 4,400m APDS-T 4,640m HEAT-T=4,640m HEP-T=4,640m	M60 mount: M240--7.62-mm M85--Cal .50 M239--Grenade Launcher M48A5 mounts: M240--7.62-mm M2HB--Cal .50 M60D Loader	M60-M32 Periscope M60A1-M32 Periscope M60A3-M35E1 Periscope M48A5-M32 Periscope	FT 105-A-3 FT 105-A-3 FT 105-A-3
152-mm Gun Tank M60A2	152-mm 46 Msl-Conv 13 33	Cal .50 1,080	7.62-mm 5,500	MISSILE HEAT-MP TP-T Cannister	MSL-3,000m(c) HEAT-MP=2,900m(b) TP-T=2,900m(b) Can=400m	M219--7.62-mm M85--Cal .50 M226--Grenade Launcher	M50 Periscope	FT 152-B-1
AR/AAV M551	152-mm 29 Msl-Conv 9 20	Cal .50 1,000	7.62-mm 3,000	MISSILE TP-T Cannister HEAT-MP	MSL-3,000m(c) TP-T=3,000m Can=400m HEAT-MP=3,000m	M219--7.62-mm M2--Cal .50 Flex M176--Grenade Launcher	M127A1 Telescope	FT 152-A-1
165-mm Gun Engr Combat Veh M728	165-mm 30	Cal .50 728	7.62-mm 3,600	HEP-T	HEP-T=1,000m	M85--Cal .50 M219--7.62-mm M239--Grenade Launcher	M105F Telescope	FT 165-A-1

*Range at which a target hit can be obtained using BOT.
(a) 57 rounds on original M41.
(b) Reticle drive motor stops at 2900 meters on M50 periscope.
(c) 3000 meters stationary target. A moving target using evasive action 2500 meters.

TABLE 4. CHARACTERISTICS OF VEHICLES

NOMENCLATURE	Gross Vehicle Weight	Height inches	Width inches	Length inches	Crew	Fuel	Max Speed mph	Cruising Range Miles	Fording w/o kit inches	Fording Depth w/ kit inches	Vehicle Obstacle inches	Span inches	Fuel Capacities Gal	Fuel Consumption MPG
Armd Recon Abn Ault Veh M551	36,000	116	110	248	4	Diesel	43	373		Unlimited	33	84	158	2.4
Carrier Cargo 6 Ton M548	28,330	106	106	227	7	Diesel	38	300		Unlimited	24	66	100	2.9
Carrier Comd Post M577A1	24,390	101	105.3 4	191.1 2	5	Diesel	40	300		Unlimited	24	66	120	3.4
Carrier Mortar 81 mm M125A1	24,527	86.1 2	106	191.1 2	6	Diesel	40	300		Unlimited	24	66	95	3.2
Carrier Mortar 4.2 Inch M106A1	26,147	86.1 2	112.3 4	194	6	Diesel	40	300		Unlimited	24	66	95	3.5
Carrier Personnel FT M113	22,615	79.1 2	105.3 4	191.1 2	1	Gas	40	200		Unlimited	24	66	80	2.5
Carrier Personnel FT M113A1	24,238	86.1 2	106	191.1 2	1	Diesel	40	300		Unlimited	24	66	95	3.2
Launcher for AV19 M60A1 Tank Chassis	83,000	124.1 2	144	340.1 2	2	Diesel	30	310	48	None	36	102	375	1.3
Tk Combat 90 mm M48A1	104,000	123.5 16	143	270.1 2	4	Gas	26	135	48	96	36	102	200	7
Tk Combat 90 mm M48A2	105,000	121.5 8	143	292.3 4	4	Gas	30	160	48	96	36	102	335	5
Tk Combat 90 mm M48A2C	99,000	121.1 2	143	292.3 4	4	Gas	30	160	48	96	36	102	335	35
Tk Combat 90 mm M48A3	104,000	123	143	292.3 4	4	Diesel	30	288	48	96	36	102	375	8
Tk Combat 105 mm M48A5	108,000	129.1 2	143	325	4	Diesel	30	310	48	96	36	102	385	8
Tk Combat 105 mm M60	102,000	126.1 5	143	320	4	Diesel	30	310	48	162	36	102	385	88
Tk Combat 105 mm M60A1	106,000	128.23	143	325	4	Diesel	30	310	48	162	36	102	375	88
Tk Combat 105 mm M60A3	113,200	129.17	143	325	4	Diesel	32	310	48	162	36	102	385	88
Tk Combat M1	118,000	93.5	143.8	353.2	4	Diesel	45	275	48	93	49	105	507.2	
Tr Ammo 1 1/2 Ton M332	2,750	18.1 4	95.7 8	148										
Tr Amphib Cargo 1/2 Ton M416	57	42	60.1 2	108.1 2										
Tr Cargo 1 1/2 Ton M105A1	2,650	98	83	166										
Tr Tank Water 400 Gal M149	2,500	76.1 2	82.1 4	161										
Trk Amb 1 1/2 Ton M718	3,560	74.3	71.2	43.2	1	Gas	65	300	21	60			17.7	19.1
Trk Amb 1 1/2 Ton M792	10,200	90.4 5	84	226.3 5	1	Diesel	55	400	30	Unlimited	18		40	10
Trk Cargo 1 1/2 Ton M561	10,200	90.4 5	84	226.3 5	1	Diesel	55	400	30	Unlimited	18		40	10
Trk Cargo 1 1/2 Ton M715	3,300	55	85	220.3 4	1	Gas	60	225	30	60			28	7.9
Trk Cargo 2 1/2 Ton M35A2 w/ winch	13,400	114.11 16	96	264.1 4	1	Multi	56	300	30	72			50	6
Trk Cargo 2 1/2 Ton M35A2 w/ winch	13,900	114.11 16	96	278.1 2	1	Multi	56	300	30	72			50	6
Trk Cargo 5 Ton 6x6 M54A2 w/ winch	20,535	116	97	314.1 4	1	Multi	54	400	30	78			78	5.1
Trk Cargo 5 Ton 8x8 M656	36,150	129	95.5	278	1	Multi	50	300		Unlimited			133	3.4
Trk Cargo 8 Ton 4x4 M520	40,780	134	108	384	2	Diesel	30	300		Unlimited	33		110	2.72
Trk Tank Fuel Servicing 2500 Gal 4x4 M55V	45,470	134	108	391	2	Diesel	30	300		Unlimited	33			
Trk Utility 1 1/2 Ton M151 Series	3,070	71	64	132	1	Gas	65	300	21	60			17.7	19.1
Trk Wrecker 5 Ton 6x6 M816	48,529	114	97.8	356	2	Diesel	52	400	30	78			133	4.5
Trk Wrecker 10 Ton 4x4 M553	47,300	124	108	401	2	Diesel	30	300		Unlimited	33		110	2.72
Vehicle Combat Engineer M728	115,000	128.1 5	146	350.4 5	4	Diesel	30	280	48	162	30	99	375	88
Vehicle Light Recovery M578	54,000	130.1 2	124	250.1 4	3	Diesel	37	450	42	None	40	93	320	1.4
Vehicle Medium Recovery M88A1	112,000	123	135	325.5	4	Diesel	26	300	56	102	42	103	400	

*Net Weight

634

AD-A115 857

ARMY ARMOR SCHOOL FORT KNOX KY

F/G 19/3

US ARMY ARMOR REFERENCE DATA IN THREE VOLUMES. VOLUME III. DIVI--ETC(U)

1981

UNCLASSIFIED

ST-17-1-1-VOL-3

SBI-AD-F250 004

NL

3-3

4/1/82



END
DATE
FILED
7 82
DTIC

TABLE 5. CHARACTERISTICS OF INDIVIDUAL AND CREW-SERVED WEAPONS

WEAPONS	Unloaded Weight (Approximate in Pounds)	Type of Feed	Method of Operation	*Sustained Rate of Fire (Rds Per Min)	*Maximum Range (In Meters)	*Maximum Effective Range (Meters)	REMARKS
MACHINEGUN, 7.62-MM, M60	23	Belt Metallic Split Link	Gas Operated Automatic	100	3,725	1,100	Maximum effective range limited by gunner's ability to see and adjust on target.
MACHINEGUN, 7.62-MM M73/M219 M240	31/22.2	Belt Metallic Split Link	Recoil with Gas Assist Automatic	100	3,700	900	Tank mounted coaxially with main gun 20-30 round burst method of target engagement.
MACHINEGUN, CAL .50 HB, M2	MG - 84 Tripnd - 44 Total 128	Belt Metallic Split Link	Recoil Semiautomatic and Automatic	40	6,800	725 AA Target; 1,830 Ground Target	
MACHINEGUN, CAL .50 M85	65	Belt Metallic Split Link	Recoil Operated Automatic Dual Rate of Fire	100	6,700	1,600 API-T	Low rate - 400-500 rds per min High rate - 800-950 rds per min
PORTABLE FLAME-TROWER, M2A1-7	42-1/2	Fuel Propelled by Gas Under Pressure	Manual	Continuous Discharge 6-9 Seconds	20 Unthickened Fuel 45 Thickened Fuel	20 Unthickened Fuel 45 Thickened Fuel	Contains 4-1 2 - 4-3 4 gallons of fuel weighing 25 to 29 pounds. To be replaced by M9-7 flamethrower.
M4 INCENDIARY BURSTER	2-1/4		Blasting Cap Fuze or any Standard Firing Device				May be used in any size container. Can be fired electrically or mechanically by fuze, blasting cap or any standard firing device.
M139 20-MM AUTOMATIC GUN	161.3	Metallic Link Belt and Automatic Gun Feeder	Gas and Recoil Blow Back, Automatic and Semi-Automatic	See Remarks	7,200	1,000 Lightly Armored 1,800 Soft Targets HEIT-1,800m TPT-1,800m APIT-1,200m	Weapon has dual rate of fire. Slow rate 200 rpm and fast rate 800-1,050 rpm. Also has 5 modes of fire. 1. Single shot. 2. Slow burst (4-6 rds at slow rate). 3. Fast burst (4-6 rds at fast rate). 4. Slow rate. (Continuous Fire.) 5. Fast rate. (Continuous Fire.)
40-MM GRENADE LAUNCHER M203	9.5 (including M16A1 rifle)	Breech Loading by Hand	Percussion Type Single Shot		400	PT Tgts - 150 Area Tgts - 350	Minimum safe range: Combat: 31 meters Training: 80 meters
66-MM ROCKET LAUNCHER M202A1	11.5	Breech Loading 4-rd (M74 pocket clip)	Semiautomatic		750	PT Tgts-200 Area Tgts-750	Minimum safe range: 20 meters
81-MM MORTAR, M29 WITH BASEPLATE, M3	M53 Sight 5 Barrel 28 Mount 40 Baseplate 25 98	Muzzle Loading by Hand	Drop Fire	8 rounds per minute	4,737	4,737	Ammunition weighs 7-11 pounds. (A).
4.2-IN MORTAR, M30 WITH MOUNT, M24A1	672.25	Muzzle Loading by Hand	Drop Fire	3	5,650	5,650	Ammunition weighs 25-29 pounds. (A).

*Sustained Rate of Fire . . . Rate which weapon can fire indefinitely without seriously overheating.

NOTE: (A) Depending upon type of ammunition used.
*Maximum Greatest distance weapon will fire.
*Maximum Effective Range . . . Greatest distance at which gunner may be expected to fire accurately.

TABLE 5 (continued). CHARACTERISTICS OF INDIVIDUAL AND CREW-SERVED WEAPONS

WEAPON	Unloaded Weight (Approximate - in Pounds)	Type of Feed	Method of Operation	*Sustained Rate of Fire (Rds Per Min)	*Maximum Range (In Meters)	*Maximum Effective Range (Meters)	REMARKS
HAND GRENADES	M26A2 1 M34 1-1/2				40 35	15 35	May be fired as a Rifle Grenade using M1A2 Projection Adapter.
WEAPON ANTIPERSONNEL M18A1	M18A1 3.5 Total Kit 6.5		Controlled Electric Detonation or Uncontrolled Trip Wire Operation		250	50	Check TC 7-3 for backblast effects. When employed in uncontrolled role Claymore must be treated as a mine and its location reported and recorded.
PISTOL, AUTOMATIC CAL .45, M1911A1	2.4	7-rd Magazine	Recoil Semiautomatic		1,500	50	
REVOLVER CALIBER .38	1.4	Cylinder Loaded	Double Action			50	
SUBMACHINE GUN, CAL .45, M3A1	8.15	30-rd Magazine	Blow Back Automatic		1,554	100	
US RIFLE 7.62-MM, M14	9.14	20-rd Magazine	Gas Operated Semiautomatic and Automatic	15 Semiauto- matic 20- Automatic	3,725	460	Full automatic capability requires installation of selector. Sustained rate based on limited tests. Bipod is a major item and used in conjunction with rifle when used as an automatic rifle.
US RIFLE 5.56-MM M16A1	6.5	20-rd Magazine	Gas Operated Semiautomatic and Automatic	12-15	2,653	460	

636

*Sustained Rate of Fire . . . Rate of which weapon can fire indefinitely without seriously overheating.

NOTE: (A) Depending upon type of ammunition used.
 *Maximum Greatest distance weapon will fire.
 *Maximum Effective Range . . . Greatest distance at which gunner may be expected to fire accurately.

TABLE 6
CHARACTERISTICS OF ANTITANK WEAPONS

WEAPON	WEIGHT (APPROXIMATE IN POUNDS)	RATE OF FIRE (PER MINUTE) MAXIMUM-SUSTAINED	MAXIMUM RANGE METERS	EFFECTIVE RANGE METERS
Light Antitank Weapon, 66-mm, M72	5 lbs. complete system	1 rd per launcher	1,000	200—stationary 165—moving
Dragon Medium Antitank Assault Weapon System M47	Round 25 lbs. Tracker 6.75	1 rd per launcher	1,000	1,000
TOW (Tube-launched, optically-tracked, wire-command link missile). Surface attack XBGM 71A. Launcher, tubular guided missile * XM151E2	54.5	3 rd per min indef.	3,000 3,750	3,000 3,750
Mounting kits for:				
XM233 Armored Personnel Carrier	514			
XM232 ¼-ton/ firing vehicle	404			
XM225 ½-ton/ TOW system	114			
XM236 ¼-ton/mis- sile carrier	72.5			

**TABLE 7
CHARACTERISTICS OF MINES**











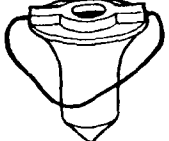
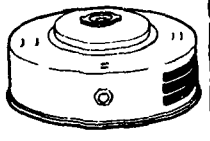
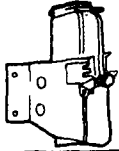

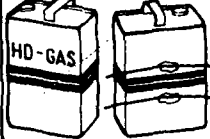
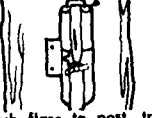
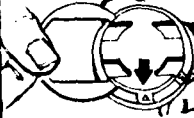
M14 BLAST ANTIPERSONNEL MINE	M25 BLAST ANTIPERSONNEL MINE (ELSIE)	M23 AND M1. 1 GALLON CHEMICAL LANDMINES	M49A1 TRIP FLARE
			
<p>Wt. 3 1/2 oz. Expl. 1 oz. Tetryl Fuze Integral with Belleville Spring Functioning 20 to 35 lb.</p>	<p>Wt. 3 1/2 oz. Expl. 1/2 oz. shaped charge Fuze Integral, with ball release Functioning 17 to 22 lb. press.</p>	<p>When armed for pressure detonation, emplace in same manner as the M15 antitank mine.</p>	<p>Has 55 to 70 sec. surface-burning period and an illumination radius of approximately 330 yds. Initiates by raut or loose trip wire.</p>
 Unscrew shipping plug from bottom of mine. Turn pressure plate to ARMED position with arming tool.	 Push mine into ground. Keep dust cap in place. If ground is hard dig hole with bayonet.	 HD-GAS	 Attach flare to post, tree, etc.
 Remove safety clip & check for malfunctioning.	 Remove dust cap.	<p>Wt. 11 lb. loaded; has an 4-ft. length of detonating cord for burster charge. May be armed for electric or trip wire actuation.</p>	 Attach trip wire to anchor, then to trigger. Pull trigger to vertical position and secure.
 Replace safety clip.	 Insert charge.	<p>Electric firing</p> <p>Attach burster charge — 4 ft. length of detonating cord — to side of mine.</p>	 To Arm: remove safety clip.
 Screw detonator into detonator well.	 Remove safety clip.	<p>Bury mine 4 in. and attach detonating cord to controlled firing system.</p>	 To Disarm: Insert safety pin.
 Bury mine & remove safety clip.	<p>The M25 will penetrate a soldier's boot and foot or puncture a 12 ply tire and tube.</p>	<p>Non-Electric Firing</p> <p>Bury mine as above and attach non electric detonator to burster.</p>	 Check both ends of trip wire, then cut near trigger.
<p>To Bury: Pressure plate should be slightly above ground level. To Disarm: Insert safety clip and remove detonator. Caution: Repeated turning of arming dial may cause excessive wear.</p>	 To Disarm: Replace safety clip and lift charge container from mine.	<p>Warning: SOLDIERS PREPARING LAYING and REMOVING CHEMICAL LAND MINES MUST WEAR PROTECTIVE MASK and PROTECTIVE CLOTHING</p>	<p>Warning: NEVER LOOK DIRECTLY AT BURNING FLARE.</p> <p>Note: For loose trip wire initiation, attach trip wire to eye of safety pin.</p>

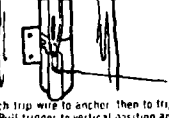
TABLE 7 (continued)
CHARACTERISTICS OF MINES

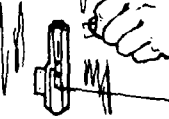



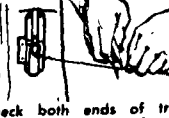





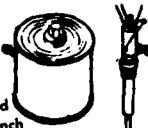

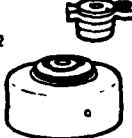

M16 SERIES BOUNDBING ANTIPERSONNEL MINE	M18A1 FRAGMENTATION ANTIPERSONNEL MINE	M15 HEAVY METALLIC ANTITANK MINES
 <p>Issued w/wrench</p>		<p>See FM 20-32</p>  <p>Issued w/wrench</p>
<p>Wt. 8.25 lb Projectile Steel Fuze M605 combination Function Pressure 8 to 20 lb Pull 3 to 8 lb</p> <p>Inspect</p>	<p>Wt. 3.5 lb Expl. 1.5 lb ± 4 Missiles 700 steel balls Equipment 1 electric cap with 100 ft leg wires per mine 1 circuit tester per 6 mines 1 electric firing device per mine Mine-is control fired</p>	<p>M15 Wt. 30 lb Expl. 2.2 lb Fuze M603 Act Wells 2 Functioning 300 to 400 lb press</p> <p>Inspect w/wrench</p>
 <p>Remove shipping plug and install fuze</p>	 <p>Blasting Cap needs to be covered Test Circuit: Mate firing device, circuit tester, and blasting cap. Depress handle; sparks should show in window. Separate test components.</p>	 <p>Inspect Remove plug and inspect fuze well</p>
 <p>Ref FM 7-11B 1/2 for complete procedure Pressure installation</p>	 <p>EYE Peep AIMING Sight Only Kwik Sight see FM 7-11B 50m Position and aim mine</p>	 <p>Inspect fuze and remove safety</p>
 <p>Trip wire installation</p>	 <p>Need to secure firing wire, remove shipping plug — priming adapter and secure cap, reaim.</p>	 <p>Insert fuze</p>
 <p>Attach trip wires — first to anchor, then to pull ring</p>	 <p>16 M Unroll firing wire and connect directly to "Safe" firing device, test set removed.</p>	 <p>Replace plug in safe position</p>
 <p>Remove locking safety first, then positive safety</p>	 <p>Direction of aim 60° Dangerous out to 250 meters 150M 100M Mine</p>	 <p>Bury Turn dial to ARMED</p>
<p>Mine bounds into air and explodes at height of 2.4 ft. Max 27 meters casualty radius. To Disarm: Reverse arming procedure.</p>	<p>Firing Position: Min of 16M to rear in fox hole. Friendly troops at side and rear should be under cover at min of 100M. To Fire: Offset safety ball and depress handle. To Disarm: Reverse arming procedure.</p>	<p>Bury: Pressure plate at ground level or slightly above. To Disarm: Reverse arming procedure.</p>

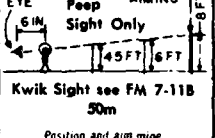
TABLE 7 (continued)
CHARACTERISTICS OF MINES

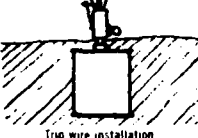

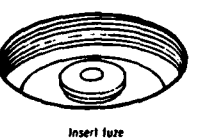
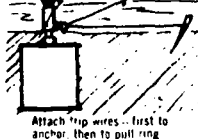
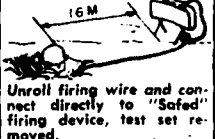

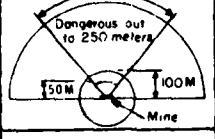

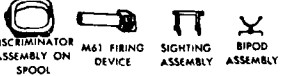
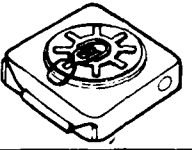
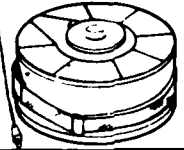

M24 OFF-ROUTE ANTITANK MINE	M19 PLASTIC HEAVY ANTITANK MINE	M21 METALLIC (KILLER) ANTITANK MINE
<p>INSTALLING AND ARMING</p>  <p>DISPENSER POUCH ACCESSORIES POUCH</p>  <p>DISCRIMINATOR ASSEMBLY ON SPOOL M61 FIRING DEVICE SIGHTING ASSEMBLY BIPOD</p> <p>1. Remove above items from accessories pouch. Insert batteries (issued separately) in firing device.</p>	 <p>Wt. ----- 28 lb. Expl. ----- 21 lb. Fuze ----- M606—Integral (with pressure plate) Secondary Fuze Wells --- 2 Functioning 350 to 500 lb. press</p>	 <p>Wt. ----- 18 lb. Expl. ----- 10.5 lb. Fuze ----- M607 Functioning 290 lb. press on ring or 20° deflection of tilt rod.</p>
<p>DISCRIMINATOR LAID ONLY FOR TRACKED VEHICLES</p>  <p>TARGET IMPACT POINT TARGET IMPACT POINT</p> <p>15° ROAD</p> <p>DISCRIMINATOR LAID FOR TRACK AND WHEELED VEHICLES</p> <p>2. Unroll discriminator starting at far side of road (perpendicular to edge for wheeled vehicles; about 15° from perpendicular for tracked vehicles)</p>	 <p>Remove pressure plate fuze.</p>	 <p>Remove closing plug. Insert M 120 booster in bottom. Replace closing plug.</p>
<p>BROWN MARKS DISCRIMINATOR</p>  <p>FIRING DEVICE</p> <p>3. Attach discriminator wire to DETECTOR of firing device (toggle switch on SAFE). Stand on two brown marks on discriminator nearest firing device. If lamp lights, circuit is good; otherwise discard system.</p>	 <p>Remove shipping plug. Inspect position of striker offset. Remove safety fork then turn dial to ARMED. Check position of striker center. Turn to SAFE and replace safety fork.</p>	 <p>Remove closure assembly from fuze.</p>
 <p>ROCKET LAUNCHER DISCRIMINATOR</p> <p>10' TO 100'</p> <p>4. Disconnect discriminator wire from firing device. Remove launcher from dispenser pouch and place in position. Remove packing blocks, push rockets forward to safety band, and remove band. Depress ejection pin and push rocket back into launcher until contact ring is exposed at base. Grounding clip must be connected. Remove tagged shorting clip and push rocket back into launcher. Tape plastic covers over ends of launcher.</p>	 <p>Screw detonator into detonator well.</p> <p>Place mine in hole. Remove safety fork and turn dial to ARMED.</p>	 <p>Remove shipping plug from mine. Screw in fuze then screw in tilt rod extension.</p> <p>Bury mine.</p>
 <p>5. Position launcher on bipod assembly or mound of earth. Mount sighting assembly and sight along discriminator to target impact point about 3° above road (soldier's belt buckle). To aim, move launcher, not sight. Fill pouches with dirt, lay over launcher, ratchet sight, re-connect discriminator wire to firing device (light out), connect rocket cable to firing device, and push toggle switch to ARMED. The system is now armed and will fire when pressure is applied to the discriminator. See TM 9-1345-200.</p>	 <p>Complete camouflage.</p> <p>To Bury: Put mine in hole with pressure plate at ground level or slightly above.</p> <p>To Disarm: Reverse arming procedure.</p>	 <p>Remove safety (pull ring assembly) and complete camouflage.</p> <p>To Bury—Pressure: Put mine in hole with fuze cap flush with ground surface.</p> <p>Tilt Rod: Seat mine firmly in snug fitting hole. Most effective in tall brush or grass.</p> <p>To Disarm: Reverse arming procedure.</p>

TABLE 8
CHARACTERISTICS OF FIELD ARTILLERY AND AIR DEFENSE ARTILLERY WEAPONS

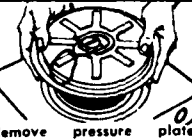
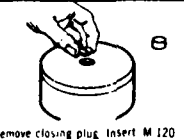
WEAPON	ON CARRIAGE TRAVERSE MILS	RANGE (METERS)	WEIGHT (LBS)	TIME TO EMLACE (MINUTES)	MAX RATE OF FIRE—NO. OF RDS FIRST 3 MINUTES	SUSTAINED RATE OF FIRE—NO. OF RDS PER HOUR	NO. OF WPNS PER UNIT	AMMUNITION		EFFECTIVE AREA COVERED BY IMPACT BURST IN METERS**	
								TYPES	FUZES	DEPTH	WIDTH
105-mm How Towed, M102	6,400	11,500	3,171	3	30	180	Inf, Abn, Ambl Div 18 Per Bn Corps	HE CML ILLUM SMK ICM APERS HEP-T RAP LEAFLET	Quick Delay VT Time Concrete Piercing	20	30
105-mm How Towed, M101A1	809	11,000	4,980	3	30	180	18 Per Bn	HE CML ILLUM SMK ICM APERS HEP-T RAP LEAFLET	Quick Delay VT Time Concrete Piercing		
155-mm How Towed, M114A1 A2	866	14,600***	12,700	3.5	12	60	Inf Div 18 Per Bn Corps	HE CML ILLUM SMK ICM APERS HEP-T RAP LEAFLET	Quick Delay VT Time Concrete Piercing		
155-mm How Towed, M198	800	24,000****	15,500	3.5	12	60	Armor & Mech Inf Div 18 Per Bn Corps	HE CML ILLUM SMK ICM APERS HEP-T RAP LEAFLET	Quick Delay VT Time Concrete Piercing	30	50
155-mm How SP, M109	6,400	14,600***	52,461	.5	12	60	18 Per Bn Corps	HE CML ILLUM SMK ICM APERS HEP-T RAP LEAFLET	Quick Delay VT Time Concrete Piercing		
155-mm How SP, M109A1	6,400	18,000****	53,740	.5	12	60	18 Per Bn Corps	HE CML ILLUM SMK ICM APERS HEP-T RAP LEAFLET	Quick Delay VT Time Concrete Piercing		
8-Inch How SP, M110	1,066	16,800	58,500	2.5	4.5	30	Inf Div 4 Armor & Mech Inf Div 12 Per Bn Corps	HE NUC CML ICM SPOT	Quick Delay VT Time Concrete Piercing	30	80
8-Inch How SP, M110A1	1,066	20,600	62,100	2.5	4.5	30	12 Per Bn Corps	HE NUC CML ICM SPOT	Quick Delay VT Time Concrete Piercing		

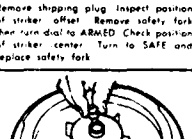
WEAPON	ON CARRIAGE TRAVERSE MILS	RANGE (METERS) AIR GROUND	WEIGHT (LBS)	TIME TO EMLACE (MINUTES)	MAX RATE OF FIRE—NO. OF RDS FIRST 3 MINUTES	SUSTAINED RATE OF FIRE—NO. OF RDS PER HOUR	NO. OF WPNS PER UNIT	AMMUNITION		EFFECTIVE AREA COVERED BY IMPACT BURST IN METERS**	
								TYPES	FUZES	DEPTH	WIDTH
Gun, M42A1, SP, Twin 40-mm Duster	6,400	1650 1850	49,500	N/A	360 Per Tube	N/A	64 Bn	HEI-T HEI-T APT	SD SD	N/A	N/A
Gun, SP, 20-mm Vulcan	6,400	1200 4500	24,700	N/A	3,000 Rds Per Min (10, 30, 60, 100 Rd Bursts)	N/A	24 Bn	HEI-T HEI-T TP	SD	N/A	N/A
Gun, Towed, 20 mm Vulcan	6,400	1200 4500	3,150	2 Min	3,000 Rds Per Min (10, 30, 60, 100 Rd Bursts)	N/A	Firing Btry Corps 12 Air Aslt 12 Abn 12	HEI-T HEI-T TP	SD	N/A	N/A

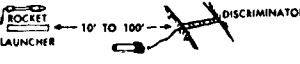
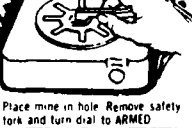
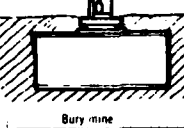
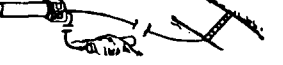
* IAW ARTEP
 ** Heavily dependent on soil consistency and weather conditions
 *** 19,400 Meters with RAP (M114A2 and M109, not M114A1)
 **** 24,000 Meters with RAP
 ***** 30,000 Meters with RAP.

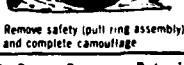
SYSTEM	RANGE METERS	WEIGHT POUNDS	NUMBER OF LAUNCHERS PER UNIT	FUEL	GUIDANCE	TYPE WARHEAD
Pershing 1A Guided Msl	185,000 to 740,000	10,275	Bn 36	Solid	Inertial	Nuc
Improved Hawk Air Defense Missile	26,000 at 38,000 ft altitude	1,401	Bn 24/27	Solid	Proportional	HE
Hercules Air Defense Missile	140,000' at 150,000 ft altitude	10,400	Bn 12	Solid	Command	HE Nuc
Lance MGM 52C	8,000 to 65,000 (Non-Nuc)	2,900 (Nuc) 3,400 (Nuc) Non Nuc	Bn 6	Liquid	Modified Inertial	Nuc Non Nuc
Chaparral M48	(s) FM 44-1A	187	Bn 24	Solid	Proportional Navigation	Continuous Rod
Redeye M41	(s) FM 44-1A	28.9	6 per Team	Solid	Uses passive IR homing	HE
Stinger	5	34.7	6 per TM	Solid	Proportional Navigation with Lead Bias using Passive IR Homing	HE

* Surface to surface range—75 nautical miles.

TABLE 9

CHARACTERISTICS OF ARMY AIRCRAFT

1. **General.** Army airplane characteristics are shown in Table 9a and Army helicopter characteristics in Table 9b. OPERATIONAL CHARACTERISTICS for Army aircraft vary with flight conditions. Airspeeds and fuel consumptions will vary with gross weight, altitude, power settings, and aircraft. See appropriate TM 55-Series-10 aircraft operator's manual for correct airspeed and fuel consumption.

2. **Definitions.**

a. **Maximum allowable gross weight:** The maximum allowed total weight of the aircraft prior to takeoff; the "basic weight" of the aircraft plus the crew, personnel equipment, special devices, passengers/cargo, and usable fuel and oil. This is limited by structure, power available, or landing load.

b. **Basic weight:** The empty weight of an aircraft in its basic configuration. It includes trapped and unusable fuel and oil and all fixed equipment, to which it is only necessary to add crew, fuel, oil, cargo, and ammunition (if carried) to determine the gross weight for the aircraft.

c. **Useful load:** The load-carrying capability of an aircraft. It includes the payload, crew, and usable fuel and oil required for the mission. (The payload is the useful load excluding the crew and fuel and oil required for the mission.) The useful load is the difference between "maximum allowable gross weight" and the "basic weight" (a and b above).

d. **Normal cruising speed:** The true airspeed which an aircraft can normally be expected to maintain at some standard power setting below rated military power. (This speed will vary with altitude.)

e. **Endurance at cruising speed:** The time that an aircraft can remain airborne at normal cruising speed with fuel aboard without using required fuel reserve.

3. U.S. Army aircraft fuel identification. JP-4 fuel is clear. Aviation gasoline-AVGAS identification colors and performance numbers are:

- a. Red - 80/87.
- b. Blue - 91/96.
- c. Green - 100/130.
- d. Purple - 115/145.

NOTE: Information in this table was extracted from Appendix F, FM 1-15, Aviation Reference Data, 30 September 1977.

**TABLE 9a
CHARACTERISTICS OF ARMY AIRPLANES**

1	2	3	4	5	6
A. AIRPLANE	UNIT	OV-1 OBSERVATION	U-8F	U-21A UTILITY	C-12A
B. NAME		MOHAWK	SEMINOLE	UTE	A200
C. CREW (200 Lbs Ea)	Ea	2	1	2	2
D. DIMENSIONS:					
(1) Length — Fuselage	Ft & In	41' 1½"	31' 6½"	35' 6"	43' 10"
(2) Width — Tread	Ft & In	9' 2"	12' 9"	12' 9"	17' 2"
(3) Height — Extreme	Ft & In	12' 8"	11' 6½"	14' 2½"	15' 5"
(4) Wing Span	Ft & In	48' 0"	45' 3½"	45' 10½"	54' 6"
E. CARGO DOOR					
Dimensions — Width/Height	In	NA	26.5/26.75	53.5/51.5	26.7/51.5
F. CARGO COMPARTMENT					
(1) Height of Floor Above Ground	In	NA	48	Approx 54	53
(2) Length Usable	In	NA	86	150	128
(3) Width Floor	In	NA	54	55	54
(4) Height (Clear of Obstructions)	In	NA	53	57	57
(5) Cargo Space Optimum	Cu Ft	NA	115	272	253
G. EXTERNAL CARGO(2)					
Maximum recommended external load	Lbs	4,000	NA	NA	NA
H. PASSENGER CAPACITY					
(1) Troop Seats (240 Lbs Per Man)	Ea	0	5	6	10
(2) Litters	Ea	NA	NA	7	NA
I. OPERATIONAL CHARACTERISTICS(1, 2)					
(1) Maximum Allowable Gross Wt	Lbs	15,302	7,300	9,650	12,585
(2) Basic Weight(1)	Lbs	10,379	4,078	5,500	10,400
(3) Useful Load	Lbs	4,923	2,322	4,100	2,100
(4) Internal Fuel Capacity	Lbs/ Gal	1,930/297	1,380/230	2,405/370	2,470/386
(5) Normal Cruising Speed(3)	Kts	200	155	164	(3)
(6) Endurance at Cruising Speed(3)	Hrs + Min	1 + 15	6 + 0	4 + 30	(3)
(7) Grade of Fuel	Oct	JP-4	115/145	JP-4/5	JP-4/5
(8) Fuel Consumption Per Hour(3)	Lbs/ Gal	1,105/170	204/34	500/83	(3)

FOOTNOTES:

- (1) Basic weight for standard aircraft (fuel and components not included).
- (2) Detail weight computations and characteristics taken from FM 101-20-1 or from appropriate aircraft operator's manuals (TM 55-series-10).
- (3) Refer to appropriate aircraft operator's manual to determine normal cruising speed, endurance, and fuel consumption rates. Data is not provided because it is dependent on density altitude, altitude and temperature.

TABLE 90
CHARACTERISTICS OF ARMY HELICOPTERS

1	2	3	4	5	6	7	8	9	10	11	12	13
A. HELICOPTER	UNIT	OH-5A OBSERVATION	OH-50A OBSERVATION	AH-1G ATTACK	AH-1G ATTACK	UH-1H UTILITY	CH-47B CARGO	CH-47C CARGO	CH-54A CARGO	CH-54B CARGO	CH-53E CARGO	CH-53K CARGO
B. NAME		CAVISE	KIOWA	COBRA	COBRA	HOQUOIS	CHINOOK	CHINOOK	TARLE	TARLE		
C. CREW (200 lbs ea)	Ea	2	2	2	2	1 (2)	3	3	3	3		2
D. DIMENSIONS:												
(1) Length-Fuselage	Pt 6 In	23'6"	32'8.8"	44'5 1/4"	44.7"	41'11 1/4"	51'0"	51'0"	70'3"	70'3"	77'10"	77'10"
(2) Length-Blades Unfolded	Pt 6 In	30'3 3/4"	40'11 3/4"	52'11 3/4"	51'11"	57'1"	98'11"	99'0"	88'5"	88'5"	107'10"	107'10"
(3) Length-Blades Folded	Pt 6 In	23'0"	32' 8.8"	NA	NA	NA	51'0"	51'0"	77'6"	77'6"	82'0"	82'0"
(4) Width-Blades Folded	Pt 6 In	NA	NA	NA	NA	NA	12'5"	12'5"	21'10"	21'10"	24'10"	24'10"
(5) Width-Tread	Pt 6 In	6'9 1/4"	6'5.4"	7'4"	7'	8'6 1/2"	10'6"	10'6"	19'9"	19'9"	19'9"	19'9"
(6) Height Extreme	Pt 6 In	8'6"	9'6 1/2"	11'7"	10'2"	14'5 1/2"	18'7"	18'7"	25'5"	25'5"	31'0"	31'0"
(7) Diameter-Main Rotor	Pt 6 In	26'4"	35'4"	44'0"	44'0"	48'0"	60'0"	60'0"	72'0"	72'0"	53'8"	53'8"
(8) Diameter-Tail Rotor	Pt 6 In	4'3"	5'2"	8'6"	8'6"	8'6"	52'0"	52'0"	16'0"	16'0"	11'	11'
E. CARGO DOORS (3)												
(1) Dimensions-Width/Height	In	NA	NA	NA	NA	74.5/48	90/78	90/78	POD-114/92	POD-114/92	48'10/27'	48'
(2) Location-Side of Fuselage	In	NA	NA	NA	NA	Both	Rear	Rear	POD-Rear	POD-Rear	Rear	NA
F. CARGO COMPARTMENT (3)												
(1) Height of Floor Above Ground	In	NA	NA	NA	NA	32	30	30	POD-18	POD-18	11'	11'
(2) Length Usable	In	NA	NA	NA	NA	92	362 1/2	362 1/2	POD-329	POD-329	151"	151"
(3) Width Floor	In	NA	NA	NA	NA	96	90	90	POD-104	POD-104	72'-94"	NA
(4) Height (Clear of Obstructions)	In	NA	NA	NA	NA	49	78	78	POD-78	POD-78	52	52
(5) Cargo Space Optimum	Cu Ft	NA	NA	NA	NA	220	1,487	1,487	POD-1599	POD-1599		18'
G. EXTERNAL CARGO (4)												
(1) Maximum recommended external load	Lbs	NA	NA	NA	NA	4,000	20,000	20,000	20,000	25,000	25,000	25,000
(2) Reserve Buist Capacity	Lbs	NA	NA	NA	NA	600	600	600	NA	NA	600	A
(3) Winch Capacity	Lbs	NA	NA	NA	NA	NA	3,000	3,000	15,000	25,000	18'	18'
H. PASSENGER CAPACITY (3)												
(1) Troop Seats (240 lbs per man)	Ea	2	2	0	0	11	33	33	POD-45	POD-45	14	14
(2) Litters	Ea	0	0	0	0	6	24	24	POD-24	POD-24	4	4
I. OPERATIONAL CHARACTERISTICS (4,5)												
(1) Maximum Allowable Gross Weight	Lbs	2,400	3,000	9,500	10,000	9,500	40,000	46,000	42,000	47,000	20,250	21,200
(2) Basic Weight	Lbs	1,163	1,700	5,635	6,900	4,900(1)	19,194	19,772	20,650	21,000	10,794	11,481
(3) Useful Load	Lbs	1,237	1,300	3,865	3,100	4,100	20,806	26,228	21,350	26,000	9,494	9,719
(4) Internal Fuel Capacity	Lbs/ Gal	400/61.5	475/73	1605/247	1703/262	1450/224	4036/621	7353/1131	8800/1353	8775/1350	1977/304	416
(5) Normal Cruising Speed	Kts	(5)	(5)	(5)	(5)	(5)	(5)	(5)	(5)	(5)	(5)	(5)
(6) Endurance at Cruising Speed (5)	Hrs + Min	(5)	(5)	(5)	(5)	(5)	(5)	(5)	(5)	(5)	(5)	(5)
(7) Grade of Fuel	Oct	JP-4/5	JP-4/5	JP-4/5	JP-4/5	JP-4/5	JP-4/5	JP-4/5	JP-4/5	JP-4/5	JP-4/5	JP-4/5
(8) Fuel Consumption Per Hour (5)	Lbs/ Gal	(5)	(5)	(5)	(5)	(5)	(5)	(5)	(5)	(5)	(5)	(5)

FOOTNOTES:

- (1) Basic weight for standard aircraft (fuel, weapons systems, and components not included).
- (2) Crew requirements may vary with mission and/or environment.
- (3) Pod for CH-54A (column 11) and CH-54B (column 12).
- (4) Detail weight computations and characteristics taken from FM 101-20-1 or from appropriate aircraft operator's manuals (TM 55-series-10M).
- (5) Refer to appropriate aircraft operating manuals to determine normal cruising speed, endurance, and fuel consumption rates. Data is not provided because it is dependent on density altitude, altitude and temperature.
- (6) AH-1G/V model aircraft are programmed for AH-1G conversion in the early 1980's.

TABLE 10. CHARACTERISTICS OF HELICOPTER ARMAMENT

ARMAMENT SUBSYSTEM	APPLICABLE AIRCRAFT	LOADED WEIGHT (IN POUNDS)	AMMUNITION STOWAGE	RATE OF FIRE (RDS PER MIN)	MAXIMUM EFFECTIVE RANGE (IN METERS)	REMARKS			
*M2	OH-13 OH-23	202/SIDE	7.62mm 1,100	550 SPM	1,100	One M60C Machinegun on each side of the aircraft.			
**M5	UH-1B/C/M	484	40mm 302	230 SPM	1,500				
M18A1	AH-1G/S	320	7.62mm 1,500	2,000 or 4,000 SPM	1,100				
**M21	UH-1B/C/M	1179.2	7.62mm 6,000	2.75 in FFAR 14	7.62mm 2,000 or 4,000 SPM	6 pr per sec	7.62mm 1,500	2.75 in FFAR 3,000	
M23	UH-1D/H UH-60A	210	7.62mm 1,100	550 SPM	1,100	One M60D Machinegun on each side of the aircraft in the doorways.			
M24	CH-47A/B/C	111	7.62mm 400	550 SPM	1,100	One M60D Machinegun on each side of the aircraft.			
M27A1	OH-6A OH-58A	234	7.62mm 2,000	2,000 or 4,000 SPM	1,100				
M28A1	AH-1G/S	1. 925 2. 880 3. 970	7.62mm 4,000 for each gun mounted.	40mm 300 for each gun mounted.	7.62mm 2,000 or 4,000 SPM	40mm 420 SPM	1,500	1,500	1. One 7.62mm Machinegun and one 40mm Grenade Launcher. 2. Two 40mm Grenade Launchers. 3. Two 7.62mm Machineguns.
M35	AH-1G	1187.4	20mm 950	750			3,500		20mm 6 barrel gatling gun mounted on left wing store.
*M3	UH-1B/C	1627	2.75 in FFAR 48	6 pr per sec			3,000		24 Rockets mounted on each side of the aircraft. Area fire weapon system.
*M6	UH-1B/C	685	7.62mm 6,700	500- 650 SPM per gun.			1,000		2 M60C Machineguns on each side of the aircraft.
*M16	UH-1B/C	1175	7.62mm 6,700	2.75 in FFAR 14	500- 650 SPM per gun.	6 pr per sec	1,000	3,000	2 M60C Machineguns and one 7-RD Rocket Pod on each side of the aircraft.
*M22 SS-11	UH-1B/C/M	685.7	Missiles 6	Gunner's Skill			3,500		3 Wire Guided Anti-Tank Missiles on each side of the aircraft.
M65 (TOW)	AH-1/S	1. 652 2. 326	Missiles 1. 8 2. 4	Gunner's Skill			3,750		1. 4 Wire Guided Anti-Tank Missiles on each side of the aircraft. 2. 2 Wire Guided Anti-Tank Missiles on each side of the aircraft.
*XM26 (TOW)	UH-1C/M	500	Missiles 6	Gunner's Skill			3,750		3 Wire Guided Anti-Tank Missiles on each side of the aircraft.
M158A1	UH-1B/C/M AH-1G/S	194 per Pod	2.75 in FFAR 7	6 pr per sec			3,000		1 Pod on each side of UH-1 aircraft (14 rds). 1 or 2 Pods on each side of AH-1G aircraft (14 or 28 rds) or 1 Pod on each side of AH-1/S (14 rds).
M200A1	UH-1B/C/M AH-1G/S	629 per Pod	2.75 in FFAR 19	6 pr per sec			3,000		1 Pod on each side of UH-1 aircraft (38 rds). 1 or 2 Pods on each side of AH-1G/S ; (38 or 76 rds).
*XM159C	UH-1B/C/M AH-1G/S	629 per Pod	2.75 in FFAR 19	6 pr per sec			3,000		1 Pod on each side of UH-1 aircraft (38 rds). 1 or 2 Pods on each side of AH-1G/S ; (38 or 76 rds).

*Currently in use in MAAG Countries.
**Currently in use by Army Reserve Units.

TABLE 11
STANDARD TACTICAL MISSIONS OF FIELD ARTILLERY

Artillery with a tactical mission of--	Answers calls for fire in priority from--	Establishes liaison with--	Establishes communication with--	Has as its zone of fire--	Furnishes FIST--	Is positioned by--	Has its fires planned by--
General support .	1. Force field artillery headquarters . 2. Own observers .	No inherent requirement .	No inherent requirement .	Zone of supported unit/formation .	No inherent requirement .	Force field artillery headquarters .	Force field artillery headquarters .
General support-reinforcing .	1. Force field artillery headquarters . 2. Reinforced artillery unit . 3. Own observers .	Reinforced field artillery unit .	Reinforced field artillery unit .	Zone of supported unit/formation to include zone of reinforced field artillery unit .	No inherent requirement .	Force field artillery headquarters or , subject to prior approval , the reinforced field artillery unit .	Force field artillery headquarters .
Reinforcing .	1. Reinforced field artillery unit . 2. Own observers . 3. Force field artillery headquarters .	Reinforced field artillery unit .	Reinforced field artillery unit .	Zone of fire of reinforced field artillery unit .	No inherent requirement .	Reinforced field artillery unit or as ordered by force field artillery headquarters .	Reinforced field artillery unit .
Direct support .	1. Supported unit . 2. Own observers . 3. Force field artillery headquarters .	Supported unit (down to battalion level) .	Supported unit .	Zone of supported unit .	To each company-size maneuver element of supported unit .	Unit commander , as deemed necessary , or ordered by force field artillery headquarters .	Develops own fire plan .

CHAPTER 11 TROOP LIST

1. This troop list is published for the information and guidance of students and faculty of the US Army Armor School. The corps structures used herein are instructional vehicles designed for either general or limited warfare in active or nonactive nuclear situations. In general, it is based on the US Army Command and General Staff College Reference Book 101-1. The type corps used herein does not include an Airborne or Airmobile division; however, for instructional purposes, a type troop list for these divisions is included in Section II.

2. To assist instructors, Corps field artillery units have been organized into groups. These groups may be restructured as needed for instruction; however, a group normally should not consist of more than 5 battalions.

SECTION I. I CORPS TROOP LIST

Unit	TOE	Unit	TOE
HQ & HQ Co, Corps	52-2H	62d FA Gp, HHB	6-401H
HHC, COSCOM	54-22H	2d Bn (155, SP), 631st FA	6-455H
HHC, 10th - 11th Spt Gp	29-102H	2d Bn (155, SP), 632d FA	6-455H
2175th - 2176th Spt Cen, Rr Area Op	29-408G	2d Bn (8, SP), 608th FA	6-445H
2421st DPU (COSCOM)	29-550T	2d Bn (175, SP), 661st FA	6-435H
2001st MMC Co (COSCOM)	54-23H	63d FA Gp, HHB	6-401H
4104th Trans MCC (COSCOM)	55-6H	2d Bn (155, SP), 633d FA	6-455H
25th Armd Div	17H	2d Bn (155, SP), 634th FA	6-455H
21st Inf Div	7H	2d Bn (8, SP), 609th FA	6-445H
52d Inf Div (Mech)	37H	2d Bn (175, SP), 662d FA	6-435H
54th Inf Div (Mech)	37H	64th FA Gp, HHB	6-401H
312th Sep Armd Bde	17-100H	2d Bn (175, SP), 663d	6-435H
1st Bn, 6th Armor	17-35H	2d Bn (175, SP), 664th	6-435H
1st Bn, 7th Armor	17-35H	1st Bn (Lance), 205th FA	6-595H
1st Bn, 8th Armor	17-35H	1st Bn (PSG), 305th FA	6-615G
1st Bn (Mech), 135th Inf	7-45H		
1st Bn (155, SP), 69th FA	6-375H	AIR DEFENSE ARTILLERY	
Troop A, 1st Sqdn, 27th Cav	17-107H	401st ADA Gp, HHB	44-12H
5022d Engr Co	5-127H	1st Bn (Chap/Vulc), 430th ADA	44-725H
312th Spt Bn	29-75H	1st Bn (Chap/Vulc), 431st ADA	44-725H
201st Armd Cav Regt	17-51H	2d Bn (Improved Hawk), 461st ADA	44-245H
207th Air Cav Cbt Bde	17-200H	2d Bn (Improved Hawk), 462d ADA	44-245H
1st Sqdn (Air), 215th Cav	17-205H	1st Bn (Improved Hawk, TRIAD), 451st ADA	44-265H
HQ & HQ Troop	17-206H		
Trp A, B, C, (Air Cav)	17-208H	AVIATION	
Trp D (Armd Cav)	17-207H	102d Avn Gp (Cbt), HHC	1-252H
120th Atk Hel Bn	17-385H	133d Avn Co (Corps)	1-127H
HQ & HQ Company	17-386H	296th MI Co (Aerial Survl)	30-128H
Co A, B, C, (Atk Hel)	17-387H	151st Avn ATC Unit	1-207H
		173d Hv Hel Co	55-259H
COMBAT SUPPORT UNITS		120th Atk Hel Bn (Sep)	17-385H
FIELD ARTILLERY		HHC, 110th Cbt Avn Bn	1-256H
I Corps Arty, HHB	6-501H	190th - 191st Aslt Spt Hel Co	1-258H
Brty A (S1), 191st FA	6-558G	178th - 179th Aslt Hel Co	7-357H
61st FA Gp, HHB	6-401H	206th Atk Hel Co	17-111H
1st Bn (155, Towed), 651st FA	6-425H	HHC, 111th Cbt Avn Bn	1-256H
1st Bn (155, Towed), 652d FA	6-425H	192d - 193d Aslt Spt Hel Co	1-258H
2d Bn (8, SP), 606th FA	6-445H	180th - 181st Aslt Hel Co	7-357H
2d Bn (8, SP), 607th FA	6-445H	207th Atk Hel Co	17-111H
		7722d - 7725th Hv Hel Co	55-259H
		7710th - 7721st Aslt Spt Hel Co	1-258H

Unit	TOE
CHEMICAL	
333d - 337th Cml Det (CBRE)	3-500H(JA)
356th - 359th Cml Det (CBR Agt Sampling & Anal)	3-500H(KA)
349th - 351st Cml Det (CBRE)	3-500H(JB)
371st - 372d Cml Det (CBR Recon)	3-500H(LA)
400th - 405th Cml Det (Cbt Spt)	3-500H(PA)
460th - 466th Cml Det (Decon)	3-500H(FA)
450th - 456th Cml Det (Decon)	3-500H(FB)
HHD, 470th Cml Smoke Genr Bn	3-266H

Unit	TOE
ENGINEER	
HHC, 51st Engr Cbt Bde (Corps)	5-101H
HHC, 61st - 62d Engr Cbt Gp	5-52H
300th - 511th Engr Cbt Bn (Corps)	5-35H
550th - 551st Engr Cbt Bn (Hv)	5-115H
HHD, 570th Engr Bn (Admin)	5-550H(AC)
5000th Engr Topo Co (Corps)	5-327G
5006th - 5007th Engr Dptrk Co	5-124H
5010th - 5014th Engr Cbt Co (Hv)	5-118H
5035th - 5036th Engr Pnl Brg Co	5-77H
5045th Engr Aslt Fltbrg Co	5-79H
5050th - 5053d Engr Fltbrg Co	5-78H
5070th - 5071st Engr Aslt Brg Co	5-64H
5076th Engr Mdm Girder Brg Co	5-74H
5080th - 5081st Engr Cbt Spt Eq Co	5-58H
5115th Engr Co (ADM)	5-57H
5665th Engr Det (Water Purification)	5-520G(GH)

Unit	TOE
COMBAT ELECTRONIC WARFARE INTELLIGENCE (CEWI)	
H&O Co, 20th CEWI Group	30-102T
HHC, 200th Aerial Xplt Bn	30-106T
Co A (II)	30-107T
Co B (Aerial Survl)	30-179T
Co C (EW Avn, Fwd)	30-199T
Co D (EW Avn, Rr)	30-193T
HHC, 210th Tac Xplt Bn	30-126T
Co A (Intg)	30-127T
Co B (OPSEC)	30-128T
Co C (LR Survl Op)	30-157T
HHD, 220th EW Bn	30-156T
Co A (Can & Proc)	30-173T
Co B (Op, Rr)	30-183T
EW Co, Fwd	30()
Spt Coll Co	30()

Unit	TOE
MILITARY POLICE	
HHD, 230th MP Bn	19-76H
270th - 272d MP Co	19-77H
330th MP ESCRG Co	19-47H

Unit	TOE
337th MP Guard Co	19-247H
363d MP Phys Scty Co	19-97H
385th MP Det (Crim Inves)	19-520H(GA)
400th MP Det (Crim Inves)	19-520H(GB)

Unit	TOE
PSYCHOLOGICAL OPERATIONS	
200th PSYOP Bn	33-500H
283d PSYOP Tac Bn	33-500H

Unit	TOE
SIGNAL	
HHC, 20th Sig Bde (Corps)	11-402H
700th Sig Bn (CO) (Corps)	11-405H
712th Sig Rda and Cable Bn	11-425H
704th Area Sig Bn	11-415H

Unit	TOE
COMBAT SERVICE SUPPORT UNITS	
RESTRUCTURED GENERAL SUPPORT (RGS)	
90th Mat Cen (Armt & Cbt Veh) (GS)	29-203T
92d Mat Cen (WVEH) (GS)	29-213T
94th Mat Cen (Comm & Elct) (GS)	29-223T
96th Mat Cen (Gnd Spt Equip) (GS)	29-233T
98th Mat Cen (Msl) (GS)	29-53T
70th Spt Cen (Avn)	55-453T
20th Gen Sup Cen (GS)	29-113T

Unit	TOE
AMMUNITION	
HHC, 50th Ord GP (Ammo) (DS/GS)	9-22H
HHC 55th - 56th Ammo Bn (DS/GS)	9-36H
500th Ord Convl Ammo Co (DS/GS)	9-38H
511th - 516th Ord Sp Ammo DS Co	9-47H
517th - 518th Ord Sp Ammo Co (DS/GS)	9-48H
519th - 520th Ord Co (GM) (GS Maint)	9-59H
530th - 533d Ord Det (EOD Con Cen)	9-520H(AB)
534th - 542d Ord Det (EOD)	9-520H(FA)

Unit	TOE
MAINTENANCE	
HHD, 90th Maint Bn (GS)	29-136H
HHD, 95th Maint Bn (DS)	29-136H
HHD, 71st Trans Acft Maint Bn (DS/GS)	55-456H
924th - 925th LE Maint Co (GS)	29-134H
930th - 931st Hv Eq Maint Co (GS)	29-137H
700th - 701st Trans Acft Maint Co (DS)	55-457H
900th - 901st Maint Co (Rr) (DS)	29-208H
908th - 910th Lt Maint Co (Fwd) (DS)	29-207H
706th - 707th Trans Acft Maint Co (GS)	55-458H
932d - 933d Coll & Class Co	29-139H
934th Tire Repair Co	9-117G

Unit	MEDICAL	TOE
HHD, 80th Medical Bde	8-112H
HHD, 82d - 83d Medical Gp	8-122H
HHD, 800th - 809th Medical Bn	8-126H
850th - 852d Med Air Amb Co	8-137H
855th - 860th Med Amb Co	8-127H
865th - 868th Med Clr Co	8-128H
871st Med Co (Armd Cav Regt)	8-147H
876th Med Co (ACCB)	8-157H
809th - 813th Cbt Spt Hosp	8-123H
834th - 836th Evac Hosp	8-581H
845th - 848th MEDSOM	8-287H

PERSONNEL AND ADMINISTRATIVE SERVICES

HHD, 10th Pers & Admin Bn	12-66H
100th - 101st Pers Svc Co (Type D)	12-67G
108th Admin Svcs Det	12-570G
110th - 112th Repl Reg Det	12-560H
126th - 143d AG Psal Svc Org	12-550H
144th - 145th SPS Org	12-530H(AA)
148th - 149th Army Band	12-107H

FINANCE

110th - 114th Fin Svc Org	14-500H
---------------------------	-------	---------

SUPPLY AND SERVICES

HHD, 33d Petrl Gp	10-202H
HHC, 20th - 22d Sup & Svc Bn	29-146H
HHC, 31st - 32d Petrl Op Bn	10-206H
HHD, 33d Petrl Sup Bn (GS)	10-226H
201st - 204th Sup & Svc Co (DS)	29-147H

Unit	TOE
223d - 225th Fld Svc Co (GS)(Fwd) 29-114H
235th Fld Svc Co (GS) 29-124H
238th - 241st Gen Sup Co (GS) 29-118H
248th - 249th Rep Parts Sup Co (GS)(Corps) 29-119H
236th Hv Mat Sup Co (GS) 29-127H
253d - 254th Acft & Msl Rep Parts Sup Co (GS) 29-129H
255th - 256th QM Adrp Sup Co 10-407G
257th - 260th Petrl Sup Co 10-227H
280th - 281st Engr Eq Op Tm (Water Purif) 5-520G(GH)
274th Sales Det 29-510H(BP)
278th QM Svc Org (Petrl Prod Lab)(Mbl) 10-560H(JC)

CIVIL AFFAIRS

HHC, 50th CA Bn	41-500H(AC)
500th - 502d CA Co	41-500H(AB)

TRANSPORTATION (LESS AVN)

HHC, 7th Trans Bde (COSCOM)	55-62H
HHD, 70th - 71st TMT Gp	55-12H
HHC, 72d Trans Comp Gp	55-52H
HHD, 771st - 778th TMT Bn	55-16H
701st - 704th Trans Lt Trk Co (2-1/2-Ton)	55-17H
705th - 708th Trans Lt Trk Co (5-Ton)	55-17H
709th - 720th Trans Mdm Trk Co (Cgo)	55-18H
721st - 724th Trans Mdm Trk Co (Petrl)	55-18H
729th - 730th Trans Hv Trk Co	55-28H
733d - 736th Trans Lt/Mdm Trk Co	55-67H
751st Trans Car Co	55-19H
753d - 754th Trans Tml Trf Co	55-118H
780th - 781st Trans Trl Trf Tm	55-540H(GE)
7700th - 7709th Hwy Reg Pt Tm	55-580H(GF)
789th - 970th Mov Con Tm	55-580H(LB)

SECTION II. DIVISION ORGANIZATIONS

1. General

Army divisions in this section are habitually used in school instruction and reflect the current TOE.

2. Maneuver Battalions

Following are the combinations of maneuver battalions normally assigned to each type of division for school instruction (divisions are tailored to specific operational environments):

<u>Infantry</u>	<u>Armored</u>	<u>Mechanized Infantry</u>	<u>Airmobile</u>	<u>Airborne</u>
8 inf bn	6 tk bn	6 mech bn	9 airmb inf bn	9 abn inf bn
1 tk bn	5 mech bn	4 tk bn		1 arm bn (abn)
1 mech bn				

3. Designations

Once a division is given a designation, it is not changed even though tactical tailoring may change the combination of combat battalions temporarily.

4. Numbering

For school purposes, the following division numerical designations are used in instruction:

- a. Infantry divisions: 15th through 21st.
- b. Armored divisions: 23d through 28th.
- c. Airmobile divisions: 47th.
- d. Infantry divisions (mechanized): 52d through 55th.
- e. Airborne divisions: 102d.

Note: The following are the primary divisions used for instruction in the Armor School:

- 21st Infantry
- 25th Armored
- 52d Mechanized Infantry
- 54th Mechanized Infantry
- 47th Airmobile
- 102d Airborne

5. Components

Designations of components of division are as follows:

a. The combat units of the divisions are designated in accordance with the combat arms regimental system (CARS).

(1) For instructional purposes, battalions and squadrons are assigned to division bases from regimental designations shown below:

- (a) Tank—1st through 15th.
- (b) Light Armor—16th.
- (c) Armored Cavalry—21st through 27th.
- (d) Air Cavalry—28th through 32d.
- (e) Field Artillery—50th through 72d.
- (f) Air Defense Artillery—439th through 450th.
- (g) Infantry.

66th through 75th (infantry divisions).
 76th through 85th (mechanized divisions).
 91st through 100th (armored divisions).
 181st through 190th (airmobile divisions).
 301st through 320th (airborne divisions).

(2) Battalions with regimental designations above will be numbered the same within a division as follows:

<u>Bn Designation</u>	<u>Armd Div</u>	<u>Inf Div (Mech)</u>	<u>Inf Div</u>	<u>Abn Div</u>	<u>Airmb Div</u>
1st	23d	53d	21st	102d	47th
2d	25th	52d	19th		
3d	26th	55th	18th		
4th	28th	54th	17th		

b. The combat support and combat service support units not included under the combat arms regimental system have the same numerical designation as the division to which assigned.

6. 25TH ARMORED DIVISION

691

Unit	TOE	Unit	TOE
HQ & HQ Co	17H	Co B (Hv Maint)	29-38H
25th NBC Defense Co	3-87H	Co C, D, E, (Fwd Spt)	29-37H
25th MP Co	19-27H	Co F (Msl Spt)	9-57H
25th Combat Aviation Battalion	17-85H	2d Bn (Chap/Vulc, SP) 440th AD Arty	44-325H
HQ & HQ Co	17-86H	HQ & HQ Btry	44-326H
Co A (Div Avn)	17-87H	Btry A & B (Vulcan)	44-327H
Co B (Cbt Spt)	57-57H	Btry C & D (Chap)	44-328H
Co C & D (Atk Helicopter)	17-387H	25th Armd Div Field Arty	6-300H
Co E (Trans Acft Maint)	55-424H	HQ & HQ Btry	6-302H
25th Sig Bn	11-35H	25th Tgt Acq Btry	6-307H
HQ & HQ Co	11-36H	2d Bn (155, SP), 50th FA	6-365H
Co A (Comd Op)	11-37H	2d Bn (155, SP), 51st FA	6-365H
Co B (Fwd Comm)	11-38H	2d Bn (155, SP), 52d FA	6-365H
Co C (Sig Spt Op)	11-39H	HQ & HQ Btry	6-366H
25th Engr Bn	5-145H	Btry A, B, C, (155, SP)	6-367H
HQ & HQ Co	5-146H	Svc Btry	6-369H
Co A, B, C, D (Cbt Engr)	5-147H	2d Bn (8-in, SP), 53d FA	6-395H
Co E (Brg)	5-148H	HQ & HQ Btry	6-396H
25th CEWI Bn	30-165H	Btry A, B, C, (8-in, SP)	6-397H
HQ & Op Co	30-166H	Svc Btry	6-399H
Co A (Coll & Jam)	30-167H	1st Bde, 25th Armd Div, HHC	17-42H
Co B (Gnd Survl)	30-168H	2d Bde, 25th Armd Div, HHC	17-42H
Co C (Svc Spt)	30-169H	3d Bde, 25th Armd Div, HHC	17-42H
2d Sqdn, 22d Cav	17-105H	2d Bn, 10th Armor	17-35H
HQ & HQ Trp	17-106H	2d Bn, 11th Armor	17-35H
Trp A, B, C, (Armd Cav)	17-107H	2d Bn, 12th Armor	17-35H
Trp D (Air)	17-108H	2d Bn, 13th Armor	17-35H
25th Armd Div Spt Comd	29-21H	2d Bn (Shillelagh), 14th Armor	17-235T
HQ & HQ Co	29-2H	2d Bn (Shillelagh), 15th Armor	17-235H
25th AG Co	12-7H	HQ & HQ Co	17-236H
25th Finance Co	14-7H	Co A, B, C	17-235H
Div Mat Mgt Ctr	29-3H	Combat Support Company	17-239H
25th Med Bn	8-35H	2d Bn (Mech), 91st Inf	7-45H
HQ & Co A (Spt)	8-36H	2d Bn (Mech), 92d Inf	7-45H
Co B, C, D, (Med)	8-37H	2d Bn (Mech), 93d Inf	7-45H
25th Sup and Trans Bn	29-115H	2d Bn (Mech), 94th Inf	7-45H
HQ & HQ Co	29-6H	2d Bn (Mech), 95th Inf	7-45H
Co A (Sup and Svc)	10-7H	HQ & HQ Co	7-46H
Co B (Mtr Trans)	55-87H	Co A, B, C	7-47H
25th Maint Bn	29-35H	Combat Support Company	7-48H
HQ & Co A (Lt Maint)	29-36H		

7. 52D INFANTRY DIVISION (MECH)

Unit	TOE
HQ & HQ Co	37-4H
52d NBC Defense Co	3-87H
52d MP Co	19-27H
52d Combat Aviation Battalion	17-85H
HQ & HQ Co	17-86H
Co A (Div Avn)	17-87H
Co B (Cbt Spt)	57-57H
Co C & D (Atk Helicopter)	17-387H
Co E (Trans Actt Maint)	55-424H
52d Sig Bn	11-35H
HQ & HQ Co	11-36H
Co A (Comd Op)	11-37H
Co B (Fwd Comm)	11-38H
Co C (Sig Spt Op)	11-39H
52d Engr Bn	5-145H
HQ & HQ Co	5-146H
Co A, B, C, D (Cbt Engr)	5-147H
Co E (Brg)	5-148H
52d CEWI Bn	30-165H
HQ & Op Co	30-166H
Co A (Coll & Jam)	30-167H
Co B (Gnd Survl)	30-168H
Co C (Svc Spt)	30-169H
2d Sqdn, 23d Cav	17-105H
HQ & HQ Trp	17-106H
Trp A, B, C (Armd Cav)	17-107H
Trp D (Air)	17-108H
52d Inf Div (Mech) Spt Comd	29-11H
HQ & HQ Co	29-2H
52d AG Co	12-7H
52d Finance Co	14-7H
Div Mat Mgt Ctr	29-3H
52d Med Bn	8-35H

Unit	TOE
52d Sup & Trans Bn	29-65H
HQ & HQ Co	29-6H
Co A (Sup & Svc)	10-7H
Co B (Mtr Trans)	55-84H
52d Maint Bn	29-25H
HQ & Co A (Light Maint)	29-26H
Co B (Hv Maint)	29-28H
Co C, D, E (Fwd Spt)	29-27H
Co F (Msl Spt)	9-37H
2d Bn (Chap/Vulc, SP) 441st ADA	44-325H
HQ & HQ Btry	44-326H
Btry A & B (Vulc)	44-327H
Btry C & D (Chap)	44-328H
52d Inf Div (Mech) Field Arty	6-300H
HQ & HQ Btry	6-302H
25th Tgt Acq Btry	6-307H
2d Bn (155, SP), 40th FA	6-365H
2d Bn (155, SP), 41st FA	6-365H
2d Bn (155, SP), 42d FA	6-365H
2d Bn (8-inch, SP), 43d FA	6-395H
1st Bde, 52d Inf Div (Mech), HHC	37-42H
2d Bde, 52d Inf Div (Mech), HHC	37-42H
3d Bde, 52d Inf Div (Mech), HHC	37-42H
2d Bn, 4th Armor	17-35H
2d Bn, 5th Armor	17-35H
2d Bn, 6th Armor	17-35H
2d Bn (Shillelagh), 7th Armor	17-235H
2d Bn, (Mech), 76th Inf	7-45H
2d Bn, (Mech), 77th Inf	7-45H
2d Bn, (Mech), 78th Inf	7-45H
2d Bn, (Mech), 79th Inf	7-45H
2d Bn, (Mech), 80th Inf	7-45H
2d Bn, (Mech), 81st Inf	7-45H

8. 54TH INFANTRY DIVISION (MECH)

653

Unit	TOE
HQ & HQ Co	37-4H
54th NBC Defense Co	3-87H
54th MP Co	19-27H
54th Combat Aviation Battalion	17-85H
HQ & HQ Co	17-86H
Co A (Div Avn)	17-87H
Co B (Cbt Spt)	57-57H
Co C & D (Atk Helicopter)	17-387H
Co E (Trans Acft Maint)	55-424H
54th Sig Bn	11-35H
HQ & HQ Co	11-36H
Co A (Comd Op)	11-37H
Co B (Fwd Comm)	11-38H
Co C (Sig Spt Op)	11-39H
54th Engr Bn	5-145H
HQ & HQ Co	5-146H
Co A, B, C, D (Cbt Engr)	5-147H
Co E (Brg)	5-148H
54th CEWI Bn	30-165H
HQ & Op Co	30-166H
Co A (Coll & Jam)	30-167H
Co B (Gnd Survl)	30-168H
Co C (Svc Spt)	30-169H
4th Sqdn, 24th Cav	17-105H
HQ & HQ Trp	17-106H
Trp A, B, C (Armd Cav)	17-107H
Trp D (Air)	17-108H
54th Inf Div (Mech) Spt Comd	29-11H
HQ & HQ Co	29-2H
54th AG Co	29-7H
54th Finance Co	14-7H
Div Mat Mgt Ctr	29-3H
54th Med Bn	8-35H

Unit	TOE
54th Sup & Trans Bn	29-65H
HQ & HQ Co	29-6H
Co A (Sup & Svc)	10-7H
Co B (Mtr Trans)	55-84H
54th Maint Bn	29-25H
HQ & Co A (Light Maint)	29-26H
Co B (Hv Maint)	29-28H
Co C, D, E (Fwd Spt)	29-27H
Co F (Msl Spt)	9-57H
4th Bn (Chap/Vul, SP) 441st ADA	44-325H
HQ & HQ Btry	44-326H
Btry A & B (Vulc)	44-327H
Btry C & D (Chap)	44-328H
54th Inf Div (Mech) Field Arty	6-300H
HQ & HQ Btry	6-302H
25th Tgt Acq Btry	6-307H
4th Bn (155, SP) 55th FA	6-365H
4th Bn (155, SP) 56th FA	6-365H
4th Bn (155, SP) 57th FA	6-365H
4th Bn (8-inch, SP) 58th FA	6-395H
1st Bde, 54th Inf Div (Mech), HHC	37-H
2d Bde, 54th Inf Div (Mech), HHC	37-H
3d Bde, 54th Inf Div (Mech), HHC	37-H
4th Bn, 4th Armor	17-35H
4th Bn, 5th Armor	17-35H
4th Bn, 6th Armor	17-35H
4th Bn (Shillelagh), 7th Armor	17-235H
4th Bn (Mech), 76th Inf	7-45H
4th Bn (Mech), 77th Inf	7-45H
4th Bn (Mech), 78th Inf	7-45H
4th Bn (Mech), 79th Inf	7-45H
4th Bn (Mech), 80th Inf	7-45H
4th Bn (Mech), 81st Inf	7-45H

9. 21ST INFANTRY DIVISION

654

Unit	TOE	Unit	TOE
HQ & HQ Co	7-4H	1st Bn (Chap/Vulc, SP) 439th ADA	44-325H
21st MP Co	19-27H	HQ & HQ Btry	44-326H
21st NBC Defense Co	3-87H	Btry A & B (Vulc)	44-327H
21st Avn Bn	57-55H	Btry C & D (Chap)	44-328H
21st Sig Bn	11-35H	21st Inf Div Field Arty	6-100
21st Engr Bn	5-155H	HQ & HQ Btry	6-302H
HQ & HQ Co	5-156H	21st Tgt Acq Btry	6-307H
Co A, B, C (Cbt Engr)	5-156H	1st Bn (105, Towed), 45th FA	6-155H
Co E (Brg)	5-148H	1st Bn (105, Towed), 46th FA	6-155H
21st CEWI Bn	30-115T	1st Bn (105, Towed), 47th FA	6-155H
HQ & Op Co	30-116T	HQ & HQ Btry	6-156H
Co A (EW)	30-117T	Btry A, B, C (105, Towed)	6-157H
Co B (Gnd Survl)	30-118T	Svc Btry	6-159H
1st Sqdn (Air), 28th Cav	17-205H	1st Bn (155, Towed/8-inch, SP) 48th FA	6-165H
HQ & HQ Trp	17-206H	HQ & HQ Btry	6-166H
Trp A, B, C (Air)	17-208H	Btry A, B, C, (155, Towed)	6-167H
Trp D (Armd Cav)	17-207H	Btry D (8-inch, SP)	6-358H
21st Inf Div Spt Comd	29-1H	Svc Btry	6-169H
HQ & HQ Co	29-2H	1st Bde, 21st Inf Div, HHC	7-42H
21st AG Co	12-7H	2d Bde, 21st Inf Div, HHC	7-42H
21st Finance Co	14-7H	3d Bde, 21st Inf Div, HHC	7-42H
Div Mat Mgt Ctr	29-3H	1st Bn, 1st Armor	17-35H
21st Med Bn	8-35H	1st Bn, (Mech), 74th Inf	7-45H
21st Sup & Trans Bn	29-5H	1st Bn, 66th Inf	7-15H
HQ & HQ Co	29-6H	1st Bn, 67th Inf	7-15H
Co A (Sup & Svc)	10-7H	1st Bn, 68th Inf	7-15H
Co B (Mtr Trans)	55-88H	1st Bn, 69th Inf	7-15H
21st Maint Bn	29-15H	1st Bn, 70th Inf	7-15H
HQ & Co A (Light Maint)	29-16H	1st Bn, 71st Inf	7-15H
Co B (Hv Maint)	29-18H	1st Bn, 72d Inf	7-15H
Co C, D, E (Fwd Spt)	29-17H	1st Bn, 73d Inf	7-15H
Co F (Msl Spt)	9-57H	HQ Co	7-16H
		Co A, B, C (Rifle)	7-18H
		Combat Support Company	7-28H

10. 102D AIRBORNE DIVISION

655

Unit	TOE	Unit	TOE
102d Abn Div	57H	102d Supply & Trans Bn	29-45H
HQ & HQ Co	57-4H	102d QM Air Eq Spt Co	10-337H
102d MP Co	19-67H	102d Maint Bn	29-55H
102d NBC Defense Co	3-87H	1st Bn (Vulc, Towed), 442d ADA	44-425H
102d Avn Bn (Cbt)	57-55H	HQ & HQ Btry	44-426H
HQ & HQ Co	57-56H	Btry A, B, C, D	44-427H
Co A (Avn GS)	57-58H	102d Abn Div Arty	6-200H
Co B (Atk Hel)	17-387H	HQ & HQ Btry	6-201H
Co C & D (Cbt Spt)	57-57H	102d Tgt Acq Btry	6-307H
Co E (Trans Acft Maint)	55-89H	1st How Bn (105, Towed), 57th Arty	6-215H
102d Sig Bn	11-215H	1st How Bn (105, Towed), 58th Arty	6-215H
HQ & HQ Co	11-216H	1st How Bn (105, Towed), 59th Arty	6-215H
Co A (Comd Op)	11-217H	HQ, HQ & Svc Btry	6-216H
Co B (Sig Spt Op)	11-218H	Btry A, B, C	6-217H
102d Engr Bn	5-25H	1st Bde, 102d Abn Div, HHC	57-42H
HQ & HQ Co	5-26H	2d Bde, 102d Abn Div, HHC	57-42H
Co A, B, C (Cbt Engr)	5-27H	3d Bde, 102d Abn Div, HHC	57-42H
102d CEWI Bn	30-115T	1st Bn, (Abn), 16th Armor	17-215H
HQ & Op Co	30-116T	HQ & HQ Co	17-216H
Co A (EW)	30-117T	Co A, B, C	17-218H
Co B (Gnd Survl)	30-118T	1st Bn, (Abn), 311th Inf	7-35H
1st Sqdn, (Air), 29th Cav	17-275H	1st Bn, (Abn), 312th Inf	7-35H
HQ & HQ Trp	17-276H	1st Bn, (Abn), 313th Inf	7-35H
Trp A, B, C (Air)	17-278H	1st Bn, (Abn), 314th Inf	7-35H
Trp D (Cav)	17-277H	1st Bn, (Abn), 315th Inf	7-35H
102d Abn Div Sp: Comd	29-51H	1st Bn, (Abn), 316th Inf	7-35H
HQ & HQ Co and Band	29-52H	1st Bn, (Abn), 317th Inf	7-35H
102d Admin Co	12-157H	1st Bn, (Abn), 318th Inf	7-35H
Div Mat Mgt Ctr	29-53H	1st Bn, (Abn), 319th Inf	7-35H
102d Med Bn	8-65H		

11. 47TH AIRMOBILE DIVISION

656

Unit	TOE
47th Airmobile Division	67H
HQ & HQ Co	67-4H
47th MP Co	19-87H
47th NBC Defense Co	3-87H
47th Signal Bn	11-205H
HQ, HQ & Svc Co	11-206H
Co A (Comd Comm)	11-207H
Co B (Fwd Comm)	11-208H
47th Engr Bn	5-215H
HQ & HQ Co	5-216H
Co A, B, C, D	5-217H
47th CEWI Bn	30-115T
HQ & Op Co	30-116T
Co A (EW)	30-117T
Co B (Gnd Survl)	30-118T
1st Sqdn (Air), 30th Cav	17-95H
HQ & HQ Trp	17-96H
Trp A, B, C (Air)	17-98H
Trp D (Cav)	17-99H
47th Airmobile Division Avn Gp	7-200H
HQ & HQ Co	7-201H
GS Avn Co	7-202H
47th Atk Hel Bn	17-385H
HQ & HQ Co	17-386H
Co A, B, C	17-387H
155th Aslt Hel Bn	7-255H
156th Aslt Hel Bn	7-255H
HQ & HQ Co	7-256H
Co A, B, C (Aslt Hel)	7-258H
Co D (Atk Hel)	7-257H
165th Aslt Spt Hel Bn	1-165H
HQ & HQ Co	1-166H
Co A, B, C	1-167H
47th Airmobile Div Spt Comd	29-41H
HQ & HQ Co	29-42H
Materiel Mgmt Center (Ambl)	29-43H
47th AG Co	12-17H
47th Finance Co	14-37H
47th Maint Bn	29-85H
HQ & Maint Spt Co	29-86H
Co A, B, D (Fwd Spt)	29-87H
Det D (Ord Msl Spt)	9-558H

Unit	TOE
47th Medical Bn	8-25H
HQ & Co A (Spt)	8-26H
Co B, C, D	8-27H
47th Trans Acft Maint Bn	55-405H
HQ & HQ Det	55-406H
Co A & B	55-407H
47th Sup & Svc Bn	29-95H
HQ & HQ Det	29-96H
Co A (Maint)	29-97H
Det B, C, D (Fwd Spt)	29-98H
Co E (Aerial Eq Spt)	10-94H
1st Bn (Vulc, Towed), 443d ADA	44-435H
HQ & HQ Btry	44-436H
Btry A, B, C, D	44-437H
47th Airmobile Div Arty	6-700H
HQ & HQ Btry	6-701H
47th Tgt Acq Btry	6-307H
Avn Btry	6-702H
1st Bn (105, Towed), 61st FA	6-705H
1st Bn (105, Towed), 62d FA	6-705H
1st Bn (105, Towed), 63d FA	6-705H
HQ, HQ & Svc Btry	6-706H
Btry A, B, C	6-707H
1st Bn (155, Towed), 64th FA	6-715H
HQ & HQ Btry	6-716H
Btry A, B, C	6-717H
Service Btry	6-719H
1st Bde, 47th Airmobile Div, HHC	67-42H
2d Bde, 47th Airmobile Div, HHC	67-42H
3d Bde, 47th Airmobile Div, HHC	67-42H
1st Bn (Ambl), 181st Inf	7-55H
1st Bn (Ambl), 182d Inf	7-55H
1st Bn (Ambl), 183d Inf	7-55H
1st Bn (Ambl), 184th Inf	7-55H
1st Bn (Ambl), 185th Inf	7-55H
1st Bn (Ambl), 186th Inf	7-55H
1st Bn (Ambl), 187th Inf	7-55H
1st Bn (Ambl), 188th Inf	7-55H
1st Bn (Ambl), 189th Inf	7-55H
HQ & HQ Co	7-56H
Co A, B, C	7-57H
Combat Support Co	7-58H

END

DATE
FILMED

7 82

DTIC