

AD-F250003

ST 17-1-1

US ARMY

AD A115856

ARMOR REFERENCE DATA

IN THREE VOLUMES

VOLUME II

NONDIVISIONAL ORGANIZATIONS

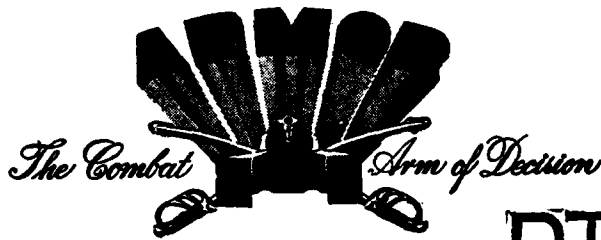

DTIC
ELECT
JUN 17 1982

F

This document has been approved for public release and sale; its distribution is unlimited.

DTIC FILE COPY



COMPLIMENTS
OF
THE ARMOR SCHOOL LIBRARY
GAFFEY HALL
624-6231
US ARMY ARMOR SCHOOL
FORT KNOX, KENTUCKY
198



82 05 28 016

INTRODUCTION

The purpose of this text is to provide a reference handbook for students and instructors of the US Army Armor School, nonresident students, instructors at other service schools, and US Army advisors to Armor units in the field. It contains data on organizations, details of equipment, and tables pertinent to armor operations.

The text reflects organizations of division level and below, as listed in *Department of the Army Tables of Organization and Equipment*, with changes available at time of preparation.

The **ARMOR REFERENCE DATA** has been prepared by the US Army Armor School. It reflects the current thought of this School and conforms to published Department of Army doctrine as closely as possible. Comments/recommendations concerning this special text should be forwarded to the Directorate of Training Developments, US Army Armor School, ATTN: ATZK-CSD, Fort Knox, Kentucky 40121.

REPORT DOCUMENTATION PAGE		READ INSTRUCTIONS BEFORE COMPLETING FORM
1. REPORT NUMBER	2. GOVT ACCESSION NO. <i>AD-A115 856</i>	3. RECIPIENT'S CATALOG NUMBER
4. TITLE (and Subtitle) US Army Armor Reference Data In Three Volumes Volume II Nondivisional Organizations		5. TYPE OF REPORT & PERIOD COVERED Special Text
		6. PERFORMING ORG. REPORT NUMBER ST 17-1-1
7. AUTHOR(s)	8. CONTRACT OR GRANT NUMBER(s)	
9. PERFORMING ORGANIZATION NAME AND ADDRESS Army Armor School Fort Knox, KY		10. PROGRAM ELEMENT, PROJECT, TASK AREA & WORK UNIT NUMBERS
11. CONTROLLING OFFICE NAME AND ADDRESS		12. REPORT DATE 1981
		13. NUMBER OF PAGES 147
14. MONITORING AGENCY NAME & ADDRESS (if different from Controlling Office)		15. SECURITY CLASS. (of this report) Unclassified
		15a. DECLASSIFICATION/DOWNGRADING SCHEDULE
16. DISTRIBUTION STATEMENT (of this Report)		
17. DISTRIBUTION STATEMENT (of the abstract entered in Block 20, if different from Report)		
18. SUPPLEMENTARY NOTES		
19. KEY WORDS (Continue on reverse side if necessary and identify by block number)		
20. ABSTRACT (Continue on reverse side if necessary and identify by block number)		

SECURITY CLASSIFICATION OF THIS PAGE(When Data Entered)

Accession For	
NSA/CSS	<input checked="" type="checkbox"/>
DoD	<input type="checkbox"/>
Other	<input type="checkbox"/>
FL 182 on file	
Distribution/	
Availability Codes	
Dist	Special
A	



SECURITY CLASSIFICATION OF THIS PAGE(When Data Entered)

INDIVIDUAL WEAPONS

Each Table of Organization and Equipment (TOE) provides that the personnel of the unit are to be armed with the rifle, 5.56mm unless otherwise indicated. Entries in the remarks column of Section II of the TOE designate specific individuals to be armed with a weapon, or weapons, other than the rifle. Rifle mounted grenade launchers, however, are authorized the squad, section, etc, in bulk for use as desired by the commander.

In this text, the following abbreviations are used to indicate the specific weapon(s) authorized each individual. Rifle grenade launchers have been included as an example of how this weapon may be distributed within the unit.

AR	Rifle, 5.56mm with bipod
GL	Launcher, grenade, M203
P	Pistol, caliber .45
R	Rifle, 5.56mm
Rev	Revolver, caliber .38
S	Submachinegun, caliber .45

SILHOUETTE IDENTIFICATION



Armored Reconnaissance Airborne Assault Vehicle (M1141)



Bridge and Launcher (AK-81160)



Carrier Ambulance (M11341)



Carrier (M1134R)



Carrier (M1134C)



Carrier Guided Missile ADA SP (Phalanx) (M130)



Carrier Guided Missile (TOW) (M1331)



Carrier Improved TOW Vehicle (M901)



Carrier Guided Missile ADA SP (Vulcan) (M741)



Carrier Missile (M106) (M106)



Carrier Guided Missile (M1)



Carrier (M1142)



Carrier (M1143)



Truck Transport (M1144)

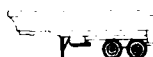

Semi-trailer Tank (M1145)

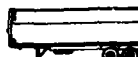

Semi-trailer Van (M1146)



Semi-trailer Van (M1147)



Semi-trailer Shop (M1148)



Semi-trailer and Trailer (M1149)



Semi-trailer Shop (M1150)



Semi-trailer Shop (M1151)



Semi-trailer Shop (M1152)

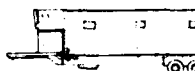

Truck (M1153)



Tank (M1154)

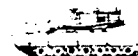

Tank (M1155)



Truck (M1156)



Truck (M1157)



Truck (M1158)



Truck (M1159)



Truck (M1160)



Truck (M1161)



Truck (M1162)



Truck (M1163)

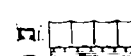

Truck (M1164)



Truck (M1165)



Truck (M1166)



Truck (M1167)



Truck (M1168)

TABLE OF CONTENTS
VOLUME II

TOE	Title	Page
CHAPTER 5.	ARMORED CAVALRY REGIMENT-----	311-364
17-51H	Armored Cavalry Regiment-----	312
17-52H	Headquarters and Headquarters Troop-----	314
30-114 (Draft)	Combat Electronics Warfare Intelligence Company-----	322
5-108H	Engineer Company-----	324
17-58H	Air Cavalry Troop-----	328
17-387H7	Attack Helicopter Company-----	334
17-55H	Armored Cavalry Squadron-----	340
17-56H	Headquarters and Headquarters Troop-----	342
17-57H	Armored Cavalry Troop-----	348
17-157H	Armored Cavalry Troop-----	352
17-27H	Tank Company-----	358
6-37H	Field Artillery Battery, 155-mm, SP-----	362
CHAPTER 6.	SEPARATE ARMORED BRIGADE-----	365-402
17-100H	Separate Armored Brigade-----	366
17-102H	Headquarters and Headquarters Company-----	368
5-127H	Engineer Company-----	376
29-75H	Support Battalion-----	382
29-76H	Headquarters and Headquarters Detachment-----	384
12-147H	Administration Company-----	386
8-147H	Medical Company-----	388
29-77H	Supply and Transport Company-----	390
29-79H	Maintenance Company-----	392
6-375H	Field Artillery Battalion, 155-mm, SP-----	394
6-376H	Headquarters and Headquarters Battery-----	396
CHAPTER 7.	AIR CAVALRY COMBAT BRIGADE-----	403-449
17-200H	Air Cavalry Combat Brigade-----	404
17-202H	Headquarters and Headquarters Troop-----	406
17-385H	Attack Helicopter Battalion-----	412
17-386H	Headquarters and Headquarters Company-----	414
17-387H	Attack Helicopter Company-----	418
17-205H	Air Cavalry Squadron-----	424
17-206H220	Headquarters and Headquarters Troop-----	426
17-208H	Air Cavalry Troop-----	432
11-59H	Signal Operations Company-----	438
29-155H	Support Battalion-----	440
29-156H	Headquarters and Headquarters Company-----	442
29-157H	Supply and Transportation Company-----	444
29-158H	Maintenance Company-----	446
55-417H	Transportation Aircraft Maintenance Company-----	448

TABLE OF CONTENTS
VOLUME III

<i>TOE</i>	<i>Title</i>	<i>Page</i>
CHAPTER 8.	Divisional Units, Division 86.....	451-512
	Armor Battalion	452
	Headquarters and Headquarters Company	454
	Tank Company	464
	Mechanized Infantry Battalion	470
	Headquarters and Headquarters Company	472
	Rifle Company	484
	Anti-Armor Company	488
	Armored Cavalry Squadron	492
	Headquarters and Headquarters Troop	494
	Armored Cavalry Troop	506
	Air Cavalry Troop	512
CHAPTER 9.	Armored Cavalry Regiment, Corps 86	515-551
	Armored Cavalry Regiment	516
	Headquarters and Headquarters Troop	520
	Armored Cavalry Squadron	526
	Headquarters and Headquarters Troop	528
	Armored Cavalry Troop	536
	Tank Company	542
	Combat Aviation Squadron	548
	Headquarters and Headquarters Troop	550
	Air Cavalry Troop	558
	Attack Helicopter Company	562
	Regimental Support Aviation Troop	566
	Field Artillery Battalion	570
	Headquarters and Headquarters Battery	572
	Field Artillery Battery	578
	Service Battery	582
	CEWI Company	588
	Engineer Company	592
	Air Defense Artillery Battery	598
	NBC Defense Company	602
	Support Squadron	606
	Headquarters and Headquarters Troop	608
	Administration Company	612
	Medical Company	616
	Supply and Transport Troop	620
	Maintenance Troop	624
CHAPTER 10.	TABLES	628-646
TABLES	1. Authorized TOE Equipment, Tank Platoon, Armored Cavalry Platoon, Scout Platoon	628
	2. Characteristics of Illumination Means	632
	3. Characteristics of Tank and Light Armor Vehicle Weapons	633
	4. Characteristics of Vehicles	634
	5. Characteristics of Individual and Crew-Served Weapons	635
	6. Characteristics of Antitank Weapons	637
	7. Characteristics of Mines	638
	8. Characteristics of Field Artillery and Air Defense Weapons	641
	9. Characteristics of Army Aircraft	642
	a. Characteristics of Army Airplanes	643
	b. Characteristics of Army Helicopters	644
	10. Characteristics of Helicopter Armament	645
	11. Standard Tactical Missions of Field Artillery	646
CHAPTER 11.	Troop List	647-656

CHAPTER 5

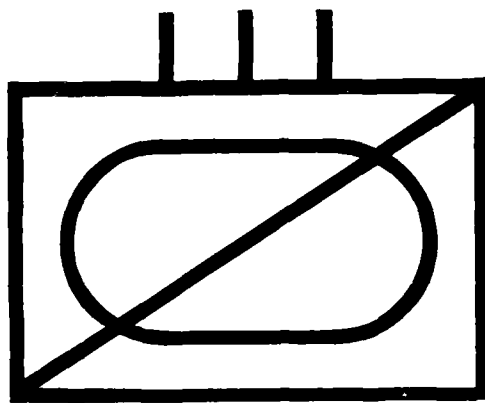

ARMORED CAVALRY REGIMENT

MISSION: To provide security and perform reconnaissance for the unit, which assigned to the field to provide offensive, defensive, delaying and economy of force operations required.

ASSIGNMENT: 1st Corps

APPROXIMATE: To provide security and reconnaissance operations for the unit, which assigned to the field to provide offensive, defensive, delaying and economy of force operations required.

312

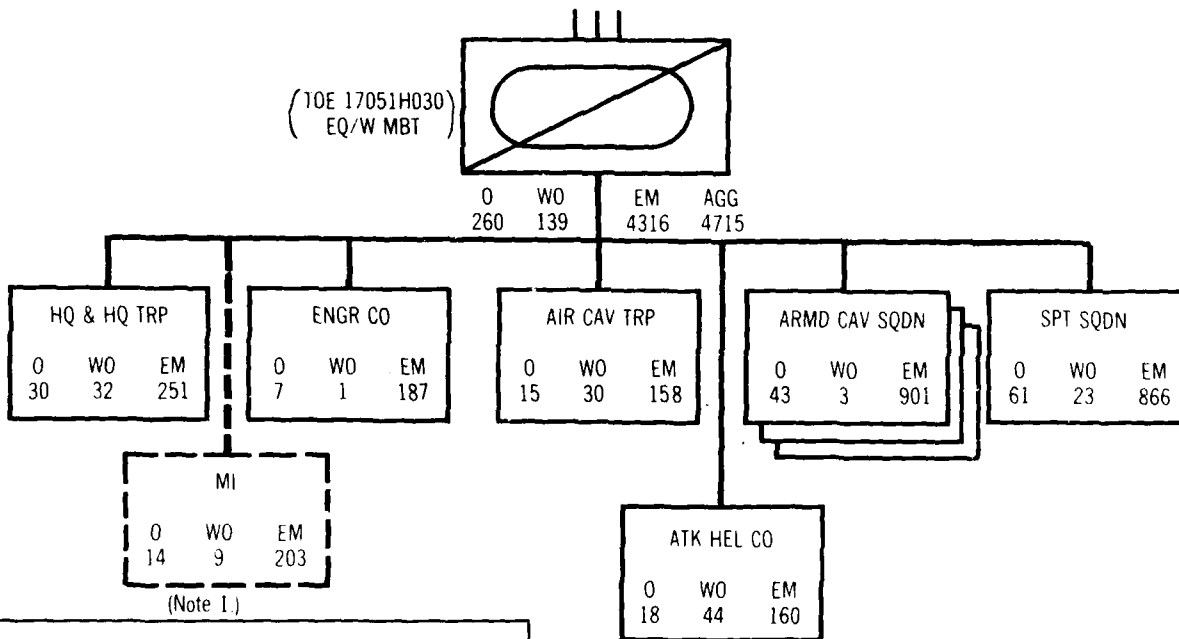

- Notes:
1. CEWI Co is test orgn. Not included in totals.
 2. Atk Hel Co is new addition to ACR.
 3. In USAREUR the Air Cav Troop is replaced by a Support Troop (Air), TOE 17-59H.

MISSION: Provide command, control, and support to the assigned aviation element.
 ASSIGNMENT: Organize, Administer, and Equip the Regiment (A1110).
 CAPABILITY: Provide command and control support to the assigned aviation element and support to the parent.

1. Provide command, control, and support to the assigned aviation element.
 2. Organize, Administer, and Equip the Regiment (A1110).
 3. Provide command and control support to the assigned aviation element and support to the parent.

314

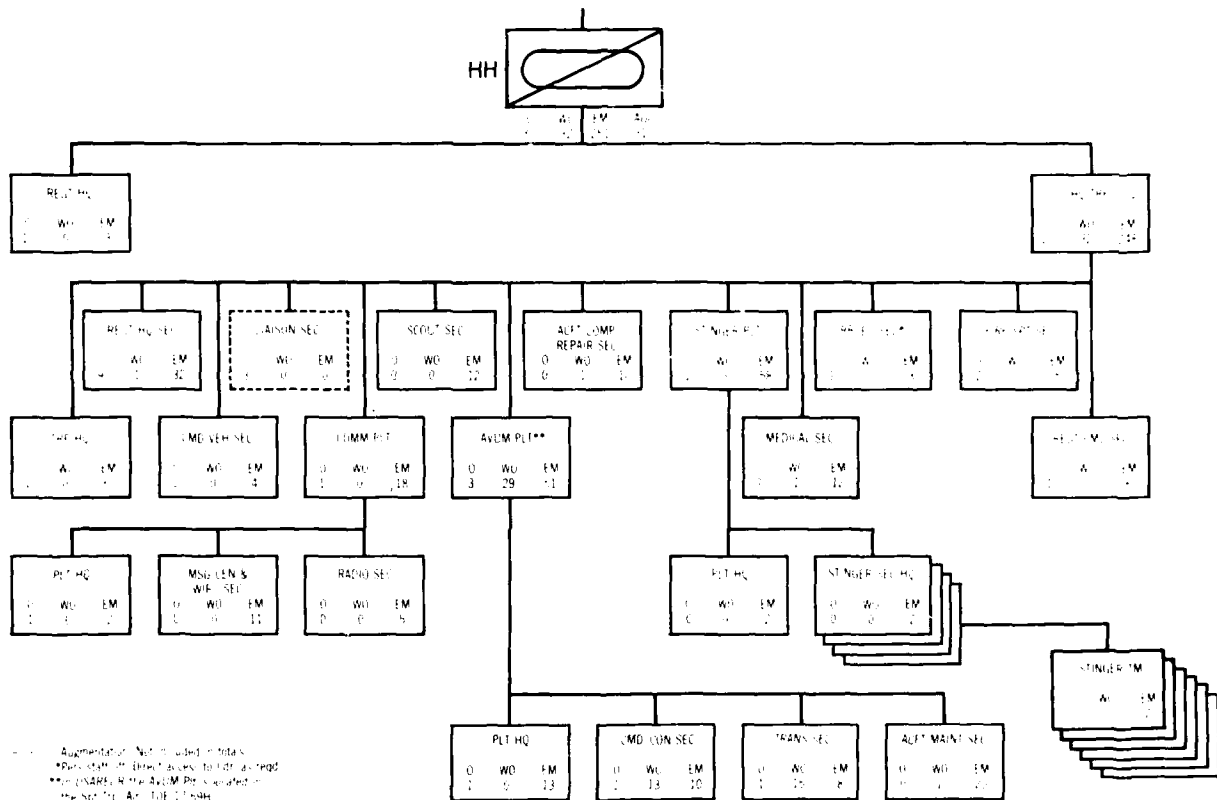

1. Augmentation Not Included in Total
 *Personnel in Brackets are to be assigned
 **Personnel in the Avium Plt is equal to the spot for Avium Plt only

SUMMARY OF EQUIPMENT

WEAPONS	
ARMT SUBSYS 7.62-MM MG LIGHT M23	13
LAUNCHER GRENADE M203	6
MACHINEGUN CAL .50 HB FLEX FOR GROUND USE	6
MACHINEGUN 7.62-MM AIRCRAFT LIGHT DOOR MTD	26
MACHINEGUN 7.62-MM FLEX	6
PISTOL CAL .45	55
REVOLVER CAL .38	51
RIFLE 5.56-MM	205
SUBMACHINEGUN CAL .45	2

VEHICLES AND VEHICLE EQUIPMENT	
CARRIER CP LT TRACK M577A1	6
CARRIER PERSONNEL FULL TRACK M113A1	2
CRANE WHEEL MTD 3-TON M63	1
KITCHEN FIELD TRLR MTD	1
RECOVERY VEHICLE LIGHT M578	1
TRAILER ACFT MAINT AMBL	1
TRAILER CARGO 1/4-TON M416	41
TRAILER CARGO 3/4-TON M101A1	1
TRAILER CARGO 1-1/2-TON M105A2	15
TRAILER TANK WATER 400-GAL M149A1	1
TRUCK AMBULANCE 1-1/4-TON M792	1
TRUCK CARGO 1-1/4-TON 6X6 M561	6
TRUCK CARGO 1-1/4-TON 4X4 w/60 AMP KIT M883	1
TRUCK CARGO 2-1/2-TON M35A2	9
TRUCK CARGO 5-TON 8X8 M656	6
TRUCK CARGO DROPSIDE 5-TON 6X6 w/WN M813A1	1
TRUCK UTILITY 1/4-TON M151A2	48
TRUCK VAN SHOP 2-1/2-TON 6X6 M109A3	2
TRUCK WRECKER 5-TON W/WN M816	1











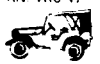

COMMUNICATION-ELECTRONICS EQUIPMENT	
ELECTRONIC TT SCTY EQUIPMENT TSEC/KW-7	3
RADIAC SET AN/PDR-27	1
RADIAC SET AN/PDR-56 (F)	1
RADIAC METER IM-93/UD	13
RADIAC METER IM-174/PD	7
RADIO SET AN/GRC-106	1
RADIO SET AN/GRC-160	2
RADIO SET AN/PRC-77	2
RADIO SET AN/PRC-90	38
RADIO SET AN/VRC-46	6
RADIO SET AN/VRC-47	36
RADIO SET AN/VRC-48	5
RADIO SET AN/VRC-49	1
RADIO SET AN/VRC-64	4
RADIO SET CONTROL GROUP AN/GRA-39	37
RADIO TT SET AN/GRC-142	1
RADIO TT SET AN/VSC-3	2
RECEIVING SET RADIO AN/URR-69	5
RECEIVER TRANSMITTER COM GP AN/GRA-6	1
SPEECH SCTY EQUIPMENT ABN TSEC/KY-28	10
SPEECH SCTY EQUIPMENT TSEC/KY-58	19
SPEECH SCTY EQUIPMENT TSEC/KY-57	77
SWITCHBOARD TEL MANUAL SB-86/P	1
TELEPHONE SET TA-1/PT	48
TELEPHONE SET TA-312/PT	28

AIRCRAFT	
HELICOPTER OBSERVATION OH-58A	6
HELICOPTER UTILITY UH-1H	13

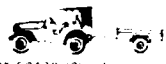
MISCELLANEOUS EQUIPMENT	
ALARM OML AGENT AUTO PTBL F/WHEEL VEH	5
DRUM FABRIC COLLAPSIBLE FUEL 500-GAL	6
FORWARD AREA REFUEL EQUIP (FARE)	2
NIGHT SIGHT CREW-SERVED WFN AN/TVS-5	3
NIGHT SIGHT INDIVIDUAL WFN AN/PVS-4	5
NIGHT VISION GOGGLES AN/PVS-5	57
TANK AND PUMP UNIT TRK MTD (1200-GAL)	1
TANK UNIT TRL MTD (600-GAL)	1



HEADQUARTERS AND HEADQUARTERS TROOP ARMORED CAVALRY REGIMENT

REGIMENTAL HEADQUARTERS, HEADQUARTERS SECTION

<p>2 TSEC/KY 57 AN/VRC 47</p>  <p>1 COL 12C00 (Regt Cdr) P 1 PFC 19D10 (Dvr) R</p> <p>AN/VRC 47 2 TSEC/KY 57</p>  <p>1 LTC 12C00 (Regt XO) P 1 PFC 19D10 (Dvr) R</p>	<p>TSEC/KY 57 AN/VRC 47</p>  <p>1 MAJ 12C00 (Regt S3) P 1 SP4 19D10 (Op Asst) (Dvr) R</p>	<p>TSEC/KY 57 AN/VRC 47</p>  <p>1 MAJ 92B00 (Regt S4) P 1 PFC 05C10 (RATT Op) R</p>	<p>TSEC/KY 57 AN/VRC 46</p>  <p>1 MAJ 56A00 (Chaplain) 1 SP6 71M30 (Sr Ch Act Sp) (Dvr) R</p>	<p>TSEC/KY 57 AN/VRC 46</p>  <p>1 CPT 56A00 (Chaplain) 1 SP5 71M20 (Ch Act Sp) (Dvr) R</p>	<p>TSEC/KY 57 AN/VRC 46</p>  <p>1 CPT 56A00 (Chaplain) 1 PFC 71M10 (Ch Act Sp) (Dvr) R</p>
<p>3 TSEC/KY 57 TSEC/KW 7 2 AN/VRC 46 AN/GRA 39 AN/VSC 3</p>  <p>1 CPT 12C00 (Asst S3) R 1 SGM 19Z50 (Op SGT) R 1 SGT 05C20 (RATT Tm Chief) R 1 SP4 05C10 (RATT Op) R 1 SP4 19D1U (Carr Dvr) P 1 PFC 05C10 (RATT Op) R</p>	<p>2 TSEC/KY 57 AN/GRA 39 AN/VRC 47</p>  <p>1 MAJ 15B12 (Avn Officer) Rev 1 CPT 12C00 (S3 Air) R 1 MSG 19Z50 (Asst Op SGT) R 1 SP4 71L10 (Clk Typist) R 1 SP4 19D1U (Carr Dvr) P 1 SP4 19D10 (Op Asst) R</p>	<p>2 TSEC/KY 57 AN/GRA 39 AN/VRC 47</p>  <p>1 MAJ 35A00 (Regt S2) P 1 CPT 35A00 (Asst S2) R 1 MSG 19Z50 (Intel SGT) R 1 SFC 19D40 (Asst Intel SGT) R 1 SP4 19D1U (Carr Dvr) P 1 SP4 71L10 (Clk Typist) R</p>	<p>3 TSEC/KY 57 TSEC/KW 7 AN/VSC 3</p>  <p>1 CPT 92B00 (Asst S4) R 1 MSG 76Z5K (Ch Sup SGT) R 1 SGT 05C20 (RATT Tm Chief) R 1 SP4 76Y10 (Gen Supplyman) R</p>	<p>AN/GRA 39 AN/VRC 47</p>  <p>1 WO 041A0 (Food Svc Tech) R 1 MSG 94B50 (Food Svc Supv) R 1 SP4 05C10 (RATT Op) R 1 SP4 19D1U (Carr Dvr) P 1 PFC 76Y10 (Gen Supplyman) R</p>	

Note Regt C-E Staff Off and Cml Off shown with respective sec







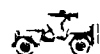
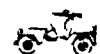
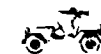

COMMAND VEHICLE SECTION

<p>2 TSEC/KY 57 AN/VRC 47</p>  <p>1 SSG 19D30 (Sec Ldr) P 1 SP4 19D1U (Carr Dvr) P</p>	<p>2 TSEC/KY 57 AN/VRC 47</p>  <p>1 SGT 19D20 (Veh Cdr) P 1 SP4 19D1U (Carr Dvr) P</p>
---	---

SCOUT SECTION

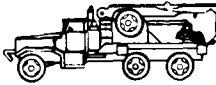

<p>TSEC/KY 57 AN/VRC 64</p>  <p>1 SSG 19D30 (Section Ldr) R 1 SP4 19D10 (Sct Dvr) R 1 PFC 19D10 (Scout) R. GL</p>	<p>TSEC/KY 57 AN/GRC 160</p>  <p>1 SGT 19D20 (Crew Ldr) R 1 SP4 19D10 (Sct Dvr) R 1 PFC 19D10 (Scout) R. GL</p>	<p>TSEC/KY 57 AN/VRC 64</p>  <p>1 SSG 19D30 (Squad Ldr) R 1 SP4 19D10 (Sct Dvr) R 1 PFC 19D10 (Scout) R. GL</p>	<p>TSEC/KY 57 AN/GRC 160</p>  <p>1 SGT 19D20 (Crew Ldr) R 1 SP4 19D10 (Sct Dvr) R 1 PFC 19D10 (Scout) R. GL</p>
--	---	--	--

TROOP HEADQUARTERS

<p>TSEC/KY 57 AN/VRC 46</p>  <p>1 CPT 12C00 (Trp Cdr) P 1 PFC 63C10 (Dvr) R</p>	<p>TSEC/KY 57 AN/VRC 46</p>  <p>1 LT 12C00 (XO) R 1 1SG 19Z5M (First Sergeant) R 1 SP5 75B20 (Unit Clk) R, GL 1 PFC 63C10 (Dvr) R 2 7.62 mm mty 3 cal 50 mg</p>	 <p>1 SFC 94B40 (Food Svc SGT) R 1 SP5 94B20 (Cook) R 1 SP4 94B10 (Cook) (Dvr) R</p>	 <p>1 SSG 94B30 (1st Cook) R 1 SP4 94B10 (Cook) (Dvr) R 2 PFC 94B10 (Cook) R</p>	<p>*</p>  <p>1 SSG 76Y30 (Sup SGT) R 1 SP4 76Y10 (Armorer) (Dvr) R, GL 1 PFC 76Y10 (Gen Supplyman) R</p>
<p>TSEC/KY 57 AN/VRC 64</p>  <p>1 SP4 63F20 (Sr Rcvy Veh Op) P, S 1 PFC 63F10 (Rcvy Veh Op) P, S</p>	 <p>1 SFC 63C40 (Mtr SGT) R 3 SGT 63C20 (Sr Track Veh Mech) R 1 SGT 76D10 (PLL Clerk) R 3 SP4 63C10 (Track Veh Mech) R 1 SP4 54E10 (Decon Eq Op) (Dvr) R 1 PFC 54E10 (Decon Eq Op) R</p>	 <p>1 SP4 63F10 (Wrecker Op) R</p>	<p>(5-ton Dropside)</p>  <p>5 PFC 63C10 (Asst Track Veh Mech) (Dvr) R 1 SP4 (LWVeh/Pwr Gen Mech) R 1 SGT (LWVeh/Pwr Gen Mech) R 1 PFC (LWVeh/Pwr Gen Mech) R</p>	<p>(w trk & trl mtd fuel units)</p>  <p>1 SP4 64C10 (Veh Dvr) R 1 SP4 (Eq Rcds Pts Spl) R</p>

317





FIRE SUPPORT SECTION

 <p>1 MAJ 13E00 (Fire Spt Off) P 1 SP4 13F10 (Fire Spt Sp) (Dvr) R</p>	<p>2 TSEC/KY 57 AN/GRA 6 2 AN/GRA 39 AN/GRC 106 AN/VRC 47</p>  <p>1 CPT 13E00 (Target Analyst) R 1 SFC 13F40 (Fire Spt SGT) R 1 SP4 05B1U (Rdo Op) (Dvr) R 1 SP4 13F10 (Fire Spt Sp) R 1 PFC 05B10 (Rdo Op) R</p>
---	--

RR/EO SEC

1 MAJ 41C00 (RR/EO Officer) P
1 SFC 00U40 (EO NCO) R
1 SSG 00U30 (EO NCO) R
1 SP4 71L10 (Clk Typist) R

AIRCRAFT COMP REPAIR SECTION

 <p>1 WO 160A0 (Act Rep Tech) R 1 SP4 76D10 (Mat Supply Sp) R 1 PFC 68F10 (Act Electrician) (Dvr) R</p>	 <p>1 SFC 68K40 (Act Comp Rep Supv) R 1 SP4 68G10 (Act Structural Rep) R 1 PFC 68H10 (Act Pneudraulics Rep) R 1 PFC 68G10 (Structural Rep) (Dvr) R</p>
 <p>1 SSG 67W3F (Act Qual Cn Supv) R 1 SP4 (Hel Wpn Sys Op) R 1 PFC 68D10 (Pwrtrain Rep) (Dvr) R</p>	 <p>1 Si 4 68B10 (Act Pwrplant Rep Op) R</p> 

*Mounts TOE cal 50 mg on ring mount

AVIATION UNIT MAINTENANCE PLATOON

PLATOON HEADQUARTERS

2 TSEC KY 57
1 TSEC KY 58
AN PRC 71
2 AN PRC 90



1 CPT 71A00 (Platoon Cdr) Rev
1 SGT 67N2F (Crew Chief) Rev
M23

TSEC KY 57
AN VRC 46



1 SFC 67240 (Platoon SGT) R
1 SP5 71P20 (Fit Op Spv) Dvr R

TSEC KY 57
AN VRC 47

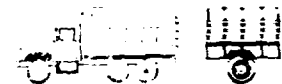

1 SSG 6738 (Materiel Supv) Rev
1 SSG 67N2F (Crew Chief) Rev



1 SFC 71A20 (Auto Sv Supv) R
1 PFC 71P20 (Auto Sv Cmn) (Dvr) R



1 SP4 71W10 (Auto Equip Hdq) (Dvr) R



1 PFC 71W10 (Auto Equip Hdq) (Dvr) R
1 Drum Eqr
1 TARE

COMMAND AND CONTROL SECTION

TSEC KY 58
TSEC KY 28
2 AN PRC 90



1 LT 15B12 (Section Cdr) Rev
1 WO 100B0 (UH Pilot) Rev
1 SGT 67N2F (Crew Chief) Rev
M23

TSEC KY 58
TSEC KY 28
2 AN PRC 90

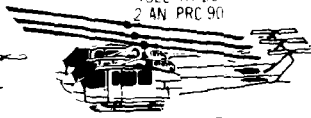

2 WO 100B0 (UH Pilot) Rev
1 SGT 67N2F (Crew Chief) Rev
M23

TSEC KY 58
TSEC KY 28
2 AN PRC 90



1 WO 100B0 (UH Pilot) Rev
2 SGT 67N20 (UH Rep) Rev
3 SP4 67V10 (UH M Rep) R
1 PFC 67N20 (UH M Rep) R

TSEC KY 58
TSEC KY 28
2 AN PRC 90

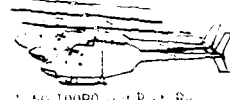

1 WO 100B0 (UH Pilot) Rev

TRANSPORT SECTION

TSEC KY 28
2 AN PRC 90



1 LT 15B12 (Section Cdr) Rev
1 WO 100BB (Fit Sfty Tech) Rev
1 SGT 67N2F (Crew Chief) Rev
M23

TSEC KY 28
2 AN PRC 90



2 WO 100BC (Instr Pilot) Rev
1 WO 100BF (Inst Exam) Rev
1 SGT 67N2F (Crew Chief) Rev
M23

TSEC KY 28
2 AN PRC 90



2 WO 100B0 (UH Pilot) Rev
1 SGT 67N2F (Crew Chief) Rev
M23

TSEC KY 28
2 AN PRC 90



2 WO 100B0 (UH Pilot) Rev
1 SGT 67N2F (Crew Chief) Rev
M23

AIRCRAFT MAINTENANCE SECTION

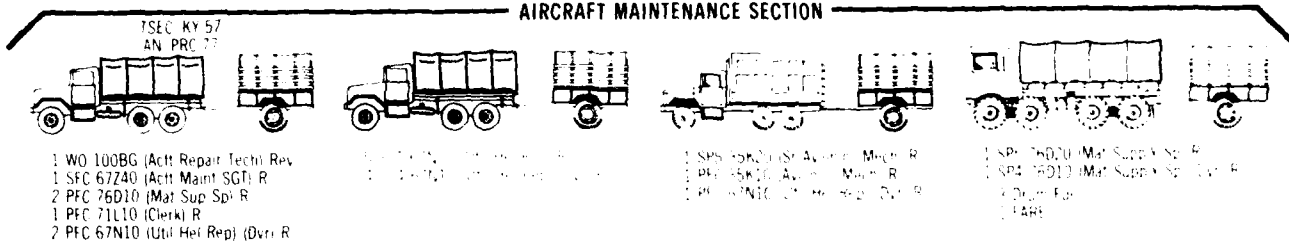

REGIMENTAL MEDICAL SECTION

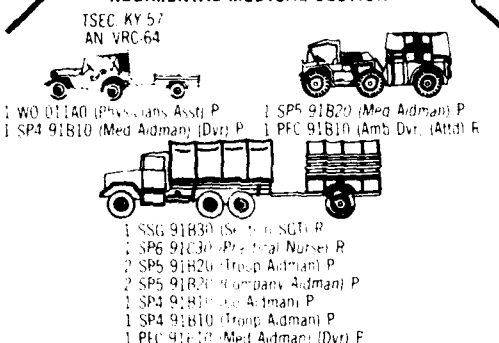

MANPADS PLT

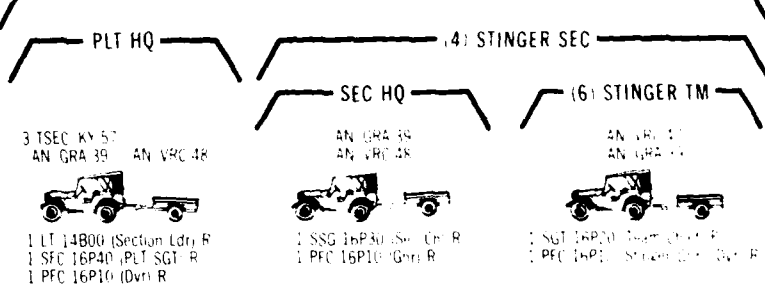

REGIMENTAL COMMUNICATION PLATOON

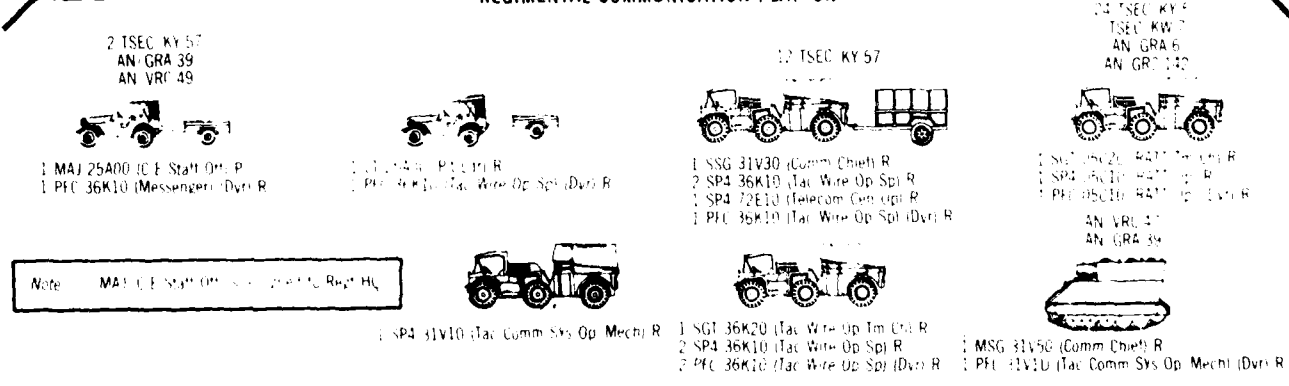

613

REGIMENTAL CHEMICAL SECTION

1 MAJ 74A00 (Chemical Off) P
1 LT 74A00 (Asst Cml Off) R
2 SFC 54E40 (NBC Op/Staff NCO) R
1 SSG 54E30 (Plotter) R
1 SGT 54E20 (NBC Op NCO) R
1 SGT 54E20 (Computer) R
1 SP4 71L10 (Clerk Typist) R

Note. MAJ, Cml Off, is assigned to Regt HQ

Notes:

SUMMARY OF EQUIPMENT

WEAPONS		ENGINEER EQUIPMENT	
GUN DEMOLITION 165-MM BII	3	BOAT RECON PNEUMATIC 3-MAN	1
LAUNCHER GRENADE SMOKE M257	2	GRADER ROAD MOTORIZED HVY	1
LAUNCHER GRENADE M203	22	LOADER SCOOP DSL 2-1/2-CU YD	1
LAUNCHER GRENADE CEV MTD M239	5	TRACTOR FULL TRACK DSL MDM	1
MACHINEGUN CAL .50 HB FLEX VEH MTD	3	TRACTOR WHL IND DSL W/BACKHOE AND LOADER	1
MACHINEGUN CAL .50 VEH FIXED	9		
MACHINEGUN 7.62-MM FLEX	4	COMMUNICATION-ELECTRONICS EQUIPMENT	
MACHINEGUN 7.62-MM VEH FIXED	3	RADIOMETER IM-93/UD	14
PISTOL CAL .45	29	RADIOMETER IM-174/PD	11
RIFLE 5.56-MM	166	RADIO SET AN/GRC-160	4
SUBMACHINEGUN CAL .45	6	RADIO SET AN/PRC-77	3
TRACKER IR GUIDED MSL SU-36 (DRAGON)	6	RADIO SET AN/VRC-46	2
		RADIO SET AN/VRC-47	6
VEHICLES AND VEHICLE EQUIPMENT		RADIO SET AN/VRC-64	6
BRIDGE AVLB SCISSOR CL60 60-FT SPAN	2	SPEECH SFTY EQUIP TSEC/KY-57	40
CARRIER CP LT TRACK M577A1	1	SWITCHBOARD TEL MANUAL SR-22/PT	1
CARRIER PERSONNEL FULL TRACK M113A1	9	SWITCHBOARD TEL MANUAL SR-993/GT	1
COMBAT ENGINEER VEHICLE FULL TRACK M72B	3	TELEPHONE SET TA-1/PT	1
KITCHEN FIELD TRAILER MMTD	1	TELEPHONE SET TA-312/PT	11
LAUNCHER M60 SERIES FOR AVLB	2		
SEMITRAILER LOW BED 25-TON M172A1	2	MISCELLANEOUS EQUIPMENT	
SHOE EQUIP CONTACT MAT TRK MTD	1	ALARM OML AGENT AUTO PTRL 3-WHEEL VEH	1
TRAILER AMMO 1-1/2-TON 332	9	DETECTING SET MINE PTRL AN/PSS-7	2
TRAILER CARGO 1/4-TON M416	7	DETECTING SET MINE PTRL AN/PSS-11	2
TRAILER CARGO 1-1/2-TON M105A2	1	NIGHT SIGHT CREW-SERVED WEN AN/PVS-5	12
TRAILER TANK WATER 400-GAL M149	1	NIGHT SIGHT INDIVIDUAL WEN AN/PVS-4	10
TRUCK CARGO 1-1/4-TON 6X6 M561	2	NIGHT VISION GOGGLES AN/PVS-5	19
TRUCK CARGO 2-1/2-TON M35A2	3	NIGHT VISION SIGHT-TRACKER IR AN/TAS-5	4
TRUCK CARGO DRUMS/DRUMS 5-TON 6X6 W/WN M113A1	1	SEARCHLIGHT AN/VSS-1	1
TRUCK CARGO 5-TON 8X8 M656	1	TANK AND PUMP UNIT TRK MTD (1200-GAL)	1
TRUCK DUMP 5-TON 6X6 M817	4	TANK UNIT TRK MTD (600-GAL)	1
TRUCK LIFT FORK 10,000 LBS CAP	1		
TRUCK TRACTOR 10-TON 6X6 W/MIDSHIP WN M123A1C	2		
TRUCK UTILITY 1/4-TON M151A2	7		
TRUCK WRECKER 5-TON 6X6 W/WN M816	1		

ENGINEER COMPANY ARMORED CAVALRY REGIMENT

COMMAND SECTION

TSEC KY 57
AN VRC 46



1 MAJ 12B40 (C) (C) P
1 PFC 12B30 (D) (V) R

3 TSEC KY 57
AN VRC 47



1 SFC 12B40 (Op) SGT R
1 NSG 12B30 (Const Em) R
1 PFC 12B10 (C) (V) R

TSEC KY 57
AN VRC 47



1 MAJ 12B40 (C) (C) P
1 NSG 12B30 (Const Em) R
1 PFC 12B10 (C) (V) R

REGT ENGR SEC

TSEC KY 57
AN VRC 46



1 CPT 12A00 (Asst Regt Engr) R
1 SSG 12B10 (C) (V) R
1 PFC 12B30 (D) (V) R

COMPANY HEADQUARTERS

AN VRC 46



1 CPT 12A00 (C) (C) P
1 SSG 12B10 (C) (V) R
1 PFC 12B30 (D) (V) R



1 SN1 127AM (C) (V) SGT R
1 SN1 31130 (Const Equip) R
1 SP4 79110 (Asst) R
1 SP4 36K10 (Tr. W/Equip) R
1 PFC 79110 (Gen. Support) (D) (V) R
1 PFC 36K10 (Tr. W/Equip) R
1 SGT 79110 (Asst) SGT R
1 SP4 31110 (Tr. Equip) R
1 SP4 31110 (Tr. Equip) R
1 SGT 36K10 (Tr. W/Equip) R
1 PFC 36K10 (Tr. W/Equip) R



1 SGT 12A00 (Asst Regt Engr) R
1 SSG 12B10 (C) (V) R
1 SSG 12B10 (C) (V) R
1 SSG 12B10 (C) (V) R
1 PFC 12B30 (D) (V) R

EQUIP/MAINT PLATOON

PLT HQ



1 CPT 12A00 (Plt Ldr) R
1 SSG 12B40 (Plt SGT) R
1 PFC 12B30 (D) (V) R

5 Ton Drop Side



1 SGT 62N40 (Const Eq Supt) R
1 SP4 64E10 (Decor Eq Op) R
1 PFC 64E10 (Decor Eq Op) (D) (V) R
1 PFC 62E10 (Const Eq Op) R



1 SGT 62E20 (Const Eq Op) (D) (V) R



1 SGT 62E20 (Const Eq Op) R
1 SP4 64E10 (Decor Eq Op) R

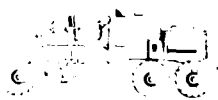

1 SP4 62J10 (Gen. Const. Mach Op) R



1 SP4 62E10 (Const Eq Op) R



1 PFC 62E10 (Const Eq Op) R



1 SP4 62E10 (Const Eq Op) R

CEV SECTION

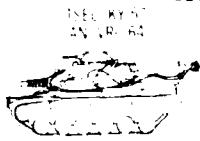

1 SEC KY 57
AN VRI 42



1 SEC KY 57
AN VRI 42

AVLB SECTION



1 SEC KY 57
AN VRI 42

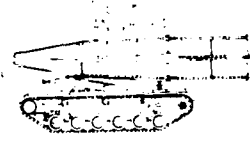

1 SEC KY 57
AN VRI 42

MAINTENANCE SEC



1 SEC KY 57
AN VRI 42

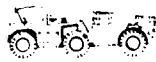

1 SEC KY 57
AN VRI 42



1 SEC KY 57
AN VRI 42



1 SEC KY 57
AN VRI 42



1 SEC KY 57
AN VRI 42

(3) ENGINEER PLATOON

(3) PLT HQ

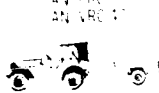

1 SEC KY 57
AN VRI 42



1 SEC KY 57
AN VRI 42

(9) ENGINEER SQUAD

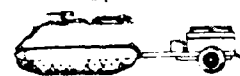

1 SEC KY 57
AN VRI 42

328

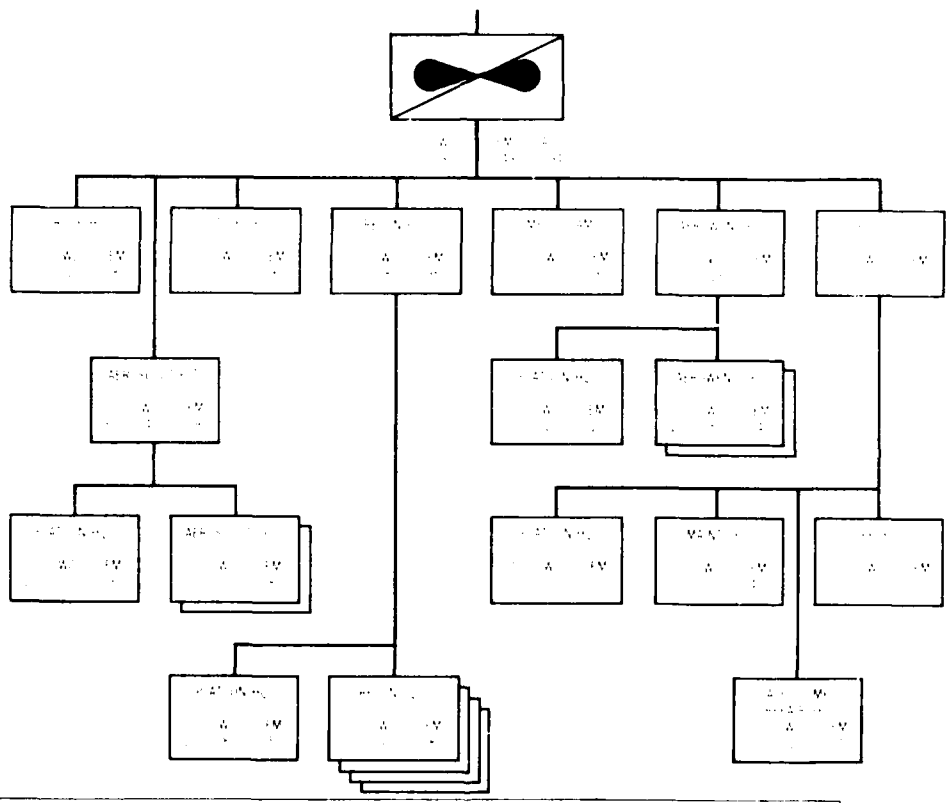

A B C D E F G H I J K L M N O P Q R S T U V W X Y Z
 1 2 3 4 5 6 7 8 9 10 11 12 13 14 15 16 17 18 19 20 21 22 23 24 25 26 27 28 29 30 31 32 33 34 35 36 37 38 39 40 41 42 43 44 45 46 47 48 49 50 51 52 53 54 55 56 57 58 59 60 61 62 63 64 65 66 67 68 69 70 71 72 73 74 75 76 77 78 79 80 81 82 83 84 85 86 87 88 89 90 91 92 93 94 95 96 97 98 99 100

AIR CAVALRY TROOP

TROOP HQ

MESS TEAM

TSEC KY 47
AN PRC 06
TSEC KY 49

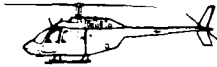

1 MAJ 15B12 (Troop Cdr) Rev
1 WO1 10086 (Plt Stry Tech) Rev
1 SP4 67V01 (Crew Chief) Rev
MCR

TSEC KY 57
AN VRC 47



1 PVT 15B12 (XO) Rev
1 SSG 1975M (First Sergeant) R
1 SP5 75B20 (Unit CL) (Dvr) R
SU 36



1 SSG 7444 (Supply SGT) R
1 SGT 94E01 (NBC Op App) R
1 SP4 74D01 (Stry Op) R
1 SP4 7441 (Armored R) R
1 PFC 74Y01 (Gen Supplyman) (Dvr) R



1 SSG 4242 (Supply SGT) R
1 SGT 42E01 (NBC Op App) R
1 SP4 42D01 (Stry Op) R
1 SP4 4241 (Armored R) R
1 PFC 42Y01 (Gen Supplyman) (Dvr) R

FLIGHT OPERATIONS SECTION

AN VRC 47
TSEC KY 38



1 CPT 15B12 (Plt Op Off) Rev
1 SP4 71P10 (Plt Op Spj) (Dvr) R

TSEC KW 7
3 TSEC KY 57
AN GRA 39
AN GRC 14
AN VRC 47



1 SSG 05V30 (Comm Chief) R
1 SGT 05C20 (RATT Trn Chief) R
1 SP4 05C10 (RATT Op) (Dvr) R
1 PFC 05C10 (RATT Op) R



1 SSG 19D40 (Plt Sgt) (Dvr) R

*Mounts 10E cal. 50 mm on ring mount

AEROSCOUPT PLATOON

PLATOON HQ

TSEC KY 58 AN PRC 77
TSEC KY 57 2 AN PRC 90



1 CPT 15B12 (Plt Cdr) Rev
1 SFC 72F (Plt SGT) Rev
1 SGT 19D2F (Sct Obsr) Rev
1 SP4 67V1F (Sct Hel Repl) Rev

TSEC KY 57
AN PRC 77
2 AN PRC 90



1 LT 15B12 (Sec Cdr) Rev
1 SGT 19D2F (Sct Obsr) Rev

TSEC KY 57
2 AN PRC 90



1 WO 100BH (Hel Pilot) Rev
1 SGT 67V20 (Sct Hel Repl) Rev
1 SGT 19D2F (Sct Obsr) Rev

TSEC KY 57
2 AN PRC 90



1 LT 15B12 (Team Ldr) Rev
1 SGT 19D2F (Sct Obsr) Rev

TSEC KY 57
2 AN PRC 90

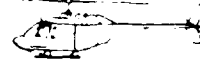

1 WO 100BH (Hel Pilot) Rev
1 SGT 67V20 (Sct Hel Repl) Rev
1 SGT 19D2F (Sct Obsr) Rev

AEROSCOUPT SECTION

AN PRC 77 TSEC KY 58
2 AN PRC 90 TSEC KY 57



1 LT 15B12 (Sec Cdr) Rev
1 SGT 19D2F (Sct Obsr) Rev
1 SP4 67V10 (Sct Hel Repl) Rev

TSEC KY 58
2 AN PRC 90



1 WO 100BH (Hel Pilot) Rev
1 SGT 67V2F (Sct Hel Repl) Rev
1 SGT 19D2F (Sct Obsr) Rev
1 SP4 67V10 (Sct Hel Repl) Rev

TSEC KY 58
2 AN PRC 90



1 LT 15B12 (Team Ldr) Rev
1 SGT 19D2F (Sct Obsr) Rev
1 SP4 67V10 (Sct Hel Repl) Rev

TSEC KY 58
2 AN PRC 90



1 WO 100BC (Hel Pilot) Rev
1 SGT 67V2F (Sct Hel Repl) Rev
1 SGT 19D2F (Sct Obsr) Rev
1 SP4 67V10 (Sct Hel Repl) Rev

NOTE Each helicopter equipped with one M16A1 rifle w/ grenade launcher, one 7.62 mm mg, M60, and one speech set equip. TSEC KY 28

RECON PLATOON

PLATOON HEADQUARTERS

TSEC KY 58
2 TSEC KY 57
2 AN PRC 77
3 AN PRC 90



1 CPT 15B12 (Plt Cdr) Rev
1 WO 100BF (Inst Exam) Rev
1 WO 100BC (Instr Pilot) Rev
1 SFC 19D40 (Plt SGT) R
1 SGT 67N2F (Crew Chief) Rev
M23
1 M202
1 AN PAS 7

TSEC KY 58 2 AN PRC 77
2 TSEC KY 57 3 AN PRC 90



2 WO 100BO (Hel Pilot) Rev
1 SGT 67N2F (Crew Chief) Rev
M23

(3) RECON SQD

1 SSG 19D30 (Sgt Ldr) R
1 SGT 19D2F (Sct Obsr) R
1 SP4 19D10 (Sct R)
1 PFC 19D10 (Sct R)

AEROWEAPONS PLATOON

PLATOON HQ

1 SGT 67000 (AN PR) R
1 SGT 67001 (AN PR) R



1 SGT 67000 (Plt Supt) R
1 WO 10000 (Plt Supt) R
1 WO 10001 (Plt Supt) R
1 WO 10002 (Plt Supt) R
1 WO 10003 (Plt Supt) R
1 WO 10004 (Plt Supt) R
1 WO 10005 (Plt Supt) R
1 WO 10006 (Plt Supt) R
1 WO 10007 (Plt Supt) R
1 WO 10008 (Plt Supt) R
1 WO 10009 (Plt Supt) R
1 WO 10010 (Plt Supt) R

(2) AEROWEAPONS SECTION

1 SGT 67000 (AN PR) R
1 SGT 67001 (AN PR) R



1 LT 15812 (Sgt Comd Rev)
1 WO 10000 (Host Exam Rev)
1 WO 10001
1 WO 10002
1 WO 10003
1 WO 10004
1 WO 10005
1 WO 10006
1 WO 10007
1 WO 10008
1 WO 10009
1 WO 10010



1 WO 10000 (Hel Photo Rev)
1 WO 10001
1 WO 10002
1 WO 10003
1 WO 10004
1 WO 10005
1 WO 10006
1 WO 10007
1 WO 10008
1 WO 10009
1 WO 10010

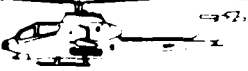

1 WO 10000 (Hel Photo Rev)
1 WO 10001
1 WO 10002
1 WO 10003
1 WO 10004
1 WO 10005
1 WO 10006
1 WO 10007
1 WO 10008
1 WO 10009
1 WO 10010

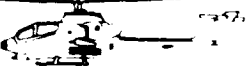

1 WO 10000 (Hel Photo Rev)
1 WO 10001
1 WO 10002
1 WO 10003
1 WO 10004
1 WO 10005
1 WO 10006
1 WO 10007
1 WO 10008
1 WO 10009
1 WO 10010

1 SGT 67000 (AN PR) R
1 SGT 67001 (AN PR) R

SERVICE PLATOON

PLATOON HQ AND MAINTENANCE SECTION

1 SGT 67000 (AN PR) R
1 SGT 67001 (AN PR) R



1 SGT 67000 (Plt Supt) R
1 WO 10000 (Plt Supt) R
1 WO 10001 (Plt Supt) R
1 WO 10002 (Plt Supt) R

1 SGT 67000 (AN PR) R
1 SGT 67001 (AN PR) R

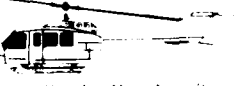

1 WO 10000 (Hel Photo Rev)
1 WO 10001 (Hel Photo Rev)
1 WO 10002 (Hel Photo Rev)
1 WO 10003 (Hel Photo Rev)
1 WO 10004 (Hel Photo Rev)
1 WO 10005 (Hel Photo Rev)
1 WO 10006 (Hel Photo Rev)
1 WO 10007 (Hel Photo Rev)
1 WO 10008 (Hel Photo Rev)
1 WO 10009 (Hel Photo Rev)
1 WO 10010 (Hel Photo Rev)

(5 ton)

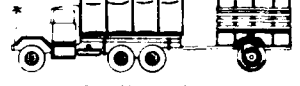

1 SGT 67000 (AN PR) R
1 SGT 67001 (AN PR) R
1 WO 10000 (Hel Photo Rev)
1 WO 10001 (Hel Photo Rev)
1 WO 10002 (Hel Photo Rev)
1 WO 10003 (Hel Photo Rev)
1 WO 10004 (Hel Photo Rev)
1 WO 10005 (Hel Photo Rev)
1 WO 10006 (Hel Photo Rev)
1 WO 10007 (Hel Photo Rev)
1 WO 10008 (Hel Photo Rev)
1 WO 10009 (Hel Photo Rev)
1 WO 10010 (Hel Photo Rev)

(5 ton)



1 SGT 67000 (AN PR) R
1 SGT 67001 (AN PR) R
1 WO 10000 (Hel Photo Rev)
1 WO 10001 (Hel Photo Rev)
1 WO 10002 (Hel Photo Rev)
1 WO 10003 (Hel Photo Rev)
1 WO 10004 (Hel Photo Rev)
1 WO 10005 (Hel Photo Rev)
1 WO 10006 (Hel Photo Rev)
1 WO 10007 (Hel Photo Rev)
1 WO 10008 (Hel Photo Rev)
1 WO 10009 (Hel Photo Rev)
1 WO 10010 (Hel Photo Rev)



1 SSG 68M30 (Hel Wpn Sys Supt) R
1 SP5 68K20 (Sr Avionics Mech) R
1 SP4 68V10 (Obsr Sct Hel Rep) R
1 PFC 68N10 (Avionics Mech) R
1 PFC 68N11 (Hel Rep) (Dvr) R



1 SSG 68V30 (Sgt Hel Tech Insp) Rev
1 SGT 68M30 (Act Wpn Sys Rep Rev)
1 SGT 68J20 (Act Fire Ct Rep) R
1 SP4 68M10 (Act Wpn Sys Rep) R
1 SP4 68J10 (Act Fire Ct Rep) R
2 PFC 68M10 (Act Wpn Sys Rep) R
2 PFC 68J10 (Act Fire Ct Rep) R

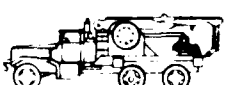

1 SGT 68K (Platoon Wpn Mech) R
1 SP4 68L (Platoon Wpn Mech) (Dvr) R

* Mounts TOE (at 50 mg on 100 mg mount)

SUPPLY SECTION

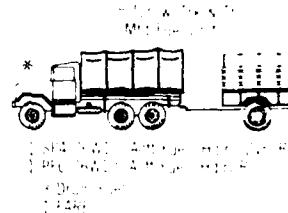
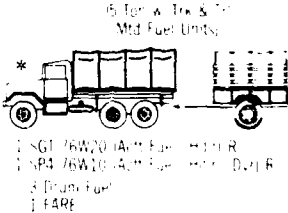
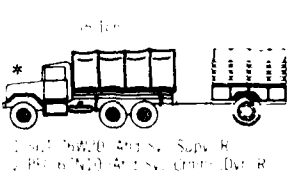
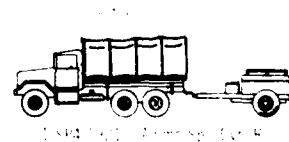
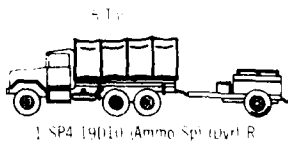
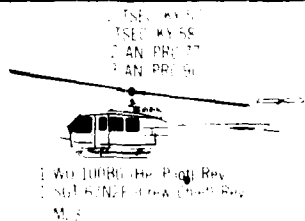

AIRCRAFT COMPONENTS REPAIR SECTION

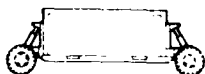
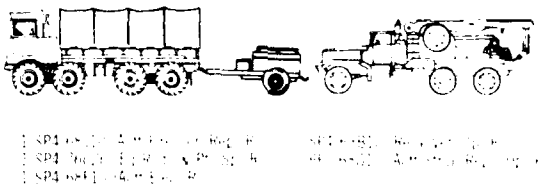
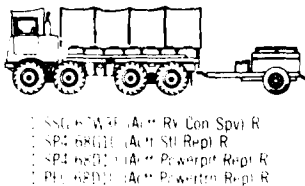
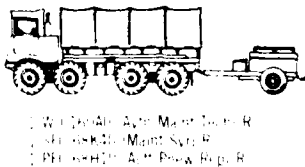

*Mounts TOE car 50 mg on engine mount

1. The purpose of this report is to provide a summary of the activities of the unit during the reporting period. This report is prepared by the unit commander and is submitted to the higher command. It should be prepared in a clear and concise manner and should include all significant events and activities.

2. This report is prepared in accordance with the instructions of the higher command. It should be prepared in a clear and concise manner and should include all significant events and activities.

334

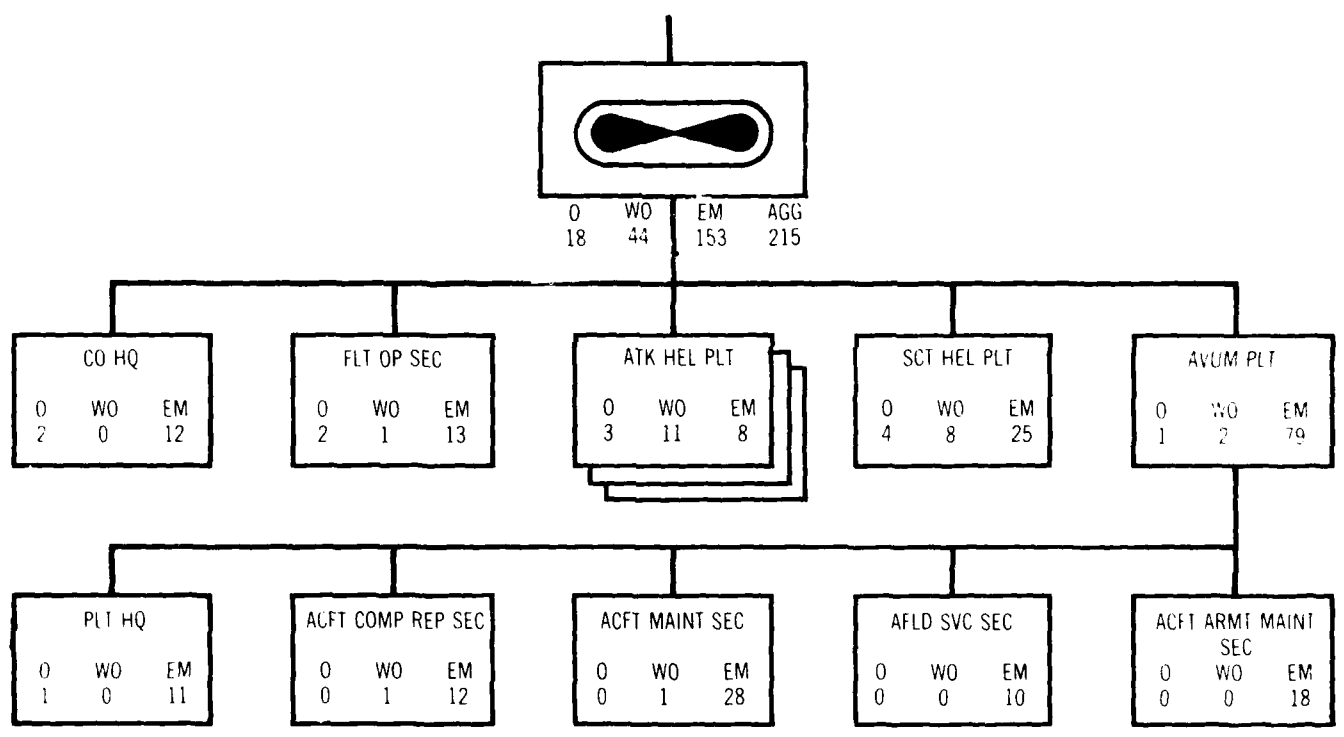

COMPANY HEADQUARTERS

1 TSEC KY 57
AN VRC 47



1 MA 15810 (Op) Rev
1 PFC 15810 (Supv) R (Dvr) R



1 CPT 15810 (Op) Rev
1 SGT 174M (1st Sgt) R
1 SP4 15810 (Wrt) R
1 PFC 15810 (Pwr) R (Wrt) Mech R

1 T40000000



1 SSG 15810 (M) R
1 SGT 15810 (Pwr) R (Wrt) Mech R
1 PFC 15810 (Wrt) R



1 SSG 15810 (M) R
1 SGT 15810 (Pwr) R (Wrt) Mech R
1 PFC 15810 (Wrt) R

FLIGHT OPERATIONS SECTION

1 TSEC KY 57
AN VRC 46



1 CPT 15810 (Op) Rev
1 PFC 15810 (Fit Op) Spl (Dvr) R (GL)

1 TSEC KY 57 1 TSEC KY 58
1 AN GRA 39 1 AN GRA 6
1 AN GPC 106 1 AN VRC 47
1 AN VRC 24



1 SSG 15810 (Comm) Chief R
1 SGT 15810 (Comm) R (Op) Supv R
1 SP4 15810 (Comm) Sys Op Mech R
1 SP4 15810 (Radio Op) (Dvr) R
1 PFC 15810 (Radio Op) R

1 TSEC KY 58
1 AN GRA 90



1 LT 15810 (Fit Op) Rev
1 SGT 15810 (Pwr) Rev
M23



1 SFC 71P40 (Fit Op) Chief R
1 SP4 71P10 (Fit Op) Spl R
1 SP4 71110 (Clerk Typist) R
1 SP4 36K10 (Fac Wire Op) Spl (Dvr) R
1 PFC 36K10 (Fac Wire Op) Spl R (GL)

1 TSEC KY 58
1 AN GRA 90



1 MA 15810 (Op) Rev
1 SGT 15810 (Pwr) Rev
M23

SERVICE PLATOON
PLATOON HEADQUARTERS

1 SEC KY 58
2 AN PRC 30



1 CPT 71A00 (Plt Ldr) Rev
1 SGT 67N2F (Crew Chief) Rev
M23

2 TSEC KY 57
AN VRC 37



1 SSG (Utl Hel Tech Insp) R
1 SFC 67240 (Plt SGT) R
1 SP4 76D10 (Plt Clerk) (Dvr) R



1 SSG 67240 (Qual Trn Supv) Rev
1 SSG 67240 (Sgt Hel Tech Insp) Rev
4 SSG 67240 (Atk Hel Tech Insp) Rev

AIRCRAFT MAINTENANCE SECTION



1 WO 100EG (Act Repair Tech) Rev
1 SGT 67Y20 (Atk Hel Rep) R
2 SP5 76C20 (Eq Red & Pts Sp) R
2 SP4 76C10 (Eq Red & Pts Sp) R
3 PFC 67Y10 (Atk Hel Rep) R
2 PFC 35K10 (Avionics Mech) R
2 PFC 76C10 (Eq Red & Pts Sp) R



1 SFC 67240 (Section Chief) R
1 SGT 67N20 (Utl Hel Rep) R
1 SP5 35K20 (Avionics Mech) R
4 SP4 67Y10 (Atk Hel Rep) R
1 SP4 67N10 (Utl Hel Rep) R
1 SP4 67V10 (Obst Sect Hel Rep) R
3 PFC 67N10 (Utl Hel Rep) R



1 SP4 68B10 (Act Maint) R (G)

AIRCRAFT COMPONENT REPAIR SECTION



1 WO 160A0 (Avn Maint Tech) R
1 SFC 67240 (Maint Supv) R



1 SP4 68B10 (Act Pwrplant Rep) R
1 SP4 68G10 (Act Struc Rep) R
1 SP4 76C10 (Eq Red & Pts Sp) R

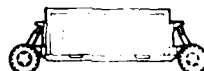

1 SP4 68D10 (Hel Pwrplant Rep) R
1 PFC 68F10 (Act Electrician) R
1 PFC 68H10 (Pneumatics Rep) R

1 PFC 68D10 (Act Pwrplant Rep) R
1 PFC 68B10 (Act Pwrplant Rep) R
3 PFC 68G10 (Act Struc Rep) R

AIRFIELD SERVICE SECTION

TSEC: KY 57
AN/PRC 77



- 1 SSG 76W30 (Section Chief) R
- 1 SP4 76W10 (Actt Fuels Hdr) (Dvr) R
- 1 SP4 67N10 (Veh Dvr) R
- 1 PFC 55B10 (Ammo Stor Asst) (Dvr) R



- 2 SGT 76W20 (Actt Fuels Hdr) R
- 1 SP4 76W10 (Actt Fuels Hdr) (Dvr) R
- 1 SP4 55B10 (Ammo Stor Sp) R
- 2 PFC 76W10 (Actt Fuels Hdr) (Dvr) R

Note Section auth 6 FARE & 18
590 gal collapsible fuel drum

339

AIRCRAFT ARMAMENT MAINTENANCE SECTION



- 1 SSG 68J30 (Hel Fire Cnt Rep Supv) R
- 3 SGT 68J20 (Hel Fire Cnt Rep Supv) R
- 1 SGT 68M20 (Hel Wpn Sys Rep) R
- 3 SP4 68J10 (Hel Fire Cnt Rep Supv) R
- 1 SP4 68M10 (Hel Wpn Sys Rep) (Dvr) R
- 5 PFC 68J10 (Hel Fire Cnt Rep Supv) R



- 1 SP4 68M10 (Hel Wpn Sys Rep) (Dvr) R

Mission: Provide security and perform reconnaissance for the unit to which assigned or attached and to manage the elements below, via delaying and economy of force operations as required.

ASSTANT: Company 1, Armored Cavalry Regiment (OE 1751)

CAPABILITY: Provide security and perform recon operations for the unit to which assigned or attached and to manage the elements below, via delaying and economy of force operations as required.

340

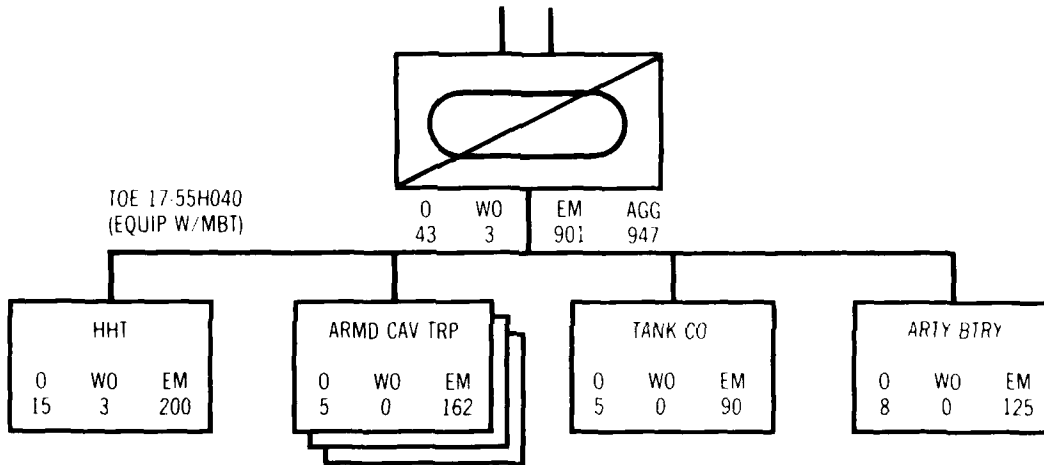

Military...
 Assignment...
 Personnel...

...
 ...
 ...

342

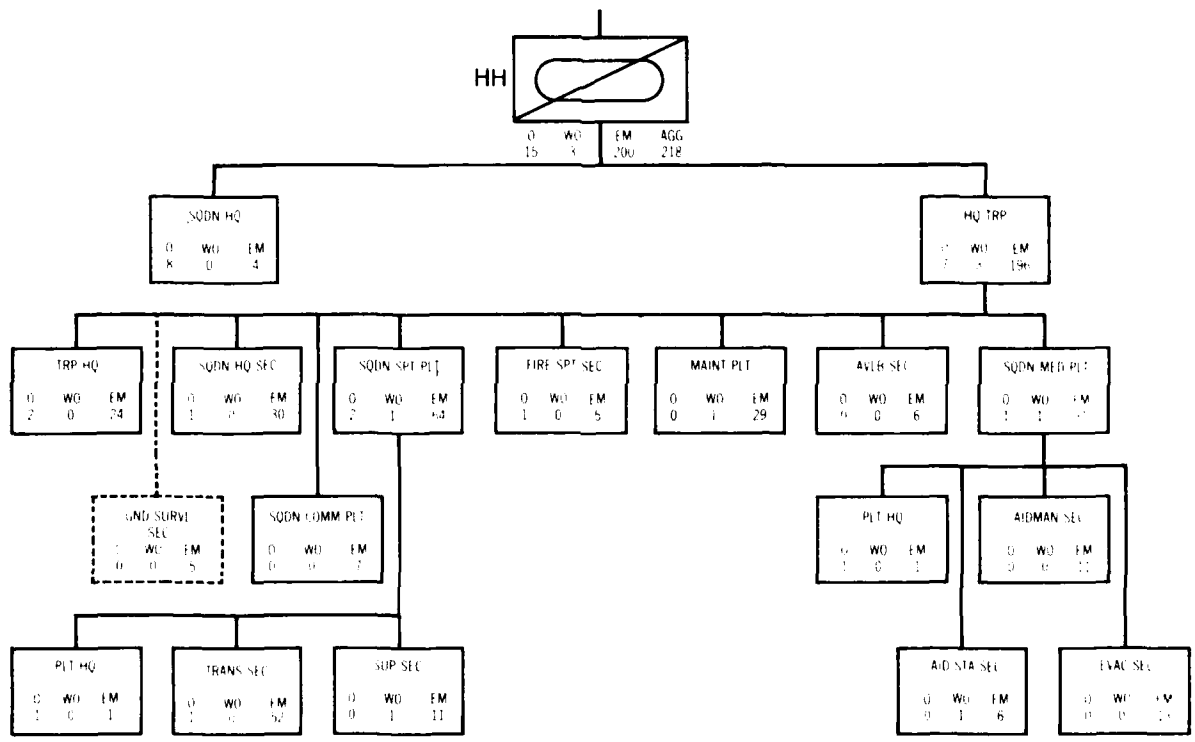

Augmental or Not included in total

SUMMARY OF EQUIPMENT

WEAPONS			
LAUNCHER GRENADE SMOKE M257	2		
LAUNCHER GRENADE M203	3		
LAUNCHER GRENADE SMOKE M239	5		
MACHINEGUN CAL .50 HB FLEX FOR GROUND USE	23		
PISTOL CAL .45	32		
RIFLE 5.56-MM	208		
SUBMACHINEGUN CAL .45	4		
VEHICLES AND VEHICLE EQUIPMENT			
BRIDGE AVLB SCISSOR CL60 50-FT SPAN	3		
CAVALRY FIGHTING VEHICLE M3	2		
CARRIER CP LT TRACK M577A1	6		
CARRIER PERSONNEL FULL TRACK M113A1	3		
KITCHEN FIELD TRLR MTD	1		
LAUNCHER 450 SERIES FOR AVLB	3		
RECOVERY VEHICLE MEDIUM M88	2		
TRAILER CARGO 1/4-TON M416	4		
TRAILER CARGO 1-1/2-TON M105A2	16		
TRAILER TANK WATER 400-GAL M149A1	1		
TRUCK AMBULANCE 1-1/4-TON 6X6 M792	1		
TRUCK CARGO 1-1/4-TON 6X6 M551	3		
TRUCK CARGO 2-1/2-TON M35A2	9		
TRUCK CARGO DROPSIDE 5-TON	3		
TRUCK CARGO 5-TON 8X8 M656	5		
TRUCK CARGO 5-TON 8X8 W/WN M556	1		
TRUCK CARGO 5-TON 6X6 LWB	2		
TRUCK CARGO 8-TON W/WN M520	14		
TRUCK TANK FUEL SVC 2500-GAL 4X4 M559	4		
TRUCK UTILITY 1/4-TON M151A2	10		
TRUCK WRECKER 5-TON 6X6	1		
TRUCK WRECKER 10-TON 4X4 M553	1		
		COMMUNICATION-ELECTRONICS EQUIPMENT	
		ELECTRONIC TT SCTY EQUIPMENT TSEC/KW-7	2
		RADIAC SET AN/PDR-27	1
		RADIACMETER IM-93/UD	13
		RADIACMETER IM-174/PD	4
		RADIO SET AN/GRC-106	2
		RADIO SET AN/VRC-12	7
		RADIO SET AN/VRC-46	3
		RADIO SET AN/VRC-47	4
		RADIO SET AN/VRC-49	2
		RADIO SET AN/VRC-54	12
		RADIO SET CONTRL GROUP AN/GRA-39	7
		RADIO TT SET AN/VSC-3	2
		RECEIVER TRANSMITTER CON GP AN/GRA-6	1
		SPEECH SCTY EQUIPMENT TSEC/KY-57	37
		SWITCHBOARD TEL MANUAL SB-22/PT	2
		TELEPHONE SET TA-312/PT	19
		MISCELLANEOUS EQUIPMENT	
		ALARM OML AGENT AUTO PTBL F/WHEEL VEH	4
		DETECTING SET MINE PTBL AN/PRS-7	1
		DETECTING SET MINE PTBL AN/PSS-11	1
		METASCOPE AN/PAS-6	4
		NIGHT SIGHT CREW-SERVED WPN AN/TVS-5	3
		NIGHT VISION GOGGLES AN/PV3-5	11
		TANK AND PUMP UNIT TRK MTD (1200-GAL)	2
		TANK UNIT TRK MTD (500-GAL)	2

343

HEADQUARTERS AND HEADQUARTERS TROOP ARMORED CAVALRY SQUADRON ARMORED CAVALRY REGIMENT

TOE 17-56H(C18)

SQUADRON HEADQUARTERS AND SQUADRON HEADQUARTERS SECTION

2 TSEC KY 57
2 AN VRC 46



1 LTC 12C00 (Cdr) P
1 SP4 05B10 (Rdo Op) (Dvr) R

4 TSEC KY 57
AN GRA 39
AN GRC 106
2 AN VRC 46



1 CPT 12C00 (S3 Arr) R
1 LT 74A00 (Cml Off) R
1 MSG 19Z50 (Op SGT) R
1 SFC 19D40 (Asst Op SGT) R
1 SSG 54E30 (NBC Op Staff NCO) R
1 SGT 05B20 (Rdo Op Supv) R
1 SP4 19D1U (Carr Dvr) R
1 SP4 05B10 (Rdo Op) R
1 PFC 05B10 (Rdo Op) R GL

2 TSEC KY 57
AN VRC 47



1 MAJ 12C00 (XU) P
1 PFC 19D10 (Dvr) R

2 TSEC KY 57
AN GRA 39 TSEC KW 7
AN VRC 47 AN VSC 3



1 CPT 35A00 (S2) R
1 MSG 19Z50 (Intel SGT) R
1 SFC 19D40 (Asst Intel SGT) R
1 SGT 05C20 (RATT Im Chief) R
1 SP4 05C10 (RATT Op) R
1 SP4 19D1U (Carr Dvr) P
1 SP4 19D10 (Ops Asst) R
1 PFC 05C10 (RATT Op) R

2 TSEC KY 57
AN VRC 47



1 MAJ 12C00 (S3) P
1 PFC 19D10 (Dvr) R

TSEC KW 7
AN GRA 39
AN VSC 3
2 TSEC KY 57



1 CPT 12C41 (S1) R
1 SGT 05C20 (RATT Im Chief) R
1 SP5 71D20 (Legal Clerk) P
1 SP4 05C10 (RATT Op) R
2 SP4 71L10 (Ck Typist) R
1 SP4 19D1U (Carr Dvr) R
1 PFC 05C10 (RATT Op) R

AN VRC 46
2 TSEC KY 57
AN VRC 12



1 SGT 19D20 (Vehicle Cdr) P
1 SP4 19D1U (Carr Dvr) P

TSEC KY 38
AN VRC 47



1 CPT 12C41 (S4) P
1 PFC 19D10 (Dvr) R



1 CSM 00Z50 (Comm Sergeant Major) R
1 SFC 75Z40 (PAC Supv) R
1 SSG 79D30 (Reenlistment NCO) R
1 SSG 75Z30 (Per Staff NCO) R
1 SP5 75B20 (PAC Clerk) R
2 SP4 75B10 (PAC Clerk) R
2 PFC 75B10 (PAC Clerk) (Dvr) R

AN VRC 46
2 TSEC KY 57
AN VRC 1



1 SGT 19D20 (Vehicle Cdr) P
1 SP4 19D1U (Carr Dvr) P

Note: CE Staff Off and Motor Officer assigned to Sqdn HQ are shown with respective units

SQUADRON COMMUNICATION PLATOON

2 TSEC KY 57
AN GRA 39
AN VRC 49



1 CPT 25A00 (CE Staff Off) R
1 SP4 36K10 (Tac Wire Op Sp) (Dvr) R

Note: CE Staff Off is assigned to Sqdn HQ



1 SP4 36K10 (Tac Wire Op Sp) (Dvr) R
2 PFC 36K10 (Tac Wire Op Sp) R

TSEC KY 57
AN GRA 39
AN VRC 46



1 SFC 31V40 (Comm Chief) R
1 SP4 36K1U (Carr Dvr) P
1 SP4 31V10 (Comm Sys Op Mech) R

TROOP HEADQUARTERS

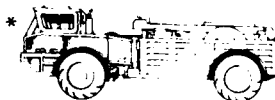
TSEC/KY 57
AN/VRC 641 CPT 12C00 (Trp Cdr) P
1 PFC 64C10 (Dvr) R1 Lt 12C00 (XO) R
1 PFC 64C10 (Dvr) R GL* 1 SSG 1925M (First SGT) R
1 SSG 76Y30 (Supply SGT) R
1 SP4 76Y10 (Armorer) (Dvr) RTSEC KY 57
AN VRC 641 SFC 63C40 (Motor SGT) R
1 SGT 76D10 (PLL Clerk) R
1 PFC 63S10 (HWht Veh Mech) (Dvr) R
1 cal 50 mg* 1 SGT 63B20 (WVeh/Pwr Gen Mech) R
1 SP4 76C10 (Eq Rec & Pts Sp) R
1 SP4 63B10 (WVeh/Pwr Gen Mech) R
2 PFC 63B10 (WVeh/Pwr Gen Mech) R
1 PFC 63C10 (Track Veh Mech) (Dvr) R* 1 SGT 63C20 (Sr Track Veh Mech) R
1 SP4 63C10 (Track Veh Mech) R
1 SP4 63S10 (Hvy WVeh Mech) R
1 SP4 63E10 (Revy Veh Op) R1 SFC 94B40 (Food Svc SGT) R
1 SSG 94B40 (1st Cook) R
1 SP5 94B20 (Cook) R
2 SP4 94B10 (Cook) (Dvr) R
1 PFC 94B10 (Cook) R

SQUADRON MAINTENANCE PLATOON

TSEC/KY 57
AN/VRC 461 CPT 12C77 (Mtr Off) R
1 SP4 63C10 (CFV Turret) (Dvr) RTSEC/KY 57
AN/VRC 641 WO 630A0 (Auto Maint Tech) R
1 MSG 63Z50 (Motor SGT) R
1 SSG (CFV Sys Mech) R
1 SGT 76D10 (PLL Clerk) (Dvr) R
2 PFC 63C10 (Track Veh Mech) R
4 cal 50 mg1 SGT 63C20 (Sr Track Veh Mech) R
2 SP4 63C10 (Track Veh Mech) R
2 PFC 63C10 (Track Veh Mech) R4 SP4 63C10 (Track Veh Mech) R
1 SP4 44B10 (Welder) (Dvr) R1 SSG 45K30 (Tank Sys Maint Supv) R
1 SGT (CFV Auto Mech) R
1 SP4 45P10 (Sheridan Trt Mech) (Dvr) R1 SGT (Sr Track Veh Mech) P
1 SP4 (Lt WVeh/Pwr Gen Mech) R
1 PFC (Lt WVeh/Pwr Gen Mech) RTSEC, KY 57
AN/VRC 461 SGT 63F20 (Sr Recov Veh Op) P, S
1 PFC 63F10 (Recov Veh Op) P, STSEC KY 57
AN VRC 46

2 PFC (Recov Veh Op) R

Notes

- 1 Mtr Off is assigned to Sqdn HQ
- 2 When organized under SRC 17055H040, 1 SP4 45P10 (Sheridan Trt Mech) (Dvr) R is replaced by 1 SP4 45N10 (Tank Trt Mech) (Dvr) R

*Mounts TOE cal 50 mg on ring mount

SQUADRON SUPPORT PLATOON

PLATOON HQ

I SEC KY 57
AN GRA 39
AN VRC 46



1 LT 12C92 (Plt Ldr) (Asst S4) R
1 PFC 64C10 (Dvr) R

SUPPLY SECTION

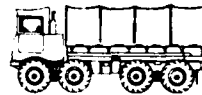

1 WO 76140 (Unit Sup Team) R
1 SGT 76Y40 (Sup SGT) R
1 SP4 76Y10 (Gen Supplyman) (Dvr) R
1 PFC 76Y10 (Gen Supplyman) R



1 SSG 76Y30 (Asst Sup SGT) R
1 SP5 76Y20 (Gen Supplyman) R
1 PFC 76Y10 (Gen Supplyman) (Dvr) R
2 cal 50 mg

TRANSPORTATION SECTION



1 LT 12C88 (Sec Cdr) R
1 SP4 (Veh Dvr) R
2 PFC 64C10 (Veh Dvr) R

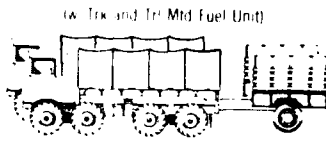

1 SP4 64C10 (Veh Dvr) R

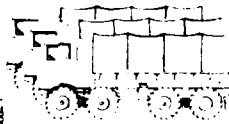

1 PFC 64C10 (Veh Dvr) R

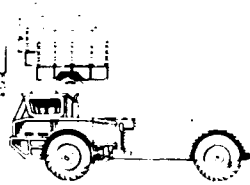

1 SSG 64C30 (Hv Veh Dvr) R

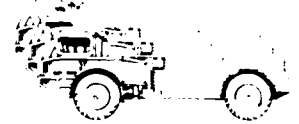

2 SP5 63C20 (Hv Veh Dvr) R



1 SFC 64C40 (Truckmaster) R
1 SP4 64C10 (Hv Veh Dvr) R
1 PFC 19D10 (Ammo Hdlr) R

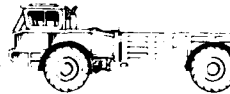

1 SP4 19D10 (Ammo Sp) R
1 SP4 64C10 (Hv Veh Dvr) R
1 PFC 19D10 (Ammo Hdlr) R



1 SP4 63C10 (Hv Veh Dvr) R
2 PFC 19D10 (Ammo Hdlr) R



1 SP4 63C10 (Hv Veh Dvr) R
2 PFC 19D10 (Ammo Hdlr) R



1 SP4 64C10 (Hv Veh Dvr) R
2 PFC 19D10 (Ammo Hdlr) R

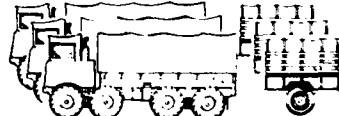

1 SP4 (Hvy Veh Dvr) R
1 PFC (Ammo Hdlr) R
1 PFC (Veh Dvr) R

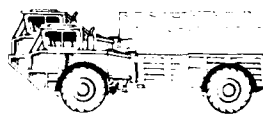

1 SP4 (Hvy Whl Veh Op) R
1 PFC (Ammo Hdlr) R

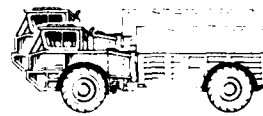

1 SP4 (Hv Whl Veh Op) R
1 PFC (Ammo Hdlr) R

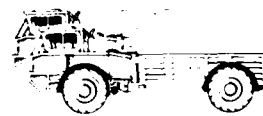

1 SP4 (Hv Whl Veh Op) R
1 PFC (Ammo Hdlr) R

SQUADRON MEDICAL PLATOON

PLT HQ

1 LT 67B00 (Med Plt Ldr) R
1 SFC 91B40 (Plt SGT) R

AID STATION SECTION

I SEC KY 57
AN VRC 64



1 WO 011A0 (Physicians Asst) P
1 SSG 91C30 (Practical Nurse) R
1 SP4 91B1U (Amb Dvr) R
1 PFC 91C10 (Patient Care Sp) R

EVACUATION SECTION

I SEC KY 57
AN VRC 64



1 SSG 91B30 (Sec SGT) R
1 SP5 91B20 (Med Aidman) R
4 SP4 91B10 (Med Aidman) R
1 PFC 91B10 (Amb Dvr) R
1 Pfc (Med Aidman) R

AIDMAN SECTION

1 SP5 91B20 (Company Aidman) P
6 SP5 91B20 (Trp Aidman) P
3 SP4 91B10 (Trp Aidman) P
1 SP4 91B10 (Btry Aidman) R

AVLB SECTION

I SEC KY 57
AN VRC 64



1 SSG 19E30 (Sec Chief) R
1 SP4 19F10 (AVLB Dvr) P

I SEC KY 57
AN VRC 64

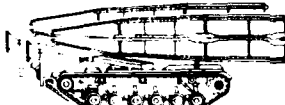

1 SP5 19F20 (AVLB Cdr) R
1 SP4 19F10 (AVLB Dvr) P

FIRE SPT SEC

AN GRA 6
AN CRC 106
AN VRC 49



1 CPT 13F00 (Fire Spt Off) R
1 SP4 13F10 (Fire Spt Sp) (Dvr) R



1 SFC 13F40 (Fire Spt SGT) R
1 SP4 13F10 (Fire Spt Sp) R
1 SP4 05B1U (Rdo Op) (Dvr) R
1 PFC 05B10 (Rdo Op) R

MISSION: To provide security and perform reconnaissance for the unit to which assigned or attached and to engage in offensive, defensive, delaying, and economic warfare operations as required.

ASSIGNMENT: Assigned to an Armored Cavalry Squadron, Armored Cavalry Regiment, TOE 17-57.

CAPABILITIES: 1. Performs reconnaissance and provides security for units which are assigned or attached.
 2. Engages in offensive, defensive, delaying, operations as required.
 3. Conducts independent operations when properly reinforced.

348

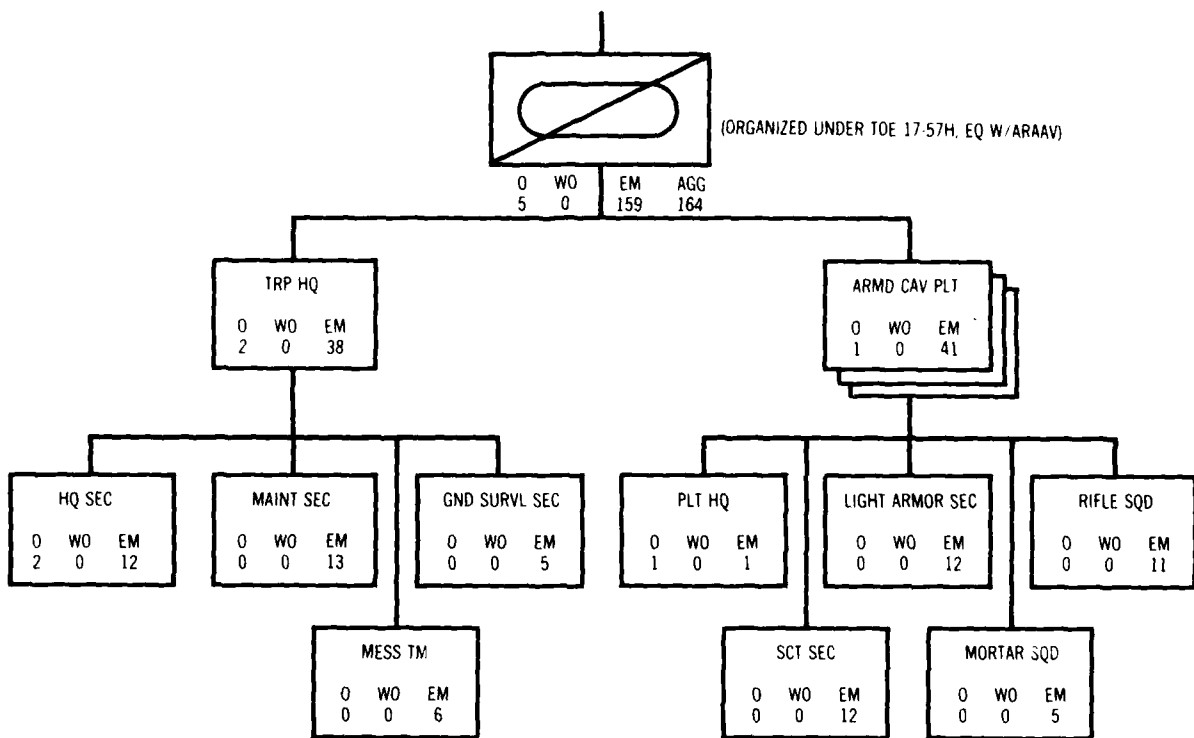

SUMMARY OF EQUIPMENT

WEAPONS			
GUN/LAUNCHER 152-MM BII	9	RADAR SET AN/PPS-5	2
LAUNCHER GRENADE M203	20	RADIAC SET AN/PDR-27	1
LAUNCHER ROCKET 66-MM 4-TUBE M202	3	RADIACMETER IM-93/UD	18
MACHINEGUN CAL .50 HB FLEX FOR GROUND USE	2	RADIACMETER IM-174/PD	5
MACHINEGUN CAL .50 HB FLEX VEH MTD	35	RADIO SET AN/GRC-106	1
MACHINEGUN 7.62-MM VEH FIXED	9	RADIO SET AN/GRC-160	8
MACHINEGUN 7.62-MM FLEX	16	RADIO SET AN/PRC-77	3
MORTAR 4.2-INCH	3	RADIO SET AN/VRC-12	7
PISTOL CAL .45	70	RADIO SET AN/VRC-46	7
RIFLE 5.56-MM	95	RADIO SET AN/VRC-47	3
SUBMACHINEGUN CAL .45	20	RADIO SET AN/VRC-64	13
		RADIO SET CONTROL GROUP AN/GRA-39	4
		SPEECH SCTY EQUIPMENT TSBC/KY-38	3
		SWITCHBOARD TEL MANUAL SB-22/PT	1
		TELEPHONE SET TA-1/PT	6
		TELEPHONE SET TA-312/PT	7
VEHICLES AND VEHICLE EQUIPMENT		MISCELLANEOUS EQUIPMENT	
ARMORED RECONNAISSANCE/AIRBORNE ASSAULT VEHICLE M551	9	ALARM OHL AGENT AUTO PTBL F/PT VEH	6
CARRIER CP LT TRACK M577A1	1	ALARM OHL AGENT AUTO PTBL F/WHEEL VEH	2
CARRIER 4.2-INCH MORTAR M106A1	3	DETECTING SET MINE PTBL AN/PRS-7	3
CARRIER PERSONNEL FULL TRACK M113A1	22	DETECTING SET MINE PTBL AN/PSS-11	3
RECOVERY VEHICLE LIGHT M578	1	NIGHT SIGHT CREW-SERVED WFN AN/TVS-5	35
KITCHEN FIELD TRAILER MOUNTED	1	NIGHT SIGHT INDIVIDUAL WFN AN/PVS-4	19
TRAILER CARGO 1/4-TON M416	1	NIGHT SIGHT TRIPOD MTD AN/TVS-4	1
TRAILER CARGO 1-1/2-TON M105A2	1	NIGHT VISION GOGGLES AN/PVS-5	48
TRAILER TANK WATER 400-GAL M149A1	1	SEARCHLIGHT AN/VSS-3	9
TRUCK CARGO 2-1/2-TON M35A2	3	VIEWER INFRARED AN/PAS-7	3
TRUCK UTILITY 1/4-TON M151A1	2		

349

ARMORED CAVALRY TROOP ARMORED CAVALRY SQUADRON, ARMORED CAVALRY REGIMENT

TOE 17-57H(C23)

TROOP HEADQUARTERS

HEADQUARTERS SECTION

TSEC KY 38
AN VRC 47



1 CPT 12C00 (Cdr) P
1 PFC 19D10 (Dvr) R GI

TSEC KY 38
AN GRA 39
AN VRC 12



1 SSG 19b30 (Veh Cdr) P
1 SGT 54E20 (NBC Op NCO) R
1 SP4 76Y10 (Armorer) R
1 SP4 19D10 (Carr Dvr) P S
1 7.62 mm mg



*
1 SSG 76Y30 (Sup SGT) R
1 PFC 76Y10 (Gen. Supplyman) (Dvr) R

TSEC KY 38
AN GRC 136
AN VRC 47



1 TSG 1975M (First Sergeant) R
1 SSG 31V30 (Comm Chft) R
1 SP4 19D10 (Carr Dvr) P S
1 SP4 05B10 (Rdr Op) R
1 PFC 05B10 (Rdr Op) R GI

GROUND SURVEILLANCE SECTION

AN PPS 5
AN GRC 160



1 SSG 17K30 (Sec Ldr) R
1 SGT 17K20 (Gnd Survl Rdr SGT) R
1 SP4 17K10 (Gnd Survl Rdr Crmn) (Dvr) P

AN PPS 5
AN GRC 160



1 SGT 17K20 (Gnd Survl Rdr SGT) R
1 SP4 17K10 (Gnd Survl Rdr Crmn) (Dvr) P

MESS TEAM



*
1 SFC 94B40 (Food Svc SGT) R
1 SSG 94B30 (1st Cook) R
1 SP5 94B20 (Cook) R
2 SP4 94B10 (Cook) (Dvr) R
1 PFC 94B10 (Cook) R

MAINTENANCE SECTION

AN VRC 47



1 LT 12C00 (XO) R
1 SP4 76C10 (Eq Rec & Pts Sp) (Dvr) R



1 SFC 63140 (Motor SGT) R
1 SP5 76D20 (PLL Clerk) R
1 SP4 31V10 (Comm Sys Op/Mech) (Dvr) R

AN VRC 64



1 SGT 63T20 (CFV Auto Mech) R
1 SGT 63N20 (M60A1 Auto Mech) R
1 SP4 63T10 (CFV Auto Mech) (Dvr) R
1 SP4 63N10 (M60A1 Auto Mech) R
1 SP4 63T10 (CFV Auto Mech) R
1 PFC 63N10 (M60A1 Auto Mech) R
1 PFC 63T10 (CFV Auto Mech) R

AN VRC 46



1 SP4 63N10 (Recov Veh Op) P S
1 PFC 63T10 (Recov Veh Op) P S

- Notes
- 1 XO assigned HQ Sec located in Maintenance Sec.
 - 2 Under variation 20 of this TOE, the main battle tank may replace the M551 ARAAV
 - 3 When equipped w. MBT, the M88 recovery vehicle replaces the M578

*Mounts TOE cal 50 mg on ring mount

(3) ARMORED CAVALRY PLATOON

PLATOON HQ

AN GRA 39
AN VRC 12



1 LT 12C00 (Plt Ldr) R
1 PFC 19D1U (Scout Dvr) P

SCOUT SECTION

AN VRC 16



1 SSG 19D30 (Sec Ldr) R
1 SP4 19D1U (Scout Dvr) P
1 PFC 19D10 (Scout) R. GL
1 7.62 mm mg

AN GRC 160



1 SGT 19D20 (Crew Ldr) R
1 SP4 19D1U (Scout Dvr) P
1 PFC 19D10 (Scout) R. GL
1 7.62 mm mg

AN VRC 46



1 SSG 19D30 (Squad Ldr) R
1 SP4 19D1U (Scout Dvr) P
1 PFC 19D10 (Scout) R. GL
1 7.62 mm mg

AN GRC 160



1 SGT 19D20 (Crew Ldr) R
1 SP4 19D1U (Scout Dvr) P
1 PFC 19D10 (Scout) R. GL
1 7.62 mm mg

RIFLE SQUAD

AN PRC 77
AN VRC 64



1 SSG 11B30 (Squad Ldr) R
2 SGT 11B20 (Team Ldr) R
2 SP4 11B10 (Auto Rifleman) AR
2 SP4 11B10 (Grenadier) R. GL
1 SP4 11B10 (Carrier Dvr) P
3 PFC 11B10 (Rifleman) R
1 M202
1 7.62 mm mg
1 AN PAS 7

LIGHT ARMOR SECTION

AN VRC 12



1 SFC 19D40 (Plt SGT) P
1 SP4 19G10 (Loader/Gnr) P
1 PFC 19G10 (Loader) P. S
1 SP5 19H20 (Sr ARAAV Dvr) P. S

AN VRC 64



1 SSG 19G30 (AR AAV Cdr) P
1 SP5 19G20 (Sr Gunner) P
1 SP4 19G10 (Loader/Gnr) P. S
1 PFC 19H10 (ARAAV Dvr) P. S

AN VRC 64



1 SSG 19G30 (AR AAV Cdr) P
1 SP5 19G20 (Sr Gunner) P
1 PFC 19G10 (Loader) P. S
1 SP4 19H10 (ARAAV Dvr) P. S

MORTAR SQUAD

AN VRC 64



1 SGT 11C20 (Squad Ldr) R
1 SP4 11C10 (Carrier Dvr) P
1 SP4 11C10 (Gunner) P
1 PFC 11C10 (Asst Gunner) P
1 PFC 11C10 (Ammo Bearer) R
1 4.2 in mortar

MISSION: To provide security and perform reconnaissance for the unit to which assigned or attached and to engage in offensive, defensive, delaying, and economy of force operations as required.

ASSIGNMENT: Organic to Armored Cavalry Squadron, Armored Cavalry Regiment, TOE 17-55.

CAPABILITIES: a. Perform reconnaissance and provide security for unit to which assigned or attached.
 b. Engage in offensive and defensive or delaying operations as required.
 c. Conduct independent action when properly authorized.

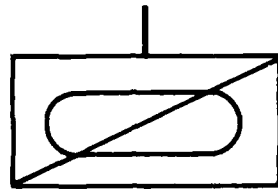

(ORGANIZED UNDER TOE 17-157H)

0	WO	EM	AGG
5	0	159	164

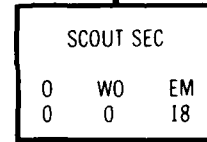
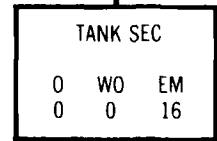
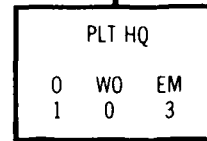
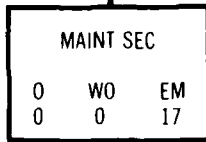
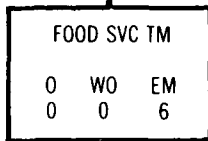
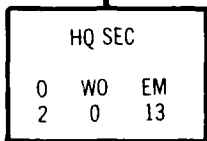
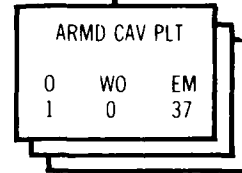
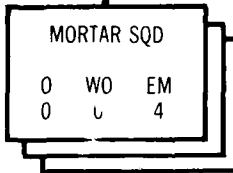
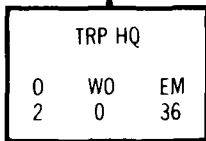

SUMMARY OF EQUIPMENT

WEAPONS	
GUN TANK 105-MM BII	12
GUN 25MM BII.....	16
LAUNCHER GRENADE M203	14
LAUNCHER GRENADE TANK MTD M239	13
MACHINEGUN CAL .50 HB FLEX FOR GROUND USE	7
MACHINEGUN CAL .50 VEH FIXED	12
MACHINEGUN 7.62-MM FLEX	16
MACHINEGUN 7.62-MM VEH FIXED	12
MORTAR 4.2-INCH	3
PISTOL CAL .45	78
RIFLE 5.56-MM	91
SUBMACHINEGUN CAL .45	26

COMMUNICATION-ELECTRONICS EQUIPMENT	
RADIAC SET AN/PIR-27	1
RADIAC METER DM-93/UD	13
RADIAC METER DM-174/PD	14
RADIO SET AN/GRC-106	1
RADIO SET AN/PRC-77	16
RADIO SET AN/VRC-12	7
RADIO SET AN/VRC-46	7
RADIO SET AN/VRC-47	3
RADIO SET AN/VRC-64	19
RADIO SET CONTROL GROUP AN/GRA-39	7
SPEECH SCTY EQUIPMENT TSEC/KY-38	6
SWITCHBOARD TEL MANUAL SB-22/PT	1
TELEPHONE SET TA-312/PT	6

353

VEHICLES AND VEHICLE EQUIPMENT	
CARRIER CP LT TRACK M577A1	1
CARRIER 4.2-INCH MORTAR M106A1	3
CARRIER PERSONNEL FULL TRACK M113A1	1
CAVALRY FIGHTING VEHICLE M3.....	16
RECOVERY VEHICLE MEDIUM M88	1
TANK CBT FULL TRACK 105-MM GUN M60A1	12
KITCHEN FIELD TRAILER MOUNTED.....	1
TRAILER CARGO 1/4-TON M416	1
TRAILER CARGO 1-1/2-TON M105A1	1
TRAILER TANK WATER 400-GAL M149A1	1
TRUCK CARGO 2-1/2-TON M35A2	3
TRUCK UTILITY 1/4-TON M151A1	2

MISCELLANEOUS EQUIPMENT	
ALARM OML AGENT AUTO PTBL P/FT VEH	12
ALARM OML AGENT AUTO PTBL P/WHEEL VEH	2
DETECTING SET MINE PTBL AN/PRS-7	3
DETECTING SET MINE PTBL AN/PSS-11	6
NIGHT SIGHT CREW-SERVED WPN AN/TVS-5	6
NIGHT SIGHT INDIVIDUAL WPN AN/PVS-4	13
NIGHT SIGHT TRIPOD MTD AN/TVS-4	3
NIGHT VISION GOGGLES AN/PVS-5	50
SEARCHLIGHT AN/VSS-3	12

ARMORED CAVALRY TROOP ARMORED CAVALRY SQUADRON, ARMORED CAVALRY REGIMENT

TOE 17-157H(C8)

TROOP HEADQUARTERS

HEADQUARTERS SECTION

FOOD SVC TM

TSEC KY 38
AN/VRC 47



1 CPT 12C00 (Cdr) P
1 Pfc 19D10 (Dvr) R

TSEC KY 38
AN GRA 39
AN PRC 77
AN/VRC 12

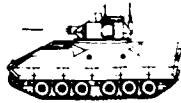

1 SSG 19D30 (Veh Cdr) P
1 SGT 54E20 (NBC Op NCO) R
1 SP4 19D1U (Scout Dvr) R
1 PFC 19D19 (Scout) R, GI
1 7.62 mm mg

TSEC KY 38
AN GRC 106
AN/VRC 47



1 SSG 19Z5M (First SGT) R
1 SSG 31V30 (Comm Chief) R
1 SP4 76Y10 (Armorer) R
1 SP4 05B10 (Radio Op) R
1 SP4 19D1U (Scout Dvr) R
1 PFC 05B10 (Radio Op) R



1 SSG 76Y30 (Supply SGT) R
1 PFC 76Y10 (Gen Supplyman) (Dvr) R



1 SGT 42B40 (Food Svc SGT) R
1 SGT 42B40 (Food Svc) R
1 SGT 42B70 (Cook) R
1 PFC 42B10 (Cook) R
1 PFC 42B30 (Cook) R

MAINTENANCE SECTION

AN/VRC 47



1 LT 12C00 (XO) R
1 PFC 31V10 (Comm Sys Op/Mech) (Dvr) R



1 SFC 63C40 (Motor SGT) R
1 SGT 63N20 (M60A1 Auto Mech) R
1 SP5 76D20 (PLL Clerk) (Dvr) R
1 SP4 76C10 (Eq Rec & Pts Sp) R, GI
1 SP4 63T10 (CFV Auto Mech) R
1 PFC 45T10 (CFV Trt Mech) R

AN/VRC 64



1 SGT 63T20 (CFV Auto Mech) R
1 SP4 45N10 (Tank Trt Mech) R
1 SP4 63T10 (CFV Auto Mech) R
1 SP4 63T1U (CFV Auto Mech) (Dvr) R
1 SP4 45T10 (CFV Trt Mech) R
1 PFC 45N10 (Tank Trt Mech) R
1 PFC 63N10 (M60A1 Auto Mech) R

AN/VRC 64

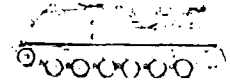

1 SSG 63N30 (M60A1 Tank Sys Mech) R
1 SP4 63N10 (Recov Veh Op) P, S
1 PFC 63N10 (Recov Veh Op) P, S

Note: XO assigned HQ Sec located in Maintenance Sec

MORTAR SQUAD

TSEC KY 38
AN/VRC 64

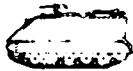

1 SSG 11C30 (Squad Ldr) R
1 SP4 11C1U (Carr Dvr) R
1 SP4 11C10 (Gunner) P
1 PFC 11C10 (Asst Gunner) R
1 4.2 in mortar

*Mounts TOE cal 50 mg on ring mount

MORTAR SQUAD

TSEC KY 38
AN/VRC 64

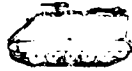

1 SGT 11C20 (Squad Ldr) R
1 SP4 11C1U (Carr Dvr) R
1 SP4 11C10 (Gunner) P
1 PFC 11C10 (Asst Gunner) R
1 4.2 in mortar

MORTAR SQUAD

TSEC KY 38
AN/VRC 64

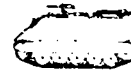

1 SGT 11C20 (Squad Ldr) R
1 SP4 11C1U (Carr Dvr) R
1 SP4 11C10 (Gunner) P
1 PFC 11C10 (Asst Gunner) R
1 4.2 in mortar

(3) ARMORED CAVALRY PLATOON

PLATOON HQ

AN GRA 39
AN PRC 77
AN VRC 12



1 LT 19000 (Plt Ldr) P
1 SGT 19020 (Veh Cdr) R
1 SP4 19010 (Scout Dvr) R
1 PFC 19010 (Scout R)
1 7.62 mm mg

SCOUT SECTION

AN PRC 77
AN VRC 46



1 SSG 19030 (Sec Ldr) R
1 SGT 19020 (Gunner) R
1 SP4 19010 (Scout Dvr) R
1 PFC 19010 (Asst Scd) R, GL
1 7.62 mm mg

AN PRC 77
AN VRC 64



1 SGT 19020 (Crew Ldr) R
1 SGT 19020 (Gunner) R
1 SP4 19010 (Scout Dvr) R
1 PFC 19010 (Scout) R
1 PFC 19010 (Asst Scout) R, GL
1 7.62 mm mg

AN PRC 77
AN GRA 36



1 SSG 19030 (Scout Ldr) R
1 SGT 19020 (Gunner) R
1 SP4 19010 (Scout Dvr) R
1 PFC 19010 (Asst Scout) R, GL
1 7.62 mm mg

AN PRC 77
AN VRC 64



1 SGT 19020 (Crew Ldr) R
1 SGT 19020 (Gunner) R
1 SP4 19010 (Scout Dvr) R
1 PFC 19010 (Scout) R
1 PFC 19010 (Asst Scout) R, GL
1 7.62 mm mg

1ST PLATOON TANK SECTION

AN GRA 39
AN VRC 12

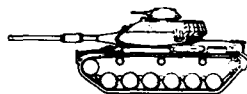

1 SGT 19040 (Plt SGT) P
1 SP5 19E20 (Sr Gunner) P
1 PFC 19E10 (Loader) P, S
1 SP4 19E10 (Tank Driver) P, S

AN VRC 64



1 SSG 19E30 (Tk Cdr) P
1 SP5 19E20 (Sr Gunner) P
1 PFC 19E10 (Loader) P, S
1 SP4 19E10 (Tank Driver) P, S

AN VRC 64



1 SSG 19E30 (Tk Cdr) P
1 SP5 19E20 (Sr Gunner) P
1 PFC 19E10 (Loader) P, S
1 SP4 19E10 (Tank Driver) P, S

AN VRC 64



1 SSG 19E30 (Tk Cdr) P
1 SP4 19E10 (Tank Driver) P, S
1 PFC 19E10 (Loader) P, S
1 SP5 19E20 (Sr Tank Dvr) P, S

2D PLATOON TANK SECTION

AN GRA 39
AN VRC 12

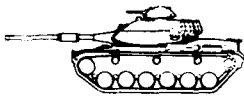

- 1 SF 19D40 (Plt SGT) P
- 1 SP5 19E20 (Sr Gunner) P
- 1 SP4 19E10 (Ldr. Gnr) P S
- 1 PF 19F10 (Tank Driver) P S

AN VRC 64

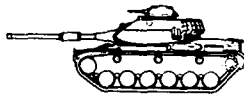

- 1 SSG 19E30 (Tk Cdr) P
- 1 SP5 19E20 (Sr Gunner) P
- 1 SP4 19E10 (Ldr. Gnr) P S
- 1 PF 19F10 (Tank Driver) P S

AN VRC 64

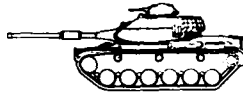

- 1 SSG 19E30 (Tk Cdr) P
- 1 SP5 19E20 (Sr Gunner) P
- 1 PF 19E10 (Loader) P S
- 1 SP4 19E10 (Tank Driver) P S

AN VRC 64

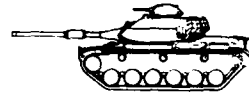

- 1 SSG 19E30 (Tk Cdr) P
- 1 SP4 19E10 (Sr Gunner) P
- 1 SP4 19E10 (Ldr. Gnr) P S
- 1 PF 19F10 (Tank Driver) P S

356

3D PLATOON TANK SECTION

AN GRA 39
AN VRC 12

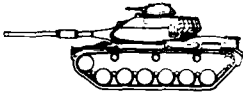

- 1 SF 19D40 (Plt SGT) P
- 1 SP5 19E20 (Sr Gunner) P
- 1 SP4 19E10 (Ldr. Gnr) P S
- 1 PF 19F10 (Tank Driver) P S

AN VRC 64



- 1 SSG 19E30 (Tk Cdr) P
- 1 SP5 19E20 (Sr Gunner) P
- 1 SP4 19E10 (Ldr. Gnr) P S
- 1 PF 19F10 (Tank Driver) P S

AN VRC 64



- 1 SSG 19E30 (Tk Cdr) P
- 1 SP4 19E10 (Ldr. Gnr) P
- 1 PF 19E10 (Loader) P S
- 1 SP5 19E20 (Sr Tank Driver) P S

AN VRC 64



- 1 SSG 19E30 (Tk Cdr) P
- 1 SP4 19E10 (Ldr. Gnr) P
- 1 PF 19E10 (Loader) P S
- 1 SP5 19E20 (Sr Tank Driver) P S

Note: 1 Plt SGT is also Master Gunner

Notes:

358

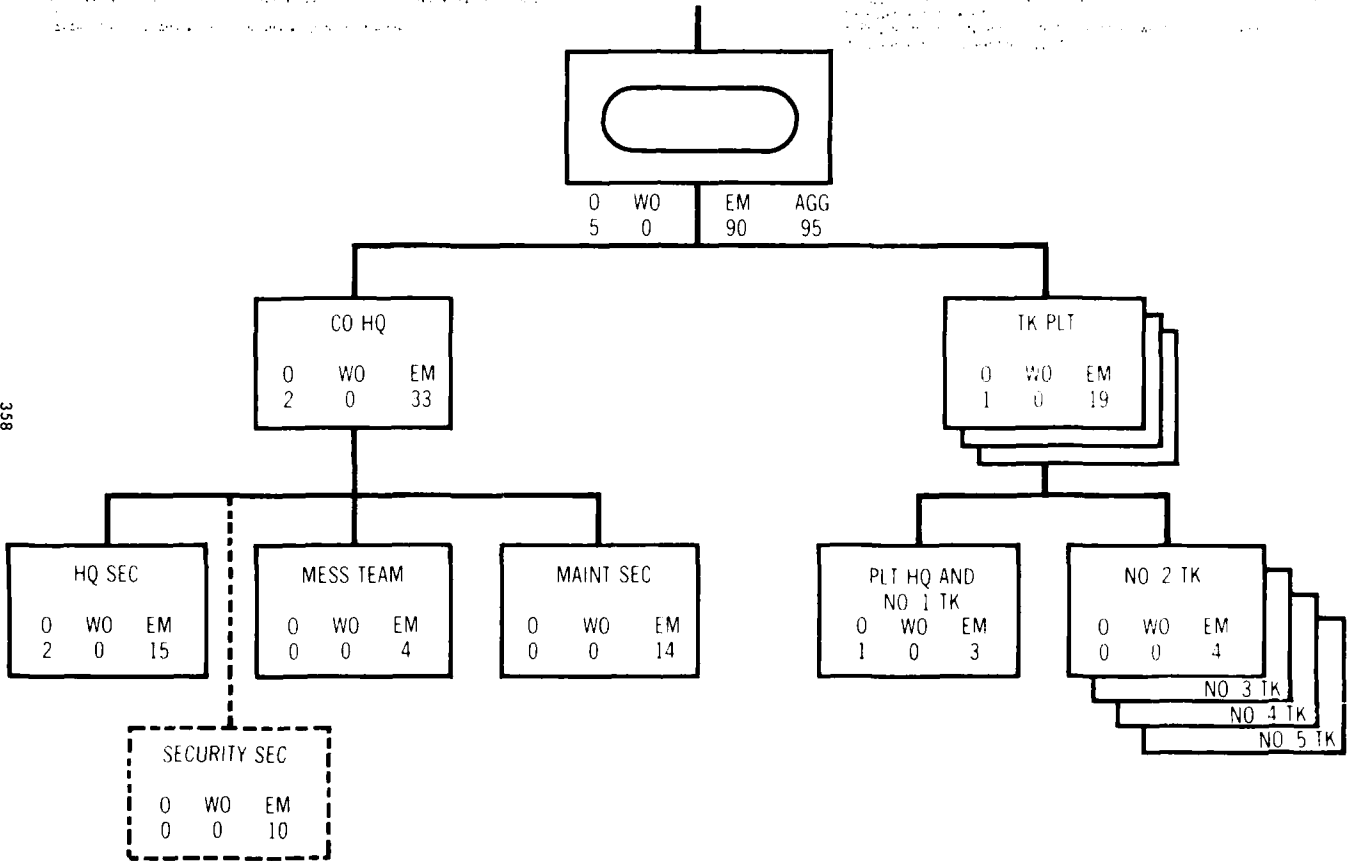

--- Augmentation Not Included in Totals.

SUMMARY OF EQUIPMENT

WEAPONS			
GUN TANK 105-MM BII	17		
LAUNCHER GRENADE M203	2		
LAUNCHER GRENADE TANK MTD M239	18		
LAUNCHER ROCKET 66-MM 4-TUBE M202	1		
MACHINEGUN CAL .50 HB FLEX FOR GROUND USE	4		
MACHINEGUN CAL .50 VEH FIXED	17		
MACHINEGUN 7.62-MM VEH FIXED	17		
PISTOL CAL .45	72		
RIFLE 5.56-MM	23		
SUBMACHINEGUN CAL .45	36		
COMMUNICATION-ELECTRONICS EQUIPMENT			
RADIAC SET AN/PDR-27		1	
RADIAC METER IM-93/UD		9	
RADIAC METER IM-174/PD		5	
RADIO SET AN/VRC-12		8	
RADIO SET AN/VRC-46		1	
RADIO SET AN/VRC-47		2	
RADIO SET AN/VRC-64		10	
RADIO SET CONTROL GROUP AN/GRA-39		5	
SPEECH SCTY EQUIPMENT TSBC/KY-38		2	
SWITCHBOARD TEL MANUAL SB-22/PT		1	
TELEPHONE SET TA-1/PT		3	
TELEPHONE SET TA-312/PT		3	
MISCELLANEOUS EQUIPMENT			
ALARM OML AGENT AUTO PTBL MANPACK		6	
ALARM OML AGENT AUTO PTBL F/WHEEL VEH		2	
BULLDOZER EARTH MOVING TK MTD		1	
DETECTING SET MINE PTBL AN/PRS-7		1	
DETECTING SET MINE PTBL AN/PSS-11		1	
METASCOPE AN/PAS-6		4	
NIGHT SIGHT CREW-SERVED WFN AN/TVS-5		4	
NIGHT SIGHT INDIVIDUAL WFN AN/PVS-4		2	
NIGHT VISION GOGGLES AN/PVS-5		19	
SEARCHLIGHT AN/VSS-3		17	
VEHICLES AND VEHICLE EQUIPMENT			
CARRIER PERSONNEL FULL TRACK M113A1	1		
RECOVERY VEHICLE MEDIUM M88	1		
TANK CBT FULL TRACK 105-MM GUN M60A1	17		
KITCHEN, FIELD TRAILER MOUNTED	1		
TRAILER CARGO 1/4-TON M416	1		
TRAILER CARGO 1-1/2-TON M105A2	1		
TRAILER TANK WATER 400-GAL M149A1	1		
TRUCK CARGO 2-1/2-TON M35A2	3		
TRUCK UTILITY 1/4-TON M151A2	3		

359

TANK COMPANY

ARMORED CAVALRY SQUADRON, ARMORED CAVALRY REGIMENT

TOE 17-27H(C20)

COMPANY HEADQUARTERS

MESS TEAM

TSEC KY 38
AN VRC 47



1 CPT 12800 (Co Cdr) P
1 PFC 19F10 (Dvr) R GI
1 M202



1 SG 1975M (1st Sergeant) R
1 SGT 44E26 (NBC Op NCO) R
1 SSG 31V30 (Comm Chief) R
1 PFC 19F10 (Dvr) R GI



1 SSG 76Y30 (Supply SGT) R
1 SP5 76Y10 (Armorer) (Dvr) R



1 SSG 44E26 (NBC Op NCO) R
1 PFC 19F10 (Dvr) R
1 SP4 44E26 (NBC Op NCO) R
1 PFC 44E26 (NBC Op NCO) R

TSEC KY 38
AN GRA 39
AN VRC 12



1 SSG 19E30 (Tank Cdr) P
1 SP4 19E10 (Ldr Gnr) P
1 PFC 19E10 (Loader) P S
1 SP5 19E20 (Sr Tank Dvr) P S

AN GRA 39
AN VRC 12



1 SSG 19E30 (Tank Cdr) P
1 SP5 19E20 (Sr Gunner) P
1 PFC 19E10 (Loader) P S
1 SP4 19F10 (Tank Dvr) P S

MAINTENANCE SECTION

AN VRC 47



1 LT 12800 (XO) R
1 PFC 63N10 (Track Veh Mech) (Dvr) R



1 SGT 45N20 (Tk Turret Mech) R
1 SP5 76D20 (PLL Clerk) R
1 SP4 31V10 (Tac Comm Sys Op/Mech) R
1 SP4 76C10 (Eq Rec & Pts Sp) R
1 PFC 45N10 (Tk Turret Mech) R
1 PFC 63N10 (Track Veh Mech) (Dvr) R

AN VRC 64



1 SFC 63C40 (Motor SGT) R
1 SGT 63C20 (Track Veh Mech) R
1 SP4 45N10 (Tk Turret Mech) R
2 SP4 63N10 (Track Veh Mech) (Dvr) P

AN VRC 46



1 SSG 63N30 (M60A1 Tank Sys Mech) R
1 SP4 63F10 (Recov Veh Opl) P S
1 PFC 63N10 (Recov Veh Opl) P S

Note: XO is included in Co HQ

*Mount 10E on 50 mm ring mount

1ST TANK PLATOON

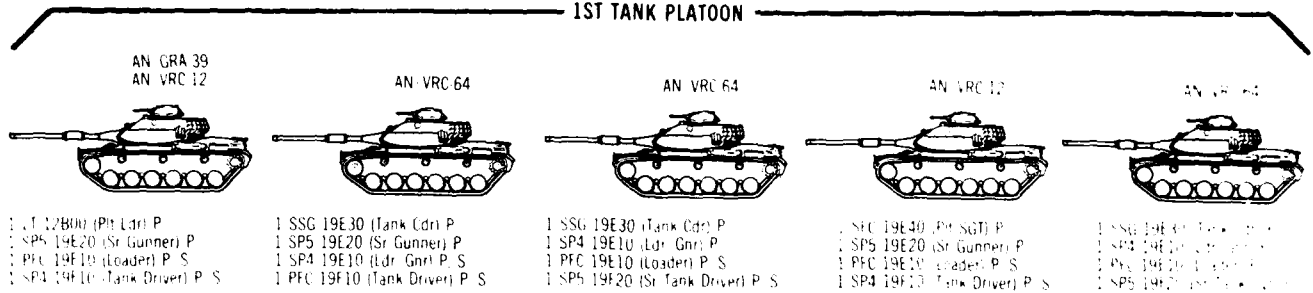

2D TANK PLATOON



3D TANK PLATOON

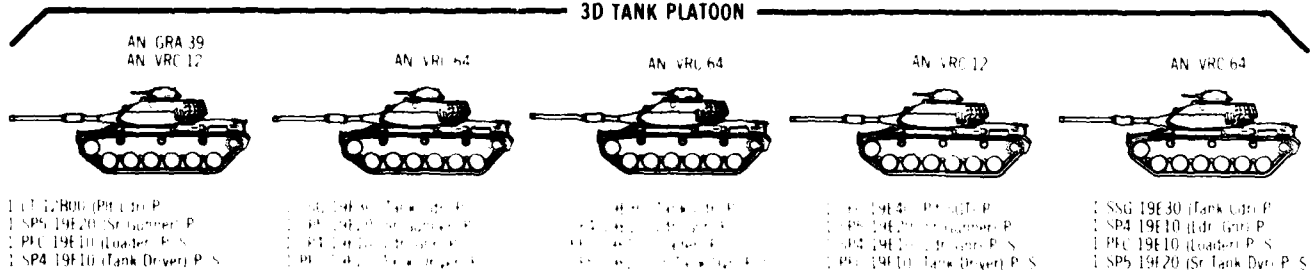

Note: One Plt SGT is also Master Gunner

1. This document is the property of the Department of Defense and is loaned to you. It and its contents are not to be distributed outside your agency.

2. This document is the property of the Department of Defense and is loaned to you. It and its contents are not to be distributed outside your agency.

362

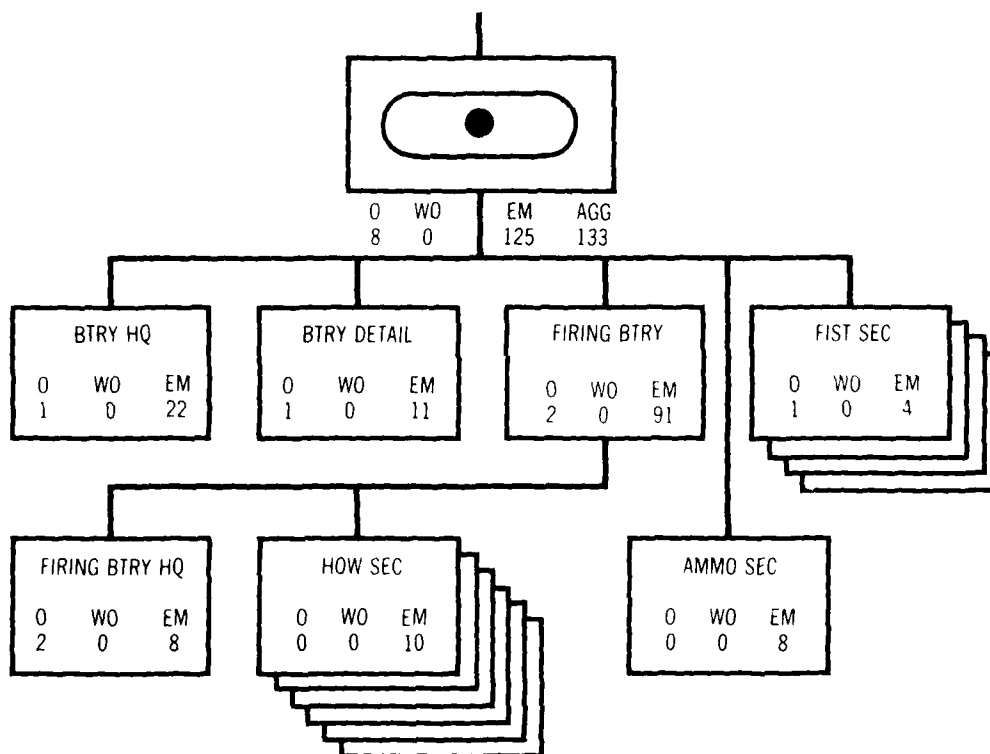

SUMMARY OF EQUIPMENT

WEAPONS			
HOWITZER 155-MM FH1	6		
LAUNCHER GRENADE M203	11		
MACHINEGUN CAL .50 HE FLEX VEH MTD	17		
MACHINEGUN 7.62-MM ELEY	5		
PISTOL CAL .45	1		
RIFLE 5.56-MM	135		
VEHICLES AND VEHICLE EQUIPMENT			
CARRIER CP LT TRACK M577A1	1		
CARRIER CARGO FT 6-TON M54R	6		
CARRIER PERSONNEL FULL TRACK M113A1	4		
HOWITZER SP 155-MM M109A1	6		
KITCHEN FIELD TRAILER MOUNTED	1		
TRAILER AMMO 1-1/2-TON M332	9		
TRAILER CARGO 1/4-TON M416	3		
TRAILER CARGO 3/4-TON M101A1	2		
TRAILER CARGO 1-1/2-TON M105A2	1		
TRAILER TANK WATER 400-GAL M149A1	1		
TRUCK CARGO 1-1/4-TON 6X6 M561	2		
TRUCK CARGO 2-1/2-TON M35A2	2		
TRUCK CARGO 2-1/2-TON W/WN M35A2	1		
TRUCK CARGO 8-TON M520	3		
TRUCK UTILITY 1/4-TON M151A2	3		
		COMMUNICATION-ELECTRONICS EQUIPMENT	
		RADIAC SET AN/PDR-27	1
		RADIACMETER IM-93/UD	4
		RADIACMETER IM-174/PT	2
		RADIO SET AN/GRC-160	8
		RADIO SET AN/GRC-77	4
		RADIO SET AN/VRC-46	3
		RADIO SET AN/VRC-47	7
		RADIO SET CONTROL GROUP AN/GRA-39	12
		SPEECH SCTY EQ TSEC/KY-57	32
		SPEECH SCTY EQUIPMENT TSEC/KY-3R	1
		SWITCHBOARD TEL MANUAL SB-22/PT	1
		SWITCHBOARD TEL MANUAL SB-993/GI	1
		TELEPHONE SET TA-312/PT	2F
		MISCELLANEOUS EQUIPMENT	
		ALARM OML AGENT AUTO PTBL F/PT VEH	1
		ALARM OML AGENT AUTO PTBL F/WHEEL VEH	1
		DETECTING SET MINE PTBL AN/PRS-7	1
		DETECTING SET MINE PTBL AN/PSS-11	1
		NIGHT SIGHT CHEN-SERVED WFN AN/TVS-5	4
		NIGHT SIGHT INDIVIDUAL WFN AN/PVS-4	4
		NIGHT SIGHT TRIPOD MTD AN/TVS-4	1
		NIGHT VISION GOGGLES AN/PVS-5	10

363

FIELD ARTILLERY BATTERY, 155-MM, SELF-PROPELLED ARMORED CAVALRY SQUADRON, ARMORED CAVALRY REGIMENT

TOE 6-37H(C26)

BATTERY HEADQUARTERS

TSEC KY 38
AN GRA 39
AN VRC 47



1 PFC (Btry Cdr) R
1 PFC (Dvr) R GL



1 1SG (First Sergeant) R
1 SSG (Sup SGT) R
1 SGT (NBC Op NCO) R
1 SP5 75B20 (Unit Clerk) R
1 SP4 (Armorer) (Dvr) R GL
2 7.62 mm mg



1 SFC (Food Svc SGT) R
1 SP5 (1st Cook) R
2 SP4 (Cook) (Dvr) R
1 PFC (Cook) R



1 SFC (Motor SGT) R
1 SGT (Track Veh Mech) R
1 SP5 (PL Clerk) R
1 SP4 (Equip Maint Ck) R
2 SP4 (Track Veh Mech) R
1 SP4 (Hy Wvch & Par Qtr Mech) R
1 SP4 (Hy Wvch Mech) R
1 SP4 (FA Turnt Mech) R
2 PFC (Track Veh Mech) (Dvr) R
1 PFC (FA Turnt Mech) R

* Mounts TOE cal 50 on ring mount

BATTERY DETAIL

AN VRC 46



1 LT (Recon Survey Off) R
1 PFC (Dvr) R GL

AN PRC 46



1 SFC (Chief of Detail) R
1 SGT (Chief of Party) R
1 PFC (PADS Vehicle Dvr) R



1 SSG (Comm Chief) R
1 SGT (Fac Wire Op Trn Dvr) R
2 SP4 (Fac Wire Op Sp) (Dvr) R
2 PFC (Fac Wire Op Sp) R GL
1 SP4 (Comm Sys Op Mech) R

AMMO SECTION



1 SGT (Sec Chief) R
1 SP5 (Hy Veh Dvr) R GL
1 7.62 mm mg



1 SP4 (Hy Veh Dvr) R
2 PFC (Ammo Handler) R GL
3 7.62 mm mg

(4) FIRE SPT TEAM (FIST)

2 AN GRA 39 TSEC KY 57
2 AN/GRC-160 AN PRC 77



1 LT (Fire Spt Trn Ch) R
1 SSG (Fire Spt SGT) R
1 SP4 (Fire Spt Sp) R GL
2 PFC (RTO) (Dvr) R

FIRING BATTERY

FIRING BATTERY HQ

TSEC KY 38 AN GRA 39
AN VRC 47



1 LT (XO) R
1 SFC (Firing Btry Chief) R
1 SP4 (Chart Op) (Dvr) R

TSEC KY 38 AN VRC 46
AN GRA 39 AN VHL 47



1 LT (Firing Dir Off) R
1 SFC (Gunnery SGT) R
1 SSG (Ch FD Compt) R
1 SGT (FD Compt) R
1 SP4 (Carr Dvr) R
2 PFC (FD Sp) R

(6) HOW SECTION



1 SSG (Sec Chief) R
1 SGT (Gunner) R
1 SP4 (Art Cr) R
1 SP4 (Engineer Assembler) R
1 SP4 (Dvr) R
4 PFC (Cannoner) R



1 SP4 (Carr Dvr) R
1 PFC (Cannoner) R

CHAPTER 6

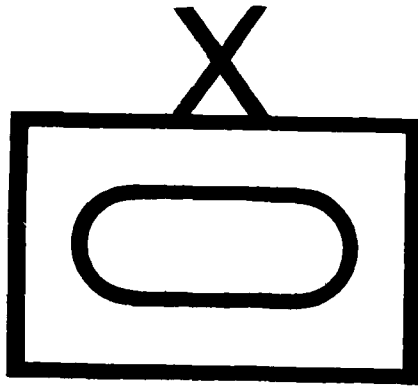

SEPARATE ARMORED BRIGADE

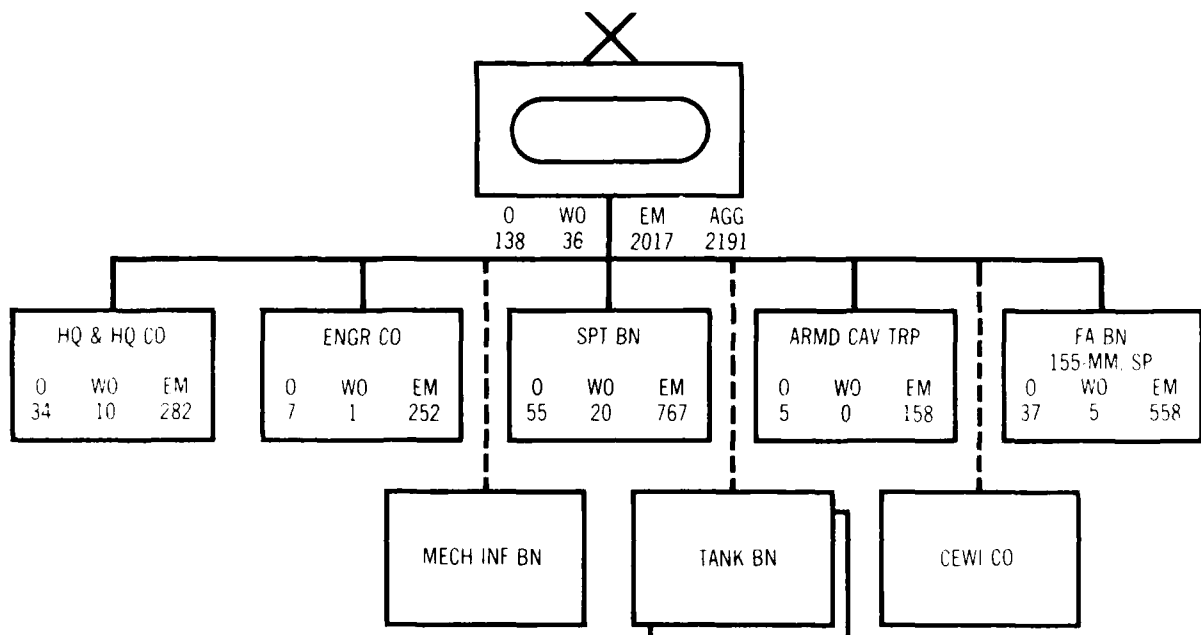

Notes 1. Tk & mech inf bns, normally attached in numbers shown, are same as those in Chap 4, Vol 1
 2. Armd Cav Trp identical to that shown on page 250 or 254, Vol I. Trp must be augmented with cellular mess team from TOE 29-500
 3. CEWI Co added for instructional purposes is same as that in Armd Cav Regt, page 340
 4. Strength of maneuver bns and CEWI Co not included in above totals

SUMMARY OF EQUIPMENT

Item Description	Quantity	Item Description	Quantity	Item Description	Quantity
WEAPONS					
ASLT GUN 4.2-INCH NO LIGHT M21	2	TRUCK CARDO 1-1/2-TON 6X4 M551	18	RADIO SET AN/VRC-12	2
2IN DEVELTON 155-MM B11	1	TRUCK CARDO 2-1/2-TON 6X4 M552	25	RADIO SET AN/VRC-41	2
GUN LOSAN B11	12	TRUCK CARDO 2-1/2-TON 6X4 M552	46	RADIO SET AN/VRC-46	81
LAUNCHER BREXIDE TVT WTD M219	18	TRUCK CARDO 2-1/2-TON 6X4 M552	10	RADIO SET AN/VRC-47	43
LAUNCHER BREXIDE M219	22	TRUCK CARDO DISMORIDE 2-1/2-TON M551	26	RADIO SET AN/VRC-48	4
MACHIN GUN CAL 50 VEH FIRED	78	TRUCK CARDO 5-TON 6X4 M511	4	RADIO SET AN/VRC-48	4
MACHIN GUN CAL 50 VEH FIRED	14	TRUCK CARDO 5-TON 6X4 M511	20	RADIO SET AN/VRC-48	20
MACHIN GUN 7.62-MM VEH FIRED	74	TRUCK CARDO 5-TON 6X4 M511	1	RADIO SET AN/VRC-48	86
MACHIN GUN 7.62-MM VEH FIRED	14	TRUCK CARDO 5-TON 6X4 M511	16	RADIO SET AN/VRC-48	6
MORTAR 4.2-INCH	1	TRUCK CARDO 5-TON 6X4 M511	1	RECEIVER SET RADIO AN/VRC-19	2
PISTOL CAL 45	99	TRUCK DUMP 5-TON 6X4 M54	1	REPEATER TRANSMITTER TUN 2P AN/VRC-19	2
REVOLVER CAL 38	1	TRUCK TANK FUEL SERVITING 400-GAL 6X4 M559	4	SPEECH SET EQUIPMENT TSB/AV-58	14
RIFLE RIFLES 30-06	1	TRUCK TRACTOR 2-1/2-TON M275A2	1	SPEECH SET EQUIPMENT TSB/AV-58	114
RIFLE 5.56-MM	1987	TRUCK TRACTOR 5-TON 6X4 M818	20	SWITCHBOARD TEL MANUAL SB-32/PT	17
RIFLE MACHIN GUN CAL 4.2	36	TRUCK TRACTOR 5-TON 6X4 M818	1	TAC DIGITAL REGR REPEATER PTBL HYL-1 TSB	4
TRACER TR 3000D MSL 50-16 (TRACON)	6	TRUCK TRACTOR 10-TON 6X4 M4000/REP W/ M517A1C	3	TELEPHONE SET TA-1/PT	49
		TRUCK TRACTOR HRT 22-1/2-TON 6X4 M744	2	TELEPHONE SET TA-4/4-PT	34
		TRUCK UTILITY 1/4-TON 6X4 M51A2	111	TELEPHONE SET TA-312/PT	246
		TRUCK VAN EXPANSIBLE 5-TON 6X4 M820	11	TELETYPEWRITER SET AN/GSC-1	1
		TRUCK VAN SHIP 2-1/2-TON 6X4 M55A3	4	TERMINAL TELEGRAPH-TELEPHONE AN/TOT-24	2
		TRUCK WRECKER 5-TON 6X4 M51A	4		
		TRUCK WRECKER 10-TON 6X4 M553	1		
		WATER PURIFICATION SET TR WTD 1500-DR	2		
VEHICLES AND VEHICLE EQUIPMENT					
BRIDGE ABLR 21000R 130 50-FT SPAN	1				
CARRIER MORTAR 4.2-INCH M104A1	3				
CARRIER CARDO PT 5-TON M548	18				
CARRIER CP LE TRACK M57A1	14				
CARRIER PERSONNEL FULL TRACK M113A1	21				
CAVALRY FIGHTING VEHICLE	16				
COMBAT ENGINEER VEHICLE FULL TRACK M728	2				
ENGINE WHEEL WTD 20-TON RT	1				
GRADER ROAD WTD 3W 6X4	1				
HOMOTER SP 155-MM M109A1	18				
KITCHEN FIELD TRAILER MOUNTED	11				
LAUNCHER M60 SERIES FOR AVLB	5				
LOADER SCOP DEL 2-1/2-CU YD	1				
RECOVERY VEHICLE LIGHT M578	2				
RECOVERY VEHICLE MEDIUM 408	14				
SEMITRAILER LOWBED 25-TON M17A1	1				
SEMITRAILER LOWBED HRT 40-TON M74	2				
SEMITRAILER STAKE 12-TON M127A2	12				
SEMITRAILER TANK FUEL 500-GAL M151A	9				
SEMITRAILER VAN REP PARTS STORAGE 4-TON M740	1				
SEMITRAILER VAN SUPPLY 12-TON M129A2	4				
SHOP EQUIP CONTACT MAINT TRK WTD	13				
SHOP EQUIP ELEC SEMITRAILER WTD	2				
TANK CFT M50A1	12				
TRACTOR FULL TRACK TEL M51	2				
TRACTOR W/RE THE DEL M/BACKHOE W/LOADER	1				
TRAILER W/HD 1-1/2-TON M132	45				
TRAILER BOLSTER CP 4-TON M796	2				
TRAILER CARDO 1/4-TON M416	107				
TRAILER CARDO 1/4-TON M101A1	16				
TRAILER CARDO 1-1/2-TON M155A2	68				
TRAILER FLATBED 10-TON M145	1				
TRAILER TANK WATER 400-GAL M149A1	15				
TRUCK AMBULANCE 1-1/4-TON 6X4 M702	14				
ENGINEER EQUIPMENT					
BOAT BRIDGE PORT ENGINEER ENG	1				
BOAT LANDING INFLATABLE 15-FT	1				
BOAT REGR INFLATABLE 15-FT	1				
BRIEFING PLATFORM RAMP 30 FT TATTAL	1				
BERRY (CONCRETE) SET BAPT	1				
OUTBOARD MOTOR 24-HP GAS	4				
SUPERSTRUCTURE DND BAY-MAB	4				
SUPERSTRUCTURE INTERIOR BAY-MAB	8				
SUPERSTRUCTURE TRANSPORTER-MAB 22X	1				
COMMUNICATION-ELECTRONICS EQUIPMENT					
CENTRAL OFFICE TEL AUTO AN/VTC-41	1				
CENTRAL OFFICE TEL MANUAL AN/VTC-29	1				
CONTROL RADIO SET AN/GSA-1	1				
ELECTRONIC SHOP SEMITR WTD AN/VSR-146	1				
ELECTRONIC SHOP SEMITR WTD AN/VSR-147	1				
ELECTRONIC TR STY EQUIPMENT TSB/AV-7	9				
RADAR SET AN/TPR-25	1				
RADIAC SET AN/POR-27	14				
RADIACOMETER IM-9/PT	2				
RADIACOMETER IM-9/PTD	116				
RADIACOMETER IM-174/PT	40				
RADIO SET AN/GRC-106	3				
RADIO SET AN/GRC-160	40				
RADIO SET AN/GRC-27	15				
RADIO SET AN/GRC-90	19				
AIRCRAFT					
HELICOPTER OBSERVATION OH-58A	4				
HELICOPTER UTILITY OH-10	2				
MISCELLANEOUS EQUIPMENT					
ALARM OIL AGENT AUTO PTBL MANNARY	5				
ALARM OIL AGENT AUTO PTBL FIXED	2				
ALARM OIL AGENT AUTO PTBL P FT VEH	2				
ALARM OIL AGENT AUTO PTBL P WRETT VEH	2				
DETECTING SET MINE PTBL AN/PSS-11	4				
DRUM FABRIC COLLAPSIBLE 500-GAL	1				
FORWARD AREA REBEL EQUIP (PANE)	1				
FUEL SYS SUPPLY PT PTBL	1				
NIGHT SIGHT CRIB-SERVE W/AN/VIS-5	11				
NIGHT SIGHT INDIVIDUAL W/AN/VIS-4	49				
NIGHT SIGHT TRIPOD W/AN/VIS-4	2				
NIGHT VISION GOGGLES AN/VIS-5	148				
SEARCHLIGHT AN/VSS-1	14				
TANK AND PUMP UNIT TRK WTD 1000-GAL	6				
TANK FABRIC COLLAPSIBLE FUEL 10,000-GAL	4				
TANK FABRIC COLLAPSIBLE WATER 500-GAL	26				
TANK FABRIC COLLAPSIBLE WATER 1000-GAL	4				
TANK UNIT TRK WTD 1000-GAL	5				

TRK 17-100H as changed

SEPARATE ARMORED BRIGADE

SUMMARY OF EQUIPMENT

WEAPONS			
ARMT SUBSYS 7.62-MM MG LIGHT M23	2	RADIO SET AN/PRC-77	3
LAUNCHER GRENADE M203	10	RADIO SET AN/PRC-90	18
MACHINEGUN CAL .50 HB FLEX FOR GROUND USE	5	RADIO SET AN/VRC-43	2
MACHINEGUN 7.62-MM FLEX	6	RADIO SET AN/VRC-46	30
PISTOL CAL .45	65	RADIO SET AN/VRC-47	1
REVOLVER CAL .38	13	RADIO SET AN/VRC-48	1
RIFLE RECOILLESS 90-MM	1	RADIO SET AN/VRC-49	1
RIFLE 5.56-MM	219	RADIO SET AN/VRC-64	5
		RADIO SET CONTROL GROUP AN/GRA-39	10
VEHICLES AND VEHICLE EQUIPMENT		RADIO TT SET AN/GRC-142	2
CARRIER CP LT TRACK M577A1	3	RECEIVER-TRANSMITTER CON GP AN/GRA-6	1
CARRIER PERSONNEL FULL TRACK M113A1	3	SPEECH SCTY EQUIPMENT ABN TSEC/KY-28	8
KITCHEN FIELD TRAILER MOUNTED	1	SPEECH SCTY EQUIPMENT TSEC/KY-38	27
TRAILER CARGO 1/4-TON M416	31	SWITCHBOARD TEL MANUAL SB-22/PT	2
TRAILER CARGO 1-1/2-TON M105A2	6	TAC DIGITAL REGEN REPEATER PTBL HYL-3/TSEC	1
TRAILER TANK WATER 400-GAL M149	1	TELEPHONE SET TA-1/PT	8
TRUCK AMBULANCE 1-1/4-TON 6X6 M792	1	TELEPHONE SET TA-838/TT	38
TRUCK CARGO 1-1/4-TON 6X6 M561	18	TELETYPEWRITER SET AN/GGC-3	1
TRUCK CARGO 2-1/2-TON M35A2	7	TERMINAL TELEGRAPH-TELEPHONE AN/TCC-29	2
TRUCK CARGO 5-TON 8X8 M656	2		
TRUCK UTILITY 1/4-TON M151A2	31	AIRCRAFT	
TRUCK WRECKER 5-TON W/WN M816	1	HELICOPTER OBSERVATION OH-58A	6
		HELICOPTER UTILITY UH-1H	2
COMMUNICATION-ELECTRONICS EQUIPMENT			
CENTRAL OFFICE TEL MANUAL AN/TTC-29	2	MISCELLANEOUS EQUIPMENT	
CONTROL RADIO SET AN/GSA-7	1	ALARM OML AGENT AUTO: PTBL MANPACK	1
ELECTRONIC TT SCTY EQUIPMENT TSEC/KW-7	4	ALARM OML AGENT AUTO: PTBL F/WHEEL VEH	1
RADIAC SET AN/PDR-27	2	DRUM FABRIC COLLAPSIBLE FUEL 500-GAL	3
RADIAC METER IM-93/UD	17	FORWARD AREA REFUEL EQUIP (FARE)	1
RADIAC METER IM-174/PD	9	NIGHT SIGHT CREW-SERVED WEN AN/TVS-5	3
RADIO SET AN/GRC-106	1	NIGHT VISION GOGGLES AN/PVS-5	35
RADIO SET AN/GRC-160	4	TANK AND PUMP UNIT TRK MTD (1200-GAL)	1
		TANK UNIT TRL MTD (600-GAL)	1

HEADQUARTERS AND HEADQUARTERS COMPANY SEPARATE ARMORED BRIGADE

TOE 17-102H(C18)

SEPARATE BRIGADE HEADQUARTERS

COMMAND SECTION

TSEC KY 38
AN VRC 47



- 1 BG (Bde Cdr) P
- 1 LT (Aide) R
- 1 SSG (Ent Aide) R
- 1 SP5 (Chauffeur) R

AN VRC 47



- 1 COL (Dep Bde Cdr) P
- 1 CSM (Cmd SGT Major) R
- 1 SP6 (Secy Stero) R
- 1 SP4 (Chauffeur) R

TSEC KY 38
AN VRC 46



- 1 SP4 (Carr Dvr) P

EXECUTIVE OFFICER SECTION

AN GRA 39
AN VRC 46



- 1 LTC (XO) P
- 1 SP4 (Clk Typist) (Dvr) R

UNIT STAFF

S1 SECTION

AN VRC 46



- 1 MAJ (S1) P
- 1 CPT (Asst S1) R
- 1 MSG (Sr Reenlistment NCO) R
- 1 SFC (Pers Mgt Supv) R
- 2 SP4 (Clk Typist) R
- 1 PFC (Carr Dvr) P

S3 SECTION

AN GRA 39
AN VRC 47



- 1 MAJ (Asst S3) P
- 1 CPT (Asst S3 Air) R
- 1 SGM (Chief Op SGT) R
- 1 SP5 (Op SGT Air) R
- 1 SP4 (Clk Typist) R
- 1 SP4 (Carr Dvr) P

TSEC KY 38
AN VRC 47



- 1 PT (Asst S3) R
- 1 MSG (Op SGT) R
- 1 SP5 (Chief Radio Op Supv) R
- 1 SP4 (Op Asst) R
- 1 SP4 (Carr Dvr) P
- 1 SP4 (Clk Typist) R
- 1 SP4 (RTO) R

S2 SECTION

TSEC KY 38
AN GRA 39
AN VRC 43



- 1 MAJ (S2) P
- 1 CPT (Asst S2) R
- 1 CPT (Asst S2 Air) R
- 1 MSG (Ch Intel SGT) R



- 1 SFC (Aerial Intel SGT) R
- 1 SP4 (Intel Asst) R
- 2 SP4 (Clk Typist) R
- 1 SP4 (Carr Dvr) P

AN VRC 46



- 1 MAJ (S4) P
- 1 SP4 (Clk Typist) (Dvr) R

S4 SECTION

AN VRC 46



- 1 CPT (Mgt Op SGT) (Asst S4) R
- 1 Wt. Equip. Supt. R
- 1 MSG (Equip. Supt. R)
- 1 MSG (Equip. Supt. SGT) R
- 1 P4 (Movement Supt. R)
- 1 P4 (Carr Dvr) P

SIG SEC
AN VRC 64



- 1 MAJ (C E Staff Off) P
- 1 WO (Crypto Tech) R
- 1 SP4 (Clk Typist) R
- 1 SP4 (Telecom Ctr Op) (Dvr) R
- 1 PFC (Telecom Ctr Op) R

CML SEC



- 1 MAJ (CML Off) P
- 1 LT (Asst CML Off) R
- 2 SFC (NBC Op Staff NCO) R
- 1 SSG (Plotter) R
- 1 SGT (NBC Op NCO) R
- 1 SGT (Computer) R
- 1 SP4 (Clk Typist) R

PM SEC
AN VRC 37



- 1 MAJ (Bde PM) P
- 1 SFC (Op SGT) R
- 1 SP4 (Clk Typist) (Dvr) R

CIVIL AFFAIRS SECTION

- 1 LTC (Civ Affairs Off) P
- 1 SFC (Admin Supv) R
- 1 SP4 (Clk Typist) R

CHAPLAIN SECTION



- 1 MAJ (Bde Chaplain)
- 1 SP6 (Sr Chapel Act Sp) (Dvr) R



- 1 CPT (Chaplain)
- 1 SP5 (Chapel Act Sp) (Dvr) R



- 1 CPT (Chaplain)
- 1 SP4 (Chapel Act Sp) (Dvr) R



- 1 CPT (Chaplain)
- 1 PFC (Chapel Act Sp) (Dvr) R

HEADQUARTERS COMPANY

COMPANY HEADQUARTERS



AN VRC 64

- 1 CPT (Co Dvr) P
- 1 PFC (Dvr) R, GL



- 1 SSG (First Sergeant) R
- 1 SP5 (Unit Clerk) (Dvr) R



- 1 SSG (Sup SGT) R
- 1 PFC (Gen Supplyman) (Dvr) R



- 1 SP4 (Armorer) (Dvr) R, GL

MESS SECTION



- 1 SFC (Food Svc SGT) R
- 1 SSG (1st Cook) R
- 1 SP5 (Cook) R
- 2 SP4 (Cook) (Dvr) R
- 2 PFC (Cook) R

MAINTENANCE SECTION



AN VRC 64

- 1 LT (XO) R
- 1 MSG (Mtr SGT) R
- 1 SP4 (PLL Clk) R
- 1 PFC (Trk Veh Mech) (Dvr) R
- 1 Cal 50 mg



- 2 SGT (Lt W Veh/Pwr Gen Mech) R
- 4 SP4 (Lt W Veh/Pwr Gen Mech) R
- 1 SP4 (Equip Maint Clerk) (Dvr) R

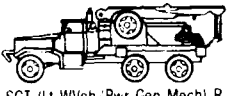

- 1 SGT (Lt W Veh/Pwr Gen Mech) R
- 1 SP4 (Wrecker Op) R



(w/trk and trl mtd fuel unit)

- 1 SGT (Sr Track Veh Mech) R
- 3 PFC (Pwr Gen W Veh Mech) R

Note: XO assigned to Co HQ

*Mounts TOE cal 50 mg on ring mount

MEDICAL SECTION

AID STATION SEC

AN/VRC 64



- 1 WO (Physician's Asst) R
- 1 SFC (Medical NCO) R
- 1 SP6 (Practical Nurse) R
- 1 SP5 (Med Aidman) R
- 1 SP4 (Med Aidman) (Dvr) R
- 1 PFC (Patient Care Sp) R
- 1 PFC (Med Aidman) R

AIDMAN-EVACUATION SEC



- 2 SP5 (Co Aidman) P
- 2 SP5 (Troop Aidman) P
- 2 SP4 (Ambi/Attendant) R



- 1 SP4 (Troop Aidman) P
- 1 SP4 (Co Aidman) P
- 2 SP4 (Ambi/Attendant) R
- 2 PFC (Amb Dvr) P

MILITARY POLICE PLATOON

PLT HQ

AN/VRC-47



- 1 LT (Plt Ldr) P
- 1 SFC (Plt SGT) R
- 1 SP4 (MP) (Dvr) R
- 1 7.62 mm mg
- 1 90 mm Recoilless Rifle

(3) MILITARY POLICE SQUAD

AN/VRC-46



- 1 SSG (Sqd Ldr) P
- 1 SP4 (MP) (Dvr) R
- 1 PFC (MP) R
- 1 7.62 mm MG

AN/VRC-64



- 1 SGT (Patrol Ldr) R
- 1 SP4 (MP) (Dvr) R
- 1 PFC (MP) R

AN/VRC-64



- 1 SP4 (MP) R
- 1 PFC (MP) R, GL
- 1 PFC (MP) (Dvr) R

1 MILITARY POLICE SQUAD

2 AN/PRT-4
2 AN/PRR-9



- 1 SSG (Sqd Ldr) P
- 1 SP4 (MP) (Dvr) R
- 1 PFC (MP) R
- 1 7.62 mm MG



- 1 SGT (Patrol Ldr) R
- 1 SP4 (MP) (Dvr) R
- 1 PFC (MP) R
- 1 7.62 mm MG



- 1 SP4 (MP) R
- 1 PFC (MP) R
- 1 PFC (MP) (Dvr) R
- 1 7.62 mm MG

COMMUNICATION PLATOON

PLT HQ

AN/VRC-64



- 1 LT (Plt Ldr) R
- 1 MSG (Comm Chief) R
- 1 SP5 (Fld Gen Comsec Rpr) R
- 1 SP5 (Comsec Rpmn) R
- 2 PFC (Comm Sys Op/Mech) R
- 1 PFC (Dvr) R
- 1 PFC (Fld Gen Comsec Rpr) R

MESSAGE CENTER AND WIRE SECTION

AN/TCC-29
AN/TTC-29
AN/GGC-3



- 1 SFC (Comm Chief) R
- 1 SGT (Tac Wire Tm Chief) R
- 1 PFC (Telecom Ctr Op) (Dvr) R
- 1 PFC (Tac Wire Op Sp) R

AN/TCC-29
AN/TTC-29
AN/PGC-1



- 1 SGT (Crypto NCO) R
- 1 SGT (Wire Sys Tm Chief) R
- 1 SGT (Tac Wire Op Tm Chief) R
- 2 SP4 (Tac Wire Op Sp) R



- 1 SGT (Tac Wire Op Tm Chief) R
- 2 SP4 (Tac Wire Op Sp) R
- 1 SP4 (Telecom Ctr Op) (Dvr) R
- 2 PFC (Tac Wire Op Sp) R



- 1 SGT (Tac Wire Op Tm Chief) R
- 2 SP4 (Tac Wire Op Sp) R
- 1 SP4 (Telecomm Ctr Op) (Dvr) R
- 2 PFC (Tac Wire Op Sp) R



- 1 SGT (Tac Wire Op Tm Chief) R
- 2 SP4 (Tac Wire Op Sp) R
- 1 SP4 (Wire Sys Inst/Op) R
- 2 PFC (Tac Wire Op Sp) (Dvr) R



- 1 SGT (Tac Wire Op Tm Chief) R
- 2 SP4 (Tac Wire Op Sp) R
- 1 SP4 (Wire Sys Inst/Op) R
- 2 PFC (Tac Wire Op Sp) (Dvr) R



- 1 SGT (Tac Wire Op Tm Chief) R
- 2 SP4 (Tac Wire Op Sp) R
- 1 SP4 (Wire Sys Inst/Op) R
- 2 PFC (Tac Wire Op Sp) (Dvr) R

RADIO SECTION

TSEC/KW-7
AN/GRA-6
AN/GRC-142



- 1 SSG (RATT Op Supv) R
- 1 SP4 (RATT Op) (Dvr) R
- 1 PFC (RATT Op) R

TSEC/KW-7
AN/GRA-6
AN/GRC-142



- 1 SGT (RATT Tm Chief) R
- 1 SP4 (RATT Op) (Dvr) R
- 1 PFC (RATT Op) R

HYL-3/TSEC
AN/VRC-49
AN/GRC-106

AN/GSA-7
TSEC/KY-38
2 AN/GRA-39



- 1 SGT (RATT Tm Chief) R
- 1 SP4 (Rdo Op) R
- 1 PFC (Rdo Op) (Dvr) R

COMMAND AVIATION SECTION

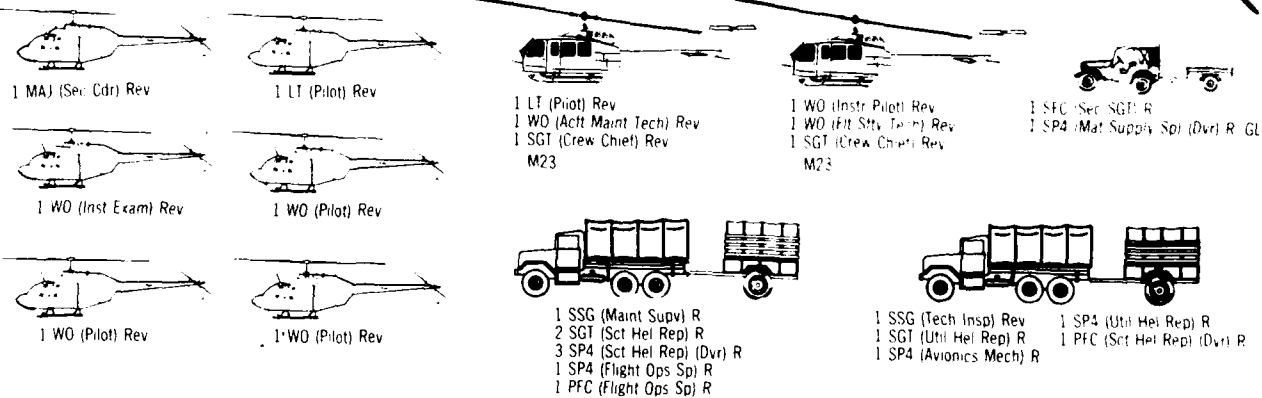

Note Each Hel has 1 TSEC/KY-28

374

ADA SECTION

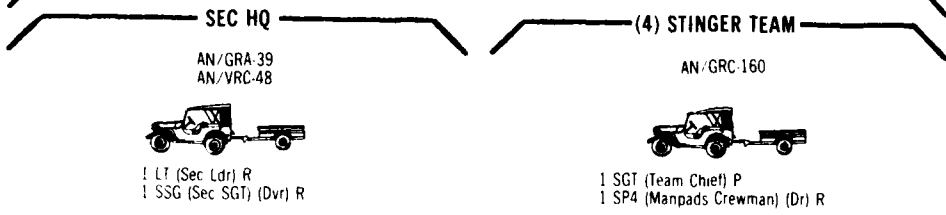

RR/EO SEC

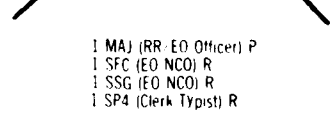

MISSION a. To increase the combat effectiveness of the separate armored brigade by providing engineer combat support

b. To provide an engineer special staff section for the brigade

ASSIGNMENT: Organic to Separate Armored Brigade, TOE 17-100, or Separate Infantry Brigade (Mechanized) TOE 37-100

CAPABILITIES: a. Provides engineer staff planning and supervision for organic and attached engineer troops

b. Provides the capability to accomplish engineer combat tasks, and when reinforced with engineer heavy equipment, may accomplish limited engineer combat support construction missions

c. Provides engineer reconnaissance and the production of engineer intelligence for the brigade

d. Provides atomic demolition munitions (ADM) support when reinforced with TOE 5-570 ADM Team

e. Provides a limited unit capability for infantry combat when required

f. Provides the capability to span three 60-foot wet or dry gaps with the class 60 armored vehicle launched bridge (AVLB)

g. When equipped with mobile assault bridging equipment, can erect up to 282 feet of class 60 floating bridge or two class 60 self-propelled ferries

h. When equipped with M416 or class 60 bridging equipment

(1) Can erect the M416 bridge which provides up to 280 feet of class 50 floating bridge or two four-float class 50 rafts and two five-float class 60 rafts. Bridge components may also be used to construct short fixed spans

(2) Can erect the class 60 bridge which provides up to 270 feet of class 60 floating bridge or two class 45 four-float rafts or two five-float class 60 rafts. Bridge components may be used to construct short fixed spans

i. Provides stream crossing equipment to support an infantry company in a river crossing when amphibious vehicles cannot be used, are not available, or river conditions preclude the use of mobile amphibious bridge or ferry vehicles. Equipment includes:

(1) Assault boats (9) and reconnaissance boats (6) to carry one infantry company by waterborne assault

(2) Light tactical raft capability to provide the following options:

(a) One class 12 ferry, or

(b) One class 12 bridge 44 feet long, or

(c) Four pontoons powered by outboard motors for use in assault crossings if required

j. Provides organizational maintenance for organic equipment

376

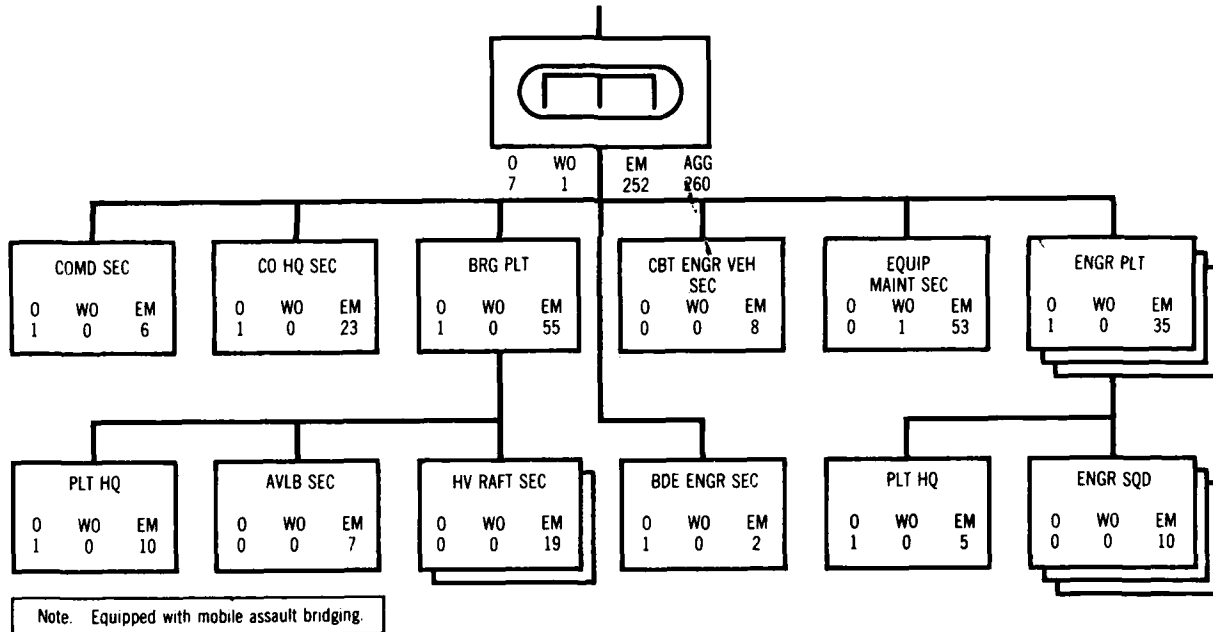

SUMMARY OF EQUIPMENT

WEAPONS	
GUN DEMOLITION 165-MM BII	2
LAUNCHER GRENADE CEV MTD M239	4
LAUNCHER GRENADE M203	24
MACHINEGUN CAL .50 HB FLEX VEH MTD	9
MACHINEGUN CAL .50 VEH FIXED	2
MACHINEGUN 7.62-MM FLEX	5
MACHINEGUN 7.62-MM VEH FIXED	2
PISTOL CAL .45	23
RIFLE 5.56-MM	237
SUBMACHINEGUN CAL .45	4
TRACKER IR GUIDED MSL SU-36 (DRAGON)	6

VEHICLES AND VEHICLE EQUIPMENT	
BRIDGE AVL SCISSOR CL 60 60-FT SPAN	3
CARRIER CP LIGHT TRACK M577A1	1
CARRIER PERSONNEL FULL TRACK M113A1	9
COMBAT ENGINEER VEHICLE FULL TRACK M728	2
CRANE WHEEL MTD 20-TON	1
GRADER ROAD MTD HV 6X4	1
LAUNCHER M60 SERIES FOR AVLB	2
LOADER SCOOP DSL 2-1/2-CU YD	2
PNEUMATIC TOOL & COMPRESSOR OUTFIT TRK MTD	1
KITCHEN FIELD TRAILER MOUNTED	1
SEMITRAILER LOMBED 25-TON M172A1	3
SHOP EQUIP CONTACT MAINT TRK MTD	1
TRACTOR FULL TRACK DSL MDM	2
TRACTOR WHL IND DSL W/BACKHOE AND LOADER	1
TRAILER AMMO 1-1/2-TON M332	9
TRAILER BOLSTER CP 4-TON M796	2
TRAILER CARGO 1/4-TON M416	7
TRAILER CARGO 1-1/2-TON M105A2	1
TRAILER FLAT BED 10-TON 4-WHEEL	1
TRAILER TANK WATER 400-GAL M149	1
TRUCK CARGO 1-1/4-TON 6X6 M561	2
TRUCK CARGO 2-1/2-TON M35A2	9
TRUCK CARGO 5-TON 8X8 M656	1
TRUCK CARGO DROPSIDE 5-TON 6 X6 W/WN M813A1	1
TRUCK DUMP 5-TON M817	1
TRUCK DUMP 5-TON W/WN M817	3
TRUCK TANK FUEL SVC 2500-GAL 4X4 M559	1
TRUCK TRACTOR 10-TON 6X6 W/MIDSHIP WN M123A1C	3
TRUCK UTILITY 1/4-TON M151A2	8
TRUCK WRECKER 5-TON M816	1
WATER PURIFICATION SET TRK MTD 1500-GPH	2

ENGINEER EQUIPMENT	
BOAT BRIDGE ERECT INBOARD	2
BOAT LANDING INFLATABLE 15-MAN	9
BOAT RECON PNEUMATIC 3-MAN	6
BRIDGE FLOATING RAFT SEC LT TACTICAL	1
FERRY CONVERSION SET RAFT INF SPT	1
OUTBOARD MOTOR GAS 25 BHP	4
SUPERSTRUCTURE END BAY-MAB	4
SUPERSTRUCTURE INTERIOR BAY-MAB	8
SUPERSTRUCTURE TRANSPORTER-MAB	12

COMMUNICATION-ELECTRONICS EQUIPMENT	
RADIAC SET AN/PDR-27	2
RADIAC METER IM-93/UD	19
RADIAC METER IM-174/PD	14
RADIO SET AN/GRC-160	15
RADIO SET AN/VRC-46	4
RADIO SET AN/VRC-47	6
RADIO SET CONTROL GROUP AN/GRA-39	1
SPEECH SCTY EQUIPMENT TSEC/KY-57	31
SWITCHBOARD TEL MANUAL SB-22/PT	1
SWITCHBOARD TEL MANUAL SB-993/GT	3
TELEPHONE SET TA-1/PT	3
TELEPHONE SET TA-312/PT	9

MISCELLANEOUS	
ALARM CML AGENT AUTO PTBL F/WHEEL VEH	1
DETECTING SET MINE PTBL AN/PVS-7	14
DETECTING SET MINE PTBL AN/PVS-11	11
DRUM FABRIC COLLAPSIBLE FUEL 500-GAL	3
NIGHT SIGHT CREW-SERVED WFN AN/PVS-5	12
NIGHT SIGHT INDIVIDUAL WFN AN/PVS-4	10
NIGHT VISION GOGGLES AN/PVS-5	30
SEARCHLIGHT AN/VSS-3	2
TANK AND PUMP UNIT TRK MTD (1200-GAL)	1
TANK FABRIC COLLAPSIBLE WATER 1500-GAL	6

TOE 5-127H(C16)

ENGINEER COMPANY, SEPARATE ARMORED BRIGADE

COMMAND SECTION

TSEC: KY 38
AN: VRC 46



- 1 MAJ (Co Cdr) P
- 1 SSG (Recon SGT) R
- 1 SGT (Recon Sp) R
- 1 SP4 (Recon Sp) (Dvr) R

AN/VRC 47



- 1 SFC (Op SGT) R
- 1 SSG (Op Asst) R
- 1 PFC (Carrier Dvr) P

CEV SECTION

AN/ GRC 160



- 1 SSG (CEV Cdr) P
- 1 SP5 (CEV Gunner) P
- 1 PFC (CEV Loader) P, S
- 1 SP4 (CEV Dvr) P

AN/ GRC 160



- 1 SSG (CEV Cdr) P
- 1 SP5 (CEV Gunner) P
- 1 PFC (CEV Loader) P, S
- 1 SP4 (CEV Dvr) P

COMPANY HEADQUARTERS SECTION

TSEC: KY 38
AN: GRA 39
AN: VRC 46



- 1 LT (XO) R
- 1 SGT (NBC Op NCO) R
- 1 PFC (Dvr) R, GL



- 1 1SG (First SGT) R
- 1 SSG (Comm Chief) R
- 1 SSG (Supply SGT) R
- 1 SP5 (Unit Clk) R
- 1 SP4 (Armorer) R, GL
- 1 SP4 (Comm Sys Op/Mech) R
- 1 PFC (Gen Supplyman) (Dvr) R
- 1 7.62-mm mg



- 1 SFC (Food Svc SGT) R
- 1 SSG (1st Cook) R
- 1 SP5 (Cook) R
- 2 SP4 (Cook) (Dvr) R
- 2 PFC (Cook) R

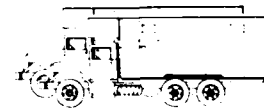

- 1 SSG (Water Production Spl) R
- 2 SGT (Water Supply SGT) R
- 2 SP4 (Water Supply Spl) (Dvr) R
- 2 PFC (Water Supply Spl) R
- 3 Tank Water 1,500 gal

EQUIPMENT-MAINTENANCE SECTION

AN: GRC 160



1 WO (Engr Eq Rep Tech) R
1 SP4 (Dvr) R
1 PFC (PLL Ck) R, GL
1 7.62 mm mg



1 SFC (Sec SGT) R
1 SGT (CEV Turret Mech) R
1 SP4 (Dispatcher) R, GL
4 SP4 (Const Eq Mech) R
1 PFC (Dvr) R
4 PFC (Const Eq Mech) R



1 SFC (Motor SGT) R
4 SGT (Const Eq Mech) R
1 SP4 (Eq Maint Ck) R
1 SP4 (Welder) R
1 PFC (Track Veh Mech) (Dvr) R

(5 Ton Dropside)



2 SGT (Pwr Gen W Veh Mech) R
3 PFC (Pwr Gen W Veh Mech) (Dvr) R

(w trk mtd fuel unit)



1 SP4 (Hv Veh Dvr) R
3 Drum Fuel

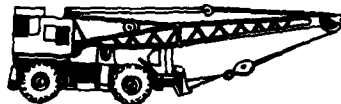

1 SGT (Lift/Load Eq Op) R
1 SP4 (Lift/Load Eq Op) R
1 PFC (Lift/Load Eq Op) R

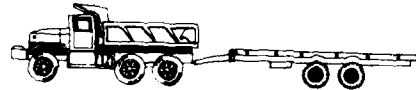

1 SP4 (Decon Eq Op) R
1 PFC (Decon Eq Op) R



1 SGT (Const Eq Op) R
1 SP4 (Gen Const Mach Op) R



1 SP4 (Const Eq Op) R
1 PFC (Const Eq Op) R



1 SGT (Track Veh Mech) R
1 SP4 (Track Veh Mech) R
2 SP4 (Pwr Gen/W Veh Mech) R
1 PFC (Track Veh Mech) (Dvr) R



2 PFC (Const Eq Op) R

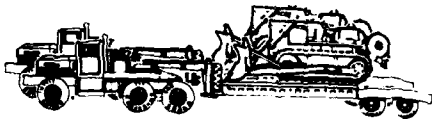

1 SGT (Const Eq Op) (Dvr) R
1 PFC (Const Eq Op) R

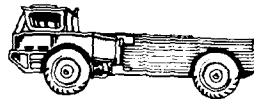

1 SGT (Hv W Veh Mech) R
1 SP4 (Hv Veh Dvr) R

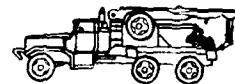

1 SP4 (Wrecker Op) R

BRIDGE PLATOON

PLATOON HEADQUARTERS

AN/VRC-47



- 1 LT (Plt Ldr) R
- 1 PFC (Bridge Sp) (Dvr) R
- 1 Fltg Raft

AN/VRC-46



- 1 SFC (Plt SGT) R
- 1 PFC (Bridge Sp) (Dvr) R



- 1 SP4 (Bridge Sp) (Dvr) R
- 1 PFC (Bridge Sp) R
- 3 Boat Recon
- 1 Bolster Trl



- 1 SP4 (Bridge Sp) (Dvr) R
- 3 Boat Aslt Landg

(2) HEAVY RAFT SEC

- 1 SSG (Sec SGT) R. GL
- 6 SGT (MAB Crew Ch) R
- 6 SP4 (MAB Crewman) R
- 6 SP4 (MAB Op) R
- 2 Superstructure End Bay
- 4 Superstructure Interior Bay
- 6 Superstructure Transporter

AVLB SEC

AN/VRC-46



- 1 SSG (Sec Chief) R
- 1 PFC (Dvr) R



- 1 SP4 (Hv Veh Dvr) R

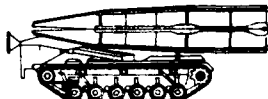

- 1 SP5 (AVLB Cdr) P
- 1 SP4 (AVLB Dvr) P

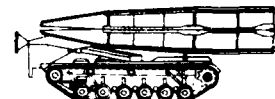

- 1 SP5 (AVLB Cdr) R
- 1 SP4 (AVLB Dvr) R

(3) ENGINEER PLATOON

PLT HQ

AN/GRC-160
AN/VRC-47



- 1 LT (Plt Ldr) R
- 1 SFC (Plt SGT) R
- 1 PFC (Dvr) R
- 1 PFC (Toolrm Keeper) R
- 2 SU-36
- 1 7.62-mm mg



- 1 SP4 (Cbt Const Sp) R
- 1 SP4 (Hv Veh Dvr) R

(3) ENGINEER SQUAD

AN/GRC-160



- 1 SSG (Sqd Ldr) R
- 1 SGT (Asst Sqd Ldr) R
- 1 SGT (Demolition Sp) R
- 3 SP4 (Cbt Const Sp) R
- 1 SP4 (Demolition Asst) R
- 1 SP4 (Carr Dvr) P
- 2 PFC (Cbt Const Sp) R, GL

381

BDE ENGR SEC

AN/VRC-47



- 1 CPT (Asst Bde Engr) R
- 1 SSG (Cbt Const Fmn) R
- 1 PFC (Dvr) R

MISSION: To provide brigade level combat service support consisting of supply, maintenance, transportation, medical, personnel and administration services, and administrative field services to all assigned and attached elements of a type separate armored brigade or separate infantry brigade (mechanized).

ASSIGNMENT: Organic to Separate Armored Brigade TOE 17 100 or Separate Infantry Brigade (mechanized) TOE 17 310.

CAPABILITIES: a. Provide organic level combat service support as specified below to all assigned and attached elements of type separate armored brigade consisting of a brigade base tank battalion and one infantry battalion (mechanized) or a type separate infantry brigade (mechanized) consisting of a brigade base two infantry battalions (mechanized) and one tank battalion.

- b. Control of ammunition allocation.
- c. A limited capability to carry brigade reserve supplies.

d. Direct support maintenance of all equipment except aircraft, ground medical and communication security equipment and organizational maintenance of mobile equipment authorized in the brigade.

e. Organic level medical services including evaluation, triage, first aid and general first aid, stabilization, emergency dental treatment.

f. Personnel and administrative services to the brigade.

g. Advise to the brigade commander and staff on supply, transportation, maintenance, medical and veterinary matters.

h. Medical services to the brigade.

i. Combat and non-combat contracting services.

j. Fire extinguisher refills and exchange services to the brigade.

382

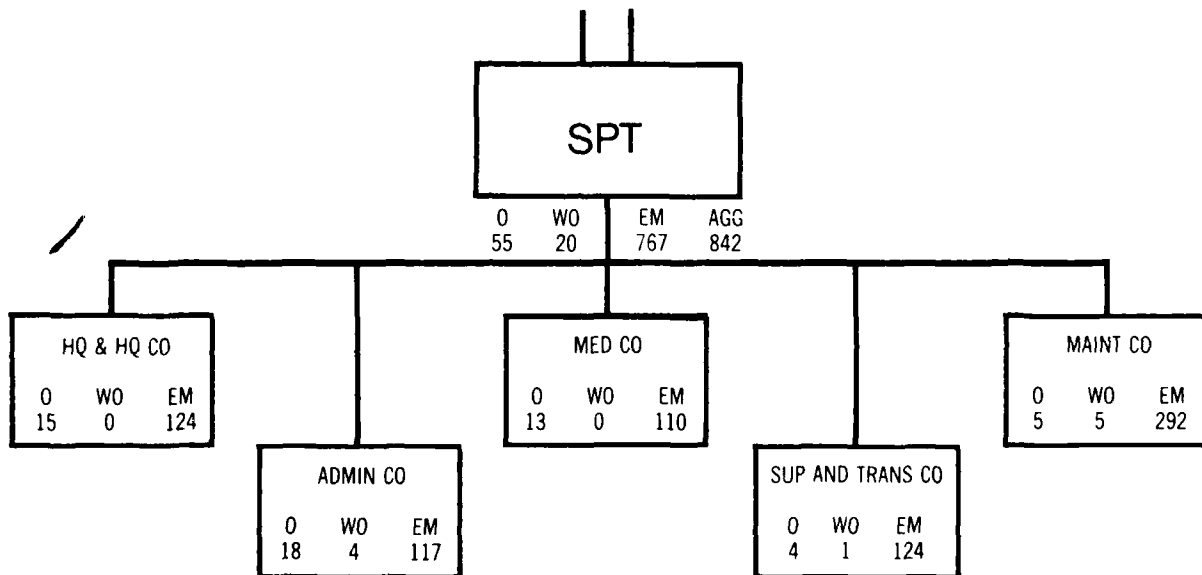

SUMMARY OF EQUIPMENT

WEAPONS		
LAUNCHER GRENADE M203	16	
MACHINEGUN CAL .50 HB FLEX FOR GND USE	6	
MACHINEGUN 7.62-MM FLEX	16	
PISTOL CAL .45	31	
RIFLE 5.56-MM	809	
SUBMACHINEGUN CAL .45	2	
VEHICLES AND VEHICLE EQUIPMENT		
ELECTRONIC SHOP SEMITRL MTD AN/ASM-146	5	
ELECTRONIC SHOP SEMITRL MTD AN/ASM-147	2	
KITCHEN FIELD TRAILER MOUNTED	2	
RECOVERY VEHICLE MEDIUM M88	1	
SEMITRAILER LOWBED HET 60-TON M747	2	
SEMITRAILER STAKE 22-1/2-TON M871	12	
SEMITRAILER TANK FUEL SERVICING 5000-GAL M131A5	9	
SEMITRAILER VAN REP PARTS STORAGE 6-TON M750	7	
SEMITRAILER VAN SUPPLY 12-TON M129A2C	4	
SHOP EQUIP CONTACT MAINT TRK MTD	5	
SHOP EQUIP ELEC REPAIR SEMITRL MTD	2	
TRAILER CARGO 1/4-TON M416	30	
TRAILER CARGO 3/4-TON M101A1	9	
TRAILER CARGO 1-1/2-TON M105A2	50	
TRAILER TANK WATER 400-GAL M149A1	6	
TRUCK AMBULANCE 1-1/4-TON 6X6 M792	12	
TRUCK CARGO 1-1/4-TON 6X6 M561	1	
TRUCK CARGO TAC 1-1/4-TON 4X4 M880	13	
TRUCK CARGO TAC 1-1/4-TON W/60AMP COMM KIT	8	
TRUCK CARGO TAC 1-1/4-TON W/100 AMP COMM KIT	1	
TRUCK CARGO 2-1/2-TON M35A2	21	
TRUCK CARGO 2-1/2-TON W/WN M35A2	1	
TRUCK CARGO DROPSIDE 2-1/2-TON M35A2C	27	
TRUCK CARGO 5-TON 6X6 M813	2	
TRUCK CARGO DROPSIDE 5-TON 6X6 M813A1	3	
TRUCK TANK FUEL SERVICING 2500-GAL 4X4 M559	1	
TRUCK TRACTOR 2-1/2-TON M275A2	3	
TRUCK TRACTOR 5-TON 6X6 M818	29	
TRUCK TRACTOR 5-TON 6X6 W/WN M818	1	
TRUCK TRACTOR HET 22-1/2-TON 8X8 M746	2	
TRUCK UTILITY 1/4-TON M151A2	30	
TRUCK VAN EXPANSIBLE 5-TON 6X6 M820	3	
TRUCK VAN SHOP 2-1/2-TON M109A3	10	
TRUCK WRECKER 5-TON M816	4	
COMMUNICATION-ELECTRONICS EQUIPMENT		
ELECTRONIC TT SCTY EQUIPMENT TSEC/KW-7		1
RADIAC SET AN/PDR-27		6
RADIAC METER IM/9-PD		2
RADIAC METER IM/93-UD		32
RADIAC METER IM/174-PD		15
RADIO SET AN/GRC-106		1
RADIO SET AN/GRC-160		1
RADIO SET AN/VRC-46		19
RADIO SET AN/VRC-47		4
RADIO SET AN/VRC-64		3
RADIO SET CONTROL GROUP AN/GRA-39		11
RADIO TT SET AN/GRC-142		1
SPEECH SCTY EQUIPMENT TSEC/KY-57		30
SWITCHBOARD TEL MANUAL SB-22/PT		5
TELEPHONE SET TA-312/PT		87
MISCELLANEOUS EQUIPMENT		
ALARM OHL AGENT AUTO PTBL MANPACK		7
ALARM OHL AGENT AUTO PTBL FIXED		10
ALARM OHL AGENT AUTO PTBL F/WHEEL VEH		1
DETECTING SET MINE PTBL AN/PRS-7		2
DETECTING SET MINE PTBL AN/PSS-11		2
DRUM FABRIC COLLAPSIBLE FUEL 500-GAL		12
FORWARD AREA REFUEL EQUIP (FARE)		2
FUEL SYS SUPPLY POINT PTBL		1
TANK AND PUMP UNIT TRK MTD (1200-GAL)		2
TANK FABRIC COLLAPSIBLE FUEL 10,000-GAL		6
TANK FABRIC COLLAPSIBLE WATER 500-GAL		15
TANK UNIT TRL MTD (600-GAL)		3

383

SUPPORT BATTALION SEPARATE ARMORED BRIGADE

TOE 29-75H (as changed)

MISSION: To provide command and control of brigade support battalion organic and attached units, except operational control of the brigade special staff elements of the Administrative Company, Separate Armored Infantry or Infantry Brigade (Mechanized), TOE 112011.

ASSIGNMENT: Organic to Support Battalion, Separate Armored Brigade, or Infantry Brigade (Mechanized), TOE 29 75, or Support Battalion, Separate Infantry Brigade, TOE 29 135.

CAPABILITIES: a. Provides supervision and control of all logistical operations of the separate brigade.

b. Advises the brigade commander on logistical operations.

c. Plans, coordinates and supervises all direct support maintenance repair part supply activities for all equipment of the separate brigade, except medical, cryptographic, quartermaster air items and missile peculiar items.

d. Provides technical supervision over the conduct of maintenance through the brigade.

e. Supervises training of personnel and units of the brigade support battalion.

f. Determines requirements for supplies and equipment for the brigade.

g. Supervises routine unit administration and supply within the brigade support battalion.

h. Procures and directs the receipt, temporary storage, issue and/or distribution of supplies and equipment. Maintains reports relating to these actions.

i. Consolidates and disseminates logistical information to brigade support battalion and higher headquarters.

j. Coordinates rear area security and area damage control plans for the brigade rear area.

384

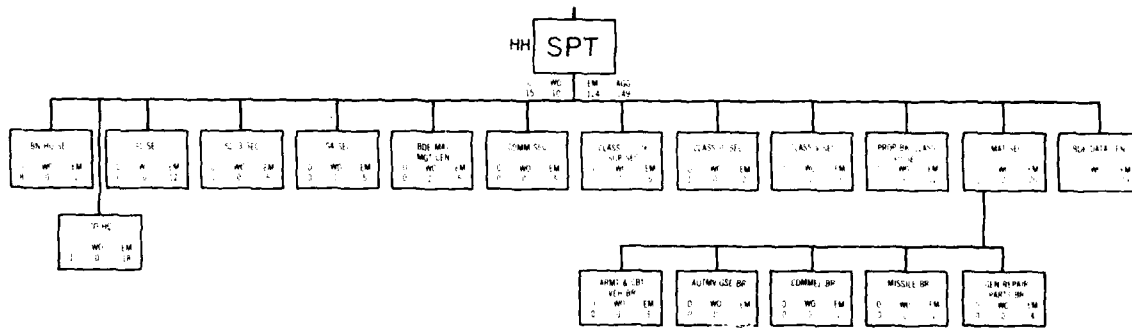

BATTALION HQ SEC	
1 LTC	Battalion Cdr 11
1 MAJ	ADPS Officer 11
1 MAJ	MO 11
1 MAJ	Material Mgt Officer 11
1 MAJ	S-2/3 11
1 CPT	C-E Staff Officer
1 CPT	S-1
1 CPT	S-4
1 SGT	Command Sergeant Major
1 SGT	Clerk Typist 01
1 SGT	Radio Set AN/VRC-46..... 3
1 SGT	Speech Sec Equip TSEC/RV-57..... 3
1 SGT	Trailer Cargo 1/4-Ton..... 2
1 SGT	Truck Utility 1/4-Ton..... 2

S-1 SECTION	
1 SFC	PAC Supervisor
1 SSG	Personnel Staff NCO
1 SPS	SR Army Career CSRA
1 SPS	Journalist
1 SPS	Legal Clerk
1 SPS	Mail Distribution Sp
1 SPS	PAC Clerk
1 SPS	PAC Clerk Typist 01
1 SPS	PAC Clerk
1 SPS	PAC Clerk
1 SPS	Trailer Cargo 3/4-Ton..... 1
1 SPS	Truck Cargo TAC 1-1/4-Ton..... 1

S-2/3 SECTION	
1 CPT	Trans Plans Con Off
1 SGT	Operations Sergeant
1 SGT	Intel-Security Sgt
1 SFC	Chemical Staff NCO
1 SPS	Clerk Typist
1 SPS	Illustrator
1 SPS	Radio Set AN/VRC-46..... 2
1 SPS	Speech Security Equip TSEC/RV-57 2
1 SPS	Trailer Cargo 1/4-Ton..... 2
1 SPS	Truck Utility 1/4-Ton..... 2

S-4 SECTION	
1 WO	Autom Maint Tech
1 SFC	Maintenance Supv
1 SFC	Supply Sergeant
1 SGT	Supply Actg Sgt
1 SPS	Supply Actg Clerk 01
1 PFC	Supply Actg Clerk 01
1 SPS	Trailer Cargo 1/4-Ton..... 1
1 SPS	Trailer Cargo 1-1/2-Ton..... 1
1 SPS	Truck Cargo 2-1/2-Ton..... 1
1 SPS	Truck Utility 1/4-Ton..... 1

BDE MATERIEL MGT CENTER	
1 WO	Maint Sys-Proc Tech
1 WO	Sup Sys-Proc Tech
1 MSG	Chief Mat Mgt Sgt
1 SPS	Admin Specialist
1 SPS	Illustrator 01
1 SPS	Machine Op
1 SPS	Machine Op
1 SPS	Radio Set AN/VRC-46..... 1
1 SPS	Speech Security Equip TSEC/RV-57 1
1 SPS	Trailer Cargo 1/4-Ton..... 1
1 SPS	Truck Utility..... 1
1 SPS	Truck Van Expansible 5-Ton..... 1

COMMUNICATIONS SECTION	
1 SFC	Communications Chief
1 SGT	Radio Team Chief
1 SGT	RMTT Team Chief
1 SGT	Tec Wire Opta Chief
1 SPS	Radio Operator
1 SPS	RMTT Operator 01
1 SPS	Tactical Comm Mech
1 SPS	Tactical Wire Op Sp
1 SPS	Telecom Center Op 01
1 PFC	Radio Operator
1 PFC	RMTT Operator 01
1 PFC	Tactical Wire Op Sp 01
1 PFC	Radio Set AN/GRC-10M..... 1
1 PFC	Radio Set AN/VRC-46..... 2
1 PFC	Radio Teletypewriter Set AN/GRC-142..... 1
1 PFC	Speech Security Equipment TSEC/RV-57..... 2
1 PFC	Trailer Cargo 3/4-Ton..... 1
1 PFC	Truck Cargo TAC 1-1/4-Ton..... 1
1 PFC	W/60 Asp-Comm Kit..... 3
1 PFC	Truck Cargo TAC 1-1/4-Ton..... 1
1 PFC	W/100 Asp-Comm Kit..... 1

CLASS I, II-IV SUP SEC	
1 CPT	Supply Off
1 SFC	Chief Supply NCO
1 SFC	Role Donat-Ton Mat Mgr
1 SFC	Role Ind-Gen Mat Mgr
1 SFC	Role Org-Pers Mat Mgr
1 SFC	Role Subsistence Mgr
1 SFC	Trailer Cargo 3/4-Ton..... 1
1 SFC	Trailer Cargo 1-1/4-Ton..... 1

CLASS III SUPPLY SEC	
1 CPT	Role Petrol Supply Officer
1 SFC	Petrol Suppl Sergeant
1 SPS	Petrol Tank Control Sp 01
1 SPS	Trailer Cargo..... 1
1 SPS	Truck Utility..... 1

CLASS V SUPPLY SEC	
1 CPT	Role Ammo Supply Off
1 WO	Ammo Supply Tech
1 SFC	Ammo Supply NCO
1 SPS	SR Ammo Records Clerk 01
1 SPS	Ammo Records Clerk 01
1 SPS	Radio Set AN/VRC-46..... 1
1 SPS	Speech Security Equip TSEC/RV-57 1
1 SPS	Trailer Cargo 1/4-Ton..... 1
1 SPS	Trailer Cargo 3/4-Ton..... 1
1 SPS	Trailer Cargo TAC 1-1/4-Ton..... 1
1 SPS	Truck Utility 1/4-Ton..... 1

PROP BV/CL VII SEC	
1 CPT	Property Book Officer
1 WO	Sup Repch - Edit Tech
2 WO	Supply Tech
1 SPS	Supply Actg Supv
2 SPS	Supply Actg NCO
1 SFC	Com. Edit-Repch Supv
1 SFC	Customer Asst NCO
1 SPS	Com. Edit-Repch Sp
2 SPS	SR Sup Actg Sp
2 SPS	Com Edit-Repch Sp 01
2 SPS	Supply Actg Sp
1 SPS	Trailer Cargo 3/4-Ton..... 1
1 SPS	Truck Cargo TAC 1-1/4-Ton..... 1
1 SPS	Truck Van, Shop 2-1/2-Ton..... 1

MATERIAL SECTION	
1 CPT	Material Officer
1 WO	Maintenance MGT Tech
1 WO	Supply MGT Tech
1 SPS	CM Maint MGT NCO
1 SFC	CM Material MGT NCO
1 SSG	DOL COM-EDIT Supv
1 SPS	DOL COM-EDIT Sp
1 SPS	Clerk-Typist
1 SPS	EO Rec & Pts Sp
1 SPS	Radio Set AN/VRC-46..... 2
1 SPS	Speech Security Equip TSEC/RV-57 2
1 SPS	Trailer Cargo 1/4-Ton..... 1
1 SPS	Trailer Cargo 3/4-Ton..... 1
1 SPS	Truck Cargo 1-1/4-Ton..... 1
1 SPS	Truck Utility 1/4-Ton..... 1
1 SPS	Truck Van Shop 2-1/2-Ton..... 1

ASPT & CPT VEH BR	
1 SSG	Asst Maint Mgr
1 SSG	Asst-CV Maint Mgr
1 SSG	Asst-CV Maint Mgr

AUTV - GSE BR	
1 SSG	Autom Maint Mgr
1 SSG	Auxiliary - GSE Maint Mgr
1 SSG	CD Spt Bq Maint Mgr

CORREL BRANCH	
1 SSG	C-E Maint Mgr
1 SSG	C-E Mat Mgr

WISLE BRANCH	
1 SSG	Missile Maint Mgr
1 SSG	Missile Mat Mgr

GEN REPAIR PARTS BR	
1 SSG	Mat Ctl Supv
1 SPS	Mat Ctl & Actg Sp
1 SPS	Mat Ctl & Actg Sp
1 PFC	Mat Ctl & Actg Sp

BRIGADE DATA CENTER	
1 WO	Data Processing Tech
1 SSG	Data Processing NCO
1 SFC	Systems Supervisor
2 SFC	Machine Operator
1 SSG	Programmer/Analyst
1 SPS	ADPS Repsman
1 SPS	Machine Op
1 SPS	Programmer/Analyst
1 SPS	Clerk Typist
3 SPS	Machine Op
2 SPS	M/Pwr Gen Op/Mech
1 SPS	Programmer/Analyst
2 SPS	Refrigerator Sp
2 PFC	Machine Operator
1 PFC	Programmer/Analyst
1 SPS	Semitrailer Van, Cargo 6-Ton..... 1
1 SPS	Semitrailer Van, Expansible 6-Ton 1
1 SPS	Trailer Cargo 3/4-Ton..... 1
1 SPS	Truck Cargo Tactical 1-1/4-Ton... 1
1 SPS	Truck Tractor 5-Ton..... 2
1 SPS	Truck Van Shop 2-1/2-Ton..... 1

HEADQUARTERS COMPANY	
1 CPT	Company Commander 11
1 SGT	First Sergeant
1 SFC	Food Service Sgt
1 SFC	Maintenance Supv
1 SFC	Supply Sgt
2 SGT	Lt. M/W/Pwr Gen Mech
1 SPS	First Cook
1 SPS	Unit Clerk
1 SPS	Armsman
2 SPS	Cook
1 SPS	Bq Rec & Pts Sp
1 PFC	PLL Clerk 01
2 SPS	Lt. M/W/Pwr Gen Mech 01
1 PFC	Cook
2 PFC	Lt. M/W/Pwr Gen Mech 01
1 PFC	Alarm Chemical Agent Auto..... 3
1 PFC	Portable Backpack..... 3
1 PFC	Kitchen Field Trailer Mounted... 1
1 PFC	Launcher Grenade 40mm..... 2
1 PFC	Machine Gun 7.62mm Light Fle... 4
1 PFC	Pistol Cal .45..... 6
1 PFC	Radio Set AN/PDR-77..... 1
1 PFC	Radiometer: DR-93/UD..... 1
1 PFC	Radiometer: DR-174/PD..... 1
1 PFC	Radio Set AN/GRC-160..... 1
1 PFC	Rifle Cal 5.56mm..... 143
1 PFC	Speech Security Equip TSEC/RV-57 1
1 PFC	Trailer Cargo 3/4-Ton..... 1
1 PFC	Trailer Tank Water 400 gal..... 1
1 PFC	Truck Cargo, Tactical 1-1/4-Ton 1
1 PFC	W/60 Asp-Comm Kit..... 1
1 PFC	Truck Cargo 2-1/2-Ton..... 1
1 PFC	Truck Cargo 2-1/2-Ton w/Winch... 1

**HEADQUARTERS AND HEADQUARTERS COMPANY
SUPPORT BATTALION, SEPARATE ARMORED BRIGADE**

COMPANY HEADQUARTERS

1 CPT	Company Cdr	11
1 1SG	First Sergeant	
1 SFC	Food Svc SGT	
1 SSG	Supply Sergeant	
1 SSG	Maint Supv	
1 SGT	NBC Op NCO	
1 SP5	First Cook	
1 SP4	Armorer	01
2 SP4	Cook	01
1 SP4	Par Gen/Wveh Mech	
1 SP4	Tac Wire Op Sp	
1 PFC	Par Gen/Wveh Mech	
1 PFC	Cook	
1 PFC	Tac Wire Op Sp	01
	Kitchen Field Trailer Mtd.....	1
	Machingun 7.62-mm Flex.....	4
	Trailer Cargo 1/4-Ton.....	1
	Trailer Tank Water 400-Gal.....	1
	Truck Cargo Tac 1-1/4-Ton.....	1
	Truck Cargo 2-1/2-Ton.....	1
	Truck Utility 1/4-Ton.....	1

INSPECTOR GENERAL SECTION

1 MAJ	Inspector General	11
1 SFC	Admin Supv	
	Trailer Cargo 1/4-Ton.....	1
	Truck Utility 1/4-Ton.....	1

STAFF JUDGE ADVOCATE SECTION

1 MAJ	Staff JA	11
1 CPT	Asst Staff JA	
3 CPT	Trial/Defense Counsel	
1 WO	Legal Admin Tech	
1 SFC	Chief Legal Clerk	
1 SP5	Court Reporter	
1 SP4	Clerk Typist	01
	Trailer Cargo 1/4-Ton.....	1
	Truck Utility 1/4-Ton.....	1

PUBLIC AFFAIRS OPC

1 CPT	Public Aff Off	
1 SFC	Public Aff Supv	01
	Trailer Cargo 1/4-Ton.....	1
	Truck Utility 1/4-Ton.....	1

FINANCE OPC HQ

1 MAJ	Finance Off	11
1 CPT	Deputy Finance Off	11
1 MSG	Finance Op Chief	
1 SSG	Customer Svc NCO	
1 SP4	Clerk Typist	01
	Trailer Cargo 1/4-Ton.....	1
	Truck Utility 1/4-Ton.....	1

QUALITY CONTROL DIV HQ

1 SFC	Div Chief	
-------	-----------	--

QUALITY ASSURANCE BR

1 SSG	Quality Assurance SGT	
1 SP5	Quality Assurance Sp	

QUALITY EDIT BR

1 SP5	Quality Edit Sp	
1 SP4	Pay Sp	
1 PFC	Pay Sp	

DISBURSING DIVISION

1 SSG	Disb Accountant	
1 SP5	Cashier	11
1 SP5	Disbursing Sp	11

PAY DIV HQ

1 LT	Military Pay Off	
1 SFC	Pay Div Chief	

CONTROL BR

1 SP5	Branch Chief	
1 SP5	Sr Pay Sp	
2 SP4	Pay Sp	
1 PFC	Pay Sp	

PFR BR

1 SP5	Branch Chief	
1 SP5	Pay Sp	
2 SP4	Pay Sp	
1 PFC	Pay Sp	

PTN SVC BR

1 SSG	Branch Chief	
1 SP5	Pay Sp	
1 SP5	Travel Sp	
2 SP4	Pay Sp	
1 PFC	Pay Sp	

AG OPC HQ

1 MAJ	Adj General	11
1 CPT	XO	
1 SP4	Clerk Typist	01
	Truck Cargo Tac 1-1/4-Ton.....	1

ADMINISTRATIVE SERVICES DIVISION

1 LT	Admin Svc Off	
1 SFC	Admin Supv	
2 SP5	Admin Sp	
3 SP4	Clerk Typist	
1 SP4	Performing Arts Sp	
1 SP4	Physical Actv Sp	

POSTAL DIVISION

1 LT	Postal Off	11
1 SSG	Postal NCO	
1 SP5	Window Clk	11
1 SP4	Window Clk	11
2 SP4	Postal Clk	
2 PFC	Postal Clk	01
	Truck Van Shop 2-1/2-Ton.....	1

PERSONNEL SERVICES DIVISION

1 CPT	Personnel Off	
1 SGM	Personnel SGT	
1 SP4	Clerk Typist	

PERSONNEL RECORDS BRANCH

1 WO	Unit Pers Tech	
1 MSG	Pers Records Supv	
3 SP5	Pers Records Sp	
7 SP4	Pers Records Sp	
8 PFC	Pers Records Sp	

PERSONNEL MANAGEMENT BR

1 LT	Pers Mgt Off	
1 MSG	Pers Mgt Supv	
1 SP5	Sr Pers Mgt Sp	
1 SP4	Pers Mgt Sp	
3 PFC	Pers Mgt Sp	

PERSONNEL ACTIONS BR

1 WO	Unit Pers Tech	
1 SSG	Pers Actions Supv	
1 SP5	Sr Pers Actions Sp	
3 SP4	Pers Actions Sp	
2 PFC	Pers Actions Sp	

STDPRS INTERFACE BR

1 WO	Unit Pers Tech	
1 MSG	Data Processing NCO	
1 SP5	Admin Sp	
2 SP5	Data Analyst Sp	
2 SP4	Clerk Typist	01/07
2 SP4	Data Analyst Sp	
1 SP4	Tab Eq Rmn	
1 PFC	Clerk Typist	
1 PFC	Data Analyst Sp	
	Trailer Cargo 1/4-Ton.....	1
	Truck Utility 1/4-Ton.....	1
	Truck Van Expandible 5-Ton.....	1

REPLACEMENT DETACHMENT

1 LT	Commander	
1 SFC	Detachment SGT	
1 PFC	Cook	
1 SP5	Unit Clerk	
1 SP4	Supply Sp	
	Trailer Cargo 1/4-Ton.....	1
	Truck Utility 1/4-Ton.....	1

REMARKS:

11 All personnel armed with rifle 5.56-mm unless otherwise indicated.

01 Also light vehicle driver.

02 Also hv vehicle driver.

11 Armed with pistol cal .45.

ADMINISTRATION COMPANY
SUPPORT BATTALION, SEPARATE BRIGADE

387

M. TOE - To provide division level medical support within a separate brigade or regiment medical staff area and assistance and unit level medical support as required on an area basis to units operating in the separate brigade or regimental area.

ASSIGNMENT - Brigade or Support Battalion, Separate Armored Brigade, TOE 29 75, or Separate Infantry Brigade, TOE 29 135.

FUNCTIONS - a. Provides command, central administration, supervision of and plans for unit level and unit level medical support rendered by elements of the medical company and service platoon.

b. Provides staff service including:

1. Keeping the commander, commander and his staff informed on the health of the command and on medical aspects of matters affecting combat service support.

2. Providing current information concerning the medical aspects of the combat service support situation to the surgeon at higher headquarters.

3. Coordinating medical support operations of the brigade or regiment.

4. Identifying, preparing, and coordinating the medical portion of brigade plans and orders.

5. Applying the appropriate medical evacuation and treatment procedures and techniques within the support platoon.

6. Provide first aid to the medical support platoon personnel and medical equipment maintenance and repair of the medical support equipment.

d. Receive and report to the medical support platoon commander:

1. Personnel and equipment status.

2. Medical platoon progress.

3. Tasks performed to date and status.

4. Requirements for medical support in an available form consistent with the medical support capability.

5. Provide inter-branch or intra-branch transport of medical supplies and equipment.

6. Provide physical and dental support rendered to unit level medical staff.

7. Provide physical and dental treatment, health maintenance, inspections, and consultation services to brigade elements and units.

8. Provide independent health care services.

88C

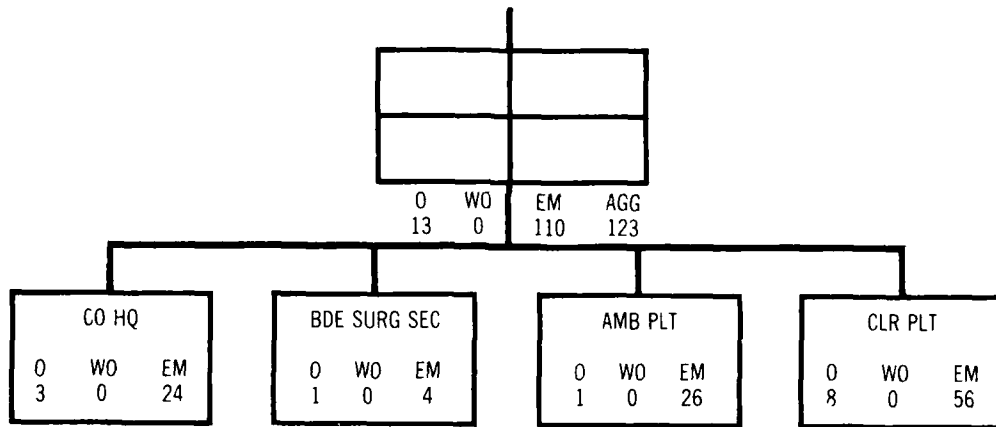

389

COMPANY HEADQUARTERS		
1 MAJ	Company Cdr	11,95
1 CPT	XO	
1 LT	Health Svc Mat Off	
1 1SG	First Sergeant	10
1 SFC	Food Svc SGT	
1 SSG	Biomed Eq Sp Adv	
1 SSG	First Cook	
1 SSG	Med Sup SGT	
1 SSG	Maint/Recovery Supv	
1 SSG	Supply Sergeant	
1 SGT	NBC Op NCO	
1 SP5	Unit Clerk	
1 SP5	Cook	
1 SP5	X-ray Biomed Eq Rpmn	
1 SP5	Pwr Gen/WVeh Mech	01
1 SP4	Armorer	
1 SP4	Clerk Typist	
2 SP4	Cook	
1 SP4	Equip Rec & Pts Clk	
1 SP4	Med Supplyman	01
2 SP4	Pwr Gen/WVeh Mech	01
1 PFC	Clerk	
2 PFC	Cook	01
2 PFC	Pwr Gen/WVeh Mech	01
1 PFC	Veh Driver	93
1 PFC	PLL Clerk	
	Radio Set AN/VRC-47	1
	Radio Set Con Op AN/GRA-39	1
	Speech Scty Eq TSEC/KY-57	2
	Trailer Cargo 1/4-Ton	3
	Trailer Cargo 1-1/2-Ton	3
	Trailer Tank Water 400-Gal	1
	Truck Cargo 1-1/4-Ton	1
	Truck Cargo 2-1/2-Ton	3
	Truck Cargo 2-1/2-Ton W/WN	1
	Truck Utility 1/4-Ton	3

CLEARING PLATOON		
1 MAJ	Platoon Cdr	11
1 MAJ	Internist	11
1 CPT	Dental Officer	11
4 CPT	Gen Medical Off	11
1 LT	Field Med Asst	
1 SFC	Platoon SGT	
1 SFC	Wardmaster	
1 SSG	Op Room Sp	
1 SSG	Section SGT	
1 SP6	Practical Nurse	
1 SP5	Behavioral Science Sp	
2 SP5	Patient Care Sp	
1 SP5	Dental Asst	
4 SP5	Med Aidman	
1 SP5	Op Room Sp	
1 SP5	Pharmacy Sp	
1 SP5	X-ray Sp	
2 SP4	Patient Care Sp	
1 SP4	Dental Asst	
4 SP4	Litter Bearer	
5 SP4	Medical Aidman	
1 SP4	Med Lab Sp	
1 SP4	Patient Care Sp	
1 SP4	Patient Admin Sp	
1 SP4	TAC Wire Ops Sp	
12 PFC	Litter Bearer	
3 PFC	Medical Aidman	
1 PFC	Med Lab Sp	01
4 PFC	Veh Driver	
1 PFC	Patient Admin Sp	
1 PFC	Patient Care Sp	
2 PFC	Radio Op	94
	Radio Set AN/VRC-47	1
	Speech Scty Eq TSEC/KY-57	2
	Trailer Cargo 1/4-Ton	1
	Trailer Cargo 1-1/2-Ton	3

Trailer Tank Water 400-Gal	1
Truck Cargo 2-1/2-Ton	4
Truck Utility 1/4-Ton	1

BDE SURG SFC		
1 CPT	Prev Med Off	11,96
1 SFC	Med NCO	
1 SP5	Envmtl Health Sp	
1 SP4	Envmtl Health Sp	
1 SP4	Patient Admin Sp	01
	Trailer Cargo 1/4-Ton	1
	Truck Utility 1/4-Ton	1

AMBULANCE PLATOON		
1 LT	Platoon Leader	
1 SFC	Platoon SGT	
3 SP5	Sr Medical Aidman	98
21 SP4	Ambulance Dvr	
1 PFC	Veh Driver	
	Trailer Cargo 1/4-Ton	1
	Truck Amb 1-1/4-Ton	12
	Truck Utility 1/4-Ton	1

REMARKS:

All personnel armed with rifle 5.56-mm unless otherwise indicated.
 01 Also light vehicle driver.
 11 Armed with pistol cal .45.
 95 Also Bde Surgeon.

**MEDICAL COMPANY, SUPPORT BATTALION
 SEPARATE ARMORED BRIGADE**

TOE R-147H(C17)

1. Provide the support for the operations of the unit and the unit's activities.

2. Provide the support for the operations of the unit and the unit's activities.

3. Provide the support for the operations of the unit and the unit's activities.

4. Provide the support for the operations of the unit and the unit's activities.

5. Provide the support for the operations of the unit and the unit's activities.

6. Provide the support for the operations of the unit and the unit's activities.

7. Provide the support for the operations of the unit and the unit's activities.

8. Provide the support for the operations of the unit and the unit's activities.

9. Provide the support for the operations of the unit and the unit's activities.

10. Provide the support for the operations of the unit and the unit's activities.

1. Provide the support for the operations of the unit and the unit's activities.

2. Provide the support for the operations of the unit and the unit's activities.

3. Provide the support for the operations of the unit and the unit's activities.

4. Provide the support for the operations of the unit and the unit's activities.

5. Provide the support for the operations of the unit and the unit's activities.

6. Provide the support for the operations of the unit and the unit's activities.

7. Provide the support for the operations of the unit and the unit's activities.

8. Provide the support for the operations of the unit and the unit's activities.

9. Provide the support for the operations of the unit and the unit's activities.

10. Provide the support for the operations of the unit and the unit's activities.

390

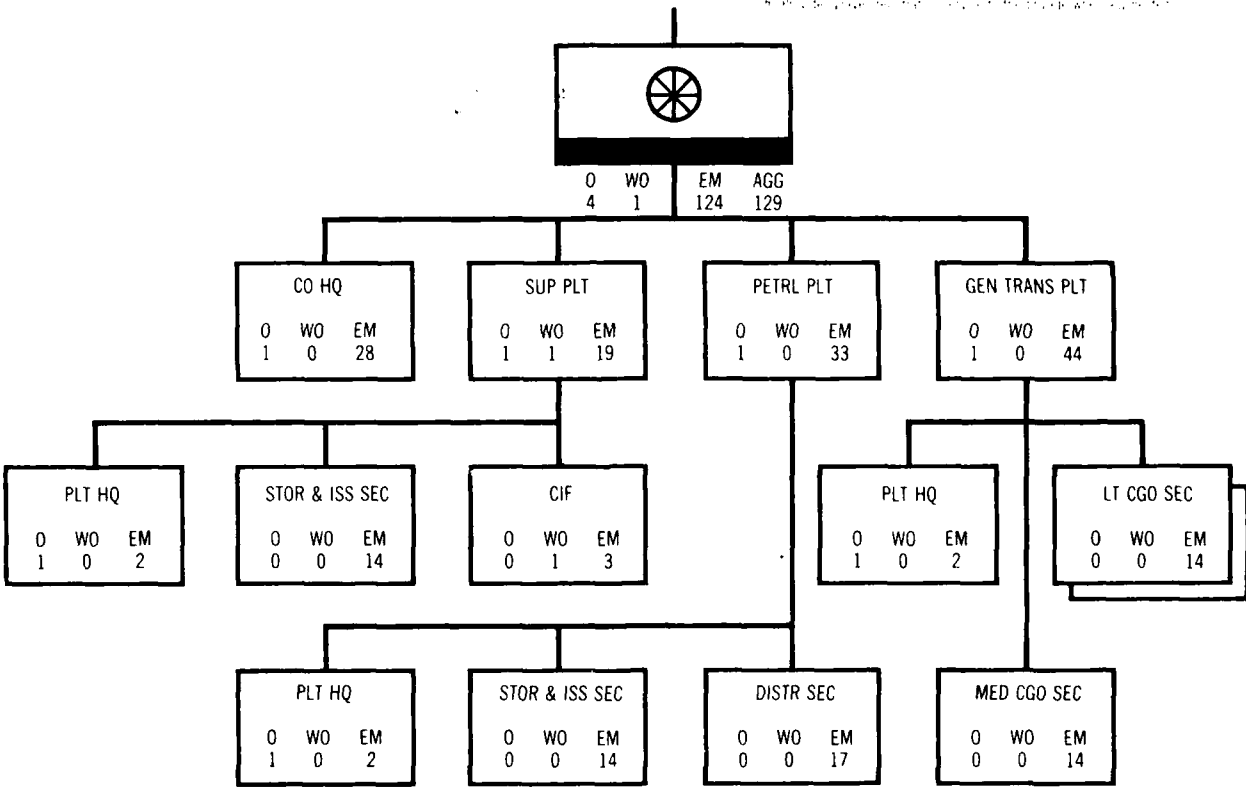

391

COMPANY HEADQUARTERS

1 CPT Company Cdr 11
 1 1SG First Sergeant
 1 SFC Food Svc SGT
 1 SFC Motor Sergeant
 1 SSG Supply Sergeant
 1 SGT GRREG NCO
 1 SGT NBC Op NCO
 3 SGT Pwr Gen/WVeh Mech
 1 SP5 First Cook
 1 SP5 Hv Wb Veh Mech
 1 SP4 Armorer
 2 SP4 Cook 01
 1 SP4 Dispatcher
 1 SP4 Equip Maint Clk
 1 PFC PLL Clerk
 3 SP4 Pwr Gen/WVeh Mech
 1 SP4 Tac Wire Op Sp
 1 SP4 Veh Dvr
 1 SP4 Wrecker Op
 1 PFC Cook
 1 PFC Qn & Chem Eq Rpr
 3 PFC Pwr Gen/WVeh Mech 01
 Machinegun 7.62-mm 4
 Radio Set AN/VRC-46 2
 Radio Set Con Gp AN/GRA-39 1
 Speech Scty Eq TSEC/KY-57 2
 Trailer Cargo 1/4-Ton 1
 Trailer Tank Water 400-Gal 1
 Truck Cargo Tac 1-1/4-Ton 1
 Truck Cargo 2-1/2-Ton 1
 Truck Utility 1/4-Ton 1
 Truck Wrecker 5-Ton 1

SUPPLY PLATOON HQ

1 LT Platoon Leader
 1 SFC Platoon SGT
 1 PFC Reports Clerk 01
 Radio Set AN/VRC-46 1
 Speech Scty Eq TSEC-KY-57 1
 Truck Cargo Tac 1-1/4-Ton 1

REC-STOR-ISSUE SECTION

1 SFC Section Chief
 1 SFC Subsistence Sup SGT
 1 SGT Ration Distr SGT

1 SP5 Salvage Insp
 2 SP4 Mat Storage Sp
 1 SP4 Supply Con & Acct Clk
 1 SP4 Subsistence Supply Sp
 3 PFC Mat Storage Sp
 2 PFC Subsistence Supply Sp
 1 PFC MHE Op
 Tank Fab Collaps Water 500-Gal... 15
 Truck Lift Fork 6000 lb 1

CENTRAL ISSUE FAC

1 WO Supply Tech
 1 SFC Supply SGT
 1 SP4 Gen Supply Sp
 1 PFC Gen Supply Sp

PETROLEUM PLATOON HQ

1 LT Platoon Leader
 1 SFC Platoon SGT
 1 SP4 Qual Survl Sp 01
 Radio Set AN/VRC-46 1
 Speech Scty Eq TSEC/KY-57 1
 Truck Cargo TAC 1-1/4-Ton 1

STORAGE AND ISSUE SECTION

1 SSG Section Chief
 4 SP4 Petrl Supply Sp
 1 SP4 Scoop Loader Op
 8 PFC Petrl Supply Sp 01
 Drum Fab Collaps Fuel 500-Gal ... 12
 Fuel Sys Sup Pt Ptbl 1
 Pwd Area Refuel Equip (FARE) 2
 Loader Scoop Type 2-1/2 CU YD 1
 Tank Fabric Fuel 10,000-Gal 6

DISTRIBUTION SECTION

1 SSG Section Chief
 5 SGT Petrl Hv Veh Dvr
 11 SP4 Petrl Hv Veh Dvr
 Semitrk Tank 5000-Gal 9
 Tank & Pump Unit Trk Mtd 2
 Truck Cargo 5-Ton 2
 Truck Tank Fuel Svc 2500-Gal 1
 Truck Tractor 5-Ton 9

GENERAL TRANSPORT PLT HQ

1 LT Platoon Leader
 1 SFC Platoon SGT
 1 SP4 Lt Veh Driver
 Radio Set AN/VRC-46 1
 Speech Scty Eq TSEC/KY-57 1
 Trailer Cargo 1/4-Ton 1
 Truck Utility 1/4-Ton 1

(2) LIGHT CARGO SECTION

1 SSG Section Chief
 1 SP5 Veh Dvr
 4 SP4 Veh Dvr
 8 PFC Veh Dvr
 Machinegun Cal .50 HB 2
 Trailer Cargo 1-1/2-Ton 10
 Truck Cargo Dropside 2-1/2-Ton 10

MEDIUM CARGO SECTION

1 SSG Section Chief
 1 SSG Hv Veh Dvr
 3 SP5 Hv Veh Dvr
 6 SP4 Hv Veh Dvr
 3 PFC Hv Veh Dvr
 Semitrailer Stake 12-Ton 10
 Truck Tractor 5-Ton 10

REMARKS:

All personnel armed with rifle 5.56-mm unless otherwise indicated.
 01 Also light vehicle driver.
 11 Armed with pistol cal .45.

**SUPPLY AND TRANSPORT COMPANY
 SUPPORT BATTALION, SEPARATE ARMORED BRIGADE**

TCE 29-77H(C17)

Maintains direct support maintenance and repair parts supply service, except for MRE, aircraft and air drop items, commensurate with stated capabilities in support of Separate Armored Brigade, TOE 17 100, consisting of the brigade base, two tank battalions, and one infantry battalion (mechanized).
 Also maintains support of the Support Battalion, Separate Armored Brigade, TOE 29 75.
 Also provides limited vehicular recovery assistance to supported units when required.

b. Maintaining an authorized stockage list (ASL) of up to 5,000 lines under mechanized stock accounting procedures (manual procedures when augmentation authorized) to include the receipt, storage, and issue of repair parts, except medical, cryptographic, and air drop items. Also capable of maintaining a direct exchange service of up to 550 line items and 1,000 line items shop supply.
 c. Operating a direct exchange service for selected items.
 d. Maintaining an operational readiness float for selected items.

392

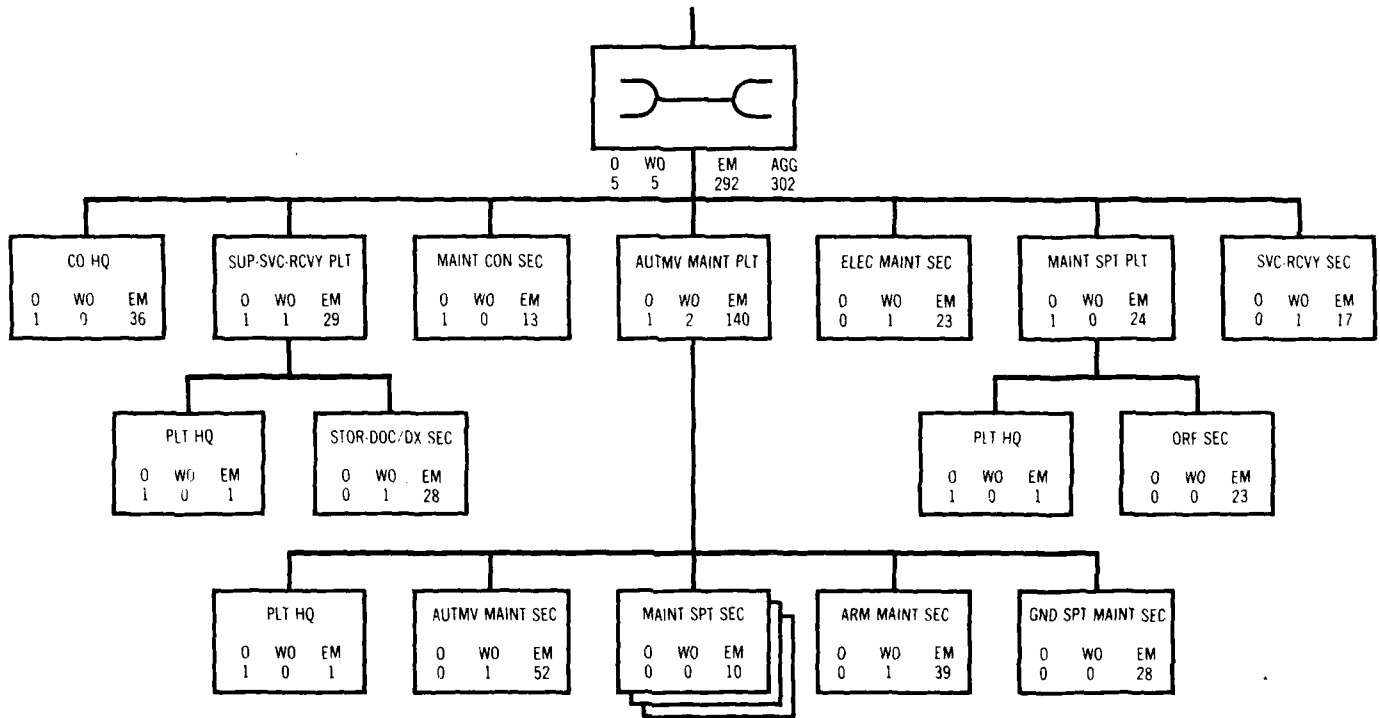

TROOP HEADQUARTERS	
1 CPT	Company Cdr
1 MSG	First Sergeant
1 SFC	Point Svc SGT
1 SFC	Motor Sergeant
1 SFC	First Cook
1 SSG	Supply Sergeant
4 SGT	Pur Gen/Veh Mech
1 SGT	Hy Wsh Mech
1 SGT	MRC Op MTC
1 SPC	Cook
1 SPC	Unit Supply Svc
1 SPC	Armorer
2 SPC	Cook
1 SPC	Const Bg Mech
1 SPC	Rg Maint Ck
1 SPC	Veh Dvr
1 PFC	PL Clerk
4 SPC	Pur Gen/Veh Mech
1 SPC	Tnk Wsh Op Sp
1 SGT	Truck Vch Mech
1 SPC	Refrigeration Sp
1 PFC	General Supply Sp
4 PFC	Pur Gen/Veh Mech
2 PFC	Cook
1	Kitchen Field Trailer Mtd
1	Machinist Cal 50 HB
1	Machinist Cal 50-W
1	Radio Set AN/VRC-47
1	Radio Set Ton Op AN/ASB-19
1	Speech Scty Rg TSSC/RY-47
1	Truck Unit Tyl Mtd (600-Gal)
1	Trailer Cargo 1/4-Ton
1	Trailer Cargo 1-1/2-Ton
1	Trailer Tank Meter 400-Gal
1	Truck Cargo 2-1/2-Ton
1	Truck Cargo 2-1/2-Ton M/W
1	Truck Utility 1/4-Ton

MAINT CONTROL SEC	
1 LT	Platoon Cdr
1 SFC	Maine Tech
2 SSG	Armament Maint Insp
1 SSG	Engr Bg Repair Insp
1 SSG	Flt Rdo Rep Insp
4 SSG	Tech Insp
1 SPC	Eq Maint Ck
1 SPC	Repair Pts Sp
1 SPC	CLMk Typist
1 PFC	Repair Pts Sp
1	Radio Set AN/VRC-47
1	Smelttr Van Repair Parts 4-Ton
1	Smelttr Van Supply 12-Ton

1	Trailer Cargo 1/4-Ton
1	Trailer Cargo 1-1/2-Ton
1	Truck Cargo TAC 1-1/4-Ton
1	Truck Tractor 5-Ton
1	Truck Utility 1/4-Ton
1	Truck Van Repair 5-Ton

ARMY MAINT PLT HQ	
1 LT	Platoon Ldr
1 SFC	Platoon Sergeant

ARMY MAINT SEC	
1 WO	Maine Tech
1 SFC	Auto Repair Supt
1 SGT	Truck Vch Rpm
2 SGT	Fuel-Elec Sys Rpm
1 SGT	Wheel Vch Repairer
10 SPC	Auto Rpm
1 SPC	Fuel-Film Sys Rpm
1 SPC	Wheel Vch Repairer
17 PFC	Truck Vch Rpm
4 PFC	Wheel Vch Repairer
4 PFC	Fuel-Elec Sys Rpm
1	Trailer Cargo 1/4-Ton
1	Trailer Cargo 1-1/2-Ton
1	Truck Cargo 2-1/2-Ton
1	Truck Utility 1/4-Ton
1	Truck Van Shop 2-1/2-Ton
2	Truck Tractor 2-1/2-Ton

ARMY MAINT SEC	
1 WO	Armt Maint Tech
1 SFC	Sec Chief
1 SFC	PC Inst Rep Frmn
1 SSG	Tank Trt Rep Frmn
1 SGT	Artillery Rpm
1 SGT	PC Inst Rpm
1 SGT	Small Arms Rpm
1 SPC	Tank Trt Rpm
1 SPC	Artillery Rpm
1 SPC	PC Inst Rpm
1 PFC	Small Arms Rpm
11 PFC	Tank Trt Rpm
1	Trailer Cargo 1/4-Ton
1	Trailer Cargo 1-1/2-Ton
1	Truck Cargo TAC 1/1/4-Ton
1	Truck Van Shop 2-1/2-Ton

1st MAINT SPT SEC	
1 SSG	Auto Rep Frmn
1 SGT	Truck Vch Repairer
1 SPC	Wheel Vch Repairer
1 SPC	Truck Vch Repairer
1 SPC	Wheel Vch Repairer
1 PFC	Truck Vch Repairer
1	Radio Set AN/VRC-48
1	Speech Scty Rg TSSC/RY-47
1	Shop Bg Contact Maint Tnk Mtd
1	Trailer Cargo 1-1/2-Ton
1	Truck Cargo Dropside 4-Ton

2nd SPT MAINT SEC	
1 SFC	Eq Equip Maint Supt
1 SGT	Const Bg Rpm
1 SGT	QM/CLM Rg Rpm
1 SPC	Pur Gen Bg Rpm
1 SPC	Refrigeration Sp
1 SPC	Ofc Machine Rpm
2 PFC	QM/CLM Rg Rpm
1 SPC	Const Bg Rpm
4 SPC	Pur Gen Bg Rpm
2 PFC	Refrigeration Sp
1 SPC	Const Bg Rpm
4 PFC	Pur Gen Bg Rpm
1 PFC	QM Bg Rpm
1	Shop Bg Contact Maint Tnk Mtd
1	Shop Bg Elec Rep Smelttr Mtd
1	Trailer Cargo 1-1/2-Ton
1	Truck Cargo 2-1/2-Ton
1	Truck Tractor 2-1/2-Ton

3rd MAINT SEC	
1 WO	C-E Bg Rep Tech
1 SFC	C-E Maint Chief
1 SPC	Dial/Man Can Ofc Rpm
1 SPC	Flt Rdo Rpm
1 SPC	PC Comp Rpr
1 SPC	SP Elec Devices Rpm
1 SPC	Dial/Man Can Ofc Rpm
1 SPC	SP Elec Devices Rpm
2 SPC	TT Rpm
1 SPC	M/W Spt Radar Rpm
1 SPC	PC Comp Rpm
4 PFC	Flt Rdo Rpm
2 PFC	SP Elec Devices Rpm
1 PFC	Dial/Man Can Ofc Rpm
1 PFC	PC Comp Rpm

1	Radio Set AN/VRC-48
1	Elec Shop Antennas AN/ASB-144
1	Shop Bg Elec Rep Smelttr Mtd
1	Trailer Cargo 1-1/2-Ton
1	Truck Cargo TAC 1-1/4-Ton
1	Truck Cargo Dropside 2-1/2-Ton
1	Truck Tractor 4-Ton

SPT-REPLY SEC	
1 WO	Repair Shop Tech
1 SFC	Section Chief
1 SSG	Rovv Supt
1 SGT	Metal Work Rpm
1 SGT	Rovv Vch Op
1 SGT	Welder
1 SPC	Fabric Repair Sp
1 SPC	Machinist
3 SPC	Rovv Vch Op
2 PFC	Metal Work Rpm
1 PFC	Rovv Vch Op
2 PFC	Welder
1	Machinist Cal 40
1	Radio set AN/VRC-46
1	Recovery Vehicle RT Medium
1	Speech Scty Bg TSSC/RY-57
1	Smelttr Lmbd HET 60-Ton
1	Trailer Cargo 1/4-Ton
1	Trailer Cargo 1-1/2-Ton
1	Truck Cargo 2-1/2-Ton
1	Truck Utility 1/4-Ton
1	Truck Tractor HET 22-1/2-Ton
1	Truck Van Shop 2-1/2-Ton
1	Truck Wrecker 5-Ton

SUB-SVC-REPLY PLT HQ	
1 LT	Platoon Ldr
1 SFC	Platoon SGT
1	Trailer Cargo 1/4-Ton
1	Truck Utility 1/4-Ton

STOR-DOC/TK SEC	
1 WO	Support Supply Tech
1 SSG	Supply Con-Strc Supt
1 SPC	Mat Stor & Hdq SPT
1 SPC	I/O Clerk
2 SPC	Life/Load Equip Op
4 SPC	Rovv Vch Op
1 SPC	Life/Load Bg Op
4 SPC	Mat Stor & Hdq Sp
1 SPC	Pack/Crate Sp
1 SPC	Maine Ctl & Actg Sp
4 PFC	Mat Stor & Hdq Sp

1 PFC	MK Ctl & Actg Sp
2 PFC	High Reliabilty Ck
1 PFC	Pack/Crate Sp
1	Smelttr Low Bed 22-1/2-Ton
1	Smelttr Van Repair Parts 4-Ton
1	Smelttr Van Supply 12-Ton
1	Trailer Cargo 1-1/2-Ton
1	Truck Cargo Dropside 2-1/2-Ton
1	Truck Tractor 4-Ton
1	Truck Lift Fork 4000 lb

MAINT SPT PLT HQ	
1 LT	Platoon Ldr
1 SFC	Platoon SGT
1	Trailer Cargo 1/4-Ton
1	Truck Utility 1/4-Ton

OFF SECTION	
1 SPC	Maine Supt
1 SGT	Pur Gen/Veh Mech
1 SGT	Tank Trt Rpm
1 SGT	Truck Vch Mech
1 PFC	PL Clerk
4 SPC	Pur Gen/Veh Mech
1 SPC	Comm Sys Op/Mech
1 SPC	Tank Trt Rpm
2 SPC	Truck Vch Mech
4 PFC	Pur Gen/Veh Mech
2 PFC	Truck Vch Mech
1	Instrument Repair Shop Truck Mtd
1	Trailer Cargo 1-1/2-Ton
2	Truck Cargo 2-1/2-Ton

REMARKS:

All personnel armed with rifle .45-cal unless otherwise indicated.

01 All light vehicle driver.

02 All heavy vehicle driver.

11 Armed with pistol cal. 45.

**MAINTENANCE COMPANY, SUPPORT BATTALION
SEPARATE ARMORED BRIGADE**

MISSION To provide field artillery fires in direct support of a separate brigade. Armored or Infantry (mechanized) or in general support of the supported force. To reinforce fires of other artillery units.

ASSIGNMENT Organic to Separate Armored Brigade. TOE 17-100 (SRC 06375H000)

CAPABILITIES a. Providing close and continuous artillery support, including target acquisition, communication, ballistic meteorology, liaison, and survey.
b. Reinforcing the fires of other field artillery battalions.

c. Rapid displacement and crosscountry mobility.

d. Providing a field artillery battalion group headquarters for a brigade.

e. Providing survey control for organic batteries and attached units.

f. Provides air defense against low altitude hostile aircraft.

g. Procures and distributes all classes of supplies to organic batteries, maintains appropriate supply and materiel records, and transports its prescribed basic load of ammunition.

h. Provides fire support sections and fire support teams (FIST) to designated maneuver elements of the brigade.

394

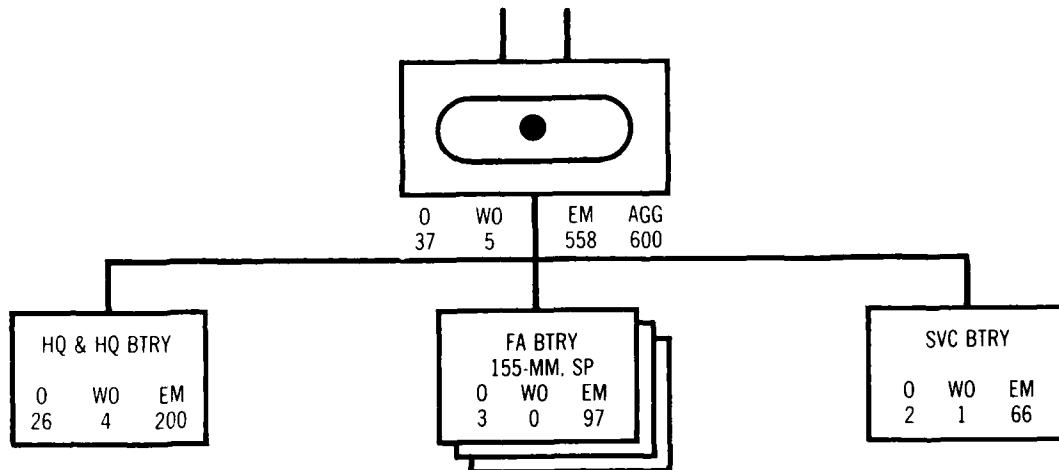

Note: FA and Svc Btry are same as those shown on pages 124 and 128

SUMMARY OF EQUIPMENT

WEAPONS			
HOWITZER 155-MM BII	18	ELECTRONIC TT SCTY EQUIPMENT TSEC/K-7	3
LAUNCHER GRENADE M203	57	RADAR MORTAR LOCATING AN/TFQ-36	1
MACHINEGUN CAL .50 HB FLEX VEH MTD	52	RADAR SET AN/TPS-25	1
MACHINEGUN 7.62-MM FLEX	31	RADIAC SET AN/PDR-27	5
PISTOL CAL .45	22	RADIAC METER IM-93/UD	25
RIFLE 5.56-MM	588	RADIAC METER IM-174/PD	13
SUBMACHINEGUN CAL .45	4	RADIO SET AN/GRC-160	24
		RADIO SET AN/PRC-77	16
		RADIO SET AN/VRC-46	21
		RADIO SET AN/VRC-47	26
		RADIO SET AN/VRC-49	5
		RADIO SET AN/VRC-64	2
		RADIO SET CONTROL GROUP AN/GRA-39	52
		RADIO TT SET AN/GRC-142	3
		SPEECH SCTY EQUIPMENT TSEC/KY-57	148
		SWITCHBOARD TEL MANUAL SB-22/PT	8
		SWITCHBOARD TEL MANUAL SB-993/GT	10
		TAC DIGITAL REGEN REPEATER PTBL HYL-3/TSEC	5
		TELEPHONE SET TA-312/PT	138
VEHICLES AND VEHICLE EQUIPMENT			
CARRIER CP LT TRACK M577A1	9		
CARRIER CARGO FT 6-TON M548	18		
CARRIER PERSONNEL FULL TRACK M113A1	10		
HOWITZER SP 155-MM M109A1	18		
KITCHEN FIELD TRAILER MTD	5		
RECOVERY VEHICLE LIGHT M578	2		
TRAILER AMMO 1-1/2-TON M332	36		
TRAILER CARGO 1/4-TON M416	14		
TRAILER CARGO 3/4-TON M101A1	7		
TRAILER CARGO 1-1/2-TON M105A2	10		
TRAILER TANK WATER 400-GAL M149A1	6		
TRUCK AMBULANCE 1-1/4-TON M792	1		
TRUCK CARGO 1-1/4-TON 6X6 M561	18		
TRUCK CARGO TAC 1-1/4-TON 4X4 M880	3		
TRUCK CARGO 2-1/2-TON M35A2	16		
TRUCK CARGO 2-1/2-TON W/WN M35A2	5		
TRUCK CARGO 5-TON 6X6 M813	3		
TRUCK CARGO 8-TON 4X4 M520	18		
TRUCK TANK FUEL SVC 2500-GAL 4X4 M559	2		
TRUCK UTILITY 1/4-TON M151A2	18		
TRUCK WRECKER 10-TON 4X4 M553	1		
TRUCK VAN SHIP 2-1/2-TON	1		
		MISCELLANEOUS EQUIPMENT	
		ALARM OML AGENT AUTO PTBL MANPACK	1
		ALARM OML AGENT AUTO PTBL F/PT VEH	4
		ALARM OML AGENT AUTO PTBL F/WHEEL VEH	6
		DETECTING SET MINE PTBL AN/PPS-7	5
		DETECTING SET MINE PTBL AN/PPS-11	5
		NIGHT SIGHT CREW-SERVED WFN AN/PVS-5	12
		NIGHT SIGHT INDIVIDUAL WFN AN/PVS-4	20
		NIGHT VISION GOGGLES AN/PVS-5	41
		TANK AND PUMP UNIT TRK MTD (1200-GAL)	1
		TANK UNIT TRL MTD (600-GAL)	1

FIELD ARTILLERY BATTALION, 155-MM, SP SEPARATE ARMORED BRIGADE

TOE 6-375H (as changed)

MISSION: a. To direct and coordinate operations of the battalion
 b. To provide facilities with which the battalion commander controls the battalion
 ASSIGNMENT: Organic to TNE 6 375H Field Artillery Battalion 155 mm Self Propelled Separate Armored Brigade (SRI 06376HQ00)
 CAPABILITIES: a. Staff plans, supervises, coordinates and controls operations of organic units of the battalion and attached units
 b. Provides a field artillery battalion group headquarters for a separate armored brigade
 c. Provides survey control and meteorological data for the battalion and other units as needed
 d. Provides countermortar radar and surveillance radar target acquisition

e. Provides unit level medical service to include medical care and evaluation for the battalion and attached units, establishing an aid station and furnishing aidmen to organic units of the battalion
 f. Provides to the Separate Armored Brigade
 (1) One maneuver brigade fire support section
 (2) Three maneuver battalion fire support sections
 (3) Seven tank company fire support teams (FIST)
 (4) Three infantry company (mechanized) fire support teams (FIST)
 g. Performs organizational level maintenance less that performed by the operator on COMMET equipment and gun direction computers FADAC for the units of the battalion
 h. Provides air defense against low altitude hostile aircraft

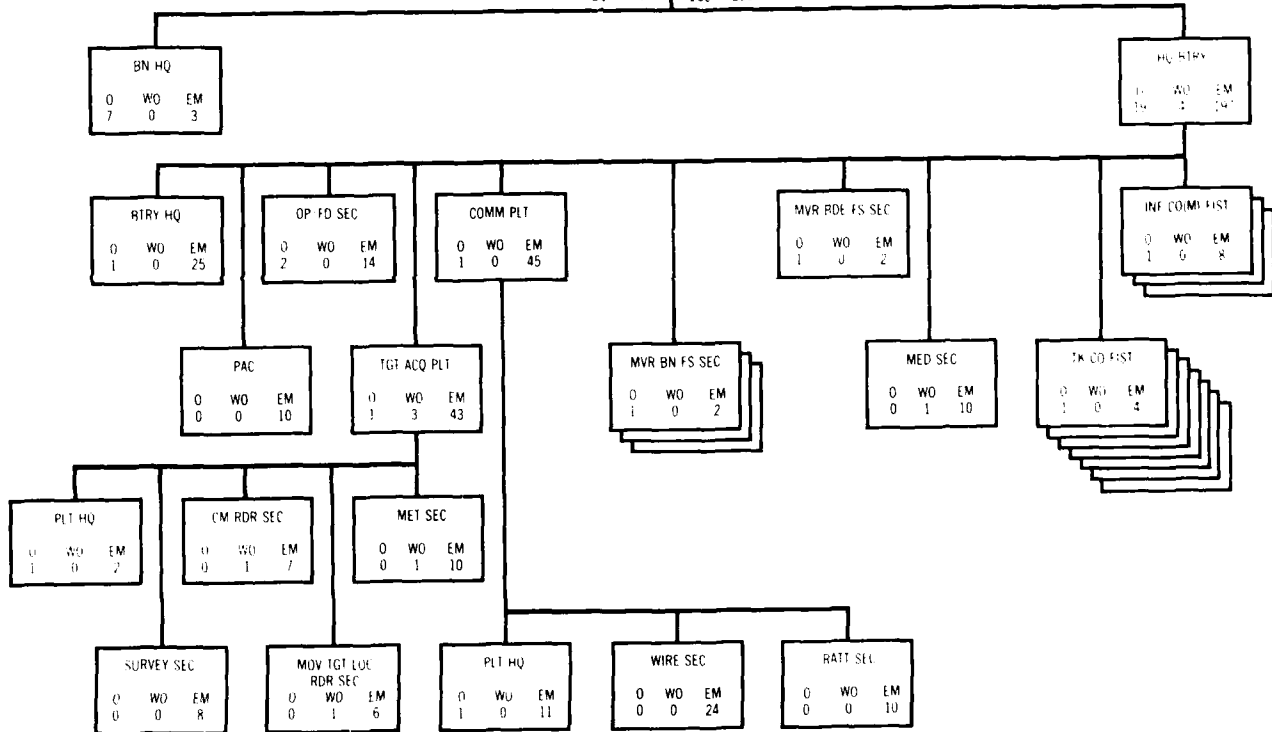
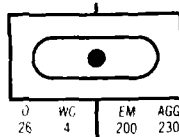

SUMMARY OF EQUIPMENT

		WEAPONS	
LAUNCHER GRENADE M203	25		
MACHINEGUN CAL .50 HB FLEX GND MTD	11		
MACHINEGUN 7.62-MM FLEX	10		
PISTOL CAL .45	14		
RIFLE 5.56-MM	226		
		COMMUNICATION-ELECTRONICS EQUIPMENT	
		ELECTRONIC TT SCTY EQUIPMENT TSEC/KW-7	3
		RADAR MORTAR LOCATING AN/TPQ-36	1
		RADAR SET AN/TPS-25	1
		RADIAC SET AN/PDR-27	1
		RADIAC METER IM-93/UD	9
		RADIAC METER IM-174/PD	5
		RADIO SET AN/GRC-160	23
		RADIO SET AN/VRC-77	16
		RADIO SET AN/VRC-46	16
		RADIO SET AN/VRC-47	17
		RADIO SET AN/VRC-49	5
		RADIO SET CONTROL GROUP AN/GNA-39	39
		RADIO TT SET AN/GRC-142	3
		SPEECH SCTY EQUIPMENT TSEC/KY-38	115
		SWITCHBOARD TEL MANUAL SB-22/PT	4
		SWITCHBOARD TEL MANUAL SB-993/GT	7
		TAC DIGITAL REGEN REPEATER PTBL HYL-3/TSEC	5
		TELEPHONE SET TA-264/PT	1
		TELEPHONE SET TA-312/PT	72
		MISCELLANEOUS EQUIPMENT	
		ALARM OML AGENT AUTO PTBL MANPACK	1
		ALARM OML AGENT AUTO PTBL F/WHEEL VEH	1
		ALARM OML AGENT AUTO PTBL F/TRACK VEH	1
		DETECTING SET MINE PTBL AN/PRS-7	1
		DETECTING SET MINE PTBL AN/PSS-11	1
		NIGHT SIGHT CREW-SERVED WFN AN/PVS-5	10
		NIGHT SIGHT INDIVIDUAL WFN AN/PVS-4	5
		NIGHT VISION GOGGLES AN/PVS-5	18
397		VEHICLES AND VEHICLE EQUIPMENT	
CARRIER CP LT TRACK M577A1	6		
CARRIER PERSONNEL FULL TRACK M113A1	10		
KITCHEN FIELD TRAILER MTD	1		
TRAILER CARGO 1/4-TON M416	10		
TRAILER CARGO 1-1/2-TON M105A2	4		
TRAILER TANK WATER 400-GAL M149	2		
TRUCK AMBULANCE 1-1/4-TON 6X6 M792	1		
TRUCK CARGO 1-1/4-TON 6X6 M561	14		
TRUCK CARGO TAC 1-1/4-TON 6X6 M880	1		
TRUCK CARGO 2-1/2-TON M35A2	4		
TRUCK CARGO 2-1/2-TON W/WN M35A2	1		
TRUCK UTILITY 1/4-TON M151A2	13		
TRUCK VAN SHOP 2-1/2-TON	1		

HEADQUARTERS AND HEADQUARTERS BATTERY FIELD ARTILLERY BATTALION, 155-MM, SELF-PROPELLED

TOE 6-376H(C17)

AD-A115 856 ARMY ARMOR SCHOOL FORT KNOX KY F/G 19/3
US ARMY ARMOR REFERENCE DATA IN THREE VOLUMES, VOLUME II. NONOI--ETC(U)
1981
UNCLASSIFIED ST-17-1-1-VOL-2 581-AD-F250 003 NL

2 of 2

AD-A115 856

END
DATE
FILMED
7 82
DTIC

**BATTALION HEADQUARTERS AND OPERATIONS
AND FIRE DIRECTION SECTION**

TSEC/KY-57
2 AN/GRA-39
AN/VRC-47



1 LTC (Bn Cdr) P
1 CSM (Cmd SGT MAJ) R
1 PFC (Dvr) R

TSEC/KY-57
AN/VRC-46



1 MAJ (XO) P
1 CPT (Motor Off) R
1 CSM (Cmd SGT MAJ) R
1 PFC (Dvr) R



1 MAJ (S3) P
1 CPT (S2) R
1 MSG (Op SGT) R
1 SP4 (Clerk-Typ) R, GL

TSEC/KY-57
AN/GRA-39
4 AN/VRC-46



1 MAJ (Fire Spct Off) P
2 CPT (FD Off) R
2 SSG (TF Computer Operator) R
1 SP4 (Chart Op) R
1 SP4 (Carr Dvr) R
1 SP4 (TF Op Sp) R

TSEC KY 57
AN/GRA-39
4 AN/VRC-46



1 SFC (Fire Control NCO) R
1 SSG (NBC Op Staff NCO) R
2 SGT (TF Equip Sp) R
1 SP4 (Chart Op) R
1 SP4 (Carr Dvr) R

AN/GRA-39
AN/VRC-47
TSEC KY 57



1 SP4 (Tac Wire Op Sp) R



2 PFC (TF Op Sp) R

Note: C-E Staff Off and S1, asg to Bn HQ, appear with respective elements.

BATTERY HEADQUARTERS

TSEC/KY-57
AN/GRC-160



1 CPT (Btry Cdr) P
1 PFC (Dvr) R, GL



1 1SG (First Sergeant) R
1 SSG (Supply SGT) R
1 SP5 (Armorer) (Dvr) R
1 SP4 (Gen Supply Sp) R
1 PFC (General Supplyman) R
1 7.62-mm mg



1 SSG (Motor SGT) R
1 SGT (Track Veh Mech) R
1 SGT (Pwr Gen/WVeh Mech) R
1 SP5 (PLL Clerk) R
1 SP4 (Equip Maint Clk) R
2 SP4 (Pwr Gen/WVeh Mech) R
1 SP4 (Track Veh Mech) R
2 PFC (Pwr Gen/WVeh Mech) R, GL
2 PFC (Track Veh Mech) (Dvr) R
1 7.62-mm mg



1 SFC (Food Svc SGT) R
1 SSG (First Cook) R
1 SP5 (Cook) R
2 SP4 (Cook) (Dvr) R
2 PFC (Cook) R

PERS/ADMIN CENTER



1 CPT (S1) R
1 SFC (Pac Supv) R
1 SSG (Pers Staff NCO) R
1 SSG (Reenlistment NCO) R
1 SP5 (Legal Clerk) R
1 SP5 (PAC Clerk) R
1 SP4 (Clerk-Typist) R
1 SP4 (PAC Clerk) R
2 PFC (PAC Clerk) R
1 PFC (Dvr) R

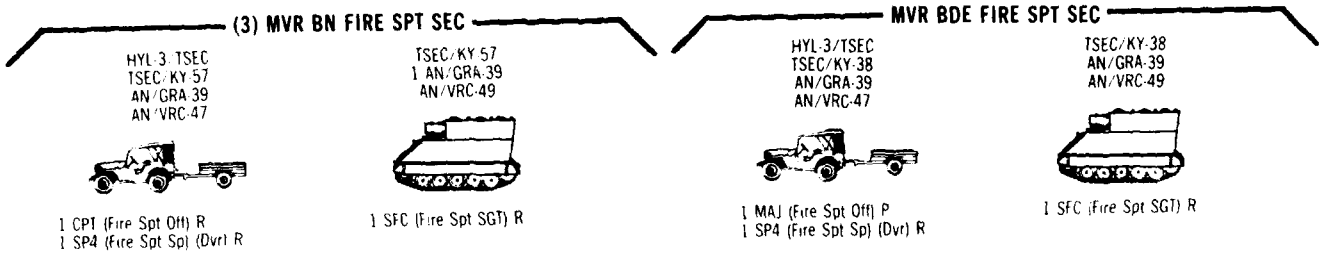

BN MEDICAL SECTION

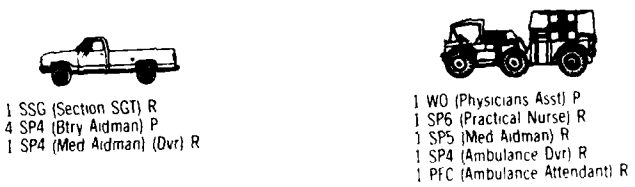

COMMUNICATION PLATOON

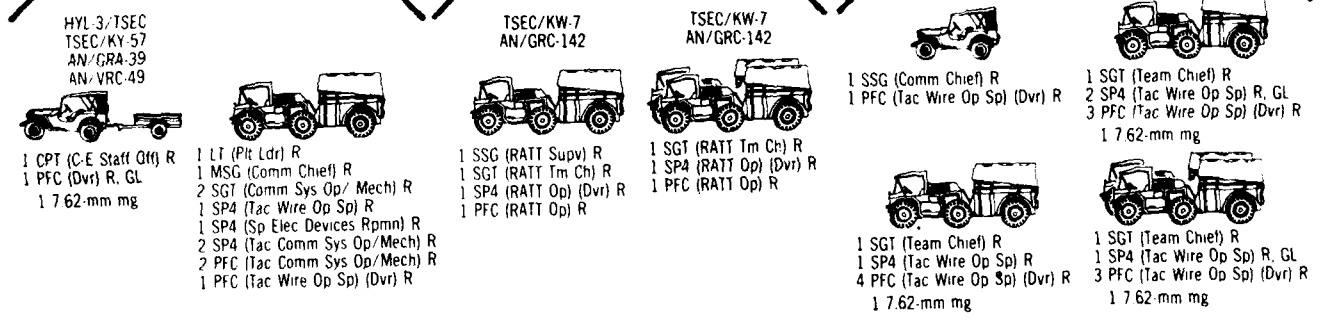

TARGET ACQUISITION PLATOON

PLT HQ

TSEC KY 57
AN VRC 47



1 LT (Plt Cdr) R
1 MSG (Plt SGT) R
1 PFC (Dvr) R

AN/PRC-77



1 SFC (Ch Surveyor) R
1 PFC (Pads Veh Dvr) R

SURVEY SECTION

AN/PRC-77



1 SSG (Ch of Survey Party) R
1 SP5 (Chief of Pads Party) (Dvr) R
1 SP4 (Instrument Op) R, GL
1 PFC (Rodman-Tapeman) R
1 7.62 mm mg



1 SP5 (Survey Computer) R
1 SP4 (Survey Cmpt Rec) R

MOV TGT LOC RADAR SEC

TSEC KY 57
AN GRA 39
AN VRC 46



1 SSG (Sec Chief) R
1 SP4 (Wpns Spt Radar Rpmnt) R
1 SP5 (FA Radar Op) R
2 SP4 (FA Radar Op) (Dvr) R



1 WO (FA Radar Tech) R
1 SP4 (Lt W Veh S Part Gen Mechs) R

CM RADAR SEC

TSEC KY 57
AN GRA 39
AN VRC 46



1 SSG (Sec Chief) R
1 SP4 (Wpns Spt Radar Rpmnt) R
1 PFC (FA Radar Op) (Dvr) R
1 7.62 mm mg

TSEC KY 57
AN VRC 46



1 SP5 (FA Radar Op) R
2 SP4 (FA Radar Op) R

METEOROLOGICAL SEC

AN/VRC 46



1 WO (MET Tech) R
1 PFC (FA MET Crmn) (Dvr) R



1 SFC (MET Sec Ch) R
1 SP5 (FA MET Crmn) R
2 SP4 (FA MET Crmn) R
1 PFC (FA MET Crmn) (Dvr) R



1 SSG (FA MET Crmn) R
1 SP5 (FA MET Crmn) R
1 SP4 (FA MET Crmn) R
1 PFC (FA MET Crmn) R

TSEC KY 57
AN VRC 46



1 WO (FA Radar Tech) R
1 PFC (FA Radar Op) R

(7) TANK COMPANY FIST

TSEC KY 57

2 AN/GRA-39 AN/PRC-77
2 AN/GRC-160 AN/VRC-47



1 LT (FIST Chief) R
1 SSG (Fire Spt SGT) R
1 SP4 (Fire Spt Sp) R, GL
2 PFC (RTO) (Dvr) R

(3) MECH INF CO FIST

TSEC KY 57

2 AN/GRA-39 3 AN/PRC-77
2 AN/GRC-160 AN/VRC-47



1 LT (FIST Chief) R
1 SSG (Fire Spt SGT) R
3 SGT (Forward Obsr) R
1 SP4 (Fire Spt Sp) R, GL
3 PFC (RTO) (Dvr) R

CHAPTER 7

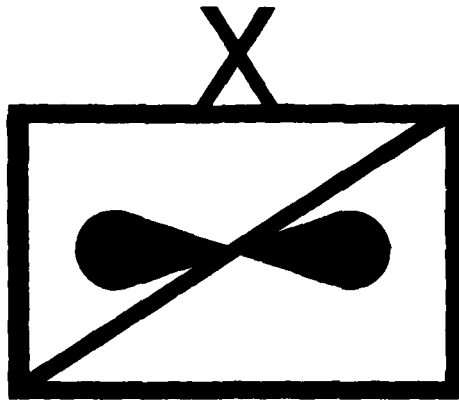

AIR CAVALRY COMBAT BRIGADE

MISSION: To conduct operations in the area of... (text is faint and partially obscured)

Area of operations... (text is faint and partially obscured)

404

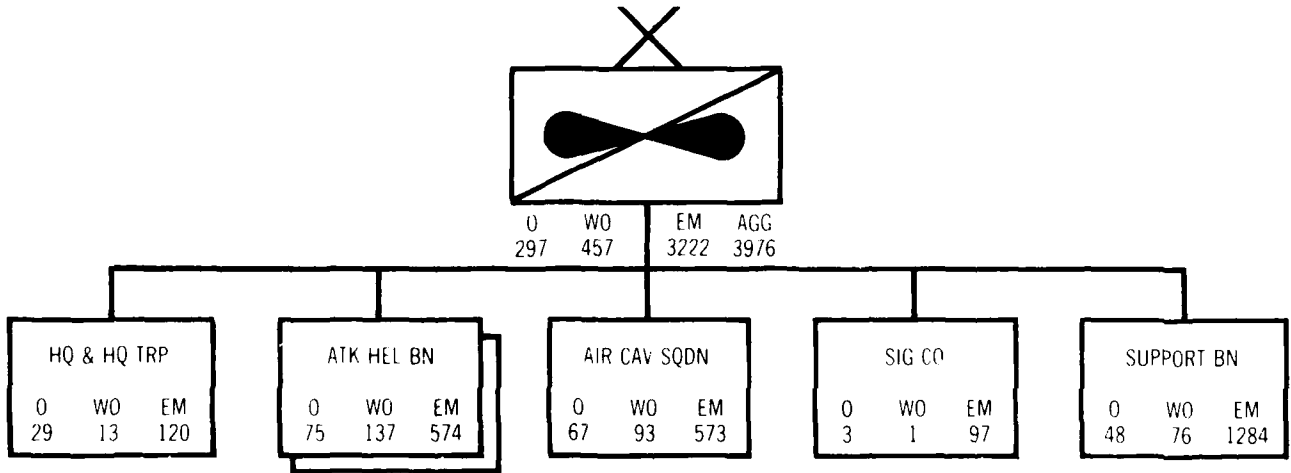

MISSION: To command and control assigned and attached combat, combat support and combat service support elements.
 ASSIGNMENT: Organized to the Air Cavalry Combat Brigade, TUE 17 200

CAPABILITIES: a. Command and control of all elements of the brigade.
 b. Provides aircraft for command and control assets.

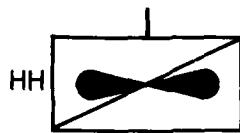

O	WO	EM	AGG
29	13	122	164

406

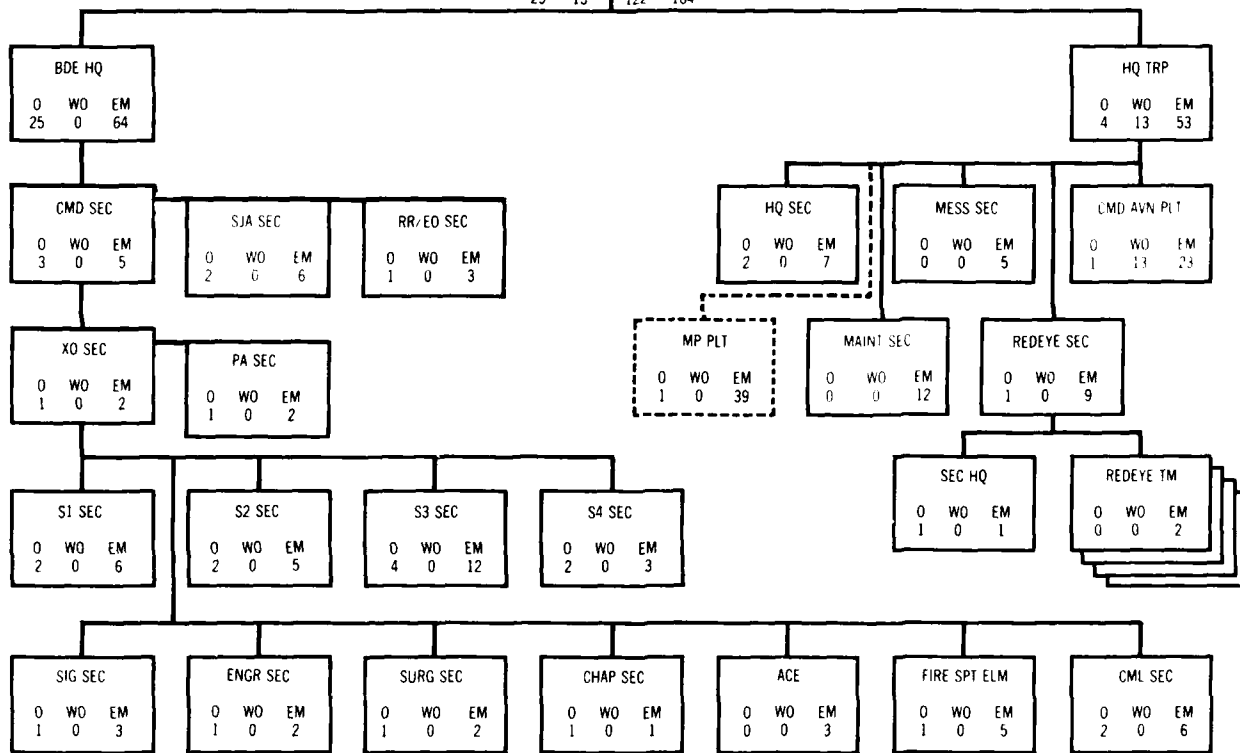

--- Augmentation Not included in totals

SUMMARY OF EQUIPMENT

WEAPONS

ARMT SUBSYS 7.62-MM MG LIGHT M23	5
LAUNCHER GRENADE M203	3
MACHINEGUN CAL .50 HB FLEX FOR GROUND USE	4
REVOLVER CAL .38	55
RIFLE 5.56-MM	113

VEHICLES AND VEHICLE EQUIPMENT

KITCHEN FIELD TRAILER MTD	1
TRAILER CARGO 1/4-TON M416	13
TRAILER CARGO 3/4-TON M101A1	5
TRAILER CARGO 1-1/2-TON M105A2	7
TRAILER TANK WATER 400-GAL M149A1	1
TRUCK CARGO TAC 1-1/4-TON 4X4 M880	3
TRUCK CARGO TAC 1-1/4-TON 4X4 W/60 AMP COMM KIT M882	6
TRUCK CARGO 2-1/2-TON M35A2	5
TRUCK CARGO 2-1/2-TON W/WN M35A2	3
TRUCK UTILITY 1/4-TON M151A2	14
TRUCK WRECKER 5-TON 6X6 W/WN M816	1

RADIO SET AN/GRC-160	4
RADIO SET AN/PRC-74	1
RADIO SET AN/PRC-77	1
RADIO SET AN/PRC-90	23
RADIO SET AN/VRC-24	2
RADIO SET AN/VRC-46	6
RADIO SET AN/VRC-47	6
RADIO SET AN/VRC-48	1
RADIO SET AN/VRC-64	2
RADIO SET CONTROL GROUP AN/GRA-39	2
SPEECH SCTY EQUIPMENT AEN TSEC/KY-28	9
SPEECH SCTY EQUIPMENT TSEC/KY-38	10
TELEPHONE SET TA-1/PT	8
TELEPHONE SET TA-312/PT	1

AIRCRAFT

HELICOPTER OBSERVATION OH-58A	4
HELICOPTER UTILITY UH-1H	5

COMMUNICATION-ELECTRONICS EQUIPMENT

RADIAC SET AN/PDR-27	1
RADIAC SET AN/PDR-56 (F)	1
RADIACMETER IM-93/UD	8
RADIACMETER IM-174/PD	4

MISCELLANEOUS EQUIPMENT

ALARM OML AGENT AUTO PTBL F/WHEEL VEH	2
DRUM FABRIC COLLAPSIBLE FUEL 500-GAL	3
FORWARD AREA REFUEL EQUIP (PARE)	1
NIGHT VISION GOGGLES AN/PVS-5	19
TANK AND PUMP UNIT TRK MTD (1200-GAL)	1
TANK UNIT TRK MTD (600-GAL)	2

HEADQUARTERS AND HEADQUARTERS TROOP AIR CAVALRY COMBAT BRIGADE

TOE 17-202H(C8)

BRIGADE HEADQUARTERS AND HEADQUARTERS SECTION

COMMAND SECTION

TSEC KY 38
AN VRC 47



- 1 BG (Bde Cdr) P
- 1 LT (Aide) Rev
- 1 SSG (Aide) R
- 1 SP5 (Chauffeur) R

TSEC KY 38
AN VRC 47



- 1 COL (Dep Cdr) Rev
- 1 CSM (Cmd SGT Major) R
- 1 SP6 (Secy Steno) R
- 1 PFC (Dvr) R

XO SECTION



- 1 LTC (XO) Rev
- 1 SP4 (Clerk Typist) R
- 1 PFC (Dvr) R

S1 SECTION

TSEC KY 38
AN VRC 46



- 1 MAJ (S1) Rev
- 1 CPT (Asst S1) Rev
- 1 MSG (S1 Reenlistment NCO) R
- 1 SFC (Pers Staff NCO) R
- 1 SP5 (Mail Distr Sp) R
- 2 SP4 (Clerk Typist) R
- 1 PFC (Dvr) R

S2 SECTION

TSEC KY 38
AN VRC 47

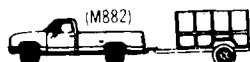

- 1 MAJ (S2) Rev
- 1 CPT (Asst S2) Rev
- 1 MSG (Ch Intel SGT) R
- 1 SFC (Intel SGT) R
- 1 SP4 (Intel Asst) R
- 1 SP4 (Clerk Typist) R
- 1 PFC (Dvr) R

S3 SECTION

2 TSEC KY 38
2 AN VRC 46



- 1 LTC (S3) Rev
- 1 MAJ (Asst S3) Rev
- 1 CPT (Asst S3 Air) Rev
- 1 CPT (Avn Safety Off) Rev
- 1 SGM (Chief Ops SGT) R
- 1 SFC (Ops SGT) R

AN PRC 74



- 1 SSG (Flt Ops Chief) R
- 1 SP4 (Ops Sp) R
- 1 SP4 (Flt Ops Sp) R
- 2 SP4 (Clerk Typist) R
- 1 SP4 (Illustrator) (Dvr) R
- 1 SP4 (Radio Op) R
- 1 PFC (Flt Ops Sp) R
- 1 PFC (Dvr) R
- 1 PFC (Radio Op) R

S4 SECTION

TSEC KY 38
AN VRC 47



- 1 MAJ (S4) Rev
- 1 CPT (Maint Off) Rev
- 1 MSG (Ch Supply SGT) R
- 1 SP4 (Clerk Typist) R
- 1 PFC (Dvr) R

SIGNAL SECTION

AN VRC 64



- 1 MAJ (Bde Sig Off) Rev
- 1 SFC (C E Ops Chief) R
- 1 SP4 (Ck Typ) R
- 1 SP4 (Telecom Ctr Op) (Dvr) R

ENGINEER SECTION

TSEC KY 38
AN VRC 46



- 1 MAJ (Bde Engr) Rev
- 1 SFC (Const Supv) R
- 1 SP4 (Craftsman) (Dvr) R

SURGEON SECTION

- 1 MAJ (Staff Surg) Rev
- 1 SSG (Staff SGT) R
- 1 SP4 (Corp Admin) R

CHAPLAIN SECTION



- 1 MAJ (Chaplain)
- 1 SSG (Sr Chapel Act Sp) (Dvr) R

AIRSPACE COORD ELEMENT

AN VRC-24
2 AN VRC-46

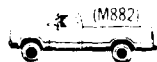

1 SSG (ACE SGT) R
1 SGT (ACE Ops SGT) R
1 SP4 (Rdo Op) (Dvr) R

FIRE SPT ELEMENT

TSEC KY-38
AN GRA-39
AN VRC-47



1 MAJ (Fire Spt Off) Rev
1 SFC (Fire Spt SGT) R
2 SP4 (Fire Spt Sp) (Dvr) R
1 SP4 (Rdo Op) R
1 PFC (Rdo Op) R

PUBLIC AFFAIRS SEC

1 CPT (Public Affairs Off) Rev
1 SFC (Public Affairs Supv) R
1 SP4 (Journalist) R

RR/EO SECTION

1 MAJ (RR, EO Off) Rev
1 SFC (EO NCO) R
1 SSG (EO NCO) R
1 SP4 (Clerk Typist) R

SJA SECTION



1 MAJ (SJA) Rev
1 CPT (Asst SJA) R
1 SFC (Legal Clerk) R
1 SP5 (Legal Clerk) R
1 SP5 (Legal Clerk) R
1 SP5 (Court Reporter) R
1 SP4 (Legal Clerk) R
1 SP4 (Clerk Typist) (Dvr) R

CML SECTION

1 MAJ (Cml Officer) Rev
1 LT (Asst Cml Off) R
2 SFC (NBC Op Staff NCO) R
1 SSG (Plotter) R
1 SGT (NBC Op NCO) R
1 SGT (Computer) R
1 SP4 (Clerk-Typist) R

ADA SECTION

SEC HQ
AN GRA-39
AN VRC-48



1 LT (Sec Ldr) R
1 SSG (Sec SGT) (Dvr) R
1 FAAR

(4) AD TEAM

AN GRC-160



1 SGT (Team Chief) Rev
1 SP4 (Medical Unitward) (Dvr) Rev
1 SP4

TROOP HEADQUARTERS

HEADQUARTERS SECTION

AN VRC-64



1 CPT (Trp Cdr) Rev
1 PFC (Dvr) R, GL



1 LT (XO) Rev
1 1SG (First Sergeant) R
1 SSG (Comm Chief) R
1 SP5 (Unit Clerk) R, GL
1 SP4 (Armorer) (Dvr) R
1 cal 50 mg



1 SSG (Supply SGT) R
1 PFC (Gen Supplyman) (Dvr) R

MESS SECTION



1 SFC (Food Svc SGT) R
1 SSG (First Cook) R
2 SP4 (Cook) (Dvr) R
1 PFC (Cook) R

*Mounts TOE cal 50 mg on ring mount

MAINTENANCE SECTION

(M880)
 1 SSG (Motor SGT) R
 1 PFC (Pwr Gen/WVeh Mech) (Dvr) R



1 SGT (Pwr Gen/WVeh Mech) R
 1 SP4 (Pwr Gen/WVeh Mech) R
 1 SP4 (Comm Sys Op) Mech R
 1 PFC (Pwr Gen/WVeh Mech) (Dvr) R
 1 PFC (Comm Sys Op) Mech R
 Total 50 mg



1 SP4 (PLL Clerk) R
 1 PFC (Pwr Gen/WVeh Mech) (Dvr) R

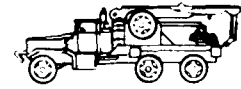

1 SP4 (Wrecker Opi) R

COMMAND AVIATION PLATOON

AN/PRC-77



1 SP4 (Avionics Mech) (Dvr) R

TSEC/KY-38
 AN/VRC-47
 AN/VRC-24

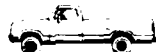

1 SFC (Plt SGT) R
 2 SSG (Tech Insp) Rev
 1 SP4 (Eq Rcds & Pts Sp) R
 1 PFC (Clerk) (Dvr) R GI
 1 PFC (Eq Rcds & Pts Sp) R

(w Trk & Tri Mtd Fuel Units)



1 SGT (Actt Fuel Hdr) (Dvr) R
 1 FARE



1 SP4 (Actt Fuels Hdr) (Dvr) R
 3 Drum Fuel



1 SGT (OH Hel Rpmnt) R
 1 SGT (OH Hel Rpmnt) R
 2 SP4 (OH Hel Rpmnt) (Dvr) R
 1 SP4 (OH Hel Rpmnt) R
 1 PFC (OH Hel Rpmnt) R
 2 PFC (OH Hel Rpmnt) R



1 CPT (Plt Ldr) Rev



1 WO (Fit Sfty Tech) Rev



1 WO (Inst Exam) Rev



1 WO (Instr Pilot) Rev



1 WO (Actt Maint Tech) Rev
 1 WO (Pilot) Rev
 1 SGT (Crew Chief) Rev
 M23

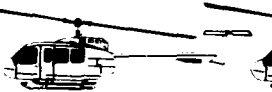

2 WO (Pilot) Rev
 1 SGT (Crew Chief) Rev
 M23



2 WO (Pilot) Rev
 1 SGT (Crew Chief) Rev
 M23



2 WO (Pilot) Rev
 1 SGT (Crew Chief) Rev
 M23



2 WO (Pilot) Rev
 1 SGT (Crew Chief) Rev
 M23

Note Each acct equipped with 1 Speech Security Equipment, TSEC/KY-28

MISSION: To destroy enemy armor and mechanized forces by aerial combat power using the speed and maneuverability of the combined arms team during offensive, defensive, and retrograde operations.

ASSIGNMENT: Operate as an Air Cavalry Combat Brigade (OF 17200) or to a corps or division as separate brigades when required.

- a. Attacks or counterattacks using stealth and maximum target standoff.
- b. Provides rapid responsive point and area target fire.
- c. Conducts operations utilizing terrain flight.
- d. Provide attack helicopter elements to ground maneuver forces for employment as a part of combined arms teams.
- e. Reconnaissance and coordinates response with other maneuver units.
- f. Provides mobility and firepower to exploit the effects of nuclear and chemical war for support.

412

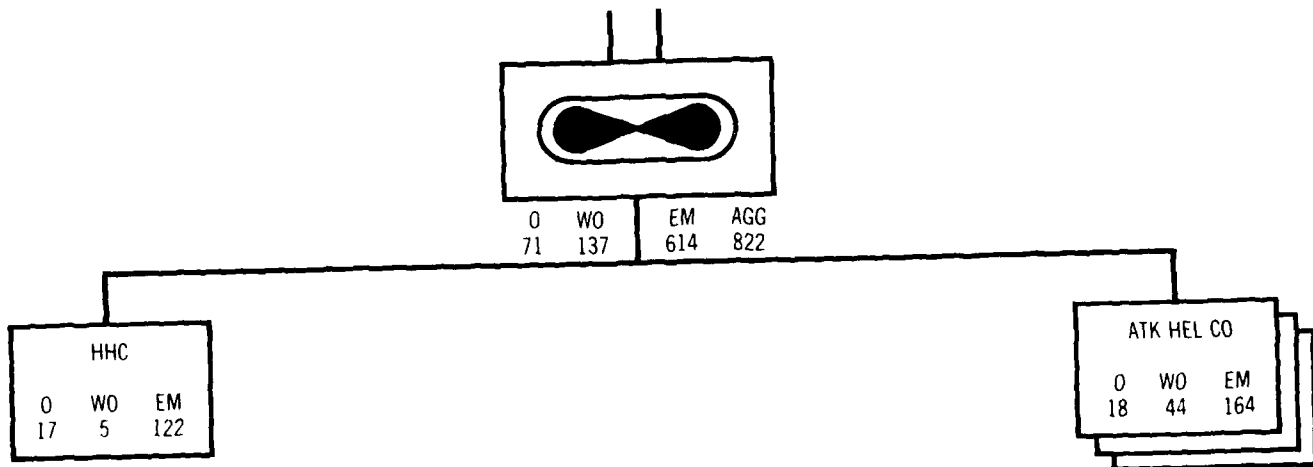

SUMMARY OF EQUIPMENT

WEAPONS			
ARMT SUBSYS TOW MISSILE	63		
ARMT SUBSYS 7.62-MM MG LIGHT M23	13		
ARMT SUBSYS 7.62-MM MG & 40 MM GL HIGH RATE M28A1	63		
LAUNCHER GRENADE M203	60		
LAUNCHER RKT 2.75-INCH 7-TUBE M158A1	126		
MACHINEGUN 7.62-MM: AIRCRAFT LIGHT DOOR MTD	26		
MACHINEGUN 7.62-MM FLEX	10		
MACHINEGUN 7.62-MM SIX BARRELS M134	63		
REVOLVER CAL .38	292		
RIFLE 5.56-MM	523		
VEHICLES AND VEHICLE EQUIPMENT			
413 CRANE WHEEL MTD 3-TON M63	3		
TRAILER ACFT MAINT AMBL	3		
TRAILER CARGO 1/4-TON M416	16		
TRAILER CARGO 3/4-TON M101A1	17		
TRAILER CARGO 1-1/2-TON M105A2	38		
TRAILER TANK WATER 400-GAL M149A1	7		
TRUCK AMBULANCE TAC 1-1/4-TON 4X4 M886	1		
TRUCK CARGO TAC 1-1/4-TON 4X4 M880	17		
TRUCK CARGO TAC 1-1/4-TON 4X4 W/60 AMP COMM KIT M882	9		
TRUCK CARGO TAC 1-1/4-TON 4X4 W/100 AMP COMM SHELTER KIT M884	2		
TRUCK CARGO 2-1/2-TON M35A2	30		
TRUCK CARGO 2-1/2-TON W/WN M35A2	5		
TRUCK CARGO 2-1/2-TON XLWB M36A2	6		
TRUCK LIFT FORK, 6000LB	3		
TRUCK PLATFORM UTILITY 1/2-TON M274A5	9		
TRUCK UTILITY 1/4-TON M151A2	17		
TRUCK WRECKER 5-TON 6X6 W/WN M819	4		
		COMMUNICATION-ELECTRONICS EQUIPMENT	
		ELECTRONIC TT SCTY EQUIPMENT TSEC/KW-7	2
		RADIAC SET AN/PDR-27	5
		RADIAC METER IM-93/UD	48
		RADIAC METER IM-174/PD	32
		RADIO SET AN/GRC-106	4
		RADIO SET AN/PRC-77	18
		RADIO SET AN/PRC-90	237
		RADIO SET AN/VRC-24	4
		RADIO SET AN/VRC-46	10
		RADIO SET AN/VRC-47	14
		RADIO SET AN/VRC-49	1
		RADIO SET AN/VRC-64	1
		RADIO SET CONTROL GROUP AN/GRA-39	12
		RADIO TT SET AN/GRC-142	2
		RECEIVER-TRANSMITTER CON GP AN/GRA-6	4
		SPEECH SCTY EQUIPMENT ARN TSEC/KY-28	112
		SPEECH SCTY EQUIPMENT TSEC/KY-38	22
		SWITCHBOARD TEL MANUAL SB-22/PT	5
		TELEPHONE SET TA-312/PT	46
		AIRCRAFT	
		HELICOPTER ATTACK AH-1S	63
		HELICOPTER OBSERVATION OH-58A	36
		HELICOPTER UTILITY UH-1H	13
		MISCELLANEOUS EQUIPMENT	
		ALARM OML AGENT AUTO PTBL MANPACK	8
		DRUM FABRIC COLLAPSIBLE FUEL 500-GAL	57
		FORWARD AREA REFUEL EQUIP (FARE)	19
		NIGHT VISION GOOGLES AN/PVS-5	132
		TANK UNIT TRL MTD (600-GAL)	7

ATTACK HELICOPTER BATTALION AIR CAVALRY COMBAT BRIGADE

TOE 17-385H (as changed)

HH



0	WO	EM	AGG
17	5	122	144

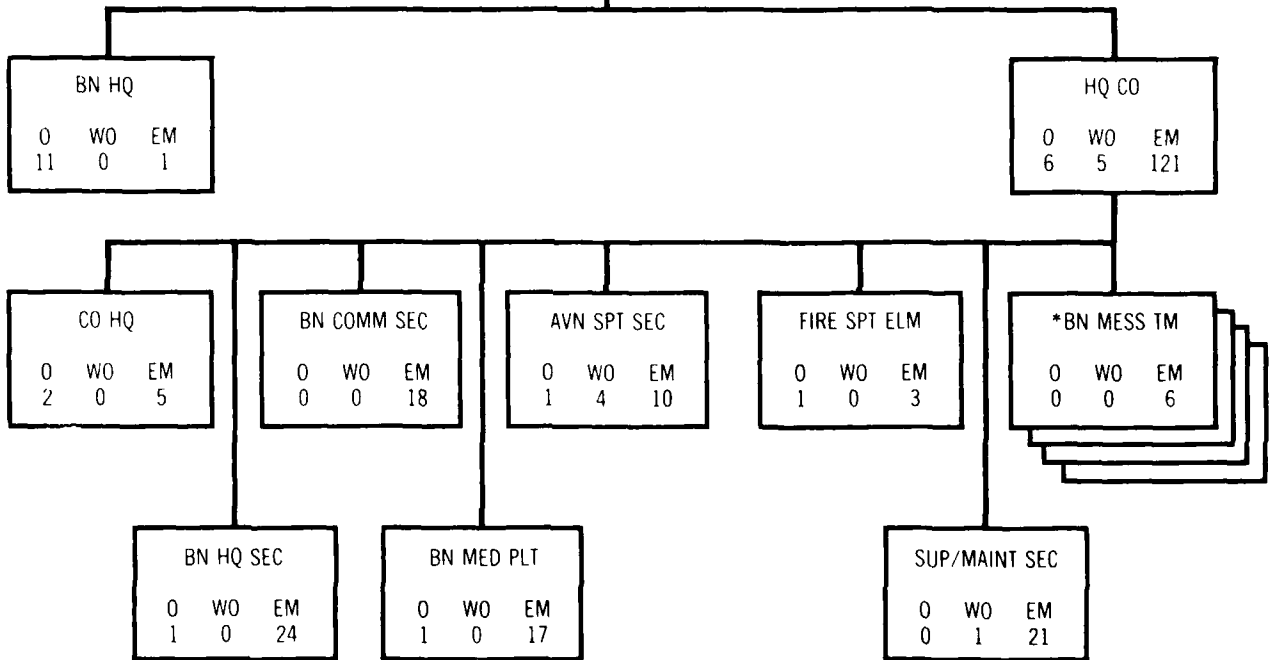

*1 Tm has 1 less EM.

SUMMARY OF EQUIPMENT

WEAPONS	
ARMT SUBSYS 7.62-MM MG LIGHT M23	4
LAUNCHER GRENADE M203	6
MACHINEGUN 7.62-MM FLEX	4
REVOLVER CAL .38	40
RIFLE 5.56-MM	100

415

VEHICLES AND VEHICLE EQUIPMENT	
TRAILER CARGO 1/4-TON M416	7
TRAILER CARGO 3/4-TON M101A1	5
TRAILER CARGO 1-1/2-TON M105A2	8
TRAILER TANK WATER 400-GAL M149A1	4
TRUCK AMBULANCE TAC 1-1/4-TON 4X4 M886	1
TRUCK CARGO TAC 1-1/4-TON 4X4 M880	3
TRUCK CARGO TAC 1-1/4-TON 4X4 W/60 AMP COMM KIT M882	3
TRUCK CARGO TAC 1-1/4-TON 4x4 W/100 AMP COMM SHELTER RT W/E....	2
TRUCK CARGO 2-1/2-TON M35A2	9
TRUCK CARGO 2-1/2-TON W/WN M35A2	2
TRUCK UTILITY 1/4-TON M151A2	8
TRUCK WRECKER 5-TON 6X6 W/WN M816	1

COMMUNICATION-ELECTRONICS EQUIPMENT	
ELECTRONIC TT SCTY EQUIPMENT TSEC/KW-7	2
RADIAC SET AN/PDR-27	2
RADIAC METER IM-93/UD	12
RADIAC METER IM-174/PD	5
RADIO SET AN/GRC-106	1
RADIO SET AN/PRC-90	12
RADIO SET AN/VRC-24	1
RADIO SET AN/VRC-46	7
RADIO SET AN/VRC-47	7
RADIO SET AN/VRC-49	5
RADIO SET AN/VRC-64	1
RADIO SET CONTROL GROUP AN/GRA-39	1
RADIO TT SET AN/GRC-142	6
RECEIVER-TRANSMITTER CON GP AN/GRA-6	2
SPEECH SCTY EQUIPMENT ABN TSEC/KY-28	1
SPEECH SCTY EQUIPMENT TSEC/KY-38	4
SWITCHBOARD TEL MANUAL SB-22/PT	13
TELEPHONE SET TA-312/PT	2
	13

AIRCRAFT	
HELICOPTER UTILITY UH-1H	4

MISCELLANEOUS EQUIPMENT	
ALARM OML AGENT AUTO PTBL MANPACK	2
DRUM FABRIC COLLAPSIBLE FUEL 500-GAL	3
FORWARD AREA REFUEL EQUIP (FARE)	1
NIGHT VISION GOGGLES AN/PVS-5	6
TANK UNIT TRL MTD (600-GAL)	1

HEADQUARTERS AND HEADQUARTERS COMPANY ATTACK HELICOPTER BATTALION, AIR CAVALRY COMBAT BRIGADE

TOE 17-386H500 (C12)

BATTALION HEADQUARTERS AND BATTALION HEADQUARTERS SECTION

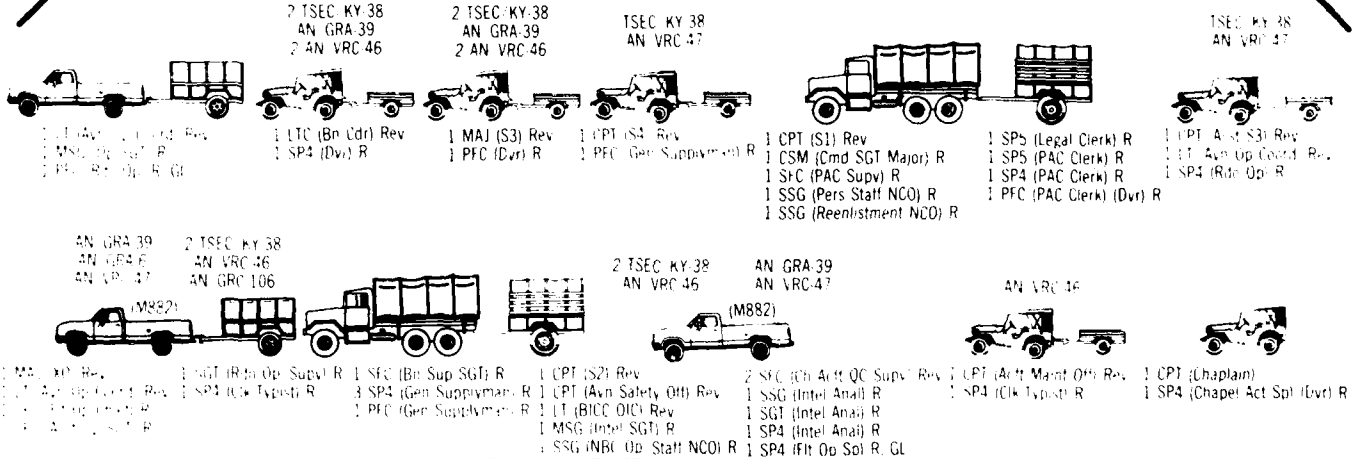

Note Flight Surgeon and C-E Staff Officer are shown with respective battalion elements

COMPANY HEADQUARTERS

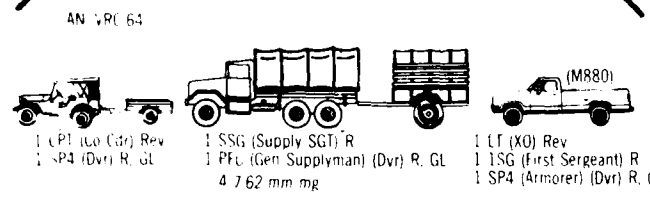

BN COMM SEC

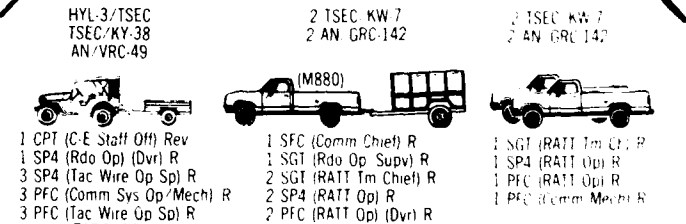

MEDICAL PLT

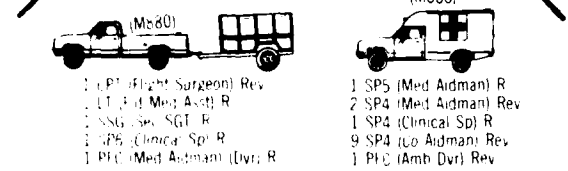

FIRE SPT ELEMENT

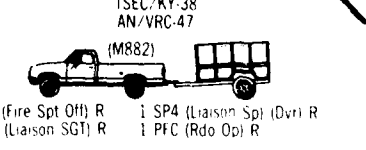

(4) MESS TEAM

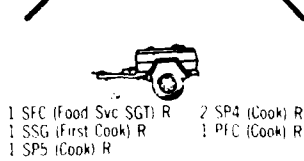

Note No vehicles provided to haul water trailers. One Tm has no SSG First Cook

S4 AND MAINTENANCE SECTION



- 1 SFL (Br Sup) SGT R
- 1 SP4 (Gen Supp) Mnt R
- 1 PFC (Gen Supp) Mnt (Dvr) R



- 1 SGT (WV) Pwr Gen Mchnt R
- 1 SP4 (Gen Supp) Mnt R
- 1 PFC (Gen Supp) Mnt (Dvr) R



- 1 SFL (Mnt) SGT R
- 1 SP4 (WV) Pwr Gen Mchnt R
- 1 SP4 (Gen Supp) Mnt R
- 1 PFC (WV) Pwr Gen Mchnt R
- 1 PFC (Mnt) Crnk (Dvr) R

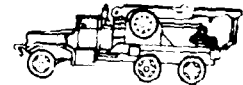

- 1 SFL (WV) Pwr Gen Mchnt R
- 1 PFC (WV) Pwr Gen Mchnt R



- 1 WFL (Mnt) SGT R
- 1 PFC (WV) Pwr Gen Mchnt R

AVIATION SUPPORT SECTION

TSEC KY-28



- 1 LT (Sec Ldr) Rev
- 1 WO (Pilot) Rev
- 1 SGT (Crew Chief) Rev
- M23

TSEC KY-28



- 1 WO (Fit Safety Tech) Rev
- 1 SGT (Crew Chief) Rev
- M23

TSEC KY-28



- 1 WO (Instr Pilot) Rev
- 1 SGT (Crew Chief) Rev
- M23

TSEC KY-28



- 1 WO (Inst Exam) Rev
- 1 SGT (Crew Chief) Rev
- M23

417



- 1 SFL (H) Tech Insp R
- 1 SP4 (H) Fuel (Dvr) R
- 1 FARJ
- 1 Drum Equip



- 1 SGT (H) Reprr R
- 1 SP4 (H) Reprr R
- 1 SP4 (Mnt Supp) Dvr R
- 1 PFC (H) Reprr R



- TSEC KY-38
- AN VRC 24
- AN VRC 46
- (M882)
- 1 SFC (Mnt Supp) R
- 1 PFC (Mnt Supp) (Dvr) R

MISSION - To destroy enemy armored, mechanized or other forces by aerial combat power using fire and maneuver as an integrated part of the combined arms team during offensive, defensive and retrograde operations.

ASSIGNMENT - Organic to Attack Helicopter Battalion, TOE 17-385.

ABILITIES - a. Attacks or counterattacks using stealth and maximum target standoff.
 b. Provides rapid responsive point and area target fire.
 c. Conducts operations at nap of the earth altitude.

d. Provides attack helicopter elements to ground maneuver forces to assist in the support of combined arms teams.
 e. Reacts to intelligence and target information given with other elements of the unit.
 f. Conducts aerial reconnaissance and security operations in support of the unit.
 g. Provides the stability and firepower to support the effects of air and ground force support.
 h. Participates in special operations as required.

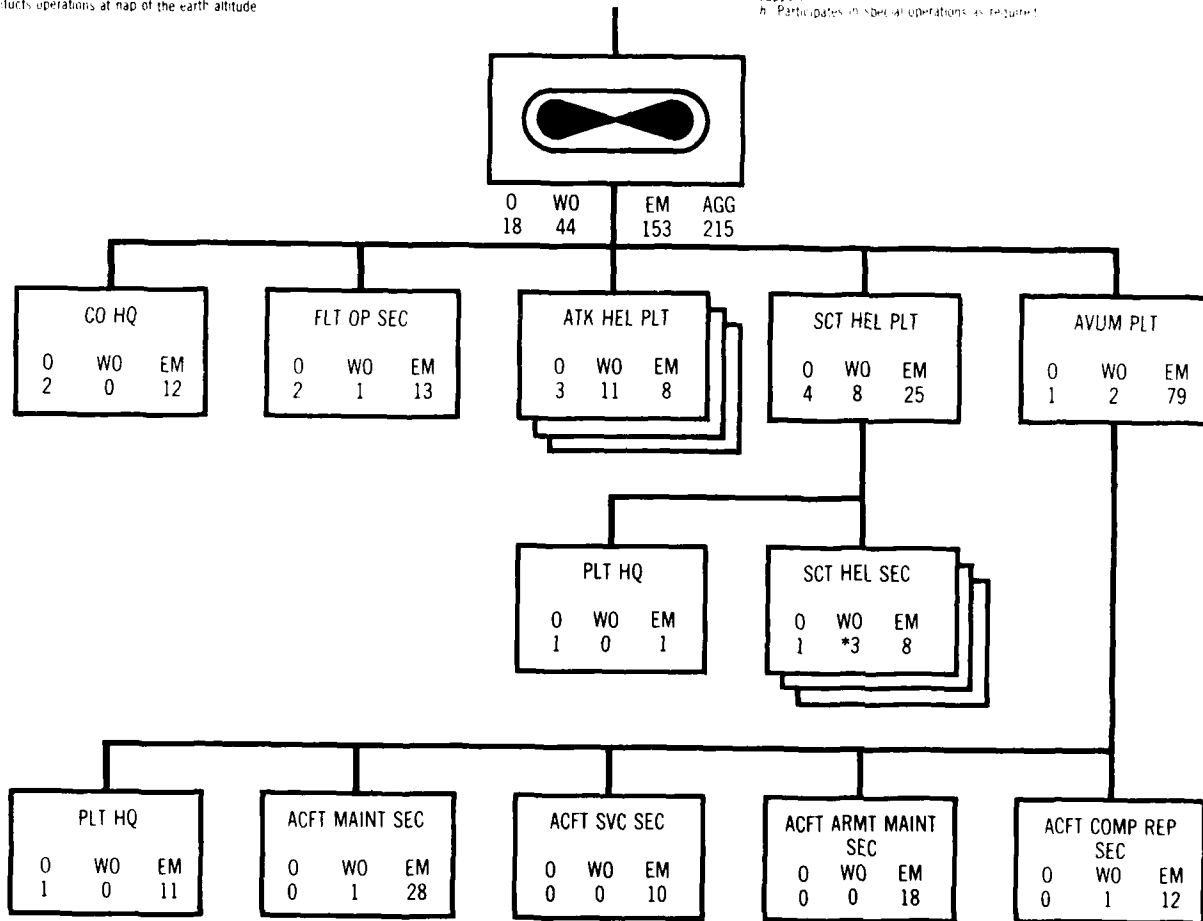

*1 Section has 1 less WO Pilot.

SUMMARY OF EQUIPMENT

	WEAPONS		
ARMT SUBSYS TOW MISSILE	21		
ARMT SUBSYS 7.62-MM MG LIGHT M23	3		
ARMT SUBSYS 7.62-MM MG & 40-MM GL HIGH RATE M28A1	21		
LAUNCHER GRENADE M203	18		
LAUNCHER RKT 2.75-INCH 7-TUBE M158A1	42		
MACHINEGUN 7.62-MM LIGHT FLEX	4		
MACHINEGUN 7.62-MM ACPT LIGHT DOOR MTD.....	6		
MACHINEGUN 7.62-MM SIX BARRELS M134	21		
REVOLVER CAL .38	84		
RIFLE 5.56-MM	150		
VEHICLES AND VEHICLE EQUIPMENT			
CRANE WHEEL MTD 3-TON M63	1		
TRAILER ACFT MAINT AMBL	1		
TRAILER AMMUNITION 1-1/2-TON.....	4		
TRAILER CARGO 1/4-TON M416	3		
TRAILER CARGO 3/4-TON.....	6		
TRAILER CARGO 1-1/2-TON M105A2	11		
TRAILER TANK WATER 400 GAL 1-1/2-TON.....	1		
TRUCK CARGO TAC 1-1/4-TON 4X4 W/E	5		
TRUCK CARGO TAC 1-1/4-TON 4X4 W/100 AMP COMM KIT M884	1		
TRUCK CARGO 2-1/2-TON M35A2	8		
TRUCK PLATFORM UTILITY 1/2-TON M274A5	3		
TRUCK UTILITY 1/4-TON M151A2	3		
TRUCK WRECKER 5-TON 6X6 W/WN MB16	2		
TRUCK CARGO 5-TON 6X6 LMB W/E.....	4		
TRUCK CARGO DROPSIDE 5-TON 6X6 W/WN, W/E.....	4		
TRUCK LIFT FORK DSL DRWN 6000LB CAP.....	1		
COMMUNICATION-ELECTRONICS EQUIPMENT			
RADIAC SET AN/PDR-27	1		
RADIAC METER IM-93/UD	24		
RADIAC METER IM-174/PD	9		
RADIO SET AN/GRC-106	1		
RADIO SET AN/PRC-77	5		
RADIO SET AN/PRC-90	75		
RADIO SET AN/VRC-24	1		
RADIO SET AN/VRC-46	1		
RADIO SET AN/VRC-47	3		
RADIO SET CONTROL GROUP AN/GRA-39	2		
RECEIVER-TRANSMITTER CON GP AN/GRA-6	1		
SPEECH SCTY EQUIPMENT ABN TSEC/KY-28	36		
SPEECH SCTY EQUIPMENT TSEC/KY-38	4		
SWITCHBOARD TEL MANUAL SB-22/PT	2		
TELEPHONE SET TA-312/PT	12		
AIRCRAFT			
HELICOPTER ATTACK AH-1S	21		
HELICOPTER OBSERVATION OH-58A	12		
HELICOPTER UTILITY UH-1H	3		
MISCELLANEOUS EQUIPMENT			
ALARM OML AGENT AUTO PTBL MANPACK	2		
DRUM FABRIC COLLAPSIBLE FUEL 500-GAL	18		
FORWARD AREA REFUEL EQUIP (FARE)	6		
NIGHT VISION GOGGLES AN/PVS-5	42		
TANK UNIT TRL MTD (600-GAL)	4		

ATTACK HELICOPTER COMPANY ATTACK HELICOPTER BATTALION, AIR CAVALRY COMBAT BRIGADE

SCOUT HELICOPTER PLATOON

PLATOON HQ

AN VRC 77
 1 CPT (Plt Ldr) Rev
 1 SFC (Plt SGT) R

(3) SCOUT SECTION

TSEC KY 28

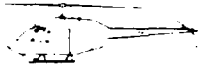
 1 LT (Sec Ldr) Rev
 1 SGT (Sct Obsr) Rev
 1 Rifle 5.56 mm
 1 M60 mg 1 M203

TSEC KY 28

 1 WO (Pilot) Rev
 1 SGT (Sct Obsr) Rev
 1 Rifle 5.56 mm
 1 M60 mg

TSEC KY 28

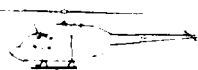
 1 WO (Pilot) Rev
 1 SGT (Sct Obsr) Rev
 1 Rifle 5.56 mm
 1 M60 mg

TSEC KY 28

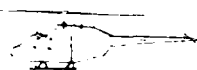

 1 WO (Pilot) Rev
 1 SGT (Sct Obsr) Rev
 1 Rifle 5.56 mm
 1 M60 mg 1 M203

Notes
 1 In 1 section, 1 WO Pilot is Instructor Pilot, MOS 100BC, 6 SGT, 4 SP4 and 2 PFC Hel Rpmn distributed between the 3 platoons
 2 One section has 1 helicopter w. assigned pilot, this aircraft is flown by the platoon leader

AVUM PLATOON

PLATOON HEADQUARTERS

TSEC KY 28

 1 SSG (Actt Fire Ctl Supv) R
 1 SP1 (Plt Ldr) R
 1 CPT (Plt Ldr) Rev
 1 SSG (AH Tech Insp) Rev
 1 SGT (Avionics Chf) Rev
 1 SP4 (Door Gnd) R
 M23

AN VRC 47

 (M881)
 1 SFC (Plt SGT) R
 4 SSG (Atk Hel Tech Insp) Rev
 7 SSG (Sct Hel Tech Insp) Rev

ACFT ARMT MAINT SECTION



1 SFC (Actt Repair Supv) R
 1 SSG (Actt Fire Ctl Supv) R
 3 SGT (Actt Fire Ctl Rpmn) R
 1 SGT (Hel Wpns Sys Rpmn) R
 2 SP4 (Hel Wpns Sys Rpmn) R
 5 PFC (Actt Fire Ctl Rpmn) R
 2 PFC (Hel Wpns Sys Rpmn) R



1 SP1 (Actt Fire Ctl Rpmn) R (1)

Note: Truck Lift Fork Dsl Drvn 6,000 lb Cap Rough Terrain

1 PFC (Hel Wpns Sys Rpmn) R

AIRCRAFT MAINT SECTION



1 WO (Actt Repair Tech) Rev
 1 SGT (AH Rpmn) R
 1 SP5 (Avionics Mech) R
 1 PFC (Avionics Mech) R
 1 SP4 (UH Rpmn) (Dvr) R
 3 PFC (UH Rpmn) R



1 SFC (Sec Chf) R
 2 SP5 (Mat Supply Sp) R
 2 SP4 (Mat Supply Sp) R
 4 SP4 (AH Rpmn) R
 1 SP4 (Obsr Sct Hel Rpmn) R
 2 PFC (Mat Supply Sp) (Dvr) R
 3 PFC (AH Rpmn) R



1 SGT (UH Rpmn) R
 1 SP1 (Wrecker Op) R (1)

AIRFIELD SERVICE SECTION

AN PRC 77



- 1 SSG (Spec. Chief) R
- 2 SP4 (Ammo Storage Asst) R
- 1 PFC (Ammo Storage Asst) (Dvr) R



- 2 SGT (Act. Fuels Hdq) R
- 2 SP4 (Act. Fuels Hdq) (Dvr) R
- 2 PFC (Act. Fuels Hdq) R

Note Section auth 6 FARE & 18 500 gal collapsible fuel drum

AIRCRAFT COMPONENT REPAIR SECTION



- 1 SSG Avn Maint Tech) R
- 1 SGT (Mant Suppl) R
- 1 SP4 (Act. Partrain Rpmn) (Dvr) R
- 1 PFC (Act. Partrain Rep) R
- 1 PFC (Act. Partrain Rep) R
- 1 PFC (Act. Partrain Rep) R



- 1 SP4 (Act. Parplant Rep) R
- 1 SP4 (Act. Struc Rep) R
- 1 SP4 (Mat Supply Sp) R

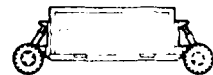

- 1 PFC (Act. Electron) R
- 1 PFC (Pneu. Instrum) Rep) R

MANUAL - To perform the above operations, refer to the following manual which is attached to this page. Manual reference is necessary for the majority of the operations explained.

APPARATUS - This is an Airway Number Branch (ANB) 11200.

OPERATION - This is an Airway Number Branch (ANB) 11200.

CAUTION - This is an Airway Number Branch (ANB) 11200.

OPERATION - This is an Airway Number Branch (ANB) 11200.

CAUTION - This is an Airway Number Branch (ANB) 11200.

1. Be sure to refer to the following manual which is attached to this page. Manual reference is necessary for the majority of the operations explained.

2. Be sure to refer to the following manual which is attached to this page. Manual reference is necessary for the majority of the operations explained.

3. Be sure to refer to the following manual which is attached to this page. Manual reference is necessary for the majority of the operations explained.

4. Be sure to refer to the following manual which is attached to this page. Manual reference is necessary for the majority of the operations explained.

424

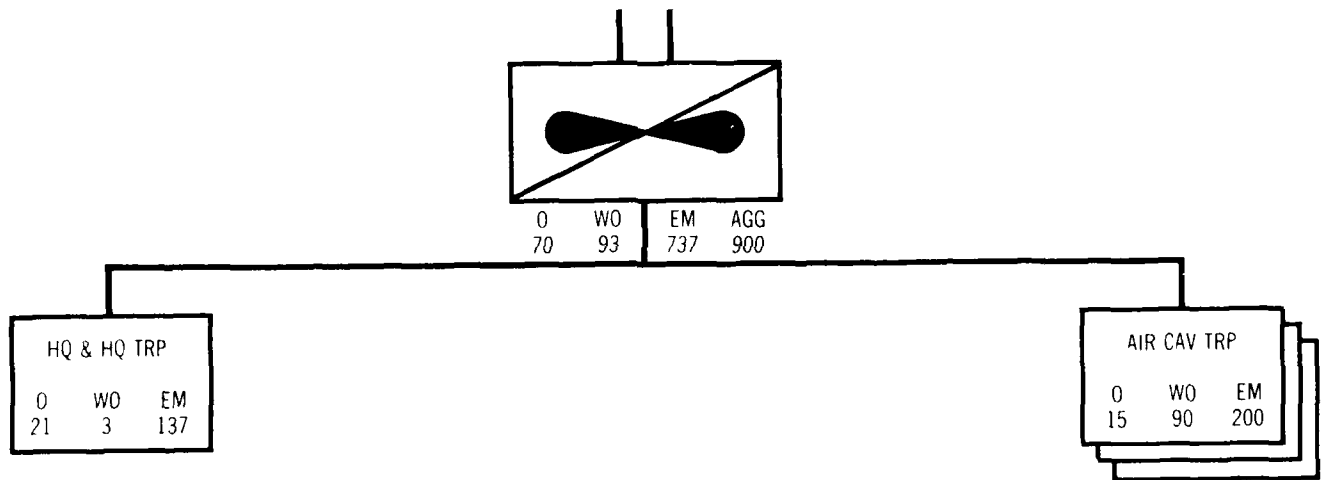

SUMMARY OF EQUIPMENT

WEAPONS			
ARMY SUBSYS TOW MISSILE	27	RADIOMETER IM-93/UD	129
ARMY SUBSYS 7.62-MM MG LIGHT M23	22	RADIOMETER IM-174/PD	66
ARMY SUBSYS 7.62-MM MG & 40 MM CL HIGH RATE M28A1	27	RADIO SET AN/GRC-106	4
LAUNCHER GRENADE M203	52	RADIO SET AN/GRC-160	4
LAUNCHER RKT 2.75-INCH 7-TUBE M158A1	54	RADIO SET AN/PRC-77	48
LAUNCHER RKT 2.75-INCH 19-TUBE M200A1	30	RADIO SET AN/PRC-90	180
LAUNCHER RKT 56-MM 4-TUBE M202	3	RADIO SET AN/VRC-24	1
MACHINEGUN CAL .50 HB FLEX FOR GROUND USE	13	RADIO SET AN/VRC-46	7
MACHINEGUN 7.62-MM ACET LT DOCK MTD	44	RADIO SET AN/VRC-47	10
MACHINEGUN 7.62-MM FLEX	11	RADIO SET AN/VRC-49	1
MACHINEGUN 7.62-MM SIX BARRELS M134	27	RADIO SET AN/VRC-64	1
REVOLVER CAT .38	249	RADIO SET CONTRCL GROUP AN/GRA-39	9
RIFLE 5.56-MM	544	RADIO TT SET AN/GRC-142	7
TRACER IR GUIDED M1 SU-3F (DRAGON)	6	RECEIVER-TRANSMITTER CON GP AN/GRA-6	6
		SPEECH SCTY EQUIPMENT ABN: TSEC/KY-28	79
		SPEECH SCTY EQUIPMENT TSEC/KY-38	17
		SWITCHBOARD TEL MANUAL SB-22/PT	6
		TELEPHONE SET TA-1/PT	20
		TELEPHONE SET TA-312/PT	45
VEHICLES AND VEHICLE EQUIPMENT			
CRANE WHEEL MTD 3-TON M63	2		
TRAILER ACFT MAINT AMBL	3		
TRAILER ANAC 1-1/2-TON M332	6		
TRAILER CARGO 1/4-TON M416	21		
TRAILER CARGO 3/4-TON M101A1	3		
TRAILER CARGO 1-1/2-TON M105A2	25		
TRAILER TANK WATER 400-GAL M149A1	4		
TRUCK AMBULANCE 1-1/4-TON 6X6 M792	1		
TRUCK CARGO 1-1/4-TON 6X6 M561	5		
TRUCK CARGO TAC 1-1/4-TON 4X4 M880	1		
TRUCK CARGO TAC 1-1/4-TON 4X4 W/60 AMP COMM KIT M882	2		
TRUCK CARGO TAC 1-1/4-TON 4X4 W/100 AMP COMM SHELTER KIT M884	2		
TRUCK CARGO 2-1/2-TON M35A2	13		
TRUCK CARGO 5-TON 6X6 M813	37		
TRUCK LIFTFORK: DIEL DRVN 6000 LB CAP	6		
TRUCK UTILITY 1/4-TON M151A2	24		
TRUCK VAN SHOP 2-1/2-TON 6X6 M109A3	3		
TRUCK WRECKER 5-TON 6X6 W/WN M816	4		
COMMUNICATION-ELECTRONICS EQUIPMENT			
CODE CHANGER KEY: KIK-18/TSEC	36		
CODE CHANGER KEY: KYK-28/TSEC	40		
ELECTRONIC TT SCTY EQUIPMENT TSEC/KW-7	3		
RADIAC SET AN/PDR-27	5		
		AIRCRAFT	
		HELICOPTER ATTACK AH-1S	27
		HELICOPTER OBSERVATION OH-58A	30
		HELICOPTER UTILITY UH-1H	22
		MISCELLANEOUS EQUIPMENT	
		ALARM OML AGENT AUTO PTBL F/WHEEL VEN	10
		DETECTING SET MINE PTBL AN/PSS-7	4
		DETECTING SET MINE PTBL AN/PSS-11	4
		DRUM FABRIC COLLAPSIBLE FUEL 500-GAL	21
		FORWARD AREA REFUEL EQUIP (FARE)	7
		METASCOPE AN/PAS-6	17
		NIGHT SIGHT INDIVIDUAL WPN AN/PVS-4	20
		NIGHT VISION GOGGLES AN/PVS-5	129
		TANK AND PUMP UNIT TRK MTD (1200-GAL)	7
		TANK UNIT TRK MTD (600-GAL)	7
		VIBRTR INFRARED AN/PAS-7	3

AIR CAVALRY SQUADRON AIR CAVALRY COMBAT BRIGADE

TOE 17-205H200

MISSION - To provide command, control, and supervision of the air cavalry squadron and attached units.
 ASSIGNMENT - Organic to the Air Cavalry Squadron, TOE 17 205.
 CAPABILITIES - a. Command, control, provides staff planning and supervises operations for organic and attached units.
 b. Provides unit level supply, medical, mess, and transportation services for the squadron.

c. Provides aircraft for command, control, and liaison by the commander and his staff.
 d. Performs organizational maintenance on organic equipment.
 e. Performs limited aviation unit maintenance.

426

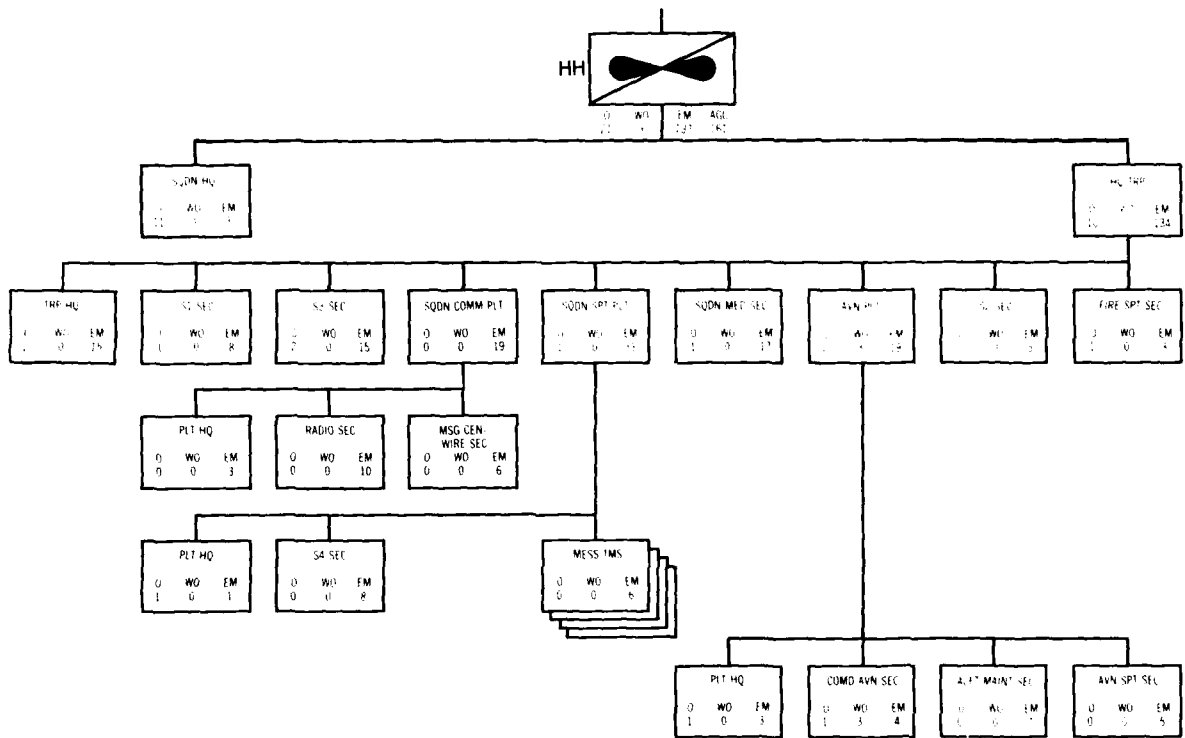

SUMMARY OF EQUIPMENT

WEAPONS

ARMT SUBSYS 7.62-MM MG LIGHT M23	4
LAUNCHER GRENADE M203	4
MACHINEGUN CAL .50 HB FLEX FOR GROUND USE	4
MACHINEGUN 7.62-MM ACFT LT DOOR MTD	8
MACHINEGUN 7.62-MM FLEX	2
REVOLVER CAL .38	36
RIFLE 5.56-MM	148

VEHICLES AND VEHICLE EQUIPMENT

TRAILER CARGO 1/4-TON M416	12
TRAILER CARGO 3/4-TON M101A1	3
TRAILER CARGO 1-1/2-TON M105A2	8
TRAILER TANK WATER 400-GAL M149	1
TRUCK AMBULANCE 1-1/4-TON 6X6 M792	1
TRUCK CARGO 1-1/4-TON 6X6 M561	2
TRUCK CARGO TAC 1-1/4-TON 4X4 M880	1
TRUCK CARGO TAC 1-1/4-TON 4X4 W/60 AMP COMM KIT M882	2
TRUCK CARGO TAC 1-1/4-TON 4X4 W/100 AMP COMM SHELTER KIT M884	2
TRUCK CARGO 2-1/2-TON M35A2	10
TRUCK CARGO 5-TON 8X8 M656	4
TRUCK UTILITY 1/4-TON M151A2	15
TRUCK WRECKER 5-TON 6X6 W/WN W/E	1

COMMUNICATION-ELECTRONICS EQUIPMENT

CODE CHANGER KEY: KIK-18/TSEC	3
CODE CHANGER KEY: KYK-28/TSEC	4
ELECTRONIC TT SCTY EQUIPMENT TSEC/KW-7	3
RADIAC SET AN/PDR-27	2
RADIAC METER 1M-93/UD	30
RADIAC METER 1M-174/PD	12
RADIO SET AN/GRC-106	2

RADIO SET AN/GRC-160	4
RADIO SET AN/PRC-90	12
RADIO SET AN/VRC-24	1
RADIO SET AN/VRC-46	7
RADIO SET AN/VRC-47	7
RADIO SET AN/VRC-48	1
RADIO SET AN/VRC-49	1
RADIO SET AN/VRC-64	1
RADIO SET CONTROL GROUP AN/GRA-39	6
RADIO TT SET AN/GRC-142	2
RECEIVER-TRANSMITTER CON GP AN/GRA-6	2
SPEECH SCTY EQUIPMENT TSEC/KY-28	4
SPEECH SCTY EQUIPMENT TSEC/KY-38	11
SWITCHBOARD TEL MANUAL SB-72/PT	2
TELEPHONE SET TA-1/PT	8
TELEPHONE SET TA-312/PT	15

AIRCRAFT

HELICOPTER UTILITY UH-1H	4
--------------------------------	---

MISCELLANEOUS EQUIPMENT

ALARM OML AGENT AUTO PTBL F/WHEEL VEH	4
DETECTING SET MINE PTBL AN/PRS-7	1
DETECTING SET MINE PTBL AN/PSS-11	1
DRUM FABRIC COLLAPSIBLE FUEL 500-GAL	3
FORWARD AREA REFUEL EQUIP (FARE)	1
METASCOPE AN/PAS-6	2
NIGHT SIGHT INDIVIDUAL WPN AN/PVS-4	2
NIGHT VISION GOGGLES AN/PVS-5	15
TANK AND PUMP UNIT TRK MTD	1
TANK UNIT TRK MTD	1

HEADQUARTERS AND HEADQUARTERS TROOP AIR CAVALRY SQUADRON AIR CAVALRY COMBAT BRIGADE

TOE 17-206H220

427

SQUADRON HEADQUARTERS AND STAFF SECTIONS

TSEC/KY-38
AN/GRA-39
2 AN/VRC-46



1 LTC (Sadrn Cdr) Rev
1 SP4 (Dvr) R

TSEC/KY-38
AN/VRC-47



1 MAJ (XO) Rev
1 PFC (Dvr) R

TSEC/KY-38
2 AN/VRC-46



1 MAJ (S3) Rev
1 SP4 (Fit Op Sp) (Dvr) R

AN VRC 47



1 CPT (S1) Rev
1 SP4 (Clerk-Typist) (Dvr) R

TSEC KY 38
AN VRC 47



1 CPT (S4) Rev
1 MSG (Maint Suov) R
1 PFC (Rdo Opt) (Dvr) R

2 AN/GRA-39 2 AN/VRC-46
TSEC/KY-57 AN/VRC-24
AN/GRA-6 AN/GRC-106



1 CPT (Chaplain)
1 SP4 (Chapel Act Sp) (Dvr) R



1 CPT (Asst S3) Rev
1 CPT (Avn Sfty Off) Rev
1 LT (Asst S3/Cml Off) R
1 MSG (Op SGT) R
1 SFC (Asst Op SGT) R
1 SSG (NBC Ops/Staff NCO) R
1 SGT (Ch Rdo Op/Supv) R
1 SP4 (Rdo Op) R
1 PFC (Rdo Op) (Dvr) R



AN/GRA-39
AN/VRC-47
AN/GRC-106

1 CPT (S2) Rev
1 LT (Tac Intel Off) Rev
1 MSG (Intel SGT) R
1 SFC (Fit Op Chief) R
1 SSG (Sr Intel Anal) R
1 SGT (Ch Rdo Op/Supv) R
1 SP5 (Intel Anal) R
1 SP4 (Intel Anal) R
1 SP4 (Rdo Op) R
2 PFC (Fit Op Sp) (Dvr) R
1 PFC (Rdo Op) R



1 CSM (Cmd SGT Major) R
1 SFC (PAC Supervisor) R
1 SSG (Pers Staff NCO) R
1 SSG (Reenlistment NCO) R
1 SP5 (Legal Clerk) R
1 SP5 (PAC Clerk) R
1 SP4 (PAC Clerk) R
1 PFC (PAC Clerk) R

Note: Avn Medical Off, C-E Staff Off, and Maint Off are shown with respective squadron elements.
S4 Sec with Spt Plt, MSG (Maint Suov) Asgd to S4 Sec

TROOP HEADQUARTERS

AN/VRC-46



1 CPT (Troop Cdr) Rev
1 PFC (Dvr) R

AN/VRC-64

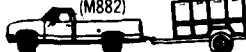

1 LT (XO) Rev
1 1SG (First SGT) R
1 SP4 (Armorer) (Dvr) R, GL



1 SSG (Supply SGT) R
1 PFC (Gen Supplyman) (Dvr) R, GL



1 SFC (Motor SGT) R
2 SGT (Pwr Gen/WVeh Mech) R
2 SP4 (Pwr Gen/WVeh Mech) R
1 SP4 (PLL Clerk) R, GL
3 PFC (Pwr Gen/WVeh Mech) (Dvr) R

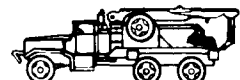

1 SP4 (Wrecker Op) R

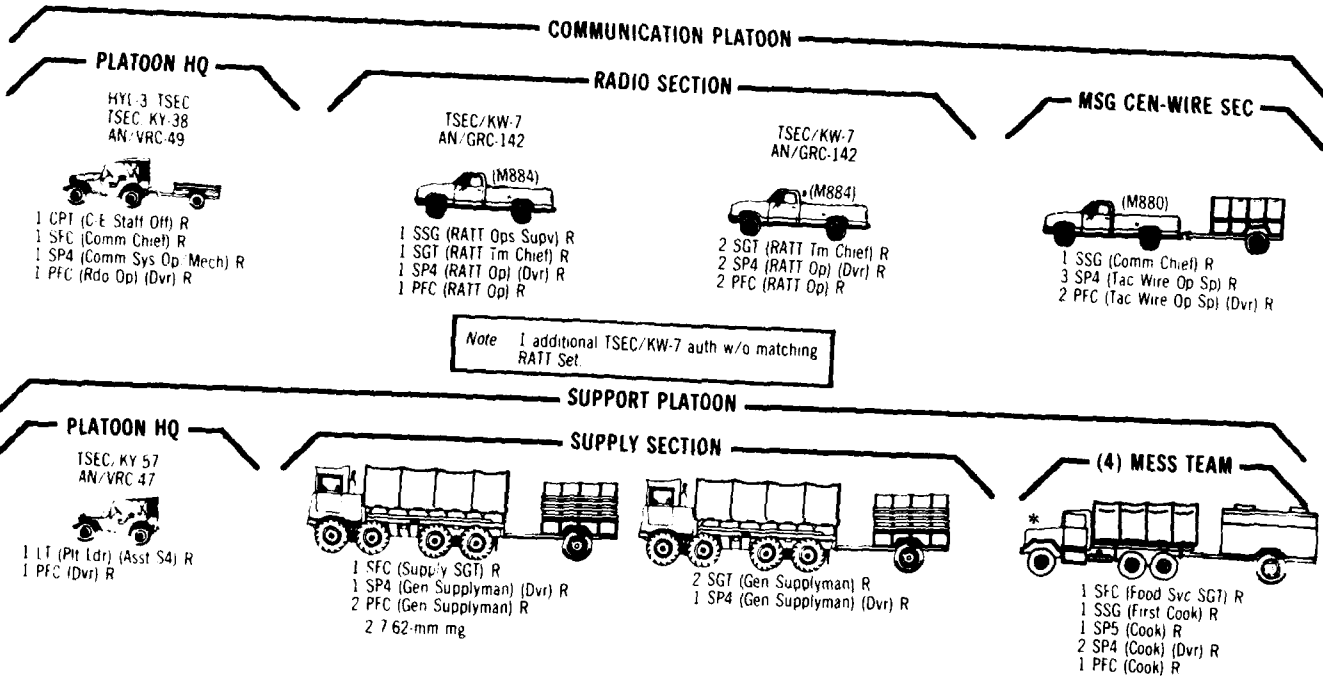

*Mounts TOE cal 50 mg on ring mount.

SQDN MEDICAL SEC



- 1 CPT (Avn Med Off) Rev
- 1 LT (Med Op Asst) R
- 1 SSG (Section SGT) R
- 2 SP4 (Med Aidman) (Dvr) R
- 3 SP4 (Troop Aidman) P



- 1 SP6 (Clinical Sp) R
- 1 SP5 (Med Aidman) R
- 6 SP5 (Troop Aidman) P
- 1 PFC (Clinical Sp) R
- 1 PFC (Ambulance Dvr) R
- 1 PFC (Med Aidman) R

FIRE SPT SEC

AN/GRA-39
AN/VRC-47

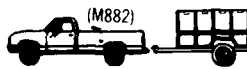

- (M882)
- 1 CPT (Fire Spt Off) R
- 1 SSG (Fire Spt SGT) R
- 1 SP4 (Fire Spt Sp) (Dvr) R
- 1 SP4 (Rdo Op) R

REDEYE SECTION

SECTION HQ

AN/GRA-39
AN/VRC-48



- 1 LT (Sec Ldr) R
- 1 SSG (Sec SGT) (Dvr) R
- 1 FAAR

(4) REDEYE TEAM

AN/GRC-160



- 1 SGT (Team Chief) P
- 1 SP4 (Redeye Gnr) (Dvr) R
- 1 FAAR

AVIATION PLATOON

PLATOON HQ

TSEC/KY-38
AN/VRC-47



- 1 CPT (Cdr) Rev
- 1 SFC (Plt SGT) R
- 1 SSG (Tech Insp) Rev
- 1 PFC (Dvr) R, GL

COMMAND AVIATION SECTION

TSEC/KY-28
TSEC/KY-58



- 1 LT (Sec Ldr) Rev
- 1 SGT (Crew Chief) Rev
- M23

TSEC/KY-28
TSEC/KY-58



- 1 WO (Instr Pilot) Rev
- 1 SGT (Crew Chief) Rev
- M23

TSEC/KY-28
TSEC/KY-58



- 1 WO (Fit Sfty Tech) Rev
- 1 SGT (Crew Chief) Rev
- M23

TSEC/KY-28
TSEC/KY-58



- 1 WO (Inst Exam) Rev
- 1 SGT (Crew Chief) Rev
- M23

AIRCRAFT MAINTENANCE SECTION



- 1 CPT (Maint Off) Rev
- 1 SSG (Sec Chief) R
- 1 SP4 (UH-1 Rpmn) (Dvr) R



- 1 SGT (UH-1 Rpmn) R
- 1 SP4 (Mat Sup Sp) (Dvr) R
- 1 SP4 (UH-1 Rpmn) R
- 1 PFC (Avionics Mech) R
- 1 PFC (UH-1 Rpmn) R

AVIATION SUPPORT SECTION

(w/Trk and Trl Mtd Fuel Unit)



- 1 SGT (Afd Service Supv) R
- 2 PFC (Actt Svcman) (Dvr) R



- 1 SGT (Actt Fuels Hldr) R
- 1 SP4 (Actt Fuels Hldr) (Dvr) R
- 3 Drum Fuel
- 1 FAAR

MISSION: To conduct by aerial means the reconnaissance and security capabilities of ground units. To engage in offensive, defensive, and degrading operations as part of a combat force.

ASSIGNMENT: Assigned to Air Cavalry Squadron TOE 17 205

FUNCTIONS: a. Perform aerial and ground reconnaissance.
 b. Provide security for the unit to which assigned or attached.

c. Accomplish aerial and ground tasks in an integrated task in support of reconnaissance and security mission.
 d. Engages in offensive, defensive, and degrading actions.
 e. Conducts chemical agent detection and radiological monitoring and survey operations, nuclear target acquisition, and nuclear damage assessment.

432

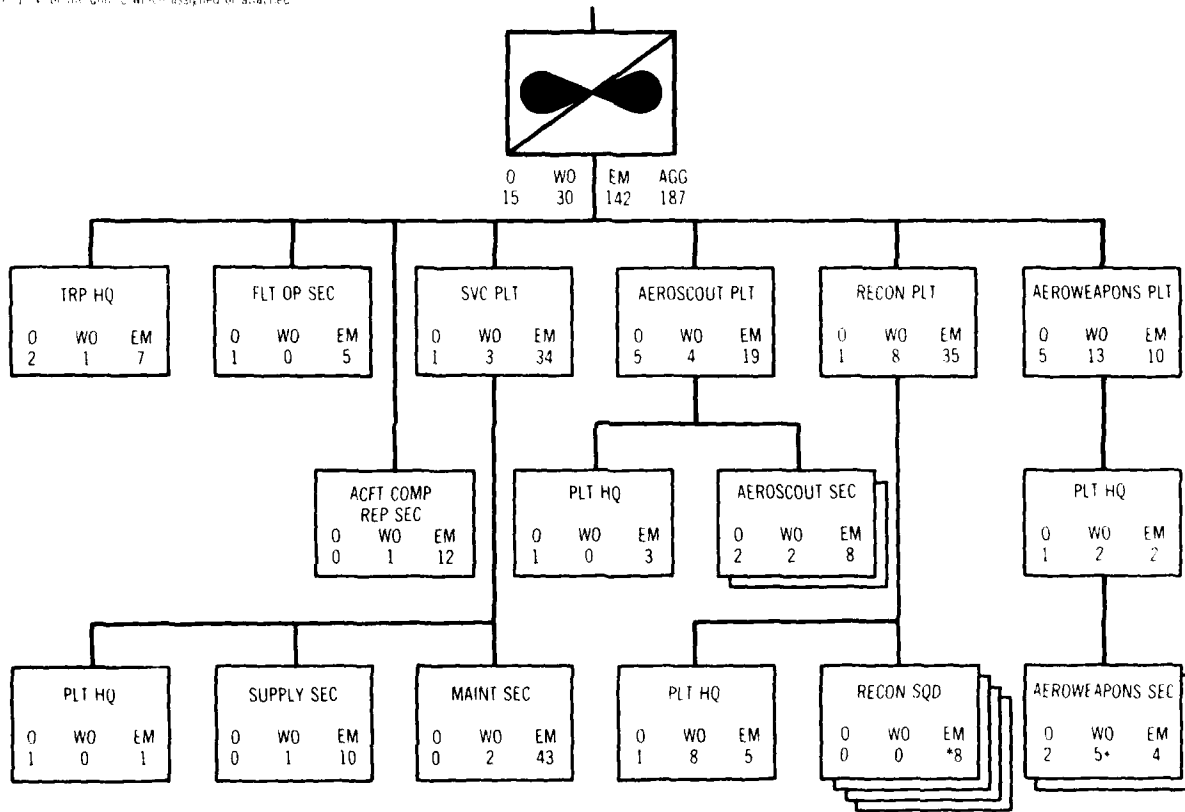

*1 Sec has additional Pilot (Examined)
 *2 Sqds have 1 less SCI

SUMMARY OF EQUIPMENT

WEAPONS	
ARMT SUBSYS TOW MISSILE	9
ARMT SUBSYS 7.62-MM MG LIGHT M23	6
ARMT SUBSYS 7.62-MM MG & 40 MM GL HIGH RATE M28A1	9
LAUNCHER GRENADE M203	16
LAUNCHER RKT 2.75-INCH 7-TUBE M158A1	18
LAUNCHER RKT 2.75-INCH 19-TUBE M200A1	10
LAUNCHER RKT 56-MM 4-TUBE M202	1
MACHINEGUN CAL .50 HB FLEX FOR GROUND USE	3
MACHINEGUN 7.62-MM LIGHT FLEX	3
MACHINEGUN 7.62-MM ACFT LIGHT DOOR MTD	12
MACHINEGUN 7.62-MM SIX BARRELS M134	9
REVOLVER CAL .38	71
RIFLE 5.56-MM	125
TRACKER BR GUIDED MSL SU-36 (DRAGON)	2

COMMUNICATION-ELECTRONICS EQUIPMENT	
RADIAC SET AN/PDR-27	1
RADIACMETER IM-93/UD	14
RADIACMETER IM-174/PD	18
RADIO SET AN/GRC-105	1
RADIO SET AN/PRC-77	14
RADIO SET AN/PRC-90	56
RADIO SET AN/VRC-47	4
RADIO SET CONTROL GROUP AN/GRA-39	1
RECEIVER-TRANSMITTER CON GP AN/GRA-6	1
SPEECH SCTY EQUIPMENT ARN TSEC/KY-57	25
SPEECH SCTY EQUIPMENT TSEC/KY-59	25
SWITCHBOARD TEL MANUAL SB-22/PT	1
TELEPHONE SET TA-1/PT	4
TELEPHONE SET TA-312/PT	10

AIRCRAFT	
HELICOPTER ATTACK AH-1S	9
HELICOPTER OBSERVATION OH-58A	10
HELICOPTER UTILITY UH-1H	7

VEHICLES AND VEHICLE EQUIPMENT	
CRANE WHEEL MTD 3-TON M63	1
TRAILER ACFT MAINT AMBL	1
TRAILER AMMO 1-1/2-TON M332	2
TRAILER CARGO 1/4-TON M416	3
TRAILER CARGO 1-1/2-TON M105A2	9
TRAILER TANK WATER 400 GAL, 1-1/2-TON	1
TRUCK CARGO 1-1/4-TON 6X6 M551	1
TRUCK CARGO 2-1/2-TON M35A2	1
TRUCK CARGO 5-TON 6X6 M813	11
TRUCK LIFTFORK, DSL DRVN 6000 LB CAP	2
TRUCK UTILITY 1/4-TON M151A2	3
TRUCK VAN SHOP 2-1/2-TON 6X6 M109A3	1
TRUCK WRECKER 5-TON 6X6 W/WN M816	1

MISCELLANEOUS EQUIPMENT	
ALARM CML AGENT AUTO PTBL F/WHEEL VEH	2
DETECTING SET MINE PTBL AN/PSS-7	1
DETECTING SET MINE PTBL AN/PSS-11	1
DRUM FABRIC COLLAPSIBLE FUEL 500-GAL	4
FORWARD AREA REFUEL EQUIP (FARE)	2
METASCOPE AN/PAS-6	5
NIGHT SIGHT INDIVIDUAL WPN AN/PVS-4	9
NIGHT VISION GOGGLES AN/PVS-5	17
TANK AND PUMP JNIT TRK MTD (1200-GAL)	2
TANK JNIT INL MTD (500-GAL)	2
VIEWER INFRARED AN/PAS-7	1

AIR CAVALRY TROOP AIR CAVALRY SQUADRON AIR CAVALRY COMBAT BRIGADE

TOE 17-208H200

TROOP HEADQUARTERS

AN VRC 47



1 MAJ (Trp Cdr) Rev
1 SP4 (Armorer) (Dvr) R

TSEC KY 57



1 CPT (XO) Rev
1 WO (Fit Sfty Tech) Rev
1 SGT (Crew Chief) Rev
1 SGT (Sct Obsr) R



1 ISG (First Sergeant) R
1 SSG (Supply SGT) R
1 SGT (NBC Ops NCO) R, GL
1 PFC (Gen Supplyman) (Dvr) R
2 SU-36

FLIGHT OPERATIONS SEC

TSEC KY 57
AN VRC 47



1 CPT (Flt Op Off) Rev
1 SP4 (Rdo Op) (Dvr) R

AN VRC 47 AN GRA 6
AN GRC 106 AN GRA 39
TSEC KY 57



1 SSG (Ops SGT) R
1 SSG (Comm Chief) R
1 SP4 (Flt Ops Sp) R, GL
1 PFC (Rdo Op) (Dvr) R

AIRCRAFT COMPONENT REPAIR SECTION



1 WO (Actt Maint Tech) Rev
1 SFC (Actt Comp Rep Supv) R
1 SP4 (Mat Supply Sp) (Dvr) R
1 SP4 (Actt Fire Ctl Rpmn) R
1 SP4 (Actt Pwrtrain Rpmn) R
1 PFC (Actt Electrician) R

1 SSG (Qual Con Supv) Rev
1 PFC (Actt Pwrtrain Rep) R
1 PFC (Actt Pwriplant Rep) (Dvr) R

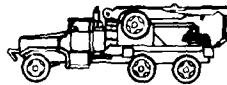

1 SP4 (Structural Rep) R
1 SP4 (Rec Veh Op) R
1 PFC (Instrc Rep) (Dvr) R



1 PFC (Pneudraulics Rep) R



434

*Note: Pers Listed Distributed on 3 5-ton Trks

AEROSCOUPT PLATOON

PLATOON HQ

TSEC KY 58
TSEC KY 57
AN PRC 77



1 CPT (Plt Cdr) Rev
1 SFC (Plt SGT) Rev
1 SGT (Scout Obsr) Rev
1 SP4 (OH Rpmn) Rev

TSEC KY 58
AN PRC 77



1 LT (Sec Cdr) Rev
1 SGT (Scout Obsr) Rev

TSEC KY 58



1 WO (Hel Pilot) Rev
1 SGT (Scout Obsr) Rev

TSEC KY 58



1 LT (Team Ldr) Rev
1 SGT (Scout Obsr) Rev

TSEC KY 58



1 WO (Hel Pilot) Rev
1 SGT (Scout Obsr) Rev

Notes 1 Platoon auth 3 SGT, 4 SP4, and 1 PFC Scout Hel Repairer
2 Each Hel equipped with 1 M16 rifle, 1 M60 mg, and 1 M203 GL

RECON PLATOON

PLATOON HQ

TSEC KY 57
2 AN PRC 77



1 CPT (Plt Cdr) Rev
1 WO (Inst Exam) Rev
1 WO (Instr Pilot) Rev
1 SFC (Plt SGT) R
1 SGT (Crew Chief) Rev
M23
M202

TSEC/KY 57
2 AN-PRC-77



2 WO (Hel Pilot) Rev
1 SGT (Crew Chief) Rev
M23

(4) RECON SQUAD

1 SSG (Squad Leader) R
2 SGT (Team Leader) R
4 SP4 (Scout) R
3 PFC (Scout) R
1 M60 mg
2 M203

4 Sgds Auth 3 SSG, 6 SGT,
12 SP4 & 9 PFC Total

AEROWEAPONS PLATOON

PLATOON HQ

TSEC KY 58
TSEC KY 57
AN-PRC 77



1 CPT (Plt Cdr) Rev
1 WO (Instr Pilot) Rev
1 SFC (Plt SGT) R
1 SGT (Crew Chief) R
1 M28A1 2 M158A1
1 M134 2 M200A1

(2) AEROWEAPONS SECTION

TSEC KY 58



1 LT (Sec Cdr) Rev
1 WO (Hel Pilot) Rev
1 M28A1 2 M158A1
1 M134 1 M200A1

TSEC KY 58



2 WO (Hel Pilot) Rev
1 M28A1 2 M158A1
1 M134 1 M200A1

TSEC KY-58



1 LT (Team Ldr) Rev
1 WO (Hel Pilot) Rev
1 M28A1 2 M158A1
1 M134 1 M200A1

TSEC KY 58



2 WO (Hel Pilot) Rev
1 M28A1 2 M158A1
1 M134 1 M200A1

Notes
1 One sec has 1 WO Inst Exam in lieu of 1 WO Pilot
2 2 SGT, 2 SP4, and 3 PFC Atk Hel Repairer shared by the 2 sections
3 One sec has two Instr Pilot from Plt HQ

SERVICE PLATOON

PLATOON HQ AND MAINTENANCE SECTION

TSEC KY 58
TSEC KY 57
AN VRC 47



1 CPT (Plt Ldr) Rev
1 SFC (Plt SGT) R
1 PFC (Pwr Gen/WVeh Mech) (Dvr) R

(5-Ton)



1 SSG (Motor SGT) R
1 SGT (Pwr Gen WVeh Mech) R
1 SP4 (PLL Clerk) R

(5-Ton)



1 SSG (Hel Wpn Sys Supv) R
2 SGT (Hel Wpn Sys Rpmn) R
1 SGT (Hel Fire Ctl Rpmn) R
2 SP4 (Hel Wpn Sys Rpmn) R
2 SP4 (UH-1 Rpmn) R
1 SP4 (Pwr Gen WVeh Mech) (Dvr) R
1 SP4 (Hel Fire Ctl Rpmn) R
2 PFC (Hel Fire Ctl Rpmn) R
2 PFC (Hel Wpn Sys Rpmn) R

(5-Ton)



2 SSG (UH Tech Insp) Rev
2 SSG (OH Tech Insp) Rev
2 SSG (AH Tech Insp) Rev
1 SP5 (Mat Supply Spl) R
1 SP4 (Mat Supplyman) R
2 PFC (UH-1 Rpmn) (Dvr) R

2 SGT (OH-1 Rpmn) R
2 SGT (AH Rpmn) R
2 SP4 (AH Rpmn) R
1 SP4 (OH Rpmn) R
1 PFC (AH Rpmn) (Dvr) R
1 PFC (Pwr Gen WVeh Mech) R

TSEC KY-28



1 WO (Acft Repair Tech) Rev
1 WO (Hel Pilot) Rev
1 SGT (Crew Chief) Rev
M23

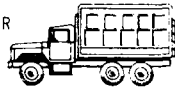

1 SP5 (Sr Avionics Mech) R
1 SP4 (Comm Sys Op Mach) (Dvr) R
1 PFC (Avionics Mech) R
2 PFC (Mat Supply Sp) R

SUPPLY SECTION

2 AN PRC 77 2 TSEC KY-57
TSEC KY-58



1 WO (Pilot) Rev
1 SGT (Crew Chief) Rev
M23

(5-Ton)



1 SGT (Aid Svc Supv) R
2 PFC (Aid Svc Crmn) (Dvr) R

(5-Ton w/Trk & Tri
Mtd Fuel Units)



1 SGT (Acft Fuels Hdlr) R
1 SP4 (Acft Fuels Hdlr) (Dvr) R
1 FARE

(5-Ton w/Trk & Tri
Mtd Fuel Units)



1 SP4 (Acft Fuels Hdlr) (Dvr) R
1 PFC (Acft Fuels Hdlr) R
6 Drum Fuel 500-gal
1 FARE

Note Truck Lift Fork, Dsl Drvn 6,000-lb. Cap Rough Terrain

(5-Ton)



1 SP4 (Ammo Spl) (Dvr) R

*Mounts TOE cal 50 mg on ring mount

Notes:

[Faint, illegible text, possibly bleed-through from the reverse side of the page]

1. A manual telephone central office facility and a local telephone terminal facility.
 2. FM radio, VSB radio, and radio teletypewriter broadcast central office facility.
 3. FM radio stations for radio wire integration, RWI, and transmission to the ground.
 4. Army FM retransmission capability.
 5. A computerized center displacement capability for the brigade headquarters.
 6. Direct support COMSEC systems for the brigade.

1. A manual telephone central office facility and a local telephone terminal facility.
 2. FM radio, VSB radio, and radio teletypewriter broadcast central office facility.
 3. FM radio stations for radio wire integration, RWI, and transmission to the ground.
 4. Army FM retransmission capability.
 5. A computerized center displacement capability for the brigade headquarters.
 6. Direct support COMSEC systems for the brigade.

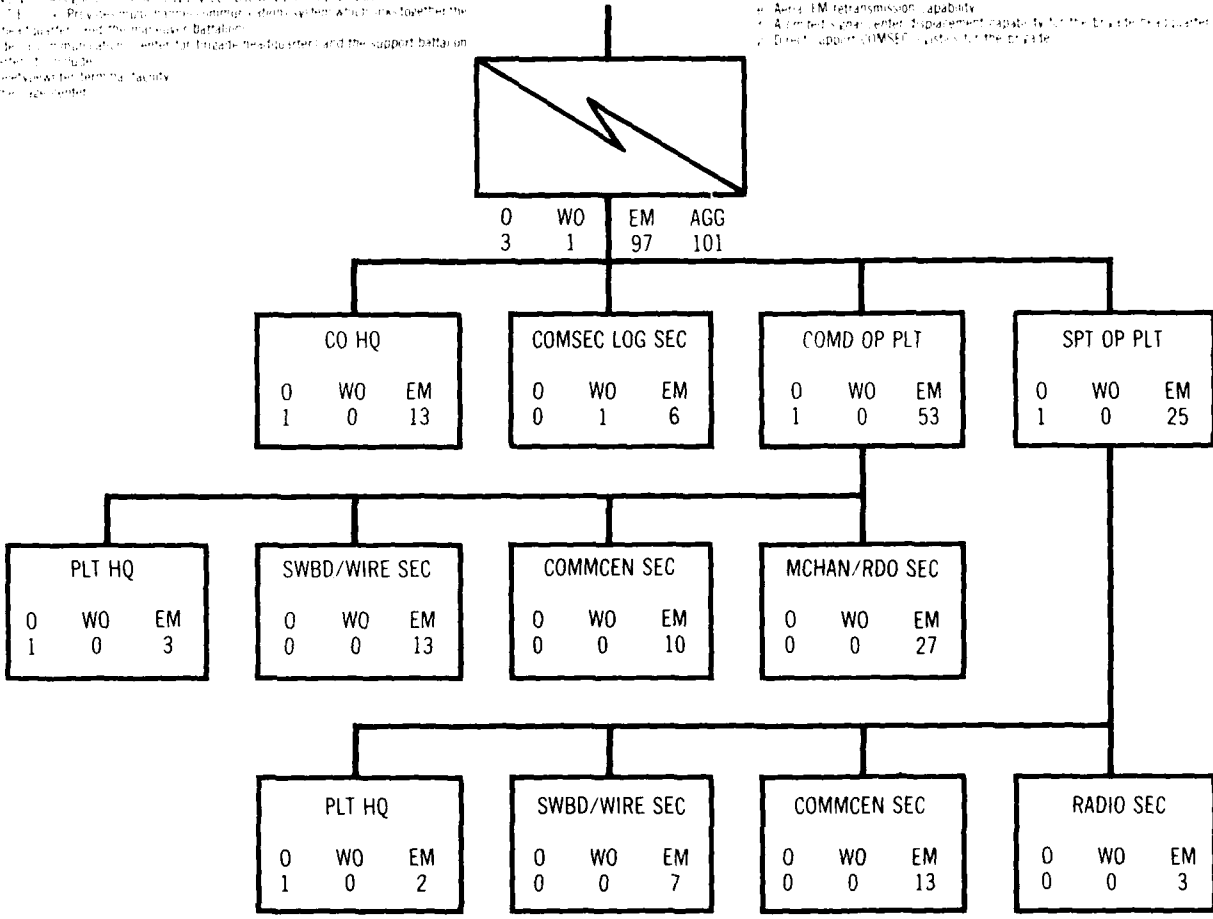

COMPANY HEADQUARTERS

1 CPT	Company Cdr	11
1 SSC	First SGT	10
1 SSG	Maint Recovery Supv	
1 SSG	Supply SGT	
1 SGT	Lt Wveh/Pwr Gen Mech	
1 SGT	NBC Op NCO	
1 SP5	Unit Clerk	97
1 SP4	Armorer	
1 SP4	Bq Rec & Pts Sp	
1 SP4	Lt Wveh/Pwr Gen Mech	
1 PFC	Cook	
1 PFC	Lt Veh Dvr	96
1 PFC	Gen Supplyman	01
1 PFC	Lt Wveh/Pwr Gen Mech	01
Machgun 7.62-mm		1
Radio Set AN/VRC-46		2
Speech Scty Bq TSEC/RV-38		1
Trailer Cargo 1/4-Ton		1
Trailer Cargo 1-1/2-Ton		1
Truck Cargo 1-1/4-Ton		1
Truck Cargo 2-1/2-Ton W/WN		1
Truck Utility 1/4-Ton		1

COMSEC LOG SEC

1 WO	COMSEC Bq Rep Tech	
1 SGT	Cryptomat NCO	
1 SP5	Fld Gen COMSEC Sp	
1 SP5	Fld Sys COMSEC Rplan	01
1 SP4	Telecomm Cen Op	
2 PFC	Fld Gen COMSEC Rep Sp	
Elec Shop	Avionics AN/ASM-146	1
Radio Set AN/VRC-64		2
Teletypewriter AN/UGC-75 (V)3		1
Teletypewriter TT-76/GOC		1
TT Scty Equip TSEC/RV-7		1
Terminal Telegraph TH-22/TR		2
Truck Cargo 1-1/4-Ton		1
Truck Cargo 2-1/2-Ton		1

COMMAND OP PLT HQ

1 LT	Platoon Leader	
1 SFC	Platoon SGT	
1 SGT	Pwr Gen/Wveh Mech	01
1 PFC	Pwr Gen/Wveh Mech	01
Radio Set AN/VRC-46		1
Radio Set Con Op AN/GRA-19		1
Truck Cargo 1-1/4-Ton		1

SHRD/WIRE SECTION

1 SSG	Section Chief	
3 SGT	Wire Sys Team Chief	
6 SP4	Wire Sys Inst/Op	
3 PFC	Wire Sys Inst/Op	01
Tel. Cen Ofc Auto AN/TTC-41 (V)2		1
Truck Cargo 1-1/4-Ton 4x4 W/Comm		1
Shelter		1
Truck Utility 1-1/4-Ton 6X6 W/E..		1

COMPCEN SECTION

1 SSG	Telecomm Cen Supv	
1 SGT	Cryptomat NCO	
1 SGT	RATT Team Chief	A4
3 SP4	Telecomm Cen Sp	01
1 SP4	RATT Op	01
1 PFC	RATT Op	
2 PFC	Telecomm Cen Op	
Radio TT Set AN/GRC-142		1
Teletypewriter AN/TTC-30		1
TT Scty Equip TSEC/RV-7		3
Truck Cargo 1-1/4-Ton		2

MCHMN/RADIO SECTION

1 SSG	Section Chief	
5 SGT	Mchan Comm Tm Chief	
2 SGT	Ch Rdo Op/Supv	
4 SP4	Radio Op	01

1 SP4	Comm Sys Op/Mech	
5 SP4	Sr Mchan Comm Bq Op	
4 PFC	Radio Op	99
5 PFC	Mchan Comm Bq Op	01
Control Rdo Set AN/GSA-7		1
Radio Set AN/GRC-106		1
Radio Set AN/VRC-46		6
Radio Set AN/VRC-49		2
Radio Set Con Op AN/GRA-39		6
Radio Terminal Set AN/MRC-127		5
Receiver-Trans Con Op AN/GRA-6		2
Speech Scty Bq TSEC/RV-38		8
Truck Cargo 1-1/4-Ton		2
Truck Platform (MULE) 1/2-Ton		1
Truck Utility 1/4-Ton		5

SPT OP PLT HQ

1 LT	Platoon Leader	
1 SFC	Platoon SGT	
1 SP4	Pwr Gen/Wveh Mech	01
Radio Set AN/VRC-46		1
Radio Set Con Op AN/GRA-39		1
Truck Cargo 1-1/4-Ton		1

SHRD/WIRE SECTION

2 SGT	Wire Sys Tm Ch	
3 SP4	Wire Sys Inst/Op	
2 PFC	Wire Sys Inst/Op	01
Cen Ofc Tel Man AN/TTC-29		1
Truck Cargo 1-1/4-Ton		2

COMPCEN SECTION

1 SSG	Telecomm Cen Supv	
1 SGT	ADP Terminal Supv	
1 SGT	RATT Team Chief	
1 SGT	Cryptomat NCO	
1 SP5	Sr ADP Machine Op	

1 SP4	ADP Machine Op	
2 SP4	ADP Terminal Op	01
2 SP4	Telecomm Cen Op	
1 SP4	RATT Op	01
1 PFC	Telecomm Cen Op	
1 PFC	RATT Op	
Radio TT Set AN/GRC-142		1
TT Scty Equip TSEC/RV-7		2
Elec Key Gen: TSEC/RG-10-1		2
Comm Terminal: AN/UGC-74A (V)3		1
Terminal Tel-Tel AN/TTC-29		1
Transceiver Sta HI Spd Relay		1
Truck Cargo 1-1/4-Ton		1
Truck Cargo 2-1/2-Ton		2

RADIO SECTION

1 SGT	Ch Rdo Op/Supv	01
1 SP4	Radio Op	
1 PFC	Radio Op	
Radio Set AN/GRC-106		1
Radio Set AN/VRC-46		1
Radio Set Con Op AN/GRA-39		1
Receiver-Trans Con Op AN/GRA-6		1
Speech Scty Bq TSEC/RV-38		1
Truck Cargo 1-1/4-Ton		1

REMARKS:

- All personnel armed with rifle 5.56-mm unless otherwise indicated.
- 01 Also light vehicle driver
- 10 Also career CSLR
- 11 Armed with pistol cal .45.
- 96 Also RDO Op
- 97 Also SB Op
- 99 One operator for aerial retrans station.

**SIGNAL OPERATIONS COMPANY
AIR CAVALRY COMBAT BRIGADE**

* Provide maintenance support for all equipment except aircraft (AMSE)
 * Provide maintenance support for all equipment except aircraft (AMSE)
 * Provide maintenance support for all equipment except aircraft (AMSE)
 * Provide maintenance support for all equipment except aircraft (AMSE)

* Provide maintenance support for all equipment except aircraft (AMSE)
 * Provide maintenance support for all equipment except aircraft (AMSE)
 * Provide maintenance support for all equipment except aircraft (AMSE)
 * Provide maintenance support for all equipment except aircraft (AMSE)

440

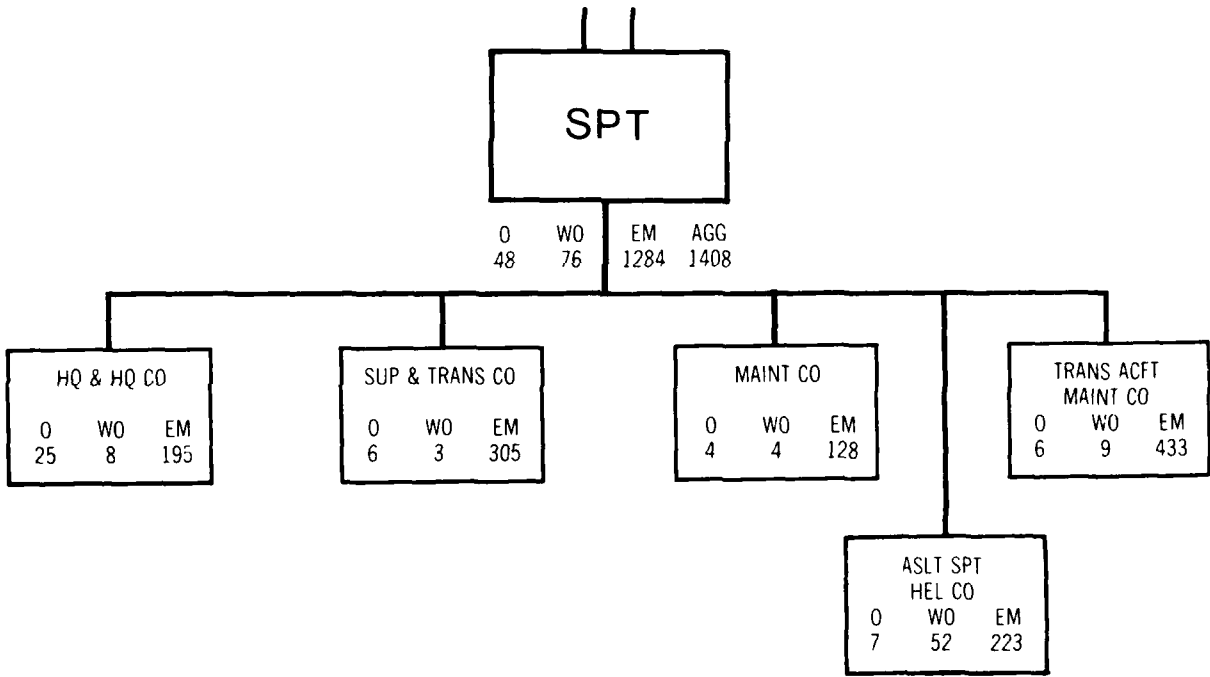

SUMMARY OF EQUIPMENT

MAINT	
ARMT CURBS 7.62-MM MG LIGHT M21	3
ARMT CURBS 7.62-MM MG TORR M7	24
LAUNCHER GRENADE M303	17
MACHINEGUN 7.62-MM ACPT LIGHT TORR M7	52
MACHINEGUN 7.62-MM PLEX	28
PISTOL CAL 45	7
REVOLVER CAL 38	102
RIFLE 5.56-MM	1214

SHOP SET AVIATION INTER MAINT: TOOL CRTB AMBUL	1
SHOP SET AVIATION INTER MAINT: TURBINE ENG AMBUL	1
TRACTOR FUEL TRUCK LOW SPEED	1
TRACTOR WHEELED ACPT TOWING	2
TRACTOR WHEELED WAREHOUSE 4000-LB	3
TRAILER ACFT MAINT AMBUL	8
TRAILER CARGO 1/4-TON M416	23
TRAILER CARGO 1-1/2-TON M105A2	15
TRAILER TANK WATER 400-GAL M149A1	47
TRUCK AMBULANCE TAC 1-1/4-TON 4X4 M88A	4
TRUCK CARGO TAC 1-1/4-TON 4X4 M88B	26
TRUCK CARGO TAC 1-1/4-TON 4X4 W/50 AMP COMP KIT M882	4
TRUCK CARGO TAC 1-1/4-TON 4X4 W/100 AMP COMP TRKTR KIT	1
TRUCK CARGO 2-1/2-TON M35A2	13
TRUCK CARGO 2-1/2-TON M35A2	4
TRUCK CARGO DROPSIDE 2-1/2-TON M5A7C	2
TRUCK CARGO 2-1/2-TON 6X6 JELAB M2	1
TRUCK CARGO 5-TON 6X6 M813	6
TRUCK CARGO DROPSIDE 5-TON 6X6 M813A1	13
TRUCK CARGO DROPSIDE 5-TON 6X6 M813A1	1
TRUCK CARGO 8-TON 4X4 M520	1
TRUCK DUMP 5-TON M817	9
TRUCK LIFT FORK 4000-LB CAP	21
TRUCK LIFT FORK 10000-LB CAP	3
TRUCK TANK FUEL SVC 500-GAL 4X4 M958	1
TRUCK TRACTOR 5-TON M818	46
TRUCK TRACTOR 5-TON 6X6	46
TRUCK TRACTOR 5-TON M919M	1
TRUCK TRACTOR 10-TON W/WIDESP W812A1C	1
TRUCK TRACTOR WRECKER 5-TON M919	2
TRUCK UTILITY 1/4-TON M151A2	10
TRUCK VAN EXPANDIBLE 5-TON M820	2
TRUCK VAN SHOP 2-1/2-TON 4X4 M109A3	9
TRUCK WRECKER 5-TON 6X6 M916	2

COMMUNICATION-ELECTRONICS EQUIPMENT	
ELECTRONIC SHOP SEMI TRL MTD AM/ASH-189	7
ELECTRONIC SHOP SEMI TRL MTD AM/ASH-190	2
RADIO SET AM/PRC-27	7
RADIOSET DM-93/UD	21
RADIOSET AM/PRC-140	18
RADIO SET AM/PRC-77	11
RADIO SET AM/PRC-90	41
RADIO SET AM/PRC-46	12
RADIO SET AM/PRC-47	4
RADIO SET CONTROL GROUP AM/COM-18	8
SPEECH SCTY EQUIPMENT TSEC/RY-47	41
SPEECH SCTY EQUIPMENT 2MW RED: TSEC/RY-58	27
SYNCHRONOUS TEL MANUAL SR-27/PT	7
TELEPHONE SET TR-112/PT	69

VEHICLES AND VEHICLE EQUIPMENT	
CRANE WHEEL MTD 3-TON M61	4
CRANE WHEEL MTD 5-TON	1
LOADER STUMP TYER 2-1/2-TON 4-WHEEL	2
SEMITRAILER LOW BED: BRP PULK/CONT TRAPER 22-1/2-TON	4
SEMITRAILER LOW BED: 26-TON 4 WHEEL	6
SEMITRAILER TANK FUEL SVC 4000-GAL 4 WHEEL	4
SEMITRAILER VAN CARGO 4-TON 2 WHEEL	1
SEMITRAILER VAN EXPANS 4-TON 4 WHEEL	3
SEMITRAILER VAN REPAIR PARTS STOR 4-TON 4 WHEEL	3
SEMITRAILER VAN SUPPLY 12-TON 4 WHEEL	10
SHOP TO STANDBY MAINT CRU MTD	3
SHOP EQ ELIC REPAIR SEMI TRL MTD	1
SHOP SET AVIATION INTER MAINT: ELAC INSTR AMBUL	1
SHOP SET AVIATION INTER MAINT: MACH SHOP AMBUL	1
SHOP SET AVIATION INTER MAINT: RAC TRAIN AMBUL	1
SHOP SET AVIATION INTER MAINT: ROTOR AMBUL	1
SHOP SET AVIATION INTER MAINT: SHEET METAL AMBUL	1

AIRCRAFT	
HELICOPTER CARGO TRANSP: OH-47C	24
HELICOPTER UTILITY UH-1H	1

MISCELLANEOUS EQUIPMENT	
ALARM CHL AGENT AUTO FTBL MANPACK	1
ALARM CHL AGENT AUTO FTBL FIXED	8
ALARM CHL AGENT AUTO FTBL F/WHEEL VEH	1
DETECTING SET HIDE FTBL AM/PSS-1	3
DETECTING SET HIDE FTBL AM/PSS-11	4
DRUM FABRIC COLLAPSIBLE FUEL 500-GAL	21
FORWARD AREA RESPL EQUIP (FANE)	1
FUEL SYS SUPPLY FT FTBL	1
NIGHT SIGHT INDIVIDUAL VEH AM/PSS-4	6
TANK AND PUMP UNIT TRU MTD (1200-GAL)	10
TANK FABRIC COLLAPSIBLE FUEL 10,000-GAL	18
TANK FABRIC COLLAPSIBLE: PETRO 3000-GAL	6
TANK UNIT TRU MTD (400-GAL)	10

SUPPORT BATTALION
AIR CAVALRY COMBAT BRIGADE

FORM 29-1558(4/61)

Miss (A) ...
 Army (MSE) ...
 ...
 ...

- 1. Determine requirements for equipment and direct the receipt, temporary storage and distribution of supplies and equipment received by the Brigade, including the MSE and unit TAG map.
- 2. Maintain a brigade ammunition stockpile for the management of ammunition receipt.
- 3. Provide operations support for the Brigade's function in the supply chain, 24-hour basis.
- 4. Provide medical and dental services to the brigade.
- 5. Provide unit level medical support for the battalion.
- 6. Provide patient and casualty support for brigade operations.

442

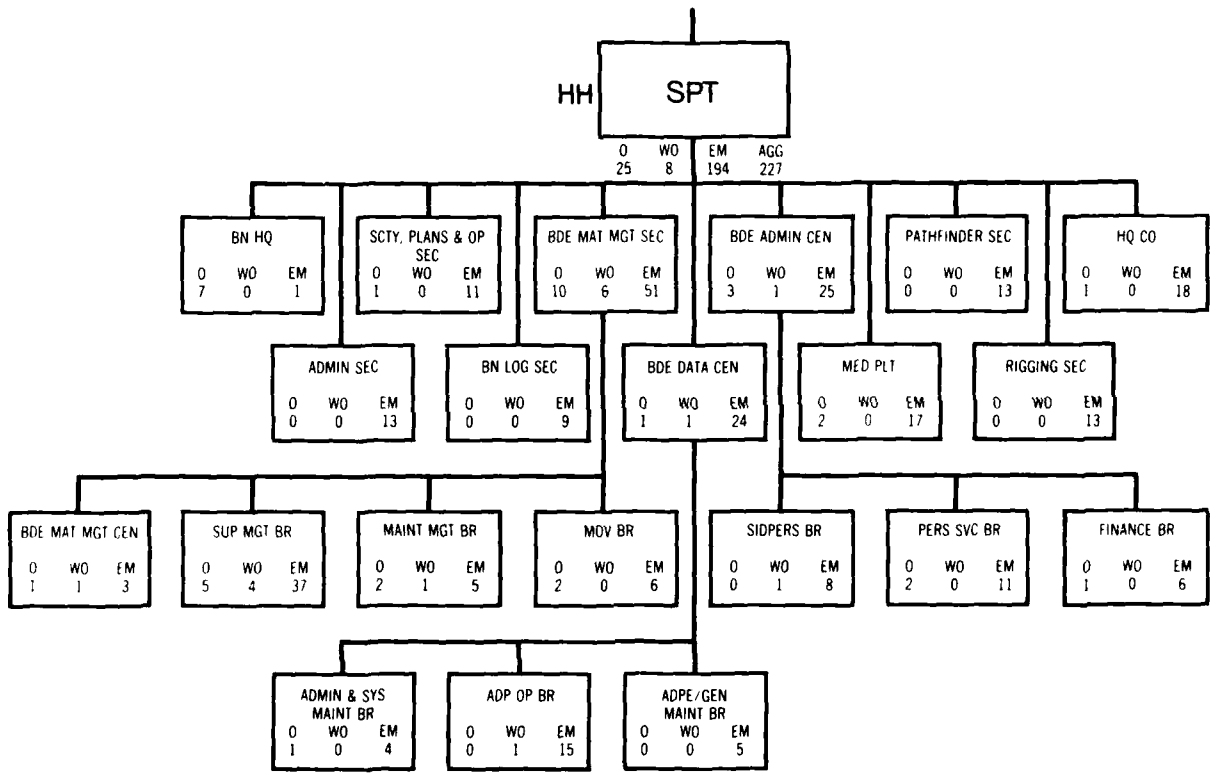

BATTALION HEADQUARTERS

- 1 LTC Battalion Cdr 16
- 1 MAJ XO 16
- 1 MAJ Scty/Plans-Op Off 11
- 1 CPT Logistics Off
- 1 CPT Chaplain
- 1 CPT Motor Off
- 1 CPT Personnel Staff Off
- 1 CSM Command Sergeant Major

HEADQUARTERS COMPANY

- 1 CPT Company Cdr 11
- 1 SSC First SGT
- 1 SSC Food Svc SGT
- 1 SSC First Cook
- 1 SSC Motor SGT
- 1 SSC Supply SGT
- 1 SGT Pwr Gen/Veh Mech
- 1 SPS Cook
- 1 SPS Armorer
- 1 SPM Eq Rec & Pts Sp
- 2 SPM Pwr Gen/Veh Mech
- 1 SPM PTL Clerk
- 1 PFC Cook
- 1 PFC Supply Clerk
- 2 PFC Pwr Gen/Veh Mech 01
- Machine Gun 7.62-mm 4
- Trailer Cargo 1/4-Ton 1
- Trailer Tank Meter 400-Gal 1
- Truck Cargo Tac 1-1/4-Ton 1
- Truck Cargo 2-1/2-Ton M/MN 1

ADMINISTRATION SEC

- 1 SPC PAC Supervisor
- 1 SSC Reenlistment NCO
- 1 SSC Personnel Staff NCO
- 1 SPS Admin Sp
- 1 SPS Legal Clerk
- 1 SPS PAC Clerk
- 1 SPM Chapel Act Sp
- 1 SPM Clerk Typist
- 1 SPM PAC Clerk
- 2 PFC PAC Clerk
- 2 PFC Lt Veh Dvr
- Radio Set AN/VRC-47 1
- Speech Scty Eq TSBC/NY-57 2
- Trailer Cargo 1/4-Ton 2
- Trailer Cargo 1/4-Ton 1
- Truck Cargo Tac 1-1/4-Ton 1
- Truck Utility 1/4-Ton 2

SCTY/PLANS-OP SEC

- 1 CPT Asst Scty/Plans-Op Off
- 1 NCO Opns SGT
- 1 SPC Acft Maint SGT
- 1 SPC Intel-Scty SGT

- 1 SPC Maint Opns SGT
- 1 SSC Supply-Service Op SGT
- 1 NCO Op/Staff NCO
- 1 SGT Ch Rdo Op/Supv
- 1 SPM Clerk Typist
- 1 SPM Radio Op
- 1 PFC Lt Veh Dvr
- 1 PFC Radio Op
- Radio Set AN/VRC-46 2
- Radio Set Con Op AN/GRA-39 2
- Speech Scty Eq TSBC/NY-57 2
- Trailer Cargo 1/4-Ton 1
- Trailer Cargo 3/4-Ton 1
- Truck Cargo Tac 1-1/4-Ton 1
- Truck Utility 1/4-Ton 1

BATTALION LOGISTICS SEC

- 1 SPC Bn Motor SGT
- 1 SGT Bn Supply SGT
- 1 SPM Supply Sp
- 1 SPM Clerk Typist
- 1 SPM Supply ACTG Clerk 01
- 2 PFC Supply ACTG Clerk
- Trailer Cargo 1/4-Ton 1
- Trailer Cargo 1-1/2-Ton 1
- Truck Cargo 2-1/2-Ton 1
- Truck Utility 1/4-Ton 1

BDE MATERIEL MGT CEN

- 1 MAJ Bde Mat Mgt Off 11
- 1 WO Food Service Tech
- 1 SGM Bde Mat Mgt NCO
- 1 MSG Food Svc Supv
- 1 SPM Clerk Typist
- Radio Set AN/VRC-46 01
- Radio Set Con Op AN/GRA-39 1
- Speech Security Equip: TSBC/NY-57 1
- Truck Utility 1/4-Ton 1

SUPPLY MGT BRANCH

- 1 CPT Bde Ammo Supply Off
- 1 CPT Bde Supply Mgt Off
- 1 CPT Bde Petrl Supply Off
- 1 CPT Bde Property Book Off
- 1 CPT Supply Sys Off
- 1 WO Ammo Supply Tech
- 1 WO Supply Tech
- 1 MSG Chief Supply NCO
- 1 SPC Chief Ammo Clerk
- 1 SPC Petrl Supply SGT
- 1 SPC Supply NCO
- 5 SSC Mat CTL & Actg SGT
- 1 SSC Subsistence Supply SGT
- 3 SSC Supply Actg NCO
- 1 SPS Admin Sp
- 1 SPS Mat CTL & Actg Sp

- 2 SPS Mat Supply Sp
- 2 SPS Sr Ammo Records Clerk
- 1 SPM Ammo Records Clerk
- 4 SPM Clerk Typist
- 4 SPM Mat CTL & Actg Sp
- 1 SPM Petrl Supply Sp
- 1 SPM Mat CTL & Actg Sp
- 1 PFC Reports Clerk 01
- Radio Set AN/GRC-160 01
- Speech Sec Equip: TSBC/NY-57 1
- Truck Utility 1/4-Ton 1
- Truck Van Expansible 5-Ton 1

MAINTENANCE MGT BR

- 1 CPT Bde Maint Mgt Off
- 1 CPT Mechanical Maint Off
- 1 WO C-E Repair Tech
- 1 NCO Op SGT
- 1 SPC Acft Comp Rep Tech Adv
- 1 SPC Asst Maint Op SGT
- 1 SPM Clerk Typist 01
- Radio Set AN/GRC-160 1
- Speech Sec Equip: TSBC/NY-57 1
- Trailer Cargo 1/4-Ton 1
- Truck Cargo Tac 1-1/4-Ton 1
- Truck Utility 1/4-Ton 1

MOVEMENTS BRANCH

- 1 CPT Movements Con Off
- 1 LT Asst Mov Con Off
- 1 SPC Movements Supv
- 2 SSC Asst Mov Supv
- 1 SPM Movements Sp
- 2 PFC Movements Sp 01
- Radio Set AN/PAC-77 2
- Radio Set AN/VRC-47 1
- Radio Set Con Op AN/GRA-39 1
- Speech Scty Eq TSBC/NY-57 4
- Truck Utility 1/4-Ton 1

SEE DATA CENTER

ADMIN/STG MAINT BR

- 1 CPT ADP Off (POH)
- 1 MSG Data Processing NCO
- 1 SPS Programmer
- 1 SPS Sys Analyst
- 1 SPM Clerk Typist 01
- Truck Cargo Tac 1-1/4-Ton 1

ADP OPERATIONS BRANCH

- 1 WO Data Processing Tech
- 1 SPC Machine Op Supv
- 1 SSC Machine Op
- 1 SPS I/O Control Clerk
- 3 SPS Machine Op
- 1 SPM I/O Control Clerk
- 3 SPM Machine Op
- 3 PFC Machine Op
- Semitrailer Van Cargo 6-Ton 1
- Semitrailer Van Exp 6-Ton 1
- Truck Tractor 5-Ton 1

ADPR/GEN MAINT BR

- 1 SPC UNIVAC 1005 Rpm
- 1 SPS UNIVAC 1005 Rpm
- 1 SPM Pwr Gen Mech 01
- 1 SPM Refrigeration Sp
- 1 PFC Pwr Gen Mech
- Truck Van Shop 2-1/2-Ton 1

BDE ADMIN CENTER

ADRS INTERFACE BR

- 1 WO ADRS Tech
- 1 SSC Pers Data Anal Supv
- 1 SPS Admin Sp
- 2 SPS Data Analyst
- 1 SPS Sys Analyst
- 1 SPM Clerk Typist 01
- 1 SPM Data Analyst
- Trailer Cargo 1/4-Ton 1
- Truck Utility 1/4-Ton 1
- Truck Van Expansible 5-Ton 1

PERSS SERVICES BRANCH

- 1 CPT Adjutant General
- 1 SPC Pers Mgmt Off
- 1 SGT Personnel SGT
- 1 SSC Admin Supv
- 1 SSC Pers Action Supv
- 1 SSC Postal NCO
- 1 SPS Admin Sp
- 1 SPS Sr Pers Mgmt Sp
- 1 SPS Sr Postal Clerk
- 1 SPM Pers Actions Sp
- 1 PFC Asst Pers Mgmt Sp
- 1 PFC Pers Actions Sp
- 1 PFC Pers Mgmt Sp

FINANCE BRANCH

- 1 CPT Finance Off
- 1 SSC Pay Supv
- 1 SSC Data Anal Supv
- 1 SPS Cashier 11
- 1 SPS Data Anal Sp
- 1 SPS Travel Sp
- 1 SPM Pay Sp
- Trailer Cargo 1/4-Ton 1
- Truck Utility 1/4-Ton 1

MEDICAL PLATOON

- 1 CPT Commander 16
- 1 CPT Gen Med Off 11
- 1 SPC Platoon SGT
- 1 SPM Practical Nurse
- 2 SPM Med Aidman
- 2 SPS X-ray Sp
- 2 SPM Med Aidman
- 1 SPM Med Lab Sp

- 1 PFC Ambulance Dvr
- 3 PFC Ambulance Attendant
- 2 PFC Med Aidman
- 1 PFC Patient Care Sp
- Radio Set AN/PAC-46
- Trailer Cargo 1/4-Ton
- Trailer Cargo 1-1/2-Ton
- Truck Ambulance Van 1-1/4-Ton
- Truck Cargo 2-1/2-Ton
- Truck Utility 1/4-Ton

BDE PATHFINDER SEC

- 1 SPC Section SGT
- 1 SSC Team Leader
- 1 SGT Team Leader
- 1 SPM Sr Pathfinder
- 1 SPM Pathfinder
- Radio Set AN/PAC-77 9
- Speech Sec Equip: TSBC/NY-57 4

BDE RIGGING SGT

- 1 SPC Chief Hel Rigging Adv
- 1 SSC Hel Rigging Adv
- 1 SGT Hel Rigging Adv
- 1 SPM Ammo Rigging Adv
- 3 SPM Ammo Rigger
- 1 SPM Petrl Rigger
- 2 PFC Asst Ammo Rigger
- 1 PFC Asst Petrl Rigger
- Trailer Cargo 1/4-Ton 2
- Truck Cargo Tac 1-1/4-Ton 2

REMARKS:

- All personnel armed with rifle 5.56-mm unless otherwise indicated.
- 01 Also light vehicle driver.
- 02 Also heavy vehicle driver.
- 11 Armed with pistol cal .45.
- 16 Armed with revolver cal .38.

**HEADQUARTERS AND HEADQUARTERS COMPANY
SUPPORT BATTALION
AIR CAVALRY COMBAT BRIGADE**

1. Based on the present situation, the personnel strength of the brigade is 450 (NMI).
 2. The present strength of the support battery is Air Cavalry Combat Brigade (ACB) 20, 255.
 3. The present strength of the support battery is 100 (NMI) and 100 (NMI) support.
 4. The present strength of the support battery is 100 (NMI) and 100 (NMI) support.
 5. The present strength of the support battery is 100 (NMI) and 100 (NMI) support.
 6. The present strength of the support battery is 100 (NMI) and 100 (NMI) support.
 7. The present strength of the support battery is 100 (NMI) and 100 (NMI) support.
 8. The present strength of the support battery is 100 (NMI) and 100 (NMI) support.
 9. The present strength of the support battery is 100 (NMI) and 100 (NMI) support.
 10. The present strength of the support battery is 100 (NMI) and 100 (NMI) support.

1. Based on the present situation, the personnel strength of the brigade is 450 (NMI).
 2. The present strength of the support battery is Air Cavalry Combat Brigade (ACB) 20, 255.
 3. The present strength of the support battery is 100 (NMI) and 100 (NMI) support.
 4. The present strength of the support battery is 100 (NMI) and 100 (NMI) support.
 5. The present strength of the support battery is 100 (NMI) and 100 (NMI) support.
 6. The present strength of the support battery is 100 (NMI) and 100 (NMI) support.
 7. The present strength of the support battery is 100 (NMI) and 100 (NMI) support.
 8. The present strength of the support battery is 100 (NMI) and 100 (NMI) support.
 9. The present strength of the support battery is 100 (NMI) and 100 (NMI) support.
 10. The present strength of the support battery is 100 (NMI) and 100 (NMI) support.

444

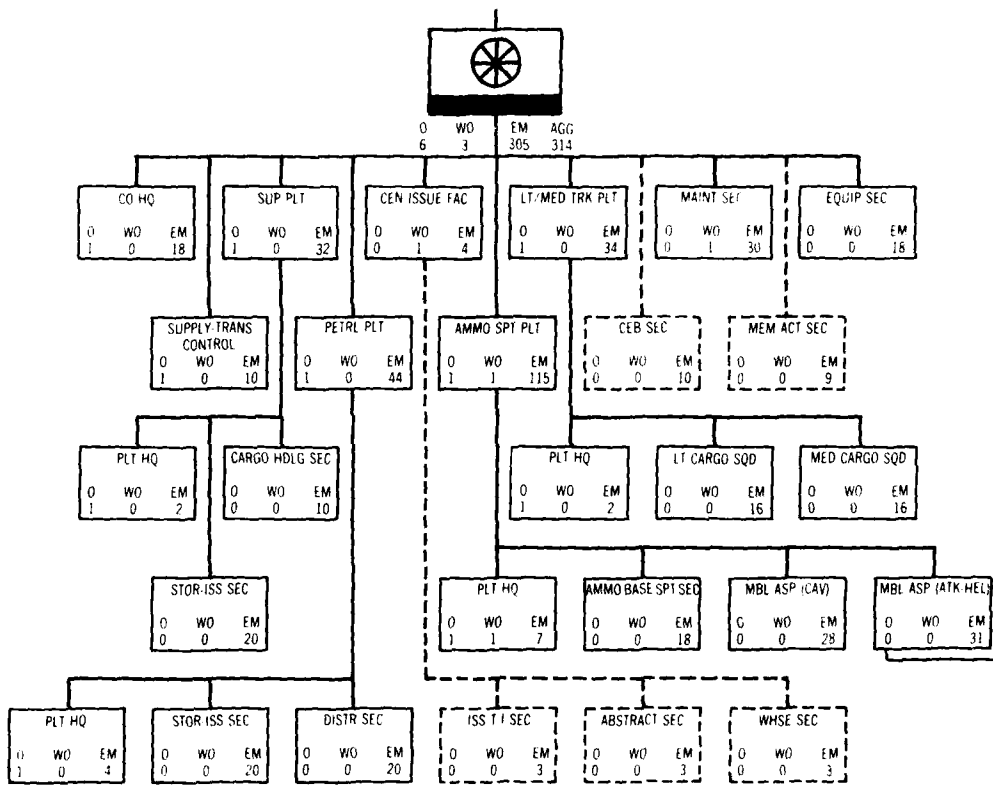

--- Augmentation Not included in totals

COMPANY HEADQUARTERS

1 MAJ Company Cdr 11
 1 SFC First Sergeant
 1 SFC Food Svc SGT
 1 SSG First Cook
 1 SSG Supply SGT
 1 SGT NCC Op NCO
 1 SPS Cook
 1 SP4 Ammover
 2 SP4 Cook
 1 SP4 Lt Veh Dvr
 1 SP4 Tac Wire Op Sp
 1 SP4 Supply Sp
 1 PFC Cook
 1 PFC Supply Clerk
 1 PFC Tac Wire Op Sp
 Machinegun 7.62mm 10
 Radio Set AN/VRC-46 1
 Trailer Cargo 1/4-Ton 1
 Trailer Tank Water 600-Gal 1
 Truck Cargo 2-1/2-Ton 1
 Truck Utility 1/4-Ton 1

SUPPLY-TRANS CON OPC

1 CPT Op Control Off
 1 SFC Ch Supply Con NCC
 1 SFC Truckmaster
 3 SPS Mat Supply Con NCC
 2 SPS Mat CTL & Acty NCC
 1 SP4 Dispatcher
 1 SP4 Mat CTL & Acty Sp
 1 PFC Reports Clerk
 Radio Set AN/VRC-47 1
 Speech Scty Bq TSEC/KY-57 2

SUPPLY PLATOON HQ

1 LT Platoon Ldr
 1 SFC Platoon SGT
 1 PFC Reports Clerk 01
 Trailer Cargo 1/4-Ton 1
 Truck Utility 1/4-Ton 1

STORAGE & ISSUE SEC

1 SSG Section Chief
 1 SGT Nacion Distr SGT
 1 SGT RT Forklift Op
 3 SPS Mat Stor & Hdq Sp
 1 SP4 Mat Stor & Hdq Sp
 1 SP4 RT Forklift Op
 1 SP4 Sub Supply Sp
 6 PFC Mat Stor & Hdq Sp

3 PFC Sub Stock Checker
 Trailer Cargo 1-1/2-Ton 1
 Truck Cargo 2-1/2-Ton 1
 Truck Lift Fork, 6000lb Cap 2

CARGO HANDLING SEC

1 SGT Section Chief
 1 SGT RT Forklift Op
 1 SP4 Mat Stor & Hdq Sp
 1 SP4 RT Forklift Op
 4 PFC Mat Stor & Hdq Sp
 Trailer Cargo 1/4-Ton 1
 Truck Cargo Tac 1-1/4-Ton 1
 Truck Lift Fork, 6000lb Cap 2

PETROL PLATOON HQ

1 LT Platoon Ldr
 1 SFC Platoon Sergeant
 2 SP4 Petroleum Lab Sp
 1 PFC Reports Clerk 01
 Radio Set AN/VRC-46 1
 Speech Sec Equip: TSEC/KY-57 1
 Trailer Cargo 1/4-Ton 1
 Truck Utility 1/4-Ton 1

STORAGE & ISSUE SEC

1 SSG Section Chief
 1 SGT Petrl Sup Foreman
 4 SP4 Fuel System Op
 4 SP4 Petrl Storage Sp
 1 SP4 RT Forklift Op
 1 SP4 Fuel System Op
 9 PFC Fuel Collaps 500-Gal 9
 Fuel Area Refuel Bq (PARA) 3
 Tank Fuel Collaps 10,000-Gal 18
 Trailer Cargo 1-1/2-Ton 2
 Truck Cargo 2-1/2-Ton 2
 Truck Lift Fork 6000lb Cap 1

DISTRIBUTION SECTION

1 SSG Section Chief
 4 SGT Petrl Hw Veh Dvr
 10 SP4 Petrl Hw Veh Dvr
 1 SP4 Petrl Lt Veh Dvr
 4 PFC Petrl Lt Veh Dvr
 Semitr Tank Fuel 5000-Gal 6
 Tank & Pump Unit Trk Mod 3
 Tank Unit Trk Mod 3
 Trailer Cargo 1-1/2-Ton 3
 Truck Cargo Dropside 5-Ton 1
 Truck Tank Fuel Svc 2500-Gal 3
 Truck Tractor 5-Ton 6

CENTRAL ISSUE FACILITY

1 MO CIF Supply Tech
 1 SFC CIF Supply SGT
 1 SGT Supply Acty SGT
 1 SP4 Supply Acty Sp
 1 PFC Reports Clerk 01
 Trailer Cargo 1-1/2-Ton 1
 Truck Cargo 2-1/2-Ton 1

AMMO SPT PLT HQ

1 CPT Platoon Ldr
 1 MO Ammo Tech
 1 SFC Platoon SGT
 2 SSG Ammo Insp 01
 2 SPS Ammo Records Clk
 1 SP4 Ammo Records Clk 01
 1 PFC Reports Clerk
 Radio Set AN/VRC-47 1
 Speech Sec Equip: TSEC/KY-57 2
 Truck Utility 1/4-Ton 2

AMMO BASE SPT SEC

1 SSG Ammo Section Chief
 1 SGT RT Forklift Op
 4 SP4 Ammo Storage Asst
 1 SP4 Carpenter/Masonry Sp
 2 SP4 RT Forklift Op
 4 PFC Ammo Storage Asst 01
 3 PFC RT Forklift Op
 Trailer Cargo 1-1/2-Ton 2
 Truck Cargo Dropside 2-1/2-Ton 2
 Truck Lift Fork, 6000lb Cap 8

MOBILE ASP (AV SQDN)

1 SSG Ammo Section Chief
 1 SGT RT Forklift Op
 1 SPS Ammo Storage Sp
 10 SP4 Hw Veh Dvr
 2 SP4 Hw Veh Dvr
 7 SP4 RT Forklift Op
 1 SP4 Veh Dvr
 9 PFC Ammo Storage Asst 01
 1 PFC Veh Dvr
 Radio Set AN/VRC-46 1
 Speech Sec Equip: TSEC/KY-57 1
 Semitr Low Bed 22-1/2-Ton 1
 Semitr Low Bed 25-Ton 1
 Truck Cargo Tac 1-1/4-Ton 4
 Truck Cargo 8-Ton 444 1
 Truck Lift Fork, 6000lb Cap 2
 Truck Tractor 5-Ton 4
 Truck Tractor 5-Ton W/MN 1

MOBILE ASP (MTR HEL BN)

1 SSG Ammo Section Chief
 1 SPS Ammo Storage Sp
 1 SPS Hw Veh Dvr
 10 SP4 Ammo Storage Asst
 2 SP4 Hw Veh Dvr
 **1 SP4 Veh Dvr
 **1 SP4 RT Forklift Op
 10 PFC Ammo Storage Asst
 1 PFC RT Forklift Op
 **3 PFC Veh Dvr
 * One Sec has 1 adtl PFC and 1 less SP4 Veh dvr.
 ** One Sec has 1 SGT instead of 1 SP4 RT Forklift Op.
 Radio Set AN/VRC-46 1
 Speech Sec Equip: TSEC/KY-57 1
 Semitr Low Bed 25-Ton 1
 Semitr Low Bed 22-1/2-Ton 1
 Truck Cargo Tac 1-1/4-Ton 1
 Truck Cargo 8-Ton 1
 Truck Lift Fork, 6000lb Cap 2
 Truck Tractor 5-Ton 6
 Truck Tractor 5-Ton W/MN 1

LT/MD TRUCK PLT HQ

1 LT Platoon Ldr
 1 SFC Platoon SGT
 1 SP4 Veh Dvr
 Radio Set AN/VRC-46 1
 Radio Set AN/VRC-57 1
 Trailer Cargo 1/4-Ton 1
 Truck Utility 1/4-Ton 1

LIGHT CARGO SQUAD

1 SSG Squad Ldr
 1 SP4 Veh Dvr
 12 PFC Veh Dvr
 Truck Cargo Dropside 5-Ton 10

MEDIUM CARGO SQUAD

1 SSG Squad Ldr
 1 SSG Hw Veh Dvr
 3 SPS Hw Veh Dvr
 6 SP4 Hw Veh Dvr
 5 PFC Hw Veh Dvr
 Semitr Low Bed 22-1/2-Ton 10
 Truck Tractor 5-Ton 10

MAINTENANCE SECTION

1 ME Maintenance Tech
 1 SFC Motor SGT
 2 SGT Hw Veh Mech
 4 SGT Pwr Gen/Lt Hw Veh Mech
 1 SP4 Const Eq Mech
 1 SP4 Equip Rec & Pts Sp
 4 SP4 Pwr Gen/Lt Veh Mech
 1 SP4 PILL Clerk
 1 SP4 Hw Veh Mech
 1 SP4 Recovery Veh Op
 6 PFC Pwr Gen/Lt Veh Mech 01
 3 PFC Hw Veh Mech
 1 PFC M & Chem Eq Repair
 Trailer Cargo 1/4-Ton 1
 Truck Cargo Tac 1-1/4-Ton 1
 Truck Cargo 2-1/2-Ton 1
 Truck wrecker 4-Ton 1

EQUIPMENT SECTION

1 SSG Section Chief
 1 SGT Asst Sec Chief
 1 SGT Loader Op
 1 SP4 Cdx Const Sp
 1 SP4 Const/Asphalt Bq Op
 4 SP4 Construction Sp
 1 SP4 Const Bq Op
 1 SP4 Hw Veh Dvr
 1 SP4 Loader Op
 1 SP4 Veh Dvr
 1 PFC Asst Demo Sp
 2 PFC Construction Sp 01
 1 PFC Veh Dvr
 Machinegun 7.62mm 1
 Radio Set AN/VRC-160 1
 Speech Sec Equip: TSEC/KY-57 1
 Loader Scoop Type 2-1/2-Cu Yd 2
 Semitr Low Bed 25-Ton 1
 Tractor FT Low Spd Dbl 1
 Truck Cargo Tac 1-1/4-Ton 1
 Truck Dump 5-Ton 2
 Truck Tractor 10-Ton 1

REMARKS:

All personnel armed with rifle 5.56mm unless otherwise indicated.
 01 Alarm light vehicle driver.
 11 Armed with pistol cal .45.

SUPPLY AND TRANSPORTATION COMPANY
 AIR CAVALRY COMBAT BRIGADE

MISSION: To provide maintenance and repair parts supply service to the 1st Cavalry Division (Airmobile) and to the 1st Cavalry Brigade (Airmobile) in the Republic of Vietnam.

PARAMETERS: 1. Base location: 1st Cavalry Division (Airmobile) Camp 1, Plei Me, RVN.
 2. Base type: Support.
 3. Base status: Active.

446

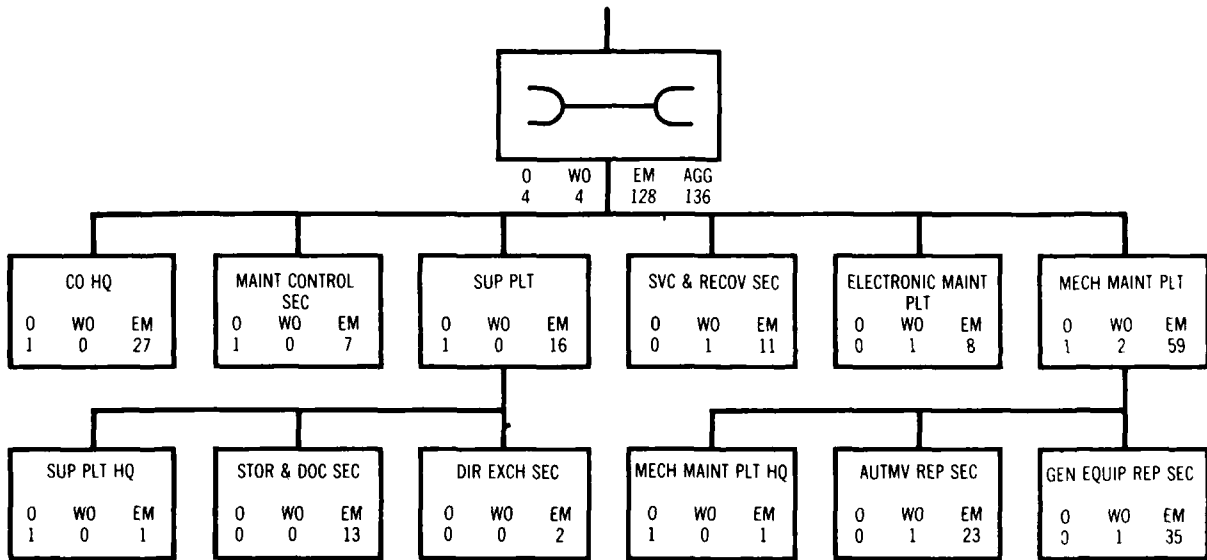

447

COMPANY HEADQUARTERS

1 CPT Company Cdr 11
 1 SGT First SGT
 1 SPC Food Svc SGT
 1 SPC Motor SGT
 1 SSG Supply SGT
 1 SGT NBC Op NCO
 3 SGT Pwr Gen/Wveh Mech
 1 SP5 First Cook
 1 SP4 Armorer
 2 SP4 Cook 01
 1 SP4 Const Bq Mech
 1 SP4 Eq Maint Clerk
 1 SP4 Comm Sys Op/Mech
 1 PFC PLL Clerk
 1 SP4 Tac Wire Op Sp
 3 SP4 Pwr Gen/Wveh Mech
 1 SP4 Lt Veh Dvr
 1 PFC Cook
 1 PFC Gen Supplyman 01
 4 PFC Pwr Gen/Wveh Mech 01
 Machinegun 7.62-mm 4
 Radio Set AN/VRC-46 1
 Radio Set Con Op AN/GRA-39 1
 Speech Scty Bq TSEC/KY-57 1
 Tank and Pump Unit Trk Mtd 1
 Tank Unit Trk Mtd 1
 Trailer Cargo 1/4-Ton 1
 Trailer Cargo 1-1/2-Ton 2
 Trailer Tank Water 400-Gal 1
 Truck Cargo 2-1/2-Ton 3
 Truck Cargo 5-Ton 1
 Truck Utility 1/4-Ton 1

MAINT CONTROL SECTION

1 LT Maint Con OIE
 1 SPC Maint Con SGT
 1 SSG Pwr Gen Eq Rep Insp
 2 SSG Tech Insp
 1 SP4 Bq Maint Clerk
 1 SP4 Repair Pts Sp
 1 PFC Records Clerk 01
 Trailer Cargo 1-1/2-Ton 1
 Truck Van Shop 2-1/2-Ton 1

SUPPLY PLATOON HQ

1 LT Platoon Leader
 1 SPC Platoon SGT

STORAGE/DOC SECTION

1 SSG Mat Control Supv
 1 SP5 Mat Stor & Hdig Sp
 2 SP4 Mat Stor & Hdig Sp 01
 1 SP4 Pack/Crating Sp 01
 2 SP4 Mat Con-Acty Clk 01
 1 SP4 Veh Dvr
 3 PFC Mat Stor & Hdig Sp
 1 PFC Mat Con-Acty Sp Clk
 1 PFC Veh Dvr
 Semitrailer 22-1/2-Ton M871 2
 Semitrailer Van 6-Ton 3
 Trailer Cargo 1-1/2-Ton 2
 Truck Cargo 2-1/2-Ton 2
 Truck Lift Fork 6000lb Cap 1
 Truck Tractor 5-Ton 3

DIRECT EXCHANGE SEC

1 SP4 Section Chief
 1 PFC Mat CTL & Actg Sp

SERVICE-RECOVERY SEC

1 WO Shop Tech
 1 SPC Section Chief
 2 SGT Metal Worker Rpm
 1 SP4 Fabric Repair Sp
 1 SP4 Lift/Load Eq Op
 1 SP4 Machinist
 1 SP4 Metal Worker Rpm
 1 SP4 Recovery Veh Op
 3 PFC Metal Worker Rpm 01
 Crane Wheel Mtd 5-Ton 1
 Trailer Cargo 1/4-Ton 1
 Trailer Cargo 1-1/2-Ton 2
 Truck Cargo 2-1/2-Ton 1
 Truck Trac Wrecker 5-Ton W/MW 1
 Truck Utility 1/4-Ton 1
 Truck Van Shop 2-1/2-Ton 1

ELECTRONIC MAINT PLT

1 WO Platoon Chief
 1 SPC Platoon SGT
 1 SP5 Elect Devices Rpm
 1 SP5 Sp Elect Dev Rpm
 1 SP4 Fld Rdo Rpm 01
 1 SP4 Dial/Man Gen Ofc Rpm
 1 SP4 Tac Move Sys Rpm
 1 SP4 Sp Elect Dev Rpm 01
 1 SP4 TT Rpm
 Elec Shop Semitr Mtd AN/ASM-189 2
 Elec Shop Semitr Mtd AN/ASM-190 1
 Shop Bq Elect Rep Semitr Mtd .. 1
 Truck Cargo 2-1/2-Ton 1
 Truck Tractor 5-Ton 2

MECH MAINT PLATOON HQ

1 LT Platoon Leader
 1 SPC Platoon SGT

AUTOMOTIVE REPAIR SEC

1 WO Auto Repair Tech
 1 SPC Section Chief
 4 SGT Wveh Rpm
 1 SP4 Fuel-Elec Sys Rpm 01
 6 SP4 Wheel Veh Mech
 1 PFC Fuel-Elec Sys Rpm
 10 PFC Wheel Veh Mech 01
 Shop Bq Cont Maint Trk Mtd 1
 Trailer Cargo 1-1/2-Ton 5
 Truck Cargo Tac 1-1/4-Ton 1
 Truck Cargo 2-1/2-Ton 3
 Truck Van Shop 2-1/2-Ton 4

GENERAL EQUIPMENT REP SEC

1 WO Engr Eq Rep Tech
 1 SSG Repair Supv
 1 SSG Engr/Util Eq Sp
 2 SGT QM Eq Rpm
 1 SGT Const Bq Rpm
 1 SP5 Office Machine Rpm
 1 SP5 Refrig Sp

1 SP5 Pwr Gen Bq Rpm
 1 SP4 Const Bq Rpm
 1 SP4 Fire Con Inst Rpm
 4 SP4 Pwr Gen Bq Rpm
 3 SP4 QM Bq Rpm 01
 1 SP4 Refrigeration Sp
 1 SP4 Small Arms Rpm 01
 1 PFC Const Bq Rpm 01
 1 SP4 Fuel-Elec Sys Rpm
 8 PFC Pwr Gen Bq Rpm
 3 PFC Refrigeration Sp
 3 PFC QM Bq Rpm
 Shop Bq Cont Maint Trk Mtd 1
 Truck Cargo Tac 1-1/4-Ton 1
 Truck Cargo 2-1/2-Ton 1
 Truck Van Shop 2-1/2-Ton 2

REMARKS:

All personnel armed with rifle
 5.56-mm unless otherwise
 indicated.
 01 Also light vehicle driver.
 11 Armed with pistol cal .45.

**MAINTENANCE COMPANY
 AIR CAVALRY COMBAT BRIGADE**

1. This unit provides intermediate maintenance (Avionics) support to all of the aircraft in the 1st Cavalry Division (aircraft repair platoon) and provides support and maintenance for the avionics and aircraft armament for all supported units. The unit is located at the 1st Cavalry Division, Ft. Cavalli, Vietnam. The unit is currently assigned to the 1st Cavalry Division, Ft. Cavalli, Vietnam. The unit is currently assigned to the 1st Cavalry Division, Ft. Cavalli, Vietnam. The unit is currently assigned to the 1st Cavalry Division, Ft. Cavalli, Vietnam.

2. This unit provides intermediate maintenance (Avionics) support to all of the aircraft in the 1st Cavalry Division (aircraft repair platoon) and provides support and maintenance for the avionics and aircraft armament for all supported units. The unit is located at the 1st Cavalry Division, Ft. Cavalli, Vietnam. The unit is currently assigned to the 1st Cavalry Division, Ft. Cavalli, Vietnam. The unit is currently assigned to the 1st Cavalry Division, Ft. Cavalli, Vietnam.

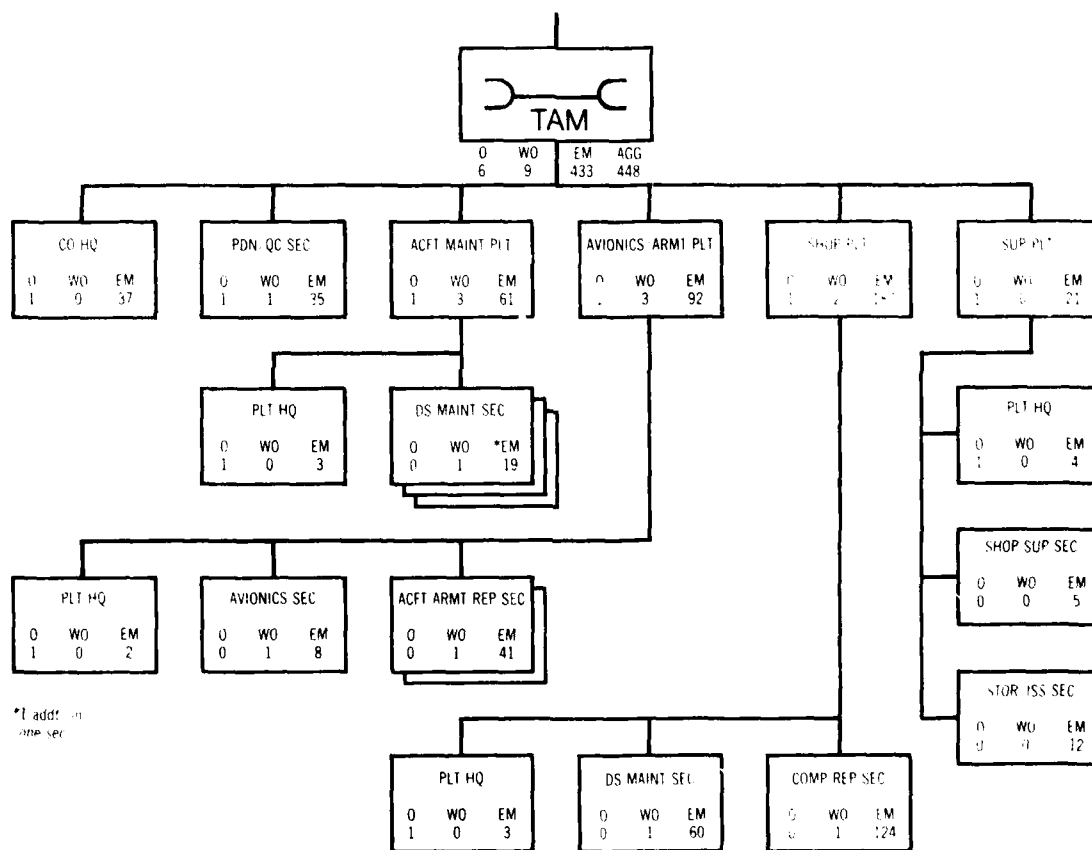

COMPANY HEADQUARTERS	
1 MAJ	Company Cdr
1 SFC	First Sergeant
1 SFC	Food Svc SGT
1 PFC	Motor SGT
1 SSG	Truck Coord
1 SGT	Utility SGT
1 SGT	AW/VEH/PLN Gen Mech
1 SGT	AW/VEH Mech
1 SPS	Cook
1 SPS	Unit Clerk
1 SP4	Acft Pwrts Hdtr
1 SP4	Armorer
1 SP4	Cook
1 SP4	ComB Equip Rpm
1 SP4	Supply Sp
1 SP4	Lt. AW/VEH/PLN Gen Mech
1 SP4	Refuel Sp
1 SP4	Mat Stor & HDLG Sp
1 SP4	Tac Wire Op Sp
1 SP4	Veh Dvr
1 SP4	Rec Veh Op
1 PFC	PLL Clerk
1 PFC	Cook
1 PFC	ComB Equip Rpm
1 PFC	Tac Wire Op Sp
1 PFC	Refuel Sp
1 PFC	Supply Sp
1 PFC	Par Gens Lt. AW/VEH Mech
1 PFC	Headquarters 7.62-Rm
1 SFC	Radio Set AN/VRC-47
1 SFC	Radio Set Con Op AN/GRA-19
1 SFC	Speech Scty Bq TSBG/KY-57
1 SFC	Tank & Pump Unit T18 HD
1 SFC	Tank Unit T18 HD
1 SFC	Trailer Cargo 1-1/2-Ton
1 SFC	Trailer Data Meter 400-Gal
1 SFC	Truck Cargo 2-1/2-Ton
1 SFC	Truck Cargo 2-1/2-Ton W/M
1 SFC	Truck Cargo Dropside 4-Ton W/M
1 SFC	Truck Utility 1-1/4-Ton
1 SFC	Truck Wrecker 5-Ton W/M
P/W/O SECTION	
1 CPT	Prof Control Off
1 WO	Qual Control Off
1 SFC	Ch. Acft QC Supv
1 SFC	Prof Control SGT

2 SSG	Acft Fire CLI T. 1.
4 SSG	Util Hel T. 1.
1 SSG	Acft Purplant Tech Insp
4 SSG	Med Hel T. 1.
3 SSG	CDW/Set Hel T. 1.
8 SSG	Atk Hel T. 1.
1 SSG	Acft Str Rep Tech Insp
2 SSG	Acft Wpm Sys T. 1.
1 SSG	Acft Qual Cont Supv
2 SGT	Util Hel Crew Chief
1 SP4	Avionics Mechanic
1 SP4	Qual Control Clerk
1 SP4	Unit Hel Repairer
1 PFC	Records Clerk
1 PFC	Armt Subsys 7.62-Rm RC M21
1 PFC	Helicopter Utility UR-1H
1 PFC	Radio Set AN/PRC-90
1 PFC	Radio Set AN/VRC-46
1 PFC	Radio Set Con Op AN/GRA-19
1 PFC	Speech Scty Bq AN TSBG/KY-58
1 PFC	Speech Scty Bq TSBG/KY-57
1 PFC	Trailer Cargo 1-1/4-Ton
1 PFC	Truck Cargo Tac 1-1/4-Ton
1 PFC	Truck Utility 1/4-Ton
ACFT MAINT PLATOON	
1 CPT	Platoon Leader
1 SFC	Platoon SGT
1 SP4	Tool Room Keeper
1 PFC	Records Clerk
1 PFC	Aerial Rec. Kit
1 PFC	Trailer Cargo 1-1/4-Ton
1 PFC	Truck Tractor 5-Ton
1 PFC	Truck Utility 1/4-Ton
DS MAINT SECTION	
1 WO	Acft Repair Tech
1 SFC	Section Chief
4 SGT	Atk Hel Repairer
2 SGT	Set Hel Repairer
1 SGT	Util Hel Repairer
1 SP4	Med Hel Repairer
2 SP4	Atk Hel Repairer
2 SP4	Set Hel Repairer
1 SP4	Util Hel Repairer
1 PFC	Atk Hel Repairer
1 PFC	Set Hel Repairer
1 PFC	Util Hel Repairer
1 PFC	Med Hel Repairer

*1 sec auth 1 adtl	
*1 sec auth 1 lead	
1 SGT	Med Hel Rep.
1 SGT	Speech Security Group
1 SGT	Trailer Cargo 1-1/2-Ton
1 SGT	Trailer Cargo 1-1/2-Ton
1 SGT	Trailer Cargo 2-1/2-Ton W/M
1 SGT	Truck Utility 1/4-Ton
1 SGT	Truck Utility 1/4-Ton
AVIONICS/ARMT PLT HQ	
1 LT	Platoon Leader
1 SFC	Platoon SGT
1 SP4	Records Clerk
1 SGT	Trailer Cargo 1/4-Ton
1 SGT	Truck Utility 1/4-Ton
AVIONICS SECTION	
1 WO	Avionics Maint Tech
1 SSG	Avionics Bq Maint Supv
1 SPS	Avionics Comm Eq Rep
1 SPS	Av MMV/Flt Con Eq Rep
1 SPS	Avionics Sp Bq Rep
1 SPS	Avionics Comm Eq Rep
1 PFC	Av MMV/Flt Con Eq Rep
1 PFC	Avionics Sp Bq Rep
1 PFC	Avionics Comm Eq Rep
1 PFC	Elect Shop Smitrl Mtd AN/ASH-199
1 PFC	Elect Shop Smitrl Mtd AN/ASH-190
1 PFC	Trailer Cargo 1-1/2-Ton
1 PFC	Trailer Cargo 2-1/2-Ton
1 PFC	Truck Tractor 5-Ton
1 PFC	Truck Utility 1/4-Ton
ACFT ARMT REP SEC	
1 WO	Acft Armt Repair Tech
1 SFC	Acft Armt Rep Supv
2 SSG	Acft Fire CLI Rep Supv
2 SSG	Acft Wpm Sys Rep Supv
4 SGT	Acft Wpm Sys Rep
4 SGT	Acft Fire CLI Rep
4 SGT	Acft Fire CLI Rep
4 SP4	Acft Wpm Sys Rep
*1 PFC	Acft Wpm Sys Rep
*1 PFC	Acft Fire CLI Rep
*1 sec auth 1 adtl	
1 SGT	Trailer Cargo 1-1/2-Ton
1 SGT	Trailer Cargo 1-1/2-Ton
1 SGT	Trailer Cargo 2-1/2-Ton
1 SGT	Truck Utility 1/4-Ton

SHOP PLATOON	
1 LT	Platoon Leader
1 SFC	Platoon SGT
1 SP4	Records Clerk
1 PFC	Tool Room Keeper
1 PFC	Shop Set Avn Inter Maint
1 PFC	Trailer Cargo 1/2-Ton
1 PFC	Tractor W/ Acft Towing
1 PFC	Tractor Wheeled Mule
1 PFC	Truck Tractor 5-Ton
1 PFC	Truck Utility 1/4-Ton
DS MAINT SECTION	
1 WO	Aviation Maint Tech
1 SFC	Acft Maint SGT
4 SSG	Maintenance Supv
7 SGT	Atk Hel Repairer
4 SGT	Med Hel Repairer
4 SGT	Set Hel Repairer
3 SGT	Util Hel Repairer
5 SP4	Atk Hel Repairer
4 SP4	Med Hel Repairer
4 SP4	Set Hel Repairer
2 SP4	Util Hel Repairer
5 PFC	Atk Hel Repairer
10 PFC	Med Hel Repairer
2 PFC	Set Hel Repairer
1 PFC	Util Hel Repairer
1 PFC	Crane Wheel Mtd 3-Ton
1 PFC	Trailer Cargo 1-1/2-Ton
1 PFC	Trailer Cargo 2-1/2-Ton
COMPONENT REPAIR SEC	
1 WO	Aviation Maint Tech
1 SFC	Acft Maint SGT
2 SSG	Acft Struc Rep Supv
1 SSG	Acft Purplant Rep Supv
3 SGT	Acft Instrument Rep
2 SGT	Acft Pnedraulics Rep
12 SGT	Acft Structural Rep
6 SGT	Acft Purplant Rep
12 SGT	Acft Purplant Rep
4 SP4	Acft Electrician
2 SP4	Acft Pnedraulics Rep
13 SP4	Acft Purplant Rep
8 SP4	Acft Structural Rep
11 SP4	Acft Structural Rep
1 SP4	Machinist
1 PFC	Acft Pnedraulics Rep
13 PFC	Acft Purplant Rep
16 PFC	Acft Purplant Rep

16 PFC	Acft Structural Rep
16 PFC	Crane Wheel Mtd 3-Ton
1 PFC	Shop Set Avn Inter Maint
1 PFC	Trailer Acft Maint Mtd
1 PFC	Trailer Cargo 1-1/2-Ton
1 PFC	Trailer Cargo 2-1/2-Ton
1 PFC	Truck Tractor 5-Ton
SUPPLY PLATOON HQ	
1 CPT	Platoon Leader
1 SFC	Platoon SGT
1 SP4	Mat Cov Acct Clerk
1 PFC	Reports Clerk
1 PFC	Mat Cov Acct Clerk
1 PFC	Truck Cargo Tac 1-1/4-Ton
STORAGE/ISSUE SECTION	
1 SSG	Mat Stor & HDLG
3 SPS	Mat Stor & HDLG SGT
1 SP4	Lift/Load Eq Op
6 SP4	Mat Stor & HDLG Sp
1 SP4	Packing/Crating Sp
1 SGT	Semitrailer Low-Bed 22-1/2-Ton
1 SGT	Semitrailer Van 12-Ton
1 SGT	Trailer Cargo 1-1/2-Ton
1 SGT	Trailer Cargo 2-1/2-Ton
1 SGT	Truck Lift Forks 4000 LB Cap.
1 SGT	Truck Tractor 5-Ton
SHOP SUPPLY SECTION	
1 SP4	Mat Stor & HDLG Sp
2 SP4	Mat Stor & HDLG Sp
2 PFC	Mat Stor & HDLG Sp
1 SGT	Semitrailer Van 12-Ton
1 SGT	Tractor 5-Ton
REMARKS:	
01	All personnel armed with rifle 4.5-mm unless otherwise indicated.
02	All light vehicle driver.
16	All heavy vehicle driver.
16	Armed with revolver cal .38.

**TRANSPORTATION AIRCRAFT MAINTENANCE COMPANY
AIR CAVALRY COMBAT BRIGADE**

END

DATE
FILMED

7-82

DTIC