

MICROCOPY RESOLUTION TEST CHART
NATIONAL BUREAU OF STANDARDS 1963-A



DEPARTMENT OF THE NAVY
NAVAL INTELLIGENCE SUPPORT CENTER
4301 Sulfur Road
Washington, DC 20390

(Handwritten mark)

8204/31

UNCLASSIFIED

AD A114766

TITLE: Recent Ship Construction and Projects

AUTHOR(S) AND/OR EDITOR(S): Harald Fock

SOURCE: Marine-Rundschau, B 1760 E, January 1982/1. pp. 16-21

ORIGINAL LANGUAGE: German

TYPEWRITTEN PAGES: 12

TRANSLATOR: C

NISC TRANSLATION NO. 6778

APPROVED CRK

DATE 8 April 1982

DTIC FILE COPY

Approved for Release	<input checked="" type="checkbox"/>
DTIC	<input type="checkbox"/>
NSA	<input type="checkbox"/>
Other	<input type="checkbox"/>
Date of Review	
Reviewing Agency	
Remarks	
A	



DTIC ELECTED
S D
MAY 24 1982

A

UNCLASSIFIED

This document has been approved for public release and sale; its distribution is unlimited.

82 05 24 094

RECENT SHIP CONSTRUCTION AND PROJECTS

/16*

[Fock, Harald: Marine-Rundschau, B 1760 E, January 1982/1. pp. 16 - 21; German]

Aero-Dynamic Ground Effect Craft - A New Aspect of Future Naval Warfare? (I)

The naval design engineer and veteran collaborator of Marine-Rundschau examines in his two-part article the technical and operational-tactical predications of ground effect craft and describes projects of the firm Rhein-Flugzeugbau GmbH and of the Transport and Passenger Aircraft Division (Unternehmensbereich Transport und Verkehrsflugzeuge) of the firm Messerschmitt-Bölkow-Blohm GmbH.

Introduction

Firepower and movement were and will continue to be in the future the determinative elements of operational concept. This applies for land, sea and air warfare. The particular attributes of the individual armed forces necessarily require certain points of emphasis. If naval warfare in WWII was characterized most conspicuously by the effectiveness of land-based and naval aircraft, which was considerably underestimated prior to WWII in this regard, then naval warfare in the future will be determined on the one hand by the amazingly advanced state of sensor technology and on the other hand by the high speed, range and destructive power of manned and unmanned aircraft and missiles employed against the enemy. If it was still possible in WWII - at least in the initial phase - to exploit some elements of experience from WWI, which had been realized some two decades previously, then this is more than problematical for anticipatory naval planning - if not entirely impossible - with reference to the frenzy of technical development of our time and the fact that the experiences of WWII will soon be forty years old and that since this time certainly a rather large number of conventional land and naval wars have occurred, but that no naval war which has exceeded the parameters of local fast attack craft skirmishes or similar actions has occurred. If the armies and air forces in the world could test modern equipment and the operational tactics since 1945 based upon such equipment in combat against an enemy and draw practical consequences from the results generated, then all naval equipment and planning concepts tend to move progressively more in the realm of the hypothetical. The projected concepts and the corresponding statements are similarly multifaceted. If some regard the concentration and emphasis of future naval warfare in submarines, and accord surface ships a chance only in the form of small ships, strategic carriers and escort vessels for aircraft carrier task forces, convoys, amphibious operations, etc., then others perceive that there are real possibilities (for example, the Soviet Navy Chief Gorshkov, apparently in the reincarnation of a surface ship of almost battle cruiser size - KIROV Class, 22,000 tons operational displacement - or the U.S. Navy with its 90,000 ton aircraft carriers). Whether or not the one or

* Numbers in the right margin indicate pagination in the original text.

premise which generated the particular decision is correct - would be determined only by war. Computer analyses provide only limited assistance in this regard: On the one hand they are contingent upon the inserted data, and on the other hand, just as for tomorrow and yesterday, they disregard essentially the human behavior effect, which is so critically decisive today in the military area under operational conditions. The same applies for maneuver! These operational conditions are in addition aggravated and complicated by the fact that both opponents in such a conflict would utilize known technology and in addition would operate in the basis of the same operational and tactical concepts. /16

If the non-relevant issues of international naval warfare are disregarded in the following discussion of the Rhein-Flugzeugbau GmbH (RFB) and Messerschmitt-Bölkow-Blohm (MBB) projects to be addressed, and if concentration is directed towards the potential aspects of current and future naval warfare to be anticipated in the coastal and littoral sea areas, then the picture would necessarily have to be more comprehensible because of such limitation. However, here as well the guiding spirits are of differing opinion. In this context the German (FRG) Minister of Defense recently ventilated an opinion (which apparently was his own) that it would have to be analyzed whether or not, for example, surface ships are still of practical value in the western Baltic with reference to (hostile) electronic surveillance and the permanent latent threat from aircraft. He ventured further whether or not it might be more advantageous to refer the defense of the Baltic area completely to submarines and land-based and therefore more cost-effective (?) guided missile units. Certainly this is superficially initially a consideration which appears to be logical - however, just as certainly this is a consideration, which ultimately reflected the currently precarious budget situation, and a consideration, which was quite defined in its ultimate consequences.

Let us analyze the facts:

- 1) The permanent surveillance and detection vulnerability of constricted sea areas by means of electronic sensors and naval air is apparent.
- 2) Land-based guided missile positions/units for operation against sea targets have only a limited degree of mobility and are correspondingly vulnerable. The available firepower lacks the mobility, which is required for sea targets.
- 3) In close coastal and littoral sea areas submarine warfare is handicapped in large areas by inadequate water depth. Under circumstances by specific mine warfare. The defensive capabilities against detection and engagement from the air - insofar as such capabilities are available - are limited. The employment of submarines against smaller objects - for example, landing craft - is hardly practical or logical.
- 4) The distribution of combat power of surface ships operating in close coastal and littoral sea areas among the greatest possible number of small and fast ships makes possible:
 - A deployment appropriate to the threat,
 - A fast concentration at the desired place with a large tactical bandwidth (spectrum of tactical options),
 - The diversion of hostile attack and defense with
 - a) appropriate survival chance of the mass of the units and
 - b) relatively large probability of success,if the units are controlled centrally and skillfully according to the situation. /17

Modern command and control systems provide all of the facilities /17 required for this purpose. With reference to the quantity, the loss of several units can be tolerated. After a brief "deus-ex machina" (orchestrated technical) operation the units withdraw to the - varying and differentiated - deployment points and are - with mobile logistical support - ready for new missions.

Centralized command and control and quantity are the decisive factors. This concept of quantity also applies to the issue as to whether or not the enemy is prepared to sacrifice complex weapons systems for defensive purpose, with reference to the fact that replacement of such weapons systems in combat is problematical. Another decisive factor is moreover the fact that any coastal port or point without major facilities is suitable as a deployment area. If such (naval) units operate then in addition with appropriately armed naval air forces, then by diversification of the means of attack any form of an enemy action (amphibious operations, mining operations, employment of guided missile carriers, support of army (ground) operations from the sea, etc.) could be contained and defeated with good prospects for success.

The perception that naval warfare in coastal and littoral sea areas requires ships which are specifically designed for this mission has always been neglected by the large navies. In this regard, for example, the Royal Navy and the U.S. Navy first had to develop their MTB, MGB, PT and other units with difficulty during the course of WWII. By 1945 considerably more than 2,000 ships of this and similar types were in operation or under construction. Similarly, in the Vietnam War the U.S. Navy had to start the large-series production of small ship units on the basis of specific experience. In contrast to this, the Soviet Navy in the course of its pre-war and post-war equipment, and particularly conspicuously in the last 25 years, has accorded ships for coastal and littoral sea warfare and ships for high-seas naval warfare absolutely the same degree of priority. And this attitude applies both for quality and quantity.

If the small ships to be addressed here are analyzed, then the Soviet development allows a clear and thoroughly logical, systematic and consequent trend to be perceived: whereas in the first fifteen post-war years the torpedo boats of the P-4, P-6 and KOMAR Classes developed on the basis of pre-war and war-time experience dominated, in the 1960's and 1970's the 150/200 ton fast attack missile and torpedo craft of the OSA and SHERSHEN Classes, which were designed as semi-planing boats (hydro-skimmers) dominated the scene. The appreciation of dependence of these units upon the seaway and of the speed limited by the size, hull form, etc., even below 40 kn of these units however led the Soviets quite early to more advanced concepts, which after many negative experiences resulted in the semi-hydrofoils of the TURYA and MATKA Classes, the hydrofoils of the PCHELA, SARANCHA and BABOCHKA Classes and finally in the hovercraft (air cushion vehicles) of the GUS and AIST Classes. In addition, research in wing-in-ground effect and other vehicles is in progress.

The direction of the trend is clearly apparent: Whereas the power requirement of a conventional displacement ship, which operates half in the dense medium water and half in the thin medium air and is supported only by the static lift, generally increases with the third power of the speed and - at least from the economic perspective - at ca. 40 kn reaches magnitudes which are unattractive, planing ships are raised partially from the water, hydrofoil ships are raised out of the dense medium water with the exception of the relatively small hydrofoils, and hovercraft (air cushion vehicles) are raised completely out of the water. The first type (planing hulls) utilizes dynamic lift

from the drive stream generated in the water, and the latter are supported by the air cushion generated by fans (blowers) and utilize the increase lift coefficients of the ground effect. Thereby on the one hand increasingly better resistance conditions and therefore higher speeds are obtained, however, as well - with certain restrictions - better sea-keeping qualities are also realized. Certainly, such developments are being prosecuted in the West, but to date they have had only minimal impact in the military area (USA, England, Italy) and have scarcely exceeded test designs with small numbers of units. In contrast to this, the Soviets already have organized units of such craft in operational service, which allow the development of operational and tactical possibilities resulting from the new developments. /17

If we summarize the development already realized by the Soviets on a broad front and in the West the development which is still at an experimental level, then a very clear trend can be noted: the attempt to operate at sea at high speed ships, which operate either partially above the border line water/air and which exceed the previous speed restrictions of conventional hull forms by at least 50 to 100%. Since hydrofoils currently reach ca. 55 kn with a relatively high expenditure of technology and hovercraft (air cushion vehicles) reach speeds up to 70 kn, but which require a relatively high power expenditure for the fan (blower), it was logical to explore other alternatives. In the Federal Republic of Germany MBB (Messerschmitt-Bölkow-Blohm) assumed this task with its facilities in Hamburg-Finkenwerder together with RFB (Rhein-Flugzeugbau GmbH) in Mönchengladbach, which was recently amalgamated with MBB.

TECHNICAL-PHYSICAL CONCEPTUAL DEFINITIONS

As noted above, the contact to the surface of the water results in the fact that the power requirement of conventional ships increases rapidly with increasing speed and that the operational speed decreases rapidly with increasing wave height. A considerable increase of the speed and of the sea-keeping quality is therefore possible only with ships, which have no direct contact with the surface of the water. This applies with qualification for hydrofoils, and applies without restriction for ground effect vehicles (hovercraft): The ship hull hovers by utilizing the ground effect, i.e., the additional lift, which is generated between the subsurface and the lift surfaces near the subsurface, in the case of an air cushion vehicle (hovercraft) completely above the water and under some circumstances completely above the surface of the ground. The improvement which is thereby achieved in the lift and lift ratio (drag ratio) impacts upon performance (power), sea-keeping qualities and operating costs.

A distinction has to be made between:

- Vehicles with aerostatic lift (air cushion vehicles), in which the lift is generated by an air cushion provided by a fan (blower). In this category are the ACV (air cushion vehicles), which are also termed hovercraft, and the SES (surface effect ships), which are also termed sidewall hovercraft. The former are more or less amphibious. Despite flexible skirting of the air cushion, they require a relatively high blower power and are dependent upon the condition of the sea for their speed. In the case of SES the sidewalls gliding through the water like keels reduce the blower power required and with efficient design also produce an certain additional static and dynamic lift because of the total shielding effect on the sides of vehicle. However, the amphibious capability is lost and a certain contact to the surface of the water, which exerts a certain effect upon the sea-keeping qualities, is again established.

- Vehicles with aerodynamic lift (wing-in-ground-effect vehicles), in which the lift is obtained from the air current passage. A natural air cushion is formed by a special configuration of the hydrofoil (wing) by exploiting the ground effect; the air cushion causes the vehicle to hover, the resistance is reduced considerably, and the vehicle is self-stabilized. /17

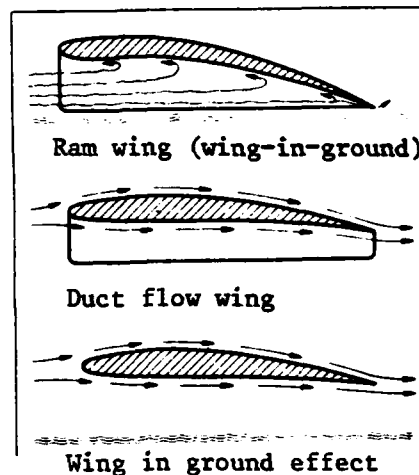

Fig. 1: Division of aerodynamic ground effect vehicles according to their method of operation.

Since aerodynamic ground effect vehicles require a very low power, approximately half of that required for an aircraft, they constitute in mastering the particular technology without a doubt the most interesting solution in the border area between ship and aircraft. The development of such vehicles was initiated by the noted German aircraft designer Dr. Alexander M. Lippisch. He succeeded as the first in holding such a vehicle longitudinally stable close to the ground and in free flight. The Lippisch Research Corporation was founded in the U.S.A. in 1966. The research and development activities were performed partially in the USA and partially at Rhein-Flugzeugbau GmbH in Germany (FRG).

In the wing-in-ground (ram wing) technology the air cushion is generated first only with increasing travel speed. Therefore, a wing-in-ground vehicle (ram-wing vehicle) floats initially in displacement condition (weight = static lift). With increasing speed the vehicle is elevated and becomes a planing hull (hydroskimmer). When a certain speed is reached, the air cushion becomes so strong, that the vehicle is lifted completely from the water and glides vertically stable in the ground effect. With sufficient propulsive power the vehicle can then be designed to fly around all three axes because of its steerability and can therefore be used unrestrictedly in the amphibious role,

The ground effect begins to operate when the flight height (altitude) h is half the span b ($h:b = 0.5$). The problem of the trim change (CP variation) because of the drift of the center of pressure of the lift effect in the transition from displacement to the hover attitude was resolved by the configuration of the wing-in-ground (ram wing) developed by Lippisch: The wings are designed in reversed Delta-form and have a more or less large V-attitude. The wing ends, which are designed as catamaran floats and the trailing edges of the wing are at the same level. Because even with low aspect ratios very good lift coefficients can be obtained, ram wing

(wing-in-ground) vehicles can be designed in remarkably compact form with conspicuously small wing spans). /18

Practically, today there exist for aerodynamic ground effect vehicles today three alternatives (Fig. 1) - which in practical design cannot always be specifically distinguished:

- 1) In the ram wing (wing-in-ground) principle the wings, the wind trailing edge and the end pieces constitute a ram (pressure) area closed on three sides. This vehicle is capable of hovering and flying.
- 2) In the duct flow principle the wings and the end plates form a ram (pressure) area closed on two sides. This device is capable of hovering but not of flying.
- 3) The simple hydrofoil (wing) which operates in the ground effect is capable of flying and hovering.

Theoretical and practical analyses revealed that aerodynamic ground effect vehicles with a consequent application of the developments realized in recent years and with introduction of the new steering and flight control systems, which are termed collectively as CCV (Control Configured Vehicle) technology from aircraft design, can be designed as sensor and effector platforms, which are essentially independent of sea-way influences, and with a large degree of economy.*

* v. Technical details of the CCV-technology in Wehrtechnik 2/76 and 3/76.

RESEARCH AT RHEIN-FLUGZEUGBAU GMBH

The research at Rhein-Flugzeugbau GmbH is based on wing-in-ground (ram wing) technology and was performed in collaboration with the David Taylor Naval Ship Research And Development Center (US Navy). Because the effects of the ground effect could be analyzed only to a limited degree in the model because of the boundary layer problem and in addition because the practical/operational questions of operational capabilities remain undefined, RFB was awarded in 1970 after previous investigations with free-flying (floating) models and the test vehicle X 112 was awarded the contract by the Ministry of Defense (Bundesministerium der Verteidigung = BMVg) to build a manned test vehicle for appropriate trials. The one-seater X 113 Am (Fig. 2, 3), which was designed in full reinforced glass fiber sandwich construction with specially selected supporting structures because of the high peak loadings resulting from water impact in starting and landing and with utilization of the RFB-longitudinal tube construction technique was 8.43 meters long and 5.89 meters wide and had a maximum weight of 0.36 tons. A 48-HP-Nelson-H63-CP-motor was used as the propulsion system which drove a propeller and was mounted above the vehicle. This produced a specific power of 9 kp/HP. The thrust system mounted on the wing was designed in such a manner, that during the flight the thrust provided to the vehicle could be recorded, in order to be able to obtain exact information in regard to the power and performance improvements which could be realized in hover flight in ground proximity. /19
The dimensions were a scale reduction at 1:1.7 of a projected four-man vehicle. The drawing and picture show that the vehicle was designed as a trimaran, whose main displacement lift was generated by the hull and the wing trailing edge, while the support floats on the wind ends provided lateral stabilization.

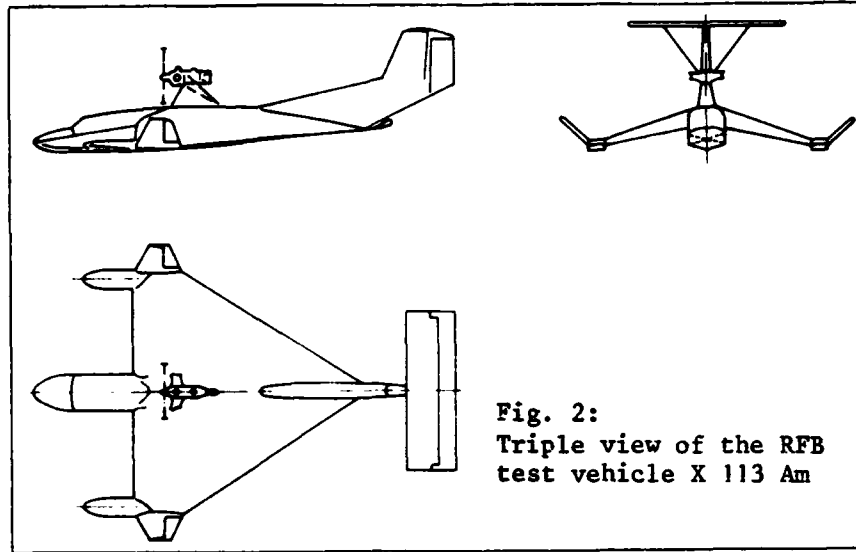

Fig. 2:
Triple view of the RFB
test vehicle X 113 Am

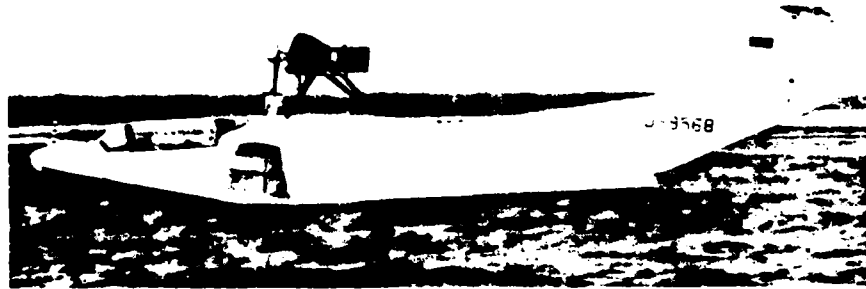
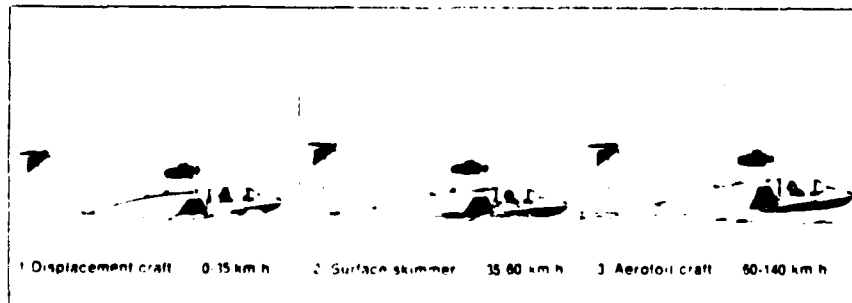

Fig. 3: The RFB test vehicle 113 Am

In 1971 at Lake Constance and in the Weser Estuary tests performed in several stages confirmed essentially the theoretical preliminary calculations and provide valuable information in regard to the flight characteristics and performance by means of built in measurement devices.

As was anticipated, during the starting procedure as a displacement craft (Fig. 4.1) a rapid increase in resistance was evidenced up to ca. 9 kn. As soon as the vehicle went on to "step", i.e., as soon as it began to plane (skim) (Fig. 4.2), first a reduction in resistance developed up to ca. 13.5 kn, when the so called "hump speed" was reached. As soon as the ground effect developed and the vehicle hovered (Fig. 4.3), the resistance was reduced drastically, until it reached its minimum in free hover flight. This was



1 Displacement craft 0-15 km/h 2 Surface skimmer 15-60 km/h 3 Aerofoil craft 60-140 km/h

at ca. 1/3 of the maximum. Because the power plant performance or the maximum possible starting weight alone is determinative for the brief starting phase, the lift and skimming coefficients reached in however flight are reflected in considerably lower operating costs/tonnage displacement as compared to conventional ships.

Because the float form of the X 113 Am was not designed for starting and landing in a seaway, and because the decisive rasion wingspan/flight height for the skim (lift) ratio did not correspond to geophysical conditions of 1.5 meter wave height prevailing for 80% of the year in the Baltic Sea area, RFB (Rhein-Flugzeugbau GmbH) was authorized by the Ministry of Defense (BMVg) because of the very interesting test results to develop a larger vehicle which would be appropriate for operational conditions in the Baltic Sea area and to provide such a vehicle for trials. The X 114 (Fig. 5, 6, 7), which was equipped with retracting landing gear to allow amphibious capability, had the following technical data:

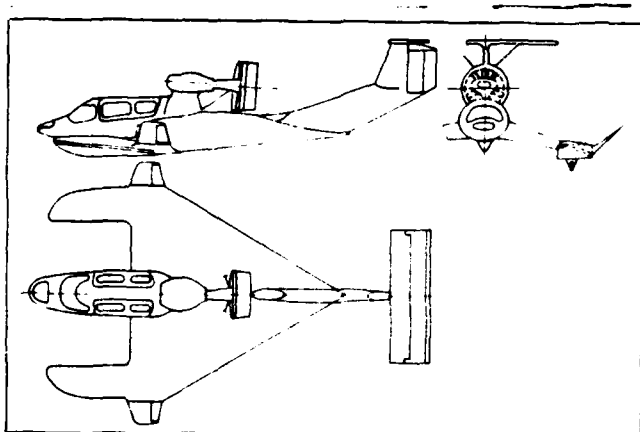

Fig. 5: Triple view of the RFB Test Vehicle X 114

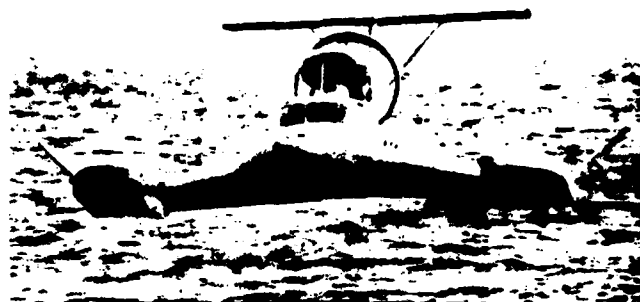

Fig. 6: The RFB Test Vehicle X 114 in hover flight

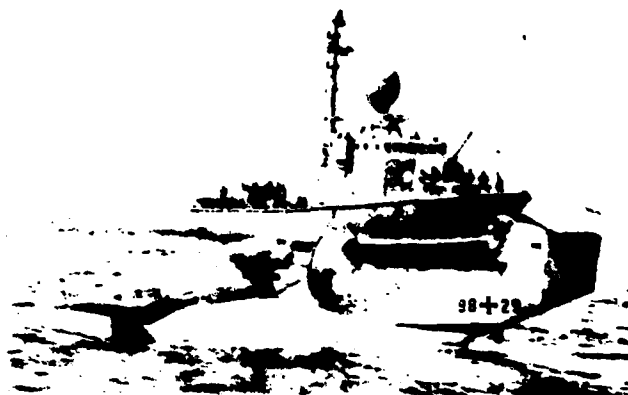

Fig. 7: The RFB Test Vehicle X 114 in floating attitude next to a Class 143 Fast Attack Missile Craft

Dimensions:

Delta wing span	7.00 m
Total length	12.80 m
Total height	2.90 m
Air foil (wing)	29.10 m
Aspect ratio	1.7

Weights

Empty weight (military load)	0.89 t
Fuel	0.08 t
Payload	0.38 t
Total weight	1.35 t

Propulsion

1 x 200-HP Lycoming 10-360 on a ducted-fan engine with variable pitch propeller (reverse thrust possible) with an optimum propulsive coefficient of 0.65 and 11 kp/h fuel consumption in hover flight.

Speeds

Speed in ground effect	80 kn
Max. flight speed	115 kn

The range of such a vehicle is necessarily a function of the flight altitude. X 114 reach 230 sm at an altitude of 3.5 m, 365 sm at 0.6 m and 540 sm at 0.3 m. It can be noted that the seaway exerts an influence only upon the range but not upon the foilborne ride quality. Generally, the economy of a wing-in-ground (ram-wing) vehicle depends therefore upon the ability constantly to operate as close to the ground as the given circumstances allow. In addition, wing-in-ground vehicles because of their ability to jump and perform free flight are capable of taking evasive action at any time even in the vertical direction.

During the ground effect flight the vehicle is extraordinarily stable. Because no Z-vibrations develop, it constitutes an excellent operational platform.

In the tests with X 114 in order to improve the starting and landing capability in a seaway, long outside floats keeled on one side with spring-mounted float bottoms were installed. It was however evidenced that this float form affected the longitudinal stability, the air resistance and the maneuverability in water and the horizontal stabilizer, which was enlarged to compensate for the destabilizing action resulted in a degradation of the flight performance because of its increased surface. In order to eliminate these disadvantages and as well the large vertical vibrations during starting and landing in a seaway, retractable hydrofoils (Fig. 8) were installed. In addition to reducing the vertical accelerations to 1/10 of the usual hull forms, the float weight could be reduced by 110 kg by use of the hydrofoils, and as well the air resistance and the destabilizing effects could also be reduced. This latter modification made it possible to return to horizontal stabilizer to its original condition. In general, the tests confirmed the good results obtained in the USA with the hydrofoils installed in the flying boats. The hydrofoil variant can also be used in an amphibious mode.

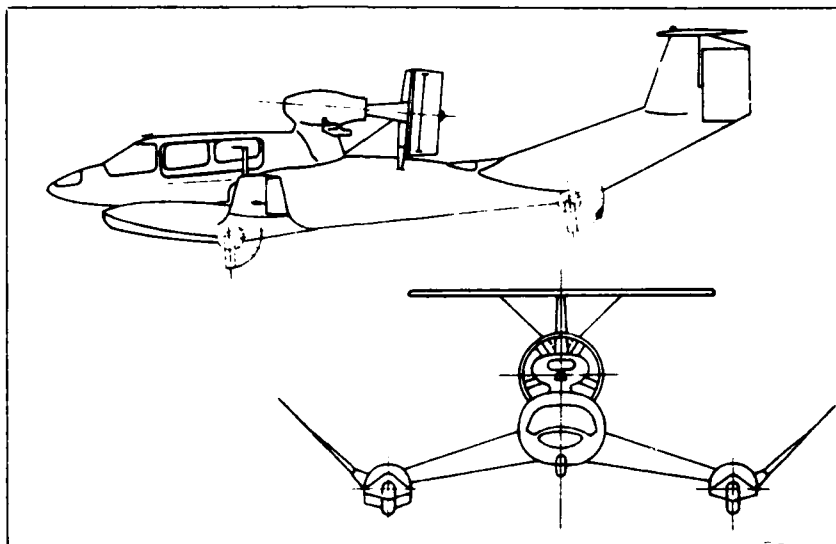

Fig. 8: Two views of the RFB Test Vehicle X 114 with retractable hydrofoils. The arrangement of wheels on the turning axes of the hydrofoils, which are exposed when the hydrofoils are retracted, makes the vehicle amphibious.

In order to test practically the recommendation of the hydrofoil manufacturer to use the hydrofoils also as a protection for the cell against unintended contact with the water during hover flight, within the parameters of the extensive trials program specific symmetrical and asymmetrical water contacts were performed. After initially very positive tests up to 80 kn, the vehicle tipped into the water on one side at higher speeds and was destroyed. In this regard it was confirmed that the vehicle is unsinkable even in the event of severe damage because of its special reinforced glass fiber construction. The results showed that hydrofoils generally provide good assistance during starting and landing in a seaway. However, in hover flight they should be retracted with small angles of attack or should be provided with predetermined breaking points to protect against negative lift forces. Of the numerous projects currently in progress at RFB (Rhein-Flugzeugbau GmbH), the following will be described:

1) The project AFC-RFB 215 derived from the X 114 (Fig. 8), which with unaltered technical data (main dimensions, propulsion, etc.) has a maximum start weight of 1.53 t (empty weight 0.84 t, fuel 0.16 t, payload 0.53 t). The lift-off speed from the surface of the water is 42 kn; the speed in ground effect is 81 kn and in free flight 115 kn. The maximum range under ideal conditions is 1,460 sm.

2) The SFF I Project, which is based in scale on the currently available technology:

Dimensions

Delta wing span	12.4 m
Total length	22.0 m
Total height	6.5 m
Wing span area	100.0 m ²
Aspect ratio	1.54

Weights

Empty weight	5.5 t
Fuel	0.9 t
Payload	3.6 t
Total weight	10.0 t

Propulsion

2 x 550-HP PT-6 motors on ducted-fan engine with variable pitch propeller (reverse thrust possible) with an optimum propulsive coefficient of 0.7 and 130 kp/h fuel consumption in hover flight.

Speeds

Lift-off speed	55 kn
Economic hover flight	100 km
Maximum flight speed	135 kn

Ranges

At 0.3 hover altitude	700 sm
At 0.6 hover altitude	500 sm
In free flight	300 sm

Aspects of A Military Application of Wing-in-Ground Vehicles

The development of wing-in-ground vehicles is currently being prosecuted in the USA, in the Soviet Union and in the Federal Republic of Germany. The theoretical and practical information which is available at RFB, and which has already been developed in collaboration with the Ministry of Defense (BMVg, FRG), the Test Facility 71 of the Bundeswehr and the David Taylor Naval Ship Research And Development Center of The US Navy have already demonstrated the general and very promising future potentials of such vehicles and justify further development of operational vehicles. From the military perspective the following factors are of interest:

/21

- 1) Wing-in-ground vehicles are characterized by
 - Speeds, which cannot be obtained by conventional ships,
 - Cost effectiveness (low operating costs, ton per kilometer, because of extremely good lift and skimming (planing) characteristics),
 - The amphibious/triphibious characteristics, i.e., according to the situation of land or sea bases, of being able to operate in the floating, hover or flight mode,
 - Remarkably good platform stability,
 - Excellent maneuvering capabilities. The operational height - depending upon the power availability and the trim position - is maintained with artificial altitude systems automatically, as well as the follow-up control.

Fig. 9:
Project AFC-RFB 215

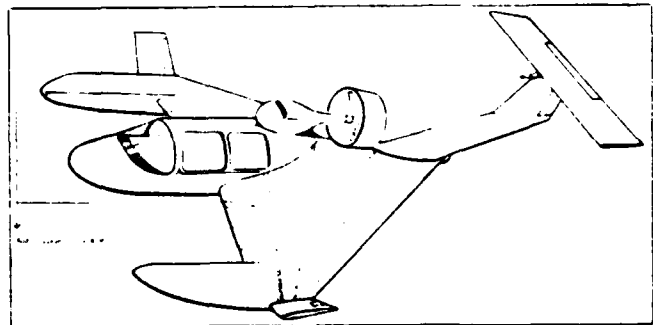

2) Ground-in-wing vehicles can because of their ability to jump can operate below the radar horizon and by means of jumps to greater heights can briefly increase their own detecting capability considerably above the values which can be obtained by conventional ships. The large expenditure of reinforced glass fiber material required for the hull (fuselage) complicates detection by radar. The minimum heat and noise radiation because of the low power in hover flight in comparison to aircraft, hovercraft and all other conventional ships makes detection difficult in the same manner as the small surface area makes engagement difficult.

SUMMARY AND PROSPECTS

Ground-in-wing vehicles open a new dimension for the use of high-speed vehicles over the sea for the civilian sector and particularly for the military sector. The design problems for controlling the structural stresses of naval design technology with the weight-oriented principles of aircraft design and issues of corrosion can be regarded as being resolved by the reinforced glass fiber light construction technique developed by RFB. The same applies for the start and landing capability up to a 3 seaway by using retractable hydrofoils. The current state of the technology allows an increase in size up to ca. 5 to 7 tons with acceptance of certain restrictions with reference to the previously used designs. Investigations which are being conducted in parallel at the Deutsche Forschungs- und Versuchsanstalt für Luft und Raumfahrt (German Research And Test Agency for Air and Aerospace (DFVLR)) and at the Institut für Luft- und Raumfahrt (Institute for Aeronautics And Aerospace) indicate even now that there are further possibilities. The same applies for the transition phases, which can still be improved, from the hydro to the aerodynamic operating condition. Here the intent is to diminish the resistance which determines the required propulsive power in the starting phase, because this coincidentally limits the permissible surface loading. The latter also exerts an influence upon the compactness, payload ratio and the operational speed.

Finally, aside from the use of hydrofoils as a starting aid there is also the possibility of using a thrust-jet engine to generate the air cushion to obtain an increase in lift at start. This so called Power Augmented Ram Wing in Ground Effect-System (PAR WIG), in which in model tests lift forces have already been generated, which are five times more powerful than static thrust, is currently being investigated for the US Navy in the USA. In a Memorandum of Understanding, collaboration has been effected with the David Taylor Naval Ship Research and Development Center, in which the know-how gained in the RFB tests in the area of ground-in-wing technology (ram-wing) can be exploited together with the US Navy in the PAR WIG area and can be brought to operational maturity.

Similar research is being conducted on a large scale in the Soviet Union. It is to be hoped that the current budget situation in the Federal Republic of Germany and the currently reinforced armament efforts in the USA will make sufficient funds available to develop a technology of tomorrow, which has already basically been successfully demonstrated. In the long term the request of the BMVg (Ministry of Defense) for 5 million DM, which has been granted, might be inadequate to expand further the technical development state which has already been realized by RFB. Later license awards abroad can however, as demonstrated by the NATO PHM (hydrofoil, Class 162), can be expensive.

[Fock, Harald: Marine-Rundschau, B 1760 E, February 1982/2, pp. 68 - 74; German]

Research at at Messerschmitt-Bölkow-Blohm GmbH -
Transport And Passenger Aircraft Division
(Unternehmensbereich Transport- und Verkehrsflugzeuge, formerly
Hamburger Flugzeugbau), Hamburg-Finkenwerder (II)

The naval design engineer and veteran collaborator of Marine-Rundschau examines in his two-part article the technical and operational-tactical predications of ground-effect craft and describes the projects of the Transport And Passenger Aircraft Division of Messerschmitt-Bölkow-Blohm.

In contrast to RFB (Rhein-Flugzeugbau GmbH), which conducted its wing-in-ground projects and studies in close collaboration with the research agency of the US Navy and the Federal Ministry of Defense (BMVg), the Unternehmensbereich Transport- und Verkehrsflugzeuge (Transport And Passenger Aircraft Division) of MBB, which is primarily engaged in development and production of the Airbus, has performed its studies for an FMPC (Fast Multi-Purpose Combat Craft) and for a HSCC (High Speed Combat Craft) to date despite limited financial means exclusively on its own initiative, in order to develop the information generated in aircraft construction for an innovation on future naval warfare. Neither an official confirmation of the "need-to-know" nor Federal (FRG) funds nor supporting advisors from the (FRG) Navy were available. This is a definite indication that today more than ever the initiatives for the research of technical development possibilities is generated more by the research of private industry than from the Armed Forces. This applies not at the least for the Bundeswehr, which - in contrast to numerous foreign armed forces - has scarcely any organic institutions for progressive development research. On the other hand, it cannot be ignored that such initiatives from private industry can only be regarded as a source of stimulation. Even firms of the size of MBB cannot finance activities going beyond this scope with their own resources, particularly because the financial burden which the firm has to sustain for the development and production of the European Airbus and its derivatives impose definite limitations upon the firm.

Stimulated by the international objective to break the "sound barrier" of the speed of conventional ships by means of progressive technologies and because of the negative decision of the Bundesmarine (FRG Navy) to build the hydrofoil Class 162/NATO-PHM, then a systematic analysis was begun in regard to:

- The general objectives to be identified as a basis for future naval weapons systems in regard to speed, sea-keeping qualities and maneuverability, range, combat power and survivability, etc.,
- The influencing factors (meteorological conditions, wave heights and frequency, visibility and ice conditions, etc.) which are relevant for the operational area of the Bundesmarine and the operational conditions (shallow water areas, configuration of the coastal area, threat, capabilities for weapons employment, etc.).

* Numbers in the right margin indicate pagination in the original text.

- The missions of the Bundesmarine within the context of NATO, etc., /68
from the beginning to insure an optimum accommodation of the projects to the
applicable conditions and the requirements to be anticipated.

On this basis MBB derived the following predications for its project
objectives:

- Operational speed over 70 kn (even at optical visibility = 0),
- All-weather capability for the North Sea and the Baltic Sea (as required
for areas north of 61 degrees latitude) including starting and landing in
up to ca. 3 m wave height and operational capability in shallow water areas
up to water depth = 0,

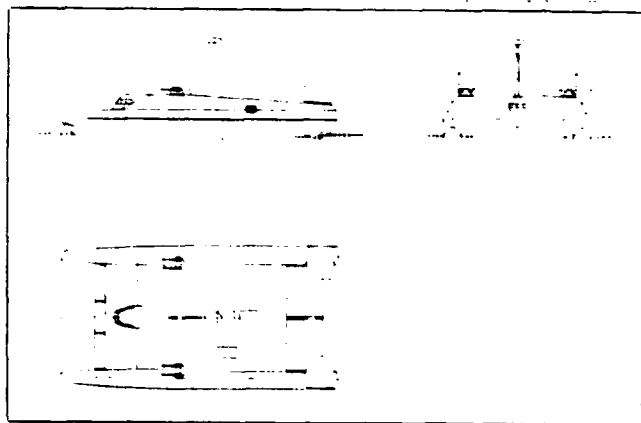

Fig. 10: Project Tandem-Wing of MBB



Fig. 11: Model test with a free-
operating Tandem-Wing in 1979/80

- Maneuverability equivalent to current displacement fast attack craft and
in addition the capability to take evasive action in the third dimension, /69
- Operational duration of 1,000 sm or three days,
- Small personnel requirement,
- Emphasis on armament with SSM with appropriate SAM and tube weapons for
own anti-air defense, capability for mine-laying and hunting and for ASW,
appropriate sensors including the capability for the integration of active
and passive ECM and ECCM-systems. Because of these remarkably comprehensive
but very realistic requirements only an aerodynamic ground effect vehicle
with the maximum possible exploitation of weight-saving principles of
aircraft design could be considered, whose size was estimated at being
between 200 to 240 tons.

Within the context of the parametric analyses several basic designs
were developed: the Types Tandem-Wing, N and AI - AIII for the aerodynamic
ground effect operation without flight, the Type B II for ground effect
operation with short-time flight and the Types CI - C II with full flight
capability on the basis of the duct flow principle. These types included
installation analyses for the 76 mm OTO MELARA naval gun, the 40 mm Bofors
and the 35 mm Oerlikon machine gun, HARPOON SSM and mines including a broad
spectrum of various combination possibilities. The lift-off speed of 75 kn
is common for all of the designs.

The Tandem-Wing Project (Fig. 10) is a catamaran-type vehicle with two
hydrofoils between the two floats. The basic design is 47 meters long,
25 meters wide and has an operational displacement of 200 tons. The hydrofoils
have a surface area of 852 m². The propulsive power of 36,500 HP driving
two shroud ring propellers or propfans is intended to provide an operational
speed of 168 kn in ground effect. The lift-off speed is ca. 75 kn, and the

range is 1,000 sm; the payload is 39.6%. For maneuvering in the floating /69 condition in each hull a small gas turbine driving hydropropellers or a water-jet propulsion system is provided. The installation of a vertical stabilizer was deliberately avoided - steering is effected with ducted propellers which are swivel-mounted on pylons with jet vanes. Model tests conducted in 1979/80 in the test tank with a free-operating model (Fig. 11) demonstrated the practicability of the technique which had been prosecuted. On the basis of the previous installation analyses, with an available weapon load of ca. 57.5 tons the following alternative weapons mixes resulted:

- 1) 1-76 mm OTO MELARA naval gun with 300 rounds
1-40 mm Bofors machine gun with 3,200 rounds
16 HARPOON ASM including two starters
2 ASMD (Anti-Ship Missile Defense) systems
in addition, 4 tons for fire control systems, 2 tons for electronics systems and 5 tons for armor for vital areas.
- 2) 2-40 mm Bofors machine guns
16 HARPOON ASM including two starters
2 ASMD systems
The weight assignments as above for fire control, electronics and armor.
- 3) 2 40 mm Bofors machine guns
42 ground mines
in addition, 2 tons weight assignment for fire control, electronics and armor.

It should be noted that in addition to the useful space in the main hydrofoil in the Tandem-Wing Project in each of the two floats (buoyancy chambers) have a free space 36 meters long, 3 meters wide and 2.2 meters high is provided, which can be utilized within the parameters of the available payload capability.

Only in the Hydrofoil-Only Project it is a design in which only one hydrofoil is installed between the catamaran-like floats and no vertical stabilizer is provided. The control of the drift of the center of pressure caused by the differentiated distance from ground is effected by deploying or activating flaps and leading edge slats to influence the lift resultant. The advantage of this solution technique would be a reduction of the main dimensions and the self-contained supporting surge. The advantage is that the lever arms between the flaps and the slats and the lift resultant are relatively short, which makes larger deflections or surfaces necessary. Practical tests with such a concept were not performed. In the Projects AI - AIII they are also catamaran-type vehicles, which like Project N have only one hydrofoil between the floats. In addition, however, there is a vertical stabilizer located behind the wings. Since the latter is completely utilized in generating lift, the total surface of the hydrofoil and the vertical stabilizer corresponds with only minor deviations to that of the Wing-Only or that of the Tandem-Wing Project. The designs AI - AIII have the previously cited 200 ton operational weight and a wing surface of 852 m². They are differentiated by the different aspect ratio of the main wing. The Project A I (Fig. 12) is 63 meters long, and 24 meters wide and at an aspect ratio of 0.53 has a chord of 40 m. The Project A II (Fig. 13) has overall dimensions of 46.5 x 32.5 meters, aspect ratio 0.96 and 30 m chord; the Project A III (Fig. 14) has overall dimensions of 38.7 x 46 m, aspect ratio 2.13 and 20 m chord. The pros and cons of the three alternatives are apparent:

Fig. 12: Projekt FMPC - A I of MBB

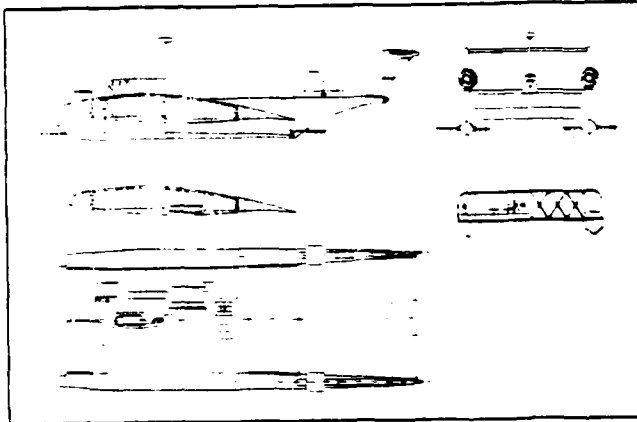

Fig. 13: Projekt FMPC - A II of MBB

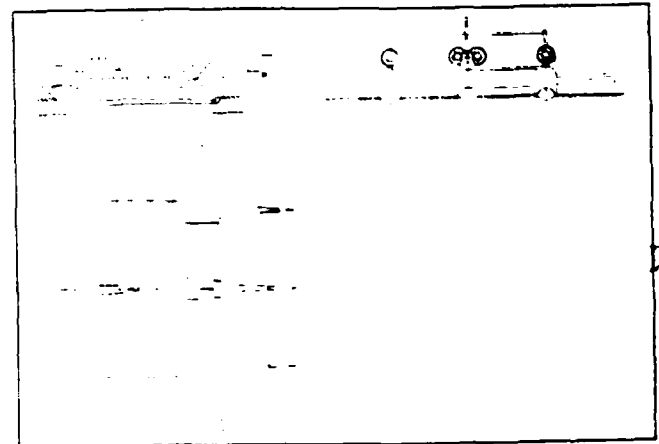
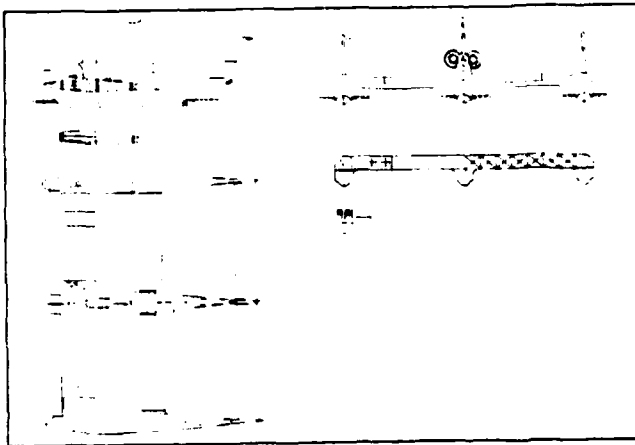
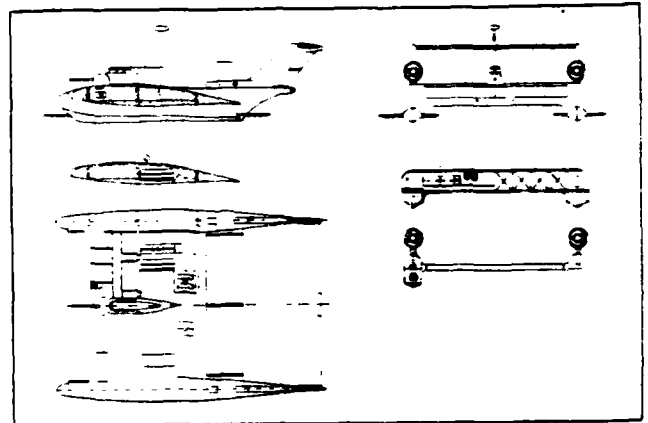

Fig. 14: Projekt FMPC - A III of MBB

Fig. 15: Projekt FMPC - B II of MBB

The Project A I has in the entire hydrofoil area between the front spar and the rear spar a height of more than 2.5 meters. Here the weapons and all the operational space required for the crew can be accommodated without difficulty. In Project A III the height at the front spar is ca. 1.6 meters, at the rear spar ca. 1.3 meters and in the center of the configuration ca. 2.2 meters. This necessarily imposes restrictions in the options for locating weapons and spaces. Therefore in Project A II the best values in regard to performance and fuel requirements can be expected, while Project A I because of its greater length would produce better results in operation in a seaway. All of the projects are intended to obtain an operational speed of ca. 150 kn in ground effect.

/70

Project B II (Fig. 15) is based on Project A II, but in order to make the vehicle capable of flying for a brief period of time was additionally equipped with stub wings and control surfaces in the form of canards. Because of this the wing surface is increased to 912 m²; the wind is increased to 56 m and the weight because of the propulsive power, which is twice as great, and because of the additional installations is increased to 237 tons. The free-flight speed is stated at 180 kn, and the corresponding range with the same fuel supply is stated at 700 sm. In operation with ground effect with half the engine power the 1,000 sm range of the basic design would almost be realized. For curving flight and maneuvering in the floating condition the stub wings can be partially completely swung up.

Whereas in the Projects A I - A III these were pure ground effect vehicles and in Project B II it was a ground-effect vehicle, which could be used for a brief period of time also in free flight, the Projects C I - C III are aircraft with required operational endurance, which can also be used to advantage in the ground-effect mode. /70

The design with reference to optimal sea-keeping qualities provides the longest possible central float (buoyancy chamber) with an hydrofoil on the end sealed with an auxiliary float. The wing trailing edge was located vertical to the longitudinal axis of the vehicle in order to insure a good flap effectiveness for the intake area seal. As in Projects A I - A III chords of 40, 30 and 20 meters were used on the hull midline. On this basis the vehicles illustrated in Fig. 16, 17 and 18 were developed with the following main data:

Design	Aspect Ratio	Operational Weight t	Length	Width	Surface Area m ²
C I	1.3	200	55.5	35.5/40	912
C II	2.09	200	53.6	47/51	912
C III		200	51.5	70/74.6	912

Fig. 16: Projekt FMPC - C I of MBB

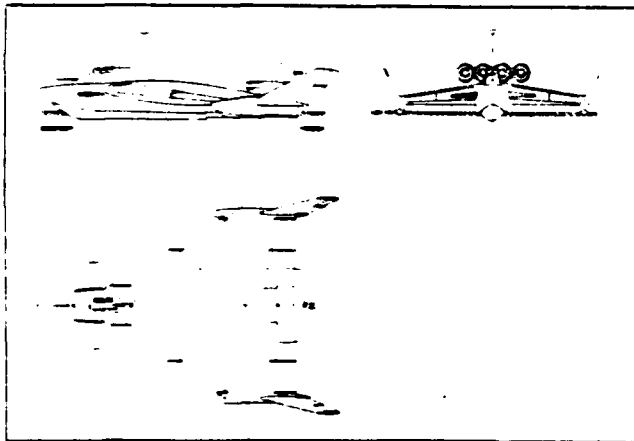

Fig. 17: Projekt FMPC - C II of MBB

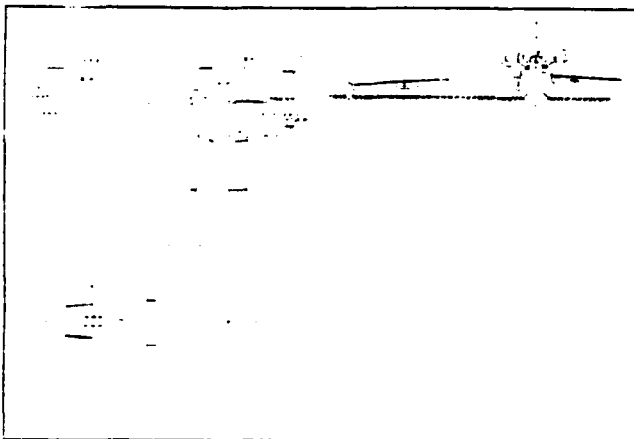
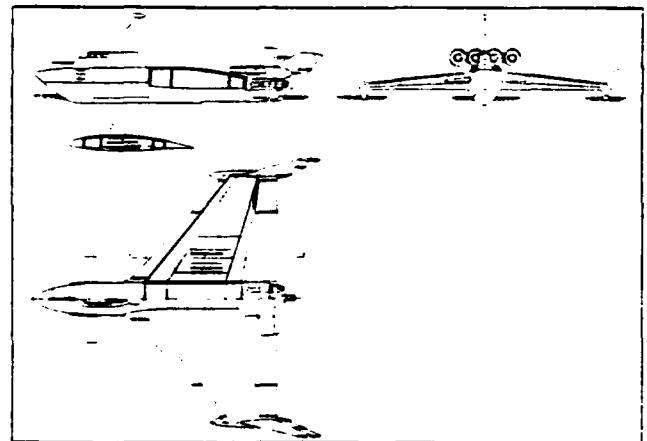

Fig. 18: Project FMPC - C III of MBB

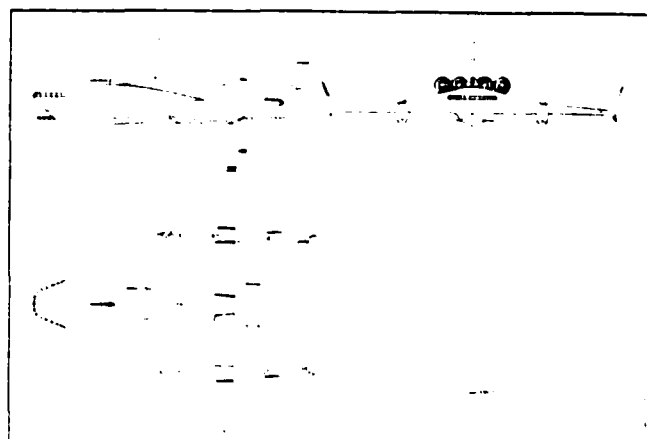

Fig. 19: Project FMPC - D of MBB

In the resulting Delta-wings in the Projects C I and C II weapons, crew and operational spaces can be well accommodated. In design C III the profile is however so low, that only weapons can be accommodated in it.

/71

Project D (Fig. 19) practically shows a combination of Projects C with Delta-wing and with T-tail unit (empennage). Because of the configuration of the T-tail unit, the carboard-wings can be eliminated, because of which the integration of hydrofoil and hull into one unit could be realized. All weapons and operational spaces can be well integrated into the present wing section.

The performance analyses of the projects which were implemented generally on the same basis but with differentiated configuration were applied to seven operating conditions:

- 1) Displacement operation up to ca. 15 kn with propulsion by propeller or water-jet for maneuvering in harbor and escorting slow ships,
- 2) Skimming operation (planing) up to ca. 40 kn with propulsion by propeller or water-jet, as required with ducted fan for escorting fast ships,
- 3) Transition from skimming to the hover/ground-effect condition at ca. 75 kn with propulsion by ducted fan. The lift of the hydrofoil is fully exploited.
- 4) Ground-effect operation in calm water, float distance from water 0.5 m, hydrofoil wings extended up to 1.5 m to the surface of the water,
- 5) Ground-effect in calm water, float distance 0.5 m from the surface of the water, hydrofoil wings not extended,
- 6) Ground-effect operation in rough seas and maneuver readiness, float distance 1.5 m from the surface of the water, hydrofoil wings not extended,
- 7) Free flight over rough seas or over land, i.e., flight beyond the ground effect.

Fig. 20 illustrates the increase of the required propulsive power with increase of the distance from the ground (surface). Therefore the specific propulsive power for normal operation at 150 kn with seaway between condition 5 and 6 at 150 HP/t. If a vehicle is to have free flight capability beyond this, then ca. 300 HP/t are necessary.

The fuel consumption is necessarily a function of the operational conditions and can most practically be compared with a conventional fast attack missile craft of the Class 148 in an operation over 200 sm at high speed: the fast attack craft covers this distance at 35 kn in 5.6 hours and in the process consumes 9.5 tons of fuel. The FMPCC covers the same distance according to the operating conditions at 150 to 200 kn in 1.4 to 1 hour and consumes in the process 4.6 to 14.3 tons of fuel. If condition 6 with 3 meter wave height and the same fuel consumption for both ships are assumed, then the FMPCC will travel five times as fast. In weather conditions in which the fast attack craft can make 35 kn, the FMPCC would operate between condition 4 and 5 and would require only 6 tons of fuel. This means at four times the speed a third less fuel consumption.

The scale comparison in size between a fast attack craft of Class 148, an FMPCC, the flying boat (amphibian aircraft) BV 238 built by Blohm & Voss in WWII and the current Airbus A 300 (Fig. 21) illustrates then that the FMPCC-Project, which was the basis for all listed analyses, does not have unusual dimensions in the size of 200 tons.

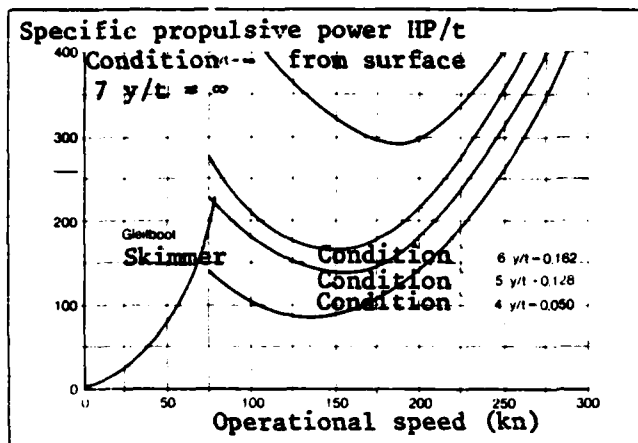

Fig. 20: Power requirement contingent upon distance from ground

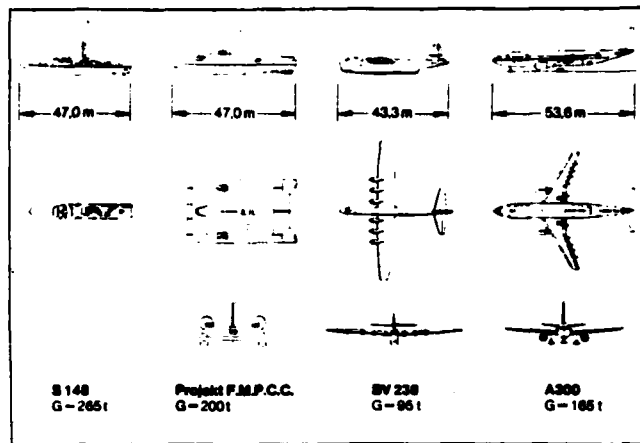

Fig. 21: Size comparison of a Class 148 fast attack craft, an FMPCC, a BV-238 flying boat and an A 300 Airbus.

Type		AI1	PAWI	PAWII	PAWIII	PA-TW
Weight	(t)	200	210	511	210	400
Surface area	(m ²)	852	852	852	350	930
Surface loading	(daN/m ²)	234	246	600	600	430
Wing length	(m)	30	30	30	19.1	43
Wing width	(m)	28.4				
Power requirement	(SHP)	36,471	40,499	136,696	56,159	
power loading	(SHP)	182	192	267	267	
Optimum Speed	(kn)	168	165	256	256	210
Consumption/h	(daN)	6,638	7,371	24,878	10,221	
Consumption/km	(daN)	21.34	24,12	52,47	21.56	
Consumption/1,000 nm	(daN)	39,529	44,671	83,012	39,935	
Payload (weapons, ammunition)	(daN)	39,606	39,543	251,148	60,122	
Payload	(%)	19.8	18.8	49.1	28.6	
Useful load	(%)	39.6	40.1	65.4	47.6	

Fig. 22: The advantages of the PAR WIG System result in considerably smaller vehicles at the same operational weight

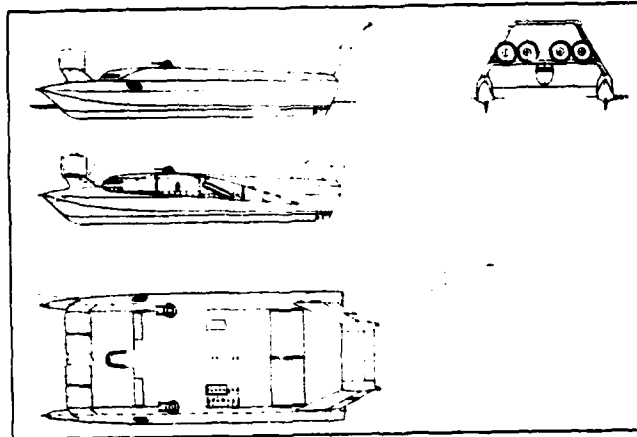

Fig. 23: Project of an FMPC according to the PAR WIG System with an operational displacement of 511 tons.

Whereas the project studies described to this point on the basis of 200 tons operational displacement were used primarily to determine the potential technical capabilities, later analyses showed that with the PAR-WIG principle (Power Augmented Ram Wing in Ground Effect) higher surface loadings could be realized, which results either in considerably larger vehicle displacements at the same size or at the same operational displacement in considerably smaller vehicles (Fig. 22). In this regard analyses showed that vehicles with the same overall dimensions as the previously described 200-ton vehicles have an operational displacement between 400 and 600 tons. Fig. 23 shows a design based on this principle with 511-ton operational displacement. The required power is increased by a factor of 3.7; the fuel consumption however because of the higher optimal speed is increased only by a factor of 2, and the payload is increased by a factor of 6.

Whereas Fig. 23 and 24 show a vehicle with swivelling engines in front of the main support wings, in Fig. 25 a ship of the same size with integrated lift system is illustrated. If the fly-off weight of 200 tons were retained, then there would be a surface area of 350 m² instead of 852 m² of the designs previously described. Because of this the vehicle would be considerably smaller. In such a design the power requirement would be higher by a factor of 1.5, but the fuel consumption would correspond to that of the initial designs without PAW-system and the payload would be higher by a factor of 1.5.

In 1981 a test was conducted with a model on the basis of the PAR-WIG principle, in which the arrangement of the engines was made in front of the lift wing in order to improve the starting and landing characteristics (Fig. 26). The engines are swivel-mounted (Fig. 24). They blow under the lift wing in starting and landing and thereby generate an artificial air cushion, which despite the low pressure is capable of lifting the vehicle even when it is stopped. The complete separation from the surface of the water occurs already at speeds, which are only half as great as the starting speed of normal ground-effect vehicles. In addition, the displacement of the center of pressure from the differentiated distance from the ground can be controlled in hovering above the sea by means of the vertical components of the engine thrust.



Fig. 24: PAR-WIG model with swivelling engines in front of the main lift wing Fig. 25: Project of a PAR-WIG vehicle with integrated propulsion

The HSCC (High Speed Combat Craft) constitutes another project idea on the basis of this principle, which is predicated on the assumption of a mass commitment in the sea area of the western Baltic. In the design the hypothesis was that in this narrow sea area, which is covered extensively electronically and by naval air, several special premises apply in the event of a military crisis:

1) From the potential enemy it can be anticipated within the parameters of naval support of army operations, amphibious operations, mining and guided missile operations. etc., that there would be a surprise appearance of a rather large number of relatively small ships, which would consist of very slow ships (landing craft), fast ships (skimmers and displacement ships) and very fast ships (hydrofoils, hovercraft) in the area of operations, and that this situation would require a rapid intervention of own units which were deployed. The mass of these targets does not justify qualitatively the commitment of complex guided missile systems such as the MM 38 EXOCET, HARPOON, etc.

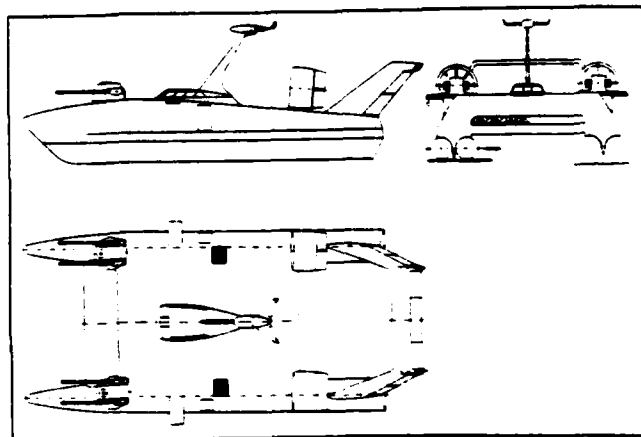
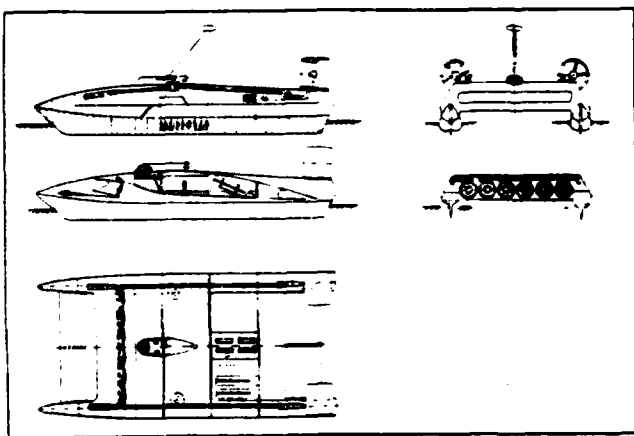

Fig. 26: PAR-WIG model with swivelling engines in front of the main lift wing Fig. 27: Project of a High Speed Combat Craft by MBB

2) The German-Danish coastal area offers for the own surface forces only relatively few deployment areas, which are somewhat protected against detection, aerial reconnaissance and attack. The capability of keeping own ships which have certain amphibious features on land at all coastal points suitable for the purpose and of launching these ships in an emergency quickly without any special equipment required increases the survivability and the operational capabilities. In addition, such a vehicle should be able

essentially to provide its own target information independently after it has been directed to the enemy, and should provide an operational endurance of 1,000 sm or three days. /73

The HSCC (Fig. 27, 28, 29), which was developed on the basis of these hypotheses and the basic projects of the FMPCC by MBB, is an aerodynamic ground effect vehicle according to the PAR-WIG system, in which the propulsion system was located astern with reference to visibility, detection and straight-ahead firing areas. The technical data are:

Max. length overall	26.50 m	Optimal speed	175 kn
Max. width overall	13.25 m	Max. speed	200 kn
Weight	60 t	Range	1,000 sm
Propulsion: 2 gas turbines on ducted fans, including 2 x bevel gear		Crew	5 men
Z-drive in the hulls for operation as displacement ship in harbor.		Armament: 2 x 35 mm Oerlikon machine guns, 8 KORMORAN mod.-ASM.	

The catamaran-type vehicle, which was designed with logical utilization of the technologies developed and tested in aircraft design for light construction, control, propulsion systems and the amphibian system, has between the hulls (fuselages) a broad lift wing, which is equipped in front and behind with a flap (foil flap). In the front section there is a fan system fed over a tube system by the main propulsion system installed, which even at stop generates an artificial air cushion beneath the vehicle and lift it essentially from the surface. Gas control vents provide while starting corresponding to the rising ram air pressure with increasing speed more and more power to the propulsive fan. The decrease of the water level in the cushion area, which is generated by the static air cushion and is initially ca. 0.5 deep and becomes rapidly smaller as the vehicle develops speed and disappears completely at 35 - 40 kn, applies only in the initial phase as resistance. Upon separation from the surface of the water, the vehicle accelerates with constant power transfer further from the air cushion to the propulsive fan, until the ram air pressure has reached 2/3 of the cushion pressure at ca. 115 kn. Now that the vehicle is hovering in aerodynamic ground effect, the air cushion fan is shut down and swung in and the speed is increased to ca. 175 kn with the fan power now driving the propulsion system completely; the maximum speed is 200 kn. The distance of the keel from the surface of the water is 0.5 - 1.0 m, but can be increased. Because vehicles with this small hull length sometimes in a seaway cut through wave crests with the undersides of the hulls, the keel was designed with a cutting edge below. According to available tests in the USA such wave cutters are non-critical even at speeds above 200 kn. /73

Because the knife-type hull underside does not generate sufficient lift in the displacement mode, to provide an adequate distance between the underside of the lift wing and the surface of the water and therefore adequate protection against wave impact, highly flexible support tubes were mounted on the undersides of the hulls, whereby the material for such tubes has already been successfully tested in the Canadian aircraft type BH 7 as an air cushion landing system. In the displacement mode the four support tubes are inflated to ca. 1.5 meter diameter, with which they provide the required static lift. As soon as the vehicle at start is raised by the static air cushion, the pressure is released from the support tubes. The material is retracted tightly between the attachment points and can be pressed tightly to the hull walls by a small vacuum. A practical air layer system, which has already

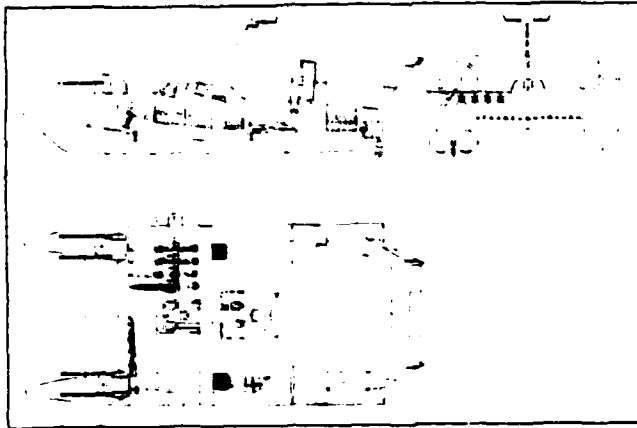

Fig. 28: Project of a High Speed Combat Craft by MBB

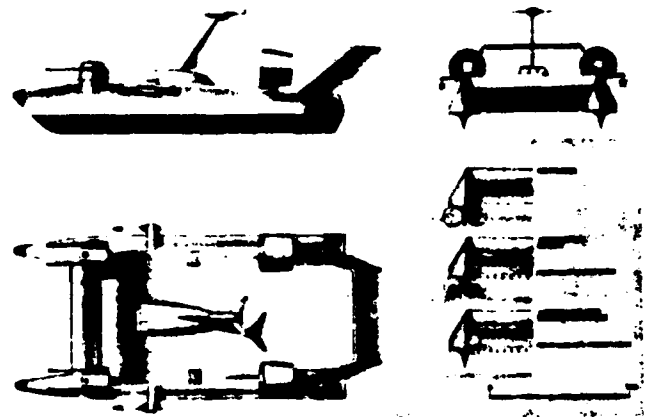

Fig. 29: Project of a High Speed Combat Craft by MBB (artist's impression)

been tested in Canada in aircraft and in model tests at MBB, in addition makes /74
it possible to travel on land on essentially level surfaces by means of the support tubes and the static air cushion under the vehicle and even to negotiate large gradients. This amphibious capability increases deployability considerably and makes it possible far better than in the case of conventional ships and aircraft, to conceal the vehicles in readiness status from hostile counter-reconnaissance. In addition, supply with fuel and ammunition can be provided on land by trucks.

The propulsive system consists of two gas generators, which are produced in series like gas turbines, i.e., normal gas turbines, in which the last turbine stage is missing, so that the exhaust has a pressure which is higher than usual. In addition, there is a folding fan group in the support wing for the static air cushion in starting and landing, which is located forward, and two fans on the stern for propulsion. A tube system allows the previously described alternative air distribution in starting and landing. The drive for the fans is provided by tip turbines. The pneumatic connection between the gas generators and the tip turbines of the fans, which has already been used successfully in the aircraft industry, has in addition to the desired power control the advantage that the fans remain operational when foreign bodies (water, seabirds, etc.) have penetrated in. In addition, the installation of the gas generators can be effected in such a manner, so that adequate measures for de-salting/de-watering the propulsion air and infrared/noise attenuation measures can be implemented and in the event of failure of one gas generator or fan the remaining part can assume the entire supply function at reduced power. In addition to the system for the aerodynamic ground effect operation a bevel gear Z-drive is installed in each hull for displacement operation, which is driven by a separate diesel or gas turbine.

The crew, which consists of five men, consists of the pilot, copilot, navigator and two men for detection, identification and manning the weapons. The crew accommodations are designed in such a manner, that the crew can operate on board for several days. In order to provide adequate independent target information after direction to the operational area, in operation in aerodynamic ground effect a towed kite is provided, whose radar and optronics transmit data over the tow line to the cockpit and the combat information center (CIC).

It should be noted that theoretical analyses revealed that the survivability of such a vehicle to hits and damage is remarkably great because of the general design and the redundancies.

174

SUMMARY AND CONCLUSIONS

There is no doubt that the development trends in detection and weapon technology will also cause change in naval warfare in the future. One decisive factor is speed. Because the speed of conventional naval ships has remained practically constant in the last sixty years and as well cannot be increased in the future because of the laws governing the resistance of displacement ships and planing ships (skimmers); in addition, the speed can be influenced negatively by the seaway, and new techniques are being explored in the East and in the West. The adoption of technologies from aircraft design was an immediate prospect. The hydrofoil vehicle was the first step, aerostatic air cushion vehicles were the second step. These types are however dependent in speed upon sea conditions. The aerodynamic ground-effect vehicle is the logical third step. In the USA the US Navy and McDonnell Douglas and Lockheed have been working on such studies since 1962. The pertinent research in the Soviet Union has progressed the furthest, where already large vehicles are in the practical testing stage, because the Soviets are prepared to make the funding available for such projects. There is no doubt that the previously unsuspected possibilities of aerodynamic ground-effect vehicles will exert decisive influence upon the future possibilities of naval warfare and offshore surveillance in the late 80's and in the 90's. It might well be advantageous to address these possibilities soon. Practical deterrence in the military sector means today as before to be in the front ranks of technological progress. The studies by MBB, which were performed without government support, merit recognition. It can be anticipated that after the fusion of the VFW firm and its 100% daughter firm RFB with Messerschmitt-Bölkow-Blohm GmbH that in the further development of the projects described a coordinated activity of the previously independently operating teams will occur. Under these conditions and with reference to the important civilian and military applications, it would be gratifying, if MBB were given the possibility by provision of research funds to continue the studies initiated systematically and to demonstrate the effectiveness of ground-effect vehicles.

DATE
FILME
— 88